

Agilent E5052A Signal Source Analyzer

Programmer's Guide

Fifth Edition

FIRMWARE REVISIONS

This manual applies directly to instruments that have the firmware revision A.02.50.

For additional information about firmware revisions, see Appendix A.



Agilent Technologies

Manufacturing No. E5052-90041

June 2006

Notices

The information contained in this document is subject to change without notice.

This document contains proprietary information that is protected by copyright. All rights are reserved. No part of this document may be photocopied, reproduced, or translated to another language without the prior written consent of Agilent Technologies.

Microsoft®, MS-DOS®, Windows®, Visual C++®, Visual Basic®, VBA® and Excel® are registered

UNIX is a registered trademark in U.S. and other countries, licensed exclusively through X/Open Company Limited.

Portions ©Copyright 1996, Microsoft Corporation. All rights reserved.

© Copyright 2004, 2005, 2006 Agilent Technologies

Manual Printing History

The manual's printing date and part number indicate its current edition. The printing date changes when a new edition is printed. (Minor corrections and updates that are incorporated at reprint do not cause the date to change.) The manual part number changes when extensive technical changes are incorporated.

August 2004	First Edition (part number: E5052-90001)
October 2004	Second Edition (part number: E5052-90011, changes for firmware version A.01.10)
February 2005	Third Edition (part number: E5052-90021, changes for firmware version A.01.50)
August 2005	Fourth Edition (part number: E5052-90031, changes for firmware version A.02.00)
June 2006	Fifth Edition (part number: E5052-90041, changes for firmware version A.02.50)

Typeface Conventions

Bold	Boldface type is used when a term is defined. For example: icons are symbols.
<i>Italic</i>	Italic type is used for emphasis and for titles of manuals and other publications.
[Key]	Indicates the hardkey whose key label is Key.
[Key] - Item	Indicates a series of key operations in which you press the [Key] key, select (highlight) the item called Item on the displayed menu using the [↓] key and so on, and then press the [Enter] key.

Documentation Map

The following manuals are available for the Agilent E5070A/E5071A.

- **User's Guide (Part Number E5052-900x0, attached to Option ABA)**

This manual describes most of the basic information needed to use the E5070A/E5071A. It provides a function overview, detailed operation procedure for each function (from preparation for measurement to analysis of measurement results), specifications, and supplemental information. For programming guidance on performing automatic measurement with the E5070A/E5071A, please see *the Programming Manual*.
- **Programmer's Guide (Part Number E5052-900x1, attached to Option ABA)**

This manual provides programming information for performing automatic measurement with the E5070A/E5071A. It includes an outline of remote control, procedures for detecting measurement start (trigger) and end (sweep end), application programming examples, a command reference, and related information.
- **VBA Programmer's Guide (Part Number E5052-900x2, attached to Option ABA)**

This manual describes programming information for performing automatic measurement with internal controller. It includes an outline of VBA programming, some sample programming examples, a COM object reference, and related information.

NOTE

The number position shown by "x" in the part numbers above indicates the edition number.

1. Making Effective Use of This Manual	
Contents of This Manual	26
How to Use This Manual	28
Looking up SCPI commands	28
How to Code the Corresponding Commands	28
2. Overview of Remote Control	
Types of Remote Control Systems	32
GPIB Remote Control System	33
What is GPIB?	33
System configuration	33
Device selector	34
LAN Remote Control System	35
System configuration	35
Control over SICL-LAN server	36
Control over telnet server	41
USB Remote Control System	44
System configuration	44
Sending SCPI command messages	50
Types and structure of commands	50
Grammar of messages	51
Remote mode	52
3. Making a Measurement	
Trigger System	54
Trigger state and transition for each measurement	56
Starting a Measurement Cycle (triggering the instrument)	58
Configuring the Instrument to Automatically Perform Continuous Measurement	58
Starting Measurement on Demand	58
Using the Averaging Trigger	58
Waiting for End of measurement	60
Using the Status Register	60
Using the *OPC? command	61
Using Wait Time	62
4. Reading/Writing Measurement Data	
Data Types for Data Transfer	64
Array type	64
Block type	65
Data Transfer Format	66
ASCII Transfer Format	67
Binary Transfer Format	68
Internal data processing	70
Data flow	70
Internal data arrays	74
Retrieving Measurement Results	76
Retrieving measurement results at marker positions	76
Retrieving internal data arrays	76

Contents

Entering Data in a Trace	78
5. Saving and Recalling (File Management)	
Saving/Recalling	82
Specifying a file	82
Saving and recalling instrument status	82
Saving measurement data	82
Saving images on LCD screen	83
Saving/loading (importing) the VBA program	83
Managing Files	84
Creating a directory (folder)	84
Deleting a file (directory)	84
Copying a file	84
Transferring files	84
Retrieving data from storage	84
Sample program	85
6. Working with Automatic Test Systems	
Preventing Erroneous Key Operation on the Front Panel (Key Lock feature)	88
Improving Command Processing Speed	89
When measurement results (trace) do need not updating	89
When measurement results (trace) need updating	89
Detecting Occurrence of an Error	90
Using the status reporting system	90
Using the error queue	90
Limit Test	92
Using Commands to define Limit Lines	92
Reading Limit Lines from Files	93
7. SCPI Command Reference	
Notational conventions in this command reference	96
Syntax	96
Description	96
Parameters	97
Query response	97
Related commands	97
Equivalent key	97
Device Configuration Using E5052A and E5053A Microwave Downconverter	98
E5052A commands	100
:ABORt	100
:CALCulate:FP[1-1]:ALLTrace:ACTive	100
:CALCulate:FP[1-1]:ALLTrace:BDMarker:X:COUPle:STATe	100
:CALCulate:FP[1-1]:ALLTrace:LIMit:FAIL	101
:CALCulate:FP[1-1]:ALLTrace:MARKer:COUPle:STATe	101
:CALCulate:FP[1-1]:ALLTrace:MARKer:DISCrete:STATe	101
:CALCulate:FP[1-1]:ALLTrace:MARKer:REFerence:NUMBer	102
:CALCulate:FP[1-1]:ALLTrace:MARKer:REFerence:STATe	102
:CALCulate:FP[1-1]:DATA:RDATa	103

:CALCulate:FP[1-1]:DATA:TDAa	103
:CALCulate:FP[1-1]:DATA:XDAa	104
:CALCulate:FP[1-1]:TRACe[1-4]:ALLMarker:ACTive	104
:CALCulate:FP[1-1]:TRACe[1-4]:ALLMarker:SEARch:DOMain:X	104
:CALCulate:FP[1-1]:TRACe[1-4]:ALLMarker:SEARch:DOMain:Y	105
:CALCulate:FP[1-1]:TRACe[1-4]:ALLMarker:SEARch:PEAK	105
:CALCulate:FP[1-1]:TRACe[1-4]:BDMarker:X:CENTer	105
:CALCulate:FP[1-1]:TRACe[1-4]:BDMarker:X:SPAN	106
:CALCulate:FP[1-1]:TRACe[1-4]:BDMarker:X:STARt	106
:CALCulate:FP[1-1]:TRACe[1-4]:BDMarker:X:STATe	106
:CALCulate:FP[1-1]:TRACe[1-4]:BDMarker:X:STOP	107
:CALCulate:FP[1-1]:TRACe[1-4]:BDMarker:Y:CENTer	107
:CALCulate:FP[1-1]:TRACe[1-4]:BDMarker:Y:SPAN	108
:CALCulate:FP[1-1]:TRACe[1-4]:BDMarker:Y:STARt	108
:CALCulate:FP[1-1]:TRACe[1-4]:BDMarker:Y:STATe	109
:CALCulate:FP[1-1]:TRACe[1-4]:BDMarker:Y:STOP	109
:CALCulate:FP[1-1]:TRACe[1-4]:DATA:COPIY	109
:CALCulate:FP[1-1]:TRACe[1-4]:DATA:FDATa	110
:CALCulate:FP[1-1]:TRACe[1-4]:DATA:FMEMOry	110
:CALCulate:FP[1-1]:TRACe[1-4]:DATA:UDATa	111
:CALCulate:FP[1-1]:TRACe[1-4]:DATA:UMEMOry	111
:CALCulate:FP[1-1]:TRACe[1-4]:FORMat:FREQuency	112
:CALCulate:FP[1-1]:TRACe[1-4]:FUNCTion:DOMain:X	112
:CALCulate:FP[1-1]:TRACe[1-4]:FUNCTion:DOMain:Y	113
:CALCulate:FP[1-1]:TRACe[1-4]:FUNCTion:LREGression:DATA	113
:CALCulate:FP[1-1]:TRACe[1-4]:FUNCTion:LREGression:MEMOry	113
:CALCulate:FP[1-1]:TRACe[1-4]:FUNCTion:STATistics:DATA	114
:CALCulate:FP[1-1]:TRACe[1-4]:FUNCTion:STATistics:MEMOry	114
:CALCulate:FP[1-1]:TRACe[1-4]:FUNCTion:TYPE	114
:CALCulate:FP[1-1]:TRACe[1-4]:HOLD	114
:CALCulate:FP[1-1]:TRACe[1-4]:LIMit:FAIL	115
:CALCulate:FP[1-1]:TRACe[1-4]:LIMit:LOWer:LDATa	115
:CALCulate:FP[1-1]:TRACe[1-4]:LIMit:LOWer:SEGment:CLEar	115
:CALCulate:FP[1-1]:TRACe[1-4]:LIMit:LOWer:SEGment:COUNT	116
:CALCulate:FP[1-1]:TRACe[1-4]:LIMit:LOWer:SEGment:DATA	116
:CALCulate:FP[1-1]:TRACe[1-4]:LIMit:REPort[:DATA]	117
:CALCulate:FP[1-1]:TRACe[1-4]:LIMit[:STATe]	117
:CALCulate:FP[1-1]:TRACe[1-4]:LIMit:UPPer:LDATa	117
:CALCulate:FP[1-1]:TRACe[1-4]:LIMit:UPPer:SEGment:CLEar	118
:CALCulate:FP[1-1]:TRACe[1-4]:LIMit:UPPer:SEGment:COUNT	118
:CALCulate:FP[1-1]:TRACe[1-4]:LIMit:UPPer:SEGment:DATA	118
:CALCulate:FP[1-1]:TRACe[1-4]:LINE:A	119
:CALCulate:FP[1-1]:TRACe[1-4]:LINE:B	119
:CALCulate:FP[1-1]:TRACe[1-4]:LINE:MEMOry	119
:CALCulate:FP[1-1]:TRACe[1-4]:MARKer[1-10]:SEARch:EXECute:LPEak	120
:CALCulate:FP[1-1]:TRACe[1-4]:MARKer[1-10]:SEARch:EXECute:LTARget	120
:CALCulate:FP[1-1]:TRACe[1-4]:MARKer[1-10]:SEARch:EXECute:MAXimum	120
:CALCulate:FP[1-1]:TRACe[1-4]:MARKer[1-10]:SEARch:EXECute:MINimum	120
:CALCulate:FP[1-1]:TRACe[1-4]:MARKer[1-10]:SEARch:EXECute:PEAK	120

Contents

:CALCulate:FP[1-1]:TRACe[1-4]:MARKer[1-10]:SEARch:EXECute:RPEak	121
:CALCulate:FP[1-1]:TRACe[1-4]:MARKer[1-10]:SEARch:EXECute:RTARget	121
:CALCulate:FP[1-1]:TRACe[1-4]:MARKer[1-10]:SEARch:EXECute:TARGet	121
:CALCulate:FP[1-1]:TRACe[1-4]:MARKer[1-10]:SEARch:PEAK:EXCursion	121
:CALCulate:FP[1-1]:TRACe[1-4]:MARKer[1-10]:SEARch:PEAK:POLarity	122
:CALCulate:FP[1-1]:TRACe[1-4]:MARKer[1-10]:SEARch:TARGet:TRAnSition	122
:CALCulate:FP[1-1]:TRACe[1-4]:MARKer[1-10]:SEARch:TARGet:Y	122
:CALCulate:FP[1-1]:TRACe[1-4]:MARKer[1-10]:SEARch:TRACking:TYPE	123
:CALCulate:FP[1-1]:TRACe[1-4]:MARKer[1-10]:STATe	123
:CALCulate:FP[1-1]:TRACe[1-4]:MARKer[1-10]:X	124
:CALCulate:FP[1-1]:TRACe[1-4]:MARKer[1-10]:Y	124
:CALCulate:FP[1-1]:TRACe[1-4]:MATH:FUNcTION	124
:CALCulate:FP[1-1]:TRACe[1-4]:MATH:MEMorize	125
:CALCulate:FP[1-1]:TRACe[1-4]:MATH:OFFSet	125
:CALCulate:FP[1-1]:TRACe[1-4]:PARAmeter	125
:CALCulate:FP[1-1]:TRACe[1-4]:REFerence:FREQuency	126
:CALCulate:FP[1-1]:TRACe[1-4]:SAPerture	126
:CALCulate:FP[1-1]:TRACe[1-4]:SMOothing:APERture	126
:CALCulate:FP[1-1]:TRACe[1-4]:SMOothing:STATe	127
:CALCulate:PN[1-1]:ALLTrace:LIMit:FAIL	127
:CALCulate:PN[1-1]:ALLTrace:MARKer:COUPle:STATe	128
:CALCulate:PN[1-1]:ALLTrace:MARKer:DISCrete:STATe	128
:CALCulate:PN[1-1]:ALLTrace:MARKer:REFerence:NUMBer	128
:CALCulate:PN[1-1]:ALLTrace:MARKer:REFerence:STATe	129
:CALCulate:PN[1-1]:DATA:CARRier	129
:CALCulate:PN[1-1]:DATA:PDATA	130
:CALCulate:PN[1-1]:DATA:RDATa	130
:CALCulate:PN[1-1]:DATA:XDATa	130
:CALCulate:PN[1-1]:TRACe[1-1]:ALLMarker:ACTive	131
:CALCulate:PN[1-1]:TRACe[1-1]:ALLMarker:SEARch:DOMain:X	131
:CALCulate:PN[1-1]:TRACe[1-1]:ALLMarker:SEARch:DOMain:Y	131
:CALCulate:PN[1-1]:TRACe[1-1]:ALLMarker:SEARch:PEAK	132
:CALCulate:PN[1-1]:TRACe[1-1]:BDMarker:X:CENTer	132
:CALCulate:PN[1-1]:TRACe[1-1]:BDMarker:X:SPAN	132
:CALCulate:PN[1-1]:TRACe[1-1]:BDMarker:X:START	133
:CALCulate:PN[1-1]:TRACe[1-1]:BDMarker:X:STATe	133
:CALCulate:PN[1-1]:TRACe[1-1]:BDMarker:X:STOP	134
:CALCulate:PN[1-1]:TRACe[1-1]:BDMarker:Y:CENTer	134
:CALCulate:PN[1-1]:TRACe[1-1]:BDMarker:Y:SPAN	135
:CALCulate:PN[1-1]:TRACe[1-1]:BDMarker:Y:START	135
:CALCulate:PN[1-1]:TRACe[1-1]:BDMarker:Y:STATe	135
:CALCulate:PN[1-1]:TRACe[1-1]:BDMarker:Y:STOP	136
:CALCulate:PN[1-1]:TRACe[1-1]:DATA:COPIY	136
:CALCulate:PN[1-1]:TRACe[1-1]:DATA:FDATa	137
:CALCulate:PN[1-1]:TRACe[1-1]:DATA:FMEMory	137
:CALCulate:PN[1-1]:TRACe[1-1]:DATA:PDATA	138
:CALCulate:PN[1-1]:TRACe[1-1]:DATA:PMEMory	138
:CALCulate:PN[1-1]:TRACe[1-1]:DATA:SDATa	139
:CALCulate:PN[1-1]:TRACe[1-1]:DATA:SMEMory	139

:CALCulate:PN[1-1]:TRACe[1-1]:DATA:UDATa	139
:CALCulate:PN[1-1]:TRACe[1-1]:DATA:UMEMory	139
:CALCulate:PN[1-1]:TRACe[1-1]:FUNCTion:AVARiance:DATA	140
:CALCulate:PN[1-1]:TRACe[1-1]:FUNCTion:AVARiance:MEMory	140
:CALCulate:PN[1-1]:TRACe[1-1]:FUNCTion:DOMain:X	141
:CALCulate:PN[1-1]:TRACe[1-1]:FUNCTion:DOMain:Y	141
:CALCulate:PN[1-1]:TRACe[1-1]:FUNCTion:INTegral:DATA	142
:CALCulate:PN[1-1]:TRACe[1-1]:FUNCTion:INTegral:MEMory	142
:CALCulate:PN[1-1]:TRACe[1-1]:FUNCTion:STATistics:DATA	142
:CALCulate:PN[1-1]:TRACe[1-1]:FUNCTion:STATistics:MEMory	142
:CALCulate:PN[1-1]:TRACe[1-1]:FUNCTion:TYPE	143
:CALCulate:PN[1-1]:TRACe[1-1]:HOLD	143
:CALCulate:PN[1-1]:TRACe[1-1]:LIMit:FAIL	143
:CALCulate:PN[1-1]:TRACe[1-1]:LIMit:LOWer:LDATa	144
:CALCulate:PN[1-1]:TRACe[1-1]:LIMit:LOWer:SEGment:CLEar	144
:CALCulate:PN[1-1]:TRACe[1-1]:LIMit:LOWer:SEGment:COUNT	144
:CALCulate:PN[1-1]:TRACe[1-1]:LIMit:LOWer:SEGment:DATa	145
:CALCulate:PN[1-1]:TRACe[1-1]:LIMit:REPort[:DATa]	145
:CALCulate:PN[1-1]:TRACe[1-1]:LIMit[:STATe]	145
:CALCulate:PN[1-1]:TRACe[1-1]:LIMit:UPPer:LDATa	146
:CALCulate:PN[1-1]:TRACe[1-1]:LIMit:UPPer:SEGment:CLEar	146
:CALCulate:PN[1-1]:TRACe[1-1]:LIMit:UPPer:SEGment:COUNT	146
:CALCulate:PN[1-1]:TRACe[1-1]:LIMit:UPPer:SEGment:DATa	147
:CALCulate:PN[1-1]:TRACe[1-1]:MARKer[1-10]:SEARch:EXECute:LPEak	147
:CALCulate:PN[1-1]:TRACe[1-1]:MARKer[1-10]:SEARch:EXECute:LTARget	147
:CALCulate:PN[1-1]:TRACe[1-1]:MARKer[1-10]:SEARch:EXECute:MAXimum	148
:CALCulate:PN[1-1]:TRACe[1-1]:MARKer[1-10]:SEARch:EXECute:MINimum	148
:CALCulate:PN[1-1]:TRACe[1-1]:MARKer[1-10]:SEARch:EXECute:PEAK	148
:CALCulate:PN[1-1]:TRACe[1-1]:MARKer[1-10]:SEARch:EXECute:RPEak	148
:CALCulate:PN[1-1]:TRACe[1-1]:MARKer[1-10]:SEARch:EXECute:RTARget	148
:CALCulate:PN[1-1]:TRACe[1-1]:MARKer[1-10]:SEARch:EXECute:TARGet	149
:CALCulate:PN[1-1]:TRACe[1-1]:MARKer[1-10]:SEARch:PEAK:EXCURsion	149
:CALCulate:PN[1-1]:TRACe[1-1]:MARKer[1-10]:SEARch:PEAK:POLarity	149
:CALCulate:PN[1-1]:TRACe[1-1]:MARKer[1-10]:SEARch:TARGet:TRANsition	150
:CALCulate:PN[1-1]:TRACe[1-1]:MARKer[1-10]:SEARch:TARGet:Y	150
:CALCulate:PN[1-1]:TRACe[1-1]:MARKer[1-10]:SEARch:TRACking:TYPE	151
:CALCulate:PN[1-1]:TRACe[1-1]:MARKer[1-10]:STATe	151
:CALCulate:PN[1-1]:TRACe[1-1]:MARKer[1-10]:X	151
:CALCulate:PN[1-1]:TRACe[1-1]:MARKer[1-10]:Y	152
:CALCulate:PN[1-1]:TRACe[1-1]:MATH:FUNCTion	152
:CALCulate:PN[1-1]:TRACe[1-1]:MATH:MEMorize	152
:CALCulate:PN[1-1]:TRACe[1-1]:MATH:OFFSet	153
:CALCulate:PN[1-1]:TRACe[1-1]:SMOothing:APERture	153
:CALCulate:PN[1-1]:TRACe[1-1]:SMOothing:STATe	153
:CALCulate:PN[1-1]:TRACe[1-1]:SPURious:OMISSion	154
:CALCulate:PN[1-1]:TRACe[1-1]:SPURious:POWER	154
:CALCulate:PN[1-1]:TRACe[1-1]:SPURious:THReshold:LEVel:MINimum	155
:CALCulate:PN[1-1]:TRACe[1-1]:SPURious:THReshold:TABLE:CLEar	155
:CALCulate:PN[1-1]:TRACe[1-1]:SPURious:THReshold:TABLE:COUNT	155

Contents

:CALCulate:PN[1-1]:TRACe[1-1]:SPURious:THReshold:TABLE:DATA	156
:CALCulate:SP[1-1]:ALLTrace:LIMit:FAIL	156
:CALCulate:SP[1-1]:ALLTrace:MARKer:COUPle:STATe	156
:CALCulate:SP[1-1]:ALLTrace:MARKer:DISCrete:STATe	157
:CALCulate:SP[1-1]:ALLTrace:MARKer:REFerence:NUMBer	157
:CALCulate:SP[1-1]:ALLTrace:MARKer:REFerence:STATe	158
:CALCulate:SP[1-1]:DATA:RDATA	158
:CALCulate:SP[1-1]:DATA:XDATA	158
:CALCulate:SP[1-1]:TRACe[1-1]:ALLMarker:ACTive	159
:CALCulate:SP[1-1]:TRACe[1-1]:ALLMarker:SEARch:DOMain:X	159
:CALCulate:SP[1-1]:TRACe[1-1]:ALLMarker:SEARch:DOMain:Y	159
:CALCulate:SP[1-1]:TRACe[1-1]:ALLMarker:SEARch:PEAK	160
:CALCulate:SP[1-1]:TRACe[1-1]:BDMarker:X:CENTer	160
:CALCulate:SP[1-1]:TRACe[1-1]:BDMarker:X:SPAN	160
:CALCulate:SP[1-1]:TRACe[1-1]:BDMarker:X:STARt	161
:CALCulate:SP[1-1]:TRACe[1-1]:BDMarker:X:STATe	161
:CALCulate:SP[1-1]:TRACe[1-1]:BDMarker:X:STOP	162
:CALCulate:SP[1-1]:TRACe[1-1]:BDMarker:Y:CENTer	162
:CALCulate:SP[1-1]:TRACe[1-1]:BDMarker:Y:SPAN	163
:CALCulate:SP[1-1]:TRACe[1-1]:BDMarker:Y:STARt	163
:CALCulate:SP[1-1]:TRACe[1-1]:BDMarker:Y:STATe	164
:CALCulate:SP[1-1]:TRACe[1-1]:BDMarker:Y:STOP	164
:CALCulate:SP[1-1]:TRACe[1-1]:DATA:COPIY	164
:CALCulate:SP[1-1]:TRACe[1-1]:DATA:FDATA	165
:CALCulate:SP[1-1]:TRACe[1-1]:DATA:FMEMory	165
:CALCulate:SP[1-1]:TRACe[1-1]:DATA:UDATA	166
:CALCulate:SP[1-1]:TRACe[1-1]:DATA:UMEMory	166
:CALCulate:SP[1-1]:TRACe[1-1]:FORMat	167
:CALCulate:SP[1-1]:TRACe[1-1]:FUNCTION:DOMain:X	167
:CALCulate:SP[1-1]:TRACe[1-1]:FUNCTION:DOMain:Y	168
:CALCulate:SP[1-1]:TRACe[1-1]:FUNCTION:STATistics:DATA	168
:CALCulate:SP[1-1]:TRACe[1-1]:FUNCTION:STATistics:MEMory	168
:CALCulate:SP[1-1]:TRACe[1-1]:FUNCTION:TYPE	168
:CALCulate:SP[1-1]:TRACe[1-1]:HOLD	169
:CALCulate:SP[1-1]:TRACe[1-1]:LIMit:FAIL	169
:CALCulate:SP[1-1]:TRACe[1-1]:LIMit:LOWer:LDATA	169
:CALCulate:SP[1-1]:TRACe[1-1]:LIMit:LOWer:SEGment:CLEar	170
:CALCulate:SP[1-1]:TRACe[1-1]:LIMit:LOWer:SEGment:COUNt	170
:CALCulate:SP[1-1]:TRACe[1-1]:LIMit:LOWer:SEGment:DATA	171
:CALCulate:SP[1-1]:TRACe[1-1]:LIMit:REPort[:DATA]	171
:CALCulate:SP[1-1]:TRACe[1-1]:LIMit[:STATe].	171
:CALCulate:SP[1-1]:TRACe[1-1]:LIMit:UPPer:LDATA	172
:CALCulate:SP[1-1]:TRACe[1-1]:LIMit:UPPer:SEGment:CLEar	172
:CALCulate:SP[1-1]:TRACe[1-1]:LIMit:UPPer:SEGment:COUNt	172
:CALCulate:SP[1-1]:TRACe[1-1]:LIMit:UPPer:SEGment:DATA	173
:CALCulate:SP[1-1]:TRACe[1-1]:MARKer[1-10]:SEARch:EXECute:LPEak	173
:CALCulate:SP[1-1]:TRACe[1-1]:MARKer[1-10]:SEARch:EXECute:LTARget	173
:CALCulate:SP[1-1]:TRACe[1-1]:MARKer[1-10]:SEARch:EXECute:MAXimum	173
:CALCulate:SP[1-1]:TRACe[1-1]:MARKer[1-10]:SEARch:EXECute:MINimum	174

:CALCulate:SP[1-1]:TRACe[1-1]:MARKer[1-10]:SEARch:EXECute:PEAK	174
:CALCulate:SP[1-1]:TRACe[1-1]:MARKer[1-10]:SEARch:EXECute:RPEak	174
:CALCulate:SP[1-1]:TRACe[1-1]:MARKer[1-10]:SEARch:EXECute:RTARget	174
:CALCulate:SP[1-1]:TRACe[1-1]:MARKer[1-10]:SEARch:EXECute:TARGet	174
:CALCulate:SP[1-1]:TRACe[1-1]:MARKer[1-10]:SEARch:PEAK:EXCursion	175
:CALCulate:SP[1-1]:TRACe[1-1]:MARKer[1-10]:SEARch:PEAK:POLarity	175
:CALCulate:SP[1-1]:TRACe[1-1]:MARKer[1-10]:SEARch:TARGet:TRAnSition	175
:CALCulate:SP[1-1]:TRACe[1-1]:MARKer[1-10]:SEARch:TARGet:Y	176
:CALCulate:SP[1-1]:TRACe[1-1]:MARKer[1-10]:SEARch:TRACking:TYPE	176
:CALCulate:SP[1-1]:TRACe[1-1]:MARKer[1-10]:STATe	177
:CALCulate:SP[1-1]:TRACe[1-1]:MARKer[1-10]:X	177
:CALCulate:SP[1-1]:TRACe[1-1]:MARKer[1-10]:Y	178
:CALCulate:SP[1-1]:TRACe[1-1]:MATH:FUNcTION	178
:CALCulate:SP[1-1]:TRACe[1-1]:MATH:MEMorize	178
:CALCulate:SP[1-1]:TRACe[1-1]:MATH:OFFSet	178
:CALCulate:SP[1-1]:TRACe[1-1]:SMOothing:APERture	179
:CALCulate:SP[1-1]:TRACe[1-1]:SMOothing:STATe	179
:CALCulate:TR[1-1]:ALLTrace:ACTive	180
:CALCulate:TR[1-1]:ALLTrace:BDMarker:X:COUPle:STATe	180
:CALCulate:TR[1-1]:ALLTrace:LIMit:FAIL	181
:CALCulate:TR[1-1]:ALLTrace:MARKer:COUPle:STATe	181
:CALCulate:TR[1-1]:ALLTrace:MARKer:DISCREte:STATe	181
:CALCulate:TR[1-1]:ALLTrace:MARKer:REFerence:NUMBer	182
:CALCulate:TR[1-1]:ALLTrace:MARKer:REFerence:STATe	182
:CALCulate:TR[1-1]:NARRow:DATA:RDATa	183
:CALCulate:TR[1-1]:NARRow:DATA:XDATa	183
:CALCulate:TR[1-1]:TRACe[1-4]:ALLMarker:ACTive	183
:CALCulate:TR[1-1]:TRACe[1-4]:ALLMarker:SEARch:DOMain:X	184
:CALCulate:TR[1-1]:TRACe[1-4]:ALLMarker:SEARch:DOMain:Y	184
:CALCulate:TR[1-1]:TRACe[1-4]:ALLMarker:SEARch:PEAK	184
:CALCulate:TR[1-1]:TRACe[1-4]:BDMarker:X:CENTer	185
:CALCulate:TR[1-1]:TRACe[1-4]:BDMarker:X:SPAN	185
:CALCulate:TR[1-1]:TRACe[1-4]:BDMarker:X:STARt	185
:CALCulate:TR[1-1]:TRACe[1-4]:BDMarker:X:STATe	186
:CALCulate:TR[1-1]:TRACe[1-4]:BDMarker:X:STOP	186
:CALCulate:TR[1-1]:TRACe[1-4]:BDMarker:Y:CENTer	187
:CALCulate:TR[1-1]:TRACe[1-4]:BDMarker:Y:SPAN	187
:CALCulate:TR[1-1]:TRACe[1-4]:BDMarker:Y:STARt	188
:CALCulate:TR[1-1]:TRACe[1-4]:BDMarker:Y:STATe	188
:CALCulate:TR[1-1]:TRACe[1-4]:BDMarker:Y:STOP	188
:CALCulate:TR[1-1]:TRACe[1-4]:DATA:COpy	189
:CALCulate:TR[1-1]:TRACe[1-4]:DATA:FDATa	189
:CALCulate:TR[1-1]:TRACe[1-4]:DATA:FMEMory	190
:CALCulate:TR[1-1]:TRACe[1-4]:DATA:UDATa	190
:CALCulate:TR[1-1]:TRACe[1-4]:DATA:UMEMory	191
:CALCulate:TR[1-1]:TRACe[1-4]:FORMat:FREQuency	191
:CALCulate:TR[1-1]:TRACe[1-4]:FORMat:PHASe:PREFerence:OFFSet	192
:CALCulate:TR[1-1]:TRACe[1-4]:FORMat:PHASe:UNIT	192
:CALCulate:TR[1-1]:TRACe[1-4]:FORMat:PHASe:WRAP	192

:CALCulate:TR[1-1]:TRACe[1-4]:FORMat:PHASe:XREFerence	193
:CALCulate:TR[1-1]:TRACe[1-4]:FUNctio:DOMain:X	193
:CALCulate:TR[1-1]:TRACe[1-4]:FUNctio:DOMain:Y	194
:CALCulate:TR[1-1]:TRACe[1-4]:FUNctio:LREGression:DATA	194
:CALCulate:TR[1-1]:TRACe[1-4]:FUNctio:LREGression:MEMory	194
:CALCulate:TR[1-1]:TRACe[1-4]:FUNctio:STATistics:DATA	195
:CALCulate:TR[1-1]:TRACe[1-4]:FUNctio:STATistics:MEMory	195
:CALCulate:TR[1-1]:TRACe[1-4]:FUNctio:TYPE	195
:CALCulate:TR[1-1]:TRACe[1-4]:HOLD	195
:CALCulate:TR[1-1]:TRACe[1-4]:LIMit:FAIL	196
:CALCulate:TR[1-1]:TRACe[1-4]:LIMit:LOWer:LDATa	196
:CALCulate:TR[1-1]:TRACe[1-4]:LIMit:LOWer:SEGMENT:CLEar	197
:CALCulate:TR[1-1]:TRACe[1-4]:LIMit:LOWer:SEGMENT:COUNt	197
:CALCulate:TR[1-1]:TRACe[1-4]:LIMit:LOWer:SEGMENT:DATA	197
:CALCulate:TR[1-1]:TRACe[1-4]:LIMit:REPort[:DATA]	198
:CALCulate:TR[1-1]:TRACe[1-4]:LIMit[:STATe]	198
:CALCulate:TR[1-1]:TRACe[1-4]:LIMit:UPPer:LDATa	198
:CALCulate:TR[1-1]:TRACe[1-4]:LIMit:UPPer:SEGMENT:CLEar	199
:CALCulate:TR[1-1]:TRACe[1-4]:LIMit:UPPer:SEGMENT:COUNt	199
:CALCulate:TR[1-1]:TRACe[1-4]:LIMit:UPPer:SEGMENT:DATA	199
:CALCulate:TR[1-1]:TRACe[1-4]:LINE:A	200
:CALCulate:TR[1-1]:TRACe[1-4]:LINE:B	200
:CALCulate:TR[1-1]:TRACe[1-4]:LINE:MEMory	200
:CALCulate:TR[1-1]:TRACe[1-4]:MARKer[1-10]:SEARch:EXECute:LPEak	201
:CALCulate:TR[1-1]:TRACe[1-4]:MARKer[1-10]:SEARch:EXECute:LTARget	201
:CALCulate:TR[1-1]:TRACe[1-4]:MARKer[1-10]:SEARch:EXECute:MAXimum	201
:CALCulate:TR[1-1]:TRACe[1-4]:MARKer[1-10]:SEARch:EXECute:MINimum	201
:CALCulate:TR[1-1]:TRACe[1-4]:MARKer[1-10]:SEARch:EXECute:PEAK	201
:CALCulate:TR[1-1]:TRACe[1-4]:MARKer[1-10]:SEARch:EXECute:RPEak	202
:CALCulate:TR[1-1]:TRACe[1-4]:MARKer[1-10]:SEARch:EXECute:RTARget	202
:CALCulate:TR[1-1]:TRACe[1-4]:MARKer[1-10]:SEARch:EXECute:TARGet	202
:CALCulate:TR[1-1]:TRACe[1-4]:MARKer[1-10]:SEARch:PEAK:EXCURsion	202
:CALCulate:TR[1-1]:TRACe[1-4]:MARKer[1-10]:SEARch:PEAK:POLarity	203
:CALCulate:TR[1-1]:TRACe[1-4]:MARKer[1-10]:SEARch:TARGet:TRANSition	203
:CALCulate:TR[1-1]:TRACe[1-4]:MARKer[1-10]:SEARch:TARGet:Y	203
:CALCulate:TR[1-1]:TRACe[1-4]:MARKer[1-10]:SEARch:TRACking:TYPE	204
:CALCulate:TR[1-1]:TRACe[1-4]:MARKer[1-10]:STATe	204
:CALCulate:TR[1-1]:TRACe[1-4]:MARKer[1-10]:X	205
:CALCulate:TR[1-1]:TRACe[1-4]:MARKer[1-10]:Y	205
:CALCulate:TR[1-1]:TRACe[1-4]:MATH:FUNctioN	205
:CALCulate:TR[1-1]:TRACe[1-4]:MATH:MEMorize	206
:CALCulate:TR[1-1]:TRACe[1-4]:MATH:OFFSet	206
:CALCulate:TR[1-1]:TRACe[1-4]:PARAmeter	206
:CALCulate:TR[1-1]:TRACe[1-4]:REFerence:FREQUency	207
:CALCulate:TR[1-1]:TRACe[1-4]:SMOothing:APERture	207
:CALCulate:TR[1-1]:TRACe[1-4]:SMOothing:STATe	207
:CALCulate:TR[1-1]:WIDE:DATA:RDATa	208
:CALCulate:TR[1-1]:WIDE:DATA:XDATa	208
:CALCulate:USER[1-1]:ALLTrace:ACTive	208

:CALCulate:USER[1-1]:ALLTrace:BDMarker:X:COUPle:STATe	209
:CALCulate:USER[1-1]:ALLTrace:LIMit:FAIL	209
:CALCulate:USER[1-1]:ALLTrace:MARKer:COUPle:STATe	210
:CALCulate:USER[1-1]:ALLTrace:MARKer:DISCrete:STATe	210
:CALCulate:USER[1-1]:ALLTrace:MARKer:REFereNce:NUMBer	210
:CALCulate:USER[1-1]:ALLTrace:MARKer:REFereNce:STATe	211
:CALCulate:USER[1-1]:TRACe[1-8]:ALLMarker:ACTive	211
:CALCulate:USER[1-1]:TRACe[1-8]:ALLMarker:SEARch:DOMain:X	212
:CALCulate:USER[1-1]:TRACe[1-8]:ALLMarker:SEARch:DOMain:Y	212
:CALCulate:USER[1-1]:TRACe[1-8]:ALLMarker:SEARch:PEAK	212
:CALCulate:USER[1-1]:TRACe[1-8]:BDMarker:X:CENTer	213
:CALCulate:USER[1-1]:TRACe[1-8]:BDMarker:X:SPAN	213
:CALCulate:USER[1-1]:TRACe[1-8]:BDMarker:X:STARt	213
:CALCulate:USER[1-1]:TRACe[1-8]:BDMarker:X:STATe	214
:CALCulate:USER[1-1]:TRACe[1-8]:BDMarker:X:STOP	214
:CALCulate:USER[1-1]:TRACe[1-8]:BDMarker:Y:CENTer	215
:CALCulate:USER[1-1]:TRACe[1-8]:BDMarker:Y:SPAN	215
:CALCulate:USER[1-1]:TRACe[1-8]:BDMarker:Y:STARt	216
:CALCulate:USER[1-1]:TRACe[1-8]:BDMarker:Y:STATe	216
:CALCulate:USER[1-1]:TRACe[1-8]:BDMarker:Y:STOP	216
:CALCulate:USER[1-1]:TRACe[1-8]:DATA:COPIY	217
:CALCulate:USER[1-1]:TRACe[1-8]:DATA:FDATA	217
:CALCulate:USER[1-1]:TRACe[1-8]:DATA:FMEMOry	218
:CALCulate:USER[1-1]:TRACe[1-8]:DATA:POINts	218
:CALCulate:USER[1-1]:TRACe[1-8]:DATA:RDATa	218
:CALCulate:USER[1-1]:TRACe[1-8]:DATA:STARt	219
:CALCulate:USER[1-1]:TRACe[1-8]:DATA:STOP	219
:CALCulate:USER[1-1]:TRACe[1-8]:DATA:UDATa	219
:CALCulate:USER[1-1]:TRACe[1-8]:DATA:UMEMOry	220
:CALCulate:USER[1-1]:TRACe[1-8]:DATA:XDATa	220
:CALCulate:USER[1-1]:TRACe[1-8]:FUNCTioN:DOMain:X	220
:CALCulate:USER[1-1]:TRACe[1-8]:FUNCTioN:DOMain:Y	221
:CALCulate:USER[1-1]:TRACe[1-8]:FUNCTioN:STATistics:DATA	221
:CALCulate:USER[1-1]:TRACe[1-8]:FUNCTioN:STATistics:MEMOry	221
:CALCulate:USER[1-1]:TRACe[1-8]:FUNCTioN:TYPE	222
:CALCulate:USER[1-1]:TRACe[1-8]:HOLD	222
:CALCulate:USER[1-1]:TRACe[1-8]:LIMit:FAIL	222
:CALCulate:USER[1-1]:TRACe[1-8]:LIMit:LOWer:LDATa	223
:CALCulate:USER[1-1]:TRACe[1-8]:LIMit:LOWer:SEGment:CLEar	223
:CALCulate:USER[1-1]:TRACe[1-8]:LIMit:LOWer:SEGment:COUNT	223
:CALCulate:USER[1-1]:TRACe[1-8]:LIMit:LOWer:SEGment:DATA	224
:CALCulate:USER[1-1]:TRACe[1-8]:LIMit:REPort[:DATA]	224
:CALCulate:USER[1-1]:TRACe[1-8]:LIMit[:STATe]	224
:CALCulate:USER[1-1]:TRACe[1-8]:LIMit:UPPer:LDATa	225
:CALCulate:USER[1-1]:TRACe[1-8]:LIMit:UPPer:SEGment:CLEar	225
:CALCulate:USER[1-1]:TRACe[1-8]:LIMit:UPPer:SEGment:COUNT	225
:CALCulate:USER[1-1]:TRACe[1-8]:LIMit:UPPer:SEGment:DATA	226
:CALCulate:USER[1-1]:TRACe[1-8]:MARKer[1-10]:SEARch:EXECute:LPEak	226
:CALCulate:USER[1-1]:TRACe[1-8]:MARKer[1-10]:SEARch:EXECute:LTARget	226

Contents

:CALCulate:USER[1-1]:TRACe[1-8]:MARKer[1-10]:SEARch:EXECute:MAXimum	227
:CALCulate:USER[1-1]:TRACe[1-8]:MARKer[1-10]:SEARch:EXECute:MINimum	227
:CALCulate:USER[1-1]:TRACe[1-8]:MARKer[1-10]:SEARch:EXECute:PEAK	227
:CALCulate:USER[1-1]:TRACe[1-8]:MARKer[1-10]:SEARch:EXECute:RPEak	227
:CALCulate:USER[1-1]:TRACe[1-8]:MARKer[1-10]:SEARch:EXECute:RTARget	227
:CALCulate:USER[1-1]:TRACe[1-8]:MARKer[1-10]:SEARch:EXECute:TARGet	228
:CALCulate:USER[1-1]:TRACe[1-8]:MARKer[1-10]:SEARch:PEAK:EXCursion	228
:CALCulate:USER[1-1]:TRACe[1-8]:MARKer[1-10]:SEARch:PEAK:POLarity	228
:CALCulate:USER[1-1]:TRACe[1-8]:MARKer[1-10]:SEARch:TARGet:TRAnSition	229
:CALCulate:USER[1-1]:TRACe[1-8]:MARKer[1-10]:SEARch:TARGet:Y	229
:CALCulate:USER[1-1]:TRACe[1-8]:MARKer[1-10]:SEARch:TRACking:TYPE	230
:CALCulate:USER[1-1]:TRACe[1-8]:MARKer[1-10]:STATe	230
:CALCulate:USER[1-1]:TRACe[1-8]:MARKer[1-10]:X	230
:CALCulate:USER[1-1]:TRACe[1-8]:MARKer[1-10]:Y	231
:CALCulate:USER[1-1]:TRACe[1-8]:MATH:FUNCTion	231
:CALCulate:USER[1-1]:TRACe[1-8]:MATH:MEMorize	231
:CALCulate:USER[1-1]:TRACe[1-8]:MATH:OFFSet	232
:CALCulate:USER[1-1]:TRACe[1-8]:SMOothing:APERture	232
:CALCulate:USER[1-1]:TRACe[1-8]:SMOothing:STATe	232
:CONTRol:HANDler:A[:DATA]	233
:CONTRol:HANDler:B[:DATA]	233
:CONTRol:HANDler:C[:DATA]	234
:CONTRol:HANDler:C:MODE	234
:CONTRol:HANDler:D[:DATA]	234
:CONTRol:HANDler:D:MODE	235
:CONTRol:HANDler:E[:DATA]	235
:CONTRol:HANDler:F[:DATA]	236
:CONTRol:HANDler:OUTPut[1-2][:DATA]	236
:DISPlay:CLOCK	236
:DISPlay:COLor[1-2]:BACK[:VALue]	237
:DISPlay:COLor[1-2]:GRATicule[1-2][:VALue]	237
:DISPlay:COLor[1-2]:LIMit[1-2][:VALue]	238
:DISPlay:COLor[1-2]:RESet	239
:DISPlay:COLor[1-2]:TRACe[1-8]:DATA[:VALue]	239
:DISPlay:COLor[1-2]:TRACe[1-8]:MEMory[:VALue]	240
:DISPlay:ECHO:ADD	241
:DISPlay:ECHO:CLEar	241
:DISPlay:ECHO:DATA	241
:DISPlay:ECHO:FSIZE	242
:DISPlay:ECHO:STATe	242
:DISPlay:ENABle	243
:DISPlay:FP[1-1]:ALLTrace:PERSiStence:CLEar	243
:DISPlay:FP[1-1]:ALLTrace:Y:SCALE:AUTO	244
:DISPlay:FP[1-1]:ANNOtation:MARKer:POSition	244
:DISPlay:FP[1-1]:ANNOtation:MEASurement:STATe	244
:DISPlay:FP[1-1]:GRATicule:AXIS:Y:RELative	244
:DISPlay:FP[1-1]:GRATicule:AXIS:Y:STATe	245
:DISPlay:FP[1-1]:LABel:DATA	245
:DISPlay:FP[1-1]:LABel:STATe	246

:DISPlay:FP[1-1]:LIMit:FSIGn	246
:DISPlay:FP[1-1]:MAXimize	246
:DISPlay:FP[1-1]:SPLit	247
:DISPlay:FP[1-1]:STATe	247
:DISPlay:FP[1-1]:TABLe[:STATe]	248
:DISPlay:FP[1-1]:TRACe[1-4]:LABel:DATA	248
:DISPlay:FP[1-1]:TRACe[1-4]:LIMit:LINE	248
:DISPlay:FP[1-1]:TRACe[1-4]:MODE	249
:DISPlay:FP[1-1]:TRACe[1-4]:PERSistence:CLEar	249
:DISPlay:FP[1-1]:TRACe[1-4]:PERSistence:STATe	249
:DISPlay:FP[1-1]:TRACe[1-4]:X[:SCALE]:AUTO	250
:DISPlay:FP[1-1]:TRACe[1-4]:X[:SCALE]:LEFT	250
:DISPlay:FP[1-1]:TRACe[1-4]:X[:SCALE]:RIGHT	251
:DISPlay:FP[1-1]:TRACe[1-4]:Y[:SCALE]:AUTO	251
:DISPlay:FP[1-1]:TRACe[1-4]:Y[:SCALE]:PDIVision	251
:DISPlay:FP[1-1]:TRACe[1-4]:Y[:SCALE]:RLEVel	252
:DISPlay:FP[1-1]:TRACe[1-4]:Y[:SCALE]:RPOSITION	252
:DISPlay:FP[1-1]:Y[:SCALE]:DIVisions	253
:DISPlay:IMAGe	253
:DISPlay:MAXimize	254
:DISPlay:MESSage:CLEar	254
:DISPlay:PN[1-1]:ALLTrace:PERSistence:CLEar	254
:DISPlay:PN[1-1]:ANNotation:MARKer:POSITION	254
:DISPlay:PN[1-1]:ANNotation:MEASurement:STATe	255
:DISPlay:PN[1-1]:GRATicule:AXIS:Y:RELative	255
:DISPlay:PN[1-1]:GRATicule:AXIS:Y:STATe	255
:DISPlay:PN[1-1]:LABel:DATA	256
:DISPlay:PN[1-1]:LABel:STATe	256
:DISPlay:PN[1-1]:LIMit:FSIGn	257
:DISPlay:PN[1-1]:MAXimize	257
:DISPlay:PN[1-1]:STATe	257
:DISPlay:PN[1-1]:TABLe[:STATe]	258
:DISPlay:PN[1-1]:TRACe[1-1]:LABel:DATA	258
:DISPlay:PN[1-1]:TRACe[1-1]:LIMit:LINE	259
:DISPlay:PN[1-1]:TRACe[1-1]:MODE	259
:DISPlay:PN[1-1]:TRACe[1-1]:PERSistence:CLEar	260
:DISPlay:PN[1-1]:TRACe[1-1]:PERSistence:STATe	260
:DISPlay:PN[1-1]:TRACe[1-1]:X[:SCALE]:AUTO	260
:DISPlay:PN[1-1]:TRACe[1-1]:X[:SCALE]:LEFT	260
:DISPlay:PN[1-1]:TRACe[1-1]:X[:SCALE]:RIGHT	261
:DISPlay:PN[1-1]:TRACe[1-1]:Y[:SCALE]:AUTO	262
:DISPlay:PN[1-1]:TRACe[1-1]:Y[:SCALE]:PDIVision	262
:DISPlay:PN[1-1]:TRACe[1-1]:Y[:SCALE]:RLEVel	262
:DISPlay:PN[1-1]:TRACe[1-1]:Y[:SCALE]:RPOSITION	263
:DISPlay:PN[1-1]:Y[:SCALE]:DIVisions	263
:DISPlay:SKEY:STATe	263
:DISPlay:SP[1-1]:ALLTrace:PERSistence:CLEar	264
:DISPlay:SP[1-1]:ANNotation:MARKer:POSITION	264
:DISPlay:SP[1-1]:ANNotation:MEASurement:STATe	264

:DISPlay:SP[1-1]:GRATicule:AXIS:Y:RELative	265
:DISPlay:SP[1-1]:GRATicule:AXIS:Y:STATe	265
:DISPlay:SP[1-1]:LABel:DATA	266
:DISPlay:SP[1-1]:LABel:STATe	266
:DISPlay:SP[1-1]:LIMit:FSIGN	266
:DISPlay:SP[1-1]:MAXimize	267
:DISPlay:SP[1-1]:STATe	267
:DISPlay:SP[1-1]:TABLe[:STATe]	268
:DISPlay:SP[1-1]:TRACe[1-1]:LABel:DATA	268
:DISPlay:SP[1-1]:TRACe[1-1]:LIMit:LINE	268
:DISPlay:SP[1-1]:TRACe[1-1]:MODE	269
:DISPlay:SP[1-1]:TRACe[1-1]:PERsistence:CLear	269
:DISPlay:SP[1-1]:TRACe[1-1]:PERsistence:STATe	269
:DISPlay:SP[1-1]:TRACe[1-1]:X[:SCALE]:AUTO	270
:DISPlay:SP[1-1]:TRACe[1-1]:X[:SCALE]:LEFT	270
:DISPlay:SP[1-1]:TRACe[1-1]:X[:SCALE]:RIGHT	271
:DISPlay:SP[1-1]:TRACe[1-1]:Y[:SCALE]:AUTO	271
:DISPlay:SP[1-1]:TRACe[1-1]:Y[:SCALE]:PDIVision	271
:DISPlay:SP[1-1]:TRACe[1-1]:Y[:SCALE]:RLEVel	272
:DISPlay:SP[1-1]:TRACe[1-1]:Y[:SCALE]:RPOSition	272
:DISPlay:SP[1-1]:Y[:SCALE]:DIVisions	273
:DISPlay:TR[1-1]:ALLTrace:PERsistence:CLear	273
:DISPlay:TR[1-1]:ALLTrace:Y:SCALE:AUTO	273
:DISPlay:TR[1-1]:ANNOtation:MARKer:POSition	273
:DISPlay:TR[1-1]:ANNOtation:MEASurement:STATe	274
:DISPlay:TR[1-1]:GRATicule:AXIS:Y:RELative	274
:DISPlay:TR[1-1]:GRATicule:AXIS:Y:STATe	274
:DISPlay:TR[1-1]:LABel:DATA	275
:DISPlay:TR[1-1]:LABel:STATe	275
:DISPlay:TR[1-1]:LIMit:FSIGN	276
:DISPlay:TR[1-1]:MAXimize	276
:DISPlay:TR[1-1]:STATe	276
:DISPlay:TR[1-1]:TABLe[:STATe]	277
:DISPlay:TR[1-1]:TRACe[1-4]:LABel:DATA	277
:DISPlay:TR[1-1]:TRACe[1-4]:LIMit:LINE	278
:DISPlay:TR[1-1]:TRACe[1-4]:MODE	278
:DISPlay:TR[1-1]:TRACe[1-4]:PERsistence:CLear	279
:DISPlay:TR[1-1]:TRACe[1-4]:PERsistence:STATe	279
:DISPlay:TR[1-1]:TRACe[1-4]:X[:SCALE]:AUTO	279
:DISPlay:TR[1-1]:TRACe[1-4]:X[:SCALE]:LEFT	279
:DISPlay:TR[1-1]:TRACe[1-4]:X[:SCALE]:RIGHT	280
:DISPlay:TR[1-1]:TRACe[1-4]:Y[:SCALE]:AUTO	281
:DISPlay:TR[1-1]:TRACe[1-4]:Y[:SCALE]:PDIVision	281
:DISPlay:TR[1-1]:TRACe[1-4]:Y[:SCALE]:RLEVel	281
:DISPlay:TR[1-1]:TRACe[1-4]:Y[:SCALE]:RPOSition	282
:DISPlay:TR[1-1]:Y[:SCALE]:DIVisions	282
:DISPlay:UPDate:IMMediate	282
:DISPlay:USER[1-1]:ALLTrace:PERsistence:CLear	283
:DISPlay:USER[1-1]:ALLTrace:Y:SCALE:AUTO	283

:DISPlay:USER[1-1]:ANNOtation:MARKer:POSition	283
:DISPlay:USER[1-1]:ANNOtation:MEASurement:STATe	283
:DISPlay:USER[1-1]:GRATicule:AXIS:Y:RELative	284
:DISPlay:USER[1-1]:GRATicule:AXIS:Y:STATe	284
:DISPlay:USER[1-1]:LABel:DATA	284
:DISPlay:USER[1-1]:LABel:STATe	285
:DISPlay:USER[1-1]:LIMit:FSIGN	285
:DISPlay:USER[1-1]:MAXimize	286
:DISPlay:USER[1-1]:STATe	286
:DISPlay:USER[1-1]:TABLe[:STATe]	286
:DISPlay:USER[1-1]:TRACe[1-8]:ANNOtation:DATA	287
:DISPlay:USER[1-1]:TRACe[1-8]:LABel:DATA	287
:DISPlay:USER[1-1]:TRACe[1-8]:LIMit:LINE	288
:DISPlay:USER[1-1]:TRACe[1-8]:MODE	288
:DISPlay:USER[1-1]:TRACe[1-8]:PERsistence:STATe	288
:DISPlay:USER[1-1]:TRACe[1-8]:STATe	289
:DISPlay:USER[1-1]:TRACe[1-8]:X[:SCALE]:AUTO	289
:DISPlay:USER[1-1]:TRACe[1-8]:X[:SCALE]:LEFT	289
:DISPlay:USER[1-1]:TRACe[1-8]:X[:SCALE]:RIGHT	290
:DISPlay:USER[1-1]:TRACe[1-8]:X:TYPE	291
:DISPlay:USER[1-1]:TRACe[1-8]:X:UNIT	291
:DISPlay:USER[1-1]:TRACe[1-8]:Y[:SCALE]:AUTO	291
:DISPlay:USER[1-1]:TRACe[1-8]:Y[:SCALE]:PDIVision	291
:DISPlay:USER[1-1]:TRACe[1-8]:Y[:SCALE]:RLEVel	292
:DISPlay:USER[1-1]:TRACe[1-8]:Y[:SCALE]:RPOSition	292
:DISPlay:USER[1-1]:TRACe[1-8]:Y:UNIT	293
:DISPlay:USER[1-1]:Y[:SCALE]:DIVisions	293
:DISPlay:WINDow:ACTive	294
:FORMat:BORDER	295
:FORMat:DATA	295
:HCOPy:ABORt	296
:HCOPy:IMAGe	296
:HCOPy:IMMediate	296
*CLS	297
*ESE	297
*ESR	297
*IDN	297
*OPC	297
*OPT	298
*RST	298
*SRE	298
*STB	299
*TRG	299
*WAI	299
:INITiate:FP[1-1]:CONTInuous	299
:INITiate:FP[1-1]:IMMediate	300
:INITiate:PN[1-1]:CONTInuous	300
:INITiate:PN[1-1]:IMMediate	300
:INITiate:SP[1-1]:CONTInuous	300

Contents

:INITiate:SP[1-1]:IMMEDIATE	301
:INITiate:TR[1-1]:CONTinuous	301
:INITiate:TR[1-1]:IMMEDIATE	301
:MMEMory:CATalog	301
:MMEMory:COpy	302
:MMEMory:DATA	302
:MMEMory:DELeT	303
:MMEMory:FP[1-1]:TRACe[1-4]:LOAD:LIMit:LOWer	303
:MMEMory:FP[1-1]:TRACe[1-4]:LOAD:LIMit:UPPer	304
:MMEMory:FP[1-1]:TRACe[1-4]:STORe[:DATA].	304
:MMEMory:FP[1-1]:TRACe[1-4]:STORe:MEMory	304
:MMEMory:LOAD:CORRection:POWer	305
:MMEMory:LOAD:PROGram	305
:MMEMory:LOAD:STATe	306
:MMEMory:MDIRectory	306
:MMEMory:PN[1-1]:TRACe[1-1]:LOAD:LIMit:LOWer	307
:MMEMory:PN[1-1]:TRACe[1-1]:LOAD:LIMit:UPPer	307
:MMEMory:PN[1-1]:TRACe[1-1]:LOAD:SPURious:THReShold	307
:MMEMory:PN[1-1]:TRACe[1-1]:STORe[:DATA]	308
:MMEMory:PN[1-1]:TRACe[1-1]:STORe:MEMory	308
:MMEMory:SP[1-1]:TRACe[1-1]:LOAD:LIMit:LOWer	309
:MMEMory:SP[1-1]:TRACe[1-1]:LOAD:LIMit:UPPer	309
:MMEMory:SP[1-1]:TRACe[1-1]:STORe[:DATA].	309
:MMEMory:SP[1-1]:TRACe[1-1]:STORe:MEMory	310
:MMEMory:STORe:IMAGe	310
:MMEMory:STORe:PROGram	311
:MMEMory:STORe:STATe	311
:MMEMory:STORe:STYPe	311
:MMEMory:TR[1-1]:TRACe[1-4]:LOAD:LIMit:LOWer	312
:MMEMory:TR[1-1]:TRACe[1-4]:LOAD:LIMit:UPPer	312
:MMEMory:TR[1-1]:TRACe[1-4]:STORe[:DATA]	313
:MMEMory:TR[1-1]:TRACe[1-4]:STORe:MEMory	313
:MMEMory:USER[1-1]:TRACe[1-8]:LOAD:LIMit:LOWer	313
:MMEMory:USER[1-1]:TRACe[1-8]:LOAD:LIMit:UPPer	314
:MMEMory:USER[1-1]:TRACe[1-8]:STORe[:DATA].	314
:MMEMory:USER[1-1]:TRACe[1-8]:STORe:MEMory	315
:PROGram:CATalog	315
:PROGram:COM:EVENT	315
:PROGram:SELeCted:NAME	316
:PROGram:SELeCted:STATe	316
:PROGram:SKEY:ITEM[1-8]:ENABLe	316
:PROGram:SKEY:ITEM[1-8]:IMMEDIATE	317
:PROGram:SKEY:ITEM[1-8]:LABEl	317
:PROGram:VARiable:ARRAy[1-10]:DATA	317
:PROGram:VARiable:ARRAy[1-10]:POINts	318
:PROGram:VARiable:DOUBle[1-10]	318
:PROGram:VARiable:INTeger[1-10]	319
:PROGram:VARiable:STRing[1-10]	319
:SENSe:ATTenuation:LEVel	320

:SENSe:CORRection:POWer:DATA	320
:SENSe:CORRection:POWer:STATe	321
:SENSe:DCONverter:IDN	321
:SENSe:DCONverter:INPut	321
:SENSe:DCONverter:MANual:CALCulate:LO?	322
:SENSe:DCONverter:MANual:IFDelta	323
:SENSe:DCONverter:MANual:IFGain[1-2]	323
:SENSe:DCONverter:MANual:LO[1-2]:FREQuency	324
:SENSe:DCONverter:MANual:LO[1-2]:LEVel	325
:SENSe:DCONverter:MANual:MEXTernal[1-2]:BIAS:CURRent	325
:SENSe:DCONverter:MANual:MEXTernal[1-2]:BIAS:STATe	326
:SENSe:DCONverter:MEXTernal	326
:SENSe:DCONverter[:STATe]	327
:SENSe:FP[1-1]:AVERage:CLear	327
:SENSe:FP[1-1]:AVERage:COUNT	328
:SENSe:FP[1-1]:AVERage:STATe	328
:SENSe:FP[1-1]:DCONverter:FREQuency	328
:SENSe:FP[1-1]:DCONverter:SSEarch:EXECute	329
:SENSe:FP[1-1]:FBANd	329
:SENSe:FP[1-1]:FREQuency:RESolution	330
:SENSe:FP[1-1]:POWer:INPut:LEVel:MAXimum	330
:SENSe:FP[1-1]:SWEep:DWELl	330
:SENSe:FP[1-1]:SWEep:TIME:DATA	331
:SENSe:PN[1-1]:AVERage:CLear	331
:SENSe:PN[1-1]:AVERage:COUNT	331
:SENSe:PN[1-1]:AVERage:STATe	332
:SENSe:PN[1-1]:CORRelation:COUNT	332
:SENSe:PN[1-1]:DCONverter:FREQuency	332
:SENSe:PN[1-1]:DCONverter:SSEarch:EXECute	333
:SENSe:PN[1-1]:EPRescaler:DIVision	333
:SENSe:PN[1-1]:EPRescaler:POWer	334
:SENSe:PN[1-1]:FBANd	334
:SENSe:PN[1-1]:FREQuency:STARt	335
:SENSe:PN[1-1]:FREQuency:STOP	336
:SENSe:PN[1-1]:IFGain	336
:SENSe:PN[1-1]:LOBandwidth	337
:SENSe:PN[1-1]:SEGTable[:MEASurement][:QUALity]	337
:SENSe:PN[1-1]:SWEep:POINts	337
:SENSe:ROSCillator:SOURce	338
:SENSe:SP[1-1]:AVERage:CLear	338
:SENSe:SP[1-1]:AVERage:COUNT	338
:SENSe:SP[1-1]:AVERage:STATe	338
:SENSe:SP[1-1]:AVERage:TYPE	339
:SENSe:SP[1-1]:BANDwidth:RESolution	339
:SENSe:SP[1-1]:CARRier:FBANd	340
:SENSe:SP[1-1]:CARRier:SET:CENTer	340
:SENSe:SP[1-1]:DETEctor:FUNCTion	341
:SENSe:SP[1-1]:FREQuency:CENTer	341
:SENSe:SP[1-1]:FREQuency:SPAN	342

:SENSe:SP[1-1]:FREQuency:StARt	343
:SENSe:SP[1-1]:FREQuency:StOP	344
:SENSe:SP[1-1]:POWer:RLEVel	345
:SENSe:SP[1-1]:SWEep:POINts	345
:SENSe:TR[1-1]:AVERAge:CLEAr	345
:SENSe:TR[1-1]:AVERAge:COUNt	345
:SENSe:TR[1-1]:AVERAge:STATe	346
:SENSe:TR[1-1]:NARRow:FREQuency:PREFErence	346
:SENSe:TR[1-1]:NARRow:FREQuency:RANGe	347
:SENSe:TR[1-1]:NARRow:FREQuency:TARGet	348
:SENSe:TR[1-1]:NARRow:SWEep:POINts	349
:SENSe:TR[1-1]:NARRow:TIME:OFFSet	349
:SENSe:TR[1-1]:NARRow:TIME:REFerence	349
:SENSe:TR[1-1]:NARRow:TIME:SPAN	350
:SENSe:TR[1-1]:POWer:INPut:LEVel:MAXimum	350
:SENSe:TR[1-1]:WIDE:FREQuency:MAXimum	350
:SENSe:TR[1-1]:WIDE:SWEep:POINts	352
:SENSe:TR[1-1]:WIDE:TIME:OFFSet	352
:SENSe:TR[1-1]:WIDE:TIME:REFerence	353
:SENSe:TR[1-1]:WIDE:TIME:SPAN	353
:SENSe:UDConverTer:HARMonic	353
:SENSe:UDConverTer:LO	354
:SENSe:UDConverTer:MODE	355
:SENSe:UDConverTer:STATe	356
:SOURce:FP[1-1]:SWEep:PARAmeter	356
:SOURce:FP[1-1]:SWEep:POINts	356
:SOURce:FP[1-1]:VOLTagE:CONTRol:CENTer	357
:SOURce:FP[1-1]:VOLTagE:CONTRol:SPAN	357
:SOURce:FP[1-1]:VOLTagE:CONTRol:StARt	358
:SOURce:FP[1-1]:VOLTagE:CONTRol:StOP	358
:SOURce:FP[1-1]:VOLTagE:POWer:CENTer	359
:SOURce:FP[1-1]:VOLTagE:POWer:SPAN	359
:SOURce:FP[1-1]:VOLTagE:POWer:StARt	360
:SOURce:FP[1-1]:VOLTagE:POWer:StOP	360
:SOURce:VOLTagE:CONTRol:AFC:FBANd	360
:SOURce:VOLTagE:CONTRol:AFC:IMMEdiate	361
:SOURce:VOLTagE:CONTRol:AFC:INPut:LEVel:MAXimum	362
:SOURce:VOLTagE:CONTRol:AFC:ITERation	362
:SOURce:VOLTagE:CONTRol:AFC:LIMit:HIGH	363
:SOURce:VOLTagE:CONTRol:AFC:LIMit:LOW	363
:SOURce:VOLTagE:CONTRol:AFC:SENSitivity	364
:SOURce:VOLTagE:CONTRol:AFC[:STATe]	364
:SOURce:VOLTagE:CONTRol:AFC:TARGet	365
:SOURce:VOLTagE:CONTRol:AFC:TOLerance	366
:SOURce:VOLTagE:CONTRol:CORRection:COLLect:ACQuire	366
:SOURce:VOLTagE:CONTRol:CORRection[:STATe]	367
:SOURce:VOLTagE:CONTRol:DELay	367
:SOURce:VOLTagE:CONTRol:LEVel:AMPLitude	367
:SOURce:VOLTagE:CONTRol:LEVel:STATe	368

:SOURce:VOLTage:CONTRol:LIMit:HIGH	368
:SOURce:VOLTage:CONTRol:LIMit:LOW	369
:SOURce:VOLTage:POWer:DELay	370
:SOURce:VOLTage:POWer:LEVel:AMPLitude	370
:SOURce:VOLTage:POWer:LEVel:STATe	371
:SOURce:VOLTage:POWer:LIMit:HIGH	371
:SOURce:VOLTage:POWer:LIMit:LOW	372
:STATus:OPERation:BIT12:CLEar	372
:STATus:OPERation:BIT12:CONDition	372
:STATus:OPERation:BIT12:ENABle	373
:STATus:OPERation:BIT12[:EVENT]	373
:STATus:OPERation:BIT12:NTRansition	373
:STATus:OPERation:BIT12:PTRansition	374
:STATus:OPERation:BIT12:SET	374
:STATus:OPERation:CONDition	374
:STATus:OPERation:ENABle	375
:STATus:OPERation[:EVENT]	375
:STATus:OPERation:NTRansition	375
:STATus:OPERation:PTRansition	376
:STATus:PRESet	376
:STATus:QUEStionable:CONDition	376
:STATus:QUEStionable:CURRent:ENABle	376
:STATus:QUEStionable:CURRent[:EVENT]	377
:STATus:QUEStionable:DCONverter:ENABle	377
:STATus:QUEStionable:DCONverter[:EVENT]	377
:STATus:QUEStionable:ENABle	377
:STATus:QUEStionable[:EVENT]	378
:STATus:QUEStionable:LIMit:CONDition	378
:STATus:QUEStionable:LIMit:ENABle	378
:STATus:QUEStionable:LIMit[:EVENT]	379
:STATus:QUEStionable:LIMit:FP[1-1]:CONDition	379
:STATus:QUEStionable:LIMit:FP[1-1]:ENABle	379
:STATus:QUEStionable:LIMit:FP[1-1][:EVENT]	379
:STATus:QUEStionable:LIMit:FP[1-1]:NTRansition	379
:STATus:QUEStionable:LIMit:FP[1-1]:PTRansition	380
:STATus:QUEStionable:LIMit:NTRansition	380
:STATus:QUEStionable:LIMit:PN[1-1]:CONDition	381
:STATus:QUEStionable:LIMit:PN[1-1]:ENABle	381
:STATus:QUEStionable:LIMit:PN[1-1][:EVENT]	381
:STATus:QUEStionable:LIMit:PN[1-1]:NTRansition	381
:STATus:QUEStionable:LIMit:PN[1-1]:PTRansition	382
:STATus:QUEStionable:LIMit:PTRansition	382
:STATus:QUEStionable:LIMit:SP[1-1]:CONDition	383
:STATus:QUEStionable:LIMit:SP[1-1]:ENABle	383
:STATus:QUEStionable:LIMit:SP[1-1][:EVENT]	383
:STATus:QUEStionable:LIMit:SP[1-1]:NTRansition	383
:STATus:QUEStionable:LIMit:SP[1-1]:PTRansition	384
:STATus:QUEStionable:LIMit:TR[1-1]:CONDition	384
:STATus:QUEStionable:LIMit:TR[1-1]:ENABle	384

:STATus:QUEStionable:LIMit:TR[1-1][:EVENT]	385
:STATus:QUEStionable:LIMit:TR[1-1]:NTRansition	385
:STATus:QUEStionable:LIMit:TR[1-1]:PTRansition	385
:STATus:QUEStionable:LIMit:USER[1-1]:CONDition	386
:STATus:QUEStionable:LIMit:USER[1-1]:ENABle	386
:STATus:QUEStionable:LIMit:USER[1-1][:EVENT]	386
:STATus:QUEStionable:LIMit:USER[1-1]:NTRansition	387
:STATus:QUEStionable:LIMit:USER[1-1]:PTRansition	387
:STATus:QUEStionable:MISC:ENABle	387
:STATus:QUEStionable:MISC[:EVENT]	388
:STATus:QUEStionable:NTRansition	388
:STATus:QUEStionable:PHASe:ENABle	388
:STATus:QUEStionable:PHASe[:EVENT]	389
:STATus:QUEStionable:POWer:ENABle	389
:STATus:QUEStionable:POWer[:EVENT]	389
:STATus:QUEStionable:PTRansition	390
:STATus:QUEStionable:REFerence:ENABle	390
:STATus:QUEStionable:REFerence[:EVENT]	390
:SYSTem:BACKlight:STATe	391
:SYSTem:BEEPer:COMPlete:IMMEDIATE	391
:SYSTem:BEEPer:COMPlete:STATe	391
:SYSTem:BEEPer:WARning:IMMEDIATE	392
:SYSTem:BEEPer:WARning:STATe	392
:SYSTem:DATE	393
:SYSTem:ERRor[:NEXT]	393
:SYSTem:KLOCK:KBD	393
:SYSTem:KLOCK:MOUSe	394
:SYSTem:POFF	394
:SYSTem:PRESet	394
:SYSTem:SECurity[:LEVel]	395
:SYSTem:TIME	395
:TRIGger:AVERage	396
:TRIGger:EXTernal:SLOPe	396
:TRIGger:FP[1-1]:MODE	397
:TRIGger:FP[1-1]:SOURce	397
:TRIGger:MODE	398
:TRIGger:PN[1-1]:SOURce	398
:TRIGger:SOPC	399
:TRIGger:SP[1-1]:SOURce	399
:TRIGger:TR[1-1]:ETTAdjust	400
:TRIGger:TR[1-1]:NARRow:VIDeo:FREQuency:CENTer	400
:TRIGger:TR[1-1]:NARRow:VIDeo:THReshold	401
:TRIGger:TR[1-1]:SOURce	401
:TRIGger:TR[1-1]:WIDE:VIDeo:FREQuency:CENTer	402
Command list	404
List by function	404
Commands with Variable Parameters and/or Setting Ranges Depending on Device Configurataion	433
Softkey Functions	435

A. Manual Changes	
Manual Changes	510
Change 5	511
Change 4	511
Change 3	512
Change 2	512
Change 1	513
B. Status Reporting System	
General Status Register Model	516
Event Register	517
Enable Register	517
Status Byte Register	517
Condition Register and Transition Filter	518
Status Register Structure	519
Using the Status Reporting System	535
C. Communication with External Instruments Using 24-bit I/O Port	
24-bit I/O Port Overview	538
I/O Signal Pin Layout and Description	539
Inputting/Outputting Data	542
Specifying signal direction of port	542
Reading data input to port	543
Data output to port	543
Preset States at Power-on	544
Timing Chart and Pulse Width	545
Electrical Characteristics	547
Input signal	547
Output signal	548
Power supply (+5 V)	548
D. Error Messages	
Error Messages	550
A	550
D	551
E	552
F	552
I	553
L	553
M	554
N	554
O	554
P	554
R	555
S	556
T	556
U	556
Warning Message	557

1 Making Effective Use of This Manual

This chapter describes the contents of this guide. Using this chapter with the table of contents helps you to retrieve description of a subject you wish to understand as well as to obtain an overview of this guide. Also see the latter part of this chapter for brief description of usage of this guide, focusing on searching commands.

Contents of This Manual

This is a programming guide with Agilent E5052A.

This guide describes programming method mainly aiming at learning how to write a program that remotely controls the E5052A using SCPI commands, focusing on sample usage with the HTBasic.

Controlling the E5052A using the built-in VBA is not covered by this guide; it is described in *VBA Programmer's Guide*. For using the E5052A VBA, see *VBA Programmer's Guide*.

Description in this guide assumes that the reader has learned manual operation of the E5052A. Thus, this guide does not describe each feature of the E5052A in detail. For detailed information on each feature, see *User's Guide*.

The chapter-by-chapter contents of this manual are as follows.

Chapter 1, "Making Effective Use of This Manual."

This chapter describes the contents of this guide. Using this chapter with the table of contents helps you to retrieve description of a subject you wish to understand as well as to obtain an overview of this guide. Also see the latter part of this chapter for brief description of usage of this guide, focusing on searching commands.

Chapter 2, "Overview of Remote Control."

This chapter provides an overview of the remote control system and the SCPI commands.

Chapter 3, "Making a Measurement."

This chapter describes how to trigger the instrument to start a new measurement cycle and how to detect the end of a measurement cycle.

Chapter 4, "Reading/Writing Measurement Data."

This chapter provides an overview of the Agilent E5052A's internal data transfer format and explains how to read and write measurement results (internal data array and marker position).

Chapter 5, "Saving and Recalling (File Management)."

This chapter explains how to save and recall instrument status and measurement results onto/from the files. The chapter also discusses file management in general.

Chapter 6, "Working with Automatic Test Systems."

This chapter describes useful features that are available when the Agilent E5052A is integrated with an automatic test system.

Chapter 7, "SCPI Command Reference."

This chapter describes the SCPI command reference for the Agilent E5052A. It describes the commands using their abbreviated format in alphabetical order. If you want to look up commands using their fully qualified format, refer to the index for the desired SCPI command. If you want to look up commands by their function, refer to SCPI command list by function.

Appendix A, “Manual Changes.”

This appendix contains the information required to adapt this manual to earlier versions or configurations of the Agilent E5052A than that indicated by the current printing date of this manual. The information in this manual applies directly to the E5052A model that has the serial number prefix listed on the title page of this manual.

Appendix B, “Status Reporting System.”

This appendix describes the status reporting system of the Agilent E5052A.

Appendix C, “Communication with External Instruments Using 24-bit I/O Port.”

This chapter provides necessary information for communicating with external instruments (for example, a handler in a production line) by using the 24-bit I/O port equipped with the Agilent E5052A.

Appendix D, “Error Messages.”

The Agilent E5052A provides error messages to indicate its operating status. This appendix describes the error messages of the E5052A, listed in alphabetical order.

How to Use This Manual

As described in “Contents of This Manual” on page 26 chapters 3 to 5 provide task-based descriptions of SCPI commands that are useful for programming and explain how you can use them. These chapters contain explanations and sample program listings that you can use to develop your custom programs. For more information on individual commands, see Chapter 7, “SCPI Command Reference,”.

Looking up SCPI commands

Chapter 7, “SCPI Command Reference,” contains a complete reference of SCPI commands. You can look up a particular COM object in any of the following ways:

Lookup by Abbreviated Command Name (see NOTE.)

The command reference is organized alphabetically according to the abbreviated name used as the title for each command’s description.

Lookup by Full Command Name (see NOTE.)

You can use the index at the end of the manual to find full command names along with the page numbers where they appear.

Lookup by Command Function

“List by function” on page 404 provides a command function list and indicates the page numbers where the commands appear in the command reference.

Lookup by Front panel key

“Softkey Functions” on page 435 provides a complete list of COM objects that correspond to the front panel key tree and indicates the page numbers where the commands appear in the command reference.

NOTE

Some SCPI commands supported by the E5052A have optional syntax elements. In the command reference conventions, these elements are enclosed between square brackets ([]) or printed in lowercase letters. See “Syntax” on page 96 for more information.

How to Code the Corresponding Commands

The description of each function may contain the corresponding SCPI commands. If SCPI command exists for each measuring mode, use **xx**. And **y** used to express the maximum trace number varies for each measuring mode, because the trace number is not the same for each mode.

Example: `CALC:xx[1-1]:TRAC[1-y]:DATA:FDAT`

The parameters for each measuring mode are as follows:

- **FP**: Frequency/Power measurement
- **PN**: Phase noise measurement

- **SP:** Spectrum monitor measurement
- **TR:** Transient measurement
- **USER:** User-defined window

NOTE

Some SCPI commands preclude the availability of certain measuring modes.

Making Effective Use of This Manual
How to Use This Manual

2

Overview of Remote Control

This chapter provides an overview of the remote control system and the SCPI commands.

Types of Remote Control Systems

Depending on the system controller and the interface, you can configure four types of remote control systems as shown in the table below.

System controller	Interface	Overview
External controller (external computer such as PC and workstation)	GPIB	System to control the E5052A and other devices connected via GPIB from the external controller. For more information, refer to “GPIB Remote Control System” on page 33.
	LAN	System to control the E5052A and other devices connected via LAN from the external controller. For more information, refer to “LAN Remote Control System” on page 35.
	USB	System to control the E5052A and other devices connected via USB from the external controller. For more information, refer to “USB Remote Control System” on page 44.
E5052A	—	System to control the E5052A itself using built-in E5052A VBA. For more information, refer to <i>VBA Programmers Guide</i> .
	USB/GPIB	System to control the E5052A itself and external devices connected via GPIB using built-in E5052A VBA. For more information, refer to <i>VBA Programmers Guide</i> .

GPIB Remote Control System

What is GPIB?

GPIB (General Purpose Interface Bus) is an interface standard for connecting computers and peripherals, and it supports the following international standards: IEEE 488.1, IEC-625, IEEE 488.2, and JIS-C1901. The GPIB interface allows you to control the Agilent E5052A from an external computer. The computer sends commands and instructions to the E5052A and receives data sent from the E5052A via GPIB.

System configuration

Use GPIB cables to connect the E5052A to the external controller (computer) and peripherals. Figure 2-1 shows an overview of the system configuration of the GPIB remote control system.

Figure 2-1 Configuration of GPIB remote control system

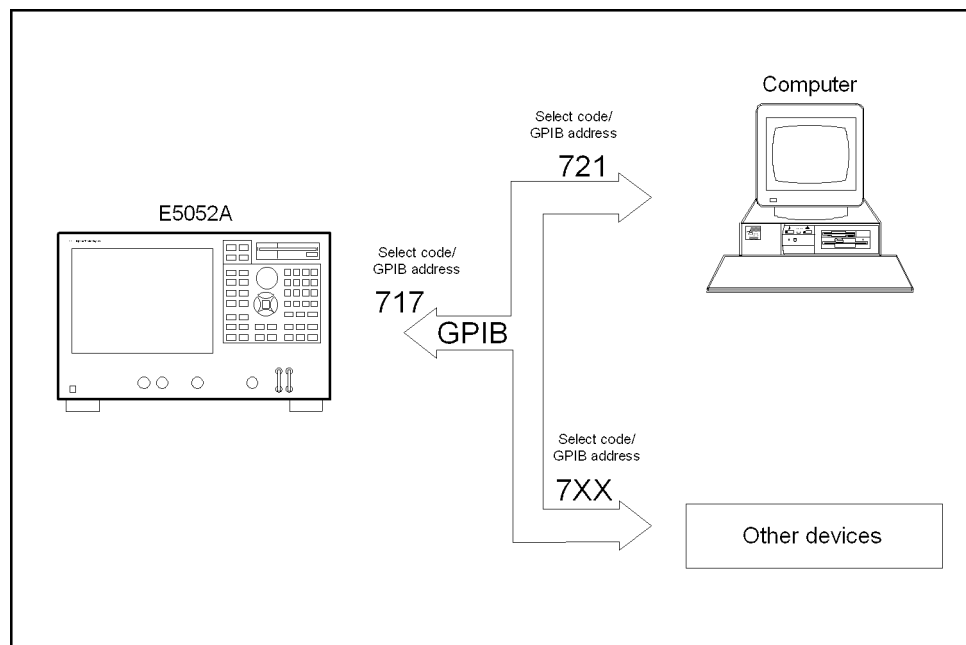

e5052ape013

NOTE

When the power of the E5052A is turned off, the SRQ signal of the built-in GPIB remains active. With the power turned off, disconnect the GPIB remote control system and the E5052A to prevent malfunction.

Overview of Remote Control GPIB Remote Control System

Required equipment

1. E5052A
2. External controller (computer)
Use a personal computer or workstation equipped with the GPIB interface. You need to install software in the external controller to control this instrument via GPIB (for example, HTBasic or Agilent VEE).
3. Other devices (other instruments and/or specific-purpose peripherals)
4. GPIB cables for connecting the E5052A, the external controller, and other devices

Size of system you can construct

- You can connect up to 15 devices in a single GPIB system.
- The length of cables connecting devices must be 4 m or less. The total length of connecting cables in a single GPIB system must be $2 \text{ m} \times$ the number of connected devices (including the controller) or shorter. You cannot construct a system with a total cable length exceeding 20 m.
- The number of connectors connected to an individual device must be 4 or fewer. If you connect 5 or more connectors, excessive force is applied to the connector part, which may result in failure.
- You can choose the device connection topology from star, linear, and combined. Loop connection is not supported.

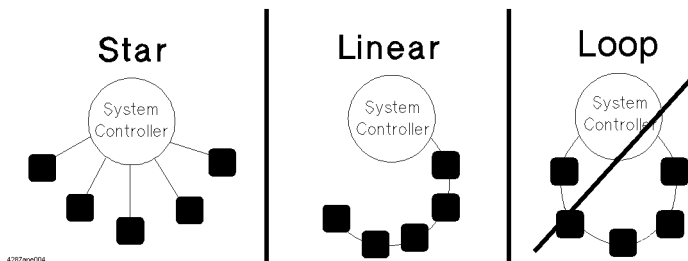

Device selector

The device selector is a unique value assigned to each device that is used by the controller to select the control target (to send/receive messages) among devices connected on the GPIB remote control system.

The device selector consists of a select code (usually 7) and a GPIB address. For example, when the select code is 7 and the GPIB address is 17, the device selector is 717. The select code must be set for each system. The GPIB address must be set to a unique value for each device, which is used to identify devices on the same system. In the descriptions and sample programs in this manual, it is assumed that the device selector is set to 717.

Setting the GPIB address of the E5052A

[System] - Misc Setup - GPIB Setup - Talker/Listener Address

LAN Remote Control System

The LAN (Local Area Network) remote control system provides two methods for controlling the E5052A: using the SICL-LAN server and using the telnet server.

System configuration

Use LAN cables to connect the E5052A and the external controller (computer). Figure 2-2 shows the configuration of the LAN remote control system.

Figure 2-2

Configuration of LAN remote control system

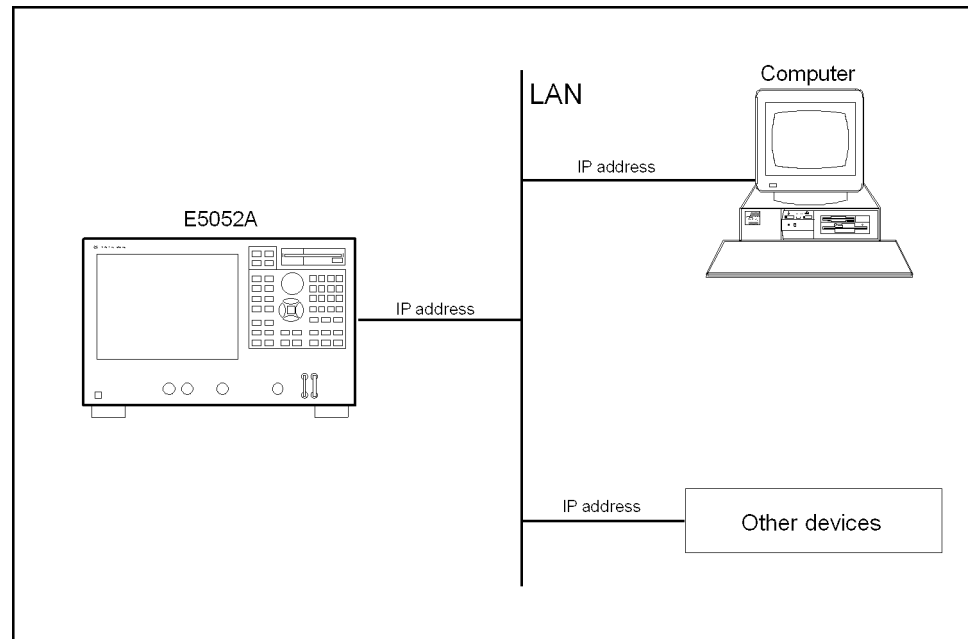

e5052ape015

Required equipment

1. E5052A
2. External controller (personal computer or workstation that can be connected to LAN, with Agilent I/O Library installed)
3. Other devices (other instruments and/or special-purpose peripherals)
4. LAN cable for connecting the E5052A with the external controller

Preparing the E5052A

Before controlling the E5052A via LAN, you need to configure the network function. For detailed information on the procedure, refer to *User's Guide*.

Control over SICL-LAN server

In the control system using the SICL-LAN server, communication between the external controller (client) and the E5052A (server) is performed using the SICL-LAN protocol. Communication is performed using SICL (Standard Instrument Control Library). You can control the E5052A by programming using SICL or VISA in C language in the UNIX environment, or Visual C++, Visual Basic, or VEE in the Windows environment.

Preparing the E5052A

To communicate with the external controller, follow these steps to turn on the SICL-LAN server of the E5052A in advance.

Step 1. Turn on the SICL-LAN server of the E5052A.

[System] - Misc Setup - Network Setup - SICL-LAN Server [ON]

Step 2. Set the GPIB address of the E5052A for control with the SICL-LAN server. “XX” indicates the address number.

[System] - Misc Setup - Network Setup - SICL-LAN Address [XX]

NOTE

You need to restart the E5052A firmware after changing the on/off setting or address setting of the SICL-LAN server.

Preparing the external controller

In order to establish communication to the E5052A using the TCP/IP protocol, you need to set the I/O interface of the external controller in advance. This section shows the setting procedure when using the external controller in the Windows environment.

NOTE

You must install the Agilent I/O Libraries in advance.

Use Agilent I/O Libraries M.01.01 or Agilent I/O Libraries Suite 14 or later.

For further information on the I/O Libraries, see the Agilent I/O Libraries Manual.

The Agilent I/O Libraries may not be available for certain external controllers or OS versions. For further details, refer to the Help guidance for the Agilent I/O Libraries.

Step 1. From your PC's Start menu, click Program - Agilent I/O Libraries Suite - Agilent Connection Expert to open the Agilent Connection Expert setting screen.

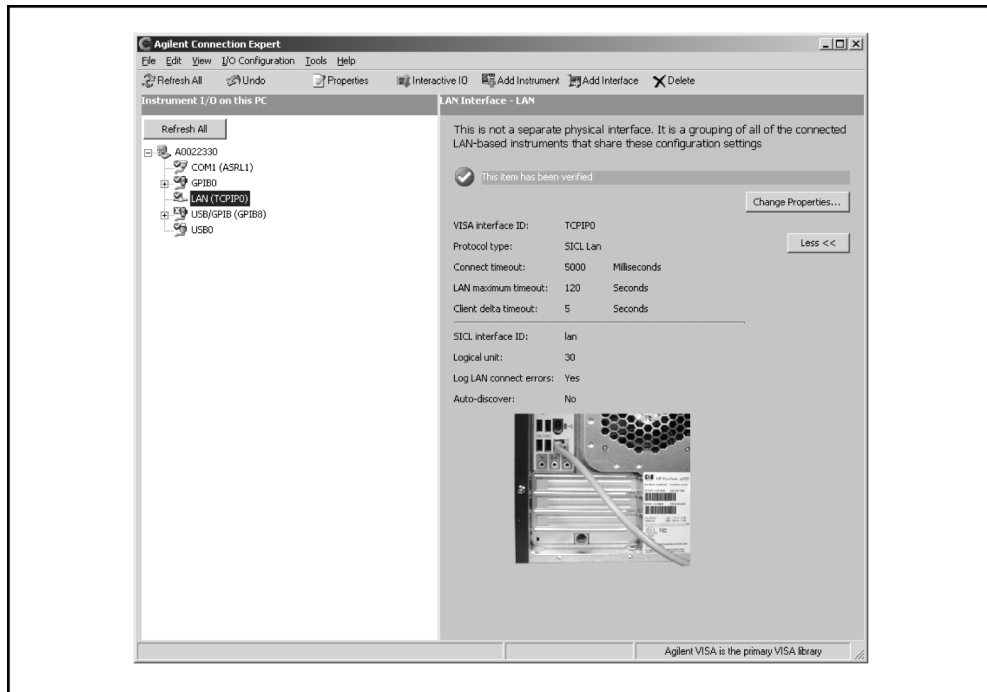

e5070bpj7002

Step 2. In the Agilent Connection Expert setting screen, select **LAN(TCPIP0) in the Instrument I/O on this PC** frame, and then select **I/O Configuration - Add Instrument** on the menu.

Step 3. In the Add Instrument screen, press **OK** as LAN has been selected.

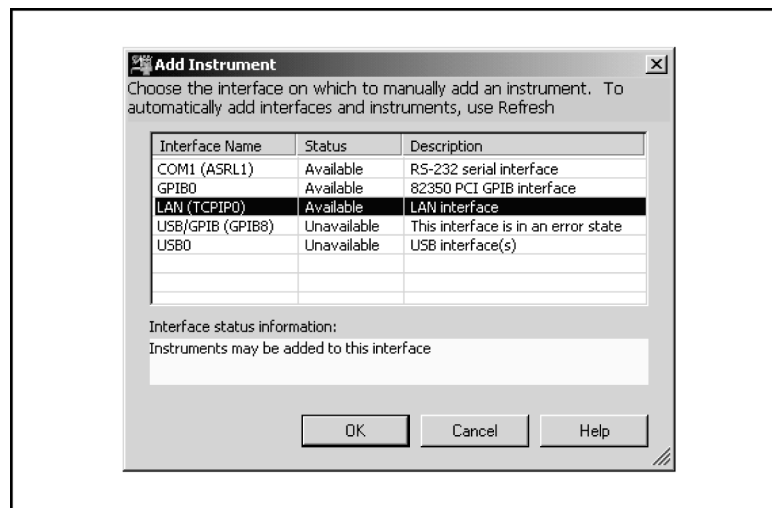

e5070bpj7003

Overview of Remote Control

LAN Remote Control System

Step 4. In the LAN Instrument Properties screen, set up the IP address of the E5052A and click **OK**. You can change settings as necessary. For details, refer to the Agilent I/O Libraries Suite manual.

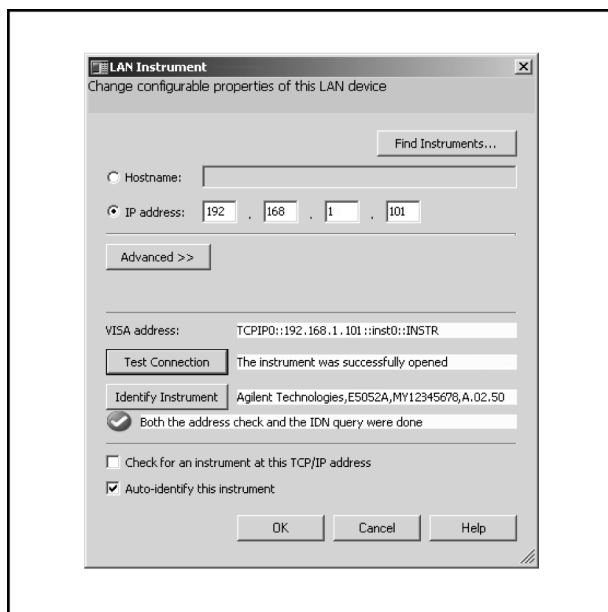

e5052apj5001

Step 5. In the Agilent Connection Expert screen, check that the E5052A has been added under **LAN(TCPIP0)** in the **Instrument I/O on this PC** frame.

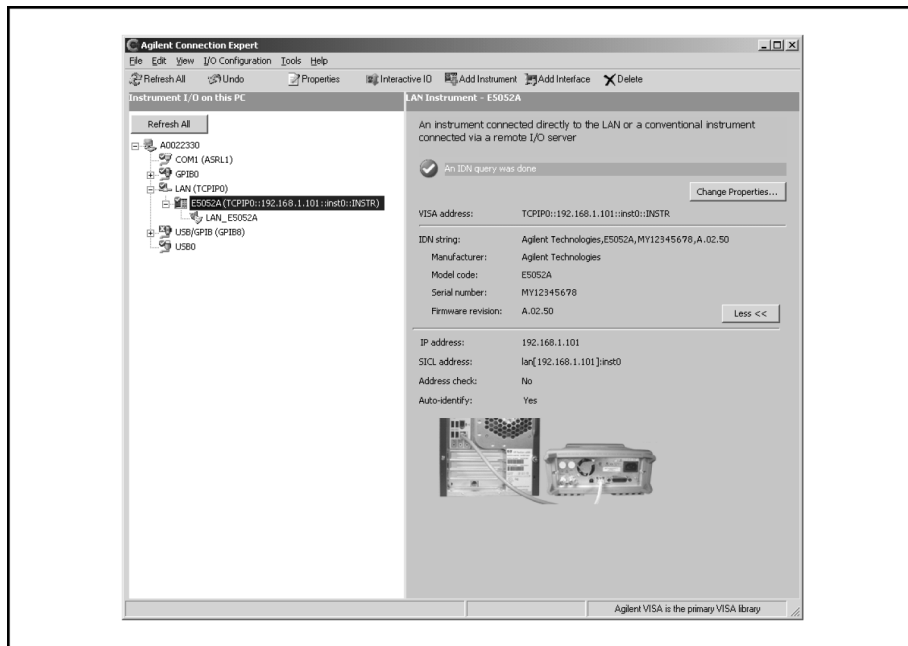

e5052apj5002

Control using C or Visual Basic

You can control the E5052A by programming using SICL with the C language in the UNIX environment, or Visual C++ or Visual Basic in the Windows environment.

Control using Agilent VEE

Agilent VEE allows you to control the E5052A via the I/O interface. The following example shows how to control the E5052A when it is set as follows: the address of the SICL-LAN server is 17 and the IP address is 1.10.100.50.

NOTE When using Agilent VEE for PC, use Agilent VEE Pro 6 for Windows or later.

- Step 1.** On the Agilent EVE's I/O menu, click **Instrument Manager...**
- Step 2.** In the Instrument Manager setting screen, click **Add...**

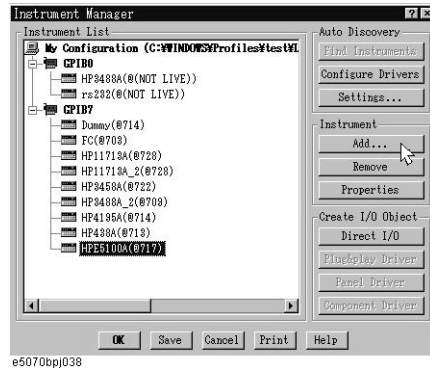

- Step 3.** The Instrument Properties setting screen appears. Make the settings as follows: Name (1 in the figure below): **SICL_LAN** (you can specify any name), Interface (2 in figure): **GP1B**, and Address (3 in figure): **917** (for the E5052A, fixed to 9; 17 is the address of the SICL-LAN server). Then, click Gateway: **This host**. The Select or Enter Gateway setting screen appears. Enter the IP address of the E5052A (4 in figure).

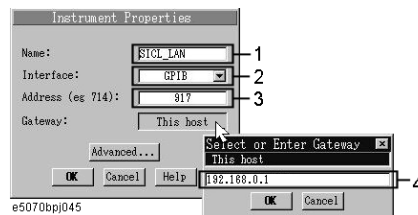

Figure 2-3 shows an example of control using the I/O interface set by the above procedure.

Control over telnet server

In the control system over a telnet server, communications are performed through a connection between the network sockets, which is a path established between the external controller and the E5052A.

A socket is an endpoint for a network connection; on the E5052A, ports 5024 and 5025 are provided for the sockets. Port 5024 is used for conversational control using telnet (user interface program for TELNET protocol) and port 5025 is used for control from a program.

Preparing the E5052A

To communicate with the external controller, follow these steps to turn on the telnet server of the E5052A in advance.

[System] - Misc Setup - Network Setup - Telnet Server [ON]

Overview of Remote Control

LAN Remote Control System

Conversational control using telnet (using port 5024)

You can use telnet to perform conversational control by sending SCPI commands to the E5052A on a message-by-message basis. For telnet, the socket of port 5024 is used for communications.

In this example, in order to show the control procedure using telnet, the E5052A (IP address: 192.168.0.1; host name: e5052a) is controlled from the external controller in the Windows environment.

- Step 1.** Open the MS-DOS command prompt screen.
- Step 2.** At the MS-DOS prompt, type telnet 192.168.0.1 5024 and press the return key.
- Step 3.** The telnet screen opens.
- Step 4.** Type a command and press the return key; this command is sent to the E5052A and executed. If you enter a command that queries some data, the query response is displayed below the line you have entered the command.

Figure 2-4 shows the screen after using the :SYSTem:PRESet command on page 394 to reset, using the :SENSe:PN[1-1]:FREQuency:STARt command on page 335 and the :SENSe:PN[1-1]:FREQuency:STOP command on page 336 to set the sweep start value and stop value of the phase noise measurement to 100 Hz and 100 kHz, respectively, and checking the settings.

Figure 2-4

Example of control using telnet

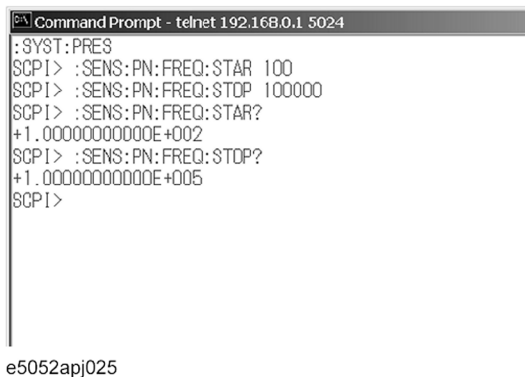

```
Command Prompt - telnet 192.168.0.1 5024
:SYST:PRESet
SCPI> :SENS:PN:FREQ:STAR 100
SCPI> :SENS:PN:FREQ:STOP 100000
SCPI> :SENS:PN:FREQ:STAR?
+1.00000000000E+002
SCPI> :SENS:PN:FREQ:STOP?
+1.00000000000E+005
SCPI>
```

e5052apj025

- Step 5.** Press] while holding down the control key on the telnet screen to display the telnet prompt. Then type “quit” and press the return key. The connection to the E5052A breaks and telnet finishes.

USB Remote Control System

The USB (Universal Serial Bus) remote control system provides device control via USB that is equivalent to control via GRIP. Connection is made through an interface in compliance with USBTMC-USB488 and USB 2.0.

System configuration

The USB remote control system controls instruments that use the name “alias.” There is no such address for GPIB connections.

Use a LAN cable to connect the E5052A to an external controller (personal computer). Figure 2-6 shows an overview of the system configuration for the USB remote control system.

Figure 2-6

USB Remote Control System Configuration

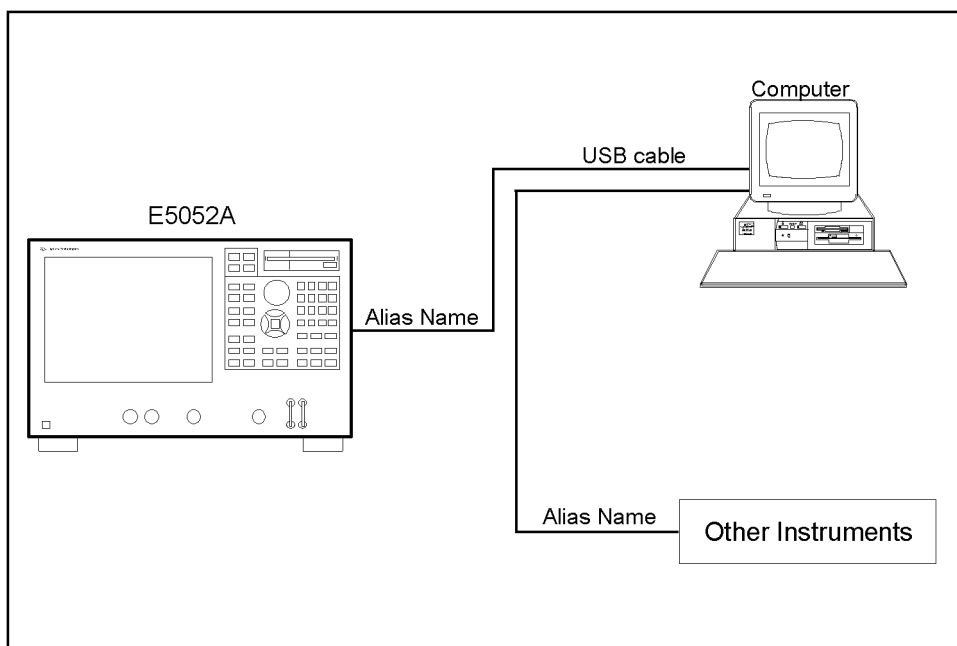

e5052ape4003



Required Equipment

1. E5052A (models with USB (USBTMC) interface port (type B)).
2. External controller (personal computer with installed Agilent I/O Libraries and USB host port (type A)).
3. Other USB compatible devices (instruments and/or peripherals for specific purposes).
4. USB cable connecting E5052A and external controller (with type A/4-prong male or type B/4-prong male connectors depending on device used).

USB Port Types

There are two standard types of USB ports. The external controller (PC) must be connected

via the USB host port (type A), while the E5052A and other USB compatible devices must be connected via the USB interface port (type B).

	Type A: USB host port
	Type B: USB (USBTMC) interface port

Preparing E5052A

You do not have to configure any softkey or command of the E5052A in order to control the E5052A from an external controller. Simply connect a USB cable to the USB interface port.

Preparing External Controller

In order to establish communication with the E5052A via USB, you must set up the I/O interface of the external controller in advance. The USB can identify devices automatically, so once you connect a USB cable to a target device, a dialog box will appear for USB device registration.

NOTE The E5052A will be identified as new device if its serial number has been changed.

NOTE You must install the Agilent I/O Libraries in advance. Use Agilent I/O Libraries M.01.01 or Agilent I/O Libraries Suite 14 or later.

For further information on the I/O Libraries, see the Agilent I/O Libraries Manual.

The Agilent I/O Libraries may not be available for certain external controllers or OS versions. For further details, refer to the Help guidance for the Agilent I/O Libraries.

1. Registering Alias When USB Cable Is Connected

When new device is connected via USB cable, the following dialog box will appear automatically. Follow the steps below to register alias, when you use the Agilent I/O Libraries Suite 14.

Step 1. In the Assign USB device alias dialog box, enter an alias and then click the **OK** button.

Figure 2-7

Registering Alias

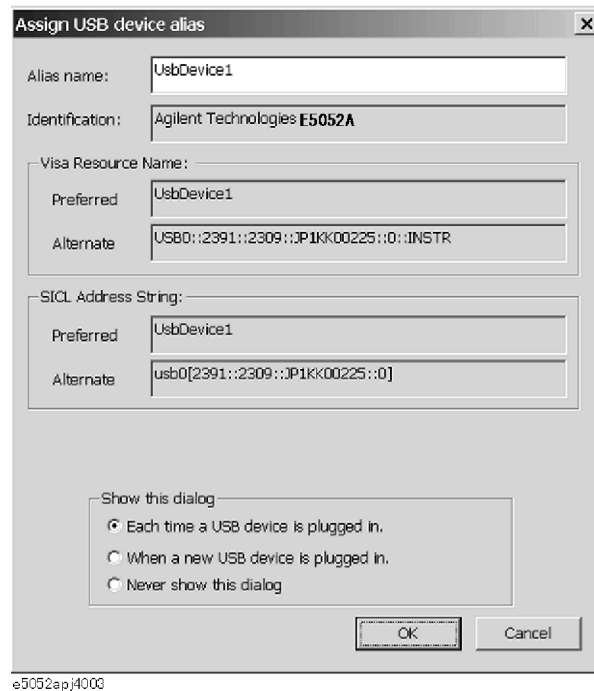

NOTE

For alias, use the ASCII format less than 127 digits. Alias is upper/lower case insensitive. If "Never show this dialog" is selected in the "Show this dialog" frame, the dialog box does not appear even if a new device is connected.

NOTE

Once new device is identified, the "New Hardware Search Wizard" will start. Follow the instruction to implement the processing.

2. Changing Alias on Setting Screen

The following are steps using the Agilent I/O Libraries Suite 14.

Step 1. Step 1: From the Start menu of your PC, click Program - Agilent IO Libraries Suite -Agilent Connection Expert to open the Config setting screen.

Step 2. In the Config setting screen, select the alias names from **USB0** onward in the **Instrument I/O on this PC** frame, and then use the **Change Properties** from **I/O Configuration** on the menu bar.

Figure 2-8

Changing Alias

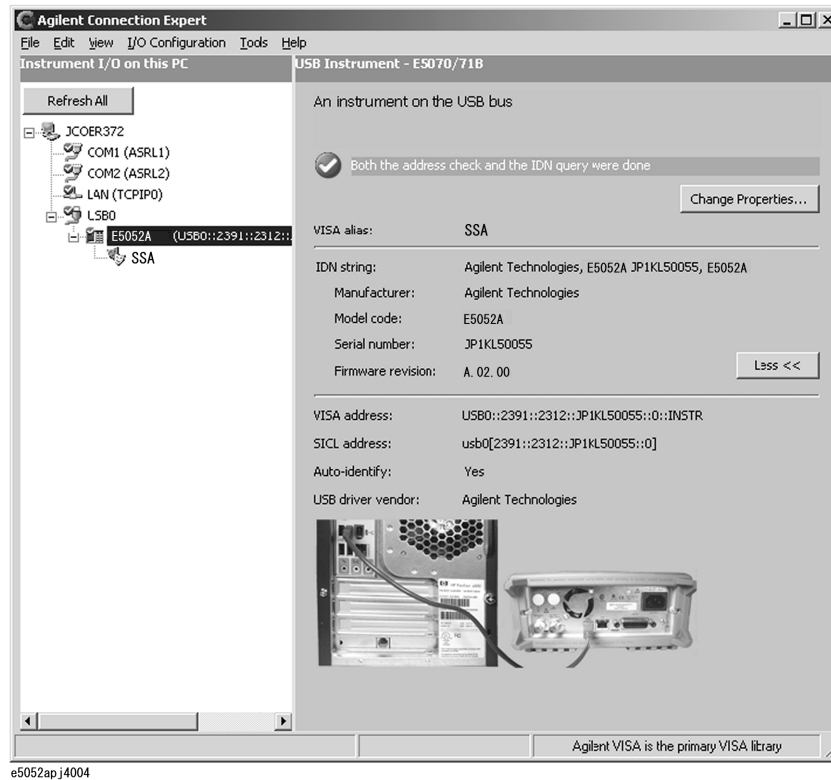

2. Overview of Remote Control

Control using C or Visual Basic

You can control the E5052A by programming using Visual C++ or Visual Basic in the Windows environment as well as SICL/VISA. For further information on controlling the E5052A, see the manual of SICL or VISA. For Agilent I/O Libraries, use Agilent I/O Libraries M.01.01 or Agilent I/O Libraries Suite 14.

You may use alias in the programming using SICL/VISA.

The following example shows an OPEN command to control the E5052A to which alias is given as SSA_USBIF.

SICL	id = iopen("SSA_USBIF")
VISA	viOpen(...,"SSA_USBIF",...)

NOTE

For further details of the programming using SICL/VISA, see the SICL Users Guide or the VISA Users Guide.

Control using Agilent VEE

Agilent VEE allows you to control the E5052A via the direct I/O interface. The following example shows how to control the E5052A to which alias is given as SSA_USBIF.

NOTE When using Agilent VEE for PC, use Agilent VEE Pro 7 for Windows or later version.

Step 1. On the Agilent VEE's **I/O** menu, click **Instrument Manager...**

Step 2. In the Instrument Manager setting screen, click **Add....**

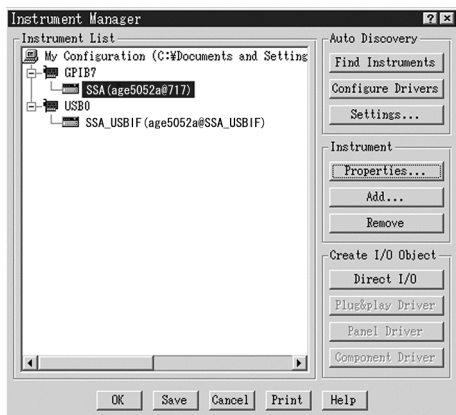

e5052ap j4005

Step 3. The Instrument Properties dialog box appears. Specify Name: **SSA_USBIF**(1 shown below, any other name acceptable), Interface: **USB**(2 shown below), Board Number: **0**(3 shown below, USB port number), and Alias: **SSA_USBIF**(4 shown below which is registered in the IO Config setting screen), then click **OK**.

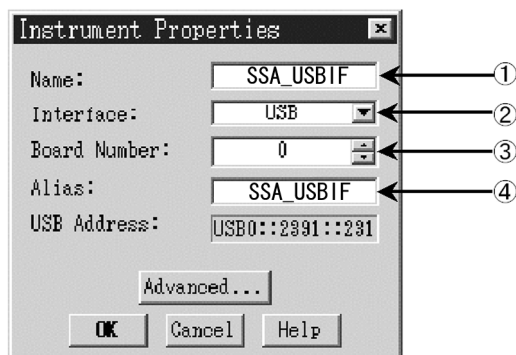

e5052ap j4006

Figure 2-9 shows an example of control using the direct I/O interface that has been set in the above procedures.

Figure 2-9 Sample Control Using Agilent VEE (USB)

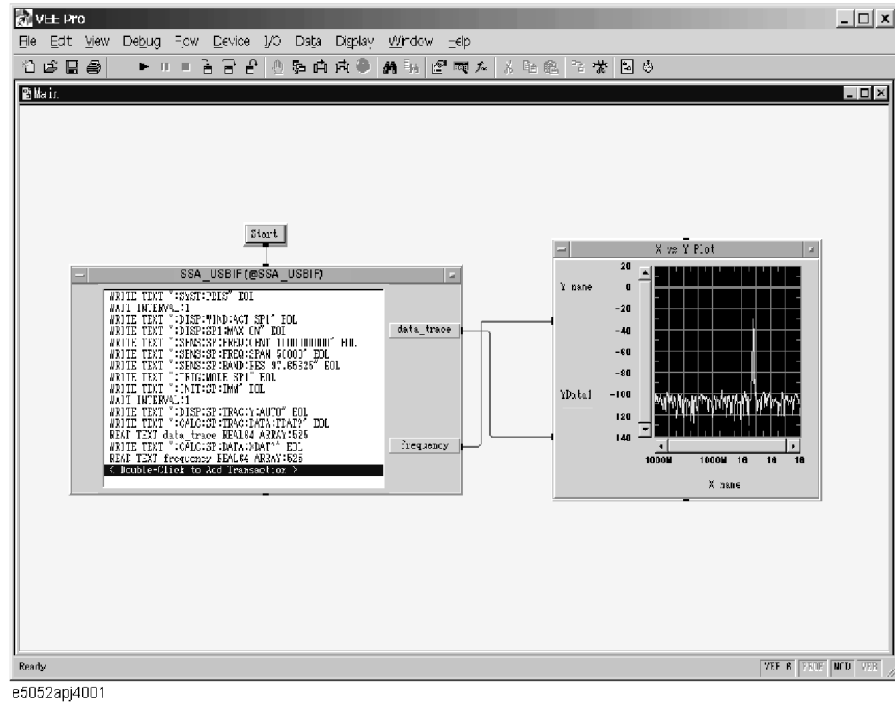

2. Overview of
Remote Control

Sending SCPI command messages

Types and structure of commands

The SCPI commands available for the E5052A are classified into two groups as follows.

E5052A commands

E5052A Commands specific to the E5052A. These cover all measurement functions of the E5052A as well as some general-purpose functions. The commands in this group are arranged in a hierarchical structure called the command tree. Each command consists of character strings (mnemonics) indicating the hierarchical levels and colon (:) separators between these levels.

IEEE common commands

Commands used to cover general-purpose functions defined in IEEE488.2 available to all instruments that support this standard. The commands in this group have an asterisk (*) at the beginning. These commands have no hierarchical structure.

Concepts of the command tree

The command at the top of the command tree is called “root command” or simply “root.” To access lower level commands in the tree, you need to specify a specific path, like a directory path in the DOS file system. After power-on or reset, the current path is set as the root. Special characters in messages change the path setting as described below.

- Message terminator A message terminator such as the
<new line> character sets the current path as the root.
- Colon (:) A colon between two command mnemonics lowers the level of the current path in the command tree. A colon used as the first character of a command specifies the command mnemonic that follows as the root-level command.
- Semicolon (;) A semicolon does not change the current path but separates two commands in the same message.

Figure 2-10 shows an example of how to use colons and semicolons to efficiently access commands in the command tree.

Figure 2-10

Using colons and semicolons in command tree

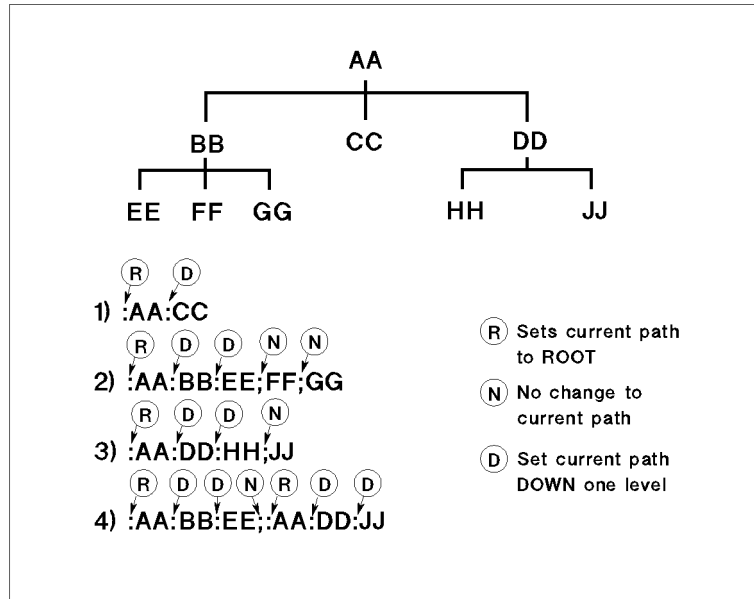

2: Overview of Remote Control

Grammar of messages

This section describes the grammar of program messages sent via GPIB. Program messages are messages that the user sends to the instrument from the external controller to control the instrument. A program message consists of one or more commands and their required parameters.

Upper/lower case sensitivity

Upper/lower case insensitive.

Program message terminator

A program message must be terminated with one of the three program message terminators: <new line>, <^END>, or <new line><^END>. <^END> indicates that EOI on the GPIB interface becomes active at the instant when the immediately previous data byte is sent. For example, the OUTPUT command of HTBasic automatically sends the message terminator after the last data byte.

Parameter

A space (ASCII code: 32) is required between a command and its first parameter. When sending several parameters in a single command, separate each parameter with a comma (,).

Message containing several commands

When sending two or more commands in a single message, separate each command with a semicolon (;). The following example shows how to send the ***CLS** command and the **:STATus:PRESet** command in a single message using HTBasic.

```
OUTPUT 717; "*CLS; :STAT:PRES"
```

Remote mode

The E5052A is not equipped for remote mode. Therefore, even if you send a GPIB command, it cannot enter into remote mode automatically. There is no local key to release remote mode.

If you need to prevent misoperation during remote control due to entry from the front panel or mouse, lock the input devices by using the following commands.

- :SYSTem:KLOCK:KBD on page 393
- :SYSTem:KLOCK:MOUSE on page 394

3 Making a Measurement

This chapter describes how to trigger the instrument to start a new measurement cycle and how to detect the end of a measurement cycle.

Trigger System

The trigger system is responsible for such tasks as detecting the start of a measurement cycle (triggering) and enabling/disabling measurement for each measurement. As shown in Figure 3-1, the trigger system has three states for each measurement: “Hold,” “Waiting for Trigger,” and “Measurement”. If any one of the measurements holds hardware and trigger port, other measurement will keep one of the states.

NOTE

The E5052A has a trigger model for each measurement (see Figure 3-1); however, only one triggered measurement can take place at a time. This is because the hardware and the trigger port are shared by four instruments. For example, even if the continuous initiation mode is enabled for all measurements and the trigger source is set to Internal, only one triggered measurement takes place.

Figure 3-1 Trigger system

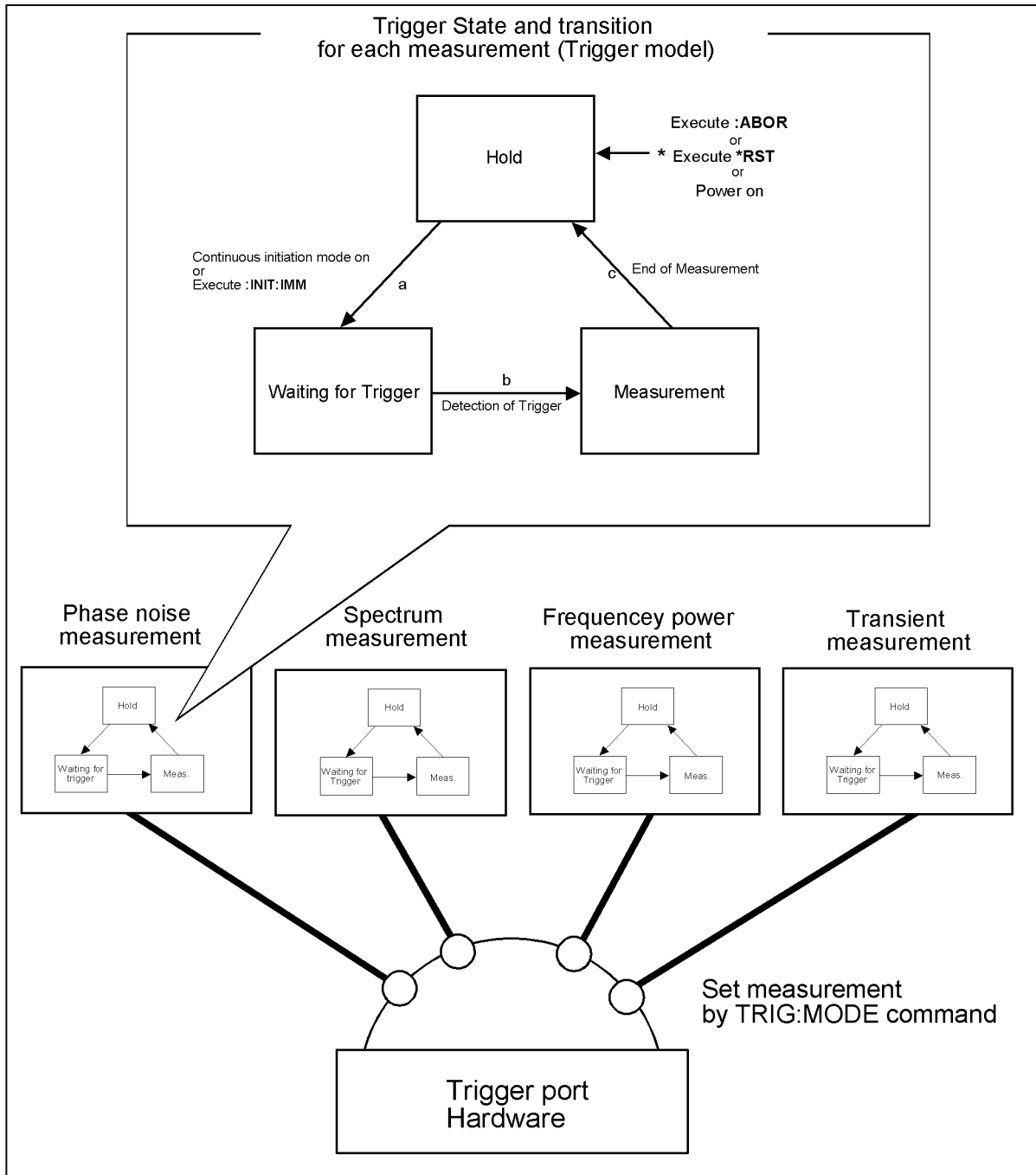

e5052ape014

3. Making a Measurement

Trigger state and transition for each measurement

The following subsections describe the states for each measurement and how the trigger system switches among the states.

“Hold” State

When one of the following commands has been executed, the trigger system switches to “Hold” state, interrupting the measurement which is underway (arrow “e” in “d” on Figure 3-1). When the power is turned on, the phase noise measurement is triggered, while the continuous initiation mode is set to ‘ON’ for the phase noise measurement and the trigger source is set to “Internal”.

- :ABORt on page 100
- *RST on page 298

During the “Hold” state, if either one of the following commands is executed or the measurement switches to the “Initiate” state by the front panel control, then the trigger system switches to the “Waiting for Trigger” state (arrow “f” in “a” in Figure 3-1). “xx” specifies the measurements (PN,SP,FP,TR) that are now waiting for trigger.

- :INITiate:xx:IMMediate
- :INITiate:xx:CONTInuous ON

“Waiting for Trigger” State

The instrument is triggered (i.e., a trigger is detected) during the “Waiting for Trigger” state, and then the trigger system switches to the “Measurement” state (arrow “B” in “b” in Figure 3-1).

As shown in the table below, how the instrument is triggered differs depending on which trigger source is specified.

Trigger Source	How instrument is triggered
Internal trigger	The instrument is automatically triggered itself.
External trigger	The instrument is triggered when a trigger signal is fed through the Ext Trig terminal.
Bus trigger	The instrument is triggered when the *TRG command on page 299 is issued.
Manual trigger	The instrument is triggered when you press [Trigger] - Trigger on the front panel. [Trigger] - Manual Trigger
Wide band trigger* ¹	In using the ‘wideband mode’ for the transient measurement, the instrument is triggered when the frequency of the measuring signal crosses the frequency value of the wideband trigger setting.
Narrow band trigger* ¹	In using the ‘narrowband mode’ for the transient measurement, the instrument is triggered when the frequency of the measuring signal crosses the frequency value of the narrowband trigger setting.

*1. This function is effective only for the transient measurement. This trigger source cannot be selected for other measurements. It is not displayed on the softkey either.

To set the trigger source, use the following command (“xx” specifies the measurements (PN,SP,FP,TR) that are now waiting for trigger):

- :TRIGger:xx:SOURce

“Measurement” State

In the “Measurement” state, the instrument starts the measurement that was in the “Initiate” state immediately before the transition to this state.

If the delay time of DC control voltage and DC power voltage are set (by :SOURce:VOLTage:CONTRol:DELay command on page 367, :SOURce:VOLTage:POWer:DELay command on page 370), the instrument waits for the elapse of the sweep delay time before starting a measurement.

When the instrument has finished measuring, the trigger system behaves in one of the following ways depending on the setting of the continuous initiation mode.

If continuous initiation mode is off:

The trigger system switches to the “Hold” state; “c” in Figure 3-1)

If continuous initiation mode is on:

The trigger system switches to the “Hold” state and then to the “Waiting for Trigger” state; “c” and “a” in Figure 3-1)

Starting a Measurement Cycle (triggering the instrument)

Configuring the Instrument to Automatically Perform Continuous Measurement

- Step 1.** Select a measurement to be triggered using the :TRIGger:MODE command on page 398.
- Step 2.** Set the trigger source of the triggered measurement to Internal using the :TRIGger:xx:SOURce command.
- Step 3.** Set the continuous initiation mode of the enabled triggered measurement using the :INITiate:xx:CONTInuous command.

Starting Measurement on Demand

- Step 1.** Select a measurement to be triggered using the :TRIGger:MODE command on page 398.
- Step 2.** Set the trigger source of the triggered measurement to Bus using the :TRIGger:xx:SOURce command.
- Step 3.** Set the continuous initiation mode of the enabled triggered measurement using the :INITiate:xx:CONTInuous command.
- Step 4.** Trigger the instrument when you want to perform measurement. An external controller can trigger the instrument by only a single command.

Command	Applicable trigger source
*TRG on page 299	Bus trigger only

- Step 5.** To start the next measurement cycle, repeat step 4.

Using the Averaging Trigger

You can make the E5052A repeat a cycle of waiting for a trigger and performing measurement for the number of times specified by the averaging factor with a single transition to the “Initiate” state. To switch between the averaging trigger mode and the normal trigger mode, use the following command.

- :TRIGger:AVERage on page 396

Averaging trigger mode	State transition for each setting
On	Turns on the averaging trigger mode. The instrument repeats a cycle of "waiting for a trigger" to "performing measurement," as many times as specified by the averaging factor, and then transitions to the “Hold” state.

Starting a Measurement Cycle (triggering the instrument)

Averaging trigger mode State transition for each setting

Off Turns off the averaging trigger mode.

When the instrument finishes a single cycle of “waiting for a trigger” to “performing measurement,” it transitions to “Hold” state.

The following table shows the operational difference between the trigger systems.

Continuous initiation mode	Averaging trigger mode	Operation of trigger system
Off (Single)	Off	The instrument waits for a trigger only once. When it receives a trigger, it performs measurement and then transitions to the “Hold” state. The averaging factor is not cleared; it is incremented.
	On	The instrument repeats a cycle of “waiting for a trigger” to “receiving a trigger” to “performing measurement,” as many times as specified by the averaging factor, and then transitions to the “Hold” state. The averaging factor is cleared before the start of measurement after receiving the first trigger.
On (Continuous)	Off	The instrument repeats a cycle of “waiting for a trigger” to “receiving a trigger” to “performing measurement.” The averaging factor is not cleared; it is incremented.
	On	The instrument repeats a cycle of “waiting for a trigger” to “receiving a trigger” to “performing measurement.” The averaging factor is cleared before the start of measurement after receiving the first trigger.

NOTE The setting made with this command is common to all of the measurement modes (PN, SP, FP, and TR). You cannot use a different setting for each measurement mode.

When the averaging mode (set with the :SENS:xx: AVER:STAT command) is off, the averaging trigger mode is not available.

3. Making a Measurement

Waiting for End of measurement

Using the Status Register

The status of the E5052A can be detected through the status registers. This section describes how to detect the end of measurement by using the status registers. For a complete description of the status report mechanism, including the specifications of each bit, see Appendix B, “Status Reporting System.”

Measurement status is reported by the operation status condition register (see Table on page 528). An SRQ (service request) is useful when you create a program that uses the information reported by this register to detect the end of measurement.

To detect the end of measurement via an SRQ, use one of the following commands:

- *SRE on page 298
- :STATus:OPERation:ENABLE on page 375
- :STATus:OPERation:PTRansition on page 376
- :STATus:OPERation:NTRansition on page 375

Follow these steps:

- Step 1.** Configure the E5052A so that it generates an SRQ when the operation status condition register's bit 4 (a bit that is set to 1 during measurement) is changed from 1 to 0.
- Step 2.** Trigger the instrument to start a measurement cycle.
- Step 3.** When an SRQ is generated, the program interrupts the measurement cycle.

Figure 3-2

SRQ generation sequence (at end of measurement)

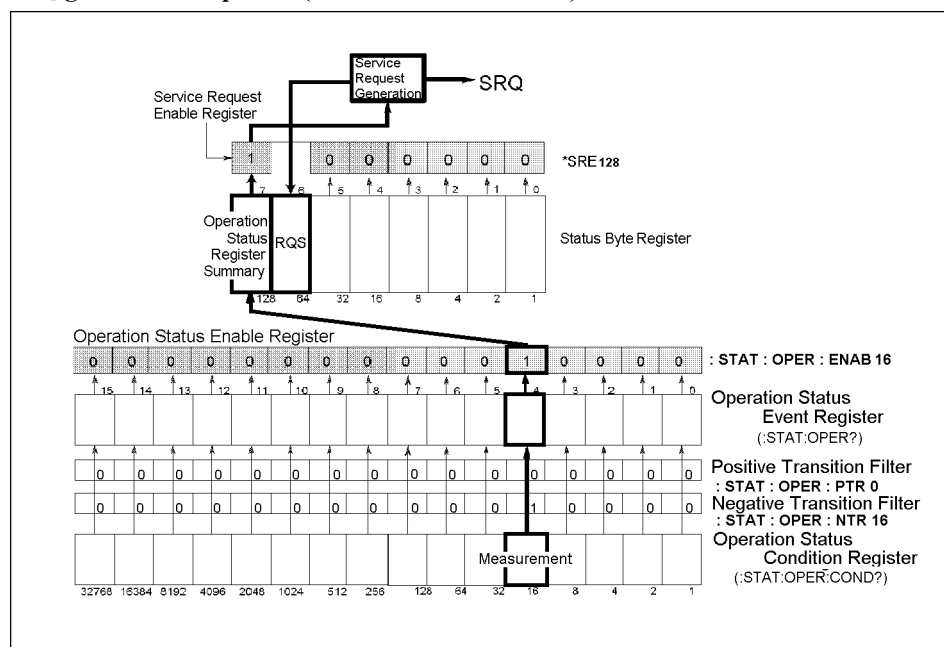

4287ape007

Sample program

Example 3-1 is a sample program that demonstrates how to use an SRQ to interrupt the end of measurement.

This program triggers the spectrum measurement of E5052A and then terminates the program when the end signal is received.

Example 3-1

Sample program showing how to interrupt the end of measurement

```

110 DIM Buff$(9)
120 INTEGER A
130 ASSIGN @Agte5052 TO 717
140 OUTPUT @Agte5052;":ABOR"
150 OUTPUT @Agte5052;":TRIG:MODE SP1"
160 OUTPUT @Agte5052;":TRIG:SP:SOUR BUS"
170 OUTPUT @Agte5052;":INIT:SP:CONT ON"
180 OUTPUT @Agte5052;":STAT:OPER:PTR 0"
190 OUTPUT @Agte5052;":STAT:OPER:NTR 16"
200 OUTPUT @Agte5052;":STAT:OPER:ENAB 16"
210 OUTPUT @Agte5052;"*SRE 128"
220 OUTPUT @Agte5052;"*CLS"
230 OUTPUT @Agte5052;"*OPC?"
240 ENTER @Agte5052;Buff$
250 ON INTR 7 GOTO Meas_end
260 ENABLE INTR 7;2
270 OUTPUT @Agte5052;"*TRG"
280 PRINT "Waiting..."
290 Meas_wait: WAIT .1
300 OUTPUT @Agte5052;"*STB?"
310 ENTER @Agte5052;A
320 PRINT "a=";A
330 GOTO Meas_wait
340 Meas_end: OFF INTR 7
350 PRINT "Measurement Complete"
360 END

```

Using the *OPC? command

You can detect end of measurement by executing the *OPC? command or the *WAI command in your program. This section describes how to detect the end of measurement using the *OPC? command.

To enable the *OPC?, *WAI, and *OPC commands, you need to turn on these commands with the :TRIGger:SOPC.

- :TRIGger:SOPC on page 399

NOTE

The setting made with this command is common to all of the measurement modes (PN, SP, FP, and TR). You cannot use a different setting for each measurement mode.

Making a Measurement

Waiting for End of measurement

The following commands work differently when the :TRIG:SOPC command is turned on.

Command	Operation when :TRIG:SOPC is on	Operation when :TRIG:SOPC is off
*OPC?	The processing of the program is suspended until the end of the measurement, and +1 is returned after the end of the measurement.	The control is returned to the program immediately without waiting for the end of the measurement.
*WAI	The processing of the program is suspended until the end of the measurement.	The control is returned to the program immediately without waiting for the end of the measurement.
*OPC	After the command is executed, the control is returned to the program without waiting for the end of the measurement. The Operation Completion bit of the Standard Event Status register is set after the end of measurement.	The control is returned to the program immediately without waiting for the end of the measurement. The Operation Completion bit of the Standard Event Status register is set without waiting for the end of measurement.

The processing of the program is suspended only during a transition period from “Waiting for Trigger” state to “Hold” state caused by the end of measurement or abortion of the measurement.

When the averaging trigger is on, the processing of the program is suspended until the “Hold” state occurs after all measurements for the averaging factor are completed.

NOTE

When the averaging trigger is on and the continuous initiation mode is on (Continuous), the processing of the program is suspended until the “Hold” state occurs after all measurements for the averaging factor are completed. However, in this case, once the measurements for the averaging factor are completed, the control is returned to the program each time a single measurement is completed for subsequent *OPC? and *WAI commands.

Using Wait Time

Before creating your program, actually measure the time between the start and end of the measurement cycle. Then code your program so that the controller waits for the actually measured time by using the appropriate command (for example, the WAIT command for HTBasic). This is a straightforward method, but care must be taken: an incorrect wait time could result in unexpected error.

4**Reading/Writing Measurement Data**

This chapter provides an overview of the Agilent E5052A's internal data transfer format and explains how to read and write measurement results (internal data array and marker position).

Data Types for Data Transfer

This section describes the data types that the E5052A uses for data transfer.

Array type

If you use any of the following commands, the data transfer will be executed using array-type data. Here, you can choose from among ASCII transfer format, IEEE 64-bit floating point binary transfer format, and IEEE 32-bit floating point binary transfer format.

For phase noise measurement

- :CALC:PN[1-1]:DATA:CARR
- :CALC:PN[1-1]:DATA:RDAT
- :CALC:PN[1-1]:DATA:XDAT?
- :CALC:PN[1-1]:TRAC[1-1]:DATA:FDAT
- :CALC:PN[1-1]:TRAC[1-1]:DATA:FMEM
- :CALC:PN[1-1]:TRAC[1-1]:DATA:PDAT
- :CALC:PN[1-1]:TRAC[1-1]:DATA:PMEM
- :CALC:PN[1-1]:TRAC[1-1]:DATA:SDAT
- :CALC:PN[1-1]:TRAC[1-1]:DATA:SMEM
- :CALC:PN[1-1]:TRAC[1-1]:DATA:UDAT
- :CALC:PN[1-1]:TRAC[1-1]:DATA:UMEM

For spectrum measurement

- :CALC:SP[1-1]:DATA:RDAT
- :CALC:SP[1-1]:DATA:XDAT?
- :CALC:SP[1-1]:TRAC[1-1]:DATA:FDAT
- :CALC:SP[1-1]:TRAC[1-1]:DATA:FMEM
- :CALC:SP[1-1]:TRAC[1-1]:DATA:UDAT
- :CALC:SP[1-1]:TRAC[1-1]:DATA:UMEM

For frequency/power measurement

- :CALC:FP[1-1]:DATA:RDAT
- :CALC:FP[1-1]:DATA:TDAT
- :CALC:FP[1-1]:DATA:XDAT?
- :CALC:FP[1-1]:TRAC[1-3]:DATA:FDAT
- :CALC:FP[1-1]:TRAC[1-3]:DATA:FMEM
- :CALC:FP[1-1]:TRAC[1-3]:DATA:UDAT
- :CALC:FP[1-1]:TRAC[1-3]:DATA:UMEM

For transient measurement

- :CALC:TR[1-1]:NARR:DATA:RDAT
- :CALC:TR[1-1]:NARR:DATA:XDAT?
- :CALC:TR[1-1]:TRAC[1-4]:DATA:FDAT
- :CALC:TR[1-1]:TRAC[1-4]:DATA:FMEM
- :CALC:TR[1-1]:TRAC[1-4]:DATA:UDAT
- :CALC:TR[1-1]:TRAC[1-4]:DATA:UMEM
- :CALC:TR[1-1]:WIDE:DATA:RDAT
- :CALC:TR[1-1]:WIDE:DATA:XDAT?

For sending and receiving data to/from VBA program

- :PROG:VAR:ARR[1-10]:DATA

Block type

If you use any of the following commands, the data transfer will be executed using block-type data. Here, you can choose either IEEE 64-bit floating point binary transfer format or IEEE 32-bit floating point binary transfer format.

- :MMEM:DATA

NOTE

The instrument always uses the ASCII transfer format when you transfer data without using array- or block-type commands.

Data Transfer Format

Set the data transfer format to transfer data of either array or block type. To set the data transfer format, use the following command:

- :FORMat:DATA on page 295

When you select the ASCII transfer format as the data transfer format, you can also specify the byte order. For more information, refer to “Binary Transfer Format” on page 68.

ASCII Transfer Format

When you select the ASCII transfer format as the data transfer format, numbers are transferred as ASCII bytes, each of which corresponds to one of the formats shown below. Note that numbers are separated from one another with a comma (,) in accordance with the IEEE 488.2 specification.

NOTE Numeric data strings vary in length. Keep this in mind when you extract data from retrieved numeric data strings in your program.

- Integer format
Figure 4-1 shows this format. Numbers are expressed as integers; for example, 201 is expressed as “+201” or “201.”

Figure 4-1 Integer format

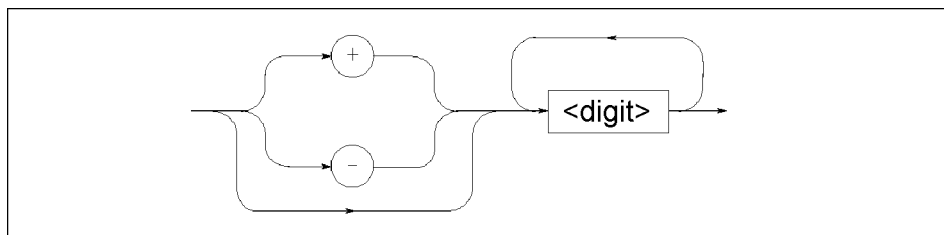

1b005013e

- Floating-point number format
Figure 4-2 shows this format. Numbers are expressed with floating points; for example, 1000 is expressed as “g+1.00000000000E+003”.

Figure 4-2 Floating-point number format

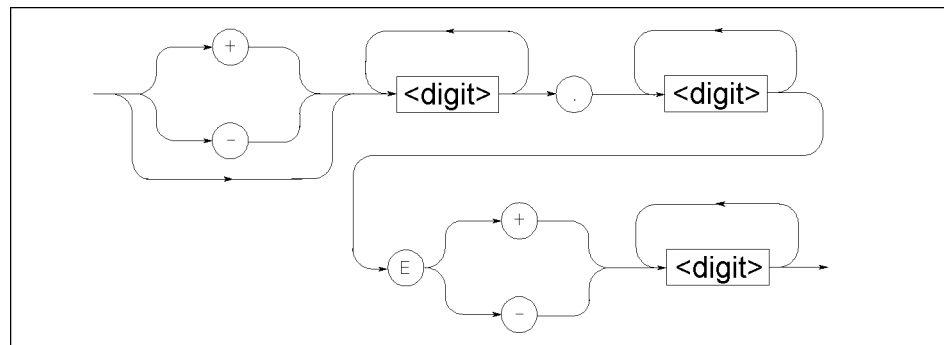

1b005015e

Binary Transfer Format

You can select the binary transfer format from the IEEE 64-bit floating point format or the IEEE 32-bit floating point format depending on the controller you use.

IEEE 64-bit floating point format

When you select the IEEE 64-bit floating point binary transfer format as the data transfer format, numbers are transferred in the format shown in Figure 4-3.

Figure 4-3

IEEE 64-bit floating point binary transfer format

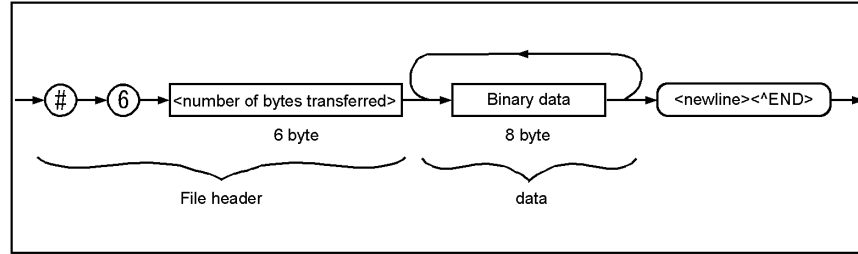

This data transfer format uses a header that consists of a sharp character (#), the number 6 (which indicates the byte size of the <number of bytes transferred> part), and the <number of bytes transferred> part in this order. The header is followed by the binary data (each number consists of 8 bytes, with the total being the byte size indicated by <number of bytes transferred>) and the message terminator <new line>^END.

The binary data is expressed in the IEEE 754 64-bit floating-point number format shown in Figure 4-4.

Figure 4-4

64-bit floating point data

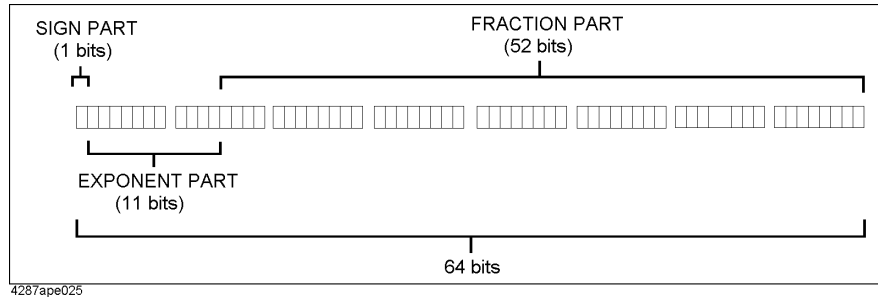

IEEE 32-bit floating point format

When you select the IEEE 32-bit floating point binary transfer format as the data transfer format, numbers are transferred in the format shown in Figure 4-5.

Figure 4-5 IEEE 32-bit floating point binary transfer format

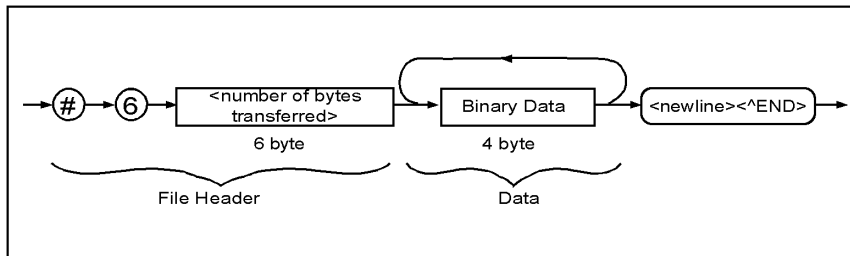

e5070bpe032

This data transfer format uses a header that consists of a sharp character (#), the number 6 (which indicates the byte size of the <number of bytes transferred> part), and the <number of bytes transferred> part in this order. The header is followed by the binary data (each number consists of 4 bytes, with the total being the byte size indicated by <number of bytes transferred>) and the message terminator <new line>^END.

The binary data is expressed in the IEEE 754 32-bit floating-point number format shown in Figure 4-6.

Figure 4-6 32-bit floating point data

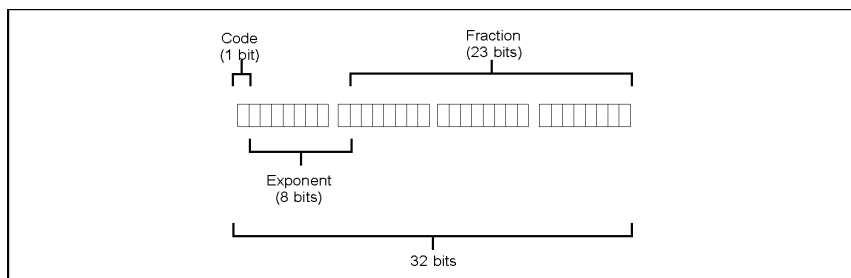

e5070bpe033

Byte order

When you choose to perform binary transfer, you can configure the instrument to transfer the bytes of the data in one of the following byte orders:

- NORMAL Transfer begins with the byte that contains the MSB (most significant bit); that is, the leftmost byte in Figure 4-4 and Figure 4-6.
- SWAPped Transfer begins with the byte that contains the LSB (least significant bit); that is, the rightmost byte in Figure 4-4 and Figure 4-6.

To set the byte order, use the following command:

- :FORMat:BORDER on page 295

Internal data processing

Data flow

Figure 4-7, Figure 4-9, Figure 4-10 and Figure 4-11 provide overviews of the E5052A's internal data processing flows. For more information on each data processing flow, refer to the "User's Guide."

Figure 4-7 Data processing flow for phase noise measurement with E5052A

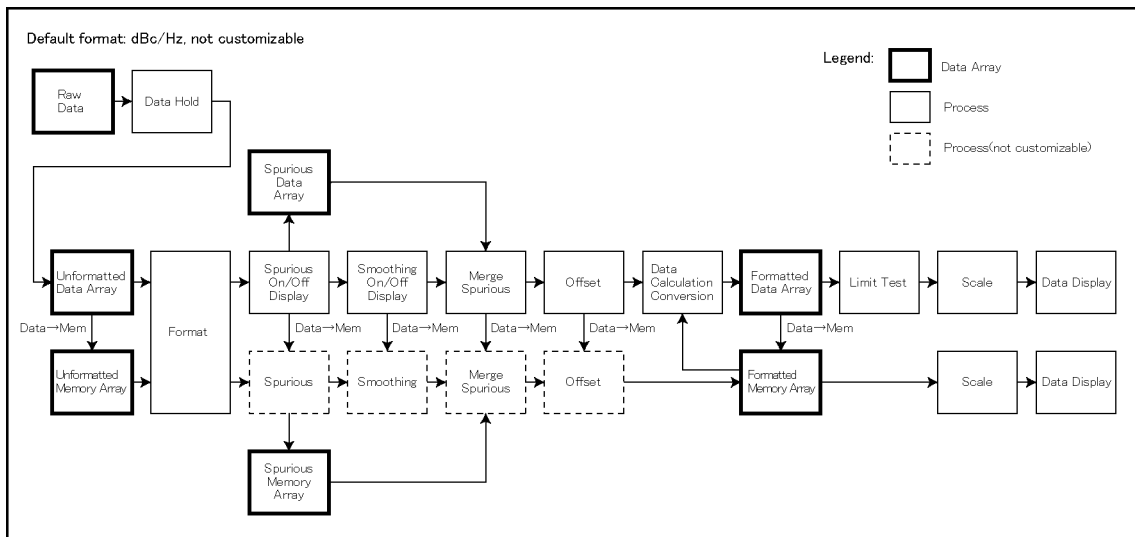

e5052ape5003

Figure 4-8 Data processing flow for spectrum measurement with E5052A

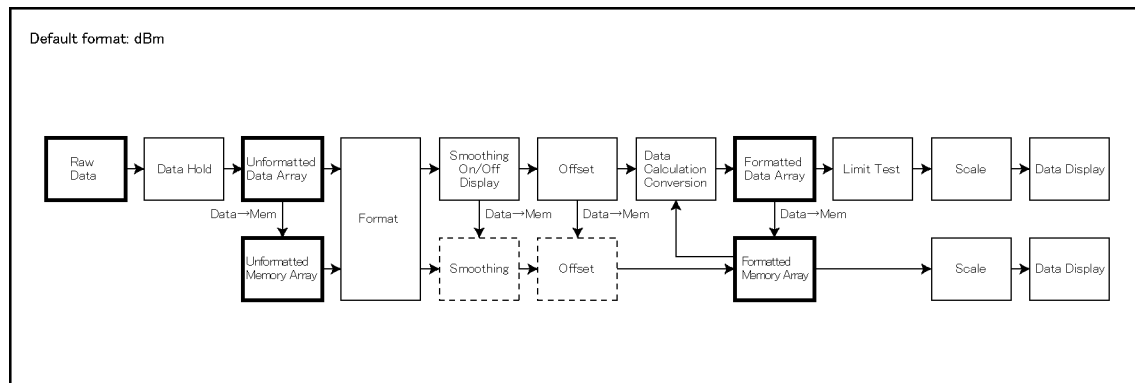

e5052ape5004

Figure 4-9 Data processing flow for frequency/power measurement with E5052A

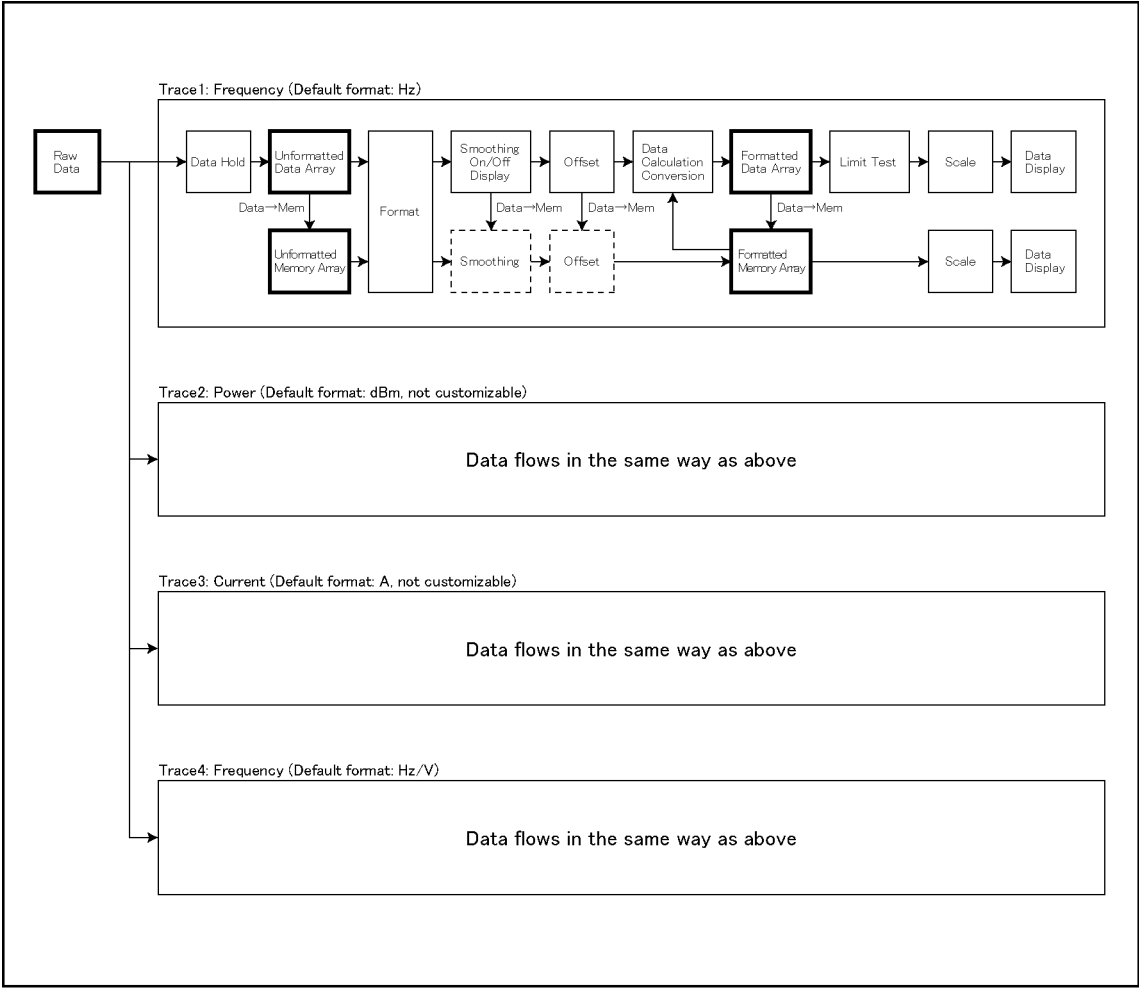

e5052ape5005

Figure 4-10

Data processing flow for transient measurement with E5052A

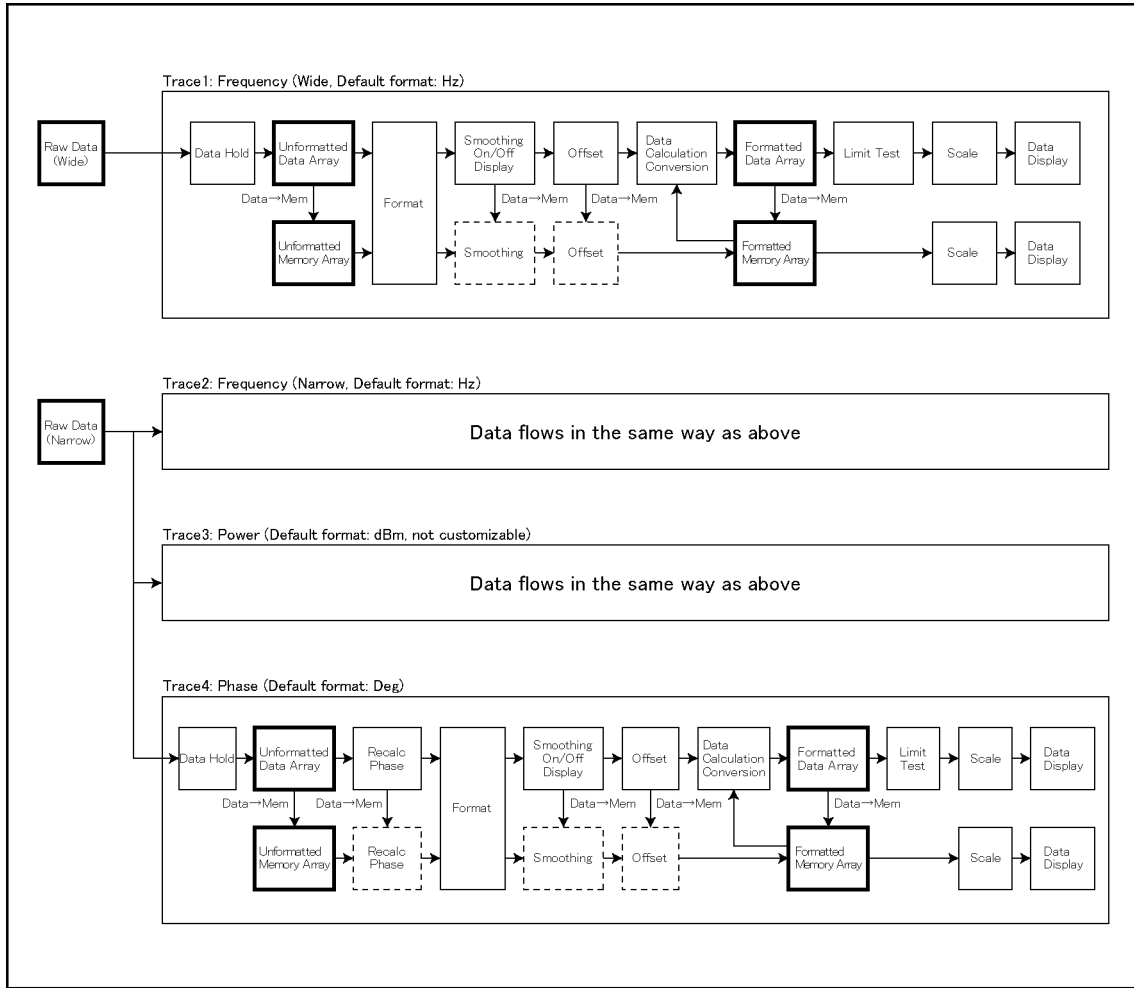

e5052ape5006

Figure 4-11 Data processing flow for user-defined function measurement with E5052A

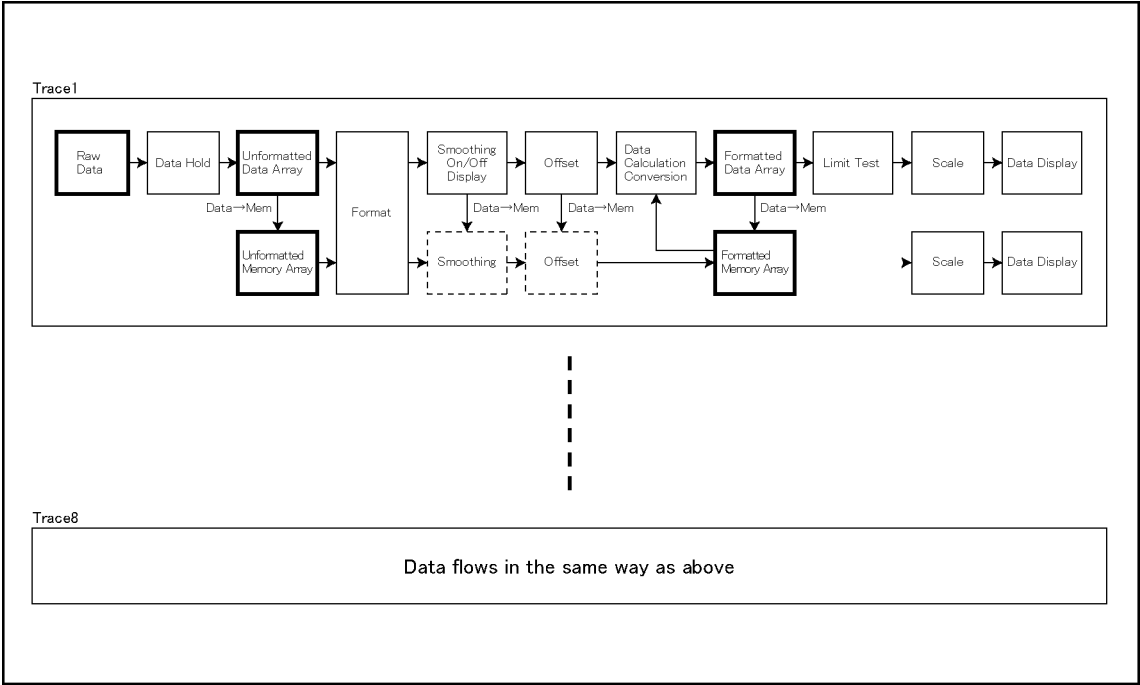

e5052ape5007

The enclosed part of the data processing flow represents the data array. By using SCPI commands, the data array can be read for processing and written for display on the E5052A's screen.

Internal data arrays

Unformatted data arrays

An unformatted array contains the raw data just as it was obtained through measurement and divided for each trace.

The instrument retains the unformatted data arrays which are associated with each trace of individual measurements. To read/write one of the unformatted data arrays, use the following command (“xx” specifies any one of the measurements (PN,SP,FP,TR,USER) while “y” specifies the number of the trace if the measurement has multiple traces.

- :CALC:xx[1-1]:TRAC[1-y]:DATA:UDAT

There is an unformatted data array formatted in dBc only when the phase noise measurement is performed.

- :CALCulate:PN[1-1]:TRACe[1-1]:DATA:PDATa on page 138

Unformatted memory arrays

When the :CALC:xx[1-1]:TRAC[1-y]:MATH:MEM command is executed on a particular unformatted memory array, a copy is stored in the corresponding unformatted data array.

The instrument retains the unformatted memory arrays associated with each trace of individual measurements. To read/write one of the unformatted memory arrays, use the following command:

- :CALC:xx[1-1]:TRAC[1-y]:DATA:UMEM

There is an unformatted memory array formatted in dBc only when the phase noise measurement is performed.

- :CALCulate:PN[1-1]:TRACe[1-1]:DATA:PMEMory on page 138

Formatted data array

A formatted data array contains the formatted data (values to be displayed) obtained by performing data math operations, measurement parameter conversion, and smoothing on a particular unformatted data array.

The instrument retains the formatted data arrays associated with each trace of individual measurements. To read/write one of the formatted data arrays, use the following command:

- :CALC:xx[1-1]:TRAC[1-y]:DATA:FDAT

Formatted memory arrays

A formatted memory array contains the formatted data (values to be displayed) obtained by performing data math operations, measurement parameter conversion, and smoothing on a particular unformatted memory array.

The instrument retains the formatted memory arrays associated with each trace of individual measurements. To read/write one of the formatted memory arrays, use the following command:

- :CALC:xx[1-1]:TRAC[1-y]:DATA:FMEM

X-axis Data Arrays

An x-axis data array contains the x-axis values for all measurement points.

The instrument retains the x-axis arrays associated with individual measurements (for the transient measurement, narrow/wide only). X-axis data arrays are read-only. To retrieve one of the x-axis data arrays, use the following command:

- `:CALC:xx[1-1]:DATA:XDAT`

For the transient measurement, you can use two types of command as follows.

- `:CALCulate:TR[1-1]:NARRow:DATA:XDATA` on page 183
- `:CALCulate:TR[1-1]:WIDE:DATA:XDATA` on page 208

Raw Data Arrays

A raw data array contains the measured values just as they were obtained, without any correction or format applied.

The instrument retains the raw data arrays associated with individual measurements (for the transient measurement, narrow/wide only). To read/write one of the raw data arrays, use the following command:

- `:CALC:xx[1-1]:DATA:RDAT`

For the transient measurement, you can use two types of command as follows:

- `:CALCulate:TR[1-1]:NARRow:DATA:RDATa` on page 183
- `:CALCulate:TR[1-1]:WIDE:DATA:RDATa` on page 208

There is a raw data array formatted in dBc only when the phase noise measurement is performed.

- `:CALCulate:PN[1-1]:DATA:PDATA` on page 130

Retrieving Measurement Results

Markers allow you to retrieve measurement results at your specified points only. “Internal data arrays” on page 74 allow you to retrieve all measurement results throughout a particular trace.

Retrieving measurement results at marker positions

In using markers to retrieve measurement results at specified points, you can use up to ten markers for each measurement graph, and you can move them to any point on the trace. You can also set any as a reference marker.

Showing/hiding markers

To show or hide each marker, use the following command (“xx” specifies any one of the measurements (PN,SP,FP,TR,) while “y” specifies the number of the trace if the measurement has multiple traces.

- :CALC:xx[1-1]:TRAC[1-y]:MARK[1-10]:STAT

Turning On or Off Reference Marker Mode

Turning on Reference Marker Mode sets the specified marker number as the reference marker and makes other markers relative with respect to it. To specify the reference marker and turn on or off Reference Marker mode, use the following command:

- :CALC:xx[1-1]:ALLT:MARK:REF:NUMB
- :CALC:xx[1-1]:ALLT:MARK:REF:STAT

Changing along the frequency axis and retrieval of marker positions

To change along the frequency axis or retrieve the reference marker position, use the following command:

- :CALC:xx[1-1]:TRAC[1-y]:MARK[1-10]:X

NOTE

When Reference Marker Mode is on, the x value at a regular marker is a relative value obtained by deducting its x value from the reference marker’s x value.

Retrieving measurement results at marker positions

To retrieve the measurement results (response values) at a particular marker or the reference marker, use the following command:

- :CALC:xx[1-1]:TRAC[1-y]:MARK[1-10]:Y?

Retrieving internal data arrays

You can chose between the ASCII and binary data transfer formats when you retrieve internal data arrays.

For more information, refer to “Data Types for Data Transfer” on page 64.

Example 4-1 and Example 4-2 show sample programs that demonstrate how to retrieve

formatted data arrays. The sample program in Example 4-1 uses the ASCII transfer format while the sample in Example 4-2 uses the binary transfer format.

These sample programs show how to retrieve the formatted data arrays of measured phase noise.

Example 4-1

Sample: Using ASCII Transfer Format to Retrieve Internal Data Arrays

```

110 REAL Fdata(1:1601), Freq(1:1601)
120 DIM Img$(30)
130 INTEGER Nop, I
140 ASSIGN @Agte5052 TO 717
150 OUTPUT @Agte5052;":SENS:PN:SWE:POIN?"
160 ENTER @Agte5052;Nop
170 PRINT "Number of Frequency points = ";Nop
180 REDIM Fdata(1:Nop), Freq(1:Nop)
190 OUTPUT @Agte5052;":FORM:DATA ASC"
200 OUTPUT @Agte5052;":CALC:PN1:TRAC1:DATA:FDAT?"
210 ENTER @Agte5052;Fdata(*)
220 OUTPUT @Agte5052;":CALC:PN1:DATA:XDAT?"
230 ENTER @Agte5052;Freq(*)
240 Img$="MD.4DE,2X,MD.6DE"
250 PRINT "Frequency      Data"
260 FOR I=1 TO Nop
270     PRINT USING Img$;Freq(I), Fdata(I)
280 NEXT I
290 END

```

Example 4-2

Sample: Using Binary Transfer Format to Retrieve Internal Data Arrays

```

110 REAL Fdata(1:1601), Freq(1:1601)
120 DIM Img$(30), Buff$(9)
130 INTEGER Nop, I
140 ASSIGN @Agte5052 TO 717
150 ASSIGN @Binary TO 717;FORMAT OFF
160 OUTPUT @Agte5052;":SENS:PN:SWE:POIN?"
170 ENTER @Agte5052;Nop
180 PRINT "Number of Frequency points = ";Nop
190 REDIM Fdata(1:Nop), Freq(1:Nop)
200 OUTPUT @Agte5052;":FORM:DATA REAL64"
210 OUTPUT @Agte5052;":CALC:PN1:TRAC1:DATA:FDAT?"
220 ENTER @Agte5052 USING "#,8A";Buff$
230 ENTER @Binary;Fdata(*)
240 ENTER @Agte5052 USING "#,1A";Buff$
250 OUTPUT @Agte5052;":CALC:PN1:DATA:XDAT?"
260 ENTER @Agte5052 USING "#,8A";Buff$
270 ENTER @Binary;Freq(*)
280 ENTER @Agte5052 USING "#,1A";Buff$
290 Img$="MD.4DE,2X,MD.6DE"
300 PRINT "Frequency      Data"
310 FOR I=1 TO Nop
320     PRINT USING Img$;Freq(I), Fdata(I)
330 NEXT I
340 END

```

Entering Data in a Trace

By using “Formatted data array” on page 74, you can change the data/memory trace on the LCD by writing the new data into the “Formatted memory arrays” on page 74.

When you write data into the formatted data/memory array, you can choose either the ASCII or binary transfer format (see “Data Types for Data Transfer” on page 64).

Example 4-3, Example 4-4, Example 4-3, and Example 4-4 show sample programs that demonstrate how to write data into formatted data arrays. The sample program in Example 4-3 uses the ASCII transfer format, while the sample in Example 4-4 uses the binary transfer format.

These sample programs write the trace data of phase noise measurements stored in a file on the formatted data arrays.

Example 4-3

Sample: Using ASCII Transfer Format to Write Formatted Data Arrays (write_a.htb)

```
110 REAL Fdata(1:1601), Freq(1:1601)
120 DIM Img$(30), File$(300)
130 INTEGER Nop, I
140 File$="a:pn_asc"
150 ASSIGN @Agte5052 TO 717
160 OUTPUT @Agte5052;":SENS:PN:SWE:POIN?"
170 ENTER @Agte5052;Nop
180 PRINT "Number of Frequency points = ";Nop
190 REDIM Fdata(1:Nop), Freq(1:Nop)
200 ASSIGN @File TO File$
210 Img$="MD.4DE,2X,MD.6DE"
220 FOR I=1 TO Nop
230     ENTER @File USING Img$;Freq(I), Fdata(I)
240 NEXT I
250 ASSIGN @File TO *
260 OUTPUT @Agte5052;":FORM:DATA ASC"
270 OUTPUT @Agte5052;":CALC:PN1:TRAC1:DATA:FDAT ";Fdata(*)
390 END
```

Example 4-4

Sample: Using Binary Transfer Format to Write Formatted Data Arrays (write_b.htb)

```
110 REAL Fdata(1:1601), Freq(1:1601)
120 DIM Img$(30), File$(300), Head$(10)
130 INTEGER Nop, I
140 File$="a:pn_asc"
150 ASSIGN @Agte5052 TO 717
160 ASSIGN @Binary TO 717;FORMAT OFF
170 OUTPUT @Agte5052;":SENS:PN:SWE:POIN?"
180 ENTER @Agte5052;Nop
190 PRINT "Number of Frequency points = ";Nop
200 REDIM Fdata(1:Nop), Freq(1:Nop)
210 ASSIGN @File TO File$
220 Img$="MD.4DE,2X,MD.6DE"
230 FOR I=1 TO Nop
240     ENTER @File USING Img$;Freq(I), Fdata(I)
250 NEXT I
```

```
260 ASSIGN @File TO *
270 OUTPUT @Agte5052;":FORM:DATA REAL64"
280 Head$="#6"&IVAL$(8*Nop,10)
290 OUTPUT @Agte5052;":CALC:PN1:TRAC1:DATA:FDAT ";Head$;
300 OUTPUT @Binary;Fdata(*),END
310 END
```

Reading/Writing Measurement Data
Entering Data in a Trace

5 Saving and Recalling (File Management)

This chapter explains how to save and recall instrument status and measurement results onto/from the files. The chapter also discusses file management in general.

Saving/Recalling

Specifying a file

When running a command for saving, recalling, or managing files, use a file name with extension to specify a particular file. Specify “A:” at the beginning of the file name when specifying a file on the floppy disk. Also, when specifying a file name with a directory, use “/” (slash) or “\” (backslash) as a delimiter.

Saving and recalling instrument status

You can save the instrument state by using one of the following methods:

- Saving the entire instrument state (setting and data) into a file
- Saving only the instrument setting into a file

Options for saving and recalling instrument status

When saving the instrument status into a file, you have two options for selecting the content to be saved: entire instrument state (setting and data) and instrument setting only.

To select the content to be saved, use the following command:

- :MMEMory:STORe:STYPe on page 311

To save the instrument setting (or instrument setting and data), use the following command:

- :MMEMory:STORe:STATe on page 311

Recalling a file saved with the above command reproduces the file’s status when it was last saved. To recall the settings from a file, use the following command:

- :MMEMory:LOAD:STATe on page 306

Auto recall

The file saved with the name F:\autorec.sta or A:\autorec.sta will be automatically recalled when the E5052A is powered on.

Saving measurement data

Measurement data (in a formatted data array) can be saved in the file in CSV (Comma Separated Value) format. To save measurement data in a file, use the following command (“xx” specifies any one of the measurements (PN, SP, FP, TR, USER) while “y” specifies the number of the trace):

- :MMEMory:xx[1-1]:TRACe[1-y]:STORe

Executing the above command will save the specified trace data of the specified measurement. Note that the data saved using the above command cannot be recalled from the E5052A.

Saving images on LCD screen

Images displayed on the LCD screen can be saved in a file in the bitmap (.bmp) or portable network graphics (.png) format. To save a screen image in a file, use the following command:

- :MMEMory:STORe:IMAGe on page 310

Executing the above command will save the screen image displayed when the command is invoked.

NOTE

Note that this gives a different result from the operation on the front panel used to save the screen image by pressing the **[Capture]** key.

Saving/loading (importing) the VBA program

Saving

Only a VBA project file can be saved using the command below.

To save the VBA project that is opened on the VBA editor in a file, use the following command:

- :MMEMory:STORe:PROGram on page 311

Loading (importing)

To load the VBA project in the VBA editor, or to import the module/form file, use the following command:

- :MMEMory:LOAD:CORRection:POWer on page 305

Executing the above command will load/import the file according to its extension as follows:

Extension	File type
vba	VBA Project
bas	Standard module
frm	User form
cls	Class Modules

Managing Files

Creating a directory (folder)

To create a directory (folder), use the following command:

- :MMEMory:MDIRectory on page 306

Deleting a file (directory)

To delete a file or directory, use the following command:

- :MMEMory:DELEte on page 303

Copying a file

To copy a file, use the following command:

- :MMEMory:COPIY on page 302

Transferring files

Files can be transferred from the external controller to the E5052A by reading data from a file on the controller and then writing them to a file on the E5052A, using the following command:

- :MMEMory:DATA on page 302

Also, file transfer from the E5052A to the external controller can be done by reading data from a file on the E5052A while using the commands as query and then writing them to the file on the controller.

Retrieving data from storage

To retrieve information from the E5052A's built-in storage (usage, properties of file located in a specified directory), use the following command:

- :MMEMory:CATalog on page 301

Sample program

Example 5-1 shows a sample program for transferring files between the external controller and the E5052A.

This program reads out data from a specified file on the E5052A and then writes them to a specified file on the external controller.

Example 5-1

Sample of file transfer

```

1000 DIM Src_file$(50),Dst_file$(50)
1010 DIM Buff$(9),Img$(32),Src_size_char$(10)
1020 INTEGER Max_bsize,Block_size
1030 REAL Src_size
1040 ASSIGN @Agte5052 TO 717
1050 Src_file$="f:\state01.sta"
1060 Dst_file$="a:state01.sta"
1070 CREATE Dst_file$,1
1080 ASSIGN @Dst_file TO Dst_file$
1090 Max_bsize=24576
1100 PRINT "Now Copying: "&Src_file$&" (@E5052) ->
"&Dst_file$&" (@Controller)"
1110 OUTPUT @Agte5052;" :MMEM:DATA? """"&Src_file$&""""
1120 WAIT .5
1130 ENTER @Agte5052 USING "#,A";Buff$
1140 ENTER @Agte5052 USING "#,A";Digit$
1150 Img$="#, "&Digit$&"A"
1160 ENTER @Agte5052 USING Img$;Src_size_char$
1170 Src_size=VAL(Src_size_char$)
1180 WHILE Src_size>0
1190     IF Src_size>Max_bsize THEN
1200         Block_size=Max_bsize
1210     ELSE
1220         Block_size=Src_size
1230     END IF
1240     ALLOCATE Dat$(Block_size)
1250     Img$="#, "&VAL$(Block_size)&"A"
1260     ENTER @Agte5052 USING Img$;Dat$
1270     OUTPUT @Dst_file USING Img$;Dat$
1280     DEALLOCATE Dat$
1290     Src_size=Src_size-Block_size
1300 END WHILE
1310 PRINT "Done"
1320 ENTER @Agte5052 USING "#,A";Buff$
1330 ASSIGN @Dst_file TO *
1340 END

```

Saving and Recalling (File Management)
Managing Files

6 Working with Automatic Test Systems

This chapter describes useful features that are available when the Agilent E5052A is integrated with an automatic test system.

Preventing Erroneous Key Operation on the Front Panel (Key Lock feature)

When no operation is required from the front panel controls, the mouse, or the keyboard, disabling these input devices can prevent erroneous operation that might occur due to accidental touching.

To turn on and off Key Locking, use the following commands:

Locking the front panel controls and the keyboard.	:SYSTem:KLOCK:KBD on page 393
Locking the mouse and the touch screen.	:SYSTem:KLOCK:MOUSE on page 394

Improving Command Processing Speed

SCPI commands should be processed quickly to improve throughput when the commands are frequently executed (for example, reading out the trace for each measurement).

With the E5052A, the processing time for SCPI commands can be improved by decreasing the refresh rate of the LCD display.

When measurement results (trace) do need not updating

When the measurement trace does not need to be updated, turn off the update function of the LCD display. This improves the processing speed of SCPI commands and eliminates the updating time needed by the screen.

To turn off the update function of the LCD display, use the following command:

- :DISPlay:ENABle on page 243

When measurement results (trace) need updating

The measurement trace can be updated by using following command with the update of the LCD display turned off.

- :DISPlay:UPDate:IMMEDIATE on page 282

NOTE

The update of the LCD display is off even if you execute this command.

Step 1. Turn Off the update of the LCD display.

- :DISPlay:ENABle on page 243

Step 2. Execute all SCPI commands required before measurement, including settings of measurement conditions.

Step 3. Perform the measurement.

Step 4. Execute the commands for reading out or analyzing the measurement result. Note that reading out the result in binary format accelerates data transfer.

Step 5. Execute the following command to update the LCD display once.

- :DISPlay:UPDate:IMMEDIATE on page 282

NOTE

When the update of the LCD display is off, “Update Off” is displayed in the instrument status bar.

Detecting Occurrence of an Error

Using the status reporting system

The status of the E5052A can be monitored through the status registers. This section describes how to detect an error using the status registers. For a complete description of the status report mechanism, including the specifications of each bit, see Appendix B, “Status Reporting System”.

The occurrence of an error will be shown in the standard event status register. An SRQ (service request) is useful when you create a program that uses the information reported by this register to detect the occurrence of errors.

To detect the an error via an SRQ, use one of the following commands:

- *SRE on page 298
- *ESE on page 297

Follow these steps:

- Step 1.** Set the E5052A so that it generates an SRQ when any of the error occurrence bits is set to 1 in the standard event status register.
- Step 2.** When an SRQ is generated, the program interrupts the measurement cycle.

Figure 6-1

SRQ Generation Sequence (when an error occurs)

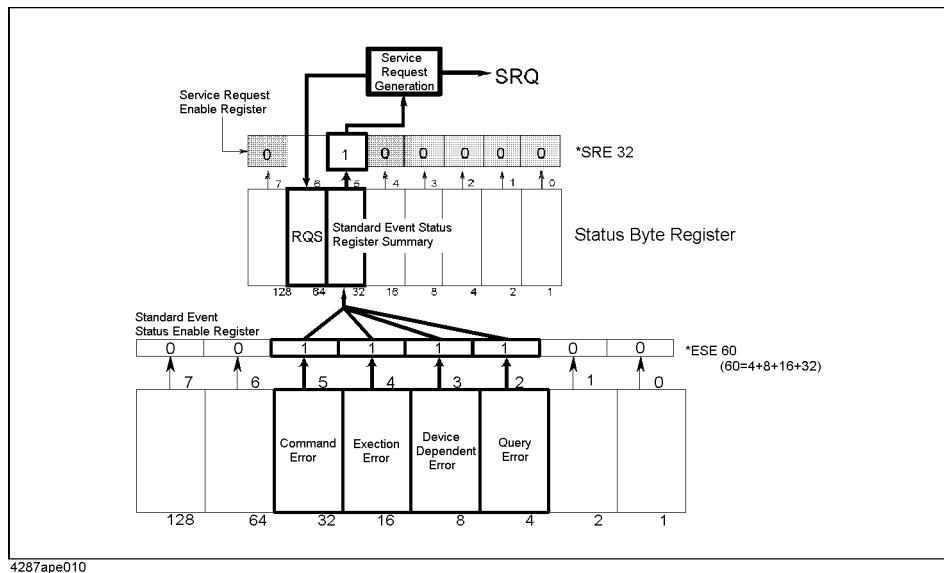

Using the error queue

An error queue holds the number for the error and the error message. Reading the error queue allows the user to verify the error that has occurred. To retrieve the content of the error queue, use the following command:

- :SYSTem:ERRor[:NEXT] on page 393

The error queue can be used in the following ways:

1. It is used as a branch for error handling. When an error queue is retrieved, it returns 0 as the error number and “No error” as the error message if no error is detected. This can be used for detecting an error and for branching the flow of a program. This is also useful for handling a specific error(s). Note that using this method prevents the user from performing any processing during the occurrence of an error.
2. When an error is detected using SRQ, the error queue is used to examine the error.

Example 6-1 is a sample program that demonstrates how to use an SRQ to detect the occurrence of an error.

This program sets the SRQs and then intentionally sets a wrong trigger to generate an error, which is handled by the program. In the error handling part, this program examines the error and then displays the error number and error message.

Example 6-1

Example of error detection using an SRQ

```
110 DIM Buff$(9),Err_msg$(100)
120 INTEGER Err_no
130 !
140 ASSIGN @Agte5052 TO 717
150 !
160 OUTPUT @Agte5052;"*ESE 60"
170 OUTPUT @Agte5052;"*SRE 32"
180 OUTPUT @Agte5052;"*CLS"
190 OUTPUT @Agte5052;"*OPC?"
200 ENTER @Agte5052;Buff$
210 !
220 ON INTR 7 GOTO Err_proc
230 ENABLE INTR 7;2
240 OUTPUT @Agte5052;":TRIG:MODE PN1"
250 OUTPUT @Agte5052;":TRIG:SP:SOUR BUS"
260 OUTPUT @Agte5052;":INIT:SP:CONT ON"
280 OUTPUT @Agte5052;"*TRG"
290 PRINT "Waiting..."
300 GOTO Skip_err
310 Err_proc: OFF INTR 7
320 OUTPUT @Agte5052;":SYST:ERR?"
330 ENTER @Agte5052;Err_no,Err_msg$
340 PRINT "Error occurred."
350 PRINT "No: ";Err_no,"Description: "&Err_msg$
360 PRINT "Program Interrupt."
370 GOTO Prog_end
380 Skip_err: PRINT "Program Done"
390 Prog_end: END
```

Limit Test

This section describes how to define the limit lines and determine pass or fail with regard to the limit test function. For more on the concept of the limit test, refer to the Chapter describing “Data Analysis and Result Output” in the User’s Guide.

Using Commands to define Limit Lines

You can define the limit lines by specifying any limit value to the parameter of SCPI commands.

The program is described in detail below:

Line 120	Define the data array (variable) for the limit lines.
Line 170 to 240	When bit 4 of the operation status condition register changes from “1” to “0” (negative transition), bit 4 of the operation status event register is set to “1”.
Line 260 to 280	Set the upper and lower limit values for the limit lines in the array.
Line 310 to 320	Specify the segment number for the upper and lower limit values.
Line 330 to 340	Specify the upper and lower limit values on the trace.
Line 360 to 400	Trigger the instrument.
Line 420 to 450	It repeats to the measurement end.
Line 460	Display the limit lines.
Line 470	Display the determination result. (For fail only.)
Line 480	Activate the limit test function.

Example 6-2

Using Commands to define Limit Lines

```
110 DIM Buff$(9)
120 REAL Udata(1:8),Ldata(1:4)
130 INTEGER St
140 !
150 ASSIGN @Agte5052 TO 717
160 !
170 OUTPUT @Agte5052;"*ESE 60"
180 OUTPUT @Agte5052;"*SRE 32"
190 OUTPUT @Agte5052;" :STAT:OPER:PRT 0"
200 OUTPUT @Agte5052;" :STAT:OPER:NTR 16"
210 OUTPUT @Agte5052;" :STAT:OPER:ENAB 16"
220 OUTPUT @Agte5052;"*CLS"
230 OUTPUT @Agte5052;"*OPC?"
240 ENTER @Agte5052;Buff$
250 !
260 READ Udata(*), Ldata(*)
270 DATA 0,1.4E+9,2.E-5,1.4E+9,2.E-5,1.6E+9,1.E-4,1.6E+9
280 DATA 0,1.2E+9,1.E-4,1.2E+9
290 !
300 OUTPUT @Agte5052;" :DISP:WIND:ACT FP1"
310 OUTPUT @Agte5052;" :CALC:FP:TRAC:LIM:UPP:SEGM:COUN 2"
320 OUTPUT @Agte5052;" :CALC:FP:TRAC:LIM:LOW:SEGM:COUN 1"
```

```

330 OUTPUT @Agte5052;":CALC:FP:TRAC:LIM:UPP:SEGM:DATA ";Udata (*)
340 OUTPUT @Agte5052;":CALC:FP:TRAC:LIM:LOW:SEGM:DATA ";Ldata (*)
350 !
360 OUTPUT @Agte5052;":TRIG:MODE FP1"
370 OUTPUT @Agte5052;":TRIG:FP:SOUR BUS"
380 OUTPUT @Agte5052;":INIT:FP:CONT OFF"
390 OUTPUT @Agte5052;":INIT:FP:IMM"
400 OUTPUT @Agte5052;"*TRG"
410 !
420 REPEAT
430     OUTPUT @Agte5052;":STAT:OPER:COND?"
440     ENTER @Agte5052;St
450 UNTIL BIT(St,4)=0
460 OUTPUT @Agte5052;"DISP:FP:TRAC:LIM:LINE ON"
470 OUTPUT @Agte5052;"DISP:FP:LIM:FSIG ON"
480 OUTPUT @Agte5052;"CALC:FP:TRAC:LIM:STAT ON"
490 PRINT "End"
500 ASSIGN @Agte5052 TO *
510 Prog_end: END

```

Reading Limit Lines from Files

You can create any upper and lower value for limit lines in the specified format in advance, and read the file later to specify the limit lines.

For information about creating upper and lower values for limit lines, refer to the chapter describing “Data analysis and Result Output” in the User’s Guide.

The file must be saved in the CSV format (with the extension *.csv).

The program is described in detail below:

NOTE

Save the upper limit values together into one file, and the lower limit values into another.

Line 110	Define the data array (variable) for the limit lines.
Line 190 to 260	When bit 4 of the operation status condition register changes from “1” to “0” (negative transition), bit 4 of the operation status event register is set to “1”.
Line 290	Read the upper limit value for the limit lines from file.
Line 300	Read the lower limit value for the limit lines from file.
Line 320 to 360	Trigger the instrument.
Line 380 to 410	It repeats to the measurement end.
Line 430	Display the limit lines.
Line 440	Display the determination result. (For fail only.)
Line 450	Activate the limit test function.

Example 6-3

Reading Limit Lines from File

```

110 DIM Ufile$[20],Lfile$[20],Buff$[9]
120 INTEGER St
130 !

```

Working with Automatic Test Systems

Limit Test

```
140 Ufile$="f:\temp\upper.csv"
150 Lfile$="f:\temp\lower.csv"
160 !
170 ASSIGN @Agte5052 TO 717
180 !
190 OUTPUT @Agte5052;"*ESE 60"
200 OUTPUT @Agte5052;"*SRE 32"
210 OUTPUT @Agte5052";:STAT:OPER:PRT 0"
220 OUTPUT @Agte5052";:STAT:OPER:NTR 16"
230 OUTPUT @Agte5052";:STAT:OPER:ENAB 16"
240 OUTPUT @Agte5052;"*CLS"
250 OUTPUT @Agte5052;"*OPC?"
260 ENTER @Agte5052;Buff$
270 !
280 OUTPUT @Agte5052";:DISP:WIND:ACT FP1"
290 OUTPUT @Agte5052";:MMEM:FP:TRAC:LOAD:LIM:UPP ""&Ufile$&""
300 OUTPUT @Agte5052";:MMEM:FP:TRAC:LOAD:LIM:LOW ""&Lfile$&""
310 !
320 OUTPUT @Agte5052";:TRIG:MODE FP1"
330 OUTPUT @Agte5052";:TRIG:FP:SOUR BUS"
340 OUTPUT @Agte5052";:INIT:FP:CONT OFF"
350 OUTPUT @Agte5052";:INIT:FP:IMM"
360 OUTPUT @Agte5052;"*TRG"
370 !
380 REPEAT
390   OUTPUT @Agte5052";:STAT:OPER:COND?"
400   ENTER @Agte5052;St
410   UNTIL BIT(St,4)=0
420 !
430 OUTPUT @Agte5052";:DISP:FP:TRAC:LIM:LINE ON"
440 OUTPUT @Agte5052";:DISP:FP:LIM:FSIG ON"
450 OUTPUT @Agte5052";:CALC:FP:TRAC:LIM:STAT ON"
460 PRINT "End"
470 ASSIGN @Agte5052 TO *
480 Prog_end: END
```

7**SCPI Command Reference**

This chapter describes the SCPI command reference for the Agilent E5052A. It describes the commands using their abbreviated format in alphabetical order. If you want to look up commands using their fully qualified format, refer to the index for the desired SCPI command. If you want to look up commands by their function, refer to SCPI command list by function.

Notational conventions in this command reference

This section describes the rules to read the description of the commands in this chapter.

Syntax

Part with heading “Syntax” describes the syntax to send a command from the external controller to the E5052A. A syntax consists of a command part and a parameter part. The separator between the command part and the parameter part is a space.

If there are several parameters, the separator between adjacent parameters is a comma (,). 3 points (...) between commas indicate that parameters in that part are omitted. For example, <numeric 1>, ..., <numeric 4> indicates that 4 parameters, <numeric 1>, <numeric 2>, <numeric 3>, <numeric 4>, are required.

String-type parameters, <string>, <string 1>, and so on, must be enclosed in double quotation marks ("). <block> shows block format data.

You can omit the lowercase letters in syntax. For example, ":SENSe:ATTenuation:LEVel" can be shortened as ":SENS:ATT:LEV".

The definition of symbols used in the syntax is as follows:

- ◊ Characters enclosed in this pair of symbols are necessary parameters when sending the command.
- [] Part enclosed in this parenthesis pair can be omitted.
- { } Part enclosed in this parenthesis pair indicates that you must select one of the items in this part. Individual items are separated by a vertical bar (|).

For example, ":SOUR:VOLT:CONT:DEL 0.001"
":SOURCE:VOLTAGE:CONTROL:DELAY 1E-3" and so on are valid for the syntax given below.

Syntax :SOURce:VOLTage:CONTRol:DELay <numeric>

Description

Part with heading “Description” describes how to use the command or the operation when executed.

Parameters

Part with heading “Parameters” describes necessary parameters when sending the command. When a parameter is a value type or a string type enclosed with $\langle \rangle$, its description, allowable setup range, preset (factory-set) value, and so on are given; when a parameter is a selection type enclosed with $\{ \}$, the description of each selection item is given.

Query response

Part with heading “Query response” describes the data format read out when query (reading out data) is available with the command.

Each readout parameter is enclosed with $\{ \}$. If there are several items within $\{ \}$ separated by the pipe ($|$), only one of them is read out.

When several parameters are read out, they are separated with a comma ($,$). Note that, 3 points (...) between commas indicate that the data of that part is omitted. For example, $\{ \text{numeric 1} \}, \dots, \{ \text{numeric 4} \}$ indicates that 4 data items, $\{ \text{numeric 1} \}$, $\{ \text{numeric 2} \}$, $\{ \text{numeric 3} \}$, and $\{ \text{numeric 4} \}$, are read out.

$\langle \text{newline} \rangle \langle \text{^END} \rangle$ after the parameters is the program message terminator.

Related commands

Part with heading “Related commands” describes the commands related to this command.

Equivalent key

Part with heading “Equivalent key” shows the operational procedure of the front panel keys that has the same effect as this command.

[Key] Indicates that you press the key named Key.

[Key] - Item Indicates a series of key operation in which you press the **[Key]** key, select (highlight) the item called **Item** on the displayed menu using the **[↓]** key and so on, and then press the **[Enter]** key.

Device Configuration Using E5052A and E5053A Microwave Downconverter

There are 4 types of device configurations using the E5052A and the E5053A Microwave Downconverter including the stand-alone use of the E5052A: A-1, A-2, B, and C(Figure 7-1)

Figure 7-1 Device Configurations Using E5052A and E5053A

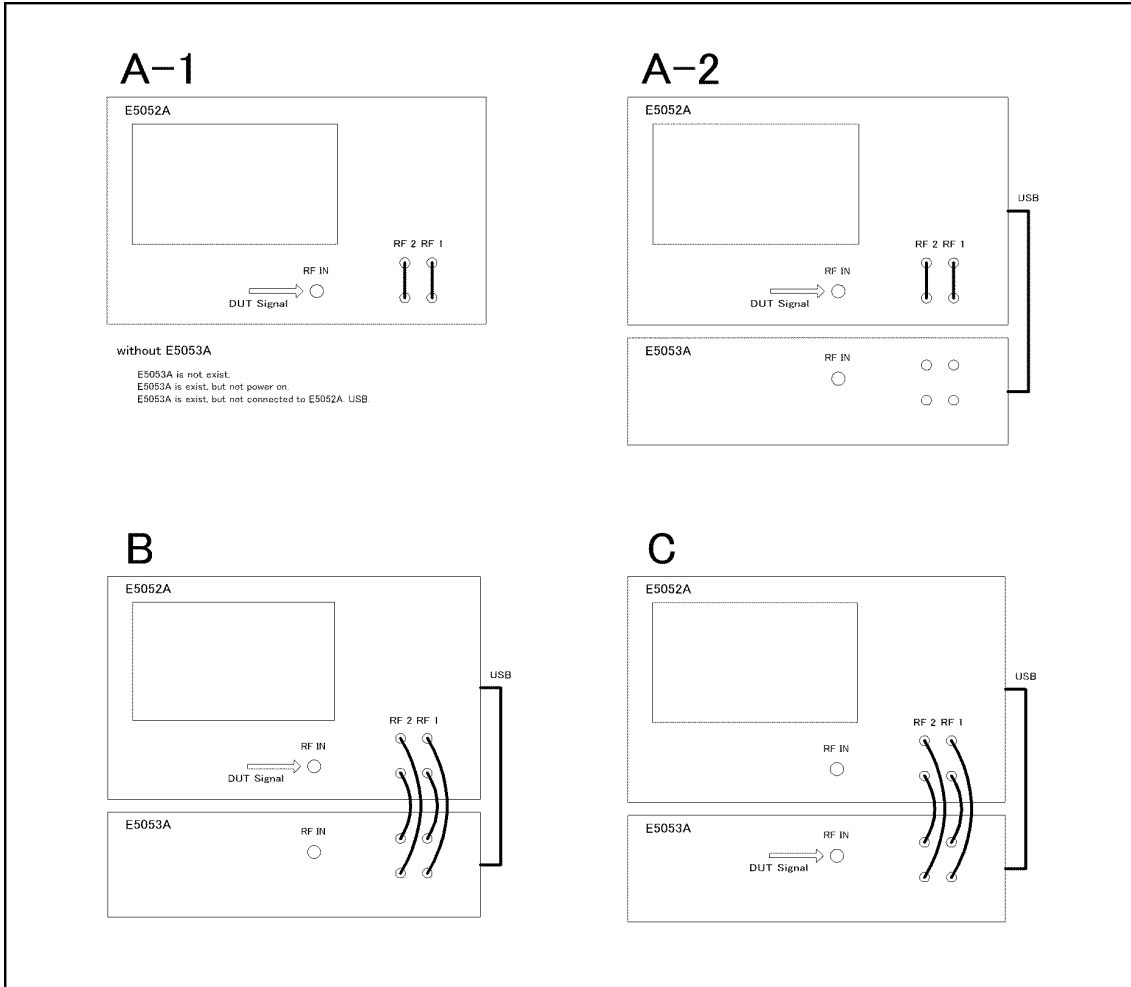

e5052auj4001

The table below lists the configuration ID used in this chapter with its description as well.

Configuration ID	Description
A-1	E5052A used stand-alone
A-2	With downconverter turned off

Device Configuration Using E5052A and E5053A Microwave Downconverter

Configuration ID	Description
B	With downconverter turned on and the RF input set to 'E5052A Direct'
C	With downconverter turned on and the RF input set to 'Downconverter'

E5052A commands

This section describes the commands specific to the E5052A.

:ABORt

Syntax	:ABORt
Description	Abort measurement (No Query)
Equivalent key	No equivalent key is available on the front panel.

:CALCulate:FP[1-1]:ALLTrace:ACTive

Syntax	:CALCulate:FP[1-1]:ALLTrace:ACTive <numeric> :CALCulate:FP[1-1]:ALLTrace:ACTive?
Description	Selects active trace
Parameter	

	<Numeric>
Range	1 to 4
Preset value	1
Unit	-
Resolution	-

Equivalent key	No equivalent key is available on the front panel.
----------------	--

:CALCulate:FP[1-1]:ALLTrace:BDMarker:X:COUPle:STATe

Syntax	:CALCulate:FP[1-1]:ALLTrace:BDMarker:X:COUPle:STATe {ON OFF 1 0} :CALCulate:FP[1-1]:ALLTrace:BDMarker:X:COUPle:STATe?
Description	Turns on/off bandmarker coupling function
Parameter	

	Description
ON or 1	Set bandmarker coupling function to 'ON'

	Description
OFF or 0(Preset value)	Set bandmarker coupling function to 'OFF'

Equivalent key FP Menu -> Marker Function -> Couple
FP Menu -> Marker Search -> Couple

:CALCulate:FP[1-1]:ALLTrace:LIMit:FAIL

Syntax :CALCulate:FP[1-1]:ALLTrace:LIMit:FAIL

Description Reads out the limit test result (Query Only)

Parameter

	Description
ON or 1	The limit test result is fail
OFF or 0(Preset value)	The limit test result is pass

When the limit test is set to OFF, OFF or 0 is always read out.

Equivalent key No equivalent key is available on the front panel.

:CALCulate:FP[1-1]:ALLTrace:MARKer:COUple:STATe

Syntax :CALCulate:FP[1-1]:ALLTrace:MARKer:COUple:STATe {ON|OFF|1|0}
:CALCulate:FP[1-1]:ALLTrace:MARKer:COUple:STATe?

Description Turns on/of marker coupling function

Parameter

	Description
ON or 1	Enable marker coupling function
OFF or 0(Preset value)	Disable marker coupling function

Equivalent key FP Menu -> Marker -> Couple

:CALCulate:FP[1-1]:ALLTrace:MARKer:DISCrete:STATe

Syntax :CALCulate:FP[1-1]:ALLTrace:MARKer:DISCrete:STATe {ON|OFF|1|0}
:CALCulate:FP[1-1]:ALLTrace:MARKer:DISCrete:STATe?

Description Turns on/off marker discrete function

Parameter

	Description
ON or 1	Enable marker discrete function
OFF or 0(Preset value)	Disable marker discrete function

Equivalent key FP Menu -> Marker -> More Functions -> Discrete

:CALCulate:FP[1-1]:ALLTrace:MARKer:REFerence:NUMBER

Syntax :CALCulate:FP[1-1]:ALLTrace:MARKer:REFerence:NUMBER <numeric>

:CALCulate:FP[1-1]:ALLTrace:MARKer:REFerence:NUMBER?

Description Sets/Reads marker reference number

Parameter

	<Numeric>
Range	1 to 10
Preset value	1
Unit	-
Resolution	-

Equivalent key FP Menu -> Marker -> More Functions -> Ref Marker

:CALCulate:FP[1-1]:ALLTrace:MARKer:REFerence:STATe

Syntax :CALCulate:FP[1-1]:ALLTrace:MARKer:REFerence:STATe {ON|OFF|1|0}

:CALCulate:FP[1-1]:ALLTrace:MARKer:REFerence:STATe?

Description Turns on/off delta marker mode

Parameter

	Description
ON or 1	Set delta marker mode mode to 'ON'

	Description
OFF or 0(Preset value)	Set delta marker mode mode to 'OFF'

Equivalent key FP Menu -> Marker -> More Functions -> Ref Marker Mode

:CALCulate:FP[1-1]:DATA:RDATa

Syntax :CALCulate:FP[1-1]:DATA:RDATa <array>
:CALCulate:FP[1-1]:DATA:RDATa?

Description Sets/Reads raw data

Parameter

	<Description>
Range	1...3003
Preset value	-
Unit	-
Resolution	-

Equivalent key No equivalent key is available on the front panel.

:CALCulate:FP[1-1]:DATA:TDATa

Syntax :CALCulate:FP[1-1]:DATA:TDATa <array>
:CALCulate:FP[1-1]:DATA:TDATa?

Description Sets/Reads tester mode data.

Parameter

	<Description>
Range	1...3
Preset value	-
Unit	-
Resolution	-

Equivalent key No equivalent key is available on the front panel.

:CALCulate:FP[1-1]:DATA:XDATA

Syntax :CALCulate:FP[1-1]:DATA:XDATA

Description Reads X-axis data (Query Only)

Equivalent key No equivalent key is available on the front panel.

:CALCulate:FP[1-1]:TRACe[1-4]:ALLMarker:ACTive

Syntax :CALCulate:FP[1-1]:TRACe[1-4]:ALLMarker:ACTive <numeric>
:CALCulate:FP[1-1]:TRACe[1-4]:ALLMarker:ACTive?

Description Sets/Reads active marker

Parameter

	<Numeric>
Range	1 to 10
Preset value	1
Unit	-
Resolution	-

Equivalent key No equivalent key is available on the front panel.

:CALCulate:FP[1-1]:TRACe[1-4]:ALLMarker:SEARch:DOMain:X

Syntax :CALCulate:FP[1-1]:TRACe[1-4]:ALLMarker:SEARch:DOMain:X
{FRANge|BDMarker}
:CALCulate:FP[1-1]:TRACe[1-4]:ALLMarker:SEARch:DOMain:X?

Description Sets/Reads marker search range (X-axis)

Parameter

	Description
FRANge(Preset value)	Set marker search range (X-axis) to 'Full Range'
BDMarker	Set marker search range (X-axis) to 'Band Marker'

Equivalent key FP Menu -> Marker Search -> Search Range (X)

:CALCulate:FP[1-1]:TRACe[1-4]:ALLMarker:SEARch:DOMain:Y

Syntax :CALCulate:FP[1-1]:TRACe[1-4]:ALLMarker:SEARch:DOMain:Y
{FRANge|BDMarker}
:CALCulate:FP[1-1]:TRACe[1-4]:ALLMarker:SEARch:DOMain:Y?

Description Sets/Reads marker search range (Y-axis)

Parameter

	Description
FRANge(Preset value)	Set marker search range (Y-axis) to 'Full Range'
BDMarker	Set marker search range (Y-axis) to 'Band Marker'

Equivalent key FP Menu -> Marker Search -> Search Range (Y)

:CALCulate:FP[1-1]:TRACe[1-4]:ALLMarker:SEARch:PEAK

Syntax :CALCulate:FP[1-1]:TRACe[1-4]:ALLMarker:SEARch:PEAK

Description Executes marker search all (No Query)

Equivalent key FP Menu -> Marker Search -> Peak -> Search Peak All

:CALCulate:FP[1-1]:TRACe[1-4]:BDMarker:X:CENTer

Syntax :CALCulate:FP[1-1]:TRACe[1-4]:BDMarker:X:CENTer <numeric>
:CALCulate:FP[1-1]:TRACe[1-4]:BDMarker:X:CENTer?

Description Sets/Reads the center value of bandmarker X

Parameter

	<Numeric>
Range	-1T to 1T
Preset value	0
Unit	-
Resolution	-

Equivalent key FP Menu -> Marker Function -> Band Marker X -> Center
FP Menu -> Marker Search -> Band Marker X -> Center

:CALCulate:FP[1-1]:TRACe[1-4]:BDMarker:X:SPAN

Syntax :CALCulate:FP[1-1]:TRACe[1-4]:BDMarker:X:SPAN <numeric>
:CALCulate:FP[1-1]:TRACe[1-4]:BDMarker:X:SPAN?

Description Sets/Reads the span value of bandmarker X

Parameter

	<Numeric>
Range	0 to 2T
Preset value	2T
Unit	-
Resolution	-

Equivalent key FP Menu -> Marker Function -> Band Marker X -> Span
FP Menu -> Marker Search -> Band Marker X -> Span

:CALCulate:FP[1-1]:TRACe[1-4]:BDMarker:X:START

Syntax :CALCulate:FP[1-1]:TRACe[1-4]:BDMarker:X:START <numeric>
:CALCulate:FP[1-1]:TRACe[1-4]:BDMarker:X:START?

Description Sets/Reads the start value of bandmarker X

Parameter

	<Numeric>
Range	-1T to 1T
Preset value	-1T
Unit	-
Resolution	-

Equivalent key FP Menu -> Marker Function -> Band Marker X -> Start
FP Menu -> Marker Search -> Band Marker X -> Start

:CALCulate:FP[1-1]:TRACe[1-4]:BDMarker:X:STATe

Syntax :CALCulate:FP[1-1]:TRACe[1-4]:BDMarker:X:STATe {ON|OFF|1|0}
:CALCulate:FP[1-1]:TRACe[1-4]:BDMarker:X:STATe?

Description Turns on/off bandmarker X

Parameter

	Description
ON or 1	Set bandmarker X mode to 'ON'
OFF or 0(Preset value)	Set bandmarker X mode to 'OFF'

Equivalent key

FP Menu -> Marker Function -> Band Marker X -> Band Marker X
FP Menu -> Marker Search -> Band Marker X -> Band Marker X

:CALCulate:FP[1-1]:TRACe[1-4]:BDMarker:X:STOP

Syntax

:CALCulate:FP[1-1]:TRACe[1-4]:BDMarker:X:STOP <numeric>
:CALCulate:FP[1-1]:TRACe[1-4]:BDMarker:X:STOP?

Description

Sets/Reads the stop value of bandmarker X

Parameter

	<Numeric>
Range	-1T to 1T
Preset value	1T
Unit	-
Resolution	-

Equivalent key

FP Menu -> Marker Function -> Band Marker X -> Stop
FP Menu -> Marker Search -> Band Marker X -> Stop

:CALCulate:FP[1-1]:TRACe[1-4]:BDMarker:Y:CENTer

Syntax

:CALCulate:FP[1-1]:TRACe[1-4]:BDMarker:Y:CENTer <numeric>
:CALCulate:FP[1-1]:TRACe[1-4]:BDMarker:Y:CENTer?

Description

Sets/Reads the center value of bandmarker Y

Parameter

	<Numeric>
Range	-1T to 1T
Preset value	0
Unit	-

	<Numeric>
Resolution	-

Equivalent key FP Menu -> Marker Function -> Band Marker Y -> Center
FP Menu -> Marker Search -> Band Marker Y -> Center

:CALCulate:FP[1-1]:TRACe[1-4]:BDMarker:Y:SPAN

Syntax :CALCulate:FP[1-1]:TRACe[1-4]:BDMarker:Y:SPAN <numeric>
:CALCulate:FP[1-1]:TRACe[1-4]:BDMarker:Y:SPAN?

Description Sets/Reads the span value of bandmarker Y

Parameter

	<Numeric>
Range	0 to 2T
Preset value	2T
Unit	-
Resolution	-

Equivalent key FP Menu -> Marker Function -> Band Marker Y -> Span
FP Menu -> Marker Search -> Band Marker Y -> Span

:CALCulate:FP[1-1]:TRACe[1-4]:BDMarker:Y:START

Syntax :CALCulate:FP[1-1]:TRACe[1-4]:BDMarker:Y:START <numeric>
:CALCulate:FP[1-1]:TRACe[1-4]:BDMarker:Y:START?

Description Sets/Reads the start value of bandmarker Y

Parameter

	<Numeric>
Range	-1T to 1T
Preset value	-1T
Unit	-
Resolution	-

Equivalent key FP Menu -> Marker Function -> Band Marker Y -> Start

FP Menu -> Marker Search -> Band Marker Y -> Start

:CALCulate:FP[1-1]:TRACe[1-4]:BDMarker:Y:STATE

Syntax :CALCulate:FP[1-1]:TRACe[1-4]:BDMarker:Y:STATE {ON|OFF|1|0}
:CALCulate:FP[1-1]:TRACe[1-4]:BDMarker:Y:STATE?

Description Turns on/off bandmarker Y

Parameter

	Description
ON or 1	Set bandmarker Y mode to 'ON'
OFF or 0(Preset value)	Set bandmarker Y mode to 'OFF'

Equivalent key FP Menu -> Marker Function -> Band Marker Y -> Band Marker Y
FP Menu -> Marker Search -> Band Marker Y -> Band Marker Y

:CALCulate:FP[1-1]:TRACe[1-4]:BDMarker:Y:STOP

Syntax :CALCulate:FP[1-1]:TRACe[1-4]:BDMarker:Y:STOP <numeric>
:CALCulate:FP[1-1]:TRACe[1-4]:BDMarker:Y:STOP?

Description Sets/Reads the stop value of bandmarker Y

Parameter

	<Numeric>
Range	-1T to 1T
Preset value	1T
Unit	-
Resolution	-

Equivalent key FP Menu -> Marker Function -> Band Marker Y -> Stop
FP Menu -> Marker Search -> Band Marker Y -> Stop

:CALCulate:FP[1-1]:TRACe[1-4]:DATA:COPY

Syntax :CALCulate:FP[1-1]:TRACe[1-4]:DATA:COPY <numeric>

Description Copies trace data to the user trace (No Query)

Parameter

	<Numeric>
Range	1 to 8
Preset value	-
Unit	-
Resolution	-

Equivalent key

FP Menu -> Trace View-> Copy to USER -> Copy to USER1
 FP Menu -> Trace View-> Copy to USER -> Copy to USER2
 FP Menu -> Trace View-> Copy to USER -> Copy to USER3
 FP Menu -> Trace View-> Copy to USER -> Copy to USER4
 FP Menu -> Trace View-> Copy to USER -> Copy to USER5
 FP Menu -> Trace View-> Copy to USER -> Copy to USER6
 FP Menu -> Trace View-> Copy to USER -> Copy to USER7
 FP Menu -> Trace View-> Copy to USER -> Copy to USER8

:CALCulate:FP[1-1]:TRACe[1-4]:DATA:FDATA

Syntax

:CALCulate:FP[1-1]:TRACe[1-4]:DATA:FDATA <array>
 :CALCulate:FP[1-1]:TRACe[1-4]:DATA:FDATA?

Description

Sets/readds formatted trace data

Parameter

	<Description>
Range	1...1001
Preset value	-
Unit	-
Resolution	-

Equivalent key

No equivalent key is available on the front panel.

:CALCulate:FP[1-1]:TRACe[1-4]:DATA:FMEMory

Syntax

:CALCulate:FP[1-1]:TRACe[1-4]:DATA:FMEMory <array>
 :CALCulate:FP[1-1]:TRACe[1-4]:DATA:FMEMory?

Description

Sets/Reads formatted memory data

Parameter

	<Description>
Range	1...1001
Preset value	-
Unit	-
Resolution	-

Equivalent key No equivalent key is available on the front panel.

:CALCulate:FP[1-1]:TRACe[1-4]:DATA:UDATa

Syntax :CALCulate:FP[1-1]:TRACe[1-4]:DATA:UDATa <array>
:CALCulate:FP[1-1]:TRACe[1-4]:DATA:UDATa?

Description Sets/Reads unformatted trace data

Parameter

	<Description>
Range	1...1001
Preset value	-
Unit	-
Resolution	-

Equivalent key No equivalent key is available on the front panel.

:CALCulate:FP[1-1]:TRACe[1-4]:DATA:UMEMory

Syntax :CALCulate:FP[1-1]:TRACe[1-4]:DATA:UMEMory <array>
:CALCulate:FP[1-1]:TRACe[1-4]:DATA:UMEMory?

Description Sets/Reads unformatted memory data

Parameter

	<Description>
Range	1...1001
Preset value	-
Unit	-

	<Description>
Resolution	-

Equivalent key No equivalent key is available on the front panel.

:CALCulate:FP[1-1]:TRACe[1-4]:FORMat:FREQUency

Syntax :CALCulate:FP[1-1]:TRACe[1-4]:FORMat:FREQUency {HZ|HZV|DHZ|PCT|PPM}
:CALCulate:FP[1-1]:TRACe[1-4]:FORMat:FREQUency?

Description FP-frequency format

Parameter

	Description
HZ(Preset value)	Set FP-frequency format to 'Hz'
HZV	Set FP-frequency format to 'Hz/V'
DHZ	Set FP-frequency format to 'ΔHz'
PCT	Set FP-frequency format to '%'
PPM	Set FP-frequency format to 'ppm'

This command is available when trace 1 or trace 4.

Equivalent key FP Menu -> Format -> Frequency Format

:CALCulate:FP[1-1]:TRACe[1-4]:FUNCTion:DOMain:X

Syntax :CALCulate:FP[1-1]:TRACe[1-4]:FUNCTion:DOMain:X {FRANge|BDMarker}
:CALCulate:FP[1-1]:TRACe[1-4]:FUNCTion:DOMain:X?

Description Sets/Reads analysis/search range (X-axis)

Parameter

	Description
FRANge	Set analysis/search range (X-axis) to 'Full Range'
BDMarker(Preset value)	Set analysis/search range (X-axis) to 'Band Marker'

Equivalent key FP Menu -> Marker Function -> Analysis Range (X)

:CALCulate:FP[1-1]:TRACe[1-4]:FUNCTion:DOMain:Y

Syntax :CALCulate:FP[1-1]:TRACe[1-4]:FUNCTion:DOMain:Y {FRANge|BDMarker}
:CALCulate:FP[1-1]:TRACe[1-4]:FUNCTion:DOMain:Y?

Description Sets/Reads analysis/search range (Y-axis)

Parameter

	Description
FRANge	Set analysis/search range (Y-axis) to 'Full Range'
BDMarker(Preset value)	Set analysis/search range (Y-axis) to 'Band Marker'

Equivalent key FP Menu -> Marker Function -> Analysis Range (Y)

:CALCulate:FP[1-1]:TRACe[1-4]:FUNCTion:LREGression:DATA

Syntax :CALCulate:FP[1-1]:TRACe[1-4]:FUNCTion:LREGression:DATA

Description Assigns trace data to the regression line coefficient (a and b) (Query Only)
When the X-axis band marker is set to on, calculation is made within the range specified by the band marker.

NOTE When less than two measurement points are in the range of the band marker, a and b return 0 (zero).

Equivalent key FP Menu -> Trace View -> Memory Trace -> Line (Y = AX + B) -> Data Trace -> A,B

:CALCulate:FP[1-1]:TRACe[1-4]:FUNCTion:LREGression:MEMory

Syntax :CALCulate:FP[1-1]:TRACe[1-4]:FUNCTion:LREGression:MEMory

Description Assigns trace memory to the regression line coefficient (a and b) (Query Only)
When the X-axis band marker is set to on, calculation is made within the range specified by the band marker.

NOTE When less than two measurement points are in the range of the band marker, a and b return 0 (zero).

Equivalent key No equivalent key is available on the front panel.

:CALCulate:FP[1-1]:TRACe[1-4]:FUNCtion:STATistics:DA TA

Syntax :CALCulate:FP[1-1]:TRACe[1-4]:FUNCtion:STATistics:DATA
Description Reads the results of statistical analysis for the data trace (Query Only)
Equivalent key No equivalent key is available on the front panel.

:CALCulate:FP[1-1]:TRACe[1-4]:FUNCtion:STATistics:M EMory

Syntax :CALCulate:FP[1-1]:TRACe[1-4]:FUNCtion:STATistics:MEMory
Description Reads the results of statistical analysis for the memory trace (Query Only)
Equivalent key No equivalent key is available on the front panel.

:CALCulate:FP[1-1]:TRACe[1-4]:FUNCtion:TYPE

Syntax :CALCulate:FP[1-1]:TRACe[1-4]:FUNCtion:TYPE {OFF|STATistics}
:CALCulate:FP[1-1]:TRACe[1-4]:FUNCtion:TYPE?
Description Sets/Reads analysis type

Parameter

	Description
OFF(Preset value)	Set analysis type to 'Off'
STATistics	Set analysis type to 'Statistics'

Equivalent key FP Menu -> Marker Function -> Analysis Type

:CALCulate:FP[1-1]:TRACe[1-4]:HOLD

Syntax :CALCulate:FP[1-1]:TRACe[1-4]:HOLD {OFF|MAXimum|MINimum}
:CALCulate:FP[1-1]:TRACe[1-4]:HOLD?
Description Selects/Reads trace data hold type

Parameter

	Description
OFF(Preset value)	Set data hold to 'Off'
MAXimum	Set data hold to 'Maximum'

	Description
MINimum	Set data hold to 'Minimum'

Equivalent key FP Menu -> Trace View -> Data Hold

:CALCulate:FP[1-1]:TRACe[1-4]:LIMit:FAIL

Syntax :CALCulate:FP[1-1]:TRACe[1-4]:LIMit:FAIL

Description Reads out the limit test result (Query Only)

Parameter

	Description
ON or 1	The limit test result is fail
OFF or 0(Preset value)	The limit test result is pass

When the limit test is set to OFF, OFF or 0 is always read out.

Equivalent key No equivalent key is available on the front panel.

:CALCulate:FP[1-1]:TRACe[1-4]:LIMit:LOWer:LDATA

Syntax :CALCulate:FP[1-1]:TRACe[1-4]:LIMit:LOWer:LDATA <array>

:CALCulate:FP[1-1]:TRACe[1-4]:LIMit:LOWer:LDATA?

Description Sets/Reads the lower limit values of all measurement points

Parameter

	<Description>
Range	1...1001
Preset value	-
Unit	-
Resolution	-

Equivalent key No equivalent key is available on the front panel.

:CALCulate:FP[1-1]:TRACe[1-4]:LIMit:LOWer:SEGment:CLEar

Syntax :CALCulate:FP[1-1]:TRACe[1-4]:LIMit:LOWer:SEGment:CLEar

Description Clears the lower limit line (No Query)

Equivalent key FP Menu -> Display-> Limit Test -> Delete Lower Limit Line

:CALCulate:FP[1-1]:TRACe[1-4]:LIMit:LOWer:SEGMENT:COUNT

Syntax :CALCulate:FP[1-1]:TRACe[1-4]:LIMit:LOWer:SEGMENT:COUNT <numeric>
:CALCulate:FP[1-1]:TRACe[1-4]:LIMit:LOWer:SEGMENT:COUNT?

Description Sets/Reads the number of segments in the lower limit line

Parameter

	<Numeric>
Range	1 to 100
Preset value	1
Unit	-
Resolution	-

Equivalent key FP Menu -> Display-> Limit Test -> Delete Lower Limit Line

:CALCulate:FP[1-1]:TRACe[1-4]:LIMit:LOWer:SEGMENT:DATA

Syntax :CALCulate:FP[1-1]:TRACe[1-4]:LIMit:LOWer:SEGMENT:DATA <array>
:CALCulate:FP[1-1]:TRACe[1-4]:LIMit:LOWer:SEGMENT:DATA?

Description Sets/Reads segment data of the lower limit line

Parameter

	<Description>
Range	1...400
Preset value	-
Unit	-
Resolution	-

Equivalent key No equivalent key is available on the front panel.

:CALCulate:FP[1-1]:TRACe[1-4]:LIMit:REPort[:DATA]

- Syntax** :CALCulate:FP[1-1]:TRACe[1-4]:LIMit:REPort[:DATA]
- Description** Reads the limit test results of all measurement points in selected traces (Query Only)
- Equivalent key** No equivalent key is available on the front panel.

:CALCulate:FP[1-1]:TRACe[1-4]:LIMit[:STATe]

- Syntax** :CALCulate:FP[1-1]:TRACe[1-4]:LIMit[:STATe] {ON|OFF|1|0}
:CALCulate:FP[1-1]:TRACe[1-4]:LIMit[:STATe]?
- Description** Turns on/off the limit test function
- Parameter**

	Description
ON or 1	Turn on the limit test function mode
OFF or 0(Preset value)	Turn off the limit test function mode

- Equivalent key** FP Menu -> Display -> Limit Test -> Limit Test

:CALCulate:FP[1-1]:TRACe[1-4]:LIMit:UPPer:LDATa

- Syntax** :CALCulate:FP[1-1]:TRACe[1-4]:LIMit:UPPer:LDATa <array>
:CALCulate:FP[1-1]:TRACe[1-4]:LIMit:UPPer:LDATa?
- Description** Sets/Reads the upper limit values of all measurement points
- Parameter**

	<Description>
Range	1...1001
Preset value	-
Unit	-
Resolution	-

- Equivalent key** No equivalent key is available on the front panel.

:CALCulate:FP[1-1]:TRACe[1-4]:LIMit:UPPer:SEGMENT:CLEAr

Syntax :CALCulate:FP[1-1]:TRACe[1-4]:LIMit:UPPer:SEGMENT:CLEAr

Description Clears the upper limit line (No Query)

Equivalent key FP Menu -> Display-> Limit Test -> Delete Upper Limit Line

:CALCulate:FP[1-1]:TRACe[1-4]:LIMit:UPPer:SEGMENT:COUNT

Syntax :CALCulate:FP[1-1]:TRACe[1-4]:LIMit:UPPer:SEGMENT:COUNT <numeric>

:CALCulate:FP[1-1]:TRACe[1-4]:LIMit:UPPer:SEGMENT:COUNT?

Description Sets/Reads the number of segments in the upper limit line

Parameter

	<Numeric>
Range	1 to 100
Preset value	1
Unit	-
Resolution	-

Equivalent key No equivalent key is available on the front panel.

:CALCulate:FP[1-1]:TRACe[1-4]:LIMit:UPPer:SEGMENT:DATA

Syntax :CALCulate:FP[1-1]:TRACe[1-4]:LIMit:UPPer:SEGMENT:DATA <array>

:CALCulate:FP[1-1]:TRACe[1-4]:LIMit:UPPer:SEGMENT:DATA?

Description Sets/Reads segment data of the upper limit line

Parameter

	<Description>
Range	1...400
Preset value	-
Unit	-
Resolution	-

Equivalent key No equivalent key is available on the front panel.

:CALCulate:FP[1-1]:TRACe[1-4]:LINE:A

Syntax :CALCulate:FP[1-1]:TRACe[1-4]:LINE:A <numeric>
:CALCulate:FP[1-1]:TRACe[1-4]:LINE:A?

Description Sets/Reads the regression line coefficient a (slope)

Parameter

	<Numeric>
Description	Regression line coefficient a
Range	-500 T to 500 T
Preset value	0
Unit	-
Resolution	-

Equivalent key FP Menu -> Trace View -> Memory Trace -> Line (Y = AX + B) -> A

:CALCulate:FP[1-1]:TRACe[1-4]:LINE:B

Syntax :CALCulate:FP[1-1]:TRACe[1-4]:LINE:B <numeric>
:CALCulate:FP[1-1]:TRACe[1-4]:LINE:B?

Description Sets/Reads the regression line coefficient b (intercept)

Parameter

	<Numeric>
Description	Regression line coefficient b
Range	-500 T to 500 T
Preset value	0
Unit	-
Resolution	-

Equivalent key FP Menu -> Trace View -> Memory Trace -> Line (Y = AX + B) -> B

:CALCulate:FP[1-1]:TRACe[1-4]:LINE:MEMory

Syntax :CALCulate:FP[1-1]:TRACe[1-4]:LINE:MEMory

Description Saves the obtained regression line to a trace memory (No Query)
Equivalent key FP Menu -> Trace View -> Memory Trace -> Line (Y = AX + B) -> Set Line to Memory

**:CALCulate:FP[1-1]:TRACe[1-4]:MARKer[1-10]:SEARch:
EXECute:LPEak**

Syntax :CALCulate:FP[1-1]:TRACe[1-4]:MARKer[1-10]:SEARch:EXECute:LPEak

Description Executes marker peak search left (No Query)

Equivalent key FP Menu -> Marker Search -> Peak -> Search Left

**:CALCulate:FP[1-1]:TRACe[1-4]:MARKer[1-10]:SEARch:
EXECute:LTARget**

Syntax :CALCulate:FP[1-1]:TRACe[1-4]:MARKer[1-10]:SEARch:EXECute:LTARget

Description Executes marker target search left (No Query)

Equivalent key FP Menu -> Marker Search -> Target -> Search Left

**:CALCulate:FP[1-1]:TRACe[1-4]:MARKer[1-10]:SEARch:
EXECute:MAXimum**

Syntax :CALCulate:FP[1-1]:TRACe[1-4]:MARKer[1-10]:SEARch:EXECute:MAXimum

Description Executes marker search maximum (No Query)

Equivalent key FP Menu -> Marker Search -> Search Max

**:CALCulate:FP[1-1]:TRACe[1-4]:MARKer[1-10]:SEARch:
EXECute:MINimum**

Syntax :CALCulate:FP[1-1]:TRACe[1-4]:MARKer[1-10]:SEARch:EXECute:MINimum

Description Executes marker search minimum (No Query)

Equivalent key FP Menu -> Marker Search -> Search Min

**:CALCulate:FP[1-1]:TRACe[1-4]:MARKer[1-10]:SEARch:
EXECute:PEAK**

Syntax :CALCulate:FP[1-1]:TRACe[1-4]:MARKer[1-10]:SEARch:EXECute:PEAK

Description Executes marker peak search (No Query)

Equivalent key FP Menu -> Marker Search -> Peak -> Search Peak

:CALCulate:FP[1-1]:TRACe[1-4]:MARKer[1-10]:SEARch:EXECute:RPEak

Syntax :CALCulate:FP[1-1]:TRACe[1-4]:MARKer[1-10]:SEARch:EXECute:RPEak
 Description Executes marker peak search right (No Query)
 Equivalent key FP Menu -> Marker Search -> Peak -> Search Right

:CALCulate:FP[1-1]:TRACe[1-4]:MARKer[1-10]:SEARch:EXECute:RTARget

Syntax :CALCulate:FP[1-1]:TRACe[1-4]:MARKer[1-10]:SEARch:EXECute:RTARget
 Description Executes marker target search right (No Query)
 Equivalent key FP Menu -> Marker Search -> Target -> Search Right

:CALCulate:FP[1-1]:TRACe[1-4]:MARKer[1-10]:SEARch:EXECute:TARGet

Syntax :CALCulate:FP[1-1]:TRACe[1-4]:MARKer[1-10]:SEARch:EXECute:TARGet
 Description Executes marker target search (No Query)
 Equivalent key FP Menu -> Marker Search -> Target -> Search Target

:CALCulate:FP[1-1]:TRACe[1-4]:MARKer[1-10]:SEARch:PEAK:EXCursion

Syntax :CALCulate:FP[1-1]:TRACe[1-4]:MARKer[1-10]:SEARch:PEAK:EXCursion <numeric>
 :CALCulate:FP[1-1]:TRACe[1-4]:MARKer[1-10]:SEARch:PEAK:EXCursion?

Description Sets/Reads the peak excursion value

Parameter

	<Numeric>
Range	0 to 10G
Preset value	0
Unit	-
Resolution	-

Equivalent key FP Menu -> Marker Search -> Peak -> Peak Excursion

:CALCulate:FP[1-1]:TRACe[1-4]:MARKer[1-10]:SEARch:PEAK:POLarity

Syntax :CALCulate:FP[1-1]:TRACe[1-4]:MARKer[1-10]:SEARch:PEAK:POLarity
{POSitive|NEGative|BOTH}
:CALCulate:FP[1-1]:TRACe[1-4]:MARKer[1-10]:SEARch:PEAK:POLarity?

Description Sets/Reads the marker peak-search polarity

Parameter

	Description
POSitive(Preset value)	Set the marker peak-search polarity to 'Positive'
NEGative	Set the marker peak-search polarity to 'Negative'
BOTH	Set the marker peak-search polarity to 'Both'

Equivalent key FP Menu -> Marker Search -> Peak -> Peak Polarity

:CALCulate:FP[1-1]:TRACe[1-4]:MARKer[1-10]:SEARch:TARGet:TRAnSition

Syntax :CALCulate:FP[1-1]:TRACe[1-4]:MARKer[1-10]:SEARch:TARGet:TRAnSition
{POSitive|NEGative|BOTH}
:CALCulate:FP[1-1]:TRACe[1-4]:MARKer[1-10]:SEARch:TARGet:TRAnSition?

Description Sets/Reads the target transition definition

Parameter

	Description
POSitive	Set the target transition definition to 'Positive'
NEGative	Set the target transition definition to 'Negative'
BOTH(Preset value)	Set the target transition definition to 'Both'

Equivalent key FP Menu -> Marker Search -> Target -> Search Transition

:CALCulate:FP[1-1]:TRACe[1-4]:MARKer[1-10]:SEARch:TARGet:Y

Syntax :CALCulate:FP[1-1]:TRACe[1-4]:MARKer[1-10]:SEARch:TARGet:Y <numeric>
:CALCulate:FP[1-1]:TRACe[1-4]:MARKer[1-10]:SEARch:TARGet:Y?

Description Sets/Reads the marker target value

Parameter

	<Numeric>
Range	-10G to 10G
Preset value	0
Unit	-
Resolution	-

Equivalent key FP Menu -> Marker Search -> Target -> Search Value

:CALCulate:FP[1-1]:TRACe[1-4]:MARKer[1-10]:SEARch:TRACking:TYPE

Syntax

:CALCulate:FP[1-1]:TRACe[1-4]:MARKer[1-10]:SEARch:TRACking:TYPE
{OFF|MAXimum|MINimum|PEAK|TARGet}

:CALCulate:FP[1-1]:TRACe[1-4]:MARKer[1-10]:SEARch:TRACking:TYPE?

Description

Sets/Reads the marker tracking type

Parameter

	Description
OFF(Preset value)	Set the marker tracking type to 'Off'
MAXimum	Set the marker tracking type to 'Maximum'
MINimum	Set the marker tracking type to 'Minimum'
PEAK	Set the marker tracking type to 'Peak'
TARGet	Set the marker tracking type to 'Target'

Equivalent key FP Menu -> Marker Search -> Tracking

:CALCulate:FP[1-1]:TRACe[1-4]:MARKer[1-10]:STATe

Syntax

:CALCulate:FP[1-1]:TRACe[1-4]:MARKer[1-10]:STATe {ON|OFF|1|0}

:CALCulate:FP[1-1]:TRACe[1-4]:MARKer[1-10]:STATe?

Description

Turns on/off markers

Parameter

	Description
ON or 1	Set markers mode 'ON'
OFF or 0(Preset value)	Set markers mode 'OFF'

Equivalent key FP Menu -> Marker -> Clear Marker Menu -> Marker 1

:CALCulate:FP[1-1]:TRACe[1-4]:MARKer[1-10]:X

Syntax :CALCulate:FP[1-1]:TRACe[1-4]:MARKer[1-10]:X <numeric>
:CALCulate:FP[1-1]:TRACe[1-4]:MARKer[1-10]:X?

Description Sets/Reads the marker X value

Parameter

	<Numeric>
Range	-
Preset value	0
Unit	-
Resolution	-

Equivalent key No equivalent key is available on the front panel.

:CALCulate:FP[1-1]:TRACe[1-4]:MARKer[1-10]:Y

Syntax :CALCulate:FP[1-1]:TRACe[1-4]:MARKer[1-10]:Y

Description Reads the marker Y value (Query Only)

Equivalent key No equivalent key is available on the front panel.

:CALCulate:FP[1-1]:TRACe[1-4]:MATH:FUNCtion

Syntax :CALCulate:FP[1-1]:TRACe[1-4]:MATH:FUNCtion
{NORMal|SUBTract|DIVide|ADD|MULTiply}
:CALCulate:FP[1-1]:TRACe[1-4]:MATH:FUNCtion?

Description Sets/Reads math operation type

Parameter

	Description
NORMAL(Preset value)	Set math operation type to 'Off'
SUBTract	Set math operation type to 'Data - Mem'
DIVide	Set math operation type to 'Data / Mem'
ADD	Set math operation type to 'Data + Mem'
MULTIply	Set math operation type to 'Data * Mem'

Equivalent key FP Menu -> Trace View -> Data Math

:CALCulate:FP[1-1]:TRACe[1-4]:MATH:MEMorize

Syntax :CALCulate:FP[1-1]:TRACe[1-4]:MATH:MEMorize

Description Copies data to memory (No Query)

Equivalent key No equivalent key is available on the front panel.

:CALCulate:FP[1-1]:TRACe[1-4]:MATH:OFFSet

Syntax :CALCulate:FP[1-1]:TRACe[1-4]:MATH:OFFSet <numeric>

:CALCulate:FP[1-1]:TRACe[1-4]:MATH:OFFSet?

Description Sets/Reads the offset value of the trace

Parameter

	<Numeric>
Description	Offset value of the trace
Range	-500 G to 500 G
Preset value	0
Unit	-
Resolution	-

Equivalent key FP Menu -> Trace View -> Offset

FP Menu -> Trace View -> [Marker -> -Offset]

:CALCulate:FP[1-1]:TRACe[1-4]:PARAmeter

Syntax :CALCulate:FP[1-1]:TRACe[1-4]:PARAmeter

Description Reads the trace parameter. (Query Only)

Equivalent key No equivalent key is available on the front panel.

:CALCulate:FP[1-1]:TRACe[1-4]:REFerence:FREQuency

Syntax :CALCulate:FP[1-1]:TRACe[1-4]:REFerence:FREQuency <numeric>
:CALCulate:FP[1-1]:TRACe[1-4]:REFerence:FREQuency?

Description Sets/Reads the frequency reference.

Parameter

	<Numeric>
Range	-500G to 500G
Preset value	0
Unit	Hz
Resolution	-

Equivalent key FP Menu -> Format -> Frequency Reference

:CALCulate:FP[1-1]:TRACe[1-4]:SAPerture

Syntax :CALCulate:FP[1-1]:TRACe[1-4]:SAPerture <numeric>
:CALCulate:FP[1-1]:TRACe[1-4]:SAPerture?

Description Sensitivity Aperture

Parameter

	<Numeric>
Range	100m to 20
Preset value	1
Unit	%
Resolution	100m

Equivalent key FP Menu -> Format -> Sensitivity Aperture

:CALCulate:FP[1-1]:TRACe[1-4]:SMOothing:APERture

Syntax :CALCulate:FP[1-1]:TRACe[1-4]:SMOothing:APERture <numeric>
:CALCulate:FP[1-1]:TRACe[1-4]:SMOothing:APERture?

Description Sets/Reads the smoothing aperture value

Parameter

	<Numeric>
Range	50m to 25
Preset value	1.5
Unit	%
Resolution	-

Equivalent key FP Menu -> Trace View -> Aperture

:CALCulate:FP[1-1]:TRACe[1-4]:SMOothing:STATe

Syntax

:CALCulate:FP[1-1]:TRACe[1-4]:SMOothing:STATe {ON|OFF|1|0}
:CALCulate:FP[1-1]:TRACe[1-4]:SMOothing:STATe?

Description

Turns on/off smoothing mode

Parameter

	Description
ON or 1	Set smoothing mode 'ON'
OFF or 0(Preset value)	Set smoothing mode 'OFF'

Equivalent key FP Menu -> Trace View -> Smoothing

:CALCulate:PN[1-1]:ALLTrace:LIMit:FAIL

Syntax

:CALCulate:PN[1-1]:ALLTrace:LIMit:FAIL

Description

Reads out the limit test result (Query Only)

Parameter

	Description
ON or 1	The limit test result is fail
OFF or 0(Preset value)	The limit test result is pass

When the limit test is set to OFF, OFF or 0 is always read out.

Equivalent key

No equivalent key is available on the front panel.

:CALCulate:PN[1-1]:ALLTrace:MARKer:COUple:STATe

Syntax :CALCulate:PN[1-1]:ALLTrace:MARKer:COUple:STATe {ON|OFF|1|0}
:CALCulate:PN[1-1]:ALLTrace:MARKer:COUple:STATe?

Description Turns on/off marker coupling function

Parameter

	Description
ON or 1	Set marker coupling function mode 'ON'
OFF or 0(Preset value)	Set marker coupling function mode 'OFF'

Equivalent key No equivalent key is available on the front panel.

:CALCulate:PN[1-1]:ALLTrace:MARKer:DISCcrete:STATe

Syntax :CALCulate:PN[1-1]:ALLTrace:MARKer:DISCcrete:STATe {ON|OFF|1|0}
:CALCulate:PN[1-1]:ALLTrace:MARKer:DISCcrete:STATe?

Description Sets/Reads marker movement (Continuous/Discrete)

Parameter

	Description
ON or 1	Set marker movement (Continuous/Discrete) mode 'ON'
OFF or 0(Preset value)	Set marker movement (Continuous/Discrete) mode 'OFF'

Equivalent key PN Menu -> Marker -> More Functions -> Discrete

:CALCulate:PN[1-1]:ALLTrace:MARKer:REFerence:NUMBer

Syntax :CALCulate:PN[1-1]:ALLTrace:MARKer:REFerence:NUMBer <numeric>
:CALCulate:PN[1-1]:ALLTrace:MARKer:REFerence:NUMBer?

Description Sets/Reads marker reference number

Parameter

	<Numeric>
Range	1 to 10

	<Numeric>
Preset value	1
Unit	-
Resolution	-

Equivalent key PN Menu -> Marker -> More Functions -> Ref Marker

:CALCulate:PN[1-1]:ALLTrace:MARKer:REFerence:STATe

Syntax :CALCulate:PN[1-1]:ALLTrace:MARKer:REFerence:STATe {ON|OFF|1|0}
:CALCulate:PN[1-1]:ALLTrace:MARKer:REFerence:STATe?

Description Turns on/off delta marker mode

Parameter

	Description
ON or 1	Set delta marker mode mode 'ON'
OFF or 0(Preset value)	Set delta marker mode mode 'OFF'

Equivalent key PN Menu -> Marker -> More Functions -> Ref Marker Mode

:CALCulate:PN[1-1]:DATA:CARRier

Syntax :CALCulate:PN[1-1]:DATA:CARRier <array>
:CALCulate:PN[1-1]:DATA:CARRier?

Description Sets/Reads the carrier frequency/power data in phase noise measurement

Parameter

	<Description>
Range	1...2
Preset value	-
Unit	-
Resolution	-

Equivalent key No equivalent key is available on the front panel.

:CALCulate:PN[1-1]:DATA:PDATA

Syntax :CALCulate:PN[1-1]:DATA:PDATA <array>
:CALCulate:PN[1-1]:DATA:PDATA?

Description Sets/Reads the raw power data (dBc)

Parameter

	<Description>
Range	1...1601
Preset value	-
Unit	-
Resolution	-

Equivalent key No equivalent key is available on the front panel.

:CALCulate:PN[1-1]:DATA:RDATA

Syntax :CALCulate:PN[1-1]:DATA:RDATA <array>
:CALCulate:PN[1-1]:DATA:RDATA?

Description Sets/Reads the measurement raw data

Parameter

	<Description>
Range	1...1601
Preset value	-
Unit	-
Resolution	-

Equivalent key No equivalent key is available on the front panel.

:CALCulate:PN[1-1]:DATA:XDATA

Syntax :CALCulate:PN[1-1]:DATA:XDATA

Description Reads the X data (Query Only)

Equivalent key No equivalent key is available on the front panel.

:CALCulate:PN[1-1]:TRACe[1-1]:ALLMarker:ACTive

Syntax :CALCulate:PN[1-1]:TRACe[1-1]:ALLMarker:ACTive <numeric>
:CALCulate:PN[1-1]:TRACe[1-1]:ALLMarker:ACTive?

Description Selects active marker

Parameter

	<Numeric>
Range	1 to 10
Preset value	1
Unit	-
Resolution	-

Equivalent key No equivalent key is available on the front panel.

:CALCulate:PN[1-1]:TRACe[1-1]:ALLMarker:SEARch:DOMain:X

Syntax :CALCulate:PN[1-1]:TRACe[1-1]:ALLMarker:SEARch:DOMain:X
{FRANge|BDMarker}
:CALCulate:PN[1-1]:TRACe[1-1]:ALLMarker:SEARch:DOMain:X?

Description Sets/Reads marker search range (X-axis)

Parameter

	Description
FRANge(Preset value)	Set marker search range (X-axis) to 'Full Range'
BDMarker	Set marker search range (X-axis) to 'Band Marker'

Equivalent key PN Menu -> Marker Search -> Search Range (X)

:CALCulate:PN[1-1]:TRACe[1-1]:ALLMarker:SEARch:DOMain:Y

Syntax :CALCulate:PN[1-1]:TRACe[1-1]:ALLMarker:SEARch:DOMain:Y
{FRANge|BDMarker}
:CALCulate:PN[1-1]:TRACe[1-1]:ALLMarker:SEARch:DOMain:Y?

Description Sets/Reads marker search range (Y-axis)

Parameter

	Description
FRANge(Preset value)	Set marker search range (Y-axis) to 'Full Range'
BDMarker	Set marker search range (Y-axis) to 'Band Marker'

Equivalent key

PN Menu -> Marker Search -> Search Range (Y)

:CALCulate:PN[1-1]:TRACe[1-1]:ALLMarker:SEARch:PEAK

Syntax

:CALCulate:PN[1-1]:TRACe[1-1]:ALLMarker:SEARch:PEAK

Description

Executes marker search all (No Query)

Equivalent key

PN Menu -> Marker Search -> Peak -> Search Peak All

:CALCulate:PN[1-1]:TRACe[1-1]:BDMarker:X:CENTer

Syntax

:CALCulate:PN[1-1]:TRACe[1-1]:BDMarker:X:CENTer <numeric>
:CALCulate:PN[1-1]:TRACe[1-1]:BDMarker:X:CENTer?

Description

Sets/Reads the center value of bandmarker X

Parameter

	<Numeric>
Range	-1T to 1T
Preset value	0
Unit	-
Resolution	-

Equivalent key

PN Menu -> Marker Function -> Band Marker X -> Center
PN Menu -> Marker Search -> Band Marker X -> Center

:CALCulate:PN[1-1]:TRACe[1-1]:BDMarker:X:SPAN

Syntax

:CALCulate:PN[1-1]:TRACe[1-1]:BDMarker:X:SPAN <numeric>
:CALCulate:PN[1-1]:TRACe[1-1]:BDMarker:X:SPAN?

Description

Sets/Reads the span value of bandmarker X

Parameter

	<Numeric>
Range	0 to 2T
Preset value	2T
Unit	-
Resolution	-

Equivalent key

PN Menu -> Marker Function -> Band Marker X -> Span

PN Menu -> Marker Search -> Band Marker X -> Span

:CALCulate:PN[1-1]:TRACe[1-1]:BDMarker:X:STARt

Syntax

:CALCulate:PN[1-1]:TRACe[1-1]:BDMarker:X:STARt <numeric>

:CALCulate:PN[1-1]:TRACe[1-1]:BDMarker:X:STARt?

Description

Sets/Reads the start value of bandmarker X

Parameter

	<Numeric>
Range	-1T to 1T
Preset value	-1T
Unit	-
Resolution	-

Equivalent key

PN Menu -> Marker Function -> Band Marker X -> Start

PN Menu -> Marker Search -> Band Marker X -> Start

:CALCulate:PN[1-1]:TRACe[1-1]:BDMarker:X:STATe

Syntax

:CALCulate:PN[1-1]:TRACe[1-1]:BDMarker:X:STATe {ON|OFF|1|0}

:CALCulate:PN[1-1]:TRACe[1-1]:BDMarker:X:STATe?

Description

Turns on/off bandmarker X

Parameter

	Description
ON or 1	Set bandmarker X mode 'ON'

	Description
OFF or 0(Preset value)	Set bandmarker X mode 'OFF'

Equivalent key PN Menu -> Marker Function -> Band Marker X -> Band Marker X
PN Menu -> Marker Search -> Band Marker X -> Band Marker X

:CALCulate:PN[1-1]:TRACe[1-1]:BDMarker:X:STOP

Syntax :CALCulate:PN[1-1]:TRACe[1-1]:BDMarker:X:STOP <numeric>
:CALCulate:PN[1-1]:TRACe[1-1]:BDMarker:X:STOP?

Description Sets/Reads the stop value of bandmarker X

Parameter

	<Numeric>
Range	-1T to 1T
Preset value	1T
Unit	-
Resolution	-

Equivalent key PN Menu -> Marker Function -> Band Marker X -> Stop
PN Menu -> Marker Search -> Band Marker X -> Stop

:CALCulate:PN[1-1]:TRACe[1-1]:BDMarker:Y:CENTer

Syntax :CALCulate:PN[1-1]:TRACe[1-1]:BDMarker:Y:CENTer <numeric>
:CALCulate:PN[1-1]:TRACe[1-1]:BDMarker:Y:CENTer?

Description Sets/Reads the center value of bandmarker Y

Parameter

	<Numeric>
Range	-1T to 1T
Preset value	0
Unit	-
Resolution	-

Equivalent key PN Menu -> Marker Function -> Band Marker Y -> Center

PN Menu -> Marker Search -> Band Marker Y -> Center

:CALCulate:PN[1-1]:TRACe[1-1]:BDMarker:Y:SPAN

Syntax :CALCulate:PN[1-1]:TRACe[1-1]:BDMarker:Y:SPAN <numeric>
:CALCulate:PN[1-1]:TRACe[1-1]:BDMarker:Y:SPAN?

Description Sets/Reads the span value of bandmarker Y

Parameter

	<Numeric>
Range	0 to 2T
Preset value	2T
Unit	-
Resolution	-

Equivalent key PN Menu -> Marker Function -> Band Marker Y -> Span
PN Menu -> Marker Search -> Band Marker Y -> Span

:CALCulate:PN[1-1]:TRACe[1-1]:BDMarker:Y:START

Syntax :CALCulate:PN[1-1]:TRACe[1-1]:BDMarker:Y:START <numeric>
:CALCulate:PN[1-1]:TRACe[1-1]:BDMarker:Y:START?

Description Sets/Reads the start value of bandmarker Y

Parameter

	<Numeric>
Range	-1T to 1T
Preset value	-1T
Unit	-
Resolution	-

Equivalent key PN Menu -> Marker Function -> Band Marker Y -> Start
PN Menu -> Marker Search -> Band Marker Y -> Start

:CALCulate:PN[1-1]:TRACe[1-1]:BDMarker:Y:STATe

Syntax :CALCulate:PN[1-1]:TRACe[1-1]:BDMarker:Y:STATe {ON|OFF|1|0}
:CALCulate:PN[1-1]:TRACe[1-1]:BDMarker:Y:STATe?

Description Turns on/off bandmarker Y

Parameter

	Description
ON or 1	Set bandmarker Y mode 'ON'
OFF or 0(Preset value)	Set bandmarker Y mode 'OFF'

Equivalent key PN Menu -> Marker Function -> Band Marker Y -> Band Marker Y
PN Menu -> Marker Search -> Band Marker Y -> Band Marker Y

:CALCulate:PN[1-1]:TRACe[1-1]:BDMarker:Y:STOP

Syntax :CALCulate:PN[1-1]:TRACe[1-1]:BDMarker:Y:STOP <numeric>
:CALCulate:PN[1-1]:TRACe[1-1]:BDMarker:Y:STOP?

Description Sets/Reads the stop value of bandmarker Y

Parameter

	<Numeric>
Range	-1T to 1T
Preset value	1T
Unit	-
Resolution	-

Equivalent key PN Menu -> Marker Function -> Band Marker Y -> Stop
PN Menu -> Marker Search -> Band Marker Y -> Stop

:CALCulate:PN[1-1]:TRACe[1-1]:DATA:COPY

Syntax :CALCulate:PN[1-1]:TRACe[1-1]:DATA:COPY <numeric>

Description Copies trace data to the user trace (No Query)

Parameter

	<Numeric>
Range	1 to 8
Preset value	-
Unit	-

	<Numeric>
Resolution	-

NOTE The annotation of a trace (carrier frequency and level) is copied into the trace's annotation area of a copy destination in the user window.

Equivalent key PN Menu -> Trace View-> Copy to USER -> Copy to USER1
 PN Menu -> Trace View-> Copy to USER -> Copy to USER2
 PN Menu -> Trace View-> Copy to USER -> Copy to USER3
 PN Menu -> Trace View-> Copy to USER -> Copy to USER4
 PN Menu -> Trace View-> Copy to USER -> Copy to USER5
 PN Menu -> Trace View-> Copy to USER -> Copy to USER6
 PN Menu -> Trace View-> Copy to USER -> Copy to USER7
 PN Menu -> Trace View-> Copy to USER -> Copy to USER8

:CALCulate:PN[1-1]:TRACe[1-1]:DATA:FDATA

Syntax :CALCulate:PN[1-1]:TRACe[1-1]:DATA:FDATA <array>
 :CALCulate:PN[1-1]:TRACe[1-1]:DATA:FDATA?

Description Sets/Gets formatted trace data

Parameter

	<Description>
Range	1...1601
Preset value	-
Unit	-
Resolution	-

Equivalent key No equivalent key is available on the front panel.

:CALCulate:PN[1-1]:TRACe[1-1]:DATA:FMEMory

Syntax :CALCulate:PN[1-1]:TRACe[1-1]:DATA:FMEMory <array>
 :CALCulate:PN[1-1]:TRACe[1-1]:DATA:FMEMory?

Description Sets/Gets formatted memory data

Parameter

	<Description>
Range	1...1601
Preset value	-
Unit	-
Resolution	-

Equivalent key

No equivalent key is available on the front panel.

:CALCulate:PN[1-1]:TRACe[1-1]:DATA:PDATa

Syntax

:CALCulate:PN[1-1]:TRACe[1-1]:DATA:PDATa <array>

:CALCulate:PN[1-1]:TRACe[1-1]:DATA:PDATa?

Description

Sets/Reads unformatted trace power data (dBc)

Parameter

	<Description>
Range	1...1601
Preset value	-
Unit	-
Resolution	-

Equivalent key

No equivalent key is available on the front panel.

:CALCulate:PN[1-1]:TRACe[1-1]:DATA:PMEMory

Syntax

:CALCulate:PN[1-1]:TRACe[1-1]:DATA:PMEMory <array>

:CALCulate:PN[1-1]:TRACe[1-1]:DATA:PMEMory?

Description

Sets/Reads unformatted memory power data (dBc)

Parameter

	<Description>
Range	1...1601
Preset value	-
Unit	-

	<Description>
Resolution	-

Equivalent key No equivalent key is available on the front panel.

:CALCulate:PN[1-1]:TRACe[1-1]:DATA:SDATa

Syntax :CALCulate:PN[1-1]:TRACe[1-1]:DATA:SDATa

Description Reads the spurious judgement results (0/1) of trace data (Query Only)

Equivalent key No equivalent key is available on the front panel.

:CALCulate:PN[1-1]:TRACe[1-1]:DATA:SMEMory

Syntax :CALCulate:PN[1-1]:TRACe[1-1]:DATA:SMEMory

Description Reads the spurious judgement results (0/1) of memory data. (Query Only)

Equivalent key No equivalent key is available on the front panel.

:CALCulate:PN[1-1]:TRACe[1-1]:DATA:UDATa

Syntax :CALCulate:PN[1-1]:TRACe[1-1]:DATA:UDATa <array>
:CALCulate:PN[1-1]:TRACe[1-1]:DATA:UDATa?

Description Sets/Gets unformatted trace data

Parameter

	<Description>
Range	1...1601
Preset value	-
Unit	-
Resolution	-

Equivalent key No equivalent key is available on the front panel.

:CALCulate:PN[1-1]:TRACe[1-1]:DATA:UMEMory

Syntax :CALCulate:PN[1-1]:TRACe[1-1]:DATA:UMEMory <array>
:CALCulate:PN[1-1]:TRACe[1-1]:DATA:UMEMory?

Description Sets/Gets unformatted memory data

Parameter

	<Description>
Range	1...1601
Preset value	-
Unit	-
Resolution	-

Equivalent key

No equivalent key is available on the front panel.

:CALCulate:PN[1-1]:TRACe[1-1]:FUNCtion:AVARiance:DATA

Syntax

:CALCulate:PN[1-1]:TRACe[1-1]:FUNCtion:AVARiance:DATA? <numeric 1>, <numeric 2>

Description

Reads specified average time, Allan avariance, and jitter at cut-off frequency from trace data (Query Only)

Parameter

	<Numeric 1>	<Numeric 2>
Description	Specified average time	Cut-off frequency
Range	1 n to 1 k	0 to 1 G
Preset value	-	-
Unit	-	-
Resolution	-	-

Examples

```

10 REAL Avg_time,Fcutoff
20 REAL Avariance,Jitter
30!
40 Avg_time=1.00E-1      ! average time      : 100 msec
50 Fcutoff=1.E+6        ! cut off frequency : 1 MHz
60!
70 OUTPUT 717;":CALCulate:PN:TRACe:FUNCtion:AVARiance:DATA? ";Avg_time,Fcutoff
80 ENTER 717;Avariance,Jitter
90 END

```

Equivalent key

No equivalent key is available on the front panel.

:CALCulate:PN[1-1]:TRACe[1-1]:FUNCtion:AVARiance:MEMory

Syntax

:CALCulate:PN[1-1]:TRACe[1-1]:FUNCtion:AVARiance:MEMory? <numeric 1>,

<numeric 2>

Description Reads specified average time, Allan avariance, and jitter at cut-off frequency from trace memory (Query Only)

Parameter

	<Numeric 1>	<Numeric 2>
Description	Specified average time	Cut-off frequency
Range	0 to 9.9e+37	0 to 9.9e+37
Preset value	-	-
Unit	-	-
Resolution	-	-

Examples

```

10 REAL Avg_time,Fcutoff
20 REAL Avariance,Jitter
30!
40 Avg_time=5.00E-1      ! average time      : 500 msec
50 Fcutoff=3.00E+8      ! cut off frequency : 300 MHz
60!
70 OUTPUT 717;":CALCulate:PN:TRACe:FUNCtion:AVARiance:MEMory? ";Avg_time,Fcutoff
80 ENTER 717;Avariance,Jitter
90 END

```

Equivalent key No equivalent key is available on the front panel.

:CALCulate:PN[1-1]:TRACe[1-1]:FUNCtion:DOMain:X

Syntax :CALCulate:PN[1-1]:TRACe[1-1]:FUNCtion:DOMain:X {FRANge|BDMarker}
:CALCulate:PN[1-1]:TRACe[1-1]:FUNCtion:DOMain:X?

Description Sets/Reads analysis/search range (X-axis)

Parameter

	Description
FRANge	Set analysis/search range (X-axis) to 'Full Range'
BDMarker(Preset value)	Set analysis/search range (X-axis) to 'Band Marker'

Equivalent key PN Menu -> Marker Function -> Analysis Range (X)

:CALCulate:PN[1-1]:TRACe[1-1]:FUNCtion:DOMain:Y

Syntax :CALCulate:PN[1-1]:TRACe[1-1]:FUNCtion:DOMain:Y {FRANge|BDMarker}

:CALCulate:PN[1-1]:TRACe[1-1]:FUNCTion:DOMain:Y?

Description Sets/Reads analysis/search range (Y-axis)

Parameter

	Description
FRANge	Set analysis/search range (Y-axis) to 'Full Range'
BDMarker(Preset value)	Set analysis/search range (Y-axis) to 'Band Marker'

Equivalent key PN Menu -> Marker Function -> Analysis Range (Y)

:CALCulate:PN[1-1]:TRACe[1-1]:FUNCTion:INTEgral:DATA

Syntax :CALCulate:PN[1-1]:TRACe[1-1]:FUNCTion:INTEgral:DATA

Description Reads the integrated phase noise, frequency range, RMS noise, RMS jitter, and residual FM of trace data. (Query Only)

Equivalent key No equivalent key is available on the front panel.

:CALCulate:PN[1-1]:TRACe[1-1]:FUNCTion:INTEgral:MEMORY

Syntax :CALCulate:PN[1-1]:TRACe[1-1]:FUNCTion:INTEgral:MEMORY

Description Reads integrated phase noise, frequency range, RMS noise, RMS jitter, and residual FM of memory data. (Query Only)

Equivalent key No equivalent key is available on the front panel.

:CALCulate:PN[1-1]:TRACe[1-1]:FUNCTion:STATistics:DATA

Syntax :CALCulate:PN[1-1]:TRACe[1-1]:FUNCTion:STATistics:DATA

Description Reads the results of statistical analysis for the data trace (Query Only)

Equivalent key No equivalent key is available on the front panel.

:CALCulate:PN[1-1]:TRACe[1-1]:FUNCTion:STATistics:MEMORY

Syntax :CALCulate:PN[1-1]:TRACe[1-1]:FUNCTion:STATistics:MEMORY

Description Reads the results of statistical analysis for the memory trace (Query Only)

Equivalent key No equivalent key is available on the front panel.

:CALCulate:PN[1-1]:TRACe[1-1]:FUNCtion:TYPE

Syntax :CALCulate:PN[1-1]:TRACe[1-1]:FUNCtion:TYPE {OFF|STATistics|INTegral}
:CALCulate:PN[1-1]:TRACe[1-1]:FUNCtion:TYPE?

Description Sets/Reads analysis type

Parameter

	Description
OFF(Preset value)	Set analysis type to 'Off'
STATistics	Set analysis type to 'Statistics'
INTegral	Set analysis type to 'Integral'

Equivalent key PN Menu -> Marker Function -> Analysis Type

:CALCulate:PN[1-1]:TRACe[1-1]:HOLD

Syntax :CALCulate:PN[1-1]:TRACe[1-1]:HOLD {OFF|MAXimum|MINimum}
:CALCulate:PN[1-1]:TRACe[1-1]:HOLD?

Description Selects/Reads trace data hold type

Parameter

	Description
OFF(Preset value)	Set data hold to 'Off'
MAXimum	Set data hold to 'Maximum'
MINimum	Set data hold to 'Minimum'

Equivalent key PN Menu -> Trace View -> Data Hold

:CALCulate:PN[1-1]:TRACe[1-1]:LIMit:FAIL

Syntax :CALCulate:PN[1-1]:TRACe[1-1]:LIMit:FAIL

Description Reads out the limit test result (Query Only)

Parameter

	Description
ON or 1	The limit test result is fail
OFF or 0(Preset value)	The limit test result is pass

When the limit test is set to OFF, OFF or 0 is always read out.

Equivalent key

No equivalent key is available on the front panel.

:CALCulate:PN[1-1]:TRACe[1-1]:LIMit:LOWer:LDATa

Syntax

:CALCulate:PN[1-1]:TRACe[1-1]:LIMit:LOWer:LDATa <array>

:CALCulate:PN[1-1]:TRACe[1-1]:LIMit:LOWer:LDATa?

Description

Sets/Reads the lower limit values of all measurement points

Parameter

	<Description>
Range	1...1601
Preset value	-
Unit	-
Resolution	-

Equivalent key

No equivalent key is available on the front panel.

**:CALCulate:PN[1-1]:TRACe[1-1]:LIMit:LOWer:SEGMENT
:CLEAr**

Syntax

:CALCulate:PN[1-1]:TRACe[1-1]:LIMit:LOWer:SEGMENT:CLEAr

Description

Clears the lower limit line (No Query)

Equivalent key

PN Menu -> Display-> Limit Test -> Delete Lower Limit Line

**:CALCulate:PN[1-1]:TRACe[1-1]:LIMit:LOWer:SEGMENT
:COUNT**

Syntax

:CALCulate:PN[1-1]:TRACe[1-1]:LIMit:LOWer:SEGMENT:COUNT <numeric>

:CALCulate:PN[1-1]:TRACe[1-1]:LIMit:LOWer:SEGMENT:COUNT?

Description

Sets/Reads the number of segments in the lower limit line

Parameter

	<Numeric>
Range	1 to 100
Preset value	1
Unit	-
Resolution	-

Equivalent key No equivalent key is available on the front panel.

:CALCulate:PN[1-1]:TRACe[1-1]:LIMit:LOWer:SEGment:DATA

Syntax :CALCulate:PN[1-1]:TRACe[1-1]:LIMit:LOWer:SEGment:DATA <array>
:CALCulate:PN[1-1]:TRACe[1-1]:LIMit:LOWer:SEGment:DATA?

Description Sets/Reads segment data of the lower limit line

Parameter

	<Description>
Range	1...400
Preset value	-
Unit	-
Resolution	-

Equivalent key No equivalent key is available on the front panel.

:CALCulate:PN[1-1]:TRACe[1-1]:LIMit:REPort[:DATA]

Syntax :CALCulate:PN[1-1]:TRACe[1-1]:LIMit:REPort[:DATA]

Description Reads the limit test results of all measurement points in selected traces (Query Only)

Equivalent key No equivalent key is available on the front panel.

:CALCulate:PN[1-1]:TRACe[1-1]:LIMit[:STATe]

Syntax :CALCulate:PN[1-1]:TRACe[1-1]:LIMit[:STATe] {ON|OFF|1|0}
:CALCulate:PN[1-1]:TRACe[1-1]:LIMit[:STATe]?

Description Turns on/off the limit test function

Parameter

	Description
ON or 1	Turn on the limit test function mode
OFF or 0(Preset value)	Turn off the limit test function mode

Equivalent key PN Menu -> Display -> Limit Test -> Limit Test

:CALCulate:PN[1-1]:TRACe[1-1]:LIMit:UPPer:LDATa

Syntax :CALCulate:PN[1-1]:TRACe[1-1]:LIMit:UPPer:LDATa <array>
:CALCulate:PN[1-1]:TRACe[1-1]:LIMit:UPPer:LDATa?

Description Sets/Reads the upper limit values of all measurement points

Parameter

	<Description>
Range	1...1601
Preset value	-
Unit	-
Resolution	-

Equivalent key No equivalent key is available on the front panel.

:CALCulate:PN[1-1]:TRACe[1-1]:LIMit:UPPer:SEGMENT:CLEAr

Syntax :CALCulate:PN[1-1]:TRACe[1-1]:LIMit:UPPer:SEGMENT:CLEAr

Description Clears the upper limit line (No Query)

Equivalent key PN Menu -> Display-> Limit Test -> Delete Upper Limit Line

:CALCulate:PN[1-1]:TRACe[1-1]:LIMit:UPPer:SEGMENT:COUNT

Syntax :CALCulate:PN[1-1]:TRACe[1-1]:LIMit:UPPer:SEGMENT:COUNT <numeric>
:CALCulate:PN[1-1]:TRACe[1-1]:LIMit:UPPer:SEGMENT:COUNT?

Description Sets/Reads the number of segments in the upper limit line

Parameter

	<Numeric>
Range	1 to 100
Preset value	1
Unit	-
Resolution	-

Equivalent key No equivalent key is available on the front panel.

:CALCulate:PN[1-1]:TRACe[1-1]:LIMit:UPPer:SEGMENT:DATA

Syntax :CALCulate:PN[1-1]:TRACe[1-1]:LIMit:UPPer:SEGMENT:DATA <array>
:CALCulate:PN[1-1]:TRACe[1-1]:LIMit:UPPer:SEGMENT:DATA?

Description Sets/Reads segment data of the upper limit line

Parameter

	<Description>
Range	1...400
Preset value	-
Unit	-
Resolution	-

Equivalent key No equivalent key is available on the front panel.

:CALCulate:PN[1-1]:TRACe[1-1]:MARKer[1-10]:SEARCh:EXECute:LPEak

Syntax :CALCulate:PN[1-1]:TRACe[1-1]:MARKer[1-10]:SEARCh:EXECute:LPEak

Description Executes marker peak search left (No Query)

Equivalent key PN Menu -> Marker Search -> Peak -> Search Left

:CALCulate:PN[1-1]:TRACe[1-1]:MARKer[1-10]:SEARCh:EXECute:LTARget

Syntax :CALCulate:PN[1-1]:TRACe[1-1]:MARKer[1-10]:SEARCh:EXECute:LTARget

Description Executes marker target search left (No Query)

Equivalent key PN Menu -> Marker Search -> Target -> Search Left

**:CALCulate:PN[1-1]:TRACe[1-1]:MARKer[1-10]:SEARch:
EXECute:MAXimum**

Syntax :CALCulate:PN[1-1]:TRACe[1-1]:MARKer[1-10]:SEARch:EXECute:MAXimum

Description Executes marker search maximum (No Query)

Equivalent key PN Menu -> Marker Search -> Search Max

**:CALCulate:PN[1-1]:TRACe[1-1]:MARKer[1-10]:SEARch:
EXECute:MINimum**

Syntax :CALCulate:PN[1-1]:TRACe[1-1]:MARKer[1-10]:SEARch:EXECute:MINimum

Description Executes marker search minimum (No Query)

Equivalent key PN Menu -> Marker Search -> Search Min

**:CALCulate:PN[1-1]:TRACe[1-1]:MARKer[1-10]:SEARch:
EXECute:PEAK**

Syntax :CALCulate:PN[1-1]:TRACe[1-1]:MARKer[1-10]:SEARch:EXECute:PEAK

Description Executes marker peak search (No Query)

Equivalent key PN Menu -> Marker Search -> Peak -> Search Peak

**:CALCulate:PN[1-1]:TRACe[1-1]:MARKer[1-10]:SEARch:
EXECute:RPEak**

Syntax :CALCulate:PN[1-1]:TRACe[1-1]:MARKer[1-10]:SEARch:EXECute:RPEak

Description Executes marker peak search right (No Query)

Equivalent key PN Menu -> Marker Search -> Peak -> Search Right

**:CALCulate:PN[1-1]:TRACe[1-1]:MARKer[1-10]:SEARch:
EXECute:RTARget**

Syntax :CALCulate:PN[1-1]:TRACe[1-1]:MARKer[1-10]:SEARch:EXECute:RTARget

Description Executes marker target search right (No Query)

Equivalent key PN Menu -> Marker Search -> Target -> Search Right

:CALCulate:PN[1-1]:TRACe[1-1]:MARKer[1-10]:SEARch:EXECute:TARGet

Syntax :CALCulate:PN[1-1]:TRACe[1-1]:MARKer[1-10]:SEARch:EXECute:TARGet
 Description Executes marker target search (No Query)
 Equivalent key PN Menu -> Marker Search -> Target -> Search Target

:CALCulate:PN[1-1]:TRACe[1-1]:MARKer[1-10]:SEARch:PEAK:EXCursion

Syntax :CALCulate:PN[1-1]:TRACe[1-1]:MARKer[1-10]:SEARch:PEAK:EXCursion
 <numeric>
 :CALCulate:PN[1-1]:TRACe[1-1]:MARKer[1-10]:SEARch:PEAK:EXCursion?

Description Sets/Reads the peak excursion value

Parameter

	<Numeric>
Range	0 to 10G
Preset value	0
Unit	-
Resolution	-

Equivalent key PN Menu -> Marker Search -> Peak -> Peak Excursion

:CALCulate:PN[1-1]:TRACe[1-1]:MARKer[1-10]:SEARch:PEAK:POLarity

Syntax :CALCulate:PN[1-1]:TRACe[1-1]:MARKer[1-10]:SEARch:PEAK:POLarity
 {POSitive|NEGative|BOTH}
 :CALCulate:PN[1-1]:TRACe[1-1]:MARKer[1-10]:SEARch:PEAK:POLarity?

Description Sets/Reads the marker peak-search polarity

Parameter

	Description
POSitive(Preset value)	Set the marker peak-search polarity to 'Positive'
NEGative	Set the marker peak-search polarity to 'Negative'

	Description
BOTH	Set the marker peak-search polarity to 'Both'

Equivalent key PN Menu -> Marker Search -> Peak -> Peak Polarity

:CALCulate:PN[1-1]:TRACe[1-1]:MARKer[1-10]:SEARch:TARGET:TRANSition

Syntax :CALCulate:PN[1-1]:TRACe[1-1]:MARKer[1-10]:SEARch:TARGET:TRANSition
{POSitive|NEGative|BOTH}
:CALCulate:PN[1-1]:TRACe[1-1]:MARKer[1-10]:SEARch:TARGET:TRANSition?

Description Sets/Reads the target transition definition

Parameter

	Description
POSitive	Set the target transition definition to 'Positive'
NEGative	Set the target transition definition to 'Negative'
BOTH(Preset value)	Set the target transition definition to 'Both'

Equivalent key PN Menu -> Marker Search -> Target -> Search Transition

:CALCulate:PN[1-1]:TRACe[1-1]:MARKer[1-10]:SEARch:TARGET:Y

Syntax :CALCulate:PN[1-1]:TRACe[1-1]:MARKer[1-10]:SEARch:TARGET:Y <numeric>
:CALCulate:PN[1-1]:TRACe[1-1]:MARKer[1-10]:SEARch:TARGET:Y?

Description Sets/Reads the marker target value

Parameter

	<Numeric>
Range	-10G to 10G
Preset value	0
Unit	-
Resolution	-

Equivalent key PN Menu -> Marker Search -> Target -> Search Value

:CALCulate:PN[1-1]:TRACe[1-1]:MARKer[1-10]:SEARCh:TRACking:TYPE

Syntax :CALCulate:PN[1-1]:TRACe[1-1]:MARKer[1-10]:SEARCh:TRACking:TYPE {OFF|MAXimum|MINimum|PEAK|TARGet}
:CALCulate:PN[1-1]:TRACe[1-1]:MARKer[1-10]:SEARCh:TRACking:TYPE?

Description Sets/Reads marker tracking type

Parameter

	Description
OFF(Preset value)	Set marker tracking type to 'Off'
MAXimum	Set marker tracking type to 'Maximum'
MINimum	Set marker tracking type to 'Minimum'
PEAK	Set marker tracking type to 'Peak'
TARGet	Set marker tracking type to 'Target'

Equivalent key PN Menu -> Marker Search -> Tracking

:CALCulate:PN[1-1]:TRACe[1-1]:MARKer[1-10]:STATe

Syntax :CALCulate:PN[1-1]:TRACe[1-1]:MARKer[1-10]:STATe {ON|OFF|1|0}
:CALCulate:PN[1-1]:TRACe[1-1]:MARKer[1-10]:STATe?

Description Turns on/off markers

Parameter

	Description
ON or 1	Set markers mode 'ON'
OFF or 0(Preset value)	Set markers mode 'OFF'

Equivalent key PN Menu -> Marker -> Clear Marker Menu -> Marker 1

:CALCulate:PN[1-1]:TRACe[1-1]:MARKer[1-10]:X

Syntax :CALCulate:PN[1-1]:TRACe[1-1]:MARKer[1-10]:X <numeric>
:CALCulate:PN[1-1]:TRACe[1-1]:MARKer[1-10]:X?

Description Sets/Reads the marker X value

Parameter

	<Numeric>
Range	-
Preset value	1k
Unit	-
Resolution	-

Equivalent key No equivalent key is available on the front panel.

:CALCulate:PN[1-1]:TRACe[1-1]:MARKer[1-10]:Y

Syntax :CALCulate:PN[1-1]:TRACe[1-1]:MARKer[1-10]:Y

Description Reads the marker Y value (Query Only)

Equivalent key No equivalent key is available on the front panel.

:CALCulate:PN[1-1]:TRACe[1-1]:MATH:FUNCTION

Syntax :CALCulate:PN[1-1]:TRACe[1-1]:MATH:FUNCTION
{NORMal|SUBTract|DIVide|ADD|MULTiply}
:CALCulate:PN[1-1]:TRACe[1-1]:MATH:FUNCTION?

Description Selects/Reads math operation type

Parameter

	Description
NORMal(Preset value)	Set math operation type to 'Off'
SUBTract	Set math operation type to 'Dat - Mem'
DIVide	Set math operation type to 'Dat / Mem'
ADD	Set math operation type to 'Dat + Mem'
MULTiply	Set math operation type to 'Dat * Mem'

Equivalent key PN Menu -> Trace View -> Data Math

:CALCulate:PN[1-1]:TRACe[1-1]:MATH:MEMorize

Syntax :CALCulate:PN[1-1]:TRACe[1-1]:MATH:MEMorize

Description Copies data to memory (No Query)

Equivalent key No equivalent key is available on the front panel.

:CALCulate:PN[1-1]:TRACe[1-1]:MATH:OFFSet

Syntax :CALCulate:PN[1-1]:TRACe[1-1]:MATH:OFFSet <numeric>
:CALCulate:PN[1-1]:TRACe[1-1]:MATH:OFFSet?

Description Sets/Reads the offset value of the trace

Parameter

	<Numeric>
Description	Offset value of the trace
Range	-500 G to 500 G
Preset value	0
Unit	-
Resolution	-

Equivalent key PN Menu -> Trace View -> Offset
PN Menu -> Trace View -> [Marker -> -Offset]

:CALCulate:PN[1-1]:TRACe[1-1]:SMOothing:APERture

Syntax :CALCulate:PN[1-1]:TRACe[1-1]:SMOothing:APERture <numeric>
:CALCulate:PN[1-1]:TRACe[1-1]:SMOothing:APERture?

Description Sets/Reads the smoothing aperture value

Parameter

	<Numeric>
Range	50m to 25
Preset value	1.5
Unit	%
Resolution	-

Equivalent key PN Menu -> Trace View -> Aperture

:CALCulate:PN[1-1]:TRACe[1-1]:SMOothing:STATe

Syntax :CALCulate:PN[1-1]:TRACe[1-1]:SMOothing:STATe {ON|OFF|1|0}

:CALCulate:PN[1-1]:TRACe[1-1]:SMOothing:STATe?

Description Turns on/off smoothing mode

Parameter

	Description
ON or 1	Set smoothing mode to 'ON'
OFF or 0(Preset value)	Set smoothing mode to 'OFF'

Equivalent key PN Menu -> Trace View -> Smoothing

:CALCulate:PN[1-1]:TRACe[1-1]:SPURious:OMISSion

Syntax :CALCulate:PN[1-1]:TRACe[1-1]:SPURious:OMISSion {ON|OFF|1|0}

:CALCulate:PN[1-1]:TRACe[1-1]:SPURious:OMISSion?

Description Turns on.off spurious omission mode

Parameter

	Description
ON or 1	Set spurious omission mode to 'ON'
OFF or 0(Preset value)	Set spurious omission mode to 'OFF'

Equivalent key PN Menu -> Trace View -> Spurious -> Omit

:CALCulate:PN[1-1]:TRACe[1-1]:SPURious:POWER

Syntax :CALCulate:PN[1-1]:TRACe[1-1]:SPURious:POWER {ON|OFF|1|0}

:CALCulate:PN[1-1]:TRACe[1-1]:SPURious:POWER?

Description Turns on/off the spurious power value display

Parameter

	Description
ON or 1	Turn on the spurious power value display mode
OFF or 0(Preset value)	Turn off the spurious power value display mode

Equivalent key PN Menu -> Trace View-> Spurious -> Power (dBc)

:CALCulate:PN[1-1]:TRACe[1-1]:SPURious:THReshold:LEVel:MINimum

Syntax :CALCulate:PN[1-1]:TRACe[1-1]:SPURious:THReshold:LEVel:MINimum <numeric>
:CALCulate:PN[1-1]:TRACe[1-1]:SPURious:THReshold:LEVel:MINimum?

Description Sets/Reads the minimum spurious level when the spurious elimination function and the power value display are on.

Parameter

	<Numeric>
Range	-500 to 500
Preset value	-500
Unit	dBc
Resolution	-

Equivalent key PN Menu -> Trace View -> Spurious -> Minimum Spur Level

:CALCulate:PN[1-1]:TRACe[1-1]:SPURious:THReshold:TABLE:CLEar

Syntax :CALCulate:PN[1-1]:TRACe[1-1]:SPURious:THReshold:TABLE:CLEar

Description Clears the threshold data (No Query)

Equivalent key PN Menu -> Trace View-> Spurious -> Clear Threshold Table

:CALCulate:PN[1-1]:TRACe[1-1]:SPURious:THReshold:TABLE:COUNT

Syntax :CALCulate:PN[1-1]:TRACe[1-1]:SPURious:THReshold:TABLE:COUNT <numeric>
:CALCulate:PN[1-1]:TRACe[1-1]:SPURious:THReshold:TABLE:COUNT?

Description Sets/Reads the number of segments in the threshold data

Parameter

	<Numeric>
Range	1 to 20
Preset value	1
Unit	-

	<Numeric>
Resolution	-

Equivalent key No equivalent key is available on the front panel.

:CALCulate:PN[1-1]:TRACe[1-1]:SPURious:THReshold:TABLE:DATA

Syntax :CALCulate:PN[1-1]:TRACe[1-1]:SPURious:THReshold:TABLE:DATA <array>
:CALCulate:PN[1-1]:TRACe[1-1]:SPURious:THReshold:TABLE:DATA?

Description Sets/Reads the threshold data

Parameter

	<Description>
Range	1...60
Preset value	-
Unit	-
Resolution	-

Equivalent key No equivalent key is available on the front panel.

:CALCulate:SP[1-1]:ALLTrace:LIMit:FAIL

Syntax :CALCulate:SP[1-1]:ALLTrace:LIMit:FAIL

Description Reads out the limit test result (Query Only)

Parameter

	Description
ON or 1	The limit test result is fail
OFF or 0(Preset value)	The limit test result is pass

When the limit test is set to OFF, OFF or 0 is always read out.

Equivalent key No equivalent key is available on the front panel.

:CALCulate:SP[1-1]:ALLTrace:MARKer:COUPlE:STATe

Syntax :CALCulate:SP[1-1]:ALLTrace:MARKer:COUPlE:STATe {ON|OFF|1|0}

:CALCulate:SP[1-1]:ALLTrace:MARKer:COUPlE:STATe?

Description Turns on/off marker coupling function

Parameter

	Description
ON or 1	Set marker coupling function mode to 'ON'
OFF or 0(Preset value)	Set marker coupling function mode to 'OFF'

Equivalent key No equivalent key is available on the front panel.

:CALCulate:SP[1-1]:ALLTrace:MARKer:DISCrete:STATe

Syntax :CALCulate:SP[1-1]:ALLTrace:MARKer:DISCrete:STATe {ON|OFF|1|0}

:CALCulate:SP[1-1]:ALLTrace:MARKer:DISCrete:STATe?

Description Sets/Reads marker movement (Continuous/Discrete)

Parameter

	Description
ON or 1	Set marker movement (Continuous/Discrete) mode to 'ON'
OFF or 0(Preset value)	Set marker movement (Continuous/Discrete) mode to 'OFF'

Equivalent key SP Menu -> Marker -> More Functions -> Discrete

:CALCulate:SP[1-1]:ALLTrace:MARKer:REFEreNce:NUMBer

Syntax :CALCulate:SP[1-1]:ALLTrace:MARKer:REFEreNce:NUMBer <numeric>

:CALCulate:SP[1-1]:ALLTrace:MARKer:REFEreNce:NUMBer?

Description Sets/Reads marker reference number

Parameter

	<Numeric>
Range	1 to 10
Preset value	1
Unit	-

	<Numeric>
Resolution	-

Equivalent key SP Menu -> Marker -> More Functions -> Ref Marker

:CALCulate:SP[1-1]:ALLTrace:MARKer:REFerence:STATe

Syntax :CALCulate:SP[1-1]:ALLTrace:MARKer:REFerence:STATe {ON|OFF|1|0}
:CALCulate:SP[1-1]:ALLTrace:MARKer:REFerence:STATe?

Description Turns on/off delta marker mode

Parameter

	Description
ON or 1	Set delta marker mode mode to 'ON'
OFF or 0(Preset value)	Set delta marker mode mode to 'OFF'

Equivalent key SP Menu -> Marker -> More Functions -> Ref Marker Mode

:CALCulate:SP[1-1]:DATA:RDATA

Syntax :CALCulate:SP[1-1]:DATA:RDATA <array>
:CALCulate:SP[1-1]:DATA:RDATA?

Description Sets/Reads the raw data

Parameter

	<Description>
Range	1...1024
Preset value	-
Unit	-
Resolution	-

Equivalent key No equivalent key is available on the front panel.

:CALCulate:SP[1-1]:DATA:XDATA

Syntax :CALCulate:SP[1-1]:DATA:XDATA

Description Reads X-axis data (Query Only)

Equivalent key No equivalent key is available on the front panel.

:CALCulate:SP[1-1]:TRACe[1-1]:ALLMarker:ACTive

Syntax :CALCulate:SP[1-1]:TRACe[1-1]:ALLMarker:ACTive <numeric>
:CALCulate:SP[1-1]:TRACe[1-1]:ALLMarker:ACTive?

Description Selects active marker

Parameter

	<Numeric>
Range	1 to 10
Preset value	1
Unit	-
Resolution	-

Equivalent key No equivalent key is available on the front panel.

:CALCulate:SP[1-1]:TRACe[1-1]:ALLMarker:SEARch:DOMain:X

Syntax :CALCulate:SP[1-1]:TRACe[1-1]:ALLMarker:SEARch:DOMain:X
{FRANge|BDMarker}
:CALCulate:SP[1-1]:TRACe[1-1]:ALLMarker:SEARch:DOMain:X?

Description Sets/Reads marker search range (X-axis)

Parameter

	Description
FRANge(Preset value)	Set marker search range (X-axis) to 'Full Range'
BDMarker	Set marker search range (X-axis) to 'Band Marker'

Equivalent key SP Menu -> Marker Search -> Search Range (X)

:CALCulate:SP[1-1]:TRACe[1-1]:ALLMarker:SEARch:DOMain:Y

Syntax :CALCulate:SP[1-1]:TRACe[1-1]:ALLMarker:SEARch:DOMain:Y
{FRANge|BDMarker}

:CALCulate:SP[1-1]:TRACe[1-1]:ALLMarker:SEARch:DOMain:Y?

Description Sets/Reads marker search range (Y-axis)

Parameter

	Description
FRANge(Preset value)	Set marker search range (Y-axis) to 'Full Range'
BDMarker	Set marker search range (Y-axis) to 'Band Marker'

Equivalent key SP Menu -> Marker Search -> Search Range (Y)

:CALCulate:SP[1-1]:TRACe[1-1]:ALLMarker:SEARch:PEAK

Syntax :CALCulate:SP[1-1]:TRACe[1-1]:ALLMarker:SEARch:PEAK

Description Executes marker search all (No Query)

Equivalent key SP Menu -> Marker Search -> Peak -> Search Peak All

:CALCulate:SP[1-1]:TRACe[1-1]:BDMarker:X:CENTer

Syntax :CALCulate:SP[1-1]:TRACe[1-1]:BDMarker:X:CENTer <numeric>

:CALCulate:SP[1-1]:TRACe[1-1]:BDMarker:X:CENTer?

Description Sets/Reads the center value of bandmarker X

Parameter

	<Numeric>
Range	-1T to 1T
Preset value	0
Unit	-
Resolution	-

Equivalent key SP Menu -> Marker Function -> Band Marker X -> Center

SP Menu -> Marker Search -> Band Marker X -> Center

:CALCulate:SP[1-1]:TRACe[1-1]:BDMarker:X:SPAN

Syntax :CALCulate:SP[1-1]:TRACe[1-1]:BDMarker:X:SPAN <numeric>

:CALCulate:SP[1-1]:TRACe[1-1]:BDMarker:X:SPAN?

Description Sets/Reads the span value of bandmarker X

Parameter

	<Numeric>
Range	0 to 2T
Preset value	2T
Unit	-
Resolution	-

Equivalent key SP Menu -> Marker Function -> Band Marker X -> Span
SP Menu -> Marker Search -> Band Marker X -> Span

:CALCulate:SP[1-1]:TRACe[1-1]:BDMarker:X:START

Syntax :CALCulate:SP[1-1]:TRACe[1-1]:BDMarker:X:START <numeric>
:CALCulate:SP[1-1]:TRACe[1-1]:BDMarker:X:START?

Description Sets/Reads the start value of bandmarker X

Parameter

	<Numeric>
Range	-1T to 1T
Preset value	-1T
Unit	-
Resolution	-

Equivalent key SP Menu -> Marker Function -> Band Marker X -> Start
SP Menu -> Marker Search -> Band Marker X -> Start

:CALCulate:SP[1-1]:TRACe[1-1]:BDMarker:X:STATE

Syntax :CALCulate:SP[1-1]:TRACe[1-1]:BDMarker:X:STATE {ON|OFF|1|0}
:CALCulate:SP[1-1]:TRACe[1-1]:BDMarker:X:STATE?

Description Turns on/off bandmarker X

Parameter

	Description
ON or 1	Set bandmarker X mode to 'ON'
OFF or 0(Preset value)	Set bandmarker X mode to 'OFF'

Equivalent key

SP Menu -> Marker Function -> Band Marker X -> Band Marker X
SP Menu -> Marker Search -> Band Marker X -> Band Marker X

:CALCulate:SP[1-1]:TRACe[1-1]:BDMarker:X:STOP

Syntax

:CALCulate:SP[1-1]:TRACe[1-1]:BDMarker:X:STOP <numeric>
:CALCulate:SP[1-1]:TRACe[1-1]:BDMarker:X:STOP?

Description

Sets/Reads the stop value of bandmarker X

Parameter

	<Numeric>
Range	-1T to 1T
Preset value	1T
Unit	-
Resolution	-

Equivalent key

SP Menu -> Marker Function -> Band Marker X -> Stop
SP Menu -> Marker Search -> Band Marker X -> Stop

:CALCulate:SP[1-1]:TRACe[1-1]:BDMarker:Y:CENTer

Syntax

:CALCulate:SP[1-1]:TRACe[1-1]:BDMarker:Y:CENTer <numeric>
:CALCulate:SP[1-1]:TRACe[1-1]:BDMarker:Y:CENTer?

Description

Sets/Reads the center value of bandmarker Y

Parameter

	<Numeric>
Range	-1T to 1T
Preset value	0
Unit	-

	<Numeric>
Resolution	-

Equivalent key SP Menu -> Marker Function -> Band Marker Y -> Center
SP Menu -> Marker Search -> Band Marker Y -> Center

:CALCulate:SP[1-1]:TRACe[1-1]:BDMarker:Y:SPAN

Syntax :CALCulate:SP[1-1]:TRACe[1-1]:BDMarker:Y:SPAN <numeric>
:CALCulate:SP[1-1]:TRACe[1-1]:BDMarker:Y:SPAN?

Description Sets/Reads the span value of bandmarker Y

Parameter

	<Numeric>
Range	0 to 2T
Preset value	2T
Unit	-
Resolution	-

Equivalent key SP Menu -> Marker Function -> Band Marker Y -> Span
SP Menu -> Marker Search -> Band Marker Y -> Span

:CALCulate:SP[1-1]:TRACe[1-1]:BDMarker:Y:START

Syntax :CALCulate:SP[1-1]:TRACe[1-1]:BDMarker:Y:START <numeric>
:CALCulate:SP[1-1]:TRACe[1-1]:BDMarker:Y:START?

Description Sets/Reads the start value of bandmarker Y

Parameter

	<Numeric>
Range	-1T to 1T
Preset value	-1T
Unit	-
Resolution	-

Equivalent key SP Menu -> Marker Function -> Band Marker Y -> Start

SP Menu -> Marker Search -> Band Marker Y -> Start

:CALCulate:SP[1-1]:TRACe[1-1]:BDMarker:Y:STATe

Syntax :CALCulate:SP[1-1]:TRACe[1-1]:BDMarker:Y:STATe {ON|OFF|1|0}
:CALCulate:SP[1-1]:TRACe[1-1]:BDMarker:Y:STATe?

Description Turns on/off bandmarker Y

Parameter

	Description
ON or 1	Set bandmarker Y mode to 'ON'
OFF or 0(Preset value)	Set bandmarker Y mode to 'OFF'

Equivalent key SP Menu -> Marker Function -> Band Marker Y -> Band Marker Y
SP Menu -> Marker Search -> Band Marker Y -> Band Marker Y

:CALCulate:SP[1-1]:TRACe[1-1]:BDMarker:Y:STOP

Syntax :CALCulate:SP[1-1]:TRACe[1-1]:BDMarker:Y:STOP <numeric>
:CALCulate:SP[1-1]:TRACe[1-1]:BDMarker:Y:STOP?

Description Sets/Reads the stop value of bandmarker Y

Parameter

	<Numeric>
Range	-1T to 1T
Preset value	1T
Unit	-
Resolution	-

Equivalent key SP Menu -> Marker Function -> Band Marker Y -> Stop
SP Menu -> Marker Search -> Band Marker Y -> Stop

:CALCulate:SP[1-1]:TRACe[1-1]:DATA:COPIY

Syntax :CALCulate:SP[1-1]:TRACe[1-1]:DATA:COPIY <numeric>

Description Copies trace data to the user trace (No Query)

Parameter

	<Numeric>
Range	1 to 8
Preset value	-
Unit	-
Resolution	-

Equivalent key

SP Menu -> Trace View-> Copy to USER -> Copy to USER1
 SP Menu -> Trace View-> Copy to USER -> Copy to USER2
 SP Menu -> Trace View-> Copy to USER -> Copy to USER3
 SP Menu -> Trace View-> Copy to USER -> Copy to USER4
 SP Menu -> Trace View-> Copy to USER -> Copy to USER5
 SP Menu -> Trace View-> Copy to USER -> Copy to USER6
 SP Menu -> Trace View-> Copy to USER -> Copy to USER7
 SP Menu -> Trace View-> Copy to USER -> Copy to USER8

:CALCulate:SP[1-1]:TRACe[1-1]:DATA:FDATa

Syntax

:CALCulate:SP[1-1]:TRACe[1-1]:DATA:FDATa <array>
 :CALCulate:SP[1-1]:TRACe[1-1]:DATA:FDATa?

Description

Sets/Reads formatted trace data

Parameter

	<Description>
Range	1...1024
Preset value	-
Unit	-
Resolution	-

Equivalent key

No equivalent key is available on the front panel.

:CALCulate:SP[1-1]:TRACe[1-1]:DATA:FMEMory

Syntax

:CALCulate:SP[1-1]:TRACe[1-1]:DATA:FMEMory <array>
 :CALCulate:SP[1-1]:TRACe[1-1]:DATA:FMEMory?

Description

Sets/Reads formatted memory data

Parameter

	<Description>
Range	1...1024
Preset value	-
Unit	-
Resolution	-

Equivalent key

No equivalent key is available on the front panel.

:CALCulate:SP[1-1]:TRACe[1-1]:DATA:UDATa

Syntax

:CALCulate:SP[1-1]:TRACe[1-1]:DATA:UDATa <array>

:CALCulate:SP[1-1]:TRACe[1-1]:DATA:UDATa?

Description

Sets/Reads unformatted trace data

Parameter

	<Description>
Range	1...1024
Preset value	-
Unit	-
Resolution	-

Equivalent key

No equivalent key is available on the front panel.

:CALCulate:SP[1-1]:TRACe[1-1]:DATA:UMEMory

Syntax

:CALCulate:SP[1-1]:TRACe[1-1]:DATA:UMEMory <array>

:CALCulate:SP[1-1]:TRACe[1-1]:DATA:UMEMory?

Description

Sets/Reads unformatted memory data

Parameter

	<Description>
Range	1...1024
Preset value	-
Unit	-

	<Description>
Resolution	-

Equivalent key No equivalent key is available on the front panel.

:CALCulate:SP[1-1]:TRACe[1-1]:FORMat

Syntax :CALCulate:SP[1-1]:TRACe[1-1]:FORMat
{DBM|DBV|WATT|VOLT|DBMHz|DBVHz|WHZ|VHZ}
:CALCulate:SP[1-1]:TRACe[1-1]:FORMat?

Description Selects SP format

Parameter

	Description
DBM(Preset value)	Set SP format to 'dBm'
DBV	Set SP format to 'dBV'
WATT	Set SP format to 'Watt'
VOLT	Set SP format to 'Volt'
DBMHz	Set SP format to 'dBm/Hz'
DBVHz	Set SP format to 'dBV/Hz'
WHZ	Set SP format to 'Watt/Hz'
VHZ	Set SP format to 'Volt/Hz'

Equivalent key SP Menu -> Format -> Format

:CALCulate:SP[1-1]:TRACe[1-1]:FUNCTION:DOMain:X

Syntax :CALCulate:SP[1-1]:TRACe[1-1]:FUNCTION:DOMain:X {FRANge|BDMarker}
:CALCulate:SP[1-1]:TRACe[1-1]:FUNCTION:DOMain:X?

Description Sets/Reads analysis/search range (X-axis)

Parameter

	Description
FRANge	Set analysis/search range (X-axis) to 'Full Range'
BDMarker(Preset value)	Set analysis/search range (X-axis) to 'Band Marker'

Equivalent key SP Menu -> Marker Function -> Analysis Range (X)

:CALCulate:SP[1-1]:TRACe[1-1]:FUNCtion:DOMain:Y

Syntax :CALCulate:SP[1-1]:TRACe[1-1]:FUNCtion:DOMain:Y {FRANge|BDMarker}
:CALCulate:SP[1-1]:TRACe[1-1]:FUNCtion:DOMain:Y?

Description Sets/Reads analysis/search range (Y-axis)

Parameter

	Description
FRANge	Set analysis/search range (Y-axis) to 'Full Range'
BDMarker(Preset value)	Set analysis/search range (Y-axis) to 'Band Marker'

Equivalent key SP Menu -> Marker Function -> Analysis Range (Y)

:CALCulate:SP[1-1]:TRACe[1-1]:FUNCtion:STATistics:DATA

Syntax :CALCulate:SP[1-1]:TRACe[1-1]:FUNCtion:STATistics:DATA

Description Reads the results of statistical analysis for the data trace (Query Only)

Equivalent key No equivalent key is available on the front panel.

:CALCulate:SP[1-1]:TRACe[1-1]:FUNCtion:STATistics:MEMory

Syntax :CALCulate:SP[1-1]:TRACe[1-1]:FUNCtion:STATistics:MEMory

Description Reads the results of statistical analysis for the memory trace (Query Only)

Equivalent key No equivalent key is available on the front panel.

:CALCulate:SP[1-1]:TRACe[1-1]:FUNCtion:TYPE

Syntax :CALCulate:SP[1-1]:TRACe[1-1]:FUNCtion:TYPE {OFF|STATistics}
:CALCulate:SP[1-1]:TRACe[1-1]:FUNCtion:TYPE?

Description Sets/Reads analysis type

Parameter

	Description
OFF(Preset value)	Set analysis type to 'Off'
STATistics	Set analysis type to 'Statistics'

Equivalent key

SP Menu -> Marker Function -> Analysis Type

:CALCulate:SP[1-1]:TRACe[1-1]:HOLD

Syntax

:CALCulate:SP[1-1]:TRACe[1-1]:HOLD {OFF|MAXimum|MINimum}
:CALCulate:SP[1-1]:TRACe[1-1]:HOLD?

Description

Selects/Reads trace data hold type

Parameter

	Description
OFF(Preset value)	Set data hold to 'Off'
MAXimum	Set data hold to 'Maximum'
MINimum	Set data hold to 'Minimum'

Equivalent key

SP Menu -> Trace View -> Data Hold

:CALCulate:SP[1-1]:TRACe[1-1]:LIMit:FAIL

Syntax

:CALCulate:SP[1-1]:TRACe[1-1]:LIMit:FAIL

Description

Reads out the limit test result (Query Only)

Parameter

	Description
ON or 1	The limit test result is fail
OFF or 0(Preset value)	The limit test result is pass

When the limit test is set to OFF, OFF or 0 is always read out.

Equivalent key

No equivalent key is available on the front panel.

:CALCulate:SP[1-1]:TRACe[1-1]:LIMit:LOWer:LDATa

Syntax

:CALCulate:SP[1-1]:TRACe[1-1]:LIMit:LOWer:LDATa <array>

:CALCulate:SP[1-1]:TRACe[1-1]:LIMit:LOWer:LDATA?

Description Sets/Reads the lower limit values of all measurement points

Parameter

	<Description>
Range	1...1024
Preset value	-
Unit	-
Resolution	-

Equivalent key No equivalent key is available on the front panel.

:CALCulate:SP[1-1]:TRACe[1-1]:LIMit:LOWer:SEGment:CLEar

Syntax :CALCulate:SP[1-1]:TRACe[1-1]:LIMit:LOWer:SEGment:CLEar

Description Clears the lower limit line (No Query)

Equivalent key SP Menu -> Display-> Limit Test -> Delete Lower Limit Line

:CALCulate:SP[1-1]:TRACe[1-1]:LIMit:LOWer:SEGment:COUNt

Syntax :CALCulate:SP[1-1]:TRACe[1-1]:LIMit:LOWer:SEGment:COUNt <numeric>

:CALCulate:SP[1-1]:TRACe[1-1]:LIMit:LOWer:SEGment:COUNt?

Description Sets/Reads the number of segments in the lower limit line

Parameter

	<Numeric>
Range	1 to 100
Preset value	1
Unit	-
Resolution	-

Equivalent key No equivalent key is available on the front panel.

:CALCulate:SP[1-1]:TRACe[1-1]:LIMit:LOWer:SEGMENT:DATA

Syntax :CALCulate:SP[1-1]:TRACe[1-1]:LIMit:LOWer:SEGMENT:DATA <array>
:CALCulate:SP[1-1]:TRACe[1-1]:LIMit:LOWer:SEGMENT:DATA?

Description Sets/Reads segment data of the lower limit line

Parameter

	<Description>
Range	1...400
Preset value	-
Unit	-
Resolution	-

Equivalent key No equivalent key is available on the front panel.

:CALCulate:SP[1-1]:TRACe[1-1]:LIMit:REPort[:DATA]

Syntax :CALCulate:SP[1-1]:TRACe[1-1]:LIMit:REPort[:DATA]

Description Reads the limit test results of all measurement points in selected traces (Query Only)

Equivalent key No equivalent key is available on the front panel.

:CALCulate:SP[1-1]:TRACe[1-1]:LIMit[:STATE]

Syntax :CALCulate:SP[1-1]:TRACe[1-1]:LIMit[:STATE] {ON|OFF|1|0}
:CALCulate:SP[1-1]:TRACe[1-1]:LIMit[:STATE]?

Description Turns on/off the limit test function

Parameter

	Description
ON or 1	Turn on the limit test function mode
OFF or 0(Preset value)	Turn off the limit test function mode

Equivalent key SP Menu -> Display -> Limit Test -> Limit Test

:CALCulate:SP[1-1]:TRACe[1-1]:LIMit:UPPer:LDATa

Syntax :CALCulate:SP[1-1]:TRACe[1-1]:LIMit:UPPer:LDATa <array>
:CALCulate:SP[1-1]:TRACe[1-1]:LIMit:UPPer:LDATa?

Description Sets/Reads the upper limit values of all measurement points

Parameter

	<Description>
Range	1...1024
Preset value	-
Unit	-
Resolution	-

Equivalent key No equivalent key is available on the front panel.

:CALCulate:SP[1-1]:TRACe[1-1]:LIMit:UPPer:SEGMent:CLEar

Syntax :CALCulate:SP[1-1]:TRACe[1-1]:LIMit:UPPer:SEGMent:CLEar

Description Clears the upper limit line (No Query)

Equivalent key SP Menu -> Display-> Limit Test -> Delete Upper Limit Line

:CALCulate:SP[1-1]:TRACe[1-1]:LIMit:UPPer:SEGMent:COUNT

Syntax :CALCulate:SP[1-1]:TRACe[1-1]:LIMit:UPPer:SEGMent:COUNT <numeric>
:CALCulate:SP[1-1]:TRACe[1-1]:LIMit:UPPer:SEGMent:COUNT?

Description Sets/Reads the number of segments in the upper limit line

Parameter

	<Numeric>
Range	1 to 100
Preset value	1
Unit	-
Resolution	-

Equivalent key No equivalent key is available on the front panel.

:CALCulate:SP[1-1]:TRACe[1-1]:LIMit:UPPer:SEGMENT:DATA

Syntax :CALCulate:SP[1-1]:TRACe[1-1]:LIMit:UPPer:SEGMENT:DATA <array>
:CALCulate:SP[1-1]:TRACe[1-1]:LIMit:UPPer:SEGMENT:DATA?

Description Sets/Reads segment data of the upper limit line

Parameter

	<Description>
Range	1...400
Preset value	-
Unit	-
Resolution	-

Equivalent key No equivalent key is available on the front panel.

:CALCulate:SP[1-1]:TRACe[1-1]:MARKer[1-10]:SEARch:EXECute:LPEak

Syntax :CALCulate:SP[1-1]:TRACe[1-1]:MARKer[1-10]:SEARch:EXECute:LPEak

Description Executes marker peak search left (No Query)

Equivalent key SP Menu -> Marker Search -> Peak -> Search Left

:CALCulate:SP[1-1]:TRACe[1-1]:MARKer[1-10]:SEARch:EXECute:LTARget

Syntax :CALCulate:SP[1-1]:TRACe[1-1]:MARKer[1-10]:SEARch:EXECute:LTARget

Description Executes marker target search left (No Query)

Equivalent key SP Menu -> Marker Search -> Target -> Search Left

:CALCulate:SP[1-1]:TRACe[1-1]:MARKer[1-10]:SEARch:EXECute:MAXimum

Syntax :CALCulate:SP[1-1]:TRACe[1-1]:MARKer[1-10]:SEARch:EXECute:MAXimum

Description Executes marker search maximum (No Query)

Equivalent key SP Menu -> Marker Search -> Search Max

**:CALCulate:SP[1-1]:TRACe[1-1]:MARKer[1-10]:SEARch:
EXECute:MINimum**

Syntax :CALCulate:SP[1-1]:TRACe[1-1]:MARKer[1-10]:SEARch:EXECute:MINimum
Description Executes marker search minimum (No Query)
Equivalent key SP Menu -> Marker Search -> Search Min

**:CALCulate:SP[1-1]:TRACe[1-1]:MARKer[1-10]:SEARch:
EXECute:PEAK**

Syntax :CALCulate:SP[1-1]:TRACe[1-1]:MARKer[1-10]:SEARch:EXECute:PEAK
Description Executes marker peak search (No Query)
Equivalent key SP Menu -> Marker Search -> Peak -> Search Peak

**:CALCulate:SP[1-1]:TRACe[1-1]:MARKer[1-10]:SEARch:
EXECute:RPEak**

Syntax :CALCulate:SP[1-1]:TRACe[1-1]:MARKer[1-10]:SEARch:EXECute:RPEak
Description Executes marker peak search right (No Query)
Equivalent key SP Menu -> Marker Search -> Peak -> Search Right

**:CALCulate:SP[1-1]:TRACe[1-1]:MARKer[1-10]:SEARch:
EXECute:RTARget**

Syntax :CALCulate:SP[1-1]:TRACe[1-1]:MARKer[1-10]:SEARch:EXECute:RTARget
Description Executes marker target search right (No Query)
Equivalent key SP Menu -> Marker Search -> Target -> Search Right

**:CALCulate:SP[1-1]:TRACe[1-1]:MARKer[1-10]:SEARch:
EXECute:TARGet**

Syntax :CALCulate:SP[1-1]:TRACe[1-1]:MARKer[1-10]:SEARch:EXECute:TARGet
Description Executes marker target search (No Query)
Equivalent key SP Menu -> Marker Search -> Target -> Search Target

:CALCulate:SP[1-1]:TRACe[1-1]:MARKer[1-10]:SEARch:PEAK:EXCursion

Syntax :CALCulate:SP[1-1]:TRACe[1-1]:MARKer[1-10]:SEARch:PEAK:EXCursion <numeric>
:CALCulate:SP[1-1]:TRACe[1-1]:MARKer[1-10]:SEARch:PEAK:EXCursion?

Description Sets/Reads the peak excursion value

Parameter

	<Numeric>
Range	0 to 10G
Preset value	0
Unit	-
Resolution	-

Equivalent key SP Menu -> Marker Search -> Peak -> Peak Excursion

:CALCulate:SP[1-1]:TRACe[1-1]:MARKer[1-10]:SEARch:PEAK:POLarity

Syntax :CALCulate:SP[1-1]:TRACe[1-1]:MARKer[1-10]:SEARch:PEAK:POLarity
{POSitive|NEGative|BOTH}
:CALCulate:SP[1-1]:TRACe[1-1]:MARKer[1-10]:SEARch:PEAK:POLarity?

Description Sets/Reads marker peak-search polarity

Parameter

	Description
POSitive(Preset value)	Set marker peak-search polarity to 'Positive'
NEGative	Set marker peak-search polarity to 'Negative'
BOTH	Set marker peak-search polarity to 'Both'

Equivalent key SP Menu -> Marker Search -> Peak -> Peak Polarity

:CALCulate:SP[1-1]:TRACe[1-1]:MARKer[1-10]:SEARch:TARGet:TRAnSition

Syntax :CALCulate:SP[1-1]:TRACe[1-1]:MARKer[1-10]:SEARch:TARGet:TRAnSition
{POSitive|NEGative|BOTH}
:CALCulate:SP[1-1]:TRACe[1-1]:MARKer[1-10]:SEARch:TARGet:TRAnSition?

Description Sets/Reads the target transition definition

Parameter

	Description
POSitive	Set the target transition definition to 'Positive'
NEGative	Set the target transition definition to 'Negative'
BOTH(Preset value)	Set the target transition definition to 'Both'

Equivalent key SP Menu -> Marker Search -> Target -> Search Transition

:CALCulate:SP[1-1]:TRACe[1-1]:MARKer[1-10]:SEARch:TARGet:Y

Syntax :CALCulate:SP[1-1]:TRACe[1-1]:MARKer[1-10]:SEARch:TARGet:Y <numeric>
:CALCulate:SP[1-1]:TRACe[1-1]:MARKer[1-10]:SEARch:TARGet:Y?

Description Sets/Reads the marker target value

Parameter

	<Numeric>
Range	-10G to 10G
Preset value	0
Unit	-
Resolution	-

Equivalent key SP Menu -> Marker Search -> Target -> Search Value

:CALCulate:SP[1-1]:TRACe[1-1]:MARKer[1-10]:SEARch:TRACking:TYPE

Syntax :CALCulate:SP[1-1]:TRACe[1-1]:MARKer[1-10]:SEARch:TRACking:TYPE
{OFF|MAXimum|MINimum|PEAK|TARGet}
:CALCulate:SP[1-1]:TRACe[1-1]:MARKer[1-10]:SEARch:TRACking:TYPE?

Description Sets/Reads the marker tracking type

Parameter

	Description
OFF(Preset value)	Set the marker tracking type to 'Off'
MAXimum	Set the marker tracking type to 'Maximum'
MINimum	Set the marker tracking type to 'Minimum'
PEAK	Set the marker tracking type to 'Peak'
TARGet	Set the marker tracking type to 'TARGet'

Equivalent key

SP Menu -> Marker Search -> Tracking

:CALCulate:SP[1-1]:TRACe[1-1]:MARKer[1-10]:STATe

Syntax

:CALCulate:SP[1-1]:TRACe[1-1]:MARKer[1-10]:STATe {ON|OFF|1|0}
:CALCulate:SP[1-1]:TRACe[1-1]:MARKer[1-10]:STATe?

Description

Turns on/off markers

Parameter

	Description
ON or 1	Set markers to 'ON'
OFF or 0(Preset value)	Set markers to 'OFF'

Equivalent key

SP Menu -> Marker -> Clear Marker Menu -> Marker 1

:CALCulate:SP[1-1]:TRACe[1-1]:MARKer[1-10]:X

Syntax

:CALCulate:SP[1-1]:TRACe[1-1]:MARKer[1-10]:X <numeric>
:CALCulate:SP[1-1]:TRACe[1-1]:MARKer[1-10]:X?

Description

Sets/Reads the marker X value

Parameter

	<Numeric>
Range	-
Preset value	992.5M
Unit	-
Resolution	-

Equivalent key No equivalent key is available on the front panel.

:CALCulate:SP[1-1]:TRACe[1-1]:MARKer[1-10]:Y

Syntax :CALCulate:SP[1-1]:TRACe[1-1]:MARKer[1-10]:Y

Description Reads the marker Y value (Query Only)

Equivalent key No equivalent key is available on the front panel.

:CALCulate:SP[1-1]:TRACe[1-1]:MATH:FUNCTION

Syntax :CALCulate:SP[1-1]:TRACe[1-1]:MATH:FUNCTION
{NORMAL|SUBTract|DIVide|ADD|MULTiply}
:CALCulate:SP[1-1]:TRACe[1-1]:MATH:FUNCTION?

Description Selects math operation type

Parameter

	Description
NORMAL(Preset value)	Set math operation type to 'Off'
SUBTract	Set math operation type to 'Data - Mem'
DIVide	Set math operation type to 'Data / Mem'
ADD	Set math operation type to 'Data + Mem'
MULTiply	Set math operation type to 'Data * Mem'

Equivalent key SP Menu -> Trace View -> Data Math

:CALCulate:SP[1-1]:TRACe[1-1]:MATH:MEMorize

Syntax :CALCulate:SP[1-1]:TRACe[1-1]:MATH:MEMorize

Description Copies data to memory (No Query)

Equivalent key No equivalent key is available on the front panel.

:CALCulate:SP[1-1]:TRACe[1-1]:MATH:OFFSet

Syntax :CALCulate:SP[1-1]:TRACe[1-1]:MATH:OFFSet <numeric>
:CALCulate:SP[1-1]:TRACe[1-1]:MATH:OFFSet?

Description Sets/Reads the offset value of the trace

Parameter

	<Numeric>
Description	Offset value of the trace
Range	-500 G to 500 G
Preset value	0
Unit	-
Resolution	-

Equivalent key

SP Menu -> Trace View -> Offset

SP Menu -> Trace View -> [Marker -> -Offset]

:CALCulate:SP[1-1]:TRACe[1-1]:SMOothing:APERture

Syntax

:CALCulate:SP[1-1]:TRACe[1-1]:SMOothing:APERture <numeric>

:CALCulate:SP[1-1]:TRACe[1-1]:SMOothing:APERture?

Description

Smoothing aperture

Parameter

	<Numeric>
Range	50m to 25
Preset value	1.5
Unit	%
Resolution	-

Equivalent key

SP Menu -> Trace View -> Aperture

:CALCulate:SP[1-1]:TRACe[1-1]:SMOothing:STATe

Syntax

:CALCulate:SP[1-1]:TRACe[1-1]:SMOothing:STATe {ON|OFF|1|0}

:CALCulate:SP[1-1]:TRACe[1-1]:SMOothing:STATe?

Description

Turns on/off smoothing mode

Parameter

	Description
ON or 1	Set smoothing mode to 'ON'

	Description
OFF or 0(Preset value)	Set smoothing mode to 'OFF'

Equivalent key SP Menu -> Trace View -> Smoothing

:CALCulate:TR[1-1]:ALLTrace:ACTive

Syntax :CALCulate:TR[1-1]:ALLTrace:ACTive <numeric>

:CALCulate:TR[1-1]:ALLTrace:ACTive?

Description Selects active trace

Parameter

	<Numeric>
Range	1 to 4
Preset value	1
Unit	-
Resolution	-

Equivalent key No equivalent key is available on the front panel.

:CALCulate:TR[1-1]:ALLTrace:BDMarker:X:COUPle:STATe

Syntax :CALCulate:TR[1-1]:ALLTrace:BDMarker:X:COUPle:STATe {ON|OFF|1|0}

:CALCulate:TR[1-1]:ALLTrace:BDMarker:X:COUPle:STATe?

Description Turns on/off bandmarker coupling function

Parameter

	Description
ON or 1	Set bandmarker coupling function mode to 'ON'
OFF or 0(Preset value)	Set bandmarker coupling function mode to 'OFF'

Equivalent key TR Menu -> Marker Function -> Couple

TR Menu -> Marker Search -> Couple

:CALCulate:TR[1-1]:ALLTrace:LIMit:FAIL

Syntax :CALCulate:TR[1-1]:ALLTrace:LIMit:FAIL

Description Reads out the limit test result (Query Only)

Parameter

	Description
ON or 1	The limit test result is fail
OFF or 0(Preset value)	The limit test result is pass

When the limit test is set to OFF, OFF or 0 is always read out.

Equivalent key No equivalent key is available on the front panel.

:CALCulate:TR[1-1]:ALLTrace:MARKer:COUPle:STATe

Syntax :CALCulate:TR[1-1]:ALLTrace:MARKer:COUPle:STATe {ON|OFF|1|0}

:CALCulate:TR[1-1]:ALLTrace:MARKer:COUPle:STATe?

Description Turns on/off marker coupling function

Parameter

	Description
ON or 1	Set marker coupling function mode to 'ON'
OFF or 0(Preset value)	Set marker coupling function mode to 'OFF'

Equivalent key TR Menu -> Marker -> Couple

:CALCulate:TR[1-1]:ALLTrace:MARKer:DISCrete:STATe

Syntax :CALCulate:TR[1-1]:ALLTrace:MARKer:DISCrete:STATe {ON|OFF|1|0}

:CALCulate:TR[1-1]:ALLTrace:MARKer:DISCrete:STATe?

Description Sets/Reads marker movement (Continuous/Discrete)

Parameter

	Description
ON or 1	Set marker movement (Continuous/Discrete) mode to 'ON'

	Description
OFF or 0(Preset value)	Set marker movement (Continuous/Discrete) mode to 'OFF'

Equivalent key TR Menu -> Marker -> More Functions -> Discrete

:CALCulate:TR[1-1]:ALLTrace:MARKer:REFerence:NUMBER

Syntax :CALCulate:TR[1-1]:ALLTrace:MARKer:REFerence:NUMBER <numeric>
:CALCulate:TR[1-1]:ALLTrace:MARKer:REFerence:NUMBER?

Description Sets/Reads marker reference number

Parameter

	<Numeric>
Range	1 to 10
Preset value	1
Unit	-
Resolution	-

Equivalent key TR Menu -> Marker -> More Functions -> Ref Marker

:CALCulate:TR[1-1]:ALLTrace:MARKer:REFerence:STATE

Syntax :CALCulate:TR[1-1]:ALLTrace:MARKer:REFerence:STATE {ON|OFF|1|0}
:CALCulate:TR[1-1]:ALLTrace:MARKer:REFerence:STATE?

Description Turns on/off delta marker mode

Parameter

	Description
ON or 1	Set delta marker mode mode to 'ON'
OFF or 0(Preset value)	Set delta marker mode mode to 'OFF'

Equivalent key TR Menu -> Marker -> More Functions -> Ref Marker Mode

:CALCulate:TR[1-1]:NARRow:DATA:RDATa

Syntax :CALCulate:TR[1-1]:NARRow:DATA:RDATa <array>
:CALCulate:TR[1-1]:NARRow:DATA:RDATa?

Description measurement raw data

Parameter

	<Description>
Range	1...3753
Preset value	-
Unit	-
Resolution	-

Equivalent key No equivalent key is available on the front panel.

:CALCulate:TR[1-1]:NARRow:DATA:XDATa

Syntax :CALCulate:TR[1-1]:NARRow:DATA:XDATa

Description X axis data (Query Only)

Equivalent key No equivalent key is available on the front panel.

:CALCulate:TR[1-1]:TRACe[1-4]:ALLMarker:ACTive

Syntax :CALCulate:TR[1-1]:TRACe[1-4]:ALLMarker:ACTive <numeric>
:CALCulate:TR[1-1]:TRACe[1-4]:ALLMarker:ACTive?

Description Selects active marker

Parameter

	<Numeric>
Range	1 to 10
Preset value	1
Unit	-
Resolution	-

Equivalent key No equivalent key is available on the front panel.

:CALCulate:TR[1-1]:TRACe[1-4]:ALLMarker:SEARch:DOMain:X

Syntax :CALCulate:TR[1-1]:TRACe[1-4]:ALLMarker:SEARch:DOMain:X
{FRANge|BDMarker}
:CALCulate:TR[1-1]:TRACe[1-4]:ALLMarker:SEARch:DOMain:X?

Description Sets/Reads marker search range (X-axis)

Parameter

	Description
FRANge(Preset value)	Set marker search range (X-axis) to 'Full Range'
BDMarker	Set marker search range (X-axis) to 'Band Marker'

Equivalent key TR Menu -> Marker Search -> Search Range (X)

:CALCulate:TR[1-1]:TRACe[1-4]:ALLMarker:SEARch:DOMain:Y

Syntax :CALCulate:TR[1-1]:TRACe[1-4]:ALLMarker:SEARch:DOMain:Y
{FRANge|BDMarker}
:CALCulate:TR[1-1]:TRACe[1-4]:ALLMarker:SEARch:DOMain:Y?

Description Sets/Reads marker search range (Y-axis)

Parameter

	Description
FRANge(Preset value)	Set marker search range (Y-axis) to 'Full Range'
BDMarker	Set marker search range (Y-axis) to 'Band Marker'

Equivalent key TR Menu -> Marker Search -> Search Range (Y)

:CALCulate:TR[1-1]:TRACe[1-4]:ALLMarker:SEARch:PEAK

Syntax :CALCulate:TR[1-1]:TRACe[1-4]:ALLMarker:SEARch:PEAK

Description Executes marker search all (No Query)

Equivalent key TR Menu -> Marker Search -> Peak -> Search Peak All

:CALCulate:TR[1-1]:TRACe[1-4]:BDMarker:X:CENTer

Syntax :CALCulate:TR[1-1]:TRACe[1-4]:BDMarker:X:CENTer <numeric>
:CALCulate:TR[1-1]:TRACe[1-4]:BDMarker:X:CENTer?

Description Sets/Reads the center value of bandmarker X

Parameter

	<Numeric>
Range	-1T to 1T
Preset value	0
Unit	-
Resolution	-

Equivalent key TR Menu -> Marker Function -> Band Marker X -> Center
TR Menu -> Marker Search -> Band Marker X -> Center

:CALCulate:TR[1-1]:TRACe[1-4]:BDMarker:X:SPAN

Syntax :CALCulate:TR[1-1]:TRACe[1-4]:BDMarker:X:SPAN <numeric>
:CALCulate:TR[1-1]:TRACe[1-4]:BDMarker:X:SPAN?

Description Sets/Reads the span value of bandmarker X

Parameter

	<Numeric>
Range	0 to 2T
Preset value	2T
Unit	-
Resolution	-

Equivalent key TR Menu -> Marker Function -> Band Marker X -> Span
TR Menu -> Marker Search -> Band Marker X -> Span

:CALCulate:TR[1-1]:TRACe[1-4]:BDMarker:X:STARt

Syntax :CALCulate:TR[1-1]:TRACe[1-4]:BDMarker:X:STARt <numeric>
:CALCulate:TR[1-1]:TRACe[1-4]:BDMarker:X:STARt?

Description Sets/Reads the start value of bandmarker X

Parameter

	<Numeric>
Range	-1T to 1T
Preset value	-1T
Unit	-
Resolution	-

Equivalent key

TR Menu -> Marker Function -> Band Marker X -> Start

TR Menu -> Marker Search -> Band Marker X -> Start

:CALCulate:TR[1-1]:TRACe[1-4]:BDMarker:X:STATe

Syntax

:CALCulate:TR[1-1]:TRACe[1-4]:BDMarker:X:STATe {ON|OFF|1|0}

:CALCulate:TR[1-1]:TRACe[1-4]:BDMarker:X:STATe?

Description

Turns on/off bandmarker X

Parameter

	Description
ON or 1	Set bandmarker X mode to 'ON'
OFF or 0(Preset value)	Set bandmarker X mode to 'OFF'

Equivalent key

TR Menu -> Marker Function -> Band Marker X -> Band Marker X

TR Menu -> Marker Search -> Band Marker X -> Band Marker X

:CALCulate:TR[1-1]:TRACe[1-4]:BDMarker:X:STOP

Syntax

:CALCulate:TR[1-1]:TRACe[1-4]:BDMarker:X:STOP <numeric>

:CALCulate:TR[1-1]:TRACe[1-4]:BDMarker:X:STOP?

Description

Sets/Reads the stop value of bandmarker X

Parameter

	<Numeric>
Range	-1T to 1T
Preset value	1T
Unit	-

	<Numeric>
Resolution	-

Equivalent key TR Menu -> Marker Function -> Band Marker X -> Stop
TR Menu -> Marker Search -> Band Marker X -> Stop

:CALCulate:TR[1-1]:TRACe[1-4]:BDMarker:Y:CENTer

Syntax :CALCulate:TR[1-1]:TRACe[1-4]:BDMarker:Y:CENTer <numeric>
:CALCulate:TR[1-1]:TRACe[1-4]:BDMarker:Y:CENTer?

Description Sets/Reads the center value of bandmarker Y

Parameter

	<Numeric>
Range	-1T to 1T
Preset value	0
Unit	-
Resolution	-

Equivalent key TR Menu -> Marker Function -> Band Marker Y -> Center
TR Menu -> Marker Search -> Band Marker Y -> Center

:CALCulate:TR[1-1]:TRACe[1-4]:BDMarker:Y:SPAN

Syntax :CALCulate:TR[1-1]:TRACe[1-4]:BDMarker:Y:SPAN <numeric>
:CALCulate:TR[1-1]:TRACe[1-4]:BDMarker:Y:SPAN?

Description Sets/Reads the span value of bandmarker Y

Parameter

	<Numeric>
Range	0 to 2T
Preset value	2T
Unit	-
Resolution	-

Equivalent key TR Menu -> Marker Function -> Band Marker Y -> Span

TR Menu -> Marker Search -> Band Marker Y -> Span

:CALCulate:TR[1-1]:TRACe[1-4]:BDMarker:Y:START

Syntax :CALCulate:TR[1-1]:TRACe[1-4]:BDMarker:Y:START <numeric>
:CALCulate:TR[1-1]:TRACe[1-4]:BDMarker:Y:START?

Description Sets/Reads the start value of bandmarker Y

Parameter

	<Numeric>
Range	-1T to 1T
Preset value	-1T
Unit	-
Resolution	-

Equivalent key TR Menu -> Marker Function -> Band Marker Y -> Start
TR Menu -> Marker Search -> Band Marker Y -> Start

:CALCulate:TR[1-1]:TRACe[1-4]:BDMarker:Y:STATE

Syntax :CALCulate:TR[1-1]:TRACe[1-4]:BDMarker:Y:STATE {ON|OFF}|1|0}
:CALCulate:TR[1-1]:TRACe[1-4]:BDMarker:Y:STATE?

Description Turns on/off bandmarker Y

Parameter

	Description
ON or 1	Set bandmarker Y mode to 'ON'
OFF or 0(Preset value)	Set bandmarker Y mode to 'OFF'

Equivalent key TR Menu -> Marker Function -> Band Marker Y -> Band Marker Y
TR Menu -> Marker Search -> Band Marker Y -> Band Marker Y

:CALCulate:TR[1-1]:TRACe[1-4]:BDMarker:Y:STOP

Syntax :CALCulate:TR[1-1]:TRACe[1-4]:BDMarker:Y:STOP <numeric>
:CALCulate:TR[1-1]:TRACe[1-4]:BDMarker:Y:STOP?

Description Sets/Reads the stop value of bandmarker Y

Parameter

	<Numeric>
Range	-1T to 1T
Preset value	1T
Unit	-
Resolution	-

Equivalent key

TR Menu -> Marker Function -> Band Marker Y -> Stop
TR Menu -> Marker Search -> Band Marker Y -> Stop

:CALCulate:TR[1-1]:TRACe[1-4]:DATA:COPI

Syntax

:CALCulate:TR[1-1]:TRACe[1-4]:DATA:COPI <numeric>

Description

Copies trace data to the user trace (No Query)

Parameter

	<Numeric>
Range	1 to 8
Preset value	-
Unit	-
Resolution	-

Equivalent key

TR Menu -> Trace View-> Copy to USER -> Copy to USER1
TR Menu -> Trace View-> Copy to USER -> Copy to USER2
TR Menu -> Trace View-> Copy to USER -> Copy to USER3
TR Menu -> Trace View-> Copy to USER -> Copy to USER4
TR Menu -> Trace View-> Copy to USER -> Copy to USER5
TR Menu -> Trace View-> Copy to USER -> Copy to USER6
TR Menu -> Trace View-> Copy to USER -> Copy to USER7
TR Menu -> Trace View-> Copy to USER -> Copy to USER8

:CALCulate:TR[1-1]:TRACe[1-4]:DATA:FDATA

Syntax

:CALCulate:TR[1-1]:TRACe[1-4]:DATA:FDATA <array>
:CALCulate:TR[1-1]:TRACe[1-4]:DATA:FDATA?

Description

Sets/Reads formatted trace data

Parameter

	<Description>
Range	1...1001
Preset value	-
Unit	-
Resolution	-

Equivalent key

No equivalent key is available on the front panel.

:CALCulate:TR[1-1]:TRACe[1-4]:DATA:FMEMory

Syntax

:CALCulate:TR[1-1]:TRACe[1-4]:DATA:FMEMory <array>

:CALCulate:TR[1-1]:TRACe[1-4]:DATA:FMEMory?

Description

Sets/Reads formatted memory data

Parameter

	<Description>
Range	1...1001
Preset value	-
Unit	-
Resolution	-

Equivalent key

No equivalent key is available on the front panel.

:CALCulate:TR[1-1]:TRACe[1-4]:DATA:UDATa

Syntax

:CALCulate:TR[1-1]:TRACe[1-4]:DATA:UDATa <array>

:CALCulate:TR[1-1]:TRACe[1-4]:DATA:UDATa?

Description

Sets/Reads unformatted trace data

Parameter

	<Description>
Range	1...1001
Preset value	-
Unit	-

	<Description>
Resolution	-

Equivalent key No equivalent key is available on the front panel.

:CALCulate:TR[1-1]:TRACe[1-4]:DATA:UMEMory

Syntax :CALCulate:TR[1-1]:TRACe[1-4]:DATA:UMEMory <array>
:CALCulate:TR[1-1]:TRACe[1-4]:DATA:UMEMory?

Description Sets/Reads unformatted memory data

Parameter

	<Description>
Range	1...1001
Preset value	-
Unit	-
Resolution	-

Equivalent key No equivalent key is available on the front panel.

:CALCulate:TR[1-1]:TRACe[1-4]:FORMat:FREQuency

Syntax :CALCulate:TR[1-1]:TRACe[1-4]:FORMat:FREQuency {HZ|DHZ|PCT|PPM}
:CALCulate:TR[1-1]:TRACe[1-4]:FORMat:FREQuency?

Description Sets/Reads the frequency format

Parameter

	Description
HZ(Preset value)	Set the frequency format to 'Hz'
DHZ	Set the frequency format to 'ΔHz'
PCT	Set the frequency format to '%'
PPM	Set the frequency format to 'ppm'

Equivalent key TR Menu -> Format -> Frequency Format

:CALCulate:TR[1-1]:TRACe[1-4]:FORMat:PHASe:PREFe rence:OFFSet

Syntax :CALCulate:TR[1-1]:TRACe[1-4]:FORMat:PHASe:PREFe
rence:OFFSet <numeric>
:CALCulate:TR[1-1]:TRACe[1-4]:FORMat:PHASe:PREFe
rence:OFFSet?

Description Sets/Reads the offset value of the phase reference frequency

Parameter

	<Numeric>
Range	-25.6M to 25.6M
Preset value	0
Unit	Hz
Resolution	1m

Equivalent key TR Menu -> Setup -> Recalc Phase Reference -> Phase Ref. Offset

:CALCulate:TR[1-1]:TRACe[1-4]:FORMat:PHASe:UNIT

Syntax :CALCulate:TR[1-1]:TRACe[1-4]:FORMat:PHASe:UNIT {DEG|RAD|GRAD}
:CALCulate:TR[1-1]:TRACe[1-4]:FORMat:PHASe:UNIT?

Description Selects phase format on transient measurement

Parameter

	Description
DEG(Preset value)	Set phase format on transient measurement to 'Deg'
RAD	Set phase format on transient measurement to 'Rad'
GRAD	Set phase format on transient measurement to 'Grad'

Equivalent key TR Menu -> Format -> Phase Unit

:CALCulate:TR[1-1]:TRACe[1-4]:FORMat:PHASe:WRAP

Syntax :CALCulate:TR[1-1]:TRACe[1-4]:FORMat:PHASe:WRAP {ON|OFF|1|0}
:CALCulate:TR[1-1]:TRACe[1-4]:FORMat:PHASe:WRAP?

Description Turns on/off wrap-phase

Parameter

	Description
ON or 1 (Preset value)	Set wrap-phase mode to 'ON'
OFF or 0	Set wrap-phase mode to 'OFF'

Equivalent key

TR Menu -> Format -> Wrap Phase

**:CALCulate:TR[1-1]:TRACe[1-4]:FORMat:PHASe:XREFe
rence**

Syntax

:CALCulate:TR[1-1]:TRACe[1-4]:FORMat:PHASe:XREFe <numeric>

:CALCulate:TR[1-1]:TRACe[1-4]:FORMat:PHASe:XREFe?

Description

Sets/Reads stimulus value that is set as phase reference (0 degree reference) of a trace

Parameter

	Numeric
Description	Stimulus value set as phase reference of a trace
Range	-8.00768 to 11.0096
Preset value	11.0096
Unit	s
Resolution	-

Equivalent key

TR Menu -> Format -> Phase X Reference

TR Menu -> Format -> [Marker -> Phase X Reference]

:CALCulate:TR[1-1]:TRACe[1-4]:FUNCtion:DOMain:X

Syntax

:CALCulate:TR[1-1]:TRACe[1-4]:FUNCtion:DOMain:X {FRANge|BDMarker}

:CALCulate:TR[1-1]:TRACe[1-4]:FUNCtion:DOMain:X?

Description

Sets/Reads analysis/search range (X-axis)

Parameter

	Description
FRANge	Set analysis/search range (X-axis) to 'Full Range'

	Description
BDMarker(Preset value)	Set analysis/search range (X-axis) to 'Band Marker'

Equivalent key TR Menu -> Marker Function -> Analysis Range (X)

:CALCulate:TR[1-1]:TRACe[1-4]:FUNCtion:DOMain:Y

Syntax :CALCulate:TR[1-1]:TRACe[1-4]:FUNCtion:DOMain:Y {FRANge|BDMarker}
:CALCulate:TR[1-1]:TRACe[1-4]:FUNCtion:DOMain:Y?

Description Sets/Reads analysis/search range (Y-axis)

Parameter

	Description
FRANge	Set analysis/search range (Y-axis) to 'Full Range'
BDMarker(Preset value)	Set analysis/search range (Y-axis) to 'Band Marker'

Equivalent key TR Menu -> Marker Function -> Analysis Range (Y)

:CALCulate:TR[1-1]:TRACe[1-4]:FUNCtion:LREGression:DATA

Syntax :CALCulate:TR[1-1]:TRACe[1-4]:FUNCtion:LREGression:DATA

Description Assigns trace data to the regression line coefficient (a and b) (Query Only)
When the X-axis band marker is set to on, calculation is made within the range specified by the band marker.

NOTE When less than two measurement points are in the range of the band marker, a and b return 0 (zero).

Equivalent key TR Menu -> Trace View -> Memory Trace -> Line (Y = AX + B) -> Data Trace -> A,B

:CALCulate:TR[1-1]:TRACe[1-4]:FUNCtion:LREGression:MEMory

Syntax :CALCulate:TR[1-1]:TRACe[1-4]:FUNCtion:LREGression:MEMory

Description In transient measurement mode, calculates the regression line coefficient (a and b of Y = aX + b) for trace memories of trace 1 (:TRAC1) to trace 4 (:TRAC4), and reads the results.
When the X-axis band marker is set to on, calculation is made within the range specified by

the band marker.

NOTE When less than two measurement points are in the range of the band marker, a and b return 0 (zero).

Equivalent key No equivalent key is available on the front panel.

:CALCulate:TR[1-1]:TRACe[1-4]:FUNCtion:STATistics:DATA

Syntax :CALCulate:TR[1-1]:TRACe[1-4]:FUNCtion:STATistics:DATA

Description Reads the result of statistical analysis for the data trace (Query Only)

Equivalent key No equivalent key is available on the front panel.

:CALCulate:TR[1-1]:TRACe[1-4]:FUNCtion:STATistics:MEMory

Syntax :CALCulate:TR[1-1]:TRACe[1-4]:FUNCtion:STATistics:MEMory

Description Reads the result of statistical analysis for the memory trace (Query Only)

Equivalent key No equivalent key is available on the front panel.

:CALCulate:TR[1-1]:TRACe[1-4]:FUNCtion:TYPE

Syntax :CALCulate:TR[1-1]:TRACe[1-4]:FUNCtion:TYPE {OFF|STATistics}
:CALCulate:TR[1-1]:TRACe[1-4]:FUNCtion:TYPE?

Description Sets/Reads analysis type

Parameter

	Description
OFF(Preset value)	Set analysis type to 'Off'
STATistics	Set analysis type to 'Statistics'

Equivalent key TR Menu -> Marker Function -> Analysis Type

:CALCulate:TR[1-1]:TRACe[1-4]:HOLD

Syntax :CALCulate:TR[1-1]:TRACe[1-4]:HOLD {OFF|MAXimum|MINimum}
:CALCulate:TR[1-1]:TRACe[1-4]:HOLD?

Description Sets/Reads trace data hold type

Parameter

	Description
OFF(Preset value)	Set data hold to 'Off'
MAXimum	Set data hold to 'Maximum'
MINimum	Set data hold to 'Minimum'

Equivalent key TR Menu -> Trace View -> Data Hold

:CALCulate:TR[1-1]:TRACe[1-4]:LIMit:FAIL

Syntax :CALCulate:TR[1-1]:TRACe[1-4]:LIMit:FAIL

Description Reads out the limit test result (Query Only)

Parameter

	Description
ON or 1	The limit test result is fail
OFF or 0(Preset value)	The limit test result is pass

When the limit test is set to OFF, OFF or 0 is always read out.

Equivalent key No equivalent key is available on the front panel.

:CALCulate:TR[1-1]:TRACe[1-4]:LIMit:LOWer:LDATa

Syntax :CALCulate:TR[1-1]:TRACe[1-4]:LIMit:LOWer:LDATa <array>

:CALCulate:TR[1-1]:TRACe[1-4]:LIMit:LOWer:LDATa?

Description Sets/Reads the lower limit values of all measurement points

Parameter

	<Description>
Range	1...1001
Preset value	-
Unit	-
Resolution	-

Equivalent key No equivalent key is available on the front panel.

:CALCulate:TR[1-1]:TRACe[1-4]:LIMit:LOWer:SEGment:CLEar

Syntax :CALCulate:TR[1-1]:TRACe[1-4]:LIMit:LOWer:SEGment:CLEar

Description Clears the lower limit line (No Query)

Equivalent key TR Menu -> Display-> Limit Test -> Delete Lower Limit Line

:CALCulate:TR[1-1]:TRACe[1-4]:LIMit:LOWer:SEGment:COUNT

Syntax :CALCulate:TR[1-1]:TRACe[1-4]:LIMit:LOWer:SEGment:COUNT <numeric>

:CALCulate:TR[1-1]:TRACe[1-4]:LIMit:LOWer:SEGment:COUNT?

Description Sets/Reads the number of segments in the lower limit line

Parameter

	<Numeric>
Range	1 to 100
Preset value	1
Unit	-
Resolution	-

Equivalent key No equivalent key is available on the front panel.

:CALCulate:TR[1-1]:TRACe[1-4]:LIMit:LOWer:SEGment:DATA

Syntax :CALCulate:TR[1-1]:TRACe[1-4]:LIMit:LOWer:SEGment:DATA <array>

:CALCulate:TR[1-1]:TRACe[1-4]:LIMit:LOWer:SEGment:DATA?

Description Sets/Reads segment data of the lower limit line

Parameter

	<Description>
Range	1...400
Preset value	-
Unit	-
Resolution	-

Equivalent key No equivalent key is available on the front panel.

:CALCulate:TR[1-1]:TRACe[1-4]:LIMit:REPort[:DATA]

Syntax :CALCulate:TR[1-1]:TRACe[1-4]:LIMit:REPort[:DATA]

Description Reads the limit test results of all measurement points in selected traces (Query Only)

Equivalent key No equivalent key is available on the front panel.

:CALCulate:TR[1-1]:TRACe[1-4]:LIMit[:STATe]

Syntax :CALCulate:TR[1-1]:TRACe[1-4]:LIMit[:STATe] {ON|OFF|1|0}

:CALCulate:TR[1-1]:TRACe[1-4]:LIMit[:STATe]?

Description Turns on/off the limit test function

Parameter

	Description
ON or 1	Turn on the limit test function mode
OFF or 0(Preset value)	Turn off the limit test function mode

Equivalent key TR Menu -> Display -> Limit Test -> Limit Test

:CALCulate:TR[1-1]:TRACe[1-4]:LIMit:UPPer:LDAa

Syntax :CALCulate:TR[1-1]:TRACe[1-4]:LIMit:UPPer:LDAa <array>

:CALCulate:TR[1-1]:TRACe[1-4]:LIMit:UPPer:LDAa?

Description Sets/Reads the upper limit values of all measurement points

Parameter

	<Description>
Range	1...1001
Preset value	-
Unit	-
Resolution	-

Equivalent key No equivalent key is available on the front panel.

:CALCulate:TR[1-1]:TRACe[1-4]:LIMit:UPPer:SEGment:CLEar

Syntax :CALCulate:TR[1-1]:TRACe[1-4]:LIMit:UPPer:SEGment:CLEar
 Description Clears the upper limit line (No Query)
 Equivalent key TR Menu -> Display-> Limit Test -> Delete Upper Limit Line

:CALCulate:TR[1-1]:TRACe[1-4]:LIMit:UPPer:SEGment:COUNT

Syntax :CALCulate:TR[1-1]:TRACe[1-4]:LIMit:UPPer:SEGment:COUNT <numeric>
 :CALCulate:TR[1-1]:TRACe[1-4]:LIMit:UPPer:SEGment:COUNT?

Description Sets/Reads the number of segments in the upper limit line

Parameter

	<Numeric>
Range	1 to 100
Preset value	1
Unit	-
Resolution	-

Equivalent key No equivalent key is available on the front panel.

:CALCulate:TR[1-1]:TRACe[1-4]:LIMit:UPPer:SEGment:DATA

Syntax :CALCulate:TR[1-1]:TRACe[1-4]:LIMit:UPPer:SEGment:DATA <array>
 :CALCulate:TR[1-1]:TRACe[1-4]:LIMit:UPPer:SEGment:DATA?

Description Sets/Reads segment data of the upper limit line

Parameter

	<Description>
Range	1...400
Preset value	-
Unit	-
Resolution	-

Equivalent key No equivalent key is available on the front panel.

:CALCulate:TR[1-1]:TRACe[1-4]:LINE:A

Syntax :CALCulate:TR[1-1]:TRACe[1-4]:LINE:A <numeric>

:CALCulate:TR[1-1]:TRACe[1-4]:LINE:A?

Description Sets/Reads the regression line coefficient a (slope)

Parameter

	<Numeric>
Description	Regression line coefficient a
Range	-500 T to 500 T
Preset value	0
Unit	-
Resolution	-

Equivalent key TR Menu -> Trace View -> Memory Trace -> Line (Y = AX + B) -> A

:CALCulate:TR[1-1]:TRACe[1-4]:LINE:B

Syntax :CALCulate:TR[1-1]:TRACe[1-4]:LINE:B <numeric>

:CALCulate:TR[1-1]:TRACe[1-4]:LINE:B?

Description Sets/Reads the regression line coefficient b (intercept)

Parameter

	<Numeric>
Description	Regression line coefficient b
Range	-500 T to 500 T
Preset value	0
Unit	-
Resolution	-

Equivalent key TR Menu -> Trace View -> Memory Trace -> Line (Y = AX + B) -> B

:CALCulate:TR[1-1]:TRACe[1-4]:LINE:MEMory

Syntax :CALCulate:TR[1-1]:TRACe[1-4]:LINE:MEMory

Description Saves the obtained regression line to a trace memory (No Query)

Equivalent key TR Menu -> Trace View -> Memory Trace -> Line (Y = AX + B) -> Set Line to Memory

:CALCulate:TR[1-1]:TRACe[1-4]:MARKer[1-10]:SEARch:EXECute:LPEak

Syntax :CALCulate:TR[1-1]:TRACe[1-4]:MARKer[1-10]:SEARch:EXECute:LPEak

Description Executes marker peak search left (No Query)

Equivalent key TR Menu -> Marker Search -> Peak -> Search Left

:CALCulate:TR[1-1]:TRACe[1-4]:MARKer[1-10]:SEARch:EXECute:LTARget

Syntax :CALCulate:TR[1-1]:TRACe[1-4]:MARKer[1-10]:SEARch:EXECute:LTARget

Description Executes marker target search left (No Query)

Equivalent key TR Menu -> Marker Search -> Target -> Search Left

:CALCulate:TR[1-1]:TRACe[1-4]:MARKer[1-10]:SEARch:EXECute:MAXimum

Syntax :CALCulate:TR[1-1]:TRACe[1-4]:MARKer[1-10]:SEARch:EXECute:MAXimum

Description Executes marker search maximum (No Query)

Equivalent key TR Menu -> Marker Search -> Search Max

:CALCulate:TR[1-1]:TRACe[1-4]:MARKer[1-10]:SEARch:EXECute:MINimum

Syntax :CALCulate:TR[1-1]:TRACe[1-4]:MARKer[1-10]:SEARch:EXECute:MINimum

Description Executes marker search minimum (No Query)

Equivalent key TR Menu -> Marker Search -> Search Min

:CALCulate:TR[1-1]:TRACe[1-4]:MARKer[1-10]:SEARch:EXECute:PEAK

Syntax :CALCulate:TR[1-1]:TRACe[1-4]:MARKer[1-10]:SEARch:EXECute:PEAK

Description Executes marker peak search (No Query)

Equivalent key TR Menu -> Marker Search -> Peak -> Search Peak

**:CALCulate:TR[1-1]:TRACe[1-4]:MARKer[1-10]:SEARch:
EXECute:RPEak**

Syntax :CALCulate:TR[1-1]:TRACe[1-4]:MARKer[1-10]:SEARch:EXECute:RPEak

Description Executes marker peak search right (No Query)

Equivalent key TR Menu -> Marker Search -> Peak -> Search Right

**:CALCulate:TR[1-1]:TRACe[1-4]:MARKer[1-10]:SEARch:
EXECute:RTARget**

Syntax :CALCulate:TR[1-1]:TRACe[1-4]:MARKer[1-10]:SEARch:EXECute:RTARget

Description Executes marker target search right (No Query)

Equivalent key TR Menu -> Marker Search -> Target -> Search Right

**:CALCulate:TR[1-1]:TRACe[1-4]:MARKer[1-10]:SEARch:
EXECute:TARGet**

Syntax :CALCulate:TR[1-1]:TRACe[1-4]:MARKer[1-10]:SEARch:EXECute:TARGet

Description Executes marker target search (No Query)

Equivalent key TR Menu -> Marker Search -> Target -> Search Target

**:CALCulate:TR[1-1]:TRACe[1-4]:MARKer[1-10]:SEARch:
PEAK:EXCursion**

Syntax :CALCulate:TR[1-1]:TRACe[1-4]:MARKer[1-10]:SEARch:PEAK:EXCursion
<numeric>

:CALCulate:TR[1-1]:TRACe[1-4]:MARKer[1-10]:SEARch:PEAK:EXCursion?

Description Sets/Reads the peak excursion value

Parameter

	<Numeric>
Range	0 to 10G
Preset value	0
Unit	-
Resolution	-

Equivalent key TR Menu -> Marker Search -> Peak -> Peak Excursion

:CALCulate:TR[1-1]:TRACe[1-4]:MARKer[1-10]:SEARch:PEAK:POLarity

Syntax :CALCulate:TR[1-1]:TRACe[1-4]:MARKer[1-10]:SEARch:PEAK:POLarity
{POSitive|NEGative|BOTH}
:CALCulate:TR[1-1]:TRACe[1-4]:MARKer[1-10]:SEARch:PEAK:POLarity?

Description Sets/Reads the marker peak-search polarity

Parameter

	Description
POSitive(Preset value)	Set the marker peak-search polarity to 'Positive'
NEGative	Set the marker peak-search polarity to 'Negative'
BOTH	Set the marker peak-search polarity to 'Both'

Equivalent key TR Menu -> Marker Search -> Peak -> Peak Polarity

:CALCulate:TR[1-1]:TRACe[1-4]:MARKer[1-10]:SEARch:TARGet:TRAnSition

Syntax :CALCulate:TR[1-1]:TRACe[1-4]:MARKer[1-10]:SEARch:TARGet:TRAnSition
{POSitive|NEGative|BOTH}
:CALCulate:TR[1-1]:TRACe[1-4]:MARKer[1-10]:SEARch:TARGet:TRAnSition?

Description Sets/Reads the target transition definition

Parameter

	Description
POSitive	Set the target transition definition to 'Positive'
NEGative	Set the target transition definition to 'Negative'
BOTH(Preset value)	Set the target transition definition to 'Both'

Equivalent key TR Menu -> Marker Search -> Target -> Search Transition

:CALCulate:TR[1-1]:TRACe[1-4]:MARKer[1-10]:SEARch:TARGet:Y

Syntax :CALCulate:TR[1-1]:TRACe[1-4]:MARKer[1-10]:SEARch:TARGet:Y <numeric>
:CALCulate:TR[1-1]:TRACe[1-4]:MARKer[1-10]:SEARch:TARGet:Y?

Description Sets/Reads the marker target value

Parameter

	<Numeric>
Range	-10G to 10G
Preset value	0
Unit	-
Resolution	-

Equivalent key TR Menu -> Marker Search -> Target -> Search Value

:CALCulate:TR[1-1]:TRACe[1-4]:MARKer[1-10]:SEARch:TRACking:TYPE

Syntax

:CALCulate:TR[1-1]:TRACe[1-4]:MARKer[1-10]:SEARch:TRACking:TYPE
{OFF|MAXimum|MINimum|PEAK|TARGet}

:CALCulate:TR[1-1]:TRACe[1-4]:MARKer[1-10]:SEARch:TRACking:TYPE?

Description

Sets/Reads the marker tracking type

Parameter

	Description
OFF(Preset value)	Set the marker tracking type to 'Off'
MAXimum	Set the marker tracking type to 'Maximum'
MINimum	Set the marker tracking type to 'Minimum'
PEAK	Set the marker tracking type to 'Peak'
TARGet	Set the marker tracking type to 'Target'

Equivalent key TR Menu -> Marker Search -> Tracking

:CALCulate:TR[1-1]:TRACe[1-4]:MARKer[1-10]:STATe

Syntax

:CALCulate:TR[1-1]:TRACe[1-4]:MARKer[1-10]:STATe {ON|OFF|1|0}

:CALCulate:TR[1-1]:TRACe[1-4]:MARKer[1-10]:STATe?

Description

Turns on/off markers

Parameter

	Description
ON or 1	Set markers mode to 'ON'
OFF or 0(Preset value)	Set markers mode to 'OFF'

Equivalent key

TR Menu -> Marker -> Clear Marker Menu -> Marker 1

:CALCulate:TR[1-1]:TRACe[1-4]:MARKer[1-10]:X

Syntax

:CALCulate:TR[1-1]:TRACe[1-4]:MARKer[1-10]:X <numeric>
:CALCulate:TR[1-1]:TRACe[1-4]:MARKer[1-10]:X?

Description

Sets/Reads the marker X value

Parameter

	<Numeric>
Range	-
Preset value	-50m
Unit	-
Resolution	-

Equivalent key

No equivalent key is available on the front panel.

:CALCulate:TR[1-1]:TRACe[1-4]:MARKer[1-10]:Y

Syntax

:CALCulate:TR[1-1]:TRACe[1-4]:MARKer[1-10]:Y

Description

Reads the marker Y value (Query Only)

Equivalent key

No equivalent key is available on the front panel.

:CALCulate:TR[1-1]:TRACe[1-4]:MATH:FUNCtion

Syntax

:CALCulate:TR[1-1]:TRACe[1-4]:MATH:FUNCtion
{NORMal|SUBTract|DIVide|ADD|MULTiply}
:CALCulate:TR[1-1]:TRACe[1-4]:MATH:FUNCtion?

Description

Selects math operation type

Parameter

	Description
NORMAL(Preset value)	Set math operation type to 'Off'
SUBTRACT	Set math operation type to 'Data - Mem'
DIVIDE	Set math operation type to 'Data / Mem'
ADD	Set math operation type to 'Data + Mem'
MULTIPLY	Set math operation type to 'Data * Mem'

Equivalent key TR Menu -> Trace View -> Data Math

:CALCulate:TR[1-1]:TRACe[1-4]:MATH:MEMorize

Syntax :CALCulate:TR[1-1]:TRACe[1-4]:MATH:MEMorize

Description Copies data to memory (No Query)

Equivalent key No equivalent key is available on the front panel.

:CALCulate:TR[1-1]:TRACe[1-4]:MATH:OFFSet

Syntax :CALCulate:TR[1-1]:TRACe[1-4]:MATH:OFFSet <numeric>

:CALCulate:TR[1-1]:TRACe[1-4]:MATH:OFFSet?

Description Sets/reads the offset value of the trace

Parameter

	<Numeric>
Description	Offset value of the trace
Range	-500G to 500G
Preset value	0
Unit	-
Resolution	-

Equivalent key TR Menu -> Trace View -> Offset

TR Menu -> Trace View -> [Marker -> -Offset]

:CALCulate:TR[1-1]:TRACe[1-4]:PARAmeter

Syntax :CALCulate:TR[1-1]:TRACe[1-4]:PARAmeter

Description Reads the trace parameter. (Query Only)

Equivalent key No equivalent key is available on the front panel.

:CALCulate:TR[1-1]:TRACe[1-4]:REFerence:FREQuency

Syntax :CALCulate:TR[1-1]:TRACe[1-4]:REFerence:FREQuency <numeric>
:CALCulate:TR[1-1]:TRACe[1-4]:REFerence:FREQuency?

Description Sets/Reads the reference frequency

Parameter

	<Numeric>
Range	-500G to 500G
Preset value	0
Unit	Hz
Resolution	-

Equivalent key TR Menu -> Format -> Frequency Reference

:CALCulate:TR[1-1]:TRACe[1-4]:SMOothing:APERture

Syntax :CALCulate:TR[1-1]:TRACe[1-4]:SMOothing:APERture <numeric>
:CALCulate:TR[1-1]:TRACe[1-4]:SMOothing:APERture?

Description Smoothing aperture

Parameter

	<Numeric>
Range	50m to 25
Preset value	1.5
Unit	%
Resolution	-

Equivalent key TR Menu -> Trace View -> Aperture

:CALCulate:TR[1-1]:TRACe[1-4]:SMOothing:STATe

Syntax :CALCulate:TR[1-1]:TRACe[1-4]:SMOothing:STATe {ON|OFF|1|0}
:CALCulate:TR[1-1]:TRACe[1-4]:SMOothing:STATe?

Description Turns on/off smoothing mode

Parameter

	Description
ON or 1	Set smoothing mode to 'ON'
OFF or 0(Preset value)	Set smoothing mode to 'OFF'

Equivalent key TR Menu -> Trace View -> Smoothing

:CALCulate:TR[1-1]:WIDE:DATA:RDATA

Syntax :CALCulate:TR[1-1]:WIDE:DATA:RDATA <array>

:CALCulate:TR[1-1]:WIDE:DATA:RDATA?

Description Sets/Reads the measurement raw data

Parameter

	<Description>
Range	1...1001
Preset value	-
Unit	-
Resolution	-

Equivalent key No equivalent key is available on the front panel.

:CALCulate:TR[1-1]:WIDE:DATA:XDATA

Syntax :CALCulate:TR[1-1]:WIDE:DATA:XDATA

Description Reads the X-axis data (Query Only)

Equivalent key No equivalent key is available on the front panel.

:CALCulate:USER[1-1]:ALLTrace:ACTive

Syntax :CALCulate:USER[1-1]:ALLTrace:ACTive <numeric>

:CALCulate:USER[1-1]:ALLTrace:ACTive?

Description Selects active trace

Parameter

	<Numeric>
Range	1 to 8
Preset value	1
Unit	-
Resolution	-

Equivalent key

No equivalent key is available on the front panel.

:CALCulate:USER[1-1]:ALLTrace:BDMarker:X:COUPle:STATe

Syntax

:CALCulate:USER[1-1]:ALLTrace:BDMarker:X:COUPle:STATe {ON|OFF|1|0}

:CALCulate:USER[1-1]:ALLTrace:BDMarker:X:COUPle:STATe?

Description

Turns on/off bandmarker coupling function

Parameter

	Description
ON or 1	Set bandmarker coupling function mode to 'ON'
OFF or 0(Preset value)	Set bandmarker coupling function mode to 'OFF'

Equivalent key

USER Menu -> Marker Function -> Couple

USER Menu -> Marker Search -> Couple

:CALCulate:USER[1-1]:ALLTrace:LIMit:FAIL

Syntax

:CALCulate:USER[1-1]:ALLTrace:LIMit:FAIL

Description

Reads out the limit test result (Query Only)

Parameter

	Description
ON or 1	The limit test result is fail
OFF or 0(Preset value)	The limit test result is pass

When the limit test is set to OFF, OFF or 0 is always read out.

Equivalent key No equivalent key is available on the front panel.

:CALCulate:USER[1-1]:ALLTrace:MARKer:COUPlE:STATe

Syntax :CALCulate:USER[1-1]:ALLTrace:MARKer:COUPlE:STATe {ON|OFF|1|0}
:CALCulate:USER[1-1]:ALLTrace:MARKer:COUPlE:STATe?

Description Turns on/off marker coupling function

Parameter

	Description
ON or 1	Set marker coupling function mode to 'ON'
OFF or 0(Preset value)	Set marker coupling function mode to 'OFF'

Equivalent key USER Menu -> Marker -> Couple

:CALCulate:USER[1-1]:ALLTrace:MARKer:DISCReTE:STATe

Syntax :CALCulate:USER[1-1]:ALLTrace:MARKer:DISCReTE:STATe {ON|OFF|1|0}
:CALCulate:USER[1-1]:ALLTrace:MARKer:DISCReTE:STATe?

Description Sets/Reads marker discrete mode

Parameter

	Description
ON or 1	Set marker discrete mode to 'ON'
OFF or 0(Preset value)	Set marker discrete mode to 'OFF'

Equivalent key USER Menu -> Marker -> More Functions -> Discrete

:CALCulate:USER[1-1]:ALLTrace:MARKer:REFerence:NUMBER

Syntax :CALCulate:USER[1-1]:ALLTrace:MARKer:REFerence:NUMBER <numeric>
:CALCulate:USER[1-1]:ALLTrace:MARKer:REFerence:NUMBER?

Description Sets/Reads marker reference number

Parameter

	<Numeric>
Range	1 to 10
Preset value	1
Unit	-
Resolution	-

Equivalent key

USER Menu -> Marker -> More Functions -> Ref Marker

:CALCulate:USER[1-1]:ALLTrace:MARKer:REFerence:STATe

Syntax

:CALCulate:USER[1-1]:ALLTrace:MARKer:REFerence:STATe {ON|OFF|1|0}

:CALCulate:USER[1-1]:ALLTrace:MARKer:REFerence:STATe?

Description

Turns on/off delta marker mode

Parameter

	Description
ON or 1	Set delta marker mode mode to 'ON'
OFF or 0(Preset value)	Set delta marker mode mode to 'OFF'

Equivalent key

USER Menu -> Marker -> More Functions -> Ref Marker Mode

:CALCulate:USER[1-1]:TRACe[1-8]:ALLMarker:ACTive

Syntax

:CALCulate:USER[1-1]:TRACe[1-8]:ALLMarker:ACTive <numeric>

:CALCulate:USER[1-1]:TRACe[1-8]:ALLMarker:ACTive?

Description

Selects active marker

Parameter

	<Numeric>
Range	1 to 10
Preset value	1
Unit	-
Resolution	-

Equivalent key No equivalent key is available on the front panel.

:CALCulate:USER[1-1]:TRACe[1-8]:ALLMarker:SEARch:DOMain:X

Syntax :CALCulate:USER[1-1]:TRACe[1-8]:ALLMarker:SEARch:DOMain:X
{FRANge|BDMarker}
:CALCulate:USER[1-1]:TRACe[1-8]:ALLMarker:SEARch:DOMain:X?

Description Sets/Reads marker search X range

Parameter

	Description
FRANge(Preset value)	Set marker search X range to 'Full Range'
BDMarker	Set marker search X range to 'Band Marker'

Equivalent key USER Menu -> Marker Search -> Search Range (X)

:CALCulate:USER[1-1]:TRACe[1-8]:ALLMarker:SEARch:DOMain:Y

Syntax :CALCulate:USER[1-1]:TRACe[1-8]:ALLMarker:SEARch:DOMain:Y
{FRANge|BDMarker}
:CALCulate:USER[1-1]:TRACe[1-8]:ALLMarker:SEARch:DOMain:Y?

Description Sets/Reads marker search Y range

Parameter

	Description
FRANge(Preset value)	Set marker search Y range to 'Full Range'
BDMarker	Set marker search Y range to 'Band Marker'

Equivalent key USER Menu -> Marker Search -> Search Range (Y)

:CALCulate:USER[1-1]:TRACe[1-8]:ALLMarker:SEARch:PEAK

Syntax :CALCulate:USER[1-1]:TRACe[1-8]:ALLMarker:SEARch:PEAK

Description Executes mearker search peak all (No Query)

Equivalent key USER Menu -> Marker Search -> Peak -> Search Peak All

:CALCulate:USER[1-1]:TRACe[1-8]:BDMarker:X:CENTer

Syntax :CALCulate:USER[1-1]:TRACe[1-8]:BDMarker:X:CENTer <numeric>
:CALCulate:USER[1-1]:TRACe[1-8]:BDMarker:X:CENTer?

Description Sets/Reads the center value of bandmarker X

Parameter

	<Numeric>
Range	-1T to 1T
Preset value	0
Unit	-
Resolution	-

Equivalent key USER Menu -> Marker Function -> Band Marker X -> Center
USER Menu -> Marker Search -> Band Marker X -> Center

:CALCulate:USER[1-1]:TRACe[1-8]:BDMarker:X:SPAN

Syntax :CALCulate:USER[1-1]:TRACe[1-8]:BDMarker:X:SPAN <numeric>
:CALCulate:USER[1-1]:TRACe[1-8]:BDMarker:X:SPAN?

Description Sets/Reads the span value of bandmarker X

Parameter

	<Numeric>
Range	0 to 2T
Preset value	2T
Unit	-
Resolution	-

Equivalent key USER Menu -> Marker Function -> Band Marker X -> Span
USER Menu -> Marker Search -> Band Marker X -> Span

:CALCulate:USER[1-1]:TRACe[1-8]:BDMarker:X:START

Syntax :CALCulate:USER[1-1]:TRACe[1-8]:BDMarker:X:START <numeric>
:CALCulate:USER[1-1]:TRACe[1-8]:BDMarker:X:START?

Description Sets/reads the start value of bandmarker X

Parameter

	<Numeric>
Range	-IT to IT
Preset value	-IT
Unit	-
Resolution	-

Equivalent key USER Menu -> Marker Function -> Band Marker X -> Start

USER Menu -> Marker Search -> Band Marker X -> Start

:CALCulate:USER[1-1]:TRACe[1-8]:BDMarker:X:STATe

Syntax

:CALCulate:USER[1-1]:TRACe[1-8]:BDMarker:X:STATe {ON|OFF|1|0}

:CALCulate:USER[1-1]:TRACe[1-8]:BDMarker:X:STATe?

Description

Turns on/off bandmarker X

Parameter

	Description
ON or 1	Set bandmarker mode to 'ON'
OFF or 0(Preset value)	Set bandmarker mode to 'OFF'

Equivalent key

USER Menu -> Marker Function -> Band Marker X -> Band Marker X

USER Menu -> Marker Search -> Band Marker X -> Band Marker X

:CALCulate:USER[1-1]:TRACe[1-8]:BDMarker:X:STOP

Syntax

:CALCulate:USER[1-1]:TRACe[1-8]:BDMarker:X:STOP <numeric>

:CALCulate:USER[1-1]:TRACe[1-8]:BDMarker:X:STOP?

Description

Sets/Reads the stop value of bandmarker X

Parameter

	<Numeric>
Range	-IT to IT
Preset value	IT

	<Numeric>
Unit	-
Resolution	-

Equivalent key
USER Menu -> Marker Function -> Band Marker X -> Stop
USER Menu -> Marker Search -> Band Marker X -> Stop

:CALCulate:USER[1-1]:TRACe[1-8]:BDMarker:Y:CENTer

Syntax
:CALCulate:USER[1-1]:TRACe[1-8]:BDMarker:Y:CENTer <numeric>
:CALCulate:USER[1-1]:TRACe[1-8]:BDMarker:Y:CENTer?

Description
Sets/Reads the center value of bandmarker Y

Parameter

	<Numeric>
Range	-1T to 1T
Preset value	0
Unit	-
Resolution	-

Equivalent key
USER Menu -> Marker Function -> Band Marker Y -> Center
USER Menu -> Marker Search -> Band Marker Y -> Center

:CALCulate:USER[1-1]:TRACe[1-8]:BDMarker:Y:SPAN

Syntax
:CALCulate:USER[1-1]:TRACe[1-8]:BDMarker:Y:SPAN <numeric>
:CALCulate:USER[1-1]:TRACe[1-8]:BDMarker:Y:SPAN?

Description
Sets/Reads the span value of bandmarker Y

Parameter

	<Numeric>
Range	0 to 2T
Preset value	2T
Unit	-
Resolution	-

Equivalent key USER Menu -> Marker Function -> Band Marker Y -> Span
USER Menu -> Marker Search -> Band Marker Y -> Span

:CALCulate:USER[1-1]:TRACe[1-8]:BDMarker:Y:START

Syntax :CALCulate:USER[1-1]:TRACe[1-8]:BDMarker:Y:START <numeric>
:CALCulate:USER[1-1]:TRACe[1-8]:BDMarker:Y:START?

Description Sets/Reads the start value of bandmarker Y

Parameter

	<Numeric>
Range	-1T to 1T
Preset value	-1T
Unit	-
Resolution	-

Equivalent key USER Menu -> Marker Function -> Band Marker Y -> Start
USER Menu -> Marker Search -> Band Marker Y -> Start

:CALCulate:USER[1-1]:TRACe[1-8]:BDMarker:Y:STATE

Syntax :CALCulate:USER[1-1]:TRACe[1-8]:BDMarker:Y:STATE {ON|OFF|1|0}
:CALCulate:USER[1-1]:TRACe[1-8]:BDMarker:Y:STATE?

Description Turns on/off bandmarker Y

Parameter

	Description
ON or 1	Set bandmarker mode to 'ON'
OFF or 0(Preset value)	Set bandmarker mode to 'OFF'

Equivalent key USER Menu -> Marker Function -> Band Marker Y -> Band Marker Y
USER Menu -> Marker Search -> Band Marker Y -> Band Marker Y

:CALCulate:USER[1-1]:TRACe[1-8]:BDMarker:Y:STOP

Syntax :CALCulate:USER[1-1]:TRACe[1-8]:BDMarker:Y:STOP <numeric>
:CALCulate:USER[1-1]:TRACe[1-8]:BDMarker:Y:STOP?

Description Sets/Reads the stop value of bandmarker Y

Parameter

	<Numeric>
Range	-1T to 1T
Preset value	1T
Unit	-
Resolution	-

Equivalent key
USER Menu -> Marker Function -> Band Marker Y -> Stop
USER Menu -> Marker Search -> Band Marker Y -> Stop

:CALCulate:USER[1-1]:TRACe[1-8]:DATA:COPY

Syntax :CALCulate:USER[1-1]:TRACe[1-8]:DATA:COPY <numeric>

Description Copies trace data to the user trace (No Query)

Parameter

	<Numeric>
Range	1 to 8
Preset value	-
Unit	-
Resolution	-

Equivalent key
USER Menu -> Trace View-> Copy to USER -> Copy to USER1
USER Menu -> Trace View-> Copy to USER -> Copy to USER2
USER Menu -> Trace View-> Copy to USER -> Copy to USER3
USER Menu -> Trace View-> Copy to USER -> Copy to USER4
USER Menu -> Trace View-> Copy to USER -> Copy to USER5
USER Menu -> Trace View-> Copy to USER -> Copy to USER6
USER Menu -> Trace View-> Copy to USER -> Copy to USER7
USER Menu -> Trace View-> Copy to USER -> Copy to USER8

:CALCulate:USER[1-1]:TRACe[1-8]:DATA:FDATa

Syntax :CALCulate:USER[1-1]:TRACe[1-8]:DATA:FDATa <array>
:CALCulate:USER[1-1]:TRACe[1-8]:DATA:FDATa?

Description Sets/Reads formatted trace data

Parameter

	<Description>
Range	1...1601
Preset value	-
Unit	-
Resolution	-

Equivalent key No equivalent key is available on the front panel.

:CALCulate:USER[1-1]:TRACe[1-8]:DATA:FMEMory

Syntax :CALCulate:USER[1-1]:TRACe[1-8]:DATA:FMEMory <array>
:CALCulate:USER[1-1]:TRACe[1-8]:DATA:FMEMory?

Description Sets/Reads formatted memory data

Parameter

	<Description>
Range	1...1601
Preset value	-
Unit	-
Resolution	-

Equivalent key No equivalent key is available on the front panel.

:CALCulate:USER[1-1]:TRACe[1-8]:DATA:POINts

Syntax :CALCulate:USER[1-1]:TRACe[1-8]:DATA:POINts

Description reads the number of measurement points (Query Only)

Equivalent key No equivalent key is available on the front panel.

:CALCulate:USER[1-1]:TRACe[1-8]:DATA:RDATa

Syntax :CALCulate:USER[1-1]:TRACe[1-8]:DATA:RDATa <array>
:CALCulate:USER[1-1]:TRACe[1-8]:DATA:RDATa?

Description Sets/Reads raw data

Parameter

	<Description>
Range	1...1601
Preset value	-
Unit	-
Resolution	-

Equivalent key No equivalent key is available on the front panel.

:CALCulate:USER[1-1]:TRACe[1-8]:DATA:START

Syntax :CALCulate:USER[1-1]:TRACe[1-8]:DATA:START

Description start frequency (Query Only)

Equivalent key No equivalent key is available on the front panel.

:CALCulate:USER[1-1]:TRACe[1-8]:DATA:STOP

Syntax :CALCulate:USER[1-1]:TRACe[1-8]:DATA:STOP

Description stop frequency (Query Only)

Equivalent key No equivalent key is available on the front panel.

:CALCulate:USER[1-1]:TRACe[1-8]:DATA:UDATa

Syntax :CALCulate:USER[1-1]:TRACe[1-8]:DATA:UDATa <array>

:CALCulate:USER[1-1]:TRACe[1-8]:DATA:UDATa?

Description Sets/Reads unformatted trace data

Parameter

	<Description>
Range	1...1601
Preset value	-
Unit	-
Resolution	-

Equivalent key No equivalent key is available on the front panel.

:CALCulate:USER[1-1]:TRACe[1-8]:DATA:UMEMory

Syntax :CALCulate:USER[1-1]:TRACe[1-8]:DATA:UMEMory <array>
:CALCulate:USER[1-1]:TRACe[1-8]:DATA:UMEMory?

Description Sets/Reads unformatted memory data

Parameter

	<Description>
Range	1...1601
Preset value	-
Unit	-
Resolution	-

Equivalent key No equivalent key is available on the front panel.

:CALCulate:USER[1-1]:TRACe[1-8]:DATA:XDATA

Syntax :CALCulate:USER[1-1]:TRACe[1-8]:DATA:XDATA <array>
:CALCulate:USER[1-1]:TRACe[1-8]:DATA:XDATA?

Description Sets/Reads the X data

Parameter

	<Description>
Range	1...1601
Preset value	-
Unit	-
Resolution	-

Equivalent key No equivalent key is available on the front panel.

:CALCulate:USER[1-1]:TRACe[1-8]:FUNCTion:DOMain:X

Syntax :CALCulate:USER[1-1]:TRACe[1-8]:FUNCTion:DOMain:X {FRANge|BDMarker}
:CALCulate:USER[1-1]:TRACe[1-8]:FUNCTion:DOMain:X?

Description Sets/Reads analysis/search range(X-axis)

Parameter

	Description
FRANge	Set marker search MINimum to 'Full Range'
BDMarker(Preset value)	Set marker search MINimum to 'Band Marker'

Equivalent key

USER Menu -> Marker Function -> Analysis Range (X)

:CALCulate:USER[1-1]:TRACe[1-8]:FUNCtion:DOMain:Y

Syntax

:CALCulate:USER[1-1]:TRACe[1-8]:FUNCtion:DOMain:Y {FRANge|BDMarker}
:CALCulate:USER[1-1]:TRACe[1-8]:FUNCtion:DOMain:Y?

Description

Sets/Reads analysis/search range(Y-axis)

Parameter

	Description
FRANge	Set marker search PEAK to 'Full Range'
BDMarker(Preset value)	Set marker search PEAK to 'Band Marker'

Equivalent key

USER Menu -> Marker Function -> Analysis Range (Y)

:CALCulate:USER[1-1]:TRACe[1-8]:FUNCtion:STATistics:DATA

Syntax

:CALCulate:USER[1-1]:TRACe[1-8]:FUNCtion:STATistics:DATA

Description

trace data statistics (Query Only)

Equivalent key

No equivalent key is available on the front panel.

:CALCulate:USER[1-1]:TRACe[1-8]:FUNCtion:STATistics:MEMory

Syntax

:CALCulate:USER[1-1]:TRACe[1-8]:FUNCtion:STATistics:MEMory

Description

memory data statistics (Query Only)

Equivalent key

No equivalent key is available on the front panel.

:CALCulate:USER[1-1]:TRACe[1-8]:FUNCtion:TYPE

Syntax :CALCulate:USER[1-1]:TRACe[1-8]:FUNCtion:TYPE {OFF|STATistics}
:CALCulate:USER[1-1]:TRACe[1-8]:FUNCtion:TYPE?

Description Analysis type

Parameter

	Description
OFF(Preset value)	Set marker search TARGeT to 'Off'
STATistics	Set marker search TARGeT to 'Statistics'

Equivalent key USER Menu -> Marker Function -> Analysis Type

:CALCulate:USER[1-1]:TRACe[1-8]:HOLD

Syntax :CALCulate:USER[1-1]:TRACe[1-8]:HOLD {OFF|MAXimum|MINimum}
:CALCulate:USER[1-1]:TRACe[1-8]:HOLD?

Description Data hold

Parameter

	Description
OFF(Preset value)	Set marker-search-peak excursion value to 'Off'
MAXimum	Set marker-search-peak excursion value to 'Maximum'
MINimum	Set marker-search-peak excursion value to 'Minimum'

Equivalent key USER Menu -> Trace View -> Data Hold

:CALCulate:USER[1-1]:TRACe[1-8]:LIMit:FAIL

Syntax :CALCulate:USER[1-1]:TRACe[1-8]:LIMit:FAIL

Description Reads out the limit test result (Query Only)

Parameter

	Description
ON or 1	The limit test result is fail
OFF or 0(Preset value)	The limit test result is pass

When the limit test is set to OFF, OFF or 0 is always read out.

Equivalent key No equivalent key is available on the front panel.

:CALCulate:USER[1-1]:TRACe[1-8]:LIMit:LOWer:LDAa

Syntax :CALCulate:USER[1-1]:TRACe[1-8]:LIMit:LOWer:LDAa <array>
:CALCulate:USER[1-1]:TRACe[1-8]:LIMit:LOWer:LDAa?

Description Sets/Reads the lower limit values of all measurement points

Parameter

	<Description>
Range	1...1601
Preset value	-
Unit	-
Resolution	-

Equivalent key No equivalent key is available on the front panel.

:CALCulate:USER[1-1]:TRACe[1-8]:LIMit:LOWer:SEGMent:CLEar

Syntax :CALCulate:USER[1-1]:TRACe[1-8]:LIMit:LOWer:SEGMent:CLEar

Description Clears the lower limit line (No Query)

Equivalent key USER Menu -> Display-> Limit Test -> Delete Lower Limit Line

:CALCulate:USER[1-1]:TRACe[1-8]:LIMit:LOWer:SEGMent:COUNT

Syntax :CALCulate:USER[1-1]:TRACe[1-8]:LIMit:LOWer:SEGMent:COUNT <numeric>
:CALCulate:USER[1-1]:TRACe[1-8]:LIMit:LOWer:SEGMent:COUNT?

Description Sets/Reads the number of segments in the lower limit line

Parameter

	<Numeric>
Range	1 to 100
Preset value	1

	<Numeric>
Unit	-
Resolution	-

Equivalent key No equivalent key is available on the front panel.

:CALCulate:USER[1-1]:TRACe[1-8]:LIMit:LOWer:SEGMent:DATA

Syntax :CALCulate:USER[1-1]:TRACe[1-8]:LIMit:LOWer:SEGMent:DATA <array>
:CALCulate:USER[1-1]:TRACe[1-8]:LIMit:LOWer:SEGMent:DATA?

Description Sets/Reads segment data of the lower limit line

Parameter

	<Description>
Range	1...400
Preset value	-
Unit	-
Resolution	-

Equivalent key No equivalent key is available on the front panel.

:CALCulate:USER[1-1]:TRACe[1-8]:LIMit:REPort[:DATA]

Syntax :CALCulate:USER[1-1]:TRACe[1-8]:LIMit:REPort[:DATA]

Description Reads the limit test results of all measurement points in selected traces (Query Only)

Equivalent key No equivalent key is available on the front panel.

:CALCulate:USER[1-1]:TRACe[1-8]:LIMit[:STATe]

Syntax :CALCulate:USER[1-1]:TRACe[1-8]:LIMit[:STATe] {ON|OFF|1|0}
:CALCulate:USER[1-1]:TRACe[1-8]:LIMit[:STATe]?

Description Turns on/off the limit test function

Parameter

	Description
ON or 1	Turn on the limit test function mode
OFF or 0(Preset value)	Turn off the limit test function mode

Equivalent key

USER Menu -> Display -> Limit Test -> Limit Test

:CALCulate:USER[1-1]:TRACe[1-8]:LIMit:UPPer:LDATa

Syntax

:CALCulate:USER[1-1]:TRACe[1-8]:LIMit:UPPer:LDATa <array>
:CALCulate:USER[1-1]:TRACe[1-8]:LIMit:UPPer:LDATa?

Description

Sets/Reads the upper limit values of all measurement points

Parameter

	<Description>
Range	1...1601
Preset value	-
Unit	-
Resolution	-

Equivalent key

No equivalent key is available on the front panel.

**:CALCulate:USER[1-1]:TRACe[1-8]:LIMit:UPPer:SEGMe
nt:CLEar**

Syntax

:CALCulate:USER[1-1]:TRACe[1-8]:LIMit:UPPer:SEGMe
nt:CLEar

Description

Clears the upper limit line (No Query)

Equivalent key

USER Menu -> Display-> Limit Test -> Delete Upper Limit Line

**:CALCulate:USER[1-1]:TRACe[1-8]:LIMit:UPPer:SEGMe
nt:COUNT**

Syntax

:CALCulate:USER[1-1]:TRACe[1-8]:LIMit:UPPer:SEGMe
nt:COUNT <numeric>
:CALCulate:USER[1-1]:TRACe[1-8]:LIMit:UPPer:SEGMe
nt:COUNT?

Description

Sets/Reads the number of segments in the upper limit line

Parameter

	<Numeric>
Range	1 to 100
Preset value	1
Unit	-
Resolution	-

Equivalent key

No equivalent key is available on the front panel.

**:CALCulate:USER[1-1]:TRACe[1-8]:LIMit:UPPer:SEGMe
nt:DATA**

Syntax

:CALCulate:USER[1-1]:TRACe[1-8]:LIMit:UPPer:SEGment:DATA <array>

:CALCulate:USER[1-1]:TRACe[1-8]:LIMit:UPPer:SEGment:DATA?

Description

Sets/Reads segment data of the upper limit line

Parameter

	<Description>
Range	1...400
Preset value	-
Unit	-
Resolution	-

Equivalent key

No equivalent key is available on the front panel.

**:CALCulate:USER[1-1]:TRACe[1-8]:MARKer[1-10]:SEAR
ch:EXECute:LPEak**

Syntax

:CALCulate:USER[1-1]:TRACe[1-8]:MARKer[1-10]:SEARch:EXECute:LPEak

Description

Executes marker peak search left (No Query)

Equivalent key

USER Menu -> Marker Search -> Peak -> Search Left

**:CALCulate:USER[1-1]:TRACe[1-8]:MARKer[1-10]:SEAR
ch:EXECute:LTARget**

Syntax

:CALCulate:USER[1-1]:TRACe[1-8]:MARKer[1-10]:SEARch:EXECute:LTARget

Description

Executes marker targetsearch left (No Query)

Equivalent key USER Menu -> Marker Search -> Target -> Search Left

:CALCulate:USER[1-1]:TRACe[1-8]:MARKer[1-10]:SEARch:EXECute:MAXimum

Syntax :CALCulate:USER[1-1]:TRACe[1-8]:MARKer[1-10]:SEARch:EXECute:MAXimum

Description Executes marker search maximum (No Query)

Equivalent key USER Menu -> Marker Search -> Search Max

:CALCulate:USER[1-1]:TRACe[1-8]:MARKer[1-10]:SEARch:EXECute:MINimum

Syntax :CALCulate:USER[1-1]:TRACe[1-8]:MARKer[1-10]:SEARch:EXECute:MINimum

Description Executes marker search minimum (No Query)

Equivalent key USER Menu -> Marker Search -> Search Min

:CALCulate:USER[1-1]:TRACe[1-8]:MARKer[1-10]:SEARch:EXECute:PEAK

Syntax :CALCulate:USER[1-1]:TRACe[1-8]:MARKer[1-10]:SEARch:EXECute:PEAK

Description Executes marker peak search (No Query)

Equivalent key USER Menu -> Marker Search -> Peak -> Search Peak

:CALCulate:USER[1-1]:TRACe[1-8]:MARKer[1-10]:SEARch:EXECute:RPEak

Syntax :CALCulate:USER[1-1]:TRACe[1-8]:MARKer[1-10]:SEARch:EXECute:RPEak

Description Executes marker peak search right (No Query)

Equivalent key USER Menu -> Marker Search -> Peak -> Search Right

:CALCulate:USER[1-1]:TRACe[1-8]:MARKer[1-10]:SEARch:EXECute:RTARget

Syntax :CALCulate:USER[1-1]:TRACe[1-8]:MARKer[1-10]:SEARch:EXECute:RTARget

Description Executes marker target search right (No Query)

Equivalent key USER Menu -> Marker Search -> Target -> Search Right

:CALCulate:USER[1-1]:TRACe[1-8]:MARKer[1-10]:SEARch:EXECute:TARGet

Syntax :CALCulate:USER[1-1]:TRACe[1-8]:MARKer[1-10]:SEARch:EXECute:TARGet
 Description Executes marker target search (No Query)
 Equivalent key USER Menu -> Marker Search -> Target -> Search Target

:CALCulate:USER[1-1]:TRACe[1-8]:MARKer[1-10]:SEARch:PEAK:EXCursion

Syntax :CALCulate:USER[1-1]:TRACe[1-8]:MARKer[1-10]:SEARch:PEAK:EXCursion
 <numeric>
 :CALCulate:USER[1-1]:TRACe[1-8]:MARKer[1-10]:SEARch:PEAK:EXCursion?
 Description Sets/Reads the peak excursion value

Parameter

	<Numeric>
Range	0 to 10G
Preset value	0
Unit	-
Resolution	-

Equivalent key USER Menu -> Marker Search -> Peak -> Peak Excursion

:CALCulate:USER[1-1]:TRACe[1-8]:MARKer[1-10]:SEARch:PEAK:POLarity

Syntax :CALCulate:USER[1-1]:TRACe[1-8]:MARKer[1-10]:SEARch:PEAK:POLarity
 {POSitive|NEGative|BOTH}
 :CALCulate:USER[1-1]:TRACe[1-8]:MARKer[1-10]:SEARch:PEAK:POLarity?

Description Sets/Reads the marker peak-search polality

Parameter

	Description
POSitive(Preset value)	Set marker-search-peak polality type to 'Positive'
NEGative	Set marker-search-peak polality type to 'Negative'

	Description
BOTH	Set marker-search-peak polarity type to 'Both'

Equivalent key USER Menu -> Marker Search -> Peak -> Peak Polarity

:CALCulate:USER[1-1]:TRACe[1-8]:MARKer[1-10]:SEARch:TARGet:TRAnSition

Syntax :CALCulate:USER[1-1]:TRACe[1-8]:MARKer[1-10]:SEARch:TARGet:TRAnSition {POSitive|NEGative|BOTH}
:CALCulate:USER[1-1]:TRACe[1-8]:MARKer[1-10]:SEARch:TARGet:TRAnSition?

Description marker-target transition type

Parameter

	Description
POSitive	Set marker-target transition type to 'Positive'
NEGative	Set marker-target transition type to 'Negative'
BOTH(Preset value)	Set marker-target transition type to 'Both'

Equivalent key USER Menu -> Marker Search -> Target -> Search Transition

:CALCulate:USER[1-1]:TRACe[1-8]:MARKer[1-10]:SEARch:TARGet:Y

Syntax :CALCulate:USER[1-1]:TRACe[1-8]:MARKer[1-10]:SEARch:TARGet:Y <numeric>
:CALCulate:USER[1-1]:TRACe[1-8]:MARKer[1-10]:SEARch:TARGet:Y?

Description Sets/Reads the marker target value

Parameter

	<Numeric>
Range	-10G to 10G
Preset value	0
Unit	-
Resolution	-

Equivalent key USER Menu -> Marker Search -> Target -> Search Value

:CALCulate:USER[1-1]:TRACe[1-8]:MARKer[1-10]:SEARch:TRACking:TYPE

Syntax :CALCulate:USER[1-1]:TRACe[1-8]:MARKer[1-10]:SEARch:TRACking:TYPE
{OFF|MAXimum|MINimum|PEAK|TARGet}
:CALCulate:USER[1-1]:TRACe[1-8]:MARKer[1-10]:SEARch:TRACking:TYPE?

Description Sets/Reads the marker tracking type

Parameter

	Description
OFF(Preset value)	Set search tracking type to 'Off'
MAXimum	Set search tracking type to 'Maximum'
MINimum	Set search tracking type to 'Minimum'
PEAK	Set search tracking type to 'Peak'
TARGet	Set search tracking type to 'Target'

Equivalent key USER Menu -> Marker Search -> Tracking

:CALCulate:USER[1-1]:TRACe[1-8]:MARKer[1-10]:STATe

Syntax :CALCulate:USER[1-1]:TRACe[1-8]:MARKer[1-10]:STATe {ON|OFF|1|0}
:CALCulate:USER[1-1]:TRACe[1-8]:MARKer[1-10]:STATe?

Description Turns on/off markers

Parameter

	Description
ON or 1	Set marker to 'ON'
OFF or 0(Preset value)	Set marker to 'OFF'

Equivalent key USER Menu -> Marker -> Clear Marker Menu -> Marker 1

:CALCulate:USER[1-1]:TRACe[1-8]:MARKer[1-10]:X

Syntax :CALCulate:USER[1-1]:TRACe[1-8]:MARKer[1-10]:X <numeric>
:CALCulate:USER[1-1]:TRACe[1-8]:MARKer[1-10]:X?

Description Sets/Reads the marker x position

Parameter

	<Numeric>
Range	-
Preset value	0
Unit	-
Resolution	-

Equivalent key No equivalent key is available on the front panel.

:CALCulate:USER[1-1]:TRACe[1-8]:MARKer[1-10]:Y

Syntax :CALCulate:USER[1-1]:TRACe[1-8]:MARKer[1-10]:Y

Description Reads the marker y position (Query Only)

Equivalent key No equivalent key is available on the front panel.

:CALCulate:USER[1-1]:TRACe[1-8]:MATH:FUNCtion

Syntax :CALCulate:USER[1-1]:TRACe[1-8]:MATH:FUNCtion
{NORMal|SUBTract|DIVide|ADD|MULTiply}
:CALCulate:USER[1-1]:TRACe[1-8]:MATH:FUNCtion?

Description Selects math operation type

Parameter

	Description
NORMal(Preset value)	Set math operation type to 'NORMal'
SUBTract	Set math operation type to 'Data - Mem'
DIVide	Set math operation type to 'Data / Mem'
ADD	Set math operation type to 'Data + Mem'
MULTiply	Set math operation type to 'Data * Mem'

Equivalent key USER Menu -> Trace View -> Data Math

:CALCulate:USER[1-1]:TRACe[1-8]:MATH:MEMorize

Syntax :CALCulate:USER[1-1]:TRACe[1-8]:MATH:MEMorize

Description Copies data to memory (No Query)

Equivalent key No equivalent key is available on the front panel.

:CALCulate:USER[1-1]:TRACe[1-8]:MATH:OFFSet

Syntax :CALCulate:USER[1-1]:TRACe[1-8]:MATH:OFFSet <numeric>
:CALCulate:USER[1-1]:TRACe[1-8]:MATH:OFFSet?

Description Sets/Reads the offset value of the trace

Parameter

	<Numeric>
Range	-500 G to 500 G
Preset value	0
Unit	-
Resolution	-

Equivalent key USER Menu -> Trace View -> Offset
USER Menu -> Trace View -> [Marker -> -Offset]

:CALCulate:USER[1-1]:TRACe[1-8]:SMOothing:APERture

Syntax :CALCulate:USER[1-1]:TRACe[1-8]:SMOothing:APERture <numeric>
:CALCulate:USER[1-1]:TRACe[1-8]:SMOothing:APERture?

Description Sets/Reads the smoothing aperture value

Parameter

	<Numeric>
Range	50m to 25
Preset value	1.5
Unit	%
Resolution	-

Equivalent key USER Menu -> Trace View -> Aperture

:CALCulate:USER[1-1]:TRACe[1-8]:SMOothing:STATe

Syntax :CALCulate:USER[1-1]:TRACe[1-8]:SMOothing:STATe {ON|OFF|1|0}
:CALCulate:USER[1-1]:TRACe[1-8]:SMOothing:STATe?

Description Turns on/off smoothing mode

Parameter

	Description
ON or 1	Set smoothing mode to 'ON'
OFF or 0(Preset value)	Set smoothing mode to 'OFF'

Equivalent key USER Menu -> Trace View -> Smoothing

:CONTrol:HANDler:A[:DATA]

Syntax :CONTrol:HANDler:A[:DATA] <numeric>

Description Outputs data using port A (No Query)

Parameter

	<Numeric>
Range	0 to 255
Preset value	-
Unit	-
Resolution	-

Equivalent key No equivalent key is available on the front panel.

:CONTrol:HANDler:B[:DATA]

Syntax :CONTrol:HANDler:B[:DATA] <numeric>

Description Outputs data using port B (No Query)

Parameter

	<Numeric>
Range	0 to 255
Preset value	-
Unit	-
Resolution	-

Equivalent key No equivalent key is available on the front panel.

:CONTRol:HANDler:C[:DATA]

Syntax :CONTRol:HANDler:C[:DATA] <numeric>
:CONTRol:HANDler:C[:DATA]?

Description Inputs/Outputs data using port C

Parameter

	<Numeric>
Range	0 to 15
Preset value	-
Unit	-
Resolution	-

Equivalent key No equivalent key is available on the front panel.

:CONTRol:HANDler:C:MODE

Syntax :CONTRol:HANDler:C:MODE {INPut|OUTPut}
:CONTRol:HANDler:C:MODE?

Description Selects input/output mode on port C

Parameter

	Description
INPut(Preset value)	Set input/output mode on port C to 'Input'
OUTPut	Set input/output mode on port C to 'Output'

Equivalent key No equivalent key is available on the front panel.

:CONTRol:HANDler:D[:DATA]

Syntax :CONTRol:HANDler:D[:DATA] <numeric>
:CONTRol:HANDler:D[:DATA]?

Description Inputs/Outputs data using port D

Parameter

	<Numeric>
Range	0 to 15
Preset value	-
Unit	-
Resolution	-

Equivalent key No equivalent key is available on the front panel.

:CONTrol:HANDler:D:MODE

Syntax :CONTrol:HANDler:D:MODE {INPut|OUTPut}
:CONTrol:HANDler:D:MODE?

Description Selects input/output mode on port D

Parameter

	Description
INPut(Preset value)	Set input/output mode on port D to 'Input'
OUTPut	Set input/output mode on port D to 'Output'

Equivalent key No equivalent key is available on the front panel.

:CONTrol:HANDler:E[:DATA]

Syntax :CONTrol:HANDler:E[:DATA] <numeric>
:CONTrol:HANDler:E[:DATA]?

Description Inputs/outputs data using port E(port C + port D; 16 bits)

Parameter

	<Numeric>
Range	0 to 255
Preset value	-
Unit	-
Resolution	-

Equivalent key No equivalent key is available on the front panel.

:CONTRol:HANDler:F[:DATA]

Syntax :CONTRol:HANDler:F[:DATA] <numeric>

Description Inputs/outputs data using port F(port A + port C; 16 bits) (No Query)

Parameter

	<Numeric>
Range	0 to 65535
Preset value	-
Unit	-
Resolution	-

Equivalent key No equivalent key is available on the front panel.

:CONTRol:HANDler:OUTPut[1-2][:DATA]

Syntax :CONTRol:HANDler:OUTPut[1-2][:DATA] <numeric>
:CONTRol:HANDler:OUTPut[1-2][:DATA]?

Description Sets/Reads OUTPUT1 and/or OUTPUT2

Parameter

	<Numeric>
Range	0 to 1
Preset value	-
Unit	-
Resolution	-

Equivalent key No equivalent key is available on the front panel.

:DISPlay:CLOCK

Syntax :DISPlay:CLOCK {ON|OFF|1|0}
:DISPlay:CLOCK?

Description Turns on/off internal clock display

Parameter

	Description
ON or 1 (Preset value)	Set internal clock display mode to 'ON'
OFF or 0	Set internal clock display mode to 'OFF'

Equivalent key

PN Menu -> System -> Misc Setup -> Clock Setup -> Show Clock
 SP Menu -> System -> Misc Setup -> Clock Setup -> Show Clock
 FP Menu -> System -> Misc Setup -> Clock Setup -> Show Clock
 TR Menu -> System -> Misc Setup -> Clock Setup -> Show Clock
 USER Menu -> System -> Misc Setup -> Clock Setup -> Show Clock

:DISPlay:COLor[1-2]:BACK[:VALue]

Syntax

:DISPlay:COLor[1-2]:BACK[:VALue] <numeric 1>, <numeric 2>, <numeric 3>
 :DISPlay:COLor[1-2]:BACK[:VALue]?

Description

Sets the background color for normal display (:COL1) and inverted display (:COL2).

Parameter

	<Numeric 1>	<Numeric 2>	<Numeric 3>
Description	Amount of red	Amount of green	Amount of blue
Range	0 to 255	0 to 255	0 to 255
Resolution	1	1	1

If the specified parameter is out of the allowable setup range, the minimum value (if the lower limit of the range is not reached) or the maximum value (if the upper limit of the range is exceeded) is set.

Equivalent key

PN Menu -> System -> Misc Setup -> Color Setup -> Normal|Invert -> Background
 SP Menu -> System -> Misc Setup -> Color Setup -> Normal|Invert -> Background
 FP Menu -> System -> Misc Setup -> Color Setup -> Normal|Invert -> Background
 TR Menu -> System -> Misc Setup -> Color Setup -> Normal|Invert -> Background
 USER Menu -> System -> Misc Setup -> Color Setup -> Normal|Invert -> Background

:DISPlay:COLor[1-2]:GRATicule[1-2][:VALue]

Syntax

:DISPlay:COLor[1-2]:GRATicule[1-2][:VALue] <Numeric 1>, <Numeric 2>, <Numeric 3>
 :DISPlay:COLor[1-2]:GRATicule[1-2][:VALue]?

SCPI Command Reference
E5052A commands

Description Sets the color of the graticule label and the outer frame line of the graph (:GRAT1) and the color of the grid lines in the graph (:GRAT2) for normal display (:COL1) and inverted display (:COL2).

Parameter

	<Numeric 1>	<Numeric 2>	<Numeric 3>
Description	Amount of red	Amount of green	Amount of blue
Range	0 to 255	0 to 255	0 to 255
Resolution	1	1	1

If the specified parameter is out of the allowable setup range, the minimum value (if the lower limit of the range is not reached) or the maximum value (if the upper limit of the range is exceeded) is set.

Equivalent key PN Menu -> System -> Misc Setup -> Color Setup -> Normal|Invert -> Graticule Main
 PN Menu -> System -> Misc Setup -> Color Setup -> Normal|Invert -> Graticule Sub
 SP Menu -> System -> Misc Setup -> Color Setup -> Normal|Invert -> Graticule Main
 SP Menu -> System -> Misc Setup -> Color Setup -> Normal|Invert -> Graticule Sub
 FP Menu -> System -> Misc Setup -> Color Setup -> Normal|Invert -> Graticule Main
 FP Menu -> System -> Misc Setup -> Color Setup -> Normal|Invert -> Graticule Sub
 TR Menu -> System -> Misc Setup -> Color Setup -> Normal|Invert -> Graticule Main
 TR Menu -> System -> Misc Setup -> Color Setup -> Normal|Invert -> Graticule Sub
 USER Menu -> System -> Misc Setup -> Color Setup -> Normal|Invert -> Graticule Main
 USER Menu -> System -> Misc Setup -> Color Setup -> Normal|Invert -> Graticule Sub

:DISPlay:COLor[1-2]:LIMit[1-2][:VALue]

Syntax :DISPlay:COLor[1-2]:LIMit[1-2][:VALue] <Numeric 1>, <Numeric 2>, <Numeric 3>
 :DISPlay:COLor[1-2]:LIMit[1-2][:VALue]?

Description Sets the “fail” display color used for the limit test result, bandwidth test result, and ripple test result (:LIM1) and the color of the limit line (:LIM2) for normal display (:COL1) and inverted display (:COL2).

Parameter

	<Numeric 1>	<Numeric 2>	<Numeric 3>
Description	Amount of red	Amount of green	Amount of blue
Range	0 to 255	0 to 255	0 to 255
Resolution	1	1	1

If the specified parameter is out of the allowable setup range, the minimum value (if the lower limit of the range is not reached) or the maximum value (if the upper limit of the range is exceeded) is set.

Equivalent key PN Menu -> System -> Misc Setup -> Color Setup -> Normal|Invert -> Limit Fail
 PN Menu -> System -> Misc Setup -> Color Setup -> Normal|Invert -> Limit Line
 SP Menu -> System -> Misc Setup -> Color Setup -> Normal|Invert -> Limit Fail
 SP Menu -> System -> Misc Setup -> Color Setup -> Normal|Invert -> Limit Line
 FP Menu -> System -> Misc Setup -> Color Setup -> Normal|Invert -> Limit Fail
 FP Menu -> System -> Misc Setup -> Color Setup -> Normal|Invert -> Limit Line
 TR Menu -> System -> Misc Setup -> Color Setup -> Normal|Invert -> Limit Fail
 TR Menu -> System -> Misc Setup -> Color Setup -> Normal|Invert -> Limit Line
 USER Menu -> System -> Misc Setup -> Color Setup -> Normal|Invert -> Limit Fail
 USER Menu -> System -> Misc Setup -> Color Setup -> Normal|Invert -> Limit Line

:DISPlay:COLor[1-2]:RESet

Syntax :DISPlay:COLor[1-2]:RESet
 Description Resets the display color settings for all the items to the factory preset state for normal display (:COL1) and inverted display (:COL2). (No query)

Equivalent key PN Menu -> System -> Misc Setup -> Color Setup -> Normal|Invert -> Reset Color -> OK
 SP Menu -> System -> Misc Setup -> Color Setup -> Normal|Invert -> Reset Color -> OK
 FP Menu -> System -> Misc Setup -> Color Setup -> Normal|Invert -> Reset Color -> OK
 TR Menu -> System -> Misc Setup -> Color Setup -> Normal|Invert -> Reset Color -> OK
 USER Menu -> System -> Misc Setup -> Color Setup -> Normal|Invert -> Reset Color -> OK

:DISPlay:COLor[1-2]:TRACe[1-8]:DATA[:VALue]

Syntax :DISPlay:COLor[1-2]:TRACe[1-8]:DATA[:VALue] <numeric 1>, <numeric 2>, <numeric 3>
 :DISPlay:COLor[1-2]:TRACe[1-8]:DATA[:VALue]?

Description Sets the color of the data trace of trace 1 (:TRAC1) to trace 8 (:TRAC8) for normal display (:COL1) and inverted display (:COL2).

Parameters

	<Numeric 1>	<Numeric 2>	<Numeric 3>
Description	Amount of red	Amount of green	Amount of blue
Range	0 to 255	0 to 255	0 to 255

	<Numeric 1>	<Numeric 2>	<Numeric 3>
Resolution	1	1	1

If the specified parameter is out of the allowable setup range, the minimum value (if the lower limit of the range is not reached) or the maximum value (if the upper limit of the range is exceeded) is set.

NOTE This setting is common to all measurement modes and individual setting for each measurement cannot be done.

Equivalent key
 PN Menu -> System -> Misc Setup -> Color Setup -> Normal|Invert -> Data Trace 1|Data Trace 2|Data Trace 3|Data Trace 4|Data Trace 5|Data Trace 6|Data Trace 7|Data Trace 8
 SP Menu -> System -> Misc Setup -> Color Setup -> Normal|Invert -> Data Trace 1|Data Trace 2|Data Trace 3|Data Trace 4|Data Trace 5|Data Trace 6|Data Trace 7|Data Trace 8
 FP Menu -> System -> Misc Setup -> Color Setup -> Normal|Invert -> Data Trace 1|Data Trace 2|Data Trace 3|Data Trace 4|Data Trace 5|Data Trace 6|Data Trace 7|Data Trace 8
 TR Menu -> System -> Misc Setup -> Color Setup -> Normal|Invert -> Data Trace 1|Data Trace 2|Data Trace 3|Data Trace 4|Data Trace 5|Data Trace 6|Data Trace 7|Data Trace 8
 USER Menu -> System -> Misc Setup -> Color Setup -> Normal|Invert -> Data Trace 1|Data Trace 2|Data Trace 3|Data Trace 4|Data Trace 5|Data Trace 6|Data Trace 7|Data Trace 8

:DISPlay:COLor[1-2]:TRACe[1-8]:MEMory[:VALue]

Syntax :DISPlay:COLor[1-2]:TRACe[1-8]:MEMory[:VALue] <Numeric 1>, <Numeric 2>, <Numeric 3>

:DISPlay:COLor[1-2]:TRACe[1-8]:MEMory[:VALue]?

Description Sets the color of the memory trace of trace 1 (:TRAC1) to trace 8 (:TRAC8) for normal display (:COL1) and inverted display (:COL2).

Parameters

	<Numeric 1>	<Numeric 2>	<Numeric 3>
Description	Amount of red	Amount of green	Amount of blue
Range	0 to 255	0 to 255	0 to 255
Resolution	1	1	1

If the specified parameter is out of the allowable setup range, the minimum value (if the lower limit of the range is not reached) or the maximum value (if the upper limit of the range is exceeded) is set.

NOTE This setting is common to all measurement modes, and thus individual setting for each measurement cannot be made.

Equivalent key PN Menu -> System -> Misc Setup -> Color Setup -> Normal|Invert -> Mem Trace 1|Mem Trace 2|Mem Trace 3|Mem Trace 4|Mem Trace 5|Mem Trace 6|Mem Trace 7|Mem Trace 8
 SP Menu -> System -> Misc Setup -> Color Setup -> Normal|Invert -> Mem Trace 1|Mem Trace 2|Mem Trace 3|Mem Trace 4|Mem Trace 5|Mem Trace 6|Mem Trace 7|Mem Trace 8
 FP Menu -> System -> Misc Setup -> Color Setup -> Normal|Invert -> Mem Trace 1|Mem Trace 2|Mem Trace 3|Mem Trace 4|Mem Trace 5|Mem Trace 6|Mem Trace 7|Mem Trace 8
 TR Menu -> System -> Misc Setup -> Color Setup -> Normal|Invert -> Mem Trace 1|Mem Trace 2|Mem Trace 3|Mem Trace 4|Mem Trace 5|Mem Trace 6|Mem Trace 7|Mem Trace 8
 USER Menu -> System -> Misc Setup -> Color Setup -> Normal|Invert -> Mem Trace 1|Mem Trace 2|Mem Trace 3|Mem Trace 4|Mem Trace 5|Mem Trace 6|Mem Trace 7|Mem Trace 8

:DISPlay:ECHO:ADD

Syntax :DISPlay:ECHO:ADD <String>
 Description Adds texts in echo window (No Query)
 Parameter

	<String>
Range	max 2000 characters
Preset value	-
Unit	-
Resolution	-

Equivalent key No equivalent key is available on the front panel.

:DISPlay:ECHO:CLEar

Syntax :DISPlay:ECHO:CLEar
 Description Clears echo window (No Query)

Equivalent key PN Menu -> Macro Setup -> Echo Window Menu -> Clear Echo
 SP Menu -> Macro Setup -> Echo Window Menu -> Clear Echo
 FP Menu -> Macro Setup -> Echo Window Menu -> Clear Echo
 TR Menu -> Macro Setup -> Echo Window Menu -> Clear Echo
 USER Menu -> Macro Setup -> Echo Window Menu -> Clear Echo

:DISPlay:ECHO:DATA

Syntax :DISPlay:ECHO:DATA <String>

:DISPlay:ECHO:DATA?

Description Sets.readsa the texts in echo window

Parameter

	<String>
Range	max 2000 characters
Preset value	""
Unit	-
Resolution	-

Equivalent key No equivalent key is available on the front panel.

:DISPlay:ECHO:FSIZE

Syntax :DISPlay:ECHO:FSIZE <numeric>

:DISPlay:ECHO:FSIZE?

Description Sets/Reads the font size in echo window

Parameter

	<Numeric>
Range	9 10 11 12 14 16 18 20 22 24 26 28 36 48 72 96 112
Preset value	11
Unit	-
Resolution	-

Equivalent key PN Menu -> Macro Setup -> Echo Window Menu -> Echo Font Size
 SP Menu -> Macro Setup -> Echo Window Menu -> Echo Font Size
 FP Menu -> Macro Setup -> Echo Window Menu -> Echo Font Size
 TR Menu -> Macro Setup -> Echo Window Menu -> Echo Font Size
 USER Menu -> Macro Setup -> Echo Window Menu -> Echo Font Size

:DISPlay:ECHO:STATE

Syntax :DISPlay:ECHO:STATe {ON|OFF|1|0}

:DISPlay:ECHO:STATe?

Description Shows/Hides echo window

Parameter

	Description
ON or 1	Set echo window mode to 'ON'
OFF or 0(Preset value)	Set echo window mode to 'OFF'

Equivalent key

PN Menu -> Macro Setup -> Echo Window Menu -> Echo Window
 SP Menu -> Macro Setup -> Echo Window Menu -> Echo Window
 FP Menu -> Macro Setup -> Echo Window Menu -> Echo Window
 TR Menu -> Macro Setup -> Echo Window Menu -> Echo Window
 USER Menu -> Macro Setup -> Echo Window Menu -> Echo Window

:DISPlay:ENABLE

Syntax

:DISPlay:ENABLE {ON|OFF|1|0}
 :DISPlay:ENABLE?

Description

Enable/disable trace update

Parameter

	Description
ON or 1(Preset value)	Set trace update mode to 'ON'
OFF or 0	Set trace update mode to 'OFF'

Equivalent key

PN Menu -> Display -> Update
 SP Menu -> Display -> Update
 FP Menu -> Display -> Update
 TR Menu -> Display -> Update
 USER Menu -> Display -> Update

:DISPlay:FP[1-1]:ALLTrace:PERSiStence:CLEAr

Syntax

:DISPlay:FP[1-1]:ALLTrace:PERSiStence:CLEAr

Description

Clears all stored traces (No Query)

Equivalent key

No equivalent key is available on the front panel.

:DISPlay:FP[1-1]:ALLTrace:Y:SCALE:AUTO

Syntax :DISPlay:FP[1-1]:ALLTrace:Y:SCALE:AUTO

Description auto scale all (No Query)

Equivalent key FP Menu -> Scale -> Auto Scale All

:DISPlay:FP[1-1]:ANNOtation:MARKer:POSition

Syntax :DISPlay:FP[1-1]:ANNOtation:MARKer:POSition {LEFT|RIGHT}

:DISPlay:FP[1-1]:ANNOtation:MARKer:POSition?

Description Sets/Reads the marker information position

Parameter

	Description
LEFT(Preset value)	Set the marker information position to 'Left'
RIGHT	Set the marker information position to 'Right'

Equivalent key FP Menu -> Display -> Marker Information

:DISPlay:FP[1-1]:ANNOtation:MEASurement:STATe

Syntax :DISPlay:FP[1-1]:ANNOtation:MEASurement:STATe {ON|OFF|1|0}

:DISPlay:FP[1-1]:ANNOtation:MEASurement:STATe?

Description Turns on/off measurement conditions

Parameter

	Description
ON or 1(Preset value)	Set measurement conditions mode to 'ON'
OFF or 0	Set measurement conditions mode to 'OFF'

Equivalent key FP Menu -> Display -> Meas Condition

:DISPlay:FP[1-1]:GRATICule:AXIS:Y:RELative

Syntax :DISPlay:FP[1-1]:GRATICule:AXIS:Y:RELative {ON|OFF|1|0}

:DISPlay:FP[1-1]:GRATICule:AXIS:Y:RELative?

Description Turns on/off relative Y-scale

Parameter

	Description
ON or 1	Set relative Y-scale mode to 'ON'
OFF or 0(Preset value)	Set relative Y-scale mode to 'OFF'

Equivalent key FP Menu -> Display -> Relative Y-Scale

:DISPlay:FP[1-1]:GRATICule:AXIS:Y:STATe

Syntax :DISPlay:FP[1-1]:GRATICule:AXIS:Y:STATe {OFF|SHORT|MIDDLE|LONG}
:DISPlay:FP[1-1]:GRATICule:AXIS:Y:STATe?

Description Sets/Reads Y graticule label

Parameter

	Description
OFF	Set Y graticule label to 'OFF'
SHORT(Preset value)	Set Y graticule label to 4 digits
MIDDLE	Set Y graticule label to 8 digits
LONG	Set Y graticule label to 12 digits

Equivalent key FP Menu -> Display -> Y # of Digits

:DISPlay:FP[1-1]:LABel:DATA

Syntax :DISPlay:FP[1-1]:LABel:DATA <String>
:DISPlay:FP[1-1]:LABel:DATA?

Description Window title label

Parameter

	<String>
Range	-
Preset value	""
Unit	-

	<String>
Resolution	-

Equivalent key FP Menu -> Display -> Edit Title Label

:DISPlay:FP[1-1]:LABel:STATe

Syntax :DISPlay:FP[1-1]:LABel:STATe {ON|OFF|1|0}

:DISPlay:FP[1-1]:LABel:STATe?

Description Shows/Hides Window Title Label

Parameter

	Description
ON or 1	Set Window Title Label mode to 'ON'
OFF or 0(Preset value)	Set Window Title Label mode to 'OFF'

Equivalent key FP Menu -> Display -> Title Label

:DISPlay:FP[1-1]:LIMit:FSIGn

Syntax :DISPlay:FP[1-1]:LIMit:FSIGn {ON|OFF|1|0}

:DISPlay:FP[1-1]:LIMit:FSIGn?

Description Turns on/off the limit test judgement display

Parameter

	Description
ON or 1(Preset value)	Turn on the limit test judgement display mode
OFF or 0	Turn off the limit test judgement display mode

Equivalent key FP Menu -> Display -> Limit Test -> Fail Sign

:DISPlay:FP[1-1]:MAXimize

Syntax :DISPlay:FP[1-1]:MAXimize {ON|OFF|1|0}

:DISPlay:FP[1-1]:MAXimize?

Description Maximizes active window

Parameter

	Description
ON or 1	Set maximize active window to 'ON'
OFF or 0(Preset value)	Set maximize active window to 'OFF'

Equivalent key No equivalent key is available on the front panel.

:DISPlay:FP[1-1]:SPLit

Syntax :DISPlay:FP[1-1]:SPLit {D11_23|D12_34}
:DISPlay:FP[1-1]:SPLit?

Description Sets/Reads the trace layout

Parameter

	Description
D11_23(Preset value)	Set the trace layout to 'x3'
D12_34	Set the trace layout to 'x4'

Equivalent key FP Menu -> Display -> Allocate

:DISPlay:FP[1-1]:STATe

Syntax :DISPlay:FP[1-1]:STATe {ON|OFF|1|0}
:DISPlay:FP[1-1]:STATe?

Description measurement display on/off. At least one meas window must be turned on.

Parameter

	Description
ON or 1(Preset value)	Set measurement display to 'ON'
OFF or 0	Set measurement display to 'OFF'

Equivalent key PN Menu -> Measurement View -> Show Window -> Freq & Power
SP Menu -> Measurement View -> Show Window -> Freq & Power
FP Menu -> Measurement View -> Show Window -> Freq & Power
TR Menu -> Measurement View -> Show Window -> Freq & Power

USER Menu -> Measurement View -> Show Window -> Freq & Power

:DISPlay:FP[1-1]:TABLe[:STATe]

Syntax :DISPlay:FP[1-1]:TABLe[:STATe] {ON|OFF|1|0}
:DISPlay:FP[1-1]:TABLe[:STATe]?

Description Turns on/off the marker list

Parameter

	Description
ON or 1	Set the marker list mode to 'ON'
OFF or 0(Preset value)	Set the marker list mode to 'OFF'

Equivalent key FP Menu -> Marker -> Marker List

:DISPlay:FP[1-1]:TRACe[1-4]:LABel:DATA

Syntax :DISPlay:FP[1-1]:TRACe[1-4]:LABel:DATA <String>
:DISPlay:FP[1-1]:TRACe[1-4]:LABel:DATA?

Description Edits trace title label

Parameter

	<String>
Range	-
Preset value	"Freq"
Unit	-
Resolution	-

Equivalent key FP Menu -> Trace View -> Trace Label

:DISPlay:FP[1-1]:TRACe[1-4]:LIMit:LINE

Syntax :DISPlay:FP[1-1]:TRACe[1-4]:LIMit:LINE {ON|OFF|1|0}
:DISPlay:FP[1-1]:TRACe[1-4]:LIMit:LINE?

Description Turns on/off the limit line

Parameter

	Description
ON or 1 (Preset value)	Turn on the limit line mode
OFF or 0	Turn off the limit line mode

Equivalent key FP Menu -> Display -> Limit Test -> Limit Line

:DISPlay:FP[1-1]:TRACe[1-4]:MODE

Syntax :DISPlay:FP[1-1]:TRACe[1-4]:MODE {OFF|DATA|MEMory|BOTH}
:DISPlay:FP[1-1]:TRACe[1-4]:MODE?

Description Sets/Reads data and/or memory trace display

Parameter

	Description
OFF	Set data and/or memory trace to 'Off'
DATA(Preset value)	Set data and/or memory trace to 'Data'
MEMory	Set data and/or memory trace to 'Memory'
BOTH	Set data and/or memory race to 'Both' (data and memory)

Equivalent key FP Menu -> Trace View -> Display Trace

:DISPlay:FP[1-1]:TRACe[1-4]:PERSistence:CLEAr

Syntax :DISPlay:FP[1-1]:TRACe[1-4]:PERSistence:CLEAr

Description Clear persistence mode (No Query)

Equivalent key FP Menu -> Trace View -> Persistence -> Clear Persistent Data

:DISPlay:FP[1-1]:TRACe[1-4]:PERSistence:STATe

Syntax :DISPlay:FP[1-1]:TRACe[1-4]:PERSistence:STATe {ON|OFF|1|0}
:DISPlay:FP[1-1]:TRACe[1-4]:PERSistence:STATe?

Description Sets/Reads persistence mode

Parameter

	Description
ON or 1	Set persistence mode mode to 'ON'
OFF or 0(Preset value)	Set persistence mode mode to 'OFF'

Equivalent key FP Menu -> Trace View -> Persistence -> Persistence Mode

:DISPlay:FP[1-1]:TRACe[1-4]:X[:SCALe]:AUTO

Syntax :DISPlay:FP[1-1]:TRACe[1-4]:X[:SCALe]:AUTO {ON|OFF|1|0}
:DISPlay:FP[1-1]:TRACe[1-4]:X[:SCALe]:AUTO?

Description Sets/Reads automatic setting of the X-axis display range to the stimulus value

Parameter

	Description
ON or 1(Preset value)	Automatically sets the range of the X-axis to the stimulus value
OFF or 0	Manually sets the range of the X-axis

Equivalent key FP Menu -> Scale -> X Axis -> Auto

:DISPlay:FP[1-1]:TRACe[1-4]:X[:SCALe]:LEFT

Syntax :DISPlay:FP[1-1]:TRACe[1-4]:X[:SCALe]:LEFT <numeric>
:DISPlay:FP[1-1]:TRACe[1-4]:X[:SCALe]:LEFT?

Description Sets/Reads the start value of the X-axis

Parameter

	<Numeric>
Description	Start value of the X-axis
Range	-15 to 1.000999999 k
Preset value	0
Unit	-
Resolution	-

NOTE This command is available only when the automatic setting of the X-axis display range (set

with :DISPlay:FP[1-1]:TRACe[1-4]:X[:SCALe]:AUTO on page 250) is set to OFF.

Equivalent key FP Menu -> Scale -> X Axis -> Left

:DISPlay:FP[1-1]:TRACe[1-4]:X[:SCALe]:RIGHT

Syntax :DISPlay:FP[1-1]:TRACe[1-4]:X[:SCALe]:RIGHT <numeric>
:DISPlay:FP[1-1]:TRACe[1-4]:X[:SCALe]:RIGHT?

Description Sets/Reads the stop value of the X-axis

Parameter

	<Numeric>
Description	Stop value of the X-axis
Range	-14.999999 to 1.001 k
Preset value	100 μ
Unit	-
Resolution	-

NOTE This command is available only when the automatic setting of the X-axis display range (set with :DISPlay:FP[1-1]:TRACe[1-4]:X[:SCALe]:AUTO on page 250) is set to OFF.

Equivalent key FP Menu -> Scale -> X Axis -> Right

:DISPlay:FP[1-1]:TRACe[1-4]:Y[:SCALe]:AUTO

Syntax :DISPlay:FP[1-1]:TRACe[1-4]:Y[:SCALe]:AUTO

Description auto scale (No Query)

Equivalent key FP Menu -> Scale -> Auto Scale

:DISPlay:FP[1-1]:TRACe[1-4]:Y[:SCALe]:PDIVision

Syntax :DISPlay:FP[1-1]:TRACe[1-4]:Y[:SCALe]:PDIVision <numeric>
:DISPlay:FP[1-1]:TRACe[1-4]:Y[:SCALe]:PDIVision?

Description scale per division

Parameter

	<Numeric>
Range	1a to 10G
Preset value	100M
Unit	-
Resolution	-

Equivalent key FP Menu -> Scale -> Scale/Div

:DISPlay:FP[1-1]:TRACe[1-4]:Y[:SCALe]:RLEVel

Syntax :DISPlay:FP[1-1]:TRACe[1-4]:Y[:SCALe]:RLEVel <numeric>

:DISPlay:FP[1-1]:TRACe[1-4]:Y[:SCALe]:RLEVel?

Description scale reference level

Parameter

	<Numeric>
Range	-500G to 500G
Preset value	1.5G
Unit	-
Resolution	-

Equivalent key FP Menu -> Scale -> Reference Value

FP Menu -> Scale -> Marker -> Reference

:DISPlay:FP[1-1]:TRACe[1-4]:Y[:SCALe]:RPOStion

Syntax :DISPlay:FP[1-1]:TRACe[1-4]:Y[:SCALe]:RPOStion <numeric>

:DISPlay:FP[1-1]:TRACe[1-4]:Y[:SCALe]:RPOStion?

Description scale reference position

Parameter

	<Numeric>
Range	0 to 30
Preset value	5

	<Numeric>
Unit	Div
Resolution	-

Equivalent key FP Menu -> Scale -> Reference Position

:DISPlay:FP[1-1]:Y[:SCALe]:DIVisions

Syntax :DISPlay:FP[1-1]:Y[:SCALe]:DIVisions <numeric>
:DISPlay:FP[1-1]:Y[:SCALe]:DIVisions?

Description Number of Y divisions

Parameter

	<Numeric>
Range	4 to 30
Preset value	10
Unit	-
Resolution	2

Equivalent key FP Menu -> Scale -> Divisions

:DISPlay:IMAGe

Syntax :DISPlay:IMAGe {NORMal|INVert}
:DISPlay:IMAGe?

Description Sets/Reads the normal display/inverted display

Parameter

	Description
NORMal(Preset value)	Sets the display to normal display (default background: black)
INVert	Sets the display to the inverted display (default background: white)

Equivalent key PN Menu -> Display -> Color Type
SP Menu -> Display -> Color Type
FP Menu -> Display -> Color Type

TR Menu -> Display -> Color Type

USER Menu -> Display -> Color Type

:DISPlay:MAXimize

Syntax :DISPlay:MAXimize {ON|OFF|1|0}
:DISPlay:MAXimize?

Description Maximizes active instrument window

Parameter

	Description
ON or 1(Preset value)	Maximize active instrument window mode to 'ON'
OFF or 0	Maximize active instrument window mode to 'OFF'

Equivalent key No equivalent key is available on the front panel.

:DISPlay:MESSage:CLEar

Syntax :DISPlay:MESSage:CLEar

Description Clears caution/message (No Query)

Equivalent key No equivalent key is available on the front panel.

:DISPlay:PN[1-1]:ALLTrace:PERStence:CLEar

Syntax :DISPlay:PN[1-1]:ALLTrace:PERStence:CLEar

Description Clears all persistent traces (No Query)

Equivalent key No equivalent key is available on the front panel.

:DISPlay:PN[1-1]:ANNotation:MARKer:POSition

Syntax :DISPlay:PN[1-1]:ANNotation:MARKer:POSition {LEFT|RIGHT}
:DISPlay:PN[1-1]:ANNotation:MARKer:POSition?

Description Sets/Reads the marker information position

Parameter

	Description
LEFT	Set the marker information position to 'Left'
RIGHt(Preset value)	Set the marker information position to 'Right'

Equivalent key PN Menu -> Display -> Marker Information

:DISPlay:PN[1-1]:ANNotation:MEASurement:STATe

Syntax :DISPlay:PN[1-1]:ANNotation:MEASurement:STATe {ON|OFF|1|0}
:DISPlay:PN[1-1]:ANNotation:MEASurement:STATe?

Description Turns on/off measurement conditions

Parameter

	Description
ON or 1(Preset value)	Set measurement conditions mode to 'ON'
OFF or 0	Set measurement conditions mode to 'OFF'

Equivalent key PN Menu -> Display -> Meas Condition

:DISPlay:PN[1-1]:GRATicule:AXIS:Y:RELative

Syntax :DISPlay:PN[1-1]:GRATicule:AXIS:Y:RELative {ON|OFF|1|0}
:DISPlay:PN[1-1]:GRATicule:AXIS:Y:RELative?

Description Sets/Reads ralative Y-scale

Parameter

	Description
ON or 1	Set relative Y-sclae mode to 'ON'
OFF or 0(Preset value)	Set relative Y-scale mode to 'OFF'

Equivalent key PN Menu -> Display -> Relative Y-Scale

:DISPlay:PN[1-1]:GRATicule:AXIS:Y:STATe

Syntax :DISPlay:PN[1-1]:GRATicule:AXIS:Y:STATe {OFF|SHORT|MIDDLE|LONG}

:DISPlay:PN[1-1]:GRATicule:AXIS:Y:STATe?

Description

Shows/Hides Y graticule label

Parameter

	Description
OFF	Set Y graticule label to 'OFF'
SHORT(Preset value)	Set Y graticule label to 4 digits
MIDDLE	Set Y graticule label to 8 digits
LONG	Set Y graticule label to 12 digits

Equivalent key

PN Menu -> Display -> Y # of Digits

:DISPlay:PN[1-1]:LABel:DATA

Syntax

:DISPlay:PN[1-1]:LABel:DATA <String>

:DISPlay:PN[1-1]:LABel:DATA?

Description

Edits window title label

Parameter

	<String>
Range	-
Preset value	""
Unit	-
Resolution	-

Equivalent key

PN Menu -> Display -> Edit Title Label

:DISPlay:PN[1-1]:LABel:STATe

Syntax

:DISPlay:PN[1-1]:LABel:STATe {ON|OFF|1|0}

:DISPlay:PN[1-1]:LABel:STATe?

Description

Shows/Hides window title label

Parameter

	Description
ON or 1	Show window title label
OFF or 0(Preset value)	Hide window title label

Equivalent key PN Menu -> Display -> Title Label

:DISPlay:PN[1-1]:LIMit:FSIGn

Syntax :DISPlay:PN[1-1]:LIMit:FSIGn {ON|OFF|1|0}
:DISPlay:PN[1-1]:LIMit:FSIGn?

Description Turns on/off the limit test judgement display

Parameter

	Description
ON or 1(Preset value)	Turn on the limit test judgement display mode
OFF or 0	Turn off the limit test judgement display mode

Equivalent key PN Menu -> Display -> Limit Test -> Fail Sign

:DISPlay:PN[1-1]:MAXimize

Syntax :DISPlay:PN[1-1]:MAXimize {ON|OFF|1|0}
:DISPlay:PN[1-1]:MAXimize?

Description Maximizes active trace

Parameter

	Description
ON or 1	Set maximize active trace mode to 'ON'
OFF or 0(Preset value)	Set maximize active trace mode to 'OFF'

Equivalent key No equivalent key is available on the front panel.

:DISPlay:PN[1-1]:STATe

Syntax :DISPlay:PN[1-1]:STATe {ON|OFF|1|0}

:DISPlay:PN[1-1]:STATe?

Description Turns on/off phase noise measurement mode

Parameter

	Description
ON or 1(Preset value)	Set phase noise measurement mode mode to 'ON'
OFF or 0	Set phase noise measurement mode mode to 'OFF'

Equivalent key
 PN Menu -> Measurement View -> Show Window -> Phase Noise
 SP Menu -> Measurement View -> Show Window -> Phase Noise
 FP Menu -> Measurement View -> Show Window -> Phase Noise
 TR Menu -> Measurement View -> Show Window -> Phase Noise
 USER Menu -> Measurement View -> Show Window -> Phase Noise

:DISPlay:PN[1-1]:TABLE[:STATe]

Syntax
 :DISPlay:PN[1-1]:TABLE[:STATe] {ON|OFF|1|0}
 :DISPlay:PN[1-1]:TABLE[:STATe]?

Description Turns on/off the marker list

Parameter

	Description
ON or 1	Enable the marker list
OFF or 0(Preset value)	Disable the marker list

Equivalent key PN Menu -> Marker -> Marker List

:DISPlay:PN[1-1]:TRACe[1-1]:LABel:DATA

Syntax
 :DISPlay:PN[1-1]:TRACe[1-1]:LABel:DATA <String>
 :DISPlay:PN[1-1]:TRACe[1-1]:LABel:DATA?

Description Edits trace title lable on phase noise measurement

Parameter

	<String>
Range	-
Preset value	"Phase Noise"
Unit	-
Resolution	-

Equivalent key PN Menu -> Trace View -> Trace Label

:DISPlay:PN[1-1]:TRACe[1-1]:LIMit:LINE

Syntax
:DISPlay:PN[1-1]:TRACe[1-1]:LIMit:LINE {ON|OFF|1|0}
:DISPlay:PN[1-1]:TRACe[1-1]:LIMit:LINE?

Description Turns on/off the limit line

Parameter

	Description
ON or 1(Preset value)	Turn on the limit line mode
OFF or 0	Turn off the limit line mode

Equivalent key PN Menu -> Display -> Limit Test -> Limit Line

:DISPlay:PN[1-1]:TRACe[1-1]:MODE

Syntax
:DISPlay:PN[1-1]:TRACe[1-1]:MODE {OFF|DATA|MEMory|BOTH}
:DISPlay:PN[1-1]:TRACe[1-1]:MODE?

Description Sets/Reads data and/or memory trace display

Parameter

	Description
OFF	Set data and/or memory trace to 'Off'
DATA(Preset value)	Set data and/or memory trace to 'Data'
MEMory	Set data and/or memory trace to 'Memory'
BOTH	Set data and/or memory race to 'Both' (data and memory)

Equivalent key PN Menu -> Trace View -> Display Trace

:DISPlay:PN[1-1]:TRACe[1-1]:PERSistence:CLEAr

Syntax :DISPlay:PN[1-1]:TRACe[1-1]:PERSistence:CLEAr

Description Clears persistent data (No Query)

Equivalent key PN Menu -> Trace View -> Persistence -> Clear Persistent Data

:DISPlay:PN[1-1]:TRACe[1-1]:PERSistence:STATe

Syntax :DISPlay:PN[1-1]:TRACe[1-1]:PERSistence:STATe {ON|OFF|1|0}

:DISPlay:PN[1-1]:TRACe[1-1]:PERSistence:STATe?

Description Sets/Reads persistence mode

Parameter

	Description
ON or 1	Set persistence mode to 'ON'
OFF or 0(Preset value)	Set persistence mode to 'OFF'

Equivalent key PN Menu -> Trace View -> Persistence -> Persistence Mode

:DISPlay:PN[1-1]:TRACe[1-1]:X[:SCALe]:AUTO

Syntax :DISPlay:PN[1-1]:TRACe[1-1]:X[:SCALe]:AUTO {ON|OFF|1|0}

:DISPlay:PN[1-1]:TRACe[1-1]:X[:SCALe]:AUTO?

Description Sets/Reads automatic setting of the X-axis display range to the stimulus value

Parameter

	Description
ON or 1(Preset value)	Automatically sets the range of the X-axis to the stimulus value
OFF or 0	Manually sets the range of the X-axis.

Equivalent key PN Menu -> Scale -> X Axis -> Auto

:DISPlay:PN[1-1]:TRACe[1-1]:X[:SCALe]:LEFT

Syntax :DISPlay:PN[1-1]:TRACe[1-1]:X[:SCALe]:LEFT <numeric>

:DISPlay:PN[1-1]:TRACe[1-1]:X[:SCALe]:LEFT?

Description

Sets/reads the start value of the X-axis

Parameter

	<Numeric>
Description	Start value of the X-axis
Range	1 to 39.9999999 M
Preset value	1 k
Unit	-
Resolution	-

NOTE

This command is available only when the automatic setting of the X-axis display range (set with :DISPlay:PN[1-1]:TRACe[1-1]:X[:SCALe]:AUTO on page 260) is set to OFF.

Equivalent key

PN Menu -> Scale -> X Axis -> Left

:DISPlay:PN[1-1]:TRACe[1-1]:X[:SCALe]:RIGHT

Syntax

:DISPlay:PN[1-1]:TRACe[1-1]:X[:SCALe]:RIGHt <numeric>

:DISPlay:PN[1-1]:TRACe[1-1]:X[:SCALe]:RIGHt?

Description

Sets/Reads the stop value of the X-axis

Parameter

	<Numeric>
Description	Stop value of the X-axis
Range	1.1 to 40 M
Preset value	10 M
Unit	-
Resolution	-

NOTE

This command is available only when the automatic setting of the X-axis display range (set with :DISPlay:PN[1-1]:TRACe[1-1]:X[:SCALe]:AUTO on page 260) is set to OFF.

Equivalent key

PN Menu -> Scale -> X Axis -> Right

:DISPlay:PN[1-1]:TRACe[1-1]:Y[:SCALe]:AUTO

Syntax :DISPlay:PN[1-1]:TRACe[1-1]:Y[:SCALe]:AUTO

Description Executes autoscale (No Query)

Equivalent key PN Menu -> Scale -> Auto Scale

:DISPlay:PN[1-1]:TRACe[1-1]:Y[:SCALe]:PDIVision

Syntax :DISPlay:PN[1-1]:TRACe[1-1]:Y[:SCALe]:PDIVision <numeric>

:DISPlay:PN[1-1]:TRACe[1-1]:Y[:SCALe]:PDIVision?

Description scale per division

Parameter

	<Numeric>
Range	1a to 10G
Preset value	10
Unit	dB/div
Resolution	-

Equivalent key PN Menu -> Scale -> Scale/Div

:DISPlay:PN[1-1]:TRACe[1-1]:Y[:SCALe]:RLEVel

Syntax :DISPlay:PN[1-1]:TRACe[1-1]:Y[:SCALe]:RLEVel <numeric>

:DISPlay:PN[1-1]:TRACe[1-1]:Y[:SCALe]:RLEVel?

Description scale reference level

Parameter

	<Numeric>
Range	-50G to 50G
Preset value	-20
Unit	dBc/Hz
Resolution	-

Equivalent key PN Menu -> Scale -> Reference Value

PN Menu -> Scale -> Marker -> Reference

:DISPlay:PN[1-1]:TRACe[1-1]:Y[:SCALe]:RPOSition

Syntax :DISPlay:PN[1-1]:TRACe[1-1]:Y[:SCALe]:RPOSition <numeric>
:DISPlay:PN[1-1]:TRACe[1-1]:Y[:SCALe]:RPOSition?

Description scale reference position

Parameter

	<Numeric>
Range	0 to 30
Preset value	16
Unit	Div
Resolution	-

Equivalent key PN Menu -> Scale -> Reference Position

:DISPlay:PN[1-1]:Y[:SCALe]:DIVisions

Syntax :DISPlay:PN[1-1]:Y[:SCALe]:DIVisions <numeric>
:DISPlay:PN[1-1]:Y[:SCALe]:DIVisions?

Description # of Y division

Parameter

	<Numeric>
Range	4 to 30
Preset value	16
Unit	-
Resolution	2

Equivalent key PN Menu -> Scale -> Divisions

:DISPlay:SKEY:STATe

Syntax :DISPlay:SKEY:STATe {ON|OFF|1|0}
:DISPlay:SKEY:STATe?

Description Shows/Hides soft key

Parameter

	Description
ON or 1(Preset value)	Show softkey
OFF or 0	Hide softkey

Equivalent key No equivalent key is available on the front panel.

:DISPlay:SP[1-1]:ALLTrace:PERStence:CLEAr

Syntax :DISPlay:SP[1-1]:ALLTrace:PERStence:CLEAr

Description Clears all persistent traces (No Query)

Equivalent key No equivalent key is available on the front panel.

:DISPlay:SP[1-1]:ANNotation:MARKer:POSition

Syntax :DISPlay:SP[1-1]:ANNotation:MARKer:POSition {LEFT|RIGHT}

:DISPlay:SP[1-1]:ANNotation:MARKer:POSition?

Description Sets/Reads the marker information position

Parameter

	Description
LEFT(Preset value)	Set the marker information position to 'Left'
RIGHT	Set the marker information position to 'Right'

Equivalent key SP Menu -> Display -> Marker Information

:DISPlay:SP[1-1]:ANNotation:MEASurement:STATe

Syntax :DISPlay:SP[1-1]:ANNotation:MEASurement:STATe {ON|OFF|1|0}

:DISPlay:SP[1-1]:ANNotation:MEASurement:STATe?

Description Turns on/off measurement conditions

Parameter

	Description
ON or 1(Preset value)	Set measurement conditions mode to 'ON'
OFF or 0	Set measurement conditions mode to 'OFF'

Equivalent key SP Menu -> Display -> Meas Condition

:DISPlay:SP[1-1]:GRATicule:AXIS:Y:RELative

Syntax :DISPlay:SP[1-1]:GRATicule:AXIS:Y:RELative {ON|OFF|1|0}
:DISPlay:SP[1-1]:GRATicule:AXIS:Y:RELative?

Description Turns on/off relative Y-scale

Parameter

	Description
ON or 1	Set relative Y-scale mode to 'ON'
OFF or 0(Preset value)	Set relative Y-scale mode to 'OFF'

Equivalent key SP Menu -> Display -> Relative Y-Scale

:DISPlay:SP[1-1]:GRATicule:AXIS:Y:STATe

Syntax :DISPlay:SP[1-1]:GRATicule:AXIS:Y:STATe {OFF|SHORT|MIDDLE|LONG}
:DISPlay:SP[1-1]:GRATicule:AXIS:Y:STATe?

Description Sets/Reads Y graticule label display

Parameter

	Description
OFF	Set Y graticule label to 'OFF'
SHORT(Preset value)	Set Y graticule label to 4 digits
MIDDLE	Set Y graticule label to 8 digits
LONG	Set Y graticule label to 12 digits

Equivalent key SP Menu -> Display -> Y # of Digits

:DISPlay:SP[1-1]:LABel:DATA

Syntax :DISPlay:SP[1-1]:LABel:DATA <String>
:DISPlay:SP[1-1]:LABel:DATA?

Description Edits window title label

Parameter

	<String>
Range	-
Preset value	""
Unit	-
Resolution	-

Equivalent key SP Menu -> Display -> Edit Title Label

:DISPlay:SP[1-1]:LABel:STATe

Syntax :DISPlay:SP[1-1]:LABel:STATe {ON|OFF|1|0}
:DISPlay:SP[1-1]:LABel:STATe?

Description Shows/Hides window title label

Parameter

	Description
ON or 1	Show window title label
OFF or 0(Preset value)	Hide window title label

Equivalent key SP Menu -> Display -> Title Label

:DISPlay:SP[1-1]:LIMit:FSIGn

Syntax :DISPlay:SP[1-1]:LIMit:FSIGn {ON|OFF|1|0}
:DISPlay:SP[1-1]:LIMit:FSIGn?

Description Turns on/off the limit test judgement display

Parameter

	Description
ON or 1(Preset value)	Turn on the limit test judgement display mode
OFF or 0	Turn off the limit test judgement display mode

Equivalent key

SP Menu -> Display -> Limit Test -> Fail Sign

:DISPlay:SP[1-1]:MAXimize

Syntax

:DISPlay:SP[1-1]:MAXimize {ON|OFF|1|0}
:DISPlay:SP[1-1]:MAXimize?

Description

Maximizes active trace

Parameter

	Description
ON or 1	Set maximize active trace mode to 'ON'
OFF or 0(Preset value)	Set maximize active trace mode to 'OFF'

Equivalent key

No equivalent key is available on the front panel.

:DISPlay:SP[1-1]:STATe

Syntax

:DISPlay:SP[1-1]:STATe {ON|OFF|1|0}
:DISPlay:SP[1-1]:STATe?

Description

Turns on/off spectrum monitor mode

Parameter

	Description
ON or 1(Preset value)	Show spectrum monitor mode
OFF or 0	Hide spectrum monitor mode

Equivalent key

PN Menu -> Measurement View -> Show Window -> Spectrum Monitor
SP Menu -> Measurement View -> Show Window -> Spectrum Monitor
FP Menu -> Measurement View -> Show Window -> Spectrum Monitor
TR Menu -> Measurement View -> Show Window -> Spectrum Monitor

USER Menu -> Measurement View -> Show Window -> Spectrum Monitor

:DISPlay:SP[1-1]:TABLe[:STATe]

Syntax :DISPlay:SP[1-1]:TABLe[:STATe] {ON|OFF|1|0}
:DISPlay:SP[1-1]:TABLe[:STATe]?

Description Turns on/off the marker list

Parameter

	Description
ON or 1	Enable the marker list
OFF or 0(Preset value)	Disable the marker list

Equivalent key SP Menu -> Marker -> Marker List

:DISPlay:SP[1-1]:TRACe[1-1]:LABel:DATA

Syntax :DISPlay:SP[1-1]:TRACe[1-1]:LABel:DATA <String>
:DISPlay:SP[1-1]:TRACe[1-1]:LABel:DATA?

Description Sets/Reads trace title lable on spectrum monitor mode

Parameter

	<String>
Range	-
Preset value	"Spectrum"
Unit	-
Resolution	-

Equivalent key SP Menu -> Trace View -> Trace Label

:DISPlay:SP[1-1]:TRACe[1-1]:LIMit:LINE

Syntax :DISPlay:SP[1-1]:TRACe[1-1]:LIMit:LINE {ON|OFF|1|0}
:DISPlay:SP[1-1]:TRACe[1-1]:LIMit:LINE?

Description Turns on/off the limit line

Parameter

	Description
ON or 1 (Preset value)	Turn on the limit line mode
OFF or 0	Turn off the limit line mode

Equivalent key

SP Menu -> Display -> Limit Test -> Limit Line

:DISPlay:SP[1-1]:TRACe[1-1]:MODE

Syntax

:DISPlay:SP[1-1]:TRACe[1-1]:MODE {OFF|DATA|MEMory|BOTH}
:DISPlay:SP[1-1]:TRACe[1-1]:MODE?

Description

Sets/Reads data and/or memory trace display

Parameter

	Description
OFF	Set data and/or memory trace to 'Off'
DATA (Preset value)	Set data and/or memory trace to 'Data'
MEMory	Set data and/or memory trace to 'Memory'
BOTH	Set data and/or memory race to 'Both' (data and memory)

Equivalent key

SP Menu -> Trace View -> Display Trace

:DISPlay:SP[1-1]:TRACe[1-1]:PERSistence:CLEAr

Syntax

:DISPlay:SP[1-1]:TRACe[1-1]:PERSistence:CLEAr

Description

Clears persistent data (No Query)

Equivalent key

SP Menu -> Trace View -> Persistence -> Clear Persistent Data

:DISPlay:SP[1-1]:TRACe[1-1]:PERSistence:STATe

Syntax

:DISPlay:SP[1-1]:TRACe[1-1]:PERSistence:STATe {ON|OFF|1|0}
:DISPlay:SP[1-1]:TRACe[1-1]:PERSistence:STATe?

Description

Sets/Reads persistence mode

Parameter

	Description
ON or 1	Set persistence mode to 'ON'
OFF or 0(Preset value)	Set persistence mode to 'OFF'

Equivalent key SP Menu -> Trace View -> Persistence -> Persistence Mode

:DISPlay:SP[1-1]:TRACe[1-1]:X[:SCALe]:AUTO

Syntax :DISPlay:SP[1-1]:TRACe[1-1]:X[:SCALe]:AUTO {ON|OFF|1|0}
:DISPlay:SP[1-1]:TRACe[1-1]:X[:SCALe]:AUTO?

Description Sets/Reads automatic setting of the X-axis display range to the stimulus value

Parameter

	Description
ON or 1(Preset value)	Automatically sets the range of the X-axis to the stimulus value
OFF or 0	Manually sets the range of the X-axis

Equivalent key SP Menu -> Scale -> X Axis -> Auto

:DISPlay:SP[1-1]:TRACe[1-1]:X[:SCALe]:LEFT

Syntax :DISPlay:SP[1-1]:TRACe[1-1]:X[:SCALe]:LEFT <numeric>
:DISPlay:SP[1-1]:TRACe[1-1]:X[:SCALe]:LEFT?

Description Sets/Reads the start value of the X-axis.

Parameter

	<Numeric>
Description	Start value of the X-axis
Range	0 to 499.999999999 G
Preset value	992.5 M
Unit	-
Resolution	-

NOTE This command is available only when the automatic setting of the X-axis display range (set

with “:DISPlay:SP[1-1]:TRACe[1-1]:X[:SCALe]:AUTO” on page 270) is set to OFF.

Equivalent key SP Menu -> Scale -> X Axis -> Left

:DISPlay:SP[1-1]:TRACe[1-1]:X[:SCALe]:RIGHT

Syntax :DISPlay:SP[1-1]:TRACe[1-1]:X[:SCALe]:RIGHT <numeric>
:DISPlay:SP[1-1]:TRACe[1-1]:X[:SCALe]:RIGHT?

Description Sets/Reads the stop value of the X-axis

Parameter

	<Numeric>
Description	Stop value of the X-axis
Range	100 m to 500 G
Preset value	1.0075 G
Unit	-
Resolution	-

NOTE

Equivalent key SP Menu -> Scale -> X Axis -> Right

:DISPlay:SP[1-1]:TRACe[1-1]:Y[:SCALe]:AUTO

Syntax :DISPlay:SP[1-1]:TRACe[1-1]:Y[:SCALe]:AUTO

Description Executes autoscale (No Query)

Equivalent key SP Menu -> Scale -> Auto Scale

:DISPlay:SP[1-1]:TRACe[1-1]:Y[:SCALe]:PDIVision

Syntax :DISPlay:SP[1-1]:TRACe[1-1]:Y[:SCALe]:PDIVision <numeric>
:DISPlay:SP[1-1]:TRACe[1-1]:Y[:SCALe]:PDIVision?

Description scale per division

Parameter

	<Numeric>
Range	1a to 10G

	<Numeric>
Preset value	10
Unit	-
Resolution	-

Equivalent key SP Menu -> Scale -> Scale/Div

:DISPlay:SP[1-1]:TRACe[1-1]:Y[:SCALe]:RLEVel

Syntax :DISPlay:SP[1-1]:TRACe[1-1]:Y[:SCALe]:RLEVel <numeric>

:DISPlay:SP[1-1]:TRACe[1-1]:Y[:SCALe]:RLEVel?

Description scale reference level

Parameter

	<Numeric>
Range	-50G to 50G
Preset value	10
Unit	-
Resolution	-

Equivalent key SP Menu -> Scale -> Reference Value

SP Menu -> Scale -> Marker -> Reference

:DISPlay:SP[1-1]:TRACe[1-1]:Y[:SCALe]:RPOSition

Syntax :DISPlay:SP[1-1]:TRACe[1-1]:Y[:SCALe]:RPOSition <numeric>

:DISPlay:SP[1-1]:TRACe[1-1]:Y[:SCALe]:RPOSition?

Description scale reference position

Parameter

	<Numeric>
Range	0 to 30
Preset value	10
Unit	Div
Resolution	-

Equivalent key SP Menu -> Scale -> Reference Position

:DISPlay:SP[1-1]:Y[:SCALe]:DIVisions

Syntax :DISPlay:SP[1-1]:Y[:SCALe]:DIVisions <numeric>
:DISPlay:SP[1-1]:Y[:SCALe]:DIVisions?

Description # of Y division

Parameter

	<Numeric>
Range	4 to 30
Preset value	10
Unit	-
Resolution	2

Equivalent key SP Menu -> Scale -> Divisions

:DISPlay:TR[1-1]:ALLTrace:PERStence:CLEar

Syntax :DISPlay:TR[1-1]:ALLTrace:PERStence:CLEar

Description Clears all stored traces (No Query)

Equivalent key No equivalent key is available on the front panel.

:DISPlay:TR[1-1]:ALLTrace:Y:SCALe:AUTO

Syntax :DISPlay:TR[1-1]:ALLTrace:Y:SCALe:AUTO

Description auto scale all (No Query)

Equivalent key TR Menu -> Scale -> Auto Scale All

:DISPlay:TR[1-1]:ANNotation:MARKer:POSition

Syntax :DISPlay:TR[1-1]:ANNotation:MARKer:POSition {LEFT|RIGHT}
:DISPlay:TR[1-1]:ANNotation:MARKer:POSition?

Description Sets/Reads the marker information position

Parameter

	Description
LEFT(Preset value)	Set the marker information position to 'Left'
RIGHt	Set the marker information position to 'Right'

Equivalent key TR Menu -> Display -> Marker Information

:DISPlay:TR[1-1]:ANNOtation:MEASurement:STATe

Syntax :DISPlay:TR[1-1]:ANNOtation:MEASurement:STATe {ON|OFF|1|0}
:DISPlay:TR[1-1]:ANNOtation:MEASurement:STATe?

Description Turns on/off measurement conditions

Parameter

	Description
ON or 1(Preset value)	Set measurement conditions mode to 'ON'
OFF or 0	Set measurement conditions mode to 'OFF'

Equivalent key TR Menu -> Display -> Meas Condition

:DISPlay:TR[1-1]:GRATicule:AXIS:Y:RELative

Syntax :DISPlay:TR[1-1]:GRATicule:AXIS:Y:RELative {ON|OFF|1|0}
:DISPlay:TR[1-1]:GRATicule:AXIS:Y:RELative?

Description Sets/Reads relative Y-scale

Parameter

	Description
ON or 1	Set relative Y-scale mode to 'ON'
OFF or 0(Preset value)	Set relative Y-scale mode to 'OFF'

Equivalent key TR Menu -> Display -> Relative Y-Scale

:DISPlay:TR[1-1]:GRATicule:AXIS:Y:STATe

Syntax :DISPlay:TR[1-1]:GRATicule:AXIS:Y:STATe {OFF|SHORT|MIDDLE|LONG}

:DISPlay:TR[1-1]:GRATICule:AXIS:Y:STATe?

Description Sets/Reads Y graticule label display

Parameter

	Description
OFF	Set Y graticule label to 'OFF'
SHORT(Preset value)	Set Y graticule label to 4 digits
MIDDLE	Set Y graticule label to 8 digits
LONG	Set Y graticule label to 12 digits

Equivalent key TR Menu -> Display -> Y # of Digits

:DISPlay:TR[1-1]:LABel:DATA

Syntax :DISPlay:TR[1-1]:LABel:DATA <String>

:DISPlay:TR[1-1]:LABel:DATA?

Description Edits window title label

Parameter

	<String>
Range	-
Preset value	""
Unit	-
Resolution	-

Equivalent key TR Menu -> Display -> Edit Title Label

:DISPlay:TR[1-1]:LABel:STATe

Syntax :DISPlay:TR[1-1]:LABel:STATe {ON|OFF|1|0}

:DISPlay:TR[1-1]:LABel:STATe?

Description Turns on/off window title lable

Parameter

	Description
ON or 1	Show window title lable mode
OFF or 0(Preset value)	Hide window title lable

Equivalent key TR Menu -> Display -> Title Label

:DISPlay:TR[1-1]:LIMit:FSIGN

Syntax :DISPlay:TR[1-1]:LIMit:FSIGN {ON|OFF|1|0}
:DISPlay:TR[1-1]:LIMit:FSIGN?

Description Turns on/off the limit test judgement display

Parameter

	Description
ON or 1(Preset value)	Turn on the limit test judgement display mode
OFF or 0	Turn off the limit test judgement display mode

Equivalent key TR Menu -> Display -> Limit Test -> Fail Sign

:DISPlay:TR[1-1]:MAXimize

Syntax :DISPlay:TR[1-1]:MAXimize {ON|OFF|1|0}
:DISPlay:TR[1-1]:MAXimize?

Description Maximizes active trace

Parameter

	Description
ON or 1	Set maximize active trace mode to 'ON'
OFF or 0(Preset value)	Set maximize active trace mode to 'OFF'

Equivalent key No equivalent key is available on the front panel.

:DISPlay:TR[1-1]:STATe

Syntax :DISPlay:TR[1-1]:STATe {ON|OFF|1|0}

:DISPlay:TR[1-1]:STATe?

Description Turns on/off transient measurement mode

Parameter

	Description
ON or 1 (Preset value)	Show transient measurement window
OFF or 0	Hide transient measurement window

Equivalent key
 PN Menu -> Measurement View -> Show Window -> Transient
 SP Menu -> Measurement View -> Show Window -> Transient
 FP Menu -> Measurement View -> Show Window -> Transient
 TR Menu -> Measurement View -> Show Window -> Transient
 USER Menu -> Measurement View -> Show Window -> Transient

:DISPlay:TR[1-1]:TABLE[:STATe]

Syntax
 :DISPlay:TR[1-1]:TABLE[:STATe] {ON|OFF|1|0}
 :DISPlay:TR[1-1]:TABLE[:STATe]?

Description Turns on/off the marker list

Parameter

	Description
ON or 1	Enable the marker list
OFF or 0 (Preset value)	Disable the marker list

Equivalent key TR Menu -> Marker -> Marker List

:DISPlay:TR[1-1]:TRACe[1-4]:LABel:DATA

Syntax
 :DISPlay:TR[1-1]:TRACe[1-4]:LABel:DATA <String>
 :DISPlay:TR[1-1]:TRACe[1-4]:LABel:DATA?

Description Sets/Reads trace title lable on transient measurement

Parameter

	<String>
Range	-
Preset value	"WB Freq"
Unit	-
Resolution	-

Equivalent key

TR Menu -> Trace View -> Trace Label

:DISPlay:TR[1-1]:TRACe[1-4]:LIMit:LINE

Syntax

:DISPlay:TR[1-1]:TRACe[1-4]:LIMit:LINE {ON|OFF|1|0}

:DISPlay:TR[1-1]:TRACe[1-4]:LIMit:LINE?

Description

Turns on/off the limit line

Parameter

	Description
ON or 1(Preset value)	Turn on the limit line mode
OFF or 0	Turn off the limit line mode

Equivalent key

TR Menu -> Display -> Limit Test -> Limit Line

:DISPlay:TR[1-1]:TRACe[1-4]:MODE

Syntax

:DISPlay:TR[1-1]:TRACe[1-4]:MODE {OFF|DATA|MEMory|BOTH}

:DISPlay:TR[1-1]:TRACe[1-4]:MODE?

Description

Sets/Reads data and/or memory trace display

Parameter

	Description
OFF	Set data and/or memory trace to 'Off'
DATA(Preset value)	Set data and/or memory trace to 'Data'
MEMory	Set data and/or memory trace to 'Memory'
BOTH	Set data and/or memory race to 'Both' (data and memory)

Equivalent key TR Menu -> Trace View -> Display Trace

:DISPlay:TR[1-1]:TRACe[1-4]:PERSistence:CLEAr

Syntax :DISPlay:TR[1-1]:TRACe[1-4]:PERSistence:CLEAr

Description Clears persistent data (No Query)

Equivalent key TR Menu -> Trace View -> Persistence -> Clear Persistent Data

:DISPlay:TR[1-1]:TRACe[1-4]:PERSistence:STATe

Syntax :DISPlay:TR[1-1]:TRACe[1-4]:PERSistence:STATe {ON|OFF|1|0}

:DISPlay:TR[1-1]:TRACe[1-4]:PERSistence:STATe?

Description Sets/Reads persistence mode

Parameter

	Description
ON or 1	Set persistence mode to 'ON'
OFF or 0(Preset value)	Set persistence mode to 'OFF'

Equivalent key TR Menu -> Trace View -> Persistence -> Persistence Mode

:DISPlay:TR[1-1]:TRACe[1-4]:X[:SCALe]:AUTO

Syntax :DISPlay:TR[1-1]:TRACe[1-4]:X[:SCALe]:AUTO {ON|OFF|1|0}

:DISPlay:TR[1-1]:TRACe[1-4]:X[:SCALe]:AUTO?

Description Sets/Reads automatic setting of the X-axis display range to the stimulus value

Parameter

	Description
ON or 1(Preset value)	Automatically sets the range of the X-axis to the stimulus value
OFF or 0	Manually sets the range of the X-axis

Equivalent key TR Menu -> Scale -> X Axis -> Auto

:DISPlay:TR[1-1]:TRACe[1-4]:X[:SCALe]:LEFT

Syntax :DISPlay:TR[1-1]:TRACe[1-4]:X[:SCALe]:LEFT <numeric>

:DISPlay:TR[1-1]:TRACe[1-4]:X[:SCALe]:LEFT?

Description Sets/Reads the start value of the X-axis

Parameter

	<Numeric>
Description	Start value of the X-axis
Range	-8 to 10.999999
Preset value	-50 m
Unit	-
Resolution	-

NOTE This command is available only when the automatic setting of the X-axis display range (set with “:DISPlay:TR[1-1]:TRACe[1-4]:X[:SCALe]:AUTO” on page 279) is set to OFF.

Equivalent key TR Menu -> Scale -> X Axis -> Left

:DISPlay:TR[1-1]:TRACe[1-4]:X[:SCALe]:RIGHT

Syntax :DISPlay:TR[1-1]:TRACe[1-4]:X[:SCALe]:RIGHT <numeric>

:DISPlay:TR[1-1]:TRACe[1-4]:X[:SCALe]:RIGHT?

Description Sets/Reads the stop value of the X-axis

Parameter

	<Numeric>
Description	Stop value of the X-axis
Range	-7.999999 to 11
Preset value	50 m
Unit	-
Resolution	-

NOTE This command is available only when the automatic setting of the X-axis display range (set with “:DISPlay:TR[1-1]:TRACe[1-4]:X[:SCALe]:AUTO” on page 279) is set to OFF.

Equivalent key TR Menu -> Scale -> X Axis -> Right

:DISPlay:TR[1-1]:TRACe[1-4]:Y[:SCALe]:AUTO

Syntax :DISPlay:TR[1-1]:TRACe[1-4]:Y[:SCALe]:AUTO

Description Executes autoscale (No Query)

Equivalent key TR Menu -> Scale -> Auto Scale

:DISPlay:TR[1-1]:TRACe[1-4]:Y[:SCALe]:PDIVision

Syntax :DISPlay:TR[1-1]:TRACe[1-4]:Y[:SCALe]:PDIVision <numeric>

:DISPlay:TR[1-1]:TRACe[1-4]:Y[:SCALe]:PDIVision?

Description scale per division

Parameter

	<Numeric>
Range	1a to 10G
Preset value	80M
Unit	-
Resolution	-

Equivalent key TR Menu -> Scale -> Scale/Div

:DISPlay:TR[1-1]:TRACe[1-4]:Y[:SCALe]:RLEVel

Syntax :DISPlay:TR[1-1]:TRACe[1-4]:Y[:SCALe]:RLEVel <numeric>

:DISPlay:TR[1-1]:TRACe[1-4]:Y[:SCALe]:RLEVel?

Description scale reference level

Parameter

	<Numeric>
Range	-500G to 500G
Preset value	800M
Unit	-
Resolution	-

Equivalent key TR Menu -> Scale -> Reference Value

TR Menu -> Scale -> Marker -> Reference

:DISPlay:TR[1-1]:TRACe[1-4]:Y[:SCALe]:RPOStion

Syntax :DISPlay:TR[1-1]:TRACe[1-4]:Y[:SCALe]:RPOStion <numeric>
:DISPlay:TR[1-1]:TRACe[1-4]:Y[:SCALe]:RPOStion?

Description scale reference position

Parameter

	<Numeric>
Range	0 to 30
Preset value	5
Unit	Div
Resolution	-

Equivalent key TR Menu -> Scale -> Reference Position

:DISPlay:TR[1-1]:Y[:SCALe]:DIVisions

Syntax :DISPlay:TR[1-1]:Y[:SCALe]:DIVisions <numeric>
:DISPlay:TR[1-1]:Y[:SCALe]:DIVisions?

Description # of Y division

Parameter

	<Numeric>
Range	4 to 30
Preset value	10
Unit	-
Resolution	2

Equivalent key TR Menu -> Scale -> Divisions

:DISPlay:UPDate:IMMediate

Syntax :DISPlay:UPDate:IMMediate

Description Update display force (No Query)

Equivalent key No equivalent key is available on the front panel.

:DISPlay:USER[1-1]:ALLTrace:PERSistence:CLEAr

Syntax :DISPlay:USER[1-1]:ALLTrace:PERSistence:CLEAr

Description Clears all stored traces (No Query)

Equivalent key USER Menu -> Trace View -> Persistence -> Clear All Persistent Data

:DISPlay:USER[1-1]:ALLTrace:Y:SCALE:AUTo

Syntax :DISPlay:USER[1-1]:ALLTrace:Y:SCALE:AUTo

Description auto scale all (No Query)

Equivalent key USER Menu -> Scale -> Auto Scale All

:DISPlay:USER[1-1]:ANNOtation:MARKer:POSition

Syntax :DISPlay:USER[1-1]:ANNOtation:MARKer:POSition {LEFT|RIGHT}
:DISPlay:USER[1-1]:ANNOtation:MARKer:POSition?

Description Sets/Reads the marker information position

Parameter

	Description
LEFT(Preset value)	Set the marker information position to 'Left'
RIGHT	Set the marker information position to 'Right'

Equivalent key USER Menu -> Display -> Marker Information

:DISPlay:USER[1-1]:ANNOtation:MEASurement:STATe

Syntax :DISPlay:USER[1-1]:ANNOtation:MEASurement:STATe {ON|OFF|1|0}
:DISPlay:USER[1-1]:ANNOtation:MEASurement:STATe?

Description Turns on/off measurement conditions

Parameter

	Description
ON or 1(Preset value)	Set measurement conditions mode to 'ON'
OFF or 0	Set measurement conditions mode to 'OFF'

Equivalent key USER Menu -> Display -> Meas Condition

:DISPlay:USER[1-1]:GRATicule:AXIS:Y:RELative

Syntax :DISPlay:USER[1-1]:GRATicule:AXIS:Y:RELative {ON|OFF|1|0}
:DISPlay:USER[1-1]:GRATicule:AXIS:Y:RELative?

Description Turns on/off relative Y-scale

Parameter

	Description
ON or 1	Set relative Y-scale mode to 'ON'
OFF or 0(Preset value)	Set relative Y-scale mode to 'OFF'

Equivalent key USER Menu -> Display -> Relative Y-Scale

:DISPlay:USER[1-1]:GRATicule:AXIS:Y:STATe

Syntax :DISPlay:USER[1-1]:GRATicule:AXIS:Y:STATe {OFF|SHORT|MIDDLE|LONG}
:DISPlay:USER[1-1]:GRATicule:AXIS:Y:STATe?

Description Sets/Reads Y graticule label display

Parameter

	Description
OFF	Set Y graticule label to 'OFF'
SHORT(Preset value)	Set Y graticule label to 4 digits
MIDDLE	Set Y graticule label to 8 digits
LONG	Set Y graticule label to 12 digits

Equivalent key USER Menu -> Display -> Y # of Digits

:DISPlay:USER[1-1]:LABel:DATA

Syntax :DISPlay:USER[1-1]:LABel:DATA <String>
:DISPlay:USER[1-1]:LABel:DATA?

Description Edits window title label

Parameter

	<String>
Range	-
Preset value	""
Unit	-
Resolution	-

Equivalent key USER Menu -> Display -> Edit Title Label

:DISPlay:USER[1-1]:LABel:STATe

Syntax :DISPlay:USER[1-1]:LABel:STATe {ON|OFF|1|0}
:DISPlay:USER[1-1]:LABel:STATe?

Description Shows/Hides Window Title Label

Parameter

	Description
ON or 1	Show window title label
OFF or 0(Preset value)	Hide window title label

Equivalent key USER Menu -> Display -> Title Label

:DISPlay:USER[1-1]:LIMit:FSIGn

Syntax :DISPlay:USER[1-1]:LIMit:FSIGn {ON|OFF|1|0}
:DISPlay:USER[1-1]:LIMit:FSIGn?

Description Turns on/off the limit test judgement display

Parameter

	Description
ON or 1(Preset value)	Turn on the limit test judgement display mode
OFF or 0	Turn off the limit test judgement display mode

Equivalent key USER Menu -> Display -> Limit Test -> Fail Sign

:DISPlay:USER[1-1]:MAXimize

Syntax :DISPlay:USER[1-1]:MAXimize {ON|OFF|1|0}
:DISPlay:USER[1-1]:MAXimize?

Description Maximizes user (definition) window

Parameter

	Description
ON or 1	Set maximize user (definition) window to 'ON'
OFF or 0(Preset value)	Set maximize user (definition) window to 'OFF'

Equivalent key No equivalent key is available on the front panel.

:DISPlay:USER[1-1]:STATe

Syntax :DISPlay:USER[1-1]:STATe {ON|OFF|1|0}
:DISPlay:USER[1-1]:STATe?

Description Turns on/off user defined window

Parameter

	Description
ON or 1	Show user defined window
OFF or 0(Preset value)	hide user defined window

Equivalent key PN Menu -> Measurement View -> Show Window -> User
SP Menu -> Measurement View -> Show Window -> User
FP Menu -> Measurement View -> Show Window -> User
TR Menu -> Measurement View -> Show Window -> User
USER Menu -> Measurement View -> Show Window -> User

:DISPlay:USER[1-1]:TABLE[:STATe]

Syntax :DISPlay:USER[1-1]:TABLE[:STATe] {ON|OFF|1|0}
:DISPlay:USER[1-1]:TABLE[:STATe]?

Description Turns on/off the marker list

Parameter

	Description
ON or 1	Enable the marker list
OFF or 0(Preset value)	Disable the marker list

Equivalent key

USER Menu -> Marker -> Marker List

:DISPlay:USER[1-1]:TRACe[1-8]:ANNotation:DATA

Syntax

:DISPlay:USER[1-1]:TRACe[1-8]:ANNotation:DATA <string>
:DISPlay:USER[1-1]:TRACe[1-8]:ANNotation:DATA?

Description

Sets/Reads the annotation of the trace

Parameter

	<String>
Description	The annotation of the trace
Range	254 characters
Preset value	""

Equivalent key

USER Menu -> Trace View -> Trace Annotation

:DISPlay:USER[1-1]:TRACe[1-8]:LABel:DATA

Syntax

:DISPlay:USER[1-1]:TRACe[1-8]:LABel:DATA <String>
:DISPlay:USER[1-1]:TRACe[1-8]:LABel:DATA?

Description

Edits trace title label

Parameter

	<String>
Range	-
Preset value	"Tr1"
Unit	-
Resolution	-

Equivalent key

USER Menu -> Trace View -> Trace Label

:DISPlay:USER[1-1]:TRACe[1-8]:LIMit:LINE

Syntax :DISPlay:USER[1-1]:TRACe[1-8]:LIMit:LINE {ON|OFF|1|0}
:DISPlay:USER[1-1]:TRACe[1-8]:LIMit:LINE?

Description Turns on/off the limit line

Parameter

	Description
ON or 1(Preset value)	Turn on the limit line mode
OFF or 0	Turn off the limit line mode

Equivalent key USER Menu -> Display -> Limit Test -> Limit Line

:DISPlay:USER[1-1]:TRACe[1-8]:MODE

Syntax :DISPlay:USER[1-1]:TRACe[1-8]:MODE {OFF|DATA|MEMory|BOTH}
:DISPlay:USER[1-1]:TRACe[1-8]:MODE?

Description Sets/Reads data and/or memory trace display

Parameter

	Description
OFF	Set data and/or memory trace to 'Off'
DATA(Preset value)	Set data and/or memory trace to 'Data'
MEMory	Set data and/or memory trace to 'Memory'
BOTH	Set data and/or memory race to 'Both' (data and memory)

Equivalent key USER Menu -> Trace View -> Display Trace

:DISPlay:USER[1-1]:TRACe[1-8]:PERSistence:STATe

Syntax :DISPlay:USER[1-1]:TRACe[1-8]:PERSistence:STATe {ON|OFF|1|0}
:DISPlay:USER[1-1]:TRACe[1-8]:PERSistence:STATe?

Description Clears persistent data

Parameter

	Description
ON or 1	Clears persistent data
OFF or 0(Preset value)	Does not clear persistent data

Equivalent key

USER Menu -> Trace View -> Persistence -> Persistence Mode

:DISPlay:USER[1-1]:TRACe[1-8]:STATe

Syntax

:DISPlay:USER[1-1]:TRACe[1-8]:STATe {ON|OFF|1|0}
:DISPlay:USER[1-1]:TRACe[1-8]:STATe?

Description

Sets/Reads persistence mode

Parameter

	Description
ON or 1(Preset value)	Set persistence mode to 'ON'
OFF or 0	Set persistence mode to 'OFF'

Equivalent key

USER Menu -> Trace View -> Enable Trace -> Trace 1

:DISPlay:USER[1-1]:TRACe[1-8]:X[:SCALe]:AUTO

Syntax

:DISPlay:USER[1-1]:TRACe[1-8]:X[:SCALe]:AUTO {ON|OFF|1|0}
:DISPlay:USER[1-1]:TRACe[1-8]:X[:SCALe]:AUTO?

Description

Sets/Reads automatic setting of the X-axis display range to the stimulus value

Parameter

	Description
ON or 1(Preset value)	Automatically sets the range of the X-axis to the stimulus value
OFF or 0	Manually sets the range of the X-axis

Equivalent key

USER Menu -> Scale -> X Axis -> Auto

:DISPlay:USER[1-1]:TRACe[1-8]:X[:SCALe]:LEFT

Syntax

:DISPlay:USER[1-1]:TRACe[1-8]:X[:SCALe]:LEFT <numeric>

:DISPlay:USER[1-1]:TRACe[1-8]:X[:SCALe]:LEFT?

Description Sets/Reads the start value of the X-axis

Parameter

	<Numeric>
Description	Start value of the X-axis
Range	-500 G to 499.999999999 G
Preset value	0
Unit	-
Resolution	-

NOTE This command is available only when the automatic setting of the X-axis display range (set with “:DISPlay:USER[1-1]:TRACe[1-8]:X[:SCALe]:AUTO” on page 289) is set to OFF.

Equivalent key USER Menu -> Scale -> X Axis -> Left

:DISPlay:USER[1-1]:TRACe[1-8]:X[:SCALe]:RIGHT

Syntax :DISPlay:USER[1-1]:TRACe[1-8]:X[:SCALe]:RIGHT <numeric>

:DISPlay:USER[1-1]:TRACe[1-8]:X[:SCALe]:RIGHT?

Description Sets/Reads the stop value of the X-axis

Parameter

	<Numeric>
Description	Stop value of the X-axis
Range	-499.999999999 G to 500 G
Preset value	100
Unit	-
Resolution	-

NOTE This command is available only when the automatic setting of the X-axis display range (set with “:DISPlay:USER[1-1]:TRACe[1-8]:X[:SCALe]:AUTO” on page 289) is set to OFF.

Equivalent key USER Menu -> Scale -> X Axis -> Right

:DISPlay:USER[1-1]:TRACe[1-8]:X:TYPE

Syntax :DISPlay:USER[1-1]:TRACe[1-8]:X:TYPE {LINear|LOGarithmic}
:DISPlay:USER[1-1]:TRACe[1-8]:X:TYPE?

Description Sets/Reads the display type of the x axis.

Parameter

	Description
LINear(Preset value)	Set the display type of the x axis to 'Linear'
LOGarithmic	Set the display type of the x axis to 'Logarithmic'

Equivalent key USER Menu -> Scale -> X Axis Type

:DISPlay:USER[1-1]:TRACe[1-8]:X:UNIT

Syntax :DISPlay:USER[1-1]:TRACe[1-8]:X:UNIT <String>
:DISPlay:USER[1-1]:TRACe[1-8]:X:UNIT?

Description X axis unit

Parameter

	<String>
Range	-
Preset value	"U"
Unit	-
Resolution	-

Equivalent key USER Menu -> Scale -> X Unit

:DISPlay:USER[1-1]:TRACe[1-8]:Y[:SCALE]:AUTO

Syntax :DISPlay:USER[1-1]:TRACe[1-8]:Y[:SCALE]:AUTO

Description Executes autoscale (No Query)

Equivalent key USER Menu -> Scale -> Auto Scale

:DISPlay:USER[1-1]:TRACe[1-8]:Y[:SCALE]:PDIVision

Syntax :DISPlay:USER[1-1]:TRACe[1-8]:Y[:SCALE]:PDIVision <numeric>

:DISPlay:USER[1-1]:TRACe[1-8]:Y[:SCALe]:PDIVision?

Description scale per division

Parameter

	<Numeric>
Range	1a to 10G
Preset value	10
Unit	-
Resolution	-

Equivalent key USER Menu -> Scale -> Scale/Div

:DISPlay:USER[1-1]:TRACe[1-8]:Y[:SCALe]:RLEVel

Syntax :DISPlay:USER[1-1]:TRACe[1-8]:Y[:SCALe]:RLEVel <numeric>

:DISPlay:USER[1-1]:TRACe[1-8]:Y[:SCALe]:RLEVel?

Description scale reference level

Parameter

	<Numeric>
Range	-500G to 500G
Preset value	-40
Unit	-
Resolution	-

Equivalent key USER Menu -> Scale -> Reference Value

USER Menu -> Scale -> Marker -> Reference

:DISPlay:USER[1-1]:TRACe[1-8]:Y[:SCALe]:RPOStion

Syntax :DISPlay:USER[1-1]:TRACe[1-8]:Y[:SCALe]:RPOStion <numeric>

:DISPlay:USER[1-1]:TRACe[1-8]:Y[:SCALe]:RPOStion?

Description scale reference position

Parameter

	<Numeric>
Range	0 to 30
Preset value	5
Unit	Div
Resolution	-

Equivalent key USER Menu -> Scale -> Reference Position

:DISPlay:USER[1-1]:TRACe[1-8]:Y:UNIT

Syntax
:DISPlay:USER[1-1]:TRACe[1-8]:Y:UNIT <String>
:DISPlay:USER[1-1]:TRACe[1-8]:Y:UNIT?

Description Y axis unit

Parameter

	<String>
Range	-
Preset value	"U"
Unit	-
Resolution	-

Equivalent key USER Menu -> Scale -> Y Unit

:DISPlay:USER[1-1]:Y[:SCALE]:DIVisions

Syntax
:DISPlay:USER[1-1]:Y[:SCALE]:DIVisions <numeric>
:DISPlay:USER[1-1]:Y[:SCALE]:DIVisions?

Description # of Y division

Parameter

	<Numeric>
Range	4 to 30
Preset value	10
Unit	-

	<Numeric>
Resolution	2

Equivalent key USER Menu -> Scale -> Divisions

:DISPlay:WINDow:ACTive

Syntax :DISPlay:WINDow:ACTive {PN1|SP1|FP1|TR1|USER1}
:DISPlay:WINDow:ACTive?

Description Sets/Reads active instrument window

Parameter

	Description
PN1(Preset value)	Set active instrument window to 'Phase Noise'
SP1	Set active instrument window to 'Spectrum Monitor'
FP1	Set active instrument window to 'Freq & Power'
TR1	Set active instrument window to 'Transient'
USER1	Set active instrument window to 'User'

Equivalent key
 PN Menu -> Measurement View -> Phase Noise
 PN Menu -> Measurement View -> Spectrum Monitor
 PN Menu -> Measurement View -> Freq & Power
 PN Menu -> Measurement View -> Transient
 PN Menu -> Measurement View -> User
 SP Menu -> Measurement View -> Phase Noise
 SP Menu -> Measurement View -> Spectrum Monitor
 SP Menu -> Measurement View -> Freq & Power
 SP Menu -> Measurement View -> Transient
 SP Menu -> Measurement View -> User
 FP Menu -> Measurement View -> Phase Noise
 FP Menu -> Measurement View -> Spectrum Monitor
 FP Menu -> Measurement View -> Freq & Power
 FP Menu -> Measurement View -> Transient
 FP Menu -> Measurement View -> User
 TR Menu -> Measurement View -> Phase Noise
 TR Menu -> Measurement View -> Spectrum Monitor

TR Menu -> Measurement View -> Freq & Power
 TR Menu -> Measurement View -> Transient
 TR Menu -> Measurement View -> User
 USER Menu -> Measurement View -> Phase Noise
 USER Menu -> Measurement View -> Spectrum Monitor
 USER Menu -> Measurement View -> Freq & Power
 USER Menu -> Measurement View -> Transient
 USER Menu -> Measurement View -> User

:FORMat:BORDER

Syntax :FORMat:BORDER {NORMal|SWAPped}
 :FORMat:BORDER?

Description Sets/Reads byte order setting for binary transfer

Parameter

	Description
NORMal(Preset value)	Set byte order so that a byte containing MSB (Most Significant Bit) is transferred first
SWAPped	Set byte order so that a byte containing LSB (Least Significant Bit) is transferred first

Equivalent key No equivalent key is available on the front panel.

:FORMat:DATA

Syntax :FORMat:DATA {ASCii|REAL32|REAL64}
 :FORMat:DATA?

Description Sets/Reads data transfer mode

Parameter

	Description
ASCii(Preset value)	Set data transfer mode to 'ASCii'
REAL32	Set data transfer mode to 'IEEE 32 floating point binay'
REAL64	Set data transfer mode to 'IEEE 64 floating point binay'

Equivalent key No equivalent key is available on the front panel.

:HCOPy:ABORt

Syntax :HCOPy:ABORt

Description Aborts printing (No Query)

Equivalent key PN Menu -> System -> Abort Printing
SP Menu -> System -> Abort Printing
FP Menu -> System -> Abort Printing
TR Menu -> System -> Abort Printing
USER Menu -> System -> Abort Printing

:HCOPy:IMAGe

Syntax :HCOPy:IMAGe {NORMal|INVert}
:HCOPy:IMAGe?

Description Sets/Reads inverse color print mode

Parameter

	Description
NORMal(Preset value)	Set inverse color print mode to 'Off'
INVert	Set inverse color print mode to 'On'

Equivalent key PN Menu -> System -> Invert Image
SP Menu -> System -> Invert Image
FP Menu -> System -> Invert Image
TR Menu -> System -> Invert Image
USER Menu -> System -> Invert Image

:HCOPy:IMMEDIATE

Syntax :HCOPy:IMMEDIATE

Description Outputs print (No Query)

Equivalent key No equivalent key is available on the front panel.

*CLS

Syntax *CLS

Description Clears registers (No Query)

Equivalent key No equivalent key is available on the front panel.

*ESE

Syntax *ESE <numeric>
*ESE?

Description Sets/Reads standard event status enable register

Parameter

	<Numeric>
Range	0 to 255
Preset value	0
Unit	-
Resolution	-

Equivalent key No equivalent key is available on the front panel.

*ESR

Syntax *ESR

Description Reads standard event status register value (Query Only)

Equivalent key No equivalent key is available on the front panel.

*IDN

Syntax *IDN

Description Reads product model information (Query Only)

Equivalent key No equivalent key is available on the front panel.

*OPC

Syntax *OPC <numeric>
*OPC?

SCPI Command Reference
E5052A commands

Description Sets OPC bit or blocks the program manipulation until the end of measurement by querying the *OPC command from the program

NOTE To use this command, the setting of “:TRIGger:SOPC” on page 399 must be on. When this command is off, OPC bit is set immediately without waiting for the end of measurement with *OPC. *OPC? is also ignored.

Parameter

	<Numeric>
Range	-
Preset value	1
Unit	-
Resolution	-

Equivalent key No equivalent key is available on the front panel.

***OPT**

Syntax *OPT

Description Reads option information (Query Only)

Equivalent key No equivalent key is available on the front panel.

***RST**

Syntax *RST

Description Preset (No Query)

Equivalent key No equivalent key is available on the front panel.

***SRE**

Syntax *SRE <numeric>

*SRE?

Description Sets service request enable register

Parameter

	<Numeric>
Range	0 to 255

	<Numeric>
Preset value	0
Unit	-
Resolution	-

Equivalent key No equivalent key is available on the front panel.

***STB**

Syntax *STB

Description Reads status byte register (Query Only)

Equivalent key No equivalent key is available on the front panel.

***TRG**

Syntax *TRG

Description BUS Trigger (No Query)

Equivalent key No equivalent key is available on the front panel.

***WAI**

Syntax *WAI

Description Blocks the program manipulation until the end of measurement by receiving the *WAI command from the program

NOTE To use this command, the setting of “:TRIGger:SOPC” on page 399 must be on. When this command is off, *WAI is ignored.

Equivalent key No equivalent key is available on the front panel.

:INITiate:FP[1-1]:CONTinuous

Syntax :INITiate:FP[1-1]:CONTinuous {ON|OFF|1|0}
:INITiate:FP[1-1]:CONTinuous?

Description Sets/Reads the trigger continuous mode

Parameter

	Description
ON or 1	Set trigger continuous mode to 'ON'
OFF or 0(Preset value)	Set trigger continuous mode to 'OFF'

Equivalent key No equivalent key is available on the front panel.

:INITiate:FP[1-1]:IMMediate

Syntax :INITiate:FP[1-1]:IMMediate

Description Triggers once to frequency and power mode (No Query)

Equivalent key No equivalent key is available on the front panel.

:INITiate:PN[1-1]:CONTInuous

Syntax :INITiate:PN[1-1]:CONTInuous {ON|OFF|1|0}

:INITiate:PN[1-1]:CONTInuous?

Description Sets/readsa the trigger continuous mode

Parameter

	Description
ON or 1	Set trigger continuous mode to 'ON'
OFF or 0(Preset value)	Set trigger continuous mode to 'OFF'

Equivalent key No equivalent key is available on the front panel.

:INITiate:PN[1-1]:IMMediate

Syntax :INITiate:PN[1-1]:IMMediate

Description Triggers once to phase noise measurement mode (No Query)

Equivalent key No equivalent key is available on the front panel.

:INITiate:SP[1-1]:CONTInuous

Syntax :INITiate:SP[1-1]:CONTInuous {ON|OFF|1|0}

:INITiate:SP[1-1]:CONTInuous?

Description Sets/Reads trigger continuous mode

Parameter

	Description
ON or 1	Set trigger continuous mode to 'ON'
OFF or 0(Preset value)	Set trigger continuous mode to 'OFF'

Equivalent key No equivalent key is available on the front panel.

:INITiate:SP[1-1]:IMMediate

Syntax :INITiate:SP[1-1]:IMMediate

Description Triggers once to spectrum monitor mode (No Query)

Equivalent key No equivalent key is available on the front panel.

:INITiate:TR[1-1]:CONTinuous

Syntax :INITiate:TR[1-1]:CONTinuous {ON|OFF|1|0}

:INITiate:TR[1-1]:CONTinuous?

Description Sets/Reads trigger continuous mode

Parameter

	Description
ON or 1	Set trigger continuous mode to 'ON'
OFF or 0(Preset value)	Set trigger continuous mode to 'OFF'

Equivalent key No equivalent key is available on the front panel.

:INITiate:TR[1-1]:IMMediate

Syntax :INITiate:TR[1-1]:IMMediate

Description Triggers once to transient measurement (No Query)

Equivalent key No equivalent key is available on the front panel.

:MMEMory:CATalog

Syntax :MMEMory:CATalog

Description List file.folder name of the current directory (Query Only)

Equivalent key No equivalent key is available on the front panel.

:MMEMory:COPY

Syntax :MMEMory:COPY <String 1>,<String 2>

Description Copies file (No Query)

Parameter

	<String 1>
Range	-
Preset value	-
Unit	-
Resolution	-

	<String 2>
Range	-
Preset value	-
Unit	-
Resolution	-

Equivalent key No equivalent key is available on the front panel.

:MMEMory:DATA

Syntax :MMEMory:DATA <String 1>,<block>

:MMEMory:DATA?

Description File transfer through SCPI
The data transfer format when this command is executed depends on the setting with the :FORMat:DATAcommand.

Parameter

	<String 1>
Range	-
Preset value	-
Unit	-

	<String 1>
Resolution	-

	block
Range	-
Preset value	-
Unit	-
Resolution	-

Equivalent key No equivalent key is available on the front panel.

:MMEMory:DELeTe

Syntax :MMEMory:DELeTe <String>

Description Deletes file/directory (No Query)

Parameter

	<String>
Range	-
Preset value	-
Unit	-
Resolution	-

Equivalent key No equivalent key is available on the front panel.

:MMEMory:FP[1-1]:TRACe[1-4]:LOAD:LIMit:LOWer

Syntax :MMEMory:FP[1-1]:TRACe[1-4]:LOAD:LIMit:LOWer <String>

Description Reads the lower limit line (No Query)

Parameter

	<String>
Range	-
Preset value	-
Unit	-

	<String>
Resolution	-

Equivalent key FP Menu -> Display -> Limit Test -> Import Lower Limit Line...

:MMEMory:FP[1-1]:TRACe[1-4]:LOAD:LIMit:UPPer

Syntax :MMEMory:FP[1-1]:TRACe[1-4]:LOAD:LIMit:UPPer <String>

Description Reads the upper limit line (No Query)

Parameter

	<String>
Range	-
Preset value	-
Unit	-
Resolution	-

Equivalent key FP Menu -> Display -> Limit Test -> Import Upper Limit Line...

:MMEMory:FP[1-1]:TRACe[1-4]:STORE[:DATA]

Syntax :MMEMory:FP[1-1]:TRACe[1-4]:STORE[:DATA] <String>

Description Saves trace data (No Query)

Parameter

	<String>
Range	-
Preset value	-
Unit	-
Resolution	-

Equivalent key No equivalent key is available on the front panel.

:MMEMory:FP[1-1]:TRACe[1-4]:STORE:MEMory

Syntax :MMEMory:FP[1-1]:TRACe[1-4]:STORE:MEMory <String>

Description Saves memory trace data (No Query)

Parameter

	<String>
Range	-
Preset value	-
Unit	-
Resolution	-

Equivalent key

No equivalent key is available on the front panel.

:MMEMory:LOAD:CORRection:POWer

Syntax

:MMEMory:LOAD:CORRection:POWer <String>

Description

Loads correction data for a specified power (No Query)

Parameter

	<String>
Range	-
Preset value	-
Unit	-
Resolution	-

Equivalent key

PN Menu -> System -> Instrument Setup -> Correction -> Import Power Correction Table
 SP Menu -> System -> Instrument Setup -> Correction -> Import Power Correction Table
 FP Menu -> System -> Instrument Setup -> Correction -> Import Power Correction Table
 TR Menu -> System -> Instrument Setup -> Correction -> Import Power Correction Table
 USER Menu -> System -> Instrument Setup -> Correction -> Import Power Correction Table
 PN Menu -> System -> Instrument Setup -> Correction -> File Dialog ...
 SP Menu -> System -> Instrument Setup -> Correction -> File Dialog ...
 FP Menu -> System -> Instrument Setup -> Correction -> File Dialog ...
 TR Menu -> System -> Instrument Setup -> Correction -> File Dialog ...
 USER Menu -> System -> Instrument Setup -> Correction -> File Dialog ...

:MMEMory:LOAD:PROGram

Syntax

:MMEMory:LOAD:PROGram <String>

Description Loads VBA project/module (No Query)

Parameter

	<String>
Range	-
Preset value	-
Unit	-
Resolution	-

Equivalent key No equivalent key is available on the front panel.

:MMEMory:LOAD:STATe

Syntax :MMEMory:LOAD:STATe <String>

Description Recalls settings (No Query)

Parameter

	<String>
Range	-
Preset value	-
Unit	-
Resolution	-

Equivalent key No equivalent key is available on the front panel.

:MMEMory:MDIRectory

Syntax :MMEMory:MDIRectory <String>

Description Creates a directory (No Query)

Parameter

	<String>
Range	-
Preset value	-
Unit	-
Resolution	-

Equivalent key No equivalent key is available on the front panel.

:MMEMory:PN[1-1]:TRACe[1-1]:LOAD:LIMit:LOWer

Syntax :MMEMory:PN[1-1]:TRACe[1-1]:LOAD:LIMit:LOWer <String>

Description Reads the lower limit line (No Query)

Parameter

	<String>
Range	-
Preset value	-
Unit	-
Resolution	-

Equivalent key PN Menu -> Display -> Limit Test -> Import Lower Limit Line...

:MMEMory:PN[1-1]:TRACe[1-1]:LOAD:LIMit:UPPer

Syntax :MMEMory:PN[1-1]:TRACe[1-1]:LOAD:LIMit:UPPer <String>

Description Reads the upper limit line (No Query)

Parameter

	<String>
Range	-
Preset value	-
Unit	-
Resolution	-

Equivalent key PN Menu -> Display -> Limit Test -> Import Upper Limit Line...

:MMEMory:PN[1-1]:TRACe[1-1]:LOAD:SPURious:THReshold

Syntax :MMEMory:PN[1-1]:TRACe[1-1]:LOAD:SPURious:THReshold <String>

Description Reads the threshold data (No Query)

Parameter

	<String>
Range	-
Preset value	-
Unit	-
Resolution	-

Equivalent key

PN Menu -> Trace View -> Spurious -> Import Threshold Table...

:MMEMory:PN[1-1]:TRACe[1-1]:STORe[:DATA]

Syntax

:MMEMory:PN[1-1]:TRACe[1-1]:STORe[:DATA] <String>

Description

Saves trace data (No Query)

Parameter

	<String>
Range	-
Preset value	-
Unit	-
Resolution	-

Equivalent key

No equivalent key is available on the front panel.

:MMEMory:PN[1-1]:TRACe[1-1]:STORe:MEMory

Syntax

:MMEMory:PN[1-1]:TRACe[1-1]:STORe:MEMory <String>

Description

Saves memory trace data (No Query)

Parameter

	<String>
Range	-
Preset value	-
Unit	-
Resolution	-

Equivalent key

No equivalent key is available on the front panel.

:MMEMory:SP[1-1]:TRACe[1-1]:LOAD:LIMit:LOWer

Syntax :MMEMory:SP[1-1]:TRACe[1-1]:LOAD:LIMit:LOWer <String>

Description Reads the lower limit line (No Query)

Parameter

	<String>
Range	-
Preset value	-
Unit	-
Resolution	-

Equivalent key SP Menu -> Display -> Limit Test -> Import Lower Limit Line...

:MMEMory:SP[1-1]:TRACe[1-1]:LOAD:LIMit:UPPer

Syntax :MMEMory:SP[1-1]:TRACe[1-1]:LOAD:LIMit:UPPer <String>

Description Reads the upper limit line (No Query)

Parameter

	<String>
Range	-
Preset value	-
Unit	-
Resolution	-

Equivalent key SP Menu -> Display -> Limit Test -> Import Upper Limit Line...

:MMEMory:SP[1-1]:TRACe[1-1]:STORE[:DATA]

Syntax :MMEMory:SP[1-1]:TRACe[1-1]:STORE[:DATA] <String>

Description Saves trace data (No Query)

Parameter

	<String>
Range	-

	<String>
Preset value	-
Unit	-
Resolution	-

Equivalent key No equivalent key is available on the front panel.

:MMEMory:SP[1-1]:TRACe[1-1]:STORE:MEMory

Syntax :MMEMory:SP[1-1]:TRACe[1-1]:STORE:MEMory <String>

Description Saves memory trace data (No Query)

Parameter

	<String>
Range	-
Preset value	-
Unit	-
Resolution	-

Equivalent key No equivalent key is available on the front panel.

:MMEMory:STORE:IMAGe

Syntax :MMEMory:STORE:IMAGe <String>

Description Saves screen image (No Query)

Parameter

	<String>
Range	-
Preset value	-
Unit	-
Resolution	-

Equivalent key No equivalent key is available on the front panel.

:MMEMory:STORe:PROGram

Syntax :MMEMory:STORe:PROGram <String>

Description Saves VBA project (No Query)

Parameter

	<String>
Range	-
Preset value	-
Unit	-
Resolution	-

Equivalent key No equivalent key is available on the front panel.

:MMEMory:STORe:STATe

Syntax :MMEMory:STORe:STATe <String>

Description Saves settings (No Query)

Parameter

	<String>
Range	-
Preset value	-
Unit	-
Resolution	-

Equivalent key No equivalent key is available on the front panel.

:MMEMory:STORe:STYPe

Syntax :MMEMory:STORe:STYPe {STAT|DST}
:MMEMory:STORe:STYPe?

Description Selects save state type

Parameter

	Description
STAT(Preset value)	Set save state type to 'State Only'
DST	Set save state type to 'State & Data'

Equivalent key

PN Menu -> Save/Recall -> Save State -> Save Type
 SP Menu -> Save/Recall -> Save State -> Save Type
 FP Menu -> Save/Recall -> Save State -> Save Type
 TR Menu -> Save/Recall -> Save State -> Save Type
 USER Menu -> Save/Recall -> Save State -> Save Type

:MMEMory:TR[1-1]:TRACe[1-4]:LOAD:LIMit:LOWer

Syntax

:MMEMory:TR[1-1]:TRACe[1-4]:LOAD:LIMit:LOWer <String>

Description

Reads the lower limit line (No Query)

Parameter

	<String>
Range	-
Preset value	-
Unit	-
Resolution	-

Equivalent key

TR Menu -> Display -> Limit Test -> Import Lower Limit Line...

:MMEMory:TR[1-1]:TRACe[1-4]:LOAD:LIMit:UPPer

Syntax

:MMEMory:TR[1-1]:TRACe[1-4]:LOAD:LIMit:UPPer <String>

Description

Reads the upper limit line (No Query)

Parameter

	<String>
Range	-
Preset value	-
Unit	-

	<String>
Resolution	-

Equivalent key TR Menu -> Display -> Limit Test -> Import Upper Limit Line...

:MMEMory:TR[1-1]:TRACe[1-4]:STORE[:DATA]

Syntax :MMEMory:TR[1-1]:TRACe[1-4]:STORE[:DATA] <String>

Description Saves trace data (No Query)

Parameter

	<String>
Range	-
Preset value	-
Unit	-
Resolution	-

Equivalent key No equivalent key is available on the front panel.

:MMEMory:TR[1-1]:TRACe[1-4]:STORE:MEMory

Syntax :MMEMory:TR[1-1]:TRACe[1-4]:STORE:MEMory <String>

Description Saves memory trace data (No Query)

Parameter

	<String>
Range	-
Preset value	-
Unit	-
Resolution	-

Equivalent key No equivalent key is available on the front panel.

:MMEMory:USER[1-1]:TRACe[1-8]:LOAD:LIMit:LOWer

Syntax :MMEMory:USER[1-1]:TRACe[1-8]:LOAD:LIMit:LOWer <String>

Description Reads the lower limit line (No Query)

Parameter

	<String>
Range	-
Preset value	-
Unit	-
Resolution	-

Equivalent key

USER Menu -> Display -> Limit Test -> Import Lower Limit Line...

:MMEMory:USER[1-1]:TRACe[1-8]:LOAD:LIMit:UPPer

Syntax

:MMEMory:USER[1-1]:TRACe[1-8]:LOAD:LIMit:UPPer <String>

Description

Reads the upper limit line (No Query)

Parameter

	<String>
Range	-
Preset value	-
Unit	-
Resolution	-

Equivalent key

USER Menu -> Display -> Limit Test -> Import Upper Limit Line...

:MMEMory:USER[1-1]:TRACe[1-8]:STORE[:DATA]

Syntax

:MMEMory:USER[1-1]:TRACe[1-8]:STORE[:DATA] <String>

Description

Saves selected trace data (No Query)

Parameter

	<String>
Range	-
Preset value	-
Unit	-
Resolution	-

Equivalent key

No equivalent key is available on the front panel.

:MMEMory:USER[1-1]:TRACe[1-8]:STORe:MEMory

Syntax :MMEMory:USER[1-1]:TRACe[1-8]:STORe:MEMory <String>

Description Saves selected memory trace data (No Query)

Parameter

	<String>
Range	-
Preset value	-
Unit	-
Resolution	-

Equivalent key No equivalent key is available on the front panel.

:PROGram:CATalog

Syntax :PROGram:CATalog

Description List all the executable macro (Query Only)

Equivalent key No equivalent key is available on the front panel.

:PROGram:COM:EVENT

Syntax :PROGram:COM:EVENT {ON|OFF|1|0}

:PROGram:COM:EVENT?

Description Turns on/off the E5052 VBA event callback function

Parameter

	Description
ON or 1	Enable E5052 VBA event callback function
OFF or 0(Preset value)	Disable E5052 VBA event callback function

Equivalent key
 PN Menu -> Macro Setup -> E5052 Event
 SP Menu -> Macro Setup -> E5052 Event
 FP Menu -> Macro Setup -> E5052 Event
 TR Menu -> Macro Setup -> E5052 Event
 USER Menu -> Macro Setup -> E5052 Event

:PROGram:SElected:NAME

Syntax :PROGram:SElected:NAME <String>
:PROGram:SElected:NAME?

Description Sets/Reads the name of the program to be selected

Parameter

	<String>
Range	-
Preset value	"E5052.Module1.Main"
Unit	-
Resolution	-

Equivalent key No equivalent key is available on the front panel.

:PROGram:SElected:STATe

Syntax :PROGram:SElected:STATe {STOP|RUN}
:PROGram:SElected:STATe?

Description Runs/stops a specified macro program

Parameter

	Description
STOP(Preset value)	Stops the macro program
RUN	Runs the macro program

Equivalent key No equivalent key is available on the front panel.

:PROGram:SKEY:ITEM[1-8]:ENABLE

Syntax :PROGram:SKEY:ITEM[1-8]:ENABLE {ON|OFF|1|0}
:PROGram:SKEY:ITEM[1-8]:ENABLE?

Description Turns on/off user defined softkey function

Parameter

	Description
ON or 1	Enable user defined softkey function
OFF or 0(Preset value)	Disable user defined softkey function

Equivalent key No equivalent key is available on the front panel.

:PROGram:SKEY:ITEM[1-8]:IMMediate

Syntax :PROGram:SKEY:ITEM[1-8]:IMMediate

Description Executes the macro assigned under the user defined softkey (No Query)

Equivalent key PN Menu -> Macro Setup -> User Menu -> User Label 1
 SP Menu -> Macro Setup -> User Menu -> User Label 1
 FP Menu -> Macro Setup -> User Menu -> User Label 1
 TR Menu -> Macro Setup -> User Menu -> User Label 1
 USER Menu -> Macro Setup -> User Menu -> User Label 1

:PROGram:SKEY:ITEM[1-8]:LABel

Syntax :PROGram:SKEY:ITEM[1-8]:LABel <String>

:PROGram:SKEY:ITEM[1-8]:LABel?

Description Sets/Reads the user defined softkey label

Parameter

	<String>
Range	30 chars
Preset value	"User Label 1"
Unit	-
Resolution	-

Equivalent key No equivalent key is available on the front panel.

:PROGram:VARiable:ARRay[1-10]:DATA

Syntax :PROGram:VARiable:ARRay[1-10]:DATA <array>

:PROGram:VARiable:ARRay[1-10]:DATA?

Description User defined array data

Parameter

	<Description>
Range	1...1601
Preset value	-
Unit	-
Resolution	-

Equivalent key No equivalent key is available on the front panel.

:PROGram:VARiable:ARRay[1-10]:POINts

Syntax :PROGram:VARiable:ARRay[1-10]:POINts <numeric>

:PROGram:VARiable:ARRay[1-10]:POINts?

Description # of points of user defined array

Parameter

	<Numeric>
Range	2 to 1601
Preset value	1601
Unit	-
Resolution	-

Equivalent key No equivalent key is available on the front panel.

:PROGram:VARiable:DOUBle[1-10]

Syntax :PROGram:VARiable:DOUBle[1-10] <numeric>

:PROGram:VARiable:DOUBle[1-10]?

Description User defined 64bit floating variable

Parameter

	<Numeric>
Range	-
Preset value	-

	<Numeric>
Unit	-
Resolution	-

Equivalent key No equivalent key is available on the front panel.

:PROGram:VARiable:INTeger[1-10]

Syntax :PROGram:VARiable:INTeger[1-10] <numeric>
:PROGram:VARiable:INTeger[1-10]?

Description User defined integer variable

Parameter

	<Numeric>
Range	-
Preset value	-
Unit	-
Resolution	-

Equivalent key No equivalent key is available on the front panel.

:PROGram:VARiable:STRing[1-10]

Syntax :PROGram:VARiable:STRing[1-10] <String>
:PROGram:VARiable:STRing[1-10]?

Description User defined string

Parameter

	<String>
Range	-
Preset value	-
Unit	-
Resolution	-

Equivalent key No equivalent key is available on the front panel.

:SENSe:ATTenuation:LEVel

Syntax :SENSe:ATTenuation:LEVel <numeric>
:SENSe:ATTenuation:LEVel?

Description Sets/Reads the input attenuator level

Parameter **When the E5052A is used stand-alone, or with the downconverter turned off, or with the downconverter on and the RF input is set to 'E5052A Direct'**

	<Description>
Range	0 to 35
Preset value	5
Unit	dB
Resolution	5

When the downconverter is turned on and the RF input is set to 'Downconverter'

	<Description>
Range	10
Preset value	10
Unit	dB
Resolution	-

Equivalent key PN Menu -> Attenuator -> Input Attenuator
SP Menu -> Attenuator -> Input Attenuator
FP Menu -> Attenuator -> Input Attenuator
TR Menu -> Attenuator -> Input Attenuator
USER Menu -> Attenuator -> Input Attenuator

:SENSe:CORRection:POWer:DATA

Syntax :SENSe:CORRection:POWer:DATA <array>
:SENSe:CORRection:POWer:DATA?

Description Sets/Reads the frequency where the correction is performed and the correction values

Parameter

	<Description>
Range	1...2002

	<Description>
Preset value	-
Unit	-
Resolution	-

Equivalent key No equivalent key is available on the front panel.

:SENSe:CORRection:POWer:STATe

Syntax :SENSe:CORRection:POWer:STATe {ON|OFF|1|0}
:SENSe:CORRection:POWer:STATe?

Description Sets user the user calibration on or off or reads its setting

Parameter

	<Description>
ON or 1	User calibration 'ON'
OFF or 0 (Preset value)	User calibration 'OFF'

Equivalent key PN Menu -> System -> Instrument Setup -> Correction -> PowerCorrection
SP Menu -> System -> Instrument Setup -> Correction -> PowerCorrection
FP Menu -> System -> Instrument Setup -> Correction -> PowerCorrection
TR Menu -> System -> Instrument Setup -> Correction -> PowerCorrection
USER Menu -> System -> Instrument Setup -> Correction -> Power Correction

:SENSe:DCONverter:IDN

Syntax :SENSe:DCONverter:IDN?

Description Reads product information of the downconverter (Query only)

Equivalent key No equivalent key is available on the front panel.

:SENSe:DCONverter:INPut

Syntax :SENSe:DCONverter:INPut {DCONverter|DIRect}
:SENSe:DCONverter:INPut?

Description Sets/Reads the signal supplied to the RF input port

Parameter

	<Description>
DCONverter (Preset value)	Sets the input port to 'Downconverter'
DIRect	Sets the input port to 'E5052A Direct'

Equivalent key

PN Menu -> Input Port -> Downconverter -> RF Input
 SP Menu -> Input Port -> Downconverter -> RF Input
 FP Menu -> Input Port -> Downconverter -> RF Input
 TR Menu -> Input Port -> Downconverter -> RF Input
 USER Menu -> Input Port -> Downconverter -> RF Input

:SENSe:DCONverter:MANual:CALCulate:LO?

Syntax

:SENSe:DCONverter:MANual:CALCulate:LO? <numeric 1>, <numeric 2>

Description

Reads LO frequency of CH1 and CH2 such that appropriate IF frequency can be obtained (Query Only)

NOTE

LO frequencies are not input to the E5052A automatically. It is necessary to set the two returned frequencies to LO1 and LO2 independently when performing measurement in the phase noise measurement mode.

Parameter

	<Numeric 1>
Description	Harmonic number
Range	1 to 34
Preset value	-
Unit	-
Resolution	-

	<Numeric 2>
Description	Input signal frequency
Range	3 G to 327 G
Preset value	-
Unit	-
Resolution	-

Examples

```

10 INTEGER Harmonic
20 REAL In_freq
30 REAL Lo1,Lo2
40!
50 Harmonic=5          ! harmonic    : 5
60 In_freq=1.00E+8    ! IF frequency : 100 MHz
70!
80 OUTPUT 717;":SENSe:DCONverter:MANual:CALCulate:LO? ";Harmonic,In_freq
90 ENTER 717;Lo1,Lo2
100 END

```

Equivalent key No equivalent key is available on the front panel.

:SENSe:DCONverter:MANual:IFDelta

Syntax
:SENSe:DCONverter:MANual:IFDelta <numeric>
:SENSe:DCONverter:MANual:IFDelta?

Description Sets/Reads the differential frequency between CH1 and CH2 from the external mixer

Parameter

	<Description>
Range	-1G to 1G
Preset value	0
Unit	Hz
Resolution	1

Equivalent key

PN Menu -> System -> Instrument Setup -> Downconverter Manual Setup -> $\Delta IF = IF2 - IF1$

SP Menu -> System -> Instrument Setup -> Downconverter Manual Setup -> $\Delta IF = IF2 - IF1$

FP Menu -> System -> Instrument Setup -> Downconverter Manual Setup -> $\Delta IF = IF2 - IF1$

TR Menu -> System -> Instrument Setup -> Downconverter Manual Setup -> $\Delta IF = IF2 - IF1$

USER Menu -> System -> Instrument Setup -> Downconverter Manual Setup -> $\Delta IF = IF2 - IF1$

:SENSe:DCONverter:MANual:IFGain[1-2]

Syntax
:SENSe:DCONverter:MANual:IFGain[1-2] <numeric>
:SENSe:DCONverter:MANual:IFGain[1-2]?

Description Sets/Reads the IF gain of the external mixer

Parameter

	<Description>
Range	0 to 40
Preset value	0
Unit	dB
Resolution	1

Equivalent key

PN Menu -> System -> Instrument Setup -> Downconverter Manual Setup -> IF Gain 1
 SP Menu -> System -> Instrument Setup -> Downconverter Manual Setup -> IF Gain 1
 FP Menu -> System -> Instrument Setup -> Downconverter Manual Setup -> IF Gain 1
 TR Menu -> System -> Instrument Setup -> Downconverter Manual Setup -> IF Gain 1
 USER Menu -> System -> Instrument Setup -> Downconverter Manual Setup -> IF Gain 1

:SENSE:DCONverter:MANual:LO[1-2]:FREQUENCY

Syntax

:SENSe:DCONverter:MANual:LO[1-2]:FREQUENCY <numeric>
 :SENSe:DCONverter:MANual:LO[1-2]:FREQUENCY?

Description

Sets/Reads the LO frequency of the external mixer

Parameter

	<Description>
Range	2.975G to 10.025G
Preset value	2.975G
Unit	Hz
Resolution	50M

Equivalent key

PN Menu -> System -> Instrument Setup -> Downconverter Manual Setup -> LO1 Frequency
 SP Menu -> System -> Instrument Setup -> Downconverter Manual Setup -> LO1 Frequency
 FP Menu -> System -> Instrument Setup -> Downconverter Manual Setup -> LO1 Frequency
 TR Menu -> System -> Instrument Setup -> Downconverter Manual Setup -> LO1 Frequency
 USER Menu -> System -> Instrument Setup -> Downconverter Manual Setup -> LO1 Frequency

:SENSe:DCONverter:MANual:LO[1-2]:LEVel

Syntax :SENSe:DCONverter:MANual:LO[1-2]:LEVel <numeric>
:SENSe:DCONverter:MANual:LO[1-2]:LEVel?

Description Sets/Reads the LO level of the external mixer

Parameter **When LO of the external mixer is between 2.975GHz and 6GHz**

	<Description>
Range	10 to 16
Preset value	10
Unit	dBm
Resolution	0.1

When LO of the external mixer is between 6GHz and 10.0256GHz

	<Description>
Range	10
Preset value	10
Unit	dBm
Resolution	-

Equivalent key PN Menu -> System -> Instrument Setup -> Downconverter Manual Setup -> LO1 Level
SP Menu -> System -> Instrument Setup -> Downconverter Manual Setup -> LO1 Level
FP Menu -> System -> Instrument Setup -> Downconverter Manual Setup -> LO1 Level
TR Menu -> System -> Instrument Setup -> Downconverter Manual Setup -> LO1 Level
USER Menu -> System -> Instrument Setup -> Downconverter Manual Setup -> LO1 Level

:SENSe:DCONverter:MANual:MEXTernal[1-2]:BIAS:CURRent

Syntax :SENSe:DCONverter:MANual:MEXTernal[1-2]:BIAS:CURRent <numeric>
:SENSe:DCONverter:MANual:MEXTernal[1-2]:BIAS:CURRent?

Description Sets/Reads the bias current to be supplied to the external mixer

Parameter

	<Description>
Range	-10m to 10m
Preset value	0
Unit	A
Resolution	10u

Equivalent key

PN Menu -> System -> Instrument Setup -> Downconverter Manual Setup -> Current
 SP Menu -> System -> Instrument Setup -> Downconverter Manual Setup -> Current
 FP Menu -> System -> Instrument Setup -> Downconverter Manual Setup -> Current
 TR Menu -> System -> Instrument Setup -> Downconverter Manual Setup -> Current
 USER Menu -> System -> Instrument Setup -> Downconverter Manual Setup -> Current

:SENSE:DCONverter:MANual:MEXTernal[1-2]:BIAS:STATe

Syntax

:SENSE:DCONverter:MANual:MEXTernal[1-2]:BIAS:STATe {ON|OFF|1|0}
 :SENSE:DCONverter:MANual:MEXTernal[1-2]:BIAS:STATe?

Description

Sets the bias current supplied to the external mixer on or off and read its settings

Parameter

	<Description>
ON or 1	Bias current 'ON'
OFF or 0 (Preset value)	Bias current 'OFF'

Equivalent key

PN Menu -> System -> Instrument Setup -> Downconverter Manual Setup -> Mixer1 Bias
 SP Menu -> System -> Instrument Setup -> Downconverter Manual Setup -> Mixer1 Bias
 FP Menu -> System -> Instrument Setup -> Downconverter Manual Setup -> Mixer1 Bias
 TR Menu -> System -> Instrument Setup -> Downconverter Manual Setup -> Mixer1 Bias
 USER Menu -> System -> Instrument Setup -> Downconverter Manual Setup -> Mixer1 Bias

:SENSE:DCONverter:MEXTernal

Syntax

:SENSE:DCONverter:MEXTernal {ON|OFF}
 :SENSE:DCONverter:MEXTernal?

Description Sets the use of the external mixer on or off and reads its settings

Parameter

	<Description>
ON	Use of the external mixer 'ON'
OFF (Preset value)	Use of the external mixer 'Not Used'

Equivalent key

PN Menu -> Input Port -> Downconverter -> External Mixer
 SP Menu -> Input Port -> Downconverter -> External Mixer
 FP Menu -> Input Port -> Downconverter -> External Mixer
 TR Menu -> Input Port -> Downconverter -> External Mixer
 USER Menu -> Input Port -> Downconverter -> External Mixer

:SENSe:DCONverter[:STATe]

Syntax

:SENSe:DCONverter[:STATe] {ON|OFF|1|0}
 :SENSe:DCONverter[:STATe]?

Description

Sets the use of the downconverter on or off and reads its setting

Parameter

	<Description>
ON or 1	Use of the downconverter 'ON'
OFF or 0 (Preset value)	Use of the downconverter 'OFF'

Equivalent key

PN Menu -> Input Port -> Downconverter -> Downconverter
 SP Menu -> Input Port -> Downconverter -> Downconverter
 FP Menu -> Input Port -> Downconverter -> Downconverter
 TR Menu -> Input Port -> Downconverter -> Downconverter
 USER Menu -> Input Port -> Downconverter -> Downconverter

:SENSe:FP[1-1]:AVERage:CLEar

Syntax

:SENSe:FP[1-1]:AVERage:CLEar

Description

Restarts averaging (No Query)

Equivalent key

FP Menu -> Average -> Averaging Restart

:SENSe:FP[1-1]:AVERage:COUNT

Syntax :SENSe:FP[1-1]:AVERage:COUNT <numeric>
:SENSe:FP[1-1]:AVERage:COUNT?

Description Sets/Reads averaging count

Parameter

	<Numeric>
Range	1 to 999
Preset value	16
Unit	-
Resolution	-

Equivalent key FP Menu -> Average -> Avg Factor

:SENSe:FP[1-1]:AVERage:STATE

Syntax :SENSe:FP[1-1]:AVERage:STATE {ON|OFF|1|0}
:SENSe:FP[1-1]:AVERage:STATE?

Description Turns on/off averaging function

Parameter

	Description
ON or 1	Enable averaging function
OFF or 0(Preset value)	Disable averaging function

Equivalent key FP Menu -> Average -> Averaging

:SENSe:FP[1-1]:DCONverter:FREQuency

Syntax :SENSe:FP[1-1]:DCONverter:FREQuency <numeric>
:SENSe:FP[1-1]:DCONverter:FREQuency?

Description Sets/Reads information on the frequency supplied to the downconverter.

Parameter

When the frequency band is 3G to 10GHz

	<Description>
Range	3G to 10G
Preset value	3G
Unit	Hz
Resolution	100m

When the frequency band is 9G to 26.5GHz

	<Description>
Range	9G to 26.5G
Preset value	9G
Unit	Hz
Resolution	100m

Equivalent Key

FP Menu -> Setup -> Nominal Frequency

:SENSe:FP[1-1]:DCONverter:SSEarch:EXECute

Syntax

:SENSe:FP[1-1]:DCONverter:SSEarch:EXECute

Description

Searches carrier signal and reflects the result to information on the input frequency of the downconverter. (No Query)

Equivalent Key

FP Menu -> Setup -> Carrier Search

:SENSe:FP[1-1]:FBAND

Syntax

:SENSe:FP[1-1]:FBAND {LOW|HIGH}
:SENSe:FP[1-1]:FBAND?

Description

Selects frequency band

Parameter

	Description
LOW	Set frequency band to 'LOW'
HIGH(Preset value)	Set frequency band to 'HIGH'

Equivalent key

FP Menu -> Setup -> Frequency Band

:SENSe:FP[1-1]:FREQuency:RESolution

Syntax :SENSe:FP[1-1]:FREQuency:RESolution {NARRow|MIDDLE|WIDE}
:SENSe:FP[1-1]:FREQuency:RESolution?

Description Sets/Reads frequency resolution

Parameter

	Description
NARRow	Set frequency resolution to 'NARRow'
MIDDLE	Set frequency resolution to 'MIDDLE'
WIDE(Preset value)	Set frequency resolution to 'WIDE'

Equivalent key FP Menu -> Setup -> Freq Resolution

:SENSe:FP[1-1]:POWer:INPut:LEVel:MAXimum

Syntax :SENSe:FP[1-1]:POWer:INPut:LEVel:MAXimum <numeric>
:SENSe:FP[1-1]:POWer:INPut:LEVel:MAXimum?

Description Sets/Reads the maximum input level of the downconverter in order to determine the IF Gain

Parameter

	<Description>
Range	-45 to 30
Preset value	0
Unit	dBm
Resolution	100m

Equivalent key FP Menu -> Setup -> Max Input Level

:SENSe:FP[1-1]:SWEep:DWELI

Syntax :SENSe:FP[1-1]:SWEep:DWELI <numeric>
:SENSe:FP[1-1]:SWEep:DWELI?

Description Sets/Reads the point delay value

Parameter

	<Numeric>
Range	0 to 1
Preset value	0
Unit	s
Resolution	100u

Equivalent key FP Menu -> Setup -> Point Delay

:SENSe:FP[1-1]:SWEep:TIME:DATA

Syntax :SENSe:FP[1-1]:SWEep:TIME:DATA

Description Reads the measurement time (Query Only)

Equivalent key No equivalent key is available on the front panel.

:SENSe:PN[1-1]:AVERage:CLEar

Syntax :SENSe:PN[1-1]:AVERage:CLEar

Description Averaging restart (No Query)

Equivalent key PN Menu -> Average -> Averaging Restart

:SENSe:PN[1-1]:AVERage:COUNT

Syntax :SENSe:PN[1-1]:AVERage:COUNT <numeric>

:SENSe:PN[1-1]:AVERage:COUNT?

Description average count

Parameter

	<Numeric>
Range	1 to 999
Preset value	16
Unit	-
Resolution	-

Equivalent key PN Menu -> Average -> Avg Factor

:SENSE:PN[1-1]:AVERage:STATE

Syntax :SENSE:PN[1-1]:AVERage:STATE {ON|OFF|1|0}
:SENSE:PN[1-1]:AVERage:STATE?

Description Turns on/off averaging mode

Parameter

	Description
ON or 1	Enable averaging function
OFF or 0(Preset value)	Disable averaging function

Equivalent key PN Menu -> Average -> Averaging

:SENSE:PN[1-1]:CORRelation:COUNT

Syntax :SENSE:PN[1-1]:CORRelation:COUNT <numeric>
:SENSE:PN[1-1]:CORRelation:COUNT?

Description Sets/Reads the number of correlation

Parameter

	<Numeric>
Range	1 to 10000 (standard) 1 (option 011, fixed value)
Preset value	1
Unit	-
Resolution	-

Equivalent key PN Menu -> Average -> Correlation *1

:SENSE:PN[1-1]:DCONverter:FREQuency

Syntax :SENSE:PN[1-1]:DCONverter:FREQuency <numeric>
:SENSE:PN[1-1]:DCONverter:FREQuency?

Description Sets/Reads the input frequency to be supplied to the downconverter

*1. The softkey is not available when option 011 is installed

Parameter

When the frequency band is 3G to 10GHz

	<Description>
Range	3G to 10G
Preset value	3G
Unit	Hz
Resolution	100m

When the frequency band is 9G to 26.5GHz

	<Description>
Range	9G to 26.5G
Preset value	9G
Unit	Hz
Resolution	100m

Equivalent key

PN Menu -> Setup -> Nominal Frequency

:SENSe:PN[1-1]:DCONverter:SSEarch:EXECute

Syntax

:SENSe:PN[1-1]:DCONverter:SSEarch:EXECute

Description

Searches carrier signal and reflects the result to the input frequency of the downconverter (No query)

Equivalent key

PN Menu -> Setup -> Carrier Search

:SENSe:PN[1-1]:EPRescaler:DIVision

Syntax

:SENSe:PN[1-1]:EPRescaler:DIVision <numeric>

:SENSe:PN[1-1]:EPRescaler:DIVision?

Description

Sets/Reads the external frequency dividing ratio of the input signal

Parameter

	<Numeric>
Description	Dividing ratio of the input signal
Range	1 2 4 8 16 32 64 128 256
Preset value	1
Unit	-

	<Numeric>
Resolution	-

Equivalent key PN Menu -> System -> Instrument Setup -> PN Ext. Prescaler -> Division

:SENSe:PN[1-1]:EPRescaler:POWer

Syntax :SENSe:PN[1-1]:EPRescaler:POWer <numeric>

:SENSe:PN[1-1]:EPRescaler:POWer?

Description Sets/Reads the output level of the frequency divider (input level to RF1 IN/RF2 of the E5052A)

Parameter

	<Numeric>
Description	Output level of the frequency divider
Range	-15 to 0
Preset value	0
Unit	dBm
Resolution	-

Equivalent key PN Menu -> System -> Instrument Setup -> PN Ext. Prescaler -> Output Power Level

:SENSe:PN[1-1]:FBANd

Syntax :SENSe:PN[1-1]:FBANd {BAND1|BAND2|BAND3|BAND4}

:SENSe:PN[1-1]:FBANd?

Description Sets/Reads frequency band

Parameter **When the E5052A is used stand-alone, or with the downconverter turned off**

	Description
BAND1	Set frequency band to '10M - 41MHz'
BAND2	Set frequency band to '39M - 101MHz'
BAND3	Set frequency band to '99M - 1.5GHz'
BAND4(Preset value)	Set frequency band to '300M - 7GHz'

When the downconverter is turned on and with the RF input is set to 'E5052A Direct'

	<Description>
BAND1	Set frequency band to '10M - 41MHz'
BAND2	Set frequency band to '39M - 101MHz'
BAND3	Set frequency band to '99M - 1.5GHz'
BAND4(Preset value)	Set frequency band to '300M - 3GHz'

When the downconverter is turned on and with the RF input is set to 'Downconverter'

	<Description>
BAND5(Preset value)	Set frequency band to '3G - 10GHz'
BAND6	Set frequency band to '9G - 26.5GHz'

Equivalent key PN Menu -> Setup -> Frequency Band

:SENSe:PN[1-1]:FREQuency:STARt

Syntax :SENSe:PN[1-1]:FREQuency:STARt <numeric>

:SENSe:PN[1-1]:FREQuency:STARt?

Description start frequency

Parameter

	<Numeric>
Range	1 10 100 1k (standard) 10 100 1k (option 011)
Preset value	1k
Unit	Hz
Resolution	-

Equivalent key PN Menu -> Start -> 1Hz^{*1}

PN Menu -> Start -> 10Hz

PN Menu -> Start -> 100Hz

PN Menu -> Start -> 1kHz

*1. 1 Hz start offset frequency is not available when option 011 is installed.

PN Menu -> Marker To -> Marker -> Start

:SENSe:PN[1-1]:FREQuency:STOP

Syntax :SENSe:PN[1-1]:FREQuency:STOP <numeric>
:SENSe:PN[1-1]:FREQuency:STOP?

Description stop frequency

Parameter

	<Numeric>
Range	100k 1M 5M 10M ^{*1} 20M ^{*1} 40M ^{*1}
Preset value	10M
Unit	Hz
Resolution	-

*1. This cannot be selected when the frequency range is Band 1 (10 M to 41 MHz).

Equivalent key PN Menu -> Stop -> 100kHz
PN Menu -> Stop -> 1MHz
PN Menu -> Stop -> 5MHz
PN Menu -> Stop -> 10MHz
PN Menu -> Stop -> 20MHz
PN Menu -> Stop -> 40MHz
PN Menu -> Marker To -> Marker -> Stop

:SENSe:PN[1-1]:IFGain

Syntax :SENSe:PN[1-1]:IFGain <numeric>
:SENSe:PN[1-1]:IFGain?

Description Sets/Reads IF Gain at 10dB steps

Parameter

	<Numeric>
Range	0 to 50 (standard) 10 (option 011, fixed value)
Preset Value	20 10 (option 011, fixed value)

	<Numeric>
Unit	dB
Resolution	10

Equivalent key PN Menu -> Setup -> IF Gain *1

:SENSe:PN[1-1]:LOBandwidth

Syntax :SENSe:PN[1-1]:LOBandwidth {NARRow|WIDE}
:SENSe:PN[1-1]:LOBandwidth?

Description Sets/readst phase noise Local bandwidth optimization.

Parameter

	Description
NARRow	Set phase noise Local bandwidth optimization to 'NARRow'
WIDE(Preset value)	Set phase noise Local bandwidth optimization to 'WIDE'

Equivalent key PN Menu -> Setup -> LO PhNoise Optimize

:SENSe:PN[1-1]:SEGTable[:MEASurement][:QUALity]

Syntax :SENSe:PN[1-1]:SEGTable[:MEASurement][:QUALity] {NORMal|FAST}
:SENSe:PN[1-1]:SEGTable[:MEASurement][:QUALity]?

Description Sets/Reads the quality level

Parameter

	Description
NORMal(Preset value)	Set the quality level to 'Normal'
FAST	Set the quality level to 'Fast'

Equivalent key PN Menu -> Setup -> Measurement Quality

:SENSe:PN[1-1]:SWEep:POINTs

Syntax :SENSe:PN[1-1]:SWEep:POINTs

*1. The value of IF Gain cannot be changed when option 011 is installed.

Description Reads the number of measurement points (Query Only)

Equivalent key No equivalent key is available on the front panel.

:SENSe:ROSCillator:SOURce

Syntax :SENSe:ROSCillator:SOURce

Description Reads source of reference oscillator (Query Only)

Equivalent key No equivalent key is available on the front panel.

:SENSe:SP[1-1]:AVERage:CLEar

Syntax :SENSe:SP[1-1]:AVERage:CLEar

Description Restarts averaging (No Query)

Equivalent key SP Menu -> Average/BW -> Averaging Restart

:SENSe:SP[1-1]:AVERage:COUNT

Syntax :SENSe:SP[1-1]:AVERage:COUNT <numeric>

:SENSe:SP[1-1]:AVERage:COUNT?

Description Sets/Reads the averaging count

Parameter

	<Numeric>
Range	1 to 999
Preset value	16
Unit	-
Resolution	-

Equivalent key SP Menu -> Average/BW -> Avg Factor

:SENSe:SP[1-1]:AVERage:STATe

Syntax :SENSe:SP[1-1]:AVERage:STATe {ON|OFF|1|0}

:SENSe:SP[1-1]:AVERage:STATe?

Description Turns on/off averaging function

Parameter

	Description
ON or 1	Enable averaging function
OFF or 0(Preset value)	Disable averaging function

Equivalent key

SP Menu -> Average/BW -> Averaging

:SENSe:SP[1-1]:AVERage:TYPE

Syntax

:SENSe:SP[1-1]:AVERage:TYPE {RMS|LOGarithmic}
:SENSe:SP[1-1]:AVERage:TYPE?

Description

Sets/Reads averaging type

Parameter

	Description
RMS	Set averaging type to 'RMS'
LOGarithmic(Preset value)	Set averaging type to 'LOGarithmic'

Equivalent key

SP Menu -> Average/BW -> Averaging Type

:SENSe:SP[1-1]:BANDwidth:RESolution

Syntax

:SENSe:SP[1-1]:BANDwidth:RESolution <numeric>
:SENSe:SP[1-1]:BANDwidth:RESolution?

Description

Sets/Reads RBW value

Parameter

	<Numeric>
Range	1.53 to 400k
Preset value	25k
Unit	Hz
Resolution	-

Equivalent key

SP Menu -> Average/BW -> RBW

:SENSE:SP[1-1]:CARRIER:FBAND

Syntax :SENSE:SP[1-1]:CARRIER:FBAND {LOW|HIGH}
:SENSE:SP[1-1]:CARRIER:FBAND?

Description Sets/Reads the carrier frequency band

Parameter **When the E5052A is used stand-alone, or with the downconverter turned off, or with the downconverter on and the RF input is set to 'E5052A Direct'**

	Description
LOW	Set the carrier frequency band to '10M - 1.5GHz'
HIGH(Preset value)	Set the carrier frequency band to '300M - 7GHz'

When the downconverter is turned on and the RF input is set to 'Downconverter'

	<Description>
BAND3(Preset value)	Set the carrier frequency band to '3G - 7GHz'
BAND4	Set the carrier frequency band to '9G - 26.5GHz'

Equivalent key SP Menu -> Start/Center -> Carrier To -> Frequency Band
SP Menu -> Stop/Span -> Carrier To -> Frequency Band

:SENSE:SP[1-1]:CARRIER:SET:CENTER

Syntax :SENSE:SP[1-1]:CARRIER:SET:CENTER <numeric>

Description Changes the center frequency to N times the carrier frequency (No Query)

Parameter

	<Numeric>
Range	1 to 20
Preset value	-
Unit	-
Resolution	1

Equivalent key SP Menu -> Start/Center -> Carrier To -> Carrier -> Center
SP Menu -> Start/Center -> Carrier To -> Carrier x2 -> Center
SP Menu -> Start/Center -> Carrier To -> Carrier x3 -> Center

SP Menu -> Start/Center -> Carrier To -> Carrier x# -> Center
 SP Menu -> Stop/Span -> Carrier To -> Carrier -> Center
 SP Menu -> Stop/Span -> Carrier To -> Carrier x2 -> Center
 SP Menu -> Stop/Span -> Carrier To -> Carrier x3 -> Center
 SP Menu -> Stop/Span -> Carrier To -> Carrier x# -> Center

:SENSe:SP[1-1]:DETECTOR:FUNCTION

Syntax :SENSe:SP[1-1]:DETECTOR:FUNCTION {POSitive|SAMPLE}
 :SENSe:SP[1-1]:DETECTOR:FUNCTION?

Description Sets/Reads detector mode

Parameter

	Description
POSitive(Preset value)	Set detector mode to 'POSitive'
SAMPLE	Set detector mode to 'SAMPLE'

Equivalent key SP Menu -> Format -> Detector Mode

:SENSe:SP[1-1]:FREQUENCY:CENTER

Syntax :SENSe:SP[1-1]:FREQUENCY:CENTER <numeric>
 :SENSe:SP[1-1]:FREQUENCY:CENTER?

Description Sets/Reads the center value of frequency span

Parameter

When the E5052A is used stand-alone, or with the downconverter turned off (Allowable setting range varies depending on whether the frequency offset is on or off, the LO frequency within the frequency offset, and the conversion mode used in the frequency offset)

	<Numeric>
Range	10M to 117G
Preset value	1G
Unit	Hz
Resolution	100m

When the downconverter is turned on and the RF input is set to 'E5052A Direct'(Allowable setting range varies depending on whether the frequency offset is on or off, the LO frequency within the frequency offset, and the conversion mode

used in the frequency offset)

	<Description>
Range	10M to 113G
Preset value	3G
Unit	Hz
Resolution	100m

When the downconverter is turned on and the RF input is set to 'Downconverter'

	<Description>
Range	3G to 26.5G
Preset value	3G
Unit	Hz
Resolution	100m

Equivalent key SP Menu -> Start/Center -> Center
 SP Menu -> Stop/Span -> Center
 SP Menu -> Marker To -> Marker -> Center

:SENSe:SP[1-1]:FREQuency:SPAN

Syntax :SENSe:SP[1-1]:FREQuency:SPAN <numeric>
 :SENSe:SP[1-1]:FREQuency:SPAN?

Description Sets/Reads the span value of frequency span

Parameter **When the E5052A is used stand-alone, or with the downconverter turned off, or with the downconverter on and the RF input is set to 'E5052A Direct'(Allowable setting range varies depending on whether the frequency offset is on or off , the LO frequency within the frequency offset, and the conversion mode used in the frequency offset)**

	<Numeric>
Range	100 to 15M
Preset value	15M
Unit	Hz
Resolution	200m

Equivalent key SP Menu -> Start/Center -> Span
 SP Menu -> Stop/Span -> Span

:SENSe:SP[1-1]:FREQuency:STARt

Syntax :SENSe:SP[1-1]:FREQuency:STARt <numeric>
:SENSe:SP[1-1]:FREQuency:STARt?

Description Sets/Reads the start value of frequency span

Parameter **When the E5052A is used stand-alone, or with the downconverter turned off (Allowable setting range varies depending on whether the frequency offset is on or off, the LO frequency within the frequency offset, and the conversion mode used in the frequency offset)**

	<Numeric>
Range	9M to 116.99999995G
Preset value	992.5M
Unit	Hz
Resolution	100m

When the downconverter is turned on and the RF input is set to 'E5052A Direct' RF (Allowable setting range varies depending on whether the frequency offset is on or off, the LO frequency within the frequency offset, and the conversion mode used in the frequency offset)

	<Description>
Range	9M to 112.99999995G
Preset value	2.9925G
Unit	Hz
Resolution	100m

When the downconverter is turned on and the RF input is set to 'Downconverter'

	<Description>
Range	2.9925G to 26.49999995G
Preset value	2.9925M
Unit	Hz
Resolution	100m

Equivalent key SP Menu -> Start/Center -> Start
SP Menu -> Stop/Span -> Start
SP Menu -> Marker To -> Marker -> Start

:SENSe:SP[1-1]:FREQuency:STOP

Syntax :SENSe:SP[1-1]:FREQuency:STOP <numeric>
:SENSe:SP[1-1]:FREQuency:STOP?

Description Sets/Reads the stop value of frequency span

Parameter **When the E5052A is used stand-alone, or with the downconverter turned off (Allowable setting range varies depending on whether the frequency offset is on or off, the LO frequency within the frequency offset, and the conversion mode used in the frequency offset)**

	<Numeric>
Range	10.00005M to 117.0075G
Preset value	1.0075G
Unit	Hz
Resolution	100m

When the downconverter is turned on and the RF input is set to 'E5052A Direct' (Allowable setting range varies depending on whether the frequency offset is on or off, the LO frequency within the frequency offset, and the conversion mode used in the frequency offset)

	<Description>
Range	10.00005M to 113.0075G
Preset value	3.0075G
Unit	Hz
Resolution	100m

When the downconverter is turned on and the RF input is set to 'Downconverter'

	<Description>
Range	3.00000005G to 26.5075G
Preset value	3.0075G
Unit	Hz
Resolution	100m

Equivalent key SP Menu -> Start/Center -> Stop
SP Menu -> Stop/Span -> Stop
SP Menu -> Marker To -> Marker -> Stop

:SENSe:SP[1-1]:POWer:RLEVel

Syntax :SENSe:SP[1-1]:POWer:RLEVel <numeric>
:SENSe:SP[1-1]:POWer:RLEVel?

Description Sets/Reads the reference level of frequency span

Parameter

	<Numeric>
Range	-45 to 30
Preset value	5
Unit	dBm
Resolution	5

Equivalent key SP Menu -> Setup -> Reference Level

:SENSe:SP[1-1]:SWEep:POINTs

Syntax :SENSe:SP[1-1]:SWEep:POINTs

Description Reads the number of measurement points (Query Only)

Equivalent key No equivalent key is available on the front panel.

:SENSe:TR[1-1]:AVERage:CLEar

Syntax :SENSe:TR[1-1]:AVERage:CLEar

Description Clears averaging (No Query)

Equivalent key TR Menu -> Average -> Averaging Restart

:SENSe:TR[1-1]:AVERage:COUNT

Syntax :SENSe:TR[1-1]:AVERage:COUNT <numeric>
:SENSe:TR[1-1]:AVERage:COUNT?

Description Sets/Reads averaging count

Parameter

	<Numeric>
Range	1 to 999

	<Numeric>
Preset value	16
Unit	-
Resolution	-

Equivalent key TR Menu -> Average -> Avg Factor

:SENSe:TR[1-1]:AVERAge:STATe

Syntax :SENSe:TR[1-1]:AVERAge:STATe {ON|OFF|1|0}

:SENSe:TR[1-1]:AVERAge:STATe?

Description Turns on/off averaging function

Parameter

	Description
ON or 1	Enable averaging function
OFF or 0(Preset value)	Disable averaging function

Equivalent key TR Menu -> Average -> Averaging

:SENSe:TR[1-1]:NARRow:FREQUency:PREFereNce

Syntax :SENSe:TR[1-1]:NARRow:FREQUency:PREFereNce <numeric>

:SENSe:TR[1-1]:NARRow:FREQUency:PREFereNce?

Description Sets/Reads phase reference frequency

Parameter

When the E5052A is used stand-alone, or with the downconverter turned off (Allowable setting range varies depending on whether the frequency offset is on or off, the LO frequency within the frequency offset, and the conversion mode used in the frequency offset)

	<Numeric>
Range	9.2M to 117.0128G
Preset value	1G
Unit	Hz
Resolution	-

When the downconverter is turned on and the RF input is set to 'E5052A

Direct'(Allowable setting range varies depending on whether the frequency offset is on or off, the LO frequency within the frequency offset, and the conversion mode used in the frequency offset)

	<Description>
Range	9.2M to 113.0128G
Preset value	3G
Unit	Hz
Resolution	100m

When the downconverter is turned on and the RF input is set to 'Downconverter'(Allowable setting range varies depending on the target frequency and frequency range of the narrow band mode)

	<Description>
Range	3G to 26.5128G
Preset value	3G
Unit	Hz
Resolution	100m

Equivalent key

TR Menu -> Setup -> Phase Reference

TR Menu -> Marker To -> Marker -> Phase Reference

:SENSe:TR[1-1]:NARRow:FREQuency:RANGe

Syntax

:SENSe:TR[1-1]:NARRow:FREQuency:RANGe {R25_6|R1_6|R0_2|R25K|R3K}

:SENSe:TR[1-1]:NARRow:FREQuency:RANGe?

Description

Sets/Reads frequency transient range in narrowband mode

Parameter

	Description
R25_6(Preset value)	Sets frequency span to 'R25_6' (25.6 MHz)
R1_6	Sets frequency span to 'R1_6' (1.6 MHz)
R0_2	Sets frequency span to 'R0_2' (200 kHz)
R25K	Sets frequency span to 'R25K' (25 kHz)
R3K	Sets frequency span to 'R3K' (3 kHz)

Equivalent key

TR Menu -> Setup -> Freq Range

:SENSe:TR[1-1]:NARRow:FREQuency:TARGet

Syntax :SENSe:TR[1-1]:NARRow:FREQuency:TARGet <numeric>
:SENSe:TR[1-1]:NARRow:FREQuency:TARGet?

Description Sets/Reads the target frequency for transient measurement

Parameter **When the E5052A is used stand-alone, or with the downconverter turned off (Allowable setting range varies depending on whether the frequency offset is on or off, the LO frequency within the frequency offset, and the conversion mode used in the frequency offset)**

	<Numeric>
Range	10M to 117G
Preset value	1G
Unit	Hz
Resolution	-

When the downconverter is turned on and the RF input is set to 'E5052A Direct'(Allowable setting range varies depending on whether the frequency offset is on or off, the LO frequency within the frequency offset, and the conversion mode used in the frequency offset)

	<Description>
Range	10M to 113G
Preset value	3G
Unit	Hz
Resolution	100m

When the downconverter is turned on and the RF input is set to 'Downconverter'

	<Description>
Range	3G to 26.5G
Preset value	3G
Unit	Hz
Resolution	100m

Equivalent key TR Menu -> Setup -> Target Freq
TR Menu -> Marker To -> Marker -> Target Freq

:SENSe:TR[1-1]:NARRow:SWEEp:POINts

- Syntax** :SENSe:TR[1-1]:NARRow:SWEEp:POINts
- Description** Reads the number of measurement points in the narrowband mode for transient measurement (Query Only)
- Equivalent key** No equivalent key is available on the front panel.

:SENSe:TR[1-1]:NARRow:TIME:OFFSet

- Syntax** :SENSe:TR[1-1]:NARRow:TIME:OFFSet <numeric>
:SENSe:TR[1-1]:NARRow:TIME:OFFSet?
- Description** Sets/Reads time offset(delay)
- Parameter**

	<Numeric>
Range	-80m to 1.1
Preset value	0
Unit	s
Resolution	10n

- Equivalent key** TR Menu -> Time Offset -> Narrow Time Offset
TR Menu -> Span -> Narrow Time Offset

:SENSe:TR[1-1]:NARRow:TIME:REFerence

- Syntax** :SENSe:TR[1-1]:NARRow:TIME:REFerence {LEFT|CENTer|RIGHT}
:SENSe:TR[1-1]:NARRow:TIME:REFerence?
- Description** Selects reference position for time span of transient measurement
- Parameter**

	Description
LEFT	Set reference position to 'LEFT'
CENTer(Preset value)	Set reference position to 'CENTER'
RIGHT	Set reference position to 'RIGHT'

- Equivalent key** TR Menu -> Time Offset -> Narrow Ref Position

TR Menu -> Span -> Narrow Ref Position

:SENSe:TR[1-1]:NARRow:TIME:SPAN

Syntax :SENSe:TR[1-1]:NARRow:TIME:SPAN <numeric>
:SENSe:TR[1-1]:NARRow:TIME:SPAN?

Description Sets/Reads time span

Parameter

	<Numeric>
Range	0 to 10.0096
Preset value	100m
Unit	s
Resolution	10n

Equivalent key TR Menu -> Time Offset -> Narrow Span
TR Menu -> Span -> Narrow Span

:SENSe:TR[1-1]:POWer:INPut:LEVel:MAXimum

Syntax :SENSe:TR[1-1]:POWer:INPut:LEVel:MAXimum <numeric>
:SENSe:TR[1-1]:POWer:INPut:LEVel:MAXimum?

Description Sets/Reads the maximum input level for transient measurement

Parameter

	<Numeric>
Range	-45 to 30
Preset value	0
Unit	dBm
Resolution	100m

Equivalent key TR Menu -> Setup -> Max Input Level

:SENSe:TR[1-1]:WIDE:FREQuency:MAXimum

Syntax :SENSe:TR[1-1]:WIDE:FREQuency:MAXimum <numeric>
:SENSe:TR[1-1]:WIDE:FREQuency:MAXimum?

Description Sets/Gets transient frequency range in the wideband mode

Parameter **When the E5052A is used stand-alone with the frequency offset is off, or with the downconverter tuened off and the frequency offset is off**

	<Numeric>
Range	150M 300M 600M 900M 1.2G 1.5G 1.8G 2.4G 3G 3.6G 4.2G 4.8G 5.4G 6G 6.6G 7.2G
Preset value	1.2G
Unit	Hz
Resolution	-

When the E5052A is used stand-alone with the frequency offset is on, or with the downconverter tuened off and the frequency offset is on (Allowable setting range varies depending on whether the LO frequency within the frequency offset, and the conversion mode used in the frequency offset)

	<Description>
Range	160M to 117G
Preset value	3.15G
Unit	Hz
Resolution	-

When the downconverter is turned on and the RF input is set to 'E5052A Direct' with the frequency offset is off

	<Description>
Range	150M 300M 600M 900M 1.2G 1.5G 1.8G 2.4G 3G
Preset value	3G
Unit	Hz
Resolution	-

When the downconverter is turned on and the RF input is set to 'E5052A Direct' with the frequency offset is on (Allowable setting range varies depending on whether the LO frequency within the frequency offset, and the conversion mode used in the frequency offset)

	<Description>
Range	160M to 113G
Preset value	3.15G
Unit	Hz

	<Description>
Resolution	-

When the downconverter is turned on and the RF input is set to 'Downconverter'

	<Description>
Range	3.5G to 26.5G
Preset value	3.5G
Unit	Hz
Resolution	100m

Equivalent key No equivalent key is available on the front panel.

:SENSe:TR[1-1]:WIDE:SWEep:POINTs

Syntax :SENSe:TR[1-1]:WIDE:SWEep:POINTs

Description Reads the number of measurement points in the wideband mode for transient measurement (Query Only)

Equivalent key No equivalent key is available on the front panel.

:SENSe:TR[1-1]:WIDE:TIME:OFFSet

Syntax :SENSe:TR[1-1]:WIDE:TIME:OFFSet <numeric>
:SENSe:TR[1-1]:WIDE:TIME:OFFSet?

Description offset for reference point

Parameter

	<Numeric>
Range	-80m to 1.1
Preset value	0
Unit	s
Resolution	10n

Equivalent key TR Menu -> Time Offset -> Wide Time Offset
TR Menu -> Span -> Wide Time Offset

:SENSe:TR[1-1]:WIDE:TIME:REFeRence

Syntax :SENSe:TR[1-1]:WIDE:TIME:REFeRence {LEFT|CENTer|RIGHt}
:SENSe:TR[1-1]:WIDE:TIME:REFeRence?

Description Selects reference position for time span

Parameter

	Description
LEFT	Set reference position to 'LEFT'
CENTer(Preset value)	Set reference position to 'CENTer'
RIGHt	Set reference position to 'RIGHt'

Equivalent key TR Menu -> Time Offset -> Wide Ref Position
TR Menu -> Span -> Wide Ref Position

:SENSe:TR[1-1]:WIDE:TIME:SPAN

Syntax :SENSe:TR[1-1]:WIDE:TIME:SPAN <numeric>
:SENSe:TR[1-1]:WIDE:TIME:SPAN?

Description Sets/Reads time span

Parameter

	<Numeric>
Range	0 to 10
Preset value	100m
Unit	s
Resolution	10n

Equivalent key TR Menu -> Time Offset -> Wide Span
TR Menu -> Span -> Wide Span

:SENSe:UDConverter:HARMonic

Syntax :SENSe:UDConverter:HARMonic <numeric>
:SENSe:UDConverter:HARMonic?

Description Sets/Reads the factor of the frequency offset

Parameter

	<Description>
Range	1 to 34
Preset value	1
Unit	-
Resolution	1

Equivalent key

PN Menu -> System -> Instrument Setup -> Frequency Offset (User Downconv.) -> Harmonic #

SP Menu -> System -> Instrument Setup -> Frequency Offset (User Downconv.) -> Harmonic #

FP Menu -> System -> Instrument Setup -> Frequency Offset (User Downconv.) -> Harmonic #

TR Menu -> System -> Instrument Setup -> Frequency Offset (User Downconv.) -> Harmonic #

USER Menu -> System -> Instrument Setup -> Frequency Offset (User Downconv.) -> Harmonic #

:SENSe:UDConverter:LO

Syntax

:SENSe:UDConverter:LO <numeric>

:SENSe:UDConverter:LO?

Description

Sets/Reads the LO frequency of the frequency offset

Maximum value which can be set is 330/Harmonic (GHz).

Parameter

When the conversion mode used in the frequency offset is $RF=N*LO+IF$ (Allowable setting range varies depending on the set value of Harmonic)

	<Description>
Range	10 M to 330 G
Preset value	3 G
Unit	Hz
Resolution	100 m

When the conversion mode used in the frequency offset is $RF=N*LO+IF$ (Allowable setting range varies depending on the set value of Harmonic)

	<Description>
Range	500 M to 330 G

	<Description>
Preset value	3 G
Unit	Hz
Resolution	100 m

Equivalent key
 PN Menu -> System -> Instrument Setup -> Frequency Offset (User Downconv.) -> LO Frequency
 SP Menu -> System -> Instrument Setup -> Frequency Offset (User Downconv.) -> LO Frequency
 FP Menu -> System -> Instrument Setup -> Frequency Offset (User Downconv.) -> LO Frequency
 TR Menu -> System -> Instrument Setup -> Frequency Offset (User Downconv.) -> LO Frequency
 USER Menu -> System -> Instrument Setup -> Frequency Offset (User Downconv.) -> LO Frequency

:SENSe:UDConverter:MODE

Syntax
 :SENSe:UDConverter:MODE {USB|LSB}
 :SENSe:UDConverter:MODE?

Description
 Sets/Reads the conversion mode of the frequency offset

Parameter

	<Description>
USB (Preset value)	Set frequency conversion to $RF = n * LO + IF$
LSB	Set frequency conversion to $RF = n * LO - IF$

Equivalent key
 PN Menu -> System -> Instrument Setup -> Frequency Offset (User Downconv.) -> Conversion Mode
 SP Menu -> System -> Instrument Setup -> Frequency Offset (User Downconv.) -> Conversion Mode
 FP Menu -> System -> Instrument Setup -> Frequency Offset (User Downconv.) -> Conversion Mode
 TR Menu -> System -> Instrument Setup -> Frequency Offset (User Downconv.) -> Conversion Mode
 USER Menu -> System -> Instrument Setup -> Frequency Offset (User Downconv.) -> Conversion Mode

:SENSe:UDConverter:STATe

Syntax :SENSe:UDConverter:STATe {ON|OFF|1|0}
:SENSe:UDConverter:STATe?

Description Sets/Reads the frequency offset

Parameter

	<Description>
ON or 1	Frequency offset 'ON'
OFF or 0 (Preset value)	Frequency offset 'OFF'

Equivalent key PN Menu -> System -> Instrument Setup -> Frequency Offset (User Downconv.) -> Frequency Offset
SP Menu -> System -> Instrument Setup -> Frequency Offset (User Downconv.) -> Frequency Offset
FP Menu -> System -> Instrument Setup -> Frequency Offset (User Downconv.) -> Frequency Offset
TR Menu -> System -> Instrument Setup -> Frequency Offset (User Downconv.) -> Frequency Offset
USER Menu -> System -> Instrument Setup -> Frequency Offset (User Downconv.) -> Frequency Offset

:SOURce:FP[1-1]:SWEep:PARAmeter

Syntax :SOURce:FP[1-1]:SWEep:PARAmeter {CONTRol|POWER}
:SOURce:FP[1-1]:SWEep:PARAmeter?

Description Sets/Reads sweep parameter

Parameter

	Description
CONTRol(Preset value)	Set sweep parameter to 'CONTRol'
POWER	Set sweep parameter to 'POWER'

Equivalent key FP Menu -> Setup -> Sweep Parameter

:SOURce:FP[1-1]:SWEep:POINTs

Syntax :SOURce:FP[1-1]:SWEep:POINTs <numeric>

:SOURce:FP[1-1]:SWEep:POINts?

Description Sets/Reads the number of measurement points

Parameter

	<Numeric>
Range	2 to 1001
Preset value	201
Unit	-
Resolution	-

Equivalent key FP Menu -> Setup -> Points

:SOURce:FP[1-1]:VOLTage:CONTrol:CENTer

Syntax :SOURce:FP[1-1]:VOLTage:CONTrol:CENTer <numeric>
:SOURce:FP[1-1]:VOLTage:CONTrol:CENTer?

Description Vcontrol center

Parameter

	<Numeric>
Range	-15 to 35
Preset value	50u
Unit	V
Resolution	50u

Equivalent key FP Menu -> Start/Center -> DC Control Center
FP Menu -> Stop/Span -> DC Control Center

:SOURce:FP[1-1]:VOLTage:CONTrol:SPAN

Syntax :SOURce:FP[1-1]:VOLTage:CONTrol:SPAN <numeric>
:SOURce:FP[1-1]:VOLTage:CONTrol:SPAN?

Description Vcontrol span

Parameter

	<Numeric>
Range	0 to 50
Preset value	100u
Unit	V
Resolution	100u

Equivalent key

FP Menu -> Start/Center -> DC Control Span

FP Menu -> Stop/Span -> DC Control Span

:SOURce:FP[1-1]:VOLTage:CONTrol:STARt

Syntax

:SOURce:FP[1-1]:VOLTage:CONTrol:STARt <numeric>

:SOURce:FP[1-1]:VOLTage:CONTrol:STARt?

Description

Vcontrol start

Parameter

	<Numeric>
Range	-15 to 35
Preset value	0
Unit	V
Resolution	100u

Equivalent key

FP Menu -> Start/Center -> DC Control Start

FP Menu -> Stop/Span -> DC Control Start

:SOURce:FP[1-1]:VOLTage:CONTrol:STOP

Syntax

:SOURce:FP[1-1]:VOLTage:CONTrol:STOP <numeric>

:SOURce:FP[1-1]:VOLTage:CONTrol:STOP?

Description

Vcontrol stop

Parameter

	<Numeric>
Range	-15 to 35
Preset value	100u

	<Numeric>
Unit	V
Resolution	100u

Equivalent key FP Menu -> Start/Center -> DC Control Stop
FP Menu -> Stop/Span -> DC Control Stop

:SOURce:FP[1-1]:VOLTage:POWer:CENTer

Syntax :SOURce:FP[1-1]:VOLTage:POWer:CENTer <numeric>
:SOURce:FP[1-1]:VOLTage:POWer:CENTer?

Description Vpower center

Parameter

	<Numeric>
Range	0 to 16
Preset value	500u
Unit	V
Resolution	500u

Equivalent key FP Menu -> Start/Center -> DC Power Center
FP Menu -> Stop/Span -> DC Power Center

:SOURce:FP[1-1]:VOLTage:POWer:SPAN

Syntax :SOURce:FP[1-1]:VOLTage:POWer:SPAN <numeric>
:SOURce:FP[1-1]:VOLTage:POWer:SPAN?

Description Vpower span

Parameter

	<Numeric>
Range	0 to 16
Preset value	1m
Unit	V
Resolution	1m

Equivalent key FP Menu -> Start/Center -> DC Power Span
FP Menu -> Stop/Span -> DC Power Span

:SOURce:FP[1-1]:VOLTage:POWer:START

Syntax :SOURce:FP[1-1]:VOLTage:POWer:START <numeric>
:SOURce:FP[1-1]:VOLTage:POWer:START?

Description Vpower start

Parameter

	<Numeric>
Range	0 to 16
Preset value	0
Unit	V
Resolution	1m

Equivalent key FP Menu -> Start/Center -> DC Power Start
FP Menu -> Stop/Span -> DC Power Start

:SOURce:FP[1-1]:VOLTage:POWer:STOP

Syntax :SOURce:FP[1-1]:VOLTage:POWer:STOP <numeric>
:SOURce:FP[1-1]:VOLTage:POWer:STOP?

Description Vpower stop

Parameter

	<Numeric>
Range	0 to 16
Preset value	1m
Unit	V
Resolution	1m

Equivalent key FP Menu -> Start/Center -> DC Power Stop
FP Menu -> Stop/Span -> DC Power Stop

:SOURce:VOLTage:CONTRol:AFC:FBAND

Syntax :SOURce:VOLTage:CONTRol:AFC:FBAND {LOW|HIGH}

:SOURce:VOLTage:CONTRol:AFC:FBAND?

Description

Sets/Reads the frequency band in the auto frequency control function

Parameter

When the E5052A is used stand-alone, or with the downconverter turned off

	Description
LOW	Set the frequency band in the auto frequency control function to '10M-1.5GHz'
HIGH(Preset value)	Set the frequency band in the auto frequency control function to '300M-7GHz'

When the downconverter is turned on and the RF input is set to 'E5052A Direct'

	<Description>
LOW	Set the frequency band in the auto frequency control function to '10M-1.5GHz'
HIGH(Preset value)	Set the frequency band in the auto frequency control function to '300M-3GHz'

When the downconverter is turned on and the RF input is set to 'Downconverter'

	<Description>
BAND3(Preset value)	Set the frequency band in the auto frequency control function to '3G-10GHz'
BAND4	Set the frequency band in the auto frequency control function to '9G-26.5GHz'

Equivalent key

PN Menu -> DC Control Voltage -> Auto Freq Control -> Frequency Band
 SP Menu -> DC Control Voltage -> Auto Freq Control -> Frequency Band
 FP Menu -> DC Control Voltage -> Auto Freq Control -> Frequency Band
 TR Menu -> DC Control Voltage -> Auto Freq Control -> Frequency Band
 USER Menu -> DC Control Voltage -> Auto Freq Control -> Frequency Band

:SOURce:VOLTage:CONTRol:AFC:IMMediate

Syntax

:SOURce:VOLTage:CONTRol:AFC:IMMediate

Description

Executes the auto frequency control once. (No Query)

Equivalent key

PN Menu -> DC Control Voltage -> Auto Freq Control -> AFC Status
 SP Menu -> DC Control Voltage -> Auto Freq Control -> AFC Status
 FP Menu -> DC Control Voltage -> Auto Freq Control -> AFC Status

TR Menu -> DC Control Voltage -> Auto Freq Control -> AFC Status

USER Menu -> DC Control Voltage -> Auto Freq Control -> AFC Status

:SOURce:VOLTage:CONTrol:AFC:INPut:LEVel:MAXimum

Syntax :SOURce:VOLTage:CONTrol:AFC:INPut:LEVel:MAXimum <numeric>

:SOURce:VOLTage:CONTrol:AFC:INPut:LEVel:MAXimum?

Description Sets/Reads the maximum input level in order to determine the IF Gain of the downconverter.

Parameter

	<Description>
Range	-45 to 30
Preset value	0
Unit	dBm
Resolution	100m

Equivalent Key
 PN Menu -> DC Control Voltage -> Auto Freq Control -> Max Input Level
 SP Menu -> DC Control Voltage -> Auto Freq Control -> Max Input Level
 FP Menu -> DC Control Voltage -> Auto Freq Control -> Max Input Level
 TR Menu -> DC Control Voltage -> Auto Freq Control -> Max Input Level
 USER Menu -> DC Control Voltage -> Auto Freq Control -> Max Input Level

:SOURce:VOLTage:CONTrol:AFC:ITERation

Syntax :SOURce:VOLTage:CONTrol:AFC:ITERation <numeric>

:SOURce:VOLTage:CONTrol:AFC:ITERation?

Description Sets/Reads the maximum number of iterations for the DC control voltage-setting loops

Parameter

	<Numeric>
Range	1 to 99
Preset value	10
Unit	-
Resolution	-

Equivalent key PN Menu -> DC Control Voltage -> Auto Freq Control -> Max Iteration
 SP Menu -> DC Control Voltage -> Auto Freq Control -> Max Iteration
 FP Menu -> DC Control Voltage -> Auto Freq Control -> Max Iteration
 TR Menu -> DC Control Voltage -> Auto Freq Control -> Max Iteration
 USER Menu -> DC Control Voltage -> Auto Freq Control -> Max Iteration

:SOURce:VOLTage:CONTRol:AFC:LIMit:HIGH

Syntax :SOURce:VOLTage:CONTRol:AFC:LIMit:HIGH <numeric>
 :SOURce:VOLTage:CONTRol:AFC:LIMit:HIGH?

Description Sets/Reads the maximum DC control voltage limit

Parameter

	<Numeric>
Range	-15 to 35
Preset value	35
Unit	V
Resolution	100u

Equivalent key PN Menu -> DC Control Voltage -> Auto Freq Control -> Max Ctrl Voltage Limit
 SP Menu -> DC Control Voltage -> Auto Freq Control -> Max Ctrl Voltage Limit
 FP Menu -> DC Control Voltage -> Auto Freq Control -> Max Ctrl Voltage Limit
 TR Menu -> DC Control Voltage -> Auto Freq Control -> Max Ctrl Voltage Limit
 USER Menu -> DC Control Voltage -> Auto Freq Control -> Max Ctrl Voltage Limit

:SOURce:VOLTage:CONTRol:AFC:LIMit:LOW

Syntax :SOURce:VOLTage:CONTRol:AFC:LIMit:LOW <numeric>
 :SOURce:VOLTage:CONTRol:AFC:LIMit:LOW?

Description Sets/Reads the minimum DC control voltage limit

Parameter

	<Numeric>
Range	-15 to 35
Preset value	-15
Unit	V

	<Numeric>
Resolution	100u

Equivalent key PN Menu -> DC Control Voltage -> Auto Freq Control -> Min Ctrl Voltage Limit
 SP Menu -> DC Control Voltage -> Auto Freq Control -> Min Ctrl Voltage Limit
 FP Menu -> DC Control Voltage -> Auto Freq Control -> Min Ctrl Voltage Limit
 TR Menu -> DC Control Voltage -> Auto Freq Control -> Min Ctrl Voltage Limit
 USER Menu -> DC Control Voltage -> Auto Freq Control -> Min Ctrl Voltage Limit

:SOURce:VOLTage:CONTrol:AFC:SENSitivity

Syntax :SOURce:VOLTage:CONTrol:AFC:SENSitivity <numeric>
 :SOURce:VOLTage:CONTrol:AFC:SENSitivity?

Description Sets/Reads the tuning sensitivity

Parameter

	<Numeric>
Range	-5G to 5G
Preset value	10M
Unit	Hz/V
Resolution	1

Equivalent key PN Menu -> DC Control Voltage -> Auto Freq Control -> Sensitivity
 SP Menu -> DC Control Voltage -> Auto Freq Control -> Sensitivity
 FP Menu -> DC Control Voltage -> Auto Freq Control -> Sensitivity
 TR Menu -> DC Control Voltage -> Auto Freq Control -> Sensitivity
 USER Menu -> DC Control Voltage -> Auto Freq Control -> Sensitivity

:SOURce:VOLTage:CONTrol:AFC[:STATe]

Syntax :SOURce:VOLTage:CONTrol:AFC[:STATe] {ON|OFF|1|0}
 :SOURce:VOLTage:CONTrol:AFC[:STATe]?

Description Turns on/off the auto frequency control function

Parameter

	Description
ON or 1	Turn on the auto frequency control function mode
OFF or 0(Preset value)	Turn off the auto frequency control function mode

Equivalent key

PN Menu -> DC Control Voltage -> Auto Freq Control -> AFC Status
 SP Menu -> DC Control Voltage -> Auto Freq Control -> AFC Status
 FP Menu -> DC Control Voltage -> Auto Freq Control -> AFC Status
 TR Menu -> DC Control Voltage -> Auto Freq Control -> AFC Status
 USER Menu -> DC Control Voltage -> Auto Freq Control -> AFC Status

:SOURce:VOLTage:CONTRol:AFC:TARGet

Syntax

:SOURce:VOLTage:CONTRol:AFC:TARGet <numeric>
 :SOURce:VOLTage:CONTRol:AFC:TARGet?

Description

Sets/Reads the target frequency in the auto frequency control function

Parameter

When the E5052A is used stand-alone, or with the downconverter turned off (Allowable setting range varies depending on whether the frequency offset is on or off, the LO frequency within the frequency offset, and the conversion mode used in the frequency offset)

	<Numeric>
Range	10M to 7G
Preset value	1G
Unit	Hz
Resolution	100m

When the downconverter is turned on and the RF input is set to 'E5052A Direct' (Allowable setting range varies depending on whether the frequency offset is on or off, the LO frequency within the frequency offset, and the conversion mode used in the frequency offset)

	<Description>
Range	10M to 113G
Preset value	3G
Unit	Hz
Resolution	100m

When the downconverter is turned on and the RF input is set to 'Downconverter'

	<Description>
Range	3G to 26.5G
Preset value	1G
Unit	Hz
Resolution	100m

Equivalent key PN Menu -> DC Control Voltage -> Auto Freq Control -> Target
 SP Menu -> DC Control Voltage -> Auto Freq Control -> Target
 FP Menu -> DC Control Voltage -> Auto Freq Control -> Target
 TR Menu -> DC Control Voltage -> Auto Freq Control -> Target
 USER Menu -> DC Control Voltage -> Auto Freq Control -> Target

:SOURce:VOLTage:CONTRol:AFC:TOLerance

Syntax :SOURce:VOLTage:CONTRol:AFC:TOLerance <numeric>
 :SOURce:VOLTage:CONTRol:AFC:TOLerance?

Description Sets/Reads the tolerance limit

Parameter

	<Numeric>
Range	20 to 10M
Preset value	1k
Unit	Hz
Resolution	100m

Equivalent key PN Menu -> DC Control Voltage -> Auto Freq Control -> Tolerance
 SP Menu -> DC Control Voltage -> Auto Freq Control -> Tolerance
 FP Menu -> DC Control Voltage -> Auto Freq Control -> Tolerance
 TR Menu -> DC Control Voltage -> Auto Freq Control -> Tolerance
 USER Menu -> DC Control Voltage -> Auto Freq Control -> Tolerance

:SOURce:VOLTage:CONTRol:CORRection:COLLect:ACQ uire

Syntax :SOURce:VOLTage:CONTRol:CORRection:COLLect:ACQuire

Description Executes DC CTRL DRIFT CAL (No Query)

Equivalent key No equivalent key is available on the front panel.

:SOURce:VOLTage:CONTRol:CORRection[:STATe]

Syntax :SOURce:VOLTage:CONTRol:CORRection[:STATe] {ON|OFF|1|0}
:SOURce:VOLTage:CONTRol:CORRection[:STATe]?

Description Sets/Reads DC CTRL DRIFT CAL state

Parameter

	Description
ON or 1	Set DC CTRL DRIFT CAL state mode to 'ON'
OFF or 0(Preset value)	Set DC CTRL DRIFT CAL state mode to 'OFF'

Equivalent key No equivalent key is available on the front panel.

:SOURce:VOLTage:CONTRol:DELay

Syntax :SOURce:VOLTage:CONTRol:DELay <numeric>
:SOURce:VOLTage:CONTRol:DELay?

Description Sets/Reads DC Control delay setting(sec)

Parameter

	<Numeric>
Range	0 to 1
Preset value	100m
Unit	s
Resolution	1m

Equivalent key PN Menu -> DC Control Voltage -> DC Control Delay
SP Menu -> DC Control Voltage -> DC Control Delay
FP Menu -> DC Control Voltage -> DC Control Delay
TR Menu -> DC Control Voltage -> DC Control Delay
USER Menu -> DC Control Voltage -> DC Control Delay

:SOURce:VOLTage:CONTRol:LEVel:AMPLitude

Syntax :SOURce:VOLTage:CONTRol:LEVel:AMPLitude <numeric>

:SOURce:VOLTage:CONTRol:LEVel:AMPLitude?

Description Sets/Reads the fixed voltage for DC Control

Parameter

	<Numeric>
Range	-15 to 35
Preset value	0
Unit	V
Resolution	100u

Equivalent key
 PN Menu -> DC Control Voltage -> DC Control Voltage
 SP Menu -> DC Control Voltage -> DC Control Voltage
 FP Menu -> DC Control Voltage -> DC Control Voltage
 TR Menu -> DC Control Voltage -> DC Control Voltage
 USER Menu -> DC Control Voltage -> DC Control Voltage

:SOURce:VOLTage:CONTRol:LEVel:STATe

Syntax
 :SOURce:VOLTage:CONTRol:LEVel:STATe {ON|OFF|1|0}
 :SOURce:VOLTage:CONTRol:LEVel:STATe?

Description Turns on/off DC Control voltage

Parameter

	Description
ON or 1	Set DC Control voltage output to 'ON'
OFF or 0(Preset value)	Set DC Control voltage output to 'OFF'

Equivalent key
 PN Menu -> DC Control Voltage -> DC Control Output
 SP Menu -> DC Control Voltage -> DC Control Output
 FP Menu -> DC Control Voltage -> DC Control Output
 TR Menu -> DC Control Voltage -> DC Control Output
 USER Menu -> DC Control Voltage -> DC Control Output

:SOURce:VOLTage:CONTRol:LIMit:HIGH

Syntax
 :SOURce:VOLTage:CONTRol:LIMit:HIGH <numeric>

:SOURce:VOLTage:CONTrol:LIMit:HIGH?

Description

Sets/Reads the maximum voltage limit for DC Control

Parameter

	<Numeric>
Range	-15 to 35
Preset value	35
Unit	V
Resolution	100u

Equivalent key

PN Menu -> DC Control Voltage -> Max Ctrl Voltage Limit

SP Menu -> DC Control Voltage -> Max Ctrl Voltage Limit

FP Menu -> DC Control Voltage -> Max Ctrl Voltage Limit

TR Menu -> DC Control Voltage -> Max Ctrl Voltage Limit

USER Menu -> DC Control Voltage -> Max Ctrl Voltage Limit

:SOURce:VOLTage:CONTrol:LIMit:LOW

Syntax

:SOURce:VOLTage:CONTrol:LIMit:LOW <numeric>

:SOURce:VOLTage:CONTrol:LIMit:LOW?

Description

Sets/Reads the minimum voltage limit for DC Control

Parameter

	<Numeric>
Range	-15 to 35
Preset value	-15
Unit	V
Resolution	100u

Equivalent key

PN Menu -> DC Control Voltage -> Min Ctrl Voltage Limit

SP Menu -> DC Control Voltage -> Min Ctrl Voltage Limit

FP Menu -> DC Control Voltage -> Min Ctrl Voltage Limit

TR Menu -> DC Control Voltage -> Min Ctrl Voltage Limit

USER Menu -> DC Control Voltage -> Min Ctrl Voltage Limit

:SOURce:VOLTage:POWer:DELay

Syntax :SOURce:VOLTage:POWer:DELay <numeric>
:SOURce:VOLTage:POWer:DELay?

Description Sets/Reads the DC Power delay setting(sec)

Parameter

	<Numeric>
Range	0 to 1
Preset value	100m
Unit	s
Resolution	1m

Equivalent key PN Menu -> DC Power Voltage -> DC Power Delay
SP Menu -> DC Power Voltage -> DC Power Delay
FP Menu -> DC Power Voltage -> DC Power Delay
TR Menu -> DC Power Voltage -> DC Power Delay
USER Menu -> DC Power Voltage -> DC Power Delay

:SOURce:VOLTage:POWer:LEVel:AMPLitude

Syntax :SOURce:VOLTage:POWer:LEVel:AMPLitude <numeric>
:SOURce:VOLTage:POWer:LEVel:AMPLitude?

Description Sets/Reads voltage for DC Power

Parameter

	<Numeric>
Range	0 to 16
Preset value	0
Unit	V
Resolution	1m

Equivalent key PN Menu -> DC Power Voltage -> DC Power Voltage
SP Menu -> DC Power Voltage -> DC Power Voltage
FP Menu -> DC Power Voltage -> DC Power Voltage
TR Menu -> DC Power Voltage -> DC Power Voltage

USER Menu -> DC Power Voltage -> DC Power Voltage

:SOURce:VOLTage:POWer:LEVel:STATe

Syntax :SOURce:VOLTage:POWer:LEVel:STATe {ON|OFF|1|0}
:SOURce:VOLTage:POWer:LEVel:STATe?

Description Turns on/off the DC Power output voltage

Parameter

	Description
ON or 1	Set DC Power voltage output to 'ON'
OFF or 0(Preset value)	Set DC Power voltage output to 'OFF'

Equivalent key
 PN Menu -> DC Power Voltage -> DC Power Output
 SP Menu -> DC Power Voltage -> DC Power Output
 FP Menu -> DC Power Voltage -> DC Power Output
 TR Menu -> DC Power Voltage -> DC Power Output
 USER Menu -> DC Power Voltage -> DC Power Output

:SOURce:VOLTage:POWer:LIMit:HIGH

Syntax :SOURce:VOLTage:POWer:LIMit:HIGH <numeric>
:SOURce:VOLTage:POWer:LIMit:HIGH?

Description Sets/Reads maximum voltage limit for DC Power

Parameter

	<Numeric>
Range	0 to 16
Preset value	16
Unit	V
Resolution	1m

Equivalent key
 PN Menu -> DC Power Voltage -> Max Pwr Voltage Limit
 SP Menu -> DC Power Voltage -> Max Pwr Voltage Limit
 FP Menu -> DC Power Voltage -> Max Pwr Voltage Limit
 TR Menu -> DC Power Voltage -> Max Pwr Voltage Limit

USER Menu -> DC Power Voltage -> Max Pwr Voltage Limit

:SOURce:VOLTage:POWer:LIMit:LOW

Syntax :SOURce:VOLTage:POWer:LIMit:LOW <numeric>
:SOURce:VOLTage:POWer:LIMit:LOW?

Description Sets/Reads minimum voltage limit for DC Power

Parameter

	<Numeric>
Range	0 to 16
Preset value	0
Unit	V
Resolution	1m

Equivalent key PN Menu -> DC Power Voltage -> Min Pwr Voltage Limit
SP Menu -> DC Power Voltage -> Min Pwr Voltage Limit
FP Menu -> DC Power Voltage -> Min Pwr Voltage Limit
TR Menu -> DC Power Voltage -> Min Pwr Voltage Limit
USER Menu -> DC Power Voltage -> Min Pwr Voltage Limit

:STATus:OPERation:BIT12:CLEAr

Syntax :STATus:OPERation:BIT12:CLEAr <numeric>

Description Clears operation-program status condition register (No Query)

Parameter

	<Numeric>
Range	0 to 14
Preset value	-
Unit	-
Resolution	-

Equivalent key No equivalent key is available on the front panel.

:STATus:OPERation:BIT12:CONDition

Syntax :STATus:OPERation:BIT12:CONDition

Description Reads operation-program status register (Query Only)

Equivalent key No equivalent key is available on the front panel.

:STATus:OPERation:BIT12:ENABLE

Syntax :STATus:OPERation:BIT12:ENABLE <numeric>
:STATus:OPERation:BIT12:ENABLE?

Description Sets/Reads operation-program status enable register

Parameter

	<Numeric>
Range	0 to 65535
Preset value	0
Unit	-
Resolution	-

Equivalent key No equivalent key is available on the front panel.

:STATus:OPERation:BIT12[:EVENT]

Syntax :STATus:OPERation:BIT12[:EVENT]

Description Reads operation-program status event register (Query Only)

Equivalent key No equivalent key is available on the front panel.

:STATus:OPERation:BIT12:NTRansition

Syntax :STATus:OPERation:BIT12:NTRansition <numeric>
:STATus:OPERation:BIT12:NTRansition?

Description Sets/Reads operation-program status negative transition filter value

Parameter

	<Numeric>
Range	0 to 65535
Preset value	0
Unit	-
Resolution	-

Equivalent key No equivalent key is available on the front panel.

:STATus:OPERation:BIT12:PTRansition

Syntax :STATus:OPERation:BIT12:PTRansition <numeric>
:STATus:OPERation:BIT12:PTRansition?

Description Sets/Reads operation-program status positive transition filter value

Parameter

	<Numeric>
Range	0 to 65535
Preset value	32767
Unit	-
Resolution	-

Equivalent key No equivalent key is available on the front panel.

:STATus:OPERation:BIT12:SET

Syntax :STATus:OPERation:BIT12:SET <numeric>

Description Sets operation-program status condition register (No Query)

Parameter

	<Numeric>
Range	0 to 14
Preset value	-
Unit	-
Resolution	-

Equivalent key No equivalent key is available on the front panel.

:STATus:OPERation:CONDition

Syntax :STATus:OPERation:CONDition

Description Reads operation status conditional register value (Query Only)

Equivalent key No equivalent key is available on the front panel.

:STATus:OPERation:ENABLE

Syntax :STATus:OPERation:ENABLE <numeric>
:STATus:OPERation:ENABLE?

Description Sets/Reads operation status enable register

Parameter

	<Numeric>
Range	0 to 65535
Preset value	0
Unit	-
Resolution	-

Equivalent key No equivalent key is available on the front panel.

:STATus:OPERation[:EVENT]

Syntax :STATus:OPERation[:EVENT]

Description Reads operation status event register (Query Only)

Equivalent key No equivalent key is available on the front panel.

:STATus:OPERation:NTRansition

Syntax :STATus:OPERation:NTRansition <numeric>
:STATus:OPERation:NTRansition?

Description Sets/Reads operation status negative transition filter value

Parameter

	<Numeric>
Range	0 to 65535
Preset value	0
Unit	-
Resolution	-

Equivalent key No equivalent key is available on the front panel.

:STATus:OPERation:PTRansition

Syntax :STATus:OPERation:PTRansition <numeric>
:STATus:OPERation:PTRansition?

Description Sets/Reads operation status positive transition filter value

Parameter

	<Numeric>
Range	0 to 65535
Preset value	32767
Unit	-
Resolution	-

Equivalent key No equivalent key is available on the front panel.

:STATus:PRESet

Syntax :STATus:PRESet

Description Reset status registers (No Query)

Equivalent key No equivalent key is available on the front panel.

:STATus:QUEStionable:CONDition

Syntax :STATus:QUEStionable:CONDition

Description Reads questionable status conditional register value (Query Only)

Equivalent key No equivalent key is available on the front panel.

:STATus:QUEStionable:CURRent:ENABle

Syntax :STATus:QUEStionable:CURRent:ENABle <numeric>
:STATus:QUEStionable:CURRent:ENABle?

Description Sets/Reads questionable-current status enable register

Parameter

	<Numeric>
Range	0 to 65535

	<Numeric>
Preset value	0
Unit	-
Resolution	-

Equivalent key No equivalent key is available on the front panel.

:STATus:QUESTIONable:CURRENT[:EVENT]

Syntax :STATus:QUESTIONable:CURRENT[:EVENT]

Description Reads questionable-current status event register value (Query Only)

Equivalent key No equivalent key is available on the front panel.

:STATus:QUESTIONable:DCONverter:ENABLE

Syntax :STATus:QUESTIONable:DCONverter:ENABLE <numeric>
:STATus:QUESTIONable:DCONverter:ENABLE?

Description Sets/Reads questionable downconverter status enable register value

Parameter

	<Description>
Range	0 to 65535
Preset value	0
Unit	-
Resolution	-

Equivalent key No equivalent key is available on the front panel.

:STATus:QUESTIONable:DCONverter[:EVENT]

Syntax :STATus:QUESTIONable:DCONverter[:EVENT]

Description Reads questionable downconverter status event register value (Query Only)

Equivalent key No equivalent key is available on the front panel.

:STATus:QUESTIONable:ENABLE

Syntax :STATus:QUESTIONable:ENABLE <numeric>

:STATus:QUESTionable:ENABle?

Description Sets/Reads questionable status enable register

Parameter

	<Numeric>
Range	0 to 65535
Preset value	0
Unit	-
Resolution	-

Equivalent key No equivalent key is available on the front panel.

:STATus:QUESTionable[:EVENT]

Syntax :STATus:QUESTionable[:EVENT]

Description Reads questionable status event register value (Query Only)

Equivalent key No equivalent key is available on the front panel.

:STATus:QUESTionable:LIMit:CONDition

Syntax :STATus:QUESTionable:LIMit:CONDition

Description Reads the questionable limit conditional register value (Query Only)

Equivalent key No equivalent key is available on the front panel.

:STATus:QUESTionable:LIMit:ENABle

Syntax :STATus:QUESTionable:LIMit:ENABle <numeric>

:STATus:QUESTionable:LIMit:ENABle?

Description Sets/Reads the questionable limit status enable value

Parameter

	<Numeric>
Range	0 to 65535
Preset value	0
Unit	-
Resolution	-

Equivalent key No equivalent key is available on the front panel.

:STATus:QUEStionable:LIMit[:EVENT]

Syntax :STATus:QUEStionable:LIMit[:EVENT]

Description Reads the questionable limit status event register value (Query Only)

Equivalent key No equivalent key is available on the front panel.

:STATus:QUEStionable:LIMit:FP[1-1]:CONDition

Syntax :STATus:QUEStionable:LIMit:FP[1-1]:CONDition

Description Reads the questionable limit FP conditional register value (Query Only)

Equivalent key No equivalent key is available on the front panel.

:STATus:QUEStionable:LIMit:FP[1-1]:ENABle

Syntax :STATus:QUEStionable:LIMit:FP[1-1]:ENABle <numeric>

:STATus:QUEStionable:LIMit:FP[1-1]:ENABle?

Description Sets/Reads the questionable limit FP status enable value

Parameter

	<Numeric>
Range	0 to 65535
Preset value	0
Unit	-
Resolution	-

Equivalent key No equivalent key is available on the front panel.

:STATus:QUEStionable:LIMit:FP[1-1][:EVENT]

Syntax :STATus:QUEStionable:LIMit:FP[1-1][:EVENT]

Description Reads the questionable limit FP status event register value (Query Only)

Equivalent key No equivalent key is available on the front panel.

:STATus:QUEStionable:LIMit:FP[1-1]:NTRansition

Syntax :STATus:QUEStionable:LIMit:FP[1-1]:NTRansition <numeric>

:STATus:QUEStionable:LIMit:FP[1-1]:NTRansition?

Description Sets/Reads the questionable limit FP status negative transition filter value

Parameter

	<Numeric>
Range	0 to 65535
Preset value	0
Unit	-
Resolution	-

Equivalent key No equivalent key is available on the front panel.

:STATus:QUEStionable:LIMit:FP[1-1]:PTRansition

Syntax :STATus:QUEStionable:LIMit:FP[1-1]:PTRansition <numeric>

:STATus:QUEStionable:LIMit:FP[1-1]:PTRansition?

Description Sets/Reads the questionable limit FP status positive transition filter value

Parameter

	<Numeric>
Range	0 to 65535
Preset value	32767
Unit	-
Resolution	-

Equivalent key No equivalent key is available on the front panel.

:STATus:QUEStionable:LIMit:NTRansition

Syntax :STATus:QUEStionable:LIMit:NTRansition <numeric>

:STATus:QUEStionable:LIMit:NTRansition?

Description Sets/Reads the questionable limit status negative transition filter value

Parameter

	<Numeric>
Range	0 to 65535

	<Numeric>
Preset value	0
Unit	-
Resolution	-

Equivalent key No equivalent key is available on the front panel.

:STATus:QUESTIONable:LIMit:PN[1-1]:CONDition

Syntax :STATus:QUESTIONable:LIMit:PN[1-1]:CONDition

Description Reads the questionable limit PN conditional register value (Query Only)

Equivalent key No equivalent key is available on the front panel.

:STATus:QUESTIONable:LIMit:PN[1-1]:ENABLE

Syntax :STATus:QUESTIONable:LIMit:PN[1-1]:ENABLE <numeric>

:STATus:QUESTIONable:LIMit:PN[1-1]:ENABLE?

Description Sets/Reads the questionable limit PN status enable value

Parameter

	<Numeric>
Range	0 to 65535
Preset value	0
Unit	-
Resolution	-

Equivalent key No equivalent key is available on the front panel.

:STATus:QUESTIONable:LIMit:PN[1-1][:EVENT]

Syntax :STATus:QUESTIONable:LIMit:PN[1-1][:EVENT]

Description Reads the questionable limit PN status event register value (Query Only)

Equivalent key No equivalent key is available on the front panel.

:STATus:QUESTIONable:LIMit:PN[1-1]:NTRansition

Syntax :STATus:QUESTIONable:LIMit:PN[1-1]:NTRansition <numeric>

:STATus:QUEStionable:LIMit:PN[1-1]:NTRansition?

Description Sets/Reads the questionable limit PN status negative transition filter value

Parameter

	<Numeric>
Range	0 to 65535
Preset value	0
Unit	-
Resolution	-

Equivalent key No equivalent key is available on the front panel.

:STATus:QUEStionable:LIMit:PN[1-1]:PTRansition

Syntax :STATus:QUEStionable:LIMit:PN[1-1]:PTRansition <numeric>
:STATus:QUEStionable:LIMit:PN[1-1]:PTRansition?

Description Sets/Reads the questionable limit PN status positive transition filter value

Parameter

	<Numeric>
Range	0 to 65535
Preset value	32767
Unit	-
Resolution	-

Equivalent key No equivalent key is available on the front panel.

:STATus:QUEStionable:LIMit:PTRansition

Syntax :STATus:QUEStionable:LIMit:PTRansition <numeric>
:STATus:QUEStionable:LIMit:PTRansition?

Description Sets/Reads the questionable limit status positive transition filter value

Parameter

	<Numeric>
Range	0 to 65535

	<Numeric>
Preset value	32767
Unit	-
Resolution	-

Equivalent key No equivalent key is available on the front panel.

:STATus:QUESTIONable:LIMit:SP[1-1]:CONDition

Syntax :STATus:QUESTIONable:LIMit:SP[1-1]:CONDition

Description Reads the questionable limit SP conditional register value (Query Only)

Equivalent key No equivalent key is available on the front panel.

:STATus:QUESTIONable:LIMit:SP[1-1]:ENABle

Syntax :STATus:QUESTIONable:LIMit:SP[1-1]:ENABle <numeric>

:STATus:QUESTIONable:LIMit:SP[1-1]:ENABle?

Description Sets/Reads the questionable limit SP status enable value

Parameter

	<Numeric>
Range	0 to 65535
Preset value	0
Unit	-
Resolution	-

Equivalent key No equivalent key is available on the front panel.

:STATus:QUESTIONable:LIMit:SP[1-1][:EVENT]

Syntax :STATus:QUESTIONable:LIMit:SP[1-1][:EVENT]

Description Reads the questionable limit SP status event register value (Query Only)

Equivalent key No equivalent key is available on the front panel.

:STATus:QUESTIONable:LIMit:SP[1-1]:NTRansition

Syntax :STATus:QUESTIONable:LIMit:SP[1-1]:NTRansition <numeric>

:STATus:QUEStionable:LIMit:SP[1-1]:NTRansition?

Description Sets/Reads the questionable limit SP status negative transition filter value

Parameter

	<Numeric>
Range	0 to 65535
Preset value	0
Unit	-
Resolution	-

Equivalent key No equivalent key is available on the front panel.

:STATus:QUEStionable:LIMit:SP[1-1]:PTRansition

Syntax :STATus:QUEStionable:LIMit:SP[1-1]:PTRansition <numeric>

:STATus:QUEStionable:LIMit:SP[1-1]:PTRansition?

Description Sets/Reads the questionable limit SP status positive transition filter value

Parameter

	<Numeric>
Range	0 to 65535
Preset value	32767
Unit	-
Resolution	-

Equivalent key No equivalent key is available on the front panel.

:STATus:QUEStionable:LIMit:TR[1-1]:CONDition

Syntax :STATus:QUEStionable:LIMit:TR[1-1]:CONDition

Description Reads the questionable limit TR conditional register value (Query Only)

Equivalent key No equivalent key is available on the front panel.

:STATus:QUEStionable:LIMit:TR[1-1]:ENABle

Syntax :STATus:QUEStionable:LIMit:TR[1-1]:ENABle <numeric>

:STATus:QUEStionable:LIMit:TR[1-1]:ENABle?

Description Sets/Reads the questionable limit TR status enable value

Parameter

	<Numeric>
Range	0 to 65535
Preset value	0
Unit	-
Resolution	-

Equivalent key No equivalent key is available on the front panel.

:STATus:QUEStionable:LIMit:TR[1-1][:EVENT]

Syntax :STATus:QUEStionable:LIMit:TR[1-1][:EVENT]

Description Reads the questionable limit TR status event register value (Query Only)

Equivalent key No equivalent key is available on the front panel.

:STATus:QUEStionable:LIMit:TR[1-1]:NTRansition

Syntax :STATus:QUEStionable:LIMit:TR[1-1]:NTRansition <numeric>

:STATus:QUEStionable:LIMit:TR[1-1]:NTRansition?

Description Sets/Reads the questionable limit TR status negative transition filter value

Parameter

	<Numeric>
Range	0 to 65535
Preset value	0
Unit	-
Resolution	-

Equivalent key No equivalent key is available on the front panel.

:STATus:QUEStionable:LIMit:TR[1-1]:PTRansition

Syntax :STATus:QUEStionable:LIMit:TR[1-1]:PTRansition <numeric>

:STATus:QUEStionable:LIMit:TR[1-1]:PTRansition?

Description Sets/Reads the questionable limit TR1 status positive transition filter value

Parameter

	<Numeric>
Range	0 to 65535
Preset value	32767
Unit	-
Resolution	-

Equivalent key No equivalent key is available on the front panel.

:STATus:QUEStionable:LIMit:USER[1-1]:CONDition

Syntax :STATus:QUEStionable:LIMit:USER[1-1]:CONDition

Description Reads the questionable limit USER1 conditional register value (Query Only)

Equivalent key No equivalent key is available on the front panel.

:STATus:QUEStionable:LIMit:USER[1-1]:ENABLE

Syntax :STATus:QUEStionable:LIMit:USER[1-1]:ENABLE <numeric>

:STATus:QUEStionable:LIMit:USER[1-1]:ENABLE?

Description Sets/Reads the questionable limit USER1 status enable value

Parameter

	<Numeric>
Range	0 to 65535
Preset value	0
Unit	-
Resolution	-

Equivalent key No equivalent key is available on the front panel.

:STATus:QUEStionable:LIMit:USER[1-1][:EVENT]

Syntax :STATus:QUEStionable:LIMit:USER[1-1][:EVENT]

Description Reads the questionable limit USER1 status event register value (Query Only)

Equivalent key No equivalent key is available on the front panel.

:STATus:QUESTIONable:LIMit:USER[1-1]:NTRansition

Syntax :STATus:QUESTIONable:LIMit:USER[1-1]:NTRansition <numeric>
:STATus:QUESTIONable:LIMit:USER[1-1]:NTRansition?

Description Sets/Reads the questionable limit USER1 status negative transition filter value

Parameter

	<Numeric>
Range	0 to 65535
Preset value	0
Unit	-
Resolution	-

Equivalent key No equivalent key is available on the front panel.

:STATus:QUESTIONable:LIMit:USER[1-1]:PTRansition

Syntax :STATus:QUESTIONable:LIMit:USER[1-1]:PTRansition <numeric>
:STATus:QUESTIONable:LIMit:USER[1-1]:PTRansition?

Description Sets/Reads the questionable limit USER1 status positive transition filter value

Parameter

	<Numeric>
Range	0 to 65535
Preset value	32767
Unit	-
Resolution	-

Equivalent key No equivalent key is available on the front panel.

:STATus:QUESTIONable:MISC:ENABLE

Syntax :STATus:QUESTIONable:MISC:ENABLE <numeric>
:STATus:QUESTIONable:MISC:ENABLE?

Description Sets/Reads questionable-misc status enable register

Parameter

	<Numeric>
Range	0 to 65535
Preset value	0
Unit	-
Resolution	-

Equivalent key No equivalent key is available on the front panel.

:STATus:QUEStionable:MISC[:EVENT]

Syntax :STATus:QUEStionable:MISC[:EVENT]

Description Reads questionable-misc status event register value (Query Only)

Equivalent key No equivalent key is available on the front panel.

:STATus:QUEStionable:NTRansition

Syntax :STATus:QUEStionable:NTRansition <numeric>

:STATus:QUEStionable:NTRansition?

Description Sets/Reads questionable status negative transition filter value

Parameter

	<Numeric>
Range	0 to 65535
Preset value	0
Unit	-
Resolution	-

Equivalent key No equivalent key is available on the front panel.

:STATus:QUEStionable:PHASe:ENABle

Syntax :STATus:QUEStionable:PHASe:ENABle <numeric>

:STATus:QUEStionable:PHASe:ENABle?

Description Sets/Reads questionable-phase status enable register

Parameter

	<Numeric>
Range	0 to 65535
Preset value	0
Unit	-
Resolution	-

Equivalent key No equivalent key is available on the front panel.

:STATus:QUEStionable:PHASe[:EVENT]

Syntax :STATus:QUEStionable:PHASe[:EVENT]

Description Reads questionable-phase status event register (Query Only)

Equivalent key No equivalent key is available on the front panel.

:STATus:QUEStionable:POWer:ENABLE

Syntax :STATus:QUEStionable:POWer:ENABLE <numeric>

:STATus:QUEStionable:POWer:ENABLE?

Description Sets/Reads questionable-power status enable register

Parameter

	<Numeric>
Range	0 to 65535
Preset value	0
Unit	-
Resolution	-

Equivalent key No equivalent key is available on the front panel.

:STATus:QUEStionable:POWer[:EVENT]

Syntax :STATus:QUEStionable:POWer[:EVENT]

Description Reads questionable-power status event register value (Query Only)

Equivalent key No equivalent key is available on the front panel.

:STATus:QUEStionable:PTRansition

Syntax :STATus:QUEStionable:PTRansition <numeric>
:STATus:QUEStionable:PTRansition?

Description Sets/Reads questionable status positive transition filter value

Parameter

	<Numeric>
Range	0 to 65535
Preset value	32767
Unit	-
Resolution	-

Equivalent key No equivalent key is available on the front panel.

:STATus:QUEStionable:REFerence:ENABle

Syntax :STATus:QUEStionable:REFerence:ENABle <numeric>
:STATus:QUEStionable:REFerence:ENABle?

Description Sets/Reads questionable-reference signal status enable register

Parameter

	<Numeric>
Range	0 to 65535
Preset value	0
Unit	-
Resolution	-

Equivalent key No equivalent key is available on the front panel.

:STATus:QUEStionable:REFerence[:EVENT]

Syntax :STATus:QUEStionable:REFerence[:EVENT]

Description Reads questionable-reference signal status event register value (Query Only)

Equivalent key No equivalent key is available on the front panel.

:SYSTem:BACKlight:STATe

Syntax :SYSTem:BACKlight:STATe {ON|OFF|1|0}
:SYSTem:BACKlight:STATe?

Description Turns on/off backlight

Parameter

	Description
ON or 1(Preset value)	Turn backlight 'ON'
OFF or 0	Turn backlight 'OFF'

Equivalent key
 PN Menu -> System -> Backlight
 SP Menu -> System -> Backlight
 FP Menu -> System -> Backlight
 TR Menu -> System -> Backlight
 USER Menu -> System -> Backlight

:SYSTem:BEEPer:COMplete:IMMediate

Syntax :SYSTem:BEEPer:COMplete:IMMediate

Description Makes beep sound for operation completion (No Query)

Equivalent key
 PN Menu -> System -> Misc Setup -> Beeper -> Test Beep Complete
 SP Menu -> System -> Misc Setup -> Beeper -> Test Beep Complete
 FP Menu -> System -> Misc Setup -> Beeper -> Test Beep Complete
 TR Menu -> System -> Misc Setup -> Beeper -> Test Beep Complete

:SYSTem:BEEPer:COMplete:STATe

Syntax :SYSTem:BEEPer:COMplete:STATe {ON|OFF|1|0}
:SYSTem:BEEPer:COMplete:STATe?

Description Turns on/off the beep for operation completion

Parameter

	Description
ON or 1(Preset value)	Set the beep for operation completion mode to 'ON'

	Description
OFF or 0	Set the beep for operation completion mode to 'OFF'

Equivalent key
 PN Menu -> System -> Misc Setup -> Beeper -> Beep Complete
 SP Menu -> System -> Misc Setup -> Beeper -> Beep Complete
 FP Menu -> System -> Misc Setup -> Beeper -> Beep Complete
 TR Menu -> System -> Misc Setup -> Beeper -> Beep Complete
 USER Menu -> System -> Misc Setup -> Beeper -> Beep Complete

:SYSTEM:BEEPer:WARNIng:IMMediate

Syntax :SYSTEM:BEEPer:WARNIng:IMMediate

Description Makes beep sound for warning (No Query)

Equivalent key
 PN Menu -> System -> Misc Setup -> Beeper -> Test Beep Warning
 SP Menu -> System -> Misc Setup -> Beeper -> Test Beep Warning
 FP Menu -> System -> Misc Setup -> Beeper -> Test Beep Warning
 TR Menu -> System -> Misc Setup -> Beeper -> Test Beep Warning
 USER Menu -> System -> Misc Setup -> Beeper -> Test Beep Warning

:SYSTEM:BEEPer:WARNIng:STATe

Syntax :SYSTEM:BEEPer:WARNIng:STATe {ON|OFF|1|0}
 :SYSTEM:BEEPer:WARNIng:STATe?

Description Turns on/off the beep for warning

Parameter

	Description
ON or 1	Set the beep for warning mode to 'ON'
OFF or 0(Preset value)	Set the beep for warning mode to 'OFF'

Equivalent key
 PN Menu -> System -> Misc Setup -> Beeper -> Beep Warning
 SP Menu -> System -> Misc Setup -> Beeper -> Beep Warning
 FP Menu -> System -> Misc Setup -> Beeper -> Beep Warning
 TR Menu -> System -> Misc Setup -> Beeper -> Beep Warning
 USER Menu -> System -> Misc Setup -> Beeper -> Beep Warning

:SYSTem:DATE

Syntax :SYSTem:DATE <numeric 1>,<numeric 2>,<numeric 3>
:SYSTem:DATE?

Description Sets/Gets system date

Parameter

	<Numeric 1>
Range	1980 to 2030
Preset value	-
Unit	-
Resolution	-

	<Numeric 2>
Range	1 to 12
Preset value	-
Unit	-
Resolution	-

	<Numeric 3>
Range	1 to 31
Preset value	-
Unit	-
Resolution	-

Equivalent key No equivalent key is available on the front panel.

:SYSTem:ERRor[:NEXT]

Syntax :SYSTem:ERRor[:NEXT]

Description Gets error code & description (Query Only)

Equivalent key No equivalent key is available on the front panel.

:SYSTem:KLOCK:kBD

Syntax :SYSTem:KLOCK:kBD {ON|OFF|1|0}

:SYSTem:KLOCK:KBD?

Description Sets/Gets front panel and keyboard lock state

Parameter

	Description
ON or 1	Set front panel and keyboard lock state mode to 'ON'
OFF or 0(Preset value)	Set front panel and keyboard lock state mode to 'OFF'

Equivalent key No equivalent key is available on the front panel.

:SYSTem:KLOCK:MOUSE

Syntax :SYSTem:KLOCK:MOUSE {ON|OFF|1|0}

:SYSTem:KLOCK:MOUSE?

Description Sets/Gets touch screen and mouse lock state

Parameter

	Description
ON or 1	Set touch screen and mouse lock state mode to 'ON'
OFF or 0(Preset value)	Set touch screen and mouse lock state mode to 'OFF'

Equivalent key No equivalent key is available on the front panel.

:SYSTem:POFF

Syntax :SYSTem:POFF

Description Power off the instrument (No Query)

Equivalent key No equivalent key is available on the front panel.

:SYSTem:PRESet

Syntax :SYSTem:PRESet

Description Preset instrument (No Query)

Equivalent key No equivalent key is available on the front panel.

:SYSTem:SECurity[:LEVel]

Syntax :SYSTem:SECurity[:LEVel] {NONE|LOW|HIGH}
:SYSTem:SECurity[:LEVel]?

Description Sets/recalls the security level

Parameter

	<Description>
NONE (Preset value)	Set the security level to 'None'
LOW	Set the security level to 'Frequency Blank'
HIGH	Set the security level to 'All Numeric Blank'

Equivalent key
 PN Menu -> Display -> Security Level
 SP Menu -> Display -> Security Level
 FP Menu -> Display -> Security Level
 TR Menu -> Display -> Security Level
 USER Menu -> Display -> Security Level

:SYSTem:TIME

Syntax :SYSTem:TIME <numeric 1>,<numeric 2>,<numeric 3>
:SYSTem:TIME?

Description Sets/Gets system time

Parameter

	<Numeric 1>
Range	0 to 23
Preset value	-
Unit	-
Resolution	-

	<Numeric 2>
Range	0 to 59
Preset value	-
Unit	-

	<Numeric 2>
Resolution	-

	<Numeric 3>
Range	0 to 59
Preset value	-
Unit	-
Resolution	-

Equivalent key No equivalent key is available on the front panel.

:TRIGger:AVERage

Syntax :TRIGger:AVERage {ON|OFF|1|0}
:TRIGger:AVERage?

Description Turns on/off averaging trigger mode

Parameter

	Description
ON or 1	Sets averaging trigger mode to 'ON'
OFF or 0(Preset value)	Sets averaging trigger mode to 'OFF'

Equivalent key PN Menu -> Trigger -> Average Trigger
SP Menu -> Trigger -> Average Trigger
FP Menu -> Trigger -> Average Trigger
TR Menu -> Trigger -> Average Trigger

:TRIGger:EXTeRnal:SLOPe

Syntax :TRIGger:EXTeRnal:SLOPe {NEGative|POSitive}
:TRIGger:EXTeRnal:SLOPe?

Description External trigger polarity

Parameter

	Description
NEGative(Preset value)	Set External trigger polarity to 'NEGative'
POSitive	Set External trigger polarity to 'POSitive'

Equivalent key

PN Menu -> Trigger -> Ext Trig Polarity
 SP Menu -> Trigger -> Ext Trig Polarity
 FP Menu -> Trigger -> Ext Trig Polarity
 TR Menu -> Trigger -> Ext Trig Polarity

:TRIGger:FP[1-1]:MODE

Syntax*1

:TRIGger:FP[1-1]:MODE {ANALyzer|TESTer}
 :TRIGger:FP[1-1]:MODE?

Description

Selects measurement mode in the Frequency, power and DC current measurement mode

Parameter

	Description
ANALyzer(Preset value)	Set trigger mode to 'ANALyzer'
TESTer	Set trigger mode to 'TESTer'

Equivalent key

FP Menu -> Trigger -> Mode

:TRIGger:FP[1-1]:SOURce

Syntax

:TRIGger:FP[1-1]:SOURce {INTernal|EXTernal|MANual|BUS}
 :TRIGger:FP[1-1]:SOURce?

Description

Selects trigger source

Parameter

	Description
INTernal(Preset value)	Set trigger source to 'INTernal'

*1. "Option not installed" error message is generated when setting the trigger mode to the analyzer mode with the option 011 instrument.

	Description
EXTernal	Set trigger source to 'EXTernal'
MANual	Set trigger source to 'MANual'
BUS	Set trigger source to 'BUS'

Equivalent key^{*1} FP Menu -> Trigger -> Source

:TRIGger:MODE

Syntax :TRIGger:MODE {PN1|SP1|FP1|TR1}
:TRIGger:MODE?

Description Selects active measurement mode

Parameter

	Description
PN1(Preset value)	Set measurement mode to 'PN1'
SP1	Set measurement mode to 'SP1'
FP1	Set measurement mode to 'FP1'
TR1	Set measurement mode to 'TR1'

Equivalent key PN Menu -> Trigger -> Trigger to Phase Noise
SP Menu -> Trigger -> Trigger to Spectrum Monitor
FP Menu -> Trigger -> Trigger to Freq & Power
TR Menu -> Trigger -> Trigger to Transient

:TRIGger:PN[1-1]:SOURce

Syntax :TRIGger:PN[1-1]:SOURce {INTernal|EXTernal|MANual|BUS}
:TRIGger:PN[1-1]:SOURce?

Description Selects trigger source

Parameter

	Description
INTernal(Preset value)	Set trigger source to 'INTernal'

*1. The softkey is not available when Option 011 is installed.

	Description
EXTernal	Set trigger source to 'EXTernal'
MANual	Set trigger source to 'MANual'
BUS	Set trigger source to 'BUS'

Equivalent key PN Menu -> Trigger -> Source

:TRIGger:SOPC

Syntax :TRIGger:SOPC {ON|OFF|1|0}
:TRIGger:SOPC?

Description Sets/Reads on/off of the *OPC, *OPC? and *WAI commands

Parameter

	Description
ON or 1	Enable the *OPC, *OPC? and *WAI commands
OFF or 0(Preset value)	Disable the *OPC, *OPC? and *WAI commands

Equivalent key No equivalent key is available on the front panel.

:TRIGger:SP[1-1]:SOURce

Syntax :TRIGger:SP[1-1]:SOURce {INTernal|EXTernal|MANual|BUS}
:TRIGger:SP[1-1]:SOURce?

Description Selects trigger source

Parameter

	Description
INTernal(Preset value)	Set trigger source to 'INTernal'
EXTernal	Set trigger source to 'EXTernal'
MANual	Set trigger source to 'MANual'
BUS	Set trigger source to 'BUS'

Equivalent key SP Menu -> Trigger -> Source

:TRIGger:TR[1-1]:ETTAdjust

Syntax :TRIGger:TR[1-1]:ETTAdjust <numeric>
:TRIGger:TR[1-1]:ETTA?

Description Sets/Reads the offset of the waiting time of the external trigger source

Parameter

	<Numeric>
Description	Waiting time of the external trigger source
Range	0 to 1 μ
Preset value	0
Unit	s
Resolution	10 n

Equivalent key TR Menu -> Trigger -> Ext Trig Timing Adj.

:TRIGger:TR[1-1]:NARRow:VIDeo:FREQuency:CENTer

Syntax :TRIGger:TR[1-1]:NARRow:VIDeo:FREQuency:CENTer <numeric>
:TRIGger:TR[1-1]:NARRow:VIDeo:FREQuency:CENTer?

Description Sets/Reads the video trigger frequency value for narrowband mode in the transient measurement

Parameter **When the E5052A is used stand-alone, or with the downconverter turned off (Allowable setting range varies depending on whether the frequency offset is on or off, the LO frequency within the frequency offset, the conversion mode used in the frequency offset, the target frequency and frequency range of the narrow band mode)**

	<Numeric>
Range	9.2M to 117.0128G
Preset value	1G
Unit	Hz
Resolution	-

When the downconverter is turned on and the RF input is set to 'E5052A Direct' (Allowable setting range varies depending on whether the frequency offset is on or off, the LO frequency within the frequency offset, the conversion mode used in the

frequency offset, the target frequency and frequency range of the narrowband mode)

	<Description>
Range	9.2M to 113.0128G
Preset value	3G
Unit	Hz
Resolution	100m

When the downconverter is turned on and the RF input is set to 'Downconverter' (Allowable setting range varies depending on the target frequency and frequency range of the narrowband mode)

	<Description>
Range	2.9872G to 26.5128G
Preset value	3G
Unit	Hz
Resolution	100m

Equivalent key TR Menu -> Setup -> Video Trigger -> Narrow Freq

:TRIGger:TR[1-1]:NARRow:VIDeo:THReshold

Syntax :TRIGger:TR[1-1]:NARRow:VIDeo:THReshold <numeric>
:TRIGger:TR[1-1]:NARRow:VIDeo:THReshold?

Description Sets/Reads the video trigger threshold level relative to maximum input level

Parameter

	<Numeric>
Range	-100 to 0
Preset value	-20
Unit	dB
Resolution	1

Equivalent key TR Menu -> Setup -> Video Trigger -> Minimum Power Level

:TRIGger:TR[1-1]:SOURce

Syntax :TRIGger:TR[1-1]:SOURce {INTERNAL|EXTERNAL|MANUAL|BUS|WVIDEO|NVIDEO}
:TRIGger:TR[1-1]:SOURce?

Description Selects trigger source

Parameter

	Description
INTernal(Preset value)	Set trigger source to 'INTernal'
EXTernal	Set trigger source to 'EXTernal'
MANual	Set trigger source to 'MANual'
BUS	Set trigger source to 'BUS'
WVIdEo	Set trigger source to 'WVIdEo'
NVIdEo	Set trigger source to 'NVIdEo'

Equivalent key TR Menu -> Trigger -> Source

:TRIGger:TR[1-1]:WIDE:VIDEo:FREQuency:CENTer

Syntax :TRIGger:TR[1-1]:WIDE:VIDEo:FREQuency:CENTer <numeric>
 :TRIGger:TR[1-1]:WIDE:VIDEo:FREQuency:CENTer?

Description Sets/Reads the video trigger frequency value for wideband mode in the transient measurement

Parameter **When the E5052A is used stand-alone, or with the downconverter turned off (Allowable setting range varies depending on whether the frequency offset is on or off, the LO frequency within the frequency offset, the conversion mode used in the frequency offset, and the transient frequency range of the wideband mode)**

	<Numeric>
Range	50M to 117G
Preset value	1G
Unit	Hz
Resolution	-

When the downconverter is turned on and the RF input is set to 'E5052A Direct' (Allowable setting range varies depending on whether the frequency offset is on or off, the LO frequency within the frequency offset, the conversion mode used in the frequency offset, and the transient frequency range of the wideband mode)

	<Description>
Range	50M to 113G
Preset value	1G
Unit	Hz
Resolution	100m

**When the downconverter is turned on and the RF input is set to 'Downconverter'
(Allowable setting range varies depending on the transient frequency range of the
wideband mode)**

	<Description>
Range	3G to 26.5G
Preset value	1G
Unit	Hz
Resolution	100m

Equivalent key

TR Menu -> Setup -> Video Trigger -> Wide Freq

Command list

List by function

Bellow table shows the SCPI command list by function.

Function	Setting/Execution item	Command
24Bit I/O control	Outputs data using port A	:CONT:HAND:A[:DATA]
	Outputs data using port B	:CONT:HAND:B[:DATA]
	Inputs/Outputs data using port C	:CONT:HAND:C[:DATA]
	Selects input/output mode on port C	:CONT:HAND:C:MODE
	Inputs/Outputs data using port D	:CONT:HAND:D[:DATA]
	Selects input/output mode on port D	:CONT:HAND:D:MODE
	Inputs/outputs data using port E(port C + port D; 16 bits)	:CONT:HAND:E[:DATA]
	Inputs/outputs data using port F(port A + port C; 16 bits)	:CONT:HAND:F[:DATA]
	Sets/Reads OUTPUT1 and/or OUTPUT2	:CONT:HAND:OUTP[1-2][:DATA]
Auto Frequency Control	Turns on/off the auto frequency control function	:SOUR:VOLT:CONT:AFC[:STAT]
	Executes the auto frequency control once.	:SOUR:VOLT:CONT:AFC:IMM
	Sets/Reads the frequency band in the auto frequency control function	:SOUR:VOLT:CONT:AFC:FBAN
	Sets/Reads the maximum number of iterations for the DC control voltage-setting loops	:SOUR:VOLT:CONT:AFC:ITER
	Sets/Reads the maximum DC control voltage limit	:SOUR:VOLT:CONT:AFC:LIM:HIGH
	Sets/Reads the minimum DC control voltage limit	:SOUR:VOLT:CONT:AFC:LIM:LOW
	Sets/Reads the maximum input level of the downconverter in order to determine the IF Gain	:SOUR:VOLT:CONT:AFC:INP:LEV:MAX
	Sets/Reads the tuning sensitivity	:SOUR:VOLT:CONT:AFC:SENS
	Sets/Reads the target frequency in the auto frequency control function	:SOUR:VOLT:CONT:AFC:TARG
	Sets/Reads the tolerance limit	:SOUR:VOLT:CONT:AFC:TOL
Beeper	Makes beep sound for operation completion	:SYST:BEEP:COMP:IMM
	Turns on/off the beep for operation completion	:SYST:BEEP:COMP:STAT
	Makes beep sound for warning	:SYST:BEEP:WARN:IMM
	Turns on/off the beep for warning	:SYST:BEEP:WARN:STAT

Function	Setting/Execution item	Command
DC sources	Executes DC CTRL DRIFT CAL	:SOUR:VOLT:CONT:CORR:COLL:ACQ
	DC CTRL DRIFT CAL state	:SOUR:VOLT:CONT:CORR[:STAT]
	DC Control delay setting(sec)	:SOUR:VOLT:CONT:DEL
	Sets/Reads DC Control voltage	:SOUR:VOLT:CONT:LEV:AMPL
	Turns on/off DC Control voltage output	:SOUR:VOLT:CONT:LEV:STAT
	Sets/Reads maximum voltage limit for DC Control	:SOUR:VOLT:CONT:LIM:HIGH
	Sets/Reads minimum voltage limit for DC Control	:SOUR:VOLT:CONT:LIM:LOW
	DC Power delay setting(sec)	:SOUR:VOLT:POW:DEL
	Sets/Reads DC Power voltage	:SOUR:VOLT:POW:LEV:AMPL
	Truns on/off DC power voltage output	:SOUR:VOLT:POW:LEV:STAT
	Sets/Reads maximum voltage limit for DC Power	:SOUR:VOLT:POW:LIM:HIGH
	Sets/Reads minimum voltage limit for DC Power	:SOUR:VOLT:POW:LIM:LOW
	Display	Turns on/off internal clock display
Adds texts in echo window		:DISP:ECHO:ADD
Clears echo window		:DISP:ECHO:CLE
Edits texts in echo window.		:DISP:ECHO:DATA
font size in echo window		:DISP:ECHO:FSIZ
Shows/Hides echo window		:DISP:ECHO:STAT
Enable/disable trce update		:DISP:ENAB
Maximizes active instrument window		:DISP:MAX
Shows/Hides softkey		:DISP:SKEY:STAT
Updates display force		:DISP:UPD:IMM
Selects active instrument window		:DISP:WIND:ACT
Sets/Reads the normal display/inverted display		:DISP:IMAG
Sets the background color for normal display and inverted display		:DISP:COL[1-2]:BACK[:VAL]
Sets the color of the graticule label and the outer frame line of the graph and the color of the grid lines in the graph for normal display and inverted display		:DISP:COL[1-2]:GRAT[1-2][:VAL]
Sets/Reads the fail display color used for the limit test result and the color of the limit line for normal display and inverted display		:DISP:COL[1-2]:LIM[1-2][:VAL]
Set the color of the data trace of trace 1 to trace 8 for normal display and inverted display		:DISP:COL[1-2]:TRAC[1-8]:DATA[:VAL]

SCPI Command Reference
Command list

Function	Setting/Execution item	Command
Display (Continued)	Set the color of the memory trace of trace 1 to trace 8 for normal display and inverted display	:DISP:COL[1-2]:TRAC[1-8]:MEM[:VAL]
	Resets the display color settings for all items to the factory preset state for normal display and inverted display	:DISP:COL[1-2]:RES
Downconverter selection	Sets downconverter on or off, or reads its settings	:SENS:DCON[:STAT]
	Sets/Reads the signal supplied to the RF input port	:SENS:DCON:INP
	Sets the use of the external mixer on or off and reads its settings	:SENS:DCON:MEXT
External mixer support	Sets/Reads the differential frequency between CH1 and CH2 from the external mixer	:SENS:DCON:MAN:IFD
	Sets/Reads the IF gain of the external mixer	:SENS:DCON:MAN:IFG[1-2]
	Sets/Reads the LO frequency of the external mixer	:SENS:DCON:MAN:LO[1-2]:FREQ
	Sets/Reads the LO level of the external mixer	:SENS:DCON:MAN:LO[1-2]:LEV
	Sets/Reads the bias current to be supplied to the external mixer	:SENS:DCON:MAN:MEXT[1-2]:BIAS:CURR
	Sets the bias current supplied to the external mixer on or off and reads its settings	:SENS:DCON:MAN:MEXT[1-2]:BIAS:STAT
	Calculates LO frequencies of CH1 and CH2 such that appropriate IF frequencies can be obtained based on input signal frequencies to the external mixer and harmonic order.	:SENS:DCON:MAN:CALC:LO?
File operation	Catalog directory	:MMEM:CAT
	Coies file	:MMEM:COPY
	File transfer through SCPI	:MMEM:DATA
	Deletes file/directory	:MMEM:DEL
	Loads program	:MMEM:LOAD:PROG
	Recalls settings	:MMEM:LOAD:STAT
	Creates a directory	:MMEM:MDIR
	Saves screen image	:MMEM:STOR:IMAG
	Saves VBA project	:MMEM:STOR:PROG
	Saves settings	:MMEM:STOR:STAT
	Selects save state type	:MMEM:STOR:STYP
Frequency Offset	Sets/Reads the frequency offset factor	:SENS:UDC:HARM
	Sets/Reads the LO frequency of the frequency offset	:SENS:UDC:LO
	Sets/Reads the conversion mode of the frequency offset	:SENS:UDC:MODE
	Sets/Reads the frequency offset	:SENS:UDC:STAT

Function	Setting/Execution item	Command
Frequency, RF power and DC current measurement - Display	Selects active trace	:CALC:FP[1-1]:ALLT:ACT
	Sets/Reads data hold type	:CALC:FP[1-1]:TRAC[1-4]:HOLD
	Sets/Reads math operation type	:CALC:FP[1-1]:TRAC[1-4]:MATH:FUNC
	Copies data to memory	:CALC:FP[1-1]:TRAC[1-4]:MATH:MEM
	Sensitivity Aperture	:CALC:FP[1-1]:TRAC[1-4]:SAP
	Smoothing aperture	:CALC:FP[1-1]:TRAC[1-4]:SMO:APER
	Smoothing on/off	:CALC:FP[1-1]:TRAC[1-4]:SMO:STAT
	Clears persistent mode	:DISP:FP[1-1]:ALLT:PERS:CLE
	Executes autoscale for all traces	:DISP:FP[1-1]:ALLT:Y:SCAL:AUTO
	Turns on/off measurement conditions	:DISP:FP[1-1]:ANN:MEAS:STAT
	Turns on/off relative Y-scale	:DISP:FP[1-1]:GRAT:AXIS:Y:REL
	Shows/Hides Y graticule label	:DISP:FP[1-1]:GRAT:AXIS:Y:STAT
	Window title label	:DISP:FP[1-1]:LAB:DATA
	Shows/Hides Window Title Label	:DISP:FP[1-1]:LAB:STAT
	Maximizes active trace	:DISP:FP[1-1]:MAX
	Turns on/off measurement display	:DISP:FP[1-1]:STAT
	Edits trace title label	:DISP:FP[1-1]:TRAC[1-4]:LAB:DATA
	Shows data and/or memory trace	:DISP:FP[1-1]:TRAC[1-4]:MODE
	Clears persistence mode	:DISP:FP[1-1]:TRAC[1-4]:PERS:CLE
	Sets/Reads persistence mode	:DISP:FP[1-1]:TRAC[1-4]:PERS:STAT
	Executes autoscale	:DISP:FP[1-1]:TRAC[1-4]:Y[:SCAL]:AUTO
	Sets/Reads scale per division	:DISP:FP[1-1]:TRAC[1-4]:Y[:SCAL]:PDIV
	Sets/Reads scale reference level	:DISP:FP[1-1]:TRAC[1-4]:Y[:SCAL]:RLEV
	Sets/Reads scale reference position	:DISP:FP[1-1]:TRAC[1-4]:Y[:SCAL]:RPOS
	Sets/Reads # of Y division	:DISP:FP[1-1]:Y[:SCAL]:DIV
	Copies trace data to the user trace	:CALC:FP[1-1]:TRAC[1-4]:DATA:COPY
	Sets/Reads the trace layout	:DISP:FP[1-1]:SPL
	FP-frequency format	:CALC:FP[1-1]:TRAC[1-4]:FORM:FREQ
	Sets/Reads the frequency reference.	:CALC:FP[1-1]:TRAC[1-4]:REF:FREQ
	Reads the trace parameter.	:CALC:FP[1-1]:TRAC[1-4]:PAR

SCPI Command Reference
Command list

Function	Setting/Execution item	Command
Frequency, RF power and DC current measurement - Display (Continued)	Sets/Reads the offset value of trace data	:CALC:FP[1-1]:TRAC[1-4]:MATH:OFFS
	Sets/Reads automatic setting of the X-axis display range of the graph of trace data to the stimulus value	:DISP:FP[1-1]:TRAC[1-4]:X[:SCAL]:AUTO
	Sets/Reads the start value of the X-axis of the graph display of trace data	:DISP:FP[1-1]:TRAC[1-4]:X[:SCAL]:LEFT
	Sets/Reads the stop value of the X-axis of the graph display of trace data	:DISP:FP[1-1]:TRAC[1-4]:X[:SCAL]:RIGH
Frequency, RF power and DC current measurement - Downconverter settings	Sets/Reads the input frequency to be supplied to the downconverter	:SENS:FP[1-1]:DCON:FREQ
	Searches carrier signal and reflects the result to the input frequency of the downconverter	:SENS:FP[1-1]:DCON:SSE:EXEC
	Sets/Reads the maximum input level of the downconverter in order to determine the IF Gain	:SENS:FP[1-1]:POW:INP:LEV:MAX
Frequency, RF power and DC current measurement - File operation	Saves trace data	:MMEM:FP[1-1]:TRAC[1-4]:STOR[:DATA]
	Saves memory trace data	:MMEM:FP[1-1]:TRAC[1-4]:STOR:MEM
Frequency, RF power and DC current measurement - Limit Test	Reads out the limit test result	:CALC:FP[1-1]:ALLT:LIM:FAIL
	Turns on/off the limit test function	:CALC:FP[1-1]:TRAC[1-4]:LIM[:STAT]
	Sets/Reads the number of segments in the upper limit line	:CALC:FP[1-1]:TRAC[1-4]:LIM:UPP:SEGM:COUN
	Sets/Reads the number of segments in the lower limit line	:CALC:FP[1-1]:TRAC[1-4]:LIM:LOW:SEGM:COUN
	Sets/Reads segment data of the upper limit line	:CALC:FP[1-1]:TRAC[1-4]:LIM:UPP:SEGM:DATA
	Sets/Reads segment data of the lower limit line	:CALC:FP[1-1]:TRAC[1-4]:LIM:LOW:SEGM:DATA
	Clears the upper limit line	:CALC:FP[1-1]:TRAC[1-4]:LIM:UPP:SEGM:CLE
	Clears the lower limit line	:CALC:FP[1-1]:TRAC[1-4]:LIM:LOW:SEGM:CLE
	Sets/Reads the upper limit values of all measurement points	:CALC:FP[1-1]:TRAC[1-4]:LIM:UPP:LDAT
	Sets/Reads the lower limit values of all measurement points	:CALC:FP[1-1]:TRAC[1-4]:LIM:LOW:LDAT
	Reads out the limit test result	:CALC:FP[1-1]:TRAC[1-4]:LIM:FAIL
	Reads the limit test results of all measurement points in selected traces	:CALC:FP[1-1]:TRAC[1-4]:LIM:REP[:DATA]
	Turns on/off the limit line	:DISP:FP[1-1]:TRAC[1-4]:LIM:LINE
	Turns on/off the limit test judgement display	:DISP:FP[1-1]:LIM:FSIG
	Reads the upper limit line	:MMEM:FP[1-1]:TRAC[1-4]:LOAD:LIM:UPP
Reads the lower limit line	:MMEM:FP[1-1]:TRAC[1-4]:LOAD:LIM:LOW	

Function	Setting/Execution item	Command
Frequency, RF power and DC current measurement - Marker/analysis	Turns on/off bandmarker coupling function	:CALC:FP[1-1]:ALLT:BDM:X:COUP:STAT
	Turns on/of marker coupling function	:CALC:FP[1-1]:ALLT:MARK:COUP:STAT
	Sets/Reads marker movement (Continuous/Discrete)	:CALC:FP[1-1]:ALLT:MARK:DISC:STAT
	Sets/Reads marker reference number	:CALC:FP[1-1]:ALLT:MARK:REF:NUMB
	Turns on/off delta marker mode	:CALC:FP[1-1]:ALLT:MARK:REF:STAT
	Selects active marker	:CALC:FP[1-1]:TRAC[1-4]:ALLM:ACT
	Sets/Reads marker search range (X-axis)	:CALC:FP[1-1]:TRAC[1-4]:ALLM:SEAR:DOM:X
	Sets/Reads marker search range (Y-axis)	:CALC:FP[1-1]:TRAC[1-4]:ALLM:SEAR:DOM:Y
	Executes marker search all	:CALC:FP[1-1]:TRAC[1-4]:ALLM:SEAR:PEAK
	Sets/Reads the center value of bandmarker X	:CALC:FP[1-1]:TRAC[1-4]:BDM:X:CENT
	Sets/Reads the span value of bandmarker X	:CALC:FP[1-1]:TRAC[1-4]:BDM:X:SPAN
	Sets/Reads the start value of bandmarker X	:CALC:FP[1-1]:TRAC[1-4]:BDM:X:STAR
	Turns on/off bandmarker X	:CALC:FP[1-1]:TRAC[1-4]:BDM:X:STAT
	Sets/Reads the stop value of bandmarker X	:CALC:FP[1-1]:TRAC[1-4]:BDM:X:STOP
	Sets/Reads the center value of bandmarker Y	:CALC:FP[1-1]:TRAC[1-4]:BDM:Y:CENT
	Sets/Reads the span value of bandmarker Y	:CALC:FP[1-1]:TRAC[1-4]:BDM:Y:SPAN
	Sets/Reads the start value of bandmarker Y	:CALC:FP[1-1]:TRAC[1-4]:BDM:Y:STAR
	Turns on/off bandmarker Y	:CALC:FP[1-1]:TRAC[1-4]:BDM:Y:STAT
	Sets/Reads the stop value of bandmarker Y	:CALC:FP[1-1]:TRAC[1-4]:BDM:Y:STOP
	Sets/Reads analysis/search range (X-axis)	:CALC:FP[1-1]:TRAC[1-4]:FUNC:DOM:X
	Sets/Reads analysis/search range (Y-axis)	:CALC:FP[1-1]:TRAC[1-4]:FUNC:DOM:Y
	Reads the results of statistical analysis for the data trace	:CALC:FP[1-1]:TRAC[1-4]:FUNC:STAT:DATA
	Reads the results of statistical analysis for the memory trace	:CALC:FP[1-1]:TRAC[1-4]:FUNC:STAT:MEM
	Sets/Reads analysis type	:CALC:FP[1-1]:TRAC[1-4]:FUNC:TYPE
	Executes marker peak search left	:CALC:FP[1-1]:TRAC[1-4]:MARK[1-10]:SEAR:EXEC:LPE
	Executes marker target search left	:CALC:FP[1-1]:TRAC[1-4]:MARK[1-10]:SEAR:EXEC:LTAR
	Executes marker search maximum	:CALC:FP[1-1]:TRAC[1-4]:MARK[1-10]:SEAR:EXEC:MAX
	Executes marker search minimum	:CALC:FP[1-1]:TRAC[1-4]:MARK[1-10]:SEAR:EXEC:MIN
	Executes marker peak search	:CALC:FP[1-1]:TRAC[1-4]:MARK[1-10]:SEAR:EXEC:PEAK

SCPI Command Reference
Command list

Function	Setting/Execution item	Command
Frequency, RF power and DC current measurement - Marker/analysis (Continued)	Executes marker peak search right	:CALC:FP[1-1]:TRAC[1-4]:MARK[1-10]:SEAR:EXEC:RPE
	Executes marker target search right	:CALC:FP[1-1]:TRAC[1-4]:MARK[1-10]:SEAR:EXEC:RTAR
	Executes marker target search	:CALC:FP[1-1]:TRAC[1-4]:MARK[1-10]:SEAR:EXEC:TARG
	Sets/Reads the peak excursion value	:CALC:FP[1-1]:TRAC[1-4]:MARK[1-10]:SEAR:PEAK:EXC
	Sets/Reads the marker peak-search polarity	:CALC:FP[1-1]:TRAC[1-4]:MARK[1-10]:SEAR:PEAK:POL
	Sets/Reads the target transition definition	:CALC:FP[1-1]:TRAC[1-4]:MARK[1-10]:SEAR:TARG:TRAN
	Sets/Reads the marker target value	:CALC:FP[1-1]:TRAC[1-4]:MARK[1-10]:SEAR:TARG:Y
	Sets/Reads the marker tracking type	:CALC:FP[1-1]:TRAC[1-4]:MARK[1-10]:SEAR:TRAC:TYPE
	Turns on/off markers	:CALC:FP[1-1]:TRAC[1-4]:MARK[1-10]:STAT
	Sets/Reads the marker X value	:CALC:FP[1-1]:TRAC[1-4]:MARK[1-10]:X
	Reads the marker Y value	:CALC:FP[1-1]:TRAC[1-4]:MARK[1-10]:Y
	Sets/Reads the marker information position	:DISP:FP[1-1]:ANN:MARK:POS
	Turns on/off the marker list	:DISP:FP[1-1]:TABL[:STAT]
	Calculates regression line coefficient (a and b of $Y = aX + b$) for trace data and reads the result	:CALC:FP[1-1]:TRAC[1-4]:FUNC:LREG:DATA
	Calculates regression line coefficient (a and b of $Y = aX + b$) for trace memory and reads the result	:CALC:FP[1-1]:TRAC[1-4]:FUNC:LREG:MEM
	Sets/Reads the a value of the line equation ($Y = aX + b$) for linearity evaluation of trace data	:CALC:FP[1-1]:TRAC[1-4]:LINE:A
	Sets/Reads the b value of the line equation ($Y = aX + b$) for linearity evaluation of trace data	:CALC:FP[1-1]:TRAC[1-4]:LINE:B
	Sets to trace memory the line which is the result of the line equation ($Y = aX + b$) for linearity evaluation of trace data	:CALC:FP[1-1]:TRAC[1-4]:LINE:MEM
	Frequency, RF power and DC current measurement - Measurement	Triggers continuous mode
Triggers once		:INIT:FP[1-1]:IMM
Selects analyzer/tester mode (Analyzer mode is not available when option 011 is installed)		:TRIG:FP[1-1]:MODE
Selects trigger source		:TRIG:FP[1-1]:SOUR

Function	Setting/Execution item	Command
Frequency, RF power and DC current measurement - Measurement conditions	Restarts averaging	:SENS:FP[1-1]:AVER:CLE
	Sets/Reads averaging count	:SENS:FP[1-1]:AVER:COUN
	Turns on/off averaging function	:SENS:FP[1-1]:AVER:STAT
	Selects frequency band	:SENS:FP[1-1]:FBAN
	Sets/Reads frequency resolution	:SENS:FP[1-1]:FREQ:RES
	Sets/Reads the point delay value	:SENS:FP[1-1]:SWE:DWEL
	Sets/Reads sweep parameter	:SOUR:FP[1-1]:SWE:PAR
	Sets/Reads the number of measurement points	:SOUR:FP[1-1]:SWE:POIN
	Sets/Reads the center value of DC Control voltage	:SOUR:FP[1-1]:VOLT:CONT:CENT
	Sets/Reads the span value of DC Control voltage	:SOUR:FP[1-1]:VOLT:CONT:SPAN
	Sets/Reads the start value of DC Control voltage	:SOUR:FP[1-1]:VOLT:CONT:STAR
	Sets/Reads the stop value of DC Control voltage	:SOUR:FP[1-1]:VOLT:CONT:STOP
	Sets/Reads the center value of DC Power voltage	:SOUR:FP[1-1]:VOLT:POW:CENT
	Sets/Reads the span value of DC Power voltage	:SOUR:FP[1-1]:VOLT:POW:SPAN
	Sets/Reads the start value of DC power voltage	:SOUR:FP[1-1]:VOLT:POW:STAR
	Sets/Reads the stop value of DC power voltage	:SOUR:FP[1-1]:VOLT:POW:STOP
Frequency, RF power and DC current measurement - Reads/writes the data	Sets/Reads raw data	:CALC:FP[1-1]:DATA:RDAT
	Sets/Reads tester mode data	:CALC:FP[1-1]:DATA:TDAT
	Reads X-axis data	:CALC:FP[1-1]:DATA:XDAT
	Sets/Gets formatted trace data	:CALC:FP[1-1]:TRAC[1-4]:DATA:FDAT
	Sets/Gets formatted memory data	:CALC:FP[1-1]:TRAC[1-4]:DATA:FMEM
	Sets/Gets unformatted trace data	:CALC:FP[1-1]:TRAC[1-4]:DATA:UDAT
	Sets/Gets unformatted memory data	:CALC:FP[1-1]:TRAC[1-4]:DATA:UMEM
	Reads the measurement time	:SENS:FP[1-1]:SWE:TIME:DATA
Internal clock	Sets/Gets system date	:SYST:DATE
	Sets/Gets system time	:SYST:TIME
Measurement	Abort measurement	:ABOR
	BUS Trigger	*TRG
	Input Attenuator level on 5dB Step	:SENS:ATT:LEV
	External trigger polarity	:TRIG:EXT:SLOP
	Selects measurement mode	:TRIG:MODE
	Sets/Reads the averaging trigger mode	:TRIG:AVER
	Turns on/off the *OPC, *OPC?, and *WAI commands	:TRIG:SOPC

SCPI Command Reference
Command list

Function	Setting/Execution item	Command
Operations	Sets/Gets front panel and keyboard lock state	:SYST:KLOC:KBD
	Sets/Gets touch screen and mouse lock state	:SYST:KLOC:MOUS
Others	Clears caution/message	:DISP:MESS:CLE
	Reads product model information	*IDN
	Reads product information of the downconverter	:SENS:DCON:IDN
	Reads option information	*OPT
	Preset	*RST
	Sets/recalls the security level	:SYST:SEC[:LEV]
	Gets source of reference oscillator	:SENS:ROSC:SOUR
	Turns on/off backlight	:SYST:BACK:STAT
	Gets error code & description	:SYST:ERR[:NEXT]
	Powers off the instrument	:SYST:POFF
	Presets instrument	:SYST:PRES
	Blocks program processing until the end of measurement	*WAI
Phase noise measurement - Display	Sets/Reads data hold type	:CALC:PN[1-1]:TRAC[1-1]:HOLD
	Selects math operation type	:CALC:PN[1-1]:TRAC[1-1]:MATH:FUNC
	Copies data to memory	:CALC:PN[1-1]:TRAC[1-1]:MATH:MEM
	Sets/Reads the smoothing aperture value	:CALC:PN[1-1]:TRAC[1-1]:SMO:APER
	Turns on/off smoothing	:CALC:PN[1-1]:TRAC[1-1]:SMO:STAT
	Turns on/off spurious omission mode	:CALC:PN[1-1]:TRAC[1-1]:SPUR:OMIS
	Clears all persistent traces	:DISP:PN[1-1]:ALLT:PERS:CLE
	Turns on/off measurement conditions	:DISP:PN[1-1]:ANN:MEAS:STAT
	Sets/Reads the relative Y-axis label	:DISP:PN[1-1]:GRAT:AXIS:Y:REL
	Shows/Hides Y graticule label	:DISP:PN[1-1]:GRAT:AXIS:Y:STAT
	Edits window title label	:DISP:PN[1-1]:LAB:DATA
	Shows/Hides Window Title Label	:DISP:PN[1-1]:LAB:STAT
	Maximizes active trace	:DISP:PN[1-1]:MAX
	Turns on/off phase noise measurement mode	:DISP:PN[1-1]:STAT
	Traces Title Label	:DISP:PN[1-1]:TRAC[1-1]:LAB:DATA
	Shows data and/or memory trace	:DISP:PN[1-1]:TRAC[1-1]:MODE
	Clears persistent data	:DISP:PN[1-1]:TRAC[1-1]:PERS:CLE
	Sets/Reads persistence mode	:DISP:PN[1-1]:TRAC[1-1]:PERS:STAT
Executes autoscale	:DISP:PN[1-1]:TRAC[1-1]:Y[:SCAL]:AUTO	

Function	Setting/Execution item	Command
Phase noise measurement - Display (Continued)	Sets/Reads scale per division	:DISP:PN[1-1]:TRAC[1-1]:Y[:SCAL]:PDIV
	Sets/Reads scale reference level	:DISP:PN[1-1]:TRAC[1-1]:Y[:SCAL]:RLEV
	Sets/Reads scale reference position	:DISP:PN[1-1]:TRAC[1-1]:Y[:SCAL]:RPOS
	Sets/Reads # of Y division	:DISP:PN[1-1]:Y[:SCAL]:DIV
	Copies trace data to the user trace	:CALC:PN[1-1]:TRAC[1-1]:DATA:COPY
	Sets/Reads the offset value of trace data	:CALC:PN[1-1]:TRAC[1-1]:MATH:OFFS
	Sets/Reads automatic setting of the X-axis display range of the graph of trace data to the stimulus value	:DISP:PN[1-1]:TRAC[1-1]:X[:SCAL]:AUTO
	Sets/Reads the start value of the X-axis of the graph display of trace data	:DISP:PN[1-1]:TRAC[1-1]:X[:SCAL]:LEFT
	Sets/Reads the stop value of the X-axis of the graph display of trace data	:DISP:PN[1-1]:TRAC[1-1]:X[:SCAL]:RIGH
Phase noise measurement - Downconverter settings	Sets/Reads input frequency of the downconverter	:SENS:PN[1-1]:DCON:FREQ
	Searches carrier signal and reflects the result to the input frequency of the downconverter	:SENS:PN[1-1]:DCON:SSE:EXEC
Phase noise measurement - File operation	Saves trace data	:MMEM:PN[1-1]:TRAC[1-1]:STOR[:DATA]
	Saves memory trace data	:MMEM:PN[1-1]:TRAC[1-1]:STOR:MEM
Phase noise measurement - Limit Test	Reads out the limit test result	:CALC:PN[1-1]:ALLT:LIM:FAIL
	Turns on/off the limit test function	:CALC:PN[1-1]:TRAC[1-1]:LIM[:STAT]
	Sets/Reads the number of segments in the upper limit line	:CALC:PN[1-1]:TRAC[1-1]:LIM:UPP:SEGM:COUN
	Sets/Reads the number of segments in the lower limit line	:CALC:PN[1-1]:TRAC[1-1]:LIM:LOW:SEGM:COUN
	Sets/Reads segment data of the upper limit line	:CALC:PN[1-1]:TRAC[1-1]:LIM:UPP:SEGM:DATA
	Sets/Reads segment data of the lower limit line	:CALC:PN[1-1]:TRAC[1-1]:LIM:LOW:SEGM:DATA
	Clears the upper limit line	:CALC:PN[1-1]:TRAC[1-1]:LIM:UPP:SEGM:CLE
	Clears the lower limit line	:CALC:PN[1-1]:TRAC[1-1]:LIM:LOW:SEGM:CLE
	Sets/Reads the upper limit values of all measurement points	:CALC:PN[1-1]:TRAC[1-1]:LIM:UPP:LDAT
	Sets/Reads the lower limit values of all measurement points	:CALC:PN[1-1]:TRAC[1-1]:LIM:LOW:LDAT
	Reads out the limit test result	:CALC:PN[1-1]:TRAC[1-1]:LIM:FAIL
	Reads the limit test results of all measurement points in selected traces	:CALC:PN[1-1]:TRAC[1-1]:LIM:REP[:DATA]
	Turns on/off the limit line	:DISP:PN[1-1]:TRAC[1-1]:LIM:LINE
	Turns on/off the limit test judgement display	:DISP:PN[1-1]:LIM:FSIG
	Reads the upper limit line	:MMEM:PN[1-1]:TRAC[1-1]:LOAD:LIM:UPP
	Reads the lower limit line	:MMEM:PN[1-1]:TRAC[1-1]:LOAD:LIM:LOW

SCPI Command Reference
Command list

Function	Setting/Execution item	Command
Phase noise measurement - Marker/analysis	Turns on/off marker coupling function	:CALC:PN[1-1]:ALLT:MARK:COUP:STAT
	Sets/Reads marker movement (Continuous/Discrete)	:CALC:PN[1-1]:ALLT:MARK:DISC:STAT
	Sets/Reads marker reference number	:CALC:PN[1-1]:ALLT:MARK:REF:NUMB
	Turns on/off delta marker mode	:CALC:PN[1-1]:ALLT:MARK:REF:STAT
	Selects active marker	:CALC:PN[1-1]:TRAC[1-1]:ALLM:ACT
	Sets/Reads marker search range (X-axis)	:CALC:PN[1-1]:TRAC[1-1]:ALLM:SEAR:DOM:X
	Sets/Reads marker search range (Y-axis)	:CALC:PN[1-1]:TRAC[1-1]:ALLM:SEAR:DOM:Y
	Executes marker search all	:CALC:PN[1-1]:TRAC[1-1]:ALLM:SEAR:PEAK
	Sets/Reads the center value of bandmarker X	:CALC:PN[1-1]:TRAC[1-1]:BDM:X:CENT
	Sets/Reads the span value of bandmarker X	:CALC:PN[1-1]:TRAC[1-1]:BDM:X:SPAN
	Sets/Reads the start value of bandmarker X	:CALC:PN[1-1]:TRAC[1-1]:BDM:X:STAR
	Turns on/off bandmarker X	:CALC:PN[1-1]:TRAC[1-1]:BDM:X:STAT
	Sets/Reads the stop value of bandmarker X	:CALC:PN[1-1]:TRAC[1-1]:BDM:X:STOP
	Sets/Reads the center value of bandmarker Y	:CALC:PN[1-1]:TRAC[1-1]:BDM:Y:CENT
	Sets/Reads the span value of bandmarker Y	:CALC:PN[1-1]:TRAC[1-1]:BDM:Y:SPAN
	Sets/Reads the start value of bandmarker Y	:CALC:PN[1-1]:TRAC[1-1]:BDM:Y:STAR
	Turns on/off bandmarker Y	:CALC:PN[1-1]:TRAC[1-1]:BDM:Y:STAT
	Sets/Reads the stop value of bandmarker Y	:CALC:PN[1-1]:TRAC[1-1]:BDM:Y:STOP
	Sets/Reads analysis/search range (X-axis)	:CALC:PN[1-1]:TRAC[1-1]:FUNC:DOM:X
	Sets/Reads analysis/search range (Y-axis)	:CALC:PN[1-1]:TRAC[1-1]:FUNC:DOM:Y
	Reads the results of statistical analysis for the data trace	:CALC:PN[1-1]:TRAC[1-1]:FUNC:STAT:DATA
	Reads the results of statistical analysis for the memory trace	:CALC:PN[1-1]:TRAC[1-1]:FUNC:STAT:MEM
	Sets/Reads analysis type	:CALC:PN[1-1]:TRAC[1-1]:FUNC:TYPE
	Executes marker peak search left	:CALC:PN[1-1]:TRAC[1-1]:MARK[1-10]:SEAR:EXEC:LPE
	Executes marker target search left	:CALC:PN[1-1]:TRAC[1-1]:MARK[1-10]:SEAR:EXEC:LTAR
	Executes marker search maximum	:CALC:PN[1-1]:TRAC[1-1]:MARK[1-10]:SEAR:EXEC:MAX
	Executes marker search minimum	:CALC:PN[1-1]:TRAC[1-1]:MARK[1-10]:SEAR:EXEC:MIN
	Executes marker peak search	:CALC:PN[1-1]:TRAC[1-1]:MARK[1-10]:SEAR:EXEC:PEAK
Executes marker peak search right	:CALC:PN[1-1]:TRAC[1-1]:MARK[1-10]:SEAR:EXEC:RPE	

Function	Setting/Execution item	Command
Phase noise measurement - Marker/analysis (Continued)	Executes marker target search right	:CALC:PN[1-1]:TRAC[1-1]:MARK[1-10]:SEAR:EXEC:RTAR
	Executes marker target search	:CALC:PN[1-1]:TRAC[1-1]:MARK[1-10]:SEAR:EXEC:TARG
	Sets/Reads the peak excursion value	:CALC:PN[1-1]:TRAC[1-1]:MARK[1-10]:SEAR:PEAK:EXC
	Sets/Reads the marker peak-search polarity	:CALC:PN[1-1]:TRAC[1-1]:MARK[1-10]:SEAR:PEAK:POL
	Sets/Reads the target transition definition	:CALC:PN[1-1]:TRAC[1-1]:MARK[1-10]:SEAR:TARG:TRAN
	Sets/Reads the marker target value	:CALC:PN[1-1]:TRAC[1-1]:MARK[1-10]:SEAR:TARG:Y
	Sets/Reads the marker tracking type	:CALC:PN[1-1]:TRAC[1-1]:MARK[1-10]:SEAR:TRAC:TYPE
	Turns on/off markers	:CALC:PN[1-1]:TRAC[1-1]:MARK[1-10]:STAT
	Sets/Reads the marker X value	:CALC:PN[1-1]:TRAC[1-1]:MARK[1-10]:X
	Reads the marker Y value	:CALC:PN[1-1]:TRAC[1-1]:MARK[1-10]:Y
	Sets/Reads the marker information position	:DISP:PN[1-1]:ANN:MARK:POS
	Turns on/off the marker list	:DISP:PN[1-1]:TABL[:STAT]
	Reads the integrated phase noise, frequency range, RMS noise, RMS jitter, and residual FM of trace data.	:CALC:PN[1-1]:TRAC[1-1]:FUNC:INT:DATA
	Reads the integrated phase noise, frequency range, RMS noise, RMS jitter, and residual FM of memory data.	:CALC:PN[1-1]:TRAC[1-1]:FUNC:INT:MEM
	Reads specified average time, Allan avariance, and jitter at cut-off frequency from trace data	:CALC:PN[1-1]:TRAC[1-1]:FUNC:AVAR:DATA
	Reads specified average time, Allan avariance, and jitter at cut-off frequency from memory data	:CALC:PN[1-1]:TRAC[1-1]:FUNC:AVAR:MEM
Phase noise measurement - Measurement	Triggers continuous	:INIT:PN[1-1]:CONT
	Triggers once	:INIT:PN[1-1]:IMM
	Selects trigger source	:TRIG:PN[1-1]:SOUR

SCPI Command Reference
Command list

Function	Setting/Execution item	Command
Phase noise measurement - Measurement conditions	Averaging restart	:SENS:PN[1-1]:AVER:CLE
	Sets/Reads averaging count	:SENS:PN[1-1]:AVER:COUN
	Turns on/off averaging function	:SENS:PN[1-1]:AVER:STAT
	Sets/Reads the number of correlation (Not available when option 011 is installed)	:SENS:PN[1-1]:CORR:COUN
	Sets/Reads frequency band	:SENS:PN[1-1]:FBAN
	Sets/Reads start frequency (The minimum value is limited down to 10 when option 011 is installed)	:SENS:PN[1-1]:FREQ:STAR
	Sets/Reads stop frequency	:SENS:PN[1-1]:FREQ:STOP
	Sets/Reads IF Gain at 10dB steps (The value is fixed as 10 when option 011 is installed)	:SENS:PN[1-1]:IFG
	Sets/readst phase noise Local bandwidth optimization.	:SENS:PN[1-1]:LOB
	Reads the number of measurement points	:SENS:PN[1-1]:SWE:POIN
	Sets/Reads the quality level	:SENS:PN[1-1]:SEGT[:MEAS][:QUAL]
	Sets/Reads the frequency-dividing ratio of the input signal divided by the external frequency divider	:SENS:PN[1-1]:EPR:DIV
	Sets/Reads output level of the frequency divider (input level to RF IN/RF2 IN port) when the input signal divided by the external frequency divider is input from RF1 IN/RF2 IN port of the E5052A	:SENS:PN[1-1]:EPR:POW
Phase noise measurement - Reads/writes the data	Sets/Reads the carrier frequency/power data in phase noise measurement	:CALC:PN[1-1]:DATA:CARR
	Sets/Reads the measurement raw data	:CALC:PN[1-1]:DATA:RDAT
	Reads the X data	:CALC:PN[1-1]:DATA:XDAT
	Sets/Reads formatted trace data	:CALC:PN[1-1]:TRAC[1-1]:DATA:FDAT
	Sets/Reads formatted memory data	:CALC:PN[1-1]:TRAC[1-1]:DATA:FMEM
	Sets/Reads unformatted trace data	:CALC:PN[1-1]:TRAC[1-1]:DATA:UDAT
	Sets/Reads unformatted memory data	:CALC:PN[1-1]:TRAC[1-1]:DATA:UMEM

Function	Setting/Execution item	Command
Phase noise measurement - Spurious display	Turns on/off the spurious power value display	:CALC:PN[1-1]:TRAC[1-1]:SPUR:POW
	Sets/Reads the raw power data (dBc)	:CALC:PN[1-1]:DATA:PDAT
	Sets/Reads unformatted trace power data (dBc)	:CALC:PN[1-1]:TRAC[1-1]:DATA:PDAT
	Sets/Reads unformatted memory power data (dBc)	:CALC:PN[1-1]:TRAC[1-1]:DATA:PMEM
	Reads the spurious judgement results (0/1) of trace data	:CALC:PN[1-1]:TRAC[1-1]:DATA:SDAT
	Reads the spurious judgement results (0/1) of memory data.	:CALC:PN[1-1]:TRAC[1-1]:DATA:SMEM
	Clears the threshold data	:CALC:PN[1-1]:TRAC[1-1]:SPUR:THR:TABL:CLE
	Sets/Reads the number of segments in the threshold data	:CALC:PN[1-1]:TRAC[1-1]:SPUR:THR:TABL:COUN
	Sets/Reads the threshold data	:CALC:PN[1-1]:TRAC[1-1]:SPUR:THR:TABL:DATA
	Reads the threshold data	:MMEM:PN[1-1]:TRAC[1-1]:LOAD:SPUR:THR
	Sets/Reads the minimum spurious level	:CALC:PN[1-1]:TRAC[1-1]:SPUR:THR:LEV:MIN
Power correction	Loads correction data for a specified power	:MMEM:LOAD:CORR:POW
	Sets/Reads the frequency where the correction is performed and the correction values	:SENS:CORR:POW:DATA
	Sets the user calibration on or off, or reads its settings	:SENS:CORR:POW:STAT
Print	Aborts printing	:HCOP:ABOR
	Selects print mode	:HCOP:IMAG
	Outputs print	:HCOP:IMM
Reads/writes the data	Sets/Reads byte order setting for binary transfer	:FORM:BORD
	Sets/Reads data transfer mode	:FORM:DATA
	User defined array data	:PROG:VAR:ARR[1-10]:DATA
	# of points of user defined array	:PROG:VAR:ARR[1-10]:POIN
	User defined 64bit floating variable	:PROG:VAR:DOUB[1-10]
	User defined integer variable	:PROG:VAR:INT[1-10]
	User defined string	:PROG:VAR:STR[1-10]
Spectrum monitor - Display	Selects spectrum monior Y-axis format	:CALC:SP[1-1]:TRAC[1-1]:FORM
	Sets/Reads data hold type	:CALC:SP[1-1]:TRAC[1-1]:HOLD
	Selects math operation type	:CALC:SP[1-1]:TRAC[1-1]:MATH:FUNC
	Copies data to memory	:CALC:SP[1-1]:TRAC[1-1]:MATH:MEM
	Sets/Reads the smoothing aperture value	:CALC:SP[1-1]:TRAC[1-1]:SMO:APER
	Turns on/off smoothing function	:CALC:SP[1-1]:TRAC[1-1]:SMO:STAT
	Clears all persistent traces	:DISP:SP[1-1]:ALLT:PERS:CLE

SCPI Command Reference
Command list

Function	Setting/Execution item	Command
Spectrum monitor - Display (Continued)	Turns on/off measurement conditions	:DISP:SP[1-1]:ANN:MEAS:STAT
	Turns on/off relative Y-scale	:DISP:SP[1-1]:GRAT:AXIS:Y:REL
	Shows/Hides Y graticule label	:DISP:SP[1-1]:GRAT:AXIS:Y:STAT
	Edits window title label	:DISP:SP[1-1]:LAB:DATA
	Shows/Hides Window Title Label	:DISP:SP[1-1]:LAB:STAT
	Maximizes active trace	:DISP:SP[1-1]:MAX
	Turns on/off spectrum monitor mode	:DISP:SP[1-1]:STAT
	Edits trace title label	:DISP:SP[1-1]:TRAC[1-1]:LAB:DATA
	Sets/Reads data and/or memory trace	:DISP:SP[1-1]:TRAC[1-1]:MODE
	Clears persistent data	:DISP:SP[1-1]:TRAC[1-1]:PERS:CLE
	Sets/Reads persistence mode	:DISP:SP[1-1]:TRAC[1-1]:PERS:STAT
	Executes autoscale	:DISP:SP[1-1]:TRAC[1-1]:Y[:SCAL]:AUTO
	Sets/Reads scale per division	:DISP:SP[1-1]:TRAC[1-1]:Y[:SCAL]:PDIV
	Sets/Reads scale reference level	:DISP:SP[1-1]:TRAC[1-1]:Y[:SCAL]:RLEV
	Sets/Reads scale reference position	:DISP:SP[1-1]:TRAC[1-1]:Y[:SCAL]:RPOS
	Sets/Reads # of Y division	:DISP:SP[1-1]:Y[:SCAL]:DIV
	Copies trace data to the user trace	:CALC:SP[1-1]:TRAC[1-1]:DATA:COPY
	Sets/Reads the offset value of trace data	:CALC:SP[1-1]:TRAC[1-1]:MATH:OFFS
	Sets/Reads automatic setting of the X-axis display range of the graph of trace data to the stimulus value	:DISP:SP[1-1]:TRAC[1-1]:X[:SCAL]:AUTO
	Sets/Reads the start value of the X-axis of the graph display of trace data	:DISP:SP[1-1]:TRAC[1-1]:X[:SCAL]:LEFT
Sets/Reads the stop value of the X-axis of the graph display of trace data	:DISP:SP[1-1]:TRAC[1-1]:X[:SCAL]:RIGH	
Spectrum monitor - File operation	Saves trace data	:MMEM:SP[1-1]:TRAC[1-1]:STOR[:DATA]
	Saves memory trace data	:MMEM:SP[1-1]:TRAC[1-1]:STOR:MEM
Spectrum monitor - Harmonics	Sets/Reads the carrier frequency band	:SENS:SP[1-1]:CARR:FBAN
	Changes the center frequency to N times the carrier frequency	:SENS:SP[1-1]:CARR:SET:CENT

Function	Setting/Execution item	Command	
Spectrum monitor - Limit Test	Reads out the limit test result	:CALC:SP[1-1]:ALLT:LIM:FAIL	
	Turns on/off the limit test function	:CALC:SP[1-1]:TRAC[1-1]:LIM[:STAT]	
	Sets/Reads the number of segments in the upper limit line	:CALC:SP[1-1]:TRAC[1-1]:LIM:UPP:SEGM:COUN	
	Sets/Reads the number of segments in the lower limit line	:CALC:SP[1-1]:TRAC[1-1]:LIM:LOW:SEGM:COUN	
	Sets/Reads segment data of the upper limit line	:CALC:SP[1-1]:TRAC[1-1]:LIM:UPP:SEGM:DATA	
	Sets/Reads segment data of the lower limit line	:CALC:SP[1-1]:TRAC[1-1]:LIM:LOW:SEGM:DATA	
	Clears the upper limit line	:CALC:SP[1-1]:TRAC[1-1]:LIM:UPP:SEGM:CLE	
	Clears the lower limit line	:CALC:SP[1-1]:TRAC[1-1]:LIM:LOW:SEGM:CLE	
	Sets/Reads the upper limit values of all measurement points	:CALC:SP[1-1]:TRAC[1-1]:LIM:UPP:LDAT	
	Sets/Reads the lower limit values of all measurement points	:CALC:SP[1-1]:TRAC[1-1]:LIM:LOW:LDAT	
	Reads out the limit test result	:CALC:SP[1-1]:TRAC[1-1]:LIM:FAIL	
	Reads the limit test results of all measurement points in selected traces	:CALC:SP[1-1]:TRAC[1-1]:LIM:REP[:DATA]	
	Turns on/off the limit line	:DISP:SP[1-1]:TRAC[1-1]:LIM:LINE	
	Turns on/off the limit test judgement display	:DISP:SP[1-1]:LIM:FSIG	
	Reads the upper limit line	:MMEM:SP[1-1]:TRAC[1-1]:LOAD:LIM:UPP	
	Reads the lower limit line	:MMEM:SP[1-1]:TRAC[1-1]:LOAD:LIM:LOW	
	Spectrum monitor - Marker/Analysis	Turns on/off marker coupling function	:CALC:SP[1-1]:ALLT:MARK:COUP:STAT
		Sets/Reads marker movement (Continuous/Discrete)	:CALC:SP[1-1]:ALLT:MARK:DISC:STAT
Sets/Reads marker reference number		:CALC:SP[1-1]:ALLT:MARK:REF:NUMB	
Turns on/off delta marker mode		:CALC:SP[1-1]:ALLT:MARK:REF:STAT	
Selects active marker		:CALC:SP[1-1]:TRAC[1-1]:ALLM:ACT	
Sets/Reads marker search range (X-axis)		:CALC:SP[1-1]:TRAC[1-1]:ALLM:SEAR:DOM:X	
Sets/Reads marker search range (Y-axis)		:CALC:SP[1-1]:TRAC[1-1]:ALLM:SEAR:DOM:Y	
Executes marker search all		:CALC:SP[1-1]:TRAC[1-1]:ALLM:SEAR:PEAK	
Sets/Reads the center value of bandmarker X		:CALC:SP[1-1]:TRAC[1-1]:BDM:X:CENT	
Sets/Reads the span value of bandmarker X		:CALC:SP[1-1]:TRAC[1-1]:BDM:X:SPAN	
Sets/Reads the start value of bandmarker X		:CALC:SP[1-1]:TRAC[1-1]:BDM:X:STAR	
Turns on/off bandmarker X		:CALC:SP[1-1]:TRAC[1-1]:BDM:X:STAT	
Sets/Reads the stop value of bandmarker X		:CALC:SP[1-1]:TRAC[1-1]:BDM:X:STOP	
Sets/Reads the center value of bandmarker Y		:CALC:SP[1-1]:TRAC[1-1]:BDM:Y:CENT	
Sets/Reads the span value of bandmarker Y		:CALC:SP[1-1]:TRAC[1-1]:BDM:Y:SPAN	

SCPI Command Reference
Command list

Function	Setting/Execution item	Command
Spectrum monitor - Marker/Analysis (Continued)	Sets/Reads the start value of bandmarker Y	:CALC:SP[1-1]:TRAC[1-1]:BDM:Y:STAR
	Turns on/off bandmarker Y	:CALC:SP[1-1]:TRAC[1-1]:BDM:Y:STAT
	Sets/Reads the stop value of bandmarker Y	:CALC:SP[1-1]:TRAC[1-1]:BDM:Y:STOP
	Sets/Reads analysis/search range (X-axis)	:CALC:SP[1-1]:TRAC[1-1]:FUNC:DOM:X
	Sets/Reads analysis/search range (Y-axis)	:CALC:SP[1-1]:TRAC[1-1]:FUNC:DOM:Y
	Reads the results of statistical analysis for the data trace	:CALC:SP[1-1]:TRAC[1-1]:FUNC:STAT:DATA
	Reads the results of statistical analysis for the memory trace	:CALC:SP[1-1]:TRAC[1-1]:FUNC:STAT:MEM
	Sets/Reads analysis type	:CALC:SP[1-1]:TRAC[1-1]:FUNC:TYPE
	Executes marker peak search left	:CALC:SP[1-1]:TRAC[1-1]:MARK[1-10]:SEAR:EXEC:LPE
	Executes marker target search left	:CALC:SP[1-1]:TRAC[1-1]:MARK[1-10]:SEAR:EXEC:LTAR
	Executes marker search maximum	:CALC:SP[1-1]:TRAC[1-1]:MARK[1-10]:SEAR:EXEC:MAX
	Executes marker search minimum	:CALC:SP[1-1]:TRAC[1-1]:MARK[1-10]:SEAR:EXEC:MIN
	Executes marker peak search	:CALC:SP[1-1]:TRAC[1-1]:MARK[1-10]:SEAR:EXEC:PEAK
	Executes marker peak search right	:CALC:SP[1-1]:TRAC[1-1]:MARK[1-10]:SEAR:EXEC:RPE
	Executes marker target search right	:CALC:SP[1-1]:TRAC[1-1]:MARK[1-10]:SEAR:EXEC:RTAR
	Executes marker target search	:CALC:SP[1-1]:TRAC[1-1]:MARK[1-10]:SEAR:EXEC:TARG
	Sets/Reads the peak excursion value	:CALC:SP[1-1]:TRAC[1-1]:MARK[1-10]:SEAR:PEAK:EXC
	Sets/Reads the marker peak-search polarity	:CALC:SP[1-1]:TRAC[1-1]:MARK[1-10]:SEAR:PEAK:POL
	Sets/Reads the target transition definition	:CALC:SP[1-1]:TRAC[1-1]:MARK[1-10]:SEAR:TARG:TRAN
	Sets/Reads the marker target value	:CALC:SP[1-1]:TRAC[1-1]:MARK[1-10]:SEAR:TARG:Y
	Sets/Reads the marker tracking type	:CALC:SP[1-1]:TRAC[1-1]:MARK[1-10]:SEAR:TRAC:TYPE
	Turns on/off markers	:CALC:SP[1-1]:TRAC[1-1]:MARK[1-10]:STAT
	Sets/Reads the marker X value	:CALC:SP[1-1]:TRAC[1-1]:MARK[1-10]:X
	Reads the marker Y value	:CALC:SP[1-1]:TRAC[1-1]:MARK[1-10]:Y
	Sets/Reads the marker information position	:DISP:SP[1-1]:ANN:MARK:POS
	Turns on/off the marker list	:DISP:SP[1-1]:TABL[:STAT]

Function	Setting/Execution item	Command
Spectrum monitor - Measurement	Triggers continuous	:INIT:SP[1-1]:CONT
	Triggers once	:INIT:SP[1-1]:IMM
	Selects trigger source	:TRIG:SP[1-1]:SOUR
Spectrum monitor - Measurement conditions	Restarts averaging	:SENS:SP[1-1]:AVER:CLE
	Sets/Reads the averaging count	:SENS:SP[1-1]:AVER:COUN
	Turns on/off averaging function	:SENS:SP[1-1]:AVER:STAT
	Sets/Reads averaging type	:SENS:SP[1-1]:AVER:TYPE
	Sets/Reads RBW value	:SENS:SP[1-1]:BAND:RES
	Sets/Reads detector mode	:SENS:SP[1-1]:DET:FUNC
	Sets/Reads the center value of frequency span	:SENS:SP[1-1]:FREQ:CENT
	Sets/Reads the span value of frequency span	:SENS:SP[1-1]:FREQ:SPAN
	Sets/Reads the start value of frequency span	:SENS:SP[1-1]:FREQ:STAR
	Sets/Reads the stop value of frequency span	:SENS:SP[1-1]:FREQ:STOP
	Sets/Reads the reference level of frequency span	:SENS:SP[1-1]:POW:RLEV
	Spectrum monitor - Reads/writes the data	Sets/Reads the raw data
Reads X-axis data		:CALC:SP[1-1]:DATA:XDAT
Sets/Reads formatted trace data		:CALC:SP[1-1]:TRAC[1-1]:DATA:FDAT
Sets/Reads formatted memory data		:CALC:SP[1-1]:TRAC[1-1]:DATA:FMEM
Sets/Reads unformatted trace data		:CALC:SP[1-1]:TRAC[1-1]:DATA:UDAT
Sets/Reads unformatted memory data		:CALC:SP[1-1]:TRAC[1-1]:DATA:UMEM
Reads the number of measurement points		:SENS:SP[1-1]:SWE:POIN
Status report system	Clears registers	*CLS
	Sets/Reads standard event status enable register	*ESE
	Reads standard event status register value	*ESR
	Sets OPC bit on operation termination	*OPC
	Sets service request enable register	*SRE
	Reads status byte register	*STB
	Clears operation-program status condition register	:STAT:OPER:BIT12:CLE
	Reads operation-program status register	:STAT:OPER:BIT12:COND
	Sets/Reads operation-program status enable register	:STAT:OPER:BIT12:ENAB
	Reads operation-program status event register	:STAT:OPER:BIT12[:EVEN]
	Sets/Reads operation-program status negative transition filter value	:STAT:OPER:BIT12:NTR
	Sets/Reads operation-program status positive transition filter value	:STAT:OPER:BIT12:PTR

SCPI Command Reference
Command list

Function	Setting/Execution item	Command
Status report system (Continued)	Sets operation-program status condition register	:STAT:OPER:BIT12:SET
	Reads operation status conditional register value	:STAT:OPER:COND
	Sets/Reads operation status enable register	:STAT:OPER:ENAB
	Reads operation status event register	:STAT:OPER[:EVEN]
	Sets/Reads operation status negative transition filter value	:STAT:OPER:NTR
	Sets/Reads operation status positive transition filter value	:STAT:OPER:PTR
	Resets status registers	:STAT:PRES
	Reads questionable status conditional register value	:STAT:QUES:COND
	Sets/Reads questionable-current status enable register	:STAT:QUES:CURR:ENAB
	Reads questionable-current status event register value	:STAT:QUES:CURR[:EVEN]
	Sets/Reads questionable downconverter status enable register value	:STAT:QUES:DCON:ENAB
	Reads questionable downconverter status event register value	:STAT:QUES:DCON[:EVEN]
	Sets/Reads questionable status enable register	:STAT:QUES:ENAB
	Reads questionable status event register value	:STAT:QUES[:EVEN]
	Sets/Reads questionable-misc status enable register	:STAT:QUES:MISC:ENAB
	Reads questionable-misc status event register value	:STAT:QUES:MISC[:EVEN]
	Sets/Reads questionable status negative transition filter value	:STAT:QUES:NTR
	Sets/Reads questionable-phase status enable register	:STAT:QUES:PHAS:ENAB
	Reads questionable-phase status event register	:STAT:QUES:PHAS[:EVEN]
	Sets/Reads questionable-power status enable register	:STAT:QUES:POW:ENAB
	Reads questionable-power status event register value	:STAT:QUES:POW[:EVEN]
	Sets/Reads questionable status positive transition filter value	:STAT:QUES:PTR
	Sets/Reads questionable-reference signal status enable register	:STAT:QUES:REF:ENAB
	Reads questionable-reference signal status event register value	:STAT:QUES:REF[:EVEN]
	Reads the questionable limit conditional register value	:STAT:QUES:LIM:COND
	Sets/Reads the questionable limit status enable value	:STAT:QUES:LIM:ENAB
	Reads the questionable limit status event register value	:STAT:QUES:LIM[:EVEN]

Function	Setting/Execution item	Command
Status report system (Continued)	Sets/Reads the questionable limit status positive transition filter value	:STAT:QUES:LIM:PTR
	Sets/Reads the questionable limit status negative transition filter value	:STAT:QUES:LIM:NTR
	Reads the questionable limit conditional register value (FP)	:STAT:QUES:LIM:FP[1-1]:COND
	Sets/Reads the questionable limit status enable value (FP)	:STAT:QUES:LIM:FP[1-1]:ENAB
	Reads the questionable limit status event register value (FP)	:STAT:QUES:LIM:FP[1-1]:[EVEN]
	Sets/Reads the questionable limit status positive transition filter value (FP)	:STAT:QUES:LIM:FP[1-1]:PTR
	Sets/Reads the questionable limit status negative transition filter value (FP)	:STAT:QUES:LIM:FP[1-1]:NTR
	Reads the questionable limit conditional register value (PN)	:STAT:QUES:LIM:PN[1-1]:COND
	Sets/Reads the questionable limit status enable value (PN)	:STAT:QUES:LIM:PN[1-1]:ENAB
	Reads the questionable limit status event register value (PN)	:STAT:QUES:LIM:PN[1-1]:[EVEN]
	Sets/Reads the questionable limit status positive transition filter value (PN)	:STAT:QUES:LIM:PN[1-1]:PTR
	Sets/Reads the questionable limit status negative transition filter value (PN)	:STAT:QUES:LIM:PN[1-1]:NTR
	Reads the questionable limit conditional register value (SP)	:STAT:QUES:LIM:SP[1-1]:COND
	Sets/Reads the questionable limit status enable value (SP)	:STAT:QUES:LIM:SP[1-1]:ENAB
	Reads the questionable limit status event register value (SP)	:STAT:QUES:LIM:SP[1-1]:[EVEN]
	Sets/Reads the questionable limit status positive transition filter value (SP)	:STAT:QUES:LIM:SP[1-1]:PTR
	Sets/Reads the questionable limit status negative transition filter value (SP)	:STAT:QUES:LIM:SP[1-1]:NTR
	Reads the questionable limit conditional register value (TR)	:STAT:QUES:LIM:TR[1-1]:COND
	Sets/Reads the questionable limit status enable value (TR)	:STAT:QUES:LIM:TR[1-1]:ENAB
	Reads the questionable limit status event register value (TR)	:STAT:QUES:LIM:TR[1-1]:[EVEN]
	Sets/Reads the questionable limit status positive transition filter value (TR)	:STAT:QUES:LIM:TR[1-1]:PTR
	Sets/Reads the questionable limit status negative transition filter value (TR)	:STAT:QUES:LIM:TR[1-1]:NTR

SCPI Command Reference
Command list

Function	Setting/Execution item	Command
Status report system (Continued)	Reads the questionable limit conditional register value (USER)	:STAT:QUES:LIM:USER[1-1]:COND
	Sets/Reads the questionable limit status enable value (USER)	:STAT:QUES:LIM:USER[1-1]:ENAB
	Reads the questionable limit status event register value (USER)	:STAT:QUES:LIM:USER[1-1]:EVEN]
	Sets/Reads the questionable limit status positive transition filter value (USER)	:STAT:QUES:LIM:USER[1-1]:PTR
	Sets/Reads the questionable limit status negative transition filter value (USER)	:STAT:QUES:LIM:USER[1-1]:NTR
Transient measurement - Display	Selects active trace	:CALC:TR[1-1]:ALLT:ACT
	Selects phase format on transient measurement	:CALC:TR[1-1]:TRAC[1-4]:FORM:PHAS:UNIT
	Turns on/off wrap-phase	:CALC:TR[1-1]:TRAC[1-4]:FORM:PHAS:WRAP
	Sets/Reads data hold	:CALC:TR[1-1]:TRAC[1-4]:HOLD
	Selects math operation type	:CALC:TR[1-1]:TRAC[1-4]:MATH:FUNC
	Copies data to memory	:CALC:TR[1-1]:TRAC[1-4]:MATH:MEM
	Sets/Reads the smoothing aperture value	:CALC:TR[1-1]:TRAC[1-4]:SMO:APER
	Turns on/off smoothing function	:CALC:TR[1-1]:TRAC[1-4]:SMO:STAT
	Clears all stored traces	:DISP:TR[1-1]:ALLT:PERS:CLE
	Executes autoscale all	:DISP:TR[1-1]:ALLT:Y:SCAL:AUTO
	Turns on/off measurement conditions	:DISP:TR[1-1]:ANN:MEAS:STAT
	Sets/Reads relative Y-scale	:DISP:TR[1-1]:GRAT:AXIS:Y:REL
	Sets/Reads the number of Y-digits	:DISP:TR[1-1]:GRAT:AXIS:Y:STAT
	Edits window title label	:DISP:TR[1-1]:LAB:DATA
	Turns on/off window title lable	:DISP:TR[1-1]:LAB:STAT
	Maximizes active trace	:DISP:TR[1-1]:MAX
	Turns on/off transient measurement mode	:DISP:TR[1-1]:STAT
	Traces Title Label	:DISP:TR[1-1]:TRAC[1-4]:LAB:DATA
	Sets/readds data and/or memory trace	:DISP:TR[1-1]:TRAC[1-4]:MODE
	Clears persistent data	:DISP:TR[1-1]:TRAC[1-4]:PERS:CLE
	Sets/Reads persistence mode	:DISP:TR[1-1]:TRAC[1-4]:PERS:STAT
	Executes autoscale	:DISP:TR[1-1]:TRAC[1-4]:Y[:SCAL]:AUTO
	Sets/Reads scale per division	:DISP:TR[1-1]:TRAC[1-4]:Y[:SCAL]:PDIV
	Sets/Reads scale reference level	:DISP:TR[1-1]:TRAC[1-4]:Y[:SCAL]:RLEV
Sets/Reads scale reference position	:DISP:TR[1-1]:TRAC[1-4]:Y[:SCAL]:RPOS	
Sets/Reads # of Y division	:DISP:TR[1-1]:Y[:SCAL]:DIV	

Function	Setting/Execution item	Command
Transient measurement - Display (Continued)	Copies trace data to the user trace	:CALC:TR[1-1]:TRAC[1-4]:DATA:COPY
	Sets/Reads the frequency format	:CALC:TR[1-1]:TRAC[1-4]:FORM:FREQ
	Sets/Reads the reference frequency	:CALC:TR[1-1]:TRAC[1-4]:REF:FREQ
	Reads the trace parameter.	:CALC:TR[1-1]:TRAC[1-4]:PAR
	Sets/Reads the offset value of trace data	:CALC:TR[1-1]:TRAC[1-4]:MATH:OFFS
	Sets/Reads stimulus value that is set as phase reference (0 degree reference) of trace data	:CALC:TR[1-1]:TRAC[1-4]:FORM:PHAS:XREF
	Sets/Reads automatic setting of the X-axis display range of the graph of trace data to the stimulus value	:DISP:TR[1-1]:TRAC[1-4]:X[:SCAL]:AUTO
	Sets/Reads the start value of the X-axis of the graph display of trace data	:DISP:TR[1-1]:TRAC[1-4]:X[:SCAL]:LEFT
	Sets/Reads the stop value of the X-axis of the graph display of trace data	:DISP:TR[1-1]:TRAC[1-4]:X[:SCAL]:RIGH
Transient measurement - File operation	Saves trace data	:MMEM:TR[1-1]:TRAC[1-4]:STOR[:DATA]
	Saves memory trace data	:MMEM:TR[1-1]:TRAC[1-4]:STOR:MEM
Transient measurement - Limit Test	Reads out the limit test result	:CALC:TR[1-1]:ALLT:LIM:FAIL
	Turns on/off the limit test function	:CALC:TR[1-1]:TRAC[1-4]:LIM[:STAT]
	Sets/Reads the number of segments in the upper limit line	:CALC:TR[1-1]:TRAC[1-4]:LIM:UPP:SEGM:COUN
	Sets/Reads the number of segments in the lower limit line	:CALC:TR[1-1]:TRAC[1-4]:LIM:LOW:SEGM:COUN
	Sets/Reads segment data of the upper limit line	:CALC:TR[1-1]:TRAC[1-4]:LIM:UPP:SEGM:DATA
	Sets/Reads segment data of the lower limit line	:CALC:TR[1-1]:TRAC[1-4]:LIM:LOW:SEGM:DATA
	Clears the upper limit line	:CALC:TR[1-1]:TRAC[1-4]:LIM:UPP:SEGM:CLE
	Clears the lower limit line	:CALC:TR[1-1]:TRAC[1-4]:LIM:LOW:SEGM:CLE
	Sets/Reads the upper limit values of all measurement points	:CALC:TR[1-1]:TRAC[1-4]:LIM:UPP:LDAT
	Sets/Reads the lower limit values of all measurement points	:CALC:TR[1-1]:TRAC[1-4]:LIM:LOW:LDAT
	Reads out the limit test result	:CALC:TR[1-1]:TRAC[1-4]:LIM:FAIL
	Reads the limit test results of all measurement points in selected traces	:CALC:TR[1-1]:TRAC[1-4]:LIM:REP[:DATA]
	Turns on/off the limit line	:DISP:TR[1-1]:TRAC[1-4]:LIM:LINE
	Turns on/off the limit test judgement display	:DISP:TR[1-1]:LIM:FSIG
	Reads the upper limit line	:MMEM:TR[1-1]:TRAC[1-4]:LOAD:LIM:UPP
	Reads the lower limit line	:MMEM:TR[1-1]:TRAC[1-4]:LOAD:LIM:LOW

SCPI Command Reference
Command list

Function	Setting/Execution item	Command
Transient measurement - Marker/analysis	Turns on/off bandmarker coupling function	:CALC:TR[1-1]:ALLT:BDM:X:COUP:STAT
	Turns on/off marker coupling function	:CALC:TR[1-1]:ALLT:MARK:COUP:STAT
	Sets/Reads marker movement (Continuous/Discrete)	:CALC:TR[1-1]:ALLT:MARK:DISC:STAT
	Sets/Reads marker reference number	:CALC:TR[1-1]:ALLT:MARK:REF:NUMB
	Turns on/off delta marker mode	:CALC:TR[1-1]:ALLT:MARK:REF:STAT
	Selects active marker	:CALC:TR[1-1]:TRAC[1-4]:ALLM:ACT
	Sets/Reads marker search range (X-axis)	:CALC:TR[1-1]:TRAC[1-4]:ALLM:SEAR:DOM:X
	Sets/Reads marker search range (Y-axis)	:CALC:TR[1-1]:TRAC[1-4]:ALLM:SEAR:DOM:Y
	Executes marker search all	:CALC:TR[1-1]:TRAC[1-4]:ALLM:SEAR:PEAK
	Sets/Reads the center value of bandmarker X	:CALC:TR[1-1]:TRAC[1-4]:BDM:X:CENT
	Sets/Reads the span value of bandmarker X	:CALC:TR[1-1]:TRAC[1-4]:BDM:X:SPAN
	Sets/Reads the start value of bandmarker X	:CALC:TR[1-1]:TRAC[1-4]:BDM:X:STAR
	Turns on/off bandmarker X	:CALC:TR[1-1]:TRAC[1-4]:BDM:X:STAT
	Sets/Reads the stop value of bandmarker X	:CALC:TR[1-1]:TRAC[1-4]:BDM:X:STOP
	Sets/Reads the center value of bandmarker Y	:CALC:TR[1-1]:TRAC[1-4]:BDM:Y:CENT
	Sets/Reads the span value of bandmarker Y	:CALC:TR[1-1]:TRAC[1-4]:BDM:Y:SPAN
	Sets/Reads the start value of bandmarker Y	:CALC:TR[1-1]:TRAC[1-4]:BDM:Y:STAR
	Turns on/off bandmarker Y	:CALC:TR[1-1]:TRAC[1-4]:BDM:Y:STAT
	Sets/Reads the stop value of bandmarker Y	:CALC:TR[1-1]:TRAC[1-4]:BDM:Y:STOP
	Sets/Reads analysis/search range (X-axis)	:CALC:TR[1-1]:TRAC[1-4]:FUNC:DOM:X
	Sets/Reads analysis/search range (Y-axis)	:CALC:TR[1-1]:TRAC[1-4]:FUNC:DOM:Y
	Reads the result of statistical analysis for the data trace	:CALC:TR[1-1]:TRAC[1-4]:FUNC:STAT:DATA
	Reads the result of statistical analysis for the memory trace	:CALC:TR[1-1]:TRAC[1-4]:FUNC:STAT:MEM
	Sets/Reads analysis type	:CALC:TR[1-1]:TRAC[1-4]:FUNC:TYPE
	Executes marker peak search left	:CALC:TR[1-1]:TRAC[1-4]:MARK[1-10]:SEAR:EXEC:LPE
	Executes marker target search left	:CALC:TR[1-1]:TRAC[1-4]:MARK[1-10]:SEAR:EXEC:LTAR
	Executes marker search maximum	:CALC:TR[1-1]:TRAC[1-4]:MARK[1-10]:SEAR:EXEC:MAX
	Executes marker search minimum	:CALC:TR[1-1]:TRAC[1-4]:MARK[1-10]:SEAR:EXEC:MIN
	Executes marker peak search	:CALC:TR[1-1]:TRAC[1-4]:MARK[1-10]:SEAR:EXEC:PEAK

Function	Setting/Execution item	Command	
Transient measurement - Marker/analysis (Continued)	Executes marker peak search right	:CALC:TR[1-1]:TRAC[1-4]:MARK[1-10]:SEAR:EXEC:RPE	
	Executes marker target search right	:CALC:TR[1-1]:TRAC[1-4]:MARK[1-10]:SEAR:EXEC:RTAR	
	Executes marker target search	:CALC:TR[1-1]:TRAC[1-4]:MARK[1-10]:SEAR:EXEC:TARG	
	Sets/Reads the peak excursion value	:CALC:TR[1-1]:TRAC[1-4]:MARK[1-10]:SEAR:PEAK:EXC	
	Sets/Reads the marker peak-search polarity	:CALC:TR[1-1]:TRAC[1-4]:MARK[1-10]:SEAR:PEAK:POL	
	Sets/Reads the target transition definition	:CALC:TR[1-1]:TRAC[1-4]:MARK[1-10]:SEAR:TARG:TRAN	
	Sets/Reads the marker target value	:CALC:TR[1-1]:TRAC[1-4]:MARK[1-10]:SEAR:TARG:Y	
	Sets/Reads the marker tracking type	:CALC:TR[1-1]:TRAC[1-4]:MARK[1-10]:SEAR:TRAC:TYPE	
	Turns on/off markers	:CALC:TR[1-1]:TRAC[1-4]:MARK[1-10]:STAT	
	Sets/Reads the marker X value	:CALC:TR[1-1]:TRAC[1-4]:MARK[1-10]:X	
	Reads the marker Y value	:CALC:TR[1-1]:TRAC[1-4]:MARK[1-10]:Y	
	Sets/Reads the marker information position	:DISP:TR[1-1]:ANN:MARK:POS	
	Turns on/off the marker list	:DISP:TR[1-1]:TABL[:STAT]	
	Calculates regression line coefficient (a and b of $Y = aX + b$) for trace data and reads the result	:CALC:TR[1-1]:TRAC[1-4]:FUNC:LREG:DATA	
	Calculates regression line coefficient (a and b of $Y = aX + b$) for trace memory and reads the result	:CALC:TR[1-1]:TRAC[1-4]:FUNC:LREG:MEM	
	Sets/Reads the a value of the line equation ($Y = aX + b$) for linearity evaluation of trace data	:CALC:TR[1-1]:TRAC[1-4]:LINE:A	
	Sets/Reads the b value of the line equation ($Y = aX + b$) for linearity evaluation of trace data	:CALC:TR[1-1]:TRAC[1-4]:LINE:B	
	Sets to trace memory the line that is the result of the line equation ($Y = aX + b$) for linearity evaluation for trace data	:CALC:TR[1-1]:TRAC[1-4]:LINE:MEM	
	Transient measurement - Measurement	Triggers continuous	:INIT:TR[1-1]:CONT
		Triggers once	:INIT:TR[1-1]:IMM

SCPI Command Reference
Command list

Function	Setting/Execution item	Command
Transient measurement - Measurement conditions	Clears averaging	:SENS:TR[1-1]:AVER:CLE
	Sets/Reads averaging count	:SENS:TR[1-1]:AVER:COUN
	Turns on/off averaging function	:SENS:TR[1-1]:AVER:STAT
	Sets/Reads phase reference frequency	:SENS:TR[1-1]:NARR:FREQ:PREF
	Sets/Reads frequency transient span (narrowband)	:SENS:TR[1-1]:NARR:FREQ:RANG
	Sets/Reads target frequency value	:SENS:TR[1-1]:NARR:FREQ:TARG
	Sets/Reads time offset (delay) for reference point	:SENS:TR[1-1]:NARR:TIME:OFFS
	Sets/Reads reference position for time span	:SENS:TR[1-1]:NARR:TIME:REF
	Sets/Reads time span	:SENS:TR[1-1]:NARR:TIME:SPAN
	Sets/Reads Max Input Level	:SENS:TR[1-1]:POW:INP:LEV:MAX
	Sets/Reads transient frequency range in the wideband mode	:SENS:TR[1-1]:WIDE:FREQ:MAX
	Sets/Reads time offset(delay) for reference point	:SENS:TR[1-1]:WIDE:TIME:OFFS
	Sets/Reads reference position for time span	:SENS:TR[1-1]:WIDE:TIME:REF
	Sets/Reads time span	:SENS:TR[1-1]:WIDE:TIME:SPAN
	Sets/Reads video trigger frequency value (narrowband)	:TRIG:TR[1-1]:NARR:VID:FREQ:CENT
	Sets/Reads the video trigger threshold level relative to max input level (narrowband)	:TRIG:TR[1-1]:NARR:VID:THR
	Selects trigger source	:TRIG:TR[1-1]:SOUR
	Sets/Reads video trigger frequency value (wideband)	:TRIG:TR[1-1]:WIDE:VID:FREQ:CENT
	Sets/Reads the offset value of the phase reference frequency	:CALC:TR[1-1]:TRAC[1-4]:FORM:PHAS:PREF:OFFS
	Sets/Reads the delay value of the external trigger source	:TRIG:TR[1-1]:ETTA
Transient measurement - Reads/writes the data	Sets/Reads measurement raw data (narrowband)	:CALC:TR[1-1]:NARR:DATA:RDAT
	Sets/Reads X axis data	:CALC:TR[1-1]:NARR:DATA:XDAT
	Sets/Reads formatted trace data	:CALC:TR[1-1]:TRAC[1-4]:DATA:FDAT
	Sets/Reads formatted memory data	:CALC:TR[1-1]:TRAC[1-4]:DATA:FMEM
	Sets/Reads unformatted trace data	:CALC:TR[1-1]:TRAC[1-4]:DATA:UDAT
	Sets/Reads unformatted memory data	:CALC:TR[1-1]:TRAC[1-4]:DATA:UMEM
	Sets/Reads measurement raw data (wideband)	:CALC:TR[1-1]:WIDE:DATA:RDAT
	Sets/Reads X axis data	:CALC:TR[1-1]:WIDE:DATA:XDAT
	Reads the number of measurement points	:SENS:TR[1-1]:NARR:SWE:POIN
	Reads the number of measurement points	:SENS:TR[1-1]:WIDE:SWE:POIN

Function	Setting/Execution item	Command
User defined window - Display	Selects active trace	:CALC:USER[1-1]:ALLT:ACT
	Selects math operation type	:CALC:USER[1-1]:TRAC[1-8]:MATH:FUNC
	Copies data to memory	:CALC:USER[1-1]:TRAC[1-8]:MATH:MEM
	Smoothing aperture	:CALC:USER[1-1]:TRAC[1-8]:SMO:APER
	Smoothing on/off	:CALC:USER[1-1]:TRAC[1-8]:SMO:STAT
	Clears all persistent mode	:DISP:USER[1-1]:ALLT:PERS:CLE
	Executes autoscale all	:DISP:USER[1-1]:ALLT:Y:SCAL:AUTO
	Turns on/off measurement conditions	:DISP:USER[1-1]:ANN:MEAS:STAT
	Sets/Reads relative Y-scale	:DISP:USER[1-1]:GRAT:AXIS:Y:REL
	Shows/Hides Y graticule label	:DISP:USER[1-1]:GRAT:AXIS:Y:STAT
	Edits Window Title Label	:DISP:USER[1-1]:LAB:DATA
	Shows/Hides Window Title Label	:DISP:USER[1-1]:LAB:STAT
	Maximizes active trace	:DISP:USER[1-1]:MAX
	Turns on/off user defined window	:DISP:USER[1-1]:STAT
	Traces Title Label	:DISP:USER[1-1]:TRAC[1-8]:LAB:DATA
	Sets/Reads data and/or memory trace	:DISP:USER[1-1]:TRAC[1-8]:MODE
	Clears persistent data	:DISP:USER[1-1]:TRAC[1-8]:PERS:STAT
	Sets/Reads persistence mode	:DISP:USER[1-1]:TRAC[1-8]:STAT
	Sets/Reads X axis unit	:DISP:USER[1-1]:TRAC[1-8]:X:UNIT
	Executes autoscale	:DISP:USER[1-1]:TRAC[1-8]:Y[:SCAL]:AUTO
	Sets/Reads scale per division	:DISP:USER[1-1]:TRAC[1-8]:Y[:SCAL]:PDIV
	Sets/Reads scale reference level	:DISP:USER[1-1]:TRAC[1-8]:Y[:SCAL]:RLEV
	Sets/Reads scale reference position	:DISP:USER[1-1]:TRAC[1-8]:Y[:SCAL]:RPOS
	Sets/Reads Y axis unit	:DISP:USER[1-1]:TRAC[1-8]:Y:UNIT
	Sets/Reads # of Y division	:DISP:USER[1-1]:Y[:SCAL]:DIV
	Sets/Reads the display type of the x axis.	:DISP:USER[1-1]:TRAC[1-8]:X:TYPE
	Copies trace data to the user trace	:CALC:USER[1-1]:TRAC[1-8]:DATA:COPY
	Sets/Reads the offset value of trace data	:CALC:USER[1-1]:TRAC[1-8]:MATH:OFFS
	Sets/Reads automatic setting of the X-axis display range of the graph of trace data to the stimulus value	:DISP:USER[1-1]:TRAC[1-8]:X[:SCAL]:AUTO
	Sets/Reads the start value of the X-axis of the graph display of trace data	:DISP:USER[1-1]:TRAC[1-8]:X[:SCAL]:LEFT
	Sets/Reads the stop value of the X-axis of the graph display of trace data	:DISP:USER[1-1]:TRAC[1-8]:X[:SCAL]:RIGHT
	Sets/Reads strings of the annotation of trace data	:DISP:USER[1-1]:TRAC[1-8]:ANN:DATA

SCPI Command Reference
Command list

Function	Setting/Execution item	Command
User defined window - File operation	Saves selected trace data	:MMEM:USER[1-1]:TRAC[1-8]:STOR[:DATA]
	Saves selected memory trace data	:MMEM:USER[1-1]:TRAC[1-8]:STOR:MEM
User defined window - Limit Test	Reads out the limit test result	:CALC:USER[1-1]:ALLT:LIM:FAIL
	Turns on/off the limit test function	:CALC:USER[1-1]:TRAC[1-8]:LIM[:STAT]
	Sets/Reads the number of segments in the upper limit line	:CALC:USER[1-1]:TRAC[1-8]:LIM:UPP:SEGM:COUN
	Sets/Reads the number of segments in the lower limit line	:CALC:USER[1-1]:TRAC[1-8]:LIM:LOW:SEGM:COU N
	Sets/Reads segment data of the upper limit line	:CALC:USER[1-1]:TRAC[1-8]:LIM:UPP:SEGM:DATA
	Sets/Reads segment data of the lower limit line	:CALC:USER[1-1]:TRAC[1-8]:LIM:LOW:SEGM:DAT A
	Clears the upper limit line	:CALC:USER[1-1]:TRAC[1-8]:LIM:UPP:SEGM:CLE
	Clears the lower limit line	:CALC:USER[1-1]:TRAC[1-8]:LIM:LOW:SEGM:CLE
	Sets/Reads the upper limit values of all measurement points	:CALC:USER[1-1]:TRAC[1-8]:LIM:UPP:LDAT
	Sets/Reads the lower limit values of all measurement points	:CALC:USER[1-1]:TRAC[1-8]:LIM:LOW:LDAT
	Reads out the limit test result	:CALC:USER[1-1]:TRAC[1-8]:LIM:FAIL
	Reads the limit test results of all measurement points in selected traces	:CALC:USER[1-1]:TRAC[1-8]:LIM:REP[:DATA]
	Turns on/off the limit line	:DISP:USER[1-1]:TRAC[1-8]:LIM:LINE
	Turns on/off the limit test judgement display	:DISP:USER[1-1]:LIM:FSIG
	Reads the upper limit line	:MMEM:USER[1-1]:TRAC[1-8]:LOAD:LIM:UPP
	Reads the lower limit line	:MMEM:USER[1-1]:TRAC[1-8]:LOAD:LIM:LOW

Function	Setting/Execution item	Command
User defined window - Marker/analysis	Turns on/off bandmarker coupling function	:CALC:USER[1-1]:ALLT:BDM:X:COUP:STAT
	Turns on/off marker coupling function	:CALC:USER[1-1]:ALLT:MARK:COUP:STAT
	Sets/Reads marker movement (Continuous/Discrete)	:CALC:USER[1-1]:ALLT:MARK:DISC:STAT
	Sets/Reads marker reference number	:CALC:USER[1-1]:ALLT:MARK:REF:NUMB
	Turns on/off delta marker mode	:CALC:USER[1-1]:ALLT:MARK:REF:STAT
	Selects active marker	:CALC:USER[1-1]:TRAC[1-8]:ALLM:ACT
	marker search X range	:CALC:USER[1-1]:TRAC[1-8]:ALLM:SEAR:DOM:X
	marker search Y range	:CALC:USER[1-1]:TRAC[1-8]:ALLM:SEAR:DOM:Y
	search peak all	:CALC:USER[1-1]:TRAC[1-8]:ALLM:SEAR:PEAK
	bandmarker X center	:CALC:USER[1-1]:TRAC[1-8]:BDM:X:CENT
	bandmarker X span	:CALC:USER[1-1]:TRAC[1-8]:BDM:X:SPAN
	bandmarker X start	:CALC:USER[1-1]:TRAC[1-8]:BDM:X:STAR
	Turns on/off bandmarker X	:CALC:USER[1-1]:TRAC[1-8]:BDM:X:STAT
	bandmarker X stop	:CALC:USER[1-1]:TRAC[1-8]:BDM:X:STOP
	bandmarker Y center	:CALC:USER[1-1]:TRAC[1-8]:BDM:Y:CENT
	bandmarker Y span	:CALC:USER[1-1]:TRAC[1-8]:BDM:Y:SPAN
	bandmarker Y start	:CALC:USER[1-1]:TRAC[1-8]:BDM:Y:STAR
	Turns on/off bandmarker Y	:CALC:USER[1-1]:TRAC[1-8]:BDM:Y:STAT
	bandmarker Y stop	:CALC:USER[1-1]:TRAC[1-8]:BDM:Y:STOP
	Sets/Reads analysis range (X-axis)	:CALC:USER[1-1]:TRAC[1-8]:FUNC:DOM:X
	Sets/Reads analysis range(Y-axis)	:CALC:USER[1-1]:TRAC[1-8]:FUNC:DOM:Y
	Traces data statistics	:CALC:USER[1-1]:TRAC[1-8]:FUNC:STAT:DATA
	memory data statistics	:CALC:USER[1-1]:TRAC[1-8]:FUNC:STAT:MEM
	analysis type	:CALC:USER[1-1]:TRAC[1-8]:FUNC:TYPE
	data hold	:CALC:USER[1-1]:TRAC[1-8]:HOLD
	Executes marker peak search left	:CALC:USER[1-1]:TRAC[1-8]:MARK[1-10]:SEAR:EXEC:LPE
	Executes marker target search left	:CALC:USER[1-1]:TRAC[1-8]:MARK[1-10]:SEAR:EXEC:LTAR
	Executes marker search maximum	:CALC:USER[1-1]:TRAC[1-8]:MARK[1-10]:SEAR:EXEC:MAX
	Executes marker search minimum	:CALC:USER[1-1]:TRAC[1-8]:MARK[1-10]:SEAR:EXEC:MIN
	Executes marker peak search	:CALC:USER[1-1]:TRAC[1-8]:MARK[1-10]:SEAR:EXEC:PEAK
	Executes marker peak search right	:CALC:USER[1-1]:TRAC[1-8]:MARK[1-10]:SEAR:EXEC:RPE

SCPI Command Reference
Command list

Function	Setting/Execution item	Command
User defined window - Marker/analysis (Continued)	Executes marker target search right	:CALC:USER[1-1]:TRAC[1-8]:MARK[1-10]:SEAR:EXEC:RTAR
	Executes marker target search	:CALC:USER[1-1]:TRAC[1-8]:MARK[1-10]:SEAR:EXEC:TARG
	Sets/Reads the peak excusion value	:CALC:USER[1-1]:TRAC[1-8]:MARK[1-10]:SEAR:PEAK:EXC
	Sets/Reads the marker peak search polality	:CALC:USER[1-1]:TRAC[1-8]:MARK[1-10]:SEAR:PEAK:POL
	marker-target transition type	:CALC:USER[1-1]:TRAC[1-8]:MARK[1-10]:SEAR:TARG:TRAN
	marker target value	:CALC:USER[1-1]:TRAC[1-8]:MARK[1-10]:SEAR:TARG:Y
	search tracking type	:CALC:USER[1-1]:TRAC[1-8]:MARK[1-10]:SEAR:TRAC:TYPE
	marker visible on/off	:CALC:USER[1-1]:TRAC[1-8]:MARK[1-10]:STAT
	marker x position	:CALC:USER[1-1]:TRAC[1-8]:MARK[1-10]:X
	marker y position	:CALC:USER[1-1]:TRAC[1-8]:MARK[1-10]:Y
	Sets/Reads the marker information position	:DISP:USER[1-1]:ANN:MARK:POS
	Turns on/off the marker list	:DISP:USER[1-1]:TABL[:STAT]
User defined window - Reads/writes the data	Sets/Reads formatted trace data	:CALC:USER[1-1]:TRAC[1-8]:DATA:FDAT
	Sets/Reads formatted momory data	:CALC:USER[1-1]:TRAC[1-8]:DATA:FMEM
	Reads the number of measurement points	:CALC:USER[1-1]:TRAC[1-8]:DATA:POIN
	Sets/Reads row data	:CALC:USER[1-1]:TRAC[1-8]:DATA:RDAT
	start frequency	:CALC:USER[1-1]:TRAC[1-8]:DATA:STAR
	stop frequency	:CALC:USER[1-1]:TRAC[1-8]:DATA:STOP
	Sets/Reads unformatted trace data	:CALC:USER[1-1]:TRAC[1-8]:DATA:UDAT
	Sets/Reads unformatted memory data	:CALC:USER[1-1]:TRAC[1-8]:DATA:UMEM
	Sets/Reads the X data	:CALC:USER[1-1]:TRAC[1-8]:DATA:XDAT
VBA Macro	Lists all the executable macro	:PROG:CAT
	Turns on/off the E5052 VBA event callback function	:PROG:COM:EVEN
	Sets/Reads the name of the program to be selected	:PROG:SEL:NAME
	Sets/Reads the state of the selected program	:PROG:SEL:STAT
	Turns on/off user defined softkey function	:PROG:SKEY:ITEM[1-8]:ENAB
	Executes the macro assigned under the user defined softkey	:PROG:SKEY:ITEM[1-8]:IMM
	Sets/Reads the user defined softkey label	:PROG:SKEY:ITEM[1-8]:LAB

Commands with Variable Parameters and/or Setting Ranges Depending on Device Configurataion

The table below lists the commands that have variable parameters and/or setting ranges depending on the device configuration.

Table 7-1 SCPI Commands with Variable Parameters and/or Setting Ranges Depending on Device Configuration

Command	Description
:SENSe:ATTenuation:LEVel	Sets/Reads the input attenuator level
:SENSe:DCONverter:INPut	Sets/Reads the signal supplied to the RF input port
:SENSe:DCONverter:MANual:IFDelta	Sets/Reads the differential frequency between CH1 and CH2 from the external mixer
:SENSe:DCONverter:MANual:IFGain[1-2]	Sets/Reads the IF gain of the external mixer
:SENSe:DCONverter:MANual:LO[1-2]:FREQuency	Sets/Reads the LO frequency of the external mixer
:SENSe:DCONverter:MANual:LO[1-2]:LEVel	Sets/Reads the LO level of the external mixer
:SENSe:DCONverter:MANual:MEXTernal[1-2]:BIAS:CURRent	Sets/Reads the bias current to be supplied to the external mixer
:SENSe:DCONverter:MANual:MEXTernal[1-2]:BIAS:STATe	Sets the bias current supplied to the external mixer on or off and reads its settings
:SENSe:DCONverter:MEXTernal	Sets the use of the external mixer on or off and reads its settings
:SENSe:FP[1-1]:DCONverter:FREQuency	Sets/Reads the input frequency to be supplied to the downconverter
:SENSe:FP[1-1]:DCONverter:SSEarch:EXECute	Searches carrier signal and reflects the result to the input frequency of the downconverter (No Query)
:SENSe:FP[1-1]:FBANd	Sets/Reads frequency band
:SENSe:FP[1-1]:POWer:INPut:LEVel:MAXimum	Sets/Reads the maximum input level of the downconverter in order to determine the IF Gain
:SENSe:PN[1-1]:DCONverter:FREQuency	Sets/Reads input frequency of the downconverter
:SENSe:PN[1-1]:DCONverter:SSEarch:EXECute	Searches carrier signal and reflects the result to the input frequency of the downconverter (No Query)
:SENSe:PN[1-1]:FBANd	Sets/Reads frequency band
:SENSe:SP[1-1]:CARRier:FBANd	Sets/Reads the carrier frequency band
:SENSe:SP[1-1]:FREQuency:CENTer	Sets/Reads the center value
:SENSe:SP[1-1]:FREQuency:STARt	Sets/Reads the start value
:SENSe:SP[1-1]:FREQuency:STOP	Sets/Reads the stop value
:SENSe:TR[1-1]:NARRow:FREQuency:PREference	Sets/Reads the phase reference frequency of the narrowband modeÇµ
:SENSe:TR[1-1]:NARRow:FREQuency:TARGet	Sets/Reads the target frequency of the narrowband mode

Table 7-1 SCPI Commands with Variable Parameters and/or Setting Ranges Depending on Device Configuration

Command	Description
:SENSe:TR[1-1]:WIDE:FREQuency:MAXimum	Sets/Reads transient frequency range in the wideband mode
:SENSe:UDConverTer:HARMonic	Sets/Reads the frequency offset factor
:SENSe:UDConverTer:LO	Sets/Reads the LO frequency of the frequency offset
:SENSe:UDConverTer:MODE	Sets/Reads the conversion mode of the frequency offset
:SENSe:UDConverTer:STATe	Sets/Reads the frequency offset
:SOURce:VOLTage:CONTRol:AFC:FBAND	Sets/Reads the frequency band in the auto frequency control function
:SOURce:VOLTage:CONTRol:AFC:INPut:LEVel:MAXimum	Sets/Reads the maximum input level of the downconverter in order to determine the IF Gain
:SOURce:VOLTage:CONTRol:AFC:TARGet	Sets/Reads the target frequency
:TRIGger:TR[1-1]:NARRow:VIDeo:FREQuency:CENTer	Sets/Reads video trigger frequency value of the narrowband mode
:TRIGger:TR[1-1]:WIDE:VIDeo:FREQuency:CENTer	Sets/Reads video trigger frequency value of the wideband mode

Softkey Functions

Bellow table shows the SCPI command list by measurement window and softkey.

FP Menu

Table 7-2 FP Menu

Key Operation	Function	SCPI Command
Attenuator		
Input Attenuator	Sets/Reads Input Attenuator level on 5dB Step	:SENS:ATT:LEV
Average		
Averaging	Turns on/off averaging function	:SENS:FP[1-1]:AVER:STAT
Averaging Restart	Restarts averaging	:SENS:FP[1-1]:AVER:CLE
Avg Factor	Sets/Reads averaging count	:SENS:FP[1-1]:AVER:COUN
DC Control Voltage		
Auto Freq Control		
AFC Status	Turns on/off the auto frequency control function. Executes the auto frequency control once.	:SOUR:VOLT:CONT:AFC[:STAT] :SOUR:VOLT:CONT:AFC:IMM
Frequency Band	Sets/Reads the frequency band in the auto frequency control function	:SOUR:VOLT:CONT:AFC:FBAN
Max Ctrl Voltage Limit	Sets/Reads the maximum DC control voltage limit	:SOUR:VOLT:CONT:AFC:LIM: HIGH
Max Input Level	Sets/Reads the maximum input level	:SOUR:VOLT:CONT:AFC:INP:L EV:MAX
Max Iteration	Sets/Reads the maximum number of iterations for the DC control voltage-setting loops	:SOUR:VOLT:CONT:AFC:ITER
Min Ctrl Voltage Limit	Sets/Reads the minimum DC control voltage limit	:SOUR:VOLT:CONT:AFC:LIM: LOW
Sensitivity	Sets/Reads the tuning sensitivity	:SOUR:VOLT:CONT:AFC:SENS
Target	Sets/Reads the target frequency in the auto frequency control function	:SOUR:VOLT:CONT:AFC:TARG
Tolerance	Sets/Reads the tolerance limit	:SOUR:VOLT:CONT:AFC:TOL
Control Voltage Cal	Enables DC Control voltage calibration	:SOUR:VOLT:CONT:CORR[:ST AT]
DC Control Delay	Sets/Reads DC Control delay (sec)	:SOUR:VOLT:CONT:DEL
DC Control Output	Turns on/off DC Control voltage	:SOUR:VOLT:CONT:LEV:STAT
DC Control Voltage	Sets/Reads DC Control voltage	:SOUR:VOLT:CONT:LEV:AMP L
Execute Control Voltage Cal	Executes DC Control voltage calibration	:SOUR:VOLT:CONT:CORR:CO LL:ACQ
Max Ctrl Voltage Limit	Sets/Reads the maximum DC Control voltage limit	:SOUR:VOLT:CONT:LIM:HIGH

Table 7-2 FP Menu

Key Operation	Function	SCPI Command
Min Ctrl Voltage Limit	Sets/Reads the minimum DC Control voltage limit	:SOUR:VOLT:CONT:LIM:LOW
DC Power Voltage		
DC Power Delay	Sets/Reads DC Power delay (sec)	:SOUR:VOLT:POW:DEL
DC Power Output	Turns on/off DC Power voltage	:SOUR:VOLT:POW:LEV:STAT
DC Power Voltage	Sets/Reads DC Power voltage	:SOUR:VOLT:POW:LEV:AMPL
Max Pwr Voltage Limit	Sets/Reads the maximum DC Power voltage limit	:SOUR:VOLT:POW:LIM:HIGH
Min Pwr Voltage Limit	Sets/Reads the minimum DC Power voltage limit	:SOUR:VOLT:POW:LIM:LOW
Display		
Allocate	Sets/Reads the trace layout	:DISP:FP[1-1]:SPL
Edit Title Label	Edits the measurement window title label	:DISP:FP[1-1]:LAB:DATA
Color Type	Sets/Reads the display type of the display (normal/inverted)	:DISP:IMAG
Limit Test		
Delete Lower Limit Line	Clears the lower limit line	:CALC:FP[1-1]:TRAC[1-4]:LIM:LOW:SEGM:CLE
Delete Upper Limit Line	Clears the upper limit line	:CALC:FP[1-1]:TRAC[1-4]:LIM:UPP:SEGM:CLE
Explorer		
Fail Sign	Turns on/off the limit test judgement display	:DISP:FP[1-1]:LIM:FSIG
Import Lower Limit Line ...	Reads the lower limit line	:MMEM:FP[1-1]:TRAC[1-4]:LOAD:LIM:LOW
Import Upper Limit Line ...	Reads the upper limit line	:MMEM:FP[1-1]:TRAC[1-4]:LOAD:LIM:UPP
Limit Line	Turns on/off the limit line	:DISP:FP[1-1]:TRAC[1-4]:LIM:LINE
Limit Test	Turns on/off the limit test function	:CALC:FP[1-1]:TRAC[1-4]:LIM[:STAT]
Marker Information	Sets/Reads the marker information position	:DISP:FP[1-1]:ANN:MARK:POS
Meas Condition	Turns on/off measurement conditions	:DISP:FP[1-1]:ANN:MEAS:STAT
Relative Y-Scale	Turns on/off relative Y-scale	:DISP:FP[1-1]:GRAT:AXIS:Y:REL
Security Level	Sets/recalls the security level	:SYST:SEC[:LEV]
Title Label	Turns on/off the measurement window title label	:DISP:FP[1-1]:LAB:STAT
Update	Turns on/off the trace updates	:DISP:ENAB

Table 7-2 FP Menu

Key Operation	Function	SCPI Command
Y # of Digits	Selects the number of digits (Y-axis)	:DISP:FP[1-1]:GRAT:AXIS:Y:STAT
Format		
Frequency Format	Selects frequency format (Hz or Hz/V)	:CALC:FP[1-1]:TRAC[1-4]:FORM:FREQ
Frequency Reference	Sets/Reads the frequency reference.	:CALC:FP[1-1]:TRAC[1-4]:REF:FREQ
Sensitivity Aperture	Sets/Reads the sensitivity aperture	:CALC:FP[1-1]:TRAC[1-4]:SAP
Input Port		
Downconverter		
Downconverter	Sets the use of the downconverter on or off, or reads its setting	:SENS:DCON[:STAT]
RF Input	Sets/Reads the signal supplied to the RF input port	:SENS:DCON:INP
External Mixer	Sets the use of the external mixer on or off and reads its settings	:SENS:DCON:MEXT
Macro Setup		
Application		
Jitter	Executes clock jitter analysis (VBA)	
mmWave	Executes phase-noise measurement (VBA)	
E5052 Event	Turns on/off the E5052 VBA event callback function	:PROG:COM:EVEN
Echo Window Menu		
Clear Echo	Clears Echo window	:DISP:ECHO:CLE
Echo Font Size	Sets/Reads the font size on Echo window	:DISP:ECHO:FSIZ
Echo Window	Turns on/off the Echo window	:DISP:ECHO:STAT
Load & Run	Loads and executes the macro selected on file names.	
Select Macro	Sets/Reads the name of the program to be selected	:PROG:SEL:NAME
Stop	Sets/Reads the state of the selected program	:PROG:SEL:STAT
User Menu		
User Label 1	Executes the macro assigned under the user defined softkey	:PROG:SKEY:ITEM[1-8]:IMM
User Label 2	Executes the macro assigned under the user defined softkey	:PROG:SKEY:ITEM[1-8]:IMM
User Label 3	Executes the macro assigned under the user defined softkey	:PROG:SKEY:ITEM[1-8]:IMM
User Label 4	Executes the macro assigned under the user defined softkey	:PROG:SKEY:ITEM[1-8]:IMM
User Label 5	Executes the macro assigned under the user defined softkey	:PROG:SKEY:ITEM[1-8]:IMM
User Label 6	Executes the macro assigned under the user defined softkey	:PROG:SKEY:ITEM[1-8]:IMM
User Label 7	Executes the macro assigned under the user defined softkey	:PROG:SKEY:ITEM[1-8]:IMM
User Label 8	Executes the macro assigned under the user defined softkey	:PROG:SKEY:ITEM[1-8]:IMM

Table 7-2 FP Menu

Key Operation	Function	SCPI Command
VBA Editor Menu		
Close Editor	Closes VBA editor	
Load Project	Loads program	:MMEM:LOAD:PROG
New Project	Opens new VBA project	
Open Editor	Opens VBA editor	
Save Project	Saves VBA Project	:MMEM:STOR:PROG
Marker		
Clear Marker Menu		
All OFF	Clears all the markers	
Marker 1	Turns on/off marker 1	:CALC:FP[1-1]:TRAC[1-4]:MARK[1-10]:STAT
:		
:		
Marker 10	Turns on/off marker 10	:CALC:FP[1-1]:TRAC[1-4]:MARK[1-10]:STAT
Couple	Turns on/off marker coupling function	:CALC:FP[1-1]:ALLT:MARK:COUP:STAT
Marker 1	Turns on/off marker 1	:CALC:FP[1-1]:TRAC[1-4]:MARK[1-10]:STAT
:		:CALC:FP[1-1]:TRAC[1-4]:MARK[1-10]:STAT
:		
Marker 6	Turns on/off marker 6	:CALC:FP[1-1]:TRAC[1-4]:MARK[1-10]:STAT
Marker List	Turns on/off the marker list	:DISP:FP[1-1]:TABL[:STAT]
More Functions		
Discrete	Sets/Reads marker movement (Continuous/Discrete)	:CALC:FP[1-1]:ALLT:MARK:DISC:STAT
Ref Marker	Sets/Reads marker reference number	:CALC:FP[1-1]:ALLT:MARK:REF:NUMB
Ref Marker Mode	Turns on/off delta marker mode	:CALC:FP[1-1]:ALLT:MARK:REF:STAT
More Markers		
Marker 7	Turns on/off marker 7	:CALC:FP[1-1]:TRAC[1-4]:MARK[1-10]:STAT
:		
:		
Marker 10	Turns on/off marker 10	:CALC:FP[1-1]:TRAC[1-4]:MARK[1-10]:STAT

Table 7-2 FP Menu

Key Operation	Function	SCPI Command
Marker Function		
Analysis Range (X)	Sets/Reads analysis/search range (X-axis)	:CALC:FP[1-1]:TRAC[1-4]:FUNCTION:DOM:X
Analysis Range (Y)	Sets/Reads analysis/search range (Y-axis)	:CALC:FP[1-1]:TRAC[1-4]:FUNCTION:DOM:Y
Analysis Type	Sets/Reads analysis type	:CALC:FP[1-1]:TRAC[1-4]:FUNCTION:TYPE
Band Marker X		
Band Marker X	Turns on/off bandmarker X	:CALC:FP[1-1]:TRAC[1-4]:BDM:X:STAT
Center	Sets/Reads the center value of bandmarker X	:CALC:FP[1-1]:TRAC[1-4]:BDM:X:CENT
Span	Sets/Reads the span value of bandmarker X	:CALC:FP[1-1]:TRAC[1-4]:BDM:X:SPAN
Start	Sets/Reads the start value of bandmarker X	:CALC:FP[1-1]:TRAC[1-4]:BDM:X:STAR
Stop	Sets/Reads the stop value of bandmarker X	:CALC:FP[1-1]:TRAC[1-4]:BDM:X:STOP
Band Marker Y		
Band Marker Y	Turns on/off bandmarker Y	:CALC:FP[1-1]:TRAC[1-4]:BDM:Y:STAT
Center	Sets/Reads the center value of bandmarker Y	:CALC:FP[1-1]:TRAC[1-4]:BDM:Y:CENT
Span	Sets/Reads the span value of bandmarker Y	:CALC:FP[1-1]:TRAC[1-4]:BDM:Y:SPAN
Start	Sets/Reads the start value of bandmarker Y	:CALC:FP[1-1]:TRAC[1-4]:BDM:Y:STAR
Stop	Sets/Reads the stop value of bandmarker Y	:CALC:FP[1-1]:TRAC[1-4]:BDM:Y:STOP
Couple	Turns on/off bandmarker coupling function	:CALC:FP[1-1]:ALLT:BDM:X:COUP:STAT
Marker Search		
Band Marker X		
Band Marker X	Turns on/off bandmarker X	:CALC:FP[1-1]:TRAC[1-4]:BDM:X:STAT
Center	Sets/Reads the center value of bandmarker X	:CALC:FP[1-1]:TRAC[1-4]:BDM:X:CENT
Span	Sets/Reads the span value of bandmarker X	:CALC:FP[1-1]:TRAC[1-4]:BDM:X:SPAN
Start	Sets/Reads the start value of bandmarker X	:CALC:FP[1-1]:TRAC[1-4]:BDM:X:STAR

Table 7-2 FP Menu

Key Operation	Function	SCPI Command
Stop	Sets/Reads the stop value of bandmarker X	:CALC:FP[1-1]:TRAC[1-4]:BDM :X:STOP
Band Marker Y		
Band Marker Y	Turns on/off bandmarker Y	:CALC:FP[1-1]:TRAC[1-4]:BDM :Y:STAT
Center	Sets/Reads the center value of bandmarker Y	:CALC:FP[1-1]:TRAC[1-4]:BDM :Y:CENT
Span	Sets/Reads the span value of bandmarker Y	:CALC:FP[1-1]:TRAC[1-4]:BDM :Y:SPAN
Start	Sets/Reads the start value of bandmarker Y	:CALC:FP[1-1]:TRAC[1-4]:BDM :Y:STAR
Stop	Sets/Reads the stop value of bandmarker Y	:CALC:FP[1-1]:TRAC[1-4]:BDM :Y:STOP
Couple	Turns on/off bandmarker coupling function	:CALC:FP[1-1]:ALLT:BDM:X:C OUP:STAT
Peak		
Peak Excursion	Sets/Reads the peak excursion value	:CALC:FP[1-1]:TRAC[1-4]:MAR K[1-10]:SEAR:PEAK:EXC
Peak Polarity	Sets/Reads the marker peak-search polarity	:CALC:FP[1-1]:TRAC[1-4]:MAR K[1-10]:SEAR:PEAK:POL
Search Left	Executes marker peak search left	:CALC:FP[1-1]:TRAC[1-4]:MAR K[1-10]:SEAR:EXEC:LPE
Search Peak	Executes marker peak search	:CALC:FP[1-1]:TRAC[1-4]:MAR K[1-10]:SEAR:EXEC:PEAK
Search Peak All	Executes marker search all	:CALC:FP[1-1]:TRAC[1-4]:ALL M:SEAR:PEAK
Search Right	Executes marker peak search right	:CALC:FP[1-1]:TRAC[1-4]:MAR K[1-10]:SEAR:EXEC:RPE
Search Max	Executes marker search maximum	:CALC:FP[1-1]:TRAC[1-4]:MAR K[1-10]:SEAR:EXEC:MAX
Search Min	Executes marker search minimum	:CALC:FP[1-1]:TRAC[1-4]:MAR K[1-10]:SEAR:EXEC:MIN
Search Range (X)	Sets/Reads marker search range (X-axis)	:CALC:FP[1-1]:TRAC[1-4]:ALL M:SEAR:DOM:X
Search Range (Y)	Sets/Reads marker search range (Y-axis)	:CALC:FP[1-1]:TRAC[1-4]:ALL M:SEAR:DOM:Y
Target		
Search Left	Executes marker target search left	:CALC:FP[1-1]:TRAC[1-4]:MAR K[1-10]:SEAR:EXEC:LTAR
Search Right	Executes marker target search right	:CALC:FP[1-1]:TRAC[1-4]:MAR K[1-10]:SEAR:EXEC:RTAR

Table 7-2 FP Menu

Key Operation	Function	SCPI Command
Search Target	Executes marker target search	:CALC:FP[1-1]:TRAC[1-4]:MARK[1-10]:SEAR:EXEC:TARG
Target Transition	Sets/Reads the target transition definition	:CALC:FP[1-1]:TRAC[1-4]:MARK[1-10]:SEAR:TARG:TRAN
Target Value	Sets/Reads the marker target value	:CALC:FP[1-1]:TRAC[1-4]:MARK[1-10]:SEAR:TARG:Y
Tracking	Sets/Reads the marker tracking type	:CALC:FP[1-1]:TRAC[1-4]:MARK[1-10]:SEAR:TRAC:TYPE
Marker To		
Marker -> Center	Sets the marker value to the center value of DC Control voltage Sets the marker value to the center value of DC Power voltage	:SOUR:FP[1-1]:VOLT:CONT:CENT :SOUR:FP[1-1]:VOLT:POW:CENT
Marker -> Start	Sets the marker value to the start value of DC Control voltage Sets the marker value to the start value of DC Power voltage	:SOUR:FP[1-1]:VOLT:CONT:STAR :SOUR:FP[1-1]:VOLT:POW:STAR
Marker -> Stop	Sets the marker value to the stop value of DC Control voltage Sets the marker value to the stop value of DC Power voltage	:SOUR:FP[1-1]:VOLT:CONT:STOP :SOUR:FP[1-1]:VOLT:POW:STOP
Measurement View		
Freq & Power	Selects frequency,power and DC current measurement window	:DISP:WIND:ACT
Phase Noise	Selects phase noise measurement window	:DISP:WIND:ACT
Show Window		
Freq & Power	Turns on/off frequency,power and DC current measurement mode	:DISP:FP[1-1]:STAT
Phase Noise	Turns on/off noise measurement mode	:DISP:PN[1-1]:STAT
Spectrum Monitor	Turns on/off spectrum monitor mode	:DISP:SP[1-1]:STAT
Transient	Turns on/off transient measurement mode	:DISP:TR[1-1]:STAT
User	Turns on/off user defined window	:DISP:USER[1-1]:STAT
Spectrum Monitor	Selects spectrum monitor mode	:DISP:WIND:ACT
Transient	Selects transient monitor mode	:DISP:WIND:ACT
User	Selects user defined window	:DISP:WIND:ACT
Preset		
Factory	Presets instrument to the initial setup state	:SYST:PRES
User	Presets instrument and recalls the Autorec.sta in the F drive	

Table 7-2 FP Menu

Key Operation	Function	SCPI Command
Save/Recall		
Explorer...	Opens windows explorer	
Recall by filename	Recalls state file by file name	:MMEM:LOAD:STAT
Recall State		
Autorec	Recalls settings	:MMEM:LOAD:STAT
File Dialog...	Opens file dialog	
State01	Recalls state file from register 1	:MMEM:LOAD:STAT
State02	Recalls state file from register 2	:MMEM:LOAD:STAT
State03	Recalls state file from register 3	:MMEM:LOAD:STAT
State04	Recalls state file from register 4	:MMEM:LOAD:STAT
State05	Recalls state file from register 5	:MMEM:LOAD:STAT
State06	Recalls state file from register 6	:MMEM:LOAD:STAT
Save Data Trace	Saves trace data	:MMEM:FP[1-1]:TRAC[1-4]:ST OR[:DATA]
Save Memory Trace	Saves memory trace data	:MMEM:FP[1-1]:TRAC[1-4]:ST OR:MEM
Save State		
Autorec	Saves settings	:MMEM:STOR:STAT
File Dialog...	Opens file dialog	
Save Type	Selects instrument state type (Entire or instrument state only)	:MMEM:STOR:STYP
State01	Saves state file to register 1	:MMEM:STOR:STAT
State02	Saves state file to register 2	:MMEM:STOR:STAT
State03	Saves state file to register 3	:MMEM:STOR:STAT
State04	Saves state file to register 4	:MMEM:STOR:STAT
State05	Saves state file to register 5	:MMEM:STOR:STAT
State06	Saves state file to register 6	:MMEM:STOR:STAT
Scale		
Auto Scale	Executes autoscale	:DISP:FP[1-1]:TRAC[1-4]:Y[:SC AL]:AUTO
Auto Scale All	Executes autoscale for all traces on frequency,power and DC current measurement window	:DISP:FP[1-1]:ALLT:Y:SCAL:A UTO
Divisions	Sets/Reads Y-scale divisions	:DISP:FP[1-1]:Y[:SCAL]:DIV
Marker -> Reference	Sets the marker value to the reference level	:DISP:FP[1-1]:TRAC[1-4]:Y[:SC AL]:RLEV
Reference Position	Sets/Reads reference position	:DISP:FP[1-1]:TRAC[1-4]:Y[:SC AL]:RPOS

Table 7-2 FP Menu

Key Operation	Function	SCPI Command
Reference Value	Sets/Reads the reference level value	:DISP:FP[1-1]:TRAC[1-4]:Y[:SCAL]:RLEV
Scale/Div	Sets/Reads scale per division	:DISP:FP[1-1]:TRAC[1-4]:Y[:SCAL]:PDIV
X Axis		
Auto	Sets/Reads automatic setting of the X-axis display range to the stimulus value	:DISP:FP[1-1]:TRAC[1-4]:X[:SCAL]:AUTO
Band Marker -> X Axis	Sets the X-axis band marker range to the X-axis display range of a graph	:DISP:FP[1-1]:TRAC[1-4]:X[:SCAL]:LEFT :DISP:FP[1-1]:TRAC[1-4]:X[:SCAL]:RIGH
Left	Sets/Reads the start value of the X-axis display range	:DISP:FP[1-1]:TRAC[1-4]:X[:SCAL]:LEFT
Right	Sets/Reads the stop value of the X-axis display range	:DISP:FP[1-1]:TRAC[1-4]:X[:SCAL]:RIGH
Setup		
Carrier Search	Searches carrier signal and reflects the result to the input frequency of the downconverter	:SENS:FP[1-1]DCON:SSE:EXEC
Freq Resolution	Sets/Reads frequency resolution	:SENS:FP[1-1]:FREQ:RES
Frequency Band	Selects frequency band	:SENS:FP[1-1]:FBAN
Max Input Level	Sets/Reads the maximum input level of the downconverter in order to determine the IF Gain	:SENS:FP[1-1]:POW:INP:LEV:MAX
Nominal Frequency	Sets/Reads the input frequency to be supplied to the downconverter	:SENS:FP[1-1]:DCON:FREQ
Point Delay	Sets/Reads the point delay value	:SENS:FP[1-1]:SWE:DWEL
Points	Sets/Reads the number of measurement points	:SOUR:FP[1-1]:SWE:POIN
Sweep Parameter	Sets/Reads sweep parameter	:SOUR:FP[1-1]:SWE:PAR
Start/Center		
DC Control Center	Sets/Reads the center value of DC Control voltage	:SOUR:FP[1-1]:VOLT:CONT:CENT
DC Control Span	Sets/Reads the span value of DC Control voltage	:SOUR:FP[1-1]:VOLT:CONT:SPAN
DC Control Start	Sets/Reads the start value of DC Control voltage	:SOUR:FP[1-1]:VOLT:CONT:START
DC Control Stop	Sets/Reads the stop value of DC Control voltage	:SOUR:FP[1-1]:VOLT:CONT:STOP
DC Power Center	Sets/Reads the center value of DC Power voltage	:SOUR:FP[1-1]:VOLT:POW:CENT
DC Power Span	Sets/Reads the span value of DC Power voltage	:SOUR:FP[1-1]:VOLT:POW:SPAN

Table 7-2 FP Menu

Key Operation	Function	SCPI Command
DC Power Start	Sets/Reads the start value of DC Power voltage	:SOUR:FP[1-1]:VOLT:POW:STAR
DC Power Stop	Sets/Reads the stop value of DC Power voltage	:SOUR:FP[1-1]:VOLT:POW:STOP
Stop/Span		
DC Control Center	Sets/Reads the center value of DC Power voltage	:SOUR:FP[1-1]:VOLT:CONT:CEN T
DC Control Span	Sets/Reads the span value of DC Power voltage	:SOUR:FP[1-1]:VOLT:CONT:SP AN
DC Control Start	Sets/Reads the start value of DC Power voltage	:SOUR:FP[1-1]:VOLT:CONT:ST AR
DC Control Stop	Sets/Reads the stop value of DC Control voltage	:SOUR:FP[1-1]:VOLT:CONT:ST OP
DC Power Center	Sets/Reads the center value of DC Power voltage	:SOUR:FP[1-1]:VOLT:POW:CEN T
DC Power Span	Sets/Reads the span value of DC Power voltage	:SOUR:FP[1-1]:VOLT:POW:SPA N
DC Power Start	Sets/Reads the start value of DC Power voltage	:SOUR:FP[1-1]:VOLT:POW:STA R
DC Power Stop	Sets/Reads the stop value of DC Power voltage	:SOUR:FP[1-1]:VOLT:POW:STO P
System		
Abort Printing	Aborts printing	:HCOP:ABOR
Backlight	Turns on/off backlight	:SYST:BACK:STAT
Instrument Setup		
Correction		
File Dialog ...	Loads correction data for a specified power	:MMEM:LOAD:CORR:POW
Import Power Correction Table	Loads correction data for a specified power	:MMEM:LOAD:CORR:POW
Power Correction	Sets user the user calibration on or off or reads its setting	:SENS:CORR:POW:STAT
Downconverter Manual Setup		
Current	Sets/Reads the bias current to be supplied to the external mixer	:SENS:DCON:MAN:MEXT[1-2]: BIAS:CURR
IF Gain 1 IF Gain 2	Sets/Reads the IF gain of the external mixer	:SENS:DCON:MAN:IFG[1-2]

Table 7-2 FP Menu

Key Operation	Function	SCPI Command
LO1 Frequency LO2 Frequency	Sets/Reads the LO frequency of the external mixer	:SNES:DCON:MAN:LO[1-2]:FREQ
LO1 Level LO2 Level	Sets/Reads the LO level of the external mixer	:SENS:DCON:MAN:LO[1-2]:LEV
Mixer 1 Bias Mixer 2 Bias	Sets the bias current supplied to the external mixer on or off and reads its settings	:SENS:DCON:MAN:MEXT[1-2]:BIAS:STAT
$\Delta IF = IF2 - IF1$	Sets/Reads the differential frequency between CH1 and CH2 from the external mixer	:SENS:DCON:MAN:IFD
Frequency Offset (User Downconv.)		
Conversion Mode	Sets/Reads the conversion mode of the frequency offset	:SENS:UDC:MODE
Frequency Offset	Sets/Reads the frequency offset	:SENS:UDC:STAT
Harmonic #	Sets/Reads the frequency offset factor	:SENS:UDC:HARM
LO Frequency	Sets/Reads the LO frequency of the frequency offset	:SENS:UDC:LO
Dump Screen Image	Saves screen image	:MMEM:STOR:IMAG
Error Log		
Clear Error Log	Clears error log	
View Error Log...	Displays error log	
Invert Image	Selects print mode	:HCOP:IMAG
Misc Setup		
Beeper		
Beep Complete	Turns on/off the beep for operation completion	:SYST:BEEP:COMP:STAT
Beep Warning	Turns on/off the beep for warning	:SYST:BEEP:WARN:STAT
Test Beep Complete	Makes beep sound for operation completion	:SYST:BEEP:COMP:IMM
Test Beep Warning	Makes beep sound for warning	:SYST:BEEP:WARN:IMM
Clock Setup		
Set Date and Time	Sets/Reads system time Sets/Reads system date	:SYST:TIME :SYST:DATE
Show Clock	Turns on/off internal clock display	:DISP:CLOC

Table 7-2 FP Menu

Key Operation	Function	SCPI Command
Color Setup		
Invert	Sets each color when the inverted display is selected	
Background	Sets/Reads the background color	:DISP:COL2:BACK[:VAL]
Data Trace 1	Sets/Reads the color of the data trace of trace 1	:DISP:COL2:TRAC1:DATA[:VAL]
:		
Data Trace 8	Sets/Reads the color of the data trace of trace 8	:DISP:COL2:TRAC8:DATA[:VAL]
Graticule Main	Sets/Reads the color of the graph	:DISP:COL2:GRAT1[:VAL]
Graticule Sub	Sets/Reads the color of the grid lines in the graph	:DISP:COL2:GRAT2[:VAL]
Limit Fail	Sets/Reads the limit display color	:DISP:COL2:LIM1[:VAL]
Limit Line	Sets/Reads the color of the limit line	:DISP:COL2:LIM2[:VAL]
Mem Trace 1	Sets/Reads the color of the memory trace of trace 1	:DISP:COL2:TRAC1:MEM[:VAL]
:		
Mem Trace 8	Sets/Reads the color of the memory trace of trace 8	:DISP:COL2:TRAC8:MEM[:VAL]
Reset Color	Resets the display color to the factory preset default setting	:DISP:COL2:RES
Normal	Sets each color when the normal display is selected	
Background	Sets/Reads the background color	:DISP:COL1:BACK[:VAL]
Data Trace 1	Sets/Reads the color of the data trace of trace 1	:DISP:COL1:TRAC1:DATA[:VAL]
:		
Data Trace 8	Sets/Reads the color of the data trace of trace 8	:DISP:COL1:TRAC8:DATA[:VAL]
Graticule Main	Sets/Reads the color of the graph	:DISP:COL1:GRAT1[:VAL]
Graticule Sub	Sets/Reads the color of the grid lines in the graph	:DISP:COL1:GRAT2[:VAL]
Limit Fail	Sets/Reads the limit display color	:DISP:COL1:LIM1[:VAL]
Limit Line	Sets/Reads the color of the limit line	:DISP:COL1:LIM2[:VAL]
Mem Trace 1	Sets/Reads the color of the memory trace of trace 1	:DISP:COL1:TRAC1:MEM[:VAL]

Table 7-2 FP Menu

Key Operation	Function	SCPI Command
:		
:		
Mem Trace 8	Sets/Reads the color of the memory trace of trace 8	:DISP:COL1:TRAC8:MEM[:VAL]
Reset Color	Resets the display color to the factory preset default setting	:DISP:COL1:RES
Control Panel ...	Opens control panel	
 GPIB Setup		
System Controller Configuration	Turns on/off system controller mode	
Talker/Listener Address	Sets/Reads talker/listener GPIB address of the	
Key Lock		
Front Panel & Keyboard Lock	Disables from panelkeyboard operations	:SYST:KLOC:KBD
Touch Screen & Mouse Lock	Disables from mouse/touch screen operations	:SYST:KLOC:MOUS
Network Setup		
MAC Address	Sets MAC address	
Network Configuration ...	Enables/disables network connections	
Network Identification ...	Sets network ID of the instrument	
SICL-LAN Address	Sets SICL-LAN address	
SICL-LAN Server	Enables/disables SICL-LAN server	
Socket Server	Enables/disables Socket server	
Telnet Server	Enables/disables telnet server	
Print	Outputs print	:HCOP:IMM
Printer Setup ...	Executes printer setup	

Table 7-2 FP Menu

Key Operation	Function	SCPI Command
Service Menu		
Administrator Menu	Displays softkeys associated with Administrator Menu. This function is not available to general users.	
Error Log		
Clear Error Log	Clears the error log	
View Error Log ...	Displays the error log	
Install Option License		
Jitter	Enters the license for clock jitter analysis	
Service Function	Displays softkeys associated with Service Menu. This function is not available to general users.	
Test Menu		
Power On Test	Performs internal test	
Display Test	Performs display test	
Front Panel	Performs front panel key (hard key) test	
Adjust Touch Screen	Performs touch screen calibration	
E5053A Test	Displays the connection status of E5053A	
Trace View		
Aperture	Smoothing aperture	:CALC:FP[1-1]:TRAC[1-4]:SMO :APER
Copy to User	Copies trace data to the user trace	:CALC:FP[1-1]:TRAC[1-4]:DAT A:COPY
Data -> Mem	Copies data to memory	:CALC:FP[1-1]:TRAC[1-4]:MAT H:MEM
Data Hold	Data hold	:CALC:FP[1-1]:TRAC[1-4]:HOL D
Data Math	Sets/Reads math operation type	:CALC:FP[1-1]:TRAC[1-4]:MAT H:FUNC
Display Trace	Shows data and/or memory trace	:DISP:FP[1-1]:TRAC[1-4]:MOD E
Marker -> -Offset	Sets sign-inverted data value of the data trace's active marker to the offset value	:CALC:FP[1-1]:TRAC[1-4]:MAT H:OFFS
Memory Trace		
Line (Y = AX + B)		
A	Sets/Reads regression line coefficient a (slope)	:CALC:FP[1-1]:TRAC[1-4]:LINE :A

Table 7-2 FP Menu

Key Operation	Function	SCPI Command
B	Sets/Reads regression line coefficient b (intercept)	:CALC:FP[1-1]:TRAC[1-4]:LINE :B
Data Trace -> A, B	Assigns the measurement results to regression line coefficients (a, b)	:CALC:FP[1-1]:TRAC[1-4]:FUN C:LREG:DATA? :CALC:FP[1-1]:TRAC[1-4]:LINE :A :CALC:FP[1-1]:TRAC[1-4]:LINE :B
Set Line to Memory	Sets the obtained regression line to the memory trace	:CALC:FP[1-1]:TRAC[1-4]:LINE :MEM
Offset	Sets/Reads the offset value of the data trace	:CALC:FP[1-1]:TRAC[1-4]:MAT H:OFFS
Persistence		
Clear Persistent Data	Clears persistent mode	:DISP:FP[1-1]:TRAC[1-4]:PERS: CLE
Persistence Mode	Sets/Reads persistent mode	:DISP:FP[1-1]:TRAC[1-4]:PERS: STAT
Smoothing	Smoothing on/off	:CALC:FP[1-1]:TRAC[1-4]:SMO :STAT
Trace Label	Edits trace title label	:DISP:FP[1-1]:TRAC[1-4]:LAB: DATA
Trigger		
Average Trigger	Sets/Reads the averaging trigger function	:TRIG:AVER
Continuous	Always moves to waiting-for-trigger state after measuring Moves once to waiting-fortrigger state	:INIT:FP[1-1]:CONT :INIT:FP[1-1]:IMM
Ext Trig Polarity	External trigger polarity	:TRIG:EXT:SLOP
Hold	Sets trigger mode to waiting-for-trigger state	:INIT:FP[1-1]:IMM
Manual Trigger	Moves once to waiting-for-trigger state	:INIT:FP[1-1]:IMM
Mode	Sets/Reads instrument mode to analyzer or tester mode ^{*1}	:TRIG:FP[1-1]:MODE ^{*2}
Restart	Moves once to waiting-for-trigger state	:INIT:FP[1-1]:IMM
Single	Always moves to waiting-for-trigger state after measuring Moves once to waiting-for-trigger state	:INIT:FP[1-1]:CONT :INIT:FP[1-1]:IMM
Source	Triggers source	:TRIG:FP[1-1]:SOUR
Trigger to Freq & Power	Selects measurement mode	:TRIG:MODE

*1. Only “Tester” mode is available when option 011 is installed.

*2. “Option not installed” error message is generated when setting the trigger mode to analyzer mode with the instrument for the option 011.

PN Menu

Table 7-3 PN Menu

Key Operation	Function	SCPI Command
Attenuator		
Input Attenuator	Sets/Reads Input Attenuator level on 5dB Step	:SENS:ATT:LEV
Average		
Averaging	Turns on/off averaging function	:SENS:PN[1-1]:AVER:STAT
Averaging Restart	Restarts averaging	:SENS:PN[1-1]:AVER:CLE
Avg Factor	Sets/Reads average count	:SENS:PN[1-1]:AVER:COUN
Correlation	Sets/Reads the number of correlation	:SENS:PN[1-1]:CORR:COUN
DC Control Voltage		
Auto Freq Control		
AFC Status	Turns on/off the auto frequency control function. Executes the auto frequency control once.	:SOUR:VOLT:CONT:AFC[:STAT] :SOUR:VOLT:CONT:AFC:IMM
Frequency Band	Sets/Reads the frequency band in the auto frequency control function	:SOUR:VOLT:CONT:AFC:FBAN
Max Ctrl Voltage Limit	Sets/Reads the maximum DC control voltage limit	:SOUR:VOLT:CONT:AFC:LIM: HIGH
Max Input Level	Sets/Reads the maximum input level	:SOUR:VOLT:CONT:AFC:INP:L EV:MAX
Max Iteration	Sets/Reads the maximum number of iterations for the DC control voltage-setting loops	:SOUR:VOLT:CONT:AFC:ITER
Min Ctrl Voltage Limit	Sets/Reads the minimum DC control voltage limit	:SOUR:VOLT:CONT:AFC:LIM: LOW
Sensitivity	Sets/Reads the tuning sensitivity	:SOUR:VOLT:CONT:AFC:SENS
Target	Sets/Reads the target frequency in the auto frequency control function	:SOUR:VOLT:CONT:AFC:TARG
Tolerance	Sets/Reads the tolerance limit	:SOUR:VOLT:CONT:AFC:TOL
Control Voltage Cal	Enables DC Control voltage calibration	:SOUR:VOLT:CONT:CORR[:ST AT]
DC Control Delay	Sets/Reads DC Control delay (sec)	:SOUR:VOLT:CONT:DEL
DC Control Output	Turns on/off DC Control voltage	:SOUR:VOLT:CONT:LEV:STAT
DC Control Voltage	Sets/Reads DC Control voltage	:SOUR:VOLT:CONT:LEV:AMP L
Execute Control Voltage Cal	Executes DC control voltage calibration	:SOUR:VOLT:CONT:CORR:CO LL:ACQ
Max Ctrl Voltage Limit	Sets/Reads the maximum DC control voltage limit	:SOUR:VOLT:CONT:LIM:HIGH
Min Ctrl Voltage Limit	Sets/Reads the minimum DC control voltage limit	:SOUR:VOLT:CONT:LIM:LOW

Table 7-3 PN Menu

Key Operation	Function	SCPI Command
DC Power Voltage		
DC Power Delay	Sets/Reads DC Power delay (sec)	:SOUR:VOLT:POW:DEL
DC Power Output	Turns on/off DC Power voltage	:SOUR:VOLT:POW:LEV:STAT
DC Power Voltage	Sets/Reads DC Power voltage	:SOUR:VOLT:POW:LEV:AMPL
Max Pwr Voltage Limit	Sets/Reads the maximum DC Power voltage limit	:SOUR:VOLT:POW:LIM:HIGH
Min Pwr Voltage Limit	Sets/Reads the minimum DC Power voltage limit	:SOUR:VOLT:POW:LIM:LOW
Display		
Edit Title Label	Edits the measurement window title label	:DISP:PN[1-1]:LAB:DATA
Color Type	Sets/Reads the display type of the display (normal/inverted)	:DISP:IMAG
Limit Test		
Delete Lower Limit Line	Clears the lower limit line	:CALC:PN[1-1]:TRAC[1-1]:LIM:LOW:SEGM:CLE
Delete Upper Limit Line	Clears the upper limit line	:CALC:PN[1-1]:TRAC[1-1]:LIM:UPP:SEGM:CLE
Explorer		
Fail Sign	Turns on/off the limit test judgement display	:DISP:PN[1-1]:LIM:FSIG
Import Lower Limit Line ...	Reads the lower limit line	:MMEM:PN[1-1]:TRAC[1-1]:LOAD:LIM:LOW
Import Upper Limit Line ...	Reads the upper limit line	:MMEM:PN[1-1]:TRAC[1-1]:LOAD:LIM:UPP
Limit Line	Turns on/off the limit line	:DISP:PN[1-1]:TRAC[1-1]:LIM:LINE
Limit Test	Turns on/off the limit test function	:CALC:PN[1-1]:TRAC[1-1]:LIM[:STAT]
Marker Information	Sets/Reads the marker information position	:DISP:PN[1-1]:ANN:MARK:POS
Meas Condition	Turns on/off measurement conditions	:DISP:PN[1-1]:ANN:MEAS:STAT
Relative Y-Scale	Turns on/off relative Y-scale	:DISP:PN[1-1]:GRAT:AXIS:Y:REL
Security Level	Sets/recalls the security level	:SYST:SEC[:LEV]
Title Label	Turns on/off the measurement window title label	:DISP:PN[1-1]:LAB:STAT
Update	Turns on/off the trace updates	:DISP:ENAB
Y # of Digits	Selects the number of digits (Y-axis)	:DISP:PN[1-1]:GRAT:AXIS:Y:STAT

Table 7-3 PN Menu

Key Operation	Function	SCPI Command
Input Port		
Downconverter		
Downconverter	Sets the use of the downconverter on or off, or reads its setting	:SENS:DCON[:STAT]
RF Input	Sets/Reads the signal supplied to the RF input port	:SENS:DCON:INP
External Mixer	Sets the use of the external mixer on or off and reads its settings	:SENS:DCON:MEXT
Macro Setup		
Application		
Jitter	Executes clock jitter analysis (VBA)	
mmWave	Executes phase-noise measurement (VBA)	
E5052 Event	Turns on/off the E5052 VBA event callback function	:PROG:COM:EVEN
Echo Window Menu		
Clear Echo	Clears echo window	:DISP:ECHO:CLE
Echo Font Size	Sets/Reads the font size on Echo window	:DISP:ECHO:FSIZ
Echo Window	Turns on./off the Echo window	:DISP:ECHO:STAT
Load & Run	Loads and executes the macro selected on file names.	
Select Macro	Sets/Reads the name of the program to be selected	:PROG:SEL:NAME
Stop	Sets/Reads the state of the selected program	:PROG:SEL:STAT
User Menu		
User Label 1	Executes the macro assigned under the user defined softkey	:PROG:SKEY:ITEM[1-8]:IMM
User Label 2	Executes the macro assigned under the user defined softkey	:PROG:SKEY:ITEM[1-8]:IMM
User Label 3	Executes the macro assigned under the user defined softkey	:PROG:SKEY:ITEM[1-8]:IMM
User Label 4	Executes the macro assigned under the user defined softkey	:PROG:SKEY:ITEM[1-8]:IMM
User Label 5	Executes the macro assigned under the user defined softkey	:PROG:SKEY:ITEM[1-8]:IMM
User Label 6	Executes the macro assigned under the user defined softkey	:PROG:SKEY:ITEM[1-8]:IMM
User Label 7	Executes the macro assigned under the user defined softkey	:PROG:SKEY:ITEM[1-8]:IMM
User Label 8	Executes the macro assigned under the user defined softkey	:PROG:SKEY:ITEM[1-8]:IMM
VBA Editor Menu		
Close Editor	Closes VBA editor	
Load Project	Loads program	:MMEM:LOAD:PROG
New Project	Opens new VBA project	
Open Editor	Opens VBA editor	
Save Project	Saves VBA project	:MMEM:STOR:PROG

Table 7-3 PN Menu

Key Operation	Function	SCPI Command
Marker		
Clear Marker Menu		
All OFF	Clears all the markers	
Marker 1	Turns on/off marker 1	:CALC:PN[1-1]:TRAC[1-1]:MARK[1-10]:STAT
:		
:		
Marker 10	Turns on/off marker 10	:CALC:PN[1-1]:TRAC[1-1]:MARK[1-10]:STAT
Marker 1	Turns on/off marker 1	:CALC:PN[1-1]:TRAC[1-1]:MARK[1-10]:STAT
:		
:		
Marker 6	Turns on/off marker 6	:CALC:PN[1-1]:TRAC[1-1]:MARK[1-10]:STAT
Marker List	Turns on/off the marker list	:DISP:PN[1-1]:TABL[:STAT]
More Functions		
Discrete	Sets/Reads marker movement (Continuous/Discrete)	:CALC:PN[1-1]:ALLT:MARK:DISC:STAT
Ref Marker	Sets/Reads marker reference number	:CALC:PN[1-1]:ALLT:MARK:REF:NUMB
Ref Marker Mode	Turns on/off delta marker mode	:CALC:PN[1-1]:ALLT:MARK:REF:STAT
More Markers		
Marker 7	Turns on/off marker 7	:CALC:PN[1-1]:TRAC[1-1]:MARK[1-10]:STAT
:		
:		
Marker 10	Turns on/off marker 10	:CALC:PN[1-1]:TRAC[1-1]:MARK[1-10]:STAT
Marker Function		
Analysis Range (X)	Sets/Reads analysis/search range (X-axis)	:CALC:PN[1-1]:TRAC[1-1]:FUNCTION:DOM:X
Analysis Range (Y)	Sets/Reads analysis/search range (Y-axis)	:CALC:PN[1-1]:TRAC[1-1]:FUNCTION:DOM:Y
Analysis Type	Sets/Reads analysis type	:CALC:PN[1-1]:TRAC[1-1]:FUNCTION:TYPE

Table 7-3 PN Menu

Key Operation	Function	SCPI Command
Band Marker X		
Band Marker X	Turns on/off bandmarker X	:CALC:PN[1-1]:TRAC[1-1]:BDM:X:STAT
Center	Sets/Reads the center value of bandmarker X	:CALC:PN[1-1]:TRAC[1-1]:BDM:X:CENT
Span	Sets/Reads the span value of bandmarker X	:CALC:PN[1-1]:TRAC[1-1]:BDM:X:SPAN
Start	Sets/Reads the start value of bandmarker X	:CALC:PN[1-1]:TRAC[1-1]:BDM:X:STAR
Stop	Sets/Reads the stop value of bandmarker X	:CALC:PN[1-1]:TRAC[1-1]:BDM:X:STOP
Band Marker Y		
Band Marker Y	Turns on/off bandmarker Y	:CALC:PN[1-1]:TRAC[1-1]:BDM:Y:STAT
Center	Sets/Reads the center value of bandmarker Y	:CALC:PN[1-1]:TRAC[1-1]:BDM:Y:CENT
Span	Sets/Reads the span value of bandmarker Y	:CALC:PN[1-1]:TRAC[1-1]:BDM:Y:SPAN
Start	Sets/Reads the start value of bandmarker Y	:CALC:PN[1-1]:TRAC[1-1]:BDM:Y:STAR
Stop	Sets/Reads the stop value of bandmarker Y	:CALC:PN[1-1]:TRAC[1-1]:BDM:Y:STOP
Marker Search		
Band Marker X		
Band Marker X	Turns on/off bandmarker X	:CALC:PN[1-1]:TRAC[1-1]:BDM:X:STAT
Center	Sets/Reads the center value of bandmarker X	:CALC:PN[1-1]:TRAC[1-1]:BDM:X:CENT
Span	Sets/Reads the span value of bandmarker X	:CALC:PN[1-1]:TRAC[1-1]:BDM:X:SPAN
Start	Sets/Reads the start value of bandmarker X	:CALC:PN[1-1]:TRAC[1-1]:BDM:X:STAR
Stop	Sets/Reads the stop value of bandmarker X	:CALC:PN[1-1]:TRAC[1-1]:BDM:X:STOP
Band Marker Y		
Band Marker Y	Turns on/off bandmarker Y	:CALC:PN[1-1]:TRAC[1-1]:BDM:Y:STAT
Center	Sets/Reads the center value of bandmarker Y	:CALC:PN[1-1]:TRAC[1-1]:BDM:Y:CENT
Span	Sets/Reads the span value of bandmarker Y	:CALC:PN[1-1]:TRAC[1-1]:BDM:Y:SPAN

Table 7-3 PN Menu

Key Operation	Function	SCPI Command
Start	Sets/Reads the start value of bandmarker Y	:CALC:PN[1-1]:TRAC[1-1]:BDM:Y:STAR
Stop	Sets/Reads the stop value of bandmarker Y	:CALC:PN[1-1]:TRAC[1-1]:BDM:Y:STOP
Peak		
Peak Excursion	Sets/Reads the peak excursion value	:CALC:PN[1-1]:TRAC[1-1]:MARK[1-10]:SEAR:PEAK:EXC
Peak Polarity	Sets/Reads the marker peak-search polarity	:CALC:PN[1-1]:TRAC[1-1]:MARK[1-10]:SEAR:PEAK:POL
Search Left	Executes marker peak search left	:CALC:PN[1-1]:TRAC[1-1]:MARK[1-10]:SEAR:EXEC:LPE
Search Peak	Executes marker peak search	:CALC:PN[1-1]:TRAC[1-1]:MARK[1-10]:SEAR:EXEC:PEAK
Search Peak All	Executes marker search all	:CALC:PN[1-1]:TRAC[1-1]:ALLM:SEAR:PEAK
Search Right	Executes marker peak search right	:CALC:PN[1-1]:TRAC[1-1]:MARK[1-10]:SEAR:EXEC:RPE
Search Max	Executes marker search maximum	:CALC:PN[1-1]:TRAC[1-1]:MARK[1-10]:SEAR:EXEC:MAX
Search Min	Executes marker search minimum	:CALC:PN[1-1]:TRAC[1-1]:MARK[1-10]:SEAR:EXEC:MIN
Search Range (X)	Sets/Reads marker search range (X-axis)	:CALC:PN[1-1]:TRAC[1-1]:ALLM:SEAR:DOM:X
Search Range (Y)	Sets/Reads marker search range (Y-axis)	:CALC:PN[1-1]:TRAC[1-1]:ALLM:SEAR:DOM:Y
Target		
Search Left	Executes marker target search left	:CALC:PN[1-1]:TRAC[1-1]:MARK[1-10]:SEAR:EXEC:LTAR
Search Right	Executes marker target search right	:CALC:PN[1-1]:TRAC[1-1]:MARK[1-10]:SEAR:EXEC:RTAR
Search Target	Executes marker target search	:CALC:PN[1-1]:TRAC[1-1]:MARK[1-10]:SEAR:EXEC:TARG
Target Transition	Sets/Reads the target transition definition	:CALC:PN[1-1]:TRAC[1-1]:MARK[1-10]:SEAR:TARG:TRAN
Target Value	Sets/Reads the marker target value	:CALC:PN[1-1]:TRAC[1-1]:MARK[1-10]:SEAR:TARG:Y
Tracking	Sets/Reads the marker tracking type	:CALC:PN[1-1]:TRAC[1-1]:MARK[1-10]:SEAR:TRAC:TYPE
Marker To		
Marker -> Start	Sets/Reads the marker value to the start value	:SENS:PN[1-1]:FREQ:STAR
Marker -> Stop	Sets/Reads the marker value to the stop value	:SENS:PN[1-1]:FREQ:STOP

Table 7-3 PN Menu

Key Operation	Function	SCPI Command
Measurement View		
Freq & Power	Selects frequency, power and DC current measurement window	:DISP:WIND:ACT
Phase Noise	Selects phase noise measurement window	:DISP:WIND:ACT
Show Window		
Freq & Power	Turns on/off frequency, power and DC current measurement mode	:DISP:FP[1-1]:STAT
Phase Noise	Turns on/off phase noise measurement mode	:DISP:PN[1-1]:STAT
Spectrum Monitor	Turns on/off spectrum monitor mode	:DISP:SP[1-1]:STAT
Transient	Turns on/off transient measurement mode	:DISP:TR[1-1]:STAT
User	Turns on/off user defined window	:DISP:USER[1-1]:STAT
Spectrum Monitor	Selects spectrum monitor mode	:DISP:WIND:ACT
Transient	Selects transient measurement mode	:DISP:WIND:ACT
User	Selects user defined window	:DISP:WIND:ACT
Preset		
Factory	Presets instrument to the initial setup state	:SYST:PRES
User	Presets instrument and recalls the Autorec.sta in the F drive	
Save/Recall		
Explorer...	Opens windows explorer	
Recall by filename	Recalls state file by file name	:MMEM:LOAD:STAT
Recall State		
Autorec	Recalls settings	:MMEM:LOAD:STAT
File Dialog...	Opens file dialog	
State01	Recalls state file from register 1	:MMEM:LOAD:STAT
State02	Recalls state file from register 2	:MMEM:LOAD:STAT
State03	Recalls state file from register 3	:MMEM:LOAD:STAT
State04	Recalls state file from register 4	:MMEM:LOAD:STAT
State05	Recalls state file from register 5	:MMEM:LOAD:STAT
State06	Recalls state file from register 6	:MMEM:LOAD:STAT
Save Data Trace	Saves trace data	:MMEM:PN[1-1]:TRAC[1-1]:ST OR[:DATA]
Save Memory Trace	Saves memory trace data	:MMEM:PN[1-1]:TRAC[1-1]:ST OR:MEM

Table 7-3 PN Menu

Key Operation	Function	SCPI Command
Save State		
Autorec	Saves settings	:MMEM:STOR:STAT
File Dialog...	Opens file dialog	
Save Type	Selects instrument state type (Entire or instrument state only)	:MMEM:STOR:STYP
State01	Saves state file to register 1	:MMEM:STOR:STAT
State02	Saves state file to register 2	:MMEM:STOR:STAT
State03	Saves state file to register 3	:MMEM:STOR:STAT
State04	Saves state file to register 4	:MMEM:STOR:STAT
State05	Saves state file to register 5	:MMEM:STOR:STAT
State06	Saves state file to register 6	:MMEM:STOR:STAT
Scale		
Auto Scale	Executes autoscale	:DISP:PN[1-1]:TRAC[1-1]:Y[:SCAL]:AUTO
Divisions	Sets/Reads Y-scale divisions	:DISP:PN[1-1]:Y[:SCAL]:DIV
Marker -> Reference	Sets the marker value to the reference level	:DISP:PN[1-1]:TRAC[1-1]:Y[:SCAL]:RLEV
Reference Position	Sets/Reads reference position	:DISP:PN[1-1]:TRAC[1-1]:Y[:SCAL]:RPOS
Reference Value	Sets/Reads the reference level value	:DISP:PN[1-1]:TRAC[1-1]:Y[:SCAL]:RLEV
Scale/Div	Sets/Reads scale per division	:DISP:PN[1-1]:TRAC[1-1]:Y[:SCAL]:PDIV
X Axis		
Auto	Sets/Reads automatic setting of the X-axis display range to the stimulus value	:DISP:PN[1-1]:TRAC[1-1]:X[:SCAL]:AUTO
Band Marker -> X Axis	Sets the X-axis band marker range to the X-axis display range of a graph	:DISP:PN[1-1]:TRAC[1-1]:X[:SCAL]:LEFT :DISP:PN[1-1]:TRAC[1-1]:X[:SCAL]:RIGH
Left	Sets/Reads the start value of the X-axis display range	:DISP:PN[1-1]:TRAC[1-1]:X[:SCAL]:LEFT
Right	Sets/Reads the stop value of the X-axis display range	:DISP:PN[1-1]:TRAC[1-1]:X[:SCAL]:RIGH
Setup		
Carrier Search	Searches carrier signal and reflects the result to the input frequency of the downconverter	:SENS:PN[1-1]:DCON:SSE:EXEC
Frequency Band	Selects frequency band	:SENS:PN[1-1]:FBAND
IF Gain	Sets/Reads the IF Gain	:SENS:PN[1-1]:IFG

Table 7-3 PN Menu

Key Operation	Function	SCPI Command
LO PhNoise Optimize	Sets/Reads phase noise Local bandwidth optimization.	:SENS:PN[1-1]:LOB
Measurement Quality	Sets/Reads the quality level.	:SENS:PN[1-1]:SEGT[:MEAS][:QUAL]
Nominal Frequency	Sets/Reads input frequency of the downconverter	:SENS:PN[1-1]:DCON:FREQ
Start		
100Hz	Sets 100Hz to the start frequency	:SENS:PN[1-1]:FREQ:STAR
10Hz	Sets 10Hz to the start frequency	:SENS:PN[1-1]:FREQ:STAR
1Hz	Sets 1Hz to the start frequency	:SENS:PN[1-1]:FREQ:STAR
1kHz	Sets 1kHz to the start frequency	:SENS:PN[1-1]:FREQ:STAR
Stop		
100kHz	Sets 100kHz to the stop frequency	:SENS:PN[1-1]:FREQ:STOP
10MHz	Sets 10MHz to the stop frequency	:SENS:PN[1-1]:FREQ:STOP
1MHz	Sets 1MHz to the stop frequency	:SENS:PN[1-1]:FREQ:STOP
20MHz	Sets 20MHz to the stop frequency	:SENS:PN[1-1]:FREQ:STOP
40MHz	Sets 40MHz to the stop frequency	:SENS:PN[1-1]:FREQ:STOP
5MHz	Sets 5MHz to the stop frequency	:SENS:PN[1-1]:FREQ:STOP
System		
Abort Printing	Aborts printing	:HCOP:ABOR
Backlight	Turns on/off backlight	:SYST:BACK:STAT
Dump Screen Image	Saves screen image	:MMEM:STOR:IMAG
Instrument Setup		
Correction		
File Dialog ...	Loads correction data for a specified power	:MMEM:LOAD:CORR:POW
Import Power Correction Table	Loads correction data for a specified power	:MMEM:LOAD:CORR:POW
Power Correction	Sets user the user calibration on or off or reads its setting	:SENS:CORR:POW:STAT
Downconverter Manual Setup		
Current	Sets/Reads the bias current to be supplied to the external mixer	:SENS:DCON:MAN:MEXT[1-2]:BIAS:CURR
IF Gain 1	Sets/Reads the IF gain of the external mixer	:SENS:DCON:MAN:IFG[1-2]
IF Gain 2		

Table 7-3 PN Menu

Key Operation	Function	SCPI Command
LO1 Frequency LO2 Frequency	Sets/Reads the LO frequency of the external mixer	:SENS:DCON:MAN:LO[1-2]:FREQ
LO1 Level LO2 Level	Sets/Reads the LO level of the external mixer	:SENS:DCON:MAN:LO[1-2]:LEV
Mixer 1 Bias Mixer 2 Bias	Sets the bias current supplied to the external mixer on or off and reads its settings	:SENS:DCON:MAN:MEXT[1-2]:BIAS:STAT
$\Delta IF = IF2 - IF1$	Sets/Reads the differential frequency between CH1 and CH2 from the external mixer	:SENS:DCON:MAN:IFD
Frequency Offset (User Downconv.)		
Conversion Mode	Sets/Reads the conversion mode of the frequency offset	:SENS:UDC:MODE
Frequency Offset	Sets/Reads the frequency offset	:SENS:UDC:STAT
Harmonic #	Sets/Reads the frequency offset factor	:SENS:UDC:HARM
LO Frequency	Sets/Reads the LO frequency of the frequency offset	:SENS:UDC:LO
PN Ext. Prescaler		
Division	Sets/Reads the frequency-dividing ratio	:SENS:PN[1-1]:EPR:DIV
Output Power Level	Sets/Reads the output level of the frequency divider	:SENS:PN[1-1]:EPR:POW
Invert Image	Selects print mode	:HCOP:IMAG
Misc Setup		
Beeper		
Beep Complete	Turns on/off the beep for operation completion	:SYST:BEEP:COMP:STAT
Beep Warning	Turns on/off the beep for warning	:SYST:BEEP:WARN:STAT
Test Beep Complete	Makes beep sound for operation completion	:SYST:BEEP:COMP:IMM
Test Beep Warning	Makes beep sound for warning	:SYST:BEEP:WARN:IMM
Clock Setup		
Set Date and Time	Sets/Reads system time Sets/Reads system date	:SYST:TIME :SYST:DATE
Show Clock	Turns on/off internal clock display	:DISP:CLOC

Table 7-3 PN Menu

Key Operation	Function	SCPI Command
Color Setup		
Invert	Sets each color when the inverted display is selected	
Background	Sets/Reads the background color	:DISP:COL2:BACK[:VAL]
Data Trace 1	Sets/Reads the color of the data trace of trace 1	:DISP:COL2:TRAC1:DATA[:VAL]
:		
Data Trace 8	Sets/Reads the color of the data trace of trace 8	:DISP:COL2:TRAC8:DATA[:VAL]
Graticule Main	Sets/Reads the color of the graph	:DISP:COL2:GRAT1[:VAL]
Graticule Sub	Sets/Reads the color of the grid lines in the graph	:DISP:COL2:GRAT2[:VAL]
Limit Fail	Sets/Reads the limit display color	:DISP:COL2:LIM1[:VAL]
Limit Line	Sets/Reads the color of the limit line	:DISP:COL2:LIM2[:VAL]
Mem Trace 1	Sets/Reads the color of the memory trace of trace 1	:DISP:COL2:TRAC1:MEM[:VAL]
:		
Mem Trace 8	Sets/Reads the color of the memory trace of trace 8	:DISP:COL2:TRAC8:MEM[:VAL]
Reset Color	Resets the display color to the factory preset default setting	:DISP:COL2:RES
Normal	Sets each color when the normal display is selected	
Background	Sets/Reads the background color	:DISP:COL1:BACK[:VAL]
Data Trace 1	Sets/Reads the color of the data trace of trace 1	:DISP:COL1:TRAC1:DATA[:VAL]
:		
Data Trace 8	Sets/Reads the color of the data trace of trace 8	:DISP:COL1:TRAC8:DATA[:VAL]
Graticule Main	Sets/Reads the color of the graph	:DISP:COL1:GRAT1[:VAL]
Graticule Sub	Sets/Reads the color of the grid lines in the graph	:DISP:COL1:GRAT2[:VAL]
Limit Fail	Sets/Reads the limit display color	:DISP:COL1:LIM1[:VAL]
Limit Line	Sets/Reads the color of the limit line	:DISP:COL1:LIM2[:VAL]
Mem Trace 1	Sets/Reads the color of the memory trace of trace 1	:DISP:COL1:TRAC1:MEM[:VAL]

Table 7-3 PN Menu

Key Operation	Function	SCPI Command
:		
:		
Mem Trace 8	Sets/Reads the color of the memory trace of trace 8	:DISP:COL1:TRAC8:MEM[:VAL]
Reset Color	Resets the display color to the factory preset default setting	:DISP:COL1:RES
Control Panel ...	Opens control panel	
 GPIB Setup		
System Controller Configuration	Turns on/off system controller mode	
Talker/Listener Address	Sets/the address for controlling the analyzer from a controller via GPIB	
Key Lock		
Front Panel & Keyboard Lock	Disables from panel/keyboard operations	:SYST:KLOC:KBD
Touch Screen & Mouse Lock	Disables from touch screen/mouse operations	:SYST:KLOC:MOUS
Network Setup		
MAC Address	Sets MAC address	
Network Configuration ...	Enables/disables network connections	
Network Identification ...	Sets network ID of the instrument	
SICL-LAN Address	Sets SICL-LAN address	
SICL-LAN Server	Enables/disables SICL-LAN server	
Socket Server	Enables/disables Socket server	
Telnet Server	Enables/disables Telnet server	
Print	Outputs print	:HCOP:IMM
Printer Setup ...	Executes printer setup	
Product Information	Reads product information	

7. SCPI Command Reference

Table 7-3 PN Menu

Key Operation	Function	SCPI Command
Service Menu		
Administrator Menu	Displays softkeys associated with Administrator Menu. This function is not available to general users.	
Error Log		
Clear Error Log	Clears the error log	
View Error Log ...	Displays the error log	
Install Option License		
Jitter	Enters the license for clock jitter analysis	
Service Function	Displays softkeys associated with Service Menu. This function is not available to general users.	
Test Menu		
Power On Test	Performs internal test	
Display Test	Performs display test	
Front Panel	Performs front panel key (hard key) test	
Adjust Touch Screen	Performs touch screen calibration	
E5053A Test	Displays the connection status of E5053A	
Trace View		
Aperture	Smoothing aperture	:CALC:PN[1-1]:TRAC[1-1]:SMO:APER
Copy to User	Copies trace data to the user trace	:CALC:PN[1-1]:TRAC[1-1]:DATA:COPY
Data -> Mem	Copies data to memory	:CALC:PN[1-1]:TRAC[1-1]:MATH:MEM
Data Hold	Data hold	:CALC:PN[1-1]:TRAC[1-1]:HOLD
Data Math	Sets/Reads math operation type	:CALC:PN[1-1]:TRAC[1-1]:MATH:FUNC
Display Trace	Shows data and/or memory trace	:DISP:PN[1-1]:TRAC[1-1]:MODE
Marker -> -Offset	Sets sign-inverted data value of active marker of data trace to the offset value	:CALC:PN[1-1]:TRAC[1-1]:MATH:OFFS
Offset	Sets/Reads the offset value of the data trace	:CALC:PN[1-1]:TRAC[1-1]:MATH:OFFS

Table 7-3 PN Menu

Key Operation	Function	SCPI Command
Persistence		
Clear Persistent Data	Clears persistent mode	:DISP:PN[1-1]:TRAC[1-4]:PERS:CLE
Persistence Mode	Sets/Reads persistent mode	:DISP:PN[1-1]:TRAC[1-4]:PERS:STAT
Smoothing	Smoothing on/off	:CALC:PN[1-1]:TRAC[1-1]:SMO:STAT
Spurious		
Clear Threshold Table	Clears the threshold data	:CALC:PN[1-1]:TRAC[1-1]:SPUR:THR:TABL:CLE
Import Threshold Table ...	Reads the threshold data	:MMEM:PN[1-1]:TRAC[1-1]:LOAD:SPUR:THR
Minimum Spur Level	Sets/Reads the minimum spurious level	:CALC:PN[1-1]:TRAC[1-1]:SPUR:THR:LEV:MIN
Normalized (dBc/Hz)	Disables the spurious power value display	:CALC:PN[1-1]:TRAC[1-1]:SPUR:POW :CALC:PN[1-1]:TRAC[1-1]:SPUR:OMIS
Omit	Enables the spurious display omission	:CALC:PN[1-1]:TRAC[1-1]:SPUR:OMIS
Power (dBc)	Enables the spurious power value display	:CALC:PN[1-1]:TRAC[1-1]:SPUR:POW
Spurious List	Displays the spurious data	
Trace Label	Edits trace title label	:DISP:PN[1-1]:TRAC[1-1]:LAB:DATA
Trigger		
Average Trigger	Sets/Reads the averaging trigger function	:TRIG:AVER
Continuous	Sets/Reads trigger continuous mode	:INIT:PN[1-1]:CONT :INIT:PN[1-1]:IMM
Ext Trig Polarity	External trigger polarity	:TRIG:EXT:SLOP
Hold	Sets trigger mode to waiting-for-trigger state	:INIT:PN[1-1]:IMM
Manual Trigger	Moves once to waiting-for-trigger state	:INIT:PN[1-1]:IMM
Restart	Moves once to waiting-for-trigger state	:INIT:PN[1-1]:IMM
Single	Always moves to waiting-for-trigger state after measuring Moves once to waiting-for-trigger state	:INIT:PN[1-1]:CONT :INIT:PN[1-1]:IMM
Source	Triggers source	:TRIG:PN[1-1]:SOUR
Trigger to Phase Noise	Selects measurement mode	:TRIG:MODE

SP Menu

Table 7-4 SP Menu

Key Operation	Function	SCPI Command
Attenuator		
Input Attenuator	Sets/Reads Input Attenuator level on 5dB Step	:SENS:ATT:LEV
Average/BW		
Averaging	Turns on/off averaging function	:SENS:SP[1-1]:AVER:STAT
Averaging Restart	Restarts averaging	:SENS:SP[1-1]:AVER:CLE
Averaging Type	Sets/Reads averaging type	:SENS:SP[1-1]:AVER:TYPE
Avg Factor	Sets/Reads the averaging count	:SENS:SP[1-1]:AVER:COUN
RBW	Sets/Reads RBW value	:SENS:SP[1-1]:BAND:RES
DC Control Voltage		
Auto Freq Control		
AFC Status	Turns on/off the auto frequency control function. Executes the auto frequency control once.	:SOUR:VOLT:CONT:AFC[STAT] :SOUR:VOLT:CONT:AFC:IMM
Frequency Band	Sets/Reads the frequency band in the auto frequency control function	:SOUR:VOLT:CONT:AFC:FBAN
Max Ctrl Voltage Limit	Sets/Reads the maximum DC control voltage limit	:SOUR:VOLT:CONT:AFC:LIM: HIGH
Max Input Level	Sets/Reads the maximum input level	:SOUR:VOLT:CONT:AFC:INP:L EV:MAX
Max Iteration	Sets/Reads the maximum number of iterations for the DC control voltage-setting loops	:SOUR:VOLT:CONT:AFC:ITER
Min Ctrl Voltage Limit	Sets/Reads the minimum DC control voltage limit	:SOUR:VOLT:CONT:AFC:LIM: LOW
Sensitivity	Sets/Reads the tuning sensitivity	:SOUR:VOLT:CONT:AFC:SENS
Target	Sets/Reads the target frequency in the auto frequency control function	:SOUR:VOLT:CONT:AFC:TARG
Tolerance	Sets/Reads the tolerance limit	:SOUR:VOLT:CONT:AFC:TOL
Control Voltage Cal	Enables DC Control voltage calibration	:SOUR:VOLT:CONT:CORR[ST AT]
DC Control Delay	Sets/Reads DC Control delay (sec)	:SOUR:VOLT:CONT:DEL
DC Control Output	Turns on/off DC Control voltage	:SOUR:VOLT:CONT:LEV:STAT
DC Control Voltage	Sets/Reads DC Control voltage	:SOUR:VOLT:CONT:LEV:AMP L
Execute Control Voltage Cal	Executes DC Control voltage calibration	:SOUR:VOLT:CONT:CORR:CO LL:ACQ
Max Ctrl Voltage Limit	Sets/Reads the maximum DC Control voltage limit	:SOUR:VOLT:CONT:LIM:HIGH

Table 7-4 SP Menu

Key Operation	Function	SCPI Command
Min Ctrl Voltage Limit	Sets/Reads the minimum DC Control voltage limit	:SOUR:VOLT:CONT:LIM:LOW
DC Power Voltage		
DC Power Delay	Sets/Reads DC Power delay (sec)	:SOUR:VOLT:POW:DEL
DC Power Output	Turns on/off DC Power voltage	:SOUR:VOLT:POW:LEV:STAT
DC Power Voltage	Sets/Reads DC Power voltage	:SOUR:VOLT:POW:LEV:AMPL
Max Pwr Voltage Limit	Sets/Reads the maximum DC Power voltage limit	:SOUR:VOLT:POW:LIM:HIG
Min Pwr Voltage Limit	Sets/Reads the minimum DC Power voltage limit	:SOUR:VOLT:POW:LIM:LOW
Display		
Edit Title Label	Edits the measurement window title label	:DISP:SP[1-1]:LAB:DATA
Color Type	Sets/Reads the display type of the display (normal/inverted)	:DISP:IMAG
Limit Test		
Delete Lower Limit Line	Clears the lower limit line	:CALC:SP[1-1]:TRAC[1-1]:LIM:LOW:SEGM:CLE
Delete Upper Limit Line	Clears the upper limit line	:CALC:SP[1-1]:TRAC[1-1]:LIM:UPP:SEGM:CLE
Explorer		
Fail Sign	Turns on/off the limit test judgement display	:DISP:SP[1-1]:LIM:FSIG
Import Lower Limit Line ...	Reads the lower limit line	:MMEM:SP[1-1]:TRAC[1-1]:LOAD:LIM:LOW
Import Upper Limit Line ...	Reads the upper limit line	:MMEM:SP[1-1]:TRAC[1-1]:LOAD:LIM:UPP
Limit Line	Turns on/off the limit line	:DISP:SP[1-1]:TRAC[1-1]:LIM:LINE
Limit Test	Turns on/off the limit test function	:CALC:SP[1-1]:TRAC[1-1]:LIM[:STAT]
Marker Information	Sets/Reads the marker information position	:DISP:SP[1-1]:ANN:MARK:POS
Meas Condition	Turns on/off measurement conditions	:DISP:SP[1-1]:ANN:MEAS:STAT
Relative Y-Scale	Turns on/off relative Y-scale	:DISP:SP[1-1]:GRAT:AXIS:Y:REL
Security Level	Sets/recalls the security level	:SYST:SEC[:LEV]
Title Label	Turns on/off measurement window title label	:DISP:SP[1-1]:LAB:STAT
Update	Turns on/off trace updates	:DISP:ENAB
Y # of Digits	Selects the number of digits (Y-axis)	:DISP:SP[1-1]:GRAT:AXIS:Y:STAT

Table 7-4 SP Menu

Key Operation	Function	SCPI Command
Format		
Detector Mode	Sets/Reads the detector mode	:SENS:SP[1-1]:DET:FUNC
Format	SP format	:CALC:SP[1-1]:TRAC[1-1]:FORM
Input Port		
Downconverter		
Downconverter	Sets the use of the downconverter on or off, or reads its setting	:SENS:DCON[:STAT]
RF Input	Sets/Reads the signal supplied to the RF input port	:SENS:DCON:INP
External Mixer	Sets the use of the external mixer on or off and reads its settings	:SENS:DCON:MEXT
Macro Setup		
Application		
Jitter	Executes clock jitter analysis (VBA)	
mmWave	Executes phase-noise measurement (VBA)	
E5052 Event	Turns on/off the E5052 VBA event callback function	:PROG:COM:EVEN
Echo Window Menu		
Clear Echo	Clears Echo window	:DISP:ECHO:CLE
Echo Font Size	Sets/Reads the font size on Echo window	:DISP:ECHO:FSIZ
Echo Window	Turns on/off the Echo window	:DISP:ECHO:STAT
Load & Run	Loads and Executes the macro selected on file names.	
Select Macro	Sets/Reads the name of the program to be selected	:PROG:SEL:NAME
Stop	Sets/Reads the state of the selected program	:PROG:SEL:STAT
User Menu		
User Label 1	Executes the macro assigned under the user defined softkey	:PROG:SKEY:ITEM[1-8]:IMM
User Label 2	Executes the macro assigned under the user defined softkey	:PROG:SKEY:ITEM[1-8]:IMM
User Label 3	Executes the macro assigned under the user defined softkey	:PROG:SKEY:ITEM[1-8]:IMM
User Label 4	Executes the macro assigned under the user defined softkey	:PROG:SKEY:ITEM[1-8]:IMM
User Label 5	Executes the macro assigned under the user defined softkey	:PROG:SKEY:ITEM[1-8]:IMM
User Label 6	Executes the macro assigned under the user defined softkey	:PROG:SKEY:ITEM[1-8]:IMM
User Label 7	Executes the macro assigned under the user defined softkey	:PROG:SKEY:ITEM[1-8]:IMM
User Label 8	Executes the macro assigned under the user defined softkey	:PROG:SKEY:ITEM[1-8]:IMM

Table 7-4 SP Menu

Key Operation	Function	SCPI Command
VBA Editor Menu		
Close Editor	Closes VBA editor	
Load Project	Loads program	:MMEM:LOAD:PROG
New Project	Opens new VBA project	
Open Editor	Opens VBA editor	
Save Project	Saves VBA project	:MMEM:STOR:PROG
Marker		
Clear Marker Menu		
All OFF	Clears all the markers	
Marker 1	Turns on/off marker 1	:CALC:SP[1-1]:TRAC[1-1]:MARK[1-10]:STAT
:		
:		
Marker 10	Turns on/off marker 10	:CALC:SP[1-1]:TRAC[1-1]:MARK[1-10]:STAT
Marker 1	Turns on/off marker 1	:CALC:SP[1-1]:TRAC[1-1]:MARK[1-10]:STAT
:		
:		
Marker 6	Turns on/off marker 6	:CALC:SP[1-1]:TRAC[1-1]:MARK[1-10]:STAT
Marker List	Turns on/off the marker list	:DISP:SP[1-1]:TABL[:STAT]
More Functions		
Discrete	Sets/Reads marker movement (Continuous/Discrete)	:CALC:SP[1-1]:ALLT:MARK:DISC:STAT
Ref Marker	Sets/Reads marker reference number	:CALC:SP[1-1]:ALLT:MARK:REF:NUMB
Ref Marker Mode	Turns on/off delta marker mode	:CALC:SP[1-1]:ALLT:MARK:REF:STAT
More Markers		
Marker 7	Turns on/off marker 7	:CALC:SP[1-1]:TRAC[1-1]:MARK[1-10]:STAT
:		
:		
Marker 10	Turns on/off marker 10	:CALC:SP[1-1]:TRAC[1-1]:MARK[1-10]:STAT

Table 7-4 SP Menu

Key Operation	Function	SCPI Command
Marker Function		
Analysis Range (X)	Sets/Reads analysis/search range (X-axis)	:CALC:SP[1-1]:TRAC[1-1]:FUNCTION:DOM:X
Analysis Range (Y)	Sets/Reads analysis/search range (Y-axis)	:CALC:SP[1-1]:TRAC[1-1]:FUNCTION:DOM:Y
Analysis Type	Sets/Reads analysis type	:CALC:SP[1-1]:TRAC[1-1]:FUNCTION:TYPE
Band Marker X		
Band Marker X	Turns on/off bandmarker X	:CALC:SP[1-1]:TRAC[1-1]:BDM:X:STAT
Center	Sets/Reads the center value of bandmarker X	:CALC:SP[1-1]:TRAC[1-1]:BDM:X:CENT
Span	Sets/Reads the span value of bandmarker X	:CALC:SP[1-1]:TRAC[1-1]:BDM:X:SPAN
Start	Sets/Reads the start value of bandmarker X	:CALC:SP[1-1]:TRAC[1-1]:BDM:X:STAR
Stop	Sets/Reads the stop value of bandmarker X	:CALC:SP[1-1]:TRAC[1-1]:BDM:X:STOP
Band Marker Y		
Band Marker Y	Turns on/off bandmarker Y	:CALC:SP[1-1]:TRAC[1-1]:BDM:Y:STAT
Center	Sets/Reads the center value of bandmarker Y	:CALC:SP[1-1]:TRAC[1-1]:BDM:Y:CENT
Span	Sets/Reads the span value of bandmarker Y	:CALC:SP[1-1]:TRAC[1-1]:BDM:Y:SPAN
Start	Sets/Reads the start value of bandmarker Y	:CALC:SP[1-1]:TRAC[1-1]:BDM:Y:STAR
Stop	Sets/Reads the stop value of bandmarker Y	:CALC:SP[1-1]:TRAC[1-1]:BDM:Y:STOP
Marker Search		
Band Marker X		
Band Marker X	Turns on/off bandmarker X	:CALC:SP[1-1]:TRAC[1-1]:BDM:X:STAT
Center	Sets/Reads the center value of bandmarker X	:CALC:SP[1-1]:TRAC[1-1]:BDM:X:CENT
Span	Sets/Reads the span value of bandmarker X	:CALC:SP[1-1]:TRAC[1-1]:BDM:X:SPAN
Start	Sets/Reads the start value of bandmarker X	:CALC:SP[1-1]:TRAC[1-1]:BDM:X:STAR
Stop	Sets/Reads the stop value of bandmarker X	:CALC:SP[1-1]:TRAC[1-1]:BDM:X:STOP

Table 7-4 SP Menu

Key Operation	Function	SCPI Command
Band Marker Y		
Band Marker Y	Turns on/off bandmarker Y	:CALC:SP[1-1]:TRAC[1-1]:BDM :Y:STAT
Center	Sets/Reads the center value of bandmarker Y	:CALC:SP[1-1]:TRAC[1-1]:BDM :Y:CENT
Span	Sets/Reads the span value of bandmarker Y	:CALC:SP[1-1]:TRAC[1-1]:BDM :Y:SPAN
Start	Sets/Reads the start value of bandmarker Y	:CALC:SP[1-1]:TRAC[1-1]:BDM :Y:STAR
Stop	Sets/Reads the stop value of bandmarker Y	:CALC:SP[1-1]:TRAC[1-1]:BDM :Y:STOP
Peak		
Peak Excursion	Sets/Reads the peak excursion value	:CALC:SP[1-1]:TRAC[1-1]:MAR K[1-10]:SEAR:PEAK:EXC
Peak Polarity	Sets/Reads the marker peak-search polarity	:CALC:SP[1-1]:TRAC[1-1]:MAR K[1-10]:SEAR:PEAK:POL
Search Left	Executes marker peak search left	:CALC:SP[1-1]:TRAC[1-1]:MAR K[1-10]:SEAR:EXEC:LPE
Search Peak	Executes marker peak search	:CALC:SP[1-1]:TRAC[1-1]:MAR K[1-10]:SEAR:EXEC:PEAK
Search Peak All	Executes marker search all	:CALC:SP[1-1]:TRAC[1-1]:ALL M:SEAR:PEAK
Search Right	Executes marker peak search right	:CALC:SP[1-1]:TRAC[1-1]:MAR K[1-10]:SEAR:EXEC:RPE
Search Max	Executes marker search maximum	:CALC:SP[1-1]:TRAC[1-1]:MAR K[1-10]:SEAR:EXEC:MAX
Search Min	Executes marker search minimum	:CALC:SP[1-1]:TRAC[1-1]:MAR K[1-10]:SEAR:EXEC:MIN
Search Range (X)	Sets/Reads marker search range (X-axis)	:CALC:SP[1-1]:TRAC[1-1]:ALL M:SEAR:DOM:X
Search Range (Y)	Sets/Reads marker search range (Y-axis)	:CALC:SP[1-1]:TRAC[1-1]:ALL M:SEAR:DOM:Y
Target		
Search Left	Executes marker target search left	:CALC:SP[1-1]:TRAC[1-1]:MAR K[1-10]:SEAR:EXEC:LTAR
Search Right	Executes marker target search right	:CALC:SP[1-1]:TRAC[1-1]:MAR K[1-10]:SEAR:EXEC:RTAR
Search Target	Executes marker target search	:CALC:SP[1-1]:TRAC[1-1]:MAR K[1-10]:SEAR:EXEC:TARG
Target Transition	Sets/Reads the target transition definition	:CALC:SP[1-1]:TRAC[1-1]:MAR K[1-10]:SEAR:TARG:TRAN

Table 7-4 SP Menu

Key Operation	Function	SCPI Command
Target Value	Sets/Reads the marker target value	:CALC:SP[1-1]:TRAC[1-1]:MARK[1-10]:SEAR:TARG:Y
Tracking	Sets/Reads the marker tracking type	:CALC:SP[1-1]:TRAC[1-1]:MARK[1-10]:SEAR:TRAC:TYPE
Marker To		
Marker -> Center	Sets/Reads the center value of frequency span	:SENS:SP[1-1]:FREQ:CENT
Marker -> Start	Sets/Reads the start value of frequency span	:SENS:SP[1-1]:FREQ:STAR
Marker -> Stop	Sets/Reads the stop value of frequency span	:SENS:SP[1-1]:FREQ:STOP
Measurement View		
Freq & Power	Selects frequency, power and DC current measurement window	:DISP:WIND:ACT
Phase Noise	Selects phase noise measurement window	:DISP:WIND:ACT
Show Window		
Freq & Power	Turns on/off frequency, power and DC current measurement mode	:DISP:FP[1-1]:STAT
Phase Noise	Turns on/off phase noise measurement mode	:DISP:PN[1-1]:STAT
Spectrum Monitor	Turns on/off spectrum monitor mode	:DISP:SP[1-1]:STAT
Transient	Turns on/off transient measurement mode	:DISP:TR[1-1]:STAT
User	Turns on/off user defined window	:DISP:USER[1-1]:STAT
Spectrum Monitor	Selects spectrum monitor mode	:DISP:WIND:ACT
Transient	Selects transient measurement mode	:DISP:WIND:ACT
User	Selects user defined window	:DISP:WIND:ACT
Preset		
Factory	Presets instrument to the initial setup state	:SYST:PRES
User	Presets instrument and recalls the Autorec.sta in the F drive	
Save/Recall		
Explorer...	Opens windows explorer	
Recall by filename	Recalls state file by file name	:MMEM:LOAD:STAT
Recall State		
Autorec	Recalls settings	:MMEM:LOAD:STAT
File Dialog...	Opens file dialog	
State01	Recalls state file from register 1	:MMEM:LOAD:STAT
State02	Recalls state file from register 2	:MMEM:LOAD:STAT
State03	Recalls state file from register 3	:MMEM:LOAD:STAT
State04	Recalls state file from register 4	:MMEM:LOAD:STAT

Table 7-4 SP Menu

Key Operation	Function	SCPI Command
State05	Recalls state file from register 5	:MMEM:LOAD:STAT
State06	Recalls state file from register 6	:MMEM:LOAD:STAT
Save Data Trace	Saves trace data	:MMEM:SP[1-1]:TRAC[1-1]:STOR[:DATA]
Save Memory Trace	Saves memory trace data	:MMEM:SP[1-1]:TRAC[1-1]:STOR:MEM
Save State		
Autorec	Saves settings	:MMEM:STOR:STAT
File Dialog...	Opens file dialog	
Save Type	Selects instrument state type (Entire or instrument state only)	:MMEM:STOR:STYP
State01	Saves state file to register 1	:MMEM:STOR:STAT
State02	Saves state file to register 2	:MMEM:STOR:STAT
State03	Saves state file to register 3	:MMEM:STOR:STAT
State04	Saves state file to register 4	:MMEM:STOR:STAT
State05	Saves state file to register 5	:MMEM:STOR:STAT
State06	Saves state file to register 6	:MMEM:STOR:STAT
Scale		
Auto Scale	Executes autoscale	:DISP:SP[1-1]:TRAC[1-1]:Y[:SCAL]:AUTO
Divisions	Sets/Reads Y-scale divisions	:DISP:SP[1-1]:Y[:SCAL]:DIV
Marker -> Reference	Sets the marker value to the reference level	:DISP:SP[1-1]:TRAC[1-1]:Y[:SCAL]:RLEV
Reference Position	Sets/Reads the reference position	:DISP:SP[1-1]:TRAC[1-1]:Y[:SCAL]:RPOS
Reference Value	Sets/Reads the reference level value	:DISP:SP[1-1]:TRAC[1-1]:Y[:SCAL]:RLEV
Scale/Div	Sets/Reads scale per division	:DISP:SP[1-1]:TRAC[1-1]:Y[:SCAL]:PDIV
X Axis		
Auto	Sets/Reads automatic setting of the X-axis display range to the stimulus value	:DISP:SP[1-1]:TRAC[1-1]:X[:SCAL]:AUTO
Band Marker -> X Axis	Sets the X-axis band marker range to the X-axis display range of a graph	:DISP:SP[1-1]:TRAC[1-1]:X[:SCAL]:LEFT :DISP:SP[1-1]:TRAC[1-1]:X[:SCAL]:RIGH
Left	Sets/Reads the start value of the X-axis display range	:DISP:SP[1-1]:TRAC[1-1]:X[:SCAL]:LEFT
Right	Sets/Reads the stop value of the X-axis display range	:DISP:SP[1-1]:TRAC[1-1]:X[:SCAL]:RIGH

Table 7-4 SP Menu

Key Operation	Function	SCPI Command
Setup		
Reference Level	Sets/Reads the reference level of frequency span	:SENS:SP[1-1]:POW:RLEV
Start/Center		
Carrier To		
Carrier -> Center	Changes the center frequency to the carrier frequency.	:SENS:SP[1-1]:CARR:SET:CEN T 1
Carrier x 2 -> Center	Changes the center frequency to 2 times the carrier frequency.	:SENS:SP[1-1]:CARR:SET:CEN T 2
Carrier x 3 -> Center	Changes the center frequency to 3 times the carrier frequency.	:SENS:SP[1-1]:CARR:SET:CEN T 3
Carrier x # -> Center	Changes the center frequency to # times the carrier frequency. (The # is assigned by Harmonic # key.)	:SENS:SP[1-1]:CARR:SET:CEN T #
Frequency Band	Sets/Reads the carrier frequency band.	:SENSe:SP[1-1]:CARRier:FBAN d
Harmonic #	Sets the magnification of carrier frequency when center frequency is set.	
Center	Sets/Reads the center value of frequency span	:SENS:SP[1-1]:FREQ:CENT
Span	Sets/Reads the span value of frequency span	:SENS:SP[1-1]:FREQ:SPAN
Start	Sets/Reads the start value of frequency span	:SENS:SP[1-1]:FREQ:STAR
Stop	Sets/Reads the stop value of frequency span	:SENS:SP[1-1]:FREQ:STOP
Stop/Span		
Carrier To		
Carrier -> Center	Changes the center frequency to the carrier frequency.	:SENS:SP[1-1]:CARR:SET:CEN T 1
Carrier x 2 -> Center	Changes the center frequency to 2 times the carrier frequency.	:SENS:SP[1-1]:CARR:SET:CEN T 2
Carrier x 3 -> Center	Changes the center frequency to 3 times the carrier frequency.	:SENS:SP[1-1]:CARR:SET:CEN T 3
Carrier x # -> Center	Changes the center frequency to # times the carrier frequency. (The # is assigned by Harmonic # key.)	:SENS:SP[1-1]:CARR:SET:CEN T #
Frequency Band	Sets/Reads the carrier frequency band.	:SENSe:SP[1-1]:CARRier:FBAN d
Harmonic #	Sets the magnification of carrier frequency when center frequency is set.	
Center	Sets/Reads the center value of frequency span	:SENS:SP[1-1]:FREQ:CENT
Span	Sets/Reads the span value of frequency span	:SENS:SP[1-1]:FREQ:SPAN
Start	Sets/Reads the start value of frequency span	:SENS:SP[1-1]:FREQ:STAR
Stop	Sets/Reads the stop value of frequency span	:SENS:SP[1-1]:FREQ:STOP

Table 7-4 SP Menu

Key Operation	Function	SCPI Command
System		
Abort Printing	Aborts printing	:HCOP:ABOR
Backlight	Turns on/off backlight	:SYST:BACK:STAT
Dump Screen Image	Saves screen image	:MMEM:STOR:IMAG
Instrument Setup		
Correction		
File Dialog ...	Loads correction data for a specified power	:MMEM:LOAD:CORR:POW
Import Power Correction Table	Loads correction data for a specified power	:MMEM:LOAD:CORR:POW
Power Correction	Sets user the user calibration on or off or reads its setting	:SENS:CORR:POW:STAT
Downconverter Manual Setup		
Current	Sets/Reads the bias current to be supplied to the external mixer	:SENS:DCON:MAN:MEXT[1-2]:BIAS:CURR
IF Gain 1 IF Gain 2	Sets/Reads the IF gain of the external mixer	:SENS:DCON:MAN:IFG[1-2]
LO1 Frequency LO2 Frequency	Sets/Reads the LO frequency of the external mixer	:SENS:DCN:MAN:LO[1-2]:FRE Q
LO1 Level LO2 Level	Sets/Reads the LO level of the external mixer	:SENS:DCON:MAN:LO[1-2]:LEV V
Mixer 1 Bias Mixer 2 Bias	Sets the bias current supplied to the external mixer on or off and reads its settings	:SENS:DCON:MAN:MEXT[1-2]:BIAS:STAT
ΔIF = IF2 - IF1	Sets/Reads the differential frequency between CH1 and CH2 from the external mixer	:SENS:DCON:MAN:IFD
Frequency Offset (User Downconv.)		
Conversion Mode	Sets/Reads the conversion mode of the frequency offset	:SNES:UDC:MODE
Frequency Offset	Sets/Reads the frequency offset	:SENS:UDC:STAT
Harmonic #	Sets/Reads the frequency offset factor	:SENS:UDC:HARM
LO Frequency	Sets/Reads the LO frequency of the frequency offset	:SENS:UDC:LO

Table 7-4 SP Menu

Key Operation	Function	SCPI Command
Invert Image	Selects print mode	:HCOP:IMAG
Misc Setup		
Beeper		
Beep Complete	Turns on/off the beep for operation completion	:SYST:BEEP:COMP:STAT
Beep Warning	Turns on/off the beep for warning	:SYST:BEEP:WARN:STAT
Test Beep Complete	Makes beep sound for operation completion	:SYST:BEEP:COMP:IMM
Test Beep Warning	Makes beep sound for warning	:SYST:BEEP:WARN:IMM
Clock Setup		
Set Date and Time	Sets/Reads system time Sets/Reads system date	:SYST:TIME :SYST:DATE
Show Clock	Turns on/off internal clock display	:DISP:CLOC
Color Setup		
Invert	Sets each color when the inverted display is selected	
Background	Sets/Reads the background color	:DISP:COL2:BACK[:VAL]
Data Trace 1	Sets/Reads the color of the data trace of trace 1	:DISP:COL2:TRAC1:DATA[:VAL]
:		
:		
Data Trace 8	Sets/Reads the color of the data trace of trace 8	:DISP:COL2:TRAC8:DATA[:VAL]
Graticule Main	Sets/Reads the color of the graph	:DISP:COL2:GRAT1[:VAL]
Graticule Sub	Sets/Reads the color of the grid lines in the graph	:DISP:COL2:GRAT2[:VAL]
Limit Fail	Sets/Reads the limit display color	:DISP:COL2:LIM1[:VAL]
Limit Line	Sets/Reads the color of the limit line	:DISP:COL2:LIM2[:VAL]
Mem Trace 1	Sets/Reads the color of the memory trace of trace 1	:DISP:COL2:TRAC1:MEM[:VAL]
:		
:		
Mem Trace 8	Sets/Reads the color of the memory trace of trace 8	:DISP:COL2:TRAC8:MEM[:VAL]
Reset Color	Resets the display color to the factory preset default setting	:DISP:COL2:RES

Table 7-4 SP Menu

Key Operation	Function	SCPI Command
Normal	Sets each color when the normal display is selected	
Background	Sets/Reads the background color	:DISP:COL1:BACK[:VAL]
Data Trace 1	Sets/Reads the color of the data trace of trace 1	:DISP:COL1:TRAC1:DATA[:VAL]
:		
Data Trace 8	Sets/Reads the color of the data trace of trace 8	:DISP:COL1:TRAC8:DATA[:VAL]
Graticule Main	Sets/Reads the color of the graph	:DISP:COL1:GRAT1[:VAL]
Graticule Sub	Sets/Reads the color of the grid lines in the graph	:DISP:COL1:GRAT2[:VAL]
Limit Fail	Sets/Reads the limit display color	:DISP:COL1:LIM1[:VAL]
Limit Line	Sets/Reads the color of the limit line	:DISP:COL1:LIM2[:VAL]
Mem Trace 1	Sets/Reads the color of the memory trace to trace 1	:DISP:COL1:TRAC1:MEM[:VAL]
:		
Mem Trace 8	Sets/Reads the color of the memory trace of trace 8	:DISP:COL1:TRAC8:MEM[:VAL]
Reset Color	Resets the display color to the factory preset default setting	:DISP:COL1:RES
Control Panel ...	Opens control panel	
GPIB Setup		
System Controller Configuration	Turns on/off system controller mode	
Talker/Listener Address	Sets the address for controlling the analyzer from a controller via GPIB.	
Key Lock		
Front Panel & Keyboard Lock	Disables from panel / keyboard operations	:SYST:KLOC:KBD
Touch Screen & Mouse Lock	Disables from touch screen / mouse operations	:SYST:KLOC:MOUS
Network Setup		
MAC Address	Sets MAC address	
Network Configuration ...	Enables/disables network connections	

Table 7-4 SP Menu

Key Operation	Function	SCPI Command
Network Identification ...	Sets network ID of the instrument	
SICL-LAN Address	Sets SICL-LAN address	
SICL-LAN Server	Enables/disables SICL-LAN server	
Socket Server	Enables/disables Socket server	
Telnet Server	Enables/disables Telnet server	
Print	Outputs print	:HCOP:IMM
Printer Setup ...	Executes printer setup	
Product Information	Reads product information	
Service Menu		
Administrator Menu	Displays softkeys associated with Administrator Menu. This function is not available to general users.	
Error Log		
Clear Error Log	Clears the error log	
View Error Log ...	Displays the error log	
Install Option License		
Jitter	Enters the license for clock jitter analysis (VBA)	
Service Function	Displays softkeys associated with Service Menu. This function is not available to general users.	
Test Menu		
Power On Test	Performs internal test	
Display Test	Performs display test	
Front Panel	Performs front panel key (hard key) test	
Adjust Touch Screen	Performs touch screen calibration	
E5053A Test	Displays the connection status of E5053A	
Trace View		
Aperture	Smoothing aperture	:CALC:SP[1-1]:TRAC[1-1]:SMO :APER
Copy to User	Copies trace data to the user trace	:CALC:SP[1-1]:TRAC[1-1]:DAT A:COPY
Data -> Mem	Copies data to memory	:CALC:SP[1-1]:TRAC[1-1]:MAT H:MEM

Table 7-4 SP Menu

Key Operation	Function	SCPI Command
Data Hold	Data hold	:CALC:SP[1-1]:TRAC[1-1]:HOLD
Data Math	Sets/Reads math operation type	:CALC:SP[1-1]:TRAC[1-1]:MATH:FUNC
Display Trace	Shows data and/or memory trace	:DISP:SP[1-1]:TRAC[1-1]:MODE
Marker -> -Offset	Sets sign-inverted data value of the data trace's active marker to the offset value	:CALC:SP[1-1]:TRAC[1-1]:MATH:OFFS
Offset	Sets/Reads the offset value of the data trace	:CALC:SP[1-1]:TRAC[1-1]:MATH:OFFS
Persistence		
Clear Persistent Data	Clears persistent mode	:DISP:SP[1-1]:TRAC[1-4]:PERS:CLE
Persistence Mode	Sets/Reads persistent mode	:DISP:SP[1-1]:TRAC[1-4]:PERS:STAT
Smoothing	Smoothing on/off	:CALC:SP[1-1]:TRAC[1-1]:SMO:STAT
Trace Label	Edits trace title label	:DISP:SP[1-1]:TRAC[1-1]:LAB:DATA
Trigger		
Average Trigger	Sets/Reads the averaging trigger function	:TRIG:AVER
Continuous	Sets/Reads trigger continuous mode	:INIT:SP[1-1]:CONT :INIT:SP[1-1]:IMM
Ext Trig Polarity	External trigger polarity	:TRIG:EXT:SLOP
Hold	Sets trigger mode to waiting-for-trigger state	:INIT:SP[1-1]:IMM
Manual Trigger	Moves once to waiting-for-trigger state	:INIT:SP[1-1]:IMM
Restart	Moves once to waiting-for-trigger state	:INIT:SP[1-1]:IMM
Single	Always moves to waiting-for-trigger state after measuring Moves once to waiting-for-trigger state	:INIT:SP[1-1]:CONT :INIT:SP[1-1]:IMM
Source	Triggers source	:TRIG:SP[1-1]:SOUR
Trigger to Spectrum Monitor	Selects measurement mode	:TRIG:MODE

TR Menu

Table 7-5 TR Menu

Key Operation	Function	SCPI Command
Attenuator		
Input Attenuator	Sets/Reads Input Attenuator level on 5dB Step	:SENS:ATT:LEV
Average		
Averaging	Turns on/off averaging function	:SENS:TR[1-1]:AVER:STAT
Averaging Restart	Restarts averaging	:SENS:TR[1-1]:AVER:CLE
Avg Factor	Sets/Reads averaging count	:SENS:TR[1-1]:AVER:COUN
DC Control Voltage		
Auto Freq Control		
AFC Status	Turns on/off the auto frequency control function. Executes the auto frequency control once.	:SOUR:VOLT:CONT:AFC[:STAT] :SOUR:VOLT:CONT:AFC:IMM
Frequency Band	Sets/Reads the frequency band in the auto frequency control function	:SOUR:VOLT:CONT:AFC:FBAN
Max Ctrl Voltage Limit	Sets/Reads the maximum DC control voltage limit	:SOUR:VOLT:CONT:AFC:LIM: HIGH
Max Input Level	Sets/Reads the maximum input level	:SOUR:VOLT:CONT:AFC:INP:L EV:MAX
Max Iteration	Sets/Reads the maximum number of iterations for the DC control voltage-setting loops	:SOUR:VOLT:CONT:AFC:ITER
Min Ctrl Voltage Limit	Sets/Reads the minimum DC control voltage limit	:SOUR:VOLT:CONT:AFC:LIM: LOW
Sensitivity	Sets/Reads the tuning sensitivity	:SOUR:VOLT:CONT:AFC:SENS
Target	Sets/Reads the target frequency in the auto frequency control function	:SOUR:VOLT:CONT:AFC:TARG
Tolerance	Sets/Reads the tolerance limit	:SOUR:VOLT:CONT:AFC:TOL
Control Voltage Cal	Enables DC Control voltage calibration	:SOUR:VOLT:CONT:CORR[:ST AT]
DC Control Delay	Sets/Reads DC Control delay (sec)	:SOUR:VOLT:CONT:DEL
DC Control Output	Turns on/off DC Control voltage	:SOUR:VOLT:CONT:LEV:STAT
DC Control Voltage	Sets/Reads DC Control voltage	:SOUR:VOLT:CONT:LEV:AMP L
Execute Control Voltage Cal	Executes DC Control voltage calibration	:SOUR:VOLT:CONT:CORR:CO LL:ACQ
Max Ctrl Voltage Limit	Sets/Reads the maximum DC control voltage limit	:SOUR:VOLT:CONT:LIM:HIGH
Min Ctrl Voltage Limit	Sets/Reads the minimum DC control voltage limit	:SOUR:VOLT:CONT:LIM:LOW

Table 7-5 TR Menu

Key Operation	Function	SCPI Command
DC Power Voltage		
DC Power Delay	Sets/Reads DC Power delay (sec)	:SOUR:VOLT:POW:DEL
DC Power Output	Turns on/off DC Power voltage	:SOUR:VOLT:POW:LEV:STAT
DC Power Voltage	Sets/Reads DC Power voltage	:SOUR:VOLT:POW:LEV:AMPL
Max Pwr Voltage Limit	Sets/Reads the maximum DC Power voltage limit	:SOUR:VOLT:POW:LIM:HIGH
Min Pwr Voltage Limit	Sets/Reads the minimum DC Power voltage limit	:SOUR:VOLT:POW:LIM:LOW
Display		
Edit Title Label	Edits the measurement window title label	:DISP:TR[1-1]:LAB:DATA
Color Type	Sets/Reads the display type of the display (normal/inverted)	:DISP:IMAG
Limit Test		
Delete Lower Limit Line	Clears the lower limit line	:CALC:TR[1-1]:TRAC[1-4]:LIM:LOW:SEGM:CLE
Delete Upper Limit Line	Clears the upper limit line	:CALC:TR[1-1]:TRAC[1-4]:LIM:UPP:SEGM:CLE
Explorer		
Fail Sign	Turns on/off the limit test judgement display	:DISP:TR[1-1]:LIM:FSIG
Import Lower Limit Line ...	Reads the lower limit line	:MMEM:TR[1-1]:TRAC[1-4]:LOAD:LIM:LOW
Import Upper Limit Line ...	Reads the upper limit line	:MMEM:TR[1-1]:TRAC[1-4]:LOAD:LIM:UPP
Limit Line	Turns on/off the limit line	:DISP:TR[1-1]:TRAC[1-4]:LIM:LINE
Limit Test	Turns on/off the limit test function	:CALC:TR[1-1]:TRAC[1-4]:LIM[:STAT]
Marker Information	Sets/Reads the marker information position	:DISP:TR[1-1]:ANN:MARK:POS
Meas Condition	Turns on/off measurement conditions	:DISP:TR[1-1]:ANN:MEAS:STAT
Relative Y-Scale	Turns on/off relative Y-scale	:DISP:TR[1-1]:GRAT:AXIS:Y:REL
Security Level	Sets/recalls the security level	:SYST:SEC[:LEV]
Title Label	Turns on/off the measurement window title lable	:DISP:TR[1-1]:LAB:STAT
Update	Turns on/off trace updates	:DISP:ENAB
Y # of Digits	Selects the number of digits (Y-axis)	:DISP:TR[1-1]:GRAT:AXIS:Y:STAT

Table 7-5 TR Menu

Key Operation	Function	SCPI Command
Format		
Frequency Format	Sets/Reads the frequency format	:CALC:TR[1-1]:TRAC[1-4]:FORM:FREQ
Frequency Reference	Sets/Reads the reference frequency	:CALC:TR[1-1]:TRAC[1-4]:REF:FREQ
Marker -> Phase X Reference	Sets/Reads the data value of the active marker's position to 0 degree reference of phase	:CALC:TR[1-1]:TRAC[1-4]:FORM:PHAS:XREF
Phase Unit	Selects phase format on transient measurement	:CALC:TR[1-1]:TRAC[1-4]:FORM:PHAS:UNIT
Phase X Reference	Sets/Reads the data value of the active trace's specified X-axis position to 0 degree reference of phase	:CALC:TR[1-1]:TRAC[1-4]:FORM:PHAS:XREF
Wrap Phase	Turns on/off wrap-phase	:CALC:TR[1-1]:TRAC[1-4]:FORM:PHAS:WRAP
Input Port		
Downconverter		
Downconverter	Sets the use of the downconverter on or off, or reads its settings	:SENS:DCON[:STAT]
RF Input	Sets/Reads the signal supplied to the RF input port	:SENS:DCON:INP
External Mixer	Sets the use of the external mixer on or off and reads its settings	:SENS:DCON:MEXT
Macro Setup		
Application		
Jitter	Executes clock jitter analysis (VBA)	
mmWave	Executes phase-noise measurement (VBA)	
E5052 Event	Turns on/off the E5052 VBA event callback function	:PROG:COM:EVEN
Echo Window Menu		
Clear Echo	Clears Echo window	:DISP:ECHO:CLE
Echo Font Size	Sets/Reads the font size on Echo window	:DISP:ECHO:FSIZ
Echo Window	Turns on/off the Echo window	:DISP:ECHO:STAT
Load & Run	Loads and executes the macro selected on file names.	
Select Macro	Sets/Reads the name of the program to be selected	:PROG:SEL:NAME
Stop	Sets/Reads the state of the selected program	:PROG:SEL:STAT
User Menu		
User Label 1	Executes the macro assigned under the user defined softkey	:PROG:SKEY:ITEM[1-8]:IMM
User Label 2	Executes the macro assigned under the user defined softkey	:PROG:SKEY:ITEM[1-8]:IMM
User Label 3	Executes the macro assigned under the user defined softkey	:PROG:SKEY:ITEM[1-8]:IMM
User Label 4	Executes the macro assigned under the user defined softkey	:PROG:SKEY:ITEM[1-8]:IMM
User Label 5	Executes the macro assigned under the user defined softkey	:PROG:SKEY:ITEM[1-8]:IMM

Table 7-5 TR Menu

Key Operation	Function	SCPI Command
User Label 6	Executes the macro assigned under the user defined softkey	:PROG:SKEY:ITEM[1-8]:IMM
User Label 7	Executes the macro assigned under the user defined softkey	:PROG:SKEY:ITEM[1-8]:IMM
User Label 8	Executes the macro assigned under the user defined softkey	:PROG:SKEY:ITEM[1-8]:IMM
VBA Editor Menu		
Close Editor	Closes VBA editor	
Load Project	Loads program	:MMEM:LOAD:PROG
New Project	Opens new VBA project	
Open Editor	Opens VBA editor	
Save Project	Saves VBA project	:MMEM:STOR:PROG
Marker		
Clear Marker Menu		
All OFF	Clears all the markers	
Marker 1	Turns on/off marker 1	:CALC:TR[1-1]:TRAC[1-4]:MARK[1-10]:STAT
:		
:		
Marker 10	Turns on/off marker 10	:CALC:TR[1-1]:TRAC[1-4]:MARK[1-10]:STAT
Couple	Turns on/off marker coupling function	:CALC:TR[1-1]:ALLT:MARK:COUP:STAT
Marker 1	Turns on/off marker 1	:CALC:TR[1-1]:TRAC[1-4]:MARK[1-10]:STAT
:		
:		
Marker 6	Turns on/off marker 6	:CALC:TR[1-1]:TRAC[1-4]:MARK[1-10]:STAT
Marker List	Turns on/off the marker list	:DISP:TR[1-1]:TABL[:STAT]
More Functions		
Discrete	Sets/Reads marker movement (Continuous/Discrete)	:CALC:TR[1-1]:ALLT:MARK:DISC:STAT
Ref Marker	Sets/Reads marker reference number	:CALC:TR[1-1]:ALLT:MARK:REF:NUMB
Ref Marker Mode	Turns on/off delta marker mode	:CALC:TR[1-1]:ALLT:MARK:REF:STAT

Table 7-5 TR Menu

Key Operation	Function	SCPI Command
More Markers		
Marker 7	Turns on/off marker 7	:CALC:TR[1-1]:TRAC[1-4]:MARK[1-10]:STAT
:		
:		
Marker 10	Turns on/off marker 7	:CALC:TR[1-1]:TRAC[1-4]:MARK[1-10]:STAT
Marker Function		
Analysis Range (X)	Sets/Reads analysis/search range (X-axis)	:CALC:TR[1-1]:TRAC[1-4]:FUNCTION:DOM:X
Analysis Range (Y)	Sets/Reads analysis/search range (Y-axis)	:CALC:TR[1-1]:TRAC[1-4]:FUNCTION:DOM:Y
Analysis Type	Sets/Reads analysis type	:CALC:TR[1-1]:TRAC[1-4]:FUNCTION:TYPE
Band Marker X		
Band Marker X	Turns on/off bandmarker X	:CALC:TR[1-1]:TRAC[1-4]:BDM:X:STAT
Center	Sets/Reads the center value of bandmarker X	:CALC:TR[1-1]:TRAC[1-4]:BDM:X:CENT
Span	Sets/Reads the span value of bandmarker X	:CALC:TR[1-1]:TRAC[1-4]:BDM:X:SPAN
Start	Sets/Reads the start value of bandmarker X	:CALC:TR[1-1]:TRAC[1-4]:BDM:X:STAR
Stop	Sets/Reads the stop value of bandmarker X	:CALC:TR[1-1]:TRAC[1-4]:BDM:X:STOP
Band Marker Y		
Band Marker Y	Turns on/off bandmarker Y	:CALC:TR[1-1]:TRAC[1-4]:BDM:Y:STAT
Center	Sets/Reads the center value of bandmarker Y	:CALC:TR[1-1]:TRAC[1-4]:BDM:Y:CENT
Span	Sets/Reads the span value of bandmarker Y	:CALC:TR[1-1]:TRAC[1-4]:BDM:Y:SPAN
Start	Sets/Reads the start value of bandmarker Y	:CALC:TR[1-1]:TRAC[1-4]:BDM:Y:STAR
Stop	Sets/Reads the stop value of bandmarker Y	:CALC:TR[1-1]:TRAC[1-4]:BDM:Y:STOP
Couple	Turns on/off bandmarker coupling function	:CALC:TR[1-1]:ALLT:BDM:X:COUP:STAT

Table 7-5 TR Menu

Key Operation	Function	SCPI Command
Marker Search		
Band Marker X		
Band Marker X	Turns on/off bandmarker X	:CALC:TR[1-1]:TRAC[1-4]:BDM:X:STAT
Center	Sets/Reads the center value of bandmarker X	:CALC:TR[1-1]:TRAC[1-4]:BDM:X:CENT
Span	Sets/Reads the span value of bandmarker X	:CALC:TR[1-1]:TRAC[1-4]:BDM:X:SPAN
Start	Sets/Reads the start value of bandmarker X	:CALC:TR[1-1]:TRAC[1-4]:BDM:X:STAR
Stop	Sets/Reads the stop value of bandmarker X	:CALC:TR[1-1]:TRAC[1-4]:BDM:X:STOP
Band Marker Y		
Band Marker Y	Turns on/off bandmarker Y	:CALC:TR[1-1]:TRAC[1-4]:BDM:Y:STAT
Center	Sets/Reads the center value of bandmarker Y	:CALC:TR[1-1]:TRAC[1-4]:BDM:Y:CENT
Span	Sets/Reads the span value of bandmarker Y	:CALC:TR[1-1]:TRAC[1-4]:BDM:Y:SPAN
Start	Sets/Reads the start value of bandmarker Y	:CALC:TR[1-1]:TRAC[1-4]:BDM:Y:STAR
Stop	Sets/Reads the stop value of bandmarker Y	:CALC:TR[1-1]:TRAC[1-4]:BDM:Y:STOP
Couple	Turns on/off bandmarker coupling function	:CALC:TR[1-1]:ALLT:BDM:X:COUP:STAT
Peak		
Peak Excursion	Sets/Reads the peak excursion value	:CALC:TR[1-1]:TRAC[1-4]:MARK[1-10]:SEAR:PEAK:EXC
Peak Polarity	Sets/Reads the marker peak-search polarity	:CALC:TR[1-1]:TRAC[1-4]:MARK[1-10]:SEAR:PEAK:POL
Search Left	Executes marker peak search left	:CALC:TR[1-1]:TRAC[1-4]:MARK[1-10]:SEAR:EXEC:LPE
Search Peak	Executes marker peak search	:CALC:TR[1-1]:TRAC[1-4]:MARK[1-10]:SEAR:EXEC:PEAK
Search Peak All	Executes marker search all	:CALC:TR[1-1]:TRAC[1-4]:ALLM:SEAR:PEAK
Search Right	Executes marker peak search right	:CALC:TR[1-1]:TRAC[1-4]:MARK[1-10]:SEAR:EXEC:RPE

Table 7-5 TR Menu

Key Operation	Function	SCPI Command
Search Max	Executes marker search maximum	:CALC:TR[1-1]:TRAC[1-4]:MARK[1-10]:SEAR:EXEC:MAX
Search Min	Executes marker search minimum	:CALC:TR[1-1]:TRAC[1-4]:MARK[1-10]:SEAR:EXEC:MIN
Search Range (X)	Sets/Reads marker search range (X-axis)	:CALC:TR[1-1]:TRAC[1-4]:ALLM:SEAR:DOM:X
Search Range (Y)	Sets/Reads marker search range (Y-axis)	:CALC:TR[1-1]:TRAC[1-4]:ALLM:SEAR:DOM:Y
Target		
Search Left	Executes marker target search left	:CALC:TR[1-1]:TRAC[1-4]:MARK[1-10]:SEAR:EXEC:LTAR
Search Right	Executes marker target search right	:CALC:TR[1-1]:TRAC[1-4]:MARK[1-10]:SEAR:EXEC:RTAR
Search Target	Executes marker target search	:CALC:TR[1-1]:TRAC[1-4]:MARK[1-10]:SEAR:EXEC:TARG
Target Transition	Sets/Reads the target transition definition	:CALC:TR[1-1]:TRAC[1-4]:MARK[1-10]:SEAR:TARG:TRAN
Target Value	Sets/Reads the marker target value	:CALC:TR[1-1]:TRAC[1-4]:MARK[1-10]:SEAR:TARG:Y
Tracking	Sets/Reads the marker tracking type	:CALC:TR[1-1]:TRAC[1-4]:MARK[1-10]:SEAR:TRAC:TYPE
Marker To		
Marker -> Phase Reference	phase reference frequency	:SENS:TR[1-1]:NARR:FREQ:PR EF
Marker -> Target Freq	target frequency	:SENS:TR[1-1]:NARR:FREQ:TARG
Measurement View		
Freq & Power	Selects frequency, power and DC current measurement window	:DISP:WIND:ACT
Phase Noise	Selects phase noise measurement window	:DISP:WIND:ACT
Show Window		
Freq & Power	Turns on/off frequency, power and DC current measurement mode	:DISP:FP[1-1]:STAT
Phase Noise	Turns on/off phase noise measurement mode	:DISP:PN[1-1]:STAT
Spectrum Monitor	Turns on/off spectrum monitor mode	:DISP:SP[1-1]:STAT
Transient	Turns on/off transient measurement mode	:DISP:TR[1-1]:STAT
User	Turns on/off user defined window	:DISP:USER[1-1]:STAT
Spectrum Monitor	Selects spectrum monitor mode	:DISP:WIND:ACT
Transient	Selects transient measurement mode	:DISP:WIND:ACT
User	Selects user defined window	:DISP:WIND:ACT

Table 7-5 TR Menu

Key Operation	Function	SCPI Command
Preset		
Factory	Presets instrument to the initial setup state	:SYST:PRES
User	Presets instrument and recalls the Autorec.sta in the F drive	
Save/Recall		
Explorer...	Opens windows explorer	
Recall by filename	Recalls state file by file name	:MMEM:LOAD:STAT
Recall State		
Autorec	Recalls settings	:MMEM:LOAD:STAT
File Dialog...	Opens file dialog	
State01	Recalls state file from register 1	:MMEM:LOAD:STAT
State02	Recalls state file from register 2	:MMEM:LOAD:STAT
State03	Recalls state file from register 3	:MMEM:LOAD:STAT
State04	Recalls state file from register 4	:MMEM:LOAD:STAT
State05	Recalls state file from register 5	:MMEM:LOAD:STAT
State06	Recalls state file from register 6	:MMEM:LOAD:STAT
Save Data Trace	Saves trace data	:MMEM:TR[1-1]:TRAC[1-4]:STOR[:DATA]
Save Memory Trace	Saves memory trace data	:MMEM:TR[1-1]:TRAC[1-4]:STOR:MEM
Save State		
Autorec	Saves settings	:MMEM:STOR:STAT
File Dialog...	Opens file dialog	
Save Type	Selects instrument state type (Entire or instrument state only)	:MMEM:STOR:STYP
State01	Saves state file to register 1	:MMEM:STOR:STAT
State02	Saves state file to register 2	:MMEM:STOR:STAT
State03	Saves state file to register 3	:MMEM:STOR:STAT
State04	Saves state file to register 4	:MMEM:STOR:STAT
State05	Saves state file to register 5	:MMEM:STOR:STAT
State06	Saves state file to register 6	:MMEM:STOR:STAT
Scale		
Auto Scale	Executes autoscale	:DISP:TR[1-1]:TRAC[1-4]:Y[:SCAL]:AUTO
Auto Scale All	Executes autoscale for all traces on transient measurement window	:DISP:TR[1-1]:ALL:Y:SCAL:AUTO
Divisions	Sets/Reads Y-scale divisions	:DISP:TR[1-1]:Y[:SCAL]:DIV

Table 7-5 TR Menu

Key Operation	Function	SCPI Command
Marker -> Reference	Sets the marker value to the reference level	:DISP:TR[1-1]:TRAC[1-4]:Y[:SCAL]:RLEV
Reference Position	Sets/Reads reference position	:DISP:TR[1-1]:TRAC[1-4]:Y[:SCAL]:RPOS
Reference Value	Sets/Reads reference level value	:DISP:TR[1-1]:TRAC[1-4]:Y[:SCAL]:RLEV
Scale/Div	Sets/Reads scale per division	:DISP:TR[1-1]:TRAC[1-4]:Y[:SCAL]:PDIV
Trigger Freq -> Reference	Sets the trigger frequency to the reference level	:DISP:TR[1-1]:TRAC[1-4]:Y[:SCAL]:RLEV
X Axis		
Auto	Sets/Reads automatic setting of the X-axis display range to the stimulus value	:DISP:TR[1-1]:TRAC[1-4]:X[:SCAL]:AUTO
Band Marker -> X Axis	Sets the X-axis band marker range to the X-axis display range of a graph	:DISP:TR[1-1]:TRAC[1-4]:X[:SCAL]:LEFT :DISP:TR[1-1]:TRAC[1-4]:X[:SCAL]:RIGHT
Left	Sets/Reads the start value of the X-axis display range	:DISP:TR[1-1]:TRAC[1-4]:X[:SCAL]:LEFT
Right	Sets/Reads the stop value of the X-axis display range	:DISP:TR[1-1]:TRAC[1-4]:X[:SCAL]:RIGHT
Setup		
Freq Range	Sets/Reads frequency transient range (Narrowband)	:SENS:TR[1-1]:NARR:FREQ:RANG
Max Input Level	Sets/Reads maximum input level	:SENS:TR[1-1]:POW:INP:LEV:MAX
Phase Reference	Sets/Reads phase reference frequency	:SENS:TR[1-1]:NARR:FREQ:REF
Recalc Phase Reference		
Phase Ref. Offset	Sets/Reads the offset value of the phase reference frequency	:CALC:TR[1-1]:TRAC[1-4]:FORM:PHAS:REF:OFFS
Target Freq	Sets/Reads target frequency	:SENS:TR[1-1]:NARR:FREQ:TARG
Video Trigger		
Minimum Power Level	Sets/Reads video trigger threshold level relative to max input level	:TRIG:TR[1-1]:NARR:VID:THR
Narrow Freq	Sets/Reads video trigger frequency value (Narrowband)	:TRIG:TR[1-1]:NARR:VID:FREQ:CENT
Wide Freq	Sets/Reads video trigger frequency value (Wideband)	:TRIG:TR[1-1]:WIDE:VID:FREQ:CENT

Table 7-5 TR Menu

Key Operation	Function	SCPI Command
Wide Freq Range	Sets/Reads transient frequency range (Wideband)	:SENS:TR[1-1]:WIDE:FREQ:MAX
Wide Max Frequency	Sets/Gets transient frequency range in the wideband mode	:SENS:TR[1-1]:WIDE:FREQ:MAX
Span		
Narrow Ref Position	Sets/Reads reference position for time span	:SENS:TR[1-1]:NARR:TIME:REF
Narrow Settings -> Wide	Sets narrowband mode settings to wideband mode settings	
Narrow Span	Sets/Reads time span (Narrowband)	:SENS:TR[1-1]:NARR:TIME:SPAN
Narrow Time Offset	Sets/Reads time offset(delay) relative to the reference point	:SENS:TR[1-1]:NARR:TIME:OFFS
Wide Ref Position	Sets/Reads reference position	:SENS:TR[1-1]:WIDE:TIME:REF
Wide Settings -> Narrow	Sets wideband mode settings to narrowband mode settings	
Wide Span	Sets/Reads time span (Wideband)	:SENS:TR[1-1]:WIDE:TIME:SPAN
Wide Time Offset	Sets/Reads time offset(delay) relative to the reference point	:SENS:TR[1-1]:WIDE:TIME:OFFS
System		
Abort Printing	Aborts printing	:HCOP:ABOR
Backlight	Turns on/off backlight	:SYST:BACK:STAT
Dump Screen Image	Saves screen image	:MMEM:STOR:IMAG
Instrument Setup		
Correction		
File Dialog ...	Loads correction data for a specified power	:MMEM:LOAD:CORR:POW
Import Power Correction Table	Loads correction data for a specified power	:MMEM:LOAD:CORR:POW
Power Correction	Sets user the user calibration on or off or reads its setting	:SENS:CORR:POW:STAT
Downconverter Manual Setup		
Current	Sets/Reads the bias current to be supplied to the external mixer	:SENS:DCON:MAN:MEXT[1-2]:BIAS:CURR
IF Gain 1	Sets/Reads the IF gain of the external mixer	:SENS:DCON:MAN:IFG[1-2]
IF Gain 2		

Table 7-5 TR Menu

Key Operation	Function	SCPI Command
LO1 Frequency LO2 Frequency	Sets/Reads the LO frequency of the external mixer	:SENS:DCON:MAN:LO[1-2]:FREQ
LO1 Level LO2 Level	Sets/Reads the LO level of the external mixer	:SENS:DCON:MAN:LO[1-2]:LEV
Mixer 1 Bias Mixer 2 Bias	Sets the bias current supplied to the external mixer on or off and reads its settings	:SENS:DCON:MAN:MEXT[1-2]:BIAS:STAT
$\Delta IF = IF2 - IF1$	Sets/Reads the differential frequency between CH1 and CH2 from the external mixer	:SENS:DCON:MAN:IFD
Frequency Offset (User Downconv.)		
Conversion Mode	Sets/Reads the conversion mode of the frequency offset	:SENS:UDC:MODE
Frequency Offset	Sets/Reads the frequency offset	:SENS:UDC:STAT
Harmonic #	Sets/Reads the frequency offset factor	:SENS:UDC:HARM
LO Frequency	Sets/Reads the LO frequency of the frequency offset	:SENS:UDC:LO
Invert Image	Selects print mode	:HCOP:IMAG
Misc Setup		
Beeper		
Beep Complete	Turns on/off the beep for operation completion	:SYST:BEEP:COMP:STAT
Beep Warning	Turns on/off the beep for warning	:SYST:BEEP:WARN:STAT
Test Beep Complete	Makes beep sound for operation completion	:SYST:BEEP:COMP:IMM
Test Beep Warning	Makes beep sound for warning	:SYST:BEEP:WARN:IMM
Clock Setup		
Set Date and Time	Sets/Reads system time Sets/Reads system date	:SYST:TIME :SYST:DATE
Show Clock	Turns on/off internal clock display	:DISP:CLOC

Table 7-5 TR Menu

Key Operation	Function	SCPI Command
Color Setup		
Invert	Sets each color when the inverted display is selected	
Background	Sets/Reads the background color	:DISP:COL2:BACK[:VAL]
Data Trace 1	Sets/Reads the color of the data trace of trace 1	:DISP:COL2:TRAC1:DATA[:VAL]
:		
Data Trace 8	Sets/Reads the color of the data trace of trace 8	:DISP:COL2:TRAC8:DATA[:VAL]
Graticule Main	Sets/Reads the color of the graph	:DISP:COL2:GRAT1[:VAL]
Graticule Sub	Sets/Reads the color of the grid lines in the graph	:DISP:COL2:GRAT2[:VAL]
Limit Fail	Sets/Reads the limit display color	:DISP:COL2:LIM1[:VAL]
Limit Line	Sets/Reads the color of the limit line	:DISP:COL2:LIM2[:VAL]
Mem Trace 1	Sets/Reads the color of the memory trace of trace 1	:DISP:COL2:TRAC1:MEM[:VAL]
:		
Mem Trace 8	Sets/Reads the color of the memory trace of trace 8	:DISP:COL2:TRAC8:MEM[:VAL]
Reset Color	Resets the display color to the factory preset default setting	:DISP:COL2:RES
Normal	Sets each color when the normal display is selected	
Background	Sets/Reads the background color	:DISP:COL1:BACK[:VAL]
Data Trace 1	Sets/Reads the color of the data trace of trace 1	:DISP:COL1:TRAC1:DATA[:VAL]
:		
Data Trace 8	Sets/Reads the color of the data trace of trace 8	:DISP:COL1:TRAC8:DATA[:VAL]
Graticule Main	Sets/Reads the color of the graph	:DISP:COL1:GRAT1[:VAL]
Graticule Sub	Sets/Reads the color of the grid lines in the graph	:DISP:COL1:GRAT2[:VAL]
Limit Fail	Sets/Reads the limit display color	:DISP:COL1:LIM1[:VAL]
Limit Line	Sets/Reads the color of the limit line	:DISP:COL1:LIM2[:VAL]
Mem Trace 1	Sets/Reads the color of the memory trace of trace 1	:DISP:COL1:TRAC1:MEM[:VAL]

Table 7-5 TR Menu

Key Operation	Function	SCPI Command
:		
:		
Mem Trace 8	Sets/Reads the color of the memory trace of trace 8	:DISP:COL1:TRAC8:MEM[VAL]
Reset Color	Resets the display color to the factory preset default setting	:DISP:COL1:RES
Control Panel ...	Opens control panel	
GPIB Setup		
System Controller Configuration	Turns on/off system controller mode	
Talker/Listener Address	Sets the address for controlling the analyzer from a controller via GPIB	
Key Lock		
Front Panel & Keyboard Lock	Disables from panel / keyboard operations	:SYST:KLOC:KBD
Touch Screen & Mouse Lock	Disables touch screen / mouse operations	:SYST:KLOC:MOUS
Network Setup		
MAC Address	Sets MAC address	
Network Configuration ...	Enables/disables network connections	
Network Identification ...	Sets network ID of the instrument	
SICL-LAN Address	Sets SICL-LAN address	
SICL-LAN Server	Enables/disables SICL-LAN server	
Socket Server	Enables/disables Socket server	
Telnet Server	Enables/disables Telnet server	
Print	Outputs print	:HCOP:IMM
Printer Setup ...	Executes printer setup	
Product Information	Reads product information	
Service Menu		
Administrator Menu	Displays softkeys associated with Administrator Menu. This function is not available to general users.	

Table 7-5 TR Menu

Key Operation	Function	SCPI Command
Error Log		
Clear Error Log	Clears the error log	
View Error Log ...	Displays the error log	
Install Option License		
Jitter	Enters the license for clock jitter analysis	
Service Function	Displays softkeys associated with Service Menu. This function is not available to general users.	
Test Menu		
Power On Test	Performs internal test	
Display Test	Performs display test	
Front Panel	Performs front panel key (hard key) test	
Adjust Touch Screen	Performs touch screen calibration	
E5053A Test	Displays the connection status of E5053A	
Time Offset		
Narrow Ref Position	Sets/Reads reference position for time span (Narrowband mode)	:SENS:TR[1-1]:NARR:TIME:REF
Narrow Settings -> Wide	Sets narrowband mode settings to wideband mode settings	
Narrow Span	Sets/Reads time span (Narrowband mode)	:SENS:TR[1-1]:NARR:TIME:SPAN
Narrow Time Offset	Sets/Reads time offset(delay) relative to the reference point	:SENS:TR[1-1]:NARR:TIME:OFFS
Wide Ref Position	Sets/Reads reference position for time span (Wideband mode)	:SENS:TR[1-1]:WIDE:TIME:REF
Wide Settings -> Narrow	Sets wideband mode settings to narrowband mode settings	
Wide Span	Sets/Reads time span (Wideband mode)	:SENS:TR[1-1]:WIDE:TIME:SPAN
Wide Time Offset	Sets/Reads time offset(delay) relative to the reference point	:SENS:TR[1-1]:WIDE:TIME:OFFS
Trace View		
Aperture	Sets/Reads smoothing aperture value	:CALC:TR[1-1]:TRAC[1-4]:SMO:APER
Copy to User	Copies trace data to the user trace	:CALC:TR[1-1]:TRAC[1-4]:DATA:COPY

Table 7-5 TR Menu

Key Operation	Function	SCPI Command
Data -> Mem	Copies data to memory	:CALC:TR[1-1]:TRAC[1-4]:MATH:MEM
Data Hold	Data hold	:CALC:TR[1-1]:TRAC[1-4]:HOLD
Data Math	Sets/Reads math operation type	:CALC:TR[1-1]:TRAC[1-4]:MATH:FUNC
Display Trace	Shows data and/or memory trace	:DISP:TR[1-1]:TRAC[1-4]:MODE
Marker -> -Offset	Sets sign-inverted data value of the data trace's active marker to the offset value	:CALC:TR[1-1]:TRAC[1-4]:MATH:OFFS
Memory Trace		
Line (Y = AX + B)		
A	Sets/Reads regression line coefficient a (slope)	:CALC:TR[1-1]:TRAC[1-4]:LINE:A
B	Sets/Reads regression line coefficient b (intercept)	:CALC:TR[1-1]:TRAC[1-4]:LINE:B
Data Trace -> A, B	Assigns the measurement results to regression line coefficients (a, b)	:CALC:TR[1-1]:TRAC[1-4]:FUNC:LREG:DATA? :CALC:TR[1-1]:TRAC[1-4]:LINE:A :CALC:TR[1-1]:TRAC[1-4]:LINE:B
Set Line to Memory	Sets the obtained regression line to the memory trace	:CALC:TR[1-1]:TRAC[1-4]:LINE:MEM
Offset	Sets/Reads the offset value of the data trace	:CALC:TR[1-1]:TRAC[1-4]:MATH:OFFS
Persistence		
Clear Persistent Data	Clears persistent mode	:DISP:TR[1-1]:TRAC[1-4]:PERSIST:CLE
Persistence Mode	Sets/Reads persistent mode	:DISP:TR[1-1]:TRAC[1-4]:PERSIST:STAT
Smoothing	Turns on/off smoothing function	:CALC:TR[1-1]:TRAC[1-4]:SMO:STAT
Trace Label	Edits trace title label	:DISP:TR[1-1]:TRAC[1-4]:LAB:DATA
Trigger		
Average Trigger	Sets/Reads the averaging trigger function	:TRIG:AVER
Continuous	Sets/Reads trigger continuous mode	:INIT:TR[1-1]:CONT :INIT:TR[1-1]:IMM
Ext Trig Adj.	Sets/Reads the waiting time for external trigger	:TRIG:TR[1-1]:ETTA
Ext Trig Polarity	External trigger polarity	:TRIG:EXT:SLOP

Table 7-5 TR Menu

Key Operation	Function	SCPI Command
Hold	Sets trigger mode to waiting-for-trigger state	:INIT:TR[1-1]:IMM
Manual Trigger	Moves once to waiting-for-trigger state	:INIT:TR[1-1]:IMM
Restart	Moves once to waiting-for-trigger state	:INIT:TR[1-1]:IMM
Single	Always moves to waiting-for-trigger state after measuring	:INIT:TR[1-1]:CONT
	Moves once to waiting-for-trigger state	:INIT:TR[1-1]:IMM
Source	Triggers source	:TRIG:TR[1-1]:SOUR
Trigger to Transient	Selects measurement mode	:TRIG:MODE

USER Menu

Table 7-6 User Menu

Key Operation	Function	SCPI Command
Attenuator		
Input Attenuator	Sets/Reads Input Attenuator level on 5dB Step	:SENS:ATT:LEV
DC Control Voltage		
Auto Freq Control		
AFC Status	Turns on/off the auto frequency control function. Executes the auto frequency control once.	:SOUR:VOLT:CONT:AFC[STAT] :SOUR:VOLT:CONT:AFC:IMM
Frequency Band	Sets/Reads the frequency band in the auto frequency control function	:SOUR:VOLT:CONT:AFC:FBAN
Max Ctrl Voltage Limit	Sets/Reads the maximum DC control voltage limit	:SOUR:VOLT:CONT:AFC:LIM: HIGH
Max Input Level	Sets/Reads the maximum input level	:SOUR:VOLT:CONT:AFC:INP:L EV:MAX
Max Iteration	Sets/Reads the maximum number of iterations for the DC control voltage-setting loops	:SOUR:VOLT:CONT:AFC:ITER
Min Ctrl Voltage Limit	Sets/Reads the minimum DC control voltage limit	:SOUR:VOLT:CONT:AFC:LIM: LOW
Sensitivity	Sets/Reads the tuning sensitivity	:SOUR:VOLT:CONT:AFC:SENS
Target	Sets/Reads the target frequency in the auto frequency control function	:SOUR:VOLT:CONT:AFC:TARG
Tolerance	Sets/Reads the tolerance limit	:SOUR:VOLT:CONT:AFC:TOL
Control Voltage Cal	Enables DC Control voltage calibration	:SOUR:VOLT:CONT:CORR[ST AT]
DC Control Delay	Sets/Reads DC Control delay (sec)	:SOUR:VOLT:CONT:DEL
DC Control Output	Turns on/off DC Control voltage	:SOUR:VOLT:CONT:LEV:STAT
DC Control Voltage	Sets/Reads DC Control voltage	:SOUR:VOLT:CONT:LEV:AMP L
Execute Control Voltage Cal	Executes DC Control voltage calibration	:SOUR:VOLT:CONT:CORR:CO LL:ACQ
Max Ctrl Voltage Limit	Sets/Reads the maximum DC Control voltage limit	:SOUR:VOLT:CONT:LIM:HIGH
Min Ctrl Voltage Limit	Sets/Reads the minimum DC Control voltage limit	:SOUR:VOLT:CONT:LIM:LOW
DC Power Voltage		
DC Power Delay	Sets/Reads DC Power delay (sec)	:SOUR:VOLT:POW:DEL
DC Power Output	Turns on/off DC Power voltage	:SOUR:VOLT:POW:LEV:STAT
DC Power Voltage	Sets/Reads DC Power voltage	:SOUR:VOLT:POW:LEV:AMPL
Max Pwr Voltage Limit	Sets/Reads the maximum DC Power voltage limit	:SOUR:VOLT:POW:LIM:HIGH

Table 7-6 User Menu

Key Operation	Function	SCPI Command
Min Pwr Voltage Limit	Sets/Reads the minimum DC Power voltage limit	:SOUR:VOLT:POW:LIM:LOW
Display		
Edit Title Label	Edits the measurement window title label	:DISP:USER[1-1]:LAB:DATA
Color Type	Sets/Reads the display type of the display (normal/inverted)	:DISP:IMAG
Limit Test		
Delete Lower Limit Line	Clears the lower limit line	:CALC:USER[1-1]:TRAC[1-8]:LIM:LOW:SEGM:CLE
Delete Upper Limit Line	Clears the upper limit line	:CALC:USER[1-1]:TRAC[1-8]:LIM:UPP:SEGM:CLE
Explorer		
Fail Sign	Turns on/off the limit test judgement display	:DISP:USER[1-1]:LIM:FSIG
Import Lower Limit Line ...	Reads the lower limit line	:MMEM:USER[1-1]:TRAC[1-8]:LOAD:LIM:LOW
Import Upper Limit Line ...	Reads the upper limit line	:MMEM:USER[1-1]:TRAC[1-8]:LOAD:LIM:UPP
Limit Line	Turns on/off the limit line	:DISP:USER[1-1]:TRAC[1-8]:LIM:LINE
Limit Test	Turns on/off the limit test function	:CALC:USER[1-1]:TRAC[1-8]:LIM[:STAT]
Marker Information	Sets/Reads the marker information position	:DISP:USER[1-1]:ANN:MARK:POS
Meas Condition	Turns on/off measurement conditions	:DISP:USER[1-1]:ANN:MEAS:STAT
Relative Y-Scale	Turns on/off relative Y-scale	:DISP:USER[1-1]:GRAT:AXIS:Y:REL
Security Level	Sets/recalls the security level	:SYST:SEC[:LEV]
Title Label	Turns on/off the measurement window title label	:DISP:USER[1-1]:LAB:STAT
Update	Turns on/off the trace updates	:DISP:ENAB
Y # of Digits	Selects the number of digits (Y-axis)	:DISP:USER[1-1]:GRAT:AXIS:Y:STAT
Input Port		
Downconverter		
Downconverter	Sets the use of the downconverter on or off, or reads its setting	:SENS:DCON[:STAT]
RF Input	Sets/Reads the signal supplied to the RF input port	:SENS:DCON:INP
External Mixer	Sets the use of the external mixer on or off and reads its settings	:SENS:DCON:MEXT

Table 7-6 User Menu

Key Operation	Function	SCPI Command
Macro Setup		
Application		
Jitter	Executes clock jitter analysis (VBA)	
mmWave	Executes phase-noise measurement (VBA)	
E5052 Event	Turns on/off the E5052 VBA event callback function	:PROG:COM:EVEN
Echo Window Menu		
Clear Echo	Clears Echo window	:DISP:ECHO:CLE
Echo Font Size	Sets/Reads the font size on Echo window	:DISP:ECHO:FSIZ
Echo Window	Turns on/off the Echo window	:DISP:ECHO:STAT
Load & Run	Loads and executes the macro selected on file names.	
Select Macro	Sets/Reads the name of the program to be selected	:PROG:SEL:NAME
Stop	Sets/Reads the state of the selected program	:PROG:SEL:STAT
User Menu		
User Label 1	Executes the macro assigned under the user defined softkey	:PROG:SKEY:ITEM[1-8]:IMM
User Label 2	Executes the macro assigned under the user defined softkey	:PROG:SKEY:ITEM[1-8]:IMM
User Label 3	Executes the macro assigned under the user defined softkey	:PROG:SKEY:ITEM[1-8]:IMM
User Label 4	Executes the macro assigned under the user defined softkey	:PROG:SKEY:ITEM[1-8]:IMM
User Label 5	Executes the macro assigned under the user defined softkey	:PROG:SKEY:ITEM[1-8]:IMM
User Label 6	Executes the macro assigned under the user defined softkey	:PROG:SKEY:ITEM[1-8]:IMM
User Label 7	Executes the macro assigned under the user defined softkey	:PROG:SKEY:ITEM[1-8]:IMM
User Label 8	Executes the macro assigned under the user defined softkey	:PROG:SKEY:ITEM[1-8]:IMM
VBA Editor Menu		
Close Editor	Closes VBA editor	
Load Project	Loads program	:MMEM:LOAD:PROG
New Project	Opens new VBA project	
Open Editor	Opens VBA editor	
Save Project	Saves VBA project	:MMEM:STOR:PROG

Table 7-6 User Menu

Key Operation	Function	SCPI Command
Marker		
Clear Marker Menu		
All OFF	Clears all the markers	
Marker 1	Turns on/off marker 1	:CALC:USER[1-1]:TRAC[1-8]: MARK[1-10]:STAT
:		
:		
Marker 6	Turns on/off marker 6	:CALC:USER[1-1]:TRAC[1-8]: MARK[1-10]:STAT
Couple	Turns on/off marker coupling function	:CALC:USER[1-1]:ALLT:MARK :COUP:STAT
Marker 1	Turns on/off marker 1	:CALC:USER[1-1]:TRAC[1-8]: MARK[1-10]:STAT
:		
:		
Marker 6	Turns on/off marker 6	:CALC:USER[1-1]:TRAC[1-8]: MARK[1-10]:STAT
Marker List	Turns on/off the marker list	:DISP:USER[1-1]:TABL[:STAT]
More Functions		
Discrete	Sets/Reads marker movement (Continuous/Discrete)	:CALC:USER[1-1]:ALLT:MARK :DISC:STAT
Ref Marker	Sets/Reads marker reference number	:CALC:USER[1-1]:ALLT:MARK :REF:NUMB
Ref Marker Mode	Turns on/off delta marker mode	:CALC:USER[1-1]:ALLT:MARK :REF:STAT
More Markers		
Marker 7	Turns on/off marker 7	:CALC:USER[1-1]:TRAC[1-8]: MARK[1-10]:STAT
:		
:		
Marker 10	Turns on/off marker 10	:CALC:USER[1-1]:TRAC[1-8]: MARK[1-10]:STAT

Table 7-6 User Menu

Key Operation	Function	SCPI Command
Marker Function		
Analysis Range (X)	Sets/Reads analysis/search range (X-axis)	:CALC:USER[1-1]:TRAC[1-8]:F UNC:DOM:X
Analysis Range (Y)	Sets/Reads analysis/search range (Y-axis)	:CALC:USER[1-1]:TRAC[1-8]:F UNC:DOM:Y
Analysis Type	Sets/Reads analysis type	:CALC:USER[1-1]:TRAC[1-8]:F UNC:TYPE
Band Marker X		
Band Marker X	Turns on/off bandmarker X	:CALC:USER[1-1]:TRAC[1-8]:B DM:X:STAT
Center	Sets/Reads the center value of bandmarker X	:CALC:USER[1-1]:TRAC[1-8]:B DM:X:CENT
Span	Sets/Reads the span value of bandmarker X	:CALC:USER[1-1]:TRAC[1-8]:B DM:X:SPAN
Start	Sets/Reads the start value of bandmarker X	:CALC:USER[1-1]:TRAC[1-8]:B DM:X:STAR
Stop	Sets/Reads the stop value of bandmarker X	:CALC:USER[1-1]:TRAC[1-8]:B DM:X:STOP
Band Marker Y		
Band Marker Y	Turns on/off bandmarker Y	:CALC:USER[1-1]:TRAC[1-8]:B DM:Y:STAT
Center	Sets/Reads the center value of bandmarker Y	:CALC:USER[1-1]:TRAC[1-8]:B DM:Y:CENT
Span	Sets/Reads the span value of bandmarker Y	:CALC:USER[1-1]:TRAC[1-8]:B DM:Y:SPAN
Start	Sets/Reads the start value of bandmarker Y	:CALC:USER[1-1]:TRAC[1-8]:B DM:Y:STAR
Stop	Sets/Reads the stop value of bandmarker Y	:CALC:USER[1-1]:TRAC[1-8]:B DM:Y:STOP
Couple	Turns on/off bandmarker coupling function	:CALC:USER[1-1]:ALLT:BDM: X:COUP:STAT
Marker Search		
Band Marker X		
Band Marker X	Turns on/off bandmarker X	:CALC:USER[1-1]:TRAC[1-8]:B DM:X:STAT
Center	Sets/Reads the center value of bandmarker X	:CALC:USER[1-1]:TRAC[1-8]:B DM:X:CENT
Span	Sets/Reads the span value of bandmarker X	:CALC:USER[1-1]:TRAC[1-8]:B DM:X:SPAN
Start	Sets/Reads the start value of bandmarker X	:CALC:USER[1-1]:TRAC[1-8]:B DM:X:STAR

Table 7-6 User Menu

Key Operation	Function	SCPI Command
Stop	Sets/Reads the stop value of bandmarker X	:CALC:USER[1-1]:TRAC[1-8]:BDM:X:STOP
Band Marker Y		
Band Marker Y	Turns on/off bandmarker Y	:CALC:USER[1-1]:TRAC[1-8]:BDM:Y:STAT
Center	Sets/Reads the center value of bandmarker Y	:CALC:USER[1-1]:TRAC[1-8]:BDM:Y:CENT
Span	Sets/Reads the span value of bandmarker Y	:CALC:USER[1-1]:TRAC[1-8]:BDM:Y:SPAN
Start	Sets/Reads the start value of bandmarker Y	:CALC:USER[1-1]:TRAC[1-8]:BDM:Y:STAR
Stop	Sets/Reads the stop value of bandmarker Y	:CALC:USER[1-1]:TRAC[1-8]:BDM:Y:STOP
Couple	Turns on/off bandmarker coupling function	:CALC:USER[1-1]:ALLT:BDM:X:COUP:STAT
Peak		
Peak Excursion	Sets/Reads the peak excursion value	:CALC:USER[1-1]:TRAC[1-8]:MARK[1-10]:SEAR:PEAK:EXC
Peak Polarity	Sets/Reads the marker peak-search polarity	:CALC:USER[1-1]:TRAC[1-8]:MARK[1-10]:SEAR:PEAK:POL
Search Left	Executes marker peak search left	:CALC:USER[1-1]:TRAC[1-8]:MARK[1-10]:SEAR:EXEC:LPE
Search Peak	Executes marker peak search	:CALC:USER[1-1]:TRAC[1-8]:MARK[1-10]:SEAR:EXEC:PEAK
Search Peak All	Executes marker search all	:CALC:USER[1-1]:TRAC[1-8]:ALLM:SEAR:PEAK
Search Right	Executes marker peak search right	:CALC:USER[1-1]:TRAC[1-8]:MARK[1-10]:SEAR:EXEC:RPE
Search Max	Executes marker search maximum	:CALC:USER[1-1]:TRAC[1-8]:MARK[1-10]:SEAR:EXEC:MAX
Search Min	Executes marker search minimum	:CALC:USER[1-1]:TRAC[1-8]:MARK[1-10]:SEAR:EXEC:MIN
Search Range (X)	Sets/Reads marker search range (X-axis)	:CALC:USER[1-1]:TRAC[1-8]:ALLM:SEAR:DOM:X
Search Range (Y)	Sets/Reads marker search range (Y-axis)	:CALC:USER[1-1]:TRAC[1-8]:ALLM:SEAR:DOM:Y

Table 7-6 User Menu

Key Operation	Function	SCPI Command
Target		
Search Left	Executes marker target search left	:CALC:USER[1-1]:TRAC[1-8]:MARK[1-10]:SEAR:EXEC:LTA R
Search Right	Executes marker target search right	:CALC:USER[1-1]:TRAC[1-8]:MARK[1-10]:SEAR:EXEC:RTA R
Search Target	Executes marker target search	:CALC:USER[1-1]:TRAC[1-8]:MARK[1-10]:SEAR:EXEC:TAR G
Target Transition	Sets/Reads the target transition definition	:CALC:USER[1-1]:TRAC[1-8]:MARK[1-10]:SEAR:TARG:TRA N
Target Value	Sets/Reads the marker target value	:CALC:USER[1-1]:TRAC[1-8]:MARK[1-10]:SEAR:TARG:Y
Tracking	Sets/Reads the marker tracking type	:CALC:USER[1-1]:TRAC[1-8]:MARK[1-10]:SEAR:TRAC:TYP E
Measurement View		
Freq & Power	Selects frequency, power and DC current measurement window	:DISP:WIND:ACT
Phase Noise	Selects phase noise measurement window	:DISP:WIND:ACT
Show Window		
Freq & Power	Turns on/off frequency, power and DC current measurement mode	:DISP:FP[1-1]:STAT
Phase Noise	Turns on/off phase noise measurement mode	:DISP:PN[1-1]:STAT
Spectrum Monitor	Turns on/off spectrum monitor mode	:DISP:SP[1-1]:STAT
Transient	Turns on/off transient measurement mode	:DISP:TR[1-1]:STAT
User	Turns on/off user defined window	:DISP:USER[1-1]:STAT
Spectrum Monitor	Selects spectrum monitor mode	:DISP:WIND:ACT
Transient	Selects transient measurement mode	:DISP:WIND:ACT
User	Selects user defined window	:DISP:WIND:ACT
Preset		
Factory	Presets instrument to the initial setup state	:SYST:PRES
User	Presets instrument and recalls the Autorec.sta in the F drive	

Table 7-6 User Menu

Key Operation	Function	SCPI Command
Save/Recall		
Explorer...	Opens windows explorer	
Recall by filename	Recalls state file by file name	:MMEM:LOAD:STAT
Recall State		
Autorec	Recalls settings	:MMEM:LOAD:STAT
File Dialog...	Opens file dialog	
State01	Recalls state file from register 1	:MMEM:LOAD:STAT
State02	Recalls state file from register 2	:MMEM:LOAD:STAT
State03	Recalls state file from register 3	:MMEM:LOAD:STAT
State04	Recalls state file from register 4	:MMEM:LOAD:STAT
State05	Recalls state file from register 5	:MMEM:LOAD:STAT
State06	Recalls state file from register 6	:MMEM:LOAD:STAT
Save Data Trace	Saves trace data	:MMEM:USER[1-1]:TRAC[1-8]:STOR[:DATA]
Save Memory Trace	Saves memory trace data	:MMEM:USER[1-1]:TRAC[1-8]:STOR:MEM
Save State		
Autorec	Saves settings	:MMEM:STOR:STAT
File Dialog...	Opens file dialog	
Save Type	Selects instrument state type (Entire or instrument state only)	:MMEM:STOR:STYP
State01	Saves state file to register 1	:MMEM:STOR:STAT
State02	Saves state file to register 2	:MMEM:STOR:STAT
State03	Saves state file to register 3	:MMEM:STOR:STAT
State04	Saves state file to register 4	:MMEM:STOR:STAT
State05	Saves state file to register 5	:MMEM:STOR:STAT
State06	Saves state file to register 6	:MMEM:STOR:STAT
Scale		
Auto Scale	Executes autoscale	:DISP:USER[1-1]:TRAC[1-8]:Y[:SCAL]:AUTO
Auto Scale All	Executes autoscale for all traces on user defined window	:DISP:USER[1-1]:ALLT:Y:SCAL:AUTO
Divisions	Sets/Reads Y-scale divisions	:DISP:USER[1-1]:Y[:SCAL]:DIV
Marker -> Reference	Sets the marker value to the reference level	:DISP:USER[1-1]:TRAC[1-8]:Y[:SCAL]:RLEV
Reference Position	Sets/Reads reference position	:DISP:USER[1-1]:TRAC[1-8]:Y[:SCAL]:RPOS

Table 7-6 User Menu

Key Operation	Function	SCPI Command
Reference Value	Sets/Reads the reference level value	:DISP:USER[1-1]:TRAC[1-8]:Y[:SCAL]:RLEV
Scale/Div	Sets/Reads scale per division	:DISP:USER[1-1]:TRAC[1-8]:Y[:SCAL]:PDIV
X Axis		
Auto	Sets/Reads automatic setting of the X-axis display range to the stimulus value	:DISP:USER[1-1]:TRAC[1-8]:X[:SCAL]:AUTO
Band Marker -> X Axis	Sets the X-axis band marker range to the X-axis display range of a graph	:DISP:USER[1-1]:TRAC[1-8]:X[:SCAL]:LEFT :DISP:USER[1-1]:TRAC[1-8]:X[:SCAL]:RIGH
Left	Sets/Reads the start value of the X-axis display range	:DISP:USER[1-1]:TRAC[1-8]:X[:SCAL]:LEFT
Right	Sets/Reads the stop value of the X-axis display range	:DISP:USER[1-1]:TRAC[1-8]:X[:SCAL]:RIGH
X Axis Type	Sets/Reads the display type of the x axis.	:DISP:USER[1-1]:TRAC[1-8]:X:TYPE
X Unit	Sets/Reads X-axis unit	:DISP:USER[1-1]:TRAC[1-8]:X:UNIT
Y Unit	Sets/Reads Y-axis unit	:DISP:USER[1-1]:TRAC[1-8]:Y:UNIT
System		
Abort Printing	Aborts printing	:HCOP:ABOR
Backlight	Turns on/off backlight	:SYST:BACK:STAT
Dump Screen Image	Saves screen image	:MMEM:STOR:IMAG
Instrument Setup		
Correction		
File Dialog ...	Loads correction data for a specified power	:MMEM:LOAD:CORR:POW
Import Power Correction Table	Loads correction data for a specified power	:MMEM:LOAD:CORR:POW
Power Correction	Sets user the user calibration on or off or reads its setting	:SENS:CORR:POW:STAT
Downconverter Manual Setup		
Current	Sets/Reads the bias current to be supplied to the external mixer	:SENS:DCON:MAN:MEXT[1-2]:BIAS:CURR
IF Gain 1	Sets/Reads the IF gain of the external mixer	:SENS:DCON:MAN:IFG[1-2]
IF Gain 2		

Table 7-6 User Menu

Key Operation	Function	SCPI Command
LO1 Frequency	Sets/Reads the LO frequency of the external mixer	:SENS:DCON:MAN:LO[1-2]:FREQ
LO2 Frequency		
LO1 Level	Sets/Reads the LO level of the external mixer	:SENS:DCON:MAN:LO[1-2]:LEV
LO2 Level		
Mixer 1 Bias	Sets the bias current supplied to the external mixer on or off and reads its settings	:SENS:DCON:MAN:MEXT[1-2]:BIAS:STAT
Mixer 2 Bias		
$\Delta IF = IF2 - IF1$	Sets/Reads the differential frequency between CH1 and CH2 from the external mixer	:SENS:DCON:MAN:IFD
Frequency Offset (User Downconv.)		
Conversion Mode	Sets/Reads the conversion mode of the frequency offset	:SNES:UDC:MODE
Frequency Offset	Sets/Reads the frequency offset	:SENS:UDC:STAT
Harmonic #	Sets/Reads the frequency offset factor	:SENS:UDC:HARM
LO Frequency	Sets/Reads the LO frequency of the frequency offset	:SENS:UDC:LO
Invert Image	Selects print mode	:HCOP:IMAG
Misc Setup		
Beeper		
Beep Complete	Turns on/off the beep for operation completion	:SYST:BEEP:COMP:STAT
Beep Warning	Turns on/off the beep for warning	:SYST:BEEP:WARN:STAT
Test Beep Complete	Makes beep sound for operation completion	:SYST:BEEP:COMP:IMM
Test Beep Warning	Makes beep sound for warning	:SYST:BEEP:WARN:IMM
Clock Setup		
Set Date and Time	Sets/Reads system time Sets/Reads system date	:SYST:TIME :SYST:DATE
Show Clock	Turns on/off internal clock display	:DISP:CLOC
Color Setup		
Invert	Sets each color when the inverted display is selected	
Background	Sets/Reads the background color	:DISP:COL2:BACK[:VAL]
Data Trace 1	Sets/Reads the color of the data trace of trace 1	:DISP:COL2:TRAC1:DATA[:VAL]

Table 7-6 User Menu

Key Operation	Function	SCPI Command
:		
:		
Data Trace 8	Sets/Reads the color of the data trace of trace 8	:DISP:COL2:TRAC8:DATA[:VAL]
Graticule Main	Sets/Reads the color of the graph	:DISP:COL2:GRAT1[:VAL]
Graticule Sub	Sets/Reads the color of the grid lines in the graph	:DISP:COL2:GRAT2[:VAL]
Limit Fail	Sets/Reads the limit display color	:DISP:COL2:LIM1[:VAL]
Limit Line	Sets/Reads the color of the limit line	:DISP:COL2:LIM2[:VAL]
Mem Trace 1	Sets/Reads the color of the memory trace of trace 1	:DISP:COL2:TRAC1:MEM[:VAL]
:		
:		
Mem Trace 8	Sets/Reads the color of the memory trace of trace 8	:DISP:COL2:TRAC8:MEM[:VAL]
Reset Color	Resets the display color to the factory preset default setting	:DISP:COL2:RES
Normal	Sets each color when the normal display is selected	
Background	Sets/Reads the background color	:DISP:COL1:BACK[:VAL]
Data Trace 1	Sets/Reads the color of the data trace of trace 1	:DISP:COL1:TRAC1:DATA[:VAL]
:		
:		
Data Trace 8	Sets/Reads the color of the data trace of trace 8	:DISP:COL1:TRAC8:DATA[:VAL]
Graticule Main	Sets/Reads the color of the graph	:DISP:COL1:GRAT1[:VAL]
Graticule Sub	Sets/Reads the color of the grid lines of the graph	:DISP:COL1:GRAT2[:VAL]
Limit Fail	Sets/Reads the limit display color	:DISP:COL1:LIM1[:VAL]
Limit Line	Sets/Reads the color of the limit line	:DISP:COL1:LIM2[:VAL]
Mem Trace 1	Sets/Read the color of the memory trace of trace 1	:DISP:COL1:TRAC1:MEM[:VAL]
:		
:		
Mem Trace 8	Sets/Reads the color of the memory trace of trace 8	:DISP:COL1:TRAC8:MEM[:VAL]
Reset Color	Resets the display color to the factory preset default setting	:DISP:COL1:RES

Table 7-6 User Menu

Key Operation	Function	SCPI Command
Control Panel ...	Opens control panel	
GPIB Setup		
System Controller Configuration	Turns on/off system controller mode	
Talker/Listener Address	Sets the address for controlling the analyzer from a controller via GPIB	
Key Lock		
Front Panel & Keyboard Lock	Disables from panel / keyboard operations	:SYST:KLOC:KBD
Touch Screen & Mouse Lock	Disables touch screen / mouse operations	:SYST:KLOC:MOUS
Network Setup		
MAC Address	Sets MAC address	
Network Configuration	Enables/disables network connections	
Network Identification	Sets network ID of the instrument	
SICL-LAN Address	Sets SICL-LAN address	
SICL-LAN Server	Enables/disables SICL-LAN server	
Socket Server	Enables/disables Socket server	
Telnet Server	Enables/disables Telnet server	
Print	Outputs print	:HCOP:IMM
Printer Setup ...	Executes printer setup	
Product Information	Reads product information	
Service Menu		
Administrator Menu	Displays softkeys associated with Administrator Menu. This function is not available to general users.	
Error Log		
Clear Error Log	Clears the error log	
View Error Log ...	Displays the error log	
Install Option License		
Jitter	Enters the license for clock jitter analysis (VBA)	

Table 7-6 User Menu

Key Operation	Function	SCPI Command
Service Function	Displays softkeys associated with Service Menu. This function is not available to general users.ÅB	
Test Menu		
Power On Test	Performs internal test	
Display Test	Performs display test	
Front Panel	Performs front panel key (hard key) test	
Adjust Touch Screen	Performs touch screen calibration	
E5053A Test	Displays the connection status of E5053A	
Trace View		
Aperture	Smoothing aperture	:CALC:USER[1-1]:TRAC[1-8]:SMO:APER
Copy to User	Copies trace data to the user trace	:CALC:USER[1-1]:TRAC[1-8]:DATA:COPY
Data -> Mem	Copies data to memory	:CALC:USER[1-1]:TRAC[1-8]:MATH:MEM
Data Hold	Data hold	:CALC:USER[1-1]:TRAC[1-8]:HOLD
Data Math	Sets/Reads math operation type	:CALC:USER[1-1]:TRAC[1-8]:MATH:FUNC
Display Trace	Shows data and/or memory trace	:DISP:USER[1-1]:TRAC[1-8]:MODE
Enable Trace		
Trace 1	Enables/disables data trace 1	:DISP:USER[1-1]:TRAC[1-8]:STAT
Trace 2	Enables/disables data trace 2	:DISP:USER[1-1]:TRAC[1-8]:STAT
Trace 3	Enables/disables data trace 3	:DISP:USER[1-1]:TRAC[1-8]:STAT
Trace 4	Enables/disables data trace 4	:DISP:USER[1-1]:TRAC[1-8]:STAT
Trace 5	Enables/disables data trace 5	:DISP:USER[1-1]:TRAC[1-8]:STAT
Trace 6	Enables/disables data trace 6	:DISP:USER[1-1]:TRAC[1-8]:STAT
Trace 7	Enables/disables data trace 7	:DISP:USER[1-1]:TRAC[1-8]:STAT
Trace 8	Enables/disables data trace 8	:DISP:USER[1-1]:TRAC[1-8]:STAT

Table 7-6 User Menu

Key Operation	Function	SCPI Command
Marker -> -Offset	Sets sign-inverted data value of active marker of data trace to the offset value	:CALC:USER[1-1]:TRAC[1-8]:MATH:OFFS
Offset	Sets/Reads the offset value of the data trace	:CALC:USER[1-1]:TRAC[1-8]:MATH:OFFS
Persistence		
Clear All Persistent Data	Clears the persistent data of all traces	:DISP:USER[1-1]:ALLT:PERS:CLE
Persistence Mode	Sets/Reads persistence mode	:DISP:USER[1-1]:TRAC[1-8]:PERS:STAT
Smoothing	Smoothing on/off	:CALC:USER[1-1]:TRAC[1-8]:SMO:STAT
Trace Annotation	Edits trace annotation	:DISP:USER[1-1]:TRAC[1-8]:ANN:DATA
Trace Label	Edits trace title label	:DISP:USER[1-1]:TRAC[1-8]:LABEL:DATA

A **Manual Changes**

This appendix contains the information required to adapt this manual to earlier versions or configurations of the Agilent E5052A than that indicated by the current printing date of this manual. The information in this manual applies directly to the E5052A model that has the serial number prefix listed on the title page of this manual.

Manual Changes

To adapt this manual to your Agilent E5052A, refer to Table A-1 and Table A-2.

Table A-1 Manual Changes by Serial Number

Serial Prefix or Number	Make Manual Changes
MY442 or later	Change 4

Table A-2 Manual Changes by Firmware Version

Version	Make Manual Changes
A.01.10 or later	Change 1
A.01.50 or later	Change 2
A.02.00 or later	Change 3
A.02.50 or later	Change 5

The ten-character serial number is stamped on the serial number plate (Figure A-1) on the rear panel.

Execute the *IDN command on page 297 to check the firmware version.

Figure A-1 Serial Number Plate (Example)



e5052apj029

Change 5

The following functions are newly integrated into the firmware version A.02.50 onward. They are not supported by firmware version A.02.00 or earlier.

- Allan variance and jitter calculation in phase noise measurement (PN)
- Addition of 20 MHz to the offset stop frequency in phase noise measurement (PN)
- Addition of 25 kHz and 3.125 kHz to the test frequency range of the narrow band in transient measurement (TR)
- Y-axis offset setting
- Function to make 0 degree reference variable when measuring phase in transient measurement (TR)
- Averaging trigger function
- Function to detect the end of measurement using the *OPC? command (except for VBA)
- Function to invert display color of a LCD display and color setting
- The number of markers changed from six to ten
- Function to set the minimum value and maximum value of X-axis
- Annotation in the user window and function that frequency and signal level are copied to the user window when traces of the phase noise measurement are copied to the user window.
- Linearity evaluation of FM chirp signal
- Timing control of external trigger in transient measurement (TR)
- Function to have the 11970 external mixer which equals to or is more than 26.5 Ghz correspond to this instrument by VBA
- Clock jitter measurement by VBA (E5001A)
- Setting the minimum level for spurious judgement
- User recovery function *1
- Expansion of the maximum number of display characters in the eco window up to 2000
- Expansion of the frequency offset setting range when using downconverter to 330 GHz, and the setting range of harmonic to 34

Change 4

The equipment with prefix MY441 or earlier does not support the USB (USBTMC) interface port nor the removable hard disk function.

*1. This function is available when the volume label on the C drive is CL250 or higher.

Change 3

The following functions are integrated newly into the firmware version A.01.50 onward. They are not supported by the firmware version A.02.00 or earlier.

- E5053A Control function
- UserCAL executive function of power measurement
- Frequency blanking
- Frequency offset function
- External mixer support
- Carrier signal search function
- Support of USB(USBTMC) interface port

Change 2

The following functions are integrated newly into the firmware version A.01.50 onward. They are not supported by the firmware version A.01.10 or earlier.

- Limit test function
- Auto frequency control function
- X-axis divisions
- Selectable preset
- Copy function of measurement result to user window
- Recall function of state file from softkey
- Selectable trace layout in frequency/power measurement mode.
- Integral phase noise, jitter and residual FM measurement in phase noise measurement
- Selectable quality level during phase noise measurement
- Display the progress of phase noise measurement
- Display spurious power value in phase noise measurement
- Moving function of harmonics to the center during spectrum monitor measurement
- Supporting $\Delta\text{Hz},\%$ and ppm data formats in frequency measurement
- Supporting 200kHz frequency range in transient measurement
- Offset adding function to phase reference frequency in transient measurement

Change 1

The functions listed below are limited when option 011 is installed.

Table A-3 Limited functions when option 011 is installed

Functions	Limitations
[PN] Start frequency	Minimum value is 10 Hz
[PN] Correlation	Not Available (The value is fixed as 1)
[PN] IF Gain	Not Available (The value is fixed as 10 dB)
[FP] Trigger Mode	Tester mode only

The SCPI commands that related the limited functions above have also the limitations on the initial values and the range of parameters.

Manual Changes
Manual Changes

B **Status Reporting System**

This appendix describes the status reporting system of the Agilent E5052A.

General Status Register Model

The Agilent E5052A has a status reporting system to report the condition of the instrument.

Figure B-1

General status register model

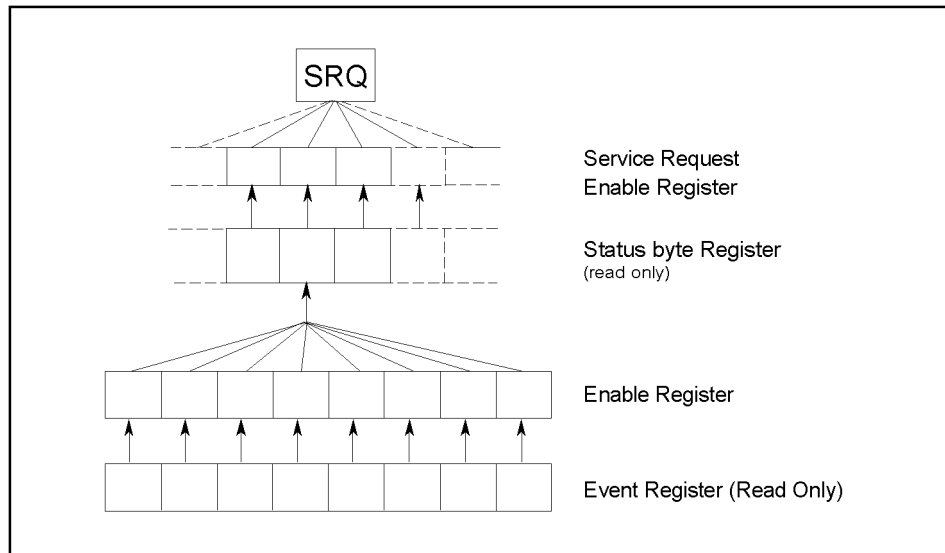

4294ape021

The status reporting system has a hierarchical structure as shown in Figure B-1. When the instrument satisfies a particular condition, the corresponding bit of the event register is set to 1. Therefore, you can check the instrument status by reading the event register.

When the event register bit is set to “1” and the corresponding enable register bit (the bit marked with an arrow in Figure B-1) is also “1,” the summary bit of the status byte register is set to “1.” You can read the status byte register by using the serial poll.

If the bit of the service request enable register is “1,” a service request (SRQ) is generated by the positive transition of the corresponding status byte register bit. By generating SRQ, you can notify the controller that the E5052A is requesting service. In other words, interruption by SRQ can be programmed.

For more information on using SRQ, see “Using the Status Register” on page 60 and “Using the status reporting system” on page 90.

NOTE

A different status-reporting system is used for each parser, such as GPIB, VBA, Telnet, or SICL-LAN. For example, if you mask the status register with VBA, the masking is valid only when VBA is used.

Event Register

This reflects the corresponding condition of the E5052A (e.g., occurrence of an event) as a bit status. These bits continuously monitor changes in the E5052A's state and change the bit status when the condition for each bit is met (e.g., changing bit status to "1" if a specific event occurs). You cannot change the bit status by issuing an SCPI command.

Enable Register

Setting the enable register allows you to specify event register bits that can set "1" to the summary bit of the status byte register when an event occurs. The register bits work as mask bits; setting an enable register to "1" will enable the corresponding bit in the event register.

For example, when you want to set "1" as the summary bit in the status byte register by a specific register condition, set the corresponding enable register to "1."

Status Byte Register

If the enabled event register is set to "1," the corresponding bit of the status byte register is also set to "1." This register also indicates the output queue and SRQ status.

The value of the status byte register can be read by using the ***STB** command on page 299 or serial poll (SPOLL statement in HTBasic) from the controller.

Reading the status byte register by using the ***STB** command does not affect the contents of the status byte register. However, reading it with the SPOLL statement of HTBasic will clear the RQS bit in the status byte register.

Also, setting the service request enable register by using the ***SRE** command on page 298 can generate a service request synchronously with the status byte register.

Condition Register and Transition Filter

When the status register has a transition filter, there is a lower register called a condition register under the event register. The transition filter is between the event register and the condition register.

The transition filter enables you to select a positive and/or negative transition of the condition register bit in order to set a bit in the corresponding event register. For example, using the negative transition filter to set bit 3 to “1” causes bit 3 of the event register to be set to “1” when bit 3 of the condition register makes a negative transition, that is, when it changes from 1 to 0.

Figure B-2

Transition filter and condition register

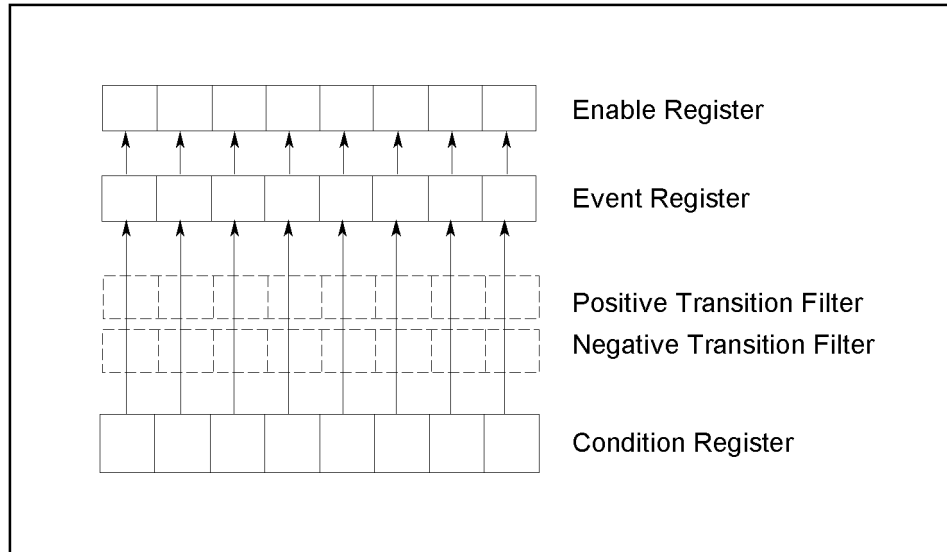

4294ape022

In the E5052A, the following registers provide a condition register and transition filter:

- Operation status register
- Operation user defined status register
- Questionable status register

Status Register Structure

The status reporting system has a hierarchical structure as shown in Figure B-3, Figure B-4 and Figure B-5. The status byte register is a summary of registers in the lower level. This section describes the E5052A's status registers in each hierarchy. Each bit of the status register is described in Table B-1 through Table B-10.

Status Reporting System Status Register Structure

Figure B-3 Status register structure (1 of 6)

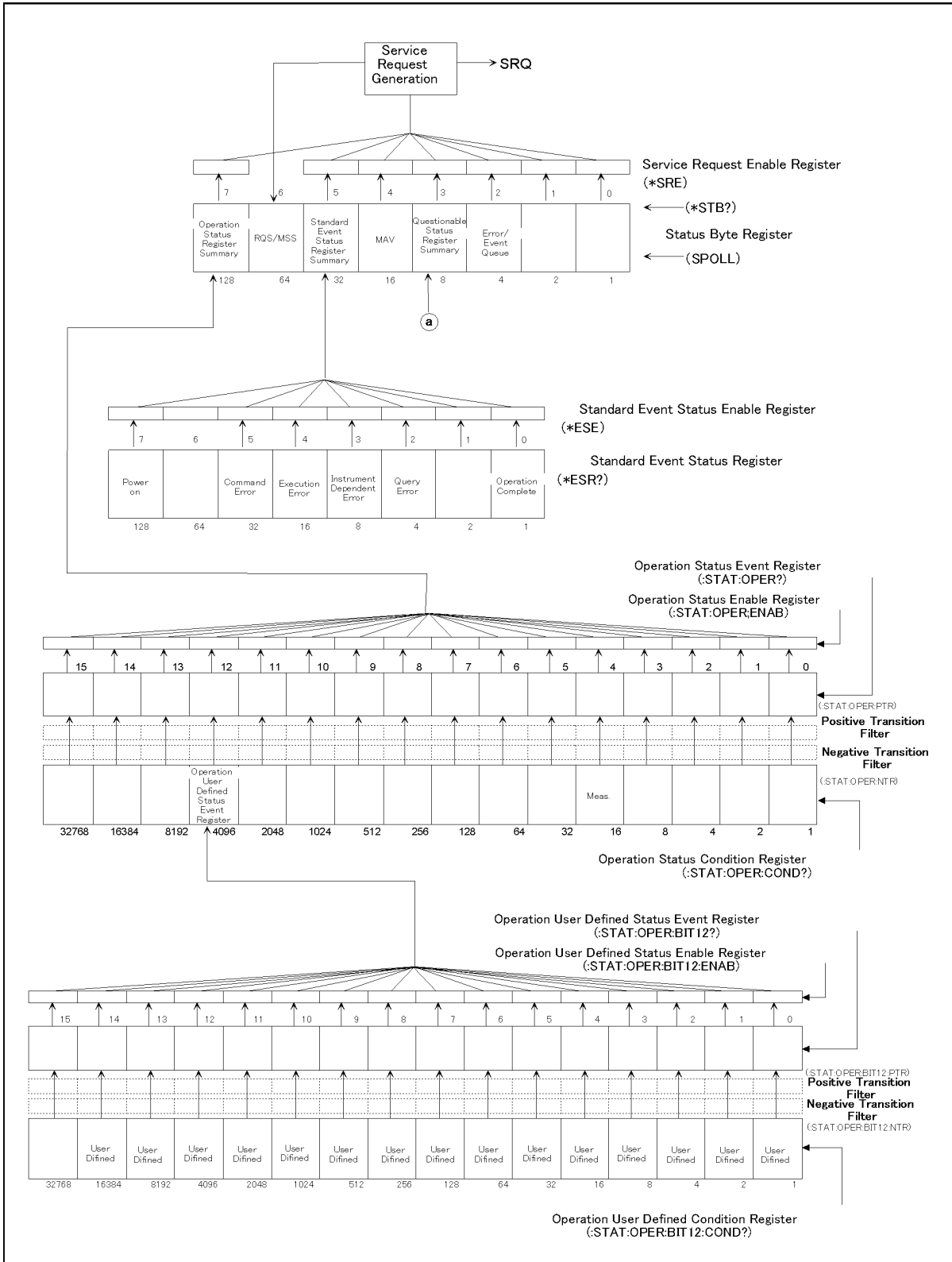

e5052ape007

Figure B-4 Status register structure (2 of 6)

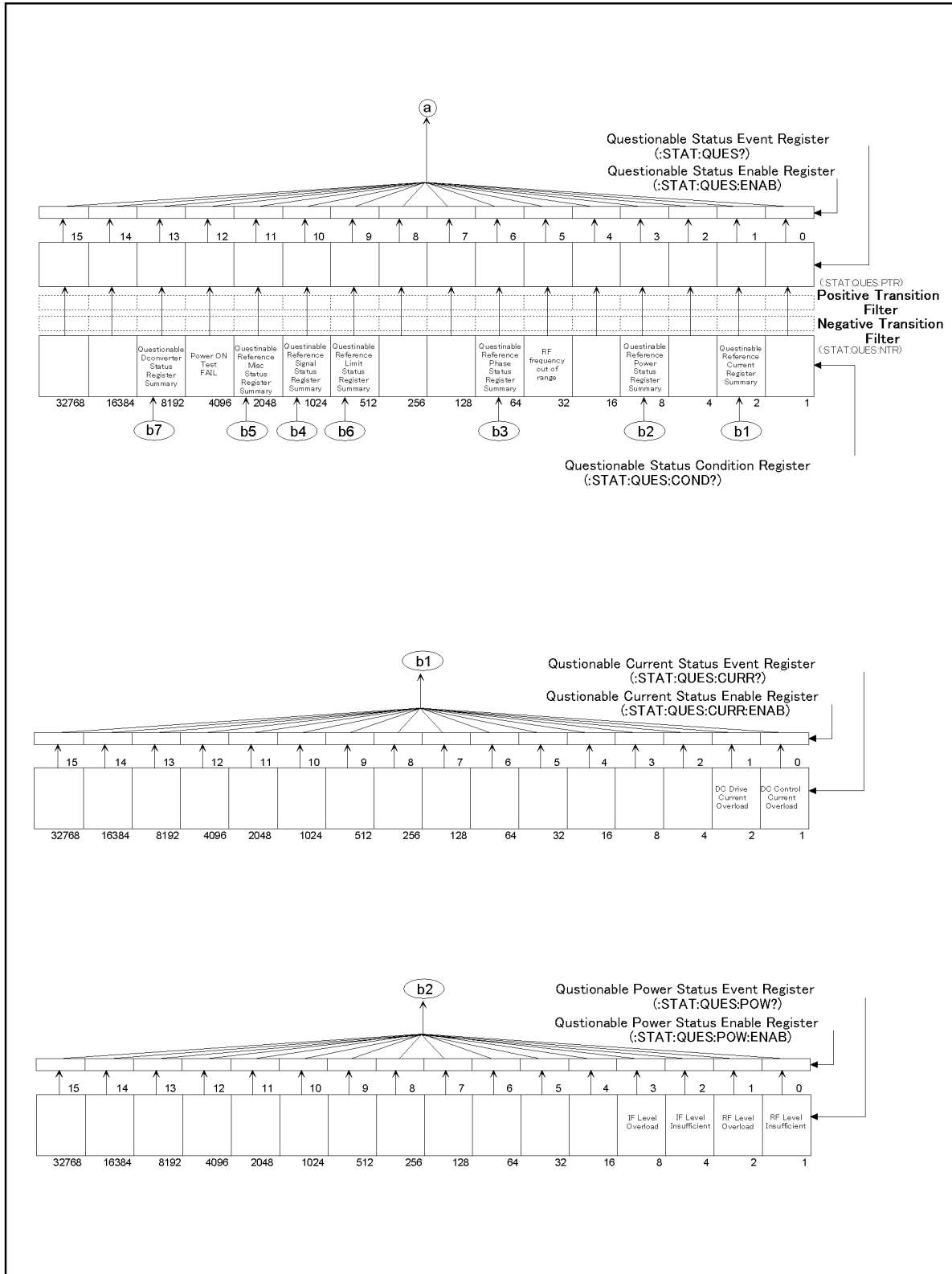

e5052ape4004

Status Reporting System
 Status Register Structure

Figure B-5 Status register structure (3 of 6)

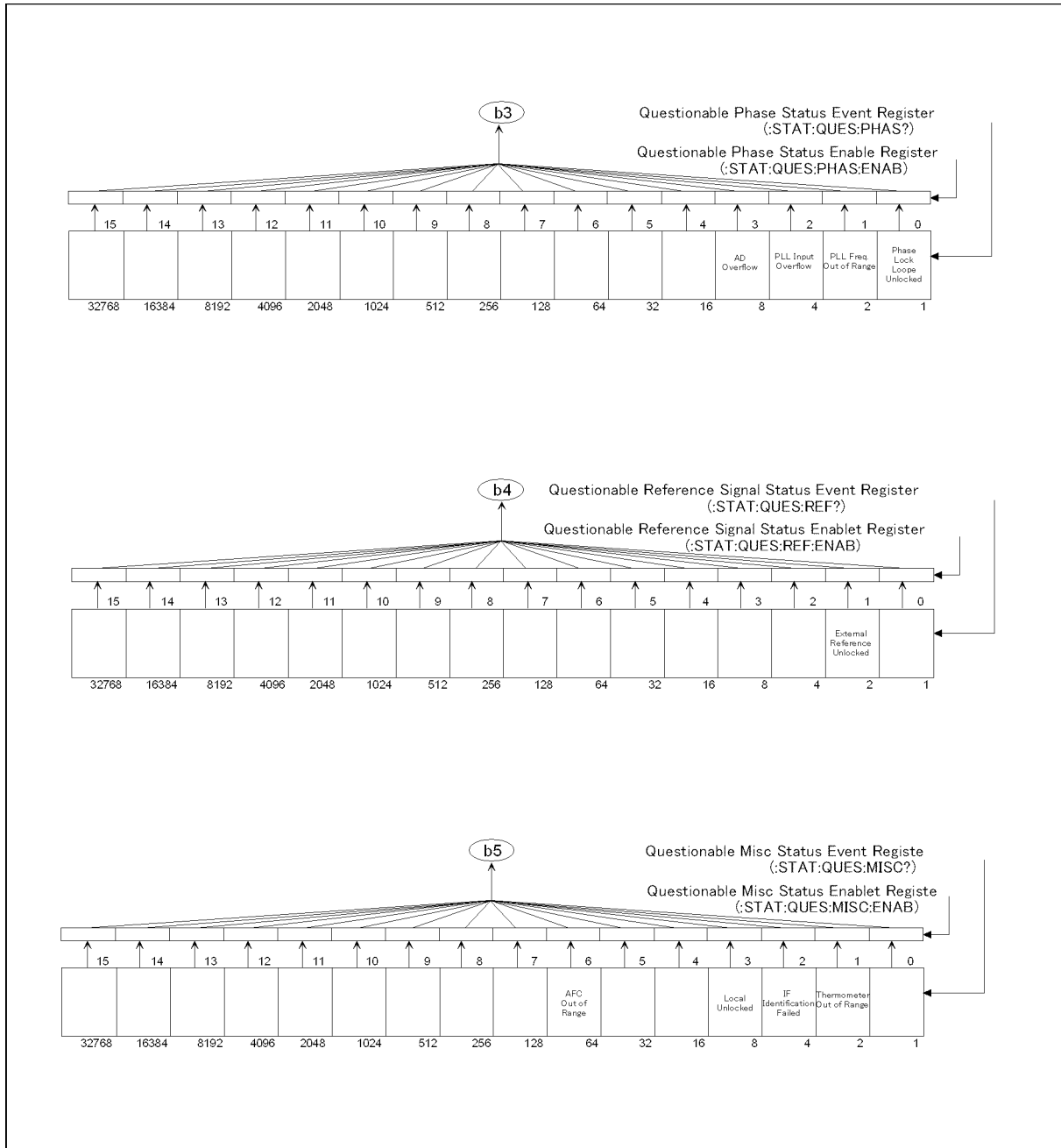

e5052ape3012

Figure B-6 Status register structure (4 of 6)

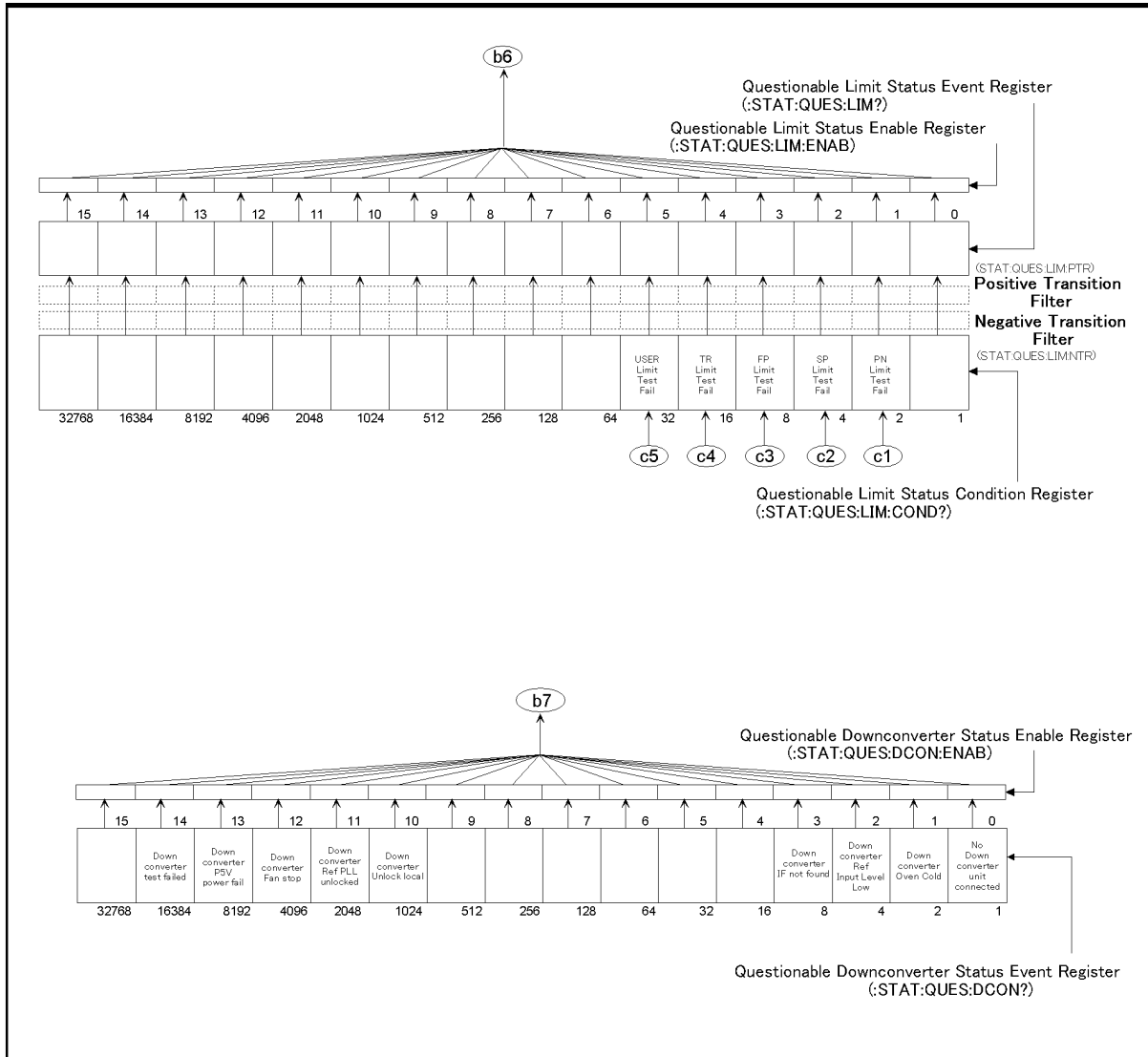

e5052ape4005

Status Reporting System
 Status Register Structure

Figure B-7 Status register structure (5 of 6)

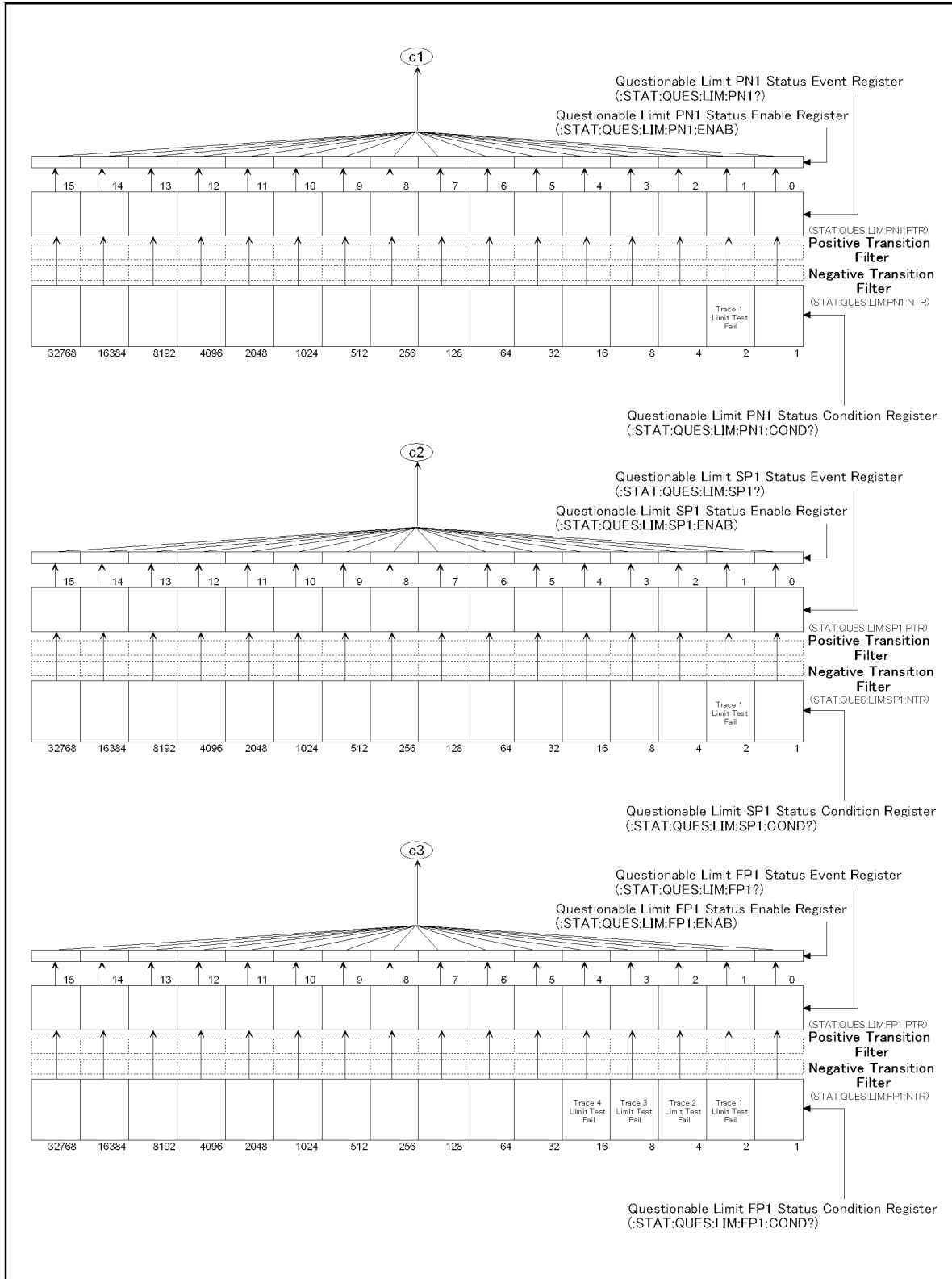

e5052ape3013

Figure B-8 Status register structure (6 of 6)

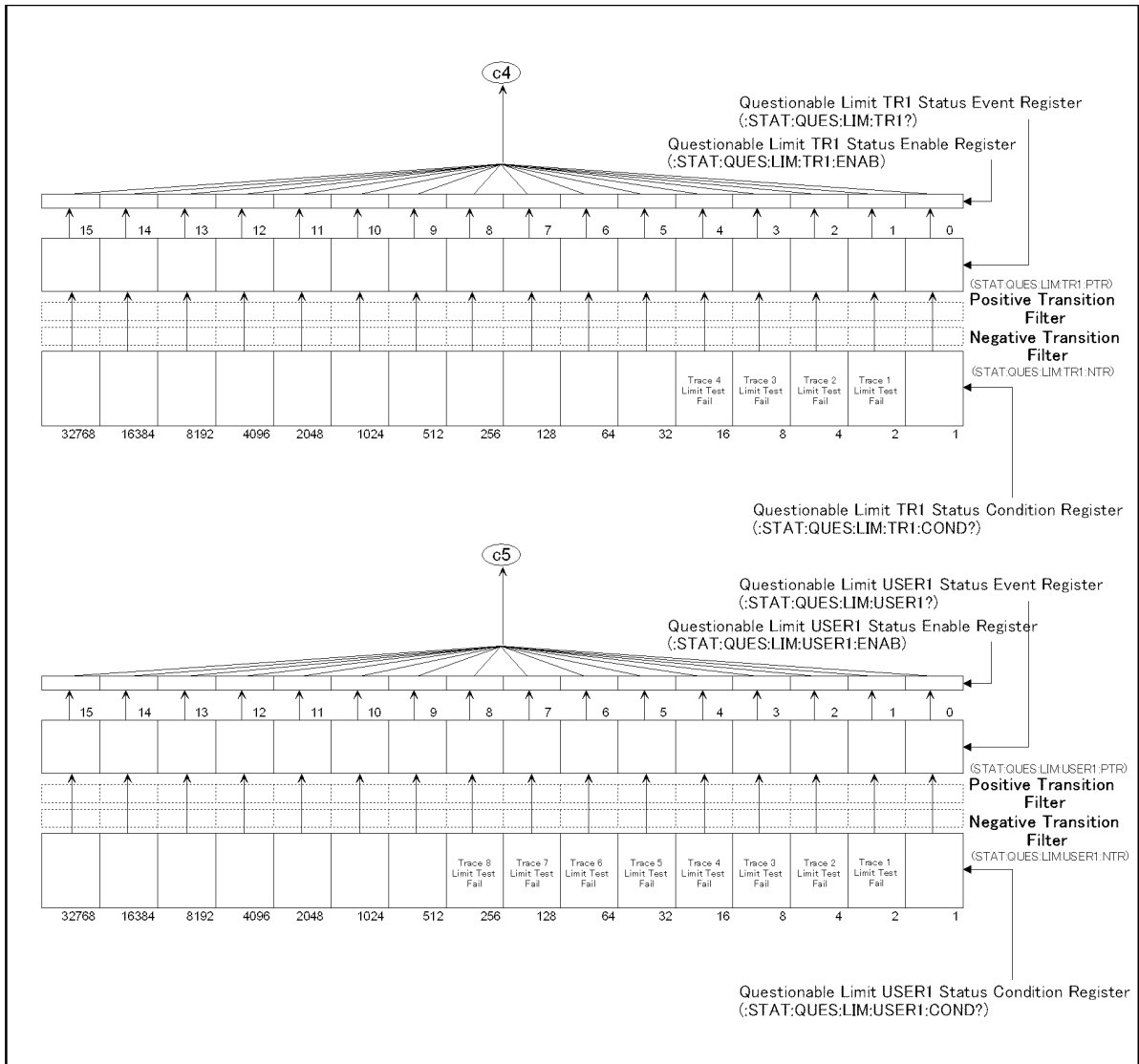

e5052ape3014

Table B-1

Status Bit Definitions of Status Byte Register

Bit Position	Name	Description
0, 1	Not used	Always 0.
2	Error/Event Queue	Set to "1" if error/event queue contains data; reset to "0" when all data has been retrieved.
3	Questionable Status Register Summary	Set to "1" when one of the enabled bits in status event status register is set to "1."
4	MAV (Message Available)	Set to "1" when output queue contains data; reset to "0" when all data has been retrieved.
5	Standard Event Status Register Summary	Set to "1" when one of the enabled bits in status event status register is set to "1."
6	RQS/MSS	Set to "1" when any of the status byte register bits enabled by service request enable register is set to "1"; reset to "0" when all data has been retrieved through serial polling. See IEEE 488.1 and IEEE 488.2 standards for details.
7	Operation Status Register Summary	Set to "1" when one of the enabled bits in operational status register is set to "1."

Issuing the ***CLS** command will clear all of the bits from the status byte register.

Table B-2

Status Bit Definitions of Standard Event Status Register (ESR)

Bit Position	Name	Description
0	Operation Complete	Always 1
1	Not used	Always 0
2	Query Error	<ol style="list-style-type: none"> Set to “1” when E5052A receives a data output request but there is no data to output. Set to “1” when the data of E5052A's output queue has been cleared for a new message received before completion of data output.
3	Instrument Dependent Error	Set to “1” for an error that is not a command, query, or execution error.
4	Execution Error	<ol style="list-style-type: none"> Set to “1” when any parameter in an SCPI command exceeds its input range or is inconsistent with E5052A's capabilities. Set to “1” when an SCPI command cannot be properly executed due to some condition of E5052A.
5	Command Error	<ol style="list-style-type: none"> Set to “1” when an IEEE 488.2 syntax error occurs (a command sent to E5052A does not follow the IEEE 488.2 syntax). Possible violations include command parameters violating E5052A listening formats or other unacceptable conditions. Set to “1” when a semantic error occurs. Possible causes include sending to E5052A a command containing misspellings or an IEEE 488.2 command not supported by E5052A. Set to “1” when GET (Group Execution Trigger) is input while receiving a program message.
6	Not used	Always 0
7	Power ON	Set to “1” when the E5052A is powered ON, or when the firmware is restarted.

Issuing the ***CLS** command will clear all of the bits from the standard event status register.

Table B-3

Status Bit Definitions of Operation Status Condition Register

Bit Position	Name	Description
0 - 3	Not used	Always 0.
4	Measurement	Set to “1” during measurement *1.
5 - 11	Not used	Always 0.
12	Operation user defined status register summary	Set to “1” when one of the enable bits in operation user defined status register is set to “1.”
13 - 15	Not used	Always 0.

*1. This is the time from the beginning of the first sweep to the end of the last sweep when several sweeps are executed for one measurement. Note that this bit is set to “1” even in the “Waiting for Trigger” state when the trigger is set to “Ext/Video” in the transient measurement. This is because pre-triggering is performed in “Waiting for Trigger” state in the transient measurement.

Issuing the ***CLS** command will clear all bits from the operation status event register.

Table B-4

Status Bit Definitions of Operation User Defined Status Condition Register

Bit Position	Name	Description
0 - 14	Defined by the user	Set to “1” as defined by the user.
15	Not used	Always 0.

The user-defined bits (0 to 14) can be specified by the user as required and are not used by the E5052A.

Table B-5

Status Bit Definitions of Questionable Status Condition Register

Bit Position	Name	Description
0	Not used	Always 0.
1	Questionable Current Status Register Summary	Set to "1" when one of the enable bits in questionable current status register is set to "1."
2	Not used	Always 0.
3	Questionable Power Status Register Summary	Set to "1" when one of the enable bits in questionable power status register is set to "1."
4	Not used	Always 0.
5	RF frequency out of range	Set to "1" when DUT's oscillation frequency is out of E5052A's measurement range. In this case, DUT's oscillation frequency should be verified.
6	Questionable Phase Status Register Summary	Set to "1" when one of the enable bits in the questionable phase status register is set to "1."
7 - 8	Not used	Always 0.
9	Questionable Limit Status Register Summary	Set to "1" when one of the enable bits in the questionable limit status register is set to "1."
10	Questionable Reference Signal Status Register Summary	Set to "1" when one of the enable bits in the questionable reference signal status register is set to "1."
11	Questionable Misc Status Register Summary	Set to "1" when one of the enable bits in the questionable misc. status register is set to "1."
12	Power-on Test FAIL	Set to "1" when the power-on self test results in "FAIL."
13 - 15	Not used	Always 0.

Issuing the ***CLS** command will clear all of the bits from the questionable status condition register.

Table B-6 Status Bit Definitions of Questionable Current Status Event Register

Bit Position	Name	Description
0	DC Control Current Overloaded	Set to "1" when excessive DC control current is loaded.
1	DC Power Current Overloaded	Set to "1" when excessive DC power current is loaded.
2-15	Not used	Always 0.

Issuing the ***CLS** command will clear all of the bits from the questionable current status event register.

Table B-7 Status Bit Definitions of Questionable Power Status Event Register

Bit Position	Name	Description
0	RF Level Insufficient	Set to "1" when an insufficient level of RF input is applied.
1	RF Level Overloaded	Set to "1" when an excessive level of RF input is applied.
2	Insufficient IF Level	Set to "1" when an insufficient level of RF input is applied.
3	IF Level Overloaded	Set to "1" when an excessive level of IF input is applied.
4-15	Not used	Always 0.

Issuing the ***CLS** command will clear all of the bits in the questionable power status event register.

Table B-8 Status Bit Definitions of Questionable Phase Status Event Register

Bit Position	Name	Description
0	Phase Lock Loop Unlocked	Set to "1" when Phase Lock Loop is not locked.
1	PLL Frequency Out of Range	Set to "1" when PLL frequency is out of E5052A's measurement range.
2	PLL Input Overflow	Set to "1" when PLL input overflows.
3	A/D Overflow	Set to "1" when signal level saturates at A/D.
4-15	Not used	Always 0.

Issuing the ***CLS** command will clear all of the bits in the questionable phase status event register.

Table B-9 Status Bit Definitions of Questionable Reference Signal Status Event Register

Bit Position	Name	Description
0	Not used	Always 0.
1	External Reference Unlock	Set to “1” when external reference is not locked.
2-15	Not used	Always 0.

Issuing the ***CLS** command will clear all of the bits in the questionable reference signal status event register.

Table B-10 Status Bit Definitions of Questionable Misc Status Event Register

Bit Position	Name	Description
0	Not used	Always 0.
1	Thermometer Out of Range	Set to “1” when thermometer is out of range.
2	IF not Detected	Set to “1” when IF is not detected.
3	Local Unlock	Set to “1” when local oscillator is unlocked.
4-5	Not used	Always 0
6	AFC Out of Loop	Set to “1” when an AFC out of loop error is applied.
7-15	Not used	Always 0.

Issuing the ***CLS** command will clear all of the bits in the questionable misc status event register.

Table B-11 Status Bit Definitions of Questionable Limit Status Event Register

Bit Position	Name	Description
0	Not used	Always 0.
1	Questionable Limit PN1 Status Register Summary	Set to “1” when one of the enable bits in questionable limit PN1 status register is set to “1.”
2	Questionable Limit SP1 Status Register Summary	Set to “1” when one of the enable bits in questionable limit SP1 status register is set to “1.”
3	Questionable Limit FP1 Status Register Summary	Set to “1” when one of the enable bits in questionable limit FP1 status register is set to “1.”
4	Questionable Limit TR1 Status Register Summary	Set to “1” when one of the enable bits in questionable limit TR1 status register is set to “1.”
5	Questionable Limit USER1 Status Register Summary	Set to “1” when one of the enable bits in questionable limit USER1 status register is set to “1.”
6-15	Not used	Always 0.

Issuing the ***CLS** command will clear all of the bits in the questionable limit status event

register.

Table B-12 Status Bit Definitions of Questionable Limit PN1 Status Event Register

Bit Position	Name	Description
0	Not used	Always 0.
1	Trace 1 Limit Test Fail	Set to “0” when a measurement cycle begins; set to “1” when the measurement cycle finishes and returns “fail” as the limit test result for trace 1.
2-15	Not used	Always 0.

Issuing the ***CLS** command will clear all of the bits in the questionable limit PN1 status event register.

Table B-13 Status Bit Definitions of Questionable Limit SP1 Status Event Register

Bit Position	Name	Description
0	Not used	Always 0.
1	Trace 1 Limit Test Fail	Set to “0” when a measurement cycle begins; set to “1” when the measurement cycle finishes and returns “fail” as the limit test result for trace 1.
2-15	Not used	Always 0.

Issuing the ***CLS** command will clear all of the bits in the questionable limit SP1 status event register.

Table B-14 Status Bit Definitions of Questionable Limit FP1 Status Event Register

Bit Position	Name	Description
0	Not used	Always 0.
1	Trace 1 Limit Test Fail	Set to “0” when a measurement cycle begins; after a measurement cycle begins, and when “fail” is returned for trace 1, “1” will be set.
2	Trace 2 Limit Test Fail	Set to “0” when a measurement cycle begins; after a measurement cycle begins, and when “fail” is returned for trace 2, “1” will be set.
3	Trace 3 Limit Test Fail	Set to “0” when a measurement cycle begins; after a measurement cycle begins, and when “fail” is returned for trace 3, “1” will be set.
4	Trace 4 Limit Test Fail	Set to “0” when a measurement cycle begins; after a measurement cycle begins, and when “fail” is returned for trace 4, “1” will be set.
5-15	Not used	Always 0.

Issuing the ***CLS** command will clear all of the bits in the questionable limit FP1 status

event register.

Table B-15 Status Bit Definitions of Questionable Limit TR1 Status Event Register

Bit Position	Name	Description
0	Not used	Always 0.
1	Trace 1 Limit Test Fail	Set to “0” when a measurement cycle begins; set to “1” when the measurement cycle finishes and returns “fail” as the limit test result for trace 1.
2	Trace 2 Limit Test Fail	Set to “0” when a measurement cycle begins; set to “1” when the measurement cycle finishes and returns “fail” as the limit test result for trace 2.
3	Trace 3 Limit Test Fail	Set to “0” when a measurement cycle begins; set to “1” when the measurement cycle finishes and returns “fail” as the limit test result for trace 3.
4	Trace 4 Limit Test Fail	Set to “0” when a measurement cycle begins; set to “1” when the measurement cycle finishes and returns “fail” as the limit test result for trace 4.
5-15	Not used	Always 0.

Issuing the ***CLS** command will clear all of the bits in the questionable limit TR1 status event register.

Table B-16 Status Bit Definitions of Questionable Limit USER1 Status Event Register

Bit Position	Name	Description
0	Not used	Always 0.
1	Trace 1 Limit Test Fail	Set to “0” when a measurement cycle begins; set to “1” when the measurement cycle finishes and returns “fail” as the limit test result for trace 1.
2	Trace 2 Limit Test Fail	Set to “0” when a measurement cycle begins; set to “1” when the measurement cycle finishes and returns “fail” as the limit test result for trace 2.
3	Trace 3 Limit Test Fail	Set to “0” when a measurement cycle begins; set to “1” when the measurement cycle finishes and returns “fail” as the limit test result for trace 3.
4	Trace 4 Limit Test Fail	Set to “0” when a measurement cycle begins; set to “1” when the measurement cycle finishes and returns “fail” as the limit test result for trace 4.
5	Trace 5 Limit Test Fail	Set to “0” when a measurement cycle begins; set to “1” when the measurement cycle finishes and returns “fail” as the limit test result for trace 5.
6	Trace 6 Limit Test Fail	Set to “0” when a measurement cycle begins; set to “1” when the measurement cycle finishes and returns “fail” as the limit test result for trace 6.
7	Trace 7 Limit Test Fail	Set to “0” when a measurement cycle begins; set to “1” when the measurement cycle finishes and returns “fail” as the limit test result for trace 7.
8	Trace 8 Limit Test Fail	Set to “0” when a measurement cycle begins; set to “1” when the measurement cycle finishes and returns “fail” as the limit test result for trace 8.

Table B-16 Status Bit Definitions of Questionable Limit USER1 Status Event Register

Bit Position	Name	Description
9-15	Not used	Always 0.

Issuing the ***CLS** command will clear all of the bits in the questionable limit USER1 status event register.

Table B-17 Status Bit Definitions of Questionable Downconverter Status Event Register

Bit Position	Name	Description
0	Downconverter not connected	Set to 1 when connection to the downconverter is not detected.
1	Downconverter Oven not ready	Set to 1 when the oven is not ready.
2	Downconverter Ref Input Level Low	Set to 1 when the 10-MHz reference signal level is low.
3	Downconverter IF not found	Set to 1 when the downconverter IF is not found.
4-9	Not used	Always 0.
10	Downconverter unlocked	Set to 1 when the downconverter cannot be locked.
11	Downconverter Ref PLL unlocked	Set to 1 when the PLL circuit of the downconverter is unlocked during measurement.
12	Downconverter Fan Stop	Set to 1 when the fan in the downconverter stops.
13	Downconverter P5V power failure	Set to 1 when the 5-V power to the downconverter fails.
14	Downconverter test failed	Set to 1 when the self-test of the downconverter fails.
15	Not used	Always 0.

Issuing the ***CLS** command will clear all of the bits in the questionable limit USER1 status event register.

Using the Status Reporting System

You can manage the status report system by using the following commands in any combination:

- *CLS on page 297
- *SRE on page 298
- *STB on page 299
- *ESE on page 297
- *ESR on page 297
- :STATus:OPERation:BIT12:CLEAr on page 372
- :STATus:OPERation:BIT12:CONDition on page 372
- :STATus:OPERation:BIT12:ENABle on page 373
- :STATus:OPERation:BIT12[:EVENT] on page 373
- :STATus:OPERation:BIT12:NTRansition on page 373
- :STATus:OPERation:BIT12:PTRansition on page 374
- :STATus:OPERation:BIT12:SET on page 374
- :STATus:OPERation:CONDition on page 374
- :STATus:OPERation:ENABle on page 375
- :STATus:OPERation[:EVENT] on page 375
- :STATus:OPERation:NTRansition on page 375
- :STATus:OPERation:PTRansition on page 376
- :STATus:PRESet on page 376
- :STATus:QUEStionable:CONDition on page 376
- :STATus:QUEStionable:CURRent:ENABle on page 376
- :STATus:QUEStionable:CURRent[:EVENT] on page 377
- :STATus:QUEStionable:DCONverter:ENABle on page 377
- :STATus:QUEStionable:DCONverter[:EVENT] on page 377
- :STATus:QUEStionable:ENABle on page 377
- :STATus:QUEStionable[:EVENT] on page 378
- :STATus:QUEStionable:LIMit:CONDition on page 378
- :STATus:QUEStionable:LIMit:ENABle on page 378
- :STATus:QUEStionable:LIMit[:EVENT] on page 379
- :STATus:QUEStionable:LIMit:FP[1-1]:CONDition on page 379
- :STATus:QUEStionable:LIMit:FP[1-1]:ENABle on page 379
- :STATus:QUEStionable:LIMit:FP[1-1][:EVENT] on page 379
- :STATus:QUEStionable:LIMit:FP[1-1]:NTRansition on page 379
- :STATus:QUEStionable:LIMit:FP[1-1]:PTRansition on page 380
- :STATus:QUEStionable:LIMit:NTRansition on page 380
- :STATus:QUEStionable:LIMit:PN[1-1]:CONDition on page 381
- :STATus:QUEStionable:LIMit:PN[1-1]:ENABle on page 381
- :STATus:QUEStionable:LIMit:PN[1-1][:EVENT] on page 381
- :STATus:QUEStionable:LIMit:PN[1-1]:NTRansition on page 381
- :STATus:QUEStionable:LIMit:PN[1-1]:PTRansition on page 382
- :STATus:QUEStionable:LIMit:PTRansition on page 382
- :STATus:QUEStionable:LIMit:SP[1-1]:CONDition on page 383
- :STATus:QUEStionable:LIMit:SP[1-1]:ENABle on page 383
- :STATus:QUEStionable:LIMit:SP[1-1][:EVENT] on page 383
- :STATus:QUEStionable:LIMit:SP[1-1]:NTRansition on page 383
- :STATus:QUEStionable:LIMit:SP[1-1]:PTRansition on page 384
- :STATus:QUEStionable:LIMit:TR[1-1]:CONDition on page 384

Status Reporting System

Using the Status Reporting System

- :STATus:QUESTionable:LIMit:TR[1-1]:ENABLE on page 384
- :STATus:QUESTionable:LIMit:TR[1-1][:EVENT] on page 385
- :STATus:QUESTionable:LIMit:TR[1-1]:NTRansition on page 385
- :STATus:QUESTionable:LIMit:TR[1-1]:PTRansition on page 385
- :STATus:QUESTionable:LIMit:USER[1-1]:CONDition on page 386
- :STATus:QUESTionable:LIMit:USER[1-1]:ENABLE on page 386
- :STATus:QUESTionable:LIMit:USER[1-1][:EVENT] on page 386
- :STATus:QUESTionable:LIMit:USER[1-1]:NTRansition on page 387
- :STATus:QUESTionable:LIMit:USER[1-1]:PTRansition on page 387
- :STATus:QUESTionable:MISC:ENABLE on page 387
- :STATus:QUESTionable:MISC[:EVENT] on page 388
- :STATus:QUESTionable:NTRansition on page 388
- :STATus:QUESTionable:PHASe:ENABLE on page 388
- :STATus:QUESTionable:PHASe[:EVENT] on page 389
- :STATus:QUESTionable:POWER:ENABLE on page 389
- :STATus:QUESTionable:POWER[:EVENT] on page 389
- :STATus:QUESTionable:PTRansition on page 390
- :STATus:QUESTionable:REFERence:ENABLE on page 390
- :STATus:QUESTionable:REFERence[:EVENT] on page 390

For sample programs that demonstrate the use of the commands listed above, refer to “Using the Status Register” on page 60 in Chapter 3.

C

Communication with External Instruments Using 24-bit I/O Port

This chapter provides necessary information for communicating with external instruments (for example, a handler in a production line) by using the 24-bit I/O port equipped with the Agilent E5052A.

24-bit I/O Port Overview

The E5052A 24-bit I/O port provides four independent parallel ports for data I/O associated with several control signal lines and the power line. All signals operate in TTL logic.

The data I/O ports are configured with 2 pairs of 8-bit output ports and 2 pairs of 4-bit bi-directional ports. Furthermore, these ports can cooperate to provide a maximum 16-bit-wide output port or a maximum 8-bit-wide input port.

The I/O signals operate on a negative logic basis. The control signal lines consist of various control output data, including completion of measurement or control signal for handshaking. Figure C-1 outlines the I/O ports and control signal lines.

Figure C-1

24-bit I/O port outline

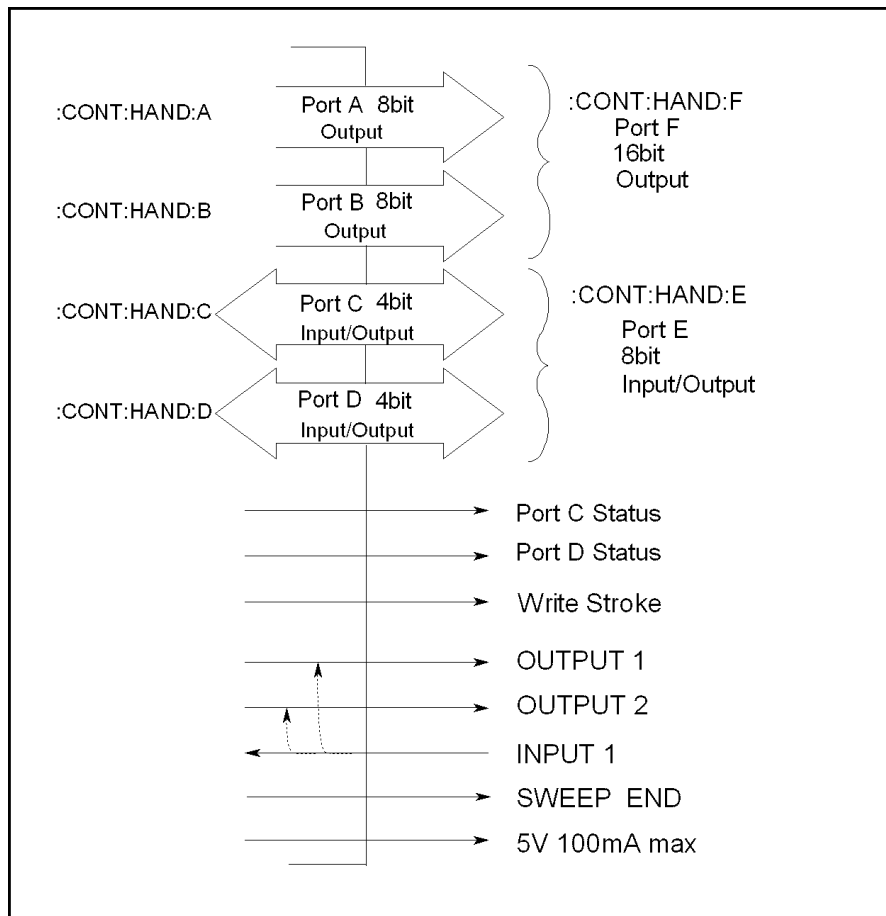

e5052ape001

I/O Signal Pin Layout and Description

Figure A-2 illustrates the layout of the I/O signal pins on the 24-bit interface connector, and Table C-1 on page 540 briefly describes these signals.

Figure C-2

24-bit interface connector pin layout

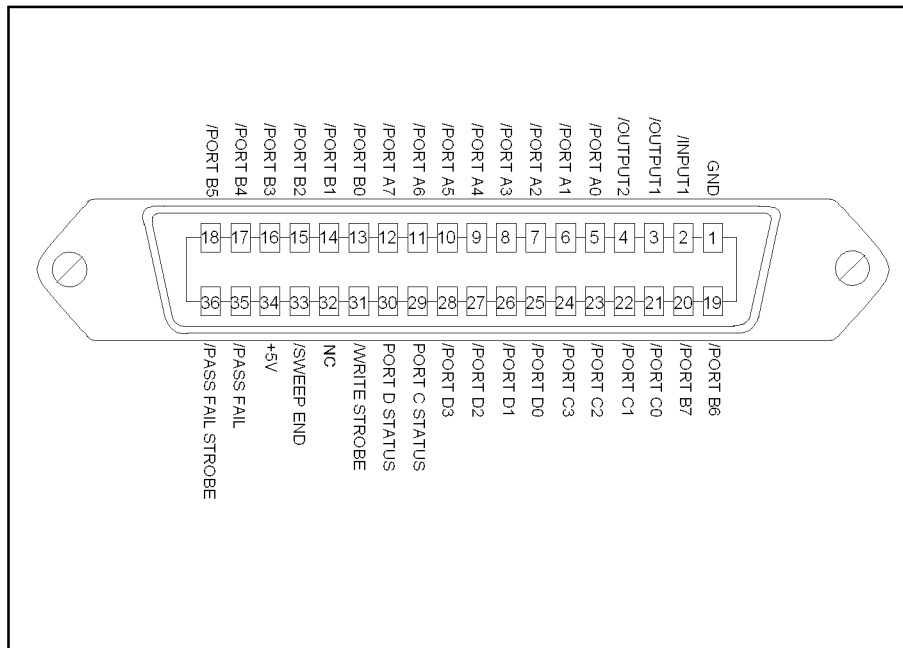

e5052apj3010

NOTE A slash (/) symbol preceding signal names means that they are negative logic (active low).

Communication with External Instruments Using 24-bit I/O Port
I/O Signal Pin Layout and Description

Table C-1 Description of the 24-bit Interface I/O Signals

Pin number	Signal name	Signal direction	Description
1	GND	—	Ground
2	/INPUT1	Input	When this port receives a negative pulse, /OUTPUT1 and /OUTPUT2 are changed to the Low level.
3	/OUTPUT1	Output	Changes to the Low level when /INPUT1 receives a negative pulse. A command is available for altering the Low/High level logic.
4	/OUTPUT2	Output	Changes to the Low level when /INPUT1 receives a negative pulse. A command is available for altering the Low/High level logic.
5	/PORT A0	Output	Bit 0 of the port A (8-bit parallel output port)
6	/PORT A1	Output	Bit 1 of the port A
7	/PORT A2	Output	Bit 2 of the port A
8	/PORT A3	Output	Bit 3 of the port A
9	/PORT A4	Output	Bit 4 of the port A
10	/PORT A5	Output	Bit 5 of the port A
11	/PORT A6	Output	Bit 6 of the port A
12	/PORT A7	Output	Bit 7 of the port A
13	/PORT B0	Output	Bit 0 of the port B (8-bit parallel output port)
14	/PORT B1	Output	Bit 1 of the port B
15	/PORT B2	Output	Bit 2 of the port B
16	/PORT B3	Output	Bit 3 of the port B
17	/PORT B4	Output	Bit 4 of the port B
18	/PORT B5	Output	Bit 5 of the port B
19	/PORT B6	Output	Bit 6 of the port B
20	/PORT B7	Output	Bit 7 of the port B
21	/PORT C0	Input/Output	Bit 0 of the port C (4-bit parallel I/O port)
22	/PORT C1	Input/Output	Bit 1 of the port C
23	/PORT C2	Input/Output	Bit 2 of the port C
24	/PORT C3	Input/Output	Bit 3 of the port C
25	/PORT D0	Input/Output	Bit 0 of the port D (4-bit parallel I/O port)
26	/PORT D1	Input/Output	Bit 1 of the port D
27	/PORT D2	Input/Output	Bit 2 of the port D
28	/PORT D3	Input/Output	Bit 3 of the port D

Table C-1 Description of the 24-bit Interface I/O Signals

Pin number	Signal name	Signal direction	Description
29	PORT C STATUS	Output	Port C status signal. This signal is changed to the High level when port C is configured to output port. It is changed to the Low level when the port is configured to input port.
30	PORT D STATUS	Output	Port D status signal. This signal is changed to the High level when port D is configured to output port. It is changed to the Low level when the port is configured to input port.
31	/WRITE STROBE	Output	A output port write strobe signal. When data is present (that is, output level changes) on any of the output ports, this signal provides a negative pulse.
32	NC*1		Not used
33	/SWEEP END	Output	A sweep completion signal. When measurement (all sweeps of all channels) and data calculation are completed, this signal provides a negative pulse.
34	+5V	Output	Provides +5V DC power supply for external instruments.
35	/PASS FAIL	Output	A limit test result*2 signal. This signal is changed to the High level when limit test result is FAIL. It is changed to the Low level when limit test result is PASS.
36	/PASS FAIL STROBE	Output	Limit test result write strobe signal. When limit test result is present on /PASS FAIL, this signal provides a negative pulse.





*1. To prevent failure that may be caused based on signal I/O, do not connect anything.

*2. The overall test result that combine the test result for all traces. Note that the /PASS FAIL port outputs the limit test result in the triggered measurement mode after every sweep, therefore, you can not obtain the limit test result combining the test results in multiple measurement modes with one trigger. In case of PASS result, the limit test result signal is outputted after the sweep ends. In case of FAIL, it is outputted when the fail result is determined.

Inputting/Outputting Data

The E5052A 24-bit I/O port provides the ports for data I/O shown in Table C-2.

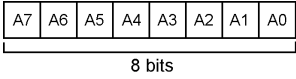
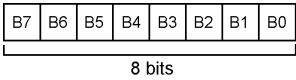
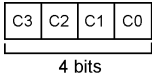
Table C-2 I/O Ports

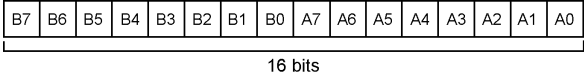
Port Name	Usage	Data Structure
Port A	Output	
Port B	Output	
Port C	Input/Output	
Port D	Input/Output	
Port E	Input/Output	
Port F	Output	

Specifying signal direction of port

Signal direction (input/output) can be changed for ports C, D, and E as shown in Table C-2. Thus, before the ports are used, the directions should be determined according to their usage.

To specify the I/O direction for ports C and D, use the following commands. The direction for port E depends on the setting of ports C and D.

Port Name	Command
Port C	:CONTRol:HANDler:C:MODE on page 234
Port D	:CONTRol:HANDler:D:MODE on page 235

Reading data input to port

When port C, D, or E is configured to input port, the binary data represented with High(0)/Low(1) of each bit of the port is read as decimal data.

To retrieve the data, use the following commands as query:

Port Name	Command
Port C	:CONTRol:HANDler:C[:DATA] on page 234
Port D	:CONTRol:HANDler:D[:DATA] on page 234
Port E	:CONTRol:HANDler:E[:DATA] on page 235

Data output to port

Binary data (decimal data when output data is specified with a command) represented with High(0)/Low(1) of each bit of the port can be output to ports A through F (ports C, D, and E should be configured to output ports).

To output data, use the following commands.

Port Name	Command
Port A	:CONTRol:HANDler:A[:DATA] on page 233
Port B	:CONTRol:HANDler:B[:DATA] on page 233
Port C	:CONTRol:HANDler:C[:DATA] on page 234
Port D	:CONTRol:HANDler:D[:DATA] on page 234
Port E	:CONTRol:HANDler:E[:DATA] on page 235
Port F	:CONTRol:HANDler:F[:DATA] on page 236

Preset States at Power-on

The 24-bit I/O port is set at power-on as follows (not affected at reset).

Port A	High (All Bits)
Port B	High (All Bits)
Port C	Input
Port D	Input
PORT C STATUS	Low
PORT D STATUS	Low
/OUTPUT1	High
/OUTPUT2	High
/SWEEP END	High
/PASS FAIL	High

Timing Chart and Pulse Width

When the formatted data calculation is completed during the sweep, a negative pulse is provided. The pulse width of the sweep completion signal is shown in Figure C-3.

Table C-3 Value of T1 in Figure C-3 (typical)

		Typical Value
T1	Pulse width of /SWEEP END	12 μ s

Figure C-3 Pulse width of /SWEEP END

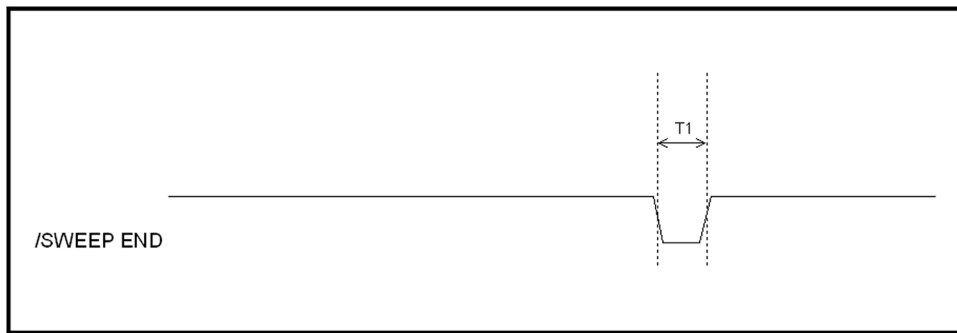

e5052apj009

Figure C-4 shows the timing chart for data output and write strobe signal output to ports A through F.

Table C-4 Values of T1 through T2 in Figure C-4 (typical)

T1	Response time of write strobe signal	1 μ s
T2	Pulse width of write strobe signal	1 μ s

Figure C-4 Timing chart of data output and write strobe signal

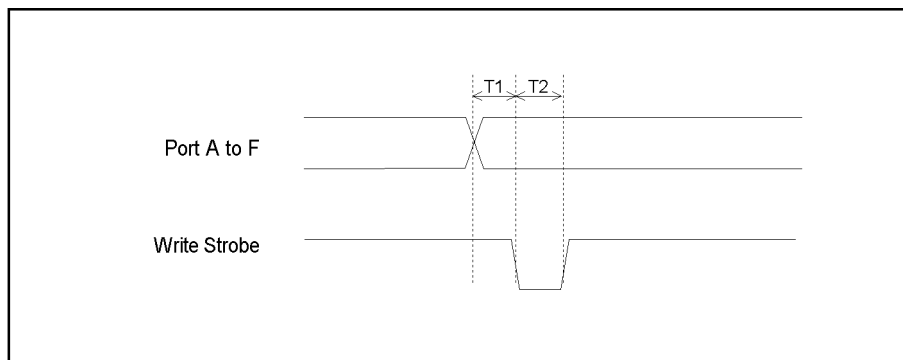

e5070ape010

Communication with External Instruments Using 24-bit I/O Port
Timing Chart and Pulse Width

Figure C-5 shows a timing chart of the pulse input to INPUT1, /OUTPUT1 signal output and /OUTPUT2 signal output.

Table C-5 Values of T1 through T2 in Figure C-5 (typical)

		Minimum value
T1	Pulse width of /INPUT1	1 μ s
T2	Response time of /OUTPUT1, /OUTPUT2	0.5 μ s

Figure C-5 Timing chart of /INPUT1 and /OUTPUT1, /OUTPUT2

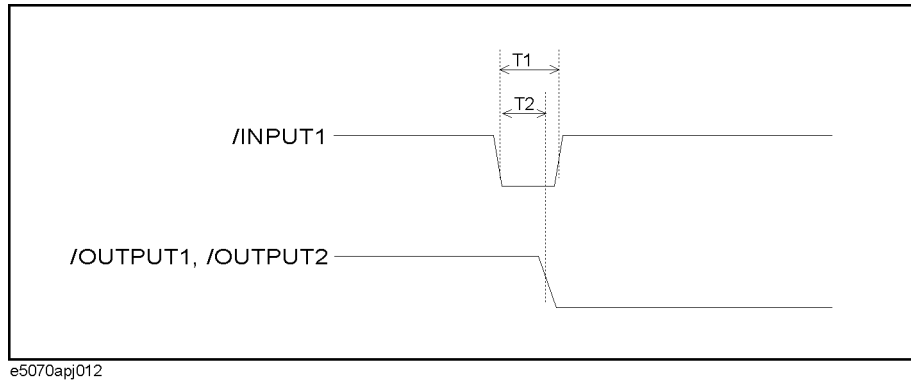
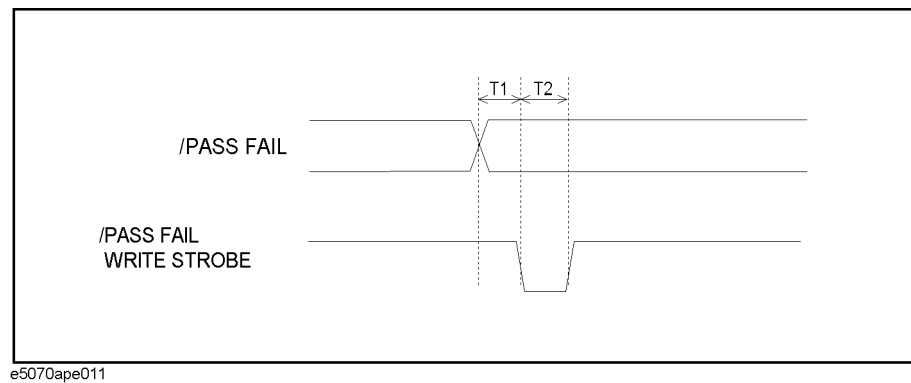

Figure C-6 shows a timing chart of limit test result output (/PASS FAIL signal output) and /PASS FAIL write strobe signal output.

Table C-6 Values of T1 through T2 in Figure C-6 (typical)

T1	Response time of /PASS FAIL write strobe	1 μ s
T2	Pulse width of /PASS FAIL write strobe	1 μ s

Figure C-6 Timing chart of data output and write strobe signal



Electrical Characteristics

Input signal

All input signals are TTL compatible. Table C-7 shows the electrical characteristics of the input signals, and Figure C-7 shows the circuit diagram of the input signals.

Table C-7 Electrical Characteristics of Input Signals (typical)

Maximum rate input voltage		-0.5 V to 5.5 V
Input voltage	High level	2.0 V to 5.0 V
	Low level	0 V to 0.5 V

Figure C-7 Circuit diagram of input signals

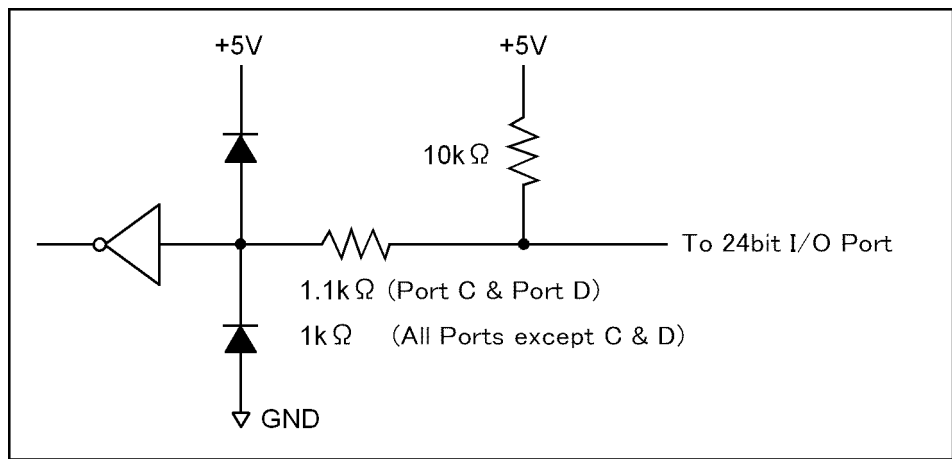

e5052ape002

Output signal

All output signals are TTL compatible. Table C-8 shows the electrical characteristics of output signals, and Figure C-8 shows the circuit diagram of the output signals.

Table C-8 Electrical Characteristics Of Output Signals (typical)

Maximum rate output current		-10 mA to 10 mA
Output current	High level	-5 mA
	Low level	-5 mA
Output voltage	High level	2.0 V to 3.3 V (when output current is -5 mA to 0 mA) 3.20 V (when output current is -1 mA) 2.75 V (when output current is -5 mA)
	Low level	0 V to 0.8 V (when output current is 0 mA to 3 mA) 0.25 V ^{*1} (when output current is 1 mA) 0.55 V (when output current is 3 mA)

*1. Note that, in the cases of C0 to C3 (port C) and D0 to D3 (port D), output voltage is 0.30 V.

Figure C-8 Circuit diagram of output signals

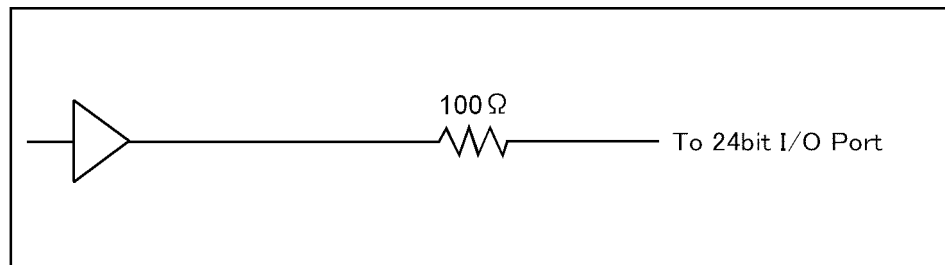

Power supply (+5 V)

Table C-9 shows the electrical characteristics of the +5 V power supply for external instruments.

Table C-9 Electrical Characteristics of +5 V Power Supply (typical)

Output voltage	4.5 V to 5.5 V
Maximum output current	100 mA

D **Error Messages**

The Agilent E5052A provides error messages to indicate its operating status. This appendix describes the error messages of the E5052A, listed in alphabetical order.

Error Messages

An error message is displayed against a red background in the instrument message/warning area in the lower-left part of the screen. Touching Entry Off key at the front panel or executing the :DISPlay:MESSAge:CLEAr command on page 254 clears the error message. Moreover, about a specific error message, when a sweep is started again, the display of an error message may disappear. Errors caused by operation of a front panel key simply appear on the display; with a few exceptions, these are not stored in the error queue.

The log of an error message, a maximum of 100 pieces are recorded, and it can go back and check from the newest error. The following procedures perform the procedure of elimination of an error check and an error log. This operation can be performed only from a front panel. It cannot be operated by the "SCPI" command.

[System] - Service Menu - Error Log - View Error Log

[System] - Service Menu - Error Log - Clear Error Log

An error with a positive error number is one uniquely defined for this instrument. On the other hand, an error with a negative error number is basically one defined for common GPIB devices in IEEE488.2

A

120

AFC Failed

This error message appears when the Automatic frequency control function could not follow the fluctuation in the measurement condition or automatic frequency control function was set on, however, the power or control voltage is not being applied to the DUT. For the corrective actions, refer to the error message "AFC out of loop" and the warning message "DC output on required in AFC".

330

AFC out of loop

The Automatic frequency control function could not follow the fluctuation in the measurement condition, and did not converge on the target frequency. Possible problems and corrective action are shown below.

- Press **DC Control** - **Auto Freq Control - Sensitivity** to specify a proper tuning sensitivity.
- Press **DC Control** - **Auto Freq Control - Max Iteration** to specify a value larger than the current setting.
- Press **DC Control** - **Auto Freq Control - Max Ctrl Voltage Limit** to specify a maximum value larger than the current setting. Be careful not to set a value that exceeds the DUT's maximum acceptable value.
- Press **DC Control** - **DC control Delay** to specify a value larger than the current setting.

51

A21 flash ROM write error

This error occurs when writing the system calibration data to ROM on the A21 board fails. Contact Agilent Technologies' Customer Contact given at the end of this guide or the company from which you bought the device.

D

- 222 **Data out of range**
- A data element (not violating the standard) outside the range defined by this instrument has been received. This error occurs, for example, when an integer-based command for which the parameter can be rounded exceeds the range of -65536 to +65536 or when a real-number-based command for which the parameter can be rounded exceeds the range of -9.9e37 to +9.9e37.
- 280 **DC control overload**
- The current through the DC CONTROL connector is too large.
- 270 **DC power overload**
- The current through the DC POWER connector is too large.
- 373 **Downconverter Fan Stop**
- This error occurs when the fan of the downconverter stops. Contact Agilent Technologies' Customer Contact given at the end of this guide or the company from which you bought the device.
- 354 **Downconverter IF not found**
- This error occurs when the down-converted signal does not fall into the expected IF range. The deviation between the set nominal frequency and the actual input signal's frequency may be too large. Execute the carrier search function, and set a correct nominal frequency.
- 352 **Downconverter Oven Cold**
- This error may occur due to the unlocked PLL because the oven is not heated sufficiently for some time after the downconverter is turned on. Heat the oven for some time with the power on.
- 374 **Downconverter P5V power fail**
- This error occurs when the 5-V power of the downconverter fails. A device failure is suspected. Contact Agilent Technologies' Customer Contact given at the end of this guide or the company from which you bought the device.
- 353 **Downconverter Ref Input Level Low**
- This error occurs when the level of the 10-MHz reference signal to the downconverter is low.
- 372 **Downconverter Ref PLL unlocked**
- This error occurs when the PLL circuit of the downconverter is unlocked during measurement. This error may occur when the carrier frequency of the measurement sample is unstable.
- It may occur also due to the same reason as "Downconverter Oven Cold."
- 375 **Downconverter test failed**
- This error occurs when the self-test of the downconverter fails. A device failure is suspected. Contact Agilent Technologies' Customer Contact given at the end of this guide or the company from which you bought the device.
- 371 **Downconverter Unlock local**
- This error occurs when the local of the downconverter cannot be locked. A device failure is

Error Messages

Error number: -200

suspected. Contact Agilent Technologies' Customer Contact given at the end of this guide or the company from which you bought the device.

E

-200

Execution error

An error associated with execution has been generated for which this instrument cannot specify the error message. This code shows the occurrence of an error associated with execution, as defined in 11.5.1.1.5, IEEE488.2.

F

72

Failed to copy file

This error occurs when copying a file (MMEM:COPY command) fails.

74

Failed to create directory

This error occurs when creating a directory (MMEM:MDIR command) fails.

73

Failed to delete file

This error occurs when deleting a file (MMEM:DEL command) fails.

91

Failed to execute user defined key

In the user menu function, this error occurs when a disabled softkey is executed.

61

Failed to hide trace

In the user window, this error occurs when the show trace "OFF" command is executed to turn off the remaining trace on the window. At least one trace should be visible at all times.

60

Failed to hide window

This error occurs when the show window "OFF" command is executed to turn off the remaining window on the screen. At least one window should be visible at all times.

70

Failed to read file

This error occurs when a VBA project file (MMEM:LOAD:PROG command) or other type of file cannot be read normally.

90

Failed to stop program

This error occurs when stopping a program fails.

71

Failed to write file

This error occurs when the display image (MMEM:STOR:IMAG command) for the LCD screen, a VBA project file (MMEM:STOR:PROG command) or other type of file cannot be written normally.

-257

File name error

A file name error. This message appears when an error exists in the file name and thus a command is not executed correctly. This error occurs, for example, when you try to copy to an improper file name.

-256

File name not found

The file name specified is not found and thus the command is not executed correctly. This error occurs, for example, when you try to read a file that does not exist in a disk or a disk

	is not correctly inserted into the drive.
80	File transfer failed This error occurs when writing data into or reading data from a file (MMEM:DATA command) fails.
	I
213	IF A/D overflow This message appears when the internal IF level is too high and it exceeds the internal A/D converter input range. In the phase noise measurement, check that the DUT's carrier signal is within the selected frequency band. Also, the message may appear if a DUT that has a large noise level and an unstable output level is measured. When measuring phase noise in such a case, decrease the IF Gain value or increase the sweep start value if possible. In the spectrum monitor measurement, decrease the DUT's carrier level, or set the reference level or input attenuator value larger than the current setting. In the transient measurement, decrease the DUT's carrier level, or set the max input level or input attenuator value larger than the current setting.
260	IF Level Overload The IF level is too high. Set the input attenuator value larger than the current setting.
312	IF not found The IF signal cannot be found. In the phase noise measurement, this error occurs when no signal is inputted to the RF IN, or the input level to the RF IN is too low. Also, the message may appear if a DUT that has an unstable output level is measured. Aside from the above reasons, there is the possibility of a device failure. Contact an Agilent Technologies sales office or the company from which you bought the device.
-224	Illegal parameter value The parameter value is improperly set.
-282	Illegal program name This error occurs when a nonexistent VBA program name is specified by the PROG:SEL:NAME command.
-213	Init ignored Because another measurement is in progress, the request for initiating a measurement ("INIT" command) is ignored.
250	Insufficient IF Level The IF level is too low. Set the input attenuator value smaller than the current setting.
230	Insufficient RF Level The input level to the RF IN connector is too low.
	L
101	License installation failed This error occurs when an invalid license code is input when installing E5001 SSA-J license.

Error Messages

Error number: 77

77

Load VBA program failed

This error occurs when loading a VBA program file fails.

M

20

Marker search failed

This error occurs when marker search fails.

-109

Missing parameter

The number of parameters is less than that required for the command, or the parameter has not been entered.

N

351

No downconverter unit connected

This error occurs when the downconverter is not turned on or when the USB (USBTMC) cable is not connected even though the downconverter is enabled. Disable the downconverter, turn on the downconverter, or connect the USB (USBTMC) cable.

111

No signal found

This error message appears when a carrier is outside the selected frequency band or the attenuator is improperly set during execution of the **Carrier to** function. Set the attenuator to 0 in case you measure a DUT whose output is less than -15 dBm.

O

100

Option not installed

The command received has been ignored because of the mismatch between the contents of an option for this instrument and the command.

This error is not generated by front key operations.

P

-220

Parameter error

When a parameter-related error other than Errors -221 through -229 occurs, that error is displayed.

-108

Parameter not allowed

The number of parameters exceeds that required for the command.

See the command reference to confirm the required number of parameters.

210

Phase lock loop unlocked

This error occurs when the PLL circuit of the instrument becomes unlocked while the measurement is in progress. This message may appear if the DUT's carrier signal is unstable. If this message is displayed in the phase noise measurement, the following problems and corrective actions are shown below.

- The DUT's noise level is too large, or a large level spurious component exists in the measurement range.

Verify the spectrum of the DUT's output signal.

Decrease the IF Gain value, or increase the sweep start value when possible.

- The DUT's output signal is being modulated in frequency.

Stop the frequency modulation.

- A large harmonics component is included in the DUT's output signal.

Insert a low-pass filter between the DUT's output terminal and the E5052A RF IN connector to eliminate the harmonics component.

211

PLL frequency range over

This error occurs when the internal PLL circuit becomes unlocked while the measurement is in progress. This error may occur when the frequency of the input signal is out of range.

212

PLL Input overflow

This error occurs when the internal PLL circuit becomes unlocked while the measurement is in progress. This error may occur when the level of the input signal is too large.

200

Power on test failed

This error occurs when the power-on test fails, indicating a failure of the instrument. Contact an Agilent Technologies sales office or the company from which you bought the instrument.

40

Printer error

This error occurs when the previous printing is still in progress or the printer fails (offline, short of paper, etc.) at the time of outputting the display image on the LCD screen to the printer (HCOP:IMM command).

41

Print failed

This error occurs when printing fails for reasons other than Error 40, Printer error.

-284

Program currently running

This error occurs when the PROG:SEL:STAT RUN command is executed when the VBA program is in the Run state.

-286

Program runtime error

An error occurring when VBA is executed.

R

75

Recall failed

This error occurs when reading an instrument status file (State01.sta, etc.) (MMEM:LOAD:STAT command) fails.

220

RF freq out of range

This error occurs when the DUT's output frequency is not within the measurement range.

240

RF level overload

This error occurs when the input to the RF IN port exceeds the maximum input level in the measurement. The measurement value obtained in such a case is not correct. In the worst case, a failure (damage to the receiver) may occur.

Error Messages

Error number: 76

S

76

Save failed

This error occurs when writing an instrument status file (State01.sta, etc.) (MMEM:STOR:STAT command) fails.

78

Save VBA program failed

This error occurs when saving a VBA program file fails.

-310

System error

One of the errors designated as “system errors” in this instrument has occurred.

T

110

Target freq out of range

This error indicates the 2nd, 3rd, or nth order harmonics is not within the E5052A measurement range. At this time, the previous measurement conditions still remain (any of sweep parameters are not changed).

-223

Too much data

The block-, expression-, or character-string-type program data that have been received conform with the standard but exceed the amount that can be processed under the conditions of the memory or conditions specific to memory-related devices. In this instrument, this error occurs when the number of characters exceeds 254 in a character-string parameter.

-211

Trigger ignored

This instrument receives and detects a trigger command (“TRIG”) or an external trigger signal, but it is ignored due to the timing conditions (the instrument is not in the wait-for-trigger state, for example). Change the setup so that a trigger command or an external trigger signal can be sent after the instrument has entered the wait-for-trigger state.

U

-113

Undefined header

A command not defined in this instrument, although not illegal in the syntactic structure, has been received. See the command reference and use correct commands.

311

Unlock local

This error occurs when the internal Local signal of the instrument cannot be unlocked. There is the possibility of a device failure. Contact an Agilent Technologies sales office or the company from which you bought the device.

Warning Message

A warning message is displayed in the instrument message/Warning area in the lower-left part of the display against a gray background. Touching Entry Off key at the front panel executing the :DISPlay:MESSAge:CLEAr command on page 254 clears the message. Moreover, about a specific warning message, when a sweep is started again, a warning message may disappear.

This message simply appears on the display, since it is not known to remote environments such as a GPIB. This message is not displayed when another error message (against a red background) has already been displayed in the instrument message/Warning area.

The warning messages for this instrument are as follows:

571

DC control out of limit

This message occurs when the specified DC control voltage or the sweep start/stop DC control voltage for the frequency & power measurement is out of the maximum/minimum allowed voltage of DC control.

580

DC control output on required in AFC

The automatic frequency control function was set on, however, the power or control voltage is not being applied to the DUT. Verify that the control voltage output is set to ON.

570

DC power out of limit

This message occurs when the specified DC power voltage or the sweep start/stop DC power voltage for the frequency & power measurement is out of the maximum/minimum allowance voltage of DC control.

560

Incompatible recall file

This message occurs when an incompatible file is read.

550

Marker tracking failed

This message occurs when marker tracking fails.

503

Set RF ATT 0dB

This message occurs when the input attenuator is set improperly. Set the input attenuator to 0 dB.

504

Set RF ATT 5dB

This message occurs when the input attenuator is set improperly. Set the input attenuator to 5 dB.

505

Set RF ATT 10dB

This message occurs when the input attenuator is set improperly. Set the input attenuator to 10 dB.

506

Set RF ATT 15dB

This message occurs when the input attenuator is set improperly. Set the input attenuator to 15 dB.

507

Set RF ATT 20dB

This message occurs when the input attenuator is set improperly. Set the input attenuator to

Error Messages

Error number: 508

20 dB.

508

Set RF ATT 25dB

This message occurs when the input attenuator is set improperly. Set the input attenuator to 25 dB.

510

Set RF ATT 30dB

This message occurs when the input attenuator is set improperly. Set the input attenuator to 30 dB.

511

Set RF ATT 35dB

This message occurs when the input attenuator is set improperly. Set the input attenuator to 35 dB.

Numerics

24-bit I/O Port, 538

A

Array Type, 64
 ASCII Transfer Format, 67
 ASCII transfer format, 64
 Auto recall, 82

B

Binary Transfer Format, 68
 Block type, 65
 Bus trigger, 56
 Byte order, 66, 69

C

C language, 43
 command reference, 96
 Condition register, 518
 Contents of This Manual, 26
 continuous initiation mode, 57
 control signal lines, 538
 Control from a program, 43
 Conversational control using telnet, 42
 Copying a file, 84
 Creating a directory (folder), 84

D

Data Flow, 70
 Data output to port, 543
 Data Transfer Format, 66
 Data Types for Data Transfer, 64
 Deleting a file (directory), 84
 Detecting Occurrence of an Error, 90
 Device, 98
 Device Configuration Using E5052A and E5053A
 Microwave Downconverter, 98
 Device selector, 34

E

Electrical Characteristics, 547
 Enable register, 517
 enable register, 516
 Entering Data in a Trace, 78
 Equivalent key, 97
 Error Messages, 550
 Event register, 517
 event register, 516
 External trigger, 56

F

firmware version, 510
 Floating-point number format, 67
 Formatted data arrays, 74
 Formatted memory arrays, 74

G

GPIB, 32, 33
 GPIB address, 34
 GPIB Remote Control System, 33
 Ground, 540

H

Hold State, 56
 How to Use This Manual, 28

I

I/O Signal Pin Layout, 539
 IEEE 32-bit floating point binary transfer format, 64, 65
 IEEE 32-bit floating point format, 68
 IEEE 64-bit floating point binary transfer format, 64
 IEEE 64-bit floating point binary transfer format, 65
 IEEE 64-bit floating point format, 68
 IEEE common commands, 50
 Input signal, 547
 Inputting/Outputting Data, 542
 Integer format, 67
 Internal data processing, 70
 Internal trigger, 56

K

Key Lock feature, 88

L

LAN, 32
 LAN remote control system, 35
 Limit Test, 92
 Looking up SCPI commands, 28

M

Manual Changes, 510
 Manual trigger, 56
 Measurement State, 57
 measuring mode, 28

N

Negative transition filter, 518
 notational convention, 96

O

Operation status condition register, 528
 Operation Status Register, 526
 Operation status register, 518
 operation status condition register, 60
 Operation User Defined Status Condition Register, 528
 Operation user defined status register, 518, 528
 Output signal, 548

P

parallel port, 538

- Parameters, 97
 - Positive transition filter, 518
 - power line, 538
 - Power supply, 548
 - prefix, 510
 - Program (sample)
 - title
 - Using the binary transfer format to retrieve internal data arrays, 77
 - Programmer's Guide, 3
 - Pulse Width, 545
- Q**
- Query response, 97
 - Questionable Current Status Event Register, 530
 - Questionable Limit FP1 Status Event Register, 532
 - Questionable Limit PN1 Status Event Register, 532
 - Questionable Limit SP1 Status Event Register, 532
 - Questionable Limit Status Event Register, 531
 - Questionable Limit TR1 Status Event Register, 533
 - Questionable Limit USER1 Status Event Register, 533
 - Questionable Misc Status Event Register, 531
 - Questionable Phase Status Event Register, 530
 - Questionable Power status Event Register, 530
 - Questionable Reference Signal Status Event Register, 531
 - Questionable Status Condition Register, 529
 - Questionable Status Register, 526
 - Questionable status register, 518
- R**
- Raw Data Arrays, 75
 - Reading data input to port, 543
 - Related commands, 97
 - Remote Control System
 - USB remote control system, 44
 - Remote mode, 52
 - Retrieving data from storage, 84
 - Retrieving internal data arrays, 76
 - Retrieving measurement results at marker positions, 76
- S**
- saving and recalling instrument status, 82
 - Saving images, 83
 - Saving measurement data, 82
 - Saving/loading (importing) the VBA program, 83
 - SCPI command, 50
 - Command reference
 - E5052A commands, 100
 - SCPI Command
 - *CLS, 297
 - *ESE, 297
 - *ESR, 297
 - *IDN, 297
 - *OPC, 297
 - *OPT, 298
 - *RST, 298
 - *SRE, 298
 - *STB, 299
 - *TRG, 299
 - *WAI, 299
 - :ABORt, 100
 - :CALCulate:FP[1-1]:ALLTrace:ACTive, 100
 - :CALCulate:FP[1-1]:ALLTrace:BDMarker:X:COUPlE:STATe, 100
 - :CALCulate:FP[1-1]:ALLTrace:LIMit:FAIL, 101
 - :CALCulate:FP[1-1]:ALLTrace:MARKer:COUPlE:STATe, 101
 - :CALCulate:FP[1-1]:ALLTrace:MARKer:DISCrete:STATe, 101
 - :CALCulate:FP[1-1]:ALLTrace:MARKer:REFerence:NUMBer, 102
 - :CALCulate:FP[1-1]:ALLTrace:MARKer:REFerence:STATe, 102
 - :CALCulate:FP[1-1]:DATA:RDATa, 103
 - :CALCulate:FP[1-1]:DATA:TDATa, 103
 - :CALCulate:FP[1-1]:DATA:XDATa, 104
 - :CALCulate:FP[1-1]:TRACe[1-4]:ALLMarker:ACTive, 104
 - :CALCulate:FP[1-1]:TRACe[1-4]:ALLMarker:SEARCh:DOMain:X, 104
 - :CALCulate:FP[1-1]:TRACe[1-4]:ALLMarker:SEARCh:DOMain:Y, 105
 - :CALCulate:FP[1-1]:TRACe[1-4]:ALLMarker:SEARCh:PEAK, 105
 - :CALCulate:FP[1-1]:TRACe[1-4]:BDMarker:X:CENTer, 105
 - :CALCulate:FP[1-1]:TRACe[1-4]:BDMarker:X:SPAN, 106
 - :CALCulate:FP[1-1]:TRACe[1-4]:BDMarker:X:STARt, 106
 - :CALCulate:FP[1-1]:TRACe[1-4]:BDMarker:X:STATe, 106
 - :CALCulate:FP[1-1]:TRACe[1-4]:BDMarker:X:STOP, 107
 - :CALCulate:FP[1-1]:TRACe[1-4]:BDMarker:Y:CENTer, 107
 - :CALCulate:FP[1-1]:TRACe[1-4]:BDMarker:Y:SPAN, 108
 - :CALCulate:FP[1-1]:TRACe[1-4]:BDMarker:Y:STARt, 108
 - :CALCulate:FP[1-1]:TRACe[1-4]:BDMarker:Y:STATe, 109
 - :CALCulate:FP[1-1]:TRACe[1-4]:BDMarker:Y:STOP, 109
 - :CALCulate:FP[1-1]:TRACe[1-4]:DATA:COpy, 109
 - :CALCulate:FP[1-1]:TRACe[1-4]:DATA:FDATa, 110
 - :CALCulate:FP[1-1]:TRACe[1-4]:DATA:FMEMory, 110
 - :CALCulate:FP[1-1]:TRACe[1-4]:DATA:UDATa, 111
 - :CALCulate:FP[1-1]:TRACe[1-4]:DATA:UMEMory, 111
 - :CALCulate:FP[1-1]:TRACe[1-4]:FORMat:FREQuency, 112
 - :CALCulate:FP[1-1]:TRACe[1-4]:FUNctioN:DOMain:X, 112

- :CALCulate:FP[1-1]:TRACe[1-4]:FUNcTion:DOMain:Y, 113
- :CALCulate:FP[1-1]:TRACe[1-4]:FUNcTion:LREGressio n:DATA, 113
- :CALCulate:FP[1-1]:TRACe[1-4]:FUNcTion:LREGressio n:MEMory, 113
- :CALCulate:FP[1-1]:TRACe[1-4]:FUNcTion:STATistics: DATA, 114
- :CALCulate:FP[1-1]:TRACe[1-4]:FUNcTion:STATistics: MEMory, 114
- :CALCulate:FP[1-1]:TRACe[1-4]:FUNcTion:TYPE, 114
- :CALCulate:FP[1-1]:TRACe[1-4]:HOLD, 114
- :CALCulate:FP[1-1]:TRACe[1-4]:LIMit:FAIL, 115
- :CALCulate:FP[1-1]:TRACe[1-4]:LIMit:LOWer:LDATA, 115
- :CALCulate:FP[1-1]:TRACe[1-4]:LIMit:LOWer:SEGMen t:CLEar, 115
- :CALCulate:FP[1-1]:TRACe[1-4]:LIMit:LOWer:SEGMen t:COUNT, 116
- :CALCulate:FP[1-1]:TRACe[1-4]:LIMit:LOWer:SEGMen t:DATA, 116
- :CALCulate:FP[1-1]:TRACe[1-4]:LIMit:REPort[:DATA], 117
- :CALCulate:FP[1-1]:TRACe[1-4]:LIMit:UPPer:LDATA, 117
- :CALCulate:FP[1-1]:TRACe[1-4]:LIMit:UPPer:SEGment :CLEar, 118
- :CALCulate:FP[1-1]:TRACe[1-4]:LIMit:UPPer:SEGment :COUNT, 118
- :CALCulate:FP[1-1]:TRACe[1-4]:LIMit:UPPer:SEGment :DATA, 118
- :CALCulate:FP[1-1]:TRACe[1-4]:LIMit[:STATe], 117
- :CALCulate:FP[1-1]:TRACe[1-4]:LINE:A, 119
- :CALCulate:FP[1-1]:TRACe[1-4]:LINE:B, 119
- :CALCulate:FP[1-1]:TRACe[1-4]:LINE:MEMory, 119
- :CALCulate:FP[1-1]:TRACe[1-4]:MARKer[1-10]:SEARc h:EXECute:LPEak, 120
- :CALCulate:FP[1-1]:TRACe[1-4]:MARKer[1-10]:SEARc h:EXECute:LTARget, 120
- :CALCulate:FP[1-1]:TRACe[1-4]:MARKer[1-10]:SEARc h:EXECute:MAXimum, 120
- :CALCulate:FP[1-1]:TRACe[1-4]:MARKer[1-10]:SEARc h:EXECute:MINimum, 120
- :CALCulate:FP[1-1]:TRACe[1-4]:MARKer[1-10]:SEARc h:EXECute:PEAK, 120
- :CALCulate:FP[1-1]:TRACe[1-4]:MARKer[1-10]:SEARc h:EXECute:RPEak, 121
- :CALCulate:FP[1-1]:TRACe[1-4]:MARKer[1-10]:SEARc h:EXECute:RTARget, 121
- :CALCulate:FP[1-1]:TRACe[1-4]:MARKer[1-10]:SEARc h:EXECute:TARGet, 121
- :CALCulate:FP[1-1]:TRACe[1-4]:MARKer[1-10]:SEARc h:PEAK:EXCursion, 121
- :CALCulate:FP[1-1]:TRACe[1-4]:MARKer[1-10]:SEARc h:PEAK:POLarity, 122
- :CALCulate:FP[1-1]:TRACe[1-4]:MARKer[1-10]:SEARc h:TARGet:TRAnSition, 122
- :CALCulate:FP[1-1]:TRACe[1-4]:MARKer[1-10]:SEARc h:TARGet:Y, 122
- :CALCulate:FP[1-1]:TRACe[1-4]:MARKer[1-10]:SEARc h:TRACking:TYPE, 123
- :CALCulate:FP[1-1]:TRACe[1-4]:MARKer[1-10]:STATe, 123
- :CALCulate:FP[1-1]:TRACe[1-4]:MARKer[1-10]:X, 124
- :CALCulate:FP[1-1]:TRACe[1-4]:MARKer[1-10]:Y, 124
- :CALCulate:FP[1-1]:TRACe[1-4]:MATH:FUNcTion, 124
- :CALCulate:FP[1-1]:TRACe[1-4]:MATH:MEMorize, 125
- :CALCulate:FP[1-1]:TRACe[1-4]:MATH:OFFSet, 125
- :CALCulate:FP[1-1]:TRACe[1-4]:PARAmeter, 125
- :CALCulate:FP[1-1]:TRACe[1-4]:REFerence:FREQuency , 126
- :CALCulate:FP[1-1]:TRACe[1-4]:SAPerture, 126
- :CALCulate:FP[1-1]:TRACe[1-4]:SMOothing:APERture, 126
- :CALCulate:FP[1-1]:TRACe[1-4]:SMOothing:STATe, 127
- :CALCulate:PN[1-1]:ALLTrace:LIMit:FAIL, 127
- :CALCulate:PN[1-1]:ALLTrace:MARKer:COUPlE:STATe, 128
- :CALCulate:PN[1-1]:ALLTrace:MARKer:DISCrete:STAT e, 128
- :CALCulate:PN[1-1]:ALLTrace:MARKer:REFerence:NU MBER, 128
- :CALCulate:PN[1-1]:ALLTrace:MARKer:REFerence:STA Te, 129
- :CALCulate:PN[1-1]:DATA:CARRier, 129
- :CALCulate:PN[1-1]:DATA:PDATA, 130
- :CALCulate:PN[1-1]:DATA:RDATA, 130
- :CALCulate:PN[1-1]:DATA:XDATA, 130
- :CALCulate:PN[1-1]:TRACe[1-1]:ALLMarker:ACTive, 131
- :CALCulate:PN[1-1]:TRACe[1-1]:ALLMarker:SEARch: DOMain:X, 131
- :CALCulate:PN[1-1]:TRACe[1-1]:ALLMarker:SEARch: DOMain:Y, 131
- :CALCulate:PN[1-1]:TRACe[1-1]:ALLMarker:SEARch:P EAK, 132
- :CALCulate:PN[1-1]:TRACe[1-1]:BDMarker:X:CENTer, 132
- :CALCulate:PN[1-1]:TRACe[1-1]:BDMarker:X:SPAN, 132
- :CALCulate:PN[1-1]:TRACe[1-1]:BDMarker:X:STARt, 133
- :CALCulate:PN[1-1]:TRACe[1-1]:BDMarker:X:STATe, 133
- :CALCulate:PN[1-1]:TRACe[1-1]:BDMarker:X:STOP, 134
- :CALCulate:PN[1-1]:TRACe[1-1]:BDMarker:Y:CENTer, 134
- :CALCulate:PN[1-1]:TRACe[1-1]:BDMarker:Y:SPAN, 135
- :CALCulate:PN[1-1]:TRACe[1-1]:BDMarker:Y:STARt, 135
- :CALCulate:PN[1-1]:TRACe[1-1]:BDMarker:Y:STATe, 135

:CALCulate:PN[1-1]:TRACe[1-1]:BDMarker:Y:STOP, 136
:CALCulate:PN[1-1]:TRACe[1-1]:DATA:COpy, 136
:CALCulate:PN[1-1]:TRACe[1-1]:DATA:FDATa, 137
:CALCulate:PN[1-1]:TRACe[1-1]:DATA:FMEMory, 137
:CALCulate:PN[1-1]:TRACe[1-1]:DATA:PDATa, 138
:CALCulate:PN[1-1]:TRACe[1-1]:DATA:PMEMory, 138
:CALCulate:PN[1-1]:TRACe[1-1]:DATA:SDATa, 139
:CALCulate:PN[1-1]:TRACe[1-1]:DATA:SMEMory, 139
:CALCulate:PN[1-1]:TRACe[1-1]:DATA:UDATa, 139
:CALCulate:PN[1-1]:TRACe[1-1]:DATA:UMEMory, 139
:CALCulate:PN[1-1]:TRACe[1-1]:FUNctioN:AVARiance:DATA, 140
:CALCulate:PN[1-1]:TRACe[1-1]:FUNctioN:AVARiance:MEMory, 140
:CALCulate:PN[1-1]:TRACe[1-1]:FUNctioN:DOMain:X, 141
:CALCulate:PN[1-1]:TRACe[1-1]:FUNctioN:DOMain:Y, 141
:CALCulate:PN[1-1]:TRACe[1-1]:FUNctioN:INTegral:DATA, 142
:CALCulate:PN[1-1]:TRACe[1-1]:FUNctioN:INTegral:MEMory, 142
:CALCulate:PN[1-1]:TRACe[1-1]:FUNctioN:STATistics:DATA, 142
:CALCulate:PN[1-1]:TRACe[1-1]:FUNctioN:STATistics:MEMory, 142
:CALCulate:PN[1-1]:TRACe[1-1]:FUNctioN:TYPE, 143
:CALCulate:PN[1-1]:TRACe[1-1]:HOLD, 143
:CALCulate:PN[1-1]:TRACe[1-1]:LIMit:FAIL, 143
:CALCulate:PN[1-1]:TRACe[1-1]:LIMit:LOWer:LDATa, 144
:CALCulate:PN[1-1]:TRACe[1-1]:LIMit:LOWer:SEGMENT:CLEar, 144
:CALCulate:PN[1-1]:TRACe[1-1]:LIMit:LOWer:SEGMENT:COUNT, 144
:CALCulate:PN[1-1]:TRACe[1-1]:LIMit:LOWer:SEGMENT:DATA, 145
:CALCulate:PN[1-1]:TRACe[1-1]:LIMit:REPort[:DATA], 145
:CALCulate:PN[1-1]:TRACe[1-1]:LIMit:UPPer:LDATa, 146
:CALCulate:PN[1-1]:TRACe[1-1]:LIMit:UPPer:SEGMENT:CLEar, 146
:CALCulate:PN[1-1]:TRACe[1-1]:LIMit:UPPer:SEGMENT:COUNT, 146
:CALCulate:PN[1-1]:TRACe[1-1]:LIMit:UPPer:SEGMENT:DATA, 147
:CALCulate:PN[1-1]:TRACe[1-1]:LIMit[:STATe], 145
:CALCulate:PN[1-1]:TRACe[1-1]:MARKer[1-10]:SEARCh:EXECute:LPEak, 147
:CALCulate:PN[1-1]:TRACe[1-1]:MARKer[1-10]:SEARCh:EXECute:LTARget, 147
:CALCulate:PN[1-1]:TRACe[1-1]:MARKer[1-10]:SEARCh:EXECute:MAXimum, 148
:CALCulate:PN[1-1]:TRACe[1-1]:MARKer[1-10]:SEARCh:EXECute:MINimum, 148
:CALCulate:PN[1-1]:TRACe[1-1]:MARKer[1-10]:SEARCh:EXECute:PEAK, 148
:CALCulate:PN[1-1]:TRACe[1-1]:MARKer[1-10]:SEARCh:EXECute:RPEak, 148
:CALCulate:PN[1-1]:TRACe[1-1]:MARKer[1-10]:SEARCh:EXECute:RTARget, 148
:CALCulate:PN[1-1]:TRACe[1-1]:MARKer[1-10]:SEARCh:EXECute:TARGet, 149
:CALCulate:PN[1-1]:TRACe[1-1]:MARKer[1-10]:SEARCh:PEAK:EXCursion, 149
:CALCulate:PN[1-1]:TRACe[1-1]:MARKer[1-10]:SEARCh:PEAK:POLarity, 149
:CALCulate:PN[1-1]:TRACe[1-1]:MARKer[1-10]:SEARCh:TARGet:TRANSition, 150
:CALCulate:PN[1-1]:TRACe[1-1]:MARKer[1-10]:SEARCh:TARGet:Y, 150
:CALCulate:PN[1-1]:TRACe[1-1]:MARKer[1-10]:SEARCh:TRACking:TYPE, 151
:CALCulate:PN[1-1]:TRACe[1-1]:MARKer[1-10]:STATe, 151
:CALCulate:PN[1-1]:TRACe[1-1]:MARKer[1-10]:X, 151
:CALCulate:PN[1-1]:TRACe[1-1]:MARKer[1-10]:Y, 152
:CALCulate:PN[1-1]:TRACe[1-1]:MATH:FUNctioN, 152
:CALCulate:PN[1-1]:TRACe[1-1]:MATH:MEMorize, 152
:CALCulate:PN[1-1]:TRACe[1-1]:MATH:OFFSet, 153
:CALCulate:PN[1-1]:TRACe[1-1]:SMOothing:APERture, 153
:CALCulate:PN[1-1]:TRACe[1-1]:SMOothing:STATe, 153
:CALCulate:PN[1-1]:TRACe[1-1]:SPURious:OMISSion, 154
:CALCulate:PN[1-1]:TRACe[1-1]:SPURious:POWER, 154
:CALCulate:PN[1-1]:TRACe[1-1]:SPURious:THReshold:LEVel:MINimum, 155
:CALCulate:PN[1-1]:TRACe[1-1]:SPURious:THReshold:TABLE:CLEar, 155
:CALCulate:PN[1-1]:TRACe[1-1]:SPURious:THReshold:TABLE:COUNT, 155
:CALCulate:PN[1-1]:TRACe[1-1]:SPURious:THReshold:TABLE:DATA, 156
:CALCulate:SP[1-1]:ALLTrace:LIMit:FAIL, 156
:CALCulate:SP[1-1]:ALLTrace:MARKer:COUPle:STATe, 156
:CALCulate:SP[1-1]:ALLTrace:MARKer:DISCrete:STATe, 157
:CALCulate:SP[1-1]:ALLTrace:MARKer:REFeRence:NUMBER, 157
:CALCulate:SP[1-1]:ALLTrace:MARKer:REFeRence:STATe, 158
:CALCulate:SP[1-1]:DATA:RDATa, 158
:CALCulate:SP[1-1]:DATA:XDATa, 158
:CALCulate:SP[1-1]:TRACe[1-1]:ALLMarker:ACTive, 159
:CALCulate:SP[1-1]:TRACe[1-1]:ALLMarker:SEARCh:DOMain:X, 159
:CALCulate:SP[1-1]:TRACe[1-1]:ALLMarker:SEARCh:DOMain:Y, 159

- :CALCulate:SP[1-1]:TRACe[1-1]:ALLMarker:SEARCh:PEAK, 160
- :CALCulate:SP[1-1]:TRACe[1-1]:BDMarker:X:CENTer, 160
- :CALCulate:SP[1-1]:TRACe[1-1]:BDMarker:X:SPAN, 160
- :CALCulate:SP[1-1]:TRACe[1-1]:BDMarker:X:STARt, 161
- :CALCulate:SP[1-1]:TRACe[1-1]:BDMarker:X:STATe, 161
- :CALCulate:SP[1-1]:TRACe[1-1]:BDMarker:X:STOP, 162
- :CALCulate:SP[1-1]:TRACe[1-1]:BDMarker:Y:CENTer, 162
- :CALCulate:SP[1-1]:TRACe[1-1]:BDMarker:Y:SPAN, 163
- :CALCulate:SP[1-1]:TRACe[1-1]:BDMarker:Y:STARt, 163
- :CALCulate:SP[1-1]:TRACe[1-1]:BDMarker:Y:STATe, 164
- :CALCulate:SP[1-1]:TRACe[1-1]:BDMarker:Y:STOP, 164
- :CALCulate:SP[1-1]:TRACe[1-1]:DATA:COPIY, 164
- :CALCulate:SP[1-1]:TRACe[1-1]:DATA:FDATa, 165
- :CALCulate:SP[1-1]:TRACe[1-1]:DATA:FMEMOry, 165
- :CALCulate:SP[1-1]:TRACe[1-1]:DATA:UDATa, 166
- :CALCulate:SP[1-1]:TRACe[1-1]:DATA:UMEMOry, 166
- :CALCulate:SP[1-1]:TRACe[1-1]:FORMat, 167
- :CALCulate:SP[1-1]:TRACe[1-1]:FUNCTio:n:DOMai:n:X, 167
- :CALCulate:SP[1-1]:TRACe[1-1]:FUNCTio:n:DOMai:n:Y, 168
- :CALCulate:SP[1-1]:TRACe[1-1]:FUNCTio:n:STATistics:DATA, 168
- :CALCulate:SP[1-1]:TRACe[1-1]:FUNCTio:n:STATistics:MEMOry, 168
- :CALCulate:SP[1-1]:TRACe[1-1]:FUNCTio:n:TYPE, 168
- :CALCulate:SP[1-1]:TRACe[1-1]:HOLD, 169
- :CALCulate:SP[1-1]:TRACe[1-1]:LIMit:FAIL, 169
- :CALCulate:SP[1-1]:TRACe[1-1]:LIMit:LOWer:LDATEa, 169
- :CALCulate:SP[1-1]:TRACe[1-1]:LIMit:LOWer:SEGMe:n:t:CLEar, 170
- :CALCulate:SP[1-1]:TRACe[1-1]:LIMit:LOWer:SEGMe:n:t:COUNt, 170
- :CALCulate:SP[1-1]:TRACe[1-1]:LIMit:LOWer:SEGMe:n:t:DATE, 171
- :CALCulate:SP[1-1]:TRACe[1-1]:LIMit:REPORt[:DATE], 171
- :CALCulate:SP[1-1]:TRACe[1-1]:LIMit:UPPer:LDATEa, 172
- :CALCulate:SP[1-1]:TRACe[1-1]:LIMit:UPPer:SEGMe:n:t:CLEar, 172
- :CALCulate:SP[1-1]:TRACe[1-1]:LIMit:UPPer:SEGMe:n:t:COUNt, 172
- :CALCulate:SP[1-1]:TRACe[1-1]:LIMit:UPPer:SEGMe:n:t:DATE, 173
- :CALCulate:SP[1-1]:TRACe[1-1]:LIMit[:STATe], 171
- :CALCulate:SP[1-1]:TRACe[1-1]:MARKer[1-10]:SEARCh:EXECute:LPEak, 173
- :CALCulate:SP[1-1]:TRACe[1-1]:MARKer[1-10]:SEARCh:EXECute:LTARget, 173
- :CALCulate:SP[1-1]:TRACe[1-1]:MARKer[1-10]:SEARCh:EXECute:MAXimum, 173
- :CALCulate:SP[1-1]:TRACe[1-1]:MARKer[1-10]:SEARCh:EXECute:MINimum, 174
- :CALCulate:SP[1-1]:TRACe[1-1]:MARKer[1-10]:SEARCh:EXECute:PEAK, 174
- :CALCulate:SP[1-1]:TRACe[1-1]:MARKer[1-10]:SEARCh:EXECute:RPEak, 174
- :CALCulate:SP[1-1]:TRACe[1-1]:MARKer[1-10]:SEARCh:EXECute:RTARget, 174
- :CALCulate:SP[1-1]:TRACe[1-1]:MARKer[1-10]:SEARCh:EXECute:TARGet, 174
- :CALCulate:SP[1-1]:TRACe[1-1]:MARKer[1-10]:SEARCh:PEAK:EXCURsion, 175
- :CALCulate:SP[1-1]:TRACe[1-1]:MARKer[1-10]:SEARCh:PEAK:POLarity, 175
- :CALCulate:SP[1-1]:TRACe[1-1]:MARKer[1-10]:SEARCh:TARGet:TRAnsitio:n, 175
- :CALCulate:SP[1-1]:TRACe[1-1]:MARKer[1-10]:SEARCh:TARGet:Y, 176
- :CALCulate:SP[1-1]:TRACe[1-1]:MARKer[1-10]:SEARCh:TRACKing:TYPE, 176
- :CALCulate:SP[1-1]:TRACe[1-1]:MARKer[1-10]:STATe, 177
- :CALCulate:SP[1-1]:TRACe[1-1]:MARKer[1-10]:X, 177
- :CALCulate:SP[1-1]:TRACe[1-1]:MARKer[1-10]:Y, 178
- :CALCulate:SP[1-1]:TRACe[1-1]:MATH:FUNCTio:n, 178
- :CALCulate:SP[1-1]:TRACe[1-1]:MATH:MEMOryze, 178
- :CALCulate:SP[1-1]:TRACe[1-1]:MATH:OFFSet, 178
- :CALCulate:SP[1-1]:TRACe[1-1]:SMOothing:APERture, 179
- :CALCulate:SP[1-1]:TRACe[1-1]:SMOothing:STATe, 179
- :CALCulate:TR[1-1]:ALLTrace:ACTive, 180
- :CALCulate:TR[1-1]:ALLTrace:BDMarker:X:COUPLE:STATe, 180
- :CALCulate:TR[1-1]:ALLTrace:LIMit:FAIL, 181
- :CALCulate:TR[1-1]:ALLTrace:MARKer:COUPLE:STATe, 181
- :CALCulate:TR[1-1]:ALLTrace:MARKer:DISCrete:STATe, 181
- :CALCulate:TR[1-1]:ALLTrace:MARKer:REFere:nce:NUMBer, 182
- :CALCulate:TR[1-1]:ALLTrace:MARKer:REFere:nce:STATe, 182
- :CALCulate:TR[1-1]:NARRow:DATE:RDATa, 183
- :CALCulate:TR[1-1]:NARRow:DATE:XDATa, 183
- :CALCulate:TR[1-1]:TRACe[1-4]:ALLMarker:ACTive, 183
- :CALCulate:TR[1-1]:TRACe[1-4]:ALLMarker:SEARCh:DOMai:n:X, 184
- :CALCulate:TR[1-1]:TRACe[1-4]:ALLMarker:SEARCh:DOMai:n:Y, 184

- :CALCulate:TR[1-1]:TRACe[1-4]:ALLMarker:SEARch:PEAK, 184
- :CALCulate:TR[1-1]:TRACe[1-4]:BDMarker:X:CENTer, 185
- :CALCulate:TR[1-1]:TRACe[1-4]:BDMarker:X:SPAN, 185
- :CALCulate:TR[1-1]:TRACe[1-4]:BDMarker:X:START, 185
- :CALCulate:TR[1-1]:TRACe[1-4]:BDMarker:X:STATe, 186
- :CALCulate:TR[1-1]:TRACe[1-4]:BDMarker:X:STOP, 186
- :CALCulate:TR[1-1]:TRACe[1-4]:BDMarker:Y:CENTer, 187
- :CALCulate:TR[1-1]:TRACe[1-4]:BDMarker:Y:SPAN, 187
- :CALCulate:TR[1-1]:TRACe[1-4]:BDMarker:Y:START, 188
- :CALCulate:TR[1-1]:TRACe[1-4]:BDMarker:Y:STATe, 188
- :CALCulate:TR[1-1]:TRACe[1-4]:BDMarker:Y:STOP, 188
- :CALCulate:TR[1-1]:TRACe[1-4]:DATA:COPI, 189
- :CALCulate:TR[1-1]:TRACe[1-4]:DATA:FDATa, 189
- :CALCulate:TR[1-1]:TRACe[1-4]:DATA:FMEMory, 190
- :CALCulate:TR[1-1]:TRACe[1-4]:DATA:UDATa, 190
- :CALCulate:TR[1-1]:TRACe[1-4]:DATA:UMEMory, 191
- :CALCulate:TR[1-1]:TRACe[1-4]:FORMat:FREQuency, 191
- :CALCulate:TR[1-1]:TRACe[1-4]:FORMat:PHASe:PREference:OFFSet, 192
- :CALCulate:TR[1-1]:TRACe[1-4]:FORMat:PHASe:UNIT, 192
- :CALCulate:TR[1-1]:TRACe[1-4]:FORMat:PHASe:WRAP, 192
- :CALCulate:TR[1-1]:TRACe[1-4]:FORMat:PHASe:XREference, 193
- :CALCulate:TR[1-1]:TRACe[1-4]:FUNctio:DOMain:X, 193
- :CALCulate:TR[1-1]:TRACe[1-4]:FUNctio:DOMain:Y, 194
- :CALCulate:TR[1-1]:TRACe[1-4]:FUNctio:LREGressio:DATA, 194
- :CALCulate:TR[1-1]:TRACe[1-4]:FUNctio:LREGressio:MEMory, 194
- :CALCulate:TR[1-1]:TRACe[1-4]:FUNctio:STATistics:DATA, 195
- :CALCulate:TR[1-1]:TRACe[1-4]:FUNctio:STATistics:MEMory, 195
- :CALCulate:TR[1-1]:TRACe[1-4]:FUNctio:TYPE, 195
- :CALCulate:TR[1-1]:TRACe[1-4]:HOLD, 195
- :CALCulate:TR[1-1]:TRACe[1-4]:LIMit:FAIL, 196
- :CALCulate:TR[1-1]:TRACe[1-4]:LIMit:LOWer:LDATa, 196
- :CALCulate:TR[1-1]:TRACe[1-4]:LIMit:LOWer:SEGMen:t:CLEar, 197
- :CALCulate:TR[1-1]:TRACe[1-4]:LIMit:LOWer:SEGMen:t:COUNt, 197
- :CALCulate:TR[1-1]:TRACe[1-4]:LIMit:LOWer:SEGMen:t:DATA, 197
- :CALCulate:TR[1-1]:TRACe[1-4]:LIMit:REPORt[:DATA], 198
- :CALCulate:TR[1-1]:TRACe[1-4]:LIMit:UPPer:LDATa, 198
- :CALCulate:TR[1-1]:TRACe[1-4]:LIMit:UPPer:SEGMen:t:CLEar, 199
- :CALCulate:TR[1-1]:TRACe[1-4]:LIMit:UPPer:SEGMen:t:COUNt, 199
- :CALCulate:TR[1-1]:TRACe[1-4]:LIMit:UPPer:SEGMen:t:DATA, 199
- :CALCulate:TR[1-1]:TRACe[1-4]:LIMit[:STATe], 198
- :CALCulate:TR[1-1]:TRACe[1-4]:LINE:A, 200
- :CALCulate:TR[1-1]:TRACe[1-4]:LINE:B, 200
- :CALCulate:TR[1-1]:TRACe[1-4]:LINE:MEMory, 200
- :CALCulate:TR[1-1]:TRACe[1-4]:MARKer[1-10]:SEARch:EXECute:LPEak, 201
- :CALCulate:TR[1-1]:TRACe[1-4]:MARKer[1-10]:SEARch:EXECute:LTARget, 201
- :CALCulate:TR[1-1]:TRACe[1-4]:MARKer[1-10]:SEARch:EXECute:MAXimum, 201
- :CALCulate:TR[1-1]:TRACe[1-4]:MARKer[1-10]:SEARch:EXECute:MINimum, 201
- :CALCulate:TR[1-1]:TRACe[1-4]:MARKer[1-10]:SEARch:EXECute:PEAK, 201
- :CALCulate:TR[1-1]:TRACe[1-4]:MARKer[1-10]:SEARch:EXECute:RPEak, 202
- :CALCulate:TR[1-1]:TRACe[1-4]:MARKer[1-10]:SEARch:EXECute:RTARget, 202
- :CALCulate:TR[1-1]:TRACe[1-4]:MARKer[1-10]:SEARch:EXECute:TARGet, 202
- :CALCulate:TR[1-1]:TRACe[1-4]:MARKer[1-10]:SEARch:PEAK:EXCURsion, 202
- :CALCulate:TR[1-1]:TRACe[1-4]:MARKer[1-10]:SEARch:PEAK:POLarity, 203
- :CALCulate:TR[1-1]:TRACe[1-4]:MARKer[1-10]:SEARch:TARGet:TRAnsitio, 203
- :CALCulate:TR[1-1]:TRACe[1-4]:MARKer[1-10]:SEARch:TARGet:Y, 203
- :CALCulate:TR[1-1]:TRACe[1-4]:MARKer[1-10]:SEARch:TRACKing:TYPE, 204
- :CALCulate:TR[1-1]:TRACe[1-4]:MARKer[1-10]:STATe, 204
- :CALCulate:TR[1-1]:TRACe[1-4]:MARKer[1-10]:X, 205
- :CALCulate:TR[1-1]:TRACe[1-4]:MARKer[1-10]:Y, 205
- :CALCulate:TR[1-1]:TRACe[1-4]:MATH:FUNctio, 205
- :CALCulate:TR[1-1]:TRACe[1-4]:MATH:MEMorize, 206
- :CALCulate:TR[1-1]:TRACe[1-4]:MATH:OFFSet, 206
- :CALCulate:TR[1-1]:TRACe[1-4]:PARameter, 206
- :CALCulate:TR[1-1]:TRACe[1-4]:REference:FREQuency, 207
- :CALCulate:TR[1-1]:TRACe[1-4]:SMOothing:APERture, 207
- :CALCulate:TR[1-1]:TRACe[1-4]:SMOothing:STATe, 207

- :CALCulate:TR[1-1]:WIDE:DATA:RDATa, 208
- :CALCulate:TR[1-1]:WIDE:DATA:XDATa, 208
- :CALCulate:USER[1-1]:ALLTrace:ACTive, 208
- :CALCulate:USER[1-1]:ALLTrace:BDMarker:X:COUPLE:STATe, 209
- :CALCulate:USER[1-1]:ALLTrace:LIMit:FAIL, 209
- :CALCulate:USER[1-1]:ALLTrace:MARKer:COUPLE:STATe, 210
- :CALCulate:USER[1-1]:ALLTrace:MARKer:DISCrete:STATe, 210
- :CALCulate:USER[1-1]:ALLTrace:MARKer:REFeRence:NUMBER, 210
- :CALCulate:USER[1-1]:ALLTrace:MARKer:REFeRence:STATe, 211
- :CALCulate:USER[1-1]:TRACe[1-8]:ALLMarker:ACTive, 211
- :CALCulate:USER[1-1]:TRACe[1-8]:ALLMarker:SEARCh:DOMain:X, 212
- :CALCulate:USER[1-1]:TRACe[1-8]:ALLMarker:SEARCh:DOMain:Y, 212
- :CALCulate:USER[1-1]:TRACe[1-8]:ALLMarker:SEARCh:PEAK, 212
- :CALCulate:USER[1-1]:TRACe[1-8]:BDMarker:X:CENTer, 213
- :CALCulate:USER[1-1]:TRACe[1-8]:BDMarker:X:SPAN, 213
- :CALCulate:USER[1-1]:TRACe[1-8]:BDMarker:X:START, 213
- :CALCulate:USER[1-1]:TRACe[1-8]:BDMarker:X:STATe, 214
- :CALCulate:USER[1-1]:TRACe[1-8]:BDMarker:X:STOP, 214
- :CALCulate:USER[1-1]:TRACe[1-8]:BDMarker:Y:CENTer, 215
- :CALCulate:USER[1-1]:TRACe[1-8]:BDMarker:Y:SPAN, 215
- :CALCulate:USER[1-1]:TRACe[1-8]:BDMarker:Y:START, 216
- :CALCulate:USER[1-1]:TRACe[1-8]:BDMarker:Y:STATe, 216
- :CALCulate:USER[1-1]:TRACe[1-8]:BDMarker:Y:STOP, 216
- :CALCulate:USER[1-1]:TRACe[1-8]:DATA:COPIY, 217
- :CALCulate:USER[1-1]:TRACe[1-8]:DATA:FDATa, 217
- :CALCulate:USER[1-1]:TRACe[1-8]:DATA:FMEMOry, 218
- :CALCulate:USER[1-1]:TRACe[1-8]:DATA:POINts, 218
- :CALCulate:USER[1-1]:TRACe[1-8]:DATA:RDATa, 218
- :CALCulate:USER[1-1]:TRACe[1-8]:DATA:STARt, 219
- :CALCulate:USER[1-1]:TRACe[1-8]:DATA:STOP, 219
- :CALCulate:USER[1-1]:TRACe[1-8]:DATA:UDATa, 219
- :CALCulate:USER[1-1]:TRACe[1-8]:DATA:UMEMOry, 220
- :CALCulate:USER[1-1]:TRACe[1-8]:DATA:XDATa, 220
- :CALCulate:USER[1-1]:TRACe[1-8]:FUNCTion:DOMain:X, 220
- :CALCulate:USER[1-1]:TRACe[1-8]:FUNCTion:DOMain:Y, 221
- :CALCulate:USER[1-1]:TRACe[1-8]:FUNCTion:STATistics:DATA, 221
- :CALCulate:USER[1-1]:TRACe[1-8]:FUNCTion:STATistics:MEMOry, 221
- :CALCulate:USER[1-1]:TRACe[1-8]:FUNCTion:TYPE, 222
- :CALCulate:USER[1-1]:TRACe[1-8]:HOLD, 222
- :CALCulate:USER[1-1]:TRACe[1-8]:LIMit:FAIL, 222
- :CALCulate:USER[1-1]:TRACe[1-8]:LIMit:LOWer:LDATa, 223
- :CALCulate:USER[1-1]:TRACe[1-8]:LIMit:LOWer:SEGMENT:CLEAr, 223
- :CALCulate:USER[1-1]:TRACe[1-8]:LIMit:LOWer:SEGMENT:COUNT, 223
- :CALCulate:USER[1-1]:TRACe[1-8]:LIMit:LOWer:SEGMENT:DATA, 224
- :CALCulate:USER[1-1]:TRACe[1-8]:LIMit:REPort[DATa], 224
- :CALCulate:USER[1-1]:TRACe[1-8]:LIMit:UPPer:LDATa, 225
- :CALCulate:USER[1-1]:TRACe[1-8]:LIMit:UPPer:SEGMENT:CLEAr, 225
- :CALCulate:USER[1-1]:TRACe[1-8]:LIMit:UPPer:SEGMENT:COUNT, 225
- :CALCulate:USER[1-1]:TRACe[1-8]:LIMit:UPPer:SEGMENT:DATA, 226
- :CALCulate:USER[1-1]:TRACe[1-8]:LIMit[STATe], 224
- :CALCulate:USER[1-1]:TRACe[1-8]:MARKer[1-10]:SEARCh:EXECute:LPEAK, 226
- :CALCulate:USER[1-1]:TRACe[1-8]:MARKer[1-10]:SEARCh:EXECute:LTARget, 226
- :CALCulate:USER[1-1]:TRACe[1-8]:MARKer[1-10]:SEARCh:EXECute:MAXimum, 227
- :CALCulate:USER[1-1]:TRACe[1-8]:MARKer[1-10]:SEARCh:EXECute:MINimum, 227
- :CALCulate:USER[1-1]:TRACe[1-8]:MARKer[1-10]:SEARCh:EXECute:PEAK, 227
- :CALCulate:USER[1-1]:TRACe[1-8]:MARKer[1-10]:SEARCh:EXECute:RPEAK, 227
- :CALCulate:USER[1-1]:TRACe[1-8]:MARKer[1-10]:SEARCh:EXECute:RTARget, 227
- :CALCulate:USER[1-1]:TRACe[1-8]:MARKer[1-10]:SEARCh:EXECute:TARGet, 228
- :CALCulate:USER[1-1]:TRACe[1-8]:MARKer[1-10]:SEARCh:PEAK:EXCURsion, 228
- :CALCulate:USER[1-1]:TRACe[1-8]:MARKer[1-10]:SEARCh:PEAK:POLarity, 228
- :CALCulate:USER[1-1]:TRACe[1-8]:MARKer[1-10]:SEARCh:TARGet:TRANSition, 229
- :CALCulate:USER[1-1]:TRACe[1-8]:MARKer[1-10]:SEARCh:TARGet:Y, 229
- :CALCulate:USER[1-1]:TRACe[1-8]:MARKer[1-10]:SEARCh:TRACking:TYPE, 230
- :CALCulate:USER[1-1]:TRACe[1-8]:MARKer[1-10]:STATe, 230

:CALCulate:USER[1-1]:TRACe[1-8]:MARKer[1-10]:X, 230
:CALCulate:USER[1-1]:TRACe[1-8]:MARKer[1-10]:Y, 231
:CALCulate:USER[1-1]:TRACe[1-8]:MATH:FUNCTION, 231
:CALCulate:USER[1-1]:TRACe[1-8]:MATH:MEMorize, 231
:CALCulate:USER[1-1]:TRACe[1-8]:MATH:OFFSet, 232
:CALCulate:USER[1-1]:TRACe[1-8]:SMOothing:APERture, 232
:CALCulate:USER[1-1]:TRACe[1-8]:SMOothing:STATe, 232
:CONTRol:HANDler:A[:DATA], 233
:CONTRol:HANDler:B[:DATA], 233
:CONTRol:HANDler:C:MODE, 234
:CONTRol:HANDler:C[:DATA], 234
:CONTRol:HANDler:D:MODE, 235
:CONTRol:HANDler:D[:DATA], 234
:CONTRol:HANDler:E[:DATA], 235
:CONTRol:HANDler:F[:DATA], 236
:CONTRol:HANDler:OUTPut[1-2][:DATA], 236
:DISPlay:CLOCK, 236
:DISPlay:COLor[1-2]:BACK, 237
:DISPlay:COLor[1-2]:GRATICule[1-2], 237
:DISPlay:COLor[1-2]:LIMit[1-2], 238
:DISPlay:COLor[1-2]:RESet, 239
:DISPlay:COLor[1-2]:TRACe[1-8]:DATA, 239
:DISPlay:COLor[1-2]:TRACe[1-8]:MEMory, 240
:DISPlay:ECHO:ADD, 241
:DISPlay:ECHO:CLEar, 241
:DISPlay:ECHO:DATA, 241
:DISPlay:ECHO:FSIZe, 242
:DISPlay:ECHO:STATe, 242
:DISPlay:ENABle, 243
:DISPlay:FP[1-1]:ALLTrace:PERsistence:CLEar, 243
:DISPlay:FP[1-1]:ALLTrace:Y:SCALE:AUTO, 244
:DISPlay:FP[1-1]:ANNotation:MARKer:POSition, 244
:DISPlay:FP[1-1]:ANNotation:MEASurement:STATe, 244
:DISPlay:FP[1-1]:GRATICule:AXIS:Y:RELative, 244
:DISPlay:FP[1-1]:GRATICule:AXIS:Y:STATe, 245
:DISPlay:FP[1-1]:LABel:DATA, 245
:DISPlay:FP[1-1]:LABel:STATe, 246
:DISPlay:FP[1-1]:LIMit:FSIGn, 246
:DISPlay:FP[1-1]:MAXimize, 246
:DISPlay:FP[1-1]:SPLit, 247
:DISPlay:FP[1-1]:STATe, 247
:DISPlay:FP[1-1]:TABLe[:STATe], 248
:DISPlay:FP[1-1]:TRACe[1-4]:LABel:DATA, 248
:DISPlay:FP[1-1]:TRACe[1-4]:LIMit:LINE, 248
:DISPlay:FP[1-1]:TRACe[1-4]:MODE, 249
:DISPlay:FP[1-1]:TRACe[1-4]:PERsistence:CLEar, 249
:DISPlay:FP[1-1]:TRACe[1-4]:PERsistence:STATe, 249
:DISPlay:FP[1-1]:TRACe[1-4]:X[:SCALE]:AUTO, 250
:DISPlay:FP[1-1]:TRACe[1-4]:X[:SCALE]:LEFT, 250
:DISPlay:FP[1-1]:TRACe[1-4]:X[:SCALE]:RIGHT, 251
:DISPlay:FP[1-1]:TRACe[1-4]:Y[:SCALE]:AUTO, 251
:DISPlay:FP[1-1]:TRACe[1-4]:Y[:SCALE]:PDIVision, 251
:DISPlay:FP[1-1]:TRACe[1-4]:Y[:SCALE]:RLEVel, 252
:DISPlay:FP[1-1]:TRACe[1-4]:Y[:SCALE]:RPOSition, 252
:DISPlay:FP[1-1]:Y[:SCALE]:DIVisions, 253
:DISPlay:IMAGe, 253
:DISPlay:MAXimize, 254
:DISPlay:MESSAge:CLEar, 254
:DISPlay:PN[1-1]:ALLTrace:PERsistence:CLEar, 254
:DISPlay:PN[1-1]:ANNotation:MARKer:POSition, 254
:DISPlay:PN[1-1]:ANNotation:MEASurement:STATe, 255
:DISPlay:PN[1-1]:GRATICule:AXIS:Y:RELative, 255
:DISPlay:PN[1-1]:GRATICule:AXIS:Y:STATe, 255
:DISPlay:PN[1-1]:LABel:DATA, 256
:DISPlay:PN[1-1]:LABel:STATe, 256
:DISPlay:PN[1-1]:LIMit:FSIGn, 257
:DISPlay:PN[1-1]:MAXimize, 257
:DISPlay:PN[1-1]:STATe, 257
:DISPlay:PN[1-1]:TABLe[:STATe], 258
:DISPlay:PN[1-1]:TRACe[1-1]:LABel:DATA, 258
:DISPlay:PN[1-1]:TRACe[1-1]:LIMit:LINE, 259
:DISPlay:PN[1-1]:TRACe[1-1]:MODE, 259
:DISPlay:PN[1-1]:TRACe[1-1]:PERsistence:CLEar, 260
:DISPlay:PN[1-1]:TRACe[1-1]:PERsistence:STATe, 260
:DISPlay:PN[1-1]:TRACe[1-1]:X[:SCALE]:AUTO, 260
:DISPlay:PN[1-1]:TRACe[1-1]:X[:SCALE]:LEFT, 260
:DISPlay:PN[1-1]:TRACe[1-1]:X[:SCALE]:RIGHT, 261
:DISPlay:PN[1-1]:TRACe[1-1]:Y[:SCALE]:AUTO, 262
:DISPlay:PN[1-1]:TRACe[1-1]:Y[:SCALE]:PDIVision, 262
:DISPlay:PN[1-1]:TRACe[1-1]:Y[:SCALE]:RLEVel, 262
:DISPlay:PN[1-1]:TRACe[1-1]:Y[:SCALE]:RPOSition, 263
:DISPlay:PN[1-1]:Y[:SCALE]:DIVisions, 263
:DISPlay:SKEY:STATe, 263
:DISPlay:SP[1-1]:ALLTrace:PERsistence:CLEar, 264
:DISPlay:SP[1-1]:ANNotation:MARKer:POSition, 264
:DISPlay:SP[1-1]:ANNotation:MEASurement:STATe, 264
:DISPlay:SP[1-1]:GRATICule:AXIS:Y:RELative, 265
:DISPlay:SP[1-1]:GRATICule:AXIS:Y:STATe, 265
:DISPlay:SP[1-1]:LABel:DATA, 266
:DISPlay:SP[1-1]:LABel:STATe, 266
:DISPlay:SP[1-1]:LIMit:FSIGn, 266
:DISPlay:SP[1-1]:MAXimize, 267
:DISPlay:SP[1-1]:STATe, 267
:DISPlay:SP[1-1]:TABLe[:STATe], 268
:DISPlay:SP[1-1]:TRACe[1-1]:LABel:DATA, 268
:DISPlay:SP[1-1]:TRACe[1-1]:LIMit:LINE, 268
:DISPlay:SP[1-1]:TRACe[1-1]:MODE, 269
:DISPlay:SP[1-1]:TRACe[1-1]:PERsistence:CLEar, 269
:DISPlay:SP[1-1]:TRACe[1-1]:PERsistence:STATe, 269
:DISPlay:SP[1-1]:TRACe[1-1]:X[:SCALE]:AUTO, 270
:DISPlay:SP[1-1]:TRACe[1-1]:X[:SCALE]:LEFT, 270
:DISPlay:SP[1-1]:TRACe[1-1]:X[:SCALE]:RIGHT, 271
:DISPlay:SP[1-1]:TRACe[1-1]:Y[:SCALE]:AUTO, 271

- :DISPlay:SP[1-1]:TRACe[1-1]:Y[:SCALe]:PDIVision, 271
- :DISPlay:SP[1-1]:TRACe[1-1]:Y[:SCALe]:RLEVel, 272
- :DISPlay:SP[1-1]:TRACe[1-1]:Y[:SCALe]:RPOSITION, 272
- :DISPlay:SP[1-1]:Y[:SCALe]:DIVisions, 273
- :DISPlay:TR[1-1]:ALLTrace:PERsistence:CLEar, 273
- :DISPlay:TR[1-1]:ALLTrace:Y:SCALe:AUTO, 273
- :DISPlay:TR[1-1]:ANNOtation:MARKer:POSITION, 273
- :DISPlay:TR[1-1]:ANNOtation:MEASurement:STATe, 274
- :DISPlay:TR[1-1]:GRATICule:AXIS:Y:RELATIVE, 274
- :DISPlay:TR[1-1]:GRATICule:AXIS:Y:STATe, 274
- :DISPlay:TR[1-1]:LABel:DATA, 275
- :DISPlay:TR[1-1]:LABel:STATe, 275
- :DISPlay:TR[1-1]:LIMit:FSIGN, 276
- :DISPlay:TR[1-1]:MAXimize, 276
- :DISPlay:TR[1-1]:STATe, 276
- :DISPlay:TR[1-1]:TABLE[:STATe], 277
- :DISPlay:TR[1-1]:TRACe[1-4]:LABel:DATA, 277
- :DISPlay:TR[1-1]:TRACe[1-4]:LIMit:LINE, 278
- :DISPlay:TR[1-1]:TRACe[1-4]:MODE, 278
- :DISPlay:TR[1-1]:TRACe[1-4]:PERsistence:CLEar, 279
- :DISPlay:TR[1-1]:TRACe[1-4]:PERsistence:STATe, 279
- :DISPlay:TR[1-1]:TRACe[1-4]:X[:SCALe]:AUTO, 279
- :DISPlay:TR[1-1]:TRACe[1-4]:X[:SCALe]:LEFT, 279
- :DISPlay:TR[1-1]:TRACe[1-4]:X[:SCALe]:RIGHT, 280
- :DISPlay:TR[1-1]:TRACe[1-4]:Y[:SCALe]:AUTO, 281
- :DISPlay:TR[1-1]:TRACe[1-4]:Y[:SCALe]:PDIVision, 281
- :DISPlay:TR[1-1]:TRACe[1-4]:Y[:SCALe]:RLEVel, 281
- :DISPlay:TR[1-1]:TRACe[1-4]:Y[:SCALe]:RPOSITION, 282
- :DISPlay:TR[1-1]:Y[:SCALe]:DIVisions, 282
- :DISPlay:UPDate:IMMediate, 282
- :DISPlay:USER[1-1]:ALLTrace:PERsistence:CLEar, 283
- :DISPlay:USER[1-1]:ALLTrace:Y:SCALe:AUTO, 283
- :DISPlay:USER[1-1]:ANNOtation:MARKer:POSITION, 283
- :DISPlay:USER[1-1]:ANNOtation:MEASurement:STATe, 283
- :DISPlay:USER[1-1]:GRATICule:AXIS:Y:RELATIVE, 284
- :DISPlay:USER[1-1]:GRATICule:AXIS:Y:STATe, 284
- :DISPlay:USER[1-1]:LABel:DATA, 284
- :DISPlay:USER[1-1]:LABel:STATe, 285
- :DISPlay:USER[1-1]:LIMit:FSIGN, 285
- :DISPlay:USER[1-1]:MAXimize, 286
- :DISPlay:USER[1-1]:STATe, 286
- :DISPlay:USER[1-1]:TABLE[:STATe], 286
- :DISPlay:USER[1-1]:TRACe[1-8]:ANNOtation:DATA, 287
- :DISPlay:USER[1-1]:TRACe[1-8]:LABel:DATA, 287
- :DISPlay:USER[1-1]:TRACe[1-8]:LIMit:LINE, 288
- :DISPlay:USER[1-1]:TRACe[1-8]:MODE, 288
- :DISPlay:USER[1-1]:TRACe[1-8]:PERsistence:STATe, 288
- :DISPlay:USER[1-1]:TRACe[1-8]:STATe, 289
- :DISPlay:USER[1-1]:TRACe[1-8]:X:TYPE, 291
- :DISPlay:USER[1-1]:TRACe[1-8]:X:UNIT, 291
- :DISPlay:USER[1-1]:TRACe[1-8]:X[:SCALe]:AUTO, 289
- :DISPlay:USER[1-1]:TRACe[1-8]:X[:SCALe]:LEFT, 289
- :DISPlay:USER[1-1]:TRACe[1-8]:X[:SCALe]:RIGHT, 290
- :DISPlay:USER[1-1]:TRACe[1-8]:Y:UNIT, 293
- :DISPlay:USER[1-1]:TRACe[1-8]:Y[:SCALe]:AUTO, 291
- :DISPlay:USER[1-1]:TRACe[1-8]:Y[:SCALe]:PDIVision, 291
- :DISPlay:USER[1-1]:TRACe[1-8]:Y[:SCALe]:RLEVel, 292
- :DISPlay:USER[1-1]:TRACe[1-8]:Y[:SCALe]:RPOSITION, 292
- :DISPlay:USER[1-1]:Y[:SCALe]:DIVisions, 293
- :DISPlay:WINDow:ACTive, 294
- :FORMat:BORDER, 295
- :FORMat:DATA, 295
- :HCOPY:ABORT, 296
- :HCOPY:IMAGe, 296
- :HCOPY:IMMediate, 296
- :INITiate:FP[1-1]:CONTinuous, 299
- :INITiate:FP[1-1]:IMMediate, 300
- :INITiate:PN[1-1]:CONTinuous, 300
- :INITiate:PN[1-1]:IMMediate, 300
- :INITiate:SP[1-1]:CONTinuous, 300
- :INITiate:SP[1-1]:IMMediate, 301
- :INITiate:TR[1-1]:CONTinuous, 301
- :INITiate:TR[1-1]:IMMediate, 301
- :MMEMory:CATalog, 301
- :MMEMory:COPY, 302
- :MMEMory:DATA, 302
- :MMEMory:DELeTe, 303
- :MMEMory:FP[1-1]:TRACe[1-4]:LOAD:LIMit:LOWer, 303
- :MMEMory:FP[1-1]:TRACe[1-4]:LOAD:LIMit:UPPer, 304
- :MMEMory:FP[1-1]:TRACe[1-4]:STORE:MEMory, 304
- :MMEMory:FP[1-1]:TRACe[1-4]:STORE[:DATA], 304
- :MMEMory:LOAD:PROGram, 305
- :MMEMory:LOAD:STATe, 306
- :MMEMory:MDIRectory, 306
- :MMEMory:PN[1-1]:TRACe[1-1]:LOAD:LIMit:LOWer, 307
- :MMEMory:PN[1-1]:TRACe[1-1]:LOAD:LIMit:UPPer, 307
- :MMEMory:PN[1-1]:TRACe[1-1]:LOAD:SPURious:THReshold, 307
- :MMEMory:PN[1-1]:TRACe[1-1]:STORE:MEMory, 308
- :MMEMory:PN[1-1]:TRACe[1-1]:STORE[:DATA], 308
- :MMEMory:SP[1-1]:TRACe[1-1]:LOAD:LIMit:LOWer, 309
- :MMEMory:SP[1-1]:TRACe[1-1]:LOAD:LIMit:UPPer, 309
- :MMEMory:SP[1-1]:TRACe[1-1]:STORE:MEMory, 310
- :MMEMory:SP[1-1]:TRACe[1-1]:STORE[:DATA], 309
- :MMEMory:STORE:IMAGe, 310

:MMEMory:STORe:PROGAm, 311
:MMEMory:STORe:STATe, 311
:MMEMory:STORe:STYPe, 311
:MMEMory:TR[1-1]:TRACe[1-4]:LOAD:LIMit:LOWer, 312
:MMEMory:TR[1-1]:TRACe[1-4]:LOAD:LIMit:UPPer, 312
:MMEMory:TR[1-1]:TRACe[1-4]:STORe:MEMory, 313
:MMEMory:TR[1-1]:TRACe[1-4]:STORe[:DATA], 313
:MMEMory:USER[1-1]:TRACe[1-8]:LOAD:LIMit:LOWer, 313
:MMEMory:USER[1-1]:TRACe[1-8]:LOAD:LIMit:UPPer, 314
:MMEMory:USER[1-1]:TRACe[1-8]:STORe:MEMory, 315
:MMEMory:USER[1-1]:TRACe[1-8]:STORe[:DATA], 314
:PROGAm:CATalog, 315
:PROGAm:COM:EVENT, 316
:PROGAm:SELEcted:NAME, 316
:PROGAm:SELEcted:STATe, 316
:PROGAm:SKEY:ITEM[1-8]:ENABLe, 316
:PROGAm:SKEY:ITEM[1-8]:IMMEdiate, 317
:PROGAm:SKEY:ITEM[1-8]:LABel, 317
:PROGAm:VARiABle:ARRAy[1-10]:DATA, 317
:PROGAm:VARiABle:ARRAy[1-10]:POINts, 318
:PROGAm:VARiABle:DOUBle[1-10], 318
:PROGAm:VARiABle:INTeger[1-10], 319
:PROGAm:VARiABle:STRing[1-10], 319
:SENSe:ATTenuation:LEVel, 320
:SENSe:CORRection:POWer:DATA, 320
:SENSe:CORRection:POWer:STATe, 321
:SENSe:DCONverter:IDN, 321
:SENSe:DCONverter:INPut, 321
:SENSe:DCONverter:MANual:CALCulate:LO?, 322
:SENSe:DCONverter:MANual:IFDelta, 323
:SENSe:DCONverter:MANual:IFGain[1-2], 323
:SENSe:DCONverter:MANual:LO[1-2]:FREQuency, 324
:SENSe:DCONverter:MANual:LO[1-2]:LEVel, 325
:SENSe:DCONverter:MANual:MEXTernal[1-2]:BIAS:CURRent, 325
:SENSe:DCONverter:MANual:MEXTernal[1-2]:BIAS:STATe, 326
:SENSe:DCONverter:MEXTernal, 326
:SENSe:DCONverter[:STATe], 327
:SENSe:FP[1-1]:AVERage:CLEar, 327
:SENSe:FP[1-1]:AVERage:COUNT, 328
:SENSe:FP[1-1]:AVERage:STATe, 328
:SENSe:FP[1-1]:DCONverter:FREQuency, 328
:SENSe:FP[1-1]:DCONverter:SSEArch:EXECute, 329
:SENSe:FP[1-1]:FBANd, 329
:SENSe:FP[1-1]:FREQuency:RESolution, 330
:SENSe:FP[1-1]:POWer:INPut:LEVel:MAXimum, 330
:SENSe:FP[1-1]:SWEep:DWELl, 330
:SENSe:FP[1-1]:SWEep:TIME:DATA, 331
:SENSe:PN[1-1]:AVERage:CLEar, 331
:SENSe:PN[1-1]:AVERage:COUNT, 331
:SENSe:PN[1-1]:AVERage:STATe, 332
:SENSe:PN[1-1]:CORRection:COUNT, 332
:SENSe:PN[1-1]:DCONverter:FREQuency, 332
:SENSe:PN[1-1]:DCONverter:SSEArch:EXECute, 333
:SENSe:PN[1-1]:EPRescaler:DIVision, 333
:SENSe:PN[1-1]:EPRescaler:POWer, 334
:SENSe:PN[1-1]:FBANd, 334
:SENSe:PN[1-1]:FREQuency:STARt, 335
:SENSe:PN[1-1]:FREQuency:STOP, 336
:SENSe:PN[1-1]:IFGain, 336
:SENSe:PN[1-1]:LOBandwidth, 337
:SENSe:PN[1-1]:SEGTable[:MEASurement][:QUALity], 337
:SENSe:PN[1-1]:SWEep:POINts, 337
:SENSe:ROSCillator:SOURce, 338
:SENSe:SP[1-1]:AVERage:CLEar, 338
:SENSe:SP[1-1]:AVERage:COUNT, 338
:SENSe:SP[1-1]:AVERage:STATe, 338
:SENSe:SP[1-1]:AVERage:TYPE, 339
:SENSe:SP[1-1]:BANDwidth:RESolution, 339
:SENSe:SP[1-1]:CARRier:FBANd, 340
:SENSe:SP[1-1]:CARRier:SET:CENter, 340
:SENSe:SP[1-1]:DETEctor:FUNction, 341
:SENSe:SP[1-1]:FREQuency:CENter, 341
:SENSe:SP[1-1]:FREQuency:SPAN, 342
:SENSe:SP[1-1]:FREQuency:STARt, 343
:SENSe:SP[1-1]:FREQuency:STOP, 344
:SENSe:SP[1-1]:POWer:RLEVel, 345
:SENSe:SP[1-1]:SWEep:POINts, 345
:SENSe:TR[1-1]:AVERage:CLEar, 345
:SENSe:TR[1-1]:AVERage:COUNT, 345
:SENSe:TR[1-1]:AVERage:STATe, 346
:SENSe:TR[1-1]:NARRow:FREQuency:PREFerence, 346
:SENSe:TR[1-1]:NARRow:FREQuency:RANGe, 347
:SENSe:TR[1-1]:NARRow:FREQuency:TARGet, 348
:SENSe:TR[1-1]:NARRow:SWEep:POINts, 349
:SENSe:TR[1-1]:NARRow:TIME:OFFSet, 349
:SENSe:TR[1-1]:NARRow:TIME:REFerence, 349
:SENSe:TR[1-1]:NARRow:TIME:SPAN, 350
:SENSe:TR[1-1]:POWer:INPut:LEVel:MAXimum, 350
:SENSe:TR[1-1]:WIDE:FREQuency:MAXimum, 350
:SENSe:TR[1-1]:WIDE:SWEep:POINts, 352
:SENSe:TR[1-1]:WIDE:TIME:OFFSet, 352
:SENSe:TR[1-1]:WIDE:TIME:REFerence, 353
:SENSe:TR[1-1]:WIDE:TIME:SPAN, 353
:SENSe:UDCONverter:HARMonic, 353
:SENSe:UDCONverter:LO, 354
:SENSe:UDCONverter:MODE, 355
:SENSe:UDCONverter:STATe, 356
:SOURce:FP[1-1]:SWEep:PARAmeter, 356
:SOURce:FP[1-1]:SWEep:POINts, 356
:SOURce:FP[1-1]:VOLTage:CONTRol:CENter, 357
:SOURce:FP[1-1]:VOLTage:CONTRol:SPAN, 357
:SOURce:FP[1-1]:VOLTage:CONTRol:STARt, 358
:SOURce:FP[1-1]:VOLTage:CONTRol:STOP, 358
:SOURce:FP[1-1]:VOLTage:POWer:CENter, 359
:SOURce:FP[1-1]:VOLTage:POWer:SPAN, 359

:SOURce:FP[1-1]:VOLTage:POWer:STARt, 360
 :SOURce:FP[1-1]:VOLTage:POWer:STOP, 360
 :SOURce:VOLTage:CONTRol:AFC:FBANd, 360
 :SOURce:VOLTage:CONTRol:AFC:IMMediate, 361
 :SOURce:VOLTage:CONTRol:AFC:INPut:LEVel:MAXImum, 362
 :SOURce:VOLTage:CONTRol:AFC:ITERation, 362
 :SOURce:VOLTage:CONTRol:AFC:LIMit:HIGH, 363
 :SOURce:VOLTage:CONTRol:AFC:LIMit:LOW, 363
 :SOURce:VOLTage:CONTRol:AFC:SENSitivity, 364
 :SOURce:VOLTage:CONTRol:AFC:TARGet, 365
 :SOURce:VOLTage:CONTRol:AFC:TOLerance, 366
 :SOURce:VOLTage:CONTRol:AFC[:STATe], 364
 :SOURce:VOLTage:CONTRol:CORRection:COLLect:ACQuire, 366
 :SOURce:VOLTage:CONTRol:CORRection[:STATe], 367
 :SOURce:VOLTage:CONTRol:DELay, 367
 :SOURce:VOLTage:CONTRol:LEVel:AMPLitude, 367
 :SOURce:VOLTage:CONTRol:LEVel:STATe, 368
 :SOURce:VOLTage:CONTRol:LIMit:HIGH, 368
 :SOURce:VOLTage:CONTRol:LIMit:LOW, 369
 :SOURce:VOLTage:POWer:DELay, 370
 :SOURce:VOLTage:POWer:LEVel:AMPLitude, 370
 :SOURce:VOLTage:POWer:LEVel:STATe, 371
 :SOURce:VOLTage:POWer:LIMit:HIGH, 371
 :SOURce:VOLTage:POWer:LIMit:LOW, 372
 :STATus:OPERation:BIT12:CLEar, 372
 :STATus:OPERation:BIT12:CONDition, 372
 :STATus:OPERation:BIT12:ENABle, 373
 :STATus:OPERation:BIT12:NTRansition, 373
 :STATus:OPERation:BIT12:PTRansition, 374
 :STATus:OPERation:BIT12:SET, 374
 :STATus:OPERation:BIT12[:EVENT], 373
 :STATus:OPERation:CONDition, 374
 :STATus:OPERation:ENABle, 375
 :STATus:OPERation:NTRansition, 375
 :STATus:OPERation:PTRansition, 376
 :STATus:OPERation[:EVENT], 375
 :STATus:PRESet, 376
 :STATus:QUEStionable:CONDition, 376
 :STATus:QUEStionable:CURREnt:ENABle, 376
 :STATus:QUEStionable:CURREnt[:EVENT], 377
 :STATus:QUEStionable:DCONverter:ENABle, 377
 :STATus:QUEStionable:DCONverter[:EVENT], 377
 :STATus:QUEStionable:ENABle, 377
 :STATus:QUEStionable:LIMit:CONDition, 378
 :STATus:QUEStionable:LIMit:ENABle, 378
 :STATus:QUEStionable:LIMit:FP[1-1]:CONDition, 379
 :STATus:QUEStionable:LIMit:FP[1-1]:ENABle, 379
 :STATus:QUEStionable:LIMit:FP[1-1]:NTRansition, 379
 :STATus:QUEStionable:LIMit:FP[1-1]:PTRansition, 380
 :STATus:QUEStionable:LIMit:FP[1-1][:EVENT], 379
 :STATus:QUEStionable:LIMit:NTRansition, 380
 :STATus:QUEStionable:LIMit:PN[1-1]:CONDition, 381
 :STATus:QUEStionable:LIMit:PN[1-1]:ENABle, 381
 :STATus:QUEStionable:LIMit:PN[1-1]:NTRansition, 381
 :STATus:QUEStionable:LIMit:PN[1-1]:PTRansition, 382
 :STATus:QUEStionable:LIMit:PN[1-1][:EVENT], 381
 :STATus:QUEStionable:LIMit:PTRansition, 382
 :STATus:QUEStionable:LIMit:SP[1-1]:CONDition, 383
 :STATus:QUEStionable:LIMit:SP[1-1]:ENABle, 383
 :STATus:QUEStionable:LIMit:SP[1-1]:NTRansition, 383
 :STATus:QUEStionable:LIMit:SP[1-1]:PTRansition, 384
 :STATus:QUEStionable:LIMit:SP[1-1][:EVENT], 383
 :STATus:QUEStionable:LIMit:TR[1-1]:CONDition, 384
 :STATus:QUEStionable:LIMit:TR[1-1]:ENABle, 384
 :STATus:QUEStionable:LIMit:TR[1-1]:NTRansition, 385
 :STATus:QUEStionable:LIMit:TR[1-1]:PTRansition, 385
 :STATus:QUEStionable:LIMit:TR[1-1][:EVENT], 385
 :STATus:QUEStionable:LIMit:USER[1-1]:CONDition, 386
 :STATus:QUEStionable:LIMit:USER[1-1]:ENABle, 386
 :STATus:QUEStionable:LIMit:USER[1-1]:NTRansition, 387
 :STATus:QUEStionable:LIMit:USER[1-1]:PTRansition, 387
 :STATus:QUEStionable:LIMit:USER[1-1][:EVENT], 386
 :STATus:QUEStionable:LIMit[:EVENT], 379
 :STATus:QUEStionable:MISC:ENABle, 387
 :STATus:QUEStionable:MISC[:EVENT], 388
 :STATus:QUEStionable:NTRansition, 388
 :STATus:QUEStionable:PHASe:ENABle, 388
 :STATus:QUEStionable:PHASe[:EVENT], 389
 :STATus:QUEStionable:POWer:ENABle, 389
 :STATus:QUEStionable:POWer[:EVENT], 389
 :STATus:QUEStionable:PTRansition, 390
 :STATus:QUEStionable:REFERence:ENABle, 390
 :STATus:QUEStionable:REFERence[:EVENT], 390
 :STATus:QUEStionable[:EVENT], 378
 :SYSTem:BACKlight:STATe, 391
 :SYSTem:BEEPer:COMPLete:IMMediate, 391
 :SYSTem:BEEPer:COMPLete:STATe, 391
 :SYSTem:BEEPer:WARning:IMMediate, 392
 :SYSTem:BEEPer:WARning:STATe, 392
 :SYSTem:DATE, 393
 :SYSTem:ERRor[:NEXT], 393
 :SYSTem:KLOCK:KBD, 393
 :SYSTem:KLOCK:MOUSE, 394
 :SYSTem:POFF, 394
 :SYSTem:PRESet, 394
 :SYSTem:TIME, 395
 :TRIGger:AVERage, 396
 :TRIGger:EXTernal:SLOPe, 396
 :TRIGger:FP[1-1]:MODE, 397
 :TRIGger:FP[1-1]:SOURce, 397
 :TRIGger:MODE, 398
 :TRIGger:PN[1-1]:SOURce, 398
 :TRIGger:SOPC, 399
 :TRIGger:SP[1-1]:SOURce, 399
 :TRIGger:TR[1-1]:ETTAdjust, 400
 :TRIGger:TR[1-1]:NARRow:VIDeo:FREQuency:CENTer, 400
 :TRIGger:TR[1-1]:NARRow:VIDeo:THReshold, 401
 :TRIGger:TR[1-1]:SOURce, 401

.TRIGger:TR[1-1]:WIDE:VIDeo:FREQuency:CENTer,
402
serial poll, 516
service request, 90, 516
service request, 60
SICL-LAN server, 36
SRQ, 60, 90, 516
Standard Event Status Register, 526
Standard event status register, 527
Status byte register, 517, 526
status byte register, 516
status register, 90
Status Register Model, 516
Status register structure, 519
Status reporting system, 516
Staus Register, 60
suffix, 510
sweep completion signal, 540
Syntax, 96

T

telnet server, 41
throughput, 89
Timing Chart, 545
Transferring files, 84
Transition filter, 518
Trigger system, 54
Triggering the instrument, 58
Types of Remote Control Systems, 32

U

Unformatted data arrays, 74
Unformatted memory arrays, 74
USB remote control system, 44
User's Guide, 3
Using the error queue, 90
Using the Status Reporting System, 535
Using the status reporting system, 90

V

VBA Programmer's Guide, 3
VEE, 43
Video trigger narrow band, 56
Video trigger wide band, 56
Visual Basic, 43

W

Waiting for the End of Measurement, 60
Waiting for Trigger State, 56
Warning Message, 557
write strobe signal, 540

X

X-axis Data Arrays, 75

REGIONAL SALES AND SUPPORT OFFICES

For more information about Agilent Technologies test and measurement products, applications, services, and for a current sales office listing, visit our web site: <http://www.agilent.com/find/tmdir>. You can also contact one of the following centers and ask for a test and measurement sales representative. 21/01/2004

United States:

Test and Measurement Call Center
(tel) 1 800 452-4844
(fax) 1 888 900-8921

Australia/New Zealand:

(tel) (61 3) 9210-5555 (Australia)
(fax) (61 3) 9210-5899
(tel) (64 4) 939-0636 (New Zealand)
(fax) (64 4) 972-5364

Canada:

Test and Measurement Call Center
(tel) 1 877 894-4414
(fax) 1 888 900-8921

Asia Pacific:

(tel) (65) 6375-8100
(fax) (65) 6836-0252
Email: tm_asia@agilent.com

China:

(tel) 800 810-0189
(fax) 800 820-2816

Europe:

(tel) (31 20) 547-2323
(fax) (31 20) 547-2390

Japan:

Call Center
(tel) 0120 421-345
(tel) (81) 426 56-7832
(fax) (81) 426 56-7840

Korea:

(tel) (82 2) 2004-5004
(fax) (82 2) 2004-5115

Latin America:

(tel) (305) 269-7500
(fax) (305) 269-7599

Taiwan:

(tel) 0800 047 866
(fax) 0800 286 331