

# Keysight N4985A System Amplifiers



Operating and  
Service Manual

# Notices

## Copyright Notice

© Keysight Technologies 2013-2019  
No part of this manual may be reproduced in any form or by any means (including electronic storage and retrieval or translation into a foreign language) without prior agreement and written consent from Keysight Technologies as governed by United States and international copyright laws.

## Manual Part Number

N4985-90001

## Edition

Edition 4, May 7, 2019

## Printed in:

Printed in Malaysia

## Published by:

Keysight Technologies  
Bayan Lepas Free Industrial Zone,  
11900 Penang, Malaysia

## Technology Licenses

The hardware and/or software described in this document are furnished under a license and may be used or copied only in accordance with the terms of such license.

## Declaration of Conformity

Declarations of Conformity for this product and for other Keysight products may be downloaded from the Web. Go to <http://www.keysight.com/go/conformity>. You can then search by product number to find the latest Declaration of Conformity.

## U.S. Government Rights

The Software is “commercial computer software,” as defined by Federal Acquisition Regulation (“FAR”) 2.101. Pursuant to FAR 12.212 and 27.405-3 and Department of Defense FAR Supplement (“DFARS”) 227.7202, the U.S. government acquires commercial computer software under the same terms by which the software is customarily provided to the public. Accordingly, Keysight provides the Software to U.S. government customers under its standard commercial license, which is embodied in its End User License Agreement (EULA), a copy of which can be found at <http://www.keysight.com/find/sweula>. The license set forth in the EULA represents the exclusive authority by which the U.S. government may use, modify, distribute, or disclose the Software. The EULA and the license set forth therein, does not require or permit, among other things, that Keysight: (1) Furnish technical information related to commercial computer software or commercial computer software documentation that is not customarily provided to the public; or (2) Relinquish to, or otherwise provide, the government rights in excess of these rights customarily provided to the public to use, modify, reproduce, release, perform, display, or disclose commercial computer software or commercial computer software documentation. No additional government requirements beyond those set forth in the EULA shall apply, except to the extent that those terms, rights, or licenses are explicitly required from all providers of commercial computer software pursuant to the FAR and the DFARS and are set forth specifically in writing elsewhere in the EULA. Keysight shall be under no obligation to update, revise or otherwise modify the Software. With respect to any technical data as defined by FAR 2.101, pursuant to FAR 12.211 and 27.404.2 and DFARS 227.7102, the U.S. government acquires no greater than Limited Rights as defined in FAR 27.401 or DFAR 227.7103-5 (c), as applicable in any technical data.

## Warranty

THE MATERIAL CONTAINED IN THIS DOCUMENT IS PROVIDED “AS IS,” AND IS SUBJECT TO BEING CHANGED, WITHOUT NOTICE, IN FUTURE EDITIONS. FURTHER, TO THE MAXIMUM EXTENT PERMITTED BY APPLICABLE LAW, KEYSIGHT DISCLAIMS ALL WARRANTIES, EITHER EXPRESS OR IMPLIED, WITH REGARD TO THIS MANUAL AND ANY INFORMATION CONTAINED HEREIN, INCLUDING BUT NOT LIMITED TO THE IMPLIED WARRANTIES OF MERCHANTABILITY AND FITNESS FOR A PARTICULAR PURPOSE. KEYSIGHT SHALL NOT BE LIABLE FOR ERRORS OR FOR INCIDENTAL OR CONSEQUENTIAL DAMAGES IN CONNECTION WITH THE FURNISHING, USE, OR PERFORMANCE OF THIS DOCUMENT OR FOR ANY INFORMATION CONTAINED HEREIN. SHOULD KEYSIGHT AND THE USER HAVE A SEPARATE WRITTEN AGREEMENT WITH WARRANTY TERMS COVERING THE MATERIAL IN THIS DOCUMENT THAT CONFLICT WITH THESE TERMS, THE WARRANTY TERMS IN THE SEPARATE AGREEMENT SHALL CONTROL.

## Safety Information

### CAUTION

A CAUTION notice denotes a hazard. It calls attention to an operating procedure, practice, or the like that, if not correctly performed or adhered to, could result in damage to the product or loss of important data. Do not proceed beyond a CAUTION notice until the indicated conditions are fully understood and met.

### WARNING

A WARNING notice denotes a hazard. It calls attention to an operating procedure, practice, or the like that, if not correctly performed or adhered to, could result in personal injury or death. Do not proceed beyond a WARNING notice until the indicated conditions are fully understood and met.

# Compliance Notices and Regulatory Information

## Compliance with Electromagnetic Compatibility (EMC)







This product conforms with the protection requirements of EMC Directive 2004/108/EC for Electromagnetic Compatibility.

This product complies to the EMC Directive by assessment according to the IEC/EN61326-1:2005 EMC standard.

In order to preserve the EMC performance of this product, any cable which becomes worn or damaged must be replaced with the same type and specifications.

This is a sensitive measurement apparatus by design and may have some performance loss (sidebands up to -60dBc, and loss of gain up to 18dB) when exposed to ambient continuous electromagnetic phenomenon in the range of 80MHz-6GHz when tested per IEC 61000-4-3.

## Regulatory markings

 <p>The CE mark is a registered trademark of the European Community. This CE mark shows that the product complies with all the relevant European Legal Directives.</p>	<p>The CE mark is a registered trademark of the European Community. This CE mark shows that the product complies with all the relevant European Legal Directives.</p>  <p>ICES/NMB-001 indicates that this ISM device complies with the Canadian ICES-001. Cet appareil ISM est conforme a la norme NMB-001 du Canada. ISM GRP.1 Class A indicates that this is an Industrial Scientific and Medical Group 1 Class A product.</p>
 <p>The RCM mark is a registered trademark of the Australian Communications and Media Authority.</p>	 <p>This symbol indicates the time period during which no hazardous or toxic substance elements are expected to leak or deteriorate during normal use. Forty years is the expected useful life of the product.</p>
<p><b>South Korean Class A EMC declaration:</b></p> <p>This equipment is Class A suitable for professional use and is for use in electromagnetic environments outside of the home.</p>  <p>KCC-ERM-ABC-XXXXXXXXXXXXXXXXXX</p> <p>A급 기기 (업무용 방송통신기자재)</p> <p>이 기기는 업무용(A급) 전자파적합기기로서 판매자 또는 사용자는 이 점을 주의하시기 바라며, 가정외의 지역에서 사용하는 것을 목적으로 합니다.</p>	 <p>This instrument complies with the WEEE Directive (2002/96/EC) marking requirement. This affixed product label indicates that you must not discard this electrical or electronic product in domestic household waste.</p>

## Waste Electrical and Electronic Equipment (WEEE) Directive 2002/96/EC

This instrument complies with the WEEE Directive (2002/96/EC) marking requirement. This affixed product label indicates that you must not discard this electrical or electronic product in domestic household waste.

### Product category

With reference to the equipment types in the WEEE directive Annex 1, this instrument is classified as a “Monitoring and Control Instrument” product.

The affixed product label is as shown below.



Do not dispose in domestic household waste.

To return this unwanted instrument, contact your nearest Keysight Service Center, or visit <http://about.keysight.com/en/companyinfo/environment/takeback.shtml> for more information.

## Sales and Technical Support

To contact Keysight for sales and technical support, refer to the support links on the following Keysight websites:

- [www.keysight.com/find/mta](http://www.keysight.com/find/mta)  
(product-specific information and support, software and documentation updates)
- [www.keysight.com/find/assist](http://www.keysight.com/find/assist)  
(worldwide contact information for repair and service)

THIS PAGE HAS BEEN INTENTIONALLY LEFT BLANK.

# Table of Contents

Compliance Notices and Regulatory Information	3
Compliance with Electromagnetic Compatibility (EMC)	3
Regulatory markings	4
Waste Electrical and Electronic Equipment (WEEE) Directive 2002/96/EC	5
Product category	5
Sales and Technical Support	5
<b>1 Introduction</b>	
Product Overview	14
Features of the Keysight N4985A amplifiers	16
Applications	17
<b>2 Installation</b>	
Initial Inspection	20
Service and Recalibration	21
Related Documentation	21
Operating and Safety Precautions	22
ESD damage	22
Connector care	22
<b>3 Specifications</b>	
General Specifications	26
Specifications	26
Supplementary Specifications	41
Physical Specifications	41
Mechanical Dimensions	42
<b>4 Operating Guide</b>	
Operating Instructions	46
Performance verification	46

Example Application .....	47
Service and Maintenance .....	48
Service .....	48
Maintenance .....	48



## List of Figures

Figure 1-1	Keysight N4985A-S30/N4985A-S50 amplifier	14
Figure 1-2	Keysight N4985A-P15/N4985A-P25 amplifier	15
Figure 3-1	Small signal parameters versus frequency (for N4985A-S30)	27
Figure 3-2	Gain versus output power ( $P_{1dB}$ indicated with *) [for N4985A-S30]	28
Figure 3-3	Saturated output power (for N4985A-S30)	28
Figure 3-4	N4985A-OA3 ( $2^{31} - 1$ ) EYE: >7 V output (1.5 V/div)	29
Figure 3-5	N4985A-OA3 ( $2^{31} - 1$ ) EYE: <500 fs added rms jitter (5 ps/div)	29
Figure 3-6	N4985A-OA3 ( $2^{31} - 1$ ) EYE: <10 ps Tf/Tf (5 ps/div)	30
Figure 3-7	N4985A-OA3 ( $2^{31} - 1$ ) EYE: Input signal from PRBS generator	30
Figure 3-8	Small signal parameters versus frequency (for N4985A-S50)	31
Figure 3-9	Gain versus output power ( $P_{1dB}$ indicated with *) [for N4985A-S50]	31
Figure 3-10	Saturated output power (for N4985A-S50)	32
Figure 3-11	Input pulse = Ch3, 420 m Vppk, 10.4 pS rise time, Output pulse = Ch4, 6.5 Vppk, 11.0 pS rise time (for N4985A-S50)	32
Figure 3-12	N4985A-OA5 ( $2^{31} - 1$ ) EYE: >7 V output (1.5 V/div)	33
Figure 3-13	N4985A-OA5 ( $2^{31} - 1$ ) EYE: <500 fs added rms jitter (5 ps/div)	33
Figure 3-14	N4985A-OA5 ( $2^{31} - 1$ ) EYE: <10 ps Tf/Tf (5 ps/div)	34
Figure 3-15	N4985A-OA5 ( $2^{31} - 1$ ) EYE: Input signal from PRBS generator	34
Figure 3-16	Typical N4985A-P15 performance (S21)	37
Figure 3-17	Typical N4985A-P15 performance (group delay)	37
Figure 3-18	Typical N4985A-P15 performance (S11, S22)	38
Figure 3-19	Typical N4985A-P15 performance (saturated output power)	38
Figure 3-20	Typical N4985A-P25 performance (S21)	39
Figure 3-21	Typical N4985A-P25 performance (group delay)	39

Figure 3-22	Typical N4985A-P25 performance (S11, S22) . . . . .	40
Figure 3-23	Typical N4985A-P25 performance (saturated output power) . . . . .	40
Figure 3-24	Mechanical dimensions of the N4985A-S30/N4985A-S50 amplifier . . . . .	42
Figure 3-25	Mechanical dimensions of the N4985A-P15/N4985A-P25 amplifier . . . . .	43
Figure 4-1	Verification setup with a power splitter . . . . .	46
Figure 4-2	Verification setup with a calibrated coupler . . . . .	46
Figure 4-3	Example of an amplified RF power measurement system 47	

## List of Tables

Table 3-1	N4985A-S30 and N4985A-S50 specifications	26
Table 3-2	Additional specifications for N4985A-OA3	27
Table 3-3	Additional specifications for N4985A-OA5	27
Table 3-4	N4985A-P15 and N4985A-P25 specifications	35
Table 3-5	Supplementary specifications for the N4985A amplifiers	41
Table 3-6	Physical specifications for the N4985A amplifiers	41

THIS PAGE HAS BEEN INTENTIONALLY LEFT BLANK.

# 1 Introduction

Product Overview 14

This chapter provides an overview of the N4985A system amplifiers.

## Product Overview

### High performance broadband RF amplifier

The N4985A-S30 and N4985A-S50 system amplifiers are high performance, broadband amplifiers featuring baseband RF (<100 kHz) through millimeter wave frequency coverage. These amplifiers, which have many uses in research, development, or production-line environment, are a useful addition to the laboratory where RF, microwave, or millimeter wave measurements are made. Typical applications include:

- RF source amplifier.
- Mixer LO amplifier.
- Noise figure LNA and noise figure system amplifier.
- Pulse amplifier and time domain applications.
- Digital communication systems.
- Antenna research and development.
- General purpose RF gain block.

N4985A-S30 amplifier



N4985A-S50 amplifier



**Figure 1-1** Keysight N4985A-S30/N4985A-S50 amplifier

## High performance system amplifier

The N4985A-P15 and N4985A-P25 are high performance, broadband amplifiers with excellent power and gain up to 50 GHz, which have many uses in research, development, or production-line environment. These amplifiers are a useful addition to the laboratory where RF, microwave, or millimeter wave measurements are made. Typical applications include:

- Driver for high power amplifiers such as TWT or linear power amplifiers.
- Overcome system losses such as long transmission lines, power dividers, etc.
- Antenna research and development; antenna characterization systems.
- Broadband RF characterization.

N4985A-P15 amplifier



N4985A-P25 amplifier



Figure 1-2 Keysight N4985A-P15/N4985A-P25 amplifier

## Features of the Keysight N4985A amplifiers

The N4985A is a high performance amplifier featuring broadband frequency coverage.

Model	Frequency range	Gain
N4985A-S30	100 kHz to 30 GHz	30 dB
N4985A-S50	100 kHz to 50 GHz	30 dB
N4985A-P15	10 MHz to 50 GHz	25 dB
N4985A-P25	2 GHz to 50 GHz	27 dB

### N4985A-S30 and N4985A-S50

- The amplifier is designed to be a multi-use laboratory RF amplifier as a gain block for frequency domain applications or as a time domain pulse amplifier.
- The amplifier's small size and versatile performance make it an excellent selection as a general purpose gain block with moderate power output in a single package potentially replacing two or three narrower band amplifiers.

### N4985A-P15 and N4985A-P25

- The amplifier is designed to be easily used in laboratory and test applications.
- It is small in size and has built-in bias power supplies allowing close placement to the measurement or source reference plane. Its high gain helps to compensate for system losses such as long transmission lines and system components.



## Applications

The N4985A-S30 and N4985A-S50 system amplifiers are an often needed companion to synthesized signal generators and microwave sources. The small size of the amplifiers allows close placement to the DUT or test fixture. High gain and greater than 20 dBm output power will overcome long cable losses from the signal source and provide the additional output power needed in many development and test applications.

The N4985A-P15 and N4985A-P25 are test amplifiers designed for broadband power and gain applications. It is ideally suited for saturated RF amplifier testing, driving TWT amplifiers, or as an antenna system amplifier. High gain and typically 22 dBm output power at 50 GHz will overcome long cable losses from the signal source, and will provide additional power required in many development and test applications.

THIS PAGE HAS BEEN INTENTIONALLY LEFT BLANK.

## 2 Installation

Initial Inspection	20
Service and Recalibration	21
Related Documentation	21
Operating and Safety Precautions	22

This chapter provides you important information on how to check and prepare your instrument for operation.

## Initial Inspection

- 1** Unpack and inspect the shipping container and its contents thoroughly to ensure that nothing was damaged during shipment. If the shipping container or cushioning material is damaged, the contents should be checked both mechanically and electrically. Check for mechanical damage such as scratches or dents. Procedures for checking electrical performance are given under “[Performance verification](#)” on page 46.
- 2** If the contents are damaged or defective, contact your nearest Keysight Technologies Service and Support office. Refer to “[Sales and Technical Support](#)” on page 5 of this manual. Keysight Technologies will arrange for repair or replacement of the damaged or defective equipment. Keep the shipping materials for the carrier’s inspection.
- 3** If you are returning the instrument under warranty or for service, repackaging the instrument requires original shipping containers and materials or their equivalents. Keysight Technologies can provide packaging materials identical to the original materials. Refer to “[Sales and Technical Support](#)” on page 5 of this manual for the Keysight Technologies nearest to you. Attach a tag indicating the type of service required, return address, model number, and serial number. Mark the container **FRAGILE** to insure careful handling. In any correspondence, refer to the instrument by model number and serial number.

## Service and Recalibration

If your N4985A amplifiers require service or repair, contact the nearest Keysight office for information on where to send it. Refer to “Sales and Technical Support” on page 5 of this manual. The performance of the N4985A can only be verified by specially-manufactured equipment and calibration standards from Keysight. The recommended interval for recalibration is 12 months.

## Related Documentation

This Operating and Service Manual is shipped with the product. It is also available at [www.keysight.com/find/mta](http://www.keysight.com/find/mta).

## Operating and Safety Precautions

Observe the following guidelines before connecting or operating the N4985A system amplifiers.

### ESD damage

Protection against electrostatic discharge (ESD) is important while handling and operating the N4985A.

Static electricity can build up on your body and can easily damage sensitive components when discharged.

Static discharges too small to be felt can cause permanent damage to the unit.

To prevent damage from ESD:

- **Use** a grounded antistatic mat in front of your test equipment and wear a grounded wrist strap attached to it when handling or operating the N4985A.
- **Wear** a heel strap when working in an area with a conductive floor.
- **Ground** yourself before you clean, inspect, or make a connection to the N4985A. You can, for example, grasp the grounded outer shell of the analyzer test port or cable connector briefly.
- **Avoid** touching the exposed connector pins.

### Connector care

Because connectors can become defective due to wear during normal use, all connectors should be inspected and maintained to maximize their service life.

- Inspect the mating surface each time a connection is made. Metal particles from connector threads often find their way onto the mating surface when a connection is made or disconnected.
- Clean dirt and contamination from the connector mating surface and threads. This simple step can extend the service life of the connector and improve the quality of your calibration and measurements.
- Gage connectors periodically. This not only provides assurance of proper mechanical tolerances and thus connector performance, but can also indicate situations where the potential for damage to another connector may exist.

**CAUTION**

The N4985A can be damaged if excessive torque is applied to the connectors.

The recommended torque value is 8 lb-in torque for 2.4 mm and 2.92 mm, 5 lb-in torque for 1.85 mm DCA sampling head.

---

THIS PAGE HAS BEEN INTENTIONALLY LEFT BLANK.



# 3 Specifications

General Specifications	26
Supplementary Specifications	41
Physical Specifications	41
Mechanical Dimensions	42

This chapter provides the specifications of the N4985A system amplifiers.

## General Specifications

### Specifications

Specifications refer to the performance standards or limits against which the N4985A is tested.

*Typical characteristics are included for additional information only and they are not specifications. These are denoted as “typical”, “nominal”, or “approximate” and are printed in italics.*

**Table 3-1** N4985A-S30 and N4985A-S50 specifications

Specification	N4985A-S30		N4985A-S50	
Frequency	100 kHz to 30 GHz		100 kHz to 50 GHz	
Gain (dB)	30 dB		30 dB	
Small signal gain	27 (min), 30 (typ)	1 GHz to 26 GHz	27 (min), 30 (typ) 24 (min), 27 (typ)	1 GHz to 26 GHz 26 GHz to 45 GHz
Output power (at $P_{\text{sat}}$ ) (dB)	20 (min), 22 (typ)	100 kHz to 26 GHz	20 (min), 22 (typ) 20 (typ) 17 (typ)	100 kHz to 26 GHz 26 GHz to 40 GHz 40 GHz to 50 GHz
Input match $S_{11}$ (dB)	-10 (typ)	1 GHz to 26 GHz	-10 (typ) -8 (typ)	1 GHz to 26 GHz 26 GHz to 45 GHz
Output match $S_{22}$ (dB)	-10 (typ)	1 GHz to 26 GHz	-10 (typ) -8 (typ)	1 GHz to 26 GHz 26 GHz to 45 GHz
Noise figure (dBm)	5 (typ)	2 GHz to 30 GHz	5 (typ) 6 (typ)	2 GHz to 3 GHz 30 GHz to 40 GHz
2nd harmonics $H_2$ (dBc) @ $P_1$	-30 (typ)	2 GHz to 25 GHz	-30 (typ)	2 GHz to 25 GHz

**Table 3-2** Additional specifications for N4985A-OA3

	Description	Minimum	Typical	Maximum
S21 (V)	Output eye amplitude	7	7.5	–
	Input eye amplitude	–	0.5	–
S21 (ps)	Jitter additive (rms)	–	< 0.5	< 1
Tr/Tf (ps)	Rise/fall time	–	< 8	< 10

**Table 3-3** Additional specifications for N4985A-OA5

	Description	Minimum	Typical	Maximum
S21 (V)	Output eye amplitude	7	7.5	–
	Input eye amplitude	–	0.5	–
S21 (ps)	Jitter additive (rms)	–	< 0.5	< 1
Tr/Tf (ps)	Rise/fall time	–	< 8	< 10

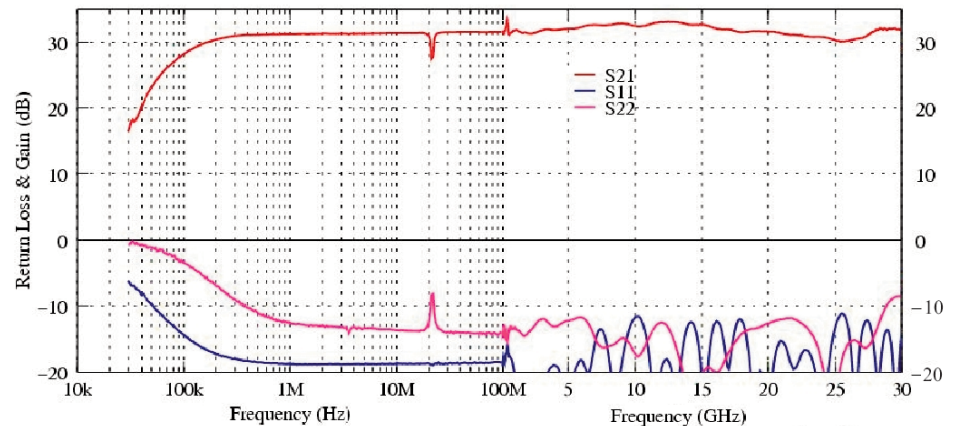

**Figure 3-1** Small signal parameters versus frequency (for N4985A-S30)

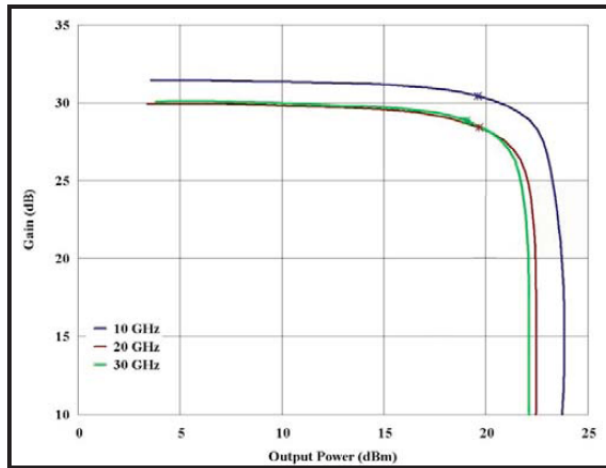

**Figure 3-2** Gain versus output power ( $P_{1dB}$  indicated with \*) [for N4985A-S30]

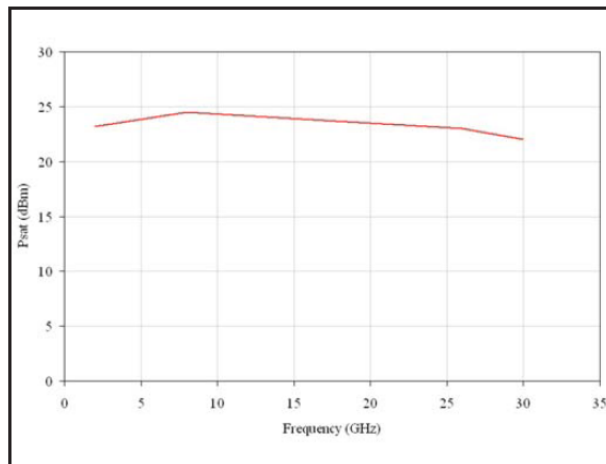

**Figure 3-3** Saturated output power (for N4985A-S30)

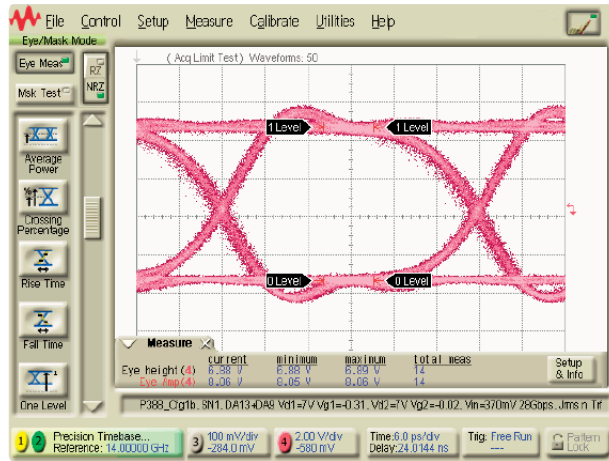

Figure 3-4 N4985A-OA3 ( $2^{31} - 1$ ) EYE: >7 V output (1.5 V/div)

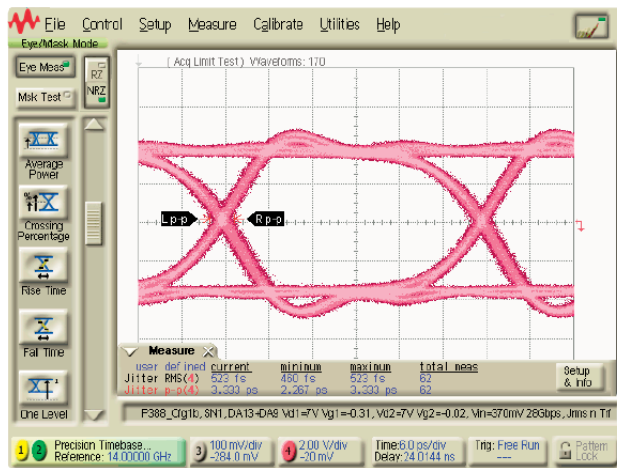

Figure 3-5 N4985A-OA3 ( $2^{31} - 1$ ) EYE: <500 fs added rms jitter (5 ps/div)

### 3 Specifications

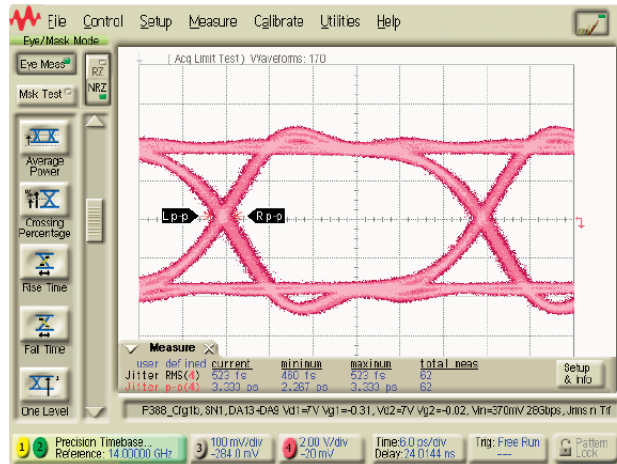

Figure 3-6 N4985A-OA3 ( $2^{31} - 1$ ) EYE: <10 ps Tf/Tf (5 ps/div)

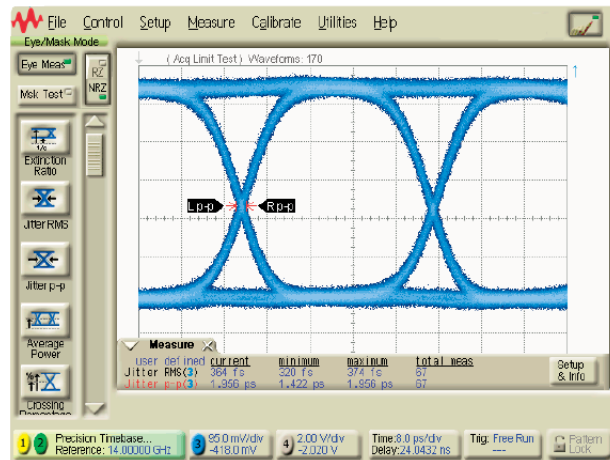
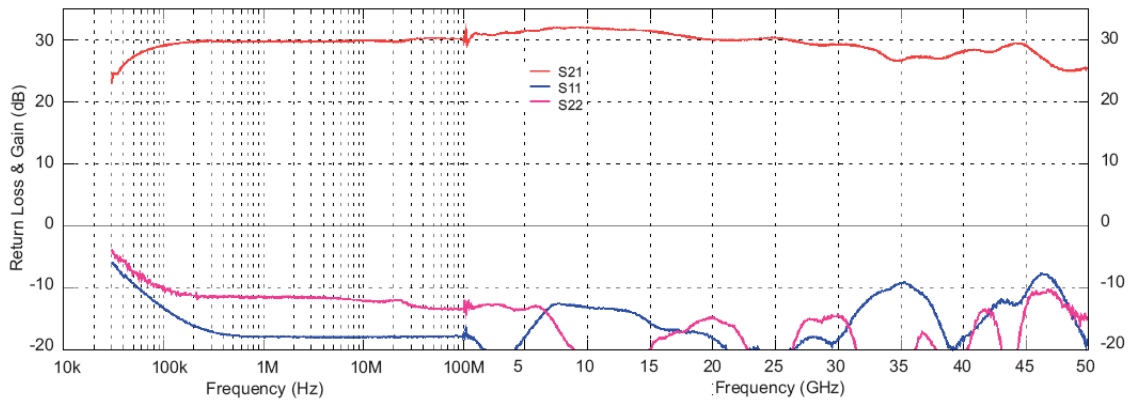
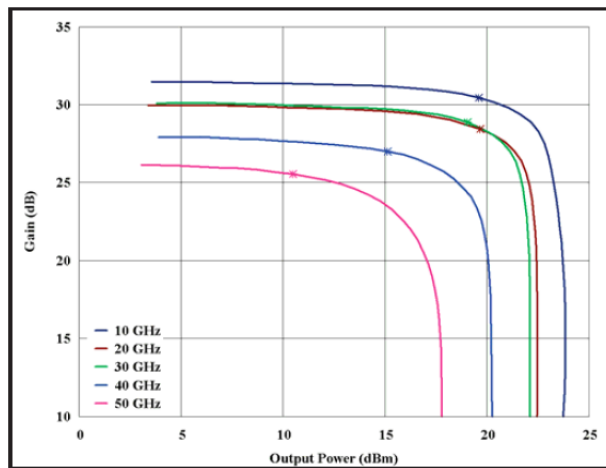

Figure 3-7 N4985A-OA3 ( $2^{31} - 1$ ) EYE: Input signal from PRBS generator



**Figure 3-8** Small signal parameters versus frequency (for N4985A-S50)



**Figure 3-9** Gain versus output power ( $P_{1dB}$  indicated with \*) [for N4985A-S50]

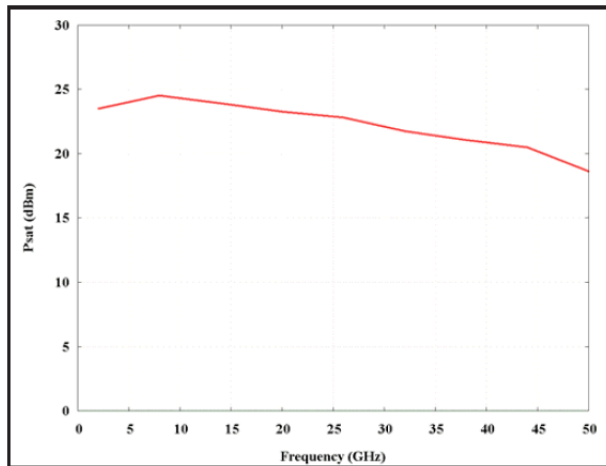

Figure 3-10 Saturated output power (for N4985A-S50)

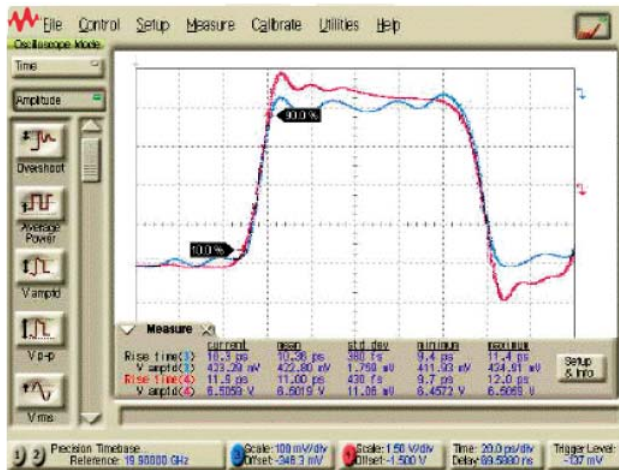

Figure 3-11 Input pulse = Ch3, 420 m Vppk, 10.4 pS rise time, Output pulse = Ch4, 6.5 Vppk, 11.0 pS rise time (for N4985A-S50)



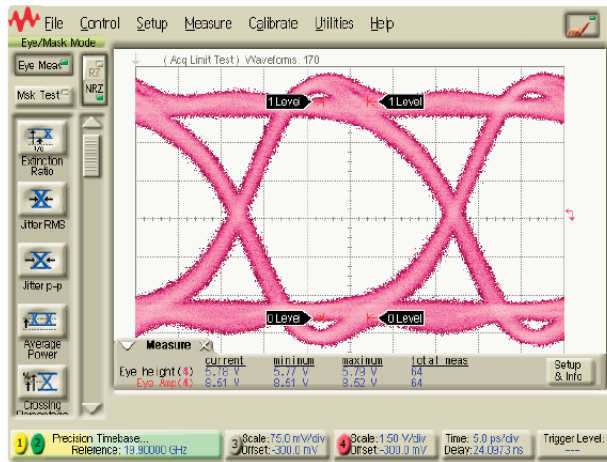

Figure 3-12 N4985A-OA5 ( $2^{31} - 1$ ) EYE: >7 V output (1.5 V/div)

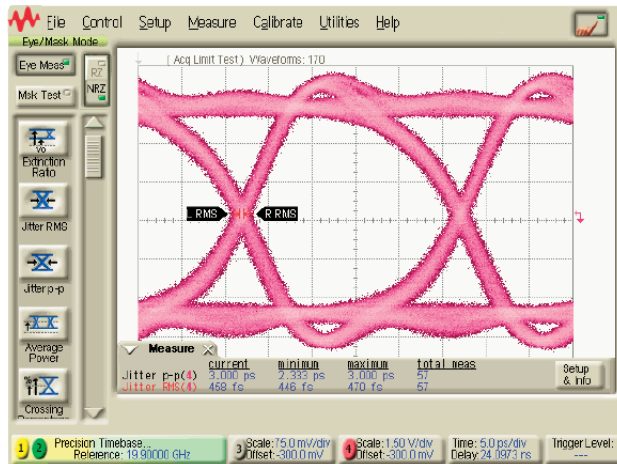

Figure 3-13 N4985A-OA5 ( $2^{31} - 1$ ) EYE: <500 fs added rms jitter (5 ps/div)

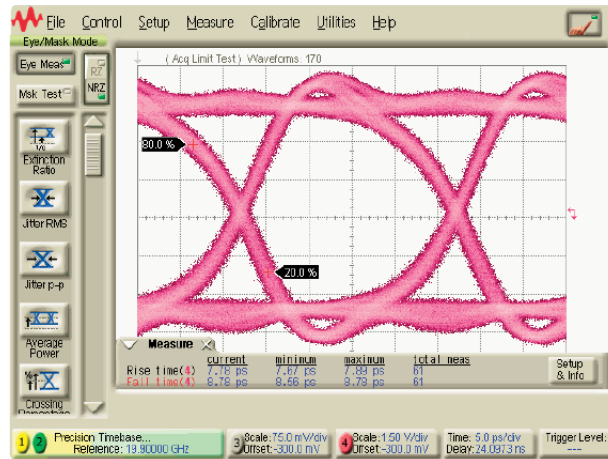

Figure 3-14 N4985A-OA5 ( $2^{31} - 1$ ) EYE: <10 ps Tf/Tf (5 ps/div)

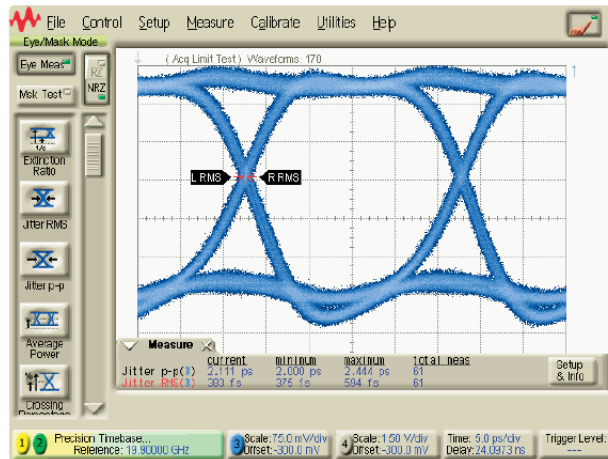

Figure 3-15 N4985A-OA5 ( $2^{31} - 1$ ) EYE: Input signal from PRBS generator

**Table 3-4** N4985A-P15 and N4985A-P25 specifications

Specification	N4985A-P15		N4985A-P25	
Frequency	10 MHz to 50 GHz		2 GHz to 50 GHz	
Gain (dB)	30 dB		30 dB	
Small signal gain	20 (min), 25 (typ)	10 MHz to 2 GHz	25 (min), 29 (typ)	2 GHz to 10 GHz
	25 (min), 29 (typ)	2 GHz to 10 GHz	24 (min), 28 (typ)	10 GHz to 30 GHz
	24 (min), 28 (typ)	10 GHz to 30 GHz	21 (min), 25 (typ)	30 GHz to 40 GHz
	21 (min), 25 (typ)	30 GHz to 40 GHz	17 (min), 24 (typ)	40 GHz to 50 GHz
	17 (min), 24 (typ)	40 GHz to 50 GHz		
Output power (at $P_{sat}$ ) (dB)	20 (min), 24 (typ)	10 MHz to 2 GHz	26 (min), 30 (typ)	2 GHz to 10 GHz
	26 (min), 30 (typ)	2 GHz to 10 GHz	25 (min), 29 (typ)	10 GHz to 30 GHz
	25 (min), 29 (typ)	10 GHz to 30 GHz	23 (min), 27 (typ)	30 GHz to 40 GHz
	23 (min), 27 (typ)	30 GHz to 40 GHz	20 (min), 24 (typ)	40 GHz to 50 GHz
	20 (min), 24 (typ)	40 GHz to 50 GHz		
Output power (at $P_{1dB}$ ) (dB)	17 (min), 22 (typ)	10 MHz to 2 GHz	24 (min), 28 (typ)	2 GHz to 10 GHz
	24 (min), 28 (typ)	2 GHz to 10 GHz	23 (min), 27 (typ)	10 GHz to 30 GHz
	23 (min), 27 (typ)	10 GHz to 30 GHz	21 (min), 25 (typ)	30 GHz to 40 GHz
	21 (min), 25 (typ)	30 GHz to 40 GHz	17 (min), 22 (typ)	40 GHz to 50 GHz
	17 (min), 22 (typ)	40 GHz to 50 GHz		
Input match $S_{11}$ (dB)	-15 (typ)	10 MHz to 2 GHz	-15 (typ)	2 GHz to 10 GHz
	-15 (typ)	2 GHz to 10 GHz	-15 (typ)	10 GHz to 30 GHz
	-15 (typ)	10 GHz to 30 GHz	-10 (typ)	30 GHz to 40 GHz
	-10 (typ)	30 GHz to 40 GHz	-8 (typ)	40 GHz to 50 GHz
	-8 (typ)	40 GHz to 50 GHz		
Output match $S_{22}$ (dB)	-6 (typ)	10 MHz to 2 GHz	-15 (typ)	2 GHz to 10 GHz
	-15 (typ)	2 GHz to 10 GHz	-10 (typ)	10 GHz to 30 GHz
	-10 (typ)	10 GHz to 30 GHz	-6 (typ)	30 GHz to 40 GHz
	-6 (typ)	30 GHz to 40 GHz	-6 (typ)	40 GHz to 50 GHz
	-6 (typ)	40 GHz to 50 GHz		

**Table 3-4** N4985A-P15 and N4985A-P25 specifications (continued)

Specification	N4985A-P15		N4985A-P25	
Reverse isolation (dB)	-60 (typ)	10 MHz to 2 GHz	-60 (typ)	2 GHz to 10 GHz
	-60 (typ)	2 GHz to 10 GHz	-60 (typ)	10 GHz to 30 GHz
	-60 (typ)	10 GHz to 30 GHz	-50 (typ)	30 GHz to 40 GHz
	-50 (typ)	30 GHz to 40 GHz	-50 (typ)	40 GHz to 50 GHz
	-50 (typ)	40 GHz to 50 GHz		
Noise figure (dBm)	9 (typ)	2 GHz to 10 GHz	9 (typ)	2 GHz to 10 GHz
	9 (typ)	10 GHz to 30 GHz	9 (typ)	10 GHz to 30 GHz
	10.5 (typ)	30 GHz to 40 GHz	10.5 (typ)	30 GHz to 40 GHz
	12 (typ)	40 GHz to 50 GHz	12 (typ)	40 GHz to 50 GHz
2nd harmonics $H_2$ (dBc) @ $P_1$	-40 (typ)	10 MHz to 2 GHz	-40 (typ)	2 GHz to 10 GHz
	-40 (typ)	2 GHz to 10 GHz	-40 (typ)	10 GHz to 30 GHz
	-40 (typ)	10 GHz to 30 GHz	-35 (typ)	30 GHz to 40 GHz
	-35 (typ)	30 GHz to 40 GHz	-30 (typ)	40 GHz to 50 GHz
	-30 (typ)	40 GHz to 50 GHz		
3rd harmonics $H_3$ (dBc) @ $P_1$	-20 (typ)	10 MHz to 2 GHz	-20 (typ)	2 GHz to 10 GHz
	-20 (typ)	2 GHz to 10 GHz	-20 (typ)	10 GHz to 30 GHz
	-20 (typ)	10 GHz to 30 GHz	-	30 GHz to 40 GHz
	-	30 GHz to 40 GHz	-	40 GHz to 50 GHz
	-	40 GHz to 50 GHz		

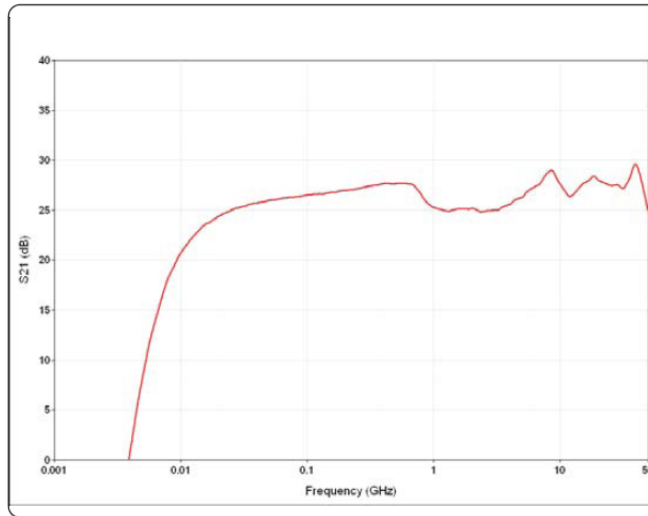

**Figure 3-16** Typical N4985A-P15 performance (S21)

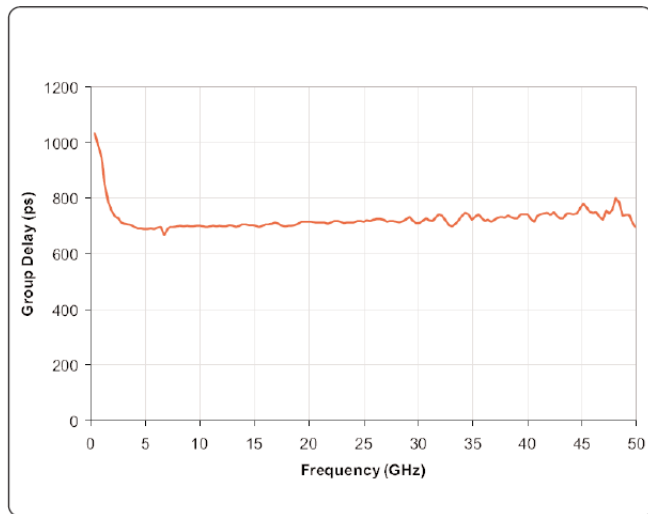

**Figure 3-17** Typical N4985A-P15 performance (group delay)

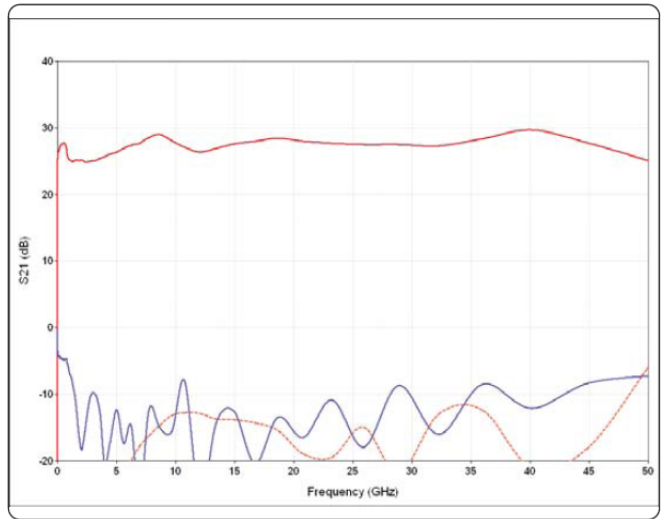

**Figure 3-18** Typical N4985A-P15 performance (S11, S22)

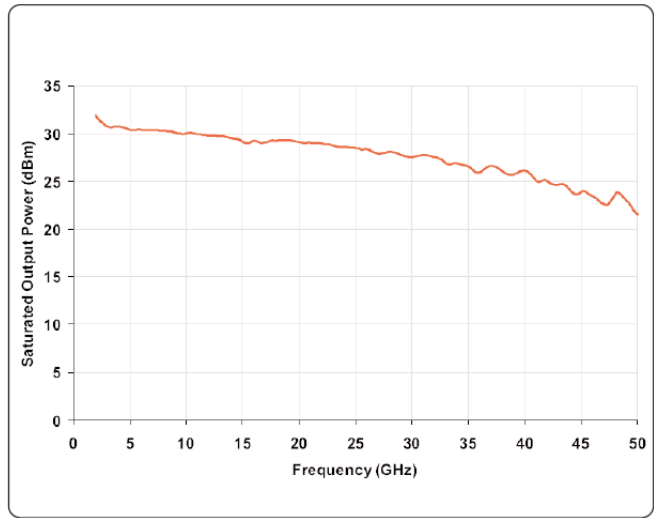

**Figure 3-19** Typical N4985A-P15 performance (saturated output power)

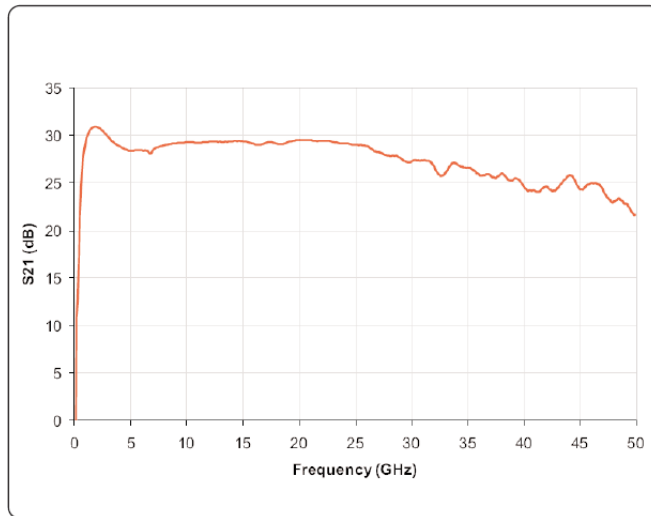

**Figure 3-20** Typical N4985A-P25 performance (S21)

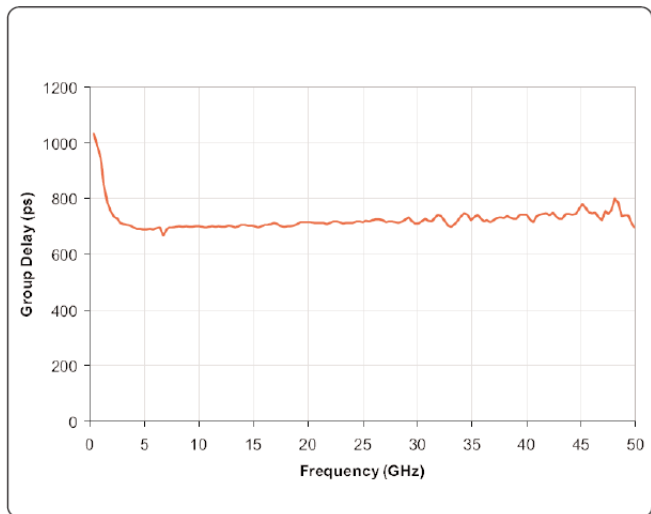

**Figure 3-21** Typical N4985A-P25 performance (group delay)

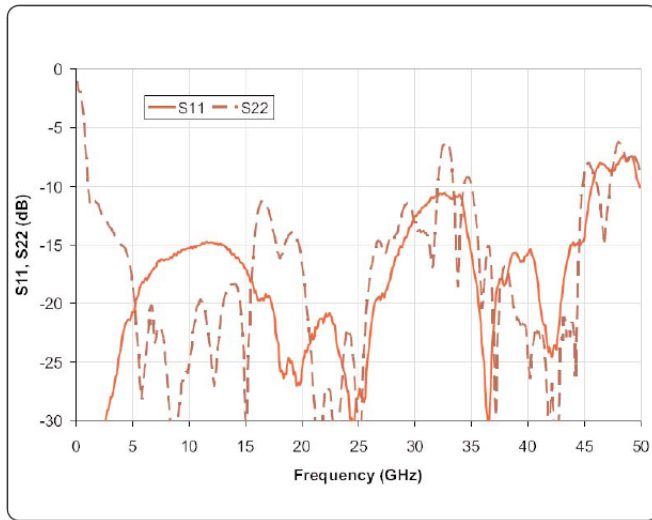

**Figure 3-22** Typical N4985A-P25 performance (S11, S22)

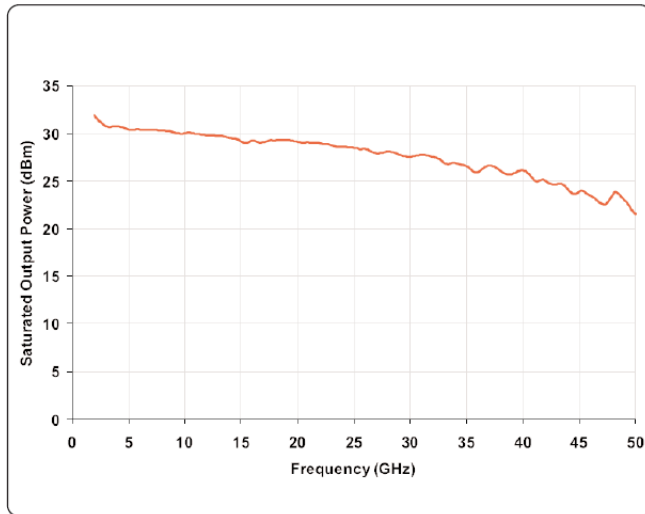

**Figure 3-23** Typical N4985A-P25 performance (saturated output power)



## Supplementary Specifications

**Table 3-5** Supplementary specifications for the N4985A amplifiers<sup>[a]</sup>

Model	N4985A-S30	N4985A-S50	N4985A-P15	N4985A-P25
Bias voltage and current	9 Vdc at 500 mA	9 Vdc at 500 mA	9 Vdc at 1.5 A	9 Vdc at 1.5 A
RF connectors	2.92 mm (f)	2.4 mm (f)	2.4 mm (f)	2.4 mm (f)
Survival input power	20 dBm	20 dBm	26 dBm	26 dBm
Operating temperature	0 to +55 °C	0 to +55 °C	0 to +55 °C	0 to +55 °C

[a] Including the power supply and the DC power supply cable.

## Physical Specifications

**Table 3-6** Physical specifications for the N4985A amplifiers

Model	N4985A-S30	N4985A-S50	N4985A-P15	N4985A-P25
Net weight	0.26 kg	0.26 kg	1.03 kg	1.03 kg
Shipping weight	1.8 kg	1.8 kg	3.2 kg	3.2 kg
Shipping dimensions				
– Length	90 mm	90 mm	114 mm	114 mm
– Width	90 mm	90 mm	140 mm	140 mm
– Height	25 mm	25 mm	70 mm	70 mm

# Mechanical Dimensions<sup>[1]</sup>

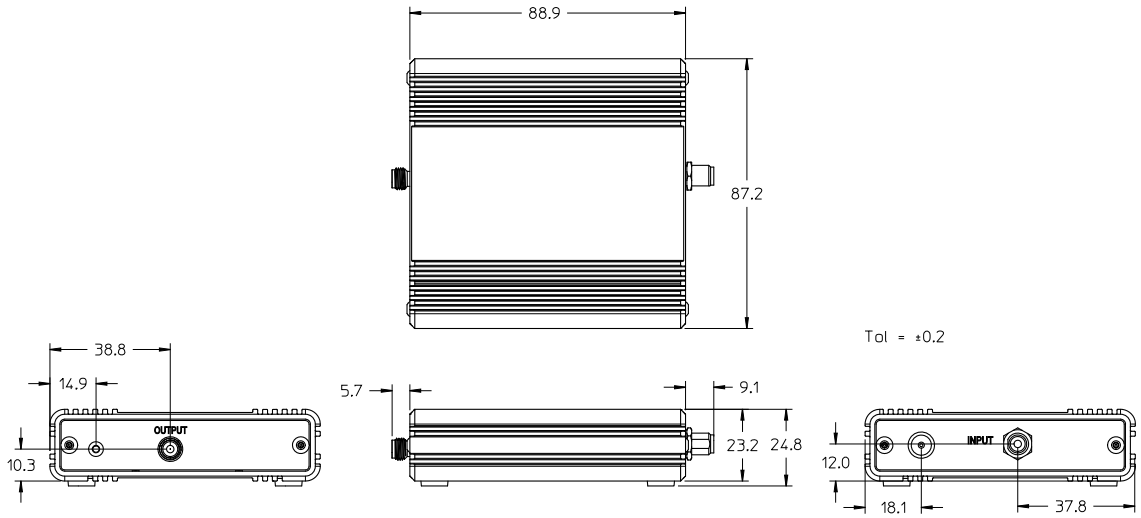

**Figure 3-24** Mechanical dimensions of the N4985A-S30/N4985A-S50 amplifier

[1] Dimensions in millimeters.



THIS PAGE HAS BEEN INTENTIONALLY LEFT BLANK.

# 4 Operating Guide

Operating Instructions	46
Service and Maintenance	48

This chapter provides the operating instructions for the N4985A system amplifiers.

## Operating Instructions

### Performance verification

The figures below show the setup used to verify the performance of the N4985A system amplifiers.

A calibrated power splitter (or calibrated coupler) connected to the amplifier input reference plane and to power sensor A, as shown, establishes the input power level. The output power is measured on power sensor B. Measurements of gain versus output power at frequencies of interest establish the amplifier performance.

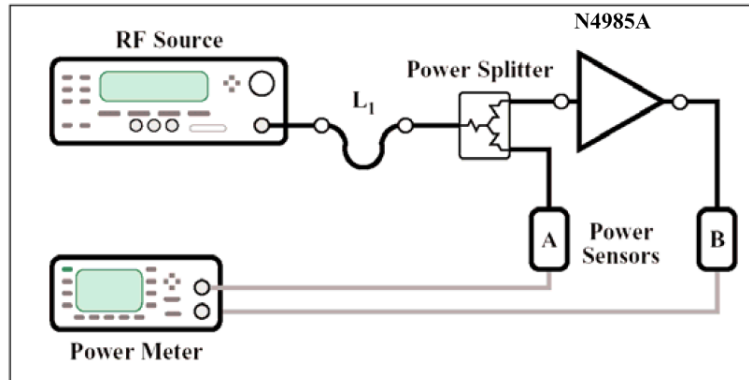

**Figure 4-1** Verification setup with a power splitter

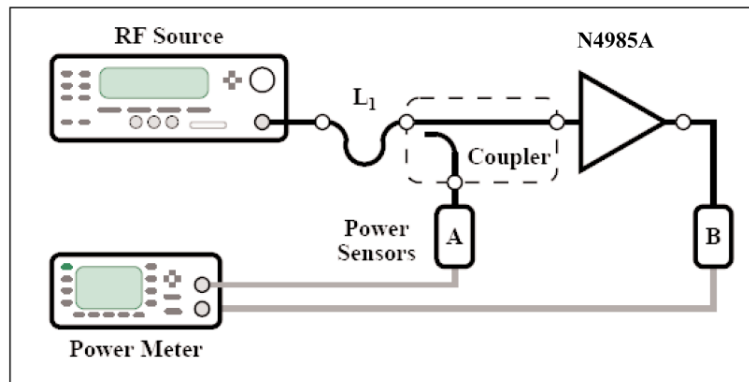

**Figure 4-2** Verification setup with a calibrated coupler

## Example Application

The N4985A amplifies the RF Source output power to the level needed to characterize DUT performance.

The small size of the N4985A is easy to place close to the DUT input “*Reference Plane*”. The high gain of the amplifier easily overcomes the cable losses from the remote RF Source.

The figure below shows an amplified RF power measurement system using the N4985A.

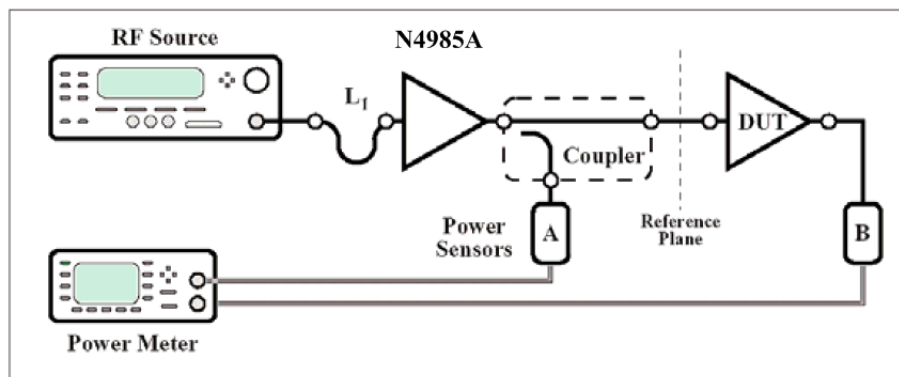

**Figure 4-3** Example of an amplified RF power measurement system

The DUT is characterized by setting the power level at the DUT input “*Reference Plane*” and measuring the output power at various input power levels for each test frequency.

The RF Source, used in this example, is a laboratory grade Synthesized Source or Signal Generator with precise amplitude control (e.g. Keysight 83650L RF Source). The power levels are measured using a power meter with two measurement port sensors (A and B) (e.g. Keysight E4419B).

An RF power coupler provides a small, proportional amount of the amplified power to power sensor A as shown in the above figure.

## Service and Maintenance

### Service

The N4985A does not have internal adjustments and should not be opened; it should only be repaired by service-trained personnel. Should it become necessary to return the N4985A for repair or service, contact your nearest Keysight Sales and Service Center.

### Maintenance

The connectors of the N4985A, particularly the connector faces, must be kept clean. Keysight recommends that the connectors be periodically inspected and cleaned if necessary. For instructions on the connection and maintenance of your connectors, refer to the *Connector Care Quick Reference Card (08510- 90360)*.



This information is subject to change without notice. Always refer to the Keysight website for the latest revision.

© Keysight Technologies 2013-2019  
Edition 4, May 7, 2019

Printed in Malaysia



N4985-90001

[www.keysight.com](http://www.keysight.com)

