

# **Agilent InfiniiVision 5000 Series Oscilloscopes**

## **Programmer's Guide**



**Agilent Technologies**

# Notices

© Agilent Technologies, Inc. 2005-2010

No part of this manual may be reproduced in any form or by any means (including electronic storage and retrieval or translation into a foreign language) without prior agreement and written consent from Agilent Technologies, Inc. as governed by United States and international copyright laws.

## Trademarks

Microsoft®, MS-DOS®, Windows®, Windows 2000®, and Windows XP® are U.S. registered trademarks of Microsoft Corporation.

Adobe®, Acrobat®, and the Acrobat Logo® are trademarks of Adobe Systems Incorporated.

## Manual Part Number

Version 06.10.0001

## Edition

June 30, 2010

Available in electronic format only

Agilent Technologies, Inc.  
1900 Garden of the Gods Road  
Colorado Springs, CO 80907 USA

## Warranty

**The material contained in this document is provided “as is,” and is subject to being changed, without notice, in future editions. Further, to the maximum extent permitted by applicable law, Agilent disclaims all warranties, either express or implied, with regard to this manual and any information contained herein, including but not limited to the implied warranties of merchantability and fitness for a particular purpose. Agilent shall not be liable for errors or for incidental or consequential damages in connection with the furnishing, use, or performance of this document or of any information contained herein. Should Agilent and the user have a separate written agreement with warranty terms covering the material in this document that conflict with these terms, the warranty terms in the separate agreement shall control.**

## Technology Licenses

The hardware and/or software described in this document are furnished under a license and may be used or copied only in accordance with the terms of such license.

## Restricted Rights Legend

If software is for use in the performance of a U.S. Government prime contract or sub-contract, Software is delivered and licensed as “Commercial computer software” as defined in DFAR 252.227-7014 (June 1995), or as a “commercial item” as defined in FAR 2.101(a) or as “Restricted computer software” as defined in FAR 52.227-19 (June 1987) or any equivalent

agency regulation or contract clause. Use, duplication or disclosure of Software is subject to Agilent Technologies’ standard commercial license terms, and non-DOD Departments and Agencies of the U.S. Government will receive no greater than Restricted Rights as defined in FAR 52.227-19(c)(1-2) (June 1987). U.S. Government users will receive no greater than Limited Rights as defined in FAR 52.227-14 (June 1987) or DFAR 252.227-7015 (b)(2) (November 1995), as applicable in any technical data.

## Safety Notices

### CAUTION

A **CAUTION** notice denotes a hazard. It calls attention to an operating procedure, practice, or the like that, if not correctly performed or adhered to, could result in damage to the product or loss of important data. Do not proceed beyond a **CAUTION** notice until the indicated conditions are fully understood and met.

### WARNING

A **WARNING** notice denotes a hazard. It calls attention to an operating procedure, practice, or the like that, if not correctly performed or adhered to, could result in personal injury or death. Do not proceed beyond a **WARNING** notice until the indicated conditions are fully understood and met.

## In This Book

This book is your guide to programming the 5000 Series oscilloscopes:

**Table 1** InfiniiVision 5000 Series Oscilloscope Models

| Channels | Input Bandwidth (Maximum Sample Rate) |                   |                   |
|----------|---------------------------------------|-------------------|-------------------|
|          | 500 MHz (4 GSa/s)                     | 300 MHz (2 GSa/s) | 100 MHz (2 GSa/s) |
| 4 analog | DSO5054A                              | DSO5034A          | DSO5014A          |
| 2 analog | DSO5052A                              | DSO5032A          | DSO5012A          |

The first few chapters describe how to set up and get started:

- Chapter 1, [Chapter 1](#), “What’s New,” starting on page 21, describes programming command changes in the latest version of oscilloscope software.
- Chapter 2, [Chapter 2](#), “Setting Up,” starting on page 37, describes the steps you must take before you can program the oscilloscope.
- Chapter 3, [Chapter 3](#), “Getting Started,” starting on page 47, gives a general overview of oscilloscope program structure and shows how to program the oscilloscope using a few simple examples.
- Chapter 4, [Chapter 4](#), “Commands Quick Reference,” starting on page 61, is a brief listing of the 5000 Series oscilloscope commands and syntax.

The next chapters provide reference information:

- Chapter 5, [Chapter 5](#), “Commands by Subsystem,” starting on page 109, describes the set of commands that belong to an individual subsystem and explains the function of each command. Command arguments and syntax are described. Some command descriptions have example code.
- Chapter 6, [Chapter 6](#), “Commands A-Z,” starting on page 625, contains an alphabetical listing of all command elements.
- Chapter 7, [Chapter 7](#), “Obsolete and Discontinued Commands,” starting on page 657, describes obsolete commands which still work but have been replaced by newer commands and discontinued commands which are no longer supported.
- Chapter 8, [Chapter 8](#), “Error Messages,” starting on page 707, lists the instrument error messages that can occur while programming the oscilloscope.

The command descriptions in this reference show upper and lowercase characters. For example, :AUToscale indicates that the entire command name is :AUTOSCALE. The short form, :AUT, is also accepted by the oscilloscope.

Then, there are chapters that describe programming topics and conceptual information in more detail:

- Chapter 9, [Chapter 9](#), “Status Reporting,” starting on page 715, describes the oscilloscope's status registers and how to check the status of the instrument.
- Chapter 10, [Chapter 10](#), “Synchronizing Acquisitions,” starting on page 739, describes how to wait for acquisitions to complete before querying measurement results or performing other operations with the captured data.
- Chapter 11, [Chapter 11](#), “More About Oscilloscope Commands,” starting on page 749, contains additional information about oscilloscope programming commands.

Finally, there is a chapter that contains programming examples:

- Chapter 12, [Chapter 12](#), “Programming Examples,” starting on page 775.

**See Also**

- For more information on using the SICL, VISA, and VISA COM libraries in general, see the documentation that comes with the Agilent IO Libraries Suite.
- For information on controller PC interface configuration, see the documentation for the interface card used (for example, the Agilent 82350A GPIB interface).
- For information on oscilloscope front-panel operation, see the *User's Guide*.
- For detailed connectivity information, refer to the *Agilent Technologies USB/LAN/GPIB Connectivity Guide*. For a printable electronic copy of the *Connectivity Guide*, direct your Web browser to "[www.agilent.com](http://www.agilent.com)" and search for "Connectivity Guide".
- For the latest versions of this and other manuals, see: "<http://www.agilent.com/find/5000manual>"

# Contents

In This Book 3

## 1 What's New

|                              |    |
|------------------------------|----|
| What's New in Version 6.10   | 22 |
| What's New in Version 6.00   | 23 |
| What's New in Version 5.25   | 25 |
| What's New in Version 5.20   | 27 |
| What's New in Version 5.15   | 30 |
| What's New in Version 5.10   | 32 |
| What's New in Version 5.00   | 33 |
| What's New in Version 4.10   | 35 |
| Version 4.00 at Introduction | 36 |

## 2 Setting Up

|   |    |
|---|----|
| Step 1. Install Agilent IO Libraries Suite software | 38 |
| Step 2. Connect and set up the oscilloscope         | 39 |
| Using the USB (Device) Interface                    | 39 |
| Using the LAN Interface                             | 39 |
| Using the GPIB Interface                            | 40 |
| Step 3. Verify the oscilloscope connection          | 41 |

## 3 Getting Started

|                                      |    |
|--------------------------------------|----|
| Basic Oscilloscope Program Structure | 48 |
| Initializing                         | 48 |
| Capturing Data                       | 48 |
| Analyzing Captured Data              | 49 |

|  |    |
|--|----|
| Programming the Oscilloscope                           | 50 |
| Referencing the IO Library                             | 50 |
| Opening the Oscilloscope Connection via the IO Library | 51 |
| Initializing the Interface and the Oscilloscope        | 51 |
| Using :AUToscale to Automate Oscilloscope Setup        | 52 |
| Using Other Oscilloscope Setup Commands                | 52 |
| Capturing Data with the :DIGitize Command              | 53 |
| Reading Query Responses from the Oscilloscope          | 55 |
| Reading Query Results into String Variables            | 56 |
| Reading Query Results into Numeric Variables           | 56 |
| Reading Definite-Length Block Query Response Data      | 56 |
| Sending Multiple Queries and Reading Results           | 57 |
| Checking Instrument Status                             | 58 |
| Other Ways of Sending Commands                         | 59 |
| Telnet Sockets   | 59 |
| Sending SCPI Commands Using Browser Web Control        | 59 |

## 4 Commands Quick Reference

|                                     |     |
|-------------------------------------|-----|
| Command Summary                     | 62  |
| Syntax Elements                     | 106 |
| Number Format                       | 106 |
| <NL> (Line Terminator)              | 106 |
| [ ] (Optional Syntax Terms)         | 106 |
| { } (Braces)                        | 106 |
| ::= (Defined As)                    | 106 |
| < > (Angle Brackets)                | 107 |
| ... (Ellipsis)                      | 107 |
| n,...,p (Value Ranges)              | 107 |
| d (Digits)                          | 107 |
| Quoted ASCII String                 | 107 |
| Definite-Length Block Response Data | 107 |

## 5 Commands by Subsystem

|                                       |     |
|---------------------------------------|-----|
| Common (*) Commands                   | 111 |
| *CLS (Clear Status)                   | 115 |
| *ESE (Standard Event Status Enable)   | 116 |
| *ESR (Standard Event Status Register) | 118 |
| *IDN (Identification Number)          | 120 |
| *LRN (Learn Device Setup)             | 121 |
| *OPC (Operation Complete)             | 122 |

|  |     |
|--|-----|
| *OPT (Option Identification)                                 | 123 |
| *RCL (Recall)  | 124 |
| *RST (Reset)   | 125 |
| *SAV (Save)  | 128 |
| *SRE (Service Request Enable)                                | 129 |
| *STB (Read Status Byte)                                      | 131 |
| *TRG (Trigger)   | 133 |
| *TST (Self Test)   | 134 |
| *WAI (Wait To Continue)                                      | 135 |
| Root (:) Commands  | 136 |
| :AER (Arm Event Register)                                    | 139 |
| :AUToscale   | 140 |
| :AUToscale:AMODE   | 142 |
| :AUToscale:CHANnels  | 143 |
| :BLANK   | 144 |
| :CDISplay  | 145 |
| :DIGitize  | 146 |
| :HWEenable (Hardware Event Enable Register)                  | 148 |
| :HWERegister:CONDition (Hardware Event Condition Register)   | 150 |
| :HWERegister[:EVENT] (Hardware Event Event Register)         | 152 |
| :MERGe   | 154 |
| :MTEenable (Mask Test Event Enable Register)                 | 155 |
| :MTERegister[:EVENT] (Mask Test Event Event Register)        | 157 |
| :OPEE (Operation Status Enable Register)                     | 159 |
| :OPERegister:CONDition (Operation Status Condition Register) | 161 |
| :OPERegister[:EVENT] (Operation Status Event Register)       | 163 |
| :OVLenable (Overload Event Enable Register)                  | 165 |
| :OVLRegister (Overload Event Register)                       | 167 |
| :PRINt   | 169 |
| :RUN   | 170 |
| :SERial  | 171 |
| :SINGle  | 172 |
| :STATus  | 173 |
| :STOP  | 174 |
| :TER (Trigger Event Register)                                | 175 |
| :VIEW  | 176 |
| :ACQuire Commands  | 177 |
| :ACQuire:AALias  | 179 |
| :ACQuire:COMPLete  | 180 |
| :ACQuire:COUNT   | 181 |
| :ACQuire:DAALias   | 182 |

|                               |     |
|-------------------------------|-----|
| :ACQUIRE:MODE                 | 183 |
| :ACQUIRE:POINTS               | 184 |
| :ACQUIRE:SEGMENTED:ANALYZE    | 185 |
| :ACQUIRE:SEGMENTED:COUNT      | 186 |
| :ACQUIRE:SEGMENTED:INDEX      | 187 |
| :ACQUIRE:SRATE                | 190 |
| :ACQUIRE:TYPE                 | 191 |
| :CALIBRATE Commands           | 193 |
| :CALIBRATE:DATE               | 195 |
| :CALIBRATE:LABEL              | 196 |
| :CALIBRATE:OUTPUT             | 197 |
| :CALIBRATE:START              | 198 |
| :CALIBRATE:STATUS             | 199 |
| :CALIBRATE:SWITCH             | 200 |
| :CALIBRATE:TEMPERATURE        | 201 |
| :CALIBRATE:TIME               | 202 |
| :CHANNEL<n> Commands          | 203 |
| :CHANNEL<n>:BWLIMIT           | 206 |
| :CHANNEL<n>:COUPLING          | 207 |
| :CHANNEL<n>:DISPLAY           | 208 |
| :CHANNEL<n>:IMPEDANCE         | 209 |
| :CHANNEL<n>:INVERT            | 210 |
| :CHANNEL<n>:LABEL             | 211 |
| :CHANNEL<n>:OFFSET            | 212 |
| :CHANNEL<n>:PROBE             | 213 |
| :CHANNEL<n>:PROBE:HEAD[:TYPE] | 214 |
| :CHANNEL<n>:PROBE:ID          | 215 |
| :CHANNEL<n>:PROBE:SKEW        | 216 |
| :CHANNEL<n>:PROBE:STYPE       | 217 |
| :CHANNEL<n>:PROTECTION        | 218 |
| :CHANNEL<n>:RANGE             | 219 |
| :CHANNEL<n>:SCALE             | 220 |
| :CHANNEL<n>:UNITS             | 221 |
| :CHANNEL<n>:VERNIER           | 222 |
| :DISPLAY Commands             | 223 |
| :DISPLAY:CLEAR                | 225 |
| :DISPLAY:DATA                 | 226 |
| :DISPLAY:LABEL                | 228 |
| :DISPLAY:LABLIST              | 229 |
| :DISPLAY:PERSISTENCE          | 230 |

|                            |     |
|----------------------------|-----|
| :DISPlay:SOURce            | 231 |
| :DISPlay:VECTors           | 232 |
| :EXTErnal Trigger Commands | 233 |
| :EXTErnal:BWLimit          | 235 |
| :EXTErnal:IMPedance        | 236 |
| :EXTErnal:PROBe            | 237 |
| :EXTErnal:PROBe:ID         | 238 |
| :EXTErnal:PROBe:STYPe      | 239 |
| :EXTErnal:PROTEction       | 240 |
| :EXTErnal:RANGe            | 241 |
| :EXTErnal:UNITs            | 242 |
| :FUNCTion Commands         | 243 |
| :FUNCTion:CENTer           | 246 |
| :FUNCTion:DISPlay          | 247 |
| :FUNCTion:GOFT:OPERation   | 248 |
| :FUNCTion:GOFT:SOURce1     | 249 |
| :FUNCTion:GOFT:SOURce2     | 250 |
| :FUNCTion:OFFSet           | 251 |
| :FUNCTion:OPERation        | 252 |
| :FUNCTion:RANGe            | 253 |
| :FUNCTion:REFerence        | 254 |
| :FUNCTion:SCALe            | 255 |
| :FUNCTion:SOURce1          | 256 |
| :FUNCTion:SOURce2          | 257 |
| :FUNCTion:SPAN             | 258 |
| :FUNCTion:WINDow           | 259 |
| :HARDcopy Commands         | 260 |
| :HARDcopy:AREA             | 262 |
| :HARDcopy:APRinter         | 263 |
| :HARDcopy:FACTors          | 264 |
| :HARDcopy:FFEed            | 265 |
| :HARDcopy:INKSaver         | 266 |
| :HARDcopy:LAYout           | 267 |
| :HARDcopy:PALette          | 268 |
| :HARDcopy:PRINter:LIST     | 269 |
| :HARDcopy:STARt            | 270 |
| :LISTer Commands           | 271 |
| :LISTer:DATA               | 272 |
| :LISTer:DISPlay            | 273 |
| :MARKer Commands           | 274 |

|                               |     |
|-------------------------------|-----|
| :MARKer:MODE                  | 276 |
| :MARKer:X1Position            | 277 |
| :MARKer:X1Y1source            | 278 |
| :MARKer:X2Position            | 279 |
| :MARKer:X2Y2source            | 280 |
| :MARKer:XDELta                | 281 |
| :MARKer:Y1Position            | 282 |
| :MARKer:Y2Position            | 283 |
| :MARKer:YDELta                | 284 |
| :MEASure Commands             | 285 |
| :MEASure:CLear                | 292 |
| :MEASure:COUNter              | 293 |
| :MEASure:DEFine               | 294 |
| :MEASure:DELay                | 297 |
| :MEASure:DUTYcycle            | 299 |
| :MEASure:FALLtime             | 300 |
| :MEASure:FREQuency            | 301 |
| :MEASure:NWIDth               | 302 |
| :MEASure:OVERshoot            | 303 |
| :MEASure:PERiod               | 305 |
| :MEASure:PHASe                | 306 |
| :MEASure:PREShoot             | 307 |
| :MEASure:PWIDth               | 308 |
| :MEASure:RESults              | 309 |
| :MEASure:RISetime             | 312 |
| :MEASure:SDEVIation           | 313 |
| :MEASure:SHOW                 | 314 |
| :MEASure:SOURce               | 315 |
| :MEASure:STATistics           | 317 |
| :MEASure:STATistics:INCRement | 318 |
| :MEASure:STATistics:RESet     | 319 |
| :MEASure:TEDGe                | 320 |
| :MEASure:TVALue               | 322 |
| :MEASure:VAMPLitude           | 324 |
| :MEASure:VAverage             | 325 |
| :MEASure:VBASe                | 326 |
| :MEASure:VMAX                 | 327 |
| :MEASure:VMIN                 | 328 |
| :MEASure:VPP                  | 329 |
| :MEASure:VRATio               | 330 |
| :MEASure:VRMS                 | 331 |

|                              |     |
|------------------------------|-----|
| :MEASure:VTIMe               | 332 |
| :MEASure:VTOp                | 333 |
| :MEASure:WINDow              | 334 |
| :MEASure:XMAX                | 335 |
| :MEASure:XMIN                | 336 |
| :MTESt Commands              | 337 |
| :MTESt:AMASk:CREate          | 342 |
| :MTESt:AMASk:SOURce          | 343 |
| :MTESt:AMASk:UNITs           | 344 |
| :MTESt:AMASk:XDELta          | 345 |
| :MTESt:AMASk:YDELta          | 346 |
| :MTESt:COUNt:FWAVEforms      | 347 |
| :MTESt:COUNt:RESet           | 348 |
| :MTESt:COUNt:TIME            | 349 |
| :MTESt:COUNt:WAVEforms       | 350 |
| :MTESt:DATA                  | 351 |
| :MTESt:DELeTe                | 352 |
| :MTESt:ENABLe                | 353 |
| :MTESt:LOCK                  | 354 |
| :MTESt:OUTPut                | 355 |
| :MTESt:RMODe                 | 356 |
| :MTESt:RMODe:FACTion:MEASure | 357 |
| :MTESt:RMODe:FACTion:PRINt   | 358 |
| :MTESt:RMODe:FACTion:SAVE    | 359 |
| :MTESt:RMODe:FACTion:STOP    | 360 |
| :MTESt:RMODe:SIGMa           | 361 |
| :MTESt:RMODe:TIME            | 362 |
| :MTESt:RMODe:WAVEforms       | 363 |
| :MTESt:SCALe:BIND            | 364 |
| :MTESt:SCALe:X1              | 365 |
| :MTESt:SCALe:XDELta          | 366 |
| :MTESt:SCALe:Y1              | 367 |
| :MTESt:SCALe:Y2              | 368 |
| :MTESt:SOURce                | 369 |
| :MTESt:TITLe                 | 370 |
| :RECall Commands             | 371 |
| :RECall:FILEname             | 372 |
| :RECall:IMAGe[:STARt]        | 373 |
| :RECall:MASK[:STARt]         | 374 |
| :RECall:PWD                  | 375 |
| :RECall:SETup[:STARt]        | 376 |

|                             |     |
|-----------------------------|-----|
| :SAVE Commands              | 377 |
| :SAVE:FILEName              | 379 |
| :SAVE:IMAGe[:START]         | 380 |
| :SAVE:IMAGe:AREA            | 381 |
| :SAVE:IMAGe:FACTors         | 382 |
| :SAVE:IMAGe:FORMat          | 383 |
| :SAVE:IMAGe:INKSaver        | 384 |
| :SAVE:IMAGe:PALette         | 385 |
| :SAVE:LISTer[:START]        | 386 |
| :SAVE:MASK[:START]          | 387 |
| :SAVE:PWD                   | 388 |
| :SAVE:SETup[:START]         | 389 |
| :SAVE:WAVEform[:START]      | 390 |
| :SAVE:WAVEform:FORMat       | 391 |
| :SAVE:WAVEform:LENGth       | 392 |
| :SAVE:WAVEform:SEGMented    | 393 |
| :SBUS Commands              | 394 |
| :SBUS:CAN:COUNT:ERRor       | 396 |
| :SBUS:CAN:COUNT:OVERload    | 397 |
| :SBUS:CAN:COUNT:RESet       | 398 |
| :SBUS:CAN:COUNT:TOTal       | 399 |
| :SBUS:CAN:COUNT:UTILization | 400 |
| :SBUS:DISPlay               | 401 |
| :SBUS:FLEXray:COUNT:NULL    | 402 |
| :SBUS:FLEXray:COUNT:RESet   | 403 |
| :SBUS:FLEXray:COUNT:SYNC    | 404 |
| :SBUS:FLEXray:COUNT:TOTal   | 405 |
| :SBUS:I2S:BASE              | 406 |
| :SBUS:IIC:ASIZe             | 407 |
| :SBUS:LIN:PARity            | 408 |
| :SBUS:M1553:BASE            | 409 |
| :SBUS:MODE                  | 410 |
| :SBUS:SPI:BITorder          | 411 |
| :SBUS:SPI:WIDTh             | 412 |
| :SBUS:UART:BASE             | 413 |
| :SBUS:UART:COUNT:ERRor      | 414 |
| :SBUS:UART:COUNT:RESet      | 415 |
| :SBUS:UART:COUNT:RXFRames   | 416 |
| :SBUS:UART:COUNT:TXFRames   | 417 |
| :SBUS:UART:FRAMing          | 418 |
| :SYSTEM Commands            | 419 |

|                                  |     |
|----------------------------------|-----|
| :SYSTem:DATE                     | 420 |
| :SYSTem:DSP                      | 421 |
| :SYSTem:ERRor                    | 422 |
| :SYSTem:LOCK                     | 423 |
| :SYSTem:PRECision                | 424 |
| :SYSTem:PROTection:LOCK          | 425 |
| :SYSTem:SETup                    | 426 |
| :SYSTem:TIME                     | 428 |
| :TIMebase Commands               | 429 |
| :TIMebase:MODE                   | 431 |
| :TIMebase:POSition               | 432 |
| :TIMebase:RANGe                  | 433 |
| :TIMebase:REFerence              | 434 |
| :TIMebase:SCALE                  | 435 |
| :TIMebase:VERNier                | 436 |
| :TIMebase:WINDow:POSition        | 437 |
| :TIMebase:WINDow:RANGe           | 438 |
| :TIMebase:WINDow:SCALE           | 439 |
| :TRIGger Commands                | 440 |
| General :TRIGger Commands        | 443 |
| :TRIGger:HFReject                | 444 |
| :TRIGger:HOLDoff                 | 445 |
| :TRIGger:LFIfty                  | 446 |
| :TRIGger:MODE                    | 447 |
| :TRIGger:NREJect                 | 448 |
| :TRIGger:PATTern                 | 449 |
| :TRIGger:SWEep                   | 451 |
| :TRIGger:CAN Commands            | 452 |
| :TRIGger:CAN:PATTern:DATA        | 454 |
| :TRIGger:CAN:PATTern:DATA:LENGth | 455 |
| :TRIGger:CAN:PATTern:ID          | 456 |
| :TRIGger:CAN:PATTern:ID:MODE     | 457 |
| :TRIGger:CAN:SAMPlepoint         | 458 |
| :TRIGger:CAN:SIGNal:BAUDrate     | 459 |
| :TRIGger:CAN:SIGNal:DEFinition   | 460 |
| :TRIGger:CAN:SOURce              | 461 |
| :TRIGger:CAN:TRIGger             | 462 |
| :TRIGger:DURation Commands       | 464 |
| :TRIGger:DURation:GREaterthan    | 465 |
| :TRIGger:DURation:LESSthan       | 466 |
| :TRIGger:DURation:PATTern        | 467 |

|                                     |     |
|-------------------------------------|-----|
| :TRIGger:DURation:QUALifier         | 468 |
| :TRIGger:DURation:RANGe             | 469 |
| :TRIGger:EBURst Commands            | 470 |
| :TRIGger:EBURst:COUNt               | 471 |
| :TRIGger:EBURst:IDLE                | 472 |
| :TRIGger:EBURst:SLOPe               | 473 |
| :TRIGger[:EDGE] Commands            | 474 |
| :TRIGger[:EDGE]:COUPling            | 475 |
| :TRIGger[:EDGE]:LEVel               | 476 |
| :TRIGger[:EDGE]:REJect              | 477 |
| :TRIGger[:EDGE]:SLOPe               | 478 |
| :TRIGger[:EDGE]:SOURce              | 479 |
| :TRIGger:FLEXray Commands           | 480 |
| :TRIGger:FLEXray:AUTOsetup          | 481 |
| :TRIGger:FLEXray:BAUDrate           | 482 |
| :TRIGger:FLEXray:CHANnel            | 483 |
| :TRIGger:FLEXray:ERRor:TYPE         | 484 |
| :TRIGger:FLEXray:EVENT:TYPE         | 485 |
| :TRIGger:FLEXray:FRAME:CCBase       | 486 |
| :TRIGger:FLEXray:FRAME:CCRepetition | 487 |
| :TRIGger:FLEXray:FRAME:ID           | 488 |
| :TRIGger:FLEXray:FRAME:TYPE         | 489 |
| :TRIGger:FLEXray:SOURce             | 490 |
| :TRIGger:FLEXray:TRIGger            | 491 |
| :TRIGger:GLITch Commands            | 492 |
| :TRIGger:GLITch:GREaterthan         | 493 |
| :TRIGger:GLITch:LESSthan            | 494 |
| :TRIGger:GLITch:LEVel               | 495 |
| :TRIGger:GLITch:POLarity            | 496 |
| :TRIGger:GLITch:QUALifier           | 497 |
| :TRIGger:GLITch:RANGe               | 498 |
| :TRIGger:GLITch:SOURce              | 499 |
| :TRIGger:I2S Commands               | 500 |
| :TRIGger:I2S:ALIGNment              | 502 |
| :TRIGger:I2S:AUDIO                  | 503 |
| :TRIGger:I2S:CLOCK:SLOPe            | 504 |
| :TRIGger:I2S:PATtern:DATA           | 505 |
| :TRIGger:I2S:PATtern:FORMat         | 507 |
| :TRIGger:I2S:RANGe                  | 508 |
| :TRIGger:I2S:RWIDth                 | 510 |
| :TRIGger:I2S:SOURce:CLOCK           | 511 |
| :TRIGger:I2S:SOURce:DATA            | 512 |

|                                  |     |
|----------------------------------|-----|
| :TRIGger:I2S:SOURce:WSElect      | 513 |
| :TRIGger:I2S:TRIGger             | 514 |
| :TRIGger:I2S:TWIDth              | 516 |
| :TRIGger:I2S:WSLow               | 517 |
| :TRIGger:IIC Commands            | 518 |
| :TRIGger:IIC:PATtern:ADDRes      | 519 |
| :TRIGger:IIC:PATtern:DATA        | 520 |
| :TRIGger:IIC:PATtern:DATA2       | 521 |
| :TRIGger:IIC[:SOURce]:CLOCK      | 522 |
| :TRIGger:IIC[:SOURce]:DATA       | 523 |
| :TRIGger:IIC:TRIGger:QUALifier   | 524 |
| :TRIGger:IIC:TRIGger[:TYPE]      | 525 |
| :TRIGger:LIN Commands            | 527 |
| :TRIGger:LIN:ID                  | 529 |
| :TRIGger:LIN:PATtern:DATA        | 530 |
| :TRIGger:LIN:PATtern:DATA:LENGth | 532 |
| :TRIGger:LIN:PATtern:FORMat      | 533 |
| :TRIGger:LIN:SAMPlepoint         | 534 |
| :TRIGger:LIN:SIGNal:BAUDrate     | 535 |
| :TRIGger:LIN:SOURce              | 536 |
| :TRIGger:LIN:STANdard            | 537 |
| :TRIGger:LIN:SYNCbreak           | 538 |
| :TRIGger:LIN:TRIGger             | 539 |
| :TRIGger:M1553 Commands          | 540 |
| :TRIGger:M1553:AUTOsetuP         | 541 |
| :TRIGger:M1553:PATtern:DATA      | 542 |
| :TRIGger:M1553:RTA               | 543 |
| :TRIGger:M1553:SOURce:LOWer      | 544 |
| :TRIGger:M1553:SOURce:UPPer      | 545 |
| :TRIGger:M1553:TYPE              | 546 |
| :TRIGger:SEQuence Commands       | 547 |
| :TRIGger:SEQuence:COUNt          | 548 |
| :TRIGger:SEQuence:EDGE           | 549 |
| :TRIGger:SEQuence:FIND           | 550 |
| :TRIGger:SEQuence:PATtern        | 551 |
| :TRIGger:SEQuence:RESet          | 552 |
| :TRIGger:SEQuence:TIMer          | 553 |
| :TRIGger:SEQuence:TRIGger        | 554 |
| :TRIGger:SPI Commands            | 555 |
| :TRIGger:SPI:CLOCK:SLOPe         | 556 |
| :TRIGger:SPI:CLOCK:TIMEout       | 557 |
| :TRIGger:SPI:FRAMing             | 558 |

|                            |     |
|----------------------------|-----|
| :TRIGger:SPI:PATtern:DATA  | 559 |
| :TRIGger:SPI:PATtern:WIDTh | 560 |
| :TRIGger:SPI:SOURce:CLOCK  | 561 |
| :TRIGger:SPI:SOURce:DATA   | 562 |
| :TRIGger:SPI:SOURce:FRAMe  | 563 |
| :TRIGger:TV Commands       | 564 |
| :TRIGger:TV:LINE           | 565 |
| :TRIGger:TV:MODE           | 566 |
| :TRIGger:TV:POLarity       | 567 |
| :TRIGger:TV:SOURce         | 568 |
| :TRIGger:TV:STANdard       | 569 |
| :TRIGger:UART Commands     | 570 |
| :TRIGger:UART:BASE         | 572 |
| :TRIGger:UART:BAUDrate     | 573 |
| :TRIGger:UART:BITorder     | 574 |
| :TRIGger:UART:BURSt        | 575 |
| :TRIGger:UART:DATA         | 576 |
| :TRIGger:UART:IDLE         | 577 |
| :TRIGger:UART:PARity       | 578 |
| :TRIGger:UART:POLarity     | 579 |
| :TRIGger:UART:QUALifier    | 580 |
| :TRIGger:UART:SOURce:RX    | 581 |
| :TRIGger:UART:SOURce:TX    | 582 |
| :TRIGger:UART:TYPE         | 583 |
| :TRIGger:UART:WIDTh        | 584 |
| :TRIGger:USB Commands      | 585 |
| :TRIGger:USB:SOURce:DMINus | 586 |
| :TRIGger:USB:SOURce:DPLus  | 587 |
| :TRIGger:USB:SPEed         | 588 |
| :TRIGger:USB:TRIGger       | 589 |
| :WAVeform Commands         | 590 |
| :WAVeform:BYTeorder        | 597 |
| :WAVeform:COUNt            | 598 |
| :WAVeform:DATA             | 599 |
| :WAVeform:FORMat           | 601 |
| :WAVeform:POINts           | 602 |
| :WAVeform:POINts:MODE      | 604 |
| :WAVeform:PREamble         | 606 |
| :WAVeform:SEGmented:COUNt  | 609 |
| :WAVeform:SEGmented:TTAG   | 610 |
| :WAVeform:SOURce           | 611 |

:WAVeform:SOURce:SUBSource 615  
 :WAVeform:TYPE 616  
 :WAVeform:UNSigned 617  
 :WAVeform:VIEW 618  
 :WAVeform:XINCrement 619  
 :WAVeform:XORigin 620  
 :WAVeform:XREFerence 621  
 :WAVeform:YINCrement 622  
 :WAVeform:YORigin 623  
 :WAVeform:YREFerence 624

## 6 Commands A-Z

### 7 Obsolete and Discontinued Commands

:CHANnel:LABel 662  
 :CHANnel2:SKEW 663  
 :CHANnel<n>:INPut 664  
 :CHANnel<n>:PMODE 665  
 :DISPlay:CONNect 666  
 :ERASe 667  
 :EXTernal:INPut 668  
 :EXTernal:PMODE 669  
 :FUNction:SOURce 670  
 :FUNction:VIEW 671  
 :HARDcopy:DESTination 672  
 :HARDcopy:DEVice 673  
 :HARDcopy:FILEname 674  
 :HARDcopy:FORMat 675  
 :HARDcopy:GRAYscale 676  
 :HARDcopy:IGColors 677  
 :HARDcopy:PDRiver 678  
 :MEASure:LOWer 679  
 :MEASure:SCRatch 680  
 :MEASure:TDELta 681  
 :MEASure:THResholds 682  
 :MEASure:TMAX 683  
 :MEASure:TMIN 684  
 :MEASure:TSTArt 685  
 :MEASure:TSTOp 686  
 :MEASure:TVOLT 687  
 :MEASure:UPPer 689  
 :MEASure:VDELta 690

|                                |     |
|--------------------------------|-----|
| :MEASure:VStArt                | 691 |
| :MEASure:VStOp                 | 692 |
| :MTESt:AMASk:{SAVE   StORe}    | 693 |
| :MTESt:AVERage                 | 694 |
| :MTESt:AVERage:COUNt           | 695 |
| :MTESt:LOAD                    | 696 |
| :MTESt:RUMode                  | 697 |
| :MTESt:RUMode:SOFailure        | 698 |
| :MTESt:{StARt   StOP}          | 699 |
| :MTESt:TRIGger:SOURce          | 700 |
| :PRINt?                        | 701 |
| :TIMebase:DELay                | 703 |
| :TRIGger:CAN:ACKNowledge       | 704 |
| :TRIGger:LIN:SIGNal:DEFinition | 705 |
| :TRIGger:TV:TVMODE             | 706 |

## 8 Error Messages

## 9 Status Reporting

|  |     |
|--|-----|
| Status Reporting Data Structures                             | 718 |
| Status Byte Register (STB)                                   | 721 |
| Service Request Enable Register (SRE)                        | 723 |
| Trigger Event Register (TER)                                 | 724 |
| Output Queue   | 725 |
| Message Queue  | 726 |
| (Standard) Event Status Register (ESR)                       | 727 |
| (Standard) Event Status Enable Register (ESE)                | 728 |
| Error Queue  | 729 |
| Operation Status Event Register (:OPERegister[:EVENT])       | 730 |
| Operation Status Condition Register (:OPERegister:CONDition) | 731 |
| Arm Event Register (AER)                                     | 732 |
| Overload Event Register (:OVLRegister)                       | 733 |
| Hardware Event Event Register (:HWERegister[:EVENT])         | 734 |
| Hardware Event Condition Register (:HWERegister:CONDition)   | 735 |
| Mask Test Event Event Register (:MTERegister[:EVENT])        | 736 |
| Clearing Registers and Queues                                | 737 |

Status Reporting Decision Chart 738

## 10 Synchronizing Acquisitions

- Synchronization in the Programming Flow 740
  - Set Up the Oscilloscope 740
  - Acquire a Waveform 740
  - Retrieve Results 740
- Blocking Synchronization 741
- Polling Synchronization With Timeout 742
- Synchronizing with a Single-Shot Device Under Test (DUT) 744
- Synchronization with an Averaging Acquisition 746

## 11 More About Oscilloscope Commands

- Command Classifications 750
  - Core Commands 750
  - Non-Core Commands 750
  - Obsolete Commands 750
- Valid Command/Query Strings 751
  - Program Message Syntax 751
  - Command Tree 755
  - Duplicate Mnemonics 769
  - Tree Traversal Rules and Multiple Commands 769
- Query Return Values 772
- All Oscilloscope Commands Are Sequential 773

## 12 Programming Examples

- VISA COM Examples 776
  - VISA COM Example in Visual Basic 776
  - VISA COM Example in C# 786
  - VISA COM Example in Visual Basic .NET 798
- VISA Examples 809
  - VISA Example in C 809
  - VISA Example in Visual Basic 818
  - VISA Example in C# 828
  - VISA Example in Visual Basic .NET 841
- SICL Examples 855
  - SICL Example in C 855
  - SICL Example in Visual Basic 864

## **Index**

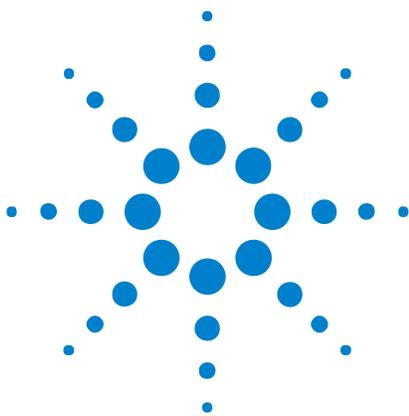

# 1 What's New

|                              |    |
|------------------------------|----|
| What's New in Version 6.10   | 22 |
| What's New in Version 6.00   | 23 |
| What's New in Version 5.25   | 25 |
| What's New in Version 5.20   | 27 |
| What's New in Version 5.15   | 30 |
| What's New in Version 5.10   | 32 |
| What's New in Version 5.00   | 33 |
| What's New in Version 4.10   | 35 |
| Version 4.00 at Introduction | 36 |



## What's New in Version 6.10

New features in version 6.10 of the InfiniiVision 5000 Series oscilloscope software are:

- When the zoomed time base mode is on, you can select whether the Main window or the Zoom window is used as the measurement window.
- An interval specification for the V average and dc RMS measurements has been added.
- A 50% trigger level command.

More detailed descriptions of the new and changed commands appear below.

### New Commands

| Command   | Description   |
|---|---|
| :MEASure:WINDow (see <a href="#">page 334</a> ) | When the zoomed time base mode is on, specifies whether the Main window or the Zoom window is used as the measurement window. |
| :TRIGger:LFI5ty (see <a href="#">page 446</a> ) | Sets the trigger level of a displayed analog channel trigger source to the waveform's 50% value.                              |

### Changed Commands

| Command  | Differences   |
|--|---|
| :MEASure:VAverage (see <a href="#">page 325</a> )              | There is now an option for specifying the interval.   |
| :MEASure:VRMS (see <a href="#">page 331</a> )                  | There is now an option for specifying the interval.   |
| :TRIGger:CAN:SIGNal:DEFinition (see <a href="#">page 460</a> ) | There are now DIFH (differential H-L) and DIFL (differential L-H) options. The DIFL option is the same as the existing DIFFerential option. Also, this command is no longer classified as obsolete. |

## What's New in Version 6.00

New features in version 6.00 of the InfiniiVision 5000 Series oscilloscope software are:

- The ability to perform measurements and math functions on a 10K-point (maximum) precision analysis data record.
- Support for the new N5469A MIL-STD 1553 triggering and decode option (Option 553).
- Support for the new N5432C FlexRay triggering and decode option (Option FLX).

More detailed descriptions of the new and changed commands appear below.

### New Commands

| Command  | Description  |
|--|--|
| :SBUS:FLEXray:COUNT:NULL? (see <a href="#">page 402</a> )  | Returns the FlexRay null frame count.  |
| :SBUS:FLEXray:COUNT:RESet (see <a href="#">page 403</a> )  | Resets the FlexRay frame counters.   |
| :SBUS:FLEXray:COUNT:SYNC? (see <a href="#">page 404</a> )  | Returns the FlexRay sync frame count.  |
| :SBUS:FLEXray:COUNT:TOTal? (see <a href="#">page 405</a> ) | Returns the FlexRay total frame count.   |
| :SBUS:M1553:BASE (see <a href="#">page 409</a> )           | Determines the base to use for the MIL-STD 1553 decode display.  |
| :SBUS:SPI:BITorder (see <a href="#">page 411</a> )         | Selects the bit order used when displaying data in the SPI serial decode waveform and in the Lister.                                   |
| :SYSTem:PRECision (see <a href="#">page 424</a> )          | Allows measurements and math functions to be performed on a <i>precision analysis record</i> (at the expense of waveform update rate). |
| :TRIGger:FLEXray Commands (see <a href="#">page 500</a> )  | Commands for triggering on FlexRay signals.  |
| :TRIGger:M1553 Commands (see <a href="#">page 540</a> )    | Commands for triggering on MIL-STD 1553 signals.   |

### Changed Commands

| Command                                       | Differences  |
|---|--|
| :SBUS:MODE (see <a href="#">page 410</a> )    | You can now select the M1553 serial bus decode mode. |
| :TRIGger:MODE (see <a href="#">page 447</a> ) | You can now select the M1553 trigger mode.           |

## 1 What's New

| Command   | Differences  |
|---|--|
| :WAVeform:POINts (see <a href="#">page 604</a> )      | In the RAW or MAXimum waveform points modes, you can now specify 4,000,000 or 8,000,000 points in place of the previous 5,000,000 option.  |
| :WAVeform:POINts:MODE (see <a href="#">page 604</a> ) | Command syntax is the same, but the NORMal mode returns: <ul style="list-style-type: none"><li>• The <i>measurement record</i> when :SYSTem:PRECision is OFF.</li><li>• The <i>precision analysis record</i> when :SYSTem:PRECision is ON.</li></ul> |

### Discontinued Commands

| Discontinued Command | Current Command Equivalent | Comments |
|----------------------|----------------------------|----------|
| :DISPlay:FREeze      | none                       |          |

## What's New in Version 5.25

New features in version 5.25 of the InfiniiVision 5000 Series oscilloscope software are:

- The Lister display for showing decoded serial data in tabular format.
- The ability to trigger on and decode I2S serial bus data with a four-channel oscilloscope that includes the Option SND license.
- The EBURst trigger mode and supporting :TRIGger:EBURst commands.
- The SEQuence trigger mode and supporting :TRIGger:SEQuence commands.
- The USB trigger mode and supporting :TRIGger:USB commands.

More detailed descriptions of the new and changed commands appear below.

### New Commands

| Command  | Description   |
|--|---|
| :CHANnel<n>:PROBe:HEAD[:TYPE] (see <a href="#">page 214</a> )    | Sets an analog channel probe head type and dB value.                                  |
| :DISPlay:FREeze  | Freezes the display without stopping currently running acquisitions.                  |
| :LISTer Commands (see <a href="#">page 271</a> )                 | Commands for turning the Lister display on/off and for returning the Lister data.     |
| :MTESt:RMODe:FACTion:MEASure (see <a href="#">page 357</a> )     | Lets you enable or disable measurements on mask test failures.                        |
| :SAVE:LISTer[:START] (see <a href="#">page 386</a> )             | Saves the Lister display data to a file.  |
| :SBUS:I2S:BASE (see <a href="#">page 406</a> )                   | Determines the base to use for the I2S decode display.                                |
| :TRIGger:EBURst Commands (see <a href="#">page 470</a> )         | Commands for triggering on the Nth edge of a burst that occurs after an idle time.    |
| :TRIGger:I2S Commands (see <a href="#">page 500</a> )            | Commands for triggering on I2S signals.   |
| :TRIGger:LIN:PATtern:DATA (see <a href="#">page 530</a> )        | Sets the data value when triggering on a LIN frame ID and data.                       |
| :TRIGger:LIN:PATtern:DATA:LENGth (see <a href="#">page 532</a> ) | Sets the byte length of the LIN data string.  |
| :TRIGger:LIN:PATtern:FORMat (see <a href="#">page 533</a> )      | Sets the entry (and query) number base used by the :TRIGger:LIN:PATtern:DATA command. |

## 1 What's New

| Command  | Description  |
|--|--|
| :TRIGger:SEQuence Commands (see <a href="#">page 547</a> ) | Commands for triggering the oscilloscope after finding a sequence of events.   |
| :TRIGger:USB Commands (see <a href="#">page 585</a> )      | Commands for triggering on a Start of Packet (SOP), End of Packet (EOP), Reset Complete, Enter Suspend, or Exit Suspend signal on the differential USB data lines. USB Low Speed and Full Speed are supported by this trigger. |

### Changed Commands

| Command  | Differences   |
|--|---|
| :SBUS:MODE (see <a href="#">page 410</a> )           | You can now select the I2S serial bus decode mode.                            |
| :TRIGger:LIN:TRIGger (see <a href="#">page 539</a> ) | You can now select the DATA option for triggering on a LIN frame ID and data. |
| :TRIGger:MODE (see <a href="#">page 447</a> )        | You can now select the EBUrSt, I2S, SEQuence, and USB trigger modes.          |
| :TRIGger:TV:STANdard (see <a href="#">page 569</a> ) | The P1080L50HZ and P1080L60HZ standards have been added.                      |

## What's New in Version 5.20

New features in version 5.20 of the InfiniiVision 5000 Series oscilloscope software are:

- Mask testing, enabled with Option LMT.
- Tracking cursors (markers) have been added.
- Measurement statistics have been added.
- Labels can now be up to 10 characters.

More detailed descriptions of the new and changed commands appear below.

### New Commands

| Command   | Description  |
|---|--|
| :ACQuire:SEGmented:ANALyze (see <a href="#">page 185</a> )                            | Calculates measurement statistics and/or infinite persistence over all segments that have been acquired. |
| :CALibrate:OUTPut (see <a href="#">page 197</a> )                                     | Selects the signal output on the rear panel TRIG OUT BNC.  |
| :HARDcopy:LAYout (see <a href="#">page 267</a> )                                      | Sets the hardcopy layout mode.   |
| :MEASure:RESults (see <a href="#">page 309</a> )                                      | Returns measurement statistics values.   |
| :MEASure:STATistics (see <a href="#">page 317</a> )                                   | Sets the type of measurement statistics to return.   |
| :MEASure:STATistics:INCRement (see <a href="#">page 318</a> )                         | Updates the statistics once (incrementing the count by one) using the current measurement values.        |
| :MEASure:STATistics:RESet (see <a href="#">page 319</a> )                             | Resets the measurement statistics values.  |
| :MTEenable (Mask Test Event Enable Register) (see <a href="#">page 155</a> )          | Sets a mask in the Mask Test Event Enable register.  |
| :MTEregister[:EVENT] (Mask Test Event Event Register) (see <a href="#">page 157</a> ) | Returns the integer value contained in the Mask Test Event Event Register and clears the register.       |
| :MTESt Commands (see <a href="#">page 337</a> )                                       | Commands and queries to control the mask test (Option LMT) features.                                     |
| :RECall:MASK[:START] (see <a href="#">page 387</a> )                                  | Recalls a mask.  |
| :SAVE:MASK[:START] (see <a href="#">page 387</a> )                                    | Saves the current mask.  |
| :SAVE:WAVEform:SEGmented (see <a href="#">page 393</a> )                              | Specifies which segments are included when the waveform is saved.  |
| :TRIGger:UART:BASE (see <a href="#">page 572</a> )                                    | Selects the front panel UART/RS232 trigger setup data selection option from HEX or BINary.               |

**Changed Commands**

| Command  | Differences  |
|--|--|
| :CHANnel<n>:LABel (see <a href="#">page 211</a> )            | Labels can now be up to 10 characters.   |
| :DISPlay:LABList (see <a href="#">page 229</a> )             | Labels can now be up to 10 characters.   |
| :MARKer:MODE (see <a href="#">page 276</a> )                 | You can now select the WAVEform tracking cursors mode.   |
| :RECall:PWD (see <a href="#">page 375</a> )                  | You can set the present working directory in addition to querying for this information.                              |
| :SAVE:IMAGe[:START] (see <a href="#">page 380</a> )          | The file extension specified will change the :SAVE:IMAGe:FORMat setting if it is a valid image file extension.       |
| :SAVE:PWD (see <a href="#">page 388</a> )                    | You can set the present working directory in addition to querying for this information.                              |
| :SAVE:WAVEform[:START] (see <a href="#">page 380</a> )       | The file extension specified will change the :SAVE:WAVEform:FORMat setting if it is a valid waveform file extension. |
| :TRIGger:CAN:SIGNal:BAUDrate (see <a href="#">page 459</a> ) | The baud rate value can now be set in 100 b/s increments.  |
| :TRIGger:LIN:SIGNal:BAUDrate (see <a href="#">page 535</a> ) | The baud rate value can now be set in 100 b/s increments.  |
| :TRIGger:UART:BAUDrate (see <a href="#">page 573</a> )       | The baud rate value can now be set in 100 b/s increments and the maximum baud rate is now 3 Mb/s.                    |
| :TRIGger:UART:DATA (see <a href="#">page 576</a> )           | You can now specify the data value using a quoted ASCII character.   |

**Obsolete Commands**

| Obsolete Command  | Current Command Equivalent                                | Behavior Differences |
|---|---|----------------------|
| :MTESt:AMASk:{SAVE   STORE} (see <a href="#">page 693</a> ) | :SAVE:MASk[:START] (see <a href="#">page 387</a> )        |                      |
| :MTESt:AVERage (see <a href="#">page 694</a> )              | :ACQuire:TYPE AVERage (see <a href="#">page 191</a> )     |                      |
| :MTESt:AVERage:COUNt (see <a href="#">page 695</a> )        | :ACQuire:COUNt (see <a href="#">page 181</a> )            |                      |
| :MTESt:LOAD (see <a href="#">page 696</a> )                 | :RECall:MASk[:START] (see <a href="#">page 374</a> )      |                      |
| :MTESt:RUMode (see <a href="#">page 697</a> )               | :MTESt:RMODE (see <a href="#">page 356</a> )              |                      |
| :MTESt:RUMode:SOFailure (see <a href="#">page 698</a> )     | :MTESt:RMODE:FACTion:STOP (see <a href="#">page 360</a> ) |                      |

| Obsolete Command                                      | Current Command Equivalent  | Behavior Differences  |
|---|---|---|
| :MTEST:{START   STOP} (see <a href="#">page 699</a> ) | :RUN (see <a href="#">page 170</a> ) or :STOP (see <a href="#">page 174</a> ) |   |
| :MTEST:TRIGger:SOURce (see <a href="#">page 700</a> ) | :TRIGger Commands (see <a href="#">page 440</a> )                             | There are various commands for setting the source with different types of triggers. |

## What's New in Version 5.15

New features in version 5.15 of the InfiniiVision 5000 Series oscilloscope software are:

- Waveform math can be performed using channels 3 and 4, and there is a new ADD operator.
- Ratio of AC RMS values measurement.
- Analog channel impedance protection lock.

More detailed descriptions of the new and changed commands appear below.

### New Commands

| Command  | Description  |
|--|--|
| :FUNction:GOFT:OPERation (see <a href="#">page 248</a> ) | Selects the math operation for the internal g(t) source that can be used as the input to the FFT, INTegrate, DIFFerentiate, and SQRT functions.                    |
| :FUNction:GOFT:SOURce1 (see <a href="#">page 249</a> )   | Selects the first input channel for the g(t) source.   |
| :FUNction:GOFT:SOURce2 (see <a href="#">page 250</a> )   | Selects the second input channel for the g(t) source.  |
| :FUNction:SOURce1 (see <a href="#">page 256</a> )        | Selects the first source for the ADD, SUBTract, and MULTiPLY arithmetic operations or the single source for the FFT, INTegrate, DIFFerentiate, and SQRT functions. |
| :FUNction:SOURce2 (see <a href="#">page 257</a> )        | Selects the second input channel for the ADD, SUBTract, and MULTiPLY arithmetic operations.  |
| :MEASure:VRATio (see <a href="#">page 330</a> )          | Measures and returns the ratio of AC RMS values of the specified sources expressed in dB.  |
| :SYSTem:PROTection:LOCK (see <a href="#">page 425</a> )  | Disables/enables the fifty ohm input impedance setting.  |

**Changed Commands**

| Command   | Differences  |
|---|--|
| :ACQuire:COUNt (see <a href="#">page 181</a> )      | The :ACQuire:COUNt 1 command has been deprecated. The AVERage acquisition type with a count of 1 is functionally equivalent to the HRESolution acquisition type; however, you should select the high-resolution acquisition mode with the :ACQuire:TYPE HRESolution command instead. |
| :FUNction:OPERation (see <a href="#">page 252</a> ) | The ADD parameter is new, and now that waveform math can be performed using channels 3 and 4, this command selects the operation only.   |
| :FUNction:WINDow (see <a href="#">page 259</a> )    | You can now select the Blackman-Harris FFT window.   |

**Obsolete Commands**

| Obsolete Command                                 | Current Command Equivalent                        | Behavior Differences   |
|--|---|--|
| :FUNction:SOURce (see <a href="#">page 670</a> ) | :FUNction:SOURce1 (see <a href="#">page 256</a> ) | Obsolete command has ADD, SUBTract, and MULTIpLy parameters; current command has GOFT parameter. |

## What's New in Version 5.10

New features in version 5.10 of the InfiniiVision 5000 Series oscilloscope software are:

- Segmented memory acquisition mode, enabled with Option SGM.

More detailed descriptions of the new and changed commands appear below.

### New Commands

| Command   | Description   |
|---|---|
| :ACQUIRE:SEGMENTED:COUNT (see <a href="#">page 186</a> )  | Sets the number of memory segments.                                     |
| :ACQUIRE:SEGMENTED:INDEX (see <a href="#">page 187</a> )  | Selects the segmented memory index.                                     |
| :WAVEFORM:SEGMENTED:COUNT (see <a href="#">page 609</a> ) | Returns the number of segments in the currently acquired waveform data. |
| :WAVEFORM:SEGMENTED:TTAG (see <a href="#">page 610</a> )  | Returns the time tag for the selected segmented memory index.           |

### Changed Commands

| Command                                       | Differences                                   |
|---|---|
| :ACQUIRE:MODE (see <a href="#">page 183</a> ) | You can now select the SEGMENTED memory mode. |

### Discontinued Commands

| Discontinued Command | Current Command Equivalent | Comments |
|----------------------|----------------------------|----------|
| :DISPLAY:FREEZE      | none                       |          |

## What's New in Version 5.00

New features in version 5.00 of the InfiniiVision 5000 Series oscilloscope software are:

- Serial triggering and decode options are now available.
- The :SAVE and :RECall command subsystems.
- Changes to the :HARDcopy command subsystem to make a clearer distinction between printing and save/recall functionality.

More detailed descriptions of the new and changed commands appear below.

### New Commands

| Command  | Description   |
|--|---|
| :HARDcopy:START (see <a href="#">page 270</a> )            | Starts a print job.   |
| :HARDcopy:APRinter (see <a href="#">page 263</a> )         | Sets the active printer.  |
| :HARDcopy:AREA (see <a href="#">page 262</a> )             | Specifies the area of the display to print (currently SCReen only).                     |
| :HARDcopy:INKSaver (see <a href="#">page 266</a> )         | Inverts screen colors to save ink when printing.  |
| :HARDcopy:PRinter:LIST (see <a href="#">page 269</a> )     | Returns a list of the available printers.   |
| :RECall Commands (see <a href="#">page 371</a> )           | Commands for recalling previously saved oscilloscope setups and traces.                 |
| :SAVE Commands (see <a href="#">page 377</a> )             | Commands for saving oscilloscope setups and traces, screen images, and data.            |
| :SBUS Commands (see <a href="#">page 394</a> )             | Commands for controlling oscilloscope functions associated with the serial decode bus.  |
| :TRIGger:CAN Commands (see <a href="#">page 452</a> )      | Commands for triggering on Controller Area Network (CAN) version 2.0A and 2.0B signals. |
| :TRIGger:IIC Commands (see <a href="#">page 518</a> )      | Commands for triggering on Inter-IC (IIC) signals.                                      |
| :TRIGger:LIN Commands (see <a href="#">page 527</a> )      | Commands for triggering on Local Interconnect Network (LIN) signals.                    |
| :TRIGger:SPI Commands (see <a href="#">page 555</a> )      | Commands for triggering on Serial Peripheral Interface (SPI) signals.                   |
| :TRIGger:UART Commands (see <a href="#">page 570</a> )     | Commands for triggering on UART/RS-232 signals.   |
| :WAVEform:SOURce:SUBSource (see <a href="#">page 615</a> ) | Selects subsource when :WAVEform:SOURce is SBUS (serial decode).                        |

## 1 What's New

### Changed Commands

| Command  | Differences  |
|--|--|
| :BLANk (see <a href="#">page 144</a> )           | Now, you can also use this command with the serial decode bus. |
| :DIGitize (see <a href="#">page 146</a> )        | Now, you can also use this command with the serial decode bus. |
| :STATus (see <a href="#">page 173</a> )          | Now, you can also use this command with the serial decode bus. |
| :TRIGger:MODE (see <a href="#">page 447</a> )    | You can now select the serial triggering modes.                |
| :VIEW (see <a href="#">page 176</a> )            | Now, you can now use this command with the serial decode bus.  |
| :WAVEform:SOURce (see <a href="#">page 611</a> ) | Now, you can also use this command with the serial decode bus. |

### Obsolete Commands

| Obsolete Command                                   | Current Command Equivalent  | Behavior Differences |
|--|---|----------------------|
| :HARDcopy:FILEname (see <a href="#">page 674</a> ) | :RECall:FILEname (see <a href="#">page 372</a> )<br>:SAVE:FILEname (see <a href="#">page 372</a> )  |                      |
| :HARDcopy:FORMat (see <a href="#">page 675</a> )   | :HARDcopy:APRinter (see <a href="#">page 263</a> )<br>:SAVE:IMAGe:FORMat (see <a href="#">page 383</a> )<br>:SAVE:WAVEform:FORMat (see <a href="#">page 391</a> ) |                      |
| :HARDcopy:IGColors (see <a href="#">page 677</a> ) | :HARDcopy:INKSaver (see <a href="#">page 266</a> )  |                      |
| :HARDcopy:PDRiver (see <a href="#">page 678</a> )  | :HARDcopy:APRinter (see <a href="#">page 263</a> )  |                      |

## What's New in Version 4.10

New features in version 4.10 of the InfiniiVision 5000 Series oscilloscope software are:

- The square root waveform math function.
- Several new hardcopy printer drivers.

More detailed descriptions of the new and changed commands appear below.

### Changed Commands

| Command   | Differences  |
|---|--|
| :FUNction:OPERation (see <a href="#">page 252</a> ) | You can now select the SQRT (square root) waveform math function.                      |
| :HARDcopy:PDRiver (see <a href="#">page 678</a> )   | You can now select the new DJPR0kx50, DJ55xx, PS470, and LJFastraster printer drivers. |

## Version 4.00 at Introduction

The Agilent InfiniiVision 5000 Series oscilloscopes were introduced with version 4.00 of oscilloscope operating software. The command set is similar to the 6000 Series oscilloscopes (and the 54620/54640 Series oscilloscopes before them) except that digital channels, rear-panel 10 Mhz reference BNC input/output, and serial bus triggering/decode features are not present.

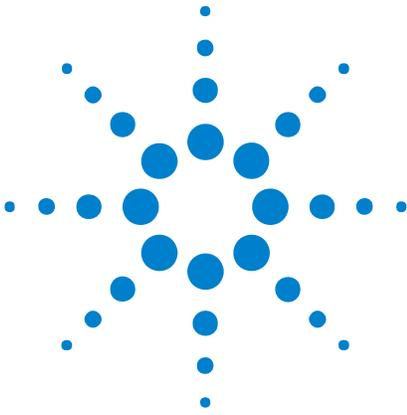

## 2 Setting Up

- Step 1. Install Agilent IO Libraries Suite software 38
- Step 2. Connect and set up the oscilloscope 39
- Step 3. Verify the oscilloscope connection 41

This chapter explains how to install the Agilent IO Libraries Suite software, connect the oscilloscope to the controller PC, set up the oscilloscope, and verify the oscilloscope connection.



## Step 1. Install Agilent IO Libraries Suite software

Insert the Automation-Ready CD that was shipped with your oscilloscope into the controller PC's CD-ROM drive, and follow its installation instructions.

You can also download the Agilent IO Libraries Suite software from the web at:

- "<http://www.agilent.com/find/iolib>"

## Step 2. Connect and set up the oscilloscope

The 5000 Series oscilloscope has three different interfaces you can use for programming: USB (device), LAN, or GPIB.

All three interfaces are "live" by default, but you can turn them off if desired. To access these settings press the **Utility** key on the front panel, then press the **I/O** softkey, then press the **Control** softkey.



**Figure 1** Control Connectors on Rear Panel

### Using the USB (Device) Interface

- 1 Connect a USB cable from the controller PC's USB port to the "USB DEVICE" port on the back of the oscilloscope.

This is a USB 2.0 high-speed port.

- 2 On the oscilloscope, verify that the controller interface is enabled:
  - a Press the **Utility** button.
  - b Using the softkeys, press **I/O** and **Control**.
  - c Ensure the box next to **USB** is selected (). If not () , use the Entry knob to select **USB**; then, press the **Control** softkey again.

### Using the LAN Interface

- 1 If the controller PC isn't already connected to the local area network (LAN), do that first.
- 2 Get the oscilloscope's network parameters (hostname, domain, IP address, subnet mask, gateway IP, DNS IP, etc.) from your network administrator.
- 3 Connect the oscilloscope to the local area network (LAN) by inserting LAN cable into the "LAN" port on the back of the oscilloscope.

- 4 On the oscilloscope, verify that the controller interface is enabled:
  - a Press the **Utility** button.
  - b Using the softkeys, press **I/O** and **Control**.
  - c Ensure the box next to **LAN** is selected (). If not () , use the Entry knob to select **LAN**; then, press the **Control** softkey again.
- 5 Configure the oscilloscope's LAN interface:
  - a Press the **Configure** softkey until "LAN" is selected.
  - b Press the **LAN Settings** softkey.
  - c Press the **Addresses** softkey. Use the **IP Options** softkey and the Entry knob to select DHCP, AutoIP, or netBIOS. Use the **Modify** softkey (and the other softkeys and the Entry knob) to enter the IP Address, Subnet Mask, Gateway IP, and DNS IP values. When you are done, press the return (up arrow) softkey.
  - d Press the **Domain** softkey. Use the **Modify** softkey (and the other softkeys and the Entry knob) to enter the Host name and the Domain name. When you are done, press the return (up arrow) softkey.

### Using the GPIB Interface

- 1 Connect a GPIB cable from the controller PC's GPIB interface to the "GPIB" port on the back of the oscilloscope.
- 2 On the oscilloscope, verify that the controller interface is enabled:
  - a Press the **Utility** button.
  - b Using the softkeys, press **I/O** and **Control**.
  - c Use the Entry knob to select "GPIB"; then, press the **Control** softkey again.

Ensure the box next to **GPIB** is selected (). If not () , use the Entry knob to select **GPIB**; then, press the **Control** softkey again.
- 3 Configure the oscilloscope's GPIB interface:
  - a Press the **Configure** softkey until "GPIB" is selected.
  - b Use the Entry knob to select the **Address** value.

### Step 3. Verify the oscilloscope connection

- 1 On the controller PC, click on the Agilent IO Control icon in the taskbar and choose **Agilent Connection Expert** from the popup menu.



- 2 In the Agilent Connection Expert application, instruments connected to the controller's USB and GPIB interfaces should automatically appear. (You can click Refresh All to update the list of instruments on these interfaces.)

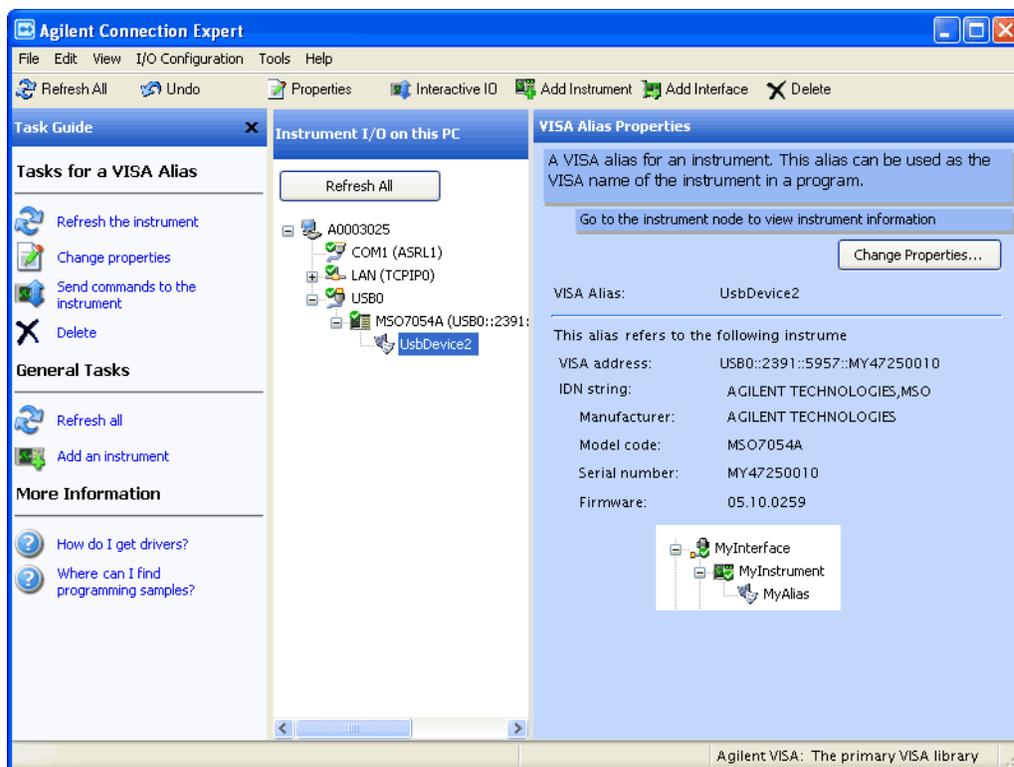

## 2 Setting Up

You must manually add instruments on LAN interfaces:

- a Right-click on the LAN interface, choose **Add Instrument** from the popup menu

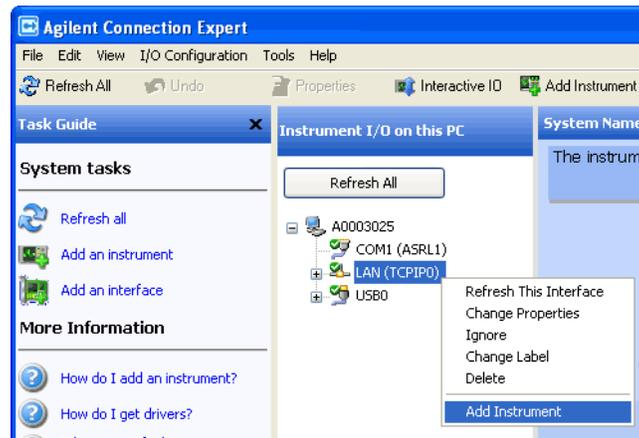

- b If the oscilloscope is on the same subnet, select it, and click **OK**.

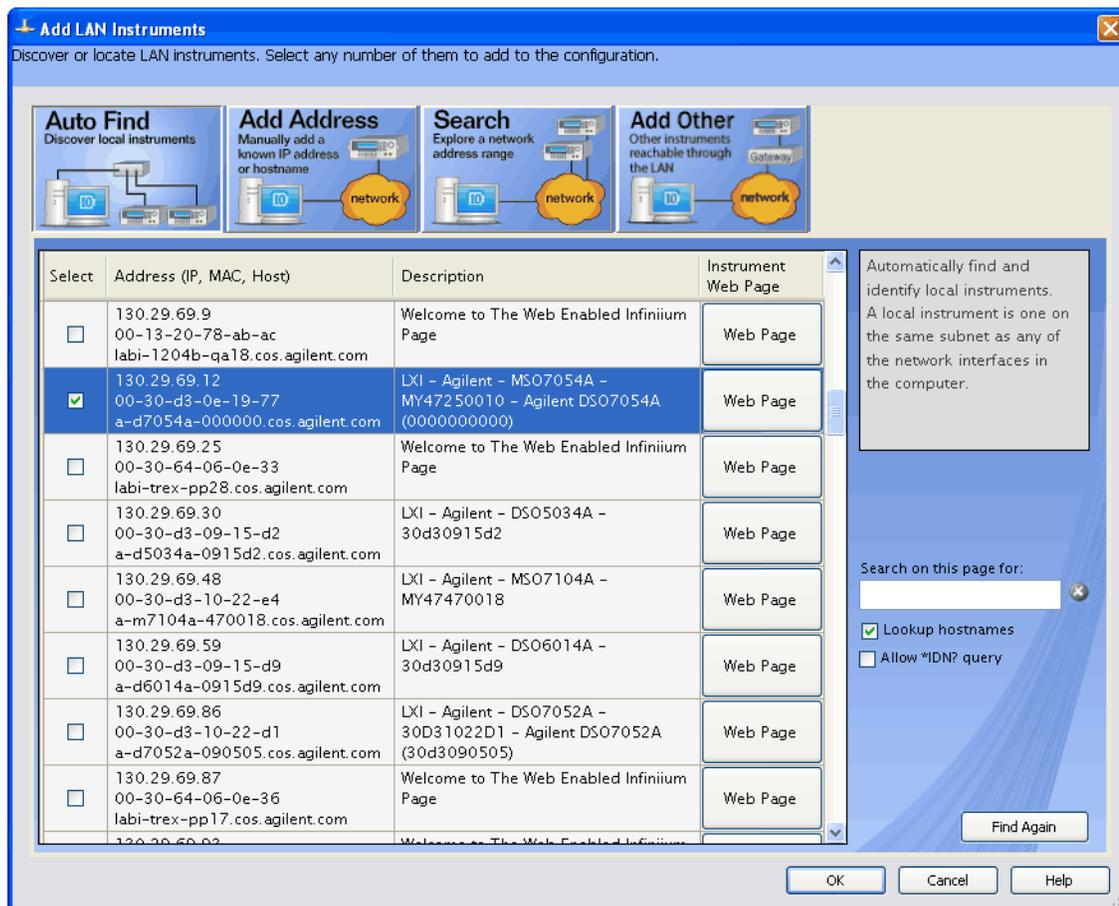

Otherwise, if the instrument is not on the same subnet, click **Add Address**.

- i In the next dialog, select either **Hostname** or **IP address**, and enter the oscilloscope's hostname or IP address.
- ii Click **Test Connection**.

## 2 Setting Up

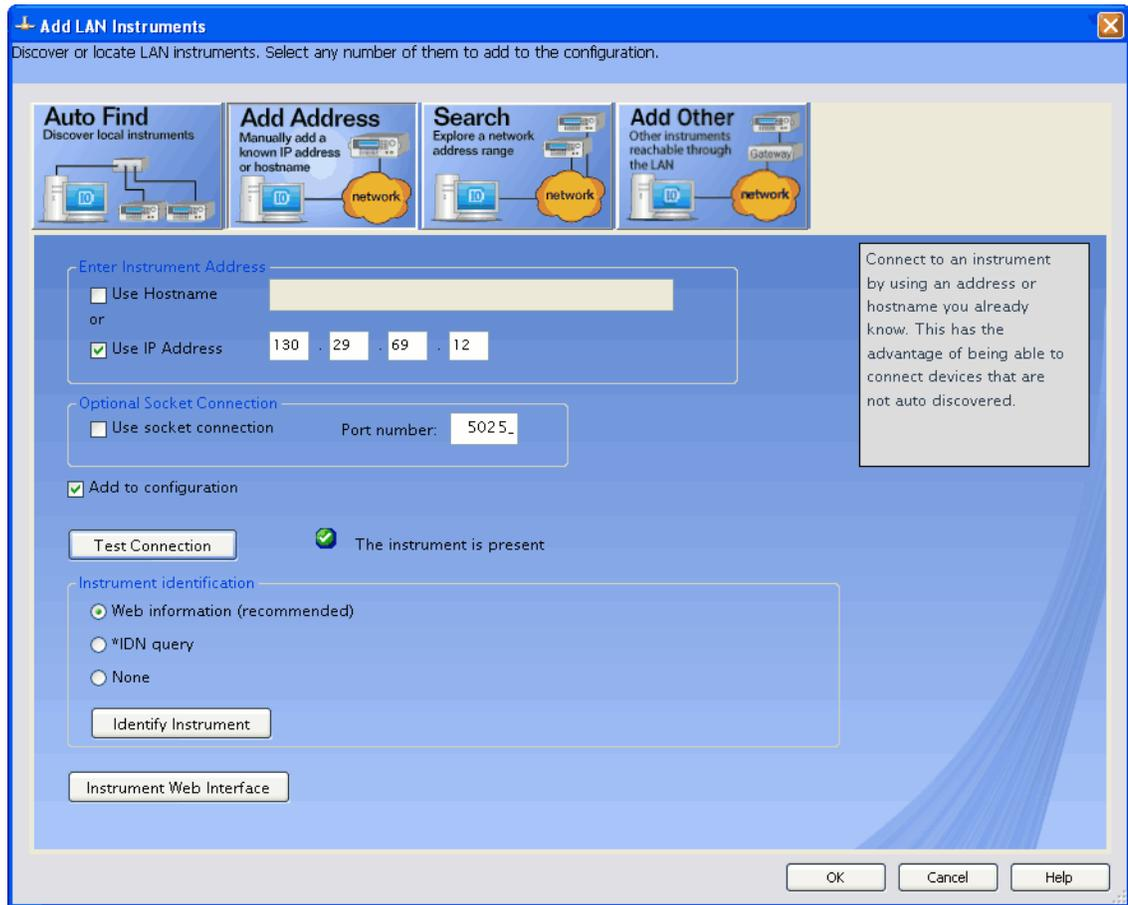

- iii If the instrument is successfully opened, click **OK** to close the dialog. If the instrument is not opened successfully, go back and verify the LAN connections and the oscilloscope setup.

- 3 Test some commands on the instrument:
  - a Right-click on the instrument and choose **Send Commands To This Instrument** from the popup menu.

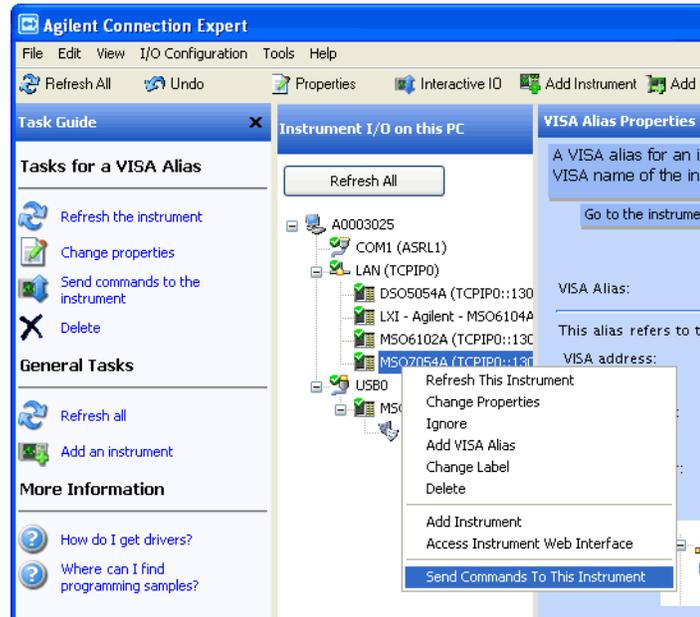

- b In the Agilent Interactive IO application, enter commands in the **Command** field and press **Send Command**, **Read Response**, or **Send&Read**.

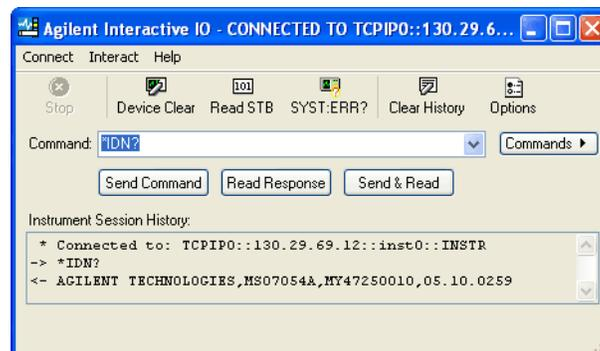

- c Choose **Connect>Exit** from the menu to exit the Agilent Interactive IO application.
- 4 In the Agilent Connection Expert application, choose **File>Exit** from the menu to exit the application.

## 2 Setting Up

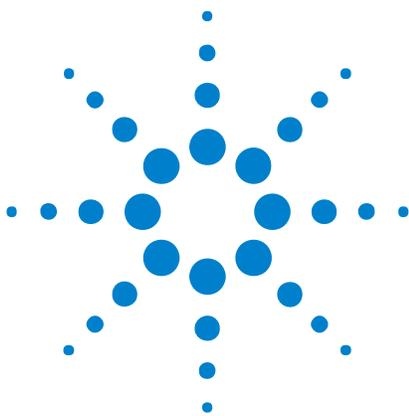

## 3 Getting Started

|                                      |    |
|--------------------------------------|----|
| Basic Oscilloscope Program Structure | 48 |
| Programming the Oscilloscope         | 50 |
| Other Ways of Sending Commands       | 59 |

This chapter gives you an overview of programming the 5000 Series oscilloscopes. It describes basic oscilloscope program structure and shows how to program the oscilloscope using a few simple examples.

The getting started examples show how to send oscilloscope setup, data capture, and query commands, and they show how to read query results.

### NOTE

#### Language for Program Examples

The programming examples in this guide are written in Visual Basic using the Agilent VISA COM library.



## Basic Oscilloscope Program Structure

The following figure shows the basic structure of every program you will write for the oscilloscope.

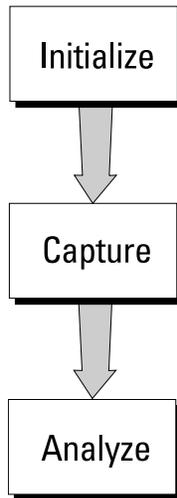

### Initializing

To ensure consistent, repeatable performance, you need to start the program, controller, and oscilloscope in a known state. Without correct initialization, your program may run correctly in one instance and not in another. This might be due to changes made in configuration by previous program runs or from the front panel of the oscilloscope.

- Program initialization defines and initializes variables, allocates memory, or tests system configuration.
- Controller initialization ensures that the interface to the oscilloscope is properly set up and ready for data transfer.
- Oscilloscope initialization sets the channel configuration, channel labels, threshold voltages, trigger specification, trigger mode, timebase, and acquisition type.

### Capturing Data

Once you initialize the oscilloscope, you can begin capturing data for analysis. Remember that while the oscilloscope is responding to commands from the controller, it is not performing acquisitions. Also, when you change the oscilloscope configuration, any data already captured will most likely be rendered.

To collect data, you use the `:DIGitize` command. This command clears the waveform buffers and starts the acquisition process. Acquisition continues until acquisition memory is full, then stops. The acquired data is displayed by the oscilloscope, and the captured data can be measured, stored in trace memory in the oscilloscope, or transferred to the controller for further analysis. Any additional commands sent while `:DIGitize` is working are buffered until `:DIGitize` is complete.

You could also put the oscilloscope into run mode, then use a wait loop in your program to ensure that the oscilloscope has completed at least one acquisition before you make a measurement. Agilent does not recommend this because the needed length of the wait loop may vary, causing your program to fail. `:DIGitize`, on the other hand, ensures that data capture is complete. Also, `:DIGitize`, when complete, stops the acquisition process so that all measurements are on displayed data, not on a constantly changing data set.

## Analyzing Captured Data

After the oscilloscope has completed an acquisition, you can find out more about the data, either by using the oscilloscope measurements or by transferring the data to the controller for manipulation by your program. Built-in measurements include: frequency, duty cycle, period, positive pulse width, and negative pulse width.

Using the `:WAVEform` commands, you can transfer the data to your controller. You may want to display the data, compare it to a known good measurement, or simply check logic patterns at various time intervals in the acquisition.

## Programming the Oscilloscope

- "Referencing the IO Library" on page 50
- "Opening the Oscilloscope Connection via the IO Library" on page 51
- "Using :AUToscale to Automate Oscilloscope Setup" on page 52
- "Using Other Oscilloscope Setup Commands" on page 52
- "Capturing Data with the :DIGitize Command" on page 53
- "Reading Query Responses from the Oscilloscope" on page 55
- "Reading Query Results into String Variables" on page 56
- "Reading Query Results into Numeric Variables" on page 56
- "Reading Definite-Length Block Query Response Data" on page 56
- "Sending Multiple Queries and Reading Results" on page 57
- "Checking Instrument Status" on page 58

## Referencing the IO Library

No matter which instrument programming library you use (SICL, VISA, or VISA COM), you must reference the library from your program.

In C/C++, you must tell the compiler where to find the include and library files (see the Agilent IO Libraries Suite documentation for more information).

To reference the Agilent VISA COM library in Visual Basic for Applications (VBA, which comes with Microsoft Office products like Excel):

- 1 Choose **Tools>References...** from the main menu.
- 2 In the References dialog, check the "VISA COM 3.0 Type Library".

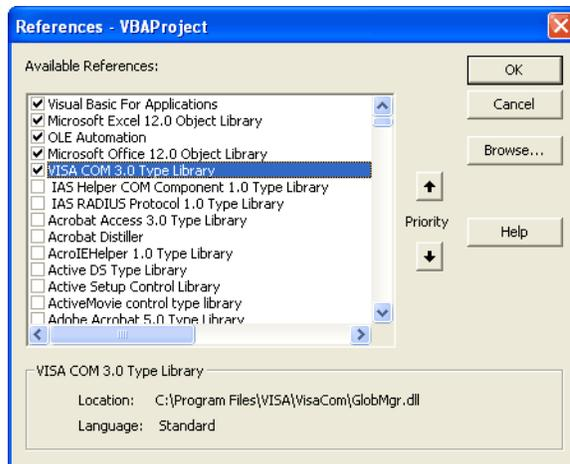

3 Click **OK**.

To reference the Agilent VISA COM library in Microsoft Visual Basic 6.0:

- 1 Choose **Project>References...** from the main menu.
- 2 In the References dialog, check the "VISA COM 3.0 Type Library".
- 3 Click **OK**.

## Opening the Oscilloscope Connection via the IO Library

PC controllers communicate with the oscilloscope by sending and receiving messages over a remote interface. Once you have opened a connection to the oscilloscope over the remote interface, programming instructions normally appear as ASCII character strings embedded inside write statements of the programming language. Read statements are used to read query responses from the oscilloscope.

For example, when using the Agilent VISA COM library in Visual Basic (after opening the connection to the instrument using the ResourceManager object's Open method), the FormattedIO488 object's WriteString, WriteNumber, WriteList, or WriteIEEEBlock methods are used for sending commands and queries. After a query is sent, the response is read using the ReadString, ReadNumber, ReadList, or ReadIEEEBlock methods.

The following Visual Basic statements open the connection and send a command that turns on the oscilloscope's label display.

```
Dim myMgr As VisaComLib.ResourceManager
Dim myScope As VisaComLib.FormattedIO488

Set myMgr = New VisaComLib.ResourceManager
Set myScope = New VisaComLib.FormattedIO488

' Open the connection to the oscilloscope. Get the VISA Address from the
' Agilent Connection Expert (installed with Agilent IO Libraries Suite).
Set myScope.IO = myMgr.Open("<VISA Address>")

' Send a command.
myScope.WriteString ":DISPlay:LABel ON"
```

The ":DISPLAY:LABEL ON" in the above example is called a *program message*. Program messages are explained in more detail in "[Program Message Syntax](#)" on page 751.

## Initializing the Interface and the Oscilloscope

To make sure the bus and all appropriate interfaces are in a known state, begin every program with an initialization statement. When using the Agilent VISA COM library, you can use the resource session object's Clear method to clear the interface buffer:

```
Dim myMgr As VisaComLib.ResourceManager
Dim myScope As VisaComLib.FormattedIO488

Set myMgr = New VisaComLib.ResourceManager
Set myScope = New VisaComLib.FormattedIO488

' Open the connection to the oscilloscope. Get the VISA Address from the
' Agilent Connection Expert (installed with Agilent IO Libraries Suite).
Set myScope.IO = myMgr.Open("<VISA Address>")

' Clear the interface buffer.
myScope.IO.Clear
```

When you are using GPIB, CLEAR also resets the oscilloscope's parser. The parser is the program which reads in the instructions which you send it.

After clearing the interface, initialize the instrument to a preset state:

```
myScope.WriteString "*RST"
```

#### NOTE

#### Information for Initializing the Instrument

The actual commands and syntax for initializing the instrument are discussed in "[Common \(\\*\) Commands](#)" on page 111.

Refer to the Agilent IO Libraries Suite documentation for information on initializing the interface.

## Using :AUToscale to Automate Oscilloscope Setup

The :AUToscale command performs a very useful function for unknown waveforms by setting up the vertical channel, time base, and trigger level of the instrument.

The syntax for the autoscale command is:

```
myScope.WriteString ":AUToscale"
```

## Using Other Oscilloscope Setup Commands

A typical oscilloscope setup would set the vertical range and offset voltage, the horizontal range, delay time, delay reference, trigger mode, trigger level, and slope. An example of the commands that might be sent to the oscilloscope are:

```
myScope.WriteString ":CHANnel1:PROBe 10"
myScope.WriteString ":CHANnel1:RANGe 16"
myScope.WriteString ":CHANnel1:OFFSet 1.00"
myScope.WriteString ":TIMEbase:MODE MAIN"
myScope.WriteString ":TIMEbase:RANGe 1E-3"
myScope.WriteString ":TIMEbase:DELay 100E-6"
```

Vertical is set to 16 V full-scale (2 V/div) with center of screen at 1 V and probe attenuation set to 10. This example sets the time base at 1 ms full-scale (100 ms/div) with a delay of 100  $\mu$ s.

### Example Oscilloscope Setup Code

This program demonstrates the basic command structure used to program the oscilloscope.

```
' Initialize the instrument interface to a known state.
myScope.IO.Clear

' Initialize the instrument to a preset state.
myScope.WriteString "*RST"

' Set the time base mode to normal with the horizontal time at
' 50 ms/div with 0 s of delay referenced at the center of the
' graticule.
myScope.WriteString ":TIMEbase:RANGe 5E-4" ' Time base to 50 us/div.
myScope.WriteString ":TIMEbase:DELay 0" ' Delay to zero.
myScope.WriteString ":TIMEbase:REFerence CENTER" ' Display ref. at
' center.

' Set the vertical range to 1.6 volts full scale with center screen
' at -0.4 volts with 10:1 probe attenuation and DC coupling.
myScope.WriteString ":CHANnel:PROBE 10" ' Probe attenuation
' to 10:1.
myScope.WriteString ":CHANnel:RANGe 1.6" ' Vertical range
' 1.6 V full scale.
myScope.WriteString ":CHANnel:OFFSet -.4" ' Offset to -0.4.
myScope.WriteString ":CHANnel:COUPLing DC" ' Coupling to DC.

' Configure the instrument to trigger at -0.4 volts with normal
' triggering.
myScope.WriteString ":TRIGger:SWEep NORMal" ' Normal triggering.
myScope.WriteString ":TRIGger:LEVel -.4" ' Trigger level to -0.4.
myScope.WriteString ":TRIGger:SLOPe POSitive" ' Trigger on pos. slope.

' Configure the instrument for normal acquisition.
myScope.WriteString ":ACQuire:TYPE NORMal" ' Normal acquisition.
```

## Capturing Data with the :DIGitize Command

The :DIGitize command captures data that meets the specifications set up by the :ACquire subsystem. When the digitize process is complete, the acquisition is stopped. The captured data can then be measured by the instrument or transferred to the controller for further analysis. The captured data consists of two parts: the waveform data record, and the preamble.

**NOTE****Ensure New Data is Collected**

When you change the oscilloscope configuration, the waveform buffers are cleared. Before doing a measurement, send the :DIGitize command to the oscilloscope to ensure new data has been collected.

---

When you send the :DIGitize command to the oscilloscope, the specified channel signal is digitized with the current :ACQUIRE parameters. To obtain waveform data, you must specify the :WAVEFORM parameters for the SOURCE channel, the FORMAT type, and the number of POINTs prior to sending the :WAVEFORM:DATA? query.

**NOTE****Set :TIMEbase:MODE to MAIN when using :DIGitize**

:TIMEbase:MODE must be set to MAIN to perform a :DIGitize command or to perform any :WAVEFORM subsystem query. A "Settings conflict" error message will be returned if these commands are executed when MODE is set to ROLL, XY, or WINDOW (zoomed). Sending the \*RST (reset) command will also set the time base mode to normal.

---

The number of data points comprising a waveform varies according to the number requested in the :ACQUIRE subsystem. The :ACQUIRE subsystem determines the number of data points, type of acquisition, and number of averages used by the :DIGitize command. This allows you to specify exactly what the digitized information contains.

The following program example shows a typical setup:

```
myScope.WriteString ":ACQUIRE:TYPE AVERAGE"  
myScope.WriteString ":ACQUIRE:COMPLETE 100"  
myScope.WriteString ":ACQUIRE:COUNT 8"  
myScope.WriteString ":DIGITIZE CHANNEL1"  
myScope.WriteString ":WAVEFORM:SOURCE CHANNEL1"  
myScope.WriteString ":WAVEFORM:FORMAT BYTE"  
myScope.WriteString ":WAVEFORM:POINTS 500"  
myScope.WriteString ":WAVEFORM:DATA?"
```

This setup places the instrument into the averaged mode with eight averages. This means that when the :DIGITIZE command is received, the command will execute until the signal has been averaged at least eight times.

After receiving the :WAVEFORM:DATA? query, the instrument will start passing the waveform information.

Digitized waveforms are passed from the instrument to the controller by sending a numerical representation of each digitized point. The format of the numerical representation is controlled with the :WAVEFORM:FORMAT command and may be selected as BYTE, WORD, or ASCII.

The easiest method of transferring a digitized waveform depends on data structures, formatting available and I/O capabilities. You must scale the integers to determine the voltage value of each point. These integers are passed starting with the left most point on the instrument's display.

For more information, see the waveform subsystem commands and corresponding program code examples in "[:WAVEform Commands](#)" on page 590.

**NOTE****Aborting a Digitize Operation Over the Programming Interface**

When using the programming interface, you can abort a digitize operation by sending a Device Clear over the bus (for example, `myScope.IO.Clear`).

**Reading Query Responses from the Oscilloscope**

After receiving a query (command header followed by a question mark), the instrument interrogates the requested function and places the answer in its output queue. The answer remains in the output queue until it is read or another command is issued. When read, the answer is transmitted across the interface to the designated listener (typically a controller).

The statement for reading a query response message from an instrument's output queue typically has a format specification for handling the response message.

When using the VISA COM library in Visual Basic, you use different read methods (`ReadString`, `ReadNumber`, `ReadList`, or `ReadIEEEBlock`) for the various query response formats. For example, to read the result of the query command `:CHANnel1:COUPLing?` you would execute the statements:

```
myScope.WriteString ":CHANnel1:COUPLing?"
Dim strQueryResult As String
strQueryResult = myScope.ReadString
```

This reads the current setting for the channel one coupling into the string variable `strQueryResult`.

All results for queries (sent in one program message) must be read before another program message is sent.

Sending another command before reading the result of the query clears the output buffer and the current response. This also causes an error to be placed in the error queue.

Executing a read statement before sending a query causes the controller to wait indefinitely.

The format specification for handling response messages depends on the programming language.

## Reading Query Results into String Variables

The output of the instrument may be numeric or character data depending on what is queried. Refer to the specific command descriptions in [Chapter 5](#), “Commands by Subsystem,” starting on page 109 for the formats and types of data returned from queries.

### NOTE

#### Express String Variables Using Exact Syntax

In Visual Basic, string variables are case sensitive and must be expressed exactly the same each time they are used.

The following example shows numeric data being returned to a string variable:

```
myScope.WriteString ":CHANnel1:RANGe?"
Dim strQueryResult As String
strQueryResult = myScope.ReadString
MsgBox "Range (string):" + strQueryResult
```

After running this program, the controller displays:

**Range (string): +40.0E+00**

## Reading Query Results into Numeric Variables

The following example shows numeric data being returned to a numeric variable:

```
myScope.WriteString ":CHANnel1:RANGe?"
Dim varQueryResult As Variant
strQueryResult = myScope.ReadNumber
MsgBox "Range (variant):" + CStr(varQueryResult)
```

After running this program, the controller displays:

**Range (variant): 40**

## Reading Definite-Length Block Query Response Data

Definite-length block query response data allows any type of device-dependent data to be transmitted over the system interface as a series of 8-bit binary data bytes. This is particularly useful for sending large quantities of data or 8-bit extended ASCII codes. The syntax is a pound sign (#) followed by a non-zero digit representing the number of digits in the decimal integer. After the non-zero digit is the decimal integer that states the number of 8-bit data bytes being sent. This is followed by the actual data.

For example, for transmitting 1000 bytes of data, the syntax would be:

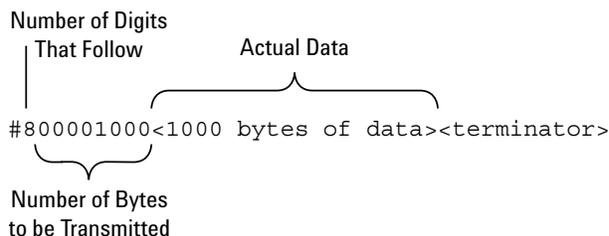

**Figure 2** Definite-length block response data

The "8" states the number of digits that follow, and "00001000" states the number of bytes to be transmitted.

The VISA COM library's `ReadIEEEBlock` and `WriteIEEEBlock` methods understand the definite-length block syntax, so you can simply use variables that contain the data:

```
' Read oscilloscope setup using ":SYSTEM:SETup?" query.
myScope.WriteString ":SYSTEM:SETup?"
Dim varQueryResult As Variant
varQueryResult = myScope.ReadIEEEBlock(BinaryType_UI1)

' Write learn string back to oscilloscope using ":SYSTEM:SETup" command:
myScope.WriteIEEEBlock ":SYSTEM:SETup ", varQueryResult
```

## Sending Multiple Queries and Reading Results

You can send multiple queries to the instrument within a single command string, but you must also read them back as a single query result. This can be accomplished by reading them back into a single string variable, multiple string variables, or multiple numeric variables.

For example, to read the `:TIMEbase:RANGE?;DElay?` query result into a single string variable, you could use the commands:

```
myScope.WriteString ":TIMEbase:RANGE?;DElay?"
Dim strQueryResult As String
strQueryResult = myScope.ReadString
MsgBox "Timebase range; delay:" + strQueryResult
```

When you read the result of multiple queries into a single string variable, each response is separated by a semicolon. For example, the output of the previous example would be:

```
Timebase range; delay: <range_value>;<delay_value>
```

To read the `:TIMEbase:RANGE?;DElay?` query result into multiple string variables, you could use the `ReadList` method to read the query results into a string array variable using the commands:

```
myScope.WriteString ":TIMEbase:RANGE?;DElay?"
Dim strResults() As String
```

```
strResults() = myScope.ReadList(ASCIIType_BSTR)
MsgBox "Timebase range: " + strResults(0) + ", delay: " + strResults(1)
```

To read the `:TIMEbase:RANGE?;DElay?` query result into multiple numeric variables, you could use the `ReadList` method to read the query results into a variant array variable using the commands:

```
myScope.WriteString ":TIMEbase:RANGE?;DElay?"
Dim varResults() As Variant
varResults() = myScope.ReadList
MsgBox "Timebase range: " + FormatNumber(varResults(0) * 1000, 4) + _
      " ms, delay: " + FormatNumber(varResults(1) * 1000000, 4) + " us"
```

## Checking Instrument Status

Status registers track the current status of the instrument. By checking the instrument status, you can find out whether an operation has been completed, whether the instrument is receiving triggers, and more.

For more information, see [Chapter 9](#), “Status Reporting,” starting on page 715 which explains how to check the status of the instrument.

## Other Ways of Sending Commands

Standard Commands for Programmable Instrumentation (SCPI) can be sent via a Telnet socket or through the Browser Web Control.

### Telnet Sockets

The following information is provided for programmers who wish to control the oscilloscope with SCPI commands in a Telnet session.

To connect to the oscilloscope via a telnet socket, issue the following command:

```
telnet <hostname> 5024
```

where <hostname> is the hostname of the oscilloscope. This will give you a command line with prompt.

For a command line without a prompt, use port 5025. For example:

```
telnet <hostname> 5025
```

### Sending SCPI Commands Using Browser Web Control

To send SCPI commands using the Browser Web Control feature, establish a connection to the oscilloscope via LAN as described in the *5000 Series Oscilloscopes User's Guide*. When you make the connection to the oscilloscope via LAN and the instrument's welcome page is displayed, select the **Browser Web Control** tab, then select the **Remote Programming** link.

### **3 Getting Started**

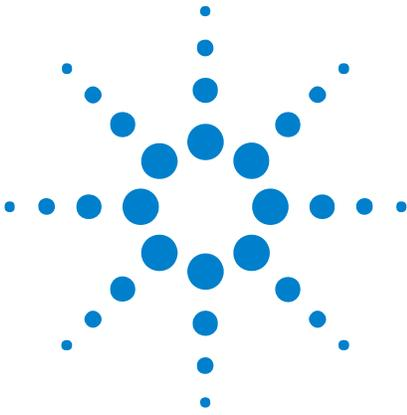

## 4 Commands Quick Reference

Command Summary 62

Syntax Elements 106



## Command Summary

**Table 2** Common (\*) Commands Summary

| Command                                     | Query                                 | Options and Query Returns   |
|---|---------------------------------------|---|
| *CLS (see <a href="#">page 115</a> )        | n/a                                   | n/a   |
| *ESE <mask> (see <a href="#">page 116</a> ) | *ESE? (see <a href="#">page 117</a> ) | <mask> ::= 0 to 255; an integer in NR1 format:<br><br>Bit Weight Name Enables<br>-----<br>7 128 PON Power On<br>6 64 URQ User Request<br>5 32 CME Command Error<br>4 16 EXE Execution Error<br>3 8 DDE Dev. Dependent Error<br>2 4 QYE Query Error<br>1 2 RQL Request Control<br>0 1 OPC Operation Complete |
| n/a   | *ESR? (see <a href="#">page 118</a> ) | <status> ::= 0 to 255; an integer in NR1 format   |
| n/a   | *IDN? (see <a href="#">page 118</a> ) | AGILENT TECHNOLOGIES,<model>,<serial number>,X.XX.XX<br><model> ::= the model number of the instrument<br><serial number> ::= the serial number of the instrument<br><X.XX.XX> ::= the software revision of the instrument  |
| n/a   | *LRN? (see <a href="#">page 121</a> ) | <learn_string> ::= current instrument setup as a block of data in IEEE 488.2 # format   |
| *OPC (see <a href="#">page 122</a> )        | *OPC? (see <a href="#">page 122</a> ) | ASCII "1" is placed in the output queue when all pending device operations have completed.  |

**Table 2** Common (\*) Commands Summary (continued)

| Command                                      | Query                                 | Options and Query Returns  |
|--|---------------------------------------|--|
| n/a  | *OPT? (see <a href="#">page 123</a> ) | <pre> &lt;return_value&gt; ::= 0,0,&lt;license info&gt; &lt;license info&gt; ::= &lt;All field&gt;, &lt;reserved&gt;, &lt;reserved&gt;, &lt;reserved&gt;, &lt;reserved&gt;, &lt;reserved&gt;, &lt;Low Speed Serial&gt;, &lt;Automotive Serial&gt;, &lt;reserved&gt;, &lt;Secure&gt;, &lt;reserved&gt;, &lt;reserved&gt;, &lt;reserved&gt;, &lt;reserved&gt;, &lt;RS-232/UART Serial&gt;, &lt;reserved&gt;, &lt;Segmented Memory&gt;, &lt;Mask Test&gt;, &lt;reserved&gt;, &lt;reserved&gt;, &lt;FlexRay Conformance&gt;, &lt;reserved&gt;, &lt;reserved&gt;, &lt;I2S Serial&gt;, &lt;FlexRay Trigger/Decode&gt;, &lt;reserved&gt;, &lt;reserved&gt;, &lt;MIL-STD 1553 Trigger/Decode&gt;, &lt;reserved&gt; &lt;All field&gt; ::= {0   All} &lt;reserved&gt; ::= 0 &lt;Low Speed Serial&gt; ::= {0   LSS} &lt;Automotive Serial&gt; ::= {0   AMS} &lt;Secure&gt; ::= {0   SEC} &lt;RS-232/UART Serial&gt; ::= {0   232} &lt;Segmented Memory&gt; ::= {0   SGM} &lt;Mask Test&gt; ::= {0   LMT} &lt;FlexRay Conformance&gt; ::= {0   FRC} &lt;I2S Serial&gt; ::= {0   SND} &lt;FlexRay Trigger/Decode&gt; ::= {0   FLX} &lt;MIL-STD 1553 Trigger/Decode&gt; ::= {0   553} </pre> |
| *RCL <value> (see <a href="#">page 124</a> ) | n/a                                   | <value> ::= {0   1   2   3   4   5   6   7   8   9}  |
| *RST (see <a href="#">page 125</a> )         | n/a                                   | See *RST (Reset) (see <a href="#">page 125</a> )   |
| *SAV <value> (see <a href="#">page 128</a> ) | n/a                                   | <value> ::= {0   1   2   3   4   5   6   7   8   9}  |

## 4 Commands Quick Reference

**Table 2** Common (\*) Commands Summary (continued)

| Command                                     | Query                                 | Options and Query Returns   |
|---|---------------------------------------|---|
| *SRE <mask> (see <a href="#">page 129</a> ) | *SRE? (see <a href="#">page 130</a> ) | <p>&lt;mask&gt; ::= sum of all bits that are set, 0 to 255; an integer in NR1 format. &lt;mask&gt; ::= following values:</p> <pre> Bit Weight Name Enables ----- 7      128 OPER Operation Status Reg 6       64 ---- (Not used.) 5       32 ESB  Event Status Bit 4       16 MAV  Message Available 3        8 ---- (Not used.) 2        4 MSG  Message 1        2 USR  User 0        1 TRG  Trigger           </pre>  |
| n/a   | *STB? (see <a href="#">page 131</a> ) | <p>&lt;value&gt; ::= 0 to 255; an integer in NR1 format, as shown in the following:</p> <pre> Bit Weight Name "1" Indicates ----- 7      128 OPER Operation status           condition occurred. 6       64 RQS/ Instrument is           MSS requesting service. 5       32 ESB  Enabled event status           condition occurred. 4       16 MAV  Message available. 3        8 ---- (Not used.) 2        4 MSG  Message displayed. 1        2 USR  User event           condition occurred. 0        1 TRG  A trigger occurred.           </pre> |
| *TRG (see <a href="#">page 133</a> )        | n/a                                   | n/a   |
| n/a   | *TST? (see <a href="#">page 134</a> ) | <result> ::= 0 or non-zero value; an integer in NR1 format  |
| *WAI (see <a href="#">page 135</a> )        | n/a                                   | n/a   |

**Table 3** Root (:) Commands Summary

| Command   | Query                                 | Options and Query Returns  |
|---|---------------------------------------|--|
| n/a   | :AER? (see <a href="#">page 139</a> ) | {0   1}; an integer in NR1 format  |
| :AUToscale<br>[<source>[,...,<source>]] (see <a href="#">page 140</a> ) | n/a                                   | <p>&lt;source&gt; ::= CHANnel&lt;n&gt;<br/>           &lt;source&gt; can be repeated up to 5 times<br/>           &lt;n&gt; ::= 1-2 or 1-4 in NR1 format</p> |

**Table 3** Root (: ) Commands Summary (continued)

| Command   | Query                                      | Options and Query Returns   |
|---|--|---|
| :AUToscale:AMODE<br><value> (see page 142)            | :AUToscale:AMODE?<br>(see page 142)        | <value> ::= {NORMAL   CURRENT}}   |
| :AUToscale:CHANnels<br><value> (see page 143)         | :AUToscale:CHANnels?<br>(see page 143)     | <value> ::= {ALL   DISPLAYed}}  |
| :BLANK [<source>]<br>(see page 144)                   | n/a  | <source> ::= {CHANnel<n>   FUNCTION   MATH}<br><n> ::= 1-2 or 1-4 in NR1 format   |
| :CDISplay (see page 145)                              | n/a  | n/a   |
| :DIGitize<br>[<source>[,...,<source>]] (see page 146) | n/a  | <source> ::= {CHANnel<n>   FUNCTION   MATH}<br><source> can be repeated up to 5 times<br><n> ::= 1-2 or 1-4 in NR1 format |
| :HWEenable <n> (see page 148)                         | :HWEenable? (see page 148)                 | <n> ::= 16-bit integer in NR1 format  |
| n/a   | :HWERegister:CONDition?<br>(see page 150)  | <n> ::= 16-bit integer in NR1 format  |
| n/a   | :HWERegister[:EVENT]?<br>(see page 152)    | <n> ::= 16-bit integer in NR1 format  |
| :MERGe <pixel memory><br>(see page 154)               | n/a  | <pixel memory> ::= {PMEMory{0   1   2   3   4   5   6   7   8   9}}   |
| :MTEenable <n> (see page 155)                         | :MTEenable? (see page 155)                 | <n> ::= 16-bit integer in NR1 format  |
| n/a   | :MTERegister[:EVENT]?<br>(see page 157)    | <n> ::= 16-bit integer in NR1 format  |
| :OPEE <n> (see page 159)                              | :OPEE? (see page 160)                      | <n> ::= 16-bit integer in NR1 format  |
| n/a   | :OPERRegister:CONDition?<br>(see page 161) | <n> ::= 16-bit integer in NR1 format  |
| n/a   | :OPERRegister[:EVENT]?<br>(see page 163)   | <n> ::= 16-bit integer in NR1 format  |

## 4 Commands Quick Reference

**Table 3** Root (:) Commands Summary (continued)

| Command   | Query   | Options and Query Returns  |
|---|---|--|
| :OVLenable <mask><br>(see <a href="#">page 165</a> )  | :OVLenable? (see <a href="#">page 166</a> )           | <mask> ::= 16-bit integer in NR1 format as shown:<br><br>Bit Weight Input<br>-----<br>10 1024 Ext Trigger Fault<br>9 512 Channel 4 Fault<br>8 256 Channel 3 Fault<br>7 128 Channel 2 Fault<br>6 64 Channel 1 Fault<br>4 16 Ext Trigger OVL<br>3 8 Channel 4 OVL<br>2 4 Channel 3 OVL<br>1 2 Channel 2 OVL<br>0 1 Channel 1 OVL |
| n/a   | :OVLRegister? (see <a href="#">page 167</a> )         | <value> ::= integer in NR1 format. See OVLenable for <value>   |
| :PRINT [<options>]<br>(see <a href="#">page 169</a> ) | n/a   | <options> ::= [<print option>][,...,<print option>]<br><print option> ::= {COLor   GRAYscale   PRINter0   BMP8bit   BMP   PNG   NOFactoRs   FACToRs}<br><print option> can be repeated up to 5 times.  |
| :RUN (see <a href="#">page 170</a> )                  | n/a   | n/a  |
| n/a   | :SERial (see <a href="#">page 171</a> )               | <return value> ::= unquoted string containing serial number  |
| :SINGle (see <a href="#">page 172</a> )               | n/a   | n/a  |
| n/a   | :STATus? <display><br>(see <a href="#">page 173</a> ) | {0   1}<br><display> ::= {CHANnel<n>   FUNCTION   MATH}<br><n> ::= 1-2 or 1-4 in NR1 format  |
| :STOP (see <a href="#">page 174</a> )                 | n/a   | n/a  |
| n/a   | :TER? (see <a href="#">page 175</a> )                 | {0   1}  |
| :VIEW <source> (see <a href="#">page 176</a> )        | n/a   | <source> ::= {CHANnel<n>   PMEMory{0   1   2   3   4   5   6   7   8   9}   FUNCTION   MATH}<br><n> ::= 1-2 or 1-4 in NR1 format   |

**Table 4** :ACQUIRE Commands Summary

| Command  | Query   | Options and Query Returns   |
|--|---|---|
| n/a  | :ACQUIRE:AALIAS? (see <a href="#">page 179</a> )          | {1   0}   |
| :ACQUIRE:COMPLETE<br><complete> (see <a href="#">page 180</a> )  | :ACQUIRE:COMPLETE? (see <a href="#">page 180</a> )        | <complete> ::= 100; an integer in NR1 format  |
| :ACQUIRE:COUNT<br><count> (see <a href="#">page 181</a> )        | :ACQUIRE:COUNT? (see <a href="#">page 181</a> )           | <count> ::= an integer from 2 to 65536 in NR1 format                                |
| :ACQUIRE:DAALIAS<br><mode> (see <a href="#">page 182</a> )       | :ACQUIRE:DAALIAS? (see <a href="#">page 182</a> )         | <mode> ::= {DISABLE   AUTO}   |
| :ACQUIRE:MODE <mode><br>(see <a href="#">page 183</a> )          | :ACQUIRE:MODE? (see <a href="#">page 183</a> )            | <mode> ::= {RTIME   ETIME   SEGMENTED}  |
| n/a  | :ACQUIRE:POINTS? (see <a href="#">page 184</a> )          | <# points> ::= an integer in NR1 format   |
| :ACQUIRE:SEGMENTED:ANALYZE (see <a href="#">page 185</a> )       | n/a   | n/a (with Option SGM)   |
| :ACQUIRE:SEGMENTED:COUNT <count> (see <a href="#">page 186</a> ) | :ACQUIRE:SEGMENTED:COUNT? (see <a href="#">page 186</a> ) | <count> ::= an integer from 2 to 2000 (w/8M memory) in NR1 format (with Option SGM) |
| :ACQUIRE:SEGMENTED:INDEX <index> (see <a href="#">page 187</a> ) | :ACQUIRE:SEGMENTED:INDEX? (see <a href="#">page 187</a> ) | <index> ::= an integer from 2 to 2000 (w/8M memory) in NR1 format (with Option SGM) |
| n/a  | :ACQUIRE:SRATE? (see <a href="#">page 190</a> )           | <sample_rate> ::= sample rate (samples/s) in NR3 format                             |
| :ACQUIRE:TYPE <type><br>(see <a href="#">page 191</a> )          | :ACQUIRE:TYPE? (see <a href="#">page 191</a> )            | <type> ::= {NORMAL   AVERAGE   HRESOLUTION   PEAK}                                  |

**Table 5** :CALIBRATE Commands Summary

| Command   | Query  | Options and Query Returns                                    |
|---|--|--|
| n/a   | :CALIBRATE:DATE? (see <a href="#">page 195</a> )   | <return value> ::= <day>, <month>, <year>; all in NR1 format |
| :CALIBRATE:LABEL<br><string> (see <a href="#">page 196</a> )  | :CALIBRATE:LABEL? (see <a href="#">page 196</a> )  | <string> ::= quoted ASCII string up to 32 characters         |
| :CALIBRATE:OUTPUT<br><signal> (see <a href="#">page 197</a> ) | :CALIBRATE:OUTPUT? (see <a href="#">page 197</a> ) | <signal> ::= {TRIGGERS   SOURCE   DSOURCE   MASK}            |

## 4 Commands Quick Reference

**Table 5** :CALibrate Commands Summary (continued)

| Command  | Query   | Options and Query Returns  |
|--|---|--|
| :CALibrate:START (see <a href="#">page 198</a> ) | n/a   | n/a  |
| n/a  | :CALibrate:STATus?<br>(see <a href="#">page 199</a> )       | <return value> ::= ALL,<status_code>,<status_string><br><status_code> ::= an integer status code<br><status_string> ::= an ASCII status string |
| n/a  | :CALibrate:SWITCh?<br>(see <a href="#">page 200</a> )       | {PROTeCted   UNPRoTeCted}  |
| n/a  | :CALibrate:TEMPeratur<br>e? (see <a href="#">page 201</a> ) | <return value> ::= degrees C delta since last cal in NR3 format  |
| n/a  | :CALibrate:TIME? (see <a href="#">page 202</a> )            | <return value> ::= <hours>,<minutes>,<seconds>; all in NR1 format  |

**Table 6** :CHANnel<n> Commands Summary

| Command  | Query  | Options and Query Returns  |
|--|--|--|
| :CHANnel<n>:BWLimit<br>{0   OFF}   {1   ON}} (see <a href="#">page 206</a> ) | :CHANnel<n>:BWLimit?<br>(see <a href="#">page 206</a> )    | {0   1}<br><n> ::= 1-2 or 1-4 in NR1 format  |
| :CHANnel<n>:COUPling<br><coupling> (see <a href="#">page 207</a> )           | :CHANnel<n>:COUPling?<br>(see <a href="#">page 207</a> )   | <coupling> ::= {AC   DC}<br><n> ::= 1-2 or 1-4 in NR1 format   |
| :CHANnel<n>:DISPlay<br>{0   OFF}   {1   ON}} (see <a href="#">page 208</a> ) | :CHANnel<n>:DISPlay?<br>(see <a href="#">page 208</a> )    | {0   1}<br><n> ::= 1-2 or 1-4 in NR1 format  |
| :CHANnel<n>:IMPedance<br><impedance> (see <a href="#">page 209</a> )         | :CHANnel<n>:IMPedance<br>? (see <a href="#">page 209</a> ) | <impedance> ::= {ONEMeg   FIFTy}<br><n> ::= 1-2 or 1-4 in NR1 format   |
| :CHANnel<n>:INVert<br>{0   OFF}   {1   ON}} (see <a href="#">page 210</a> )  | :CHANnel<n>:INVert?<br>(see <a href="#">page 210</a> )     | {0   1}<br><n> ::= 1-2 or 1-4 in NR1 format  |
| :CHANnel<n>:LABel<br><string> (see <a href="#">page 211</a> )                | :CHANnel<n>:LABel?<br>(see <a href="#">page 211</a> )      | <string> ::= any series of 10 or less ASCII characters enclosed in quotation marks<br><n> ::= 1-2 or 1-4 in NR1 format |

**Table 6** :CHANnel<n> Commands Summary (continued)

| Command   | Query  | Options and Query Returns   |
|---|--|---|
| :CHANnel<n>:OFFSet<br><offset>[suffix] (see <a href="#">page 212</a> )        | :CHANnel<n>:OFFSet?<br>(see <a href="#">page 212</a> )         | <offset> ::= Vertical offset value in NR3 format<br>[suffix] ::= {V   mV}<br><n> ::= 1-2 or 1-4; in NR1 format                  |
| :CHANnel<n>:PROBe<br><attenuation> (see <a href="#">page 213</a> )            | :CHANnel<n>:PROBe?<br>(see <a href="#">page 213</a> )          | <attenuation> ::= Probe attenuation ratio in NR3 format<br><n> ::= 1-2 or 1-4r in NR1 format                                    |
| :CHANnel<n>:PROBe:HEAD[:TYPE] <head_param><br>(see <a href="#">page 214</a> ) | :CHANnel<n>:PROBe:HEAD[:TYPE]? (see <a href="#">page 214</a> ) | <head_param> ::= {SEND0   SEND6   SEND12   SEND20   DIFF0   DIFF6   DIFF12   DIFF20   NONE}<br><n> ::= 1-2 or 1-4 in NR1 format |
| n/a   | :CHANnel<n>:PROBe:ID?<br>(see <a href="#">page 215</a> )       | <probe id> ::= unquoted ASCII string up to 11 characters<br><n> ::= 1-2 or 1-4 in NR1 format                                    |
| :CHANnel<n>:PROBe:SKEW <skew_value> (see <a href="#">page 216</a> )           | :CHANnel<n>:PROBe:SKEW?<br>(see <a href="#">page 216</a> )     | <skew_value> ::= -100 ns to +100 ns in NR3 format<br><n> ::= 1-2 or 1-4 in NR1 format   |
| :CHANnel<n>:PROBe:STYPe <signal type> (see <a href="#">page 217</a> )         | :CHANnel<n>:PROBe:STYPe?<br>(see <a href="#">page 217</a> )    | <signal type> ::= {DIFFerential   SINGLE}<br><n> ::= 1-2 or 1-4 in NR1 format   |
| :CHANnel<n>:PROTection (see <a href="#">page 218</a> )                        | :CHANnel<n>:PROTection?<br>(see <a href="#">page 218</a> )     | {NORM   TRIP}<br><n> ::= 1-2 or 1-4 in NR1 format   |
| :CHANnel<n>:RANGe<br><range>[suffix] (see <a href="#">page 219</a> )          | :CHANnel<n>:RANGe?<br>(see <a href="#">page 219</a> )          | <range> ::= Vertical full-scale range value in NR3 format<br>[suffix] ::= {V   mV}<br><n> ::= 1-2 or 1-4 in NR1 format          |
| :CHANnel<n>:SCALE<br><scale>[suffix] (see <a href="#">page 220</a> )          | :CHANnel<n>:SCALE?<br>(see <a href="#">page 220</a> )          | <scale> ::= Vertical units per division value in NR3 format<br>[suffix] ::= {V   mV}<br><n> ::= 1-2 or 1-4 in NR1 format        |
| :CHANnel<n>:UNITs<br><units> (see <a href="#">page 221</a> )                  | :CHANnel<n>:UNITs?<br>(see <a href="#">page 221</a> )          | <units> ::= {VOLT   AMPere}<br><n> ::= 1-2 or 1-4 in NR1 format   |
| :CHANnel<n>:VERNier<br>{0   OFF}   {1   ON}} (see <a href="#">page 222</a> )  | :CHANnel<n>:VERNier?<br>(see <a href="#">page 222</a> )        | {0   1}<br><n> ::= 1-2 or 1-4 in NR1 format   |

## 4 Commands Quick Reference

**Table 7** :DISPlay Commands Summary

| Command   | Query  | Options and Query Returns  |
|---|--|--|
| :DISPlay:CLEar (see <a href="#">page 225</a> )  | n/a  | n/a  |
| :DISPlay:DATA<br>[<format>][,][<area>]<br>[,][<palette>]<displa<br>y data> (see<br><a href="#">page 226</a> ) | :DISPlay:DATA?<br>[<format>][,][<area>]<br>[,][<palette>] (see<br><a href="#">page 226</a> ) | <format> ::= {TIFF} (command)<br><area> ::= {GRATICule} (command)<br><palette> ::= {MONochrome}<br>(command)<br><format> ::= {TIFF   BMP  <br>BMP8bit   PNG} (query)<br><area> ::= {GRATICule   SCReen}<br>(query)<br><palette> ::= {MONochrome  <br>GRAYscale   COLor} (query)<br><display data> ::= data in IEEE<br>488.2 # format |
| :DISPlay:LAbel {{0  <br>OFF}   {1   ON}} (see<br><a href="#">page 228</a> )                                   | :DISPlay:LAbel? (see<br><a href="#">page 228</a> )   | {0   1}  |
| :DISPlay:LAbList<br><binary block> (see<br><a href="#">page 229</a> )   | :DISPlay:LAbList?<br>(see <a href="#">page 229</a> )   | <binary block> ::= an ordered<br>list of up to 75 labels, each 10<br>characters maximum, separated by<br>newline characters  |
| :DISPlay:PERsistence<br><value> (see<br><a href="#">page 230</a> )  | :DISPlay:PERsistence?<br>(see <a href="#">page 230</a> )                                     | <value> ::= {MINimum   INFinite}}  |
| :DISPlay:SOURce<br><value> (see<br><a href="#">page 231</a> )   | :DISPlay:SOURce? (see<br><a href="#">page 231</a> )  | <value> ::= {PMEMory{0   1   2  <br>3   4   5   6   7   8   9}}  |
| :DISPlay:VECTors {{1<br>  ON}   {0   OFF}}<br>(see <a href="#">page 232</a> )                                 | :DISPlay:VECTors?<br>(see <a href="#">page 232</a> )   | {1   0}  |

**Table 8** :EXTErnal Trigger Commands Summary

| Command   | Query   | Options and Query Returns        |
|---|---|----------------------------------|
| :EXTErnal:BWLimit<br><bwlimit> (see<br><a href="#">page 235</a> ) | :EXTErnal:BWLimit?<br>(see <a href="#">page 235</a> )   | <bwlimit> ::= {0   OFF}          |
| :EXTErnal:IMPedance<br><value> (see<br><a href="#">page 236</a> ) | :EXTErnal:IMPedance?<br>(see <a href="#">page 236</a> ) | <impedance> ::= {ONEMeg   FIFTy} |

**Table 8** :EXtErnal Trigger Commands Summary (continued)

| Command  | Query                                     | Options and Query Returns   |
|--|---|---|
| :EXtErnal:PROBe<br><attenuation> (see<br>page 237)       | :EXtErnal:PROBe? (see<br>page 237)        | <attenuation> ::= probe<br>attenuation ratio in NR3 format                            |
| n/a  | :EXtErnal:PROBe:ID?<br>(see page 238)     | <probe id> ::= unquoted ASCII<br>string up to 11 characters                           |
| :EXtErnal:PROBe:STYPe<br><signal type> (see<br>page 239) | :EXtErnal:PROBe:STYPe<br>? (see page 239) | <signal type> ::= {DIFFerential  <br>SINGle}  |
| :EXtErnal:PROtEction[<br>:CLear] (see<br>page 240)       | :EXtErnal:PROtEction?<br>(see page 240)   | {NORM   TRIP}   |
| :EXtErnal:RANGe<br><range> [<suffix>]<br>(see page 241)  | :EXtErnal:RANGe? (see<br>page 241)        | <range> ::= vertical full-scale<br>range value in NR3 format<br><suffix> ::= {V   mV} |
| :EXtErnal:UNITs<br><units> (see<br>page 242)             | :EXtErnal:UNITs? (see<br>page 242)        | <units> ::= {VOLT   AMPere}   |

**Table 9** :FUNctIon Commands Summary

| Command   | Query  | Options and Query Returns   |
|---|--|---|
| :FUNctIon:CENTer<br><frequency> (see<br>page 246)             | :FUNctIon:CENTer?<br>(see page 246)          | <frequency> ::= the current<br>center frequency in NR3 format.<br>The range of legal values is from<br>0 Hz to 25 GHz.                        |
| :FUNctIon:DISPlay {{0<br>  OFF}   {1   ON}}<br>(see page 247) | :FUNctIon:DISPlay?<br>(see page 247)         | {0   1}   |
| :FUNctIon:GOFT:OPERat<br>ion <operation> (see<br>page 248)    | :FUNctIon:GOFT:OPERat<br>ion? (see page 248) | <operation> ::= {ADD   SUBTract  <br>MULTiply}  |
| :FUNctIon:GOFT:SOURce<br>1 <source> (see<br>page 249)         | :FUNctIon:GOFT:SOURce<br>1? (see page 249)   | <source> ::= CHANnel<n><br><n> ::= {1   2   3   4} for 4ch<br>models<br><n> ::= {1   2} for 2ch models  |
| :FUNctIon:GOFT:SOURce<br>2 <source> (see<br>page 250)         | :FUNctIon:GOFT:SOURce<br>2? (see page 250)   | <source> ::= CHANnel<n><br><n> ::= {{1   2}   {3   4}} for<br>4ch models, depending on SOURce1<br>selection<br><n> ::= {1   2} for 2ch models |

## 4 Commands Quick Reference

**Table 9** :FUNCTION Commands Summary (continued)

| Command  | Query   | Options and Query Returns   |
|--|---|---|
| :FUNCTION:OFFSet<br><offset> (see <a href="#">page 251</a> )               | :FUNCTION:OFFSet?<br>(see <a href="#">page 251</a> )    | <offset> ::= the value at center screen in NR3 format.<br>The range of legal values is +/-10 times the current sensitivity of the selected function.  |
| :FUNCTION:OPERation<br><operation> (see <a href="#">page 252</a> )         | :FUNCTION:OPERation?<br>(see <a href="#">page 252</a> ) | <operation> ::= {ADD   SUBTract   MULTiply   INTegrate   DIFFerentiate   FFT   SQRT}  |
| :FUNCTION:RANGe<br><range> (see <a href="#">page 253</a> )                 | :FUNCTION:RANGe? (see <a href="#">page 253</a> )        | <range> ::= the full-scale vertical axis value in NR3 format.<br>The range for ADD, SUBT, MULT is 8E-6 to 800E+3. The range for the INTegrate function is 8E-9 to 400E+3.<br>The range for the DIFFerentiate function is 80E-3 to 8.0E12 (depends on current sweep speed).<br>The range for the FFT function is 8 to 800 dBV. |
| :FUNCTION:REFerence<br><level> (see <a href="#">page 254</a> )             | :FUNCTION:REFerence?<br>(see <a href="#">page 254</a> ) | <level> ::= the value at center screen in NR3 format.<br>The range of legal values is +/-10 times the current sensitivity of the selected function.   |
| :FUNCTION:SCALe<br><scale value>[<suffix>] (see <a href="#">page 255</a> ) | :FUNCTION:SCALe? (see <a href="#">page 255</a> )        | <scale value> ::= integer in NR1 format<br><suffix> ::= {V   dB}  |
| :FUNCTION:SOURce1<br><source> (see <a href="#">page 256</a> )              | :FUNCTION:SOURce1?<br>(see <a href="#">page 256</a> )   | <source> ::= {CHANnel<n>   GOFT}<br><n> ::= {1   2   3   4} for 4ch models<br><n> ::= {1   2} for 2ch models<br>GOFT is only for FFT, INTegrate, DIFFerentiate, and SQRT operations.  |
| :FUNCTION:SOURce2<br><source> (see <a href="#">page 257</a> )              | :FUNCTION:SOURce2?<br>(see <a href="#">page 257</a> )   | <source> ::= {CHANnel<n>   NONE}<br><n> ::= {{1   2}   {3   4}} for 4ch models, depending on SOURce1 selection<br><n> ::= {1   2} for 2ch models  |

**Table 9** :FUNCTION Commands Summary (continued)

| Command  | Query  | Options and Query Returns   |
|--|--|---|
| :FUNCTION:SPAN <span><br>(see <a href="#">page 258</a> )     | :FUNCTION:SPAN? (see <a href="#">page 258</a> )      | <span> ::= the current frequency span in NR3 format.<br>Legal values are 1 Hz to 100 GHz. |
| :FUNCTION:WINDOW<br><window> (see <a href="#">page 259</a> ) | :FUNCTION:WINDOW?<br>(see <a href="#">page 259</a> ) | <window> ::= {RECTangular   HANNing   FLATtop   BHARRis}                                  |

**Table 10** :HARDcopy Commands Summary

| Command   | Query  | Options and Query Returns   |
|---|--|---|
| :HARDcopy:AREA <area><br>(see <a href="#">page 262</a> )                    | :HARDcopy:AREA? (see <a href="#">page 262</a> )        | <area> ::= SCReen   |
| :HARDcopy:APRinter<br><active_printer> (see <a href="#">page 263</a> )      | :HARDcopy:APRinter?<br>(see <a href="#">page 263</a> ) | <active_printer> ::= {<index>   <name>}<br><index> ::= integer index of printer in list<br><name> ::= name of printer in list |
| :HARDcopy:FACTors {{0   OFF}   {1   ON}}<br>(see <a href="#">page 264</a> ) | :HARDcopy:FACTors?<br>(see <a href="#">page 264</a> )  | {0   1}   |
| :HARDcopy:FFEed {{0   OFF}   {1   ON}} (see <a href="#">page 265</a> )      | :HARDcopy:FFEed? (see <a href="#">page 265</a> )       | {0   1}   |
| :HARDcopy:INKSaver {{0   OFF}   {1   ON}} (see <a href="#">page 266</a> )   | :HARDcopy:INKSaver?<br>(see <a href="#">page 266</a> ) | {0   1}   |
| :HARDcopy:LAYout<br><layout> (see <a href="#">page 267</a> )                | :HARDcopy:LAYout?<br>(see <a href="#">page 267</a> )   | <layout> ::= {LANDscape   PORTRait}   |
| :HARDcopy:PALette<br><palette> (see <a href="#">page 268</a> )              | :HARDcopy:PALette?<br>(see <a href="#">page 268</a> )  | <palette> ::= {COLor   GRAYscale   NONE}  |

## 4 Commands Quick Reference

**Table 10** :HARDcopy Commands Summary (continued)

| Command   | Query   | Options and Query Returns   |
|---|---|---|
| n/a   | :HARDcopy:PRINter:LIST? (see <a href="#">page 269</a> ) | <code>&lt;list&gt; ::= [&lt;printer_spec&gt;] ...<br/>                     [&lt;printer_spec&gt;]<br/>                     &lt;printer_spec&gt; ::=<br/>                     "&lt;index&gt;,&lt;active&gt;,&lt;name&gt;;"<br/>                     &lt;index&gt; ::= integer index of<br/>                     printer<br/>                     &lt;active&gt; ::= {Y   N}<br/>                     &lt;name&gt; ::= name of printer</code> |
| :HARDcopy:START (see <a href="#">page 270</a> ) | n/a   | n/a   |

**Table 11** :LISTer Commands Summary

| Command  | Query  | Options and Query Returns   |
|--|--|---|
| n/a  | :LISTer:DATA? (see <a href="#">page 272</a> )    | <code>&lt;binary_block&gt; ::=<br/>                     comma-separated data with<br/>                     newlines at the end of each row</code> |
| :LISTer:DISPlay {{0   OFF}   {1   ON}} (see <a href="#">page 273</a> ) | :LISTer:DISPlay? (see <a href="#">page 273</a> ) | {0   1}   |

**Table 12** :MARKer Commands Summary

| Command   | Query   | Options and Query Returns   |
|---|---|---|
| :MARKer:MODE <mode> (see <a href="#">page 276</a> )                   | :MARKer:MODE? (see <a href="#">page 276</a> )       | <code>&lt;mode&gt; ::= {OFF   MEASurement  <br/>                     MANual   WAVeform}</code>  |
| :MARKer:X1Position <position>[suffix] (see <a href="#">page 277</a> ) | :MARKer:X1Position? (see <a href="#">page 277</a> ) | <code>&lt;position&gt; ::= X1 cursor position<br/>                     value in NR3 format<br/>                     [suffix] ::= {s   ms   us   ns  <br/>                     ps   Hz   kHz   MHz}<br/>                     &lt;return_value&gt; ::= X1 cursor<br/>                     position value in NR3 format</code> |
| :MARKer:X1Y1source <source> (see <a href="#">page 278</a> )           | :MARKer:X1Y1source? (see <a href="#">page 278</a> ) | <code>&lt;source&gt; ::= {CHANnel&lt;n&gt;  <br/>                     FUNction   MATH}<br/>                     &lt;n&gt; ::= 1-2 or 1-4 in NR1 format<br/>                     &lt;return_value&gt; ::= &lt;source&gt;</code>  |

**Table 12** :MARKer Commands Summary (continued)

| Command   | Query  | Options and Query Returns   |
|---|--|---|
| :MARKer:X2Position<br><position>[suffix]<br>(see <a href="#">page 279</a> ) | :MARKer:X2Position?<br>(see <a href="#">page 279</a> ) | <position> ::= X2 cursor position value in NR3 format<br>[suffix] ::= {s   ms   us   ns   ps   Hz   kHz   MHz}<br><return_value> ::= X2 cursor position value in NR3 format |
| :MARKer:X2Y2source<br><source> (see <a href="#">page 280</a> )              | :MARKer:X2Y2source?<br>(see <a href="#">page 280</a> ) | <source> ::= {CHANnel<n>   FUNCTION   MATH}<br><n> ::= 1-2 or 1-4 in NR1 format<br><return_value> ::= <source>  |
| n/a   | :MARKer:XDELta? (see <a href="#">page 281</a> )        | <return_value> ::= X cursors delta value in NR3 format  |
| :MARKer:Y1Position<br><position>[suffix]<br>(see <a href="#">page 282</a> ) | :MARKer:Y1Position?<br>(see <a href="#">page 282</a> ) | <position> ::= Y1 cursor position value in NR3 format<br>[suffix] ::= {V   mV   dB}<br><return_value> ::= Y1 cursor position value in NR3 format                            |
| :MARKer:Y2Position<br><position>[suffix]<br>(see <a href="#">page 283</a> ) | :MARKer:Y2Position?<br>(see <a href="#">page 283</a> ) | <position> ::= Y2 cursor position value in NR3 format<br>[suffix] ::= {V   mV   dB}<br><return_value> ::= Y2 cursor position value in NR3 format                            |
| n/a   | :MARKer:YDELta? (see <a href="#">page 284</a> )        | <return_value> ::= Y cursors delta value in NR3 format  |

**Table 13** :MEASure Commands Summary

| Command  | Query   | Options and Query Returns   |
|--|---|---|
| :MEASure:CLear (see <a href="#">page 292</a> )                 | n/a   | n/a   |
| :MEASure:COUNter<br>[<source>] (see <a href="#">page 293</a> ) | :MEASure:COUNter?<br>[<source>] (see <a href="#">page 293</a> ) | <source> ::= {CHANnel<n>   EXTERNAL}<br><n> ::= 1-2 or 1-4 in NR1 format<br><return_value> ::= counter frequency in Hertz in NR3 format |

**Table 13** :MEASure Commands Summary (continued)

| Command   | Query   | Options and Query Returns  |
|---|---|--|
| :MEASure:DEFine<br>DElay, <delay spec><br>(see <a href="#">page 294</a> )             | :MEASure:DEFine?<br>DElay (see <a href="#">page 295</a> )                         | <delay spec> ::=<br><edge_spec1>,<edge_spec2><br>edge_spec1 ::=<br>[<slope>]<occurrence><br>edge_spec2 ::=<br>[<slope>]<occurrence><br><slope> ::= {+   -}<br><occurrence> ::= integer |
| :MEASure:DEFine<br>THResholds,<br><threshold spec> (see<br><a href="#">page 294</a> ) | :MEASure:DEFine?<br>THResholds (see<br><a href="#">page 295</a> )                 | <threshold spec> ::= {STANdard}  <br>{<threshold mode>,<upper>,<br><middle>,<lower>}<br><threshold mode> ::= {PERCent  <br>ABSolute}   |
| :MEASure:DElay<br>[<source1>]<br>[,<source2>] (see<br><a href="#">page 297</a> )      | :MEASure:DElay?<br>[<source1>]<br>[,<source2>] (see<br><a href="#">page 297</a> ) | <source1,2> ::= {CHANnel<n>  <br>FUNction   MATH}<br><n> ::= 1-2 or 1-4 in NR1 format<br><return_value> ::=<br>floating-point number delay time<br>in seconds in NR3 format            |
| :MEASure:DUTYcycle<br>[<source>] (see<br><a href="#">page 299</a> )                   | :MEASure:DUTYcycle?<br>[<source>] (see<br><a href="#">page 299</a> )              | <source> ::= {CHANnel<n>  <br>FUNction   MATH}<br><n> ::= 1-2 or 1-4 in NR1 format<br><return_value> ::= ratio of<br>positive pulse width to period in<br>NR3 format                   |
| :MEASure:FALLtime<br>[<source>] (see<br><a href="#">page 300</a> )                    | :MEASure:FALLtime?<br>[<source>] (see<br><a href="#">page 300</a> )               | <source> ::= {CHANnel<n>  <br>FUNction   MATH}<br><n> ::= 1-2 or 1-4 in NR1 format<br><return_value> ::= time in<br>seconds between the lower and<br>upper thresholds in NR3 format    |
| :MEASure:FREQuency<br>[<source>] (see<br><a href="#">page 301</a> )                   | :MEASure:FREQuency?<br>[<source>] (see<br><a href="#">page 301</a> )              | <source> ::= {CHANnel<n>  <br>FUNction   MATH}<br><n> ::= 1-2 or 1-4 in NR1 format<br><return_value> ::= frequency in<br>Hertz in NR3 format   |
| :MEASure:NWIDth<br>[<source>] (see<br><a href="#">page 302</a> )                      | :MEASure:NWIDth?<br>[<source>] (see<br><a href="#">page 302</a> )                 | <source> ::= {CHANnel<n>  <br>FUNction   MATH}<br><n> ::= 1-2 or 1-4 in NR1 format<br><return_value> ::= negative<br>pulse width in seconds-NR3 format                                 |

**Table 13** :MEASure Commands Summary (continued)

| Command   | Query  | Options and Query Returns  |
|---|--|--|
| :MEASure:OVERshoot<br>[<source>] (see<br>page 303)              | :MEASure:OVERshoot?<br>[<source>] (see<br>page 303)              | <source> ::= {CHANnel<n>  <br>FUNction   MATH}<br><n> ::= 1-2 or 1-4 in NR1 format<br><return_value> ::= the percent of<br>the overshoot of the selected<br>waveform in NR3 format |
| :MEASure:PERiod<br>[<source>] (see<br>page 305)                 | :MEASure:PERiod?<br>[<source>] (see<br>page 305)                 | <source> ::= {CHANnel<n>  <br>FUNction   MATH}<br><n> ::= 1-2 or 1-4 in NR1 format<br><return_value> ::= waveform<br>period in seconds in NR3 format                               |
| :MEASure:PHASe<br>[<source1>]<br>[,<source2>] (see<br>page 306) | :MEASure:PHASe?<br>[<source1>]<br>[,<source2>] (see<br>page 306) | <source1,2> ::= {CHANnel<n>  <br>FUNction   MATH}<br><n> ::= 1-2 or 1-4 in NR1 format<br><return_value> ::= the phase<br>angle value in degrees in NR3<br>format                   |
| :MEASure:PREShoot<br>[<source>] (see<br>page 307)               | :MEASure:PREShoot?<br>[<source>] (see<br>page 307)               | <source> ::= {CHANnel<n>  <br>FUNction   MATH}<br><n> ::= 1-2 or 1-4 in NR1 format<br><return_value> ::= the percent of<br>preshoot of the selected waveform<br>in NR3 format      |
| :MEASure:PWIDth<br>[<source>] (see<br>page 308)                 | :MEASure:PWIDth?<br>[<source>] (see<br>page 308)                 | <source> ::= {CHANnel<n>  <br>FUNction   MATH}<br><n> ::= 1-2 or 1-4 in NR1 format<br><return_value> ::= width of<br>positive pulse in seconds in NR3<br>format                    |
| n/a   | :MEASure:RESults?<br><result_list> (see<br>page 309)             | <result_list> ::=<br>comma-separated list of<br>measurement results  |
| :MEASure:RISetime<br>[<source>] (see<br>page 312)               | :MEASure:RISetime?<br>[<source>] (see<br>page 312)               | <source> ::= {CHANnel<n>  <br>FUNction   MATH}<br><n> ::= 1-2 or 1-4 in NR1 format<br><return_value> ::= rise time in<br>seconds in NR3 format                                     |
| :MEASure:SDEVIation<br>[<source>] (see<br>page 313)             | :MEASure:SDEVIation?<br>[<source>] (see<br>page 313)             | <source> ::= {CHANnel<n>  <br>FUNction   MATH}<br><n> ::= 1-2 or 1-4 in NR1 format<br><return_value> ::= calculated<br>std deviation in NR3 format                                 |

**Table 13** :MEASure Commands Summary (continued)

| Command   | Query   | Options and Query Returns  |
|---|---|--|
| :MEASure:SHOW {1   ON} (see <a href="#">page 314</a> )                  | :MEASure:SHOW? (see <a href="#">page 314</a> )  | {1}  |
| :MEASure:SOURce <source1> [, <source2>] (see <a href="#">page 315</a> ) | :MEASure:SOURce? (see <a href="#">page 315</a> )  | <source1,2> ::= {CHANnel<n>   FUNCTION   MATH   EXTERNAL}<br><n> ::= 1-2 or 1-4 in NR1 format<br><return_value> ::= {<source>   NONE}  |
| :MEASure:STATistics <type> (see <a href="#">page 317</a> )              | :MEASure:STATistics? (see <a href="#">page 317</a> )  | <type> ::= {{ON   1}   CURRENT   MEAN   MINimum   MAXimum   STDDev   COUNT}<br>ON ::= all statistics returned  |
| :MEASure:STATistics:INCRement (see <a href="#">page 318</a> )           | n/a   | n/a  |
| :MEASure:STATistics:RESET (see <a href="#">page 319</a> )               | n/a   | n/a  |
| n/a   | :MEASure:TEDGE? <slope><occurrence>[, <source>] (see <a href="#">page 320</a> )               | <slope> ::= direction of the waveform<br><occurrence> ::= the transition to be reported<br><source> ::= {CHANnel<n>   FUNCTION   MATH}<br><n> ::= 1-2 or 1-4 in NR1 format<br><return_value> ::= time in seconds of the specified transition   |
| n/a   | :MEASure:TVALUE? <value> [, <slope>]<occurrence> [, <source>] (see <a href="#">page 322</a> ) | <value> ::= voltage level that the waveform must cross.<br><slope> ::= direction of the waveform when <value> is crossed.<br><occurrence> ::= transitions reported.<br><return_value> ::= time in seconds of specified voltage crossing in NR3 format<br><source> ::= {CHANnel<n>   FUNCTION   MATH}<br><n> ::= 1-2 or 1-4 in NR1 format |

**Table 13** :MEASure Commands Summary (continued)

| Command  | Query   | Options and Query Returns  |
|--|---|--|
| :MEASure:VAMplitude<br>[<source>] (see<br>page 324)              | :MEASure:VAMplitude?<br>[<source>] (see<br>page 324)              | <source> ::= {CHANnel<n>  <br>FUNctIon   MATH}<br><n> ::= 1-2 or 1-4 in NR1 format<br><return_value> ::= the amplitude<br>of the selected waveform in volts<br>in NR3 format                       |
| :MEASure:VAverage<br>[<interval>][,][<source>]<br>(see page 325) | :MEASure:VAverage?<br>[<interval>][,][<source>]<br>(see page 325) | <interval> ::= {CYCLe   DISPlay  <br>AUTO}<br><source> ::= {CHANnel<n>  <br>FUNctIon   MATH}<br><n> ::= 1-2 or 1-4 in NR1 format<br><return_value> ::= calculated<br>average voltage in NR3 format |
| :MEASure:VBASe<br>[<source>] (see<br>page 326)                   | :MEASure:VBASe?<br>[<source>] (see<br>page 326)                   | <source> ::= {CHANnel<n>  <br>FUNctIon   MATH}<br><n> ::= 1-2 or 1-4 in NR1 format<br><base_voltage> ::= voltage at the<br>base of the selected waveform in<br>NR3 format                          |
| :MEASure:VMAX<br>[<source>] (see<br>page 327)                    | :MEASure:VMAX?<br>[<source>] (see<br>page 327)                    | <source> ::= {CHANnel<n>  <br>FUNctIon   MATH}<br><n> ::= 1-2 or 1-4 in NR1 format<br><return_value> ::= maximum<br>voltage of the selected waveform<br>in NR3 format                              |
| :MEASure:VMIN<br>[<source>] (see<br>page 328)                    | :MEASure:VMIN?<br>[<source>] (see<br>page 328)                    | <source> ::= {CHANnel<n>  <br>FUNctIon   MATH}<br><n> ::= 1-2 or 1-4 in NR1 format<br><return_value> ::= minimum<br>voltage of the selected waveform<br>in NR3 format                              |
| :MEASure:VPP<br>[<source>] (see<br>page 329)                     | :MEASure:VPP?<br>[<source>] (see<br>page 329)                     | <source> ::= {CHANnel<n>  <br>FUNctIon   MATH}<br><n> ::= 1-2 or 1-4 in NR1 format<br><return_value> ::= voltage<br>peak-to-peak of the selected<br>waveform in NR3 format                         |
| :MEASure:VRATio<br>[<source1>]<br>[,<source2>] (see<br>page 306) | :MEASure:VRATio?<br>[<source1>]<br>[,<source2>] (see<br>page 330) | <source1,2> ::= {CHANnel<n>  <br>FUNctIon   MATH}<br><n> ::= 1-2 or 1-4 in NR1 format<br><return_value> ::= the ratio<br>value in dB in NR3 format   |

**Table 13** :MEASure Commands Summary (continued)

| Command  | Query   | Options and Query Returns   |
|--|---|---|
| :MEASure:VRMS<br>[<interval>][,][<source>] (see <a href="#">page 331</a> ) | :MEASure:VRMS?<br>[<interval>][,][<source>] (see <a href="#">page 331</a> ) | <interval> ::= {CYCLe   DISPlay   AUTO}<br><source> ::= {CHANnel<n>   FUNCTION   MATH}<br><n> ::= 1-2 or 1-4 in NR1 format<br><return_value> ::= calculated dc RMS voltage in NR3 format                              |
| n/a  | :MEASure:VTIME?<br><vtime>[,<source>] (see <a href="#">page 332</a> )       | <vtime> ::= displayed time from trigger in seconds in NR3 format<br><return_value> ::= voltage at the specified time in NR3 format<br><source> ::= {CHANnel<n>   FUNCTION   MATH}<br><n> ::= 1-2 or 1-4 in NR1 format |
| :MEASure:VTOP<br>[<source>] (see <a href="#">page 333</a> )                | :MEASure:VTOP?<br>[<source>] (see <a href="#">page 333</a> )                | <source> ::= {CHANnel<n>   FUNCTION   MATH}<br><n> ::= 1-2 or 1-4 in NR1 format<br><return_value> ::= voltage at the top of the waveform in NR3 format  |
| :MEASure:WINDow<br><window> (see <a href="#">page 334</a> )                | :MEASure:WINDow? (see <a href="#">page 334</a> )                            | <window> ::= {MAIN   ZOOM   AUTO}   |
| :MEASure:XMAX<br>[<source>] (see <a href="#">page 335</a> )                | :MEASure:XMAX?<br>[<source>] (see <a href="#">page 335</a> )                | <source> ::= {CHANnel<n>   FUNCTION   MATH}<br><n> ::= 1-2 or 1-4 in NR1 format<br><return_value> ::= horizontal value of the maximum in NR3 format   |
| :MEASure:XMIN<br>[<source>] (see <a href="#">page 336</a> )                | :MEASure:XMIN?<br>[<source>] (see <a href="#">page 336</a> )                | <source> ::= {CHANnel<n>   FUNCTION   MATH}<br><n> ::= 1-2 or 1-4 in NR1 format<br><return_value> ::= horizontal value of the maximum in NR3 format   |

**Table 14** :MTEST Commands Summary

| Command  | Query   | Options and Query Returns   |
|--|---|---|
| :MTEST:AMASK:CREate<br>(see <a href="#">page 342</a> )               | n/a   | n/a   |
| :MTEST:AMASK:SOURce<br><source> (see <a href="#">page 343</a> )      | :MTEST:AMASK:SOURce?<br>(see <a href="#">page 343</a> )                   | <source> ::= CHANnel<n><br><n> ::= {1   2   3   4} for 4ch models<br><n> ::= {1   2} for 2ch models |
| :MTEST:AMASK:UNITs<br><units> (see <a href="#">page 344</a> )        | :MTEST:AMASK:UNITs?<br>(see <a href="#">page 344</a> )                    | <units> ::= {CURRENT   DIVisions}   |
| :MTEST:AMASK:XDELta<br><value> (see <a href="#">page 345</a> )       | :MTEST:AMASK:XDELta?<br>(see <a href="#">page 345</a> )                   | <value> ::= X delta value in NR3 format   |
| :MTEST:AMASK:YDELta<br><value> (see <a href="#">page 346</a> )       | :MTEST:AMASK:YDELta?<br>(see <a href="#">page 346</a> )                   | <value> ::= Y delta value in NR3 format   |
| n/a  | :MTEST:COUNT:FWAVEfor<br>ms? [CHANnel<n>] (see <a href="#">page 347</a> ) | <failed> ::= number of failed waveforms in NR1 format   |
| :MTEST:COUNT:RESet<br>(see <a href="#">page 348</a> )                | n/a   | n/a   |
| n/a  | :MTEST:COUNT:TIME?<br>(see <a href="#">page 349</a> )                     | <time> ::= elapsed seconds in NR3 format  |
| n/a  | :MTEST:COUNT:WAVEform<br>s? (see <a href="#">page 350</a> )               | <count> ::= number of waveforms in NR1 format   |
| :MTEST:DATA <mask><br>(see <a href="#">page 351</a> )                | :MTEST:DATA? (see <a href="#">page 351</a> )                              | <mask> ::= data in IEEE 488.2 # format.   |
| :MTEST:DELeTe (see <a href="#">page 352</a> )                        | n/a   | n/a   |
| :MTEST:ENABle {{0   OFF}   {1   ON}} (see <a href="#">page 353</a> ) | :MTEST:ENABle? (see <a href="#">page 353</a> )                            | {0   1}   |
| :MTEST:LOCK {{0   OFF}   {1   ON}} (see <a href="#">page 354</a> )   | :MTEST:LOCK? (see <a href="#">page 354</a> )                              | {0   1}   |
| :MTEST:OUTPut<br><signal> (see <a href="#">page 355</a> )            | :MTEST:OUTPut? (see <a href="#">page 355</a> )                            | <signal> ::= {FAIL   PASS}  |
| :MTEST:RMODE <rmode><br>(see <a href="#">page 356</a> )              | :MTEST:RMODE? (see <a href="#">page 356</a> )                             | <rmode> ::= {FOREver   TIME   SIGMa   WAVEforms}  |

## 4 Commands Quick Reference

**Table 14** :MTESt Commands Summary (continued)

| Command   | Query   | Options and Query Returns                      |
|---|---|--|
| :MTESt:RMODE:FACTION:MEASure {{0   OFF}   {1   ON}} (see <a href="#">page 357</a> ) | :MTESt:RMODE:FACTION:MEASure? (see <a href="#">page 357</a> ) | {0   1}  |
| :MTESt:RMODE:FACTION:PRINT {{0   OFF}   {1   ON}} (see <a href="#">page 358</a> )   | :MTESt:RMODE:FACTION:PRINT? (see <a href="#">page 358</a> )   | {0   1}  |
| :MTESt:RMODE:FACTION:SAVE {{0   OFF}   {1   ON}} (see <a href="#">page 359</a> )    | :MTESt:RMODE:FACTION:SAVE? (see <a href="#">page 359</a> )    | {0   1}  |
| :MTESt:RMODE:FACTION:STOP {{0   OFF}   {1   ON}} (see <a href="#">page 360</a> )    | :MTESt:RMODE:FACTION:STOP? (see <a href="#">page 360</a> )    | {0   1}  |
| :MTESt:RMODE:SIGMa <level> (see <a href="#">page 361</a> )                          | :MTESt:RMODE:SIGMa? (see <a href="#">page 361</a> )           | <level> ::= from 0.1 to 9.3 in NR3 format      |
| :MTESt:RMODE:TIME <seconds> (see <a href="#">page 362</a> )                         | :MTESt:RMODE:TIME? (see <a href="#">page 362</a> )            | <seconds> ::= from 1 to 86400 in NR3 format    |
| :MTESt:RMODE:WAVeform s <count> (see <a href="#">page 363</a> )                     | :MTESt:RMODE:WAVeform s? (see <a href="#">page 363</a> )      | <count> ::= number of waveforms in NR1 format  |
| :MTESt:SCALE:BIND {{0   OFF}   {1   ON}} (see <a href="#">page 364</a> )            | :MTESt:SCALE:BIND? (see <a href="#">page 364</a> )            | {0   1}  |
| :MTESt:SCALE:X1 <x1_value> (see <a href="#">page 365</a> )                          | :MTESt:SCALE:X1? (see <a href="#">page 365</a> )              | <x1_value> ::= X1 value in NR3 format          |
| :MTESt:SCALE:XDELta <xdelta_value> (see <a href="#">page 366</a> )                  | :MTESt:SCALE:XDELta? (see <a href="#">page 366</a> )          | <xdelta_value> ::= X delta value in NR3 format |
| :MTESt:SCALE:Y1 <y1_value> (see <a href="#">page 367</a> )                          | :MTESt:SCALE:Y1? (see <a href="#">page 367</a> )              | <y1_value> ::= Y1 value in NR3 format          |
| :MTESt:SCALE:Y2 <y2_value> (see <a href="#">page 368</a> )                          | :MTESt:SCALE:Y2? (see <a href="#">page 368</a> )              | <y2_value> ::= Y2 value in NR3 format          |

**Table 14** :MTESt Commands Summary (continued)

| Command                                  | Query                         | Options and Query Returns  |
|--|-------------------------------|--|
| :MTESt:SOURce<br><source> (see page 369) | :MTESt:SOURce? (see page 369) | <source> ::= {CHANnel<n>   NONE}<br><n> ::= {1   2   3   4} for 4ch models<br><n> ::= {1   2} for 2ch models |
| n/a                                      | :MTESt:TITLe? (see page 370)  | <title> ::= a string of up to 128 ASCII characters   |

**Table 15** :RECall Commands Summary

| Command   | Query                               | Options and Query Returns   |
|---|-------------------------------------|---|
| :RECall:FIleName<br><base_name> (see page 372)        | :RECall:FIleName?<br>(see page 372) | <base_name> ::= quoted ASCII string   |
| :RECall:IMAGe[:START]<br>[<file_spec>] (see page 373) | n/a                                 | <file_spec> ::= {<internal_loc>   <file_name>}<br><internal_loc> ::= 0-9; an integer in NR1 format<br><file_name> ::= quoted ASCII string |
| :RECall:MASk[:START]<br>[<file_spec>] (see page 374)  | n/a                                 | <file_spec> ::= {<internal_loc>   <file_name>}<br><internal_loc> ::= 0-3; an integer in NR1 format<br><file_name> ::= quoted ASCII string |
| :RECall:PWD<br><path_name> (see page 375)             | :RECall:PWD? (see page 375)         | <path_name> ::= quoted ASCII string   |
| :RECall:SETup[:START]<br>[<file_spec>] (see page 376) | n/a                                 | <file_spec> ::= {<internal_loc>   <file_name>}<br><internal_loc> ::= 0-9; an integer in NR1 format<br><file_name> ::= quoted ASCII string |

**Table 16** :SAVE Commands Summary

| Command  | Query                                   | Options and Query Returns  |
|--|---|--|
| :SAVE:FILEname<br><base_name> (see<br>page 379)                  | :SAVE:FILEname? (see<br>page 379)       | <base_name> ::= quoted ASCII<br>string   |
| :SAVE:IMAGe[:START]<br>[<file_spec>] (see<br>page 380)           | n/a                                     | <file_spec> ::= {<internal_loc><br>  <file_name>}<br><internal_loc> ::= 0-9; an<br>integer in NR1 format<br><file_name> ::= quoted ASCII<br>string |
| n/a  | :SAVE:IMAGe:AREA?<br>(see page 381)     | <area> ::= {GRAT   SCR}  |
| :SAVE:IMAGe:FACTors<br>{{0   OFF}   {1  <br>ON}} (see page 382)  | :SAVE:IMAGe:FACTors?<br>(see page 382)  | {0   1}  |
| :SAVE:IMAGe:FORMat<br><format> (see<br>page 383)                 | :SAVE:IMAGe:FORMat?<br>(see page 383)   | <format> ::= {TIFF   {BMP  <br>BMP24bit}   BMP8bit   PNG   NONE}   |
| :SAVE:IMAGe:INKSaver<br>{{0   OFF}   {1  <br>ON}} (see page 384) | :SAVE:IMAGe:INKSaver?<br>(see page 384) | {0   1}  |
| :SAVE:IMAGe:PALette<br><palette> (see<br>page 385)               | :SAVE:IMAGe:PALette?<br>(see page 385)  | <palette> ::= {COLor   GRAYscale<br>  MONochrome}  |
| :SAVE:LISTer[:START]<br>[<file_name>] (see<br>page 386)          | n/a                                     | <file_name> ::= quoted ASCII<br>string   |
| :SAVE:MASK[:START]<br>[<file_spec>] (see<br>page 387)            | n/a                                     | <file_spec> ::= {<internal_loc><br>  <file_name>}<br><internal_loc> ::= 0-3; an<br>integer in NR1 format<br><file_name> ::= quoted ASCII<br>string |
| :SAVE:PWD <path_name><br>(see page 388)                          | :SAVE:PWD? (see<br>page 388)            | <path_name> ::= quoted ASCII<br>string   |
| :SAVE:SETup[:START]<br>[<file_spec>] (see<br>page 389)           | n/a                                     | <file_spec> ::= {<internal_loc><br>  <file_name>}<br><internal_loc> ::= 0-9; an<br>integer in NR1 format<br><file_name> ::= quoted ASCII<br>string |

**Table 16** :SAVE Commands Summary (continued)

| Command  | Query   | Options and Query Returns                                 |
|--|---|---|
| :SAVE:WAVEform[:START] [<file_name>] (see <a href="#">page 390</a> ) | n/a   | <file_name> ::= quoted ASCII string                       |
| :SAVE:WAVEform:FORMat <format> (see <a href="#">page 391</a> )       | :SAVE:WAVEform:FORMat? (see <a href="#">page 391</a> )  | <format> ::= {ALB   ASCIixy   CSV   BINary   NONE}        |
| :SAVE:WAVEform:LENGth <length> (see <a href="#">page 392</a> )       | :SAVE:WAVEform:LENGth? (see <a href="#">page 392</a> )  | <length> ::= 100 to max. length; an integer in NR1 format |
| :SAVE:WAVEform:SEGMent <option> (see <a href="#">page 393</a> )      | :SAVE:WAVEform:SEGMent? (see <a href="#">page 393</a> ) | <option> ::= {ALL   CURRent}                              |

**Table 17** :SBUS Commands Summary

| Command  | Query  | Options and Query Returns                  |
|--|--|--|
| n/a  | :SBUS:CAN:COUNT:ERRor? (see <a href="#">page 396</a> )       | <frame_count> ::= integer in NR1 format    |
| n/a  | :SBUS:CAN:COUNT:OVERload? (see <a href="#">page 397</a> )    | <frame_count> ::= integer in NR1 format    |
| :SBUS:CAN:COUNT:RESet (see <a href="#">page 398</a> )                | n/a  | n/a  |
| n/a  | :SBUS:CAN:COUNT:TOTal? (see <a href="#">page 399</a> )       | <frame_count> ::= integer in NR1 format    |
| n/a  | :SBUS:CAN:COUNT:UTILization? (see <a href="#">page 400</a> ) | <percent> ::= floating-point in NR3 format |
| :SBUS:DISPlay {{0   OFF}   {1   ON}} (see <a href="#">page 401</a> ) | :SBUS:DISPlay? (see <a href="#">page 401</a> )               | {0   1}                                    |
| n/a  | :SBUS:FLEXray:COUNT:NULl? (see <a href="#">page 402</a> )    | <frame_count> ::= integer in NR1 format    |
| :SBUS:FLEXray:COUNT:RESet (see <a href="#">page 403</a> )            | n/a  | n/a  |
| n/a  | :SBUS:FLEXray:COUNT:SYNC? (see <a href="#">page 404</a> )    | <frame_count> ::= integer in NR1 format    |
| n/a  | :SBUS:FLEXray:COUNT:TOTal? (see <a href="#">page 405</a> )   | <frame_count> ::= integer in NR1 format    |

## 4 Commands Quick Reference

**Table 17** :SBUS Commands Summary (continued)

| Command   | Query  | Options and Query Returns   |
|---|--|---|
| :SBUS:I2S:BASE <base><br>(see <a href="#">page 406</a> )                      | :SBUS:I2S:BASE? (see <a href="#">page 406</a> )                | <base> ::= {DECimal   HEX}  |
| :SBUS:IIC:ASize<br><size> (see <a href="#">page 407</a> )                     | :SBUS:IIC:ASize? (see <a href="#">page 407</a> )               | <size> ::= {BIT7   BIT8}  |
| :SBUS:LIN:PARity {{0<br>  OFF}   {1   ON}}<br>(see <a href="#">page 408</a> ) | :SBUS:LIN:PARity?<br>(see <a href="#">page 408</a> )           | {0   1}   |
| :SBUS:M1553:BASE<br><base> (see <a href="#">page 409</a> )                    | :SBUS:M1553:BASE?<br>(see <a href="#">page 409</a> )           | <base> ::= {DECimal   HEX}  |
| :SBUS:MODE <mode><br>(see <a href="#">page 410</a> )                          | :SBUS:MODE? (see <a href="#">page 410</a> )                    | <mode> ::= {CAN   I2S   IIC   LIN<br>  SPI   UART}  |
| :SBUS:SPI:BITorder<br><order> (see <a href="#">page 411</a> )                 | :SBUS:SPI:BITorder?<br>(see <a href="#">page 411</a> )         | <order> ::= {LSBFirst   MSBFirst}   |
| :SBUS:SPI:WIDTh<br><word_width> (see <a href="#">page 412</a> )               | :SBUS:SPI:WIDTh? (see <a href="#">page 412</a> )               | <word_width> ::= integer 4-16 in<br>NR1 format  |
| :SBUS:UART:BASE<br><base> (see <a href="#">page 413</a> )                     | :SBUS:UART:BASE? (see <a href="#">page 413</a> )               | <base> ::= {ASCii   BINary   HEX}   |
| n/a   | :SBUS:UART:COUNT:ERRO<br>r? (see <a href="#">page 414</a> )    | <frame_count> ::= integer in NR1<br>format  |
| :SBUS:UART:COUNT:RESe<br>t (see <a href="#">page 415</a> )                    | n/a  | n/a   |
| n/a   | :SBUS:UART:COUNT:RXFR<br>ames? (see <a href="#">page 416</a> ) | <frame_count> ::= integer in NR1<br>format  |
| n/a   | :SBUS:UART:COUNT:TXFR<br>ames? (see <a href="#">page 417</a> ) | <frame_count> ::= integer in NR1<br>format  |
| :SBUS:UART:FRAMing<br><value> (see <a href="#">page 418</a> )                 | :SBUS:UART:FRAMing?<br>(see <a href="#">page 418</a> )         | <value> ::= {OFF   <decimal>  <br><nondecimal>}<br><decimal> ::= 8-bit integer from<br>0-255 (0x00-0xff)<br><nondecimal> ::= #Hnn where n ::=<br>{0,...,9   A,...,F} for hexadecimal<br><nondecimal> ::= #Bnn...n where n<br>::= {0   1} for binary |

**Table 18** :SYSTem Commands Summary

| Command   | Query  | Options and Query Returns  |
|---|--|--|
| :SYSTem:DATE <date><br>(see <a href="#">page 420</a> )              | :SYSTem:DATE? (see <a href="#">page 420</a> )                | <date> ::= <year>,<month>,<day><br><year> ::= 4-digit year in NR1 format<br><month> ::= {1,...,12   JANuary   FEBruary   MARCH   APRil   MAY   JUNe   JULy   AUGust   SEPtember   OCTober   NOVember   DECember}<br><day> ::= {1,..31} |
| :SYSTem:DSP <string><br>(see <a href="#">page 421</a> )             | n/a  | <string> ::= up to 254 characters as a quoted ASCII string   |
| n/a   | :SYSTem:ERRor? (see <a href="#">page 422</a> )               | <error> ::= an integer error code<br><error string> ::= quoted ASCII string.<br>See Error Messages (see <a href="#">page 707</a> ).  |
| :SYSTem:LOCK <value><br>(see <a href="#">page 423</a> )             | :SYSTem:LOCK? (see <a href="#">page 423</a> )                | <value> ::= {{1   ON}   {0   OFF}}   |
| :SYSTem:PRECIson<br><value> (see <a href="#">page 424</a> )         | :SYSTem:PRECIson? (see <a href="#">page 424</a> )            | <value> ::= {{1   ON}   {0   OFF}}   |
| :SYSTem:PROTEction:LO<br>CK <value> (see <a href="#">page 425</a> ) | :SYSTem:PROTEction:LO<br>CK? (see <a href="#">page 425</a> ) | <value> ::= {{1   ON}   {0   OFF}}   |
| :SYSTem:SETup<br><setup_data> (see <a href="#">page 426</a> )       | :SYSTem:SETup? (see <a href="#">page 426</a> )               | <setup_data> ::= data in IEEE 488.2 # format.  |
| :SYSTem:TIME <time><br>(see <a href="#">page 428</a> )              | :SYSTem:TIME? (see <a href="#">page 428</a> )                | <time> ::= hours,minutes,seconds in NR1 format   |

**Table 19** :TIMebase Commands Summary

| Command   | Query   | Options and Query Returns  |
|---|---|--|
| :TIMebase:MODE<br><value> (see <a href="#">page 431</a> )   | :TIMebase:MODE? (see <a href="#">page 431</a> )     | <value> ::= {MAIN   WINDow   XY   ROLL}  |
| :TIMebase:POSition<br><pos> (see <a href="#">page 432</a> ) | :TIMebase:POSition? (see <a href="#">page 432</a> ) | <pos> ::= time from the trigger event to the display reference point in NR3 format |

## 4 Commands Quick Reference

**Table 19** :TIMebase Commands Summary (continued)

| Command  | Query  | Options and Query Returns  |
|--|--|--|
| :TIMebase:RANGe<br><range_value> (see <a href="#">page 433</a> )               | :TIMebase:RANGe? (see <a href="#">page 433</a> )               | <range_value> ::= 10 ns through 500 s in NR3 format                                    |
| :TIMebase:REFerence<br>{LEFT   CENTER   RIGHT} (see <a href="#">page 434</a> ) | :TIMebase:REFerence? (see <a href="#">page 434</a> )           | <return_value> ::= {LEFT   CENTER   RIGHT}   |
| :TIMebase:SCALe<br><scale_value> (see <a href="#">page 435</a> )               | :TIMebase:SCALe? (see <a href="#">page 435</a> )               | <scale_value> ::= scale value in seconds in NR3 format                                 |
| :TIMebase:VERNier {{0   OFF}   {1   ON}} (see <a href="#">page 436</a> )       | :TIMebase:VERNier? (see <a href="#">page 436</a> )             | {0   1}  |
| :TIMebase:WINDow:POSi<br>tion <pos> (see <a href="#">page 437</a> )            | :TIMebase:WINDow:POSi<br>tion? (see <a href="#">page 437</a> ) | <pos> ::= time from the trigger event to the zoomed view reference point in NR3 format |
| :TIMebase:WINDow:RANG<br>e <range_value> (see <a href="#">page 438</a> )       | :TIMebase:WINDow:RANG<br>e? (see <a href="#">page 438</a> )    | <range value> ::= range value in seconds in NR3 format for the zoomed window           |
| :TIMebase:WINDow:SCAL<br>e <scale_value> (see <a href="#">page 439</a> )       | :TIMebase:WINDow:SCAL<br>e? (see <a href="#">page 439</a> )    | <scale_value> ::= scale value in seconds in NR3 format for the zoomed window           |

**Table 20** General :TRIGger Commands Summary

| Command  | Query  | Options and Query Returns                      |
|--|--|--|
| :TRIGger:HFReject {{0   OFF}   {1   ON}} (see <a href="#">page 444</a> ) | :TRIGger:HFReject? (see <a href="#">page 444</a> ) | {0   1}  |
| :TRIGger:HOLDoff<br><holdoff_time> (see <a href="#">page 445</a> )       | :TRIGger:HOLDoff? (see <a href="#">page 445</a> )  | <holdoff_time> ::= 60 ns to 10 s in NR3 format |
| :TRIGger:LFIFTy (see <a href="#">page 446</a> )                          | n/a  | n/a  |

**Table 20** General :TRIGger Commands Summary (continued)

| Command  | Query  | Options and Query Returns   |
|--|--|---|
| :TRIGger:MODE <mode><br>(see <a href="#">page 447</a> )                                    | :TRIGger:MODE? (see <a href="#">page 447</a> )       | <mode> ::= {EDGE   GLITCh   PATtern   CAN   DURation   I2S   IIC   EBURst   LIN   M1553   SEQuence   SPI   TV   UART   USB   FLEXray}<br><return_value> ::= {<mode>   <none>}<br><none> ::= query returns "NONE" if the :TIMEbase:MODE is ROLL or XY  |
| :TRIGger:NREJect {{0   OFF}   {1   ON}}<br>(see <a href="#">page 448</a> )                 | :TRIGger:NREJect?<br>(see <a href="#">page 448</a> ) | {0   1}   |
| :TRIGger:PATtern <value>, <mask> [, <edge source>, <edge>] (see <a href="#">page 449</a> ) | :TRIGger:PATtern?<br>(see <a href="#">page 449</a> ) | <value> ::= integer in NR1 format or <string><br><mask> ::= integer in NR1 format or <string><br><string> ::= "0xnn"; n ::= {0,...,9   A,...,F} (# bits = # channels)<br><edge source> ::= {CHANnel<n>   EXTernal   NONE}<br><edge> ::= {POSitive   NEGative}<br><n> ::= 1-2 or 1-4 in NR1 format |
| :TRIGger:SWEep <sweep> (see <a href="#">page 451</a> )                                     | :TRIGger:SWEep? (see <a href="#">page 451</a> )      | <sweep> ::= {AUTO   NORMal}   |

**Table 21** :TRIGger:CAN Commands Summary

| Command  | Query   | Options and Query Returns   |
|--|---|---|
| :TRIGger:CAN:PATtern:DATA <value>, <mask><br>(see <a href="#">page 454</a> ) | :TRIGger:CAN:PATtern:DATA? (see <a href="#">page 454</a> )        | <value> ::= 64-bit integer in decimal, <nondecimal>, or <string> (with Option AMS)<br><mask> ::= 64-bit integer in decimal, <nondecimal>, or <string><br><nondecimal> ::= #Hnn...n where n ::= {0,...,9   A,...,F} for hexadecimal<br><nondecimal> ::= #Bnn...n where n ::= {0   1} for binary<br><string> ::= "0xnn...n" where n ::= {0,...,9   A,...,F} for hexadecimal |
| :TRIGger:CAN:PATtern:DATA:LENGth <length><br>(see <a href="#">page 455</a> ) | :TRIGger:CAN:PATtern:DATA:LENGth? (see <a href="#">page 455</a> ) | <length> ::= integer from 1 to 8 in NR1 format (with Option AMS)  |
| :TRIGger:CAN:PATtern:ID <value>, <mask><br>(see <a href="#">page 456</a> )   | :TRIGger:CAN:PATtern:ID? (see <a href="#">page 456</a> )          | <value> ::= 32-bit integer in decimal, <nondecimal>, or <string> (with Option AMS)<br><mask> ::= 32-bit integer in decimal, <nondecimal>, or <string><br><nondecimal> ::= #Hnn...n where n ::= {0,...,9   A,...,F} for hexadecimal<br><nondecimal> ::= #Bnn...n where n ::= {0   1} for binary<br><string> ::= "0xnn...n" where n ::= {0,...,9   A,...,F} for hexadecimal |
| :TRIGger:CAN:PATtern:ID:MODE <value> (see <a href="#">page 457</a> )         | :TRIGger:CAN:PATtern:ID:MODE? (see <a href="#">page 457</a> )     | <value> ::= {STANdard   EXTended} (with Option AMS)   |
| :TRIGger:CAN:SAMPlepo int <value> (see <a href="#">page 458</a> )            | :TRIGger:CAN:SAMPlepo int? (see <a href="#">page 458</a> )        | <value> ::= {60   62.5   68   70   75   80   87.5} in NR3 format  |
| :TRIGger:CAN:SIGNAL:BAUDrate <baudrate><br>(see <a href="#">page 459</a> )   | :TRIGger:CAN:SIGNAL:BAUDrate? (see <a href="#">page 459</a> )     | <baudrate> ::= integer from 10000 to 1000000 in 100 b/s increments  |
| :TRIGger:CAN:SIGNAL:DEFinition <value><br>(see <a href="#">page 460</a> )    | :TRIGger:CAN:SIGNAL:DEFinition? (see <a href="#">page 460</a> )   | <value> ::= {CANH   CANL   RX   TX   DIFFerential   DIFL   DIFH}  |

**Table 21** :TRIGger:CAN Commands Summary (continued)

| Command   | Query  | Options and Query Returns   |
|---|--|---|
| :TRIGger:CAN:SOURce<br><source> (see <a href="#">page 461</a> )     | :TRIGger:CAN:SOURce?<br>(see <a href="#">page 461</a> )  | <source> ::= {CHANnel<n>   EXTErnal}<br><n> ::= 1-2 or 1-4 in NR1 format  |
| :TRIGger:CAN:TRIGger<br><condition> (see <a href="#">page 462</a> ) | :TRIGger:CAN:TRIGger?<br>(see <a href="#">page 463</a> ) | <condition> ::= {SOF} (without Option AMS)<br><condition> ::= {SOF   DATA   ERRor   IDData   IDEither   IDRemote   ALLerrors   OVERload   ACKerror} (with Option AMS) |

**Table 22** :TRIGger:DURation Commands Summary

| Command   | Query  | Options and Query Returns   |
|---|--|---|
| :TRIGger:DURation:GREaterthan <greater than time>[suffix] (see <a href="#">page 465</a> )                           | :TRIGger:DURation:GREaterthan? (see <a href="#">page 465</a> ) | <greater_than_time> ::= floating-point number in NR3 format<br>[suffix] ::= {s   ms   us   ns   ps}   |
| :TRIGger:DURation:LESSthan <less than time>[suffix] (see <a href="#">page 466</a> )                                 | :TRIGger:DURation:LESSthan? (see <a href="#">page 466</a> )    | <less_than_time> ::= floating-point number from in NR3 format<br>[suffix] ::= {s   ms   us   ns   ps}   |
| :TRIGger:DURation:PATtern <value>, <mask> (see <a href="#">page 467</a> )   | :TRIGger:DURation:PATtern? (see <a href="#">page 467</a> )     | <value> ::= integer or <string><br><mask> ::= integer or <string><br><string> ::= "0xnxxxxnn" n ::= {0,...,9   A,...,F}                                       |
| :TRIGger:DURation:QUALifier <qualifier> (see <a href="#">page 468</a> )   | :TRIGger:DURation:QUALifier? (see <a href="#">page 468</a> )   | <qualifier> ::= {GREaterthan   LESSthan   INRange   OUTRange   TIMEout}   |
| :TRIGger:DURation:RANGe<br><less_than_time>[suffix],<br><greater_than_time>[suffix] (see <a href="#">page 469</a> ) | :TRIGger:DURation:RANGe? (see <a href="#">page 469</a> )       | <less_than_time> ::= 15 ns to 10 seconds in NR3 format<br><greater_than_time> ::= 10 ns to 9.99 seconds in NR3 format<br>[suffix] ::= {s   ms   us   ns   ps} |

## 4 Commands Quick Reference

**Table 23** :TRIGger:EBURst Commands Summary

| Command  | Query   | Options and Query Returns                      |
|--|---|--|
| :TRIGger:EBURst:COUNT<br><count> (see <a href="#">page 471</a> )     | :TRIGger:EBURst:COUNT?<br>(see <a href="#">page 471</a> ) | <count> ::= integer in NR1 format              |
| :TRIGger:EBURst:IDLE<br><time_value> (see <a href="#">page 472</a> ) | :TRIGger:EBURst:IDLE?<br>(see <a href="#">page 472</a> )  | <time_value> ::= time in seconds in NR3 format |
| :TRIGger:EBURst:SLOPe<br><slope> (see <a href="#">page 473</a> )     | :TRIGger:EBURst:SLOPe?<br>(see <a href="#">page 473</a> ) | <slope> ::= {NEGative   POSitive}              |

**Table 24** :TRIGger[:EDGE] Commands Summary

| Command  | Query  | Options and Query Returns  |
|--|--|--|
| :TRIGger[:EDGE]:COUPling {AC   DC   LF}<br>(see <a href="#">page 475</a> )       | :TRIGger[:EDGE]:COUPling?<br>(see <a href="#">page 475</a> )         | {AC   DC   LF}   |
| :TRIGger[:EDGE]:LEVEl<br><level> [, <source>]<br>(see <a href="#">page 476</a> ) | :TRIGger[:EDGE]:LEVEl?<br>[<source>] (see <a href="#">page 476</a> ) | For internal triggers, <level> ::= .75 x full-scale voltage from center screen in NR3 format.<br>For external triggers, <level> ::= ±(external range setting) in NR3 format.<br><source> ::= {CHANnel<n>   EXTErnal}<br><n> ::= 1-2 or 1-4 in NR1 format |
| :TRIGger[:EDGE]:REJect {OFF   LF   HF}<br>(see <a href="#">page 477</a> )        | :TRIGger[:EDGE]:REJect?<br>(see <a href="#">page 477</a> )           | {OFF   LF   HF}  |
| :TRIGger[:EDGE]:SLOPe<br><polarity> (see <a href="#">page 478</a> )              | :TRIGger[:EDGE]:SLOPe?<br>(see <a href="#">page 478</a> )            | <polarity> ::= {POSitive   NEGative   EITHER   ALTErnate}  |
| :TRIGger[:EDGE]:SOURC<br>e <source> (see <a href="#">page 479</a> )              | :TRIGger[:EDGE]:SOURC<br>e? (see <a href="#">page 479</a> )          | <source> ::= {CHANnel<n>   EXTErnal}<br><n> ::= 1-2 or 1-4 in NR1 format   |

**Table 25** :TRIGger:FLEXray Commands Summary

| Command  | Query  | Options and Query Returns  |
|--|--|--|
| :TRIGger:FLEXray:AUTOsetup (see <a href="#">page 481</a> )                                   | n/a  | n/a  |
| :TRIGger:FLEXray:BAUDrate <baudrate> (see <a href="#">page 482</a> )                         | :TRIGger:FLEXray:BAUDrate? (see <a href="#">page 482</a> )           | <baudrate> ::= {2500000   5000000   10000000}                                      |
| :TRIGger:FLEXray:CHANnel <channel> (see <a href="#">page 483</a> )                           | :TRIGger:FLEXray:CHANnel? (see <a href="#">page 483</a> )            | <channel> ::= {A   B}  |
| :TRIGger:FLEXray:ERROR:TYPE <error_type> (see <a href="#">page 484</a> )                     | :TRIGger:FLEXray:ERROR:TYPE? (see <a href="#">page 484</a> )         | <error_type> ::= {ALL   HCRC   FCRC}   |
| :TRIGger:FLEXray:EVENT:TYPE <event> (see <a href="#">page 485</a> )                          | :TRIGger:FLEXray:EVENT:TYPE? (see <a href="#">page 485</a> )         | <event> ::= {WAKEup   TSS   {FES   DTS}   BSS}                                     |
| :TRIGger:FLEXray:FRAME:CBase <cycle_count_base> (see <a href="#">page 486</a> )              | :TRIGger:FLEXray:FRAME:CBase? (see <a href="#">page 486</a> )        | <cycle_count_base> ::= integer from 0-63   |
| :TRIGger:FLEXray:FRAME:CCRepetition <cycle_count_repetition> (see <a href="#">page 487</a> ) | :TRIGger:FLEXray:FRAME:CCRepetition? (see <a href="#">page 487</a> ) | <cycle_count_repetition> ::= {ALL   <rep #>}<br><rep #> ::= integer from 2-64      |
| :TRIGger:FLEXray:FRAME:ID <frame_id> (see <a href="#">page 488</a> )                         | :TRIGger:FLEXray:FRAME:ID? (see <a href="#">page 488</a> )           | <frame_id> ::= {ALL   <frame #>}<br><frame #> ::= integer from 1-2047              |
| :TRIGger:FLEXray:FRAME:TYPE <frame_type> (see <a href="#">page 489</a> )                     | :TRIGger:FLEXray:FRAME:TYPE? (see <a href="#">page 489</a> )         | <frame_type> ::= {NORMAL   STARTup   NULL   SYNC   NSTArtup   NNULL   NSYNc   ALL} |
| :TRIGger:FLEXray:SOURCE <source> (see <a href="#">page 490</a> )                             | :TRIGger:FLEXray:SOURCE? (see <a href="#">page 490</a> )             | <source> ::= {CHANnel<n>}<br><n> ::= 1-2 or 1-4 in NR1 format                      |
| :TRIGger:FLEXray:TRIGGER <condition> (see <a href="#">page 491</a> )                         | :TRIGger:FLEXray:TRIGGER? (see <a href="#">page 491</a> )            | <condition> ::= {FRAME   ERROR   EVENT}  |

**Table 26** :TRIGger:GLITCh Commands Summary

| Command   | Query  | Options and Query Returns  |
|---|--|--|
| :TRIGger:GLITCh:GREAt<br>erthan<br><greater_than_time>[s<br>uffix] (see <a href="#">page 493</a> )                        | :TRIGger:GLITCh:GREAt<br>erthan? (see <a href="#">page 493</a> ) | <greater_than_time> ::= floating-point number in NR3 format<br>[suffix] ::= {s   ms   us   ns   ps}  |
| :TRIGger:GLITCh:LESSt<br>han<br><less_than_time>[suff<br>ix] (see <a href="#">page 494</a> )                              | :TRIGger:GLITCh:LESSt<br>han? (see <a href="#">page 494</a> )    | <less_than_time> ::= floating-point number in NR3 format<br>[suffix] ::= {s   ms   us   ns   ps}   |
| :TRIGger:GLITCh:LEVel<br><level> [<source>]<br>(see <a href="#">page 495</a> )  | :TRIGger:GLITCh:LEVel<br>? (see <a href="#">page 495</a> )       | For internal triggers, <level> ::= .75 x full-scale voltage from center screen in NR3 format.<br>For external triggers, <level> ::= ±(external range setting) in NR3 format.<br><source> ::= {CHANnel<n>   EXTernal}<br><n> ::= 1-2 or 1-4 in NR1 format |
| :TRIGger:GLITCh:POLAr<br>ity <polarity> (see <a href="#">page 496</a> )   | :TRIGger:GLITCh:POLAr<br>ity? (see <a href="#">page 496</a> )    | <polarity> ::= {POSitive   NEGative}   |
| :TRIGger:GLITCh:QUALi<br>fier <qualifier> (see <a href="#">page 497</a> )   | :TRIGger:GLITCh:QUALi<br>fier? (see <a href="#">page 497</a> )   | <qualifier> ::= {GREAterthan   LESSthan   RANGE}   |
| :TRIGger:GLITCh:RANGe<br><less_than_time>[suff<br>ix],<br><greater_than_time>[s<br>uffix] (see <a href="#">page 498</a> ) | :TRIGger:GLITCh:RANGe<br>? (see <a href="#">page 498</a> )       | <less_than_time> ::= 15 ns to 10 seconds in NR3 format<br><greater_than_time> ::= 10 ns to 9.99 seconds in NR3 format<br>[suffix] ::= {s   ms   us   ns   ps}  |
| :TRIGger:GLITCh:SOURC<br>e <source> (see <a href="#">page 499</a> )   | :TRIGger:GLITCh:SOURC<br>e? (see <a href="#">page 499</a> )      | <source> ::= {CHANnel<n>   EXTernal}<br><n> ::= 1-2 or 1-4 in NR1 format   |

**Table 27** :TRIGger:I2S Commands Summary

| Command  | Query  | Options and Query Returns  |
|--|--|--|
| :TRIGger:I2S:ALIGnment <setting> (see <a href="#">page 502</a> )   | :TRIGger:I2S:ALIGnment? (see <a href="#">page 502</a> )      | <setting> ::= {I2S   LJ   RJ}  |
| :TRIGger:I2S:AUDio <audio_ch> (see <a href="#">page 503</a> )      | :TRIGger:I2S:AUDio? (see <a href="#">page 503</a> )          | <audio_ch> ::= {RIGHT   LEFT   EITHER}   |
| :TRIGger:I2S:CLOCK:SLOPe <slope> (see <a href="#">page 504</a> )   | :TRIGger:I2S:CLOCK:SLOPe? (see <a href="#">page 504</a> )    | <slope> ::= {NEGative   POSitive}  |
| :TRIGger:I2S:PATtern:DATA <string> (see <a href="#">page 505</a> ) | :TRIGger:I2S:PATtern:DATA? (see <a href="#">page 506</a> )   | <string> ::= "n" where n ::= 32-bit integer in signed decimal when <base> = DECimal<br><string> ::= "nn...n" where n ::= {0   1   X   \$} when <base> = BINary<br><string> ::= "0xnn...n" where n ::= {0,...,9   A,...,F   X   \$} when <base> = HEX   |
| :TRIGger:I2S:PATtern:FORMat <base> (see <a href="#">page 507</a> ) | :TRIGger:I2S:PATtern:FORMat? (see <a href="#">page 507</a> ) | <base> ::= {BINary   HEX   DECimal}  |
| :TRIGger:I2S:RANGE <upper>,<lower> (see <a href="#">page 508</a> ) | :TRIGger:I2S:RANGE? (see <a href="#">page 508</a> )          | <upper> ::= 32-bit integer in signed decimal, <nondecimal>, or <string><br><lower> ::= 32-bit integer in signed decimal, <nondecimal>, or <string><br><nondecimal> ::= #Hnn...n where n ::= {0,...,9   A,...,F} for hexadecimal<br><nondecimal> ::= #Bnn...n where n ::= {0   1} for binary<br><string> ::= "0xnn...n" where n ::= {0,...,9   A,...,F} for hexadecimal |
| :TRIGger:I2S:RWIDth <receiver> (see <a href="#">page 510</a> )     | :TRIGger:I2S:RWIDth? (see <a href="#">page 510</a> )         | <receiver> ::= 4-32 in NR1 format  |
| :TRIGger:I2S:SOURce:CLOCK <source> (see <a href="#">page 511</a> ) | :TRIGger:I2S:SOURce:CLOCK? (see <a href="#">page 511</a> )   | <source> ::= {CHANnel<n>   EXTERNAL}<br><n> ::= 1-2 or 1-4 in NR1 format   |

## 4 Commands Quick Reference

**Table 27** :TRIGger:I2S Commands Summary (continued)

| Command  | Query  | Options and Query Returns  |
|--|--|--|
| :TRIGger:I2S:SOURce:D<br>ATA <source> (see<br>page 512)    | :TRIGger:I2S:SOURce:D<br>ATA? (see page 512)       | <source> ::= {CHANnel<n>  <br>EXTernal}<br><n> ::= 1-2 or 1-4 in NR1 format  |
| :TRIGger:I2S:SOURce:W<br>SELEct <source> (see<br>page 513) | :TRIGger:I2S:SOURce:W<br>SELEct? (see<br>page 513) | <source> ::= {CHANnel<n>  <br>EXTernal}<br><n> ::= 1-2 or 1-4 in NR1 format  |
| :TRIGger:I2S:TRIGger<br><operator> (see<br>page 514)       | :TRIGger:I2S:TRIGger?<br>(see page 514)            | <operator> ::= {EQUal   NOTequal<br>  LESSthan   GREATERthan  <br>INRange   OUtRange   INCReasing  <br>DECReasing} |
| :TRIGger:I2S:TWIDth<br><word_size> (see<br>page 516)       | :TRIGger:I2S:TWIDth?<br>(see page 516)             | <word_size> ::= 4-32 in NR1<br>format  |
| :TRIGger:I2S:WSLow<br><low_def> (see<br>page 517)          | :TRIGger:I2S:WSLow?<br>(see page 517)              | <low_def> ::= {LEFT   RIGHT}   |

**Table 28** :TRIGger:IIC Commands Summary

| Command  | Query   | Options and Query Returns   |
|--|---|---|
| :TRIGger:IIC:PATtern:<br>ADDRess <value> (see<br>page 519) | :TRIGger:IIC:PATtern:<br>ADDRess? (see<br>page 519) | <value> ::= integer or <string><br><string> ::= "0xnn" n ::= {0,...,9<br>  A,...,F} |
| :TRIGger:IIC:PATtern:<br>DATA <value> (see<br>page 520)    | :TRIGger:IIC:PATtern:<br>DATA? (see page 520)       | <value> ::= integer or <string><br><string> ::= "0xnn" n ::= {0,...,9<br>  A,...,F} |
| :TRIGger:IIC:PATtern:<br>DATA2 <value> (see<br>page 521)   | :TRIGger:IIC:PATtern:<br>DATA2? (see page 521)      | <value> ::= integer or <string><br><string> ::= "0xnn" n ::= {0,...,9<br>  A,...,F} |
| :TRIGger:IIC[:SOURce]<br>:CLOCK <source> (see<br>page 522) | :TRIGger:IIC[:SOURce]<br>:CLOCK? (see<br>page 522)  | <source> ::= {CHANnel<n>  <br>EXTernal}<br><n> ::= 1-2 or 1-4 in NR1 format         |
| :TRIGger:IIC[:SOURce]<br>:DATA <source> (see<br>page 523)  | :TRIGger:IIC[:SOURce]<br>:DATA? (see page 523)      | <source> ::= {CHANnel<n>  <br>EXTernal}<br><n> ::= 1-2 or 1-4 in NR1 format         |

**Table 28** :TRIGger:IIC Commands Summary (continued)

| Command  | Query   | Options and Query Returns   |
|--|---|---|
| :TRIGger:IIC:TRIGger:QUALifier <value> (see <a href="#">page 524</a> ) | :TRIGger:IIC:TRIGger:QUALifier? (see <a href="#">page 524</a> ) | <value> ::= {EQUAL   NOTequal   LESSthan   GREATERthan}   |
| :TRIGger:IIC:TRIGger[:TYPE] <type> (see <a href="#">page 525</a> )     | :TRIGger:IIC:TRIGger[:TYPE]? (see <a href="#">page 525</a> )    | <type> ::= {START   STOP   READ7   READEprom   WRITe7   WRITe10   NACKnowledge   ANACKnowledge   R7Data2   W7Data2   REStart} |

**Table 29** :TRIGger:LIN Commands Summary

| Command   | Query   | Options and Query Returns  |
|---|---|--|
| :TRIGger:LIN:ID <value> (see <a href="#">page 529</a> )                   | :TRIGger:LIN:ID? (see <a href="#">page 529</a> )                  | <value> ::= 7-bit integer in decimal, <nondecimal>, or <string> from 0-63 or 0x00-0x3f (with Option AMS)<br><nondecimal> ::= #Hnn where n ::= {0,...,9   A,...,F} for hexadecimal<br><nondecimal> ::= #Bnn...n where n ::= {0   1} for binary<br><string> ::= "0xnn" where n ::= {0,...,9   A,...,F} for hexadecimal |
| :TRIGger:LIN:PATtern:DATA <string> (see <a href="#">page 530</a> )        | :TRIGger:LIN:PATtern:DATA? (see <a href="#">page 531</a> )        | <string> ::= "n" where n ::= 32-bit integer in signed decimal when <base> = DECimal<br><string> ::= "nn...n" where n ::= {0   1   X   \$} when <base> = BINary<br><string> ::= "0xnn...n" where n ::= {0,...,9   A,...,F   X   \$} when <base> = HEX   |
| :TRIGger:LIN:PATtern:DATA:LENGth <length> (see <a href="#">page 532</a> ) | :TRIGger:LIN:PATtern:DATA:LENGth? (see <a href="#">page 532</a> ) | <length> ::= integer from 1 to 8 in NR1 format   |
| :TRIGger:LIN:PATtern:FORMat <base> (see <a href="#">page 533</a> )        | :TRIGger:LIN:PATtern:FORMat? (see <a href="#">page 533</a> )      | <base> ::= {BINary   HEX   DECimal}  |
| :TRIGger:LIN:SAMPlepo int <value> (see <a href="#">page 534</a> )         | :TRIGger:LIN:SAMPlepo int? (see <a href="#">page 534</a> )        | <value> ::= {60   62.5   68   70   75   80   87.5} in NR3 format   |
| :TRIGger:LIN:SIGNAL:B AUDrate <baudrate> (see <a href="#">page 535</a> )  | :TRIGger:LIN:SIGNAL:B AUDrate? (see <a href="#">page 535</a> )    | <baudrate> ::= integer from 2400 to 625000 in 100 b/s increments   |

## 4 Commands Quick Reference

**Table 29** :TRIGger:LIN Commands Summary (continued)

| Command   | Query                                      | Options and Query Returns   |
|---|--|---|
| :TRIGger:LIN:SOURce<br><source> (see<br>page 536)     | :TRIGger:LIN:SOURce?<br>(see page 536)     | <source> ::= {CHANnel<n>  <br>EXTernal}<br><n> ::= 1-2 or 1-4 in NR1 format   |
| :TRIGger:LIN:STANdard<br><std> (see page 537)         | :TRIGger:LIN:STANdard<br>? (see page 537)  | <std> ::= {LIN13   LIN20}   |
| :TRIGger:LIN:SYNCbrea<br>k <value> (see<br>page 538)  | :TRIGger:LIN:SYNCbrea<br>k? (see page 538) | <value> ::= integer = {11   12  <br>13}   |
| :TRIGger:LIN:TRIGger<br><condition> (see<br>page 539) | :TRIGger:LIN:TRIGger?<br>(see page 539)    | <condition> ::= {SYNCbreak}<br>(without Option AMS)<br><condition> ::= {SYNCbreak   ID  <br>DATA} (with Option AMS) |

**Table 30** :TRIGger:M1553 Commands Summary

| Command  | Query  | Options and Query Returns   |
|--|--|---|
| :TRIGger:M1553:AUTOse<br>tup (see page 541)                | n/a  | n/a   |
| :TRIGger:M1553:PATTer<br>n:DATA <string> (see<br>page 542) | :TRIGger:M1553:PATTer<br>n:DATA? (see<br>page 542) | <string> ::= "nn...n" where n ::=<br>{0   1   X}  |
| :TRIGger:M1553:RTA<br><value> (see<br>page 543)            | :TRIGger:M1553:RTA?<br>(see page 543)              | <value> ::= 5-bit integer in<br>decimal, <nondecimal>, or<br><string> from 0-31<br><nondecimal> ::= #Hnn where n ::=<br>{0,...,9 A,...,F}<br><string> ::= "0xnn" where n ::=<br>{0,...,9 A,...,F} |
| :TRIGger:M1553:SOURce<br>:LOWer <source> (see<br>page 544) | :TRIGger:M1553:SOURce<br>:LOWer? (see<br>page 544) | <source> ::= {CHANnel<n>}<br><n> ::= {2   4}  |
| :TRIGger:M1553:SOURce<br>:UPPer <source> (see<br>page 545) | :TRIGger:M1553:SOURce<br>:UPPer? (see<br>page 545) | <source> ::= {CHANnel<n>}<br><n> ::= {1   3}  |
| :TRIGger:M1553:TYPE<br><type> (see page 546)               | :TRIGger:M1553:TYPE?<br>(see page 546)             | <type> ::= {DSTArt   DSTOp  <br>CSTArt   CSTOp   RTA   PERRor  <br>SERRor   MERRor   RTA11}   |

**Table 31** :TRIGger:SEQuence Commands Summary

| Command  | Query   | Options and Query Returns  |
|--|---|--|
| :TRIGger:SEQuence:COU<br>Nt <count> (see<br>page 548)                  | :TRIGger:SEQuence:COU<br>Nt? (see page 548)           | <count> ::= integer in NR1 format  |
| :TRIGger:SEQuence:EDG<br>E{1 2} <source>,<br><slope> (see<br>page 549) | :TRIGger:SEQuence:EDG<br>E{1 2}? (see<br>page 549)    | <source> ::= {CHANnel<n>  <br>EXTernal}<br><slope> ::= {POSitive   NEGative}<br><n> ::= 1-2 or 1-4 in NR1 format<br><return_value> ::= query returns<br>"NONE" if edge source is disabled  |
| :TRIGger:SEQuence:FIN<br>D <value> (see<br>page 550)                   | :TRIGger:SEQuence:FIN<br>D? (see page 550)            | <value> ::= {PATtern1,ENTered  <br>PATtern1,EXITed   EDGE1  <br>PATtern1,AND,EDGE1}  |
| :TRIGger:SEQuence:PAT<br>Tern{1 2} <value>,<br><mask> (see page 551)   | :TRIGger:SEQuence:PAT<br>Tern{1 2}? (see<br>page 551) | <value> ::= integer or <string><br><mask> ::= integer or <string><br><string> ::= "0xn timer" n ::=<br>{0,...,9   A,...,F}   |
| :TRIGger:SEQuence:RES<br>et <value> (see<br>page 552)                  | :TRIGger:SEQuence:RES<br>et? (see page 552)           | <value> ::= {NONE  <br>PATtern1,ENTered  <br>PATtern1,EXITed   EDGE1  <br>PATtern1,AND,EDGE1  <br>PATtern2,ENTered  <br>PATtern2,EXITed   EDGE2   TIMER}<br>Values used in find and trigger<br>stages not available. EDGE2 not<br>available if EDGE2,COUNT used in<br>trigger stage. |
| :TRIGger:SEQuence:TIM<br>er <time_value> (see<br>page 553)             | :TRIGger:SEQuence:TIM<br>er? (see page 553)           | <time_value> ::= time from 10 ns<br>to 10 seconds in NR3 format  |
| :TRIGger:SEQuence:TRI<br>Gger <value> (see<br>page 554)                | :TRIGger:SEQuence:TRI<br>Gger? (see page 554)         | <value> ::= {PATtern2,ENTered  <br>PATtern2,EXITed   EDGE2  <br>PATtern2,AND,EDGE2   EDGE2,COUNT<br>  EDGE2,COUNT,NREFind}   |

## 4 Commands Quick Reference

**Table 32** :TRIGger:SPI Commands Summary

| Command   | Query  | Options and Query Returns  |
|---|--|--|
| :TRIGger:SPI:CLOCK:SL<br>OPe <slope> (see<br>page 556)          | :TRIGger:SPI:CLOCK:SL<br>OPe? (see page 556)   | <slope> ::= {NEGative   POSitive}  |
| :TRIGger:SPI:CLOCK:TI<br>Meout <time_value><br>(see page 557)   | :TRIGger:SPI:CLOCK:TI<br>Meout? (see page 557) | <time_value> ::= time in seconds<br>in NR1 format  |
| :TRIGger:SPI:FRAMing<br><value> (see<br>page 558)               | :TRIGger:SPI:FRAMing?<br>(see page 558)        | <value> ::= {CHIPselect  <br>NOTChipselect   TIMEout}  |
| :TRIGger:SPI:PATtern:<br>DATA <value>, <mask><br>(see page 559) | :TRIGger:SPI:PATtern:<br>DATA? (see page 559)  | <value> ::= integer or <string><br><mask> ::= integer or <string><br><string> ::= "0xnxxxxxx" where n<br>::= {0,...,9   A,...,F} |
| :TRIGger:SPI:PATtern:<br>WIDTh <width> (see<br>page 560)        | :TRIGger:SPI:PATtern:<br>WIDTh? (see page 560) | <width> ::= integer from 4 to 32<br>in NR1 format  |
| :TRIGger:SPI:SOURce:C<br>LOCK <source> (see<br>page 561)        | :TRIGger:SPI:SOURce:C<br>LOCK? (see page 561)  | <value> ::= {CHANnel<n>  <br>EXTernal}<br><n> ::= 1-2 or 1-4 in NR1 format   |
| :TRIGger:SPI:SOURce:D<br>ATA <source> (see<br>page 562)         | :TRIGger:SPI:SOURce:D<br>ATA? (see page 562)   | <value> ::= {CHANnel<n>  <br>EXTernal}<br><n> ::= 1-2 or 1-4 in NR1 format   |
| :TRIGger:SPI:SOURce:F<br>RAME <source> (see<br>page 563)        | :TRIGger:SPI:SOURce:F<br>RAME? (see page 563)  | <value> ::= {CHANnel<n>  <br>EXTernal}<br><n> ::= 1-2 or 1-4 in NR1 format   |

**Table 33** :TRIGger:TV Commands Summary

| Command  | Query                                   | Options and Query Returns  |
|--|---|--|
| :TRIGger:TV:LINE<br><line number> (see<br>page 565)  | :TRIGger:TV:LINE?<br>(see page 565)     | <line number> ::= integer in NR1<br>format   |
| :TRIGger:TV:MODE <tv<br>mode> (see page 566)         | :TRIGger:TV:MODE?<br>(see page 566)     | <tv mode> ::= {FIEld1   FIEld2  <br>AFIElds   ALINes   LINE  <br>VERTical   LFIeld1   LFIeld2  <br>LALternate   LVERTical} |
| :TRIGger:TV:POLarity<br><polarity> (see<br>page 567) | :TRIGger:TV:POLarity?<br>(see page 567) | <polarity> ::= {POSitive  <br>NEGative}  |

**Table 33** :TRIGger:TV Commands Summary (continued)

| Command   | Query                                   | Options and Query Returns  |
|---|---|--|
| :TRIGger:TV:SOURce<br><source> (see page 568)     | :TRIGger:TV:SOURce?<br>(see page 568)   | <source> ::= {CHANnel<n>}<br><n> ::= 1-2 or 1-4 integer in NR1 format  |
| :TRIGger:TV:STANdard<br><standard> (see page 569) | :TRIGger:TV:STANdard?<br>(see page 569) | <standard> ::= {GENeric   NTSC   PALM   PAL   SECam   {P480L60HZ   P480}   {P720L60HZ   P720}   {P1080L24HZ   P1080}   P1080L25HZ   P1080L50HZ   P1080L60HZ   {I1080L50HZ   I1080}   I1080L60HZ} |

**Table 34** :TRIGger:UART Commands Summary

| Command   | Query                                     | Options and Query Returns  |
|---|---|--|
| :TRIGger:UART:BASE<br><base> (see page 572)         | :TRIGger:UART:BASE?<br>(see page 572)     | <base> ::= {ASCii   HEX}   |
| :TRIGger:UART:BAUDrate<br><baudrate> (see page 573) | :TRIGger:UART:BAUDrate?<br>(see page 573) | <baudrate> ::= integer from 1200 to 3000000 in 100 b/s increments  |
| :TRIGger:UART:BITorder<br><bitorder> (see page 574) | :TRIGger:UART:BITorder?<br>(see page 574) | <bitorder> ::= {LSBFirst   MSBFirst}   |
| :TRIGger:UART:BURSt<br><value> (see page 575)       | :TRIGger:UART:BURSt?<br>(see page 575)    | <value> ::= {OFF   1 to 4096 in NR1 format}  |
| :TRIGger:UART:DATA<br><value> (see page 576)        | :TRIGger:UART:DATA?<br>(see page 576)     | <value> ::= 8-bit integer from 0-255 (0x00-0xff) in decimal, <hexadecimal>, <binary>, or <quoted_string> format<br><hexadecimal> ::= #Hnn where n ::= {0,...,9   A,...,F} for hexadecimal<br><binary> ::= #Bnn...n where n ::= {0   1} for binary<br><quoted_string> ::= any of the 128 valid 7-bit ASCII characters (or standard abbreviations) |
| :TRIGger:UART:IDLE<br><time_value> (see page 577)   | :TRIGger:UART:IDLE?<br>(see page 577)     | <time_value> ::= time from 1 us to 10 s in NR3 format  |

## 4 Commands Quick Reference

**Table 34** :TRIGger:UART Commands Summary (continued)

| Command  | Query                                       | Options and Query Returns  |
|--|---|--|
| :TRIGger:UART:PARity<br><parity> (see<br>page 578)     | :TRIGger:UART:PARity?<br>(see page 578)     | <parity> ::= {EVEN   ODD   NONE}   |
| :TRIGger:UART:POLarity<br><polarity> (see<br>page 579) | :TRIGger:UART:POLarity?<br>(see page 579)   | <polarity> ::= {HIGH   LOW}  |
| :TRIGger:UART:QUALifier<br><value> (see<br>page 580)   | :TRIGger:UART:QUALifier?<br>(see page 580)  | <value> ::= {EQUAL   NOTequal   GREATERthan   LESSthan}  |
| :TRIGger:UART:SOURce:<br>RX <source> (see<br>page 581) | :TRIGger:UART:SOURce:<br>RX? (see page 581) | <source> ::= {CHANnel<n>  <br>EXTernal}<br><n> ::= 1-2 or 1-4 in NR1 format  |
| :TRIGger:UART:SOURce:<br>TX <source> (see<br>page 582) | :TRIGger:UART:SOURce:<br>TX? (see page 582) | <source> ::= {CHANnel<n>  <br>EXTernal}<br><n> ::= 1-2 or 1-4 in NR1 format  |
| :TRIGger:UART:TYPE<br><value> (see<br>page 583)        | :TRIGger:UART:TYPE?<br>(see page 583)       | <value> ::= {RSTART   RSTOP  <br>RDATa   RD1   RD0   RDX  <br>PARityerror   TSTART   TSTOP  <br>TDATa   TD1   TD0   TDX} |
| :TRIGger:UART:WIDTH<br><width> (see<br>page 584)       | :TRIGger:UART:WIDTH?<br>(see page 584)      | <width> ::= {5   6   7   8   9}  |

**Table 35** :TRIGger:USB Commands Summary

| Command   | Query  | Options and Query Returns   |
|---|--|---|
| :TRIGger:USB:SOURce:D<br>MINus <source> (see<br>page 586) | :TRIGger:USB:SOURce:D<br>MINus? (see page 586) | <source> ::= {CHANnel<n>  <br>EXTernal}<br><n> ::= 1-2 or 1-4 in NR1 format |
| :TRIGger:USB:SOURce:D<br>PLus <source> (see<br>page 587)  | :TRIGger:USB:SOURce:D<br>PLus? (see page 587)  | <source> ::= {CHANnel<n>  <br>EXTernal}<br><n> ::= 1-2 or 1-4 in NR1 format |
| :TRIGger:USB:SPEed<br><value> (see<br>page 588)           | :TRIGger:USB:SPEed?<br>(see page 588)          | <value> ::= {LOW   FULL}  |
| :TRIGger:USB:TRIGger<br><value> (see<br>page 589)         | :TRIGger:USB:TRIGger?<br>(see page 589)        | <value> ::= {SOP   EOP  <br>ENTersuspend   EXITsuspend  <br>RESet}          |

**Table 36** :WAVeform Commands Summary

| Command  | Query                                     | Options and Query Returns  |
|--|---|--|
| :WAVeform:BYTeorder<br><value> (see<br>page 597)         | :WAVeform:BYTeorder?<br>(see page 597)    | <value> ::= {LSBFirst   MSBFirst}  |
| n/a  | :WAVeform:COUNT? (see<br>page 598)        | <count> ::= an integer from 1 to<br>65536 in NR1 format  |
| n/a  | :WAVeform:DATA? (see<br>page 599)         | <binary block length bytes>,<br><binary data><br>For example, to transmit 1000<br>bytes of data, the syntax would<br>be: #800001000<1000 bytes of<br>data><NL><br>8 is the number of digits that<br>follow<br>00001000 is the number of bytes<br>to be transmitted<br><1000 bytes of data> is the<br>actual data |
| :WAVeform:FORMat<br><value> (see<br>page 601)            | :WAVeform:FORMat?<br>(see page 601)       | <value> ::= {WORD   BYTE   ASCII}  |
| :WAVeform:POINTs<br><# points> (see<br>page 602)         | :WAVeform:POINTs?<br>(see page 602)       | <# points> ::= {100   250   500  <br>1000   <points_mode>} if waveform<br>points mode is NORMAl<br><# points> ::= {100   250   500  <br>1000   2000 ... 8000000 in 1-2-5<br>sequence   <points_mode>} if<br>waveform points mode is MAXimum<br>or RAW<br><points_mode> ::= {NORMAl  <br>MAXimum   RAW}           |
| :WAVeform:POINTs:MODE<br><points_mode> (see<br>page 604) | :WAVeform:POINTs:MODE<br>? (see page 605) | <points_mode> ::= {NORMAl  <br>MAXimum   RAW}  |

## 4 Commands Quick Reference

**Table 36** :WAVEform Commands Summary (continued)

| Command   | Query   | Options and Query Returns  |
|---|---|--|
| n/a   | :WAVEform:PREAmble?<br>(see <a href="#">page 606</a> )      | <p>&lt;preamble_block&gt; ::= &lt;format NR1&gt;, &lt;type NR1&gt;,&lt;points NR1&gt;,&lt;count NR1&gt;, &lt;xincrement NR3&gt;, &lt;xorigin NR3&gt;, &lt;xreference NR1&gt;,&lt;yincrement NR3&gt;, &lt;yorigin NR3&gt;, &lt;yreference NR1&gt;</p> <p>&lt;format&gt; ::= an integer in NR1 format:</p> <ul style="list-style-type: none"> <li>• 0 for BYTE format</li> <li>• 1 for WORD format</li> <li>• 2 for ASCII format</li> </ul> <p>&lt;type&gt; ::= an integer in NR1 format:</p> <ul style="list-style-type: none"> <li>• 0 for NORMAL type</li> <li>• 1 for PEAK detect type</li> <li>• 2 for AVERAGE type</li> <li>• 3 for HRESolution type</li> </ul> <p>&lt;count&gt; ::= Average count, or 1 if PEAK detect type or NORMAL; an integer in NR1 format</p> |
| n/a   | :WAVEform:SEGmented:COUNT? (see <a href="#">page 609</a> )  | <count> ::= an integer from 2 to 250 in NR1 format (with Option SGM)   |
| n/a   | :WAVEform:SEGmented:TAG? (see <a href="#">page 610</a> )    | <time_tag> ::= in NR3 format (with Option SGM)   |
| :WAVEform:SOURce <source> (see <a href="#">page 611</a> )                 | :WAVEform:SOURce? (see <a href="#">page 611</a> )           | <p>&lt;source&gt; ::= {CHANnel&lt;n&gt;   FUNCTION   MATH}</p> <p>&lt;n&gt; ::= 1-2 or 1-4 in NR1 format</p>   |
| :WAVEform:SOURce:SUBSource <subsource> (see <a href="#">page 615</a> )    | :WAVEform:SOURce:SUBSource? (see <a href="#">page 615</a> ) | <subsource> ::= {{NONE   RX}   TX}   |
| n/a   | :WAVEform:TYPE? (see <a href="#">page 616</a> )             | <return_mode> ::= {NORM   PEAK   AVER   HRES}  |
| :WAVEform:UNSigned {{0   OFF}   {1   ON}} (see <a href="#">page 617</a> ) | :WAVEform:UNSigned? (see <a href="#">page 617</a> )         | {0   1}  |
| :WAVEform:VIEW <view> (see <a href="#">page 618</a> )                     | :WAVEform:VIEW? (see <a href="#">page 618</a> )             | <view> ::= {MAIN}  |
| n/a   | :WAVEform:XINCrement? (see <a href="#">page 619</a> )       | <return_value> ::= x-increment in the current preamble in NR3 format   |

**Table 36** :WAVeform Commands Summary (continued)

| Command | Query  | Options and Query Returns  |
|---------|--|--|
| n/a     | :WAVeform:XORigin?<br>(see <a href="#">page 620</a> )    | <return_value> ::= x-origin value in the current preamble in NR3 format        |
| n/a     | :WAVeform:XREference?<br>(see <a href="#">page 621</a> ) | <return_value> ::= 0 (x-reference value in the current preamble in NR1 format) |
| n/a     | :WAVeform:YINcrement?<br>(see <a href="#">page 622</a> ) | <return_value> ::= y-increment value in the current preamble in NR3 format     |
| n/a     | :WAVeform:YORigin?<br>(see <a href="#">page 623</a> )    | <return_value> ::= y-origin in the current preamble in NR3 format              |
| n/a     | :WAVeform:YREference?<br>(see <a href="#">page 624</a> ) | <return_value> ::= y-reference value in the current preamble in NR1 format     |

## Syntax Elements

- "Number Format" on page 106
- "<NL> (Line Terminator)" on page 106
- "[ ] (Optional Syntax Terms)" on page 106
- "{ } (Braces)" on page 106
- "::<= (Defined As)" on page 106
- "< > (Angle Brackets)" on page 107
- "... (Ellipsis)" on page 107
- "n,...,p (Value Ranges)" on page 107
- "d (Digits)" on page 107
- "Quoted ASCII String" on page 107
- "Definite-Length Block Response Data" on page 107

### Number Format

NR1 specifies integer data.

NR3 specifies exponential data in floating point format (for example, -1.0E-3).

### <NL> (Line Terminator)

<NL> = new line or linefeed (ASCII decimal 10).

The line terminator, or a leading colon, will send the parser to the "root" of the command tree.

### [ ] (Optional Syntax Terms)

Items enclosed in square brackets, [ ], are optional.

### { } (Braces)

When several items are enclosed by braces, { }, only one of these elements may be selected. Vertical line ( | ) indicates "or". For example, {ON | OFF} indicates that only ON or OFF may be selected, not both.

### ::= (Defined As)

::= means "defined as".

For example, <A> ::= <B> indicates that <A> can be replaced by <B> in any statement containing <A>.

### < > (Angle Brackets)

< > Angle brackets enclose words or characters that symbolize a program code parameter or an interface command.

### ... (Ellipsis)

... An ellipsis (trailing dots) indicates that the preceding element may be repeated one or more times.

### n,...,p (Value Ranges)

n,...,p ::= all integers between n and p inclusive.

### d (Digits)

d ::= A single ASCII numeric character 0 - 9.

### Quoted ASCII String

A quoted ASCII string is a string delimited by either double quotes (") or single quotes ('). Some command parameters require a quoted ASCII string. For example, when using the Agilent VISA COM library in Visual Basic, the command:

```
myScope.WriteString ":CHANNEL1:LABEL 'One'"
```

has a quoted ASCII string of:

```
'One'
```

In order to read quoted ASCII strings from query return values, some programming languages require special handling or syntax.

### Definite-Length Block Response Data

Definite-length block response data allows any type of device-dependent data to be transmitted over the system interface as a series of 8-bit binary data bytes. This is particularly useful for sending large quantities of data or 8-bit extended ASCII codes. This syntax is a pound sign (#) followed by a non-zero digit representing the number of digits in the decimal integer. After the non-zero digit is the decimal integer that states the number of 8-bit data bytes being sent. This is followed by the actual data.

For example, for transmitting 1000 bytes of data, the syntax would be

## 4 Commands Quick Reference

#800001000<1000 bytes of data> <NL>

**8** is the number of digits that follow

**00001000** is the number of bytes to be transmitted

**<1000 bytes of data>** is the actual data

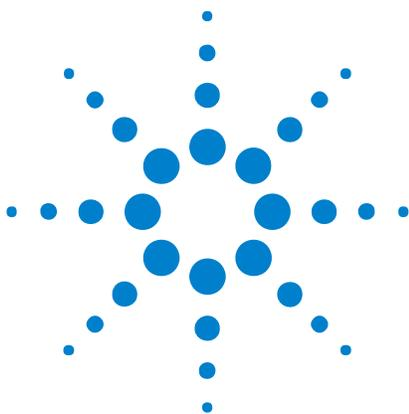

## 5 Commands by Subsystem

| Subsystem                                | Description  |
|--|--|
| "Common (*) Commands" on page 111        | Commands defined by IEEE 488.2 standard that are common to all instruments.                                  |
| "Root (:) Commands" on page 136          | Control many of the basic functions of the oscilloscope and reside at the root level of the command tree.    |
| ":ACQuire Commands" on page 177          | Set the parameters for acquiring and storing data.   |
| ":CALibrate Commands" on page 193        | Utility commands for determining the state of the calibration factor protection switch.                      |
| ":CHANnel<n> Commands" on page 203       | Control all oscilloscope functions associated with individual analog channels or groups of channels.         |
| ":DISPlay Commands" on page 223          | Control how waveforms, graticule, and text are displayed and written on the screen.                          |
| ":EXTeRnal Trigger Commands" on page 233 | Control the input characteristics of the external trigger input.   |
| ":FUNctioN Commands" on page 243         | Control functions in the measurement/storage module.   |
| ":HARDcopy Commands" on page 260         | Set and query the selection of hardcopy device and formatting options.                                       |
| ":LISTer Commands" on page 271           | Turn on/off the Lister display for decoded serial data and get the Lister data.                              |
| ":MARKer Commands" on page 274           | Set and query the settings of X-axis markers (X1 and X2 cursors) and the Y-axis markers (Y1 and Y2 cursors). |
| ":MEASure Commands" on page 285          | Select automatic measurements to be made and control time markers.   |
| ":MTESt Commands" on page 337            | Control the mask test features provided with Option LMT.   |



## 5 Commands by Subsystem

| Subsystem  | Description   |
|--|---|
| <a href="#">":RECall Commands" on page 371</a>   | Recall previously saved oscilloscope setups and traces.               |
| <a href="#">":SAVE Commands" on page 377</a>     | Save oscilloscope setups and traces, screen images, and data.         |
| <a href="#">":SBUS Commands" on page 394</a>     | Control oscilloscope functions associated with the serial decode bus. |
| <a href="#">":SYSTem Commands" on page 419</a>   | Control basic system functions of the oscilloscope.                   |
| <a href="#">":TIMebase Commands" on page 429</a> | Control all horizontal sweep functions.                               |
| <a href="#">":TRIGger Commands" on page 440</a>  | Control the trigger modes and parameters for each trigger type.       |
| <a href="#">":WAVEform Commands" on page 590</a> | Provide access to waveform data.                                      |

**Command Types** Three types of commands are used:

- **Common (\*) Commands** – See ["Introduction to Common \(\\*\) Commands"](#) on page 113 for more information.
- **Root Level (: ) Commands** – See ["Introduction to Root \(: \) Commands"](#) on page 138 for more information.
- **Subsystem Commands** – Subsystem commands are grouped together under a common node of the ["Command Tree"](#) on page 755, such as the :TIMebase commands. Only one subsystem may be selected at any given time. When the instrument is initially turned on, the command parser is set to the root of the command tree; therefore, no subsystem is selected.

## Common (\*) Commands

Commands defined by IEEE 488.2 standard that are common to all instruments. See "Introduction to Common (\*) Commands" on page 113.

**Table 37** Common (\*) Commands Summary

| Command                                     | Query                                 | Options and Query Returns   |
|---|---------------------------------------|---|
| *CLS (see <a href="#">page 115</a> )        | n/a                                   | n/a   |
| *ESE <mask> (see <a href="#">page 116</a> ) | *ESE? (see <a href="#">page 117</a> ) | <p>&lt;mask&gt; ::= 0 to 255; an integer in NR1 format:</p> <pre> Bit Weight Name Enables ----- 7      128 PON  Power On 6       64 URQ  User Request 5       32 CME  Command Error 4       16 EXE  Execution Error 3        8 DDE  Dev. Dependent Error 2        4 QYE  Query Error 1        2 RQL  Request Control 0         1 OPC  Operation Complete                     </pre> |
| n/a   | *ESR? (see <a href="#">page 118</a> ) | <status> ::= 0 to 255; an integer in NR1 format   |
| n/a   | *IDN? (see <a href="#">page 118</a> ) | <p>AGILENT TECHNOLOGIES,&lt;model&gt;,&lt;serial number&gt;,X.XX.XX</p> <p>&lt;model&gt; ::= the model number of the instrument</p> <p>&lt;serial number&gt; ::= the serial number of the instrument</p> <p>&lt;X.XX.XX&gt; ::= the software revision of the instrument</p>   |
| n/a   | *LRN? (see <a href="#">page 121</a> ) | <learn_string> ::= current instrument setup as a block of data in IEEE 488.2 # format   |
| *OPC (see <a href="#">page 122</a> )        | *OPC? (see <a href="#">page 122</a> ) | ASCII "1" is placed in the output queue when all pending device operations have completed.  |

**Table 37** Common (\*) Commands Summary (continued)

| Command                                      | Query                                 | Options and Query Returns  |
|--|---------------------------------------|--|
| n/a  | *OPT? (see <a href="#">page 123</a> ) | <pre> &lt;return_value&gt; ::= 0,0,&lt;license info&gt; &lt;license info&gt; ::= &lt;All field&gt;, &lt;reserved&gt;, &lt;reserved&gt;, &lt;reserved&gt;, &lt;reserved&gt;, &lt;reserved&gt;, &lt;Low Speed Serial&gt;, &lt;Automotive Serial&gt;, &lt;reserved&gt;, &lt;Secure&gt;, &lt;reserved&gt;, &lt;reserved&gt;, &lt;reserved&gt;, &lt;reserved&gt;, &lt;RS-232/UART Serial&gt;, &lt;reserved&gt;, &lt;Segmented Memory&gt;, &lt;Mask Test&gt;, &lt;reserved&gt;, &lt;reserved&gt;, &lt;FlexRay Conformance&gt;, &lt;reserved&gt;, &lt;reserved&gt;, &lt;I2S Serial&gt;, &lt;FlexRay Trigger/Decode&gt;, &lt;reserved&gt;, &lt;reserved&gt;, &lt;MIL-STD 1553 Trigger/Decode&gt;, &lt;reserved&gt; &lt;All field&gt; ::= {0   All} &lt;reserved&gt; ::= 0 &lt;Low Speed Serial&gt; ::= {0   LSS} &lt;Automotive Serial&gt; ::= {0   AMS} &lt;Secure&gt; ::= {0   SEC} &lt;RS-232/UART Serial&gt; ::= {0   232} &lt;Segmented Memory&gt; ::= {0   SGM} &lt;Mask Test&gt; ::= {0   LMT} &lt;FlexRay Conformance&gt; ::= {0   FRC} &lt;I2S Serial&gt; ::= {0   SND} &lt;FlexRay Trigger/Decode&gt; ::= {0   FLX} &lt;MIL-STD 1553 Trigger/Decode&gt; ::= {0   553} </pre> |
| *RCL <value> (see <a href="#">page 124</a> ) | n/a                                   | <pre> &lt;value&gt; ::= {0   1   2   3   4   5   6   7   8   9} </pre>   |
| *RST (see <a href="#">page 125</a> )         | n/a                                   | See *RST (Reset) (see <a href="#">page 125</a> )   |
| *SAV <value> (see <a href="#">page 128</a> ) | n/a                                   | <pre> &lt;value&gt; ::= {0   1   2   3   4   5   6   7   8   9} </pre>   |

**Table 37** Common (\*) Commands Summary (continued)

| Command                    | Query                | Options and Query Returns  |
|----------------------------|----------------------|--|
| *SRE <mask> (see page 129) | *SRE? (see page 130) | <p>&lt;mask&gt; ::= sum of all bits that are set, 0 to 255; an integer in NR1 format. &lt;mask&gt; ::= following values:</p> <pre> Bit Weight Name Enables ----- 7      128 OPER Operation Status Reg 6       64 ---- (Not used.) 5       32 ESB  Event Status Bit 4       16 MAV  Message Available 3        8 ---- (Not used.) 2        4 MSG  Message 1        2 USR  User 0         1 TRG  Trigger                     </pre>  |
| n/a                        | *STB? (see page 131) | <p>&lt;value&gt; ::= 0 to 255; an integer in NR1 format, as shown in the following:</p> <pre> Bit Weight Name "1" Indicates ----- 7      128 OPER Operation status                     condition occurred. 6       64 RQS/ Instrument is                     MSS requesting service. 5       32 ESB  Enabled event status                     condition occurred. 4       16 MAV  Message available. 3        8 ---- (Not used.) 2        4 MSG  Message displayed. 1        2 USR  User event                     condition occurred. 0         1 TRG  A trigger occurred.                     </pre> |
| *TRG (see page 133)        | n/a                  | n/a  |
| n/a                        | *TST? (see page 134) | <result> ::= 0 or non-zero value; an integer in NR1 format   |
| *WAI (see page 135)        | n/a                  | n/a  |

**Introduction to Common (\*) Commands**

The common commands are defined by the IEEE 488.2 standard. They are implemented by all instruments that comply with the IEEE 488.2 standard. They provide some of the basic instrument functions, such as instrument identification and reset, reading the instrument setup, and determining how status is read and cleared.

Common commands can be received and processed by the instrument whether they are sent over the interface as separate program messages or within other program messages. If an instrument subsystem has been

## 5 Commands by Subsystem

selected and a common command is received by the instrument, the instrument remains in the selected subsystem. For example, if the program message ":ACQUIRE:TYPE AVERAGE; \*CLS; COUNT 256" is received by the instrument, the instrument sets the acquire type, then clears the status information and sets the average count.

In contrast, if a root level command or some other subsystem command is within the program message, you must re-enter the original subsystem after the command. For example, the program message ":ACQUIRE:TYPE AVERAGE; :AUTOSCALE; :ACQUIRE:COUNT 256" sets the acquire type, completes the autoscale, then sets the acquire count. In this example, :ACQUIRE must be sent again after the :AUTOSCALE command in order to re-enter the ACQUIRE subsystem and set the count.

### NOTE

Each of the status registers has an enable (mask) register. By setting the bits in the enable register, you can select the status information you want to use.

---

## \*CLS (Clear Status)

**C** (see [page 750](#))

### Command Syntax

\*CLS

The \*CLS common command clears the status data structures, the device-defined error queue, and the Request-for-OPC flag.

### NOTE

If the \*CLS command immediately follows a program message terminator, the output queue and the MAV (message available) bit are cleared.

- See Also**
- ["Introduction to Common \(\\*\) Commands"](#) on page 113
  - ["\\*STB \(Read Status Byte\)"](#) on page 131
  - ["\\*ESE \(Standard Event Status Enable\)"](#) on page 116
  - ["\\*ESR \(Standard Event Status Register\)"](#) on page 118
  - ["\\*SRE \(Service Request Enable\)"](#) on page 129
  - [":SYSTem:ERRor"](#) on page 422

### \*ESE (Standard Event Status Enable)

**C** (see page 750)

**Command Syntax** \*ESE <mask\_argument>

<mask\_argument> ::= integer from 0 to 255

The \*ESE common command sets the bits in the Standard Event Status Enable Register. The Standard Event Status Enable Register contains a mask value for the bits to be enabled in the Standard Event Status Register. A "1" in the Standard Event Status Enable Register enables the corresponding bit in the Standard Event Status Register. A zero disables the bit.

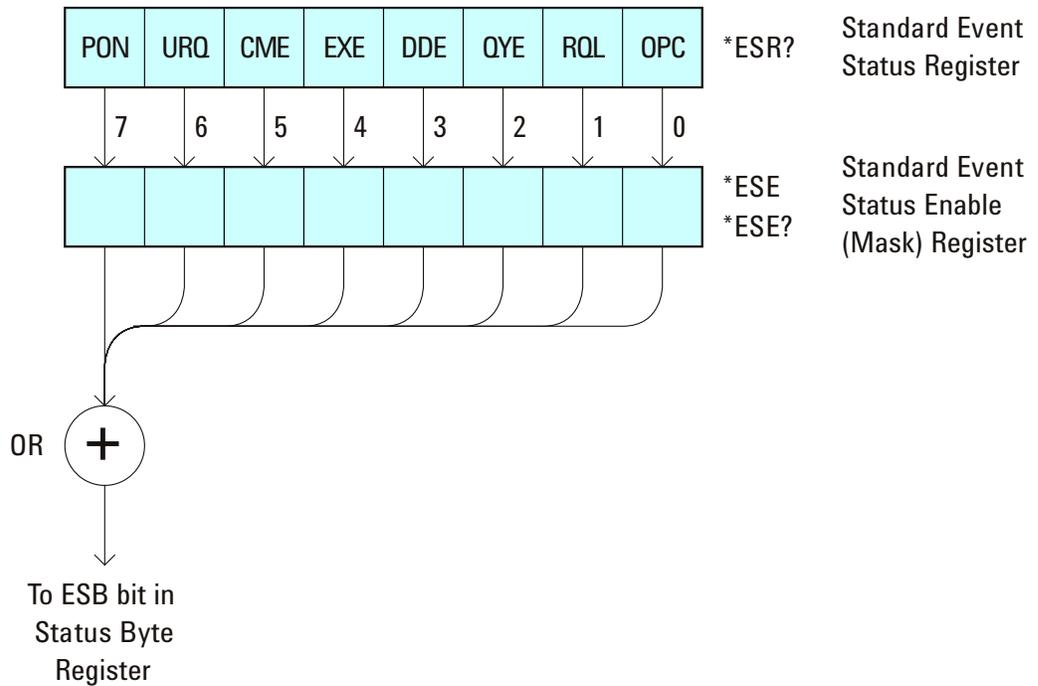

**Table 38** Standard Event Status Enable (ESE)

| Bit | Name | Description            | When Set (1 = High = True), Enables:             |
|-----|------|------------------------|--|
| 7   | PON  | Power On               | Event when an OFF to ON transition occurs.       |
| 6   | URQ  | User Request           | Event when a front-panel key is pressed.         |
| 5   | CME  | Command Error          | Event when a command error is detected.          |
| 4   | EXE  | Execution Error        | Event when an execution error is detected.       |
| 3   | DDE  | Device Dependent Error | Event when a device-dependent error is detected. |
| 2   | QYE  | Query Error            | Event when a query error is detected.            |

**Table 38** Standard Event Status Enable (ESE) (continued)

| Bit | Name | Description        | When Set (1 = High = True), Enables:                     |
|-----|------|--------------------|--|
| 1   | RQL  | Request Control    | Event when the device is requesting control. (Not used.) |
| 0   | OPC  | Operation Complete | Event when an operation is complete.                     |

**Query Syntax** \*ESE?

The \*ESE? query returns the current contents of the Standard Event Status Enable Register.

**Return Format** <mask\_argument><NL>

<mask\_argument> ::= 0,...,255; an integer in NR1 format.

- See Also**
- ["Introduction to Common \(\\*\) Commands"](#) on page 113
  - ["\\*ESR \(Standard Event Status Register\)"](#) on page 118
  - ["\\*OPC \(Operation Complete\)"](#) on page 122
  - ["\\*CLS \(Clear Status\)"](#) on page 115

### \*ESR (Standard Event Status Register)

**C** (see page 750)

**Query Syntax** \*ESR?

The \*ESR? query returns the contents of the Standard Event Status Register. When you read the Event Status Register, the value returned is the total bit weights of all of the bits that are high at the time you read the byte. Reading the register clears the Event Status Register.

The following table shows bit weight, name, and condition for each bit.

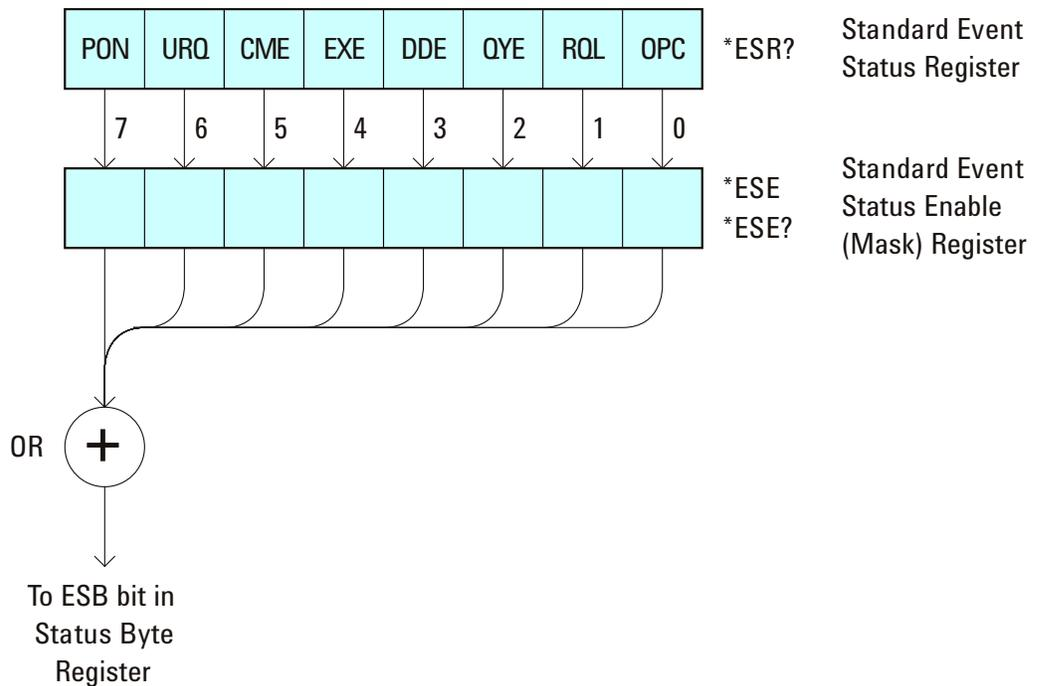

**Table 39** Standard Event Status Register (ESR)

| Bit | Name | Description            | When Set (1 = High = True), Indicates:      |
|-----|------|------------------------|---|
| 7   | PON  | Power On               | An OFF to ON transition has occurred.       |
| 6   | URQ  | User Request           | A front-panel key has been pressed.         |
| 5   | CME  | Command Error          | A command error has been detected.          |
| 4   | EXE  | Execution Error        | An execution error has been detected.       |
| 3   | DDE  | Device Dependent Error | A device-dependent error has been detected. |
| 2   | QYE  | Query Error            | A query error has been detected.            |

**Table 39** Standard Event Status Register (ESR) (continued)

| Bit | Name | Description        | When Set (1 = High = True), Indicates:        |
|-----|------|--------------------|---|
| 1   | RQL  | Request Control    | The device is requesting control. (Not used.) |
| 0   | OPC  | Operation Complete | Operation is complete.                        |

**Return Format** <status><NL>  
 <status> ::= 0,..,255; an integer in NR1 format.

**NOTE**

Reading the Standard Event Status Register clears it. High or 1 indicates the bit is true.

- See Also**
- ["Introduction to Common \(\\*\) Commands"](#) on page 113
  - ["\\*ESE \(Standard Event Status Enable\)"](#) on page 116
  - ["\\*OPC \(Operation Complete\)"](#) on page 122
  - ["\\*CLS \(Clear Status\)"](#) on page 115
  - [":SYSTem:ERRor"](#) on page 422

## \*IDN (Identification Number)

**C** (see [page 750](#))

**Query Syntax** \*IDN?

The \*IDN? query identifies the instrument type and software version.

**Return Format** AGILENT TECHNOLOGIES,<model>,<serial number>,X.XX.XX <NL>

<model> ::= the model number of the instrument

<serial number> ::= the serial number of the instrument

X.XX.XX ::= the software revision of the instrument

- See Also**
- ["Introduction to Common \(\\*\) Commands"](#) on page 113
  - ["\\*OPT \(Option Identification\)"](#) on page 123

## \*LRN (Learn Device Setup)

**C** (see [page 750](#))

### Query Syntax

\*LRN?

The \*LRN? query result contains the current state of the instrument. This query is similar to the :SYSTEM:SETup? (see [page 426](#)) query, except that it contains ":SYST:SET " before the binary block data. The query result is a valid command that can be used to restore instrument settings at a later time.

### Return Format

<learn\_string><NL>

<learn\_string> ::= :SYST:SET <setup\_data>

<setup\_data> ::= binary block data in IEEE 488.2 # format

<learn string> specifies the current instrument setup. The block size is subject to change with different firmware revisions.

### NOTE

The \*LRN? query return format has changed from previous Agilent oscilloscopes to match the IEEE 488.2 specification which says that the query result must contain ":SYST:SET " before the binary block data.

### See Also

- "[Introduction to Common \(\\*\) Commands](#)" on page 113
- "[\\*RCL \(Recall\)](#)" on page 124
- "[\\*SAV \(Save\)](#)" on page 128
- "[:SYSTEM:SETup](#)" on page 426

## \*OPC (Operation Complete)

**C** (see [page 750](#))

**Command Syntax** \*OPC

The \*OPC command sets the operation complete bit in the Standard Event Status Register when all pending device operations have finished.

**Query Syntax** \*OPC?

The \*OPC? query places an ASCII "1" in the output queue when all pending device operations have completed. The interface hangs until this query returns.

**Return Format** <complete><NL>

<complete> ::= 1

- See Also**
- ["Introduction to Common \(\\*\) Commands"](#) on page 113
  - ["\\*ESE \(Standard Event Status Enable\)"](#) on page 116
  - ["\\*ESR \(Standard Event Status Register\)"](#) on page 118
  - ["\\*CLS \(Clear Status\)"](#) on page 115



### \*RCL (Recall)

**C** (see [page 750](#))

**Command Syntax** \*RCL <value>

<value> ::= {0 | 1 | 2 | 3 | 4 | 5 | 6 | 7 | 8 | 9}

The \*RCL command restores the state of the instrument from the specified save/recall register.

- See Also**
- ["Introduction to Common \(\\*\) Commands"](#) on page 113
  - ["\\*SAV \(Save\)"](#) on page 128

## \*RST (Reset)

**C** (see [page 750](#))

### Command Syntax \*RST

The \*RST command places the instrument in a known state. Reset conditions are:

| Acquire Menu |        |
|--------------|--------|
| Mode         | Normal |
| Realtime     | On     |
| Averaging    | Off    |
| # Averages   | 8      |

| Analog Channel Menu |  |
|---------------------|--|
| Channel 1           | On   |
| Channel 2           | Off  |
| Volts/division      | 5.00 V   |
| Offset              | 0.00   |
| Coupling            | DC   |
| Probe attenuation   | AutoProbe (if AutoProbe is connected), otherwise 1.0:1 |
| Vernier             | Off  |
| Invert              | Off  |
| BW limit            | Off  |
| Impedance           | 1 M Ohm  |
| Units               | Volts  |
| Skew                | 0  |

| Cursor Menu |           |
|-------------|-----------|
| Source      | Channel 1 |

## 5 Commands by Subsystem

| <b>Display Menu</b>  |     |
|----------------------|-----|
| Definite persistence | Off |
| Grid                 | 33% |
| Vectors              | On  |

| <b>Quick Meas Menu</b> |           |
|------------------------|-----------|
| Source                 | Channel 1 |

| <b>Run Control</b> |                  |
|--------------------|------------------|
|                    | Scope is running |

| <b>Time Base Menu</b> |        |
|-----------------------|--------|
| Main time/division    | 100 us |
| Main time base delay  | 0.00 s |
| Delay time/division   | 500 ns |
| Delay time base delay | 0.00 s |
| Reference             | center |
| Mode                  | main   |
| Vernier               | Off    |

| <b>Trigger Menu</b>        |   |
|----------------------------|---|
| Type                       | Edge  |
| Mode                       | Auto  |
| Coupling                   | dc  |
| Source                     | Channel 1   |
| Level                      | 0.0 V   |
| Slope                      | Positive  |
| HF Reject and noise reject | Off   |
| Holdoff                    | 60 ns   |
| External probe attenuation | AutoProbe (if AutoProbe is connected),<br>otherwise 1.0:1 |

| Trigger Menu       |         |
|--------------------|---------|
| External Units     | Volts   |
| External Impedance | 1 M Ohm |

**See Also** • ["Introduction to Common \(\\*\) Commands"](#) on page 113

**Example Code**

```
' RESET - This command puts the oscilloscope into a known state.
' This statement is very important for programs to work as expected.
' Most of the following initialization commands are initialized by
' *RST. It is not necessary to reinitialize them unless the default
' setting is not suitable for your application.
myScope.WriteString "*RST" ' Reset the oscilloscope to the defaults.
```

Example program from the start: ["VISA COM Example in Visual Basic"](#) on page 776

### \*SAV (Save)

**C** (see [page 750](#))

**Command Syntax** \*SAV <value>

<value> ::= {0 | 1 | 2 | 3 | 4 | 5 | 6 | 7 | 8 | 9}

The \*SAV command stores the current state of the instrument in a save register. The data parameter specifies the register where the data will be saved.

- See Also**
- ["Introduction to Common \(\\*\) Commands"](#) on page 113
  - ["\\*RCL \(Recall\)"](#) on page 124

### \*SRE (Service Request Enable)

**C** (see page 750)

**Command Syntax** \*SRE <mask>

<mask> ::= integer with values defined in the following table.

The \*SRE command sets the bits in the Service Request Enable Register. The Service Request Enable Register contains a mask value for the bits to be enabled in the Status Byte Register. A one in the Service Request Enable Register enables the corresponding bit in the Status Byte Register. A zero disables the bit.

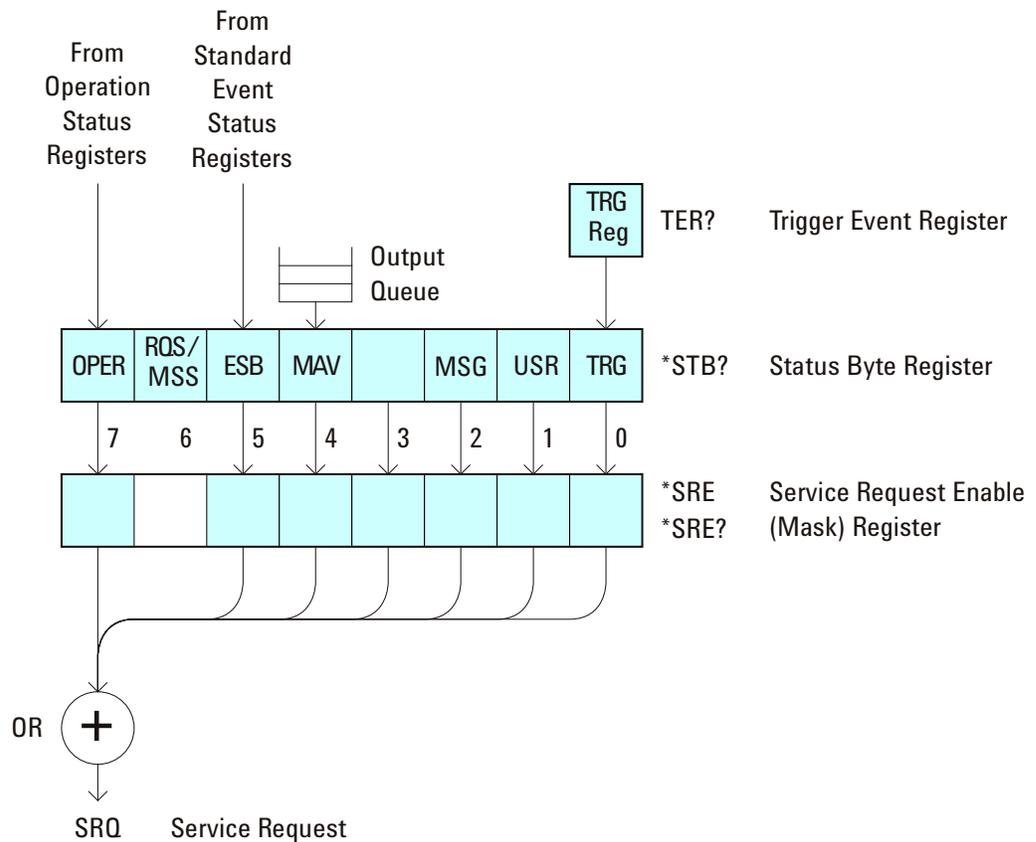

**Table 40** Service Request Enable Register (SRE)

| Bit | Name | Description               | When Set (1 = High = True), Enables:  |
|-----|------|---------------------------|---|
| 7   | OPER | Operation Status Register | Interrupts when enabled conditions in the Operation Status Register (OPER) occur. |
| 6   | ---  | ---                       | (Not used.)   |

**Table 40** Service Request Enable Register (SRE) (continued)

| Bit | Name | Description       | When Set (1 = High = True), Enables:  |
|-----|------|-------------------|---|
| 5   | ESB  | Event Status Bit  | Interrupts when enabled conditions in the Standard Event Status Register (ESR) occur. |
| 4   | MAV  | Message Available | Interrupts when messages are in the Output Queue.                                     |
| 3   | ---  | ---               | (Not used.)   |
| 2   | MSG  | Message           | Interrupts when an advisory has been displayed on the oscilloscope.                   |
| 1   | USR  | User Event        | Interrupts when enabled user event conditions occur.                                  |
| 0   | TRG  | Trigger           | Interrupts when a trigger occurs.   |

**Query Syntax** \*SRE?

The \*SRE? query returns the current value of the Service Request Enable Register.

**Return Format** <mask><NL>

<mask> ::= sum of all bits that are set, 0,...,255;  
an integer in NR1 format

- See Also**
- ["Introduction to Common \(\\*\) Commands"](#) on page 113
  - ["\\*STB \(Read Status Byte\)"](#) on page 131
  - ["\\*CLS \(Clear Status\)"](#) on page 115

### \*STB (Read Status Byte)

**C** (see page 750)

**Query Syntax** \*STB?

The \*STB? query returns the current value of the instrument's status byte. The MSS (Master Summary Status) bit is reported on bit 6 instead of the RQS (request service) bit. The MSS indicates whether or not the device has at least one reason for requesting service.

**Return Format** <value><NL>  
 <value> ::= 0,...,255; an integer in NR1 format

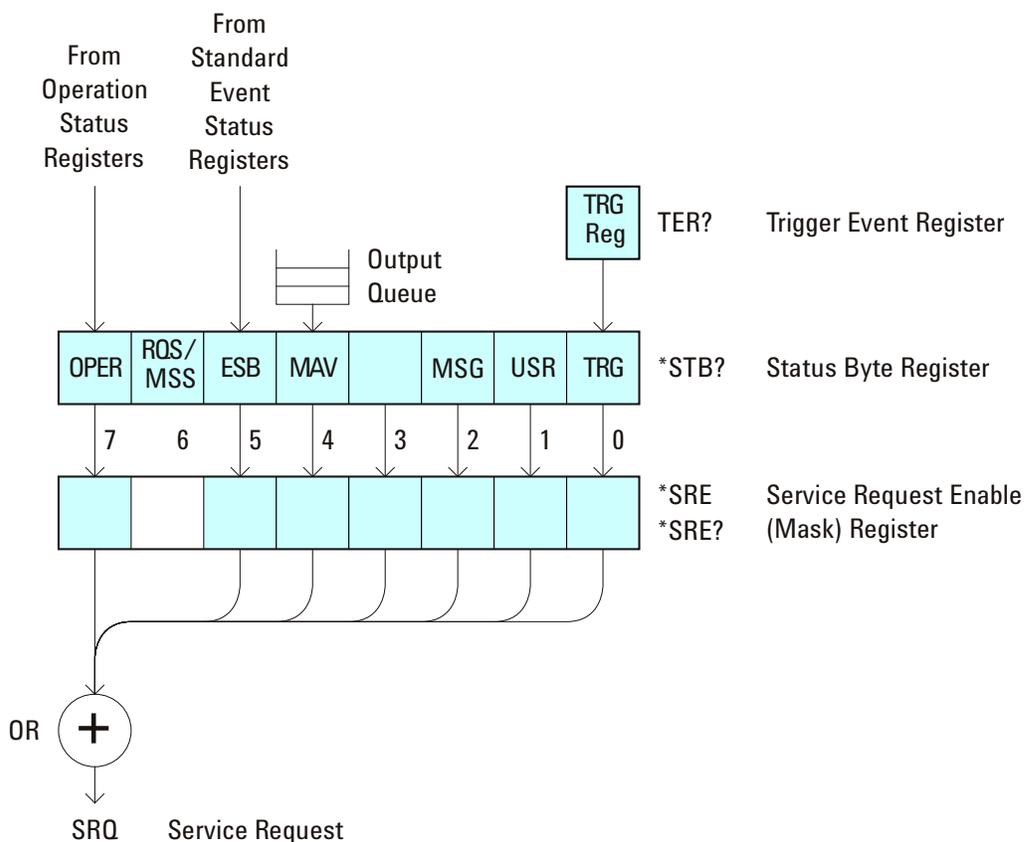

**Table 41** Status Byte Register (STB)

| Bit | Name | Description               | When Set (1 = High = True), Indicates:                                     |
|-----|------|---------------------------|--|
| 7   | OPER | Operation Status Register | An enabled condition in the Operation Status Register (OPER) has occurred. |

**Table 41** Status Byte Register (STB) (continued)

| Bit | Name | Description           | When Set (1 = High = True), Indicates:   |
|-----|------|-----------------------|--|
| 6   | RQS  | Request Service       | When polled, that the device is requesting service.                            |
|     | MSS  | Master Summary Status | When read (by *STB?), whether the device has a reason for requesting service.  |
| 5   | ESB  | Event Status Bit      | An enabled condition in the Standard Event Status Register (ESR) has occurred. |
| 4   | MAV  | Message Available     | There are messages in the Output Queue.  |
| 3   | ---  | ---                   | (Not used, always 0.)  |
| 2   | MSG  | Message               | An advisory has been displayed on the oscilloscope.                            |
| 1   | USR  | User Event            | An enabled user event condition has occurred.                                  |
| 0   | TRG  | Trigger               | A trigger has occurred.  |

**NOTE**

To read the instrument's status byte with RQS reported on bit 6, use the interface Serial Poll.

- See Also**
- ["Introduction to Common \(\\*\) Commands"](#) on page 113
  - ["\\*SRE \(Service Request Enable\)"](#) on page 129

## \*TRG (Trigger)

**C** (see [page 750](#))

### Command Syntax

\*TRG

The \*TRG command has the same effect as the :DIGitize command with no parameters.

- See Also**
- ["Introduction to Common \(\\*\) Commands"](#) on page 113
  - [":DIGitize"](#) on page 146
  - [":RUN"](#) on page 170
  - [":STOP"](#) on page 174

### \*TST (Self Test)

**C** (see [page 750](#))

**Query Syntax** \*TST?

The \*TST? query performs a self-test on the instrument. The result of the test is placed in the output queue. A zero indicates the test passed and a non-zero indicates the test failed. If the test fails, refer to the troubleshooting section of the *Service Guide*.

**Return Format** <result><NL>

<result> ::= 0 or non-zero value; an integer in NR1 format

**See Also** • ["Introduction to Common \(\\*\) Commands"](#) on page 113

## \*WAI (Wait To Continue)

**C** (see [page 750](#))

**Command Syntax** \*WAI

The \*WAI command has no function in the oscilloscope, but is parsed for compatibility with other instruments.

**See Also** • ["Introduction to Common \(\\*\) Commands"](#) on page 113

## Root (:) Commands

Control many of the basic functions of the oscilloscope and reside at the root level of the command tree. See ["Introduction to Root \(:\) Commands"](#) on page 138.

**Table 42** Root (:) Commands Summary

| Command   | Query  | Options and Query Returns   |
|---|--|---|
| n/a   | :AER? (see <a href="#">page 139</a> )                      | {0   1}; an integer in NR1 format   |
| :AUToscale<br>[<source>[,...,<source>]] (see <a href="#">page 140</a> ) | n/a  | <source> ::= CHANNEL<n><br><source> can be repeated up to 5 times<br><n> ::= 1-2 or 1-4 in NR1 format                       |
| :AUToscale:AMODE<br><value> (see <a href="#">page 142</a> )             | :AUToscale:AMODE?<br>(see <a href="#">page 142</a> )       | <value> ::= {NORMAL   CURRENT}}   |
| :AUToscale:CHANnels<br><value> (see <a href="#">page 143</a> )          | :AUToscale:CHANnels?<br>(see <a href="#">page 143</a> )    | <value> ::= {ALL   DISPLAYed}}  |
| :BLANK [<source>]<br>(see <a href="#">page 144</a> )                    | n/a  | <source> ::= {CHANNEL<n>}  <br>FUNCTION   MATH<br><n> ::= 1-2 or 1-4 in NR1 format  |
| :CDISplay (see <a href="#">page 145</a> )                               | n/a  | n/a   |
| :DIGitize<br>[<source>[,...,<source>]] (see <a href="#">page 146</a> )  | n/a  | <source> ::= {CHANNEL<n>  <br>FUNCTION   MATH<br><source> can be repeated up to 5 times<br><n> ::= 1-2 or 1-4 in NR1 format |
| :HWEenable <n> (see <a href="#">page 148</a> )                          | :HWEenable? (see <a href="#">page 148</a> )                | <n> ::= 16-bit integer in NR1 format  |
| n/a   | :HWERegister:CONDition?<br>(see <a href="#">page 150</a> ) | <n> ::= 16-bit integer in NR1 format  |
| n/a   | :HWERegister[:EVENT]?<br>(see <a href="#">page 152</a> )   | <n> ::= 16-bit integer in NR1 format  |
| :MERGe <pixel memory><br>(see <a href="#">page 154</a> )                | n/a  | <pixel memory> ::= {PMEMory{0   1<br>  2   3   4   5   6   7   8   9}}  |
| :MTEenable <n> (see <a href="#">page 155</a> )                          | :MTEenable? (see <a href="#">page 155</a> )                | <n> ::= 16-bit integer in NR1 format  |
| n/a   | :MTERegister[:EVENT]?<br>(see <a href="#">page 157</a> )   | <n> ::= 16-bit integer in NR1 format  |

**Table 42** Root (: ) Commands Summary (continued)

| Command                           | Query                                   | Options and Query Returns  |
|-----------------------------------|---|--|
| :OPEE <n> (see page 159)          | :OPEE? (see page 160)                   | <n> ::= 16-bit integer in NR1 format   |
| n/a                               | :OPERregister:CONDition? (see page 161) | <n> ::= 16-bit integer in NR1 format   |
| n/a                               | :OPERRegister[:EVENT]? (see page 163)   | <n> ::= 16-bit integer in NR1 format   |
| :OVLenable <mask> (see page 165)  | :OVLenable? (see page 166)              | <p>&lt;mask&gt; ::= 16-bit integer in NR1 format as shown:</p> <pre> Bit Weight Input ----- 10  1024  Ext Trigger Fault  9   512  Channel 4 Fault  8   256  Channel 3 Fault  7   128  Channel 2 Fault  6    64  Channel 1 Fault  4    16  Ext Trigger OVL  3     8  Channel 4 OVL  2     4  Channel 3 OVL  1     2  Channel 2 OVL  0     1  Channel 1 OVL </pre> |
| n/a                               | :OVLRegister? (see page 167)            | <value> ::= integer in NR1 format. See OVLenable for <value>   |
| :PRINT [<options>] (see page 169) | n/a                                     | <p>&lt;options&gt; ::= [&lt;print option&gt;][, ..., &lt;print option&gt;]</p> <p>&lt;print option&gt; ::= {COLor   GRAYscale   PRINter0   BMP8bit   BMP   PNG   NOFactoRs   FACToRs}</p> <p>&lt;print option&gt; can be repeated up to 5 times.</p>   |
| :RUN (see page 170)               | n/a                                     | n/a  |
| n/a                               | :SERial (see page 171)                  | <return value> ::= unquoted string containing serial number  |
| :SINGle (see page 172)            | n/a                                     | n/a  |
| n/a                               | :STATus? <display> (see page 173)       | <p>{0   1}</p> <p>&lt;display&gt; ::= {CHANnel&lt;n&gt;   FUNCTION   MATH}</p> <p>&lt;n&gt; ::= 1-2 or 1-4 in NR1 format</p>   |
| :STOP (see page 174)              | n/a                                     | n/a  |

## 5 Commands by Subsystem

**Table 42** Root (:) Commands Summary (continued)

| Command  | Query                                 | Options and Query Returns  |
|--|---------------------------------------|--|
| n/a  | :TER? (see <a href="#">page 175</a> ) | {0   1}  |
| :VIEW <source> (see <a href="#">page 176</a> ) | n/a                                   | <source> ::= {CHANnel<n>   PMemory{0   1   2   3   4   5   6   7   8   9}   FUNCTION   MATH}<br><n> ::= 1-2 or 1-4 in NR1 format |

**Introduction to Root (:) Commands** Root level commands control many of the basic operations of the instrument. These commands are always recognized by the parser if they are prefixed with a colon, regardless of current command tree position. After executing a root-level command, the parser is positioned at the root of the command tree.

**:AER (Arm Event Register)**

**C** (see [page 750](#))

**Query Syntax** :AER?

The AER query reads the Arm Event Register. After the Arm Event Register is read, it is cleared. A "1" indicates the trigger system is in the armed state, ready to accept a trigger.

The Armed Event Register is summarized in the Wait Trig bit of the Operation Status Event Register. A Service Request can be generated when the Wait Trig bit transitions and the appropriate enable bits have been set in the Operation Status Enable Register (OPEE) and the Service Request Enable Register (SRE).

**Return Format** <value><NL>

<value> ::= {0 | 1}; an integer in NR1 format.

- See Also**
- ["Introduction to Root \(: \) Commands"](#) on page 138
  - [":OPEE \(Operation Status Enable Register\)"](#) on page 159
  - [":OPERRegister:CONDition \(Operation Status Condition Register\)"](#) on page 161
  - [":OPERRegister\[:EVENT\] \(Operation Status Event Register\)"](#) on page 163
  - ["\\*STB \(Read Status Byte\)"](#) on page 131
  - ["\\*SRE \(Service Request Enable\)"](#) on page 129

**:AUToscale**

**C** (see [page 750](#))

**Command Syntax** :AUToscale

```
:AUToscale [<source>[,...,<source>]]
```

```
<source> ::= CHANnel<n>
```

```
<n> ::= {1 | 2 | 3 | 4} for the four channel oscilloscope models
```

```
<n> ::= {1 | 2} for the two channel oscilloscope models
```

The <source> parameter may be repeated up to 5 times.

The :AUToscale command evaluates all input signals and sets the correct conditions to display the signals. This is the same as pressing the Autoscale key on the front panel.

If one or more sources are specified, those specified sources will be enabled and all others blanked. The autoscale channels mode (see [":AUToscale:CHANnels"](#) on page 143) is set to DISPLAYed channels. Then, the autoscale is performed.

When the :AUToscale command is sent, the following conditions are affected and actions are taken:

- Thresholds.
- Channels with activity around the trigger point are turned on, others are turned off.
- Channels are reordered on screen; analog channel 1 first, followed by the remaining analog channels.
- Delay is set to 0 seconds.
- Time/Div.

The :AUToscale command does not affect the following conditions:

- Label names.
- Trigger conditioning.

The :AUToscale command turns off the following items:

- Cursors.
- Measurements.
- Trace memories.
- Zoomed (delayed) time base mode.

For further information on :AUToscale, see the *User's Guide*.

- See Also**
- ["Introduction to Root \(: \) Commands"](#) on page 138
  - [":AUToscale:CHANnels"](#) on page 143

- [":AUToscale:AMODE"](#) on page 142

**Example Code**

```
' AUTOSCALE - This command evaluates all the input signals and sets  
' the correct conditions to display all of the active signals.  
myScope.WriteString ":AUTOSCALE" ' Same as pressing Autoscale key.
```

Example program from the start: ["VISA COM Example in Visual Basic"](#) on page 776

## :AUToscale:AMODE

**N** (see [page 750](#))

**Command Syntax** :AUToscale:AMODE <value>  
<value> ::= {NORMal | CURRent}

The :AUToscale:AMODE command specifies the acquisition mode that is set by subsequent :AUToscales.

- When NORMal is selected, an :AUToscale command sets the NORMal acquisition type and the RTIME (real-time) acquisition mode.
- When CURRent is selected, the current acquisition type and mode are kept on subsequent :AUToscales.

Use the :ACQUIRE:TYPE and :ACQUIRE:MODE commands to set the acquisition type and mode.

**Query Syntax** :AUToscale:AMODE?

The :AUToscale:AMODE? query returns the autoscale acquire mode setting.

**Return Format** <value><NL>  
<value> ::= {NORM | CURR}

- See Also**
- ["Introduction to Root \(: \) Commands"](#) on page 138
  - [":AUToscale"](#) on page 140
  - [":AUToscale:CHANnels"](#) on page 143
  - [":ACQUIRE:TYPE"](#) on page 191
  - [":ACQUIRE:MODE"](#) on page 183

**:AUToscale:CHANnels**

**N** (see [page 750](#))

**Command Syntax** :AUToscale:CHANnels <value>  
 <value> ::= {ALL | DISplayed}

The :AUToscale:CHANnels command specifies which channels will be displayed on subsequent :AUToscales.

- When ALL is selected, all channels that meet the requirements of :AUToscale will be displayed.
- When DISplayed is selected, only the channels that are turned on are autoscaled.

Use the :VIEW or :BLANK root commands to turn channels on or off.

**Query Syntax** :AUToscale:CHANnels?

The :AUToscale:CHANnels? query returns the autoscale channels setting.

**Return Format** <value><NL>  
 <value> ::= {ALL | DISP}

- See Also**
- "[Introduction to Root \(:\) Commands](#)" on page 138
  - "[:AUToscale](#)" on page 140
  - "[:AUToscale:AMODE](#)" on page 142
  - "[:VIEW](#)" on page 176
  - "[:BLANK](#)" on page 144

### :BLANK

**N** (see [page 750](#))

#### Command Syntax

:BLANK [<source>]

<source> ::= {CHANnel<n> | FUNCTION | MATH | SBUS}

<n> ::= {1 | 2 | 3 | 4} for the four channel oscilloscope models

<n> ::= {1 | 2} for the two channel oscilloscope models

The :BLANK command turns off (stops displaying) the specified channel, math function, or serial decode bus. The :BLANK command with no parameter turns off all sources.

#### NOTE

To turn on (start displaying) a channel, etc., use the :VIEW command. The DISPLAY commands, :CHANnel<n>:DISPlay, :FUNCTION:DISPlay, or :SBUS:DISPlay are the preferred method to turn on/off a channel, etc.

#### NOTE

MATH is an alias for FUNCTION.

- See Also**
- "[Introduction to Root \(: \) Commands](#)" on page 138
  - "[:CDISplay](#)" on page 145
  - "[:CHANnel<n>:DISPlay](#)" on page 208
  - "[:FUNCTION:DISPlay](#)" on page 247
  - "[:SBUS:DISPlay](#)" on page 401
  - "[:STATus](#)" on page 173
  - "[:VIEW](#)" on page 176

- Example Code**
- "[Example Code](#)" on page 176

## :CDISplay

**C** (see [page 750](#))

**Command Syntax** :CDISplay

The :CDISplay command clears the display and resets all associated measurements. If the oscilloscope is stopped, all currently displayed data is erased. If the oscilloscope is running, all the data in active channels and functions is erased; however, new data is displayed on the next acquisition.

- See Also**
- "[Introduction to Root \(:\)](#) Commands" on page 138
  - "[:DISplay:CLEar](#)" on page 225

**:DIGitize**

**C** (see [page 750](#))

**Command Syntax** :DIGitize [<source>[,...,<source>]]

<source> ::= {CHANnel<n> | FUNction | MATH | SBUS}

<n> ::= {1 | 2 | 3 | 4} for the four channel oscilloscope models

<n> ::= {1 | 2} for the two channel oscilloscope models

The <source> parameter may be repeated up to 5 times.

The :DIGitize command is a specialized RUN command. It causes the instrument to acquire waveforms according to the settings of the :ACQUIRE commands subsystem. When the acquisition is complete, the instrument is stopped. If no argument is given, :DIGitize acquires the channels currently displayed. If no channels are displayed, all channels are acquired.

**NOTE**

To halt a :DIGitize in progress, use the device clear command.

**NOTE**

MATH is an alias for FUNction.

- See Also**
- ["Introduction to Root \(: \) Commands"](#) on page 138
  - [":RUN"](#) on page 170
  - [":SINGLE"](#) on page 172
  - [":STOP"](#) on page 174
  - [":ACQUIRE Commands"](#) on page 177
  - [":WAVEFORM Commands"](#) on page 590

**Example Code**

```
' DIGITIZE - Used to acquire the waveform data for transfer over
' the interface. Sending this command causes an acquisition to
' take place with the resulting data being placed in the buffer.
'
' NOTE! The DIGITIZE command is highly recommended for triggering
' modes other than SINGLE. This ensures that sufficient data is
' available for measurement. If DIGITIZE is used with single mode,
' the completion criteria may never be met. The number of points
' gathered in Single mode is related to the sweep speed, memory
' depth, and maximum sample rate. For example, take an oscilloscope
' with a 1000-point memory, a sweep speed of 10 us/div (100 us
' total time across the screen), and a 20 MSa/s maximum sample rate.
' 1000 divided by 100 us equals 10 MSa/s. Because this number is
' less than or equal to the maximum sample rate, the full 1000 points
' will be digitized in a single acquisition. Now, use 1 us/div
' (10 us across the screen). 1000 divided by 10 us equals 100 MSa/s;
```

```
' because this is greater than the maximum sample rate by 5 times,  
' only 400 points (or 1/5 the points) can be gathered on a single  
' trigger. Keep in mind when the oscilloscope is running,  
' communication with the computer interrupts data acquisition.  
' Setting up the oscilloscope over the bus causes the data buffers  
' to be cleared and internal hardware to be reconfigured. If a  
' measurement is immediately requested, there may have not been  
' enough time for the data acquisition process to collect data, and  
' the results may not be accurate. An error value of 9.9E+37 may be  
' returned over the bus in this situation.  
'  
myScope.WriteString ":DIGITIZE CHAN1"
```

Example program from the start: ["VISA COM Example in Visual Basic"](#) on page 776

## :HWEenable (Hardware Event Enable Register)

**N** (see [page 750](#))

**Command Syntax** :HWEenable <mask>  
 <mask> ::= 16-bit integer

The :HWEenable command sets a mask in the Hardware Event Enable register. Set any of the following bits to "1" to enable bit 12 in the Operation Status Condition Register and potentially cause an SRQ (Service Request interrupt) to be generated.

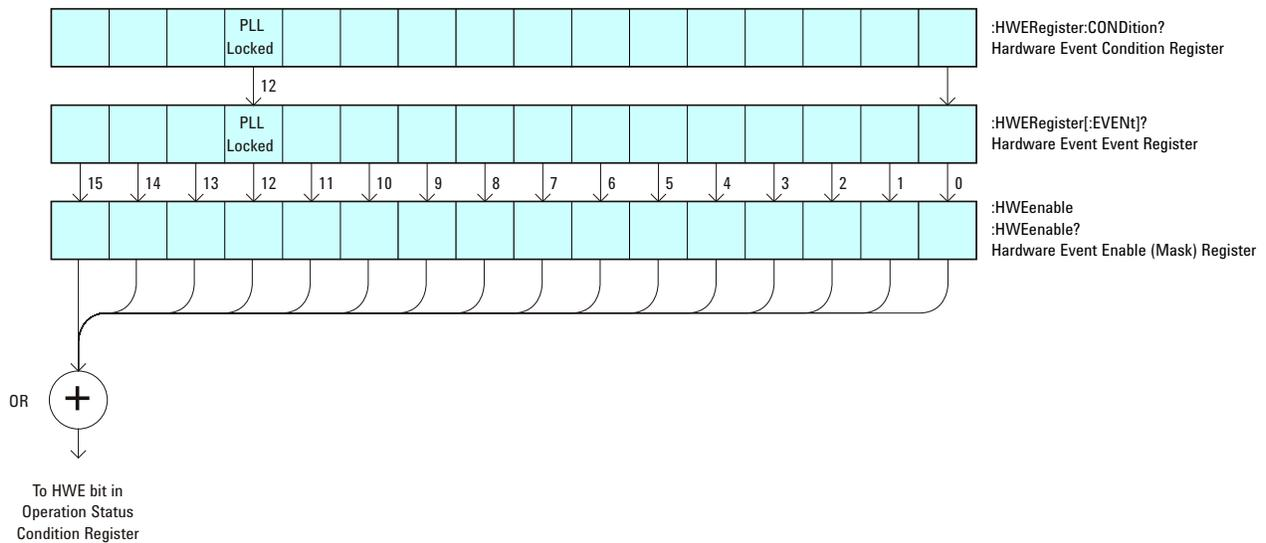

**Table 43** Hardware Event Enable Register (HWEenable)

| Bit   | Name       | Description | When Set (1 = High = True), Enables:                              |
|-------|------------|-------------|---|
| 15-13 | ---        | ---         | (Not used.)   |
| 12    | PLL Locked | PLL Locked  | This bit is for internal use and is not intended for general use. |
| 11-0  | ---        | ---         | (Not used.)   |

**Query Syntax** :HWEenable?

The :HWEenable? query returns the current value contained in the Hardware Event Enable register as an integer number.

**Return Format** <value><NL>  
 <value> ::= integer in NR1 format.

**See Also** • ["Introduction to Root \(: \) Commands"](#) on page 138

- ":AER (Arm Event Register)" on page 139
- ":CHANnel<n>:PROTection" on page 218
- ":EXTErnal:PROTection" on page 240
- ":OPERegister[:EVENT] (Operation Status Event Register)" on page 163
- ":OVLenable (Overload Event Enable Register)" on page 165
- ":OVLRegister (Overload Event Register)" on page 167
- "\*\*STB (Read Status Byte)" on page 131
- "\*\*SRE (Service Request Enable)" on page 129

## :HWERegister:CONDition (Hardware Event Condition Register)

**N** (see page 750)

**Query Syntax** :HWERegister:CONDition?

The :HWERegister:CONDition? query returns the integer value contained in the Hardware Event Condition Register.

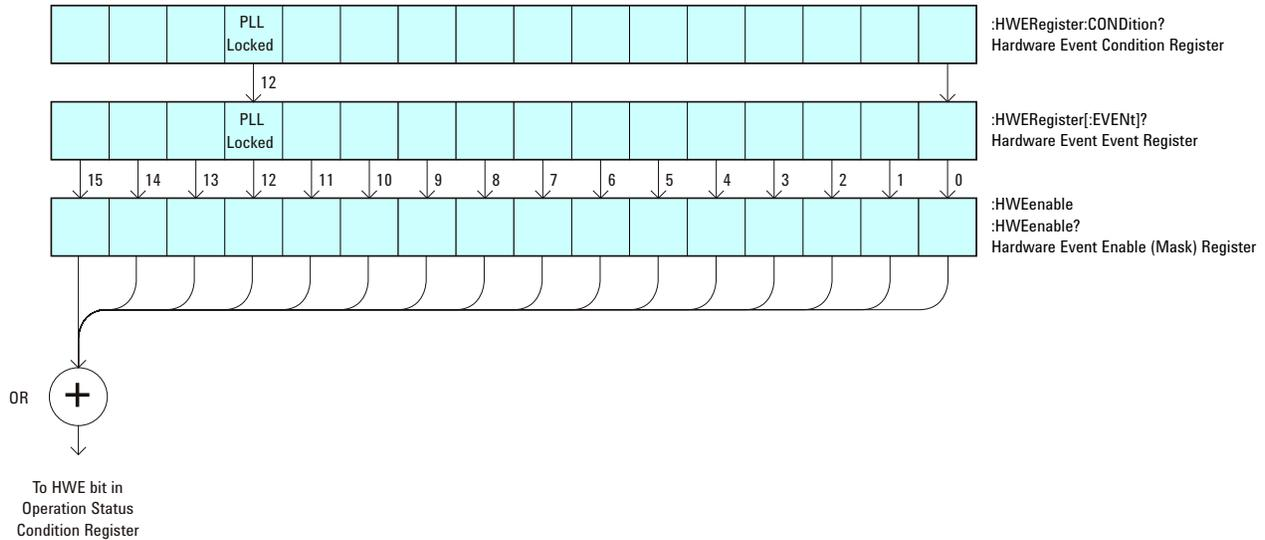

**Table 44** Hardware Event Condition Register

| Bit   | Name       | Description | When Set (1 = High = True), Indicates:                            |
|-------|------------|-------------|---|
| 15-13 | ---        | ---         | (Not used.)   |
| 12    | PLL Locked | PLL Locked  | This bit is for internal use and is not intended for general use. |
| 11-0  | ---        | ---         | (Not used.)   |

**Return Format** <value><NL>

<value> ::= integer in NR1 format.

- See Also**
- "Introduction to Root (: ) Commands" on page 138
  - ":CHANnel<n>:PROTection" on page 218
  - ":EXTeRnal:PROTection" on page 240
  - ":OPEE (Operation Status Enable Register)" on page 159
  - ":OPERegister[:EVENT] (Operation Status Event Register)" on page 163
  - ":OVLenable (Overload Event Enable Register)" on page 165

- ":OVLRegister (Overload Event Register)" on page 167
- "\*STB (Read Status Byte)" on page 131
- "\*SRE (Service Request Enable)" on page 129

## :HWERegister[:EVENT] (Hardware Event Event Register)

**N** (see page 750)

**Query Syntax** :HWERegister[:EVENT]?

The :HWERegister[:EVENT]? query returns the integer value contained in the Hardware Event Event Register.

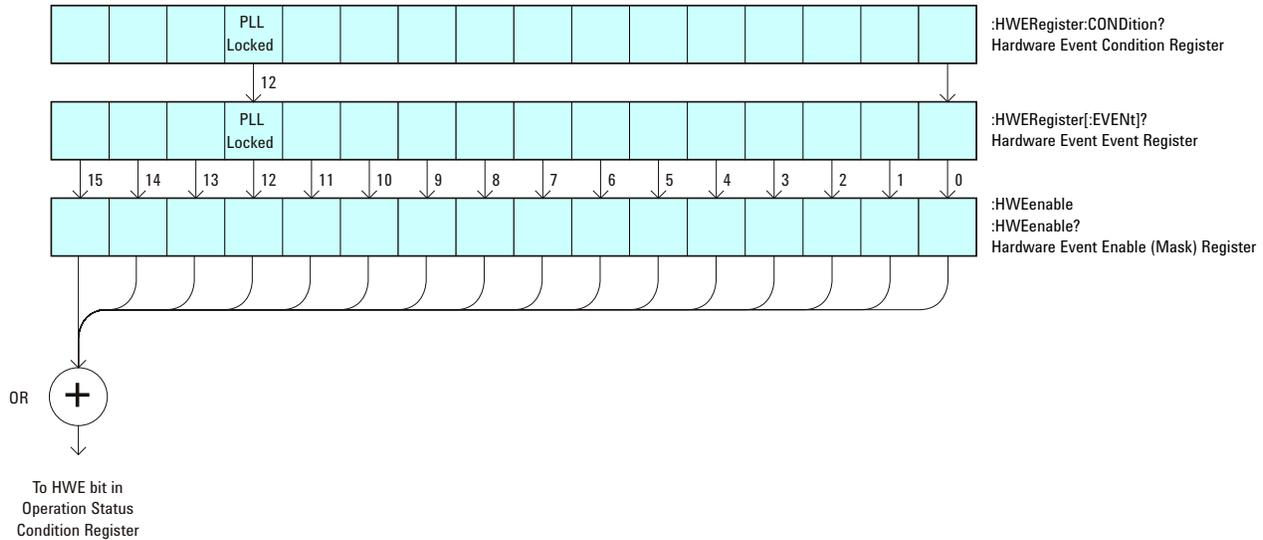

**Table 45** Hardware Event Event Register

| Bit   | Name       | Description | When Set (1 = High = True), Indicates:                            |
|-------|------------|-------------|---|
| 15-13 | ---        | ---         | (Not used.)   |
| 12    | PLL Locked | PLL Locked  | This bit is for internal use and is not intended for general use. |
| 11-0  | ---        | ---         | (Not used.)   |

**Return Format** <value><NL>

<value> ::= integer in NR1 format.

- See Also**
- "Introduction to Root (: ) Commands" on page 138
  - ":CHANnel<n>:PROTection" on page 218
  - ":EXTeRnal:PROTection" on page 240
  - ":OPEE (Operation Status Enable Register)" on page 159
  - ":OPERegister:CONDition (Operation Status Condition Register)" on page 161
  - ":OVLenable (Overload Event Enable Register)" on page 165

- ":OVLRegister (Overload Event Register)" on page 167
- "\*STB (Read Status Byte)" on page 131
- "\*SRE (Service Request Enable)" on page 129

### :MERGe

**N** (see [page 750](#))

**Command Syntax** :MERGe <pixel memory>

```
<pixel memory> ::= {PMEemory0 | PMEemory1 | PMEemory2 | PMEemory3  
                   | PMEemory4 | PMEemory5 | PMEemory6 | PMEemory7  
                   | PMEemory8 | PMEemory9}
```

The :MERGe command stores the contents of the active display in the specified pixel memory. The previous contents of the pixel memory are overwritten. The pixel memories are PMEemory0 through PMEemory9. This command is similar to the function of the "Save To: INTERN\_<n>" key in the Save/Recall menu.

- See Also**
- ["Introduction to Root \(: \) Commands"](#) on page 138
  - ["\\*SAV \(Save\)"](#) on page 128
  - ["\\*RCL \(Recall\)"](#) on page 124
  - [":VIEW"](#) on page 176
  - [":BLANK"](#) on page 144

## :MTEenable (Mask Test Event Enable Register)

**N** (see page 750)

**Command Syntax** :MTEenable <mask>  
 <mask> ::= 16-bit integer

The :MTEenable command sets a mask in the Mask Test Event Enable register. Set any of the following bits to "1" to enable bit 9 in the Operation Status Condition Register and potentially cause an SRQ (Service Request interrupt) to be generated.

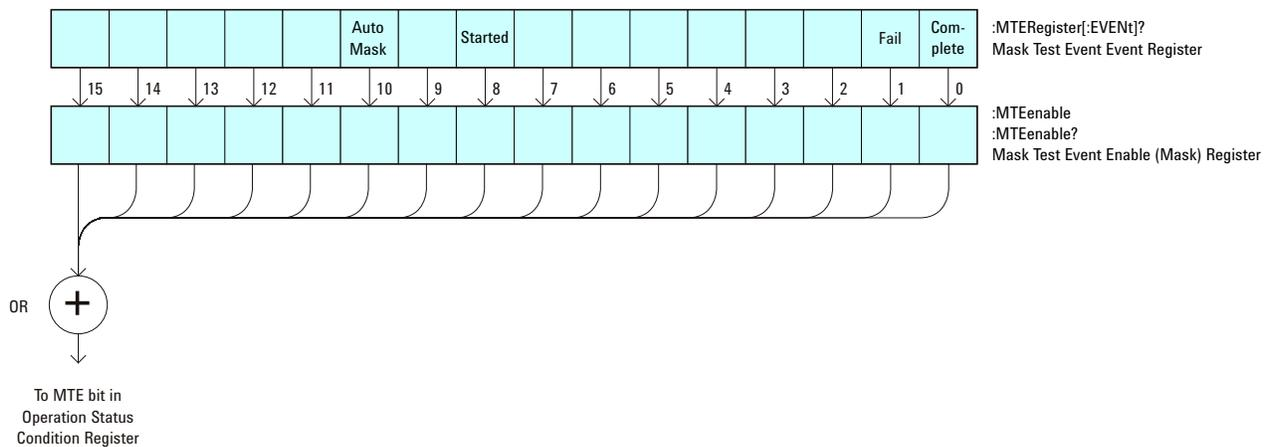

**Table 46** Mask Test Event Enable Register (MTEenable)

| Bit   | Name      | Description          | When Set (1 = High = True), Enables: |
|-------|-----------|----------------------|--------------------------------------|
| 15-11 | ---       | ---                  | (Not used.)                          |
| 10    | Auto Mask | Auto Mask Created    | Auto mask creation completed.        |
| 9     | ---       | ---                  | (Not used.)                          |
| 8     | Started   | Mask Testing Started | Mask testing started.                |
| 7-2   | ---       | ---                  | (Not used.)                          |
| 1     | Fail      | Mask Test Fail       | Mask test failed.                    |
| 0     | Complete  | Mask Test Complete   | Mask test is complete.               |

**Query Syntax** :MTEenable?

The :MTEenable? query returns the current value contained in the Mask Test Event Enable register as an integer number.

## 5 Commands by Subsystem

**Return Format** <value><NL>

<value> ::= integer in NR1 format.

- See Also**
- ["Introduction to Root \(: \) Commands"](#) on page 138
  - [":AER \(Arm Event Register\)"](#) on page 139
  - [":CHANnel<n>:PROTection"](#) on page 218
  - [":EXTernal:PROTection"](#) on page 240
  - [":OPERegister\[:EVENT\] \(Operation Status Event Register\)"](#) on page 163
  - [":OVLenable \(Overload Event Enable Register\)"](#) on page 165
  - [":OVLRegister \(Overload Event Register\)"](#) on page 167
  - ["\\*STB \(Read Status Byte\)"](#) on page 131
  - ["\\*SRE \(Service Request Enable\)"](#) on page 129

## :MTERegister[:EVENT] (Mask Test Event Event Register)

**N** (see page 750)

**Query Syntax** :MTERegister[:EVENT]?

The :MTERegister[:EVENT]? query returns the integer value contained in the Mask Test Event Event Register and clears the register.

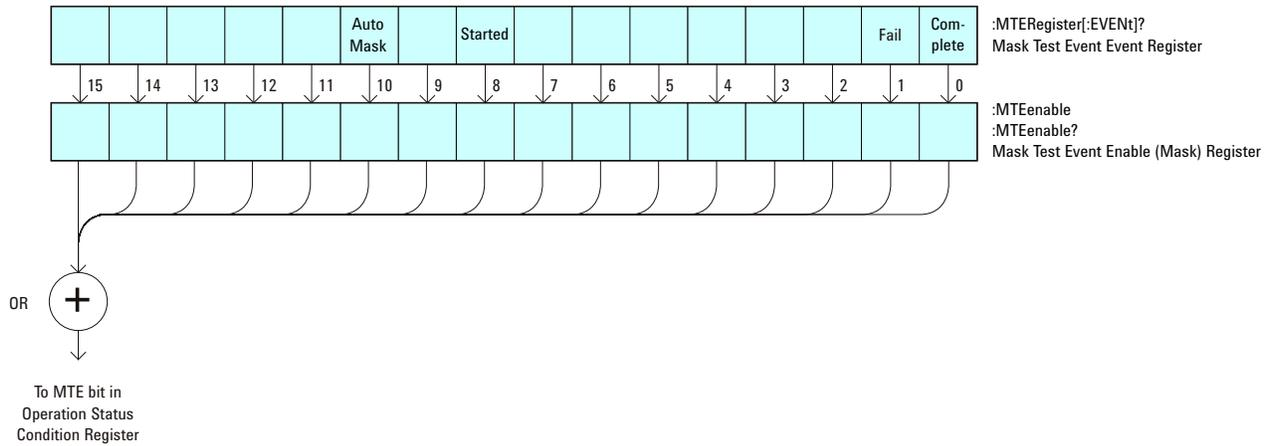

**Table 47** Mask Test Event Event Register

| Bit   | Name      | Description          | When Set (1 = High = True), Indicates: |
|-------|-----------|----------------------|--|
| 15-11 | ---       | ---                  | (Not used.)                            |
| 10    | Auto Mask | Auto Mask Created    | Auto mask creation completed.          |
| 9     | ---       | ---                  | (Not used.)                            |
| 8     | Started   | Mask Testing Started | Mask testing started.                  |
| 7-2   | ---       | ---                  | (Not used.)                            |
| 1     | Fail      | Mask Test Fail       | The mask test failed.                  |
| 0     | Complete  | Mask Test Complete   | The mask test is complete.             |

**Return Format** <value><NL>  
 <value> ::= integer in NR1 format.

- See Also**
- "Introduction to Root (: ) Commands" on page 138
  - ":CHANnel<n>:PROTection" on page 218
  - ":EXTernal:PROTection" on page 240

## 5 Commands by Subsystem

- ":OPEE (Operation Status Enable Register)" on page 159
- ":OPERegister:CONDition (Operation Status Condition Register)" on page 161
- ":OVLenable (Overload Event Enable Register)" on page 165
- ":OVLRegister (Overload Event Register)" on page 167
- "\*STB (Read Status Byte)" on page 131
- "\*SRE (Service Request Enable)" on page 129

## :OPEE (Operation Status Enable Register)

**C** (see page 750)

**Command Syntax** :OPEE <mask>  
 <mask> ::= 16-bit integer

The :OPEE command sets a mask in the Operation Status Enable register. Set any of the following bits to "1" to enable bit 7 in the Status Byte Register and potentially cause an SRQ (Service Request interrupt) to be generated.

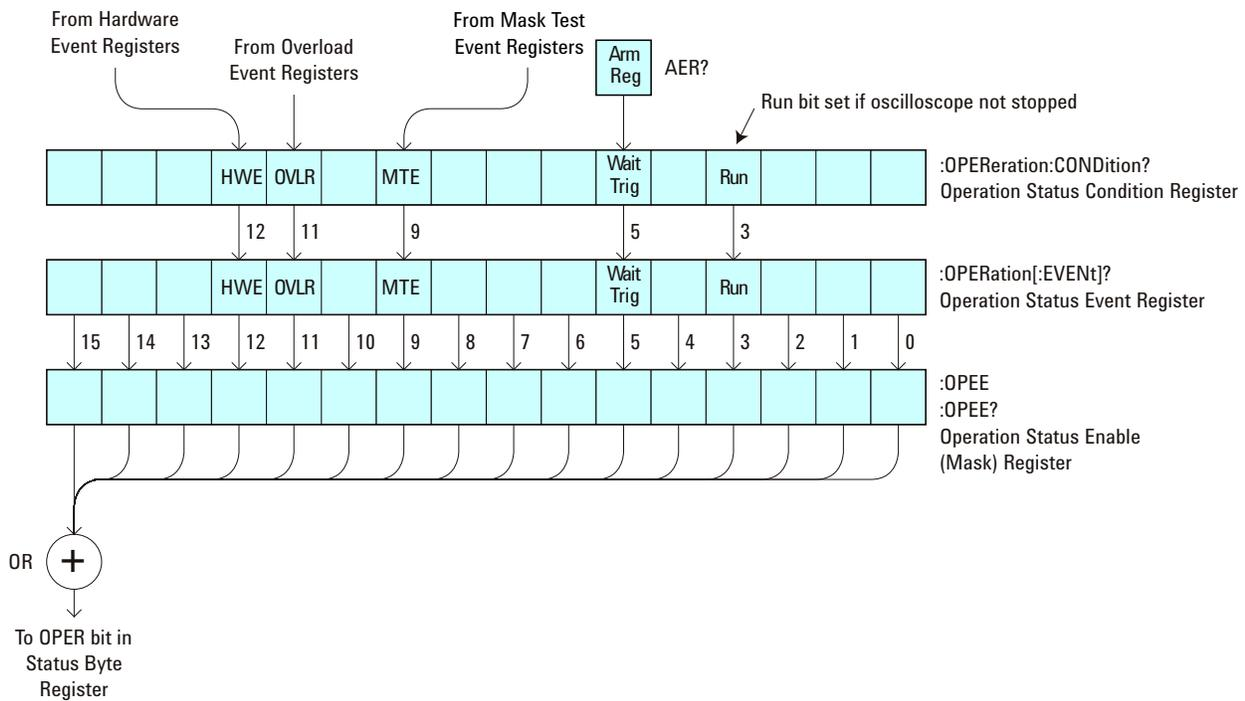

**Table 48** Operation Status Enable Register (OPEE)

| Bit   | Name | Description     | When Set (1 = High = True), Enables:  |
|-------|------|-----------------|---------------------------------------|
| 15-13 | ---  | ---             | (Not used.)                           |
| 12    | HWE  | Hardware Event  | Event when hardware event occurs.     |
| 11    | OVL  | Overload        | Event when 50Ω input overload occurs. |
| 10    | ---  | ---             | (Not used.)                           |
| 9     | MTE  | Mask Test Event | Event when mask test event occurs.    |
| 8-6   | ---  | ---             | (Not used.)                           |

**Table 48** Operation Status Enable Register (OPEE) (continued)

| Bit | Name      | Description | When Set (1 = High = True), Enables:                  |
|-----|-----------|-------------|---|
| 5   | Wait Trig | Wait Trig   | Event when the trigger is armed.                      |
| 4   | ---       | ---         | (Not used.)   |
| 3   | Run       | Running     | Event when the oscilloscope is running (not stopped). |
| 2-0 | ---       | ---         | (Not used.)   |

**Query Syntax** :OPEE?

The :OPEE? query returns the current value contained in the Operation Status Enable register as an integer number.

**Return Format** <value><NL>

<value> ::= integer in NR1 format.

- See Also**
- ["Introduction to Root \(: \) Commands"](#) on page 138
  - [":AER \(Arm Event Register\)"](#) on page 139
  - [":CHANnel<n>:PROTection"](#) on page 218
  - [":EXTeRnal:PROTection"](#) on page 240
  - [":OPERegister\[:EVENT\] \(Operation Status Event Register\)"](#) on page 163
  - [":OVLenable \(Overload Event Enable Register\)"](#) on page 165
  - [":OVLRegister \(Overload Event Register\)"](#) on page 167
  - ["\\*STB \(Read Status Byte\)"](#) on page 131
  - ["\\*SRE \(Service Request Enable\)"](#) on page 129

## :OPERRegister:CONDition (Operation Status Condition Register)

**C** (see page 750)

**Query Syntax** :OPERRegister:CONDition?

The :OPERRegister:CONDition? query returns the integer value contained in the Operation Status Condition Register.

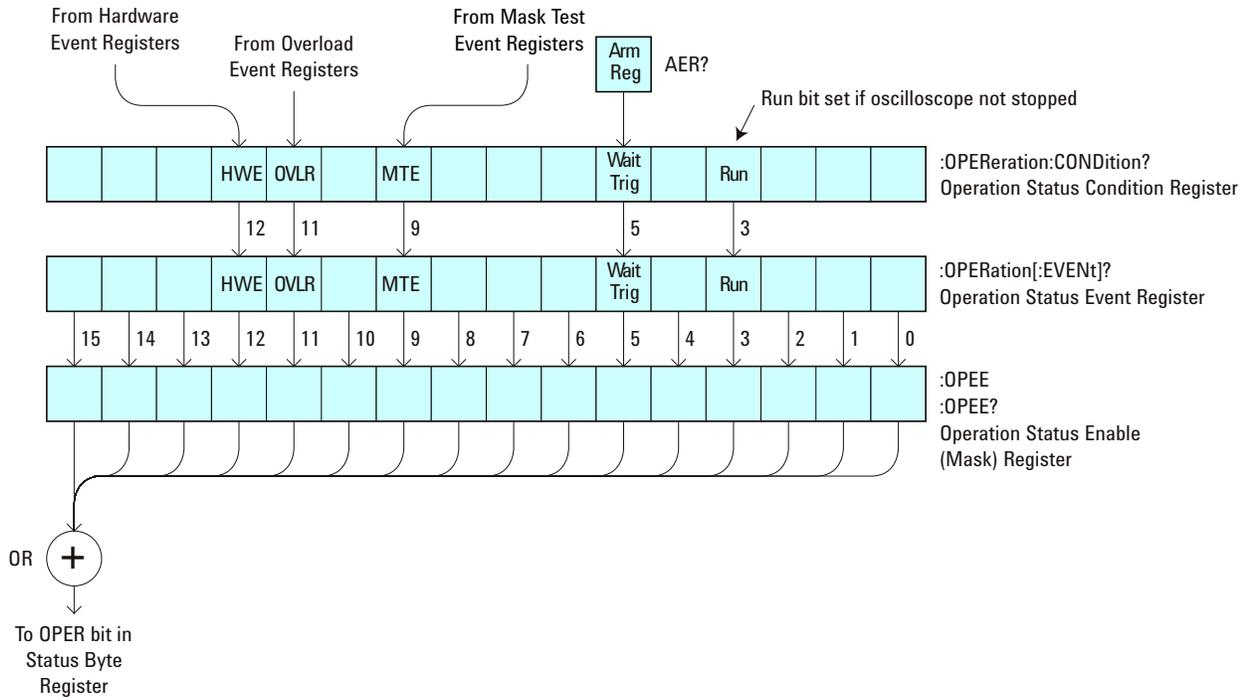

**Table 49** Operation Status Condition Register

| Bit   | Name      | Description     | When Set (1 = High = True), Indicates:                                |
|-------|-----------|-----------------|---|
| 15-13 | ---       | ---             | (Not used.)   |
| 12    | HWE       | Hardware Event  | A hardware event has occurred..                                       |
| 11    | OVLRL     | Overload        | A 50Ω input overload has occurred.                                    |
| 10    | ---       | ---             | (Not used.)   |
| 9     | MTE       | Mask Test Event | A mask test event has occurred.                                       |
| 8-6   | ---       | ---             | (Not used.)   |
| 5     | Wait Trig | Wait Trig       | The trigger is armed (set by the Trigger Armed Event Register (TER)). |
| 4     | ---       | ---             | (Not used.)   |

**Table 49** Operation Status Condition Register (continued)

| Bit | Name | Description | When Set (1 = High = True), Indicates:     |
|-----|------|-------------|--|
| 3   | Run  | Running     | The oscilloscope is running (not stopped). |
| 2-0 | ---  | ---         | (Not used.)                                |

**Return Format** <value><NL>

<value> ::= integer in NR1 format.

- See Also**
- ["Introduction to Root \(: \) Commands"](#) on page 138
  - [":CHANnel<n>:PROTection"](#) on page 218
  - [":EXTeRnal:PROTection"](#) on page 240
  - [":OPEE \(Operation Status Enable Register\)"](#) on page 159
  - [":OPERegister\[:EVENT\] \(Operation Status Event Register\)"](#) on page 163
  - [":OVLenable \(Overload Event Enable Register\)"](#) on page 165
  - [":OVLRegister \(Overload Event Register\)"](#) on page 167
  - ["\\*STB \(Read Status Byte\)"](#) on page 131
  - ["\\*SRE \(Service Request Enable\)"](#) on page 129
  - [":HWERegister\[:EVENT\] \(Hardware Event Event Register\)"](#) on page 152
  - [":HWEenable \(Hardware Event Enable Register\)"](#) on page 148
  - [":MTERegister\[:EVENT\] \(Mask Test Event Event Register\)"](#) on page 157
  - [":MTEenable \(Mask Test Event Enable Register\)"](#) on page 155

## :OPERRegister[:EVENT] (Operation Status Event Register)

**C** (see page 750)

**Query Syntax** :OPERRegister[:EVENT]?

The :OPERRegister[:EVENT]? query returns the integer value contained in the Operation Status Event Register.

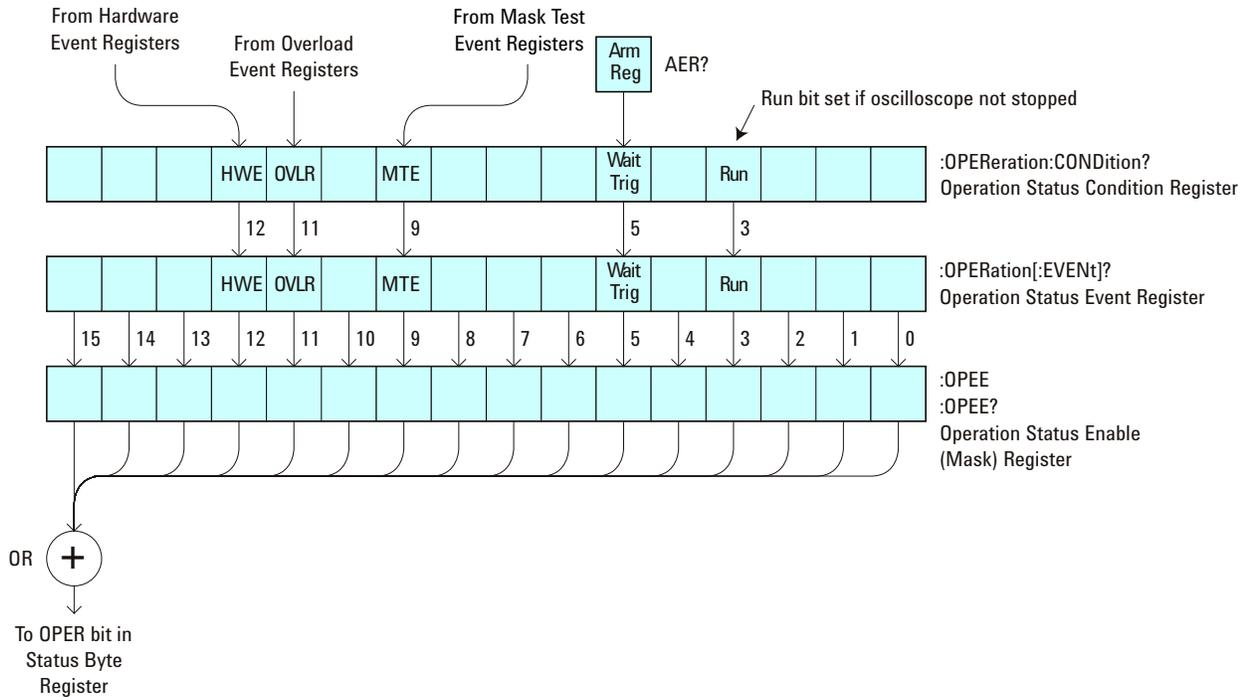

**Table 50** Operation Status Event Register

| Bit   | Name      | Description     | When Set (1 = High = True), Indicates:                                |
|-------|-----------|-----------------|---|
| 15-13 | ---       | ---             | (Not used.)   |
| 12    | HWE       | Hardware Event  | A hardware event has occurred.  |
| 11    | OVL       | Overload        | A 50Ω input overload has occurred.                                    |
| 10    | ---       | ---             | (Not used.)   |
| 9     | MTE       | Mask Test Event | A mask test event has occurred.                                       |
| 8-6   | ---       | ---             | (Not used.)   |
| 5     | Wait Trig | Wait Trig       | The trigger is armed (set by the Trigger Armed Event Register (TER)). |
| 4     | ---       | ---             | (Not used.)   |

**Table 50** Operation Status Event Register (continued)

| Bit | Name | Description | When Set (1 = High = True), Indicates:                                    |
|-----|------|-------------|---|
| 3   | Run  | Running     | The oscilloscope has gone from a stop state to a single or running state. |
| 2-0 | ---  | ---         | (Not used.)   |

**Return Format** <value><NL>

<value> ::= integer in NR1 format.

- See Also**
- ["Introduction to Root \(: \) Commands"](#) on page 138
  - [":CHANnel<n>:PROTection"](#) on page 218
  - [":EXTeRnal:PROTection"](#) on page 240
  - [":OPEE \(Operation Status Enable Register\)"](#) on page 159
  - [":OPERegister:CONDition \(Operation Status Condition Register\)"](#) on page 161
  - [":OVLenable \(Overload Event Enable Register\)"](#) on page 165
  - [":OVLRegister \(Overload Event Register\)"](#) on page 167
  - ["\\*STB \(Read Status Byte\)"](#) on page 131
  - ["\\*SRE \(Service Request Enable\)"](#) on page 129
  - [":HWERegister\[:EVENT\] \(Hardware Event Event Register\)"](#) on page 152
  - [":HWEenable \(Hardware Event Enable Register\)"](#) on page 148
  - [":MTERegister\[:EVENT\] \(Mask Test Event Event Register\)"](#) on page 157
  - [":MTEenable \(Mask Test Event Enable Register\)"](#) on page 155

## :OVLenable (Overload Event Enable Register)

**C** (see page 750)

**Command Syntax** :OVLenable <enable\_mask>  
 <enable\_mask> ::= 16-bit integer

The overload enable mask is an integer representing an input as described in the following table.

The :OVLenable command sets the mask in the Overload Event Enable Register and enables the reporting of the Overload Event Register. If an overvoltage is sensed on a 50Ω input, the input will automatically switch to 1 MΩ input impedance. If enabled, such an event will set bit 11 in the Operation Status Register.

**NOTE**

You can set analog channel input impedance to 50Ω. If there are only two analog channels, you can also set external trigger input impedance to 50Ω.

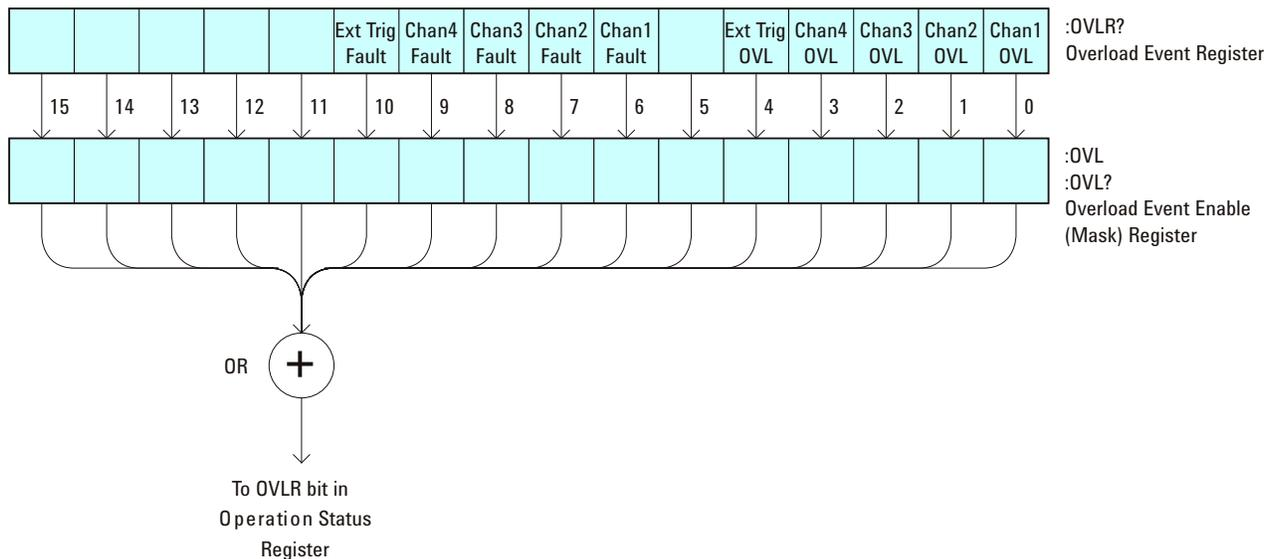

**Table 51** Overload Event Enable Register (OVL)

| Bit   | Description            | When Set (1 = High = True), Enables:               |
|-------|------------------------|--|
| 15-11 | ---                    | (Not used.)  |
| 10    | External Trigger Fault | Event when fault occurs on External Trigger input. |
| 9     | Channel 4 Fault        | Event when fault occurs on Channel 4 input.        |
| 8     | Channel 3 Fault        | Event when fault occurs on Channel 3 input.        |

**Table 51** Overload Event Enable Register (OVL) (continued)

| Bit | Description          | When Set (1 = High = True), Enables:                  |
|-----|----------------------|---|
| 7   | Channel 2 Fault      | Event when fault occurs on Channel 2 input.           |
| 6   | Channel 1 Fault      | Event when fault occurs on Channel 1 input.           |
| 5   | ---                  | (Not used.)   |
| 4   | External Trigger OVL | Event when overload occurs on External Trigger input. |
| 3   | Channel 4 OVL        | Event when overload occurs on Channel 4 input.        |
| 2   | Channel 3 OVL        | Event when overload occurs on Channel 3 input.        |
| 1   | Channel 2 OVL        | Event when overload occurs on Channel 2 input.        |
| 0   | Channel 1 OVL        | Event when overload occurs on Channel 1 input.        |

**Query Syntax** :OVLenable?

The :OVLenable query returns the current enable mask value contained in the Overload Event Enable Register.

**Return Format** <enable\_mask><NL>

<enable\_mask> ::= integer in NR1 format.

- See Also**
- "[Introduction to Root \(:\)](#) Commands" on page 138
  - "[:CHANnel<n>:PROTection](#)" on page 218
  - "[:EXTeRnal:PROTection](#)" on page 240
  - "[:OPEE \(Operation Status Enable Register\)](#)" on page 159
  - "[:OPERegister:CONDition \(Operation Status Condition Register\)](#)" on page 161
  - "[:OPERegister\[:EVENT\] \(Operation Status Event Register\)](#)" on page 163
  - "[:OVLRegister \(Overload Event Register\)](#)" on page 167
  - "[\\*STB \(Read Status Byte\)](#)" on page 131
  - "[\\*SRE \(Service Request Enable\)](#)" on page 129

## :OVLRegister (Overload Event Register)

**C** (see page 750)

**Query Syntax** :OVLRegister?

The :OVLRegister query returns the overload protection value stored in the Overload Event Register (OVL). If an overvoltage is sensed on a 50Ω input, the input will automatically switch to 1 MΩ input impedance. A "1" indicates an overload has occurred.

**NOTE**

You can set analog channel input impedance to 50Ω. If there are only two analog channels, you can also set external trigger input impedance to 50Ω.

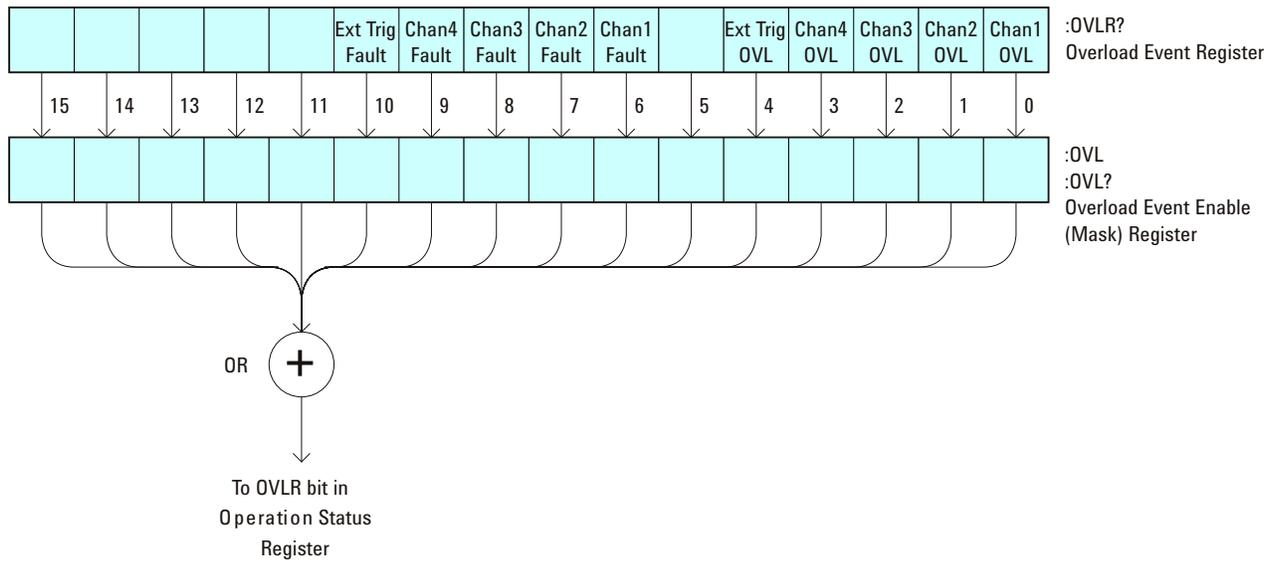

**Table 52** Overload Event Register (OVL)

| Bit   | Description            | When Set (1 = High = True), Indicates:        |
|-------|------------------------|---|
| 15-11 | ---                    | (Not used.)                                   |
| 10    | External Trigger Fault | Fault has occurred on External Trigger input. |
| 9     | Channel 4 Fault        | Fault has occurred on Channel 4 input.        |
| 8     | Channel 3 Fault        | Fault has occurred on Channel 3 input.        |
| 7     | Channel 2 Fault        | Fault has occurred on Channel 2 input.        |
| 6     | Channel 1 Fault        | Fault has occurred on Channel 1 input.        |
| 5     | ---                    | (Not used.)                                   |

**Table 52** Overload Event Register (OVLr) (continued)

| Bit | Description          | When Set (1 = High = True), Indicates:           |
|-----|----------------------|--|
| 4   | External Trigger OVL | Overload has occurred on External Trigger input. |
| 3   | Channel 4 OVL        | Overload has occurred on Channel 4 input.        |
| 2   | Channel 3 OVL        | Overload has occurred on Channel 3 input.        |
| 1   | Channel 2 OVL        | Overload has occurred on Channel 2 input.        |
| 0   | Channel 1 OVL        | Overload has occurred on Channel 1 input.        |

**Return Format** <value><NL>

<value> ::= integer in NR1 format.

- See Also**
- ["Introduction to Root \(: \) Commands"](#) on page 138
  - [":CHANnel<n>:PROTection"](#) on page 218
  - [":EXTernal:PROTection"](#) on page 240
  - [":OPEE \(Operation Status Enable Register\)"](#) on page 159
  - [":OVLenable \(Overload Event Enable Register\)"](#) on page 165
  - ["\\*STB \(Read Status Byte\)"](#) on page 131
  - ["\\*SRE \(Service Request Enable\)"](#) on page 129

**:PRINT**

**C** (see [page 750](#))

**Command Syntax**

```
:PRINT [<options>]
```

```
<options> ::= [<print option>][,...,<print option>]
```

```
<print option> ::= {COLor | GRAYscale | PRINter0 | BMP8bit | BMP | PNG  
                  | NOFactors | FACTors}
```

The <print option> parameter may be repeated up to 5 times.

The PRINT command formats the output according to the currently selected format (device). If an option is not specified, the value selected in the Print Config menu is used. Refer to "[:HARDcopy:FORMat](#)" on page 675 for more information.

- See Also**
- "[Introduction to Root \(:\)](#) Commands" on page 138
  - "[Introduction to :HARDcopy Commands](#)" on page 261
  - "[:HARDcopy:FORMat](#)" on page 675
  - "[:HARDcopy:FACTors](#)" on page 264
  - "[:HARDcopy:GRAYscale](#)" on page 676
  - "[:DISPlay:DATA](#)" on page 226

### :RUN

**C** (see [page 750](#))

**Command Syntax** :RUN

The :RUN command starts repetitive acquisitions. This is the same as pressing the Run key on the front panel.

- See Also**
- ["Introduction to Root \(: \) Commands"](#) on page 138
  - [":SINGLE"](#) on page 172
  - [":STOP"](#) on page 174

**Example Code**

```
' RUN_STOP - (not executed in this example)
' - RUN starts the data acquisition for the active waveform display.
' - STOP stops the data acquisition and turns off AUTOSTORE.
' myScope.WriteString ":RUN"      ' Start data acquisition.
' myScope.WriteString ":STOP"    ' Stop the data acquisition.
```

Example program from the start: ["VISA COM Example in Visual Basic"](#) on page 776

**:SERial**

**N** (see [page 750](#))

**Query Syntax** :SERial?

The :SERial? query returns the serial number of the instrument.

**Return Format:** Unquoted string<NL>

**See Also** • ["Introduction to Root \(: \) Commands"](#) on page 138

### :SINGle

**C** (see [page 750](#))

**Command Syntax** :SINGle

The :SINGle command causes the instrument to acquire a single trigger of data. This is the same as pressing the Single key on the front panel.

- See Also**
- ["Introduction to Root \(:\) Commands"](#) on page 138
  - [":RUN"](#) on page 170
  - [":STOP"](#) on page 174

**:STATus**

**N** (see [page 750](#))

**Query Syntax**

```
:STATus? <source>
```

```
<source> ::= {CHANnel<n> | FUNCTION | MATH | SBUS}
```

```
<n> ::= {1 | 2 | 3 | 4} for the four channel oscilloscope models
```

```
<n> ::= {1 | 2} for the two channel oscilloscope models
```

The :STATus? query reports whether the channel, function, or serial decode bus specified by <source> is displayed.

**NOTE**

MATH is an alias for FUNCTION.

**Return Format**

```
<value><NL>
```

```
<value> ::= {1 | 0}
```

**See Also**

- "[Introduction to Root \(:\)](#) Commands" on page 138
- "[:BLANK](#)" on page 144
- "[:CHANnel<n>:DISPlay](#)" on page 208
- "[:FUNCTION:DISPlay](#)" on page 247
- "[:SBUS:DISPlay](#)" on page 401
- "[:VIEW](#)" on page 176

### **:STOP**

**C** (see [page 750](#))

**Command Syntax** :STOP

The :STOP command stops the acquisition. This is the same as pressing the Stop key on the front panel.

- See Also**
- ["Introduction to Root \(:\) Commands"](#) on page 138
  - [":RUN"](#) on page 170
  - [":SINGLE"](#) on page 172

- Example Code**
- ["Example Code"](#) on page 170

**:TER (Trigger Event Register)**

**C** (see [page 750](#))

**Query Syntax** :TER?

The :TER? query reads the Trigger Event Register. After the Trigger Event Register is read, it is cleared. A one indicates a trigger has occurred. A zero indicates a trigger has not occurred.

The Trigger Event Register is summarized in the TRG bit of the Status Byte Register (STB). A Service Request (SRQ) can be generated when the TRG bit of the Status Byte transitions, and the TRG bit is set in the Service Request Enable register. The Trigger Event Register must be cleared each time you want a new service request to be generated.

**Return Format** <value><NL>

<value> ::= {1 | 0}; a 16-bit integer in NR1 format.

- See Also**
- ["Introduction to Root \(: \) Commands"](#) on page 138
  - ["\\*SRE \(Service Request Enable\)"](#) on page 129
  - ["\\*STB \(Read Status Byte\)"](#) on page 131

**:VIEW**

**N** (see [page 750](#))

**Command Syntax**

```
:VIEW <source>
```

```
<source> ::= {CHANnel<n> | PMemory0,...,PMemory9 | FUNCTION | MATH  
            | SBUS}
```

```
<n> ::= {1 | 2 | 3 | 4} for the four channel oscilloscope models
```

```
<n> ::= {1 | 2} for the two channel oscilloscope models
```

The :VIEW command turns on the specified channel, function, trace memory, or serial decode bus.

**NOTE**

MATH is an alias for FUNCTION.

- See Also**
- ["Introduction to Root \(: \) Commands"](#) on page 138
  - [":BLANK"](#) on page 144
  - [":CHANnel<n>:DISPlay"](#) on page 208
  - [":FUNCTION:DISPlay"](#) on page 247
  - [":SBUS:DISPlay"](#) on page 401
  - [":STATus"](#) on page 173

**Example Code**

```
' VIEW_BLANK - (not executed in this example)
' - VIEW turns on (starts displaying) a channel or pixel memory.
' - BLANK turns off (stops displaying) a channel or pixel memory.
' myScope.WriteString ":BLANK CHANNEL1" ' Turn channel 1 off.
' myScope.WriteString ":VIEW CHANNEL1" ' Turn channel 1 on.
```

Example program from the start: ["VISA COM Example in Visual Basic"](#) on page 776

## :ACQUIRE Commands

Set the parameters for acquiring and storing data. See "[Introduction to :ACQUIRE Commands](#)" on page 177.

**Table 53** :ACQUIRE Commands Summary

| Command  | Query   | Options and Query Returns   |
|--|---|---|
| n/a  | :ACQUIRE:AAlias? (see <a href="#">page 179</a> )          | {1   0}   |
| :ACQUIRE:COMPLETE<br><complete> (see <a href="#">page 180</a> )  | :ACQUIRE:COMPLETE?<br>(see <a href="#">page 180</a> )     | <complete> ::= 100; an integer in NR1 format  |
| :ACQUIRE:COUNT<br><count> (see <a href="#">page 181</a> )        | :ACQUIRE:COUNT? (see <a href="#">page 181</a> )           | <count> ::= an integer from 2 to 65536 in NR1 format                                |
| :ACQUIRE:DAALIAS<br><mode> (see <a href="#">page 182</a> )       | :ACQUIRE:DAALIAS?<br>(see <a href="#">page 182</a> )      | <mode> ::= {DISABLE   AUTO}   |
| :ACQUIRE:MODE <mode><br>(see <a href="#">page 183</a> )          | :ACQUIRE:MODE? (see <a href="#">page 183</a> )            | <mode> ::= {RTIME   ETIME   SEGMENTED}  |
| n/a  | :ACQUIRE:POINTS? (see <a href="#">page 184</a> )          | <# points> ::= an integer in NR1 format   |
| :ACQUIRE:SEGMENTED:ANALYZE (see <a href="#">page 185</a> )       | n/a   | n/a (with Option SGM)   |
| :ACQUIRE:SEGMENTED:COUNT <count> (see <a href="#">page 186</a> ) | :ACQUIRE:SEGMENTED:COUNT? (see <a href="#">page 186</a> ) | <count> ::= an integer from 2 to 2000 (w/8M memory) in NR1 format (with Option SGM) |
| :ACQUIRE:SEGMENTED:INDEX <index> (see <a href="#">page 187</a> ) | :ACQUIRE:SEGMENTED:INDEX? (see <a href="#">page 187</a> ) | <index> ::= an integer from 2 to 2000 (w/8M memory) in NR1 format (with Option SGM) |
| n/a  | :ACQUIRE:SRATE? (see <a href="#">page 190</a> )           | <sample_rate> ::= sample rate (samples/s) in NR3 format                             |
| :ACQUIRE:TYPE <type><br>(see <a href="#">page 191</a> )          | :ACQUIRE:TYPE? (see <a href="#">page 191</a> )            | <type> ::= {NORMAL   AVERAGE   HRESOLUTION   PEAK}                                  |

**Introduction to :ACQUIRE Commands** The ACQUIRE subsystem controls the way in which waveforms are acquired. These acquisition types are available: normal, averaging, peak detect, and high resolution. Two acquisition modes are available: real-time mode, and equivalent-time mode.

Normal

The `:ACQUIRE:TYPE NORMAL` command sets the oscilloscope in the normal acquisition mode. For the majority of user models and signals, `NORMAL` mode yields the best oscilloscope picture of the waveform.

### Averaging

The `:ACQUIRE:TYPE AVERAGE` command sets the oscilloscope in the averaging mode. You can set the count by sending the `:ACQUIRE:COUNT` command followed by the number of averages. In this mode, the value for averages is an integer from 2 to 65536. The `COUNT` value determines the number of averages that must be acquired.

### High-Resolution

The `:ACQUIRE:TYPE HRESOLUTION` command sets the oscilloscope in the high-resolution mode (also known as *smoothing*). This mode is used to reduce noise at slower sweep speeds where the digitizer samples faster than needed to fill memory for the displayed time range. Instead of decimating samples, they are averaged together to provide the value for one display point. The slower the sweep speed, the greater the number of samples that are averaged together for each display point.

### Peak Detect

The `:ACQUIRE:TYPE PEAK` command sets the oscilloscope in the peak detect mode. In this mode, `:ACQUIRE:COUNT` has no meaning.

### Real-time Mode

The `:ACQUIRE:MODE RTIME` command sets the oscilloscope in real-time mode. This mode is useful to inhibit equivalent time sampling at fast sweep speeds.

### Equivalent-time Mode

The `:ACQUIRE:MODE ETIME` command sets the oscilloscope in equivalent-time mode.

### Reporting the Setup

Use `:ACQUIRE?` to query setup information for the `ACQUIRE` subsystem.

### Return Format

The following is a sample response from the `:ACQUIRE?` query. In this case, the query was issued following a `*RST` command.

```
:ACQ:MODE RTIM;TYPE NORM;COMP 100;COUNT 8;SEGM:COUN 2
```

## :ACQUIRE:AALIAS

**N** (see [page 750](#))

**Query Syntax** :ACQUIRE:AALIAS?

The :ACQUIRE:AALIAS? query returns the current state of the oscilloscope acquisition anti-alias control. This control can be directly disabled or disabled automatically.

**Return Format** <value><NL>

<value> ::= {1 | 0}

- See Also**
- "[Introduction to :ACQUIRE Commands](#)" on page 177
  - "[:ACQUIRE:DAALIAS](#)" on page 182

**:ACQUIRE:COMPLETE**

**C** (see [page 750](#))

**Command Syntax** :ACQUIRE:COMPLETE <complete>  
 <complete> ::= 100; an integer in NR1 format

The :ACQUIRE:COMPLETE command affects the operation of the :DIGITIZE command. It specifies the minimum completion criteria for an acquisition. The parameter determines the percentage of the time buckets that must be "full" before an acquisition is considered complete. If :ACQUIRE:TYPE is NORMAL, it needs only one sample per time bucket for that time bucket to be considered full.

The only legal value for the :COMPLETE command is 100. All time buckets must contain data for the acquisition to be considered complete.

**Query Syntax** :ACQUIRE:COMPLETE?

The :ACQUIRE:COMPLETE? query returns the completion criteria (100) for the currently selected mode.

**Return Format** <completion\_criteria><NL>  
 <completion\_criteria> ::= 100; an integer in NR1 format

- See Also**
- ["Introduction to :ACQUIRE Commands"](#) on page 177
  - [":ACQUIRE:TYPE"](#) on page 191
  - [":DIGITIZE"](#) on page 146
  - [":WAVEFORM:POINTS"](#) on page 602

**Example Code**

```
' ACQUIRE_COMPLETE - Specifies the minimum completion criteria for
' an acquisition. The parameter determines the percentage of time
' buckets needed to be "full" before an acquisition is considered
' to be complete.
myScope.WriteString ":ACQUIRE:COMPLETE 100"
```

Example program from the start: ["VISA COM Example in Visual Basic"](#) on page 776

**:ACquire:COUNT**

**C** (see [page 750](#))

**Command Syntax** :ACquire:COUNT <count>  
 <count> ::= integer in NR1 format

In averaging mode, the :ACquire:COUNT command specifies the number of values to be averaged for each time bucket before the acquisition is considered to be complete for that time bucket. When :ACquire:TYPE is set to AVERage, the count can be set to any value from 2 to 65536.

**NOTE**

The :ACquire:COUNT 1 command has been deprecated. The AVERage acquisition type with a count of 1 is functionally equivalent to the HRESolution acquisition type; however, you should select the high-resolution acquisition mode with the :ACquire:TYPE HRESolution command instead.

**Query Syntax** :ACquire:COUNT?

The :ACquire:COUNT? query returns the currently selected count value for averaging mode.

**Return Format** <count\_argument><NL>  
 <count\_argument> ::= an integer from 2 to 65536 in NR1 format

- See Also**
- ["Introduction to :ACquire Commands"](#) on page 177
  - [":ACquire:TYPE"](#) on page 191
  - [":DIGitize"](#) on page 146
  - [":WAVEform:COUNT"](#) on page 598

## :ACQUIRE:DAALIAS

**N** (see [page 750](#))

**Command Syntax** :ACQUIRE:DAALIAS <mode>  
<mode> ::= {DISABLE | AUTO}

The :ACQUIRE:DAALIAS command sets the disable anti-alias mode of the oscilloscope.

When set to DISABLE, anti-alias is always disabled. This is good for cases where dithered data is not desired.

When set to AUTO, the oscilloscope turns off anti-alias control as needed. Such cases are when the FFT or differentiate math functions are silent. The :DIGITIZE command always turns off the anti-alias control as well.

**Query Syntax** :ACQUIRE:DAALIAS?

The :ACQUIRE:DAALIAS? query returns the oscilloscope's current disable anti-alias mode setting.

**Return Format** <mode><NL>

<mode> ::= {DIS | AUTO}

- See Also**
- ["Introduction to :ACQUIRE Commands"](#) on page 177
  - [":ACQUIRE:AALIAS"](#) on page 179

**:ACquire:MODE**

**C** (see [page 750](#))

**Command Syntax** :ACquire:MODE <mode>

<mode> ::= {RTIME | ETIME | SEGmented}

The :ACquire:MODE command sets the acquisition mode of the oscilloscope.

- The :ACquire:MODE RTIME command sets the oscilloscope in real time mode. This mode is useful to inhibit equivalent time sampling at fast sweep speeds.

Real time mode is not available when averaging (:ACquire:TYPE AVERage).

**NOTE**

The obsolete command ACquire:TYPE:REALtime is functionally equivalent to sending ACquire:MODE RTIME; TYPE NORMAl.

- The :ACquire:MODE ETIME command sets the oscilloscope in equivalent time mode.
- The :ACquire:MODE SEGmented command sets the oscilloscope in segmented memory mode.

**Query Syntax** :ACquire:MODE?

The :ACquire:MODE? query returns the acquisition mode of the oscilloscope.

**Return Format** <mode\_argument><NL>

<mode\_argument> ::= {RTIM | ETIM | SEGM}

- See Also**
- ["Introduction to :ACquire Commands"](#) on page 177
  - [":ACquire:TYPE"](#) on page 191

### :ACQUIRE:POINTS

**C** (see [page 750](#))

**Query Syntax** :ACQUIRE:POINTS?

The :ACQUIRE:POINTS? query returns the number of data points that the hardware will acquire from the input signal. The number of points acquired is not directly controllable. To set the number of points to be transferred from the oscilloscope, use the command :WAVEFORM:POINTS. The :WAVEFORM:POINTS? query will return the number of points available to be transferred from the oscilloscope.

**Return Format** <points\_argument><NL>

<points\_argument> ::= an integer in NR1 format

- See Also**
- ["Introduction to :ACQUIRE Commands"](#) on page 177
  - [":DIGITIZE"](#) on page 146
  - [":WAVEFORM:POINTS"](#) on page 602

**:ACQUIRE:SEGMENTED:ANALYZE****N** (see [page 750](#))**Command Syntax** :ACQUIRE:SEGMENTED:ANALYZE**NOTE**

This command is available when the segmented memory option (Option SGM) is enabled.

---

This command calculates measurement statistics and/or infinite persistence over all segments that have been acquired. It corresponds to the front panel **Analyze Segments** softkey which appears in both the Measurement Statistics and Segmented Memory Menus.

In order to use this command, the oscilloscope must be stopped and in segmented acquisition mode, with either quick measurements or infinite persistence on.

- See Also**
- [":ACQUIRE:MODE"](#) on page 183
  - [":ACQUIRE:SEGMENTED:COUNT"](#) on page 186
  - ["Introduction to :ACQUIRE Commands"](#) on page 177

**:ACQUIRE:SEGMENTED:COUNT**

**N** (see [page 750](#))

**Command Syntax** :ACQUIRE:SEGMENTED:COUNT <count>  
 <count> ::= an integer from 2 to 2000 (w/8M memory) in NR1 format

**NOTE**

This command is available when the segmented memory option (Option SGM) is enabled.

The :ACQUIRE:SEGMENTED:COUNT command sets the number of memory segments to acquire.

The segmented memory acquisition mode is enabled with the :ACQUIRE:MODE command, and data is acquired using the :DIGITIZE, :SINGLE, or :RUN commands. The number of memory segments in the current acquisition is returned by the :WAVEFORM:SEGMENTED:COUNT? query.

The maximum number of segments may be limited by the memory depth of your oscilloscope. For example, an oscilloscope with 1M memory allows a maximum of 250 segments.

**Query Syntax** :ACQUIRE:SEGMENTED:COUNT?

The :ACQUIRE:SEGMENTED:COUNT? query returns the current count setting.

**Return Format** <count><NL>  
 <count> ::= an integer from 2 to 2000 (w/8M memory) in NR1 format

- See Also**
- [":ACQUIRE:MODE"](#) on page 183
  - [":DIGITIZE"](#) on page 146
  - [":SINGLE"](#) on page 172
  - [":RUN"](#) on page 170
  - [":WAVEFORM:SEGMENTED:COUNT"](#) on page 609
  - [":ACQUIRE:SEGMENTED:ANALYZE"](#) on page 185
  - ["Introduction to :ACQUIRE Commands"](#) on page 177

**Example Code** • ["Example Code"](#) on page 187

**:ACQUIRE:SEGMENTED:INDEX**

**N** (see [page 750](#))

**Command Syntax** :ACQUIRE:SEGMENTED:INDEX <index>  
 <index> ::= an integer from 2 to 2000 (w/8M memory) in NR1 format

**NOTE**

This command is available when the segmented memory option (Option SGM) is enabled.

The :ACQUIRE:SEGMENTED:INDEX command sets the index into the memory segments that have been acquired.

The segmented memory acquisition mode is enabled with the :ACQUIRE:MODE command. The number of segments to acquire is set using the :ACQUIRE:SEGMENTED:COUNT command, and data is acquired using the :DIGITIZE, :SINGLE, or :RUN commands. The number of memory segments that have been acquired is returned by the :WAVEFORM:SEGMENTED:COUNT? query. The time tag of the currently indexed memory segment is returned by the :WAVEFORM:SEGMENTED:TTAG? query.

The maximum number of segments may be limited by the memory depth of your oscilloscope. For example, an oscilloscope with 1M memory allows a maximum of 250 segments.

**Query Syntax** :ACQUIRE:SEGMENTED:INDEX?

The :ACQUIRE:SEGMENTED:INDEX? query returns the current segmented memory index setting.

**Return Format** <index><NL>  
 <index> ::= an integer from 2 to 2000 (w/8M memory) in NR1 format

- See Also**
- [":ACQUIRE:MODE"](#) on page 183
  - [":ACQUIRE:SEGMENTED:COUNT"](#) on page 186
  - [":DIGITIZE"](#) on page 146
  - [":SINGLE"](#) on page 172
  - [":RUN"](#) on page 170
  - [":WAVEFORM:SEGMENTED:COUNT"](#) on page 609
  - [":WAVEFORM:SEGMENTED:TTAG"](#) on page 610
  - [":ACQUIRE:SEGMENTED:ANALYZE"](#) on page 185
  - ["Introduction to :ACQUIRE Commands"](#) on page 177

**Example Code** ' Segmented memory commands example.  
 ' -----

## 5 Commands by Subsystem

```
Option Explicit

Public myMgr As VisaComLib.ResourceManager
Public myScope As VisaComLib.FormattedIO488
Public varQueryResult As Variant
Public strQueryResult As String

Private Declare Sub Sleep Lib "kernel32" (ByVal dwMilliseconds As Long)

Sub Main()

    On Error GoTo VisaComError

    ' Create the VISA COM I/O resource.
    Set myMgr = New VisaComLib.ResourceManager
    Set myScope = New VisaComLib.FormattedIO488
    Set myScope.IO = myMgr.Open("TCPIP0::130.29.70.228::inst0::INSTR")
    myScope.IO.Clear ' Clear the interface.

    ' Turn on segmented memory acquisition mode.
    myScope.WriteString ":ACQUIRE:MODE SEGMENTED"
    myScope.WriteString ":ACQUIRE:MODE?"
    strQueryResult = myScope.ReadString
    Debug.Print "Acquisition mode: " + strQueryResult

    ' Set the number of segments to 50.
    myScope.WriteString ":ACQUIRE:SEGMENTED:COUNT 50"
    myScope.WriteString ":ACQUIRE:SEGMENTED:COUNT?"
    strQueryResult = myScope.ReadString
    Debug.Print "Acquisition memory segments: " + strQueryResult

    ' If data will be acquired within the IO timeout:
    'myScope.IO.Timeout = 10000
    'myScope.WriteString ":DIGITIZE"
    'Debug.Print ":DIGITIZE blocks until all segments acquired."
    'myScope.WriteString ":WAVEFORM:SEGMENTED:COUNT?"
    'varQueryResult = myScope.ReadNumber

    ' Or, to poll until the desired number of segments acquired:
    myScope.WriteString ":SINGLE"
    Debug.Print ":SINGLE does not block until all segments acquired."
    Do
        Sleep 100 ' Small wait to prevent excessive queries.
        myScope.WriteString ":WAVEFORM:SEGMENTED:COUNT?"
        varQueryResult = myScope.ReadNumber
    Loop Until varQueryResult = 50

    Debug.Print "Number of segments in acquired data: " _
        + FormatNumber(varQueryResult)

    Dim lngSegments As Long
    lngSegments = varQueryResult

    ' For each segment:
    Dim dblTimeTag As Double
    Dim lngI As Long
```

```
For lngI = lngSegments To 1 Step -1

    ' Set the segmented memory index.
    myScope.WriteString ":ACquire:SEGmented:INDEX " + CStr(lngI)
    myScope.WriteString ":ACquire:SEGmented:INDEX?"
    strQueryResult = myScope.ReadString
    Debug.Print "Acquisition memory segment index: " + strQueryResult

    ' Display the segment time tag.
    myScope.WriteString ":WAVEform:SEGmented:TTAG?"
    dblTimeTag = myScope.ReadNumber
    Debug.Print "Segment " + CStr(lngI) + " time tag: " _
        + FormatNumber(dblTimeTag, 12)

Next lngI

Exit Sub

VisaComError:
    MsgBox "VISA COM Error:" + vbCrLf + Err.Description

End Sub
```

## **:ACquire:SRATe**

**N** (see [page 750](#))

**Query Syntax** :ACquire:SRATe?

The :ACquire:SRATe? query returns the current oscilloscope acquisition sample rate. The sample rate is not directly controllable.

**Return Format** <sample\_rate><NL>

<sample\_rate> ::= sample rate in NR3 format

- See Also**
- ["Introduction to :ACquire Commands"](#) on page 177
  - [":ACquire:POINTs"](#) on page 184

**:ACquire:TYPE**

**C** (see [page 750](#))

**Command Syntax** :ACquire:TYPE <type>

<type> ::= {NORMal | AVERage | HRESolution | PEAK}

The :ACquire:TYPE command selects the type of data acquisition that is to take place. The acquisition types are: NORMal, AVERage, HRESolution, and PEAK.

- The :ACquire:TYPE NORMal command sets the oscilloscope in the normal mode.
- The :ACquire:TYPE AVERage command sets the oscilloscope in the averaging mode. You can set the count by sending the :ACquire:COUNT command followed by the number of averages. In this mode, the value for averages is an integer from 1 to 65536. The COUNT value determines the number of averages that must be acquired.

Setting the :ACquire:TYPE to AVERage automatically sets :ACquire:MODE to ETIME (equivalent time sampling).

The AVERage type is not available when in segmented memory mode (:ACquire:MODE SEGmented).

- The :ACquire:TYPE HRESolution command sets the oscilloscope in the high-resolution mode (also known as *smoothing*). This mode is used to reduce noise at slower sweep speeds where the digitizer samples faster than needed to fill memory for the displayed time range.

For example, if the digitizer samples at 200 MSa/s, but the effective sample rate is 1 MSa/s (because of a slower sweep speed), only 1 out of every 200 samples needs to be stored. Instead of storing one sample (and throwing others away), the 200 samples are averaged together to provide the value for one display point. The slower the sweep speed, the greater the number of samples that are averaged together for each display point.

- The :ACquire:TYPE PEAK command sets the oscilloscope in the peak detect mode. In this mode, :ACquire:COUNT has no meaning.

**NOTE**

The obsolete command ACquire:TYPE:REALtime is functionally equivalent to sending ACquire:MODE RTIME; TYPE NORMal.

**Query Syntax** :ACquire:TYPE?

The :ACquire:TYPE? query returns the current acquisition type.

**Return Format** <acq\_type><NL>

<acq\_type> ::= {NORM | AVER | HRES | PEAK}

- See Also**
- ["Introduction to :ACQUIRE Commands"](#) on page 177
  - [":ACQUIRE:COUNt"](#) on page 181
  - [":ACQUIRE:MODE"](#) on page 183
  - [":DIGitize"](#) on page 146
  - [":WAVEform:TYPE"](#) on page 616
  - [":WAVEform:PREamble"](#) on page 606

**Example Code**

```
' ACQUIRE_TYPE - Sets the acquisition mode, which can be NORMAL,  
' PEAK, or AVERAGE.  
myScope.WriteString ":ACQUIRE:TYPE NORMAL"
```

Example program from the start: ["VISA COM Example in Visual Basic"](#) on page 776

## :CALibrate Commands

Utility commands for viewing calibration status and for starting the user calibration procedure. See "[Introduction to :CALibrate Commands](#)" on page 193.

**Table 54** :CALibrate Commands Summary

| Command  | Query  | Options and Query Returns  |
|--|--|--|
| n/a  | :CALibrate:DATE? (see <a href="#">page 195</a> )         | <return value> ::= <day>,<month>,<year>; all in NR1 format   |
| :CALibrate:LABel <string> (see <a href="#">page 196</a> )  | :CALibrate:LABel? (see <a href="#">page 196</a> )        | <string> ::= quoted ASCII string up to 32 characters   |
| :CALibrate:OUTPut <signal> (see <a href="#">page 197</a> ) | :CALibrate:OUTPut? (see <a href="#">page 197</a> )       | <signal> ::= {TRIGgers   SOURce   DSOURce   MASK}  |
| :CALibrate:START (see <a href="#">page 198</a> )           | n/a  | n/a  |
| n/a  | :CALibrate:STATus? (see <a href="#">page 199</a> )       | <return value> ::= ALL,<status_code>,<status_string><br><status_code> ::= an integer status code<br><status_string> ::= an ASCII status string |
| n/a  | :CALibrate:SWITCh? (see <a href="#">page 200</a> )       | {PROTeCted   UNPRoTeCted}  |
| n/a  | :CALibrate:TEMPeratur e? (see <a href="#">page 201</a> ) | <return value> ::= degrees C delta since last cal in NR3 format  |
| n/a  | :CALibrate:TIME? (see <a href="#">page 202</a> )         | <return value> ::= <hours>,<minutes>,<seconds>; all in NR1 format  |

### Introduction to :CALibrate Commands

The CALibrate subsystem provides utility commands for:

- Determining the state of the calibration factor protection switch (CAL PROTECT).
- Saving and querying the calibration label string.
- Reporting the calibration time and date.
- Reporting changes in the temperature since the last calibration.

## 5 Commands by Subsystem

- Starting the user calibration procedure.

**:CALibrate:DATE**

**N** (see [page 750](#))

**Query Syntax** :CALibrate:DATE?

The :CALibrate:DATE? query returns the date of the last calibration.

**Return Format** <date><NL>

<date> ::= day,month,year in NR1 format<NL>

**See Also** • ["Introduction to :CALibrate Commands"](#) on page 193

## :CALibrate:LABel

**N** (see [page 750](#))

**Command Syntax** :CALibrate:LABel <string>

<string> ::= quoted ASCII string of up to 32 characters in length, not including the quotes

The CALibrate:LABel command saves a string that is up to 32 characters in length into the instrument's non-volatile memory. The string may be used to record calibration dates or other information as needed.

**Query Syntax** :CALibrate:LABel?

The :CALibrate:LABel? query returns the contents of the calibration label string.

**Return Format** <string><NL>

<string> ::= unquoted ASCII string of up to 32 characters in length

**See Also** • ["Introduction to :CALibrate Commands"](#) on page 193

**:CALibrate:OUTPut**

**N** (see [page 750](#))

**Command Syntax** :CALibrate:OUTPut <signal>  
 <signal> ::= {TRIGgers | SOURce | DSOurce | MASK}

The CALibrate:OUTPut command sets the signal that is available on the rear panel TRIG OUT BNC:

- TRIGgers – pulse when a trigger event occurs.
- SOURce – raw output of trigger comparator.
- DSOurce – SOURce frequency divided by 8.
- MASK – signal from mask test indicating a success or fail mask test.

**Query Syntax** :CALibrate:OUTPut?

The :CALibrate:OUTPut query returns the current source of the TRIG OUT BNC signal.

**Return Format** <signal><NL>  
 <signal> ::= {TRIG | SOUR | DSO | MASK}

- See Also**
- ["Introduction to :CALibrate Commands"](#) on page 193
  - [":MTEST:OUTPut"](#) on page 355

## :CALibrate:START

**N** (see [page 750](#))

**Command Syntax** :CALibrate:START

The CALibrate:START command starts the user calibration procedure.

### NOTE

Before starting the user calibration procedure, you must set the rear panel CALIBRATION switch to UNPROTECTED, and you must connect BNC cables from the TRIG OUT connector to the analog channel inputs. See the *User's Guide* for details.

- See Also**
- "[Introduction to :CALibrate Commands](#)" on page 193
  - "[:CALibrate:SWITCh](#)" on page 200

**:CALibrate:STATus**

**N** (see [page 750](#))

**Query Syntax** :CALibrate:STATus?

The :CALibrate:STATus? query returns the summary results of the last user calibration procedure.

**Return Format** <return value><NL>

<return value> ::= ALL,<status\_code>,<status\_string>

<status\_code> ::= an integer status code

<status\_string> ::= an ASCII status string

**See Also** • ["Introduction to :CALibrate Commands"](#) on page 193

## :CALibrate:SWITCh

**N** (see [page 750](#))

**Query Syntax** :CALibrate:SWITCh?

The :CALibrate:SWITCh? query returns the rear-panel calibration protect (CAL PROTECT) switch state. The value PROTECTED indicates calibration is disabled, and UNPROTECTED indicates calibration is enabled.

**Return Format** <switch><NL>  
<switch> ::= {PROT | UNPR}

**See Also** • ["Introduction to :CALibrate Commands"](#) on page 193

**:CALibrate:TEMPerature**

**N** (see [page 750](#))

**Query Syntax** :CALibrate:TEMPerature?

The :CALibrate:TEMPerature? query returns the change in temperature since the last user calibration procedure.

**Return Format** <return value><NL>

<return value> ::= degrees C delta since last cal in NR3 format

**See Also** • ["Introduction to :CALibrate Commands"](#) on page 193

## :CALibrate:TIME

**N** (see [page 750](#))

**Query Syntax** :CALibrate:TIME?

The :CALibrate:TIME? query returns the time of the last calibration.

**Return Format** <date><NL>

<date> ::= hour,minutes,seconds in NR1 format

**See Also** • ["Introduction to :CALibrate Commands"](#) on page 193

## :CHANnel<n> Commands

Control all oscilloscope functions associated with individual analog channels or groups of channels. See ["Introduction to :CHANnel<n> Commands"](#) on page 204.

**Table 55** :CHANnel<n> Commands Summary

| Command   | Query  | Options and Query Returns   |
|---|--|---|
| :CHANnel<n>:BWLimit<br>{0   OFF}   {1   ON}} (see <a href="#">page 206</a> )  | :CHANnel<n>:BWLimit?<br>(see <a href="#">page 206</a> )        | {0   1}<br><n> ::= 1-2 or 1-4 in NR1 format   |
| :CHANnel<n>:COUpling<br><coupling> (see <a href="#">page 207</a> )            | :CHANnel<n>:COUpling?<br>(see <a href="#">page 207</a> )       | <coupling> ::= {AC   DC}<br><n> ::= 1-2 or 1-4 in NR1 format  |
| :CHANnel<n>:DISPlay<br>{0   OFF}   {1   ON}} (see <a href="#">page 208</a> )  | :CHANnel<n>:DISPlay?<br>(see <a href="#">page 208</a> )        | {0   1}<br><n> ::= 1-2 or 1-4 in NR1 format   |
| :CHANnel<n>:IMPedance<br><impedance> (see <a href="#">page 209</a> )          | :CHANnel<n>:IMPedance?<br>(see <a href="#">page 209</a> )      | <impedance> ::= {ONEMeg   FIFTy}<br><n> ::= 1-2 or 1-4 in NR1 format  |
| :CHANnel<n>:INVert<br>{0   OFF}   {1   ON}} (see <a href="#">page 210</a> )   | :CHANnel<n>:INVert?<br>(see <a href="#">page 210</a> )         | {0   1}<br><n> ::= 1-2 or 1-4 in NR1 format   |
| :CHANnel<n>:LABel<br><string> (see <a href="#">page 211</a> )                 | :CHANnel<n>:LABel?<br>(see <a href="#">page 211</a> )          | <string> ::= any series of 10 or less ASCII characters enclosed in quotation marks<br><n> ::= 1-2 or 1-4 in NR1 format          |
| :CHANnel<n>:OFFSet<br><offset>[suffix] (see <a href="#">page 212</a> )        | :CHANnel<n>:OFFSet?<br>(see <a href="#">page 212</a> )         | <offset> ::= Vertical offset value in NR3 format<br>[suffix] ::= {V   mV}<br><n> ::= 1-2 or 1-4; in NR1 format                  |
| :CHANnel<n>:PROBe<br><attenuation> (see <a href="#">page 213</a> )            | :CHANnel<n>:PROBe?<br>(see <a href="#">page 213</a> )          | <attenuation> ::= Probe attenuation ratio in NR3 format<br><n> ::= 1-2 or 1-4r in NR1 format                                    |
| :CHANnel<n>:PROBe:HEAD[:TYPE] <head_param><br>(see <a href="#">page 214</a> ) | :CHANnel<n>:PROBe:HEAD[:TYPE]? (see <a href="#">page 214</a> ) | <head_param> ::= {SEND0   SEND6   SEND12   SEND20   DIFF0   DIFF6   DIFF12   DIFF20   NONE}<br><n> ::= 1-2 or 1-4 in NR1 format |
| n/a   | :CHANnel<n>:PROBe:ID?<br>(see <a href="#">page 215</a> )       | <probe id> ::= unquoted ASCII string up to 11 characters<br><n> ::= 1-2 or 1-4 in NR1 format                                    |

**Table 55** :CHANnel<n> Commands Summary (continued)

| Command   | Query                                   | Options and Query Returns  |
|---|---|--|
| :CHANnel<n>:PROBe:SKEW <skew_value> (see page 216)        | :CHANnel<n>:PROBE:SKEW? (see page 216)  | <skew_value> ::= -100 ns to +100 ns in NR3 format<br><n> ::= 1-2 or 1-4 in NR1 format                                    |
| :CHANnel<n>:PROBe:STYPe <signal type> (see page 217)      | :CHANnel<n>:PROBE:STYPe? (see page 217) | <signal type> ::= {DIFFerential   SINGLE}<br><n> ::= 1-2 or 1-4 in NR1 format  |
| :CHANnel<n>:PROTection (see page 218)                     | :CHANnel<n>:PROTECTioN? (see page 218)  | {NORM   TRIP}<br><n> ::= 1-2 or 1-4 in NR1 format  |
| :CHANnel<n>:RANGe <range>[suffix] (see page 219)          | :CHANnel<n>:RANGE? (see page 219)       | <range> ::= Vertical full-scale range value in NR3 format<br>[suffix] ::= {V   mV}<br><n> ::= 1-2 or 1-4 in NR1 format   |
| :CHANnel<n>:SCALE <scale>[suffix] (see page 220)          | :CHANnel<n>:SCALE? (see page 220)       | <scale> ::= Vertical units per division value in NR3 format<br>[suffix] ::= {V   mV}<br><n> ::= 1-2 or 1-4 in NR1 format |
| :CHANnel<n>:UNITs <units> (see page 221)                  | :CHANnel<n>:UNITs? (see page 221)       | <units> ::= {VOLT   AMPere}<br><n> ::= 1-2 or 1-4 in NR1 format  |
| :CHANnel<n>:VERNier {{0   OFF}   {1   ON}} (see page 222) | :CHANnel<n>:VERNier? (see page 222)     | {0   1}<br><n> ::= 1-2 or 1-4 in NR1 format  |

**Introduction to :CHANnel<n> Commands**

<n> ::= {1 | 2 | 3 | 4} for the four channel oscilloscope models  
<n> ::= {1 | 2} for the two channel oscilloscope models

The CHANnel<n> subsystem commands control an analog channel (vertical or Y-axis of the oscilloscope). Channels are independently programmable for all offset, probe, coupling, bandwidth limit, inversion, vernier, and range (scale) functions. The channel number (1, 2, 3, or 4) specified in the command selects the analog channel that is affected by the command.

A label command provides identifying annotations of up to 10 characters.

You can toggle the channel displays on and off with the :CHANnel<n>:DISPlay command as well as with the root level commands :VIEW and :BLANK.

**NOTE**

The obsolete CHANnel subsystem is supported.

### Reporting the Setup

Use :CHANnel1?, :CHANnel2?, :CHANnel3? or :CHANnel4? to query setup information for the CHANnel<n> subsystem.

### Return Format

The following are sample responses from the :CHANnel<n>? query. In this case, the query was issued following a \*RST command.

```
:CHAN1:RANG +40.0E+00;OFFS +0.00000E+00;COUP DC;IMP ONEM;DISP 1;BWL 0;  
INV 0;LAB "1";UNIT VOLT;PROB +10E+00;PROB:SKEW +0.00E+00;STYP SING
```

## :CHANnel<n>:BWLimit

**C** (see [page 750](#))

**Command Syntax** :CHANnel<n>:BWLimit <bwlimit>

<bwlimit> ::= {{1 | ON} | {0 | OFF}}

<n> ::= {1 | 2 | 3 | 4} for the four channel oscilloscope models

<n> ::= {1 | 2} for the two channel oscilloscope models

The :CHANnel<n>:BWLimit command controls an internal low-pass filter. When the filter is on, the bandwidth of the specified channel is limited to approximately 25 MHz.

**Query Syntax** :CHANnel<n>:BWLimit?

The :CHANnel<n>:BWLimit? query returns the current setting of the low-pass filter.

**Return Format** <bwlimit><NL>

<bwlimit> ::= {1 | 0}

**See Also** • ["Introduction to :CHANnel<n> Commands"](#) on page 204

**:CHANnel<n>:COUPling**

**C** (see [page 750](#))

**Command Syntax** :CHANnel<n>:COUPling <coupling>

<coupling> ::= {AC | DC}

<n> ::= {1 | 2 | 3 | 4} for the four channel oscilloscope models

<n> ::= {1 | 2} for the two channel oscilloscope models

The :CHANnel<n>:COUPling command selects the input coupling for the specified channel. The coupling for each analog channel can be set to AC or DC.

**Query Syntax** :CHANnel<n>:COUPling?

The :CHANnel<n>:COUPling? query returns the current coupling for the specified channel.

**Return Format** <coupling value><NL>

<coupling value> ::= {AC | DC}

**See Also** • ["Introduction to :CHANnel<n> Commands"](#) on page 204

## :CHANnel<n>:DISPlay

**C** (see [page 750](#))

**Command Syntax** :CHANnel<n>:DISPlay <display value>  
<display value> ::= {{1 | ON} | {0 | OFF}}  
<n> ::= {1 | 2 | 3 | 4} for the four channel oscilloscope models  
<n> ::= {1 | 2} for the two channel oscilloscope models

The :CHANnel<n>:DISPlay command turns the display of the specified channel on or off.

**Query Syntax** :CHANnel<n>:DISPlay?

The :CHANnel<n>:DISPlay? query returns the current display setting for the specified channel.

**Return Format** <display value><NL>  
<display value> ::= {1 | 0}

- See Also**
- ["Introduction to :CHANnel<n> Commands"](#) on page 204
  - [":VIEW"](#) on page 176
  - [":BLANK"](#) on page 144
  - [":STATus"](#) on page 173

**:CHANnel<n>:IMPedance**

**C** (see [page 750](#))

**Command Syntax** :CHANnel<n>:IMPedance <impedance>

<impedance> ::= {ONEMeg | FIFTy}

<n> ::= {1 | 2 | 3 | 4} for the four channel oscilloscope models

<n> ::= {1 | 2} for the two channel oscilloscope models

The :CHANnel<n>:IMPedance command selects the input impedance setting for the specified analog channel. The legal values for this command are ONEMeg (1 M $\Omega$ ) and FIFTy (50 $\Omega$ ).

**Query Syntax** :CHANnel<n>:IMPedance?

The :CHANnel<n>:IMPedance? query returns the current input impedance setting for the specified channel.

**Return Format** <impedance value><NL>

<impedance value> ::= {ONEM | FIFT}

**See Also** • ["Introduction to :CHANnel<n> Commands"](#) on page 204

## **:CHANnel<n>:INVert**

**N** (see [page 750](#))

**Command Syntax** :CHANnel<n>:INVert <invert value>

<invert value> ::= {{1 | ON} | {0 | OFF}}

<n> ::= {1 | 2 | 3 | 4} for the four channel oscilloscope models

<n> ::= {1 | 2} for the two channel oscilloscope models

The :CHANnel<n>:INVert command selects whether or not to invert the input signal for the specified channel. The inversion may be 1 (ON/inverted) or 0 (OFF/not inverted).

**Query Syntax** :CHANnel<n>:INVert?

The :CHANnel<n>:INVert? query returns the current state of the channel inversion.

**Return Format** <invert value><NL>

<invert value> ::= {0 | 1}

**See Also** • ["Introduction to :CHANnel<n> Commands"](#) on page 204

**:CHANnel<n>:LABel**

**N** (see [page 750](#))

**Command Syntax** :CHANnel<n>:LABel <string>  
 <string> ::= quoted ASCII string  
 <n> ::= {1 | 2 | 3 | 4} for the four channel oscilloscope models  
 <n> ::= {1 | 2} for the two channel oscilloscope models

**NOTE**

Label strings are 10 characters or less, and may contain any commonly used ASCII characters. Labels with more than 10 characters are truncated to 10 characters. Lower case characters are converted to upper case.

The :CHANnel<n>:LABel command sets the analog channel label to the string that follows. Setting a label for a channel also adds the name to the label list in non-volatile memory (replacing the oldest label in the list).

**Query Syntax** :CHANnel<n>:LABel?

The :CHANnel<n>:LABel? query returns the label associated with a particular analog channel.

**Return Format** <string><NL>  
 <string> ::= quoted ASCII string

- See Also**
- ["Introduction to :CHANnel<n> Commands"](#) on page 204
  - [":DISPlay:LABel"](#) on page 228
  - [":DISPlay:LABList"](#) on page 229

**Example Code**

```
' LABEL - This command allows you to write a name (10 characters
' maximum) next to the channel number. It is not necessary, but
' can be useful for organizing the display.
myScope.WriteString ":CHANNEL1:LABEL " "CAL 1"" ' Label ch1 "CAL 1".
myScope.WriteString ":CHANNEL2:LABEL " "CAL2"" ' Label ch1 "CAL2".
```

Example program from the start: ["VISA COM Example in Visual Basic"](#) on page 776

**:CHANnel<n>:OFFSet**

**C** (see [page 750](#))

**Command Syntax** :CHANnel<n>:OFFSet <offset> [<suffix>]

<offset> ::= Vertical offset value in NR3 format

<suffix> ::= {V | mV}

<n> ::= {1 | 2 | 3 | 4} for the four channel oscilloscope models

<n> ::= {1 | 2} for the two channel oscilloscope models

The :CHANnel<n>:OFFSet command sets the value that is represented at center screen for the selected channel. The range of legal values varies with the value set by the :CHANnel<n>:RANGe and :CHANnel<n>:SCALE commands. If you set the offset to a value outside of the legal range, the offset value is automatically set to the nearest legal value. Legal values are affected by the probe attenuation setting.

**Query Syntax** :CHANnel<n>:OFFSet?

The :CHANnel<n>:OFFSet? query returns the current offset value for the selected channel.

**Return Format** <offset><NL>

<offset> ::= Vertical offset value in NR3 format

- See Also**
- "[Introduction to :CHANnel<n> Commands](#)" on page 204
  - "[:CHANnel<n>:RANGe](#)" on page 219
  - "[:CHANnel<n>:SCALE](#)" on page 220
  - "[:CHANnel<n>:PROBe](#)" on page 213

**:CHANnel<n>:PROBe**

**C** (see [page 750](#))

**Command Syntax** :CHANnel<n>:PROBe <attenuation>

<attenuation> ::= probe attenuation ratio in NR3 format

<n> ::= {1 | 2 | 3 | 4} for the four channel oscilloscope models

<n> ::= {1 | 2} for the two channel oscilloscope models

The obsolete attenuation values X1, X10, X20, X100 are also supported.

The :CHANnel<n>:PROBe command specifies the probe attenuation factor for the selected channel. The probe attenuation factor may be 0.1 to 1000. This command does not change the actual input sensitivity of the oscilloscope. It changes the reference constants for scaling the display factors, for making automatic measurements, and for setting trigger levels.

If an AutoProbe probe is connected to the oscilloscope, the attenuation value cannot be changed from the sensed value. Attempting to set the oscilloscope to an attenuation value other than the sensed value produces an error.

**Query Syntax** :CHANnel<n>:PROBe?

The :CHANnel<n>:PROBe? query returns the current probe attenuation factor for the selected channel.

**Return Format** <attenuation><NL>

<attenuation> ::= probe attenuation ratio in NR3 format

- See Also**
- ["Introduction to :CHANnel<n> Commands"](#) on page 204
  - [":CHANnel<n>:RANGe"](#) on page 219
  - [":CHANnel<n>:SCALE"](#) on page 220
  - [":CHANnel<n>:OFFSet"](#) on page 212

**Example Code**

```
' CHANNEL_PROBE - Sets the probe attenuation factor for the selected
' channel. The probe attenuation factor may be set from 0.1 to 1000.
myScope.WriteString ":CHAN1:PROBE 10" ' Set Probe to 10:1.
```

Example program from the start: ["VISA COM Example in Visual Basic"](#) on page 776

**:CHANnel<n>:PROBE:HEAD[:TYPE]**

**C** (see page 750)

**Command Syntax****NOTE**

This command is valid only for the 113xA Series probes.

```
:CHANnel<n>:PROBE:HEAD[:TYPE] <head_param>
<head_param> ::= {SEND0 | SEND6 | SEND12 | SEND20 | DIFF0 | DIFF6
                  | DIFF12 | DIFF20 | NONE}
<n> ::= {1 | 2 | 3 | 4}
```

The :CHANnel<n>:PROBE:HEAD[:TYPE] command sets an analog channel probe head type and dB value. You can choose from:

- SEND0 – Single-ended, 0dB.
- SEND6 – Single-ended, 6dB.
- SEND12 – Single-ended, 12dB.
- SEND20 – Single-ended, 20dB.
- DIFF0 – Differential, 0dB.
- DIFF6 – Differential, 6dB.
- DIFF12 – Differential, 12dB.
- DIFF20 – Differential, 20dB.

**Query Syntax** :CHANnel<n>:PROBE:HEAD[:TYPE]?

The :CHANnel<n>:PROBE:HEAD[:TYPE]? query returns the current probe head type setting for the selected channel.

**Return Format** <head\_param><NL>

```
<head_param> ::= {SEND0 | SEND6 | SEND12 | SEND20 | DIFF0 | DIFF6
                  | DIFF12 | DIFF20 | NONE}
```

- See Also**
- "Introduction to :CHANnel<n> Commands" on page 204
  - ":CHANnel<n>:PROBE" on page 213
  - ":CHANnel<n>:PROBE:ID" on page 215
  - ":CHANnel<n>:PROBE:SKEW" on page 216
  - ":CHANnel<n>:PROBE:STYPe" on page 217

**:CHANnel<n>:PROBe:ID**

**C** (see [page 750](#))

**Query Syntax** :CHANnel<n>:PROBe:ID?

<n> ::= {1 | 2 | 3 | 4} for the four channel oscilloscope models

<n> ::= {1 | 2} for the two channel oscilloscope models

The :CHANnel<n>:PROBe:ID? query returns the type of probe attached to the specified oscilloscope channel.

**Return Format** <probe id><NL>

<probe id> ::= unquoted ASCII string up to 11 characters

Some of the possible returned values are:

- 1131A
- 1132A
- 1134A
- 1147A
- 1153A
- 1154A
- 1156A
- 1157A
- 1158A
- 1159A
- AutoProbe
- E2621A
- E2622A
- E2695A
- E2697A
- HP1152A
- HP1153A
- NONE
- Probe
- Unknown
- Unsupported

**See Also** • ["Introduction to :CHANnel<n> Commands"](#) on page 204

## :CHANnel<n>:PROBe:SKEW

**C** (see [page 750](#))

**Command Syntax** :CHANnel<n>:PROBe:SKEW <skew value>  
<skew value> ::= skew time in NR3 format  
<skew value> ::= -100 ns to +100 ns  
<n> ::= {1 | 2 | 3 | 4}

The :CHANnel<n>:PROBe:SKEW command sets the channel-to-channel skew factor for the specified channel. Each analog channel can be adjusted + or -100 ns for a total of 200 ns difference between channels. You can use the oscilloscope's probe skew control to remove cable-delay errors between channels.

**Query Syntax** :CHANnel<n>:PROBe:SKEW?

The :CHANnel<n>:PROBe:SKEW? query returns the current probe skew setting for the selected channel.

**Return Format** <skew value><NL>  
<skew value> ::= skew value in NR3 format

**See Also** • ["Introduction to :CHANnel<n> Commands"](#) on page 204

**:CHANnel<n>:PROBe:STYPe**

**C** (see [page 750](#))

**Command Syntax****NOTE**

This command is valid only for the 113xA Series probes.

```
:CHANnel<n>:PROBe:STYPe <signal type>
<signal type> ::= {DIFFerential | SINGLE}
<n> ::= {1 | 2 | 3 | 4} for the four channel oscilloscope models
<n> ::= {1 | 2} for the two channel oscilloscope models
```

The :CHANnel<n>:PROBe:STYPe command sets the channel probe signal type (STYPe) to differential or single-ended when using the 113xA Series probes and determines how offset is applied.

When single-ended is selected, the :CHANnel<n>:OFFset command changes the offset value of the probe amplifier. When differential is selected, the :CHANnel<n>:OFFset command changes the offset value of the channel amplifier.

**Query Syntax** :CHANnel<n>:PROBe:STYPe?

The :CHANnel<n>:PROBe:STYPe? query returns the current probe signal type setting for the selected channel.

**Return Format** <signal type><NL>

```
<signal type> ::= {DIFF | SING}
```

- See Also**
- "[Introduction to :CHANnel<n> Commands](#)" on page 204
  - "[:CHANnel<n>:OFFSet](#)" on page 212

**:CHANnel<n>:PROTection**

**N** (see [page 750](#))

**Command Syntax** :CHANnel<n>:PROTection[:CLEar]

<n> ::= {1 | 2 | 3 | 4}

When the analog channel input impedance is set to 50Ω, the input channels are protected against overvoltage. When an overvoltage condition is sensed, the input impedance for the channel is automatically changed to 1 MΩ. The :CHANnel<n>:PROTection[:CLEar] command is used to clear (reset) the overload protection. It allows the channel to be used again in 50Ω mode after the signal that caused the overload has been removed from the channel input. Reset the analog channel input impedance to 50Ω (see [":CHANnel<n>:IMPedance"](#) on page 209) after clearing the overvoltage protection.

**Query Syntax** :CHANnel<n>:PROTection?

The :CHANnel<n>:PROTection query returns the state of the input protection for CHANnel<n>. If a channel input has experienced an overload, TRIP (tripped) will be returned; otherwise NORM (normal) is returned.

**Return Format** {NORM | TRIP}<NL>

- See Also**
- ["Introduction to :CHANnel<n> Commands"](#) on page 204
  - [":CHANnel<n>:COUPling"](#) on page 207
  - [":CHANnel<n>:IMPedance"](#) on page 209
  - [":CHANnel<n>:PROBe"](#) on page 213

**:CHANnel<n>:RANGe**

**C** (see [page 750](#))

**Command Syntax** :CHANnel<n>:RANGe <range>[<suffix>]

<range> ::= vertical full-scale range value in NR3 format

<suffix> ::= {V | mV}

<n> ::= {1 | 2 | 3 | 4} for the four channel oscilloscope models

<n> ::= {1 | 2} for the two channel oscilloscope models

The :CHANnel<n>:RANGe command defines the full-scale vertical axis of the selected channel. When using 1:1 probe attenuation, the range can be set to any value from:

- 16 mV to 40 V (input impedance 1 M $\Omega$  or 50  $\Omega$ ).

If the probe attenuation is changed, the range value is multiplied by the probe attenuation factor.

**Query Syntax** :CHANnel<n>:RANGe?

The :CHANnel<n>:RANGe? query returns the current full-scale range setting for the specified channel.

**Return Format** <range\_argument><NL>

<range\_argument> ::= vertical full-scale range value in NR3 format

- See Also**
- ["Introduction to :CHANnel<n> Commands"](#) on page 204
  - [":CHANnel<n>:SCALE"](#) on page 220
  - [":CHANnel<n>:PROBE"](#) on page 213

**Example Code**

```
' CHANNEL_RANGE - Sets the full scale vertical range in volts. The
' range value is 8 times the volts per division.
myScope.WriteString ":CHANNEL1:RANGE 8" ' Set the vertical range to
8 volts.
```

Example program from the start: ["VISA COM Example in Visual Basic"](#) on page 776

### **:CHANnel<n>:SCALe**

**N** (see [page 750](#))

**Command Syntax** :CHANnel<n>:SCALe <scale>[<suffix>]

<scale> ::= vertical units per division in NR3 format

<suffix> ::= {V | mV}

<n> ::= {1 | 2 | 3 | 4} for the four channel oscilloscope models

<n> ::= {1 | 2} for the two channel oscilloscope models

The :CHANnel<n>:SCALe command sets the vertical scale, or units per division, of the selected channel. When using 1:1 probe attenuation, legal values for the scale range from:

- 2 mV to 5 V (input impedance 1 M $\Omega$  or 50  $\Omega$ ).

If the probe attenuation is changed, the scale value is multiplied by the probe's attenuation factor.

**Query Syntax** :CHANnel<n>:SCALe?

The :CHANnel<n>:SCALe? query returns the current scale setting for the specified channel.

**Return Format** <scale value><NL>

<scale value> ::= vertical units per division in NR3 format

- See Also**
- ["Introduction to :CHANnel<n> Commands"](#) on page 204
  - [":CHANnel<n>:RANGe"](#) on page 219
  - [":CHANnel<n>:PROBe"](#) on page 213

**:CHANnel<n>:UNITs**

**N** (see [page 750](#))

**Command Syntax** :CHANnel<n>:UNITs <units>

<units> ::= {VOLT | AMPere}

<n> ::= {1 | 2} for the two channel oscilloscope models

<n> ::= {1 | 2 | 3 | 4} for the four channel oscilloscope models

The :CHANnel<n>:UNITs command sets the measurement units for the connected probe. Select VOLT for a voltage probe and select AMPere for a current probe. Measurement results, channel sensitivity, and trigger level will reflect the measurement units you select.

**Query Syntax** :CHANnel<n>:UNITs?

The :CHANnel<n>:UNITs? query returns the current units setting for the specified channel.

**Return Format** <units><NL>

<units> ::= {VOLT | AMP}

- See Also**
- ["Introduction to :CHANnel<n> Commands"](#) on page 204
  - [":CHANnel<n>:RANGe"](#) on page 219
  - [":CHANnel<n>:PROBe"](#) on page 213
  - [":EXTernal:UNITs"](#) on page 242

## :CHANnel<n>:VERNier

**N** (see [page 750](#))

**Command Syntax** :CHANnel<n>:VERNier <vernier value>

<vernier value> ::= {{1 | ON} | {0 | OFF}}

<n> ::= {1 | 2 | 3 | 4} for the four channel oscilloscope models

<n> ::= {1 | 2} for the two channel oscilloscope models

The :CHANnel<n>:VERNier command specifies whether the channel's vernier (fine vertical adjustment) setting is ON (1) or OFF (0).

**Query Syntax** :CHANnel<n>:VERNier?

The :CHANnel<n>:VERNier? query returns the current state of the channel's vernier setting.

**Return Format** <vernier value><NL>

<vernier value> ::= {0 | 1}

**See Also** • ["Introduction to :CHANnel<n> Commands"](#) on page 204

## :DISPlay Commands

Control how waveforms, graticule, and text are displayed and written on the screen. See "[Introduction to :DISPlay Commands](#)" on page 223.

**Table 56** :DISPlay Commands Summary

| Command  | Query   | Options and Query Returns   |
|--|---|---|
| :DISPlay:CLear (see <a href="#">page 225</a> )   | n/a   | n/a   |
| :DISPlay:DATA<br>[<format>][,][<area>]<br>[,][<palette>]<display data> (see <a href="#">page 226</a> ) | :DISPlay:DATA?<br>[<format>][,][<area>]<br>[,][<palette>] (see <a href="#">page 226</a> ) | <format> ::= {TIFF} (command)<br><area> ::= {GRATicule} (command)<br><palette> ::= {MONochrome} (command)<br><format> ::= {TIFF   BMP   BMP8bit   PNG} (query)<br><area> ::= {GRATicule   SCReen} (query)<br><palette> ::= {MONochrome   GRAYscale   COLor} (query)<br><display data> ::= data in IEEE 488.2 # format |
| :DISPlay:LABel {{0   OFF}   {1   ON}} (see <a href="#">page 228</a> )                                  | :DISPlay:LABel? (see <a href="#">page 228</a> )   | {0   1}   |
| :DISPlay:LABList<br><binary block> (see <a href="#">page 229</a> )                                     | :DISPlay:LABList? (see <a href="#">page 229</a> )   | <binary block> ::= an ordered list of up to 75 labels, each 10 characters maximum, separated by newline characters  |
| :DISPlay:PERsistence<br><value> (see <a href="#">page 230</a> )  | :DISPlay:PERsistence? (see <a href="#">page 230</a> )                                     | <value> ::= {MINimum   INFinite}}   |
| :DISPlay:SOURce<br><value> (see <a href="#">page 231</a> )   | :DISPlay:SOURce? (see <a href="#">page 231</a> )  | <value> ::= {PMEMemory{0   1   2   3   4   5   6   7   8   9}}  |
| :DISPlay:VECTors {{1   ON}   {0   OFF}} (see <a href="#">page 232</a> )                                | :DISPlay:VECTors? (see <a href="#">page 232</a> )   | {1   0}   |

### Introduction to :DISPlay Commands

The DISPlay subsystem is used to control the display storage and retrieval of waveform data, labels, and text. This subsystem allows the following actions:

- Clear the waveform area on the display.
- Turn vectors on or off.

## 5 Commands by Subsystem

- Set waveform persistence.
- Specify labels.
- Save and Recall display data.

### Reporting the Setup

Use :DISPlay? to query the setup information for the DISPlay subsystem.

### Return Format

The following is a sample response from the :DISPlay? query. In this case, the query was issued following a \*RST command.

```
:DISP:CONN 1;PERS MIN;SOUR PMEM1
```

## :DISPlay:CLEAr

**N** (see [page 750](#))

**Command Syntax** :DISPlay:CLEAr

The :DISPlay:CLEAr command clears the display and resets all associated measurements. If the oscilloscope is stopped, all currently displayed data is erased. If the oscilloscope is running, all of the data for active channels and functions is erased; however, new data is displayed on the next acquisition.

- See Also**
- "[Introduction to :DISPlay Commands](#)" on page 223
  - "[:CDISplay](#)" on page 145

**:DISPlay:DATA**

**N** (see [page 750](#))

**Command Syntax** :DISPlay:DATA [<format>][,] [<area>][,] [<palette>]<display data>  
 <format> ::= {TIFF}  
 <area> ::= {GRATicule}  
 <palette> ::= {MONochrome}  
 <display data> ::= binary block data in IEEE-488.2 # format.

The :DISPlay:DATA command writes trace memory data (a display bitmap) to the display or to one of the trace memories in the instrument.

If a data format or area is specified, the :DISPlay:DATA command transfers the data directly to the display. If neither the data format nor the area is specified, the command transfers data to the trace memory specified by the :DISPlay:SOURce command. Available trace memories are PMEMory0-9 and these memories correspond to the INTERN\_0-9 files in the front panel Save/Recall menu.

Graticule data is a low resolution bitmap of the graticule area in TIFF format. This is the same data saved using the front panel Save/Recall menu or the \*SAV (Save) command.

**Query Syntax** :DISPlay:DATA? [<format>][,] [<area>][,] [<palette>]  
 <format> ::= {TIFF | BMP | BMP8bit | PNG}  
 <area> ::= {GRATicule | SCReen}  
 <palette> ::= {MONochrome | GRAYscale | COLor}

The :DISPlay:DATA? query reads display data from the screen or from one of the trace memories in the instrument. The format for the data transmission is the # format defined in the IEEE 488.2 specification.

If a data format or area is specified, the :DISPlay:DATA query transfers the data directly from the display. If neither the data format nor the area is specified, the query transfers data from the trace memory specified by the :DISPlay:SOURce command.

Screen data is the full display and is high resolution in grayscale or color. The :HARDcopy:INKSaver setting also affects the screen data. It may be read from the instrument in 24-bit bmp, 8-bit bmp, or 24-bit png format. This data cannot be sent back to the instrument.

Graticule data is a low resolution bitmap of the graticule area in TIFF format. You can get this data and send it back to the oscilloscope.

**NOTE**

If the format is TIFF, the only valid value area parameter is GRATICule, and the only valid palette parameter is MONOchrome.

If the format is something other than TIFF, the only valid area parameter is SCReen, and the only valid values for palette are GRAYscale or COLor.

**Return Format** <display data><NL>

<display data> ::= binary block data in IEEE-488.2 # format.

- See Also**
- ["Introduction to :DISPlay Commands"](#) on page 223
  - [":DISPlay:SOURce"](#) on page 231
  - [":HARDcopy:INKSaver"](#) on page 266
  - [":MERGe"](#) on page 154
  - [":PRINT"](#) on page 169
  - ["\\*RCL \(Recall\)"](#) on page 124
  - ["\\*SAV \(Save\)"](#) on page 128
  - [":VIEW"](#) on page 176

**Example Code**

```
' IMAGE_TRANSFER - In this example, we will query for the image data
' with ":DISPLAY:DATA?", read the data, and then save it to a file.
Dim byteData() As Byte
myScope.IO.Timeout = 15000
myScope.WriteString ":DISPLAY:DATA? BMP, SCREEN, COLOR"
byteData = myScope.ReadIEEEBlock(BinaryType_UI1)
' Output display data to a file:
strPath = "c:\scope\data\screen.bmp"
' Remove file if it exists.
If Len(Dir(strPath)) Then
    Kill strPath
End If
Close #1 ' If #1 is open, close it.
Open strPath For Binary Access Write Lock Write As #1 ' Open file f
or output.
Put #1, , byteData ' Write data.
Close #1 ' Close file.
myScope.IO.Timeout = 5000
```

Example program from the start: ["VISA COM Example in Visual Basic"](#) on page 776

## :DISPlay:LABel

**N** (see [page 750](#))

**Command Syntax** :DISPlay:LABel <value>  
<value> ::= {{1 | ON} | {0 | OFF}}

The :DISPlay:LABel command turns the analog channel labels on and off.

**Query Syntax** :DISPlay:LABel?

The :DISPlay:LABel? query returns the display mode of the analog channel labels.

**Return Format** <value><NL>  
<value> ::= {0 | 1}

- See Also**
- ["Introduction to :DISPlay Commands"](#) on page 223
  - [":CHANnel<n>:LABel"](#) on page 211

**Example Code**

```
' DISP_LABEL (not executed in this example)
' - Turns label names ON or OFF on the analyzer display.
myScope.WriteString ":DISPLAY:LABEL ON" ' Turn on labels.
```

Example program from the start: ["VISA COM Example in Visual Basic"](#) on page 776

**:DISPlay:LABList**

**N** (see [page 750](#))

**Command Syntax** :DISPlay:LABList <binary block data>

<binary block> ::= an ordered list of up to 75 labels, a maximum of 10 characters each, separated by newline characters.

The :DISPlay:LABList command adds labels to the label list. Labels are added in alphabetical order.

**NOTE**

Labels that begin with the same alphabetic base string followed by decimal digits are considered duplicate labels. Duplicate labels are not added to the label list. For example, if label "A0" is in the list and you try to add a new label called "A123456789", the new label is not added.

**Query Syntax** :DISPlay:LABList?

The :DISPlay:LABList? query returns the alphabetical label list.

**Return Format** <binary block><NL>

<binary block> ::= an ordered list of up to 75 labels, a maximum of 10 characters each, separated by newline characters.

- See Also**
- "[Introduction to :DISPlay Commands](#)" on page 223
  - "[:DISPlay:LABel](#)" on page 228
  - "[:CHANnel<n>:LABel](#)" on page 211

## :DISPlay:PERStence

**N** (see [page 750](#))

**Command Syntax** :DISPlay:PERStence <value>  
<value> ::= {MINimum | INFinite}

The :DISPlay:PERStence command specifies the persistence setting. MINimum indicates zero persistence and INFinite indicates infinite persistence. Use the :DISPlay:CLEar or :CDISplay root command to erase points stored by infinite persistence.

**Query Syntax** :DISPlay:PERStence?

The :DISPlay:PERStence? query returns the specified persistence value.

**Return Format** <value><NL>  
<value> ::= {MIN | INF}

- See Also**
- "[Introduction to :DISPlay Commands](#)" on page 223
  - "[:DISPlay:CLEar](#)" on page 225
  - "[:CDISplay](#)" on page 145

**:DISPlay:SOURce**

**N** (see [page 750](#))

**Command Syntax** :DISPlay:SOURce <value>

```
<value> ::= {PMEMory0 | PMEMory1 | PMEMory2 | PMEMory3 | PMEMory4
            | PMEMory5 | PMEMory6 | PMEMory7 | PMEMory8 | PMEMory9}
```

```
PMEMory0-9 ::= pixel memory 0 through 9
```

The :DISPlay:SOURce command specifies the default source and destination for the :DISPlay:DATA command and query. PMEMory0-9 correspond to the INTERN\_0-9 files found in the front panel Save/Recall menu.

**Query Syntax** :DISPlay:SOURce?

The :DISPlay:SOURce? query returns the specified SOURCE.

**Return Format** <value><NL>

```
<value> ::= {PMEM0 | PMEM1 | PMEM2 | PMEM3 | PMEM4 | PMEM5 | PMEM6
            | PMEM7 | PMEM8 | PMEM9}
```

- See Also**
- ["Introduction to :DISPlay Commands"](#) on page 223
  - [":DISPlay:DATA"](#) on page 226

## :DISPlay:VECTors

**N** (see [page 750](#))

**Command Syntax** :DISPlay:VECTors <vectors>

<vectors> ::= {{1 | ON} | {0 | OFF}}

The :DISPlay:VECTors command turns vector display on or off. When vectors are turned on, the oscilloscope displays lines connecting sampled data points. When vectors are turned off, only the sampled data is displayed.

**Query Syntax** :DISPlay:VECTors?

The :DISPlay:VECTors? query returns whether vector display is on or off.

**Return Format** <vectors><NL>

<vectors> ::= {1 | 0}

**See Also** • ["Introduction to :DISPlay Commands"](#) on page 223

## :EXternal Trigger Commands

Control the input characteristics of the external trigger input. See "[Introduction to :EXternal Trigger Commands](#)" on page 233.

**Table 57** :EXternal Trigger Commands Summary

| Command   | Query   | Options and Query Returns  |
|---|---|--|
| :EXternal:BWLimit<br><bwlimit> (see <a href="#">page 235</a> )          | :EXternal:BWLimit?<br>(see <a href="#">page 235</a> )     | <bwlimit> ::= {0   OFF}  |
| :EXternal:IMPedance<br><value> (see <a href="#">page 236</a> )          | :EXternal:IMPedance?<br>(see <a href="#">page 236</a> )   | <impedance> ::= {ONEMeg   FIFTy}   |
| :EXternal:PROBe<br><attenuation> (see <a href="#">page 237</a> )        | :EXternal:PROBe? (see <a href="#">page 237</a> )          | <attenuation> ::= probe attenuation ratio in NR3 format                            |
| n/a   | :EXternal:PROBe:ID?<br>(see <a href="#">page 238</a> )    | <probe id> ::= unquoted ASCII string up to 11 characters                           |
| :EXternal:PROBe:STYPe<br><signal type> (see <a href="#">page 239</a> )  | :EXternal:PROBe:STYPe?<br>(see <a href="#">page 239</a> ) | <signal type> ::= {DIFFerential   SINGle}  |
| :EXternal:PROTection[<br>:CLEar] (see <a href="#">page 240</a> )        | :EXternal:PROTection?<br>(see <a href="#">page 240</a> )  | {NORM   TRIP}  |
| :EXternal:RANGe<br><range>[<suffix>]<br>(see <a href="#">page 241</a> ) | :EXternal:RANGe? (see <a href="#">page 241</a> )          | <range> ::= vertical full-scale range value in NR3 format<br><suffix> ::= {V   mV} |
| :EXternal:UNITs<br><units> (see <a href="#">page 242</a> )              | :EXternal:UNITs? (see <a href="#">page 242</a> )          | <units> ::= {VOLT   AMPere}  |

**Introduction to :EXternal Trigger Commands** The EXternal trigger subsystem commands control the input characteristics of the external trigger input. The probe factor, impedance, input range, input protection state, units, and bandwidth limit settings may all be queried. Depending on the instrument type, some settings may be changeable.

### Reporting the Setup

Use :EXternal? to query setup information for the EXternal subsystem.

### Return Format

## 5 Commands by Subsystem

The following is a sample response from the :EXTERNAL query. In this case, the query was issued following a \*RST command.

```
:EXT:BWL 0;IMP ONEM;RANG +8.0E+00;UNIT VOLT;PROB +1.0E+00;PROB:STYP SING
```

**:EXternal:BWLimit**

**C** (see [page 750](#))

**Command Syntax** :EXternal:BWLimit <bwlimit>

<bwlimit> ::= {0 | OFF}

The :EXternal:BWLimit command is provided for product compatibility. The only legal value is 0 or OFF. Use the :TRIGger:HFReject command to limit bandwidth on the external trigger input.

**Query Syntax** :EXternal:BWLimit?

The :EXternal:BWLimit? query returns the current setting of the low-pass filter (always 0).

**Return Format** <bwlimit><NL>

<bwlimit> ::= 0

- See Also**
- ["Introduction to :EXternal Trigger Commands"](#) on page 233
  - ["Introduction to :TRIGger Commands"](#) on page 440
  - [":TRIGger:HFReject"](#) on page 444

## :EXternal:IMPedance

**C** (see [page 750](#))

**Command Syntax** :EXternal:IMPedance <value>  
<value> ::= {ONEMeg | FIFTy}

The :EXternal:IMPedance command selects the input impedance setting for the external trigger. The legal values for this command are ONEMeg (1 MΩ) and FIFTy (50Ω).

**Query Syntax** :EXternal:IMPedance?

The :EXternal:IMPedance? query returns the current input impedance setting for the external trigger.

**Return Format** <impedance value><NL>  
<impedance value> ::= {ONEM | FIFT}

- See Also**
- ["Introduction to :EXternal Trigger Commands"](#) on page 233
  - ["Introduction to :TRIGger Commands"](#) on page 440
  - [":CHANnel<n>:IMPedance"](#) on page 209

**:EXtErnal:PROBe**

**C** (see [page 750](#))

**Command Syntax** :EXtErnal:PROBe <attenuation>

<attenuation> ::= probe attenuation ratio in NR3 format

The :EXtErnal:PROBe command specifies the probe attenuation factor for the external trigger. The probe attenuation factor may be 0.1 to 1000. This command does not change the actual input sensitivity of the oscilloscope. It changes the reference constants for scaling the display factors and for setting trigger levels.

If an AutoProbe probe is connected to the oscilloscope, the attenuation value cannot be changed from the sensed value. Attempting to set the oscilloscope to an attenuation value other than the sensed value produces an error.

**Query Syntax** :EXtErnal:PROBe?

The :EXtErnal:PROBe? query returns the current probe attenuation factor for the external trigger.

**Return Format** <attenuation><NL>

<attenuation> ::= probe attenuation ratio in NR3 format

- See Also**
- ["Introduction to :EXtErnal Trigger Commands"](#) on page 233
  - [":EXtErnal:RANGe"](#) on page 241
  - ["Introduction to :TRIGger Commands"](#) on page 440
  - [":CHANnel<n>:PROBe"](#) on page 213

## **:EXternal:PROBe:ID**

**C** (see [page 750](#))

**Query Syntax** :EXternal:PROBe:ID?

The :EXternal:PROBe:ID? query returns the type of probe attached to the external trigger input.

**Return Format** <probe id><NL>

<probe id> ::= unquoted ASCII string up to 11 characters

Some of the possible returned values are:

- 1131A
- 1132A
- 1134A
- 1147A
- 1153A
- 1154A
- 1156A
- 1157A
- 1158A
- 1159A
- AutoProbe
- E2621A
- E2622A
- E2695A
- E2697A
- HP1152A
- HP1153A
- NONE
- Probe
- Unknown
- Unsupported

**See Also** • ["Introduction to :EXternal Trigger Commands"](#) on page 233

**:EXternal:PROBe:STYPe**

**C** (see [page 750](#))

**Command Syntax****NOTE**

This command is valid only for the 113xA Series probes.

```
:EXternal:PROBe:STYPe <signal type>
<signal type> ::= {DIFFerential | SINGle}
```

The :EXternal:PROBe:STYPe command sets the external trigger probe signal type (STYPe) to differential or single-ended when using the 113xA Series probes and determines how offset is applied.

**Query Syntax** :EXternal:PROBe:STYPe?

The :EXternal:PROBe:STYPe? query returns the current probe signal type setting for the external trigger.

**Return Format** <signal type><NL>

```
<signal type> ::= {DIFF | SING}
```

**See Also** • ["Introduction to :EXternal Trigger Commands"](#) on page 233

## :EXternal:PROtection

**N** (see [page 750](#))

**Command Syntax** :EXternal:PROtection[:CLEar]

When the external trigger input impedance is set to 50Ω, the external trigger input is protected against overvoltage. When an overvoltage condition is sensed, the input impedance for the external trigger is automatically changed to 1 MΩ. The :EXternal:PROtection[:CLEar] command is used to clear (reset) the overload protection. It allows the external trigger to be used again in 50Ω mode after the signal that caused the overload has been removed from the external trigger input. Reset the external trigger input impedance to 50Ω (see ":EXternal:IMPedance" on [page 236](#)) after clearing the overvoltage protection.

**Query Syntax** :EXternal:PROtection?

The :EXternal:PROtection query returns the state of the input protection for external trigger. If the external trigger input has experienced an overload, TRIP (tripped) will be returned; otherwise NORM (normal) is returned.

**Return Format** {NORM | TRIP}<NL>

- See Also**
- "[Introduction to :EXternal Trigger Commands](#)" on [page 233](#)
  - "[:EXternal:IMPedance](#)" on [page 236](#)
  - "[:EXternal:PROBe](#)" on [page 237](#)

**:EXtErnal:RANGe**

**C** (see [page 750](#))

**Command Syntax** :EXtErnal:RANGe <range>[<suffix>]

<range> ::= vertical full-scale range value in NR3 format

<suffix> ::= {V | mV}

The :EXtErnal:RANGe command is provided for product compatibility. When using 1:1 probe attenuation:

- In 2-channel models, the range can be set to 1.0 V or 8.0 V.
- In 4-channel models, the range can only be set to 5.0 V.

If the probe attenuation is changed, the range value is multiplied by the probe attenuation factor.

**Query Syntax** :EXtErnal:RANGe?

The :EXtErnal:RANGe? query returns the current full-scale range setting for the external trigger.

**Return Format** <range\_argument><NL>

<range\_argument> ::= external trigger range value in NR3 format

- See Also**
- ["Introduction to :EXtErnal Trigger Commands"](#) on page 233
  - [":EXtErnal:PROBe"](#) on page 237
  - ["Introduction to :TRIGger Commands"](#) on page 440

## :EXtErnal:UNITs

**N** (see [page 750](#))

**Command Syntax** :EXtErnal:UNITs <units>  
<units> ::= {VOLT | AMPere}

The :EXtErnal:UNITs command sets the measurement units for the probe connected to the external trigger input. Select VOLT for a voltage probe and select AMPere for a current probe. Measurement results, channel sensitivity, and trigger level will reflect the measurement units you select.

**Query Syntax** :EXtErnal:UNITs?

The :CHANnel<n>:UNITs? query returns the current units setting for the external trigger.

**Return Format** <units><NL>  
<units> ::= {VOLT | AMP}

- See Also**
- ["Introduction to :EXtErnal Trigger Commands"](#) on page 233
  - ["Introduction to :TRIGger Commands"](#) on page 440
  - [":EXtErnal:RANGe"](#) on page 241
  - [":EXtErnal:PROBe"](#) on page 237
  - [":CHANnel<n>:UNITs"](#) on page 221

## :FUNCTION Commands

Control functions in the measurement/storage module. See "Introduction to :FUNCTION Commands" on page 245.

**Table 58** :FUNCTION Commands Summary

| Command  | Query  | Options and Query Returns   |
|--|--|---|
| :FUNCTION:CENter<br><frequency> (see page 246)             | :FUNCTION:CENter?<br>(see page 246)          | <frequency> ::= the current center frequency in NR3 format. The range of legal values is from 0 Hz to 25 GHz.                                     |
| :FUNCTION:DISPlay {{0   OFF}   {1   ON}}<br>(see page 247) | :FUNCTION:DISPlay?<br>(see page 247)         | {0   1}   |
| :FUNCTION:GOFT:OPERat ion <operation> (see page 248)       | :FUNCTION:GOFT:OPERat ion?<br>(see page 248) | <operation> ::= {ADD   SUBtract   MULTiply}   |
| :FUNCTION:GOFT:SOURce 1 <source> (see page 249)            | :FUNCTION:GOFT:SOURce 1?<br>(see page 249)   | <source> ::= CHANnel<n><br><n> ::= {1   2   3   4} for 4ch models<br><n> ::= {1   2} for 2ch models   |
| :FUNCTION:GOFT:SOURce 2 <source> (see page 250)            | :FUNCTION:GOFT:SOURce 2?<br>(see page 250)   | <source> ::= CHANnel<n><br><n> ::= {{1   2}   {3   4}} for 4ch models, depending on SOURce1 selection<br><n> ::= {1   2} for 2ch models           |
| :FUNCTION:OFFSet <offset> (see page 251)                   | :FUNCTION:OFFSet?<br>(see page 251)          | <offset> ::= the value at center screen in NR3 format. The range of legal values is +/-10 times the current sensitivity of the selected function. |
| :FUNCTION:OPERation <operation> (see page 252)             | :FUNCTION:OPERation?<br>(see page 252)       | <operation> ::= {ADD   SUBtract   MULTiply   INTegrate   DIFFerentiate   FFT   SQRT}  |

**Table 58** :FUNCTION Commands Summary (continued)

| Command   | Query                               | Options and Query Returns   |
|---|-------------------------------------|---|
| :FUNCTION:RANGE<br><range> (see page 253)                 | :FUNCTION:RANGE? (see page 253)     | <range> ::= the full-scale vertical axis value in NR3 format.<br>The range for ADD, SUBT, MULT is 8E-6 to 800E+3. The range for the INTEGRATE function is 8E-9 to 400E+3.<br>The range for the DIFFERENTIATE function is 80E-3 to 8.0E12 (depends on current sweep speed).<br>The range for the FFT function is 8 to 800 dBV. |
| :FUNCTION:REFERENCE<br><level> (see page 254)             | :FUNCTION:REFERENCE? (see page 254) | <level> ::= the value at center screen in NR3 format.<br>The range of legal values is +/-10 times the current sensitivity of the selected function.   |
| :FUNCTION:SCALE<br><scale value>[<suffix>] (see page 255) | :FUNCTION:SCALE? (see page 255)     | <scale value> ::= integer in NR1 format<br><suffix> ::= {V   dB}  |
| :FUNCTION:SOURCE1<br><source> (see page 256)              | :FUNCTION:SOURCE1? (see page 256)   | <source> ::= {CHANNEL<n>   GOFT}<br><n> ::= {1   2   3   4} for 4ch models<br><n> ::= {1   2} for 2ch models<br>GOFT is only for FFT, INTEGRATE, DIFFERENTIATE, and SQRT operations.  |
| :FUNCTION:SOURCE2<br><source> (see page 257)              | :FUNCTION:SOURCE2? (see page 257)   | <source> ::= {CHANNEL<n>   NONE}<br><n> ::= {{1   2}   {3   4}} for 4ch models, depending on SOURCE1 selection<br><n> ::= {1   2} for 2ch models  |
| :FUNCTION:SPAN <span><br>(see page 258)                   | :FUNCTION:SPAN? (see page 258)      | <span> ::= the current frequency span in NR3 format.<br>Legal values are 1 Hz to 100 GHz.   |
| :FUNCTION:WINDOW<br><window> (see page 259)               | :FUNCTION:WINDOW? (see page 259)    | <window> ::= {RECTANGULAR   HANNING   FLATTOP   BHARRIS}  |

**Introduction to :FUNCTION Commands** The FUNCTION subsystem controls the math functions in the oscilloscope. Add, subtract, multiply, differentiate, integrate, square root, and FFT (Fast Fourier Transform) operations are available. These math operations only use the analog (vertical) channels.

The SOURce1, DISPlay, RANGE, and OFFSet commands apply to any function. The SPAN, CENTER, and WINDow commands are only useful for FFT functions. When FFT is selected, the cursors change from volts and time to decibels (dB) and frequency (Hz).

#### Reporting the Setup

Use :FUNCTION? to query setup information for the FUNCTION subsystem.

#### Return Format

The following is a sample response from the :FUNCTION? queries. In this case, the query was issued following a \*RST command.

```
:FUNC:OPER ADD;DISP 0;SOUR1 CHAN1;SOUR2 CHAN2;RANG +8.00E+00;OFFS  
+0.0E+00;:FUNC:GOFT:OPER ADD;SOUR1 CHAN1;SOUR2 CHAN2
```

## :FUNCTION:CENTer

**N** (see [page 750](#))

**Command Syntax** :FUNCTION:CENTer <frequency>

<frequency> ::= the current center frequency in NR3 format. The range of legal values is from 0 Hz to 25 GHz.

The :FUNCTION:CENTer command sets the center frequency when FFT (Fast Fourier Transform) is selected.

**Query Syntax** :FUNCTION:CENTer?

The :FUNCTION:CENTer? query returns the current center frequency in Hertz.

**Return Format** <frequency><NL>

<frequency> ::= the current center frequency in NR3 format. The range of legal values is from 0 Hz to 25 GHz.

### NOTE

After a \*RST (Reset) or :AUToscale command, the values returned by the :FUNCTION:CENTer? and :FUNCTION:SPAN? queries depend on the current :TIMEbase:RANGe value. Once you change either the :FUNCTION:CENTer or :FUNCTION:SPAN value, they no longer track the :TIMEbase:RANGe value.

- See Also**
- "[Introduction to :FUNCTION Commands](#)" on page 245
  - "[:FUNCTION:SPAN](#)" on page 258
  - "[:TIMEbase:RANGe](#)" on page 433
  - "[:TIMEbase:SCALE](#)" on page 435

**:FUNCTION:DISPlay**

**N** (see [page 750](#))

**Command Syntax** :FUNCTION:DISPlay <display>  
 <display> ::= {{1 | ON} | {0 | OFF}}

The :FUNCTION:DISPlay command turns the display of the function on or off. When ON is selected, the function performs as specified using the other FUNCTION commands. When OFF is selected, function is neither calculated nor displayed.

**Query Syntax** :FUNCTION:DISPlay?

The :FUNCTION:DISPlay? query returns whether the function display is on or off.

**Return Format** <display><NL>  
 <display> ::= {1 | 0}

- See Also**
- ["Introduction to :FUNCTION Commands"](#) on page 245
  - [":VIEW"](#) on page 176
  - [":BLANK"](#) on page 144
  - [":STATus"](#) on page 173

## :FUNCTION:GOFT:OPERation

**N** (see [page 750](#))

**Command Syntax** :FUNCTION:GOFT:OPERation <operation>

<operation> ::= {ADD | SUBTract | MULTiPLY}

The :FUNCTION:GOFT:OPERation command sets the math operation for the g(t) source that can be used as the input to the FFT, INTegrate, DIFFerentiate, or SQRT functions:

- ADD – Source1 + source2.
- SUBTract – Source1 - source2.
- MULTiPLY – Source1 \* source2.

The :FUNCTION:GOFT:SOURce1 and :FUNCTION:GOFT:SOURce2 commands are used to select source1 and source2.

**Query Syntax** :FUNCTION:GOFT:OPERation?

The :FUNCTION:GOFT:OPERation? query returns the current g(t) source operation setting.

**Return Format** <operation><NL>

<operation> ::= {ADD | SUBT | MULT}

- See Also**
- ["Introduction to :FUNCTION Commands"](#) on page 245
  - [":FUNCTION:GOFT:SOURce1"](#) on page 249
  - [":FUNCTION:GOFT:SOURce2"](#) on page 250
  - [":FUNCTION:SOURce1"](#) on page 256

**:FUNCTION:GOFT:SOURce1**

**N** (see [page 750](#))

**Command Syntax** :FUNCTION:GOFT:SOURce1 <value>  
 <value> ::= CHANnel<n>  
 <n> ::= {1 | 2 | 3 | 4} for 4ch models  
 <n> ::= {1 | 2} for 2ch models

The :FUNCTION:GOFT:SOURce1 command selects the first input channel for the g(t) source that can be used as the input to the FFT, INTEGRate, DIFFerentiate, or SQRT functions.

**Query Syntax** :FUNCTION:GOFT:SOURce1?

The :FUNCTION:GOFT:SOURce1? query returns the current selection for the first input channel for the g(t) source.

**Return Format** <value><NL>  
 <value> ::= CHAN<n>  
 <n> ::= {1 | 2 | 3 | 4} for the 4ch models  
 <n> ::= {1 | 2} for the 2ch models

- See Also**
- ["Introduction to :FUNCTION Commands"](#) on page 245
  - [":FUNCTION:GOFT:SOURce2"](#) on page 250
  - [":FUNCTION:GOFT:OPERation"](#) on page 248

**:FUNCTION:GOFT:SOURce2**

**N** (see [page 750](#))

**Command Syntax** :FUNCTION:GOFT:SOURce2 <value>

<value> ::= CHANnel<n>

<n> ::= {{1 | 2} | {3 | 4}} for 4ch models, depending on SOURce1 selection

<n> ::= {1 | 2} for 2ch models

The :FUNCTION:GOFT:SOURce2 command selects the second input channel for the g(t) source that can be used as the input to the FFT, INTegrate, DIFFerentiate, or SQRT functions.

If CHANnel1 or CHANnel2 is selected for :FUNCTION:GOFT:SOURce1, the SOURce2 selection can be CHANnel1 or CHANnel2. Likewise, if CHANnel3 or CHANnel4 is selected for :FUNCTION:GOFT:SOURce1, the SOURce2 selection can be CHANnel3 or CHANnel4.

**Query Syntax** :FUNCTION:GOFT:SOURce2?

The :FUNCTION:GOFT:SOURce2? query returns the current selection for the second input channel for the g(t) source.

**Return Format** <value><NL>

<value> ::= CHAN<n>

<n> ::= {{1 | 2} | {3 | 4}} for 4ch models, depending on SOURce1 selection

<n> ::= {1 | 2} for 2ch models

- See Also**
- ["Introduction to :FUNCTION Commands"](#) on page 245
  - [":FUNCTION:GOFT:SOURce1"](#) on page 249
  - [":FUNCTION:GOFT:OPERation"](#) on page 248

**:FUNCTION:OFFSet**

**N** (see [page 750](#))

**Command Syntax** :FUNCTION:OFFSet <offset>

<offset> ::= the value at center screen in NR3 format.

The :FUNCTION:OFFSet command sets the voltage or vertical value represented at center screen for the selected function. The range of legal values is generally +/- 10 times the current scale of the selected function, but will vary by function. If you set the offset to a value outside of the legal range, the offset value is automatically set to the nearest legal value.

**NOTE**

The :FUNCTION:OFFSet command is equivalent to the :FUNCTION:REFerence command.

**Query Syntax** :FUNCTION:OFFSet?

The :FUNCTION:OFFSet? query outputs the current offset value for the selected function.

**Return Format** <offset><NL>

<offset> ::= the value at center screen in NR3 format.

- See Also**
- ["Introduction to :FUNCTION Commands"](#) on page 245
  - [":FUNCTION:RANGE"](#) on page 253
  - [":FUNCTION:REFerence"](#) on page 254
  - [":FUNCTION:SCALE"](#) on page 255

**:FUNCTION:OPERation**

**N** (see [page 750](#))

**Command Syntax** :FUNCTION:OPERation <operation>  
 <operation> ::= {ADD | SUBtract | MULTiply | INTegrate | DIFFerentiate  
 | FFT | SQRT}

The :FUNCTION:OPERation command sets the desired waveform math operation:

- ADD – Source1 + source2.
- SUBtract – Source1 - source2.
- MULTiply – Source1 \* source2.
- INTegrate – Integrate the selected waveform source.
- DIFFerentiate – Differentiate the selected waveform source.
- FFT – Fast Fourier Transform on the selected waveform source.
- SQRT – Square root on the selected waveform source.

When the operation is ADD, SUBtract, or MULTiply, the :FUNCTION:SOURce1 and :FUNCTION:SOURce2 commands are used to select source1 and source2. For all other operations, the :FUNCTION:SOURce1 command selects the waveform source.

**Query Syntax** :FUNCTION:OPERation?

The :FUNCTION:OPERation? query returns the current operation for the selected function.

**Return Format** <operation><NL>  
 <operation> ::= {ADD | SUBT | MULT | INT | DIFF | FFT | SQRT}

- See Also**
- ["Introduction to :FUNCTION Commands"](#) on page 245
  - [":FUNCTION:SOURce1"](#) on page 256
  - [":FUNCTION:SOURce2"](#) on page 257

**:FUNCTION:RANGe**

**N** (see [page 750](#))

**Command Syntax** :FUNCTION:RANGe <range>

<range> ::= the full-scale vertical axis value in NR3 format.

The :FUNCTION:RANGe command defines the full-scale vertical axis for the selected function.

**Query Syntax** :FUNCTION:RANGe?

The :FUNCTION:RANGe? query returns the current full-scale range value for the selected function.

**Return Format** <range><NL>

<range> ::= the full-scale vertical axis value in NR3 format.

The range for ADD, SUBT, MULT is 8E-6 to 800E+3.

The range for the INTegrate function is 8E-9 to 400E+3 (depends on sweep speed).

The range for the DIFFerentiate function is 80E-3 to 8.0E12 (depends on sweep speed).

The range for the FFT (Fast Fourier Transform) function is 8 to 800 dBV.

- See Also**
- "Introduction to :FUNCTION Commands" on page 245
  - ":FUNCTION:SCALE" on page 255

## :FUNCTION:REFERENCE

**N** (see [page 750](#))

**Command Syntax** :FUNCTION:REFERENCE <level>

<level> ::= the current reference level in NR3 format.

The :FUNCTION:REFERENCE command sets the voltage or vertical value represented at center screen for the selected function. The range of legal values is generally +/- 10 times the current scale of the selected function, but will vary by function. If you set the reference level to a value outside of the legal range, the level is automatically set to the nearest legal value.

**NOTE**

The FUNCTION:REFERENCE command is equivalent to the :FUNCTION:OFFSET command.

---

**Query Syntax** :FUNCTION:REFERENCE?

The :FUNCTION:REFERENCE? query outputs the current reference level value for the selected function.

**Return Format** <level><NL>

<level> ::= the current reference level in NR3 format.

- See Also**
- ["Introduction to :FUNCTION Commands"](#) on page 245
  - [":FUNCTION:OFFSET"](#) on page 251
  - [":FUNCTION:RANGE"](#) on page 253
  - [":FUNCTION:SCALE"](#) on page 255

**:FUNCTION:SCALE**

**N** (see [page 750](#))

**Command Syntax** :FUNCTION:SCALE <scale value>[<suffix>]  
 <scale value> ::= integer in NR1 format  
 <suffix> ::= {V | dB}

The :FUNCTION:SCALE command sets the vertical scale, or units per division, of the selected function. Legal values for the scale depend on the selected function.

**Query Syntax** :FUNCTION:SCALE?

The :FUNCTION:SCALE? query returns the current scale value for the selected function.

**Return Format** <scale value><NL>  
 <scale value> ::= integer in NR1 format

- See Also**
- ["Introduction to :FUNCTION Commands"](#) on page 245
  - [":FUNCTION:RANGE"](#) on page 253

**:FUNCTION:SOURce1**

**N** (see [page 750](#))

**Command Syntax** :FUNCTION:SOURce1 <value>  
 <value> ::= {CHANnel<n> | GOFT}  
 <n> ::= {1 | 2 | 3 | 4} for 4ch models  
 <n> ::= {1 | 2} for 2ch models

The :FUNCTION:SOURce1 command is used for any :FUNCTION:OPERation selection (including the ADD, SUBTract, or MULTiPLY channel math operations and the FFT, INTegrate, DIFFerentiate, or SQRT transforms). This command selects the first source for channel math operations or the single source for the transforms.

The GOFT parameter is only available for the FFT, INTegrate, DIFFerentiate, or SQRT functions. It lets you specify, as the function input source, the addition, subtraction, or multiplication of two channels. When GOFT is used, the g(t) source is specified by the :FUNCTION:GOFT:OPERation, :FUNCTION:GOFT:SOURce1, and :FUNCTION:GOFT:SOURce2 commands.

**NOTE**

Another shorthand notation for SOURce1 in this command/query (besides SOUR1) is SOUR.

**Query Syntax** :FUNCTION:SOURce1?

The :FUNCTION:SOURce1? query returns the current source1 for function operations.

**Return Format** <value><NL>  
 <value> ::= {CHAN<n> | GOFT}  
 <n> ::= {1 | 2 | 3 | 4} for 4ch models  
 <n> ::= {1 | 2} for 2ch models

- See Also**
- "[Introduction to :FUNCTION Commands](#)" on page 245
  - "[:FUNCTION:OPERation](#)" on page 252
  - "[:FUNCTION:GOFT:OPERation](#)" on page 248
  - "[:FUNCTION:GOFT:SOURce1](#)" on page 249
  - "[:FUNCTION:GOFT:SOURce2](#)" on page 250

**:FUNCTION:SOURce2**

**N** (see [page 750](#))

**Command Syntax** :FUNCTION:SOURce2 <value>

<value> ::= {CHANnel<n> | NONE}

<n> ::= {{1 | 2} | {3 | 4}} for 4ch models, depending on SOURce1 selection

<n> ::= {1 | 2} for 2ch models

The :FUNCTION:SOURce2 command is only used when an FFT (Fast Fourier Transform), DIFF, or INT operation is selected (see the:FUNCTION:OPERation command for more information about selecting an operation). The :FUNCTION:SOURce2 command selects the source for function operations. Choose CHANnel<n>, or ADD, SUBT, or MULT to specify the desired source for function DIFFerentiate, INTegrate, and FFT operations specified by the :FUNCTION:OPERation command.

If CHANnel1 or CHANnel2 is selected for :FUNCTION:SOURce1, the SOURce2 selection can be CHANnel1 or CHANnel2. Likewise, if CHANnel3 or CHANnel4 is selected for :FUNCTION:SOURce1, the SOURce2 selection can be CHANnel3 or CHANnel4.

**Query Syntax** :FUNCTION:SOURce2?

The :FUNCTION:SOURce2? query returns the second source for function operations on two waveforms.

**Return Format** <value><NL>

<value> ::= {CHAN<n> | NONE}

<n> ::= {{1 | 2} | {3 | 4}} for 4ch models, depending on SOURce1 selection

<n> ::= {1 | 2} for 2ch models

- See Also**
- ["Introduction to :FUNCTION Commands"](#) on page 245
  - [":FUNCTION:OPERation"](#) on page 252

## :FUNCTION:SPAN

**N** (see [page 750](#))

**Command Syntax** :FUNCTION:SPAN <span>

<span> ::= the current frequency span in NR3 format. Legal values are 1 Hz to 100 GHz.

If you set the frequency span to a value outside of the legal range, the step size is automatically set to the nearest legal value.

The :FUNCTION:SPAN command sets the frequency span of the display (left graticule to right graticule) when FFT (Fast Fourier Transform) is selected.

**Query Syntax** :FUNCTION:SPAN?

The :FUNCTION:SPAN? query returns the current frequency span in Hertz.

### NOTE

After a \*RST (Reset) or :AUTOScale command, the values returned by the :FUNCTION:CENTer? and :FUNCTION:SPAN? queries depend on the current :TIMEbase:RANGe value. Once you change either the :FUNCTION:CENTer or :FUNCTION:SPAN value, they no longer track the :TIMEbase:RANGe value.

**Return Format** <span><NL>

<span> ::= the current frequency span in NR3 format. Legal values are 1 Hz to 100 GHz.

- See Also**
- ["Introduction to :FUNCTION Commands"](#) on page 245
  - [":FUNCTION:CENTer"](#) on page 246
  - [":TIMEbase:RANGe"](#) on page 433
  - [":TIMEbase:SCALE"](#) on page 435

**:FUNCTION:WINDow**

**N** (see [page 750](#))

**Command Syntax** :FUNCTION:WINDow <window>

<window> ::= {RECTangular | HANNing | FLATtop | BHARris}

The :FUNCTION:WINDow command allows the selection of four different windowing transforms or operations for the FFT (Fast Fourier Transform) function.

The FFT operation assumes that the time record repeats. Unless an integral number of sampled waveform cycles exist in the record, a discontinuity is created between the end of one record and the beginning of the next. This discontinuity introduces additional frequency components about the peaks into the spectrum. This is referred to as leakage. To minimize leakage, windows that approach zero smoothly at the start and end of the record are employed as filters to the FFTs. Each window is useful for certain classes of input signals.

- RECTangular – useful for transient signals, and signals where there are an integral number of cycles in the time record.
- HANNing – useful for frequency resolution and general purpose use. It is good for resolving two frequencies that are close together, or for making frequency measurements. This is the default window.
- FLATtop – best for making accurate amplitude measurements of frequency peaks.
- BHARris (Blackman-Harris) – reduces time resolution compared to the rectangular window, but it improves the capacity to detect smaller impulses due to lower secondary lobes (provides minimal spectral leakage).

**Query Syntax** :FUNCTION:WINDow?

The :FUNCTION:WINDow? query returns the value of the window selected for the FFT function.

**Return Format** <window><NL>

<window> ::= {RECT | HANN | FLAT | BHAR}

**See Also** • ["Introduction to :FUNCTION Commands"](#) on page 245

## :HARDcopy Commands

Set and query the selection of hardcopy device and formatting options. See "[Introduction to :HARDcopy Commands](#)" on page 261.

**Table 59** :HARDcopy Commands Summary

| Command   | Query   | Options and Query Returns   |
|---|---|---|
| :HARDcopy:AREA <area><br>(see <a href="#">page 262</a> )                    | :HARDcopy:AREA? (see <a href="#">page 262</a> )             | <area> ::= SCREEN   |
| :HARDcopy:APRinter<br><active_printer> (see <a href="#">page 263</a> )      | :HARDcopy:APRinter?<br>(see <a href="#">page 263</a> )      | <active_printer> ::= {<index>   <name>}<br><index> ::= integer index of printer in list<br><name> ::= name of printer in list   |
| :HARDcopy:FACTors {{0   OFF}   {1   ON}}<br>(see <a href="#">page 264</a> ) | :HARDcopy:FACTors?<br>(see <a href="#">page 264</a> )       | {0   1}   |
| :HARDcopy:FFEed {{0   OFF}   {1   ON}} (see <a href="#">page 265</a> )      | :HARDcopy:FFEed? (see <a href="#">page 265</a> )            | {0   1}   |
| :HARDcopy:INKSaver {{0   OFF}   {1   ON}} (see <a href="#">page 266</a> )   | :HARDcopy:INKSaver?<br>(see <a href="#">page 266</a> )      | {0   1}   |
| :HARDcopy:LAYout<br><layout> (see <a href="#">page 267</a> )                | :HARDcopy:LAYout?<br>(see <a href="#">page 267</a> )        | <layout> ::= {LANDscape   PORTRait}   |
| :HARDcopy:PALette<br><palette> (see <a href="#">page 268</a> )              | :HARDcopy:PALette?<br>(see <a href="#">page 268</a> )       | <palette> ::= {COLor   GRAYscale   NONE}  |
| n/a   | :HARDcopy:PRINter:LIS<br>T? (see <a href="#">page 269</a> ) | <list> ::= [<printer_spec>] ...<br>[printer_spec]<br><printer_spec> ::=<br>"<index>,<active>,<name>;"<br><index> ::= integer index of printer<br><active> ::= {Y   N}<br><name> ::= name of printer |
| :HARDcopy:STARt (see <a href="#">page 270</a> )                             | n/a   | n/a   |

**Introduction to :HARDcopy Commands** The HARDcopy subsystem provides commands to set and query the selection of hardcopy device and formatting options such as inclusion of instrument settings (FACTors) and generation of formfeed (FFEed).

:HARDC is an acceptable short form for :HARDcopy.

#### Reporting the Setup

Use :HARDcopy? to query setup information for the HARDcopy subsystem.

#### Return Format

The following is a sample response from the :HARDcopy? query. In this case, the query was issued following the \*RST command.

```
:HARD:APR " ";AREA SCR;FACT 0;FFE 0;INKS 1;PAL NONE;LAY PORT
```

## :HARDcopy:AREA

**N** (see [page 750](#))

**Command Syntax** :HARDcopy:AREA <area>  
<area> ::= SCReen

The :HARDcopy:AREA command controls what part of the display area is printed. Currently, the only legal choice is SCReen.

**Query Syntax** :HARDcopy:AREA?

The :HARDcopy:AREA? query returns the selected display area.

**Return Format** <area><NL>

<area> ::= SCR

- See Also**
- ["Introduction to :HARDcopy Commands"](#) on page 261
  - [":HARDcopy:START"](#) on page 270
  - [":HARDcopy:APRinter"](#) on page 263
  - [":HARDcopy:PRINter:LIST"](#) on page 269
  - [":HARDcopy:FACTors"](#) on page 264
  - [":HARDcopy:FFEed"](#) on page 265
  - [":HARDcopy:INKSaver"](#) on page 266
  - [":HARDcopy:LAYout"](#) on page 267
  - [":HARDcopy:PALette"](#) on page 268

**:HARDcopy:APRinter**

**N** (see [page 750](#))

**Command Syntax** :HARDcopy:APRinter <active\_printer>  
 <active\_printer> ::= {<index> | <name>}  
 <index> ::= integer index of printer in list  
 <name> ::= name of printer in list

The :HARDcopy:APRinter command sets the active printer.

**Query Syntax** :HARDcopy:APRinter?

The :HARDcopy:APRinter? query returns the name of the active printer.

**Return Format** <name><NL>  
 <name> ::= name of printer in list

- See Also**
- ["Introduction to :HARDcopy Commands"](#) on page 261
  - [":HARDcopy:PRINter:LIST"](#) on page 269
  - [":HARDcopy:START"](#) on page 270

## :HARDcopy:FACTors

**N** (see [page 750](#))

**Command Syntax** :HARDcopy:FACTors <factors>  
<factors> ::= {{OFF | 0} | {ON | 1}}

The HARDcopy:FACTors command controls whether the scale factors are output on the hardcopy dump.

**Query Syntax** :HARDcopy:FACTors?

The :HARDcopy:FACTors? query returns a flag indicating whether oscilloscope instrument settings are output on the hardcopy.

**Return Format** <factors><NL>  
<factors> ::= {0 | 1}

- See Also**
- "[Introduction to :HARDcopy Commands](#)" on page 261
  - "[:HARDcopy:START](#)" on page 270
  - "[:HARDcopy:FFeEd](#)" on page 265
  - "[:HARDcopy:INKSaver](#)" on page 266
  - "[:HARDcopy:LAYout](#)" on page 267
  - "[:HARDcopy:PALETTE](#)" on page 268

**:HARDcopy:FFeed**

**N** (see [page 750](#))

**Command Syntax** :HARDcopy:FFeed <ffeed>  
 <ffeed> ::= {{OFF | 0} | {ON | 1}}

The HARDcopy:FFeed command controls whether a formfeed is output between the screen image and factors of a hardcopy dump.

ON (or 1) is only valid when PRINter0 or PRINter1 is set as the :HARDcopy:FORMat type.

**Query Syntax** :HARDcopy:FFeed?

The :HARDcopy:FFeed? query returns a flag indicating whether a formfeed is output at the end of the hardcopy dump.

**Return Format** <ffeed><NL>  
 <ffeed> ::= {0 | 1}

- See Also**
- ["Introduction to :HARDcopy Commands"](#) on page 261
  - [":HARDcopy:START"](#) on page 270
  - [":HARDcopy:FACTors"](#) on page 264
  - [":HARDcopy:INKSaver"](#) on page 266
  - [":HARDcopy:LAYout"](#) on page 267
  - [":HARDcopy:PALette"](#) on page 268

## :HARDcopy:INKSaver

**N** (see [page 750](#))

**Command Syntax** :HARDcopy:INKSaver <value>  
<value> ::= {{OFF | 0} | {ON | 1}}

The HARDcopy:INKSaver command controls whether the graticule colors are inverted or not.

**Query Syntax** :HARDcopy:INKSaver?

The :HARDcopy:INKSaver? query returns a flag indicating whether graticule colors are inverted or not.

**Return Format** <value><NL>  
<value> ::= {0 | 1}

- See Also**
- "[Introduction to :HARDcopy Commands](#)" on page 261
  - "[:HARDcopy:START](#)" on page 270
  - "[:HARDcopy:FACTors](#)" on page 264
  - "[:HARDcopy:FFEed](#)" on page 265
  - "[:HARDcopy:LAYout](#)" on page 267
  - "[:HARDcopy:PALETTE](#)" on page 268

**:HARDcopy:LAYout**

**N** (see [page 750](#))

**Command Syntax** :HARDcopy:LAYout <layout>

<layout> ::= {LANDscape | PORTRait}

The :HARDcopy:LAYout command sets the hardcopy layout mode.

**Query Syntax** :HARDcopy:LAYout?

The :HARDcopy:LAYout? query returns the selected hardcopy layout mode.

**Return Format** <layout><NL>

<layout> ::= {LAND | PORT}

- See Also**
- ["Introduction to :HARDcopy Commands"](#) on page 261
  - [":HARDcopy:START"](#) on page 270
  - [":HARDcopy:FACTors"](#) on page 264
  - [":HARDcopy:PALETTE"](#) on page 268
  - [":HARDcopy:FFEEd"](#) on page 265
  - [":HARDcopy:INKSaver"](#) on page 266

## :HARDcopy:PALETTE

**N** (see [page 750](#))

**Command Syntax** :HARDcopy:PALETTE <palette>  
<palette> ::= {COLOR | GRAYscale | NONE}

The :HARDcopy:PALETTE command sets the hardcopy palette color.

### NOTE

If no printer is connected, NONE is the only valid parameter.

---

**Query Syntax** :HARDcopy:PALETTE?

The :HARDcopy:PALETTE? query returns the selected hardcopy palette color.

**Return Format** <palette><NL>  
<palette> ::= {COL | GRAY | NONE}

- See Also**
- "[Introduction to :HARDcopy Commands](#)" on page 261
  - "[:HARDcopy:START](#)" on page 270
  - "[:HARDcopy:FACTors](#)" on page 264
  - "[:HARDcopy:LAYout](#)" on page 267
  - "[:HARDcopy:FFEed](#)" on page 265
  - "[:HARDcopy:INKSaver](#)" on page 266

**:HARDcopy:PRINter:LIST**

**N** (see [page 750](#))

**Query Syntax** :HARDcopy:PRINter:LIST?

The :HARDcopy:PRINter:LIST? query returns a list of available printers. The list can be empty.

**Return Format** <list><NL>

```
<list> ::= [<printer_spec>] ... [<printer_spec>]
<printer_spec> ::= "<index>,<active>,<name>;"
<index> ::= integer index of printer
<active> ::= {Y | N}
<name> ::= name of printer (for example "DESKJET 950C")
```

- See Also**
- ["Introduction to :HARDcopy Commands"](#) on page 261
  - [":HARDcopy:APRinter"](#) on page 263
  - [":HARDcopy:START"](#) on page 270

## :HARDcopy:STARt

**N** (see [page 750](#))

**Command Syntax** :HARDcopy:STARt

The :HARDcopy:STARt command starts a print job.

- See Also**
- "[Introduction to :HARDcopy Commands](#)" on page 261
  - "[:HARDcopy:APRinter](#)" on page 263
  - "[:HARDcopy:PRINter:LIST](#)" on page 269
  - "[:HARDcopy:FACTors](#)" on page 264
  - "[:HARDcopy:FFEed](#)" on page 265
  - "[:HARDcopy:INKSaver](#)" on page 266
  - "[:HARDcopy:LAYout](#)" on page 267
  - "[:HARDcopy:PALETTE](#)" on page 268

## :LISTer Commands

**Table 60** :LISTer Commands Summary

| Command  | Query  | Options and Query Returns  |
|--|--|--|
| n/a  | :LISTer:DATA? (see <a href="#">page 272</a> )    | <binary_block> ::= comma-separated data with newlines at the end of each row |
| :LISTer:DISPlay {{0   OFF}   {1   ON}} (see <a href="#">page 273</a> ) | :LISTer:DISPlay? (see <a href="#">page 273</a> ) | {0   1}  |

**Introduction to :LISTer Commands** The LISTer subsystem is used to turn on/off the serial decode Lister display and return data from the Lister display.

## :LISTer:DATA

**N** (see [page 750](#))

**Query Syntax** :LISTer:DATA?

The :LISTer:DATA? query returns the lister data.

**Return Format** <binary\_block><NL>

<binary\_block> ::= comma-separated data with newlines at the end of each row

- See Also**
- ["Introduction to :LISTer Commands"](#) on page 271
  - [":LISTer:DISPlay"](#) on page 273
  - ["Definite-Length Block Response Data"](#) on page 107

## :LISTer:DISPlay

**N** (see [page 750](#))

**Command Syntax** :LISTer:DISPlay <value>  
<value> ::= {{1 | ON} | {0 | OFF}}

The :LISTer:DISPlay command turns on or off the on-screen lister display.

**Query Syntax** :LISTer:DISPlay?

The :LISTer:DISPlay? query returns lister display setting.

**Return Format** <value><NL>  
<value> ::= {0 | 1}

- See Also**
- "[Introduction to :LISTer Commands](#)" on page 271
  - "[:LISTer:DATA](#)" on page 272

## :MARKer Commands

Set and query the settings of X-axis markers (X1 and X2 cursors) and the Y-axis markers (Y1 and Y2 cursors). See "Introduction to :MARKer Commands" on page 275.

**Table 61** :MARKer Commands Summary

| Command   | Query                                 | Options and Query Returns   |
|---|---------------------------------------|---|
| :MARKer:MODE <mode><br>(see page 276)                   | :MARKer:MODE? (see page 276)          | <mode> ::= {OFF   MEASurement   MANual   WAVeform}  |
| :MARKer:X1Position <position>[suffix]<br>(see page 277) | :MARKer:X1Position?<br>(see page 277) | <position> ::= X1 cursor position value in NR3 format<br>[suffix] ::= {s   ms   us   ns   ps   Hz   kHz   MHz}<br><return_value> ::= X1 cursor position value in NR3 format |
| :MARKer:X1Y1source <source> (see page 278)              | :MARKer:X1Y1source?<br>(see page 278) | <source> ::= {CHANnel<n>   FUNCTION   MATH}<br><n> ::= 1-2 or 1-4 in NR1 format<br><return_value> ::= <source>  |
| :MARKer:X2Position <position>[suffix]<br>(see page 279) | :MARKer:X2Position?<br>(see page 279) | <position> ::= X2 cursor position value in NR3 format<br>[suffix] ::= {s   ms   us   ns   ps   Hz   kHz   MHz}<br><return_value> ::= X2 cursor position value in NR3 format |
| :MARKer:X2Y2source <source> (see page 280)              | :MARKer:X2Y2source?<br>(see page 280) | <source> ::= {CHANnel<n>   FUNCTION   MATH}<br><n> ::= 1-2 or 1-4 in NR1 format<br><return_value> ::= <source>  |
| n/a   | :MARKer:XDELta? (see page 281)        | <return_value> ::= X cursors delta value in NR3 format  |
| :MARKer:Y1Position <position>[suffix]<br>(see page 282) | :MARKer:Y1Position?<br>(see page 282) | <position> ::= Y1 cursor position value in NR3 format<br>[suffix] ::= {V   mV   dB}<br><return_value> ::= Y1 cursor position value in NR3 format                            |

**Table 61** :MARKer Commands Summary (continued)

| Command   | Query  | Options and Query Returns  |
|---|--|--|
| :MARKer:Y2Position<br><position>[suffix]<br>(see <a href="#">page 283</a> ) | :MARKer:Y2Position?<br>(see <a href="#">page 283</a> ) | <position> ::= Y2 cursor position value in NR3 format<br>[suffix] ::= {V   mV   dB}<br><return_value> ::= Y2 cursor position value in NR3 format |
| n/a   | :MARKer:YDELta? (see <a href="#">page 284</a> )        | <return_value> ::= Y cursors delta value in NR3 format   |

**Introduction to :MARKer Commands** The MARKer subsystem commands set and query the settings of X-axis markers (X1 and X2 cursors) and the Y-axis markers (Y1 and Y2 cursors). You can set and query the marker mode and source, the position of the X and Y cursors, and query delta X and delta Y cursor values.

Reporting the Setup

Use :MARKer? to query setup information for the MARKer subsystem.

Return Format

The following is a sample response from the :MARKer? query. In this case, the query was issued following a \*RST and :MARKer:MODE:MANual command.

```
:MARK:X1Y1 NONE;X2Y2 NONE;MODE OFF
```

**:MARKer:MODE**

**N** (see [page 750](#))

**Command Syntax** :MARKer:MODE <mode>

<mode> ::= {OFF | MEASurement | MANual | WAVeform}

The :MARKer:MODE command sets the cursors mode:

- OFF – removes the cursor information from the display.
- MANual – enables manual placement of the X and Y cursors.

If the front-panel cursors are off, or are set to the front-panel Hex or Binary mode, setting :MARKer:MODE MANual will put the cursors in the front-panel Normal mode.

- MEASurement – cursors track the most recent measurement.

Setting the mode to MEASurement sets the marker sources (:MARKer:X1Y1source and :MARKer:X2Y2source) to the measurement source (:MEASure:SOURce). Setting the measurement source remotely always sets the marker sources.

- WAVeform – the Y1 cursor tracks the voltage value at the X1 cursor of the waveform specified by the X1Y1source, and the Y2 cursor does the same for the X2 cursor and its X2Y2source.

**Query Syntax** :MARKer:MODE?

The :MARKer:MODE? query returns the current cursors mode.

**Return Format** <mode><NL>

<mode> ::= {OFF | MEAS | MAN | WAV}

- See Also**
- "[Introduction to :MARKer Commands](#)" on page 275
  - "[:MARKer:X1Y1source](#)" on page 278
  - "[:MARKer:X2Y2source](#)" on page 280
  - "[:MEASure:SOURce](#)" on page 315
  - "[:MARKer:X1Position](#)" on page 277
  - "[:MARKer:X2Position](#)" on page 279
  - "[:MARKer:Y1Position](#)" on page 282
  - "[:MARKer:Y2Position](#)" on page 283

**:MARKer:X1Position**

**N** (see [page 750](#))

**Command Syntax** :MARKer:X1Position <position> [suffix]  
 <position> ::= X1 cursor position in NR3 format  
 <suffix> ::= {s | ms | us | ns | ps | Hz | kHz | MHz}

The :MARKer:X1Position command:

- Sets :MARKer:MODE to MANual if it is not currently set to WAVEform (see [":MARKer:MODE"](#) on page 276).
- Sets the X1 cursor position to the specified value.

**Query Syntax** :MARKer:X1Position?

The :MARKer:X1Position? query returns the current X1 cursor position. This is functionally equivalent to the obsolete :MEASure:TSTArt command/query.

**NOTE**

If the front-panel cursors are off, the marker position values are not defined and an error is generated. Make sure to set :MARKer:MODE to MANual or WAVEform to put the cursors in the front-panel Normal mode.

**Return Format** <position><NL>  
 <position> ::= X1 cursor position in NR3 format

- See Also**
- ["Introduction to :MARKer Commands"](#) on page 275
  - [":MARKer:MODE"](#) on page 276
  - [":MARKer:X2Position"](#) on page 279
  - [":MARKer:X1Y1source"](#) on page 278
  - [":MARKer:X2Y2source"](#) on page 280
  - [":MEASure:TSTArt"](#) on page 685

**:MARKer:X1Y1source**

**N** (see [page 750](#))

**Command Syntax** :MARKer:X1Y1source <source>

<source> ::= {CHANnel<n> | FUNCTION | MATH}

<n> ::= {1 | 2 | 3 | 4} for the four channel oscilloscope models

<n> ::= {1 | 2} for the two channel oscilloscope models

The :MARKer:X1Y1source command sets the source for the cursors. The channel you specify must be enabled for cursors to be displayed. If the channel or function is not on, an error message is issued.

If the marker mode is not currently WAVEform (see [":MARKer:MODE"](#) on [page 276](#)):

- Sending a :MARKer:X1Y1source command will put the cursors in the MANual mode.
- Setting the source for one pair of markers (for example, X1Y1) sets the source for the other (for example, X2Y2).

If the marker mode is currently WAVEform, the X1Y1 source can be set separate from the X2Y2 source.

If :MARKer:MODE is set to OFF or MANual, setting :MEASure:SOURce to CHANnel<n>, FUNCTION, or MATH will also set :MARKer:X1Y1source and :MARKer:X2Y2source to this value.

**NOTE**

MATH is an alias for FUNCTION. The query will return FUNC if the source is FUNCTION or MATH.

**Query Syntax** :MARKer:X1Y1source?

The :MARKer:X1Y1source? query returns the current source for the cursors. If all channels are off or if :MARKer:MODE is set to OFF, the query returns NONE.

**Return Format** <source><NL>

<source> ::= {CHAN<n> | FUNC | NONE}

- See Also**
- ["Introduction to :MARKer Commands"](#) on [page 275](#)
  - [":MARKer:MODE"](#) on [page 276](#)
  - [":MARKer:X2Y2source"](#) on [page 280](#)
  - [":MEASure:SOURce"](#) on [page 315](#)

**:MARKer:X2Position**

**N** (see [page 750](#))

**Command Syntax** :MARKer:X2Position <position> [suffix]  
 <position> ::= X2 cursor position in NR3 format  
 <suffix> ::= {s | ms | us | ns | ps | Hz | kHz | MHz}

The :MARKer:X2Position command:

- Sets :MARKer:MODE to MANual if it is not currently set to WAVEform (see [":MARKer:MODE"](#) on page 276).
- Sets the X2 cursor position to the specified value.

**Query Syntax** :MARKer:X2Position?

The :MARKer:X2Position? query returns current X2 cursor position. This is functionally equivalent to the obsolete :MEASure:TSTOp command/query.

**NOTE**

If the front-panel cursors are off, the marker position values are not defined and an error is generated. Make sure to set :MARKer:MODE to MANual or WAVEform to put the cursors in the front-panel Normal mode.

**Return Format** <position><NL>  
 <position> ::= X2 cursor position in NR3 format

- See Also**
- ["Introduction to :MARKer Commands"](#) on page 275
  - [":MARKer:MODE"](#) on page 276
  - [":MARKer:X1Position"](#) on page 277
  - [":MARKer:X2Y2source"](#) on page 280
  - [":MEASure:TSTOp"](#) on page 686

**:MARKer:X2Y2source**

**N** (see [page 750](#))

**Command Syntax** :MARKer:X2Y2source <source>

<source> ::= {CHANnel<n> | FUNCTION | MATH}

<n> ::= {1 | 2 | 3 | 4} for the four channel oscilloscope models

<n> ::= {1 | 2} for the two channel oscilloscope models

The :MARKer:X2Y2source command sets the source for the cursors. The channel you specify must be enabled for cursors to be displayed. If the channel or function is not on, an error message is issued.

If the marker mode is not currently WAVEform (see [":MARKer:MODE"](#) on [page 276](#)):

- Sending a :MARKer:X2Y2source command will put the cursors in the MANual mode.
- Setting the source for one pair of markers (for example, X2Y2) sets the source for the other (for example, X1Y1).

If the marker mode is currently WAVEform, the X2Y2 source can be set separate from the X1Y1 source.

If :MARKer:MODE is set to OFF or MANual, setting :MEASure:SOURce to CHANnel<n>, FUNCTION, or MATH will also set :MARKer:X1Y1source and :MARKer:X2Y2source to this value.

**NOTE**

MATH is an alias for FUNCTION. The query will return FUNC if the source is FUNCTION or MATH.

**Query Syntax** :MARKer:X2Y2source?

The :MARKer:X2Y2source? query returns the current source for the cursors. If all channels are off or if :MARKer:MODE is set to OFF, the query returns NONE.

**Return Format** <source><NL>

<source> ::= {CHAN<n> | FUNC | NONE}

- See Also**
- ["Introduction to :MARKer Commands"](#) on [page 275](#)
  - [":MARKer:MODE"](#) on [page 276](#)
  - [":MARKer:X1Y1source"](#) on [page 278](#)
  - [":MEASure:SOURce"](#) on [page 315](#)

**:MARKer:XDELta**

**N** (see [page 750](#))

**Query Syntax** :MARKer:XDELta?

The MARKer:XDELta? query returns the value difference between the current X1 and X2 cursor positions.

Xdelta = (Value at X2 cursor) - (Value at X1 cursor)

**NOTE**

If the front-panel cursors are off, the marker position values are not defined. Make sure to set :MARKer:MODE to MANual or WAVEform to put the cursors in the front-panel Normal mode.

**Return Format** <value><NL>

<value> ::= difference value in NR3 format.

- See Also**
- "[Introduction to :MARKer Commands](#)" on page 275
  - "[:MARKer:MODE](#)" on page 276
  - "[:MARKer:X1Position](#)" on page 277
  - "[:MARKer:X2Position](#)" on page 279
  - "[:MARKer:X1Y1source](#)" on page 278
  - "[:MARKer:X2Y2source](#)" on page 280

**:MARKer:Y1Position**

**N** (see [page 750](#))

**Command Syntax** :MARKer:Y1Position <position> [suffix]  
 <position> ::= Y1 cursor position in NR3 format  
 <suffix> ::= {mV | V | dB}

If the :MARKer:MODE is not currently set to WAVEform (see "[:MARKer:MODE](#)" on page 276), the :MARKer:Y1Position command:

- Sets :MARKer:MODE to MANual.
- Sets the Y1 cursor position to the specified value.

When the :MARKer:MODE is set to WAVEform, Y positions cannot be set.

**Query Syntax** :MARKer:Y1Position?

The :MARKer:Y1Position? query returns current Y1 cursor position. This is functionally equivalent to the obsolete :MEASure:VStArt command/query.

**NOTE**

If the front-panel cursors are off or are set to Binary or Hex Mode, the marker position values are not defined and an error is generated. Make sure to set :MARKer:MODE to MANual or WAVEform to put the cursors in the front-panel Normal mode.

**Return Format** <position><NL>  
 <position> ::= Y1 cursor position in NR3 format

- See Also**
- "[Introduction to :MARKer Commands](#)" on page 275
  - "[:MARKer:MODE](#)" on page 276
  - "[:MARKer:X1Y1source](#)" on page 278
  - "[:MARKer:X2Y2source](#)" on page 280
  - "[:MARKer:Y2Position](#)" on page 283
  - "[:MEASure:VStArt](#)" on page 691

**:MARKer:Y2Position**

**N** (see [page 750](#))

**Command Syntax** :MARKer:Y2Position <position> [suffix]  
 <position> ::= Y2 cursor position in NR3 format  
 <suffix> ::= {mV | V | dB}

If the :MARKer:MODE is not currently set to WAVEform (see "[:MARKer:MODE](#)" on page 276), the :MARKer:Y1Position command:

- Sets :MARKer:MODE to MANual.
- Sets the Y2 cursor position to the specified value.

When the :MARKer:MODE is set to WAVEform, Y positions cannot be set.

**Query Syntax** :MARKer:Y2Position?

The :MARKer:Y2Position? query returns current Y2 cursor position. This is functionally equivalent to the obsolete :MEASure:VSTOP command/query.

**NOTE**

If the front-panel cursors are off or are set to Binary or Hex Mode, the marker position values are not defined and an error is generated. Make sure to set :MARKer:MODE to MANual or WAVEform to put the cursors in the front-panel Normal mode.

**Return Format** <position><NL>  
 <position> ::= Y2 cursor position in NR3 format

- See Also**
- "[Introduction to :MARKer Commands](#)" on page 275
  - "[:MARKer:MODE](#)" on page 276
  - "[:MARKer:X1Y1source](#)" on page 278
  - "[:MARKer:X2Y2source](#)" on page 280
  - "[:MARKer:Y1Position](#)" on page 282
  - "[:MEASure:VSTOP](#)" on page 692

### :MARKer:YDELta

**N** (see [page 750](#))

**Query Syntax** :MARKer:YDELta?

The :MARKer:YDELta? query returns the value difference between the current Y1 and Y2 cursor positions.

$Ydelta = (\text{Value at Y2 cursor}) - (\text{Value at Y1 cursor})$

#### NOTE

If the front-panel cursors are off or are set to Binary or Hex Mode, the marker position values are not defined. Make sure to set :MARKer:MODE to MANual or WAVeform to put the cursors in the front-panel Normal mode.

**Return Format** <value><NL>

<value> ::= difference value in NR3 format

- See Also**
- "[Introduction to :MARKer Commands](#)" on page 275
  - "[:MARKer:MODE](#)" on page 276
  - "[:MARKer:X1Y1source](#)" on page 278
  - "[:MARKer:X2Y2source](#)" on page 280
  - "[:MARKer:Y1Position](#)" on page 282
  - "[:MARKer:Y2Position](#)" on page 283

## :MEASure Commands

Select automatic measurements to be made and control time markers. See "Introduction to :MEASure Commands" on page 290.

**Table 62** :MEASure Commands Summary

| Command  | Query   | Options and Query Returns  |
|--|---|--|
| :MEASure:CLear (see <a href="#">page 292</a> )                                 | n/a   | n/a  |
| :MEASure:COUNter<br>[<source>] (see <a href="#">page 293</a> )                 | :MEASure:COUNter?<br>[<source>] (see <a href="#">page 293</a> )                 | <source> ::= {CHANnel<n>   EXTernal}<br><n> ::= 1-2 or 1-4 in NR1 format<br><return_value> ::= counter frequency in Hertz in NR3 format  |
| :MEASure:DEFine DELay, <delay spec> (see <a href="#">page 294</a> )            | :MEASure:DEFine? DELay (see <a href="#">page 295</a> )                          | <delay spec> ::= <edge_spec1>, <edge_spec2><br>edge_spec1 ::= [<slope>]<occurrence><br>edge_spec2 ::= [<slope>]<occurrence><br><slope> ::= {+   -}<br><occurrence> ::= integer |
| :MEASure:DEFine THResholds, <threshold spec> (see <a href="#">page 294</a> )   | :MEASure:DEFine? THResholds (see <a href="#">page 295</a> )                     | <threshold spec> ::= {STANdard}   {<threshold mode>, <upper>, <middle>, <lower>}<br><threshold mode> ::= {PERCent   ABSolute}  |
| :MEASure:DELay<br>[<source1>]<br>[, <source2>] (see <a href="#">page 297</a> ) | :MEASure:DELay?<br>[<source1>]<br>[, <source2>] (see <a href="#">page 297</a> ) | <source1,2> ::= {CHANnel<n>   FUNction   MATH}<br><n> ::= 1-2 or 1-4 in NR1 format<br><return_value> ::= floating-point number delay time in seconds in NR3 format             |
| :MEASure:DUTYcycle<br>[<source>] (see <a href="#">page 299</a> )               | :MEASure:DUTYcycle?<br>[<source>] (see <a href="#">page 299</a> )               | <source> ::= {CHANnel<n>   FUNction   MATH}<br><n> ::= 1-2 or 1-4 in NR1 format<br><return_value> ::= ratio of positive pulse width to period in NR3 format                    |

**Table 62** :MEASure Commands Summary (continued)

| Command   | Query  | Options and Query Returns   |
|---|--|---|
| :MEASure:FALLtime<br>[<source>] (see<br>page 300)               | :MEASure:FALLtime?<br>[<source>] (see<br>page 300)               | <source> ::= {CHANnel<n>  <br>FUNctIon   MATH}<br><n> ::= 1-2 or 1-4 in NR1 format<br><return_value> ::= time in<br>seconds between the lower and<br>upper thresholds in NR3 format |
| :MEASure:FREQuency<br>[<source>] (see<br>page 301)              | :MEASure:FREQuency?<br>[<source>] (see<br>page 301)              | <source> ::= {CHANnel<n>  <br>FUNctIon   MATH}<br><n> ::= 1-2 or 1-4 in NR1 format<br><return_value> ::= frequency in<br>Hertz in NR3 format  |
| :MEASure:NWIDth<br>[<source>] (see<br>page 302)                 | :MEASure:NWIDth?<br>[<source>] (see<br>page 302)                 | <source> ::= {CHANnel<n>  <br>FUNctIon   MATH}<br><n> ::= 1-2 or 1-4 in NR1 format<br><return_value> ::= negative<br>pulse width in seconds-NR3 format                              |
| :MEASure:OVERshoot<br>[<source>] (see<br>page 303)              | :MEASure:OVERshoot?<br>[<source>] (see<br>page 303)              | <source> ::= {CHANnel<n>  <br>FUNctIon   MATH}<br><n> ::= 1-2 or 1-4 in NR1 format<br><return_value> ::= the percent of<br>the overshoot of the selected<br>waveform in NR3 format  |
| :MEASure:PERiod<br>[<source>] (see<br>page 305)                 | :MEASure:PERiod?<br>[<source>] (see<br>page 305)                 | <source> ::= {CHANnel<n>  <br>FUNctIon   MATH}<br><n> ::= 1-2 or 1-4 in NR1 format<br><return_value> ::= waveform<br>period in seconds in NR3 format                                |
| :MEASure:PHASe<br>[<source1>]<br>[,<source2>] (see<br>page 306) | :MEASure:PHASe?<br>[<source1>]<br>[,<source2>] (see<br>page 306) | <source1,2> ::= {CHANnel<n>  <br>FUNctIon   MATH}<br><n> ::= 1-2 or 1-4 in NR1 format<br><return_value> ::= the phase<br>angle value in degrees in NR3<br>format                    |
| :MEASure:PREShoot<br>[<source>] (see<br>page 307)               | :MEASure:PREShoot?<br>[<source>] (see<br>page 307)               | <source> ::= {CHANnel<n>  <br>FUNctIon   MATH}<br><n> ::= 1-2 or 1-4 in NR1 format<br><return_value> ::= the percent of<br>preshoot of the selected waveform<br>in NR3 format       |

**Table 62** :MEASure Commands Summary (continued)

| Command  | Query  | Options and Query Returns   |
|--|--|---|
| :MEASure:PWIDth<br>[<source>] (see<br>page 308)                | :MEASure:PWIDth?<br>[<source>] (see<br>page 308)     | <source> ::= {CHANnel<n>  <br>FUNction   MATH}<br><n> ::= 1-2 or 1-4 in NR1 format<br><return_value> ::= width of<br>positive pulse in seconds in NR3<br>format |
| n/a  | :MEASure:RESults?<br><result_list> (see<br>page 309) | <result_list> ::=<br>comma-separated list of<br>measurement results   |
| :MEASure:RISetime<br>[<source>] (see<br>page 312)              | :MEASure:RISetime?<br>[<source>] (see<br>page 312)   | <source> ::= {CHANnel<n>  <br>FUNction   MATH}<br><n> ::= 1-2 or 1-4 in NR1 format<br><return_value> ::= rise time in<br>seconds in NR3 format                  |
| :MEASure:SDEVIation<br>[<source>] (see<br>page 313)            | :MEASure:SDEVIation?<br>[<source>] (see<br>page 313) | <source> ::= {CHANnel<n>  <br>FUNction   MATH}<br><n> ::= 1-2 or 1-4 in NR1 format<br><return_value> ::= calculated<br>std deviation in NR3 format              |
| :MEASure:SHOW {1  <br>ON} (see page 314)                       | :MEASure:SHOW? (see<br>page 314)                     | {1}   |
| :MEASure:SOURce<br><source1><br>[,<source2>] (see<br>page 315) | :MEASure:SOURce? (see<br>page 315)                   | <source1,2> ::= {CHANnel<n>  <br>FUNction   MATH   EXTernal}<br><n> ::= 1-2 or 1-4 in NR1 format<br><return_value> ::= {<source>  <br>NONE}                     |
| :MEASure:STATistics<br><type> (see page 317)                   | :MEASure:STATistics?<br>(see page 317)               | <type> ::= {{ON   1}   CURRent  <br>MEAN   MINimum   MAXimum   STDDev<br>  COUNT}<br>ON ::= all statistics returned   |
| :MEASure:STATistics:I<br>NCRement (see<br>page 318)            | n/a  | n/a   |
| :MEASure:STATistics:R<br>ESet (see page 319)                   | n/a  | n/a   |

**Table 62** :MEASure Commands Summary (continued)

| Command  | Query  | Options and Query Returns  |
|--|--|--|
| n/a  | :MEASure:TEDGE?<br><slope><occurrence>[,<br><source>] (see<br>page 320)                | <slope> ::= direction of the<br>waveform<br><occurrence> ::= the transition<br>to be reported<br><source> ::= {CHANnel<n>  <br>FUNctIon   MATH}<br><n> ::= 1-2 or 1-4 in NR1 format<br><return_value> ::= time in<br>seconds of the specified<br>transition  |
| n/a  | :MEASure:TVALue?<br><value>,<br>[<slope>]<occurrence><br>[,<source>] (see<br>page 322) | <value> ::= voltage level that<br>the waveform must cross.<br><slope> ::= direction of the<br>waveform when <value> is crossed.<br><occurrence> ::= transitions<br>reported.<br><return_value> ::= time in<br>seconds of specified voltage<br>crossing in NR3 format<br><source> ::= {CHANnel<n>  <br>FUNctIon   MATH}<br><n> ::= 1-2 or 1-4 in NR1 format |
| :MEASure:VAMplitude<br>[<source>] (see<br>page 324)              | :MEASure:VAMplitude?<br>[<source>] (see<br>page 324)                                   | <source> ::= {CHANnel<n>  <br>FUNctIon   MATH}<br><n> ::= 1-2 or 1-4 in NR1 format<br><return_value> ::= the amplitude<br>of the selected waveform in volts<br>in NR3 format   |
| :MEASure:VAverage<br>[<interval>][,][<source>]<br>(see page 325) | :MEASure:VAverage?<br>[<interval>][,][<source>]<br>(see page 325)                      | <interval> ::= {CYCLE   DISPLAY  <br>AUTO}<br><source> ::= {CHANnel<n>  <br>FUNctIon   MATH}<br><n> ::= 1-2 or 1-4 in NR1 format<br><return_value> ::= calculated<br>average voltage in NR3 format   |
| :MEASure:VBASe<br>[<source>] (see<br>page 326)                   | :MEASure:VBASe?<br>[<source>] (see<br>page 326)  | <source> ::= {CHANnel<n>  <br>FUNctIon   MATH}<br><n> ::= 1-2 or 1-4 in NR1 format<br><base_voltage> ::= voltage at the<br>base of the selected waveform in<br>NR3 format  |

**Table 62** :MEASure Commands Summary (continued)

| Command  | Query   | Options and Query Returns  |
|--|---|--|
| :MEASure:VMAX<br>[<source>] (see<br>page 327)                    | :MEASure:VMAX?<br>[<source>] (see<br>page 327)                    | <source> ::= {CHANnel<n>  <br>FUNction   MATH}<br><n> ::= 1-2 or 1-4 in NR1 format<br><return_value> ::= maximum<br>voltage of the selected waveform<br>in NR3 format  |
| :MEASure:VMIN<br>[<source>] (see<br>page 328)                    | :MEASure:VMIN?<br>[<source>] (see<br>page 328)                    | <source> ::= {CHANnel<n>  <br>FUNction   MATH}<br><n> ::= 1-2 or 1-4 in NR1 format<br><return_value> ::= minimum<br>voltage of the selected waveform<br>in NR3 format  |
| :MEASure:VPP<br>[<source>] (see<br>page 329)                     | :MEASure:VPP?<br>[<source>] (see<br>page 329)                     | <source> ::= {CHANnel<n>  <br>FUNction   MATH}<br><n> ::= 1-2 or 1-4 in NR1 format<br><return_value> ::= voltage<br>peak-to-peak of the selected<br>waveform in NR3 format   |
| :MEASure:VRATio<br>[<source1>]<br>[,<source2>] (see<br>page 306) | :MEASure:VRATio?<br>[<source1>]<br>[,<source2>] (see<br>page 330) | <source1,2> ::= {CHANnel<n>  <br>FUNction   MATH}<br><n> ::= 1-2 or 1-4 in NR1 format<br><return_value> ::= the ratio<br>value in dB in NR3 format   |
| :MEASure:VRMS<br>[<interval>][,][<sour<br>ce>] (see page 331)    | :MEASure:VRMS?<br>[<interval>][,][<sour<br>ce>] (see page 331)    | <interval> ::= {CYCLe   DISPlay  <br>AUTO}<br><source> ::= {CHANnel<n>  <br>FUNction   MATH}<br><n> ::= 1-2 or 1-4 in NR1 format<br><return_value> ::= calculated dc<br>RMS voltage in NR3 format                              |
| n/a  | :MEASure:VTIME?<br><vtime>[,<source>]<br>(see page 332)           | <vtime> ::= displayed time from<br>trigger in seconds in NR3 format<br><return_value> ::= voltage at the<br>specified time in NR3 format<br><source> ::= {CHANnel<n>  <br>FUNction   MATH}<br><n> ::= 1-2 or 1-4 in NR1 format |
| :MEASure:VTOP<br>[<source>] (see<br>page 333)                    | :MEASure:VTOP?<br>[<source>] (see<br>page 333)                    | <source> ::= {CHANnel<n>  <br>FUNction   MATH}<br><n> ::= 1-2 or 1-4 in NR1 format<br><return_value> ::= voltage at the<br>top of the waveform in NR3 format   |

**Table 62** :MEASure Commands Summary (continued)

| Command                                    | Query                                       | Options and Query Returns   |
|--|---|---|
| :MEASure:WINDow<br><window> (see page 334) | :MEASure:WINDow? (see page 334)             | <window> ::= {MAIN   ZOOM   AUTO}   |
| :MEASure:XMAX<br>[<source>] (see page 335) | :MEASure:XMAX?<br>[<source>] (see page 335) | <source> ::= {CHANnel<n>   FUNCTION   MATH}<br><n> ::= 1-2 or 1-4 in NR1 format<br><return_value> ::= horizontal value of the maximum in NR3 format |
| :MEASure:XMIN<br>[<source>] (see page 336) | :MEASure:XMIN?<br>[<source>] (see page 336) | <source> ::= {CHANnel<n>   FUNCTION   MATH}<br><n> ::= 1-2 or 1-4 in NR1 format<br><return_value> ::= horizontal value of the maximum in NR3 format |

**Introduction to :MEASure Commands**

The commands in the MEASure subsystem are used to make parametric measurements on displayed waveforms.

**Measurement Setup**

To make a measurement, the portion of the waveform required for that measurement must be displayed on the oscilloscope screen.

| Measurement Type                 | Portion of waveform that must be displayed |
|----------------------------------|--|
| period, duty cycle, or frequency | at least one complete cycle                |
| pulse width                      | the entire pulse                           |
| rise time                        | rising edge, top and bottom of pulse       |
| fall time                        | falling edge, top and bottom of pulse      |

**Measurement Error**

If a measurement cannot be made (typically because the proper portion of the waveform is not displayed), the value +9.9E+37 is returned for that measurement.

**Making Measurements**

If more than one waveform, edge, or pulse is displayed, time measurements are made on the portion of the displayed waveform closest to the trigger reference (left, center, or right).

When making measurements in the zoomed (delayed) time base mode (:TIMEbase:MODE WINDOW), the oscilloscope will attempt to make the measurement inside the zoomed sweep window. If the measurement is an average and there are not three edges, the oscilloscope will revert to the mode of making the measurement at the start of the main sweep.

When the command form is used, the measurement result is displayed on the instrument. When the query form of these measurements is used, the measurement is made one time, and the measurement result is returned over the bus.

Measurements are made on the displayed waveforms specified by the :MEASure:SOURce command. The MATH source is an alias for the FUNction source.

Not all measurements are available on the FFT (Fast Fourier Transform).

#### Reporting the Setup

Use the :MEASure? query to obtain setup information for the MEASure subsystem. (Currently, this is only :MEASure:SOURce.)

#### Return Format

The following is a sample response from the :MEASure? query. In this case, the query was issued following a \*RST command.

```
:MEAS:SOUR CHAN1,CHAN2;STAT ON
```

## **:MEASure:CLEar**

**N** (see [page 750](#))

**Command Syntax** :MEASure:CLEar

This command clears all selected measurements and markers from the screen.

**See Also** • ["Introduction to :MEASure Commands"](#) on page 290

**:MEASure:COUNter**

**N** (see [page 750](#))

**Command Syntax** :MEASure:COUNter [<source>]

<source> ::= {CHANnel<n> | EXTernal}

<n> ::= {1 | 2 | 3 | 4} for the four channel oscilloscope models

<n> ::= {1 | 2} for the two channel oscilloscope models

The :MEASure:COUNter command installs a screen measurement and starts a counter measurement. If the optional source parameter is specified, the current source is modified. Any channel except Math may be selected for the source.

The counter measurement counts trigger level crossings at the selected trigger slope and displays the results in Hz. The gate time for the measurement is automatically adjusted to be 100 ms or twice the current time window, whichever is longer, up to 1 second. The counter measurement can measure frequencies up to 125 MHz. The minimum frequency supported is 1/(2 X gate time).

The Y cursor shows the the edge threshold level used in the measurement.

Only one counter measurement may be displayed at a time.

**NOTE**

This command is not available if the source is MATH.

**Query Syntax** :MEASure:COUNter? [<source>]

The :MEASure:COUNter? query measures and outputs the counter frequency of the specified source.

**NOTE**

The :MEASure:COUNter? query times out if the counter measurement is installed on the front panel. Use :MEASure:CLEar to remove the front-panel measurement before executing the :MEASure:COUNter? query.

**Return Format** <source><NL>

<source> ::= count in Hertz in NR3 format

- See Also**
- ["Introduction to :MEASure Commands"](#) on page 290
  - [":MEASure:SOURce"](#) on page 315
  - [":MEASure:FREQuency"](#) on page 301
  - [":MEASure:CLEar"](#) on page 292

## :MEASure:DEFine

**N** (see page 750)

**Command Syntax** :MEASure:DEFine <meas\_spec>  
 <meas\_spec> ::= {DElay | THResholds}

The :MEASure:DEFine command sets up the definition for measurements by specifying the delta time or threshold values. Changing these values may affect the results of other measure commands. The table below identifies which measurement results that can be affected by redefining the DElay specification or the THResholds values. For example, changing the THResholds definition from the default 10%, 50%, and 90% values may change the returned measurement result.

| MEASure Command | DElay | THResholds |
|-----------------|-------|------------|
| DUTYcycle       |       | x          |
| DElay           | x     | x          |
| FALLtime        |       | x          |
| FREQuency       |       | x          |
| NWIDth          |       | x          |
| OVERshoot       |       | x          |
| PERiod          |       | x          |
| PHASe           |       | x          |
| PREShoot        |       | x          |
| PWIDth          |       | x          |
| RISetime        |       | x          |
| VAVerage        |       | x          |
| VRMS            |       | x          |

**:MEASure:DEFine DElay Command Syntax**

```
:MEASure:DEFine DElay,<delay spec>
<delay spec> ::= <edge_spec1>,<edge_spec2>
<edge_spec1> ::= [<slope>]<occurrence>
<edge_spec2> ::= [<slope>]<occurrence>
<slope> ::= {+ | -}
<occurrence> ::= integer
```

This command defines the behavior of the `:MEASure:DELay?` query by specifying the start and stop edge to be used. `<edge_spec1>` specifies the slope and edge number on source1. `<edge_spec2>` specifies the slope and edge number on source2. The measurement is taken as:

$$\text{delay} = t(\text{<edge\_spec2>}) - t(\text{<edge\_spec1>})$$

#### NOTE

The `:MEASure:DELay` command and the front-panel delay measurement use an auto-edge selection method to determine the actual edge used for the measurement. The `:MEASure:DEFine` command has no effect on these delay measurements. The edges specified by the `:MEASure:DEFine` command only define the edges used by the `:MEASure:DELay?` query.

#### **:MEASure:DEFine THResholds Command Syntax**

```
:MEASure:DEFine THResholds,<threshold spec>
```

```
<threshold spec> ::= {STANdard  
                    | {<threshold mode>,<upper>,<middle>,<lower>}}
```

```
<threshold mode> ::= {PERCent | ABSolute}
```

for `<threshold mode> = PERCent`:

```
<upper>,<middle>,<lower> ::= A number specifying the upper, middle,  
                           and lower threshold percentage values  
                           between Vbase and Vtop in NR3 format.
```

for `<threshold mode> = ABSolute`:

```
<upper>,<middle>,<lower> ::= A number specifying the upper, middle,  
                           and lower threshold absolute values in  
                           NR3 format.
```

- STANdard threshold specification sets the lower, middle, and upper measurement thresholds to 10%, 50%, and 90% values between Vbase and Vtop.
- Threshold mode PERCent sets the measurement thresholds to any user-defined percentages between 5% and 95% of values between Vbase and Vtop.
- Threshold mode ABSolute sets the measurement thresholds to absolute values. ABSolute thresholds are dependent on channel scaling (`:CHANnel<n>:RANGe` or `" :CHANnel<n>:SCALe"` on page 220:`CHANnel<n>:SCALe`), probe attenuation (`:CHANnel<n>:PROBe`), and probe units (`:CHANnel<n>:UNITs`). Always set these values first before setting ABSolute thresholds.

#### **Query Syntax**

```
:MEASure:DEFine? <meas_spec>
```

```
<meas_spec> ::= {DELay | THResholds}
```

The `:MEASure:DEFine?` query returns the current edge specification for the delay measurements setup or the current specification for the thresholds setup.

**Return Format** for <meas\_spec> = DELay:

```
{ <edge_spec1> | <edge_spec2> | <edge_spec1>,<edge_spec2>} <NL>
```

for <meas\_spec> = THResholds and <threshold mode> = PERCent:

```
THR,PERC,<upper>,<middle>,<lower><NL>
```

<upper>, <middle>, <lower> ::= A number specifying the upper, middle, and lower threshold percentage values between Vbase and Vtop in NR3 format.

for <meas\_spec> = THResholds and <threshold mode> = ABSolute:

```
THR,ABS,<upper>,<middle>,<lower><NL>
```

<upper>, <middle>, <lower> ::= A number specifying the upper, middle, and lower threshold voltages in NR3 format.

for <threshold spec> = STANdard:

```
THR,PERC,+90.0,+50.0,+10.0
```

- See Also**
- ["Introduction to :MEASure Commands"](#) on page 290
  - [":MEASure:DELay"](#) on page 297
  - [":MEASure:SOURce"](#) on page 315
  - [":CHANnel<n>:RANGe"](#) on page 219
  - [":CHANnel<n>:SCALE"](#) on page 220
  - [":CHANnel<n>:PROBE"](#) on page 213
  - [":CHANnel<n>:UNITs"](#) on page 221

**:MEASure:DElay**

**N** (see page 750)

**Command Syntax** :MEASure:DElay [<source1>][,<source2>]  
 <source1>, <source2> ::= {CHANnel<n> | FUNction | MATH}  
 <n> ::= {1 | 2 | 3 | 4} for the four channel oscilloscope models  
 <n> ::= {1 | 2} for the two channel oscilloscope models

The :MEASure:DElay command places the instrument in the continuous measurement mode and starts a delay measurement.

The measurement is taken as:

$$\text{delay} = t(\text{<edge spec 2>}) - t(\text{<edge spec 1>})$$

where the <edge spec> definitions are set by the :MEASure:DEFine command

**NOTE**

The :MEASure:DElay command and the front-panel delay measurement differ from the :MEASure:DElay? query.

The delay command or front-panel measurement run the delay measurement in auto-edge select mode. In this mode, you can select the edge polarity, but the instrument will select the edges that will make the best possible delay measurement. The source1 edge chosen will be the edge that meets the polarity specified and is closest to the trigger reference point. The source2 edge selected will be that edge of the specified polarity that gives the first of the following criteria:

- The smallest positive delay value that is less than source1 period.
- The smallest negative delay that is less than source1 period.
- The smallest absolute value of delay.

The :MEASure:DElay? query will make the measurement using the edges specified by the :MEASure:DEFine command.

**Query Syntax** :MEASure:DElay? [<source1>][,<source2>]

The :MEASure:DElay? query measures and returns the delay between source1 and source2. The delay measurement is made from the user-defined slope and edge count of the signal connected to source1, to the defined slope and edge count of the signal connected to source2. Delay measurement slope and edge parameters are selected using the :MEASure:DEFine command.

Also in the :MEASure:DEFine command, you can set upper, middle, and lower threshold values. *It is the middle threshold value that is used when performing the delay query.* The standard upper, middle, and lower measurement thresholds are 90%, 50%, and 10% values between Vbase and

## 5 Commands by Subsystem

Vtop. If you want to move the delay measurement point nearer to Vtop or Vbase, you must change the threshold values with the :MEASure:DEFine THResholds command.

**Return Format** <value><NL>

<value> ::= floating-point number delay time in seconds in NR3 format

- See Also**
- ["Introduction to :MEASure Commands"](#) on page 290
  - [":MEASure:DEFine"](#) on page 294
  - [":MEASure:PHASe"](#) on page 306

**:MEASure:DUTYcycle**

**C** (see [page 750](#))

**Command Syntax** :MEASure:DUTYcycle [<source>]

<source> ::= {CHANnel<n> | FUNCTION | MATH}

<n> ::= {1 | 2 | 3 | 4} for the four channel oscilloscope models

<n> ::= {1 | 2} for the two channel oscilloscope models

The :MEASure:DUTYcycle command installs a screen measurement and starts a duty cycle measurement on the current :MEASure:SOURce. If the optional source parameter is specified, the current source is modified.

**NOTE**

The signal must be displayed to make the measurement. This command is not available if the source is FFT (Fast Fourier Transform).

**Query Syntax** :MEASure:DUTYcycle? [<source>]

The :MEASure:DUTYcycle? query measures and outputs the duty cycle of the signal specified by the :MEASure:SOURce command. The value returned for the duty cycle is the ratio of the positive pulse width to the period. The positive pulse width and the period of the specified signal are measured, then the duty cycle is calculated with the following formula:

$$\text{duty cycle} = (\text{pulse width}/\text{period}) * 100$$

**Return Format** <value><NL>

<value> ::= ratio of positive pulse width to period in NR3 format

- See Also**
- ["Introduction to :MEASure Commands"](#) on page 290
  - [":MEASure:PERiod"](#) on page 305
  - [":MEASure:PWIDth"](#) on page 308
  - [":MEASure:SOURce"](#) on page 315

- Example Code**
- ["Example Code"](#) on page 315

**:MEASure:FALLtime**

**C** (see [page 750](#))

**Command Syntax** :MEASure:FALLtime [<source>]

<source> ::= {CHANnel<n> | FUNCTION | MATH}

<n> ::= {1 | 2 | 3 | 4} for the four channel oscilloscope models

<n> ::= {1 | 2} for the two channel oscilloscope models

The :MEASure:FALLtime command installs a screen measurement and starts a fall-time measurement. For highest measurement accuracy, set the sweep speed as fast as possible, while leaving the falling edge of the waveform on the display. If the optional source parameter is specified, the current source is modified.

**NOTE**

This command is not available if the source is FFT (Fast Fourier Transform).

**Query Syntax** :MEASure:FALLtime? [<source>]

The :MEASure:FALLtime? query measures and outputs the fall time of the displayed falling (negative-going) edge closest to the trigger reference. The fall time is determined by measuring the time at the upper threshold of the falling edge, then measuring the time at the lower threshold of the falling edge, and calculating the fall time with the following formula:

$$\text{fall time} = \text{time at lower threshold} - \text{time at upper threshold}$$

**Return Format** <value><NL>

<value> ::= time in seconds between the lower threshold and upper threshold in NR3 format

- See Also**
- "[Introduction to :MEASure Commands](#)" on page 290
  - "[:MEASure:RISetime](#)" on page 312
  - "[:MEASure:SOURce](#)" on page 315

**:MEASure:FREQuency**

**C** (see [page 750](#))

**Command Syntax** :MEASure:FREQuency [<source>]

<source> ::= {CHANnel<n> | FUNction | MATH}

<n> ::= {1 | 2 | 3 | 4} for the four channel oscilloscope models

<n> ::= {1 | 2} for the two channel oscilloscope models

The :MEASure:FREQuency command installs a screen measurement and starts a frequency measurement. If the optional source parameter is specified, the current source is modified.

IF the edge on the screen closest to the trigger reference is rising:

THEN frequency = 1/(time at trailing rising edge - time at leading rising edge)

ELSE frequency = 1/(time at trailing falling edge - time at leading falling edge)

**NOTE**

This command is not available if the source is FFT (Fast Fourier Transform).

**Query Syntax** :MEASure:FREQuency? [<source>]

The :MEASure:FREQuency? query measures and outputs the frequency of the cycle on the screen closest to the trigger reference.

**Return Format** <source><NL>

<source> ::= frequency in Hertz in NR3 format

- See Also**
- ["Introduction to :MEASure Commands"](#) on page 290
  - [":MEASure:SOURce"](#) on page 315
  - [":MEASure:PERiod"](#) on page 305

**Example Code**

- ["Example Code"](#) on page 315

## :MEASure:NWIDth

**C** (see [page 750](#))

**Command Syntax** :MEASure:NWIDth [<source>]

<source> ::= {CHANnel<n> | FUNCTION | MATH}

<n> ::= {1 | 2 | 3 | 4} for the four channel oscilloscope models

<n> ::= {1 | 2} for the two channel oscilloscope models

The :MEASure:NWIDth command installs a screen measurement and starts a negative pulse width measurement. If the optional source parameter is specified, the current source is modified.

**NOTE**

This command is not available if the source is FFT (Fast Fourier Transform).

**Query Syntax** :MEASure:NWIDth? [<source>]

The :MEASure:NWIDth? query measures and outputs the width of the negative pulse on the screen closest to the trigger reference using the midpoint between the upper and lower thresholds.

FOR the negative pulse closest to the trigger point:

width = (time at trailing rising edge - time at leading falling edge)

**Return Format** <value><NL>

<value> ::= negative pulse width in seconds in NR3 format

- See Also**
- ["Introduction to :MEASure Commands"](#) on page 290
  - [":MEASure:SOURce"](#) on page 315
  - [":MEASure:PWIDth"](#) on page 308
  - [":MEASure:PERiod"](#) on page 305

**:MEASure:OVERshoot**

**C** (see page 750)

**Command Syntax** :MEASure:OVERshoot [<source>]

<source> ::= {CHANnel<n> | FUNCTION | MATH}

<n> ::= {1 | 2 | 3 | 4} for the four channel oscilloscope models

<n> ::= {1 | 2} for the two channel oscilloscope models

The :MEASure:OVERshoot command installs a screen measurement and starts an overshoot measurement. If the optional source parameter is specified, the current source is modified.

**NOTE**

This command is not available if the source is FFT (Fast Fourier Transform).

**Query Syntax** :MEASure:OVERshoot? [<source>]

The :MEASure:OVERshoot? query measures and returns the overshoot of the edge closest to the trigger reference, displayed on the screen. The method used to determine overshoot is to make three different vertical value measurements: Vtop, Vbase, and either Vmax or Vmin, depending on whether the edge is rising or falling.

For a rising edge:

$$\text{overshoot} = ((V_{\text{max}} - V_{\text{top}}) / (V_{\text{top}} - V_{\text{base}})) \times 100$$

For a falling edge:

$$\text{overshoot} = ((V_{\text{base}} - V_{\text{min}}) / (V_{\text{top}} - V_{\text{base}})) \times 100$$

Vtop and Vbase are taken from the normal histogram of all waveform vertical values. The extremum of Vmax or Vmin is taken from the waveform interval right after the chosen edge, halfway to the next edge. This more restricted definition is used instead of the normal one, because it is conceivable that a signal may have more preshoot than overshoot, and the normal extremum would then be dominated by the preshoot of the following edge.

**Return Format** <overshoot><NL>

<overshoot> ::= the percent of the overshoot of the selected waveform in NR3 format

- See Also**
- "Introduction to :MEASure Commands" on page 290
  - ":MEASure:PREShoot" on page 307
  - ":MEASure:SOURce" on page 315
  - ":MEASure:VMAX" on page 327

## 5 Commands by Subsystem

- `":MEASure:VTOP"` on page 333
- `":MEASure:VBASe"` on page 326
- `":MEASure:VMIN"` on page 328

**:MEASure:PERiod**

**C** (see [page 750](#))

**Command Syntax** :MEASure:PERiod [<source>]

<source> ::= {CHANnel<n> | FUNCTION | MATH}

<n> ::= {1 | 2 | 3 | 4} for the four channel oscilloscope models

<n> ::= {1 | 2} for the two channel oscilloscope models

The :MEASure:PERiod command installs a screen measurement and starts the period measurement. If the optional source parameter is specified, the current source is modified.

**NOTE**

This command is not available if the source is FFT (Fast Fourier Transform).

**Query Syntax** :MEASure:PERiod? [<source>]

The :MEASure:PERiod? query measures and outputs the period of the cycle closest to the trigger reference on the screen. The period is measured at the midpoint of the upper and lower thresholds.

IF the edge closest to the trigger reference on screen is rising:

THEN period = (time at trailing rising edge - time at leading rising edge)

ELSE period = (time at trailing falling edge - time at leading falling edge)

**Return Format** <value><NL>

<value> ::= waveform period in seconds in NR3 format

- See Also**
- ["Introduction to :MEASure Commands"](#) on page 290
  - [":MEASure:SOURce"](#) on page 315
  - [":MEASure:NWIDTH"](#) on page 302
  - [":MEASure:PWIDTh"](#) on page 308
  - [":MEASure:FREQUency"](#) on page 301

- Example Code**
- ["Example Code"](#) on page 315

**:MEASure:PHASe**

**N** (see [page 750](#))

**Command Syntax** :MEASure:PHASe [<source1>][,<source2>]  
 <source1>, <source2> ::= {CHANnel<n> | FUNction | MATH}  
 <n> ::= {1 | 2 | 3 | 4} for the four channel oscilloscope models  
 <n> ::= {1 | 2} for the two channel oscilloscope models

The :MEASure:PHASe command places the instrument in the continuous measurement mode and starts a phase measurement.

**Query Syntax** :MEASure:PHASe? [<source1>][,<source2>]

The :MEASure:PHASe? query measures and returns the phase between the specified sources.

A phase measurement is a combination of the period and delay measurements. First, the period is measured on source1. Then the delay is measured between source1 and source2. The edges used for delay are the source1 rising edge used for the period measurement closest to the horizontal reference and the rising edge on source 2. See :MEASure:DELAy for more detail on selecting the 2nd edge.

The phase is calculated as follows:

$$\text{phase} = (\text{delay} / \text{period of input 1}) \times 360$$

**Return Format** <value><NL>  
 <value> ::= the phase angle value in degrees in NR3 format

- See Also**
- ["Introduction to :MEASure Commands"](#) on page 290
  - [":MEASure:DELAy"](#) on page 297
  - [":MEASure:PERiod"](#) on page 305
  - [":MEASure:SOURce"](#) on page 315

**:MEASure:PREShoot**

**C** (see [page 750](#))

**Command Syntax** :MEASure:PREShoot [<source>]

<source> ::= {CHANnel<n> | FUNCTION | MATH}

<n> ::= {1 | 2 | 3 | 4} for the four channel oscilloscope models

<n> ::= {1 | 2} for the two channel oscilloscope models

The :MEASure:PREShoot command installs a screen measurement and starts a preshoot measurement. If the optional source parameter is specified, the current source is modified.

**Query Syntax** :MEASure:PREShoot? [<source>]

The :MEASure:PREShoot? query measures and returns the preshoot of the edge closest to the trigger, displayed on the screen. The method used to determine preshoot is to make three different vertical value measurements: Vtop, Vbase, and either Vmin or Vmax, depending on whether the edge is rising or falling.

For a rising edge:

$$\text{preshoot} = ((V_{\text{min}} - V_{\text{base}}) / (V_{\text{top}} - V_{\text{base}})) \times 100$$

For a falling edge:

$$\text{preshoot} = ((V_{\text{max}} - V_{\text{top}}) / (V_{\text{top}} - V_{\text{base}})) \times 100$$

Vtop and Vbase are taken from the normal histogram of all waveform vertical values. The extremum of Vmax or Vmin is taken from the waveform interval right before the chosen edge, halfway back to the previous edge. This more restricted definition is used instead of the normal one, because it is likely that a signal may have more overshoot than preshoot, and the normal extremum would then be dominated by the overshoot of the preceding edge.

**Return Format** <value><NL>

<value> ::= the percent of preshoot of the selected waveform  
in NR3 format

- See Also**
- ["Introduction to :MEASure Commands"](#) on page 290
  - [":MEASure:SOURce"](#) on page 315
  - [":MEASure:VMIN"](#) on page 328
  - [":MEASure:VMAX"](#) on page 327
  - [":MEASure:VTOP"](#) on page 333
  - [":MEASure:VBASe"](#) on page 326

**:MEASure:PWIDth**

**C** (see [page 750](#))

**Command Syntax** :MEASure:PWIDth [<source>]

<source> ::= {CHANnel<n> | FUNCTION | MATH}

<n> ::= {1 | 2 | 3 | 4} for the four channel oscilloscope models

<n> ::= {1 | 2} for the two channel oscilloscope models

The :MEASure:PWIDth command installs a screen measurement and starts the positive pulse width measurement. If the optional source parameter is specified, the current source is modified.

**NOTE**

This command is not available if the source is FFT (Fast Fourier Transform).

**Query Syntax** :MEASure:PWIDth? [<source>]

The :MEASure:PWIDth? query measures and outputs the width of the displayed positive pulse closest to the trigger reference. Pulse width is measured at the midpoint of the upper and lower thresholds.

IF the edge on the screen closest to the trigger is falling:

THEN width = (time at trailing falling edge - time at leading rising edge)

ELSE width = (time at leading falling edge - time at leading rising edge)

**Return Format** <value><NL>

<value> ::= width of positive pulse in seconds in NR3 format

- See Also**
- "[Introduction to :MEASure Commands](#)" on page 290
  - "[:MEASure:SOURce](#)" on page 315
  - "[:MEASure:NWIDth](#)" on page 302
  - "[:MEASure:PERiod](#)" on page 305

## :MEASure:RESults

**N** (see [page 750](#))

**Query Syntax** :MEASure:RESults?

The :MEASure:RESults? query returns the results of the continuously displayed measurements. The response to the MEASure:RESults? query is a list of comma-separated values.

If more than one measurement is running continuously, the :MEASure:RESults return values are duplicated for each continuous measurement from the first to last (left to right) result displayed. Each result returned is separated from the previous result by a comma. There is a maximum of four continuous measurements that can be continuously displayed at a time.

When no quick measurements are installed, the :MEASure:RESults? query returns nothing (empty string). When the count for any of the measurements is 0, the value of infinity (9.9E+37) is returned for the min, max, mean, and standard deviation.

**Return Format** <result\_list><NL>

<result\_list> ::= comma-separated list of measurement results

The following shows the order of values received for a single measurement if :MEASure:STATistics is set to ON.

| Measurement label | current | min | max | mean | std dev | count |
|-------------------|---------|-----|-----|------|---------|-------|
|-------------------|---------|-----|-----|------|---------|-------|

Measurement label, current, min, max, mean, std dev, and count are only returned if :MEASure:STATistics is ON.

If :MEASure:STATistics is set to CURRENT, MIN, MAX, MEAN, STDDDev, or COUNT only that particular statistic value is returned for each measurement that is on.

- See Also**
- ["Introduction to :MEASure Commands"](#) on page 290
  - [":MEASure:STATistics"](#) on page 317

**Example Code**

```
' This program shows the InfiniiVision oscilloscopes' measurement
' statistics commands.
' -----

Option Explicit

Public myMgr As VisaComLib.ResourceManager
Public myScope As VisaComLib.FormattedIO488
Public varQueryResult As Variant
Public strQueryResult As String
```

## 5 Commands by Subsystem

```
Private Declare Sub Sleep Lib "kernel32" (ByVal dwMilliseconds As Long)

Sub Main()

    On Error GoTo VisaComError

    ' Create the VISA COM I/O resource.
    Set myMgr = New VisaComLib.ResourceManager
    Set myScope = New VisaComLib.FormattedIO488
    Set myScope.IO = myMgr.Open("TCPIP0::130.29.70.228::inst0::INSTR")

    ' Initialize.
    myScope.IO.Clear ' Clear the interface.
    myScope.WriteString "*RST" ' Reset to the defaults.
    myScope.WriteString "*CLS" ' Clear the status data structures.
    myScope.WriteString ":AUToscale"

    ' Install some measurements.
    myScope.WriteString ":MEASure:SOURce CHANnel1" ' Input source.

    Dim MeasurementArray(3) As String
    MeasurementArray(0) = "FREQuency"
    MeasurementArray(1) = "DUTYcycle"
    MeasurementArray(2) = "VAMPLitude"
    MeasurementArray(3) = "VPP"
    Dim Measurement As Variant

    For Each Measurement In MeasurementArray
        myScope.WriteString ":MEASure:" + Measurement
        myScope.WriteString ":MEASure:" + Measurement + "?"
        varQueryResult = myScope.ReadNumber ' Read measurement value.
        Debug.Print Measurement + ": " + FormatNumber(varQueryResult, 4)
    Next

    myScope.WriteString ":MEASure:STATistics:RESet" ' Reset stats.
    Sleep 5000 ' Wait for 5 seconds.

    ' Select the statistics results type.
    Dim ResultsTypeArray(6) As String
    ResultsTypeArray(0) = "CURRent"
    ResultsTypeArray(1) = "MINimum"
    ResultsTypeArray(2) = "MAXimum"
    ResultsTypeArray(3) = "MEAN"
    ResultsTypeArray(4) = "STDDev"
    ResultsTypeArray(5) = "COUNT"
    ResultsTypeArray(6) = "ON" ' All results.
    Dim ResultType As Variant

    Dim ResultsList()

    Dim ValueColumnArray(6) As String
    ValueColumnArray(0) = "Meas_Lbl"
    ValueColumnArray(1) = "Current"
    ValueColumnArray(2) = "Min"
    ValueColumnArray(3) = "Max"
    ValueColumnArray(4) = "Mean"
```

```

ValueColumnArray(5) = "Std_Dev"
ValueColumnArray(6) = "Count"
Dim ValueColumn As Variant

For Each ResultType In ResultsTypeArray
    myScope.WriteString ":MEASure:STATistics " + ResultType

    ' Get the statistics results.
    Dim intCounter As Integer
    intCounter = 0
    myScope.WriteString ":MEASure:RESults?"
    ResultsList() = myScope.ReadList

    For Each Measurement In MeasurementArray

        If ResultType = "ON" Then ' All statistics.

            For Each ValueColumn In ValueColumnArray
                If VarType(ResultsList(intCounter)) <> vbString Then
                    Debug.Print "Measure statistics result CH1, " + _
                        Measurement + ", "; ValueColumn + ": " + _
                        FormatNumber(ResultsList(intCounter), 4)

                Else ' Result is a string (e.g., measurement label).
                    Debug.Print "Measure statistics result CH1, " + _
                        Measurement + ", "; ValueColumn + ": " + _
                        ResultsList(intCounter)

                End If

                intCounter = intCounter + 1

            Next

        Else ' Specific statistic (e.g., Current, Max, Min, etc.).

            Debug.Print "Measure statistics result CH1, " + _
                Measurement + ", "; ResultType + ": " + _
                FormatNumber(ResultsList(intCounter), 4)

            intCounter = intCounter + 1

        End If

    Next

Next

Exit Sub

VisaComError:
    MsgBox "VISA COM Error:" + vbCrLf + Err.Description

End Sub

```

**:MEASure:RISetime**

**C** (see [page 750](#))

**Command Syntax** :MEASure: RISetime [<source>]

<source> ::= {CHANnel<n> | FUNction | MATH}

<n> ::= {1 | 2 | 3 | 4} for the four channel oscilloscope models

<n> ::= {1 | 2} for the two channel oscilloscope models

The :MEASure:RISetime command installs a screen measurement and starts a rise-time measurement. If the optional source parameter is specified, the current source is modified.

**NOTE**

This command is not available if the source is FFT (Fast Fourier Transform).

**Query Syntax** :MEASure: RISetime? [<source>]

The :MEASure:RISetime? query measures and outputs the rise time of the displayed rising (positive-going) edge closest to the trigger reference. For maximum measurement accuracy, set the sweep speed as fast as possible while leaving the leading edge of the waveform on the display. The rise time is determined by measuring the time at the lower threshold of the rising edge and the time at the upper threshold of the rising edge, then calculating the rise time with the following formula:

$$\text{rise time} = \text{time at upper threshold} - \text{time at lower threshold}$$

**Return Format** <value><NL>

<value> ::= rise time in seconds in NR3 format

- See Also**
- ["Introduction to :MEASure Commands"](#) on page 290
  - [":MEASure:SOURce"](#) on page 315
  - [":MEASure:FALLtime"](#) on page 300

**:MEASure:SDEVIation**

**N** (see [page 750](#))

**Command Syntax** :MEASure:SDEVIation [<source>]

<source> ::= {CHANnel<n> | FUNction | MATH}

<n> ::= {1 | 2 | 3 | 4} for the four channel oscilloscope models

<n> ::= {1 | 2} for the two channel oscilloscope models

The :MEASure:SDEVIation command installs a screen measurement and starts std deviation measurement. If the optional source parameter is specified, the current source is modified.

**NOTE**

This command is not available if the source is FFT (Fast Fourier Transform).

**Query Syntax** :MEASure:SDEVIation? [<source>]

The :MEASure:SDEVIation? query measures and outputs the std deviation of the selected waveform. The oscilloscope computes the std deviation on all displayed data points.

**Return Format** <value><NL>

<value> ::= calculated std deviation value in NR3 format

- See Also**
- ["Introduction to :MEASure Commands"](#) on page 290
  - [":MEASure:SOURce"](#) on page 315

## **:MEASure:SHOW**

**N** (see [page 750](#))

**Command Syntax** :MEASure:SHOW <show>  
<show> ::= {1 | ON}

The :MEASure:SHOW command enables markers for tracking measurements on the display. This feature is always on.

**Query Syntax** :MEASure:SHOW?

The :MEASure:SHOW? query returns the current state of the markers.

**Return Format** <show><NL>  
<show> ::= 1

**See Also** • ["Introduction to :MEASure Commands"](#) on page 290

**:MEASure:SOURce**

**C** (see [page 750](#))

**Command Syntax** :MEASure:SOURce <source1>[,<source2>]  
 <source1>,<source2> ::= {CHANnel<n> | FUNCtion | MATH | EXTernal}  
 <n> ::= {1 | 2 | 3 | 4} for the four channel oscilloscope models  
 <n> ::= {1 | 2} for the two channel oscilloscope models

The :MEASure:SOURce command sets the default sources for measurements. The specified sources are used as the sources for the MEASure subsystem commands if the sources are not explicitly set with the command.

If a source is specified for any measurement, the current source is changed to this new value.

If :MARKer:MODE is set to OFF or MANual, setting :MEASure:SOURce to CHANnel<n>, FUNCtion, or MATH will also set :MARKer:X1Y1source to source1 and :MARKer:X2Y2source to source2.

EXTernal is only a valid source for the counter measurement (and <source1>).

**Query Syntax** :MEASure:SOURce?

The :MEASure:SOURce? query returns the current source selections. If source2 is not specified, the query returns "NONE" for source2. If all channels are off, the query returns "NONE,NONE". Source2 only applies to :MEASure:DELay and :MEASure:PHASe measurements.

**NOTE**

MATH is an alias for FUNCtion. The query will return FUNC if the source is FUNCtion or MATH.

**Return Format** <source1>,<source2><NL>  
 <source1>,<source2> ::= {CHAN<n> | FUNC | EXT | NONE}

- See Also:**
- ["Introduction to :MEASure Commands"](#) on page 290
  - [":MARKer:MODE"](#) on page 276
  - [":MARKer:X1Y1source"](#) on page 278
  - [":MARKer:X2Y2source"](#) on page 280
  - [":MEASure:DELay"](#) on page 297
  - [":MEASure:PHASe"](#) on page 306

**Example Code**

```
' MEASURE - The commands in the MEASURE subsystem are used to make
' measurements on displayed waveforms.
myScope.WriteString ":MEASURE:SOURCE CHANNEL1" ' Source to measure.
```

## 5 Commands by Subsystem

```
myScope.WriteString ":MEASURE:FREQUENCY?" ' Query for frequency.
varQueryResult = myScope.ReadNumber ' Read frequency.
MsgBox "Frequency:" + vbCrLf _
      + FormatNumber(varQueryResult / 1000, 4) + " kHz"
myScope.WriteString ":MEASURE:DUTYCYCLE?" ' Query for duty cycle.
varQueryResult = myScope.ReadNumber ' Read duty cycle.
MsgBox "Duty cycle:" + vbCrLf _
      + FormatNumber(varQueryResult, 3) + "%"
myScope.WriteString ":MEASURE:RISETIME?" ' Query for risetime.
varQueryResult = myScope.ReadNumber ' Read risetime.
MsgBox "Risetime:" + vbCrLf _
      + FormatNumber(varQueryResult * 1000000, 4) + " us"
myScope.WriteString ":MEASURE:VPP?" ' Query for Pk to Pk voltage.
varQueryResult = myScope.ReadNumber ' Read VPP.
MsgBox "Peak to peak voltage:" + vbCrLf _
      + FormatNumber(varQueryResult, 4) + " V"
myScope.WriteString ":MEASURE:VMAX?" ' Query for Vmax.
varQueryResult = myScope.ReadNumber ' Read Vmax.
MsgBox "Maximum voltage:" + vbCrLf _
      + FormatNumber(varQueryResult, 4) + " V"
```

Example program from the start: ["VISA COM Example in Visual Basic"](#) on page 776

**:MEASure:STATistics**

**N** (see [page 750](#))

**Command Syntax** :MEASure:STATistics <type>

```
<type> ::= {{ON | 1} | CURRent | MINimum | MAXimum | MEAN | STDDev
           | COUNT}
```

The :MEASure:STATistics command determines the type of information returned by the :MEASure:RESults? query. ON means all the statistics are on.

**Query Syntax** :MEASure:STATistics?

The :MEASure:STATistics? query returns the current statistics mode.

**Return Format** <type><NL>

```
<type> ::= {ON | CURR | MIN | MAX | MEAN | STDD | COUN}
```

- See Also**
- ["Introduction to :MEASure Commands"](#) on page 290
  - [":MEASure:RESults"](#) on page 309
  - [":MEASure:STATistics:RESet"](#) on page 319
  - [":MEASure:STATistics:INCRement"](#) on page 318

**Example Code** • ["Example Code"](#) on page 309

## :MEASure:STATistics:INCRement

**N** (see [page 750](#))

**Command Syntax** :MEASure:STATistics:INCRement

This command updates the statistics once (incrementing the count by one) using the current measurement values. It corresponds to the front panel **Increment Statistics** softkey in the Measurement Statistics Menu. This command lets you, for example, gather statistics over multiple pulses captured in a single acquisition. To do this, change the horizontal position and enter the command for each new pulse that is measured.

This command is only allowed when the oscilloscope is stopped and quick measurements are on.

The command is allowed in segmented acquisition mode even though the corresponding front panel softkey is not available.

- See Also**
- ["Introduction to :MEASure Commands"](#) on page 290
  - [":MEASure:STATistics"](#) on page 317
  - [":MEASure:STATistics:RESet"](#) on page 319
  - [":MEASure:RESults"](#) on page 309

**:MEASure:STATistics:RESet**

**N** (see [page 750](#))

**Command Syntax** :MEASure:STATistics:RESet

This command resets the measurement statistics, zeroing the counts.

Note that the measurement (statistics) configuration is not deleted.

- See Also**
- ["Introduction to :MEASure Commands"](#) on page 290
  - [":MEASure:STATistics"](#) on page 317
  - [":MEASure:RESults"](#) on page 309
  - [":MEASure:STATistics:INCRement"](#) on page 318

- Example Code**
- ["Example Code"](#) on page 309

**:MEASure:TEDGe**

**N** (see [page 750](#))

**Query Syntax** :MEASure:TEDGe? <slope><occurrence>[,<source>]

<slope> ::= direction of the waveform. A rising slope is indicated by a space or plus sign (+). A falling edge is indicated by a minus sign (-).

<occurrence> ::= the transition to be reported. If the occurrence number is one, the first crossing from the left screen edge is reported. If the number is two, the second crossing is reported, etc.

<source> ::= {CHANnel<n> | FUNCTION | MATH}

<n> ::= {1 | 2 | 3 | 4} for the four channel oscilloscope models

<n> ::= {1 | 2} for the two channel oscilloscope models

When the :MEASure:TEDGe query is sent, the displayed signal is searched for the specified transition. The time interval between the trigger event and this occurrence is returned as the response to the query. The sign of the slope selects a rising (+) or falling (-) edge. If no sign is specified for the slope, it is assumed to be the rising edge.

The magnitude of occurrence defines the occurrence to be reported. For example, +3 returns the time for the third time the waveform crosses the midpoint threshold in the positive direction. Once this crossing is found, the oscilloscope reports the time at that crossing in seconds, with the trigger point (time zero) as the reference.

If the specified crossing cannot be found, the oscilloscope reports +9.9E+37. This value is returned if the waveform does not cross the specified vertical value, or if the waveform does not cross the specified vertical value for the specific number of times in the direction specified.

You can make delay and phase measurements using the MEASure:TEDGe command:

Delay = time at the nth rising or falling edge of the channel - time at the same edge of another channel

Phase = (delay between channels / period of channel) x 360

For an example of making a delay and phase measurement, see [":MEASure:TEDGe Code"](#) on page 321.

If the optional source parameter is specified, the current source is modified.

**NOTE**

This query is not available if the source is FFT (Fast Fourier Transform).

**Return Format** <value><NL>

<value> ::= time in seconds of the specified transition in NR3 format

**:MEASure:TEDGe  
Code**

```
' Make a delay measurement between channel 1 and 2.
Dim dblChan1Edge1 As Double
Dim dblChan2Edge1 As Double
Dim dblChan1Edge2 As Double
Dim dblDelay As Double
Dim dblPeriod As Double
Dim dblPhase As Double

' Query time at 1st rising edge on ch1.
myScope.WriteString ":MEASURE:TEDGE? +1, CHAN1"

' Read time at edge 1 on ch 1.
dblChan1Edge1 = myScope.ReadNumber

' Query time at 1st rising edge on ch2.
myScope.WriteString ":MEASURE:TEDGE? +1, CHAN2"

' Read time at edge 1 on ch 2.
dblChan2Edge1 = myScope.ReadNumber

' Calculate delay time between ch1 and ch2.
dblDelay = dblChan2Edge1 - dblChan1Edge1

' Write calculated delay time to screen.
MsgBox "Delay = " + vbCrLf + CStr(dblDelay)

' Make a phase difference measurement between channel 1 and 2.
' Query time at 1st rising edge on ch1.
myScope.WriteString ":MEASURE:TEDGE? +2, CHAN1"

' Read time at edge 2 on ch 1.
dblChan1Edge2 = myScope.ReadNumber

' Calculate period of ch 1.
dblPeriod = dblChan1Edge2 - dblChan1Edge1

' Calculate phase difference between ch1 and ch2.
dblPhase = (dblDelay / dblPeriod) * 360
MsgBox "Phase = " + vbCrLf + CStr(dblPhase)
```

Example program from the start: ["VISA COM Example in Visual Basic"](#) on page 776

- See Also**
- ["Introduction to :MEASure Commands"](#) on page 290
  - [":MEASure:TVALue"](#) on page 322
  - [":MEASure:VTIME"](#) on page 332

**:MEASure:TVALue**

**C** (see page 750)

**Query Syntax** :MEASure:TVALue? <value>, [<slope>]<occurrence>[,<source>]

<value> ::= the vertical value that the waveform must cross. The value can be volts or a math function value such as dB, Vs, or V/s.

<slope> ::= direction of the waveform. A rising slope is indicated by a plus sign (+). A falling edge is indicated by a minus sign (-).

<occurrence> ::= the transition to be reported. If the occurrence number is one, the first crossing is reported. If the number is two, the second crossing is reported, etc.

<source> ::= {CHANnel<n> | FUNCTION | MATH}

<n> ::= {1 | 2 | 3 | 4} for the four channel oscilloscope models

<n> ::= {1 | 2} for the two channel oscilloscope models

When the :MEASure:TVALue? query is sent, the displayed signal is searched for the specified value level and transition. The time interval between the trigger event and this defined occurrence is returned as the response to the query.

The specified value can be negative or positive. To specify a negative value, use a minus sign (-). The sign of the slope selects a rising (+) or falling (-) edge. If no sign is specified for the slope, it is assumed to be the rising edge.

The magnitude of the occurrence defines the occurrence to be reported. For example, +3 returns the time for the third time the waveform crosses the specified value level in the positive direction. Once this value crossing is found, the oscilloscope reports the time at that crossing in seconds, with the trigger point (time zero) as the reference.

If the specified crossing cannot be found, the oscilloscope reports +9.9E+37. This value is returned if the waveform does not cross the specified value, or if the waveform does not cross the specified value for the specified number of times in the direction specified.

If the optional source parameter is specified, the current source is modified.

**NOTE**

This query is not available if the source is FFT (Fast Fourier Transform).

**Return Format** <value><NL>

<value> ::= time in seconds of the specified value crossing in  
NR3 format

- See Also**
- ["Introduction to :MEASure Commands"](#) on page 290
  - [":MEASure:TEDGE"](#) on page 320
  - [":MEASure:VTIME"](#) on page 332

**:MEASure:VAMPlitude**

**C** (see [page 750](#))

**Command Syntax** :MEASure:VAMPlitude [<source>]

<source> ::= {CHANnel<n> | FUNction | MATH}

<n> ::= {1 | 2 | 3 | 4} for the four channel oscilloscope models

<n> ::= {1 | 2} for the two channel oscilloscope models

The :MEASure:VAMPlitude command installs a screen measurement and starts a vertical amplitude measurement. If the optional source parameter is specified, the current source is modified.

**Query Syntax** :MEASure:VAMPlitude? [<source>]

The :MEASure:VAMPlitude? query measures and returns the vertical amplitude of the waveform. To determine the amplitude, the instrument measures Vtop and Vbase, then calculates the amplitude as follows:

$$\text{vertical amplitude} = V_{\text{top}} - V_{\text{base}}$$

**Return Format** <value><NL>

<value> ::= the amplitude of the selected waveform in NR3 format

- See Also**
- ["Introduction to :MEASure Commands"](#) on page 290
  - [":MEASure:SOURce"](#) on page 315
  - [":MEASure:VBASe"](#) on page 326
  - [":MEASure:VTOP"](#) on page 333
  - [":MEASure:VPP"](#) on page 329

**:MEASure:VAverage**

**C** (see [page 750](#))

**Command Syntax** :MEASure:VAverage [<interval>][,][<source>]

<interval> ::= {CYCLE | DISPlay | AUTO}

<source> ::= {CHANnel<n> | FUNCTION | MATH}

<n> ::= {1 | 2 | 3 | 4} for the four channel oscilloscope models

<n> ::= {1 | 2} for the two channel oscilloscope models

The :MEASure:VAverage command installs a screen measurement and starts an average value measurement. If the optional source parameter is specified, the current source is modified.

**Query Syntax** :MEASure:VAverage? [<interval>][,][<source>]

The :MEASure:VAverage? query returns the average value of an integral number of periods of the signal. If at least three edges are not present, the oscilloscope averages all data points.

The :MEASure:VRMS? query returns the average value of the selected waveform. How the average value is measured depends on the <interval> specification:

- If <interval> is CYCLE, the average value is measured on an integral number of periods of the displayed signal. If less than three edges are present, the measurement fails, and +9.9E+37 is returned.
- If <interval> is DISPlay, the average value is measured on all displayed data points.
- If <interval> is AUTO or is not specified, the measurement attempts to compute a value using the CYCLE interval. If less than three edges are present, the measurement is computed using the DISPlay interval.

**Return Format** <value><NL>

<value> ::= calculated average value in NR3 format

- See Also**
- ["Introduction to :MEASure Commands"](#) on page 290
  - [":MEASure:SOURce"](#) on page 315

## :MEASure:VBASe

**C** (see [page 750](#))

**Command Syntax** :MEASure:VBASe [<source>]

<source> ::= {CHANnel<n> | FUNCTION | MATH}

<n> ::= {1 | 2 | 3 | 4} for the four channel oscilloscope models

<n> ::= {1 | 2} for the two channel oscilloscope models

The :MEASure:VBASe command installs a screen measurement and starts a waveform base value measurement. If the optional source parameter is specified, the current source is modified.

**NOTE**

This command is not available if the source is FFT (Fast Fourier Transform).

**Query Syntax** :MEASure:VBASe? [<source>]

The :MEASure:VBASe? query returns the vertical value at the base of the waveform. The base value of a pulse is normally not the same as the minimum value.

**Return Format** <base\_voltage><NL>

<base\_voltage> ::= value at the base of the selected waveform in NR3 format

- See Also**
- ["Introduction to :MEASure Commands"](#) on page 290
  - [":MEASure:SOURce"](#) on page 315
  - [":MEASure:VTOP"](#) on page 333
  - [":MEASure:VAMPLitude"](#) on page 324
  - [":MEASure:VMIN"](#) on page 328

**:MEASure:VMAX**

**C** (see [page 750](#))

**Command Syntax** :MEASure:VMAX [<source>]

<source> ::= {CHANnel<n> | FUNCTION | MATH}

<n> ::= {1 | 2 | 3 | 4} for the four channel oscilloscope models

<n> ::= {1 | 2} for the two channel oscilloscope models

The :MEASure:VMAX command installs a screen measurement and starts a maximum vertical value measurement. If the optional source parameter is specified, the current source is modified.

**Query Syntax** :MEASure:VMAX? [<source>]

The :MEASure:VMAX? query measures and outputs the maximum vertical value present on the selected waveform.

**Return Format** <value><NL>

<value> ::= maximum vertical value of the selected waveform in NR3 format

- See Also**
- ["Introduction to :MEASure Commands"](#) on page 290
  - [":MEASure:SOURce"](#) on page 315
  - [":MEASure:VMIN"](#) on page 328
  - [":MEASure:VPP"](#) on page 329
  - [":MEASure:VTOP"](#) on page 333

## :MEASure:VMIN

**C** (see [page 750](#))

**Command Syntax** :MEASure:VMIN [<source>]

<source> ::= {CHANnel<n> | FUNCTION | MATH}

<n> ::= {1 | 2 | 3 | 4} for the four channel oscilloscope models

<n> ::= {1 | 2} for the two channel oscilloscope models

The :MEASure:VMIN command installs a screen measurement and starts a minimum vertical value measurement. If the optional source parameter is specified, the current source is modified.

**Query Syntax** :MEASure:VMIN? [<source>]

The :MEASure:VMIN? query measures and outputs the minimum vertical value present on the selected waveform.

**Return Format** <value><NL>

<value> ::= minimum vertical value of the selected waveform in NR3 format

- See Also**
- ["Introduction to :MEASure Commands"](#) on page 290
  - [":MEASure:SOURce"](#) on page 315
  - [":MEASure:VBASe"](#) on page 326
  - [":MEASure:VMAX"](#) on page 327
  - [":MEASure:VPP"](#) on page 329

**:MEASure:VPP**

**C** (see [page 750](#))

**Command Syntax** :MEASure:VPP [<source>]

<source> ::= {CHANnel<n> | FUNCTION | MATH}

<n> ::= {1 | 2 | 3 | 4} for the four channel oscilloscope models

<n> ::= {1 | 2} for the two channel oscilloscope models

The :MEASure:VPP command installs a screen measurement and starts a vertical peak-to-peak measurement. If the optional source parameter is specified, the current source is modified.

**Query Syntax** :MEASure:VPP? [<source>]

The :MEASure:VPP? query measures the maximum and minimum vertical value for the selected source, then calculates the vertical peak-to-peak value and returns that value. The peak-to-peak value (Vpp) is calculated with the following formula:

$$V_{pp} = V_{max} - V_{min}$$

Vmax and Vmin are the vertical maximum and minimum values present on the selected source.

**Return Format** <value><NL>

<value> ::= vertical peak to peak value in NR3 format

- See Also**
- ["Introduction to :MEASure Commands"](#) on page 290
  - [":MEASure:SOURce"](#) on page 315
  - [":MEASure:VMAX"](#) on page 327
  - [":MEASure:VMIN"](#) on page 328
  - [":MEASure:VAMPLitude"](#) on page 324

## :MEASure:VRATio

**N** (see [page 750](#))

**Command Syntax** :MEASure:VRATio [<source1>][,<source2>]

<source1>, <source2> ::= {CHANnel<n> | FUNction | MATH}

<n> ::= {1 | 2 | 3 | 4} for the four channel oscilloscope models

<n> ::= {1 | 2} for the two channel oscilloscope models

The :MEASure:VRATio command places the instrument in the continuous measurement mode and starts a ratio measurement.

**Query Syntax** :MEASure:VRATio? [<source1>][,<source2>]

The :MEASure:VRATio? query measures and returns the ratio of AC RMS values of the specified sources expressed as dB.

**Return Format** <value><NL>

<value> ::= the ratio value in dB in NR3 format

- See Also**
- ["Introduction to :MEASure Commands"](#) on page 290
  - [":MEASure:VRMS"](#) on page 331
  - [":MEASure:SOURce"](#) on page 315

**:MEASure:VRMS**

**C** (see [page 750](#))

**Command Syntax** :MEASure:VRMS [<interval>][,][<source>]  
 <interval> ::= {CYCLe | DISPlay | AUTO}  
 <source> ::= {CHANnel<n> | FUNCTION | MATH}  
 <n> ::= {1 | 2 | 3 | 4} for the four channel oscilloscope models  
 <n> ::= {1 | 2} for the two channel oscilloscope models

The :MEASure:VRMS command installs a screen measurement and starts a dc RMS value measurement. If the optional source parameter is specified, the current source is modified.

**NOTE**

This command is not available if the source is FFT (Fast Fourier Transform).

**Query Syntax** :MEASure:VRMS? [<interval>][,][<source>]

The :MEASure:VRMS? query measures and outputs the dc RMS value of the selected waveform. How the dc RMS value is measured depends on the <interval> specification:

- If <interval> is CYCLe, the dc RMS value is measured on an integral number of periods of the displayed signal. If less than three edges are present, the measurement fails, and +9.9E+37 is returned.
- If <interval> is DISPlay, the dc RMS value is measured on all displayed data points.
- If <interval> is AUTO or is not specified, the measurement attempts to compute a value using the CYCLe interval. If less than three edges are present, the measurement is computed using the DISPlay interval.

**Return Format** <value><NL>  
 <value> ::= calculated dc RMS value in NR3 format

- See Also**
- ["Introduction to :MEASure Commands"](#) on page 290
  - [":MEASure:SOURce"](#) on page 315

## :MEASure:VTIME

**N** (see [page 750](#))

**Query Syntax** :MEASure:VTIME? <vtime\_argument>[,<source>]

<vtime\_argument> ::= time from trigger in seconds

<source> ::= {CHANnel<n> | FUNCTION | MATH}

<n> ::= {1 | 2 | 3 | 4} for the four channel oscilloscope models

<n> ::= {1 | 2} for the two channel oscilloscope models

The :MEASure:VTIME? query returns the value at a specified time on the source specified with :MEASure:SOURce. The specified time must be on the screen and is referenced to the trigger event. If the optional source parameter is specified, the current source is modified.

**NOTE**

This query is not available if the source is FFT (Fast Fourier Transform).

---

**Return Format** <value><NL>

<value> ::= value at the specified time in NR3 format

- See Also**
- ["Introduction to :MEASure Commands"](#) on page 290
  - [":MEASure:SOURce"](#) on page 315
  - [":MEASure:TEDGE"](#) on page 320
  - [":MEASure:TVALue"](#) on page 322

**:MEASure:VTOP**

**C** (see [page 750](#))

**Command Syntax** :MEASure:VTOP [<source>]

<source> ::= {CHANnel<n> | FUNCTION | MATH}

<n> ::= {1 | 2 | 3 | 4} for the four channel oscilloscope models

<n> ::= {1 | 2} for the two channel oscilloscope models

The :MEASure:VTOP command installs a screen measurement and starts a waveform top value measurement.

**NOTE**

This query is not available if the source is FFT (Fast Fourier Transform).

**Query Syntax** :MEASure:VTOP? [<source>]

The :MEASure:VTOP? query returns the vertical value at the top of the waveform. The top value of the pulse is normally not the same as the maximum value.

**Return Format** <value><NL>

<value> ::= vertical value at the top of the waveform in NR3 format

- See Also**
- ["Introduction to :MEASure Commands"](#) on page 290
  - [":MEASure:SOURce"](#) on page 315
  - [":MEASure:VMAX"](#) on page 327
  - [":MEASure:VAMPLitude"](#) on page 324
  - [":MEASure:VBASe"](#) on page 326

## :MEASure:WINDow

**C** (see [page 750](#))

**Command Syntax** :MEASure:WINDow <window>  
<window> ::= {MAIN | ZOOM | AUTO}

The :MEASure:WINDow command specifies, in the zoomed time base mode, which window is used as the measurement window:

- MAIN – the measurement window is the Main window.
- ZOOM – the measurement window is the Zoom window.
- AUTO – the measurement is attempted in the Zoom window; if it cannot be made there, the Main window is used.

**Query Syntax** :MEASure:WINDow?

The :MEASure:WINDow? query returns the currently specified measurement window.

**Return Format** <window><NL>  
<window> ::= {MAIN | ZOOM | AUTO}

**See Also** • ["Introduction to :MEASure Commands"](#) on page 290

**:MEASure:XMAX**

**N** (see [page 750](#))

**Command Syntax** :MEASure:XMAX [<source>]

<source> ::= {CHANnel<n> | FUNCTION | MATH}

<n> ::= {1 | 2 | 3 | 4} for the four channel oscilloscope models

<n> ::= {1 | 2} for the two channel oscilloscope models

The :MEASure:XMAX command installs a screen measurement and starts an X-at-Max-Y measurement on the selected window. If the optional source parameter is specified, the current source is modified.

**NOTE**

:MEASure:XMAX is an alias for :MEASure:TMAX.

**Query Syntax** :MEASure:XMAX? [<source>]

The :MEASure:XMAX? query measures and returns the horizontal axis value at which the maximum vertical value occurs. If the optional source is specified, the current source is modified. If all channels are off, the query returns 9.9E+37.

**Return Format** <value><NL>

<value> ::= horizontal value of the maximum in NR3 format

- See Also**
- ["Introduction to :MEASure Commands"](#) on page 290
  - [":MEASure:XMIN"](#) on page 336
  - [":MEASure:TMAX"](#) on page 683

## :MEASure:XMIn

**N** (see page 750)

**Command Syntax** :MEASure:XMIn [<source>]

<source> ::= {CHANnel<n> | FUNction | MATH}

<n> ::= {1 | 2 | 3 | 4} for the four channel oscilloscope models

<n> ::= {1 | 2} for the two channel oscilloscope models

The :MEASure:XMIn command installs a screen measurement and starts an X-at-Min-Y measurement on the selected window. If the optional source parameter is specified, the current source is modified.

**NOTE**

:MEASure:XMIn is an alias for :MEASure:TMin.

**Query Syntax** :MEASure:XMIn? [<source>]

The :MEASure:XMIn? query measures and returns the horizontal axis value at which the minimum vertical value occurs. If the optional source is specified, the current source is modified. If all channels are off, the query returns 9.9E+37.

**Return Format** <value><NL>

<value> ::= horizontal value of the minimum in NR3 format

- See Also**
- "Introduction to :MEASure Commands" on page 290
  - ":MEASure:XMIn" on page 335
  - ":MEASure:TMin" on page 684

## :MTESt Commands

The MTESt subsystem commands and queries control the mask test features. See "[Introduction to :MTESt Commands](#)" on page 339.

**Table 63** :MTESt Commands Summary

| Command  | Query   | Options and Query Returns   |
|--|---|---|
| :MTESt:AMASk:CREate<br>(see <a href="#">page 342</a> )               | n/a   | n/a   |
| :MTESt:AMASk:SOURce<br><source> (see <a href="#">page 343</a> )      | :MTESt:AMASk:SOURce?<br>(see <a href="#">page 343</a> )               | <source> ::= CHANnel<n><br><n> ::= {1   2   3   4} for 4ch models<br><n> ::= {1   2} for 2ch models |
| :MTESt:AMASk:UNITs<br><units> (see <a href="#">page 344</a> )        | :MTESt:AMASk:UNITs?<br>(see <a href="#">page 344</a> )                | <units> ::= {CURRent   DIVisions}   |
| :MTESt:AMASk:XDELta<br><value> (see <a href="#">page 345</a> )       | :MTESt:AMASk:XDELta?<br>(see <a href="#">page 345</a> )               | <value> ::= X delta value in NR3 format   |
| :MTESt:AMASk:YDELta<br><value> (see <a href="#">page 346</a> )       | :MTESt:AMASk:YDELta?<br>(see <a href="#">page 346</a> )               | <value> ::= Y delta value in NR3 format   |
| n/a  | :MTESt:COUNT:FwAVeforms? [CHANnel<n>] (see <a href="#">page 347</a> ) | <failed> ::= number of failed waveforms in NR1 format   |
| :MTESt:COUNT:RESet<br>(see <a href="#">page 348</a> )                | n/a   | n/a   |
| n/a  | :MTESt:COUNT:TIME?<br>(see <a href="#">page 349</a> )                 | <time> ::= elapsed seconds in NR3 format  |
| n/a  | :MTESt:COUNT:WAVEformS?<br>(see <a href="#">page 350</a> )            | <count> ::= number of waveforms in NR1 format   |
| :MTESt:DATA <mask><br>(see <a href="#">page 351</a> )                | :MTESt:DATA? (see <a href="#">page 351</a> )                          | <mask> ::= data in IEEE 488.2 # format.   |
| :MTESt:DELeTe (see <a href="#">page 352</a> )                        | n/a   | n/a   |
| :MTESt:ENABle {{0   OFF}   {1   ON}} (see <a href="#">page 353</a> ) | :MTESt:ENABle? (see <a href="#">page 353</a> )                        | {0   1}   |
| :MTESt:LOCK {{0   OFF}   {1   ON}} (see <a href="#">page 354</a> )   | :MTESt:LOCK? (see <a href="#">page 354</a> )                          | {0   1}   |

## 5 Commands by Subsystem

**Table 63** :MTESt Commands Summary (continued)

| Command  | Query   | Options and Query Returns                           |
|--|---|---|
| :MTESt:OUTPut<br><signal> (see<br>page 355)                                  | :MTESt:OUTPut? (see<br>page 355)                    | <signal> ::= {FAIL   PASS}                          |
| :MTESt:RMODe <rmode><br>(see page 356)                                       | :MTESt:RMODe? (see<br>page 356)                     | <rmode> ::= {FORever   TIME  <br>SIGMa   WAVEforms} |
| :MTESt:RMODe:FACTION:<br>MEASure {{0   OFF}  <br>{1   ON}} (see<br>page 357) | :MTESt:RMODe:FACTION:<br>MEASure? (see<br>page 357) | {0   1}   |
| :MTESt:RMODe:FACTION:<br>PRINt {{0   OFF}   {1<br>  ON}} (see page 358)      | :MTESt:RMODe:FACTION:<br>PRINt? (see page 358)      | {0   1}   |
| :MTESt:RMODe:FACTION:<br>SAVE {{0   OFF}   {1<br>  ON}} (see page 359)       | :MTESt:RMODe:FACTION:<br>SAVE? (see page 359)       | {0   1}   |
| :MTESt:RMODe:FACTION:<br>STOP {{0   OFF}   {1<br>  ON}} (see page 360)       | :MTESt:RMODe:FACTION:<br>STOP? (see page 360)       | {0   1}   |
| :MTESt:RMODe:SIGMa<br><level> (see<br>page 361)                              | :MTESt:RMODe:SIGMa?<br>(see page 361)               | <level> ::= from 0.1 to 9.3 in<br>NR3 format        |
| :MTESt:RMODe:TIME<br><seconds> (see<br>page 362)                             | :MTESt:RMODe:TIME?<br>(see page 362)                | <seconds> ::= from 1 to 86400 in<br>NR3 format      |
| :MTESt:RMODe:WAVEform<br>s <count> (see<br>page 363)                         | :MTESt:RMODe:WAVEform<br>s? (see page 363)          | <count> ::= number of waveforms<br>in NR1 format    |
| :MTESt:SCALE:BINd {{0<br>  OFF}   {1   ON}}<br>(see page 364)                | :MTESt:SCALE:BINd?<br>(see page 364)                | {0   1}   |
| :MTESt:SCALE:X1<br><x1_value> (see<br>page 365)                              | :MTESt:SCALE:X1? (see<br>page 365)                  | <x1_value> ::= X1 value in NR3<br>format            |
| :MTESt:SCALE:XDELta<br><xdelta_value> (see<br>page 366)                      | :MTESt:SCALE:XDELta?<br>(see page 366)              | <xdelta_value> ::= X delta value<br>in NR3 format   |
| :MTESt:SCALE:Y1<br><y1_value> (see<br>page 367)                              | :MTESt:SCALE:Y1? (see<br>page 367)                  | <y1_value> ::= Y1 value in NR3<br>format            |

**Table 63** :MTESt Commands Summary (continued)

| Command   | Query                              | Options and Query Returns   |
|---|------------------------------------|---|
| :MTESt:SCALe:Y2<br><y2_value> (see<br>page 368) | :MTESt:SCALe:Y2? (see<br>page 368) | <y2_value> ::= Y2 value in NR3<br>format  |
| :MTESt:SOURce<br><source> (see<br>page 369)     | :MTESt:SOURce? (see<br>page 369)   | <source> ::= {CHANnel<n>   NONE}<br><n> ::= {1   2   3   4} for 4ch<br>models<br><n> ::= {1   2} for 2ch models |
| n/a   | :MTESt:TITLe? (see<br>page 370)    | <title> ::= a string of up to 128<br>ASCII characters   |

**Introduction to :MTESt Commands** Mask testing automatically compares the current displayed waveform with the boundaries of a set of polygons that you define. Any waveform or sample that falls within the boundaries of one or more polygons is recorded as a failure.

**Reporting the Setup**

Use :MTESt? to query setup information for the MTESt subsystem.

**Return Format**

The following is a sample response from the :MTESt? query. In this case, the query was issued following a \*RST command.

```
:MTES:SOUR CHAN1;ENAB 0;LOCK 1;:MTES:AMAS:SOUR CHAN1;UNIT DIV;XDEL
+2.50000000E-001;YDEL +2.50000000E-001;:MTES:SCAL:X1 +200.000E-06;XDEL
+400.000E-06;Y1 -3.00000E+00;Y2 +3.00000E+00;BIND 0;:MTES:RMOD
FOR;RMOD:TIME +1E+00;WAV 1000;SIGM +6.0E+00;:MTES:RMOD:FACT:STOP
0;PRIN 0;SAVE 0
```

**Example Code**

```
' Mask testing commands example.
' -----

Option Explicit

Public myMgr As VisaComLib.ResourceManager
Public myScope As VisaComLib.FormattedIO488
Public varQueryResult As Variant
Public strQueryResult As String

Private Declare Sub Sleep Lib "kernel32" (ByVal dwMilliseconds As Long)

Sub Main()

    On Error GoTo VisaComError

    ' Create the VISA COM I/O resource.
```

## 5 Commands by Subsystem

```
Set myMgr = New VisaComLib.ResourceManager
Set myScope = New VisaComLib.FormattedIO488
Set myScope.IO = myMgr.Open("TCPIP0::130.29.70.228::inst0::INSTR")
myScope.IO.Clear ' Clear the interface.

' Make sure oscilloscope is running.
myScope.WriteString ":RUN"

' Set mask test termination conditions.
myScope.WriteString ":MTESt:RMODe SIGMa"
myScope.WriteString ":MTESt:RMODe?"
strQueryResult = myScope.ReadString
Debug.Print "Mask test termination mode: " + strQueryResult

myScope.WriteString ":MTESt:RMODe:SIGMa 4.2"
myScope.WriteString ":MTESt:RMODe:SIGMa?"
varQueryResult = myScope.ReadNumber
Debug.Print "Mask test termination 'test sigma': " + _
    FormatNumber(varQueryResult)

' Use auto-mask to create mask.
myScope.WriteString ":MTESt:AMASk:SOURce CHANnel1"
myScope.WriteString ":MTESt:AMASk:SOURce?"
strQueryResult = myScope.ReadString
Debug.Print "Mask test auto-mask source: " + strQueryResult

myScope.WriteString ":MTESt:AMASk:UNITs DIVIsions"
myScope.WriteString ":MTESt:AMASk:UNITs?"
strQueryResult = myScope.ReadString
Debug.Print "Mask test auto-mask units: " + strQueryResult

myScope.WriteString ":MTESt:AMASk:XDELta 0.1"
myScope.WriteString ":MTESt:AMASk:XDELta?"
varQueryResult = myScope.ReadNumber
Debug.Print "Mask test auto-mask X delta: " + _
    FormatNumber(varQueryResult)

myScope.WriteString ":MTESt:AMASk:YDELta 0.1"
myScope.WriteString ":MTESt:AMASk:YDELta?"
varQueryResult = myScope.ReadNumber
Debug.Print "Mask test auto-mask Y delta: " + _
    FormatNumber(varQueryResult)

' Enable "Auto Mask Created" event (bit 10, &H400)
myScope.WriteString "*CLS"
myScope.WriteString ":MTEenable " + CStr(CInt("&H400"))

' Create mask.
myScope.WriteString ":MTESt:AMASk:CREate"
Debug.Print "Auto-mask created, mask test automatically enabled."

' Set up timeout variables.
Dim lngTimeout As Long ' Max millisecs to wait.
Dim lngElapsed As Long
lngTimeout = 60000 ' 60 seconds.

' Wait until mask is created.
```

```

lngElapsed = 0
Do While lngElapsed <= lngTimeout
  myScope.WriteString ":OPERRegister:CONDition?"
  varQueryResult = myScope.ReadNumber
  ' Operation Status Condition Register MTE bit (bit 9, &H200).
  If (varQueryResult And &H200) <> 0 Then
    Exit Do
  Else
    Sleep 100 ' Small wait to prevent excessive queries.
    lngElapsed = lngElapsed + 100
  End If
Loop

' Look for RUN bit = stopped (mask test termination).
lngElapsed = 0
Do While lngElapsed <= lngTimeout
  myScope.WriteString ":OPERRegister:CONDition?"
  varQueryResult = myScope.ReadNumber
  ' Operation Status Condition Register RUN bit (bit 3, &H8).
  If (varQueryResult And &H8) = 0 Then
    Exit Do
  Else
    Sleep 100 ' Small wait to prevent excessive queries.
    lngElapsed = lngElapsed + 100
  End If
Loop

' Get total waveforms, failed waveforms, and test time.
myScope.WriteString ":MTESt:COUNT:WAVEforms?"
strQueryResult = myScope.ReadString
Debug.Print "Mask test total waveforms: " + strQueryResult

myScope.WriteString ":MTESt:COUNT:FWAVEforms?"
strQueryResult = myScope.ReadString
Debug.Print "Mask test failed waveforms: " + strQueryResult

myScope.WriteString ":MTESt:COUNT:TIME?"
strQueryResult = myScope.ReadString
Debug.Print "Mask test elapsed seconds: " + strQueryResult

Exit Sub

VisaComError:
  MsgBox "VISA COM Error:" + vbCrLf + Err.Description

End Sub

```

## **:MTESt:AMASk:CREate**

**N** (see [page 750](#))

**Command Syntax** :MTESt:AMASk:CREate

The :MTESt:AMASk:CREate command automatically constructs a mask around the current selected channel, using the tolerance parameters defined by the :MTESt:AMASk:XDELta, :MTESt:AMASk:YDELta, and :MTESt:AMASk:UNITs commands. The mask only encompasses the portion of the waveform visible on the display, so you must ensure that the waveform is acquired and displayed consistently to obtain repeatable results.

The :MTESt:SOURce command selects the channel and should be set before using this command.

- See Also**
- ["Introduction to :MTESt Commands"](#) on page 339
  - [":MTESt:AMASk:XDELta"](#) on page 345
  - [":MTESt:AMASk:YDELta"](#) on page 346
  - [":MTESt:AMASk:UNITs"](#) on page 344
  - [":MTESt:AMASk:SOURce"](#) on page 343
  - [":MTESt:SOURce"](#) on page 369

- Example Code**
- ["Example Code"](#) on page 339

**:MTESt:AMASk:SOURce**

**N** (see [page 750](#))

**Command Syntax** :MTESt:AMASk:SOURce <source>

<source> ::= CHANnel<n>

<n> ::= {1 | 2 | 3 | 4} for the four channel oscilloscope models

<n> ::= {1 | 2} for the two channel oscilloscope models

The :MTESt:AMASk:SOURce command selects the source for the interpretation of the :MTESt:AMASk:XDELta and :MTESt:AMASk:YDELta parameters when :MTESt:AMASk:UNITs is set to CURRent.

When UNITs are CURRent, the XDELta and YDELta parameters are defined in terms of the channel units, as set by the :CHANnel<n>:UNITs command, of the selected source.

Suppose that UNITs are CURRent and that you set SOURce to CHANNEL1, which is using units of volts. Then you can define AMASk:XDELta in terms of volts and AMASk:YDELta in terms of seconds.

This command is the same as the :MTESt:SOURce command.

**Query Syntax** :MTESt:AMASk:SOURce?

The :MTESt:AMASk:SOURce? query returns the currently set source.

**Return Format** <source> ::= CHAN<n>

<n> ::= {1 | 2 | 3 | 4} for the four channel oscilloscope models

<n> ::= {1 | 2} for the two channel oscilloscope models

- See Also**
- ["Introduction to :MTESt Commands"](#) on page 339
  - [":MTESt:AMASk:XDELta"](#) on page 345
  - [":MTESt:AMASk:YDELta"](#) on page 346
  - [":MTESt:AMASk:UNITs"](#) on page 344
  - [":MTESt:SOURce"](#) on page 369

**Example Code** • ["Example Code"](#) on page 339

## :MTESt:AMASk:UNITs

**N** (see [page 750](#))

**Command Syntax** :MTESt:AMASk:UNITs <units>  
<units> ::= {CURRent | DIVisions}

The :MTESt:AMASk:UNITs command alters the way the mask test subsystem interprets the tolerance parameters for automasking as defined by :MTESt:AMASk:XDELta and :MTESt:AMASk:YDELta commands.

- CURRent – the mask test subsystem uses the units as set by the :CHANnel<n>:UNITs command, usually time for  $\Delta X$  and voltage for  $\Delta Y$ .
- DIVisions – the mask test subsystem uses the graticule as the measurement system, so tolerance settings are specified as parts of a screen division. The mask test subsystem maintains separate XDELta and YDELta settings for CURRent and DIVisions. Thus, XDELta and YDELta are not converted to new values when the UNITs setting is changed.

**Query Syntax** :MTESt:AMASk:UNITs?

The :MTESt:AMASk:UNITs query returns the current measurement units setting for the mask test automask feature.

**Return Format** <units><NL>  
<units> ::= {CURR | DIV}

- See Also**
- "[Introduction to :MTESt Commands](#)" on page 339
  - "[:MTESt:AMASk:XDELta](#)" on page 345
  - "[:MTESt:AMASk:YDELta](#)" on page 346
  - "[:CHANnel<n>:UNITs](#)" on page 221
  - "[:MTESt:AMASk:SOURce](#)" on page 343
  - "[:MTESt:SOURce](#)" on page 369

**Example Code** • "[Example Code](#)" on page 339

**:MTEST:AMASK:XDELta**

**N** (see [page 750](#))

**Command Syntax** :MTEST:AMASK:XDELta <value>  
 <value> ::= X delta value in NR3 format

The :MTEST:AMASK:XDELta command sets the tolerance in the X direction around the waveform for the automasking feature. The absolute value of the tolerance will be added and subtracted to horizontal values of the waveform to determine the boundaries of the mask.

The horizontal tolerance value is interpreted based on the setting specified by the :MTEST:AMASK:UNITs command; thus, if you specify 250-E3, the setting for :MTEST:AMASK:UNITs is CURRent, and the current setting specifies time in the horizontal direction, the tolerance will be  $\pm 250$  ms. If the setting for :MTEST:AMASK:UNITs is DIVisions, the same X delta value will set the tolerance to  $\pm 250$  millidivisions, or 1/4 of a division.

**Query Syntax** :MTEST:AMASK:XDELta?

The :MTEST:AMASK:XDELta? query returns the current setting of the  $\Delta X$  tolerance for automasking. If your computer program will interpret this value, it should also request the current measurement system using the :MTEST:AMASK:UNITs query.

**Return Format** <value><NL>  
 <value> ::= X delta value in NR3 format

- See Also**
- "[Introduction to :MTEST Commands](#)" on page 339
  - "[:MTEST:AMASK:UNITs](#)" on page 344
  - "[:MTEST:AMASK:YDELta](#)" on page 346
  - "[:MTEST:AMASK:SOURce](#)" on page 343
  - "[:MTEST:SOURce](#)" on page 369

- Example Code**
- "[Example Code](#)" on page 339

**:MTESt:AMASk:YDELta**

**N** (see [page 750](#))

**Command Syntax** :MTESt:AMASk:YDELta <value>  
 <value> ::= Y delta value in NR3 format

The :MTESt:AMASk:YDELta command sets the vertical tolerance around the waveform for the automasking feature. The absolute value of the tolerance will be added and subtracted to vertical values of the waveform to determine the boundaries of the mask.

The vertical tolerance value is interpreted based on the setting specified by the :MTESt:AMASk:UNITs command; thus, if you specify 250-E3, the setting for :MTESt:AMASk:UNITs is CURRent, and the current setting specifies voltage in the vertical direction, the tolerance will be  $\pm 250$  mV. If the setting for :MTESt:AMASk:UNITs is DIVisions, the same Y delta value will set the tolerance to  $\pm 250$  millidivisions, or 1/4 of a division.

**Query Syntax** :MTESt:AMASk:YDELta?

The :MTESt:AMASk:YDELta? query returns the current setting of the  $\Delta Y$  tolerance for automasking. If your computer program will interpret this value, it should also request the current measurement system using the :MTESt:AMASk:UNITs query.

**Return Format** <value><NL>  
 <value> ::= Y delta value in NR3 format

- See Also**
- ["Introduction to :MTESt Commands"](#) on page 339
  - [":MTESt:AMASk:UNITs"](#) on page 344
  - [":MTESt:AMASk:XDELta"](#) on page 345
  - [":MTESt:AMASk:SOURce"](#) on page 343
  - [":MTESt:SOURce"](#) on page 369

- Example Code**
- ["Example Code"](#) on page 339

**:MTESt:COUNT:FWAVEforms**

**N** (see [page 750](#))

**Query Syntax** :MTESt:COUNT:FWAVEforms? [CHANnel<n>]

<n> ::= {1 | 2 | 3 | 4} for the four channel oscilloscope models

<n> ::= {1 | 2} for the two channel oscilloscope models

The :MTESt:COUNT:FWAVEforms? query returns the total number of failed waveforms in the current mask test run. This count is for all regions and all waveforms.

**Return Format** <failed><NL>

<failed> ::= number of failed waveforms in NR1 format.

- See Also**
- ["Introduction to :MTESt Commands"](#) on page 339
  - [":MTESt:COUNT:WAVEforms"](#) on page 350
  - [":MTESt:COUNT:TIME"](#) on page 349
  - [":MTESt:COUNT:RESet"](#) on page 348
  - [":MTESt:SOURce"](#) on page 369

- Example Code**
- ["Example Code"](#) on page 339

## **:MTESt:COUNT:RESet**

**N** (see [page 750](#))

**Command Syntax** :MTESt:COUNT:RESet

The :MTESt:COUNT:RESet command resets the mask statistics.

- See Also**
- ["Introduction to :MTESt Commands"](#) on page 339
  - [":MTESt:COUNT:WAVEforms"](#) on page 350
  - [":MTESt:COUNT:FWAVEforms"](#) on page 347
  - [":MTESt:COUNT:TIME"](#) on page 349

**:MTEST:COUNT:TIME**

**N** (see [page 750](#))

**Query Syntax** :MTEST:COUNT:TIME?

The :MTEST:COUNT:TIME? query returns the elapsed time in the current mask test run.

**Return Format** <time><NL>

<time> ::= elapsed seconds in NR3 format.

- See Also**
- ["Introduction to :MTEST Commands"](#) on page 339
  - [":MTEST:COUNT:WAVEforms"](#) on page 350
  - [":MTEST:COUNT:FWAVEforms"](#) on page 347
  - [":MTEST:COUNT:RESet"](#) on page 348

**Example Code** • ["Example Code"](#) on page 339

## **:MTESt:COUNT:WAVEforms**

**N** (see [page 750](#))

**Query Syntax** :MTESt:COUNT:WAVEforms?

The :MTESt:COUNT:WAVEforms? query returns the total number of waveforms acquired in the current mask test run.

**Return Format** <count><NL>

<count> ::= number of waveforms in NR1 format.

- See Also**
- ["Introduction to :MTESt Commands"](#) on page 339
  - [":MTESt:COUNT:FWAVEforms"](#) on page 347
  - [":MTESt:COUNT:TIME"](#) on page 349
  - [":MTESt:COUNT:RESEt"](#) on page 348

**Example Code** • ["Example Code"](#) on page 339

**:MTEST:DATA**

**N** (see [page 750](#))

**Command Syntax** :MTEST:DATA <mask>

<mask> ::= binary block data in IEEE 488.2 # format.

The :MTEST:DATA command loads a mask from binary block data.

**Query Syntax** :MTEST:DATA?

The :MTEST:DATA? query returns a mask in binary block data format. The format for the data transmission is the # format defined in the IEEE 488.2 specification.

**Return Format** <mask><NL>

<mask> ::= binary block data in IEEE 488.2 # format

- See Also**
- [":SAVE:MASK\[:START\]"](#) on page 387
  - [":RECall:MASK\[:START\]"](#) on page 374

## **:MTESt:DELeTe**

**N** (see [page 750](#))

**Command Syntax** :MTESt:DELeTe

The :MTESt:DELeTe command clears the currently loaded mask.

- See Also**
- ["Introduction to :MTESt Commands"](#) on page 339
  - [":MTESt:AMASk:CREate"](#) on page 342

**:MTESt:ENABle**

**N** (see [page 750](#))

**Command Syntax** :MTESt:ENABle <on\_off>

<on\_off> ::= {{1 | ON} | {0 | OFF}}

The :MTESt:ENABle command enables or disables the mask test features.

- ON – Enables the mask test features.
- OFF – Disables the mask test features.

**Query Syntax** :MTESt:ENABle?

The :MTESt:ENABle? query returns the current state of mask test features.

**Return Format** <on\_off><NL>

<on\_off> ::= {1 | 0}

**See Also** • ["Introduction to :MTESt Commands"](#) on page 339

## :MTEST:LOCK

**N** (see [page 750](#))

**Command Syntax** :MTEST:LOCK <on\_off>  
<on\_off> ::= {{1 | ON} | {0 | OFF}}

The :MTEST:LOCK command enables or disables the mask lock feature:

- ON – Locks a mask to the SOURCE. As the vertical or horizontal scaling or position of the SOURCE changes, the mask is redrawn accordingly.
- OFF – The mask is static and does not move.

**Query Syntax** :MTEST:LOCK?

The :MTEST:LOCK? query returns the current mask lock setting.

**Return Format** <on\_off><NL>  
<on\_off> ::= {1 | 0}

- See Also**
- "[Introduction to :MTEST Commands](#)" on page 339
  - "[:MTEST:SOURCE](#)" on page 369

**:MTESt:OUTPut**

**N** (see [page 750](#))

**Command Syntax** :MTESt:OUTPut <signal>  
 <signal> ::= {FAIL | PASS}

The :MTESt:OUTPut command selects the mask test output condition:

- FAIL – the output occurs when there are mask test failures.
- PASS – the output occurs when the mask test passes.

You can place the mask test signal on the rear panel TRIG OUT BNC using the [":CALibrate:OUTPut"](#) on page 197 command.

**Query Syntax** :MTESt:OUTPut?

The :MTESt:OUTPut? query returns the currently set output signal.

**Return Format** <signal><NL>  
 <signal> ::= {FAIL | PASS}

- See Also**
- ["Introduction to :MTESt Commands"](#) on page 339
  - [":CALibrate:OUTPut"](#) on page 197

### :MTESt:RMODe

**N** (see [page 750](#))

**Command Syntax** :MTESt:RMODe <rmode>  
<rmode> ::= {FORever | SIGMa | TIME | WAVeforms}

The :MTESt:RMODe command specifies the termination conditions for the mask test:

- **FORever** – the mask test runs until it is turned off.
- **SIGMa** – the mask test runs until the Sigma level is reached. This level is set by the [":MTESt:RMODe:SIGMa"](#) on page 361 command.
- **TIME** – the mask test runs for a fixed amount of time. The amount of time is set by the [":MTESt:RMODe:TIME"](#) on page 362 command.
- **WAVeforms** – the mask test runs until a fixed number of waveforms are acquired. The number of waveforms is set by the [":MTESt:RMODe:WAVeforms"](#) on page 363 command.

**Query Syntax** :MTESt:RMODe?

The :MTESt:RMODe? query returns the currently set termination condition.

**Return Format** <rmode><NL>  
<rmode> ::= {FOR | SIGM | TIME | WAV}

- See Also**
- ["Introduction to :MTESt Commands"](#) on page 339
  - [":MTESt:RMODe:SIGMa"](#) on page 361
  - [":MTESt:RMODe:TIME"](#) on page 362
  - [":MTESt:RMODe:WAVeforms"](#) on page 363

**Example Code** • ["Example Code"](#) on page 339

**:MTESt:RMODe:FACTion:MEASure**

**N** (see [page 750](#))

**Command Syntax** :MTESt:RMODe:FACTion:MEASure <on\_off>

<on\_off> ::= {{1 | ON} | {0 | OFF}}

The :MTESt:RMODe:FACTion:MEASure command sets measuring only mask failures on or off.

When ON, measurements and measurement statistics run only on waveforms that contain a mask violation; passing waveforms do not affect measurements and measurement statistics.

This mode is not available when the acquisition mode is set to Averaging.

**Query Syntax** :MTESt:RMODe:FACTion:MEASure?

The :MTESt:RMODe:FACTion:MEASure? query returns the current mask failure measure setting.

**Return Format** <on\_off><NL>

<on\_off> ::= {1 | 0}

- See Also**
- ["Introduction to :MTESt Commands"](#) on page 339
  - [":MTESt:RMODe:FACTion:PRINT"](#) on page 358
  - [":MTESt:RMODe:FACTion:SAVE"](#) on page 359
  - [":MTESt:RMODe:FACTion:STOP"](#) on page 360

## :MTESt:RMODe:FACTion:PRINt

**N** (see page 750)

**Command Syntax** :MTESt:RMODe:FACTion:PRINt <on\_off>  
<on\_off> ::= {{1 | ON} | {0 | OFF}}

The :MTESt:RMODe:FACTion:PRINt command sets printing on mask failures on or off.

**NOTE**

Setting :MTESt:RMODe:FACTion:PRINt ON automatically sets :MTESt:RMODe:FACTion:SAVE OFF.

---

See "[:HARDcopy Commands](#)" on page 260 for more information on setting the hardcopy device and formatting options.

**Query Syntax** :MTESt:RMODe:FACTion:PRINt?

The :MTESt:RMODe:FACTion:PRINt? query returns the current mask failure print setting.

**Return Format** <on\_off><NL>  
<on\_off> ::= {1 | 0}

- See Also**
- "[Introduction to :MTESt Commands](#)" on page 339
  - "[:MTESt:RMODe:FACTion:MEASure](#)" on page 357
  - "[:MTESt:RMODe:FACTion:SAVE](#)" on page 359
  - "[:MTESt:RMODe:FACTion:STOP](#)" on page 360

**:MTESt:RMODe:FACTion:SAVE**

**N** (see [page 750](#))

**Command Syntax** :MTESt:RMODe:FACTion:SAVE <on\_off>  
 <on\_off> ::= {{1 | ON} | {0 | OFF}}

The :MTESt:RMODe:FACTion:SAVE command sets saving on mask failures on or off.

**NOTE**

Setting :MTESt:RMODe:FACTion:SAVE ON automatically sets :MTESt:RMODe:FACTion:PRINT OFF.

See "[:SAVE Commands](#)" on [page 377](#) for more information on save options.

**Query Syntax** :MTESt:RMODe:FACTion:SAVE?

The :MTESt:RMODe:FACTion:SAVE? query returns the current mask failure save setting.

**Return Format** <on\_off><NL>  
 <on\_off> ::= {1 | 0}

- See Also**
- "[Introduction to :MTESt Commands](#)" on [page 339](#)
  - "[:MTESt:RMODe:FACTion:MEASure](#)" on [page 357](#)
  - "[:MTESt:RMODe:FACTion:PRINT](#)" on [page 358](#)
  - "[:MTESt:RMODe:FACTion:STOP](#)" on [page 360](#)

## **:MTESt:RMODe:FACTion:STOP**

**N** (see [page 750](#))

**Command Syntax** :MTESt:RMODe:FACTion:STOP <on\_off>  
<on\_off> ::= {{1 | ON} | {0 | OFF}}

The :MTESt:RMODe:FACTion:STOP command sets stopping on a mask failure on or off. When this setting is ON and a mask violation is detected, the mask test is stopped and the acquisition system is stopped.

**Query Syntax** :MTESt:RMODe:FACTion:STOP?

The :MTESt:RMODe:FACTion:STOP? query returns the current mask failure stop setting.

**Return Format** <on\_off><NL>  
<on\_off> ::= {1 | 0}

- See Also**
- "[Introduction to :MTESt Commands](#)" on page 339
  - "[:MTESt:RMODe:FACTion:MEASure](#)" on page 357
  - "[:MTESt:RMODe:FACTion:PRINt](#)" on page 358
  - "[:MTESt:RMODe:FACTion:SAVE](#)" on page 359

**:MTESt:RMODe:SIGMa**

**N** (see [page 750](#))

**Command Syntax** :MTESt:RMODe:SIGMa <level>  
 <level> ::= from 0.1 to 9.3 in NR3 format

When the :MTESt:RMODe command is set to SIGMa, the :MTESt:RMODe:SIGMa command sets the *test sigma* level to which a mask test runs. *Test sigma* is the best achievable process sigma, assuming no failures. (*Process sigma* is calculated using the number of failures per test.) The *test sigma* level indirectly specifies the number of waveforms that must be tested (in order to reach the sigma level).

**Query Syntax** :MTESt:RMODe:SIGMa?

The :MTESt:RMODe:SIGMa? query returns the current Sigma level setting.

**Return Format** <level><NL>  
 <level> ::= from 0.1 to 9.3 in NR3 format

- See Also**
- ["Introduction to :MTESt Commands"](#) on page 339
  - [":MTESt:RMODe"](#) on page 356

- Example Code**
- ["Example Code"](#) on page 339

## :MTESt:RMODe:TIME

**N** (see [page 750](#))

**Command Syntax** :MTESt:RMODe:TIME <seconds>  
<seconds> ::= from 1 to 86400 in NR3 format

When the :MTESt:RMODe command is set to TIME, the :MTESt:RMODe:TIME command sets the number of seconds for a mask test to run.

**Query Syntax** :MTESt:RMODe:TIME?

The :MTESt:RMODe:TIME? query returns the number of seconds currently set.

**Return Format** <seconds><NL>  
<seconds> ::= from 1 to 86400 in NR3 format

- See Also**
- "[Introduction to :MTESt Commands](#)" on page 339
  - "[:MTESt:RMODe](#)" on page 356

**:MTESt:RMODe:WAVeforms**

**N** (see [page 750](#))

**Command Syntax** :MTESt:RMODe:WAVeforms <count>

<count> ::= number of waveforms in NR1 format  
from 1 to 2,000,000,000

When the :MTESt:RMODe command is set to WAVeforms, the :MTESt:RMODe:WAVeforms command sets the number of waveform acquisitions that are mask tested.

**Query Syntax** :MTESt:RMODe:WAVeforms?

The :MTESt:RMODe:WAVeforms? query returns the number of waveforms currently set.

**Return Format** <count><NL>

<count> ::= number of waveforms in NR1 format  
from 1 to 2,000,000,000

- See Also**
- "[Introduction to :MTESt Commands](#)" on page 339
  - "[:MTESt:RMODe](#)" on page 356

**:MTESt:SCALe:BIND**

**N** (see [page 750](#))

**Command Syntax** :MTESt:SCALe:BIND <on\_off>

<on\_off> ::= {{1 | ON} | {0 | OFF}}

The :MTESt:SCALe:BIND command enables or disables Bind 1 & 0 Levels (Bind -1 & 0 Levels for inverted masks) control:

- ON –

If the Bind 1 & 0 Levels control is enabled, the 1 Level and the 0 Level controls track each other. Adjusting either the 1 Level or the 0 Level control shifts the position of the mask up or down without changing its size.

If the Bind -1 & 0 Levels control is enabled, the -1 Level and the 0 Level controls track each other. Adjusting either the -1 Level or the 0 Level control shifts the position of the mask up or down without changing its size.

- OFF –

If the Bind 1 & 0 Levels control is disabled, adjusting either the 1 Level or the 0 Level control changes the vertical height of the mask.

If the Bind -1 & 0 Levels control is disabled, adjusting either the -1 Level or the 0 Level control changes the vertical height of the mask.

**Query Syntax** :MTESt:SCALe:BIND?

The :MTESt:SCALe:BIND? query returns the value of the Bind 1&0 control (Bind -1&0 for inverted masks).

**Return Format** <on\_off><NL>

<on\_off> ::= {1 | 0}

- See Also**
- "Introduction to :MTESt Commands" on page 339
  - ":MTESt:SCALe:X1" on page 365
  - ":MTESt:SCALe:XDELta" on page 366
  - ":MTESt:SCALe:Y1" on page 367
  - ":MTESt:SCALe:Y2" on page 368

**:MTESt:SCALe:X1**

**N** (see [page 750](#))

**Command Syntax** :MTESt:SCALe:X1 <x1\_value>

<x1\_value> ::= X1 value in NR3 format

The :MTESt:SCALe:X1 command defines where X=0 in the base coordinate system used for mask testing. The other X-coordinate is defined by the :MTESt:SCALe:XDELta command. Once the X1 and XDELta coordinates are set, all X values of vertices in the mask regions are defined with respect to this value, according to the equation:

$$X = (X * \Delta X) + X1$$

Thus, if you set X1 to 100 ms, and XDELta to 100 ms, an X value of 0.100 is a vertex at 110 ms.

The oscilloscope uses this equation to normalize vertices. This simplifies reprogramming to handle different data rates. For example, if you halve the period of the waveform of interest, you need only to adjust the XDELta value to set up the mask for the new waveform.

The X1 value is a time value specifying the location of the X1 coordinate, which will then be treated as X=0 for mask regions coordinates.

**Query Syntax** :MTESt:SCALe:X1?

The :MTESt:SCALe:X1? query returns the current X1 coordinate setting.

**Return Format** <x1\_value><NL>

<x1\_value> ::= X1 value in NR3 format

- See Also**
- ["Introduction to :MTESt Commands"](#) on page 339
  - [":MTESt:SCALe:BIND"](#) on page 364
  - [":MTESt:SCALe:XDELta"](#) on page 366
  - [":MTESt:SCALe:Y1"](#) on page 367
  - [":MTESt:SCALe:Y2"](#) on page 368

**:MTESt:SCALe:XDELta**

**N** (see [page 750](#))

**Command Syntax** :MTESt:SCALe:XDELta <xdelta\_value>  
 <xdelta\_value> ::= X delta value in NR3 format

The :MTESt:SCALe:XDELta command defines the position of the X2 marker with respect to the X1 marker. In the mask test coordinate system, the X1 marker defines where X=0; thus, the X2 marker defines where X=1.

Because all X vertices of the regions defined for mask testing are normalized with respect to X1 and ΔX, redefining ΔX also moves those vertices to stay in the same locations with respect to X1 and ΔX. Thus, in many applications, it is best if you define XDELta as a pulse width or bit period. Then, a change in data rate without corresponding changes in the waveform can easily be handled by changing ΔX.

The X-coordinate of polygon vertices is normalized using this equation:

$$X = (X * \Delta X) + X1$$

The X delta value is a time value specifying the distance of the X2 marker with respect to the X1 marker.

For example, if the period of the waveform you wish to test is 1 ms, setting ΔX to 1 ms ensures that the waveform's period is between the X1 and X2 markers.

**Query Syntax** :MTESt:SCALe:XDELta?

The :MTESt:SCALe:XDELta? query returns the current value of ΔX.

**Return Format** <xdelta\_value><NL>  
 <xdelta\_value> ::= X delta value in NR3 format

- See Also**
- ["Introduction to :MTESt Commands"](#) on page 339
  - [":MTESt:SCALe:BIND"](#) on page 364
  - [":MTESt:SCALe:X1"](#) on page 365
  - [":MTESt:SCALe:Y1"](#) on page 367
  - [":MTESt:SCALe:Y2"](#) on page 368

**:MTESt:SCALe:Y1**

**N** (see [page 750](#))

**Command Syntax** :MTESt:SCALe:Y1 <y1\_value>  
 <y1\_value> ::= Y1 value in NR3 format

The :MTESt:SCALe:Y1 command defines where Y=0 in the coordinate system for mask testing. All Y values of vertices in the coordinate system are defined with respect to the boundaries set by SCALe:Y1 and SCALe:Y2 according to the equation:

$$Y = (Y * (Y2 - Y1)) + Y1$$

Thus, if you set Y1 to 100 mV, and Y2 to 1 V, a Y value of 0.100 in a vertex is at 190 mV.

The Y1 value is a voltage value specifying the point at which Y=0.

**Query Syntax** :MTESt:SCALe:Y1?

The :MTESt:SCALe:Y1? query returns the current setting of the Y1 marker.

**Return Format** <y1\_value><NL>  
 <y1\_value> ::= Y1 value in NR3 format

- See Also**
- ["Introduction to :MTESt Commands"](#) on page 339
  - [":MTESt:SCALe:BIND"](#) on page 364
  - [":MTESt:SCALe:X1"](#) on page 365
  - [":MTESt:SCALe:XDELta"](#) on page 366
  - [":MTESt:SCALe:Y2"](#) on page 368

**:MTEST:SCALE:Y2**

**N** (see [page 750](#))

**Command Syntax** :MTEST:SCALE:Y2 <y2\_value>

<y2\_value> ::= Y2 value in NR3 format

The :MTEST:SCALE:Y2 command defines the Y2 marker in the coordinate system for mask testing. All Y values of vertices in the coordinate system are defined with respect to the boundaries defined by SCALE:Y1 and SCALE:Y2 according to the following equation:

$$Y = (Y * (Y2 - Y1)) + Y1$$

Thus, if you set Y1 to 100 mV, and Y2 to 1 V, a Y value of 0.100 in a vertex is at 190 mV.

The Y2 value is a voltage value specifying the location of the Y2 marker.

**Query Syntax** :MTEST:SCALE:Y2?

The :MTEST:SCALE:Y2? query returns the current setting of the Y2 marker.

**Return Format** <y2\_value><NL>

<y2\_value> ::= Y2 value in NR3 format

- See Also**
- ["Introduction to :MTEST Commands"](#) on page 339
  - [":MTEST:SCALE:BIND"](#) on page 364
  - [":MTEST:SCALE:X1"](#) on page 365
  - [":MTEST:SCALE:XDELta"](#) on page 366
  - [":MTEST:SCALE:Y1"](#) on page 367

**:MTESt:SOURce**

**N** (see [page 750](#))

**Command Syntax** :MTESt:SOURce <source>

<source> ::= CHANnel<n>

<n> ::= {1 | 2 | 3 | 4} for the four channel oscilloscope models

<n> ::= {1 | 2} for the two channel oscilloscope models

The :MTESt:SOURce command selects the channel which is configured by the commands contained in a mask file when it is loaded.

**Query Syntax** :MTESt:SOURce?

The :MTESt:SOURce? query returns the channel which is configured by the commands contained in the current mask file.

**Return Format** <source><NL>

<source> ::= {CHAN<n> | NONE}

<n> ::= {1 | 2 | 3 | 4} for the four channel oscilloscope models

<n> ::= {1 | 2} for the two channel oscilloscope models

- See Also**
- ["Introduction to :MTESt Commands"](#) on page 339
  - [":MTESt:AMASk:SOURce"](#) on page 343

## **:MTESt:TITLe**

**N** (see [page 750](#))

**Query Syntax** :MTESt:TITLe?

The :MTESt:TITLe? query returns the mask title which is a string of up to 128 characters. The title is displayed in the mask test dialog box and mask test tab when a mask file is loaded.

**Return Format** <title><NL>

<title> ::= a string of up to 128 ASCII characters.

**See Also** • ["Introduction to :MTESt Commands"](#) on page 339

## :RECall Commands

Recall previously saved oscilloscope setups and traces. See "Introduction to :RECall Commands" on page 371.

**Table 64** :RECall Commands Summary

| Command   | Query                               | Options and Query Returns   |
|---|-------------------------------------|---|
| :RECall:FILENAME<br><base_name> (see page 372)        | :RECall:FILENAME?<br>(see page 372) | <base_name> ::= quoted ASCII string   |
| :RECall:IMAGE[:START]<br>[<file_spec>] (see page 373) | n/a                                 | <file_spec> ::= {<internal_loc>   <file_name>}<br><internal_loc> ::= 0-9; an integer in NR1 format<br><file_name> ::= quoted ASCII string |
| :RECall:MASK[:START]<br>[<file_spec>] (see page 374)  | n/a                                 | <file_spec> ::= {<internal_loc>   <file_name>}<br><internal_loc> ::= 0-3; an integer in NR1 format<br><file_name> ::= quoted ASCII string |
| :RECall:PWD<br><path_name> (see page 375)             | :RECall:PWD? (see page 375)         | <path_name> ::= quoted ASCII string   |
| :RECall:SETup[:START]<br>[<file_spec>] (see page 376) | n/a                                 | <file_spec> ::= {<internal_loc>   <file_name>}<br><internal_loc> ::= 0-9; an integer in NR1 format<br><file_name> ::= quoted ASCII string |

### Introduction to :RECall Commands

The :RECall subsystem provides commands to recall previously saved oscilloscope setups and traces.

#### Reporting the Setup

Use :RECall? to query setup information for the RECall subsystem.

#### Return Format

The following is a sample response from the :RECall? query. In this case, the query was issued following the \*RST command.

```
:REC:FIL "scope_0"
```

## :RECall:FILEname

**N** (see [page 750](#))

**Command Syntax** :RECall:FILEname <base\_name>

<base\_name> ::= quoted ASCII string

The :RECall:FILEname command specifies the source for any RECall operations.

**NOTE**

This command specifies a file's base name only, without path information or an extension.

---

**Query Syntax** :RECall:FILEname?

The :RECall:FILEname? query returns the current RECall filename.

**Return Format** <base\_name><NL>

<base\_name> ::= quoted ASCII string

- See Also**
- ["Introduction to :RECall Commands"](#) on page 371
  - [":RECall:IMAGe\[:START\]"](#) on page 373
  - [":RECall:SETup\[:START\]"](#) on page 376
  - [":SAVE:FILEname"](#) on page 379

**:RECall:IMAGe[:START]**

**N** (see [page 750](#))

**Command Syntax** :RECall:IMAGe[:START] [<file\_spec>]  
 <file\_spec> ::= {<internal\_loc> | <file\_name>}  
 <internal\_loc> ::= 0-9; an integer in NR1 format  
 <file\_name> ::= quoted ASCII string

The :RECall:IMAGe[:START] command recalls a trace (TIFF) image.

**NOTE**

If a file extension is provided as part of a specified <file\_name>, it must be ".tif".

- See Also**
- "[Introduction to :RECall Commands](#)" on page 371
  - "[:RECall:FILENAME](#)" on page 372
  - "[:SAVE:IMAGe\[:START\]](#)" on page 380

## **:RECall:MASK[:START]**

**N** (see [page 750](#))

**Command Syntax** :RECall:MASK[:START] [<file\_spec>]  
<file\_spec> ::= {<internal\_loc> | <file\_name>}  
<internal\_loc> ::= 0-3; an integer in NR1 format  
<file\_name> ::= quoted ASCII string

The :RECall:MASK[:START] command recalls a mask.

### **NOTE**

If a file extension is provided as part of a specified <file\_name>, it must be ".msk".

- See Also**
- ["Introduction to :RECall Commands"](#) on page 371
  - [":RECall:FILENAME"](#) on page 372
  - [":SAVE:MASK\[:START\]"](#) on page 387
  - [":MTEST:DATA"](#) on page 351

## :RECall:PWD

**N** (see [page 750](#))

**Command Syntax** :RECall:PWD <path\_name>  
<path\_name> ::= quoted ASCII string

The :RECall:PWD command sets the present working directory for recall operations.

**Query Syntax** :RECall:PWD?

The :RECall:PWD? query returns the currently set working directory for recall operations.

**Return Format** <path\_name><NL>  
<path\_name> ::= quoted ASCII string

- See Also**
- ["Introduction to :RECall Commands"](#) on page 371
  - [":SAVE:PWD"](#) on page 388

## :RECall:SETup[:START]

**N** (see [page 750](#))

**Command Syntax** :RECall:SETup[:START] [<file\_spec>]  
<file\_spec> ::= {<internal\_loc> | <file\_name>}  
<internal\_loc> ::= 0-9; an integer in NR1 format  
<file\_name> ::= quoted ASCII string

The :RECall:SETup[:START] command recalls an oscilloscope setup.

**NOTE**

If a file extension is provided as part of a specified <file\_name>, it must be ".scp".

- 
- See Also**
- "[Introduction to :RECall Commands](#)" on page 371
  - "[:RECall:FILENAME](#)" on page 372
  - "[:SAVE:SETup\[:START\]](#)" on page 389

## :SAVE Commands

Save oscilloscope setups and traces, screen images, and data. See "[Introduction to :SAVE Commands](#)" on page 378.

**Table 65** :SAVE Commands Summary

| Command  | Query  | Options and Query Returns   |
|--|--|---|
| :SAVE:FILENAME<br><base_name> (see <a href="#">page 379</a> )                  | :SAVE:FILENAME? (see <a href="#">page 379</a> )          | <base_name> ::= quoted ASCII string   |
| :SAVE:IMAGE[:START]<br>[<file_spec>] (see <a href="#">page 380</a> )           | n/a  | <file_spec> ::= {<internal_loc>   <file_name>}<br><internal_loc> ::= 0-9; an integer in NR1 format<br><file_name> ::= quoted ASCII string |
| n/a  | :SAVE:IMAGE:AREA?<br>(see <a href="#">page 381</a> )     | <area> ::= {GRAT   SCR}   |
| :SAVE:IMAGE:FACTors<br>{{0   OFF}   {1   ON}} (see <a href="#">page 382</a> )  | :SAVE:IMAGE:FACTors?<br>(see <a href="#">page 382</a> )  | {0   1}   |
| :SAVE:IMAGE:FORMat<br><format> (see <a href="#">page 383</a> )                 | :SAVE:IMAGE:FORMat?<br>(see <a href="#">page 383</a> )   | <format> ::= {TIFF   {BMP   BMP24bit}   BMP8bit   PNG   NONE}   |
| :SAVE:IMAGE:INKSaver<br>{{0   OFF}   {1   ON}} (see <a href="#">page 384</a> ) | :SAVE:IMAGE:INKSaver?<br>(see <a href="#">page 384</a> ) | {0   1}   |
| :SAVE:IMAGE:PALette<br><palette> (see <a href="#">page 385</a> )               | :SAVE:IMAGE:PALette?<br>(see <a href="#">page 385</a> )  | <palette> ::= {COLor   GRAYscale   MONochrome}  |
| :SAVE:LISTer[:START]<br>[<file_name>] (see <a href="#">page 386</a> )          | n/a  | <file_name> ::= quoted ASCII string   |
| :SAVE:MASK[:START]<br>[<file_spec>] (see <a href="#">page 387</a> )            | n/a  | <file_spec> ::= {<internal_loc>   <file_name>}<br><internal_loc> ::= 0-3; an integer in NR1 format<br><file_name> ::= quoted ASCII string |
| :SAVE:PWD <path_name><br>(see <a href="#">page 388</a> )                       | :SAVE:PWD? (see <a href="#">page 388</a> )               | <path_name> ::= quoted ASCII string   |

**Table 65** :SAVE Commands Summary (continued)

| Command   | Query                                  | Options and Query Returns   |
|---|--|---|
| :SAVE:SETup[:START] [<file_spec>] (see page 389)    | n/a                                    | <file_spec> ::= {<internal_loc>   <file_name>}<br><internal_loc> ::= 0-9; an integer in NR1 format<br><file_name> ::= quoted ASCII string |
| :SAVE:WAVEform[:START] [<file_name>] (see page 390) | n/a                                    | <file_name> ::= quoted ASCII string   |
| :SAVE:WAVEform:FORMat <format> (see page 391)       | :SAVE:WAVEform:FORMat ? (see page 391) | <format> ::= {ALB   ASCiixy   CSV   BINary   NONE}  |
| :SAVE:WAVEform:LENGth <length> (see page 392)       | :SAVE:WAVEform:LENGth ? (see page 392) | <length> ::= 100 to max. length; an integer in NR1 format   |
| :SAVE:WAVEform:SEGMent <option> (see page 393)      | :SAVE:WAVEform:SEGMent? (see page 393) | <option> ::= {ALL   CURRent}  |

**Introduction to :SAVE Commands**

The :SAVE subsystem provides commands to save oscilloscope setups and traces, screen images, and data.

:SAV is an acceptable short form for :SAVE.

**Reporting the Setup**

Use :SAVE? to query setup information for the SAVE subsystem.

**Return Format**

The following is a sample response from the :SAVE? query. In this case, the query was issued following the \*RST command.

```
:SAVE:FIL " "; :SAVE:IMAG:AREA GRAT;FACT 0;FORM TIFF;INKS 0;PAL
MON; :SAVE:PWD "C:/setups/"; :SAVE:WAV:FORM NONE;LENG 1000;SEGM CURR
```

**:SAVE:FILEname**

**N** (see [page 750](#))

**Command Syntax** :SAVE:FILEname <base\_name>

<base\_name> ::= quoted ASCII string

The :SAVE:FILEname command specifies the source for any SAVE operations.

**NOTE**

This command specifies a file's base name only, without path information or an extension.

**Query Syntax** :SAVE:FILEname?

The :SAVE:FILEname? query returns the current SAVE filename.

**Return Format** <base\_name><NL>

<base\_name> ::= quoted ASCII string

- See Also**
- ["Introduction to :SAVE Commands"](#) on page 378
  - [":SAVE:IMAGe\[:START\]"](#) on page 380
  - [":SAVE:SETup\[:START\]"](#) on page 389
  - [":SAVE:WAVEform\[:START\]"](#) on page 390
  - [":SAVE:PWD"](#) on page 388
  - [":RECall:FILEname"](#) on page 372

## **:SAVE:IMAGe[:START]**

**N** (see [page 750](#))

**Command Syntax** :SAVE:IMAGe[:START] [<file\_spec>]  
<file\_spec> ::= {<internal\_loc> | <file\_name>}  
<internal\_loc> ::= 0-9; an integer in NR1 format  
<file\_name> ::= quoted ASCII string

The :SAVE:IMAGe[:START] command saves an image.

**NOTE**

If a file extension is provided as part of a specified <file\_name>, and it does not match the extension expected by the format specified in :SAVE:IMAGe:FORMat, the format will be changed if the extension is a valid image file extension.

**NOTE**

If the extension ".bmp" is used and the current :SAVE:IMAGe:FORMat is not BMP or BMP8, the format will be changed to BMP.

**NOTE**

When the <internal\_loc> option is used, the :SAVE:IMAGe:FORMat will be changed to TIFF.

- See Also**
- "[Introduction to :SAVE Commands](#)" on page 378
  - "[:SAVE:IMAGe:AREA](#)" on page 381
  - "[:SAVE:IMAGe:FACTors](#)" on page 382
  - "[:SAVE:IMAGe:FORMat](#)" on page 383
  - "[:SAVE:IMAGe:INKSaver](#)" on page 384
  - "[:SAVE:IMAGe:PALette](#)" on page 385
  - "[:SAVE:FILEname](#)" on page 379
  - "[:RECall:IMAGe\[:START\]](#)" on page 373

## :SAVE:IMAGe:AREA

**N** (see [page 750](#))

**Query Syntax** :SAVE:IMAGe:AREA?

The :SAVE:IMAGe:AREA? query returns the selected image area. If the :SAVE:IMAGe:FORMat is TIFF, the area is GRAT (graticule). Otherwise, it is SCR (screen).

**Return Format** <area><NL>

<area> ::= {GRAT | SCR}

- See Also**
- "[Introduction to :SAVE Commands](#)" on [page 378](#)
  - "[:SAVE:IMAGe\[:START\]](#)" on [page 380](#)
  - "[:SAVE:IMAGe:FACTors](#)" on [page 382](#)
  - "[:SAVE:IMAGe:FORMat](#)" on [page 383](#)
  - "[:SAVE:IMAGe:INKSaver](#)" on [page 384](#)
  - "[:SAVE:IMAGe:PALette](#)" on [page 385](#)

## :SAVE:IMAGe:FACTors

**N** (see [page 750](#))

**Command Syntax** :SAVE:IMAGe:FACTors <factors>  
<factors> ::= {{OFF | 0} | {ON | 1}}

The :SAVE:IMAGe:FACTors command controls whether the oscilloscope factors are output along with the image.

**NOTE**

Factors are written to a separate file with the same path and base name but with the ".txt" extension.

**Query Syntax** :SAVE:IMAGe:FACTors?

The :SAVE:IMAGe:FACTors? query returns a flag indicating whether oscilloscope factors are output along with the image.

**Return Format** <factors><NL>  
<factors> ::= {0 | 1}

- See Also**
- ["Introduction to :SAVE Commands"](#) on page 378
  - [":SAVE:IMAGe\[:START\]"](#) on page 380
  - [":SAVE:IMAGe:AREA"](#) on page 381
  - [":SAVE:IMAGe:FORMat"](#) on page 383
  - [":SAVE:IMAGe:INKSaver"](#) on page 384
  - [":SAVE:IMAGe:PALette"](#) on page 385

**:SAVE:IMAGe:FORMat**

**N** (see [page 750](#))

**Command Syntax** :SAVE:IMAGe:FORMat <format>

<format> ::= {TIFF | {BMP | BMP24bit} | BMP8bit | PNG}

The :SAVE:IMAGe:FORMat command sets the image format type.

**Query Syntax** :SAVE:IMAGe:FORMat?

The :SAVE:IMAGe:FORMat? query returns the selected image format type.

**Return Format** <format><NL>

<format> ::= {TIFF | BMP | BMP8 | PNG | NONE}

When NONE is returned, it indicates that a waveform data file format is currently selected.

- See Also**
- ["Introduction to :SAVE Commands"](#) on page 378
  - [":SAVE:IMAGe\[:START\]"](#) on page 380
  - [":SAVE:IMAGe:AREA"](#) on page 381
  - [":SAVE:IMAGe:FACTors"](#) on page 382
  - [":SAVE:IMAGe:INKSaver"](#) on page 384
  - [":SAVE:IMAGe:PALette"](#) on page 385
  - [":SAVE:WAVEform:FORMat"](#) on page 391

## :SAVE:IMAGe:INKSaver

**N** (see [page 750](#))

**Command Syntax** :SAVE:IMAGe:INKSaver <value>  
<value> ::= {{OFF | 0} | {ON | 1}}

The :SAVE:IMAGe:INKSaver command controls whether the graticule colors are inverted or not.

**Query Syntax** :SAVE:IMAGe:INKSaver?

The :SAVE:IMAGe:INKSaver? query returns a flag indicating whether graticule colors are inverted or not.

**Return Format** <value><NL>  
<value> ::= {0 | 1}

- See Also**
- ["Introduction to :SAVE Commands"](#) on page 378
  - [":SAVE:IMAGe\[:START\]"](#) on page 380
  - [":SAVE:IMAGe:AREA"](#) on page 381
  - [":SAVE:IMAGe:FACTors"](#) on page 382
  - [":SAVE:IMAGe:FORMat"](#) on page 383
  - [":SAVE:IMAGe:PALette"](#) on page 385

**:SAVE:IMAGe:PALette**

**N** (see [page 750](#))

**Command Syntax** :SAVE:IMAGe:PALette <palette>  
 <palette> ::= {COLor | GRAYscale | MONochrome}

The :SAVE:IMAGe:PALette command sets the image palette color.

**NOTE**

MONochrome is the only valid choice when the :SAVE:IMAGe:FORMat is TIFF. COLor and GRAYscale are the only valid choices when the format is not TIFF.

**Query Syntax** :SAVE:IMAGe:PALette?

The :SAVE:IMAGe:PALette? query returns the selected image palette color.

**Return Format** <palette><NL>  
 <palette> ::= {COL | GRAY | MON}

- See Also**
- "[Introduction to :SAVE Commands](#)" on page 378
  - "[:SAVE:IMAGe\[:START\]](#)" on page 380
  - "[:SAVE:IMAGe:AREA](#)" on page 381
  - "[:SAVE:IMAGe:FACTors](#)" on page 382
  - "[:SAVE:IMAGe:FORMat](#)" on page 383
  - "[:SAVE:IMAGe:INKSaver](#)" on page 384

## **:SAVE:LISTer[:START]**

**N** (see [page 750](#))

**Command Syntax** :SAVE:LISTer[:START] [<file\_name>  
<file\_name> ::= quoted ASCII string

The :SAVE:LISTer[:START] command saves the Lister display data to a file.

### **NOTE**

If a file extension is provided as part of a specified <file\_name>, it must be ".csv".

- 
- See Also**
- ["Introduction to :SAVE Commands"](#) on page 378
  - [":SAVE:FILENAME"](#) on page 379
  - [":LISTer Commands"](#) on page 271

**:SAVE:MASK[:START]**

**N** (see [page 750](#))

**Command Syntax** :SAVE:MASK[:START] [<file\_spec>]  
 <file\_spec> ::= {<internal\_loc> | <file\_name>}  
 <internal\_loc> ::= 0-3; an integer in NR1 format  
 <file\_name> ::= quoted ASCII string

The :SAVE:MASK[:START] command saves a mask.

**NOTE**

If a file extension is provided as part of a specified <file\_name>, it must be ".msk".

- See Also**
- ["Introduction to :SAVE Commands"](#) on page 378
  - [":SAVE:FILENAME"](#) on page 379
  - [":RECALL:MASK\[:START\]"](#) on page 374
  - [":MTEST:DATA"](#) on page 351

### **:SAVE:PWD**

**N** (see [page 750](#))

**Command Syntax** :SAVE:PWD <path\_name>  
<path\_name> ::= quoted ASCII string

The :SAVE:PWD command sets the present working directory for save operations.

**Query Syntax** :SAVE:PWD?

The :SAVE:PWD? query returns the currently set working directory for save operations.

**Return Format** <path\_name><NL>  
<path\_name> ::= quoted ASCII string

- See Also**
- ["Introduction to :SAVE Commands"](#) on page 378
  - [":SAVE:FILENAME"](#) on page 379
  - [":RECALL:PWD"](#) on page 375

**:SAVE:SETup[:START]**

**N** (see [page 750](#))

**Command Syntax** :SAVE:SETup[:START] [<file\_spec>]  
<file\_spec> ::= {<internal\_loc> | <file\_name>}  
<internal\_loc> ::= 0-9; an integer in NR1 format  
<file\_name> ::= quoted ASCII string

The :SAVE:SETup[:START] command saves an oscilloscope setup.

**NOTE**

If a file extension is provided as part of a specified <file\_name>, it must be ".scp".

- 
- See Also**
- "[Introduction to :SAVE Commands](#)" on page 378
  - "[:SAVE:FILENAME](#)" on page 379
  - "[:RECall:SETup\[:START\]](#)" on page 376

### **:SAVE:WAVEform[:START]**

**N** (see [page 750](#))

**Command Syntax** :SAVE:WAVEform[:START] [<file\_name>]  
<file\_name> ::= quoted ASCII string

The :SAVE:WAVEform[:START] command saves oscilloscope waveform data to a file.

#### **NOTE**

If a file extension is provided as part of a specified <file\_name>, and it does not match the extension expected by the format specified in :SAVE:WAVEform:FORMat, the format will be changed if the extension is a valid waveform file extension.

- See Also**
- ["Introduction to :SAVE Commands"](#) on page 378
  - [":SAVE:WAVEform:FORMat"](#) on page 391
  - [":SAVE:WAVEform:LENGth"](#) on page 392
  - [":SAVE:FILEname"](#) on page 379
  - [":RECall:SETup\[:START\]"](#) on page 376

**:SAVE:WAVEform:FORMat**

**N** (see [page 750](#))

**Command Syntax** :SAVE:WAVEform:FORMat <format>

<format> ::= {ALB | ASCiixy | CSV | BINary}

The :SAVE:WAVEform:FORMat command sets the waveform data format type:

- ALB – creates an Agilent module binary format file. These files can be viewed offline by the *Agilent Logic Analyzer* application software. The proper file extension for this format is ".alb".
- ASCiixy – creates comma-separated value files for each analog channel that is displayed (turned on). The proper file extension for this format is ".csv".
- CSV – creates one comma-separated value file that contains information for all analog channels that are displayed (turned on). The proper file extension for this format is ".csv".
- BINary – creates an oscilloscope binary data format file. See the *User's Guide* for a description of this format. The proper file extension for this format is ".bin".

**Query Syntax** :SAVE:WAVEform:FORMat?

The :SAVE:WAVEform:FORMat? query returns the selected waveform data format type.

**Return Format** <format><NL>

<format> ::= {ALB | ASC | CSV | BIN | NONE}

When NONE is returned, it indicates that an image file format is currently selected.

- See Also**
- "[Introduction to :SAVE Commands](#)" on page 378
  - "[:SAVE:WAVEform\[:START\]](#)" on page 390
  - "[:SAVE:WAVEform:LENGth](#)" on page 392
  - "[:SAVE:IMAGe:FORMat](#)" on page 383

## **:SAVE:WAVEform:LENGth**

**N** (see [page 750](#))

**Command Syntax** :SAVE:WAVEform:LENGth <length>

<length> ::= 100 to max. length; an integer in NR1 format

The :SAVE:WAVEform:LENGth command sets the waveform data length (that is, the number of points saved).

**Query Syntax** :SAVE:WAVEform:LENGth?

The :SAVE:WAVEform:LENGth? query returns the specified waveform data length.

**Return Format** <length><NL>

<length> ::= 100 to max. length; an integer in NR1 format

- See Also**
- ["Introduction to :SAVE Commands"](#) on page 378
  - [":SAVE:WAVEform\[:START\]"](#) on page 390
  - [":WAVEform:POINTs"](#) on page 602
  - [":SAVE:WAVEform:FORMat"](#) on page 391

**:SAVE:WAVEform:SEGmented**

**N** (see [page 750](#))

**Command Syntax** :SAVE:WAVEform:SEGmented <option>

<option> ::= {ALL | CURRent}

When segmented memory is used for acquisitions, the :SAVE:WAVEform:SEGmented command specifies which segments are included when the waveform is saved:

- ALL – all acquired segments are saved.
- CURRent – only the currently selected segment is saved.

**Query Syntax** :SAVE:WAVEform:SEGmented?

The :SAVE:WAVEform:SEGmented? query returns the current segmented waveform save option setting.

**Return Format** <option><NL>

<option> ::= {ALL | CURR}

- See Also**
- ["Introduction to :SAVE Commands"](#) on page 378
  - [":SAVE:WAVEform\[:START\]"](#) on page 390
  - [":SAVE:WAVEform:FORMat"](#) on page 391
  - [":SAVE:WAVEform:LENGth"](#) on page 392

## :SBUS Commands

Control oscilloscope functions associated with the serial decode bus. See "Introduction to :SBUS Commands" on page 395.

**Table 66** :SBUS Commands Summary

| Command   | Query  | Options and Query Returns                       |
|---|--|---|
| n/a   | :SBUS:CAN:COUNT:ERROR?<br>(see page 396)       | <frame_count> ::= integer in NR1 format         |
| n/a   | :SBUS:CAN:COUNT:OVERLOAD?<br>(see page 397)    | <frame_count> ::= integer in NR1 format         |
| :SBUS:CAN:COUNT:RESET<br>(see page 398)                   | n/a  | n/a   |
| n/a   | :SBUS:CAN:COUNT:TOTAL?<br>(see page 399)       | <frame_count> ::= integer in NR1 format         |
| n/a   | :SBUS:CAN:COUNT:UTILIZATION?<br>(see page 400) | <percent> ::= floating-point in NR3 format      |
| :SBUS:DISPLAY {{0   OFF}   {1   ON}}<br>(see page 401)    | :SBUS:DISPLAY? (see page 401)                  | {0   1}   |
| n/a   | :SBUS:FLEXRAY:COUNT:NULL?<br>(see page 402)    | <frame_count> ::= integer in NR1 format         |
| :SBUS:FLEXRAY:COUNT:RESET<br>(see page 403)               | n/a  | n/a   |
| n/a   | :SBUS:FLEXRAY:COUNT:SYNCH?<br>(see page 404)   | <frame_count> ::= integer in NR1 format         |
| n/a   | :SBUS:FLEXRAY:COUNT:TOTAL?<br>(see page 405)   | <frame_count> ::= integer in NR1 format         |
| :SBUS:I2S:BASE <base><br>(see page 406)                   | :SBUS:I2S:BASE? (see page 406)                 | <base> ::= {DECIMAL   HEX}                      |
| :SBUS:IIC:ASIZE <size><br>(see page 407)                  | :SBUS:IIC:ASIZE? (see page 407)                | <size> ::= {BIT7   BIT8}                        |
| :SBUS:LIN:PARITY {{0   OFF}   {1   ON}}<br>(see page 408) | :SBUS:LIN:PARITY?<br>(see page 408)            | {0   1}   |
| :SBUS:M1553:BASE <base><br>(see page 409)                 | :SBUS:M1553:BASE?<br>(see page 409)            | <base> ::= {DECIMAL   HEX}                      |
| :SBUS:MODE <mode><br>(see page 410)                       | :SBUS:MODE? (see page 410)                     | <mode> ::= {CAN   I2S   IIC   LIN   SPI   UART} |

**Table 66** :SBUS Commands Summary (continued)

| Command  | Query   | Options and Query Returns   |
|--|---|---|
| :SBUS:SPI:BITorder<br><order> (see page 411)   | :SBUS:SPI:BITorder?<br>(see page 411)         | <order> ::= {LSBFirst   MSBFirst}   |
| :SBUS:SPI:WIDTH<br><word_width> (see page 412) | :SBUS:SPI:WIDTH? (see page 412)               | <word_width> ::= integer 4-16 in NR1 format   |
| :SBUS:UART:BASE<br><base> (see page 413)       | :SBUS:UART:BASE? (see page 413)               | <base> ::= {ASCIi   BINary   HEX}   |
| n/a  | :SBUS:UART:COUNT:ERROr?<br>(see page 414)     | <frame_count> ::= integer in NR1 format   |
| :SBUS:UART:COUNT:RESe<br>t (see page 415)      | n/a   | n/a   |
| n/a  | :SBUS:UART:COUNT:RXFR<br>ames? (see page 416) | <frame_count> ::= integer in NR1 format   |
| n/a  | :SBUS:UART:COUNT:TXFR<br>ames? (see page 417) | <frame_count> ::= integer in NR1 format   |
| :SBUS:UART:FRAMing<br><value> (see page 418)   | :SBUS:UART:FRAMing?<br>(see page 418)         | <value> ::= {OFF   <decimal>   <nondecimal>}<br><decimal> ::= 8-bit integer from 0-255 (0x00-0xff)<br><nondecimal> ::= #Hnn where n ::= {0,...,9   A,...,F} for hexadecimal<br><nondecimal> ::= #Bnn...n where n ::= {0   1} for binary |

**Introduction to  
:SBUS  
Commands**

The :SBUS subsystem commands control the serial decode bus viewing, mode, and other options.

**NOTE**

These commands are only valid on 4 (analog) channel oscilloscope models when a serial decode option has been licensed.

### Reporting the Setup

Use :SBUS? to query setup information for the :SBUS subsystem.

### Return Format

The following is a sample response from the :SBUS? query. In this case, the query was issued following a \*RST command.

```
:SBUS:DISP 0;MODE IIC
```

## **:SBUS:CAN:COUNT:ERRor**

**N** (see [page 750](#))

**Query Syntax** :SBUS:CAN:COUNT:ERRor?

Returns the error frame count.

**Return Format** <frame\_count><NL>

<frame\_count> ::= integer in NR1 format

**Errors** • ["-241, Hardware missing"](#) on page 709

- See Also**
- [":SBUS:CAN:COUNT:RESet"](#) on page 398
  - ["Introduction to :SBUS Commands"](#) on page 395
  - [":SBUS:MODE"](#) on page 410
  - [":TRIGger:CAN Commands"](#) on page 452

**:SBUS:CAN:COUNT:OVERload****N** (see [page 750](#))**Query Syntax** :SBUS:CAN:COUNT:OVERload?

Returns the overload frame count.

**Return Format** <frame\_count><NL>

&lt;frame\_count&gt; ::= integer in NR1 format

**Errors** • ["-241, Hardware missing"](#) on page 709

- See Also**
- 
- [":SBUS:CAN:COUNT:RESet"](#)
- on page 398
- 
- 
- ["Introduction to :SBUS Commands"](#)
- on page 395
- 
- 
- [":SBUS:MODE"](#)
- on page 410
- 
- 
- [":TRIGger:CAN Commands"](#)
- on page 452

## **:SBUS:CAN:COUNt:RESet**

**N** (see [page 750](#))

**Command Syntax** :SBUS:CAN:COUNt:RESet

Resets the frame counters.

**Errors** • ["-241, Hardware missing"](#) on page 709

- See Also**
- [":SBUS:CAN:COUNt:ERRor"](#) on page 396
  - [":SBUS:CAN:COUNt:OVERload"](#) on page 397
  - [":SBUS:CAN:COUNt:TOTal"](#) on page 399
  - [":SBUS:CAN:COUNt:UTILization"](#) on page 400
  - ["Introduction to :SBUS Commands"](#) on page 395
  - [":SBUS:MODE"](#) on page 410
  - [":TRIGger:CAN Commands"](#) on page 452

**:SBUS:CAN:COUNT:TOTAL****N** (see [page 750](#))**Query Syntax** :SBUS:CAN:COUNT:TOTAL?

Returns the total frame count.

**Return Format** <frame\_count><NL>

&lt;frame\_count&gt; ::= integer in NR1 format

**Errors** • ["-241, Hardware missing"](#) on page 709

- See Also**
- 
- [":SBUS:CAN:COUNT:RESet"](#)
- on page 398
- 
- 
- ["Introduction to :SBUS Commands"](#)
- on page 395
- 
- 
- [":SBUS:MODE"](#)
- on page 410
- 
- 
- [":TRIGger:CAN Commands"](#)
- on page 452

## **:SBUS:CAN:COUNT:UTILization**

**N** (see [page 750](#))

**Query Syntax** :SBUS:CAN:COUNT:UTILization?

Returns the percent utilization.

**Return Format** <percent><NL>

<percent> ::= floating-point in NR3 format

**Errors** • ["-241, Hardware missing"](#) on page 709

- See Also**
- [":SBUS:CAN:COUNT:RESet"](#) on page 398
  - ["Introduction to :SBUS Commands"](#) on page 395
  - [":SBUS:MODE"](#) on page 410
  - [":TRIGger:CAN Commands"](#) on page 452

**:SBUS:DISPlay**

**N** (see [page 750](#))

**Command Syntax** :SBUS:DISPlay <display>  
 <display> ::= {{1 | ON} | {0 | OFF}}

The :SBUS:DISPlay command turns displaying of the serial decode bus on or off.

**NOTE**

This command is only valid on 4 (analog) channel oscilloscope models when a serial decode option has been licensed.

**Query Syntax** :SBUS:DISPlay?

The :SBUS:DISPlay? query returns the current display setting of the serial decode bus.

**Return Format** <display><NL>  
 <display> ::= {0 | 1}

**Errors** • ["-241, Hardware missing"](#) on page 709

**See Also** • ["Introduction to :SBUS Commands"](#) on page 395  
 • [":CHANnel<n>:DISPlay"](#) on page 208  
 • [":VIEW"](#) on page 176  
 • [":BLANK"](#) on page 144  
 • [":STATus"](#) on page 173

## **:SBUS:FLEXray:COUNT:NULL**

**N** (see [page 750](#))

**Query Syntax** :SBUS:FLEXray:COUNT:NULL?

Returns the FlexRay null frame count.

**Return Format** <frame\_count><NL>

<frame\_count> ::= integer in NR1 format

**Errors** • "-241, Hardware missing" on [page 709](#)

- See Also**
- [":SBUS:FLEXray:COUNT:RESet"](#) on [page 403](#)
  - ["Introduction to :SBUS Commands"](#) on [page 395](#)
  - [":SBUS:MODE"](#) on [page 410](#)
  - [":TRIGger:FLEXray Commands"](#) on [page 480](#)

**:SBUS:FLEXray:COUNT:RESet****N** (see [page 750](#))**Command Syntax** :SBUS:FLEXray:COUNT:RESet

Resets the FlexRay frame counters.

**Errors** • "-241, Hardware missing" on [page 709](#)

- See Also**
- 
- [":SBUS:FLEXray:COUNT:NULL"](#)
- on
- [page 402](#)
- 
- 
- [":SBUS:FLEXray:COUNT:SYNC"](#)
- on
- [page 404](#)
- 
- 
- [":SBUS:FLEXray:COUNT:TOTAl"](#)
- on
- [page 405](#)
- 
- 
- ["Introduction to :SBUS Commands"](#)
- on
- [page 395](#)
- 
- 
- [":SBUS:MODE"](#)
- on
- [page 410](#)
- 
- 
- [":TRIGger:FLEXray Commands"](#)
- on
- [page 480](#)

## **:SBUS:FLEXray:COUNT:SYNC**

**N** (see [page 750](#))

**Query Syntax** :SBUS:FLEXray:COUNT:SYNC?

Returns the FlexRay sync frame count.

**Return Format** <frame\_count><NL>

<frame\_count> ::= integer in NR1 format

**Errors** • "-241, Hardware missing" on [page 709](#)

- See Also**
- [":SBUS:FLEXray:COUNT:RESet"](#) on [page 403](#)
  - ["Introduction to :SBUS Commands"](#) on [page 395](#)
  - [":SBUS:MODE"](#) on [page 410](#)
  - [":TRIGger:FLEXray Commands"](#) on [page 480](#)

**:SBUS:FLEXray:COUNT:TOTal****N** (see [page 750](#))**Query Syntax** :SBUS:FLEXray:COUNT:TOTal?

Returns the FlexRay total frame count.

**Return Format** <frame\_count><NL>

&lt;frame\_count&gt; ::= integer in NR1 format

**Errors** • ["-241, Hardware missing"](#) on page 709

- See Also**
- 
- [":SBUS:FLEXray:COUNT:RESet"](#)
- on page 403
- 
- 
- ["Introduction to :SBUS Commands"](#)
- on page 395
- 
- 
- [":SBUS:MODE"](#)
- on page 410
- 
- 
- [":TRIGger:FLEXray Commands"](#)
- on page 480

## :SBUS:I2S:BASE

**N** (see [page 750](#))

**Command Syntax** :SBUS:I2S:BASE <base>  
<base> ::= {DECimal | HEX}

The :SBUS:I2S:BASE command determines the base to use for the I2S decode display.

### NOTE

This command is only valid on 4 (analog) channel oscilloscope models when the I2S serial decode option (Option SND) has been licensed.

**Query Syntax** :SBUS:I2S:BASE?

The :SBUS:I2S:BASE? query returns the current I2S display decode base.

**Return Format** <base><NL>  
<base> ::= {DECimal | HEX}

**Errors** • ["-241, Hardware missing"](#) on page 709

**See Also** • ["Introduction to :SBUS Commands"](#) on page 395  
• [":TRIGger:I2S Commands"](#) on page 500

**:SBUS:IIC:ASIZE**

**N** (see [page 750](#))

**Command Syntax** :SBUS:IIC:ASIZE <size>  
 <size> ::= {BIT7 | BIT8}

The :SBUS:IIC:ASIZE command determines whether the Read/Write bit is included as the LSB in the display of the IIC address field of the decode bus.

**NOTE**

This command is only valid on 4 (analog) channel oscilloscope models when the low-speed IIC and SPI serial decode option (Option LSS) has been licensed.

**Query Syntax** :SBUS:IIC:ASIZE?

The :SBUS:IIC:ASIZE? query returns the current IIC address width setting.

**Return Format** <mode><NL>  
 <mode> ::= {BIT7 | BIT8}

**Errors** • "-241, Hardware missing" on [page 709](#)

**See Also** • "Introduction to :SBUS Commands" on [page 395](#)  
 • ":TRIGger:IIC Commands" on [page 518](#)

## :SBUS:LIN:PARity

**N** (see [page 750](#))

**Command Syntax** :SBUS:LIN:PARity <display>  
<display> ::= {{1 | ON} | {0 | OFF}}

The :SBUS:LIN:PARity command determines whether the parity bits are included as the most significant bits (MSB) in the display of the Frame Id field in the LIN decode bus.

### NOTE

This command is only valid on 4 (analog) channel oscilloscope models when the automotive CAN and LIN serial decode option (Option AMS) has been licensed.

**Query Syntax** :SBUS:LIN:PARity?

The :SBUS:LIN:PARity? query returns the current LIN parity bits display setting of the serial decode bus.

**Return Format** <display><NL>  
<display> ::= {0 | 1}

**Errors** • "-241, Hardware missing" on [page 709](#)

**See Also** • ["Introduction to :SBUS Commands"](#) on [page 395](#)  
• [":TRIGger:LIN Commands"](#) on [page 527](#)

**:SBUS:M1553:BASE**

**N** (see [page 750](#))

**Command Syntax** :SBUS:M1553:BASE <base>  
 <base> ::= {BINary | HEX}

The :SBUS:M1553:BASE command determines the base to use for the MIL-STD 1553 decode display.

**NOTE**

This command is only valid on 4 (analog) channel oscilloscope models when the MIL-STD 1553 serial decode option (Option 553) has been licensed.

**Query Syntax** :SBUS:M1553:BASE?

The :SBUS:M1553:BASE? query returns the current MIL-STD 1553 display decode base.

**Return Format** <base><NL>  
 <base> ::= {BIN | HEX}

**Errors** • "-241, Hardware missing" on [page 709](#)

**See Also** • "Introduction to :SBUS Commands" on [page 395](#)  
 • ":TRIGger:M1553 Commands" on [page 540](#)

### :SBUS:MODE

**N** (see [page 750](#))

**Command Syntax** :SBUS:MODE <mode>

<mode> ::= {CAN | FLEXray | I2S | IIC | LIN | M1553 | SPI | UART}

The :SBUS:MODE command determines the decode mode for the serial bus.

#### NOTE

This command is only valid on 4 (analog) channel oscilloscope models when a serial decode option has been licensed.

**Query Syntax** :SBUS:MODE?

The :SBUS:MODE? query returns the current serial bus decode mode setting.

**Return Format** <mode><NL>

<mode> ::= {CAN | FLEX | I2S | IIC | LIN | M1553 | SPI | UART | NONE}

**Errors** • "-241, Hardware missing" on [page 709](#)

- See Also**
- "[Introduction to :SBUS Commands](#)" on [page 395](#)
  - "[:TRIGger:MODE](#)" on [page 447](#)
  - "[:TRIGger:CAN Commands](#)" on [page 452](#)
  - "[:TRIGger:FLEXray Commands](#)" on [page 480](#)
  - "[:TRIGger:I2S Commands](#)" on [page 500](#)
  - "[:TRIGger:IIC Commands](#)" on [page 518](#)
  - "[:TRIGger:LIN Commands](#)" on [page 527](#)
  - "[:TRIGger:M1553 Commands](#)" on [page 540](#)
  - "[:TRIGger:SPI Commands](#)" on [page 555](#)
  - "[:TRIGger:UART Commands](#)" on [page 570](#)

**:SBUS:SPI:BITorder**

**N** (see [page 750](#))

**Command Syntax** :SBUS:SPI:BITorder <order>  
 <order> ::= {LSBFirst | MSBFirst}

The :SBUS:SPI:BITorder command selects the bit order, most significant bit first (MSB) or least significant bit first (LSB), used when displaying data in the serial decode waveform and in the Lister.

**NOTE**

This command is only valid on 4 (analog) channel oscilloscope models when the low-speed IIC and SPI serial decode option (Option LSS) has been licensed.

**Query Syntax** :SBUS:SPI:BITorder?

The :SBUS:SPI:BITorder? query returns the current SPI decode bit order.

**Return Format** <order><NL>  
 <order> ::= {LSBF | MSBF}

**Errors** • "-241, Hardware missing" on [page 709](#)

**See Also** • ["Introduction to :SBUS Commands"](#) on [page 395](#)  
 • [":SBUS:MODE"](#) on [page 410](#)  
 • [":TRIGger:SPI Commands"](#) on [page 555](#)

## :SBUS:SPI:WIDTH

**N** (see [page 750](#))

**Command Syntax** :SBUS:SPI:WIDTH <word\_width>  
<word\_width> ::= integer 4-16 in NR1 format

The :SBUS:SPI:WIDTH command determines the number of bits in a word of data for SPI.

### NOTE

This command is only valid on 4 (analog) channel oscilloscope models when the low-speed IIC and SPI serial decode option (Option LSS) has been licensed.

**Query Syntax** :SBUS:SPI:WIDTH?

The :SBUS:SPI:WIDTH? query returns the current SPI decode word width.

**Return Format** <word\_width><NL>  
<word\_width> ::= integer 4-16 in NR1 format

**Errors** • ["-241, Hardware missing"](#) on [page 709](#)

**See Also** • ["Introduction to :SBUS Commands"](#) on [page 395](#)  
• [":SBUS:MODE"](#) on [page 410](#)  
• [":TRIGger:SPI Commands"](#) on [page 555](#)

**:SBUS:UART:BASE**

**N** (see [page 750](#))

**Command Syntax** :SBUS:UART:BASE <base>  
 <base> ::= {ASCIi | BINary | HEX}

The :SBUS:UART:BASE command determines the base to use for the UART decode display.

**NOTE**

This command is only valid on 4 (analog) channel oscilloscope models when the UART/RS-232 triggering and serial decode option (Option 232) has been licensed.

**Query Syntax** :SBUS:UART:BASE?

The :SBUS:UART:BASE? query returns the current UART decode base setting.

**Return Format** <base><NL>  
 <base> ::= {ASCIi | BINary | HEX}

**Errors** • "-241, Hardware missing" on [page 709](#)

**See Also** • "[Introduction to :SBUS Commands](#)" on [page 395](#)  
 • "[:TRIGger:UART Commands](#)" on [page 570](#)

## **:SBUS:UART:COUNT:ERRor**

**N** (see [page 750](#))

**Query Syntax** :SBUS:UART:COUNT:ERRor?

Returns the UART error frame count.

### **NOTE**

This command is only valid on 4 (analog) channel oscilloscope models when the UART/RS-232 triggering and serial decode option (Option 232) has been licensed.

---

**Return Format** <frame\_count><NL>

<frame\_count> ::= integer in NR1 format

**Errors** • "-241, Hardware missing" on [page 709](#)

- See Also**
- [":SBUS:UART:COUNT:RESet"](#) on [page 415](#)
  - ["Introduction to :SBUS Commands"](#) on [page 395](#)
  - [":SBUS:MODE"](#) on [page 410](#)
  - [":TRIGger:UART Commands"](#) on [page 570](#)

**:SBUS:UART:COUNt:RESet****N** (see [page 750](#))**Command Syntax** :SBUS:UART:COUNt:RESet

Resets the UART frame counters.

**NOTE**

This command is only valid on 4 (analog) channel oscilloscope models when the UART/RS-232 triggering and serial decode option (Option 232) has been licensed.

- 
- Errors**
- ["-241, Hardware missing"](#) on page 709
- See Also**
- [":SBUS:UART:COUNt:ERRor"](#) on page 414
  - [":SBUS:UART:COUNt:RXFRames"](#) on page 416
  - [":SBUS:UART:COUNt:TXFRames"](#) on page 417
  - ["Introduction to :SBUS Commands"](#) on page 395
  - [":SBUS:MODE"](#) on page 410
  - [":TRIGger:UART Commands"](#) on page 570

## **:SBUS:UART:COUNt:RXFRames**

**N** (see [page 750](#))

**Query Syntax** :SBUS:UART:COUNt:RXFRames?

Returns the UART Rx frame count.

### **NOTE**

This command is only valid on 4 (analog) channel oscilloscope models when the UART/RS-232 triggering and serial decode option (Option 232) has been licensed.

---

**Return Format** <frame\_count><NL>

<frame\_count> ::= integer in NR1 format

**Errors** • "-241, Hardware missing" on [page 709](#)

- See Also**
- [":SBUS:UART:COUNt:RESet"](#) on [page 415](#)
  - ["Introduction to :SBUS Commands"](#) on [page 395](#)
  - [":SBUS:MODE"](#) on [page 410](#)
  - [":TRIGger:UART Commands"](#) on [page 570](#)

**:SBUS:UART:COUNt:TXFRames****N** (see [page 750](#))**Query Syntax** :SBUS:UART:COUNt:TXFRames?

Returns the UART Tx frame count.

**NOTE**

This command is only valid on 4 (analog) channel oscilloscope models when the UART/RS-232 triggering and serial decode option (Option 232) has been licensed.

**Return Format** <frame\_count><NL>

&lt;frame\_count&gt; ::= integer in NR1 format

**Errors** • "-241, Hardware missing" on [page 709](#)

- See Also**
- 
- [":SBUS:UART:COUNt:RESet"](#)
- on
- [page 415](#)
- 
- 
- ["Introduction to :SBUS Commands"](#)
- on
- [page 395](#)
- 
- 
- [":SBUS:MODE"](#)
- on
- [page 410](#)
- 
- 
- [":TRIGger:UART Commands"](#)
- on
- [page 570](#)

## :SBUS:UART:FRAMing

**N** (see [page 750](#))

**Command Syntax** :SBUS:UART:FRAMing <value>  
<value> ::= {OFF | <decimal> | <nondecimal>}  
<decimal> ::= 8-bit integer in decimal from 0-255 (0x00-0xff)  
<nondecimal> ::= #Hnn where n ::= {0,...,9 | A,...,F} for hexadecimal  
<nondecimal> ::= #Bnn...n where n ::= {0 | 1} for binary

The :SBUS:UART:FRAMing command determines the byte value to use for framing (end of packet) or to turn off framing for UART decode.

### NOTE

This command is only valid on 4 (analog) channel oscilloscope models when the UART/RS-232 triggering and serial decode option (Option 232) has been licensed.

**Query Syntax** :SBUS:UART:FRAMing?

The :SBUS:UART:FRAMing? query returns the current UART decode base setting.

**Return Format** <value><NL>  
<value> ::= {OFF | <decimal>}  
<decimal> ::= 8-bit integer in decimal from 0-255

**Errors** • "-241, Hardware missing" on [page 709](#)

**See Also** • ["Introduction to :SBUS Commands"](#) on [page 395](#)  
• [":TRIGger:UART Commands"](#) on [page 570](#)

## :SYSTEM Commands

Control basic system functions of the oscilloscope. See "Introduction to :SYSTEM Commands" on page 419.

**Table 67** :SYSTEM Commands Summary

| Command   | Query  | Options and Query Returns  |
|---|--|--|
| :SYSTEM:DATE <date><br>(see <a href="#">page 420</a> )          | :SYSTEM:DATE? (see <a href="#">page 420</a> )            | <date> ::= <year>,<month>,<day><br><year> ::= 4-digit year in NR1 format<br><month> ::= {1,...,12   JANuary   FEBruary   MARch   APRil   MAY   JUNE   JULy   AUGust   SEPTember   OCTober   NOVember   DECember}<br><day> ::= {1,..31} |
| :SYSTEM:DSP <string><br>(see <a href="#">page 421</a> )         | n/a  | <string> ::= up to 254 characters as a quoted ASCII string   |
| n/a   | :SYSTEM:ERROR? (see <a href="#">page 422</a> )           | <error> ::= an integer error code<br><error string> ::= quoted ASCII string.<br>See Error Messages (see <a href="#">page 707</a> ).  |
| :SYSTEM:LOCK <value><br>(see <a href="#">page 423</a> )         | :SYSTEM:LOCK? (see <a href="#">page 423</a> )            | <value> ::= {{1   ON}   {0   OFF}}   |
| :SYSTEM:PRECision <value> (see <a href="#">page 424</a> )       | :SYSTEM:PRECision? (see <a href="#">page 424</a> )       | <value> ::= {{1   ON}   {0   OFF}}   |
| :SYSTEM:PROTection:LOCK <value> (see <a href="#">page 425</a> ) | :SYSTEM:PROTection:LOCK? (see <a href="#">page 425</a> ) | <value> ::= {{1   ON}   {0   OFF}}   |
| :SYSTEM:SETup <setup_data> (see <a href="#">page 426</a> )      | :SYSTEM:SETup? (see <a href="#">page 426</a> )           | <setup_data> ::= data in IEEE 488.2 # format.  |
| :SYSTEM:TIME <time><br>(see <a href="#">page 428</a> )          | :SYSTEM:TIME? (see <a href="#">page 428</a> )            | <time> ::= hours,minutes,seconds in NR1 format   |

**Introduction to :SYSTEM Commands** SYSTEM subsystem commands enable writing messages to the display, setting and reading both the time and the date, querying for errors, and saving and recalling setups.

## :SYSTem:DATE

**N** (see [page 750](#))

**Command Syntax** :SYSTem:DATE <date>

<date> ::= <year>,<month>,<day>

<year> ::= 4-digit year in NR1 format

<month> ::= {1,..,12 | JANuary | FEBruary | MARCH | APRil | MAY | JUNE  
| JULy | AUGust | SEPTember | OCTober | NOVember | DECember}

<day> ::= {1,..,31}

The :SYSTem:DATE command sets the date. Validity checking is performed to ensure that the date is valid.

**Query Syntax** :SYSTem:DATE?

The SYSTem:DATE? query returns the date.

**Return Format** <year>,<month>,<day><NL>

- See Also**
- "[Introduction to :SYSTem Commands](#)" on page 419
  - "[:SYSTem:TIME](#)" on page 428

## :SYSTem:DSP

**N** (see [page 750](#))

**Command Syntax** :SYSTem:DSP <string>  
<string> ::= quoted ASCII string (up to 254 characters)

The :SYSTem:DSP command writes the quoted string (excluding quotation marks) to a text box in the center of the display. Use :SYSTem:DSP "" to remotely remove the message from the display. (Two sets of quote marks without a space between them creates a NULL string.) Press any menu key to manually remove the message from the display.

**See Also** • ["Introduction to :SYSTem Commands"](#) on page 419

## :SYSTem:ERRor

**C** (see [page 750](#))

**Query Syntax** :SYSTem:ERRor?

The :SYSTem:ERRor? query outputs the next error number and text from the error queue. The instrument has an error queue that is 30 errors deep and operates on a first-in, first-out basis. Repeatedly sending the :SYSTem:ERRor? query returns the errors in the order that they occurred until the queue is empty. Any further queries then return zero until another error occurs.

**Return Format** <error number>,<error string><NL>

<error number> ::= an integer error code in NR1 format

<error string> ::= quoted ASCII string containing the error message

Error messages are listed in [Chapter 8](#), “Error Messages,” starting on page 707.

- See Also**
- ["Introduction to :SYSTem Commands"](#) on page 419
  - ["\\*ESR \(Standard Event Status Register\)"](#) on page 118
  - ["\\*CLS \(Clear Status\)"](#) on page 115

## :SYSTem:LOCK

**N** (see [page 750](#))

**Command Syntax** :SYSTem:LOCK <value>  
<value> ::= {{1 | ON} | {0 | OFF}}

The :SYSTem:LOCK command disables the front panel. LOCK ON is the equivalent of sending a local lockout message over the programming interface.

**Query Syntax** :SYSTem:LOCK?

The :SYSTem:LOCK? query returns the lock status of the front panel.

**Return Format** <value><NL>  
<value> ::= {1 | 0}

**See Also** • ["Introduction to :SYSTem Commands"](#) on page 419

**:SYSTem:PRECision**

**N** (see [page 750](#))

**Command Syntax** :SYSTem:PRECision <value>  
 <value> ::= {{1 | ON} | {0 | OFF}}

The :SYSTem:PRECision command turns the oscilloscope's precision analysis setting on or off.

- OFF (0) – provides the maximum oscilloscope waveform update rate by performing measurements and math functions on a 1000-point *measurement record*.
- ON (1) – at the expense of oscilloscope waveform update rate, this setting allows measurements and math functions to be performed on a *precision analysis record* (see [":WAVEform:POINts:MODE"](#) on page 604).

The precision analysis setting is OFF after a \*RST command.

Precision analysis is not available when:

- Realtime sampling mode is off.
- Averaging or High Resolution acquisition modes are selected.
- XY or Roll time modes are selected.

**Query Syntax** :SYSTem:PRECision?

The :SYSTem:PRECision? query returns the current precision analysis setting.

**Return Format** <value><NL>  
 <value> ::= {1 | 0}

- See Also**
- ["Introduction to :SYSTem Commands"](#) on page 419
  - [":WAVEform:POINts:MODE"](#) on page 604
  - ["\\*RST \(Reset\)"](#) on page 125

**:SYSTem:PROTection:LOCK****N** (see [page 750](#))

**Command Syntax** :SYSTem:PROTection:LOCK <value>  
<value> ::= {{1 | ON} | {0 | OFF}}

The :SYSTem:PROTection:LOCK command disables the fifty ohm impedance setting for all analog channels.

**Query Syntax** :SYSTem:PROTection:LOCK?

The :SYSTem:PROTection:LOCK? query returns the analog channel protection lock status.

**Return Format** <value><NL>  
<value> ::= {1 | 0}

**See Also** • ["Introduction to :SYSTem Commands"](#) on page 419

**:SYSTem:SETup**

**C** (see [page 750](#))

**Command Syntax** :SYSTem:SETup <setup\_data>

<setup\_data> ::= binary block data in IEEE 488.2 # format.

The :SYSTem:SETup command sets the oscilloscope as defined by the data in the setup (learn) string sent from the controller. The setup string does not change the interface mode or interface address.

**Query Syntax** :SYSTem:SETup?

The :SYSTem:SETup? query operates the same as the \*LRN? query. It outputs the current oscilloscope setup in the form of a learn string to the controller. The setup (learn) string is sent and received as a binary block of data. The format for the data transmission is the # format defined in the IEEE 488.2 specification.

**Return Format** <setup\_data><NL>

<setup\_data> ::= binary block data in IEEE 488.2 # format

- See Also**
- ["Introduction to :SYSTem Commands"](#) on page 419
  - ["\\*LRN \(Learn Device Setup\)"](#) on page 121

**Example Code**

```
' SAVE_SYSTEM_SETUP - The :SYSTEM:SETUP? query returns a program
' message that contains the current state of the instrument. Its
' format is a definite-length binary block, for example,
' #800002204<setup string><NL>
' where the setup string is 2204 bytes in length.
myScope.WriteString ":SYSTEM:SETUP?"
varQueryResult = myScope.ReadIEEEBlock(BinaryType_UI1)
CheckForInstrumentErrors ' After reading query results.

' Output setup string to a file:
Dim strPath As String
strPath = "c:\scope\config\setup.dat"

' Open file for output.
Close #1 ' If #1 is open, close it.
Open strPath For Binary Access Write Lock Write As #1
Put #1, , varQueryResult ' Write data.
Close #1 ' Close file.

' RESTORE_SYSTEM_SETUP - Read the setup string from a file and
' write it back to the oscilloscope.
Dim varSetupString As Variant
strPath = "c:\scope\config\setup.dat"

' Open file for input.
Open strPath For Binary Access Read As #1
Get #1, , varSetupString ' Read data.
Close #1 ' Close file.
```

```
' Write setup string back to oscilloscope using ":SYSTEM:SETUP"  
' command:  
myScope.WriteIEEEBlock ":SYSTEM:SETUP ", varSetupString  
CheckForInstrumentErrors
```

Example program from the start: ["VISA COM Example in Visual Basic"](#) on page 776

### :SYSTem:TIME

**N** (see [page 750](#))

**Command Syntax** :SYSTem:TIME <time>

<time> ::= hours,minutes,seconds in NR1 format

The :SYSTem:TIME command sets the system time, using a 24-hour format. Commas are used as separators. Validity checking is performed to ensure that the time is valid.

**Query Syntax** :SYSTem:TIME? <time>

The :SYSTem:TIME? query returns the current system time.

**Return Format** <time><NL>

<time> ::= hours,minutes,seconds in NR1 format

- See Also**
- "[Introduction to :SYSTEM Commands](#)" on page 419
  - "[:SYSTEM:DATE](#)" on page 420

## :TIMebase Commands

Control all horizontal sweep functions. See "Introduction to :TIMebase Commands" on page 429.

**Table 68** :TIMebase Commands Summary

| Command   | Query                                     | Options and Query Returns  |
|---|---|--|
| :TIMebase:MODE<br><value> (see page 431)                      | :TIMebase:MODE? (see page 431)            | <value> ::= {MAIN   WINDOW   XY   ROLL}  |
| :TIMebase:POSition<br><pos> (see page 432)                    | :TIMebase:POSition? (see page 432)        | <pos> ::= time from the trigger event to the display reference point in NR3 format     |
| :TIMebase:RANGe<br><range_value> (see page 433)               | :TIMebase:RANGe? (see page 433)           | <range_value> ::= 10 ns through 500 s in NR3 format                                    |
| :TIMebase:REFerence<br>{LEFT   CENTER   RIGHT} (see page 434) | :TIMebase:REFerence? (see page 434)       | <return_value> ::= {LEFT   CENTER   RIGHT}   |
| :TIMebase:SCALe<br><scale_value> (see page 435)               | :TIMebase:SCALe? (see page 435)           | <scale_value> ::= scale value in seconds in NR3 format                                 |
| :TIMebase:VERNier {{0   OFF}   {1   ON}} (see page 436)       | :TIMebase:VERNier? (see page 436)         | {0   1}  |
| :TIMebase:WINDOW:POSition<br><pos> (see page 437)             | :TIMebase:WINDOW:POSition? (see page 437) | <pos> ::= time from the trigger event to the zoomed view reference point in NR3 format |
| :TIMebase:WINDOW:RANGe<br><range_value> (see page 438)        | :TIMebase:WINDOW:RANGe? (see page 438)    | <range value> ::= range value in seconds in NR3 format for the zoomed window           |
| :TIMebase:WINDOW:SCALe<br><scale_value> (see page 439)        | :TIMebase:WINDOW:SCALe? (see page 439)    | <scale_value> ::= scale value in seconds in NR3 format for the zoomed window           |

**Introduction to :TIMebase Commands** The TIMebase subsystem commands control the horizontal (X-axis) functions and set the oscilloscope to X-Y mode (where channel 1 becomes the X input and channel 2 becomes the Y input). The time per division, delay, vernier control, and reference can be controlled for the main and window (zoomed) time bases.

Reporting the Setup

## 5 Commands by Subsystem

Use `:TIMebase?` to query setup information for the TIMEbase subsystem.

### Return Format

The following is a sample response from the `:TIMebase?` query. In this case, the query was issued following a `*RST` command.

```
:TIM:MODE MAIN;REF CENT;MAIN:RANG +1.00E-03;POS +0.0E+00
```

**:TIMEbase:MODE**

**C** (see [page 750](#))

**Command Syntax** :TIMEbase:MODE <value>  
 <value> ::= {MAIN | WINDow | XY | ROLL}

The :TIMEbase:MODE command sets the current time base. There are four time base modes:

- **MAIN** – The normal time base mode is the main time base. It is the default time base mode after the \*RST (Reset) command.
- **WINDow** – In the WINDow (zoomed or delayed) time base mode, measurements are made in the zoomed time base if possible; otherwise, the measurements are made in the main time base.
- **XY** – In the XY mode, the :TIMEbase:RANGe, :TIMEbase:POSition, and :TIMEbase:REFerence commands are not available. No measurements are available in this mode.
- **ROLL** – In the ROLL mode, data moves continuously across the display from left to right. The oscilloscope runs continuously and is untriggered. The :TIMEbase:REFerence selection changes to RIGHT.

**NOTE**

If a :DIGitize command is executed when the :TIMEbase:MODE is not MAIN, the :TIMEbase:MODE is set to MAIN.

**Query Syntax** :TIMEbase:MODE?

The :TIMEbase:MODE query returns the current time base mode.

**Return Format** <value><NL>  
 <value> ::= {MAIN | WIND | XY | ROLL}

- See Also**
- ["Introduction to :TIMEbase Commands"](#) on page 429
  - ["\\*RST \(Reset\)"](#) on page 125
  - [":TIMEbase:RANGe"](#) on page 433
  - [":TIMEbase:POSition"](#) on page 432
  - [":TIMEbase:REFerence"](#) on page 434

**Example Code**

```
' TIMEBASE_MODE - (not executed in this example)
' Set the time base mode to MAIN, DELAYED, XY, or ROLL.

' Set time base mode to main.
myScope.WriteString ":TIMEBASE:MODE MAIN"
```

Example program from the start: ["VISA COM Example in Visual Basic"](#) on page 776

### :TIMEbase:POSition

**C** (see [page 750](#))

**Command Syntax** :TIMEbase:POSition <pos>

<pos> ::= time in seconds from the trigger to the display reference  
in NR3 format

The :TIMEbase:POSition command sets the time interval between the trigger event and the display reference point on the screen. The display reference point is either left, right, or center and is set with the :TIMEbase:REFerence command. The maximum position value depends on the time/division settings.

#### NOTE

This command is an alias for the :TIMEbase:DELay command.

**Query Syntax** :TIMEbase:POSition?

The :TIMEbase:POSition? query returns the current time from the trigger to the display reference in seconds.

**Return Format** <pos><NL>

<pos> ::= time in seconds from the trigger to the display reference  
in NR3 format

- See Also**
- "[Introduction to :TIMEbase Commands](#)" on page 429
  - "[:TIMEbase:REFerence](#)" on page 434
  - "[:TIMEbase:RANGe](#)" on page 433
  - "[:TIMEbase:SCALE](#)" on page 435
  - "[:TIMEbase:WINDow:POSition](#)" on page 437
  - "[:TIMEbase:DELay](#)" on page 703

**:TIMEbase:RANGe**

**C** (see [page 750](#))

**Command Syntax** :TIMEbase:RANGe <range\_value>

<range\_value> ::= 10 ns through 500 s in NR3 format

The :TIMEbase:RANGe command sets the full-scale horizontal time in seconds for the main window. The range is 10 times the current time-per-division setting.

**Query Syntax** :TIMEbase:RANGe?

The :TIMEbase:RANGe query returns the current full-scale range value for the main window.

**Return Format** <range\_value><NL>

<range\_value> ::= 10 ns through 500 s in NR3 format

- See Also**
- ["Introduction to :TIMEbase Commands"](#) on page 429
  - [":TIMEbase:MODE"](#) on page 431
  - [":TIMEbase:SCALE"](#) on page 435
  - [":TIMEbase:WINDow:RANGe"](#) on page 438

**Example Code**

```
' TIME_RANGE - Sets the full scale horizontal time in seconds. The
' range value is 10 times the time per division.
myScope.WriteString ":TIM:RANG 2e-3" ' Set the time range to 0.002
seconds.
```

Example program from the start: ["VISA COM Example in Visual Basic"](#) on page 776

## :TIMEbase:REFErence

**C** (see [page 750](#))

**Command Syntax** :TIMEbase:REFErence <reference>  
<reference> ::= {LEFT | CENTer | RIGHT}

The :TIMEbase:REFErence command sets the time reference to one division from the left side of the screen, to the center of the screen, or to one division from the right side of the screen. Time reference is the point on the display where the trigger point is referenced.

**Query Syntax** :TIMEbase:REFErence?

The :TIMEbase:REFErence? query returns the current display reference for the main window.

**Return Format** <reference><NL>  
<reference> ::= {LEFT | CENT | RIGH}

- See Also**
- ["Introduction to :TIMEbase Commands"](#) on page 429
  - [":TIMEbase:MODE"](#) on page 431

**Example Code**

```
' TIME_REFERENCE - Possible values are LEFT and CENTER.  
' - LEFT sets the display reference on time division from the left.  
' - CENTER sets the display reference to the center of the screen.  
myScope.WriteString ":TIMEBASE:REFERENCE CENTER" ' Set reference to  
center.
```

Example program from the start: ["VISA COM Example in Visual Basic"](#) on page 776

**:TIMEbase:SCALE**

**N** (see [page 750](#))

**Command Syntax** :TIMEbase:SCALE <scale\_value>

<scale\_value> ::= 1 ns through 50 s in NR3 format

The :TIMEbase:SCALE command sets the horizontal scale or units per division for the main window.

**Query Syntax** :TIMEbase:SCALE?

The :TIMEbase:SCALE? query returns the current horizontal scale setting in seconds per division for the main window.

**Return Format** <scale\_value><NL>

<scale\_value> ::= 1 ns through 50 s in NR3 format

- See Also**
- "[Introduction to :TIMEbase Commands](#)" on page 429
  - "[:TIMEbase:RANGE](#)" on page 433
  - "[:TIMEbase:WINDOW:SCALE](#)" on page 439
  - "[:TIMEbase:WINDOW:RANGE](#)" on page 438

### :TIMEbase:VERNier

**N** (see [page 750](#))

**Command Syntax** :TIMEbase:VERNier <vernier value>  
<vernier value> ::= {{1 | ON} | {0 | OFF}}

The :TIMEbase:VERNier command specifies whether the time base control's vernier (fine horizontal adjustment) setting is ON (1) or OFF (0).

**Query Syntax** :TIMEbase:VERNier?

The :TIMEbase:VERNier? query returns the current state of the time base control's vernier setting.

**Return Format** <vernier value><NL>  
<vernier value> ::= {0 | 1}

**See Also** • ["Introduction to :TIMEbase Commands"](#) on page 429

**:TIMEbase:WINDow:POSition**

**C** (see [page 750](#))

**Command Syntax** :TIMEbase:WINDow:POSition <pos value>

<pos value> ::= time from the trigger event to the zoomed (delayed) view reference point in NR3 format

The :TIMEbase:WINDow:POSition command sets the horizontal position in the zoomed (delayed) view of the main sweep. The main sweep range and the main sweep horizontal position determine the range for this command. The value for this command must keep the zoomed view window within the main sweep range.

**Query Syntax** :TIMEbase:WINDow:POSition?

The :TIMEbase:WINDow:POSition? query returns the current horizontal window position setting in the zoomed view.

**Return Format** <value><NL>

<value> ::= position value in seconds

- See Also**
- ["Introduction to :TIMEbase Commands"](#) on page 429
  - [":TIMEbase:MODE"](#) on page 431
  - [":TIMEbase:POSition"](#) on page 432
  - [":TIMEbase:RANGe"](#) on page 433
  - [":TIMEbase:SCALe"](#) on page 435
  - [":TIMEbase:WINDow:RANGe"](#) on page 438
  - [":TIMEbase:WINDow:SCALe"](#) on page 439

## :TIMebase:WINDow:RANGe

**C** (see [page 750](#))

**Command Syntax** :TIMebase:WINDow:RANGe <range value>

<range value> ::= range value in seconds in NR3 format

The :TIMebase:WINDow:RANGe command sets the full-scale horizontal time in seconds for the zoomed (delayed) window. The range is 10 times the current zoomed view window seconds per division setting. The main sweep range determines the range for this command. The maximum value is one half of the :TIMebase:RANGe value.

**Query Syntax** :TIMebase:WINDow:RANGe?

The :TIMebase:WINDow:RANGe? query returns the current window timebase range setting.

**Return Format** <value><NL>

<value> ::= range value in seconds

- See Also**
- ["Introduction to :TIMebase Commands"](#) on page 429
  - [":TIMebase:RANGe"](#) on page 433
  - [":TIMebase:POSition"](#) on page 432
  - [":TIMebase:SCALE"](#) on page 435

**:TIMEbase:WINDow:SCALE**

**N** (see [page 750](#))

**Command Syntax** :TIMEbase:WINDow:SCALE <scale\_value>

<scale\_value> ::= scale value in seconds in NR3 format

The :TIMEbase:WINDow:SCALE command sets the zoomed (delayed) window horizontal scale (seconds/division). The main sweep scale determines the range for this command. The maximum value is one half of the :TIMEbase:SCALE value.

**Query Syntax** :TIMEbase:WINDow:SCALE?

The :TIMEbase:WINDow:SCALE? query returns the current zoomed window scale setting.

**Return Format** <scale\_value><NL>

<scale\_value> ::= current seconds per division for the zoomed window

- See Also**
- ["Introduction to :TIMEbase Commands"](#) on page 429
  - [":TIMEbase:RANGe"](#) on page 433
  - [":TIMEbase:POSition"](#) on page 432
  - [":TIMEbase:SCALE"](#) on page 435
  - [":TIMEbase:WINDow:RANGe"](#) on page 438

## :TRIGger Commands

Control the trigger modes and parameters for each trigger type. See:

- "Introduction to :TRIGger Commands" on page 440
- "General :TRIGger Commands" on page 443
- ":TRIGger:CAN Commands" on page 452
- ":TRIGger:DURation Commands" on page 464
- ":TRIGger:EBURst Commands" on page 470
- ":TRIGger[:EDGE] Commands" on page 474
- ":TRIGger:FLEXray Commands" on page 480
- ":TRIGger:GLITCh Commands" on page 492 (Pulse Width trigger)
- ":TRIGger:I2S Commands" on page 500
- ":TRIGger:IIC Commands" on page 518
- ":TRIGger:LIN Commands" on page 527
- ":TRIGger:M1553 Commands" on page 540
- ":TRIGger:SEQuence Commands" on page 547
- ":TRIGger:SPI Commands" on page 555
- ":TRIGger:TV Commands" on page 564
- ":TRIGger:UART Commands" on page 570
- ":TRIGger:USB Commands" on page 585

### Introduction to :TRIGger Commands

The commands in the TRIGger subsystem define the conditions for an internal trigger. Many of these commands are valid in multiple trigger modes.

The default trigger mode is :EDGE.

The trigger subsystem controls the trigger sweep mode and the trigger specification. The trigger sweep (see ":TRIGger:SWEep" on page 451) can be AUTO or NORMAl.

- **NORMAl** mode – displays a waveform only if a trigger signal is present and the trigger conditions are met. Otherwise the oscilloscope does not trigger and the display is not updated. This mode is useful for low-repetitive-rate signals.
- **AUTO** trigger mode – generates an artificial trigger event if the trigger specification is not satisfied within a preset time, acquires unsynchronized data and displays it.

AUTO mode is useful for signals other than low-repetitive-rate signals. You must use this mode to display a DC signal because there are no edges on which to trigger.

The following trigger types are available (see `":TRIGger:MODE"` on page 447).

- **CAN (Controller Area Network) triggering**— will trigger on CAN version 2.0A and 2.0B signals. Setup consists of connecting the oscilloscope to a CAN signal. Baud rate, signal source, and signal polarity, and type of data to trigger on can be specified. With the automotive CAN and LIN serial decode option (Option ASM), you can also trigger on CAN data and identifier patterns, set the bit sample point, and have the module send an acknowledge to the bus when it receives a valid message.

#### NOTE

The CAN and LIN serial decode option (Option ASM) replaces the functionality that was available with the N2758A CAN trigger module for the 54620/54640 Series oscilloscopes.

- **Duration triggering**— lets you define a pattern, then trigger on a specified time duration.
- **Nth Edge Burst triggering**— lets you trigger on the Nth edge of a burst that occurs after an idle time.
- **Edge triggering**— identifies a trigger by looking for a specified slope and voltage level on a waveform.
- **Pulse width triggering**— (`:TRIGger:GLITCh` commands) sets the oscilloscope to trigger on a positive pulse or on a negative pulse of a specified width.
- **Pattern triggering**— identifies a trigger condition by looking for a specified pattern. This pattern is a logical AND combination of the channels.
- **I2S (Inter-IC Sound or Integrated Interchip Sound bus) triggering**— consists of connecting the oscilloscope to the serial clock, word select, and serial data lines, then triggering on a data value.
- **IIC (Inter-IC bus) triggering**— consists of connecting the oscilloscope to the serial data (SDA) line and the serial clock (SCL) line, then triggering on a stop/start condition, a restart, a missing acknowledge, or on a read/write frame with a specific device address and data value.
- **LIN (Local Interconnect Network) triggering**— will trigger on LIN sync break at the beginning of a message frame. With the automotive CAN and LIN serial decode option (Option ASM), you can also trigger on Frame IDs.
- **MIL-STD 1553 triggering** (with Option 553) — lets you trigger on MIL-STD 1553 serial data.

- **Sequence triggering**– allows you to trigger the oscilloscope after finding a sequence of events. Defining a sequence trigger requires three steps:
  - a Define the event to find before you trigger on the next event. This event can be a pattern, and edge from a single channel, or the combination of a pattern and a channel edge.
  - b Define the trigger event. This event can be a pattern, and edge from a single channel, the combination of a pattern and a channel edge, or the nth occurrence of an edge from a single channel.
  - c Set an optional reset event. This event can be a pattern, an edge from a single channel, the combination of a pattern and a channel edge, or a timeout value.
- **SPI (Serial Peripheral Interface) triggering**– consists of connecting the oscilloscope to a clock, data, and framing signal. You can then trigger on a data pattern during a specific framing period. The serial data string can be specified to be from 4 to 32 bits long.
- **TV triggering**– is used to capture the complicated waveforms of television equipment. The trigger circuitry detects the vertical and horizontal interval of the waveform and produces triggers based on the TV trigger settings you selected. TV triggering requires greater than  $\frac{1}{2}$  division of sync amplitude with any analog channel as the trigger source.
- **UART/RS-232 triggering** (with Option 232) – lets you trigger on RS-232 serial data.
- **USB (Universal Serial Bus) triggering**– will trigger on a Start of Packet (SOP), End of Packet (EOP), Reset Complete, Enter Suspend, or Exit Suspend signal on the differential USB data lines. USB Low Speed and Full Speed are supported by this trigger.

#### Reporting the Setup

Use `:TRIGger?` to query setup information for the TRIGger subsystem.

#### Return Format

The return format for the `TRIGger?` query varies depending on the current mode. The following is a sample response from the `:TRIGger?` query. In this case, the query was issued following a `*RST` command.

```
:TRIG:MODE EDGE;SWE AUTO;NREJ 0;HFR 0;HOLD +60.0000000000000E-09;
:TRIG:EDGE:SOUR CHAN1;LEV +0.00000E+00;SLOP POS;REJ OFF;COUP DC
```

## General :TRIGger Commands

**Table 69** General :TRIGger Commands Summary

| Command  | Query   | Options and Query Returns   |
|--|---|---|
| :TRIGger:HFReject {{0   OFF}   {1   ON}}<br>(see <a href="#">page 444</a> )                      | :TRIGger:HFReject?<br>(see <a href="#">page 444</a> ) | {0   1}   |
| :TRIGger:HOLDoff<br><holdoff_time> (see <a href="#">page 445</a> )                               | :TRIGger:HOLDoff?<br>(see <a href="#">page 445</a> )  | <holdoff_time> ::= 60 ns to 10 s<br>in NR3 format   |
| :TRIGger:LFIFTy (see <a href="#">page 446</a> )  | n/a   | n/a   |
| :TRIGger:MODE <mode><br>(see <a href="#">page 447</a> )  | :TRIGger:MODE? (see <a href="#">page 447</a> )        | <mode> ::= {EDGE   GLITCh   PATTern   CAN   DURation   I2S   IIC   EBURst   LIN   M1553   SEQuence   SPI   TV   UART   USB   FLEXray}<br><return_value> ::= {<mode>   <none>}<br><none> ::= query returns "NONE" if the :TIMEbase:MODE is ROLL or XY  |
| :TRIGger:NREJect {{0   OFF}   {1   ON}}<br>(see <a href="#">page 448</a> )                       | :TRIGger:NREJect?<br>(see <a href="#">page 448</a> )  | {0   1}   |
| :TRIGger:PATTern<br><value>, <mask><br>[, <edge source>, <edge>] (see <a href="#">page 449</a> ) | :TRIGger:PATTern?<br>(see <a href="#">page 449</a> )  | <value> ::= integer in NR1 format or <string><br><mask> ::= integer in NR1 format or <string><br><string> ::= "0xnn"; n ::= {0,...,9   A,...,F} (# bits = # channels)<br><edge source> ::= {CHANnel<n>   EXTernal   NONE}<br><edge> ::= {POSitive   NEGative}<br><n> ::= 1-2 or 1-4 in NR1 format |
| :TRIGger:SWEep<br><sweep> (see <a href="#">page 451</a> )  | :TRIGger:SWEep? (see <a href="#">page 451</a> )       | <sweep> ::= {AUTO   NORMal}   |

## :TRIGger:HFReject

**C** (see [page 750](#))

**Command Syntax** :TRIGger:HFReject <value>  
<value> ::= {{0 | OFF} | {1 | ON}}

The :TRIGger:HFReject command turns the high frequency reject filter off and on. The high frequency reject filter adds a 50 kHz low-pass filter in the trigger path to remove high frequency components from the trigger waveform. Use this filter to remove high-frequency noise, such as AM or FM broadcast stations, from the trigger path.

**Query Syntax** :TRIGger:HFReject?

The :TRIGger:HFReject? query returns the current high frequency reject filter mode.

**Return Format** <value><NL>  
<value> ::= {0 | 1}

- See Also**
- ["Introduction to :TRIGger Commands"](#) on page 440
  - [":TRIGger\[:EDGE\]:REJect"](#) on page 477

**:TRIGger:HOLDoff**

**C** (see [page 750](#))

**Command Syntax** :TRIGger:HOLDoff <holdoff\_time>  
 <holdoff\_time> ::= 60 ns to 10 s in NR3 format

The :TRIGger:HOLDoff command defines the holdoff time value in seconds. Holdoff keeps a trigger from occurring until after a certain amount of time has passed since the last trigger. This feature is valuable when a waveform crosses the trigger level multiple times during one period of the waveform. Without holdoff, the oscilloscope could trigger on each of the crossings, producing a confusing waveform. With holdoff set correctly, the oscilloscope always triggers on the same crossing. The correct holdoff setting is typically slightly less than one period.

**Query Syntax** :TRIGger:HOLDoff?

The :TRIGger:HOLDoff? query returns the holdoff time value for the current trigger mode.

**Return Format** <holdoff\_time><NL>  
 <holdoff\_time> ::= the holdoff time value in seconds in NR3 format.

**See Also** • ["Introduction to :TRIGger Commands"](#) on page 440

### **:TRIGger:LFIFty**

**C** (see [page 750](#))

**Command Syntax** :TRIGger:LFIFty

The :TRIGger:LFIFty command sets the trigger level of a displayed analog channel trigger source to the waveform's 50% value.

- See Also**
- "Introduction to :TRIGger Commands" on page 440
  - ":TRIGger[:EDGE]:SOURce" on page 479
  - ":TRIGger[:EDGE]:LEVel" on page 476

**:TRIGger:MODE**

**C** (see [page 750](#))

**Command Syntax** :TRIGger:MODE <mode>

```
<mode> ::= {EDGE | GLITch | PATTern | CAN | DURation | I2S | IIC
            | EBURst | LIN | M1553 | SEQuence | SPI | TV | UART
            | USB | FLEXray}
```

The :TRIGger:MODE command selects the trigger mode (trigger type).

**Query Syntax** :TRIGger:MODE?

The :TRIGger:MODE? query returns the current trigger mode. If the :TIMEbase:MODE is ROLL or XY, the query returns "NONE".

**Return Format** <mode><NL>

```
<mode> ::= {NONE | EDGE | GLIT | PATT | CAN | DUR | I2S
            | IIC | EBUR | LIN | M1553 | SEQ | SPI | TV | UART
            | USB | FLEX}
```

- See Also**
- ["Introduction to :TRIGger Commands" on page 440](#)
  - [":TRIGger:SWEep" on page 451](#)
  - [":TIMEbase:MODE" on page 431](#)

**Example Code**

```
' TRIGGER_MODE - Set the trigger mode to EDGE.
myScope.WriteString ":TRIGGER:MODE EDGE"
```

Example program from the start: ["VISA COM Example in Visual Basic" on page 776](#)

### :TRIGger:NREJect

**C** (see [page 750](#))

**Command Syntax** :TRIGger:NREJect <value>  
<value> ::= {{0 | OFF} | {1 | ON}}

The :TRIGger:NREJect command turns the noise reject filter off and on. When the noise reject filter is on, the trigger circuitry is less sensitive to noise but may require a greater amplitude waveform to trigger the oscilloscope. This command is not valid in TV trigger mode.

**Query Syntax** :TRIGger:NREJect?

The :TRIGger:NREJect? query returns the current noise reject filter mode.

**Return Format** <value><NL>  
<value> ::= {0 | 1}

**See Also** • ["Introduction to :TRIGger Commands"](#) on page 440

## :TRIGger:PATtern

**C** (see [page 750](#))

**Command Syntax** :TRIGger:PATtern <pattern>  
 <pattern> ::= <value>, <mask> [, <edge source>, <edge>]  
 <value> ::= integer in NR1 format or <string>  
 <mask> ::= integer in NR1 format or <string>  
 <string> ::= "0xnn"; n ::= {0,..,9 | A,..,F}  
 (# bits = # channels, see following table)  
 <edge source> ::= {CHANnel<n> | EXTERNAL | NONE}  
 <n> ::= {1 | 2 | 3 | 4} for the four channel oscilloscope models  
 <n> ::= {1 | 2} for the two channel oscilloscope models  
 <edge> ::= {POSitive | NEGative}

The :TRIGger:PATtern command defines the specified pattern resource according to the value and the mask. For both <value> and <mask>, each bit corresponds to a possible trigger channel. The bit assignments vary by instrument:

| Oscilloscope Models      | Value and Mask Bit Assignments  |
|--------------------------|---|
| <b>4 analog channels</b> | Bits 0 through 3 - analog channels 1 through 4. Bit 4 - external trigger. |
| <b>2 analog channels</b> | Bits 0 and 1 - analog channels 1 and 2. Bit 4 - external trigger.         |

Set a <value> bit to "0" to set the pattern for the corresponding channel to low. Set a <value> bit to "1" to set the pattern to high.

Set a <mask> bit to "0" to ignore the data for the corresponding channel. Only channels with a "1" set on the appropriate mask bit are used.

**NOTE**

The optional source and the optional edge should be sent together or not at all. The edge will be set in the simple pattern if it is included. If the edge source is also specified in the mask, the edge takes precedence.

**Query Syntax** :TRIGger:PATtern?

The :TRIGger:PATtern? query returns the pattern value, the mask, and the edge of interest in the simple pattern.

**Return Format** <pattern><NL>

**See Also** • ["Introduction to :TRIGger Commands"](#) on page 440

## 5 Commands by Subsystem

- `":TRIGger:MODE"` on page 447

**:TRIGger:SWEep**

**C** (see [page 750](#))

**Command Syntax** :TRIGger:SWEep <sweep>  
 <sweep> ::= {AUTO | NORMAl}

The :TRIGger:SWEep command selects the trigger sweep mode.

When AUTO sweep mode is selected, a baseline is displayed in the absence of a signal. If a signal is present but the oscilloscope is not triggered, the unsynchronized signal is displayed instead of a baseline.

When NORMAl sweep mode is selected and no trigger is present, the instrument does not sweep, and the data acquired on the previous trigger remains on the screen.

**NOTE**

This feature is called "Mode" on the instrument's front panel.

**Query Syntax** :TRIGger:SWEep?

The :TRIGger:SWEep? query returns the current trigger sweep mode.

**Return Format** <sweep><NL>  
 <sweep> ::= current trigger sweep mode

**See Also** • ["Introduction to :TRIGger Commands"](#) on page 440

## :TRIGger:CAN Commands

**Table 70** :TRIGger:CAN Commands Summary

| Command  | Query  | Options and Query Returns   |
|--|--|---|
| :TRIGger:CAN:PAATtern:DATA <value>, <mask> (see <a href="#">page 454</a> ) | :TRIGger:CAN:PAATtern:DATA? (see <a href="#">page 454</a> )        | <value> ::= 64-bit integer in decimal, <nondecimal>, or <string> (with Option AMS)<br><mask> ::= 64-bit integer in decimal, <nondecimal>, or <string><br><nondecimal> ::= #Hnn...n where n ::= {0,...,9   A,...,F} for hexadecimal<br><nondecimal> ::= #Bnn...n where n ::= {0   1} for binary<br><string> ::= "0xnn...n" where n ::= {0,...,9   A,...,F} for hexadecimal |
| :TRIGger:CAN:PAATtern:DATA:LENGth <length> (see <a href="#">page 455</a> ) | :TRIGger:CAN:PAATtern:DATA:LENGth? (see <a href="#">page 455</a> ) | <length> ::= integer from 1 to 8 in NR1 format (with Option AMS)  |
| :TRIGger:CAN:PAATtern:ID <value>, <mask> (see <a href="#">page 456</a> )   | :TRIGger:CAN:PAATtern:ID? (see <a href="#">page 456</a> )          | <value> ::= 32-bit integer in decimal, <nondecimal>, or <string> (with Option AMS)<br><mask> ::= 32-bit integer in decimal, <nondecimal>, or <string><br><nondecimal> ::= #Hnn...n where n ::= {0,...,9   A,...,F} for hexadecimal<br><nondecimal> ::= #Bnn...n where n ::= {0   1} for binary<br><string> ::= "0xnn...n" where n ::= {0,...,9   A,...,F} for hexadecimal |
| :TRIGger:CAN:PAATtern:ID:MODE <value> (see <a href="#">page 457</a> )      | :TRIGger:CAN:PAATtern:ID:MODE? (see <a href="#">page 457</a> )     | <value> ::= {STANdard   EXTENDED} (with Option AMS)   |
| :TRIGger:CAN:SAMPlepo int <value> (see <a href="#">page 458</a> )          | :TRIGger:CAN:SAMPlepo int? (see <a href="#">page 458</a> )         | <value> ::= {60   62.5   68   70   75   80   87.5} in NR3 format  |
| :TRIGger:CAN:SIGNAL:B AUDRate <baudrate> (see <a href="#">page 459</a> )   | :TRIGger:CAN:SIGNAL:B AUDRate? (see <a href="#">page 459</a> )     | <baudrate> ::= integer from 10000 to 1000000 in 100 b/s increments  |

**Table 70** :TRIGger:CAN Commands Summary (continued)

| Command   | Query  | Options and Query Returns   |
|---|--|---|
| :TRIGger:CAN:SIGNal:DEFinition <value><br>(see <a href="#">page 460</a> ) | :TRIGger:CAN:SIGNal:DEFinition?<br>(see <a href="#">page 460</a> ) | <value> ::= {CANH   CANL   RX   TX   DIFFerential   DIFL   DIFH}  |
| :TRIGger:CAN:SOURce <source><br>(see <a href="#">page 461</a> )           | :TRIGger:CAN:SOURce?<br>(see <a href="#">page 461</a> )            | <source> ::= {CHANnel<n>   EXTernal}<br><n> ::= 1-2 or 1-4 in NR1 format  |
| :TRIGger:CAN:TRIGger <condition><br>(see <a href="#">page 462</a> )       | :TRIGger:CAN:TRIGger?<br>(see <a href="#">page 463</a> )           | <condition> ::= {SOF} (without Option AMS)<br><condition> ::= {SOF   DATA   ERRor   IDData   IDEither   IDRemote   ALLerrors   OVERload   ACKerror} (with Option AMS) |

**:TRIGger:CAN:PATtern:DATA**

**N** (see [page 750](#))

**Command Syntax** :TRIGger:CAN:PATtern:DATA <value>,<mask>  
 <value> ::= 64-bit integer in decimal, <nondecimal>, or <string>  
 <mask> ::= 64-bit integer in decimal, <nondecimal>, or <string>  
 <nondecimal> ::= #Hnn...n where n ::= {0,...,9 | A,...,F} for hexadecimal  
 <nondecimal> ::= #Bnn...n where n ::= {0 | 1} for binary  
 <string> ::= "0xnn...n" where n ::= {0,...,9 | A,...,F} for hexadecimal

The :TRIGger:CAN:PATtern:DATA command defines the CAN data pattern resource according to the value and the mask. This pattern, along with the data length (set by the :TRIGger:CAN:PATtern:DATA:LENGth command), control the data pattern searched for in each CAN message.

Set a <value> bit to "0" to set the corresponding bit in the data pattern to low. Set a <value> bit to "1" to set the bit to high.

Set a <mask> bit to "0" to ignore that bit in the data stream. Only bits with a "1" set on the mask are used.

**NOTE**

If more bytes are sent for <value> or <mask> than specified by the :TRIGger:CAN:PATtern:DATA:LENGth command, the most significant bytes will be truncated. If the data length is changed after the <value> and <mask> are programmed, the added or deleted bytes will be added to or deleted from the least significant bytes.

**NOTE**

This command is only valid when the automotive CAN and LIN serial decode option (Option AMS) has been licensed.

**Query Syntax** :TRIGger:CAN:PATtern:DATA?

The :TRIGger:CAN:PATtern:DATA? query returns the current settings of the specified CAN data pattern resource.

**Return Format** <value>,<mask><NL> in nondecimal format

**Errors** • "-241, Hardware missing" on [page 709](#)

**See Also** • ["Introduction to :TRIGger Commands"](#) on [page 440](#)  
 • [":TRIGger:CAN:PATtern:DATA:LENGth"](#) on [page 455](#)  
 • [":TRIGger:CAN:PATtern:ID"](#) on [page 456](#)

**:TRIGger:CAN:PATtern:DATA:LENGth**

**N** (see [page 750](#))

**Command Syntax** :TRIGger:CAN:PATtern:DATA:LENGth <length>

<length> ::= integer from 1 to 8 in NR1 format

The :TRIGger:CAN:PATtern:DATA:LENGth command sets the number of 8-bit bytes in the CAN data string. The number of bytes in the string can be anywhere from 0 bytes to 8 bytes (64 bits). The value for these bytes is set by the :TRIGger:CAN:PATtern:DATA command.

**NOTE**

This command is only valid when the automotive CAN and LIN serial decode option (Option AMS) has been licensed.

**Query Syntax** :TRIGger:CAN:PATtern:DATA:LENGth?

The :TRIGger:CAN:PATtern:DATA:LENGth? query returns the current CAN data pattern length setting.

**Return Format** <count><NL>

<count> ::= integer from 1 to 8 in NR1 format

**Errors** • ["-241, Hardware missing"](#) on [page 709](#)

**See Also** • ["Introduction to :TRIGger Commands"](#) on [page 440](#)  
 • [":TRIGger:CAN:PATtern:DATA"](#) on [page 454](#)  
 • [":TRIGger:CAN:SOURce"](#) on [page 461](#)

**:TRIGger:CAN:PATtern:ID**

**N** (see [page 750](#))

**Command Syntax** :TRIGger:CAN:PATtern:ID <value>, <mask>

<value> ::= 32-bit integer in decimal, <nondecimal>, or <string>

<mask> ::= 32-bit integer in decimal, <nondecimal>, or <string>

<nondecimal> ::= #Hnn...n where n ::= {0,...,9 | A,...,F} for hexadecimal

<nondecimal> ::= #Bnn...n where n ::= {0 | 1} for binary

<string> ::= "0xnn...n" where n ::= {0,...,9 | A,...,F} for hexadecimal

The :TRIGger:CAN:PATtern:ID command defines the CAN identifier pattern resource according to the value and the mask. This pattern, along with the identifier mode (set by the :TRIGger:CAN:PATtern:ID:MODE command), control the identifier pattern searched for in each CAN message.

Set a <value> bit to "0" to set the corresponding bit in the identifier pattern to low. Set a <value> bit to "1" to set the bit to high.

Set a <mask> bit to "0" to ignore that bit in the identifier stream. Only bits with a "1" set on the mask are used.

**NOTE**

If more bits are sent than allowed (11 bits in standard mode, 29 bits in extended mode) by the :TRIGger:CAN:PATtern:ID:MODE command, the most significant bytes will be truncated. If the ID mode is changed after the <value> and <mask> are programmed, the added or deleted bits will be added to or deleted from the most significant bits.

**NOTE**

This command is only valid when the automotive CAN and LIN serial decode option (Option AMS) has been licensed.

**Query Syntax** :TRIGger:CAN:PATtern:ID?

The :TRIGger:CAN:PATtern:ID? query returns the current settings of the specified CAN identifier pattern resource.

**Return Format** <value>, <mask><NL> in nondecimal format

**Errors**

- "-241, Hardware missing" on [page 709](#)

**See Also**

- "[Introduction to :TRIGger Commands](#)" on [page 440](#)
- ":TRIGger:CAN:PATtern:ID:MODE" on [page 457](#)
- ":TRIGger:CAN:PATtern:DATA" on [page 454](#)

**:TRIGger:CAN:PATtern:ID:MODE**

**N** (see [page 750](#))

**Command Syntax** :TRIGger:CAN:PATtern:ID:MODE <value>  
 <value> ::= {STANdard | EXTended}

The :TRIGger:CAN:PATtern:ID:MODE command sets the CAN identifier mode. STANdard selects the standard 11-bit identifier. EXTended selects the extended 29-bit identifier. The CAN identifier is set by the :TRIGger:CAN:PATtern:ID command.

**NOTE**

This command is only valid when the automotive CAN and LIN serial decode option (Option AMS) has been licensed.

**Query Syntax** :TRIGger:CAN:PATtern:ID:MODE?

The :TRIGger:CAN:PATtern:ID:MODE? query returns the current setting of the CAN identifier mode.

**Return Format** <value><NL>  
 <value> ::= {STAN | EXT}

**Errors** • "-241, Hardware missing" on [page 709](#)

**See Also** • ["Introduction to :TRIGger Commands"](#) on [page 440](#)  
 • [":TRIGger:MODE"](#) on [page 447](#)  
 • [":TRIGger:CAN:PATtern:DATA"](#) on [page 454](#)  
 • [":TRIGger:CAN:PATtern:DATA:LENGth"](#) on [page 455](#)  
 • [":TRIGger:CAN:PATtern:ID"](#) on [page 456](#)

## :TRIGger:CAN:SAMPlEpoint

**N** (see [page 750](#))

**Command Syntax** :TRIGger:CAN:SAMPlEpoint <value>  
<value><NL>

<value> ::= {60 | 62.5 | 68 | 70 | 75 | 80 | 87.5} in NR3 format

The :TRIGger:CAN:SAMPlEpoint command sets the point during the bit time where the bit level is sampled to determine whether the bit is dominant or recessive. The sample point represents the percentage of time between the beginning of the bit time to the end of the bit time.

**Query Syntax** :TRIGger:CAN:SAMPlEpoint?

The :TRIGger:CAN:SAMPlEpoint? query returns the current CAN sample point setting.

**Return Format** <value><NL>

<value> ::= {60 | 62.5 | 68 | 70 | 75 | 80 | 87.5} in NR3 format

- See Also**
- ["Introduction to :TRIGger Commands"](#) on page 440
  - [":TRIGger:MODE"](#) on page 447
  - [":TRIGger:CAN:TRIGger"](#) on page 462

**:TRIGger:CAN:SIGNa:BAUDrate**

**N** (see [page 750](#))

**Command Syntax** :TRIGger:CAN:SIGNa:BAUDrate <baudrate>

<baudrate> ::= integer from 10000 to 1000000 in 100 b/s increments

The :TRIGger:CAN:SIGNa:BAUDrate command sets the standard baud rate of the CAN signal from 10 kb/s to 1 Mb/s in 100 b/s increments. If you enter a baud rate that is not divisible by 100 b/s, the baud rate is set to the nearest baud rate divisible by 100 b/s.

If the baud rate you select does not match the system baud rate, false triggers may occur.

**Query Syntax** :TRIGger:CAN:SIGNa:BAUDrate?

The :TRIGger:CAN:SIGNa:BAUDrate? query returns the current CAN baud rate setting.

**Return Format** <baudrate><NL>

<baudrate> ::= integer from 10000 to 1000000 in 100 b/s increments

- See Also**
- "[Introduction to :TRIGger Commands](#)" on page 440
  - "[:TRIGger:MODE](#)" on page 447
  - "[:TRIGger:CAN:TRIGger](#)" on page 462
  - "[:TRIGger:CAN:SIGNa:DEFinition](#)" on page 460
  - "[:TRIGger:CAN:SOURce](#)" on page 461

**:TRIGger:CAN:SIGNaL:DEFinition**

**N** (see [page 750](#))

**Command Syntax** :TRIGger:CAN:SIGNaL:DEFinition <value>

<value> ::= {CANH | CANL | RX | TX | DIFFerential | DIFL | DIFH}

The :TRIGger:CAN:SIGNaL:DEFinition command sets the CAN signal type when :TRIGger:CAN:TRIGger is set to SOF (start of frame). These signals can be set to:

Dominant high signal:

- CANH – the actual CAN\_H differential bus signal.
- DIFH – the CAN differential (H-L) bus signal connected to an analog source channel using a differential probe.

Dominant low signals:

- CANL – the actual CAN\_L differential bus signal.
- RX – the Receive signal from the CAN bus transceiver.
- TX – the Transmit signal to the CAN bus transceiver.
- DIFFerential – the CAN differential bus signal connected to an analog source channel using a differential probe.
- DIFL – the CAN differential (L-H) bus signal connected to an analog source channel using a differential probe. This is the same as DIFFerential.

**Query Syntax** :TRIGger:CAN:SIGNaL:DEFinition?

The :TRIGger:CAN:SIGNaL:DEFinition? query returns the current CAN signal type.

**Return Format** <value><NL>

<value> ::= {CANH | CANL | RX | TX | DIFF | DIFH}

- See Also**
- ["Introduction to :TRIGger Commands"](#) on page 440
  - [":TRIGger:MODE"](#) on page 447
  - [":TRIGger:CAN:SIGNaL:BAUDrate"](#) on page 459
  - [":TRIGger:CAN:SOURce"](#) on page 461
  - [":TRIGger:CAN:TRIGger"](#) on page 462

**:TRIGger:CAN:SOURce**

**N** (see [page 750](#))

**Command Syntax** :TRIGger:CAN:SOURce <source>

<source> ::= {CHANnel<n> | EXTernal}

<n> ::= {1 | 2 | 3 | 4} for the four channel oscilloscope models

<n> ::= {1 | 2} for the two channel oscilloscope models

The :TRIGger:CAN:SOURce command sets the source for the CAN signal. The source setting is only valid when :TRIGger:CAN:TRIGger is set to SOF (start of frame).

**Query Syntax** :TRIGger:CAN:SOURce?

The :TRIGger:CAN:SOURce? query returns the current source for the CAN signal.

**Return Format** <source><NL>

- See Also**
- ["Introduction to :TRIGger Commands"](#) on page 440
  - [":TRIGger:MODE"](#) on page 447
  - [":TRIGger:CAN:TRIGger"](#) on page 462
  - [":TRIGger:CAN:SIGNAL:DEFinition"](#) on page 460

**:TRIGger:CAN:TRIGger**

**N** (see page 750)

**Command Syntax** :TRIGger:CAN:TRIGger <condition>

```
<condition> ::= {SOF | DATA | ERRor | IDData | IDEither | IDRemote |
                ALLerrors | OVERload | ACKerror}
```

The :TRIGger:CAN:TRIGger command sets the CAN trigger on condition:

- SOF - will trigger on the Start of Frame (SOF) bit of a Data frame, Remote Transfer Request (RTR) frame, or an Overload frame.
- DATA - will trigger on CAN Data frames matching the specified Id, Data, and the DLC (Data length code).
- ERRor - will trigger on CAN Error frame.
- IDData - will trigger on CAN frames matching the specified Id of a Data frame.
- IDEither - will trigger on the specified Id, regardless if it is a Remote frame or a Data frame.
- IDRemote - will trigger on CAN frames matching the specified Id of a Remote frame.
- ALLerrors - will trigger on CAN active error frames and unknown bus conditions.
- OVERload - will trigger on CAN overload frames.
- ACKerror - will trigger on a data or remote frame acknowledge bit that is recessive.

The table below shows the programming parameter and the corresponding front-panel softkey selection:

| Remote <condition> parameter | Front-panel Trigger on: softkey selection<br>(softkey text - softkey popup text) |
|------------------------------|--|
| SOF                          | SOF - Start of Frame   |
| DATA                         | Id & Data - Data Frame Id and Data   |
| ERRor                        | Error - Error frame  |
| IDData                       | Id & ~RTR - Data Frame Id (~RTR)   |
| IDEither                     | Id - Remote or Data Frame Id   |
| IDRemote                     | Id & RTR - Remote Frame Id (RTR)   |
| ALLerrors                    | All Errors - All Errors  |
| OVERload                     | Overload - Overload Frame  |
| ACKerror                     | Ack Error - Acknowledge Error  |

CAN Id specification is set by the `:TRIGger:CAN:PATtern:ID` and `:TRIGger:CAN:PATtern:ID:MODE` commands.

CAN Data specification is set by the `:TRIGger:CAN:PATtern:DATA` command.

CAN Data Length Code is set by the `:TRIGger:CAN:PATtern:DATA:LENGth` command.

**NOTE**

SOF is the only valid selection for analog oscilloscopes. If the automotive CAN and LIN serial decode option (Option AMS) has not been licensed, SOF is the only valid selection.

**Query Syntax** `:TRIGger:CAN:TRIGger?`

The `:TRIGger:CAN:TRIGger?` query returns the current CAN trigger on condition.

**Return Format** `<condition><NL>`

`<condition> ::= {SOF | DATA | ERR | IDD | IDE | IDR | ALL | OVER | ACK}`

**Errors**

- ["-241, Hardware missing"](#) on page 709

**See Also**

- ["Introduction to :TRIGger Commands"](#) on page 440
- [":TRIGger:MODE"](#) on page 447
- [":TRIGger:CAN:PATtern:DATA"](#) on page 454
- [":TRIGger:CAN:PATtern:DATA:LENGth"](#) on page 455
- [":TRIGger:CAN:PATtern:ID"](#) on page 456
- [":TRIGger:CAN:PATtern:ID:MODE"](#) on page 457
- [":TRIGger:CAN:SIGNal:DEFinition"](#) on page 460
- [":TRIGger:CAN:SOURce"](#) on page 461

## :TRIGger:DURation Commands

**Table 71** :TRIGger:DURation Commands Summary

| Command   | Query  | Options and Query Returns   |
|---|--|---|
| :TRIGger:DURation:GREaterthan <greater than time>[suffix] (see <a href="#">page 465</a> )                     | :TRIGger:DURation:GREaterthan? (see <a href="#">page 465</a> ) | <greater_than_time> ::= floating-point number in NR3 format<br>[suffix] ::= {s   ms   us   ns   ps}   |
| :TRIGger:DURation:LESSthan <less than time>[suffix] (see <a href="#">page 466</a> )                           | :TRIGger:DURation:LESSthan? (see <a href="#">page 466</a> )    | <less_than_time> ::= floating-point number from in NR3 format<br>[suffix] ::= {s   ms   us   ns   ps}   |
| :TRIGger:DURation:PATTERN <value>, <mask> (see <a href="#">page 467</a> )                                     | :TRIGger:DURation:PATTERN? (see <a href="#">page 467</a> )     | <value> ::= integer or <string><br><mask> ::= integer or <string><br><string> ::= "0xnxxxxxx" n ::= {0,...,9   A,...,F}                                       |
| :TRIGger:DURation:QUALifier <qualifier> (see <a href="#">page 468</a> )                                       | :TRIGger:DURation:QUALifier? (see <a href="#">page 468</a> )   | <qualifier> ::= {GREaterthan   LESSthan   INRange   OUTRange   TIMEout}   |
| :TRIGger:DURation:RANGE <less_than_time>[suffix], <greater_than_time>[suffix] (see <a href="#">page 469</a> ) | :TRIGger:DURation:RANGE? (see <a href="#">page 469</a> )       | <less_than_time> ::= 15 ns to 10 seconds in NR3 format<br><greater_than_time> ::= 10 ns to 9.99 seconds in NR3 format<br>[suffix] ::= {s   ms   us   ns   ps} |

## **:TRIGger:DURation:GREaterthan**

**N** (see [page 750](#))

**Command Syntax** :TRIGger:DURation:GREaterthan <greater\_than\_time> [<suffix>]

<greater\_than\_time> ::= minimum trigger duration in seconds  
in NR3 format

<suffix> ::= {s | ms | us | ns | ps }

The :TRIGger:DURation:GREaterthan command sets the minimum duration for the defined pattern when :TRIGger:DURation:QUALifier is set to GREaterthan. The command also sets the timeout value when the :TRIGger:DURation:QUALifier is set to TIMEout.

**Query Syntax** :TRIGger:DURation:GREaterthan?

The :TRIGger:DURation:GREaterthan? query returns the minimum duration time for the defined pattern.

**Return Format** <greater\_than\_time><NL>

- See Also**
- ["Introduction to :TRIGger Commands"](#) on page 440
  - [":TRIGger:DURation:PATtern"](#) on page 467
  - [":TRIGger:DURation:QUALifier"](#) on page 468
  - [":TRIGger:MODE"](#) on page 447

## :TRIGger:DURation:LESSthan

**N** (see [page 750](#))

**Command Syntax** :TRIGger:DURation:LESSthan <less\_than\_time>[<suffix>]  
<less\_than\_time> ::= maximum trigger duration in seconds  
in NR3 format  
<suffix> ::= {s | ms | us | ns | ps}

The :TRIGger:DURation:LESSthan command sets the maximum duration for the defined pattern when :TRIGger:DURation:QUALifier is set to LESSthan.

**Query Syntax** :TRIGger:DURation:LESSthan?

The :TRIGger:DURation:LESSthan? query returns the duration time for the defined pattern.

**Return Format** <less\_than\_time><NL>

- See Also**
- "[Introduction to :TRIGger Commands](#)" on page 440
  - "[:TRIGger:DURation:PATtern](#)" on page 467
  - "[:TRIGger:DURation:QUALifier](#)" on page 468
  - "[:TRIGger:MODE](#)" on page 447

## :TRIGger:DURation:PATtern

**N** (see [page 750](#))

**Command Syntax** :TRIGger:DURation:PATtern <value>, <mask>  
 <value> ::= integer or <string>  
 <mask> ::= integer or <string>  
 <string> ::= "0xnmmnnn"; n ::= {0,...,9 | A,...,F}

The :TRIGger:DURation:PATtern command defines the specified duration pattern resource according to the value and the mask. For both <value> and <mask>, each bit corresponds to a possible trigger channel. The bit assignments vary by instrument:

| Oscilloscope Models | Value and Mask Bit Assignments  |
|---------------------|---|
| 4 analog channels   | Bits 0 through 3 - analog channels 1 through 4. Bit 4 - external trigger. |
| 2 analog channels   | Bits 0 and 1 - analog channels 1 and 2. Bit 4 - external trigger.         |

Set a <value> bit to "0" to set the pattern for the corresponding channel to low. Set a <value> bit to "1" to set the pattern to high.

Set a <mask> bit to "0" to ignore the data for the corresponding channel. Only channels with a "1" set on the appropriate mask bit are used.

**Query Syntax** :TRIGger:DURation:PATtern?

The :TRIGger:DURation:PATtern? query returns the pattern value.

**Return Format** <value>, <mask><NL>  
 <value> ::= a 32-bit integer in NR1 format.  
 <mask> ::= a 32-bit integer in NR1 format.

- See Also**
- ["Introduction to :TRIGger Commands"](#) on page 440
  - [":TRIGger:PATtern"](#) on page 449

## :TRIGger:DURation:QUALifier

**N** (see [page 750](#))

**Command Syntax** :TRIGger:DURation:QUALifier <qualifier>

<qualifier> ::= {GREaterthan | LESSthan | INRange | OUTRange | TIMEout}

The :TRIGger:DURation:QUALifier command qualifies the trigger duration.

Set the GREaterthan qualifier value with the :TRIGger:DURation:GREaterthan command.

Set the LESSthan qualifier value with the :TRIGger:DURation:LESSthan command.

Set the INRange and OUTRange qualifier values with the :TRIGger:DURation:RANGE command.

Set the TIMEout qualifier value with the :TRIGger:DURation:GREaterthan command.

**Query Syntax** :TRIGger:DURation:QUALifier?

The :TRIGger:DURation:QUALifier? query returns the trigger duration qualifier.

**Return Format** <qualifier><NL>

- See Also**
- ["Introduction to :TRIGger Commands"](#) on page 440
  - [":TRIGger:DURation:GREaterthan"](#) on page 465
  - [":TRIGger:DURation:LESSthan"](#) on page 466
  - [":TRIGger:DURation:RANGE"](#) on page 469

## :TRIGger:DURation:RANGe

**N** (see [page 750](#))

**Command Syntax** :TRIGger:DURation:RANGe <less\_than\_time> [<suffix>],  
 <greater\_than\_time> [<suffix>]  
 <greater\_than\_time> ::= 10 ns to 9.99 seconds in NR3 format  
 <less\_than\_time> ::= 15 ns to 10 seconds in NR3 format  
 <suffix> ::= {s | ms | us | ns | ps}

The :TRIGger:DURation:RANGe command sets the duration for the defined pattern when the :TRIGger:DURation:QUALifier command is set to INRange or OUTRange. You can enter the parameters in any order – the smaller value becomes the <greater\_than\_time> and the larger value becomes the <less\_than\_time>.

**Query Syntax** :TRIGger:DURation:RANGe?

The :TRIGger:DURation:RANGe? query returns the duration time for the defined pattern.

**Return Format** <less\_than\_time>,<greater\_than\_time><NL>

- See Also**
- "[Introduction to :TRIGger Commands](#)" on page 440
  - "[:TRIGger:DURation:PATtern](#)" on page 467
  - "[:TRIGger:DURation:QUALifier](#)" on page 468
  - "[:TRIGger:MODE](#)" on page 447

**:TRIGger:EBURst Commands****Table 72** :TRIGger:EBURst Commands Summary

| Command   | Query  | Options and Query Returns                         |
|---|--|---|
| :TRIGger:EBURst:COUNT<br><count> (see<br><a href="#">page 471</a> )     | :TRIGger:EBURst:COUNT<br>? (see <a href="#">page 471</a> ) | <count> ::= integer in NR1 format                 |
| :TRIGger:EBURst:IDLE<br><time_value> (see<br><a href="#">page 472</a> ) | :TRIGger:EBURst:IDLE?<br>(see <a href="#">page 472</a> )   | <time_value> ::= time in seconds<br>in NR3 format |
| :TRIGger:EBURst:SLOPe<br><slope> (see<br><a href="#">page 473</a> )     | :TRIGger:EBURst:SLOPe<br>? (see <a href="#">page 473</a> ) | <slope> ::= {NEGative   POSitive}                 |

The :TRIGger:EDGE:SOURce command is used to specify the source channel for the Nth Edge Burst trigger. The :TRIGger:EDGE:LEVel command is used to set the Nth Edge Burst trigger level.

**:TRIGger:EBURst:COUNT**

**N** (see [page 750](#))

**Command Syntax** :TRIGger:EBURst:COUNT <count>

<count> ::= integer in NR1 format

The :TRIGger:EBURst:COUNT command sets the Nth edge at burst counter resource. The edge counter is used in the trigger stage to determine which edge in a burst will generate a trigger.

**Query Syntax** :TRIGger:EBURst:COUNT?

The :TRIGger:EBURst:COUNT? query returns the current Nth edge of burst edge counter setting.

**Return Format** <count><NL>

<count> ::= integer in NR1 format

- See Also**
- ["Introduction to :TRIGger Commands"](#) on page 440
  - [":TRIGger:EBURst:SLOPe"](#) on page 473
  - [":TRIGger:EBURst:IDLE"](#) on page 472

## :TRIGger:EBURst:IDLE

**N** (see [page 750](#))

**Command Syntax** :TRIGger:EBURst:IDLE <time\_value>

<time\_value> ::= time in seconds in NR3 format

The :TRIGger:EBURst:IDLE command sets the Nth edge in a burst idle resource in seconds from 10 ns to 10 s. The timer is used to set the minimum time before the next burst.

**Query Syntax** :TRIGger:EBURst:IDLE?

The :TRIGger:EBURst:IDLE? query returns current Nth edge in a burst idle setting.

**Return Format** <time value><NL>

<time\_value> ::= time in seconds in NR3 format

- See Also**
- "[Introduction to :TRIGger Commands](#)" on page 440
  - "[:TRIGger:EBURst:SLOPe](#)" on page 473
  - "[:TRIGger:EBURst:COUnT](#)" on page 471

**:TRIGger:EBURst:SLOPe**

**N** (see [page 750](#))

**Command Syntax** :TRIGger:EBURst:SLOPe <slope>

<slope> ::= {NEGative | POSitive}

The :TRIGger:EBURst:SLOPe command specifies whether the rising edge (POSitive) or falling edge (NEGative) of the Nth edge in a burst will generate a trigger.

**Query Syntax** :TRIGger:EBURst:SLOPe?

The :TRIGger:EBURst:SLOPe? query returns the current Nth edge in a burst slope.

**Return Format** <slope><NL>

<slope> ::= {NEG | POS}

- See Also**
- "[Introduction to :TRIGger Commands](#)" on page 440
  - "[:TRIGger:EBURst:IDLE](#)" on page 472
  - "[:TRIGger:EBURst:COUNT](#)" on page 471

## :TRIGger[:EDGE] Commands

**Table 73** :TRIGger[:EDGE] Commands Summary

| Command  | Query  | Options and Query Returns  |
|--|--|--|
| :TRIGger[:EDGE]:COUPling {AC   DC   LF} (see <a href="#">page 475</a> )    | :TRIGger[:EDGE]:COUPling? (see <a href="#">page 475</a> )            | {AC   DC   LF}   |
| :TRIGger[:EDGE]:LEVel <level> [, <source>] (see <a href="#">page 476</a> ) | :TRIGger[:EDGE]:LEVel ? [, <source>] (see <a href="#">page 476</a> ) | For internal triggers, <level> ::= .75 x full-scale voltage from center screen in NR3 format.<br>For external triggers, <level> ::= ±(external range setting) in NR3 format.<br><source> ::= {CHANnel<n>   EXTernal}<br><n> ::= 1-2 or 1-4 in NR1 format |
| :TRIGger[:EDGE]:REJect {OFF   LF   HF} (see <a href="#">page 477</a> )     | :TRIGger[:EDGE]:REJect? (see <a href="#">page 477</a> )              | {OFF   LF   HF}  |
| :TRIGger[:EDGE]:SLOPe <polarity> (see <a href="#">page 478</a> )           | :TRIGger[:EDGE]:SLOPe ? (see <a href="#">page 478</a> )              | <polarity> ::= {POSitive   NEGative   EITHer   ALTernate}  |
| :TRIGger[:EDGE]:SOURC e <source> (see <a href="#">page 479</a> )           | :TRIGger[:EDGE]:SOURC e? (see <a href="#">page 479</a> )             | <source> ::= {CHANnel<n>   EXTernal}<br><n> ::= 1-2 or 1-4 in NR1 format   |

**:TRIGger[:EDGE]:COUPLing**

**C** (see [page 750](#))

**Command Syntax** :TRIGger[:EDGE]:COUPLing <coupling>  
 <coupling> ::= {AC | DC | LFReject}

The :TRIGger[:EDGE]:COUPLing command sets the input coupling for the selected trigger sources. The coupling can be set to AC, DC, or LFReject.

- AC coupling places a high-pass filter (10 Hz for analog channels, and 3.5 Hz for all External trigger inputs) in the trigger path, removing dc offset voltage from the trigger waveform. Use AC coupling to get a stable edge trigger when your waveform has a large dc offset.
- LFReject coupling places a 50 KHz high-pass filter in the trigger path.
- DC coupling allows dc and ac signals into the trigger path.

**NOTE**

The :TRIGger[:EDGE]:COUPLing and the :TRIGger[:EDGE]:REJect selections are coupled. Changing the setting of the :TRIGger[:EDGE]:REJect can change the COUPLing setting.

**Query Syntax** :TRIGger[:EDGE]:COUPLing?

The :TRIGger[:EDGE]:COUPLing? query returns the current coupling selection.

**Return Format** <coupling><NL>  
 <coupling> ::= {AC | DC | LFR}

- See Also**
- "[Introduction to :TRIGger Commands](#)" on page 440
  - "[:TRIGger:MODE](#)" on page 447
  - "[:TRIGger\[:EDGE\]:REJect](#)" on page 477

**:TRIGger[:EDGE]:LEVel**

**C** (see [page 750](#))

**Command Syntax** :TRIGger[:EDGE]:LEVel <level>  
 <level> ::= <level>[,<source>]  
 <level> ::= 0.75 x full-scale voltage from center screen in NR3 format  
 for internal triggers  
 <level> ::= ±(external range setting) in NR3 format  
 for external triggers  
 <source> ::= {CHANnel<n> | EXTernal}  
 <n> ::= {1 | 2 | 3 | 4} for the four channel oscilloscope models  
 <n> ::= {1 | 2} for the two channel oscilloscope models

The :TRIGger[:EDGE]:LEVel command sets the trigger level voltage for the active trigger source.

**NOTE**

If the optional source is specified and is not the active source, the level on the active source is not affected and the active source is not changed.

**Query Syntax** :TRIGger[:EDGE]:LEVel? [<source>]

The :TRIGger[:EDGE]:LEVel? query returns the trigger level of the current trigger source.

**Return Format** <level><NL>

- See Also**
- "[Introduction to :TRIGger Commands](#)" on page 440
  - "[:TRIGger\[:EDGE\]:SOURce](#)" on page 479
  - "[:EXTernal:RANGe](#)" on page 241

**:TRIGger[:EDGE]:REJect**

**C** (see [page 750](#))

**Command Syntax** :TRIGger[:EDGE]:REJect <reject>  
 <reject> ::= {OFF | LFReject | HFReject}

The :TRIGger[:EDGE]:REJect command turns the low-frequency or high-frequency reject filter on or off. You can turn on one of these filters at a time.

- The high frequency reject filter adds a 50 kHz low-pass filter in the trigger path to remove high frequency components from the trigger waveform. Use the high frequency reject filter to remove high-frequency noise, such as AM or FM broadcast stations, from the trigger path.
- The low frequency reject filter adds a 50 kHz high-pass filter in series with the trigger waveform to remove any unwanted low frequency components from a trigger waveform, such as power line frequencies, that can interfere with proper triggering.

**NOTE**

The :TRIGger[:EDGE]:REJect and the :TRIGger[:EDGE]:COUPling selections are coupled. Changing the setting of the :TRIGger[:EDGE]:COUPling can change the COUPling setting.

**Query Syntax** :TRIGger[:EDGE]:REJect?

The :TRIGger[:EDGE]:REJect? query returns the current status of the reject filter.

**Return Format** <reject><NL>  
 <reject> ::= {OFF | LFR | HFR}

- See Also**
- "[Introduction to :TRIGger Commands](#)" on page 440
  - "[:TRIGger:HFReject](#)" on page 444
  - "[:TRIGger\[:EDGE\]:COUPling](#)" on page 475

## :TRIGger[:EDGE]:SLOPe

**C** (see [page 750](#))

**Command Syntax** :TRIGger[:EDGE]:SLOPe <slope>  
<slope> ::= {NEGative | POSitive | ALTernate}

The :TRIGger[:EDGE]:SLOPe command specifies the slope of the edge for the trigger. The SLOPe command is not valid in TV trigger mode. Instead, use :TRIGger:TV:POLarity to set the polarity in TV trigger mode.

**Query Syntax** :TRIGger[:EDGE]:SLOPe?

The :TRIGger[:EDGE]:SLOPe? query returns the current trigger slope.

**Return Format** <slope><NL>  
<slope> ::= {NEG | POS | ALT}

- See Also**
- ["Introduction to :TRIGger Commands"](#) on page 440
  - [":TRIGger:MODE"](#) on page 447
  - [":TRIGger:TV:POLarity"](#) on page 567

**Example Code**

```
' TRIGGER_EDGE_SLOPE - Sets the slope of the edge for the trigger.  
  
' Set the slope to positive.  
myScope.WriteString ":TRIGGER:EDGE:SLOPE POSITIVE"
```

Example program from the start: ["VISA COM Example in Visual Basic"](#) on page 776

**:TRIGger[:EDGE]:SOURce**

**C** (see [page 750](#))

**Command Syntax** :TRIGger[:EDGE]:SOURce <source>

<source> ::= {CHANnel<n> | EXTERNAL | LINE}

<n> ::= {1 | 2 | 3 | 4} for the four channel oscilloscope models

<n> ::= {1 | 2} for the two channel oscilloscope models

The :TRIGger[:EDGE]:SOURce command selects the channel that produces the trigger.

**Query Syntax** :TRIGger[:EDGE]:SOURce?

The :TRIGger[:EDGE]:SOURce? query returns the current source. If all channels are off, the query returns "NONE."

**Return Format** <source><NL>

<source> ::= {CHAN<n> | EXT | LINE | NONE}

- See Also**
- ["Introduction to :TRIGger Commands"](#) on page 440
  - [":TRIGger:MODE"](#) on page 447

**Example Code**

```
' TRIGGER_EDGE_SOURCE - Selects the channel that actually produces the
edge trigger. Any channel can be selected.
myScope.WriteString ":TRIGGER:EDGE:SOURCE CHANNEL1"
```

Example program from the start: ["VISA COM Example in Visual Basic"](#) on page 776

## :TRIGger:FLEXray Commands

**Table 74** :TRIGger:FLEXray Commands Summary

| Command  | Query  | Options and Query Returns  |
|--|--|--|
| :TRIGger:FLEXray:AUTOsetup (see <a href="#">page 481</a> )                                   | n/a  | n/a  |
| :TRIGger:FLEXray:BAUDrate <baudrate> (see <a href="#">page 482</a> )                         | :TRIGger:FLEXray:BAUDrate? (see <a href="#">page 482</a> )           | <baudrate> ::= {2500000   5000000   10000000}                                      |
| :TRIGger:FLEXray:CHANNEL <channel> (see <a href="#">page 483</a> )                           | :TRIGger:FLEXray:CHANNEL? (see <a href="#">page 483</a> )            | <channel> ::= {A   B}  |
| :TRIGger:FLEXray:ERROR:TYPE <error_type> (see <a href="#">page 484</a> )                     | :TRIGger:FLEXray:ERROR:TYPE? (see <a href="#">page 484</a> )         | <error_type> ::= {ALL   HCRC   FCRC}   |
| :TRIGger:FLEXray:EVENT:TYPE <event> (see <a href="#">page 485</a> )                          | :TRIGger:FLEXray:EVENT:TYPE? (see <a href="#">page 485</a> )         | <event> ::= {WAKEup   TSS   {FES   DTS}   BSS}                                     |
| :TRIGger:FLEXray:FRAME:CCBase <cycle_count_base> (see <a href="#">page 486</a> )             | :TRIGger:FLEXray:FRAME:CCBase? (see <a href="#">page 486</a> )       | <cycle_count_base> ::= integer from 0-63   |
| :TRIGger:FLEXray:FRAME:CCRepetition <cycle_count_repetition> (see <a href="#">page 487</a> ) | :TRIGger:FLEXray:FRAME:CCRepetition? (see <a href="#">page 487</a> ) | <cycle_count_repetition> ::= {ALL   <rep #>}<br><rep #> ::= integer from 2-64      |
| :TRIGger:FLEXray:FRAME:ID <frame_id> (see <a href="#">page 488</a> )                         | :TRIGger:FLEXray:FRAME:ID? (see <a href="#">page 488</a> )           | <frame_id> ::= {ALL   <frame #>}<br><frame #> ::= integer from 1-2047              |
| :TRIGger:FLEXray:FRAME:TYPE <frame_type> (see <a href="#">page 489</a> )                     | :TRIGger:FLEXray:FRAME:TYPE? (see <a href="#">page 489</a> )         | <frame_type> ::= {NORMAL   STARTup   NULL   SYNC   NSTARTup   NNULL   NSYNc   ALL} |
| :TRIGger:FLEXray:SOURCE <source> (see <a href="#">page 490</a> )                             | :TRIGger:FLEXray:SOURCE? (see <a href="#">page 490</a> )             | <source> ::= {CHANNEL<n>}<br><n> ::= 1-2 or 1-4 in NR1 format                      |
| :TRIGger:FLEXray:TRIGGER <condition> (see <a href="#">page 491</a> )                         | :TRIGger:FLEXray:TRIGGER? (see <a href="#">page 491</a> )            | <condition> ::= {FRAME   ERROR   EVENT}  |

## :TRIGger:FLEXray:AUTosetup

**N** (see [page 750](#))

**Command Syntax** :TRIGger:FLEXray:AUTosetup

The :TRIGger:FLEXray:AUTosetup command automatically configures oscilloscope settings to facilitate FlexRay triggering and serial decode.

- Sets the selected source channel's impedance to 50 Ohms.
- Sets the selected source channel's probe attenuation to 10:1.
- Sets the trigger level (on the selected source channel) to -300 mV.
- Turns on trigger Noise Reject.
- Turns on Serial Decode.
- Sets the trigger type to FlexRay.

### NOTE

This command is only valid when the FLEXray triggering and serial decode option (Option FLX) has been licensed.

- See Also**
- "[Introduction to :TRIGger Commands](#)" on page 440
  - "[:TRIGger:FLEXray:TRIGger](#)" on page 491
  - "[:TRIGger:FLEXray:BAUDrate](#)" on page 482
  - "[:TRIGger\[:EDGE\]:LEVel](#)" on page 476
  - "[:TRIGger:FLEXray:SOURce](#)" on page 490

## :TRIGger:FLEXray:BAUDrate

**N** (see [page 750](#))

**Command Syntax** :TRIGger:FLEXray:BAUDrate <baudrate>  
<baudrate> ::= {2500000 | 5000000 | 10000000}

The :TRIGger:FLEXray:BAUDrate command specifies the baud rate as 2.5 Mb/s, 5 Mb/s, or 10 Mb/s.

### NOTE

This command is only valid on 4 (analog) channel oscilloscope models when the FlexRay triggering and serial decode option (Option FLX) has been licensed.

---

**Query Syntax** :TRIGger:FLEXray:BAUDrate?

The :TRIGger:FLEXray:BAUDrate? query returns the current baud rate setting.

**Return Format** <baudrate><NL>  
<baudrate> ::= {2500000 | 5000000 | 10000000}

- See Also**
- ["Introduction to :TRIGger Commands"](#) on page 440
  - [":TRIGger:FLEXray Commands"](#) on page 480

**:TRIGger:FLEXray:CHANnel**

**N** (see [page 750](#))

**Command Syntax** :TRIGger:FLEXray:CHANnel <channel>  
 <channel> ::= {A | B}

The :TRIGger:FLEXray:CHANnel command specifies the bus channel, A or B, of the FlexRay signal.

**NOTE**

This command is only valid on 4 (analog) channel oscilloscope models when the FlexRay triggering and serial decode option (Option FLX) has been licensed.

**Query Syntax** :TRIGger:FLEXray:CHANnel?

The :TRIGger:FLEXray:CHANnel? query returns the current bus channel setting.

**Return Format** <channel><NL>

<channel> ::= {A | B}

- See Also**
- ["Introduction to :TRIGger Commands"](#) on page 440
  - [":TRIGger:FLEXray Commands"](#) on page 480

## :TRIGger:FLEXray:ERRor:TYPE

**N** (see [page 750](#))

**Command Syntax** :TRIGger:FLEXray:ERRor:TYPE <error\_type>  
<error\_type> ::= {ALL | HCRC | FCRC}

Selects the FlexRay error type to trigger on. The error type setting is only valid when the FlexRay trigger mode is set to ERROR.

- ALL – triggers on ALL errors.
- HCRC – triggers on only Header CRC errors.
- FCRC – triggers on only Frame CRC errors.

### NOTE

This command is only valid when the FLEXray triggering and serial decode option (Option FLX) has been licensed.

**Query Syntax** :TRIGger:FLEXray:ERRor:TYPE?

The :TRIGger:FLEXray:ERRor:TYPE? query returns the currently selected FLEXray error type.

**Return Format** <error\_type><NL>

<error\_type> ::= {ALL | HCRC | FCRC}

- See Also**
- ["Introduction to :TRIGger Commands"](#) on page 440
  - [":TRIGger:FLEXray:TRIGger"](#) on page 491

**:TRIGger:FLEXray:EVENT:TYPE**

**N** (see [page 750](#))

**Command Syntax** :TRIGger:FLEXray:EVENT:TYPE <event>

<event> ::= {WAKEup | TSS | {FES | DTS} | BSS}

Selects the FlexRay event to trigger on. The event setting is only valid when the FlexRay trigger mode is set to EVENT.

- WAKEup – triggers on Wake-Up event.
- TSS – triggers on Transmission Start Sequence event.
- FES – triggers on Frame End Sequence event.
- DTS – triggers on Dynamic Trailing Sequence event.
- BSS – triggers on Byte Start Sequence event.

**NOTE**

FES and DTS are equivalent.

**NOTE**

This command is only valid when the FLEXray triggering and serial decode option (Option FLX) has been licensed.

**Query Syntax** :TRIGger:FLEXray:EVENT:TYPE?

The :TRIGger:FLEXray:EVENT:TYPE? query returns the currently selected FLEXray event.

**Return Format** <event><NL>

<event> ::= {WAK | TSS | {FES | DTS} | BSS}

- See Also**
- ["Introduction to :TRIGger Commands"](#) on page 440
  - [":TRIGger:FLEXray:TRIGger"](#) on page 491
  - [":TRIGger:FLEXray:AUTOsetup"](#) on page 481
  - [":TRIGger:FLEXray:SOURce"](#) on page 490

## :TRIGger:FLEXray:FRAME:CCBase

**N** (see [page 750](#))

**Command Syntax** :TRIGger:FLEXray:FRAME:CCBase <cycle\_count\_base>  
<cycle\_count\_base> ::= integer from 0-63

The :TRIGger:FLEXray:FRAME:CCBase command sets the base of the FlexRay cycle count (in the frame header) to trigger on. The cycle count base setting is only valid when the FlexRay trigger mode is set to FRAME.

**NOTE**

This command is only valid when the FlexRay triggering and serial decode option (Option FLX) has been licensed.

---

**Query Syntax** :TRIGger:FLEXray:FRAME:CCBase?

The :TRIGger:FLEXray:FRAME:CCBase? query returns the current cycle count base setting for the FlexRay frame trigger setup.

**Return Format** <cycle\_count\_base><NL>  
<cycle\_count\_base> ::= integer from 0-63

- See Also**
- ["Introduction to :TRIGger Commands"](#) on page 440
  - [":TRIGger:FLEXray:TRIGger"](#) on page 491

**:TRIGger:FLEXray:FRAME:CCRepetition**

**N** (see [page 750](#))

**Command Syntax** :TRIGger:FLEXray:FRAME:CCRepetition <cycle\_count\_repetition>  
 <cycle\_count\_repetition> ::= {ALL | <rep #>}  
 <rep #> ::= integer from 2-64

The :TRIGger:FLEXray:FRAME:CCRepetition command sets the repetition number of the FlexRay cycle count (in the frame header) to trigger on. The cycle count repetition setting is only valid when the FlexRay trigger mode is set to FRAME.

**NOTE**

This command is only valid when the FLEXray triggering and serial decode option (Option FLX) has been licensed.

**Query Syntax** :TRIGger:FLEXray:FRAME:CCRepetition?

The :TRIGger:FLEXray:FRAME:CCRepetition? query returns the current cycle count repetition setting for the FlexRay frame trigger setup.

**Return Format** <cycle\_count\_repetition><NL>  
 <cycle\_count\_repetition> ::= {ALL | <rep #>}  
 <rep #> ::= integer from 2-64

**See Also**

- ["Introduction to :TRIGger Commands"](#) on page 440
- [":TRIGger:FLEXray:TRIGger"](#) on page 491

## :TRIGger:FLEXray:FRAME:ID

**N** (see page 750)

**Command Syntax** :TRIGger:FLEXray:FRAME:ID <frame\_id>  
<frame\_id> ::= {ALL | <frame #>}  
<frame #> ::= integer from 1-2047

The :TRIGger:FLEXray:FRAME:ID command sets the FlexRay frame ID to trigger on . The frame IF setting is only valid when the FlexRay trigger mode is set to FRAME.

**NOTE**

This command is only valid when the FLEXray triggering and serial decode option (Option FLX) has been licensed.

**Query Syntax** :TRIGger:FLEXray:FRAME:ID?

The :TRIGger:FLEXray:FRAME:ID? query returns the current frame ID setting for the FlexRay frame trigger setup.

**Return Format** <frame\_id><NL>  
<frame\_id> ::= {ALL | <frame #>}  
<frame #> ::= integer from 1-2047

- See Also**
- "Introduction to :TRIGger Commands" on page 440
  - ":TRIGger:MODE" on page 447
  - ":TRIGger:FLEXray:TRIGger" on page 491

**:TRIGger:FLEXray:FRAME:TYPE**

**N** (see [page 750](#))

**Command Syntax** :TRIGger:FLEXray:FRAME:TYPE <frame\_type>

```
<frame_type> ::= {NORMAL | STARTup | NULL | SYNC | NSTArtup | NNULL |
                  NSYNc | ALL}
```

The :TRIGger:FLEXray:FRAME:TYPE command sets the FlexRay frame type to trigger on. The frame type setting is only valid when the FlexRay trigger mode is set to FRAME.

- **NORMAL** – will trigger on only normal (NSTArtup & NNULL & NSYNc) frames.
- **STARTup** – will trigger on only startup frames.
- **NULL** – will trigger on only null frames.
- **SYNC** – will trigger on only sync frames.
- **NSTArtup** – will trigger on frames other than startup frames.
- **NNULL** – will trigger on frames other than null frames.
- **NSYNc** – will trigger on frames other than sync frames.
- **ALL** – will trigger on all FlexRay frame types.

**NOTE**

This command is only valid when the FLEXray triggering and serial decode option (Option FLX) has been licensed.

**Query Syntax** :TRIGger:FLEXray:FRAME:TYPE?

The :TRIGger:FLEXray:FRAME:TYPE? query returns the current frame type setting for the FlexRay frame trigger setup.

**Return Format** <frame\_type><NL>

```
<frame_type> ::= {NORM | STAR | NULL | SYNC | NSTA | NNUL |
                  NSYN | ALL}
```

- See Also**
- ["Introduction to :TRIGger Commands"](#) on page 440
  - [":TRIGger:MODE"](#) on page 447
  - [":TRIGger:FLEXray:TRIGger"](#) on page 491

## :TRIGger:FLEXray:SOURce

**N** (see [page 750](#))

**Command Syntax** :TRIGger:FLEXray:SOURce <source>

<source> ::= {CHANnel<n>}

<n> ::= {1 | 2 | 3 | 4}

The :TRIGger:FLEXray:SOURce command specifies the input source for the FlexRay signal.

### NOTE

This command is only valid when the FLEXray triggering and serial decode option (Option FLX) has been licensed.

**Query Syntax** :TRIGger:FLEXray:SOURce?

The :TRIGger:FLEXray:SOURce? query returns the current source for the FlexRay signal.

**Return Format** <source><NL>

- See Also**
- "[Introduction to :TRIGger Commands](#)" on page 440
  - "[:TRIGger:FLEXray:TRIGger](#)" on page 491
  - "[:TRIGger:FLEXray:EVENT:TYPE](#)" on page 485
  - "[:TRIGger:FLEXray:AUTosetup](#)" on page 481

**:TRIGger:FLEXray:TRIGger**

**N** (see [page 750](#))

**Command Syntax** :TRIGger:FLEXray:TRIGger <condition>  
 <condition> ::= {FRAMe | ERRor | EVENT}

The :TRIGger:FLEXray:TRIGger command sets the FLEXray trigger on condition:

- FRAMe – triggers on specified frames (without errors).
- ERRor – triggers on selected active error frames and unknown bus conditions.
- EVENT – triggers on specified FlexRay event/symbol.

**NOTE**

This command is only valid when the FLEXray triggering and serial decode option (Option FLX) has been licensed.

**Query Syntax** :TRIGger:FLEXray:TRIGger?

The :TRIGger:FLEXray:TRIGger? query returns the current FLEXray trigger on condition.

**Return Format** <condition><NL>  
 <condition> ::= {FRAM | ERR | EVEN}

- See Also**
- "[Introduction to :TRIGger Commands](#)" on page 440
  - "[:TRIGger:MODE](#)" on page 447
  - "[:TRIGger:FLEXray:ERRor:TYPE](#)" on page 484
  - "[:TRIGger:FLEXray:EVENT:TYPE](#)" on page 485
  - "[:TRIGger:FLEXray:FRAMe:CCBase](#)" on page 486
  - "[:TRIGger:FLEXray:FRAMe:CCRepetition](#)" on page 487
  - "[:TRIGger:FLEXray:FRAMe:ID](#)" on page 488
  - "[:TRIGger:FLEXray:FRAMe:TYPE](#)" on page 489

## :TRIGger:GLITch Commands

**Table 75** :TRIGger:GLITch Commands Summary

| Command   | Query   | Options and Query Returns  |
|---|---|--|
| :TRIGger:GLITch:GREAt<br>erthan<br><greater_than_time>[s<br>uffix] (see <a href="#">page 493</a> )                        | :TRIGger:GLITch:GREAt<br>erthan? (see<br><a href="#">page 493</a> ) | <greater_than_time> ::= floating-point number in NR3 format<br>[suffix] ::= {s   ms   us   ns   ps}  |
| :TRIGger:GLITch:LESSt<br>han<br><less_than_time>[suff<br>ix] (see <a href="#">page 494</a> )                              | :TRIGger:GLITch:LESSt<br>han? (see <a href="#">page 494</a> )       | <less_than_time> ::= floating-point number in NR3 format<br>[suffix] ::= {s   ms   us   ns   ps}   |
| :TRIGger:GLITch:LEVel<br><level> [<source>]<br>(see <a href="#">page 495</a> )  | :TRIGger:GLITch:LEVel<br>? (see <a href="#">page 495</a> )          | For internal triggers, <level> ::= .75 x full-scale voltage from center screen in NR3 format.<br>For external triggers, <level> ::= ±(external range setting) in NR3 format.<br><source> ::= {CHANnel<n>   EXTernal}<br><n> ::= 1-2 or 1-4 in NR1 format |
| :TRIGger:GLITch:POLar<br>ity <polarity> (see<br><a href="#">page 496</a> )  | :TRIGger:GLITch:POLar<br>ity? (see <a href="#">page 496</a> )       | <polarity> ::= {POSitive   NEGative}   |
| :TRIGger:GLITch:QUALi<br>fier <qualifier> (see<br><a href="#">page 497</a> )  | :TRIGger:GLITch:QUALi<br>fier? (see <a href="#">page 497</a> )      | <qualifier> ::= {GREATERthan   LESSthan   RANGE}   |
| :TRIGger:GLITch:RANGe<br><less_than_time>[suff<br>ix],<br><greater_than_time>[s<br>uffix] (see <a href="#">page 498</a> ) | :TRIGger:GLITch:RANGe<br>? (see <a href="#">page 498</a> )          | <less_than_time> ::= 15 ns to 10 seconds in NR3 format<br><greater_than_time> ::= 10 ns to 9.99 seconds in NR3 format<br>[suffix] ::= {s   ms   us   ns   ps}  |
| :TRIGger:GLITch:SOURc<br>e <source> (see<br><a href="#">page 499</a> )  | :TRIGger:GLITch:SOURc<br>e? (see <a href="#">page 499</a> )         | <source> ::= {CHANnel<n>   EXTernal}<br><n> ::= 1-2 or 1-4 in NR1 format   |

**:TRIGger:GLITch:GREaterthan**

**N** (see [page 750](#))

**Command Syntax** :TRIGger:GLITch:GREaterthan <greater\_than\_time>[<suffix>]  
 <greater\_than\_time> ::= floating-point number in NR3 format  
 <suffix> ::= {s | ms | us | ns | ps}

The :TRIGger:GLITch:GREaterthan command sets the minimum pulse width duration for the selected :TRIGger:GLITch:SOURce.

**Query Syntax** :TRIGger:GLITch:GREaterthan?

The :TRIGger:GLITch:GREaterthan? query returns the minimum pulse width duration time for :TRIGger:GLITch:SOURce.

**Return Format** <greater\_than\_time><NL>  
 <greater\_than\_time> ::= floating-point number in NR3 format.

- See Also**
- "[Introduction to :TRIGger Commands](#)" on page 440
  - "[:TRIGger:GLITch:SOURce](#)" on page 499
  - "[:TRIGger:GLITch:QUALifier](#)" on page 497
  - "[:TRIGger:MODE](#)" on page 447

## :TRIGger:GLITCh:LESSthan

**N** (see [page 750](#))

**Command Syntax** :TRIGger:GLITCh:LESSthan <less\_than\_time>[<suffix>]  
<less\_than\_time> ::= floating-point number in NR3 format  
<suffix> ::= {s | ms | us | ns | ps}

The :TRIGger:GLITCh:LESSthan command sets the maximum pulse width duration for the selected :TRIGger:GLITCh:SOURce.

**Query Syntax** :TRIGger:GLITCh:LESSthan?

The :TRIGger:GLITCh:LESSthan? query returns the pulse width duration time for :TRIGger:GLITCh:SOURce.

**Return Format** <less\_than\_time><NL>  
<less\_than\_time> ::= floating-point number in NR3 format.

- See Also**
- "[Introduction to :TRIGger Commands](#)" on page 440
  - "[:TRIGger:GLITCh:SOURce](#)" on page 499
  - "[:TRIGger:GLITCh:QUALifier](#)" on page 497
  - "[:TRIGger:MODE](#)" on page 447

**:TRIGger:GLITCh:LEVel**

**N** (see [page 750](#))

**Command Syntax** :TRIGger:GLITCh:LEVel <level\_argument>  
 <level\_argument> ::= <level>[, <source>]  
 <level> ::= .75 x full-scale voltage from center screen in NR3 format  
 for internal triggers  
 <level> ::= ±(external range setting) in NR3 format  
 for external triggers  
 <source> ::= {CHANnel<n> | EXTernal}  
 <n> ::= {1 | 2 | 3 | 4} for the four channel oscilloscope models  
 <n> ::= {1 | 2} for the two channel oscilloscope models

The :TRIGger:GLITCh:LEVel command sets the trigger level voltage for the active pulse width trigger.

**Query Syntax** :TRIGger:GLITCh:LEVel?

The :TRIGger:GLITCh:LEVel? query returns the trigger level of the current pulse width trigger mode. If all channels are off, the query returns "NONE."

**Return Format** <level\_argument><NL>

- See Also**
- ["Introduction to :TRIGger Commands"](#) on page 440
  - [":TRIGger:MODE"](#) on page 447
  - [":TRIGger:GLITCh:SOURce"](#) on page 499
  - [":EXTernal:RANGe"](#) on page 241

## **:TRIGger:GLITch:POLarity**

**N** (see [page 750](#))

**Command Syntax** :TRIGger:GLITch:POLarity <polarity>  
<polarity> ::= {POSitive | NEGative}

The :TRIGger:GLITch:POLarity command sets the polarity for the glitch pulse width trigger.

**Query Syntax** :TRIGger:GLITch:POLarity?

The :TRIGger:GLITch:POLarity? query returns the glitch pulse width trigger polarity.

**Return Format** <polarity><NL>  
<polarity> ::= {POS | NEG}

- See Also**
- ["Introduction to :TRIGger Commands"](#) on page 440
  - [":TRIGger:MODE"](#) on page 447
  - [":TRIGger:GLITch:SOURce"](#) on page 499

**:TRIGger:GLITCh:QUALifier**

**N** (see [page 750](#))

**Command Syntax** :TRIGger:GLITCh:QUALifier <operator>

<operator> ::= {GREaterthan | LESSthan | RANGe}

This command sets the mode of operation of the glitch pulse width trigger. The oscilloscope can trigger on a pulse width that is greater than a time value, less than a time value, or within a range of time values.

**Query Syntax** :TRIGger:GLITCh:QUALifier?

The :TRIGger:GLITCh:QUALifier? query returns the glitch pulse width qualifier.

**Return Format** <operator><NL>

<operator> ::= {GRE | LESS | RANG}

- See Also**
- "[Introduction to :TRIGger Commands](#)" on page 440
  - "[:TRIGger:GLITCh:SOURce](#)" on page 499
  - "[:TRIGger:MODE](#)" on page 447

## :TRIGger:GLITch:RANGe

**N** (see [page 750](#))

**Command Syntax** :TRIGger:GLITch:RANGe <less\_than\_time>[suffix],  
<greater\_than\_time>[suffix]  
  
<less\_than\_time> ::= (15 ns - 10 seconds) in NR3 format  
<greater\_than\_time> ::= (10 ns - 9.99 seconds) in NR3 format  
[suffix] ::= {s | ms | us | ns | ps}

The :TRIGger:GLITch:RANGe command sets the pulse width duration for the selected :TRIGger:GLITch:SOURce. You can enter the parameters in any order – the smaller value becomes the <greater\_than\_time> and the larger value becomes the <less\_than\_time>.

**Query Syntax** :TRIGger:GLITch:RANGe?

The :TRIGger:GLITch:RANGe? query returns the pulse width duration time for :TRIGger:GLITch:SOURce.

**Return Format** <less\_than\_time>,<greater\_than\_time><NL>

- See Also**
- ["Introduction to :TRIGger Commands"](#) on page 440
  - [":TRIGger:GLITch:SOURce"](#) on page 499
  - [":TRIGger:GLITch:QUALifier"](#) on page 497
  - [":TRIGger:MODE"](#) on page 447

**:TRIGger:GLITch:SOURce**

**N** (see [page 750](#))

**Command Syntax** :TRIGger:GLITch:SOURce <source>

<source> ::= {CHANnel<n> | EXTernal}

<n> ::= {1 | 2 | 3 | 4} for the four channel oscilloscope models

<n> ::= {1 | 2} for the two channel oscilloscope models

The :TRIGger:GLITch:SOURce command selects the channel that produces the pulse width trigger.

**Query Syntax** :TRIGger:GLITch:SOURce?

The :TRIGger:GLITch:SOURce? query returns the current pulse width source. If all channels are off, the query returns "NONE."

**Return Format** <source><NL>

- See Also**
- ["Introduction to :TRIGger Commands"](#) on page 440
  - [":TRIGger:MODE"](#) on page 447
  - [":TRIGger:GLITch:LEVel"](#) on page 495
  - [":TRIGger:GLITch:POLarity"](#) on page 496
  - [":TRIGger:GLITch:QUALifier"](#) on page 497
  - [":TRIGger:GLITch:RANGE"](#) on page 498

**Example Code** • ["Example Code"](#) on page 479

## :TRIGger:I2S Commands

**Table 76** :TRIGger:I2S Commands Summary

| Command  | Query  | Options and Query Returns   |
|--|--|---|
| :TRIGger:I2S:ALIGnmen<br>t <setting> (see<br>page 502)   | :TRIGger:I2S:ALIGnmen<br>t? (see page 502)         | <setting> ::= {I2S   LJ   RJ}   |
| :TRIGger:I2S:AUDio<br><audio_ch> (see<br>page 503)       | :TRIGger:I2S:AUDio?<br>(see page 503)              | <audio_ch> ::= {RIGHT   LEFT  <br>EITHer}   |
| :TRIGger:I2S:CLOCK:SL<br>OPe <slope> (see<br>page 504)   | :TRIGger:I2S:CLOCK:SL<br>OPe? (see page 504)       | <slope> ::= {NEGative   POSitive}   |
| :TRIGger:I2S:PATtern:<br>DATA <string> (see<br>page 505) | :TRIGger:I2S:PATtern:<br>DATA? (see page 506)      | <string> ::= "n" where n ::=<br>32-bit integer in signed decimal<br>when <base> = DECimal<br><string> ::= "nn...n" where n ::=<br>{0   1   X   \$} when <base> =<br>BINary<br><string> ::= "0xnn...n" where n<br>::= {0,...,9   A,...,F   X   \$}<br>when <base> = HEX  |
| :TRIGger:I2S:PATtern:<br>FORMat <base> (see<br>page 507) | :TRIGger:I2S:PATtern:<br>FORMat? (see<br>page 507) | <base> ::= {BINary   HEX  <br>DECimal}  |
| :TRIGger:I2S:RANGe<br><upper>,<lower> (see<br>page 508)  | :TRIGger:I2S:RANGe?<br>(see page 508)              | <upper> ::= 32-bit integer in<br>signed decimal, <nondecimal>, or<br><string><br><lower> ::= 32-bit integer in<br>signed decimal, <nondecimal>, or<br><string><br><nondecimal> ::= #Hnn...n where n<br>::= {0,...,9   A,...,F} for<br>hexadecimal<br><nondecimal> ::= #Bnn...n where n<br>::= {0   1} for binary<br><string> ::= "0xnn...n" where n<br>::= {0,...,9   A,...,F} for<br>hexadecimal |
| :TRIGger:I2S:RWIDth<br><receiver> (see<br>page 510)      | :TRIGger:I2S:RWIDth?<br>(see page 510)             | <receiver> ::= 4-32 in NR1 format   |
| :TRIGger:I2S:SOURce:C<br>LOCK <source> (see<br>page 511) | :TRIGger:I2S:SOURce:C<br>LOCK? (see page 511)      | <source> ::= {CHANnel<n>  <br>EXTernal}<br><n> ::= 1-2 or 1-4 in NR1 format   |

**Table 76** :TRIGger:I2S Commands Summary (continued)

| Command  | Query  | Options and Query Returns  |
|--|--|--|
| :TRIGger:I2S:SOURce:D<br>ATA <source> (see<br>page 512)    | :TRIGger:I2S:SOURce:D<br>ATA? (see page 512)       | <source> ::= {CHANnel<n>  <br>EXTernal}<br><n> ::= 1-2 or 1-4 in NR1 format  |
| :TRIGger:I2S:SOURce:W<br>SElect <source> (see<br>page 513) | :TRIGger:I2S:SOURce:W<br>SElect? (see<br>page 513) | <source> ::= {CHANnel<n>  <br>EXTernal}<br><n> ::= 1-2 or 1-4 in NR1 format  |
| :TRIGger:I2S:TRIGger<br><operator> (see<br>page 514)       | :TRIGger:I2S:TRIGger?<br>(see page 514)            | <operator> ::= {EQUal   NOTequal<br>  LESSthan   GREaterthan  <br>INRange   OUTRange   INCReasing  <br>DECReasing} |
| :TRIGger:I2S:TWIDTH<br><word_size> (see<br>page 516)       | :TRIGger:I2S:TWIDTH?<br>(see page 516)             | <word_size> ::= 4-32 in NR1<br>format  |
| :TRIGger:I2S:WSLow<br><low_def> (see<br>page 517)          | :TRIGger:I2S:WSLow?<br>(see page 517)              | <low_def> ::= {LEFT   RIGHT}   |

## :TRIGger:I2S:ALIGnment

**N** (see [page 750](#))

**Command Syntax** :TRIGger:I2S:ALIGnment <setting>  
<setting> ::= {I2S | LJ | RJ}

The :TRIGger:I2S:ALIGnment command selects the data alignment of the I2S bus for the serial decoder and/or trigger when in I2S mode:

- I2S – standard.
- LJ – left justified.
- RJ – right justified.

Note that the word select (WS) polarity is specified separately with the :TRIGger:I2S:WSHigh command.

**Query Syntax** :TRIGger:I2S:ALIGnment?

The :TRIGger:I2S:ALIGnment? query returns the currently selected I2S data alignment.

**Return Format** <setting><NL>  
<setting> ::= {I2S | LJ | RJ}

- See Also**
- ["Introduction to :TRIGger Commands"](#) on page 440
  - [":TRIGger:I2S:CLOCK:SLOPe"](#) on page 504
  - [":TRIGger:I2S:RWIDth"](#) on page 510
  - [":TRIGger:I2S:TWIDth"](#) on page 516
  - [":TRIGger:I2S:WSLow"](#) on page 517

**:TRIGger:I2S:AUDio**

**N** (see [page 750](#))

**Command Syntax** :TRIGger:I2S:AUDio <audio\_ch>  
 <audio\_ch> ::= {RIGHT | LEFT | EITHER}

The :TRIGger:I2S:AUDio command specifies the audio channel to trigger on:

- RIGHT – right channel.
- LEFT – left channel.
- EITHER – right channel.

**Query Syntax** :TRIGger:I2S:AUDio?

The :TRIGger:I2S:AUDio? query returns the current audio channel for the I2S trigger.

**Return Format** <audio\_ch><NL>  
 <audio\_ch> ::= {RIGH | LEFT | EITH}

- See Also**
- ["Introduction to :TRIGger Commands"](#) on page 440
  - [":TRIGger:I2S:TRIGger"](#) on page 514

## :TRIGger:I2S:CLOCK:SLOPe

**N** (see [page 750](#))

**Command Syntax** :TRIGger:I2S:CLOCK:SLOPe <slope>  
<slope> ::= {NEGative | POSitive}

The :TRIGger:I2S:CLOCK:SLOPe command specifies which edge of the I2S serial clock signal clocks in data.

- NEGative – Falling edge.
- POSitive – Rising edge.

**Query Syntax** :TRIGger:I2S:CLOCK:SLOPe?

The :TRIGger:I2S:CLOCK:SLOPe? query returns the current I2S clock slope setting.

**Return Format** <slope><NL>  
<slope> ::= {NEG | POS}

- See Also**
- "[Introduction to :TRIGger Commands](#)" on page 440
  - "[:TRIGger:I2S:ALIGNment](#)" on page 502
  - "[:TRIGger:I2S:RWIDth](#)" on page 510
  - "[:TRIGger:I2S:TWIDth](#)" on page 516
  - "[:TRIGger:I2S:WSLow](#)" on page 517

**:TRIGger:I2S:PATtern:DATA**

**N** (see page 750)

**Command Syntax** :TRIGger:I2S:PATtern:DATA <string>

<string> ::= "n" where n ::= 32-bit integer in signed decimal when  
<base> = DECimal

<string> ::= "nn...n" where n ::= {0 | 1 | X | \$} when  
<base> = BINary

<string> ::= "0xnn...n" where n ::= {0,...,9 | A,...,F | X | \$} when  
<base> = HEX

**NOTE**

<base> is specified with the :TRIGger:I2S:PATtern:FORMat command. The default <base> is DECimal.

The :TRIGger:I2S:PATtern:DATA command specifies the I2S trigger data pattern searched for in each I2S message.

Set a <string> bit to "0" or "1" to set the corresponding bit in the data pattern to low or high, respectively.

Set a <string> bit to "X" to ignore (mask off) that bit in the data pattern.

Use the "\$" character to indicate that the value of the corresponding bit will not be changed (the existing bit value is used).

When <base> = DECimal, the "X" and "\$" characters cannot be entered. When queried, the "\$" character is returned when any bits in the pattern have the value of "X" and <base> = DECimal. When any bits in a given nibble have the value of "X" and <base> = HEX, the "\$" character is returned for the corresponding nibble.

**NOTE**

The :TRIGger:I2S:PATtern:DATA command specifies the I2S trigger data pattern used by the EQUal, NOTequal, GREaterthan, and LESSthan trigger conditions. If the GREaterthan or LESSthan trigger condition is selected, the bits specified to be masked off ("X") will be interpreted as 0's.

**NOTE**

The length of the trigger data value is determined by the :TRIGger:I2S:RWIDth and :TRIGger:I2S:TWIDth commands. When the receiver word size is less than the transmitter word size, the data length is equal to the receiver word size. When the receiver word size is greater than the transmitter word size, the data length is equal to the transmitter word size.

**NOTE**

If more bits are sent for <string> than the specified trigger data length, the most significant bits will be truncated. If the word size is changed after the <string> is programmed, the added or deleted bits will be added to or deleted from the least significant bits.

---

**Query Syntax**    :TRIGger:I2S:PATtern:DATA?

The :TRIGger:I2S:PATtern:DATA? query returns the currently specified I2S trigger data pattern.

**Return Format**    <string><NL>

- See Also**
- ["Introduction to :TRIGger Commands"](#) on page 440
  - [":TRIGger:I2S:PATtern:FORMat"](#) on page 507
  - [":TRIGger:I2S:TRIGger"](#) on page 514
  - [":TRIGger:I2S:RWIDth"](#) on page 510
  - [":TRIGger:I2S:TWIDth"](#) on page 516
  - [":TRIGger:I2S:AUDio"](#) on page 503

**:TRIGger:I2S:PATtern:FORMat**

**N** (see [page 750](#))

**Command Syntax** :TRIGger:I2S:PATtern:FORMat <base>  
 <base> ::= {BINary | HEX | DECimal}

The :TRIGger:I2S:PATtern:FORMat command sets the entry (and query) number base used by the :TRIGger:I2S:PATtern:DATA command. The default <base> is DECimal.

**Query Syntax** :TRIGger:I2S:PATtern:FORMat?

The :TRIGger:I2S:PATtern:FORMat? query returns the currently set number base for I2S pattern data.

**Return Format** <base><NL>  
 <base> ::= {BIN | HEX | DEC}

- See Also**
- "[Introduction to :TRIGger Commands](#)" on page 440
  - "[:TRIGger:I2S:AUDio](#)" on page 503
  - "[:TRIGger:I2S:TRIGger](#)" on page 514

**:TRIGger:I2S:RANGe**

**N** (see [page 750](#))

**Command Syntax** :TRIGger:I2S:RANGe <upper>,<lower>

<upper> ::= 32-bit integer in signed decimal, <nondecimal>, or <string>

<lower> ::= 32-bit integer in signed decimal, <nondecimal> or <string>

<nondecimal> ::= #Hnn...n where n ::= {0,...,9 | A,...,F} for hexadecimal

<nondecimal> ::= #Bnn...n where n ::= {0 | 1} for binary

<string> ::= "0xnn...n" where n ::= {0,...,9 | A,...,F} for hexadecimal

The :TRIGger:I2S:RANGe command sets the upper and lower range boundaries used by the INRange, OUTRange, INCRaising, and DECRaising trigger conditions. You can enter the parameters in any order – the smaller value becomes the <lower> and the larger value becomes the <upper>.

Note that for INCRaising and DECRaising, the <upper> and <lower> values correspond to the "Armed" and "Trigger" softkeys.

**NOTE**

The length of the <upper> and <lower> values is determined by the :TRIGger:I2S:RWIDth and :TRIGger:I2S:TWIDth commands. When the receiver word size is less than the transmitter word size, the length is equal to the receiver word size. When the receiver word size is greater than the transmitter word size, the length is equal to the transmitter word size.

**Query Syntax** :TRIGger:I2S:RANGe?

The :TRIGger:I2S:RANGe? query returns the currently set upper and lower range boundaries.

**Return Format** <upper>,<lower><NL>

<upper> ::= 32-bit integer in signed decimal, <nondecimal>, or <string>

<lower> ::= 32-bit integer in signed decimal, <nondecimal> or <string>

<nondecimal> ::= #Hnn...n where n ::= {0,...,9 | A,...,F} for hexadecimal

<nondecimal> ::= #Bnn...n where n ::= {0 | 1} for binary

<string> ::= "0xnn...n" where n ::= {0,...,9 | A,...,F} for hexadecimal

**See Also** • ["Introduction to :TRIGger Commands"](#) on page 440

- `":TRIGger:I2S:TRIGger"` on page 514
- `":TRIGger:I2S:RWIDth"` on page 510
- `":TRIGger:I2S:TWIDth"` on page 516
- `":TRIGger:I2S:WSLow"` on page 517

## :TRIGger:I2S:RWIDth

**N** (see [page 750](#))

**Command Syntax** :TRIGger:I2S:RWIDth <receiver>

<receiver> ::= 4-32 in NR1 format

The :TRIGger:I2S:RWIDth command sets the width of the receiver (decoded) data word in I2S anywhere from 4 bits to 32 bits.

**Query Syntax** :TRIGger:I2S:RWIDth?

The :TRIGger:I2S:RWIDth? query returns the currently set I2S receiver data word width.

**Return Format** <receiver><NL>

<receiver> ::= 4-32 in NR1 format

- See Also**
- "[Introduction to :TRIGger Commands](#)" on page 440
  - "[:TRIGger:I2S:ALIGNment](#)" on page 502
  - "[:TRIGger:I2S:CLOCK:SLOPe](#)" on page 504
  - "[:TRIGger:I2S:TWIDth](#)" on page 516
  - "[:TRIGger:I2S:WSLow](#)" on page 517

**:TRIGger:I2S:SOURce:CLOCK**

**N** (see [page 750](#))

**Command Syntax** :TRIGger:I2S:SOURce:CLOCK <source>

<source> ::= {CHANnel<n> | EXTernal}

<n> ::= {1 | 2 | 3 | 4} for the four channel oscilloscope models

<n> ::= {1 | 2} for the two channel oscilloscope models

The :TRIGger:I2S:SOURce:CLOCK controls which signal is used as the serial clock (SCLK) source by the serial decoder and/or trigger when in I2S mode.

**Query Syntax** :TRIGger:I2S:SOURce:CLOCK?

The :TRIGger:I2S:SOURce:CLOCK? query returns the current source for the I2S serial clock (SCLK).

**Return Format** <source><NL>

- See Also**
- ["Introduction to :TRIGger Commands"](#) on page 440
  - [":TRIGger:I2S:SOURce:DATA"](#) on page 512
  - [":TRIGger:I2S:SOURce:WSElect"](#) on page 513

## :TRIGger:I2S:SOURce:DATA

**N** (see [page 750](#))

**Command Syntax** :TRIGger:I2S:SOURce:DATA <source>

<source> ::= {CHANnel<n> | EXTernal}

<n> ::= {1 | 2 | 3 | 4} for the four channel oscilloscope models

<n> ::= {1 | 2} for the two channel oscilloscope models

The :TRIGger:I2S:SOURce:DATA command controls which signal is used as the serial data (SDATA) source by the serial decoder and/or trigger when in I2S mode.

**Query Syntax** :TRIGger:I2S:SOURce:DATA?

The :TRIGger:I2S:SOURce:DATA? query returns the current source for the I2S serial data (SDATA).

**Return Format** <source><NL>

- See Also**
- ["Introduction to :TRIGger Commands"](#) on page 440
  - [":TRIGger:I2S:SOURce:CLOCK"](#) on page 511
  - [":TRIGger:I2S:SOURce:WSElect"](#) on page 513

**:TRIGger:I2S:SOURce:WSElect**

**N** (see [page 750](#))

**Command Syntax** :TRIGger:I2S:SOURce:WSElect <source>

<source> ::= {CHANnel<n> | EXTernal}

<n> ::= {1 | 2 | 3 | 4} for the four channel oscilloscope models

<n> ::= {1 | 2} for the two channel oscilloscope models

The :TRIGger:I2S:SOURce:WSElect command controls which signal is used as the word select (WS) source by the serial decoder and/or trigger when in I2S mode.

**Query Syntax** :TRIGger:I2S:SOURce:WSElect?

The :TRIGger:I2S:SOURce:WSElect? query returns the current source for I2S word select (WS).

**Return Format** <source><NL>

- See Also**
- ["Introduction to :TRIGger Commands"](#) on page 440
  - [":TRIGger:I2S:SOURce:CLOCK"](#) on page 511
  - [":TRIGger:I2S:SOURce:DATA"](#) on page 512

**:TRIGger:I2S:TRIGger**

**N** (see page 750)

**Command Syntax** :TRIGger:I2S:TRIGger <operator>

<operator> ::= {EQUAL | NOTequal | LESSthan | GREATERthan | INRange  
| OUTRange | INCRasing | DECRasing}

The :TRIGger:I2S:TRIGger command sets the I2S trigger operator:

- **EQUAL**— triggers on the specified audio channel's data word when it equals the specified word.
- **NOTequal** — triggers on any word other than the specified word.
- **LESSthan** — triggers when the channel's data word is less than the specified value.
- **GREATERthan** — triggers when the channel's data word is greater than the specified value.
- **INRange** — enter upper and lower values to specify the range in which to trigger.
- **OUTRange** — enter upper and lower values to specify range in which trigger will not occur.
- **INCRasing** — triggers when the data value makes a certain increase over time and the specified value is met or exceeded. Use the :TRIGger:I2S:RANGe command to set "Trigger" and "Armed" values. The "Trigger" value is the value that must be met or exceeded to cause the trigger. The "Armed" value is the value the data must go below in order to re-arm the oscilloscope (ready it to trigger again).

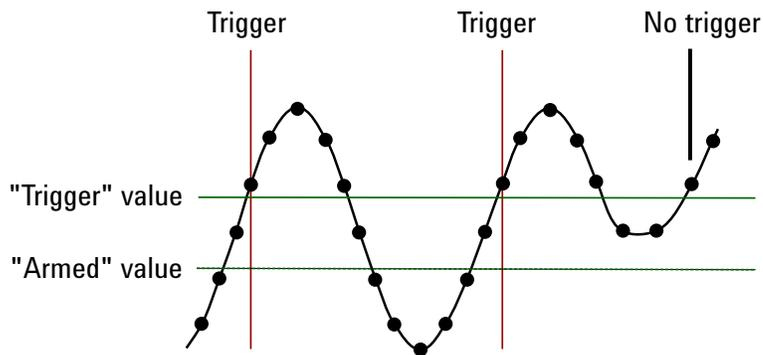

- **DECRasing** — similar to INCRasing except the trigger occurs on a certain decrease over time and the "Trigger" data value is less than the "Armed" data value.

**Query Syntax** :TRIGger:I2S:TRIGger?

The `:TRIGger:I2S:TRIGger?` query returns the current I2S trigger operator.

**Return Format** `<operator><NL>`

`<operator> ::= {EQU | NOT | LESS | GRE | INR | OUTR | INCR | DECR}`

- See Also**
- ["Introduction to :TRIGger Commands"](#) on page 440
  - [":TRIGger:I2S:AUDio"](#) on page 503
  - [":TRIGger:I2S:RANGe"](#) on page 508
  - [":TRIGger:I2S:PATtern:FORMat"](#) on page 507

### :TRIGger:I2S:TWIDth

**N** (see [page 750](#))

**Command Syntax** :TRIGger:I2S:TWIDth <word\_size>

<word\_size> ::= 4-32 in NR1 format

The :TRIGger:I2S:TWIDth command sets the width of the transmitted data word in I2S anywhere from 4 bits to 32 bits.

**Query Syntax** :TRIGger:I2S:TWIDth?

The :TRIGger:I2S:TWIDth? query returns the currently set I2S transmitted data word width.

**Return Format** <word\_size><NL>

<word\_size> ::= 4-32 in NR1 format

- See Also**
- "[Introduction to :TRIGger Commands](#)" on page 440
  - "[:TRIGger:I2S:ALIGNment](#)" on page 502
  - "[:TRIGger:I2S:CLOCK:SLOPe](#)" on page 504
  - "[:TRIGger:I2S:RWIDth](#)" on page 510
  - "[:TRIGger:I2S:WSLow](#)" on page 517

**:TRIGger:I2S:WSLow**

**N** (see [page 750](#))

**Command Syntax** :TRIGger:I2S:WSLow <low\_def>

<low\_def> ::= {LEFT | RIGHT}

The :TRIGger:I2S:WSLow command selects the polarity of the word select (WS) signal:

- LEFT— a word select (WS) state of low indicates left channel data is active on the I2S bus, and a WS state of high indicates right channel data is active on the bus.
- RIGHT — a word select (WS) state of low indicates right channel data is active on the I2S bus, and a WS state of high indicates left channel data is active on the bus.

**Query Syntax** :TRIGger:I2S:WSLow?

The :TRIGger:I2S:WSLow? query returns the currently selected I2S word select (WS) polarity.

**Return Format** <low\_def><NL>

<low\_def> ::= {LEFT | RIGHT}

- See Also**
- ["Introduction to :TRIGger Commands"](#) on page 440
  - [":TRIGger:I2S:ALIGNment"](#) on page 502
  - [":TRIGger:I2S:CLOCK:SLOPe"](#) on page 504
  - [":TRIGger:I2S:RWIDth"](#) on page 510
  - [":TRIGger:I2S:TWIDth"](#) on page 516

## :TRIGger:IIC Commands

**Table 77** :TRIGger:IIC Commands Summary

| Command  | Query   | Options and Query Returns   |
|--|---|---|
| :TRIGger:IIC:PATtern:ADDRESS <value> (see <a href="#">page 519</a> )   | :TRIGger:IIC:PATtern:ADDRESS? (see <a href="#">page 519</a> )   | <value> ::= integer or <string><br><string> ::= "0xnn" n ::= {0,...,9   A,...,F}  |
| :TRIGger:IIC:PATtern:DATA <value> (see <a href="#">page 520</a> )      | :TRIGger:IIC:PATtern:DATA? (see <a href="#">page 520</a> )      | <value> ::= integer or <string><br><string> ::= "0xnn" n ::= {0,...,9   A,...,F}  |
| :TRIGger:IIC:PATtern:DATA2 <value> (see <a href="#">page 521</a> )     | :TRIGger:IIC:PATtern:DATA2? (see <a href="#">page 521</a> )     | <value> ::= integer or <string><br><string> ::= "0xnn" n ::= {0,...,9   A,...,F}  |
| :TRIGger:IIC[:SOURce]:CLOCK <source> (see <a href="#">page 522</a> )   | :TRIGger:IIC[:SOURce]:CLOCK? (see <a href="#">page 522</a> )    | <source> ::= {CHANnel<n>   EXTERNAL}<br><n> ::= 1-2 or 1-4 in NR1 format  |
| :TRIGger:IIC[:SOURce]:DATA <source> (see <a href="#">page 523</a> )    | :TRIGger:IIC[:SOURce]:DATA? (see <a href="#">page 523</a> )     | <source> ::= {CHANnel<n>   EXTERNAL}<br><n> ::= 1-2 or 1-4 in NR1 format  |
| :TRIGger:IIC:TRIGger:QUALifier <value> (see <a href="#">page 524</a> ) | :TRIGger:IIC:TRIGger:QUALifier? (see <a href="#">page 524</a> ) | <value> ::= {EQUAL   NOTequal   LESSthan   GREATERthan}   |
| :TRIGger:IIC:TRIGger[:TYPE] <type> (see <a href="#">page 525</a> )     | :TRIGger:IIC:TRIGger[:TYPE]? (see <a href="#">page 525</a> )    | <type> ::= {START   STOP   READ7   READEprom   WRITe7   WRITe10   NACKnowledge   ANACKnowledge   R7Data2   W7Data2   REStart} |

**:TRIGger:IIC:PATtern:ADDRess**

**N** (see [page 750](#))

**Command Syntax** :TRIGger:IIC:PATtern:ADDRess <value>

<value> ::= integer or <string>

<string> ::= "0xnn" where n ::= {0,...,9 | A,...,F}

The :TRIGger:IIC:PATtern:ADDRess command sets the address for IIC data. The address can range from 0x00 to 0x7F (7-bit) or 0x3FF (10-bit) hexadecimal. Use the don't care address (-1 or 0xFFFFFFFF) to ignore the address value.

**Query Syntax** :TRIGger:IIC:PATtern:ADDRess?

The :TRIGger:IIC:PATtern:ADDRess? query returns the current address for IIC data.

**Return Format** <value><NL>

<value> ::= integer

- See Also**
- ["Introduction to :TRIGger Commands"](#) on page 440
  - [":TRIGger:IIC:PATtern:DATA"](#) on page 520
  - [":TRIGger:IIC:PATtern:DATA2"](#) on page 521
  - [":TRIGger:IIC:TRIGger\[:TYPE\]"](#) on page 525

## :TRIGger:IIC:PATtern:DATA

**N** (see [page 750](#))

**Command Syntax** :TRIGger:IIC:PATtern:DATA <value>

<value> ::= integer or <string>

<string> ::= "0xnn" where n ::= {0,...,9 | A,...,F}

The :TRIGger:IIC:PATtern:DATA command sets IIC data. The data value can range from 0x00 to 0x0FF (hexadecimal). Use the don't care data pattern (-1 or 0xFFFFFFFF) to ignore the data value.

**Query Syntax** :TRIGger:IIC:PATtern:DATA?

The :TRIGger:IIC:PATtern:DATA? query returns the current pattern for IIC data.

**Return Format** <value><NL>

- See Also**
- ["Introduction to :TRIGger Commands"](#) on page 440
  - [":TRIGger:IIC:PATtern:ADDRess"](#) on page 519
  - [":TRIGger:IIC:PATtern:DATA2"](#) on page 521
  - [":TRIGger:IIC:TRIGger\[:TYPE\]"](#) on page 525

**:TRIGger:IIC:PATtern:DATA2**

**N** (see [page 750](#))

**Command Syntax** :TRIGger:IIC:PATtern:DATA2 <value>

<value> ::= integer or <string>

<string> ::= "0xnn" where n ::= {0,...,9 | A,...,F}

The :TRIGger:IIC:PATtern:DATA2 command sets IIC data 2. The data value can range from 0x00 to 0x0FF (hexadecimal). Use the don't care data pattern (-1 or 0xFFFFFFFF) to ignore the data value.

**Query Syntax** :TRIGger:IIC:PATtern:DATA2?

The :TRIGger:IIC:PATtern:DATA2? query returns the current pattern for IIC data 2.

**Return Format** <value><NL>

- See Also**
- ["Introduction to :TRIGger Commands"](#) on page 440
  - [":TRIGger:IIC:PATtern:ADDRESS"](#) on page 519
  - [":TRIGger:IIC:PATtern:DATA"](#) on page 520
  - [":TRIGger:IIC:TRIGger\[:TYPE\]"](#) on page 525

## **:TRIGger:IIC[:SOURce]:CLOCK**

**N** (see [page 750](#))

**Command Syntax** :TRIGger:IIC:[SOURce:]CLOCK <source>

<source> ::= {CHANnel<n> | EXTernal}

<n> ::= {1 | 2 | 3 | 4} for the four channel oscilloscope models

<n> ::= {1 | 2} for the two channel oscilloscope models

The :TRIGger:IIC:[SOURce:]CLOCK command sets the source for the IIC serial clock (SCL).

**Query Syntax** :TRIGger:IIC:[SOURce:]CLOCK?

The :TRIGger:IIC:[SOURce:]CLOCK? query returns the current source for the IIC serial clock.

**Return Format** <source><NL>

- See Also**
- ["Introduction to :TRIGger Commands"](#) on page 440
  - [":TRIGger:IIC\[:SOURce\]:DATA"](#) on page 523

**:TRIGger:IIC[:SOURce]:DATA**

**N** (see [page 750](#))

**Command Syntax** :TRIGger:IIC:[SOURce:]DATA <source>

<source> ::= {CHANnel<n> | EXTernal}

<n> ::= {1 | 2 | 3 | 4} for the four channel oscilloscope models

<n> ::= {1 | 2} for the two channel oscilloscope models

The :TRIGger:IIC:[SOURce:]DATA command sets the source for IIC serial data (SDA).

**Query Syntax** :TRIGger:IIC:[SOURce:]DATA?

The :TRIGger:IIC:[SOURce:]DATA? query returns the current source for IIC serial data.

**Return Format** <source><NL>

- See Also**
- ["Introduction to :TRIGger Commands"](#) on page 440
  - [":TRIGger:IIC\[:SOURce\]:CLOCK"](#) on page 522

## **:TRIGger:IIC:TRIGger:QUALifier**

**N** (see [page 750](#))

**Command Syntax** :TRIGger:IIC:TRIGger:QUALifier <value>  
<value> ::= {EQUAL | NOTequal | LESSthan | GREATERthan}

The :TRIGger:IIC:TRIGger:QUALifier command sets the IIC data qualifier when TRIGger:IIC:TRIGger[:TYPE] is set to READEprom.

**Query Syntax** :TRIGger:IIC:TRIGger:QUALifier?

The :TRIGger:IIC:TRIGger:QUALifier? query returns the current IIC data qualifier value.

**Return Format** <value><NL>  
<value> ::= {EQUAL | NOTequal | LESSthan | GREATERthan}

- See Also**
- "[Introduction to :TRIGger Commands](#)" on page 440
  - "[:TRIGger:MODE](#)" on page 447
  - "[:TRIGger:IIC:TRIGger\[:TYPE\]](#)" on page 525

**:TRIGger:IIC:TRIGger[:TYPE]**

**N** (see [page 750](#))

**Command Syntax** :TRIGger:IIC:TRIGger[:TYPE] <value>

<value> ::= {START | STOP | READ7 | READEprom | WRITe7 | WRITe10  
| NACKnowledge | ANACKnowledge | R7Data2 | W7Data2 | REStart}

The :TRIGger:IIC:TRIGger[:TYPE] command sets the IIC trigger type:

- START – Start condition.
- STOP – Stop condition.
- READ7 – 7-bit address frame containing (Start:Address7:Read:Ack:Data). The value READ is also accepted for READ7.
- R7Data2 – 7-bit address frame containing (Start:Address7:Read:Ack:Data:Ack:Data2).
- READEprom – EEPROM data read.
- WRITe7 – 7-bit address frame containing (Start:Address7:Write:Ack:Data). The value WRITE is also accepted for WRITe7.
- W7Data2 – 7-bit address frame containing (Start:Address7:Write:Ack:Data:Ack:Data2).
- WRITe10 – 10-bit address frame containing (Start:Address byte1:Write:Ack:Address byte 2:Data).
- NACKnowledge – Missing acknowledge.
- ANACKnowledge – Address with no acknowledge.
- REStart – Another start condition occurs before a stop condition.

**NOTE**

The short form of READ7 (READ7), READEprom (READE), WRITe7 (WRIT7), and WRITe10 (WRIT10) do not follow the defined Long Form to Short Form Truncation Rules (see [page 752](#)).

**Query Syntax** :TRIGger:IIC:TRIGger[:TYPE]?

The :TRIGger:IIC:TRIGger[:TYPE]? query returns the current IIC trigger type value.

**Return Format** <value><NL>

<value> ::= {STAR | STOP | READ7 | READE | WRIT7 | WRIT10 | NACK | ANAC  
| R7D2 | W7D2 | REST}

- See Also**
- ["Introduction to :TRIGger Commands"](#) on page 440
  - [":TRIGger:MODE"](#) on page 447

## 5 Commands by Subsystem

- [":TRIGger:IIC:PATtern:ADDRess"](#) on page 519
- [":TRIGger:IIC:PATtern:DATA"](#) on page 520
- [":TRIGger:IIC:PATtern:DATA2"](#) on page 521
- [":TRIGger:IIC:TRIGger:QUALifier"](#) on page 524
- ["Long Form to Short Form Truncation Rules"](#) on page 752

## :TRIGger:LIN Commands

**Table 78** :TRIGger:LIN Commands Summary

| Command   | Query   | Options and Query Returns  |
|---|---|--|
| :TRIGger:LIN:ID<br><value> (see <a href="#">page 529</a> )                | :TRIGger:LIN:ID? (see <a href="#">page 529</a> )                  | <value> ::= 7-bit integer in decimal, <nondecimal>, or <string> from 0-63 or 0x00-0x3f (with Option AMS)<br><nondecimal> ::= #Hnn where n ::= {0,...,9   A,...,F} for hexadecimal<br><nondecimal> ::= #Bnn...n where n ::= {0   1} for binary<br><string> ::= "0xnn" where n ::= {0,...,9   A,...,F} for hexadecimal |
| :TRIGger:LIN:PATtern:DATA <string> (see <a href="#">page 530</a> )        | :TRIGger:LIN:PATtern:DATA? (see <a href="#">page 531</a> )        | <string> ::= "n" where n ::= 32-bit integer in signed decimal when <base> = DECimal<br><string> ::= "nn...n" where n ::= {0   1   X   \$} when <base> = BINary<br><string> ::= "0xnn...n" where n ::= {0,...,9   A,...,F   X   \$} when <base> = HEX   |
| :TRIGger:LIN:PATtern:DATA:LENGth <length> (see <a href="#">page 532</a> ) | :TRIGger:LIN:PATtern:DATA:LENGth? (see <a href="#">page 532</a> ) | <length> ::= integer from 1 to 8 in NR1 format   |
| :TRIGger:LIN:PATtern:FORMat <base> (see <a href="#">page 533</a> )        | :TRIGger:LIN:PATtern:FORMat? (see <a href="#">page 533</a> )      | <base> ::= {BINary   HEX   DECimal}  |
| :TRIGger:LIN:SAMplepo int <value> (see <a href="#">page 534</a> )         | :TRIGger:LIN:SAMplepo int? (see <a href="#">page 534</a> )        | <value> ::= {60   62.5   68   70   75   80   87.5} in NR3 format   |
| :TRIGger:LIN:SIGNAL:BAUDrate <baudrate> (see <a href="#">page 535</a> )   | :TRIGger:LIN:SIGNAL:BAUDrate? (see <a href="#">page 535</a> )     | <baudrate> ::= integer from 2400 to 625000 in 100 b/s increments   |
| :TRIGger:LIN:SOURce <source> (see <a href="#">page 536</a> )              | :TRIGger:LIN:SOURce? (see <a href="#">page 536</a> )              | <source> ::= {CHANnel<n>   EXTERNAL}<br><n> ::= 1-2 or 1-4 in NR1 format   |
| :TRIGger:LIN:STANdard <std> (see <a href="#">page 537</a> )               | :TRIGger:LIN:STANdard? (see <a href="#">page 537</a> )            | <std> ::= {LIN13   LIN20}  |

## 5 Commands by Subsystem

**Table 78** :TRIGger:LIN Commands Summary (continued)

| Command  | Query   | Options and Query Returns   |
|--|---|---|
| :TRIGger:LIN:SYNCbreak <value> (see <a href="#">page 538</a> )   | :TRIGger:LIN:SYNCbreak? (see <a href="#">page 538</a> ) | <value> ::= integer = {11   12   13}  |
| :TRIGger:LIN:TRIGger <condition> (see <a href="#">page 539</a> ) | :TRIGger:LIN:TRIGger? (see <a href="#">page 539</a> )   | <condition> ::= {SYNCbreak} (without Option AMS)<br><condition> ::= {SYNCbreak   ID   DATA} (with Option AMS) |

**:TRIGger:LIN:ID**

**N** (see [page 750](#))

**Command Syntax** :TRIGger:LIN:ID <value>

<value> ::= 7-bit integer in decimal, <nondecimal>, or <string>  
from 0-63 or 0x00-0x3f

<nondecimal> ::= #Hnn where n ::= {0,...,9 | A,...,F} for hexadecimal

<nondecimal> ::= #Bnn...n where n ::= {0 | 1} for binary

<string> ::= "0xnn" where n ::= {0,...,9 | A,...,F} for hexadecimal

The :TRIGger:LIN:ID command defines the LIN identifier searched for in each CAN message when the LIN trigger mode is set to frame ID.

**NOTE**

This command is only valid when the automotive CAN and LIN serial decode option (Option AMS) has been licensed.

Setting the ID to a value of "-1" results in "0xXX" which is equivalent to all IDs.

**Query Syntax** :TRIGger:LIN:ID?

The :TRIGger:LIN:ID? query returns the current LIN identifier setting.

**Return Format** <value><NL>

<value> ::= integer in decimal

**Errors** • ["-241, Hardware missing"](#) on page 709

**See Also** • ["Introduction to :TRIGger Commands"](#) on page 440  
• [":TRIGger:MODE"](#) on page 447  
• [":TRIGger:LIN:TRIGger"](#) on page 539  
• [":TRIGger:LIN:SIGNAL:DEFinition"](#) on page 705  
• [":TRIGger:LIN:SOURce"](#) on page 536

**:TRIGger:LIN:PATtern:DATA**

**N** (see page 750)

**Command Syntax** :TRIGger:LIN:PATtern:DATA <string>

<string> ::= "n" where n ::= 32-bit integer in signed decimal when  
<base> = DECimal

<string> ::= "nn...n" where n ::= {0 | 1 | X | \$} when  
<base> = BINary

<string> ::= "0xnn...n" where n ::= {0,...,9 | A,...,F | X | \$} when  
<base> = HEX

**NOTE**

<base> is specified with the :TRIGger:LIN:PATtern:FORMat command. The default <base> is DECimal.

The :TRIGger:LIN:PATtern:DATA command specifies the LIN trigger data pattern searched for in each LIN data field.

Set a <string> bit to "0" or "1" to set the corresponding bit in the data pattern to low or high, respectively.

Set a <string> bit to "X" to ignore (mask off) that bit in the data pattern.

Use the "\$" character to indicate that the value of the corresponding bit will not be changed (the existing bit value is used).

When <base> = DECimal, the "X" and "\$" characters cannot be entered. When queried, the "\$" character is returned when any bits in the pattern have the value of "X" and <base> = DECimal. When any bits in a given nibble have the value of "X" and <base> = HEX, the "\$" character is returned for the corresponding nibble.

**NOTE**

The :TRIGger:LIN:PATtern:DATA command specifies the LIN trigger data pattern used by the DATA trigger condition. This command is only valid when the automotive CAN and LIN serial decode option (Option AMS) has been licensed.

**NOTE**

The length of the trigger data value is determined by the :TRIGger:LIN:PATtern:DATA:LENGth command.

**NOTE**

If more bits are sent for <string> than the specified trigger pattern data length, the most significant bits will be truncated. If the data length size is changed after the <string> is programmed, the added or deleted bits will be added to or deleted from the least significant bits.

**Query Syntax**    `:TRIGger:LIN:PATtern:DATA?`

The `:TRIGger:LIN:PATtern:DATA?` query returns the currently specified LIN trigger data pattern.

**Return Format**    `<string><NL>`

- See Also**
- ["Introduction to :TRIGger Commands"](#) on page 440
  - [":TRIGger:LIN:PATtern:FORMat"](#) on page 533
  - [":TRIGger:LIN:TRIGger"](#) on page 539
  - [":TRIGger:LIN:PATtern:DATA:LENGth"](#) on page 532

## :TRIGger:LIN:PATtern:DATA:LENGth

**N** (see [page 750](#))

**Command Syntax** :TRIGger:LIN:PATtern:DATA:LENGth <length>  
<length> ::= integer from 1 to 8 in NR1 format

The :TRIGger:LIN:PATtern:DATA:LENGth command sets the number of 8-bit bytes in the LIN data string. The number of bytes in the string can be anywhere from 0 bytes to 8 bytes (64 bits). The value for these bytes is set by the :TRIGger:LIN:PATtern:DATA command.

**NOTE**

This command is only valid when the automotive CAN and LIN serial decode option (Option AMS) has been licensed.

**Query Syntax** :TRIGger:LIN:PATtern:DATA:LENGth?

The :TRIGger:LIN:PATtern:DATA:LENGth? query returns the current LIN data pattern length setting.

**Return Format** <count><NL>  
<count> ::= integer from 1 to 8 in NR1 format

**Errors** • "-241, Hardware missing" on [page 709](#)

- See Also**
- "Introduction to :TRIGger Commands" on [page 440](#)
  - ":TRIGger:LIN:PATtern:DATA" on [page 530](#)
  - ":TRIGger:LIN:SOURce" on [page 536](#)

**:TRIGger:LIN:PATtern:FORMat**

**N** (see [page 750](#))

**Command Syntax** :TRIGger:LIN:PATtern:FORMat <base>  
 <base> ::= {BINary | HEX | DECimal}

The :TRIGger:LIN:PATtern:FORMat command sets the entry (and query) number base used by the :TRIGger:LIN:PATtern:DATA command. The default <base> is DECimal.

**NOTE**

This command is only valid when the automotive CAN and LIN serial decode option (Option AMS) has been licensed.

**Query Syntax** :TRIGger:LIN:PATtern:FORMat?

The :TRIGger:LIN:PATtern:FORMat? query returns the currently set number base for LIN pattern data.

**Return Format** <base><NL>  
 <base> ::= {BIN | HEX | DEC}

- See Also**
- "[Introduction to :TRIGger Commands](#)" on page 440
  - "[:TRIGger:LIN:PATtern:DATA](#)" on page 530
  - "[:TRIGger:LIN:PATtern:DATA:LENGth](#)" on page 532

## :TRIGger:LIN:SAMPlEpoint

**N** (see [page 750](#))

**Command Syntax** :TRIGger:LIN:SAMPlEpoint <value>

<value><NL>

<value> ::= {60 | 62.5 | 68 | 70 | 75 | 80 | 87.5} in NR3 format

The :TRIGger:LIN:SAMPlEpoint command sets the point during the bit time where the bit level is sampled to determine whether the bit is dominant or recessive. The sample point represents the percentage of time between the beginning of the bit time to the end of the bit time.

### NOTE

The sample point values are not limited by the baud rate.

**Query Syntax** :TRIGger:LIN:SAMPlEpoint?

The :TRIGger:LIN:SAMPlEpoint? query returns the current LIN sample point setting.

**Return Format** <value><NL>

<value> ::= {60 | 62.5 | 68 | 70 | 75 | 80 | 87.5} in NR3 format

- See Also**
- "[Introduction to :TRIGger Commands](#)" on page 440
  - "[:TRIGger:MODE](#)" on page 447
  - "[:TRIGger:LIN:TRIGger](#)" on page 539

**:TRIGger:LIN:SIGNal:BAUDrate**

**N** (see [page 750](#))

**Command Syntax** :TRIGger:LIN:SIGNal:BAUDrate <baudrate>

<baudrate> ::= integer from 2400 to 625000 in 100 b/s increments

The :TRIGger:LIN:SIGNal:BAUDrate command sets the standard baud rate of the LIN signal from 2400 b/s to 625 kb/s in 100 b/s increments. If you enter a baud rate that is not divisible by 100 b/s, the baud rate is set to the nearest baud rate divisible by 100 b/s.

**Query Syntax** :TRIGger:LIN:SIGNal:BAUDrate?

The :TRIGger:LIN:SIGNal:BAUDrate? query returns the current LIN baud rate setting.

**Return Format** <baudrate><NL>

<baudrate> ::= integer from 2400 to 625000 in 100 b/s increments

- See Also**
- ["Introduction to :TRIGger Commands"](#) on page 440
  - [":TRIGger:MODE"](#) on page 447
  - [":TRIGger:LIN:TRIGger"](#) on page 539
  - [":TRIGger:LIN:SIGNal:DEFinition"](#) on page 705
  - [":TRIGger:LIN:SOURce"](#) on page 536

## :TRIGger:LIN:SOURce

**N** (see [page 750](#))

**Command Syntax** :TRIGger:LIN:SOURce <source>

<source> ::= {CHANnel<n> | EXTernal}

<n> ::= {1 | 2 | 3 | 4} for the four channel oscilloscope models

<n> ::= {1 | 2} for the two channel oscilloscope models

The :TRIGger:LIN:SOURce command sets the source for the LIN signal.

**Query Syntax** :TRIGger:LIN:SOURce?

The :TRIGger:LIN:SOURce? query returns the current source for the LIN signal.

**Return Format** <source><NL>

- See Also**
- ["Introduction to :TRIGger Commands"](#) on page 440
  - [":TRIGger:MODE"](#) on page 447
  - [":TRIGger:LIN:TRIGger"](#) on page 539
  - [":TRIGger:LIN:SIGNAL:DEFinition"](#) on page 705

**:TRIGger:LIN:STANdard**

**N** (see [page 750](#))

**Command Syntax** :TRIGger:LIN:STANdard <std>  
 <std> ::= {LIN13 | LIN20}

The :TRIGger:LIN:STANdard command sets the LIN standard in effect for triggering and decoding to be LIN1.3 or LIN2.0.

**Query Syntax** :TRIGger:LIN:STANdard?

The :TRIGger:LIN:STANdard? query returns the current LIN standard setting.

**Return Format** <std><NL>  
 <std> ::= {LIN13 | LIN20}

- See Also**
- "[Introduction to :TRIGger Commands](#)" on page 440
  - "[:TRIGger:MODE](#)" on page 447
  - "[:TRIGger:LIN:SIGNAL:DEFinition](#)" on page 705
  - "[:TRIGger:LIN:SOURce](#)" on page 536

### :TRIGger:LIN:SYNCbreak

**N** (see [page 750](#))

**Command Syntax** :TRIGger:LIN:SYNCbreak <value>  
<value> ::= integer = {11 | 12 | 13}

The :TRIGger:LIN:SYNCbreak command sets the length of the LIN sync break to be greater than or equal to 11, 12, or 13 clock lengths. The sync break is the idle period in the bus activity at the beginning of each packet that distinguishes one information packet from the previous one.

**Query Syntax** :TRIGger:LIN:SYNCbreak?

The :TRIGger:LIN:STANdard? query returns the current LIN sync break setting.

**Return Format** <value><NL>  
<value> ::= {11 | 12 | 13}

- See Also**
- "[Introduction to :TRIGger Commands](#)" on page 440
  - "[:TRIGger:MODE](#)" on page 447
  - "[:TRIGger:LIN:SIGNal:DEFinition](#)" on page 705
  - "[:TRIGger:LIN:SOURce](#)" on page 536

**:TRIGger:LIN:TRIGger**

**N** (see [page 750](#))

**Command Syntax** :TRIGger:LIN:TRIGger <condition>  
 <condition> ::= {SYNCbreak | ID | DATA}

The :TRIGger:LIN:TRIGger command sets the LIN trigger condition to be:

- SYNCbreak – Sync Break.
- ID – Frame ID.

Use the :TRIGger:LIN:ID command to specify the frame ID.

- DATA – Frame ID and Data.

Use the :TRIGger:LIN:ID command to specify the frame ID.

Use the :TRIGger:LIN:PATtern:DATA:LENGth and :TRIGger:LIN:PATtern:DATA commands to specify the data string length and value.

**NOTE**

The ID and DATA options are available when the automotive CAN and LIN serial decode option (Option AMS) has been licensed.

**Query Syntax** :TRIGger:LIN:TRIGger?

The :TRIGger:LIN:TRIGger? query returns the current LIN trigger value.

**Return Format** <condition><NL>  
 <condition> ::= {SYNC | ID | DATA}

**Errors** • "-241, Hardware missing" on [page 709](#)

**See Also** • ["Introduction to :TRIGger Commands"](#) on [page 440](#)  
 • [":TRIGger:MODE"](#) on [page 447](#)  
 • [":TRIGger:LIN:ID"](#) on [page 529](#)  
 • [":TRIGger:LIN:PATtern:DATA:LENGth"](#) on [page 532](#)  
 • [":TRIGger:LIN:PATtern:DATA"](#) on [page 530](#)  
 • [":TRIGger:LIN:SIGNal:DEFinition"](#) on [page 705](#)  
 • [":TRIGger:LIN:SOURce"](#) on [page 536](#)

## :TRIGger:M1553 Commands

**Table 79** :TRIGger:M1553 Commands Summary

| Command  | Query  | Options and Query Returns   |
|--|--|---|
| :TRIGger:M1553:AUTOsetup (see <a href="#">page 541</a> )             | n/a  | n/a   |
| :TRIGger:M1553:PATTERN:DATA <string> (see <a href="#">page 542</a> ) | :TRIGger:M1553:PATTERN:DATA? (see <a href="#">page 542</a> ) | <string> ::= "nn...n" where n ::= {0   1   X}   |
| :TRIGger:M1553:RTA <value> (see <a href="#">page 543</a> )           | :TRIGger:M1553:RTA? (see <a href="#">page 543</a> )          | <value> ::= 5-bit integer in decimal, <nondecimal>, or <string> from 0-31<br><nondecimal> ::= #Hnn where n ::= {0,...,9 A,...,F}<br><string> ::= "0xnn" where n ::= {0,...,9 A,...,F} |
| :TRIGger:M1553:SOURCE:LOWER <source> (see <a href="#">page 544</a> ) | :TRIGger:M1553:SOURCE:LOWER? (see <a href="#">page 544</a> ) | <source> ::= {CHANNEL<n>}<br><n> ::= {2   4}  |
| :TRIGger:M1553:SOURCE:UPPER <source> (see <a href="#">page 545</a> ) | :TRIGger:M1553:SOURCE:UPPER? (see <a href="#">page 545</a> ) | <source> ::= {CHANNEL<n>}<br><n> ::= {1   3}  |
| :TRIGger:M1553:TYPE <type> (see <a href="#">page 546</a> )           | :TRIGger:M1553:TYPE? (see <a href="#">page 546</a> )         | <type> ::= {DSTART   DSTOP   CSTART   CSTOP   RTA   PERROR   SERROR   MERROR   RTA11}   |

## :TRIGger:M1553:AUTOsetup

**N** (see [page 750](#))

**Command Syntax** :TRIGger:M1553:AUTOsetup

The :TRIGger:M1553:AUTOsetup command copies the position, volts/div, and probe attenuation from the upper threshold channel to the lower threshold channel, sets the upper/lower trigger levels to +/- 500 mV, turns on serial decode, and sets the trigger mode to M1553.

- See Also**
- ["Introduction to :TRIGger Commands"](#) on page 440
  - [":TRIGger:MODE"](#) on page 447
  - [":TRIGger:M1553:SOURce:UPPer"](#) on page 545

## **:TRIGger:M1553:PATtern:DATA**

**N** (see [page 750](#))

**Command Syntax** :TRIGger:M1553:PATtern:DATA <string>

<string> ::= "nn...n" where n ::= {0 | 1 | X}

The :TRIGger:M1553:PATtern:DATA command sets the 11 bits to trigger on if the trigger type has been set to RTA11 (RTA + 11 Bits) using the :TRIG:M1553:TYPE command.

**Query Syntax** :TRIGger:M1553:PATtern:DATA?

The :TRIGger:M1553:PATtern:DATA? query returns the current 11-bit setting.

**Return Format** <string><NL>

<string> ::= "nn...n" where n ::= {0 | 1 | X}

- See Also**
- "[Introduction to :TRIGger Commands](#)" on page 440
  - "[:TRIGger:M1553:TYPE](#)" on page 546

**:TRIGger:M1553:RTA**

**N** (see [page 750](#))

**Command Syntax** :TRIGger:M1553:RTA <value>  
 <value> ::= 5-bit integer in decimal, <nondecimal>, or  
 <string> from 0-31  
 <nondecimal> ::= #Hnn where n ::= {0,...,9|A,...,F}  
 <string> ::= "0xnn" where n ::= {0,...,9|A,...,F}

The :TRIGger:M1553:RTA command sets the Remote Terminal Address (RTA) to trigger on if the trigger type has been set to RTA using the :TRIG:M1553:TYPE command.

**Query Syntax** :TRIGger:M1553:RTA?

The :TRIGger:M1553:RTA? query returns the current TV trigger line number setting.

**Return Format** <value><NL> in nondecimal format

- See Also**
- "[Introduction to :TRIGger Commands](#)" on page 440
  - "[:TRIGger:M1553:TYPE](#)" on page 546

## **:TRIGger:M1553:SOURce:LOWer**

**N** (see [page 750](#))

**Command Syntax** :TRIGger:M1553:SOURce:LOWer <source>  
<source> ::= {CHANnel<n>}  
<n> ::= {2 | 4}

The :TRIGger:M1553:SOURce:LOWer command controls which signal is used as the Lower Threshold Channel source by the serial decoder and/or trigger when in MIL-1553 mode.

**Query Syntax** :TRIGger:M1553:SOURce:LOWer?

The :TRIGger:M1553:SOURce:LOWer? query returns the currently set Lower Threshold Channel source.

**Return Format** <source><NL>  
<source> ::= {CHAN<n>}  
<n> ::= {2 | 4}

- See Also**
- ["Introduction to :TRIGger Commands"](#) on page 440
  - [":TRIGger:MODE"](#) on page 447
  - [":TRIGger:M1553:SOURce:UPPer"](#) on page 545

**:TRIGger:M1553:SOURce:UPPer**

**N** (see [page 750](#))

**Command Syntax** :TRIGger:M1553:SOURce:UPPer <source>

<source> ::= {CHANnel<n>}

<n> ::= {1 | 3}

The :TRIGger:M1553:SOURce:UPPer command controls which signal is used as the Upper Threshold Channel source by the serial decoder and/or trigger when in MIL-1553 mode.

**Query Syntax** :TRIGger:M1553:SOURce:UPPer?

The :TRIGger:M1553:SOURce:UPPer? query returns the currently set Upper Threshold Channel source.

**Return Format** <source><NL>

<source> ::= {CHAN<n>}

<n> ::= {1 | 3}

- See Also**
- ["Introduction to :TRIGger Commands"](#) on page 440
  - [":TRIGger:MODE"](#) on page 447
  - [":TRIGger:M1553:SOURce:LOWer"](#) on page 544

**:TRIGger:M1553:TYPE**

**N** (see page 750)

**Command Syntax** :TRIGger:M1553:TYPE <type>

```
<type> ::= {DSTart | DSTOp | CSTArt | CSTOp | RTA | PERRor | SERRor
            | MERRor | RTA11}
```

The :TRIGger:M1553:TYPE command specifies the type of MIL-STD 1553 trigger to be used:

- **DSTart** – (Data Word Start) triggers on the start of a Data word (at the end of a valid Data Sync pulse).
- **DSTOp** – (Data Word Stop) triggers on the end of a Data word.
- **CSTArt** – (Command/Status Word Start) triggers on the start of Command/Status word (at the end of a valid C/S Sync pulse).
- **CSTOp** – (Command/Status Word Stop) triggers on the end of a Command/Status word.
- **RTA** – (Remote Terminal Address) triggers if the RTA of the Command/Status word matches the specified value. The value is specified in hex.
- **RTA11** – (RTA + 11 Bits) triggers if the RTA and the remaining 11 bits match the specified criteria. The RTA can be specified as a hex value, and the remaining 11 bits can be specified as a 1, 0, or X (don't care).
- **PERRor** – (Parity Error) triggers if the (odd) parity bit is incorrect for the data in the word.
- **MERRor** – (Manchester Error) triggers if a Manchester encoding error is detected.
- **SERRor** – (Sync Error) triggers if an invalid Sync pulse is found.

**Query Syntax** :TRIGger:M1553:TYPE?

The :TRIGger:M1553:TYPE? query returns the currently set MIL-STD 1553 trigger type.

**Return Format** <type><NL>

```
<type> ::= {DSTA | DSTO | CSTA | CSTO | RTA | PERR | SERR
            | MERR | RTA11}
```

- See Also**
- "Introduction to :TRIGger Commands" on page 440
  - ":TRIGger:M1553:RTA" on page 543
  - ":TRIGger:M1553:PATtern:DATA" on page 542
  - ":TRIGger:MODE" on page 447

## :TRIGger:SEQuence Commands

**Table 80** :TRIGger:SEQuence Commands Summary

| Command  | Query   | Options and Query Returns  |
|--|---|--|
| :TRIGger:SEQuence:COU<br>Nt <count> (see<br>page 548)                  | :TRIGger:SEQuence:COU<br>Nt? (see page 548)           | <count> ::= integer in NR1 format  |
| :TRIGger:SEQuence:EDG<br>E{1 2} <source>,<br><slope> (see<br>page 549) | :TRIGger:SEQuence:EDG<br>E{1 2}? (see<br>page 549)    | <source> ::= {CHANnel<n>  <br>EXTernal}<br><slope> ::= {POSitive   NEGative}<br><n> ::= 1-2 or 1-4 in NR1 format<br><return_value> ::= query returns<br>"NONE" if edge source is disabled  |
| :TRIGger:SEQuence:FIN<br>D <value> (see<br>page 550)                   | :TRIGger:SEQuence:FIN<br>D? (see page 550)            | <value> ::= {PATtern1,ENTerEd  <br>PATtern1,EXITed   EDGE1  <br>PATtern1,AND,EDGE1}  |
| :TRIGger:SEQuence:PAT<br>Tern{1 2} <value>,<br><mask> (see page 551)   | :TRIGger:SEQuence:PAT<br>Tern{1 2}? (see<br>page 551) | <value> ::= integer or <string><br><mask> ::= integer or <string><br><string> ::= "0xnxxxxn" n ::=<br>{0,...,9   A,...,F}  |
| :TRIGger:SEQuence:RES<br>et <value> (see<br>page 552)                  | :TRIGger:SEQuence:RES<br>et? (see page 552)           | <value> ::= {NONE  <br>PATtern1,ENTerEd  <br>PATtern1,EXITed   EDGE1  <br>PATtern1,AND,EDGE1  <br>PATtern2,ENTerEd  <br>PATtern2,EXITed   EDGE2   TIMer}<br>Values used in find and trigger<br>stages not available. EDGE2 not<br>available if EDGE2,COUNT used in<br>trigger stage. |
| :TRIGger:SEQuence:TIM<br>er <time_value> (see<br>page 553)             | :TRIGger:SEQuence:TIM<br>er? (see page 553)           | <time_value> ::= time from 10 ns<br>to 10 seconds in NR3 format  |
| :TRIGger:SEQuence:TRI<br>Gger <value> (see<br>page 554)                | :TRIGger:SEQuence:TRI<br>Gger? (see page 554)         | <value> ::= {PATtern2,ENTerEd  <br>PATtern2,EXITed   EDGE2  <br>PATtern2,AND,EDGE2   EDGE2,COUNT<br>  EDGE2,COUNT,NREFind}   |

## **:TRIGger:SEQuence:COUNT**

**N** (see [page 750](#))

**Command Syntax** :TRIGger:SEQuence:COUNT <count>  
<count> ::= integer in NR1 format

The :TRIGger:SEQuence:COUNT command sets the sequencer edge counter resource. The edge counter is used in the trigger stage to determine the number of edges that must be found before the sequencer generates a trigger.

**Query Syntax** :TRIGger:SEQuence:COUNT?

The :TRIGger:SEQuence:COUNT? query returns the current sequencer edge counter setting.

**Return Format** <count><NL>  
<count> ::= integer in NR1 format

- See Also**
- ["Introduction to :TRIGger Commands"](#) on page 440
  - [":TRIGger:SEQuence:TRIGger"](#) on page 554
  - [":TRIGger:SEQuence:EDGE"](#) on page 549

**:TRIGger:SEQuence:EDGE**

**N** (see [page 750](#))

**Command Syntax** :TRIGger:SEQuence:EDGE{1 | 2} <source>, <slope>

<source> ::= {CHANnel<n> | EXTernal}

<slope> ::= {POSitive | NEGative}

<n> ::= {1 | 2 | 3 | 4} for the four channel oscilloscope models

<n> ::= {1 | 2} for the two channel oscilloscope models

The :TRIGger:SEQuence:EDGE<n> command defines the specified sequencer edge resource according to the specified <source> and <slope>. To disable an edge resource, set its <source> to NONE. In this case, <slope> has no meaning.

**Query Syntax** :TRIGger:SEQuence:EDGE{1 | 2}?

The :TRIGger:SEQuence:EDGE<n>? query returns the specified sequencer edge resource setting. If the edge resource is disabled, the returned <source> value is NONE. In this case, the <slope> is undefined.

**Return Format** <source>, <slope><NL>

- See Also**
- ["Introduction to :TRIGger Commands"](#) on page 440
  - [":TRIGger:SEQuence:FIND"](#) on page 550
  - [":TRIGger:SEQuence:TRIGger"](#) on page 554
  - [":TRIGger:SEQuence:RESet"](#) on page 552
  - [":TRIGger:SEQuence:COUNT"](#) on page 548

**:TRIGger:SEQuence:FIND**

**N** (see [page 750](#))

**Command Syntax** :TRIGger:SEQuence:FIND <value>  
 <value> ::= {PATTern1,ENTered | PATTern1,EXITed | EDGE1  
 | PATTern1,AND,EDGE1}

The :TRIGger:SEQuence:FIND command specifies the find stage of a sequence trigger. This command accepts three program data parameters; you can use NONE to fill out the parameter list (for example,"EDGE1,NONE,NONE").

PATTern1 is specified with the":TRIGger:SEQuence:PATTern command. EDGE1 is specified with the :TRIGger:SEQuence:EDGE command.

**Query Syntax** :TRIGger:SEQuence:FIND?

The :TRIGger:SEQuence:FIND? query returns the find stage specification for a sequence trigger. NONE is returned for unused parameters.

**Return Format** <find\_value><NL>  
 <find\_value> ::= {PATT1,ENT,NONE | PATT1,EXIT,NONE | EDGE1,NONE,NONE  
 | PATT1,AND,EDGE1}

- See Also**
- "[Introduction to :TRIGger Commands](#)" on page 440
  - "[:TRIGger:SEQuence:PATTern](#)" on page 551
  - "[:TRIGger:SEQuence:EDGE](#)" on page 549
  - "[:TRIGger:SEQuence:TRIGger](#)" on page 554
  - "[:TRIGger:SEQuence:RESet](#)" on page 552

## :TRIGger:SEQuence:PATtern

**N** (see [page 750](#))

**Command Syntax** :TRIGger:SEQuence:PATtern{1 | 2} <value>,<mask>  
 <value> ::= integer or <string>  
 <mask> ::= integer or <string>  
 <string> ::= "0xnmmnnn" where n ::= {0,...,9 | A,...,F}

The :TRIGger:SEQuence:PATtern<n> command defines the specified sequence pattern resource according to the value and the mask. For both <value> and <mask>, each bit corresponds to a possible trigger channel. The bit assignments vary by instrument:

| Oscilloscope Models | Value and Mask Bit Assignments   |
|---------------------|--|
| 4 analog channels   | Bits 0 through 3 - analog channels 1 through 4.<br>Bit 4 - external trigger. |
| 2 analog channels   | Bits 0 and 1 - analog channels 1 and 2. Bit 4 - external trigger.            |

Set a <value> bit to "0" to set the pattern for the corresponding channel to low. Set a <value> bit to "1" to set the pattern to high.

Set a <mask> bit to "0" to ignore the data for the corresponding channel. Only channels with a "1" set on the appropriate mask bit are used.

**Query Syntax** :TRIGger:SEQuence:PATtern{1 | 2}?

The :TRIGger:SEQuence:PATtern<n>? query returns the current settings of the specified pattern resource.

**Return Format** <value>,<mask><NL>

- See Also**
- ["Introduction to :TRIGger Commands"](#) on page 440
  - [":TRIGger:SEQuence:FIND"](#) on page 550
  - [":TRIGger:SEQuence:TRIGger"](#) on page 554
  - [":TRIGger:SEQuence:RESet"](#) on page 552

**:TRIGger:SEQuence:RESet**

**N** (see [page 750](#))

**Command Syntax** :TRIGger:SEQuence:RESet <value>

```
<value> ::= {NONE | PATTErn1,ENTERed | PATTErn1,EXITed | EDGE1
            | PATTErn1,AND,EDGE1 | PATTErn2,ENTERed | PATTErn2,EXITed
            | EDGE2 | TIMer}
```

Values used in find and trigger stages are not available. EDGE2 is not available if EDGE2,COUNT is used in trigger stage.

The :TRIGger:SEQuence:RESet command specifies the reset stage of a sequence trigger. In multi-level trigger specifications, you may find a pattern, then search for another in sequence, but reset the entire search to the beginning if another condition occurs. This command accepts three program data parameters; you can use NONE to fill out the parameter list (for example, "EDGE1,NONE,NONE").

PATTErn1 and PATTErn2 are specified with the :TRIGger:SEQuence:PATTErn command. EDGE1 and EDGE2 are specified with the :TRIGger:SEQuence:EDGE command. TIMer is specified with the :TRIGger:SEQuence:TIMer command.

**Query Syntax** :TRIGger:SEQuence:RESet?

The :TRIGger:SEQuence:RESet? query returns the reset stage specification for a sequence trigger. NONE is returned for unused parameters.

**Return Format** <reset\_value><NL>

```
<reset_value> ::= {NONE,NONE,NONE | PATT1,ENT,NONE | PATT1,EXIT,NONE
                  | EDGE1,NONE,NONE | PATT1,AND,EDGE1 | PATT2,ENT,NONE
                  | PATT2,EXIT,NONE | EDGE2,NONE,NONE | TIM,NONE,NONE}
```

- See Also**
- ["Introduction to :TRIGger Commands"](#) on page 440
  - [":TRIGger:SEQuence:PATTErn"](#) on page 551
  - [":TRIGger:SEQuence:EDGE"](#) on page 549
  - [":TRIGger:SEQuence:TIMer"](#) on page 553
  - [":TRIGger:SEQuence:FIND"](#) on page 550
  - [":TRIGger:SEQuence:TRIGger"](#) on page 554

**:TRIGger:SEQuence:TIMer**

**N** (see [page 750](#))

**Command Syntax** :TRIGger:SEQuence:TIMer <time\_value>

<time\_value> ::= time in seconds in NR1 format

The :TRIGger:SEQuence:TIMer command sets the sequencer timer resource in seconds from 10 ns to 10 s. The timer is used in the reset stage to determine how long to wait for the trigger to occur before restarting.

**Query Syntax** :TRIGger:SEQuence:TIMer?

The :TRIGger:SEQuence:TIMer? query returns current sequencer timer setting.

**Return Format** <time value><NL>

<time\_value> ::= time in seconds in NR1 format

- See Also**
- "[Introduction to :TRIGger Commands](#)" on page 440
  - "[:TRIGger:SEQuence:RESet](#)" on page 552

**:TRIGger:SEQuence:TRIGger**

**N** (see [page 750](#))

**Command Syntax** :TRIGger:SEQuence:TRIGger <value>

```
<value> ::= {PATTern2,ENTerEd | PATTern2,EXITed | EDGE2
            | PATTern2,AND,EDGE2 | EDGE2,COUNT | EDGE2,COUNT,NREFind}
```

The :TRIGger:SEQuence:TRIGger command specifies the trigger stage of a sequence trigger. The sequence commands set various search terms. After all of these are found in sequence, the trigger condition itself is searched for. This command accepts three program data parameters; you can use NONE to fill out the parameter list (for example, "EDGE2,NONE,NONE").

PATTern2 is specified with the :TRIGger:SEQuence:PATTern command. EDGE2 is specified with the :TRIGger:SEQuence:EDGE command. COUNT is specified with the :TRIGger:SEQuence:COUNt command.

**Query Syntax** :TRIGger:SEQuence:TRIGger?

The :TRIGger:SEQuence:TRIGger? query returns the trigger stage specification for a sequence trigger. NONE is returned for unused parameters.

**Return Format** <trigger\_value><NL>

```
<trigger_value> ::= {PATT2,ENT,NONE | PATT2,EXIT,NONE
                    | EDGE2,NONE,NONE | PATT2,AND,EDGE2
                    | EDGE2,COUN,NONE | EDGE2,COUN,NREF}
```

- See Also**
- "Introduction to :TRIGger Commands" on page 440
  - ":TRIGger:SEQuence:PATTern" on page 551
  - ":TRIGger:SEQuence:EDGE" on page 549
  - ":TRIGger:SEQuence:COUNt" on page 548
  - ":TRIGger:SEQuence:FIND" on page 550
  - ":TRIGger:SEQuence:RESet" on page 552
  - ":TRIGger:SEQuence:RESet" on page 552

## :TRIGger:SPI Commands

**Table 81** :TRIGger:SPI Commands Summary

| Command   | Query  | Options and Query Returns   |
|---|--|---|
| :TRIGger:SPI:CLOCK:SL<br>OPe <slope> (see<br>page 556)          | :TRIGger:SPI:CLOCK:SL<br>OPe? (see page 556)   | <slope> ::= {NEGative   POSitive}   |
| :TRIGger:SPI:CLOCK:TI<br>Meout <time_value><br>(see page 557)   | :TRIGger:SPI:CLOCK:TI<br>Meout? (see page 557) | <time_value> ::= time in seconds<br>in NR1 format   |
| :TRIGger:SPI:FRAMing<br><value> (see<br>page 558)               | :TRIGger:SPI:FRAMing?<br>(see page 558)        | <value> ::= {CHIPselect  <br>NOTChipselect   TIMEout}   |
| :TRIGger:SPI:PATtern:<br>DATA <value>, <mask><br>(see page 559) | :TRIGger:SPI:PATtern:<br>DATA? (see page 559)  | <value> ::= integer or <string><br><mask> ::= integer or <string><br><string> ::= "0xnxxxxx" where n<br>::= {0,...,9   A,...,F} |
| :TRIGger:SPI:PATtern:<br>WIDTh <width> (see<br>page 560)        | :TRIGger:SPI:PATtern:<br>WIDTh? (see page 560) | <width> ::= integer from 4 to 32<br>in NR1 format   |
| :TRIGger:SPI:SOURce:C<br>LOCK <source> (see<br>page 561)        | :TRIGger:SPI:SOURce:C<br>LOCK? (see page 561)  | <value> ::= {CHANnel<n>  <br>EXTernal}<br><n> ::= 1-2 or 1-4 in NR1 format  |
| :TRIGger:SPI:SOURce:D<br>ATA <source> (see<br>page 562)         | :TRIGger:SPI:SOURce:D<br>ATA? (see page 562)   | <value> ::= {CHANnel<n>  <br>EXTernal}<br><n> ::= 1-2 or 1-4 in NR1 format  |
| :TRIGger:SPI:SOURce:F<br>RAME <source> (see<br>page 563)        | :TRIGger:SPI:SOURce:F<br>RAME? (see page 563)  | <value> ::= {CHANnel<n>  <br>EXTernal}<br><n> ::= 1-2 or 1-4 in NR1 format  |

## :TRIGger:SPI:CLOCK:SLOPe

**N** (see [page 750](#))

**Command Syntax** :TRIGger:SPI:CLOCK:SLOPe <slope>  
<slope> ::= {NEGative | POSitive}

The :TRIGger:SPI:CLOCK:SLOPe command specifies the rising edge (POSitive) or falling edge (NEGative) of the SPI clock source that will clock in the data.

**Query Syntax** :TRIGger:SPI:CLOCK:SLOPe?

The :TRIGger:SPI:CLOCK:SLOPe? query returns the current SPI clock source slope.

**Return Format** <slope><NL>  
<slope> ::= {NEG | POS}

- See Also**
- ["Introduction to :TRIGger Commands"](#) on page 440
  - [":TRIGger:SPI:CLOCK:TIMEout"](#) on page 557
  - [":TRIGger:SPI:SOURce:CLOCK"](#) on page 561

**:TRIGger:SPI:CLOCK:TIMEout**

**N** (see [page 750](#))

**Command Syntax** :TRIGger:SPI:CLOCK:TIMEout <time\_value>

<time\_value> ::= time in seconds in NR1 format

The :TRIGger:SPI:CLOCK:TIMEout command sets the SPI signal clock timeout resource in seconds from 500 ns to 10 s when the :TRIGger:SPI:FRAMing command is set to TIMEout. The timer is used to frame a signal by a clock timeout.

**Query Syntax** :TRIGger:SPI:CLOCK:TIMEout?

The :TRIGger:SPI:CLOCK:TIMEout? query returns current SPI clock timeout setting.

**Return Format** <time value><NL>

<time\_value> ::= time in seconds in NR1 format

- See Also**
- ["Introduction to :TRIGger Commands"](#) on page 440
  - [":TRIGger:SPI:CLOCK:SLOPe"](#) on page 556
  - [":TRIGger:SPI:SOURce:CLOCK"](#) on page 561
  - [":TRIGger:SPI:FRAMing"](#) on page 558

## :TRIGger:SPI:FRAMing

**N** (see [page 750](#))

**Command Syntax** :TRIGger:SPI:FRAMing <value>

<value> ::= {CHIPselect | NOTChipselect | TIMEout}

The :TRIGger:SPI:FRAMing command sets the SPI trigger framing value. If TIMEout is selected, the timeout value is set by the :TRIGger:SPI:CLOCK:TIMEout command.

**Query Syntax** :TRIGger:SPI:FRAMing?

The :TRIGger:SPI:FRAMing? query returns the current SPI framing value.

**Return Format** <value><NL>

<value> ::= {CHIPselect | NOTChipselect | TIMEout}

- See Also**
- "[Introduction to :TRIGger Commands](#)" on page 440
  - "[:TRIGger:MODE](#)" on page 447
  - "[:TRIGger:SPI:CLOCK:TIMEout](#)" on page 557
  - "[:TRIGger:SPI:SOURce:FRAME](#)" on page 563

**:TRIGger:SPI:PATtern:DATA**

**N** (see [page 750](#))

**Command Syntax** :TRIGger:SPI:PATtern:DATA <value>,<mask>

<value> ::= integer or <string>

<mask> ::= integer or <string>

<string> ::= "0xnnnnnn" where n ::= {0,...,9 | A,...,F}

The :TRIGger:SPI:PATtern:DATA command defines the SPI data pattern resource according to the value and the mask. This pattern, along with the data width, control the data pattern searched for in the data stream.

Set a <value> bit to "0" to set the corresponding bit in the data pattern to low. Set a <value> bit to "1" to set the bit to high.

Set a <mask> bit to "0" to ignore that bit in the data stream. Only bits with a "1" set on the mask are used.

**Query Syntax** :TRIGger:SPI:PATtern:DATA?

The :TRIGger:SPI:PATtern:DATA? query returns the current settings of the specified SPI data pattern resource.

**Return Format** <value> , <mask><NL>

- See Also**
- ["Introduction to :TRIGger Commands"](#) on page 440
  - [":TRIGger:SPI:PATtern:WIDTh"](#) on page 560
  - [":TRIGger:SPI:SOURce:DATA"](#) on page 562

## **:TRIGger:SPI:PATtern:WIDTh**

**N** (see [page 750](#))

**Command Syntax** :TRIGger:SPI:PATtern:WIDTh <width>  
<width> ::= integer from 4 to 32 in NR1 format

The :TRIGger:SPI:PATtern:WIDTh command sets the width of the SPI data pattern anywhere from 4 bits to 32 bits.

**Query Syntax** :TRIGger:SPI:PATtern:WIDTh?

The :TRIGger:SPI:PATtern:WIDTh? query returns the current SPI data pattern width setting.

**Return Format** <width><NL>  
<width> ::= integer from 4 to 32 in NR1 format

- See Also**
- "[Introduction to :TRIGger Commands](#)" on page 440
  - "[:TRIGger:SPI:PATtern:DATA](#)" on page 559
  - "[:TRIGger:SPI:SOURce:DATA](#)" on page 562

**:TRIGger:SPI:SOURce:CLOCK**

**N** (see [page 750](#))

**Command Syntax** :TRIGger:SPI:SOURce:CLOCK <source>  
 <source> ::= {CHANnel<n> | EXTernal}  
 <n> ::= {1 | 2 | 3 | 4} for the four channel oscilloscope models  
 <n> ::= {1 | 2} for the two channel oscilloscope models

The :TRIGger:SPI:SOURce:CLOCK command sets the source for the SPI serial clock.

**Query Syntax** :TRIGger:SPI:SOURce:CLOCK?

The :TRIGger:SPI:SOURce:CLOCK? query returns the current source for the SPI serial clock.

**Return Format** <source><NL>

- See Also**
- ["Introduction to :TRIGger Commands"](#) on page 440
  - [":TRIGger:SPI:CLOCK:SLOPe"](#) on page 556
  - [":TRIGger:SPI:CLOCK:TIMEout"](#) on page 557
  - [":TRIGger:SPI:SOURce:FRAMe"](#) on page 563
  - [":TRIGger:SPI:SOURce:DATA"](#) on page 562

## :TRIGger:SPI:SOURce:DATA

**N** (see [page 750](#))

**Command Syntax** :TRIGger:SPI:SOURce:DATA <source>

<source> ::= {CHANnel<n> | EXTernal}

<n> ::= {1 | 2 | 3 | 4} for the four channel oscilloscope models

<n> ::= {1 | 2} for the two channel oscilloscope models

The :TRIGger:SPI:SOURce:DATA command sets the source for the SPI serial data.

**Query Syntax** :TRIGger:SPI:SOURce:DATA?

The :TRIGger:SPI:SOURce:DATA? query returns the current source for the SPI serial data.

**Return Format** <source><NL>

- See Also**
- ["Introduction to :TRIGger Commands"](#) on page 440
  - [":TRIGger:SPI:SOURce:CLOCK"](#) on page 561
  - [":TRIGger:SPI:SOURce:FRAME"](#) on page 563
  - [":TRIGger:SPI:PATtern:DATA"](#) on page 559
  - [":TRIGger:SPI:PATtern:WIDTh"](#) on page 560

**:TRIGger:SPI:SOURce:FRAME**

**N** (see [page 750](#))

**Command Syntax** :TRIGger:SPI:SOURce:FRAME <source>

<source> ::= {CHANnel<n> | EXTernal}

<n> ::= {1 | 2 | 3 | 4} for the four channel oscilloscope models

<n> ::= {1 | 2} for the two channel oscilloscope models

The :TRIGger:SPI:SOURce:FRAME command sets the frame source when :TRIGger:SPI:FRAMing is set to CHIPselect or NOTChipselect.

**Query Syntax** :TRIGger:SPI:SOURce:FRAME?

The :TRIGger:SPI:SOURce:FRAME? query returns the current frame source for the SPI serial frame.

**Return Format** <source><NL>

- See Also**
- ["Introduction to :TRIGger Commands"](#) on page 440
  - [":TRIGger:SPI:SOURce:CLOCK"](#) on page 561
  - [":TRIGger:SPI:SOURce:DATA"](#) on page 562
  - [":TRIGger:SPI:FRAMing"](#) on page 558

## :TRIGger:TV Commands

**Table 82** :TRIGger:TV Commands Summary

| Command  | Query                                   | Options and Query Returns  |
|--|---|--|
| :TRIGger:TV:LINE<br><line number> (see<br>page 565)  | :TRIGger:TV:LINE?<br>(see page 565)     | <line number> ::= integer in NR1<br>format   |
| :TRIGger:TV:MODE <tv<br>mode> (see page 566)         | :TRIGger:TV:MODE?<br>(see page 566)     | <tv mode> ::= {FIELD1   FIELD2  <br>AFIELDS   ALINES   LINE  <br>VERTICAL   LFIELD1   LFIELD2  <br>LALTERNATE   LVERTICAL}   |
| :TRIGger:TV:POLarity<br><polarity> (see<br>page 567) | :TRIGger:TV:POLarity?<br>(see page 567) | <polarity> ::= {POSitive  <br>NEGative}  |
| :TRIGger:TV:SOURce<br><source> (see<br>page 568)     | :TRIGger:TV:SOURce?<br>(see page 568)   | <source> ::= {CHANnel<n>}<br><n> ::= 1-2 or 1-4 integer in NR1<br>format   |
| :TRIGger:TV:STANdard<br><standard> (see<br>page 569) | :TRIGger:TV:STANdard?<br>(see page 569) | <standard> ::= {GENeric   NTSC  <br>PALM   PAL   SECam   {P480L60HZ  <br>P480}   {P720L60HZ   P720}  <br>{P1080L24HZ   P1080}   P1080L25HZ<br>  P1080L50HZ   P1080L60HZ  <br>{I1080L50HZ   I1080}  <br>I1080L60HZ} |

## :TRIGger:TV:LINE

**N** (see page 750)

**Command Syntax** :TRIGger:TV:LINE <line\_number>

<line\_number> ::= integer in NR1 format

The :TRIGger:TV:LINE command allows triggering on a specific line of video. The line number limits vary with the standard and mode, as shown in the following table.

**Table 83** TV Trigger Line Number Limits

| TV Standard | Mode      |           |            |            |           |
|-------------|-----------|-----------|------------|------------|-----------|
|             | LINE      | LField1   | LField2    | LALternate | VERTical  |
| NTSC        |           | 1 to 263  | 1 to 262   | 1 to 262   |           |
| PAL         |           | 1 to 313  | 314 to 625 | 1 to 312   |           |
| PAL-M       |           | 1 to 263  | 264 to 525 | 1 to 262   |           |
| SECAM       |           | 1 to 313  | 314 to 625 | 1 to 312   |           |
| GENERIC     |           | 1 to 1024 | 1 to 1024  |            | 1 to 1024 |
| P480L60HZ   | 1 to 525  |           |            |            |           |
| P720L60HZ   | 1 to 750  |           |            |            |           |
| P1080L24HZ  | 1 to 1125 |           |            |            |           |
| P1080L25HZ  | 1 to 1125 |           |            |            |           |
| P1080L50HZ  | 1 to 1125 |           |            |            |           |
| P1080L60HZ  | 1 to 1125 |           |            |            |           |
| I1080L50HZ  | 1 to 1125 |           |            |            |           |
| I1080L60HZ  | 1 to 1125 |           |            |            |           |

**Query Syntax** :TRIGger:TV:LINE?

The :TRIGger:TV:LINE? query returns the current TV trigger line number setting.

**Return Format** <line\_number><NL>

<line\_number> ::= integer in NR1 format

- See Also**
- "Introduction to :TRIGger Commands" on page 440
  - ":TRIGger:TV:STANdard" on page 569
  - ":TRIGger:TV:MODE" on page 566

**:TRIGger:TV:MODE**

**N** (see [page 750](#))

**Command Syntax** :TRIGger:TV:MODE <mode>

```
<mode> ::= {FIEld1 | FIEld2 | AFIElds | ALINes | LINE | VERTical
            | LFIeld1 | LFIeld2 | LALTernate | LVERTical}
```

The :TRIGger:TV:MODE command selects the TV trigger mode and field. The LVERTical parameter is only available when :TRIGger:TV:STANdard is GENERIC. The LALTernate parameter is not available when :TRIGger:TV:STANdard is GENERIC.

Old forms for <mode> are accepted:

| <mode>     | Old Forms Accepted |
|------------|--------------------|
| FIEld1     | F1                 |
| FIEld2     | F2                 |
| AFIElds    | ALLFields, ALLFLDS |
| ALINes     | ALLLines           |
| LFIeld1    | LINEF1, LINEFIELD1 |
| LFIeld2    | LINEF2, LINEFIELD2 |
| LALTernate | LINEAlt            |
| LVERTical  | LINEVert           |

**Query Syntax** :TRIGger:TV:MODE?

The :TRIGger:TV:MODE? query returns the TV trigger mode.

**Return Format** <value><NL>

```
<value> ::= {FIE1 | FIE2 | AFI | ALIN | LINE | VERT | LFI1 | LFI2
            | LALT | LVER}
```

- See Also**
- ["Introduction to :TRIGger Commands"](#) on page 440
  - [":TRIGger:TV:STANdard"](#) on page 569
  - [":TRIGger:MODE"](#) on page 447

## **:TRIGger:TV:POLarity**

**N** (see [page 750](#))

**Command Syntax** :TRIGger:TV:POLarity <polarity>  
<polarity> ::= {POSitive | NEGative}

The :TRIGger:TV:POLarity command sets the polarity for the TV trigger.

**Query Syntax** :TRIGger:TV:POLarity?

The :TRIGger:TV:POLarity? query returns the TV trigger polarity.

**Return Format** <polarity><NL>  
<polarity> ::= {POS | NEG}

- See Also**
- ["Introduction to :TRIGger Commands"](#) on page 440
  - [":TRIGger:MODE"](#) on page 447
  - [":TRIGger:TV:SOURce"](#) on page 568

## :TRIGger:TV:SOURce

**N** (see [page 750](#))

**Command Syntax** :TRIGger:TV:SOURce <source>

<source> ::= {CHANnel<n>}

<n> ::= {1 | 2 | 3 | 4} for the four channel oscilloscope models

<n> ::= {1 | 2} for the two channel oscilloscope models

The :TRIGger:TV:SOURce command selects the channel used to produce the trigger.

**Query Syntax** :TRIGger:TV:SOURce?

The :TRIGger:TV:SOURce? query returns the current TV trigger source.

**Return Format** <source><NL>

<source> ::= {CHAN<n>}

- See Also**
- ["Introduction to :TRIGger Commands"](#) on page 440
  - [":TRIGger:MODE"](#) on page 447
  - [":TRIGger:TV:POLarity"](#) on page 567

**Example Code**

- ["Example Code"](#) on page 479

**:TRIGger:TV:STANdard**

**N** (see page 750)

**Command Syntax** :TRIGger:TV:STANdard <standard>

```
<standard> ::= {GENeric | NTSC | PALM | PAL | SECam
                | {P480L60HZ | P480} | {P720L60HZ | P720}
                | {P1080L24HZ | P1080} | P1080L25HZ
                | P1080L50HZ | P1080L60HZ
                | {I1080L50HZ | I1080} | I1080L60HZ}
```

The :TRIGger:TV:STANdard command selects the video standard. GENeric mode is non-interlaced.

**Query Syntax** :TRIGger:TV:STANdard?

The :TRIGger:TV:STANdard? query returns the current TV trigger standard setting.

**Return Format** <standard><NL>

```
<standard> ::= {GEN | NTSC | PALM | PAL | SEC | P480L60HZ | P760L60HZ
                | P1080L24HZ | P1080L25HZ | P1080L50HZ | P1080L60HZ
                | I1080L50HZ | I1080L60HZ}
```

## :TRIGger:UART Commands

**Table 84** :TRIGger:UART Commands Summary

| Command  | Query  | Options and Query Returns  |
|--|--|--|
| :TRIGger:UART:BASE<br><base> (see <a href="#">page 572</a> )         | :TRIGger:UART:BASE?<br>(see <a href="#">page 572</a> )       | <base> ::= {ASCIi   HEX}   |
| :TRIGger:UART:BAUDrate<br><baudrate> (see <a href="#">page 573</a> ) | :TRIGger:UART:BAUDrate?<br>(see <a href="#">page 573</a> )   | <baudrate> ::= integer from 1200 to 3000000 in 100 b/s increments  |
| :TRIGger:UART:BITorder<br><bitorder> (see <a href="#">page 574</a> ) | :TRIGger:UART:BITorder?<br>(see <a href="#">page 574</a> )   | <bitorder> ::= {LSBFirst   MSBFirst}   |
| :TRIGger:UART:BURSt<br><value> (see <a href="#">page 575</a> )       | :TRIGger:UART:BURSt?<br>(see <a href="#">page 575</a> )      | <value> ::= {OFF   1 to 4096 in NR1 format}  |
| :TRIGger:UART:DATA<br><value> (see <a href="#">page 576</a> )        | :TRIGger:UART:DATA?<br>(see <a href="#">page 576</a> )       | <value> ::= 8-bit integer from 0-255 (0x00-0xff) in decimal, <hexadecimal>, <binary>, or <quoted_string> format<br><hexadecimal> ::= #Hnn where n ::= {0,...,9   A,...,F} for hexadecimal<br><binary> ::= #Bnn...n where n ::= {0   1} for binary<br><quoted_string> ::= any of the 128 valid 7-bit ASCII characters (or standard abbreviations) |
| :TRIGger:UART:IDLE<br><time_value> (see <a href="#">page 577</a> )   | :TRIGger:UART:IDLE?<br>(see <a href="#">page 577</a> )       | <time_value> ::= time from 1 us to 10 s in NR3 format  |
| :TRIGger:UART:PARity<br><parity> (see <a href="#">page 578</a> )     | :TRIGger:UART:PARity?<br>(see <a href="#">page 578</a> )     | <parity> ::= {EVEN   ODD   NONE}   |
| :TRIGger:UART:POLarity<br><polarity> (see <a href="#">page 579</a> ) | :TRIGger:UART:POLarity?<br>(see <a href="#">page 579</a> )   | <polarity> ::= {HIGH   LOW}  |
| :TRIGger:UART:QUALifier<br><value> (see <a href="#">page 580</a> )   | :TRIGger:UART:QUALifier?<br>(see <a href="#">page 580</a> )  | <value> ::= {EQUAL   NOTequal   GREATERthan   LESSthan}  |
| :TRIGger:UART:SOURce:<br>RX <source> (see <a href="#">page 581</a> ) | :TRIGger:UART:SOURce:<br>RX? (see <a href="#">page 581</a> ) | <source> ::= {CHANnel<n>   EXTERNAL}<br><n> ::= 1-2 or 1-4 in NR1 format   |

**Table 84** :TRIGger:UART Commands Summary (continued)

| Command  | Query                                       | Options and Query Returns  |
|--|---|--|
| :TRIGger:UART:SOURce:<br>TX <source> (see<br>page 582) | :TRIGger:UART:SOURce:<br>TX? (see page 582) | <source> ::= {CHANnel<n>  <br>EXTernal}<br><n> ::= 1-2 or 1-4 in NR1 format  |
| :TRIGger:UART:TYPE<br><value> (see<br>page 583)        | :TRIGger:UART:TYPE?<br>(see page 583)       | <value> ::= {RSTArt   RSTOp  <br>RDATA   RD1   RD0   RDX  <br>PARityerror   TSTArt   TSTOp  <br>TDATA   TD1   TD0   TDX} |
| :TRIGger:UART:WIDTh<br><width> (see<br>page 584)       | :TRIGger:UART:WIDTh?<br>(see page 584)      | <width> ::= {5   6   7   8   9}  |

## :TRIGger:UART:BASE

**N** (see [page 750](#))

**Command Syntax** :TRIGger:UART:BASE <base>  
<base> ::= {ASCIi | HEX}

The :TRIGger:UART:BASE command sets the front panel UART/RS232 trigger setup data selection option:

- ASCii – front panel data selection is from ASCII values.
- HEX – front panel data selection is from hexadecimal values.

The :TRIGger:UART:BASE setting does not affect the :TRIGger:UART:DATA command which can always set data values using ASCII or hexadecimal values.

### NOTE

The :TRIGger:UART:BASE command is independent of the :SBUS:UART:BASE command which affects decode only.

**Query Syntax** :TRIGger:UART:BASE?

The :TRIGger:UART:BASE? query returns the current UART base setting.

**Return Format** <base><NL>  
<base> ::= {ASC | HEX}

- See Also**
- ["Introduction to :TRIGger Commands"](#) on page 440
  - [":TRIGger:MODE"](#) on page 447
  - [":TRIGger:UART:DATA"](#) on page 576

**:TRIGger:UART:BAUDrate**

**N** (see [page 750](#))

**Command Syntax** :TRIGger:UART:BAUDrate <baudrate>

<baudrate> ::= integer from 1200 to 3000000 in 100 b/s increments

The :TRIGger:UART:BAUDrate command selects the bit rate (in bps) for the serial decoder and/or trigger when in UART mode. The baud rate can be set from 1200 b/s to 3 Mb/s in 100 b/s increments. If you enter a baud rate that is not divisible by 100 b/s, the baud rate is set to the nearest baud rate divisible by 100 b/s.

If the baud rate you select does not match the system baud rate, false triggers may occur.

**Query Syntax** :TRIGger:UART:BAUDrate?

The :TRIGger:UART:BAUDrate? query returns the current UART baud rate setting.

**Return Format** <baudrate><NL>

<baudrate> ::= integer from 1200 to 3000000 in 100 b/s increments

- See Also**
- ["Introduction to :TRIGger Commands"](#) on page 440
  - [":TRIGger:MODE"](#) on page 447
  - [":TRIGger:UART:TYPE"](#) on page 583

## :TRIGger:UART:BITorder

**N** (see [page 750](#))

**Command Syntax** :TRIGger:UART:BITorder <bitorder>  
<bitorder> ::= {LSBFirst | MSBFirst}

The :TRIGger:UART:BITorder command specifies the order of transmission used by the physical Tx and Rx input signals for the serial decoder and/or trigger when in UART mode. LSBFirst sets the least significant bit of each message "byte" as transmitted first. MSBFirst sets the most significant bit as transmitted first.

**Query Syntax** :TRIGger:UART:BITorder?

The :TRIGger:UART:BITorder? query returns the current UART bit order setting.

**Return Format** <bitorder><NL>  
<bitorder> ::= {LSBF | MSBF}

- See Also**
- ["Introduction to :TRIGger Commands"](#) on page 440
  - [":TRIGger:MODE"](#) on page 447
  - [":TRIGger:UART:TYPE"](#) on page 583
  - [":TRIGger:UART:SOURce:RX"](#) on page 581
  - [":TRIGger:UART:SOURce:TX"](#) on page 582

**:TRIGger:UART:BURSt**

**N** (see [page 750](#))

**Command Syntax** :TRIGger:UART:BURSt <value>  
 <value> ::= {OFF | 1 to 4096 in NR1 format}

The :TRIGger:UART:BURSt command selects the burst value (Nth frame after idle period) in the range 1 to 4096 or OFF, for the trigger when in UART mode.

**Query Syntax** :TRIGger:UART:BURSt?

The :TRIGger:UART:BURSt? query returns the current UART trigger burst value.

**Return Format** <value><NL>  
 <value> ::= {OFF | 1 to 4096 in NR1 format}

- See Also**
- ["Introduction to :TRIGger Commands"](#) on page 440
  - [":TRIGger:MODE"](#) on page 447
  - [":TRIGger:UART:IDLE"](#) on page 577
  - [":TRIGger:UART:TYPE"](#) on page 583

**:TRIGger:UART:DATA**

**N** (see [page 750](#))

**Command Syntax** :TRIGger:UART:DATA <value>

<value> ::= 8-bit integer from 0-255 (0x00-0xff) in decimal, hexadecimal, <binary>, or <quoted\_string> format

<hexadecimal> ::= #Hnn where n ::= {0,...,9 | A,...,F} for hexadecimal

<binary> ::= #Bnn...n where n ::= {0 | 1} for binary

<quoted\_string> ::= any of the 128 valid 7-bit ASCII characters (or standard abbreviations)

The :TRIGger:UART:DATA command selects the data byte value (0x00 to 0xFF) for the trigger QUALifier when in UART mode. The data value is used when one of the RD or TD trigger types is selected.

When entering an ASCII character via the quoted string, it must be one of the 128 valid characters (case-sensitive): "NUL", "SOH", "STX", "ETX", "EOT", "ENQ", "ACK", "BEL", "BS", "HT", "LF", "VT", "FF", "CR", "SO", "SI", "DLE", "DC1", "DC2", "DC3", "DC4", "NAK", "SYN", "ETB", "CAN", "EM", "SUB", "ESC", "FS", "GS", "RS", "US", "SP", "!", "\", "#", "\$", "%", "&", "\", "(", ")", "\*", "+", ",", "-", ".", "/", "0", "1", "2", "3", "4", "5", "6", "7", "8", "9", ":", ";", "<", "=", ">", "?", "@", "A", "B", "C", "D", "E", "F", "G", "H", "I", "J", "K", "L", "M", "N", "O", "P", "Q", "R", "S", "T", "U", "V", "W", "X", "Y", "Z", "[", "\\", "]", "^", "\_", "`", "a", "b", "c", "d", "e", "f", "g", "h", "i", "j", "k", "l", "m", "n", "o", "p", "q", "r", "s", "t", "u", "v", "w", "x", "y", "z", "{", "|", "}", "~", or "DEL".

**Query Syntax** :TRIGger:UART:DATA?

The :TRIGger:UART:DATA? query returns the current UART trigger data value.

**Return Format** <value><NL>

<value> ::= 8-bit integer in decimal from 0-255

- See Also**
- ["Introduction to :TRIGger Commands"](#) on page 440
  - [":TRIGger:MODE"](#) on page 447
  - [":TRIGger:UART:BASE"](#) on page 572
  - [":TRIGger:UART:TYPE"](#) on page 583

**:TRIGger:UART:IDLE**

**N** (see [page 750](#))

**Command Syntax** :TRIGger:UART:IDLE <time\_value>

<time\_value> ::= time from 1 us to 10 s in NR3 format

The :TRIGger:UART:IDLE command selects the value of the idle period for burst trigger in the range from 1 us to 10 s when in UART mode.

**Query Syntax** :TRIGger:UART:IDLE?

The :TRIGger:UART:IDLE? query returns the current UART trigger idle period time.

**Return Format** <time\_value><NL>

<time\_value> ::= time from 1 us to 10 s in NR3 format

- See Also**
- "[Introduction to :TRIGger Commands](#)" on page 440
  - "[:TRIGger:MODE](#)" on page 447
  - "[:TRIGger:UART:BURSt](#)" on page 575
  - "[:TRIGger:UART:TYPE](#)" on page 583

## :TRIGger:UART:PARity

**N** (see [page 750](#))

**Command Syntax** :TRIGger:UART:PARity <parity>

<parity> ::= {EVEN | ODD | NONE}

The :TRIGger:UART:PARity command selects the parity to be used with each message "byte" for the serial decoder and/or trigger when in UART mode.

**Query Syntax** :TRIGger:UART:PARity?

The :TRIGger:UART:PARity? query returns the current UART parity setting.

**Return Format** <parity><NL>

<parity> ::= {EVEN | ODD | NONE}

- See Also**
- "[Introduction to :TRIGger Commands](#)" on page 440
  - "[:TRIGger:MODE](#)" on page 447
  - "[:TRIGger:UART:TYPE](#)" on page 583

## :TRIGger:UART:POLarity

**N** (see [page 750](#))

**Command Syntax** :TRIGger:UART:POLarity <polarity>  
<polarity> ::= {HIGH | LOW}

The :TRIGger:UART:POLarity command selects the polarity as idle low or idle high for the serial decoder and/or trigger when in UART mode.

**Query Syntax** :TRIGger:UART:POLarity?

The :TRIGger:UART:POLarity? query returns the current UART polarity setting.

**Return Format** <polarity><NL>  
<polarity> ::= {HIGH | LOW}

- See Also**
- ["Introduction to :TRIGger Commands"](#) on page 440
  - [":TRIGger:MODE"](#) on page 447
  - [":TRIGger:UART:TYPE"](#) on page 583

## :TRIGger:UART:QUALifier

**N** (see [page 750](#))

**Command Syntax** :TRIGger:UART:QUALifier <value>  
<value> ::= {EQUAL | NOTequal | GREATERthan | LESSthan}

The :TRIGger:UART:QUALifier command selects the data qualifier when :TYPE is set to RDATA, RD1, RD0, RDX, TDATA, TD1, TD0, or TDX for the trigger when in UART mode.

**Query Syntax** :TRIGger:UART:QUALifier?

The :TRIGger:UART:QUALifier? query returns the current UART trigger qualifier.

**Return Format** <value><NL>  
<value> ::= {EQU | NOT | GRE | LESS}

- See Also**
- ["Introduction to :TRIGger Commands"](#) on page 440
  - [":TRIGger:MODE"](#) on page 447
  - [":TRIGger:UART:TYPE"](#) on page 583

**:TRIGger:UART:SOURce:RX**

**N** (see [page 750](#))

**Command Syntax** :TRIGger:UART:SOURce:RX <source>

<source> ::= {CHANnel<n> | EXTernal}

<n> ::= {1 | 2 | 3 | 4} for the four channel oscilloscope models

<n> ::= {1 | 2} for the two channel oscilloscope models

The :TRIGger:UART:SOURce:RX command controls which signal is used as the Rx source by the serial decoder and/or trigger when in UART mode.

**Query Syntax** :TRIGger:UART:SOURce:RX?

The :TRIGger:UART:SOURce:RX? query returns the current source for the UART Rx signal.

**Return Format** <source><NL>

- See Also**
- ["Introduction to :TRIGger Commands"](#) on page 440
  - [":TRIGger:MODE"](#) on page 447
  - [":TRIGger:UART:TYPE"](#) on page 583
  - [":TRIGger:UART:BITorder"](#) on page 574

## :TRIGger:UART:SOURce:TX

**N** (see [page 750](#))

**Command Syntax** :TRIGger:UART:SOURce:TX <source>

<source> ::= {CHANnel<n> | EXTernal}

<n> ::= {1 | 2 | 3 | 4} for the four channel oscilloscope models

<n> ::= {1 | 2} for the two channel oscilloscope models

The :TRIGger:UART:SOURce:TX command controls which signal is used as the Tx source by the serial decoder and/or trigger when in UART mode.

**Query Syntax** :TRIGger:UART:SOURce:TX?

The :TRIGger:UART:SOURce:TX? query returns the current source for the UART Tx signal.

**Return Format** <source><NL>

- See Also**
- ["Introduction to :TRIGger Commands"](#) on page 440
  - [":TRIGger:MODE"](#) on page 447
  - [":TRIGger:UART:TYPE"](#) on page 583
  - [":TRIGger:UART:BITorder"](#) on page 574

**:TRIGger:UART:TYPE**

**N** (see [page 750](#))

**Command Syntax** :TRIGger:UART:TYPE <value>

```
<value> ::= {RSTArt | RSTOp | RDATA | RD1 | RD0 | RDX | PARityerror
             | TSTArt | TSTOp | TDATa | TD1 | TD0 | TDX}
```

The :TRIGger:UART:TYPE command selects the UART trigger type.

When one of the RD or TD types is selected, the :TRIGger:UART:DATA and :TRIGger:UART:QUALifier commands are used to specify the data value and comparison operator.

The RD1, RD0, RDX, TD1, TD0, and TDX types (for triggering on data and alert bit values) are only valid when a 9-bit width has been selected.

**Query Syntax** :TRIGger:UART:TYPE?

The :TRIGger:UART:TYPE? query returns the current UART trigger data value.

**Return Format** <value><NL>

```
<value> ::= {RSTA | RSTO | RDAT | RD1 | RD0 | RDX | PAR | TSTA |
             TSTO | TDAT | TD1 | TD0 | TDX}
```

- See Also**
- ["Introduction to :TRIGger Commands"](#) on page 440
  - [":TRIGger:MODE"](#) on page 447
  - [":TRIGger:UART:DATA"](#) on page 576
  - [":TRIGger:UART:QUALifier"](#) on page 580
  - [":TRIGger:UART:WIDTH"](#) on page 584

## :TRIGger:UART:WIDTH

**N** (see [page 750](#))

**Command Syntax** :TRIGger:UART:WIDTH <width>

<width> ::= {5 | 6 | 7 | 8 | 9}

The :TRIGger:UART:WIDTH command determines the number of bits (5-9) for each message "byte" for the serial decoder and/or trigger when in UART mode.

**Query Syntax** :TRIGger:UART:WIDTH?

The :TRIGger:UART:WIDTH? query returns the current UART width setting.

**Return Format** <width><NL>

<width> ::= {5 | 6 | 7 | 8 | 9}

- See Also**
- "[Introduction to :TRIGger Commands](#)" on page 440
  - "[:TRIGger:MODE](#)" on page 447
  - "[:TRIGger:UART:TYPE](#)" on page 583

## :TRIGger:USB Commands

**Table 85** :TRIGger:USB Commands Summary

| Command  | Query   | Options and Query Returns   |
|--|---|---|
| :TRIGger:USB:SOURce:D<br>MINus <source> (see<br><a href="#">page 586</a> ) | :TRIGger:USB:SOURce:D<br>MINus? (see <a href="#">page 586</a> ) | <source> ::= {CHANnel<n>  <br>EXTernal}<br><n> ::= 1-2 or 1-4 in NR1 format |
| :TRIGger:USB:SOURce:D<br>PLus <source> (see<br><a href="#">page 587</a> )  | :TRIGger:USB:SOURce:D<br>PLus? (see <a href="#">page 587</a> )  | <source> ::= {CHANnel<n>  <br>EXTernal}<br><n> ::= 1-2 or 1-4 in NR1 format |
| :TRIGger:USB:SPEEd<br><value> (see<br><a href="#">page 588</a> )           | :TRIGger:USB:SPEEd?<br>(see <a href="#">page 588</a> )          | <value> ::= {LOW   FULL}  |
| :TRIGger:USB:TRIGger<br><value> (see<br><a href="#">page 589</a> )         | :TRIGger:USB:TRIGger?<br>(see <a href="#">page 589</a> )        | <value> ::= {SOP   EOP  <br>ENTersuspend   EXITsuspend  <br>RESet}          |

## :TRIGger:USB:SOURce:DMINus

**N** (see [page 750](#))

**Command Syntax** :TRIGger:USB:SOURce:DMINus <source>

<source> ::= {CHANnel<n> | EXTernal}

<n> ::= {1 | 2 | 3 | 4} for the four channel oscilloscope models

<n> ::= {1 | 2} for the two channel oscilloscope models

The :TRIGger:USB:SOURce:DMINus command sets the source for the USB D- signal.

**Query Syntax** :TRIGger:USB:SOURce:DMINus?

The :TRIGger:USB:SOURce:DMINus? query returns the current source for the USB D- signal.

**Return Format** <source><NL>

- See Also**
- "[Introduction to :TRIGger Commands](#)" on page 440
  - "[:TRIGger:MODE](#)" on page 447
  - "[:TRIGger:USB:SOURce:DPLus](#)" on page 587
  - "[:TRIGger:USB:TRIGger](#)" on page 589

**:TRIGger:USB:SOURce:DPLus**

**N** (see [page 750](#))

**Command Syntax** :TRIGger:USB:SOURce:DPLus <source>

<source> ::= {CHANnel<n> | EXTernal}

<n> ::= {1 | 2 | 3 | 4} for the four channel oscilloscope models

<n> ::= {1 | 2} for the two channel oscilloscope models

The :TRIGger:USB:SOURce:DPLus command sets the source for the USB D+ signal.

**Query Syntax** :TRIGger:USB:SOURce:DPLus?

The :TRIGger:USB:SOURce:DPLus? query returns the current source for the USB D+ signal.

**Return Format** <source><NL>

- See Also**
- ["Introduction to :TRIGger Commands"](#) on page 440
  - [":TRIGger:MODE"](#) on page 447
  - [":TRIGger:USB:SOURce:DMINus"](#) on page 586
  - [":TRIGger:USB:TRIGger"](#) on page 589

## **:TRIGger:USB:SPEEd**

**N** (see [page 750](#))

**Command Syntax** :TRIGger:USB:SPEEd <value>  
<value> ::= {LOW | FULL}

The :TRIGger:USB:SPEEd command sets the expected USB signal speed to be Low Speed (1.5 Mb/s) or Full Speed (12 Mb/s).

**Query Syntax** :TRIGger:USB:SPEEd?

The :TRIGger:USB:SPEEd? query returns the current speed value for the USB signal.

**Return Format** <value><NL>

- See Also**
- "[Introduction to :TRIGger Commands](#)" on page 440
  - "[:TRIGger:MODE](#)" on page 447
  - "[:TRIGger:USB:SOURce:DMINus](#)" on page 586
  - "[:TRIGger:USB:SOURce:DPLus](#)" on page 587
  - "[:TRIGger:USB:TRIGger](#)" on page 589

**:TRIGger:USB:TRIGger**

**N** (see [page 750](#))

**Command Syntax** :TRIGger:USB:TRIGger <value>

<value> ::= {SOP | EOP | ENTersuspend | EXITsuspend | RESet}

The :TRIGger:USB:TRIGger command sets where the USB trigger will occur:

- SOP – Start of packet.
- EOP – End of packet.
- ENTersuspend – Enter suspend state.
- EXITsuspend – Exit suspend state.
- RESet – Reset complete.

**Query Syntax** :TRIGger:USB:TRIGger?

The :TRIGger:USB:TRIGger? query returns the current USB trigger value.

**Return Format** <value><NL>

<value> ::= {SOP | EOP | ENTersuspend | EXITsuspend | RESet}

- See Also**
- ["Introduction to :TRIGger Commands"](#) on page 440
  - [":TRIGger:MODE"](#) on page 447
  - [":TRIGger:USB:SPEed"](#) on page 588

## :WAVEform Commands

Provide access to waveform data. See "Introduction to :WAVEform Commands" on page 592.

**Table 86** :WAVEform Commands Summary

| Command   | Query                                  | Options and Query Returns  |
|---|--|--|
| :WAVEform:BYTeorder<br><value> (see page 597)         | :WAVEform:BYTeorder?<br>(see page 597) | <value> ::= {LSBFirst   MSBFirst}  |
| n/a   | :WAVEform:COUNT? (see page 598)        | <count> ::= an integer from 1 to 65536 in NR1 format   |
| n/a   | :WAVEform:DATA? (see page 599)         | <binary block length bytes>,<br><binary data><br>For example, to transmit 1000 bytes of data, the syntax would be: #800001000<1000 bytes of data><NL><br>8 is the number of digits that follow<br>00001000 is the number of bytes to be transmitted<br><1000 bytes of data> is the actual data |
| :WAVEform:FORMat<br><value> (see page 601)            | :WAVEform:FORMat?<br>(see page 601)    | <value> ::= {WORD   BYTE   ASCII}  |
| :WAVEform:POINTs<br><# points> (see page 602)         | :WAVEform:POINTs?<br>(see page 602)    | <# points> ::= {100   250   500   1000   <points_mode>} if waveform points mode is NORMAl<br><# points> ::= {100   250   500   1000   2000 ... 8000000 in 1-2-5 sequence   <points_mode>} if waveform points mode is MAXimum or RAW<br><points_mode> ::= {NORMAl   MAXimum   RAW}              |
| :WAVEform:POINTs:MODE<br><points_mode> (see page 604) | :WAVEform:POINTs:MODE ? (see page 605) | <points_mode> ::= {NORMAl   MAXimum   RAW}   |

**Table 86** :WAVeform Commands Summary (continued)

| Command   | Query   | Options and Query Returns  |
|---|---|--|
| n/a   | :WAVeform:PREAmble?<br>(see <a href="#">page 606</a> )      | <p>&lt;preamble_block&gt; ::= &lt;format NR1&gt;, &lt;type NR1&gt;,&lt;points NR1&gt;,&lt;count NR1&gt;, &lt;xincrement NR3&gt;, &lt;xorigin NR3&gt;, &lt;xreference NR1&gt;,&lt;yincrement NR3&gt;, &lt;yorigin NR3&gt;, &lt;yreference NR1&gt;</p> <p>&lt;format&gt; ::= an integer in NR1 format:</p> <ul style="list-style-type: none"> <li>• 0 for BYTE format</li> <li>• 1 for WORD format</li> <li>• 2 for ASCII format</li> </ul> <p>&lt;type&gt; ::= an integer in NR1 format:</p> <ul style="list-style-type: none"> <li>• 0 for NORMAl type</li> <li>• 1 for PEAK detect type</li> <li>• 2 for AVERAge type</li> <li>• 3 for HRESolution type</li> </ul> <p>&lt;count&gt; ::= Average count, or 1 if PEAK detect type or NORMAl; an integer in NR1 format</p> |
| n/a   | :WAVeform:SEGmented:COUNT? (see <a href="#">page 609</a> )  | <count> ::= an integer from 2 to 250 in NR1 format (with Option SGM)   |
| n/a   | :WAVeform:SEGmented:TAG? (see <a href="#">page 610</a> )    | <time_tag> ::= in NR3 format (with Option SGM)   |
| :WAVeform:SOURce <source> (see <a href="#">page 611</a> )                 | :WAVeform:SOURce? (see <a href="#">page 611</a> )           | <p>&lt;source&gt; ::= {CHANnel&lt;n&gt;   FUNCTION   MATH}</p> <p>&lt;n&gt; ::= 1-2 or 1-4 in NR1 format</p>   |
| :WAVeform:SOURce:SUBSource <subsource> (see <a href="#">page 615</a> )    | :WAVeform:SOURce:SUBSource? (see <a href="#">page 615</a> ) | <subsource> ::= {{NONE   RX}   TX}   |
| n/a   | :WAVeform:TYPE? (see <a href="#">page 616</a> )             | <return_mode> ::= {NORM   PEAK   AVER   HRES}  |
| :WAVeform:UNSigned {{0   OFF}   {1   ON}} (see <a href="#">page 617</a> ) | :WAVeform:UNSigned? (see <a href="#">page 617</a> )         | {0   1}  |
| :WAVeform:VIEW <view> (see <a href="#">page 618</a> )                     | :WAVeform:VIEW? (see <a href="#">page 618</a> )             | <view> ::= {MAIN}  |
| n/a   | :WAVeform:XINCrement? (see <a href="#">page 619</a> )       | <return_value> ::= x-increment in the current preamble in NR3 format   |

**Table 86** :WAVeform Commands Summary (continued)

| Command | Query  | Options and Query Returns  |
|---------|--|--|
| n/a     | :WAVeform:XORigin?<br>(see <a href="#">page 620</a> )    | <return_value> ::= x-origin value in the current preamble in NR3 format        |
| n/a     | :WAVeform:XREFerence?<br>(see <a href="#">page 621</a> ) | <return_value> ::= 0 (x-reference value in the current preamble in NR1 format) |
| n/a     | :WAVeform:YINCrement?<br>(see <a href="#">page 622</a> ) | <return_value> ::= y-increment value in the current preamble in NR3 format     |
| n/a     | :WAVeform:YORigin?<br>(see <a href="#">page 623</a> )    | <return_value> ::= y-origin in the current preamble in NR3 format              |
| n/a     | :WAVeform:YREFerence?<br>(see <a href="#">page 624</a> ) | <return_value> ::= y-reference value in the current preamble in NR1 format     |

**Introduction to :WAVeform Commands**

The WAVeform subsystem is used to transfer data to a controller from the oscilloscope waveform memories. The queries in this subsystem will only operate when the channel selected by :WAVeform:SOURce is on.

**Waveform Data and Preamble**

The waveform record is actually contained in two portions: the preamble and waveform data. The waveform record must be read from the oscilloscope by the controller using two separate commands, :WAVeform:DATA (see [page 599](#)) and :WAVeform:PREAmble (see [page 606](#)). The waveform data is the actual data acquired for each point in the specified source. The preamble contains the information for interpreting the waveform data, which includes the number of points acquired, the format of acquired data, and the type of acquired data. The preamble also contains the X and Y increments, origins, and references for the acquired data, so that word and byte data can be translated to time and voltage values.

**Data Acquisition Types**

There are four types of waveform acquisitions that can be selected for analog channels with the :ACQUIRE:TYPE command (see [page 191](#)): NORMAL, AVERage, PEAK, and HRESolution. When the data is acquired using the :DIGitize command (see [page 146](#)) or :RUN command (see [page 170](#)), the data is placed in the channel buffer of the specified source.

Once you have acquired data with the :DIGitize command, the instrument is stopped. If the instrument is restarted (via the programming interface or the front panel), or if any instrument setting is changed, the data acquired with the :DIGitize command may be overwritten. You should first acquire the data with the :DIGitize command, then immediately read the data with the :WAVeform:DATA? query (see [page 599](#)) before changing any instrument setup.

A waveform record consists of either all of the acquired points or a subset of the acquired points. The number of points acquired may be queried using :ACQUIRE:POINTS? (see [page 184](#)).

### Helpful Hints:

The number of points transferred to the computer is controlled using the :WAVeform:POINTS command (see [page 602](#)). If :WAVeform:POINTS MAXimum is specified and the instrument is not running (stopped), all of the points that are displayed are transferred. This can be as many as 4,000,000 in some operating modes. Fewer points may be specified to speed data transfers and minimize controller analysis time. The :WAVeform:POINTS may be varied even after data on a channel is acquired. However, this decimation may result in lost pulses and transitions. The number of points selected for transfer using :WAVeform:POINTS must be an even divisor of 1,000 or be set to MAXimum. :WAVeform:POINTS determines the increment between time buckets that will be transferred. If POINTS = MAXimum, the data cannot be decimated. For example:

- :WAVeform:POINTS 1000 – returns time buckets 0, 1, 2, 3, 4 ,,, 999.
- :WAVeform:POINTS 500 – returns time buckets 0, 2, 4, 6, 8 ,,, 998.
- :WAVeform:POINTS 250 – returns time buckets 0, 4, 8, 12, 16 ,,, 996.
- :WAVeform:POINTS 100 – returns time buckets 0, 10, 20, 30, 40 ,,, 990.

### Analog Channel Data

#### NORMAL Data

Normal data consists of the last data point (hit) in each time bucket. This data is transmitted over the programming interface in a linear fashion starting with time bucket 0 and going through time bucket  $n - 1$ , where  $n$  is the number returned by the :WAVeform:POINTS? query (see [page 602](#)). Only the magnitude values of each data point are transmitted. The first voltage value corresponds to the first time bucket on the left side of the screen and the last value corresponds to the next-to-last time bucket on the right side of the screen. Time buckets without data return 0. The time values for each data point correspond to the position of the data point in the data array. These time values are not transmitted.

**AVERage Data**

AVERage data consists of the average of the first *n* hits in a time bucket, where *n* is the value returned by the :ACQUIRE:COUNT query (see [page 181](#)). Time buckets that have fewer than *n* hits return the average of the data they do have. If a time bucket does not have any data in it, it returns 0.

This data is transmitted over the interface linearly, starting with time bucket 0 and proceeding through time bucket *n*-1, where *n* is the number returned by the :WAVEFORM:POINTS? query (see [page 602](#)). The first value corresponds to a point at the left side of the screen and the last value corresponds to one point away from the right side of the screen. The maximum number of points that can be returned in average mode is 1000 unless ACQUIRE:COUNT has been set to 1.

**PEAK Data**

Peak detect display mode is used to detect glitches for time base settings of 500 us/div and slower. In this mode, the oscilloscope can sample more data than it can store and display. So, when peak detect is turned on, the oscilloscope scans through the extra data, picks up the minimum and maximum for each time bucket, then stores the data in an array. Each time bucket contains two data sample.

The array is transmitted over the interface bus linearly, starting with time bucket 0 proceeding through time bucket *n*-1, where *n* is the number returned by the :WAVEFORM:POINTS? query (see [page 602](#)). In each time bucket, two values are transmitted, first the minimum, followed by the maximum. The first pair of values corresponds to the time bucket at the leftmost side of the screen. The last pair of values corresponds to the time bucket at the far right side of the screen. In :ACQUIRE:TYPE PEAK mode (see [page 191](#)), the value returned by the :WAVEFORM:XINCREMENT query (see [page 619](#)) should be doubled to find the time difference between the min-max pairs.

**HRESolution Data**

The high resolution (*smoothing*) mode is used to reduce noise at slower sweep speeds where the digitizer samples faster than needed to fill memory for the displayed time range.

**Data Conversion**

Word or byte data sent from the oscilloscope must be scaled for useful interpretation. The values used to interpret the data are the X and Y references, X and Y origins, and X and Y increments. These values are read from the waveform preamble. Each channel has its own waveform preamble.

In converting a data value to a voltage value, the following formula is used:

$$\text{voltage} = [(\text{data value} - \text{yreference}) * \text{yincrement}] + \text{yorigin}$$

If the :WAVEform:FORMat data format is ASCII (see [page 601](#)), the data values are converted internally and sent as floating point values separated by commas.

In converting a data value to time, the time value of a data point can be determined by the position of the data point. For example, the fourth data point sent with :WAVEform:XORigin = 16 ns, :WAVEform:XREFerence = 0, and :WAVEform:XINCrement = 2 ns, can be calculated using the following formula:

$$\text{time} = [(\text{data point number} - \text{xreference}) * \text{xincrement}] + \text{xorigin}$$

This would result in the following calculation for time bucket 3:

$$\text{time} = [(3 - 0) * 2 \text{ ns}] + 16 \text{ ns} = 22 \text{ ns}$$

In :ACquire:TYPE PEAK mode (see [page 191](#)), because data is acquired in max-min pairs, modify the previous time formula to the following:

$$\text{time}=[(\text{data pair number} - \text{xreference}) * \text{xincrement} * 2] + \text{xorigin}$$

### Data Format for Transfer

There are three formats for transferring waveform data over the interface: BYTE, WORD and ASCII (see ":WAVEform:FORMat" on [page 601](#)). BYTE, WORD and ASCII formatted waveform records are transmitted using the arbitrary block program data format specified in IEEE 488.2.

When you use the block data format, the ASCII character string "#8<DD...D>" is sent prior to sending the actual data. The 8 indicates how many Ds follow. The Ds are ASCII numbers that indicate how many data bytes follow.

For example, if 1000 points will be transferred, and the WORD format was specified, the block header "#800001000" would be sent. The 8 indicates that eight length bytes follow, and 00001000 indicates that 1000 binary data bytes follow.

Use the :WAVEform:UNSigned command (see [page 617](#)) to control whether data values are sent as unsigned or signed integers. This command can be used to match the instrument's internal data type to the data type used by the programming language. This command has no effect if the data format is ASCII.

### Data Format for Transfer - ASCII format

The ASCII format (see ":WAVEform:FORMat" on [page 601](#)) provides access to the waveform data as real Y-axis values without using Y origin, Y reference, and Y increment to convert the binary data. Values are transferred as ASCII digits in floating point format separated by commas. In ASCII format, holes are represented by the value 9.9e+37.

The setting of :WAVeform:BYTeorder (see [page 597](#)) and :WAVeform:UNSigned (see [page 617](#)) have no effect when the format is ASCii.

### Data Format for Transfer - WORD format

WORD format (see [":WAVeform:FORMat"](#) on page 601) provides 16-bit access to the waveform data. In the WORD format, the number of data bytes is twice the number of data points. The number of data points is the value returned by the :WAVeform:POINts? query (see [page 602](#)). If the data intrinsically has less than 16 bits of resolution, the data is left-shifted to provide 16 bits of resolution and the least significant bits are set to 0. Currently, the greatest intrinsic resolution of any data is 12 bits, so at least the lowest 4 bits of data will be 0. If there is a hole in the data, the hole is represented by a 16 bit value equal to 0.

Use :WAVeform:BYTeorder (see [page 597](#)) to determine if the least significant byte or most significant byte is to be transferred first. The :BYTeorder command can be used to alter the transmit sequence to match the storage sequence of an integer in the programming language being used.

### Data Format for Transfer - BYTE format

The BYTE format (see [":WAVeform:FORMat"](#) on page 601 ) allows 8-bit access to the waveform data. If the data intrinsically has more than 8 bits of resolution (averaged data), the data is right-shifted (truncated) to fit into 8 bits. If there is a hole in the data, the hole is represented by a value of 0. The BYTE-formatted data transfers over the programming interface faster than ASCii or WORD-formatted data, because in ASCii format, as many as 13 bytes per point are transferred, in BYTE format one byte per point is transferred, and in WORD format two bytes per point are transferred.

The :WAVeform:BYTeorder command (see [page 597](#)) has no effect when the data format is BYTE.

### Reporting the Setup

The following is a sample response from the :WAVeform? query. In this case, the query was issued following a \*RST command.

```
:WAV:UNS 1;VIEW MAIN;BYT MSBF;FORM BYTE;POIN +1000;SOUR CHAN1;SOUR:SUBS  
NONE
```

**:WAVeform:BYTeorder**

**C** (see [page 750](#))

**Command Syntax** :WAVeform:BYTeorder <value>  
 <value> ::= {LSBFirst | MSBFirst}

The :WAVeform:BYTeorder command sets the output sequence of the WORD data. The parameter MSBFirst sets the most significant byte to be transmitted first. The parameter LSBFirst sets the least significant byte to be transmitted first. This command affects the transmitting sequence only when :WAVeform:FORMat WORD is selected. The default setting is LSBFirst.

**Query Syntax** :WAVeform:BYTeorder?

The :WAVeform:BYTeorder query returns the current output sequence.

**Return Format** <value><NL>  
 <value> ::= {LSBF | MSBF}

- See Also**
- ["Introduction to :WAVeform Commands"](#) on page 592
  - [":WAVeform:DATA"](#) on page 599
  - [":WAVeform:FORMat"](#) on page 601
  - [":WAVeform:PREamble"](#) on page 606

- Example Code**
- ["Example Code"](#) on page 611
  - ["Example Code"](#) on page 607

## :WAVeform:COUNT

**C** (see [page 750](#))

**Query Syntax** :WAVeform:COUNT?

The :WAVeform:COUNT? query returns the count used to acquire the current waveform. This may differ from current values if the unit has been stopped and its configuration modified. For all acquisition types except average, this value is 1.

**Return Format** <count\_argument><NL>

<count\_argument> ::= an integer from 1 to 65536 in NR1 format

- See Also**
- ["Introduction to :WAVeform Commands"](#) on page 592
  - [":ACQUIRE:COUNT"](#) on page 181
  - [":ACQUIRE:TYPE"](#) on page 191

**:WAVeform:DATA**

**C** (see [page 750](#))

**Query Syntax** :WAVeform:DATA?

The :WAVeform:DATA query returns the binary block of sampled data points transmitted using the IEEE 488.2 arbitrary block data format. The binary data is formatted according to the settings of the :WAVeform:UNSigned, :WAVeform:BYTeorder, :WAVeform:FORMat, and :WAVeform:SOURce commands. The number of points returned is controlled by the :WAVeform:POINts command.

In BYTE or WORD waveform formats, these data values have special meaning:

- 0x00 or 0x0000 – Hole. Holes are locations where data has not yet been acquired. Holes can be reasonably expected in the equivalent time acquisition mode (especially at slower horizontal sweep speeds when measuring low frequency signals).

Another situation where there can be zeros in the data, incorrectly, is when programming over telnet port 5024. Port 5024 provides a command prompt and is intended for ASCII transfers. Use telnet port 5025 instead.

- 0x01 or 0x0001 – Clipped low. These are locations where the waveform is clipped at the bottom of the oscilloscope display.
- 0xFF or 0xFFFF – Clipped high. These are locations where the waveform is clipped at the top of the oscilloscope display.

**Return Format** <binary block data><NL>

- See Also**
- For a more detailed description of the data returned for different acquisition types, see: "[Introduction to :WAVeform Commands](#)" on page 592
  - "[:WAVeform:UNSigned](#)" on page 617
  - "[:WAVeform:BYTeorder](#)" on page 597
  - "[:WAVeform:FORMat](#)" on page 601
  - "[:WAVeform:POINts](#)" on page 602
  - "[:WAVeform:PREAmble](#)" on page 606
  - "[:WAVeform:SOURce](#)" on page 611
  - "[:WAVeform:TYPE](#)" on page 616

**Example Code**

```
' QUERY_WAVE_DATA - Outputs waveform data that is stored in a buffer.

' Query the oscilloscope for the waveform data.
myScope.WriteString ":WAV:DATA?"

' READ_WAVE_DATA - The wave data consists of two parts: the header,
```

## 5 Commands by Subsystem

```
' and the actual waveform data followed by a new line (NL) character.
' The query data has the following format:
'
'   <header><waveform_data><NL>
'
' Where:
'   <header> = #800001000 (This is an example header)
' The "#8" may be stripped off of the header and the remaining
' numbers are the size, in bytes, of the waveform data block. The
' size can vary depending on the number of points acquired for the
' waveform. You can then read that number of bytes from the
' oscilloscope and the terminating NL character.
'
Dim lngI As Long
Dim lngDataValue As Long

varQueryResult = myScope.ReadIEEEBlock(BinaryType_UI1)
' Unsigned integer bytes.
For lngI = 0 To UBound(varQueryResult) - 1
    Step (UBound(varQueryResult) / 20) ' 20 points.
    If intBytesPerData = 2 Then
        lngDataValue = varQueryResult(lngI) * 256 _
            + varQueryResult(lngI + 1) ' 16-bit value.
    Else
        lngDataValue = varQueryResult(lngI) ' 8-bit value.
    End If
    strOutput = strOutput + "Data point " + _
        CStr(lngI / intBytesPerData) + ", " + _
        FormatNumber((lngDataValue - lngYReference) _
            * sngYIncrement + sngYOrigin) + " V, " + _
        FormatNumber(((lngI / intBytesPerData - lngXReference) _
            * sngXIncrement + dblXOrigin) * 1000000) + " us" + vbCrLf
Next lngI
MsgBox "Waveform data:" + vbCrLf + strOutput
```

Example program from the start: ["VISA COM Example in Visual Basic"](#) on page 776

**:WAVeform:FORMat**

**C** (see [page 750](#))

**Command Syntax** :WAVeform:FORMat <value>

<value> ::= {WORD | BYTE | ASCii}

The :WAVeform:FORMat command sets the data transmission mode for waveform data points. This command controls how the data is formatted when sent from the oscilloscope.

- ASCii formatted data converts the internal integer data values to real Y-axis values. Values are transferred as ASCii digits in floating point notation, separated by commas.

ASCII formatted data is transferred ASCII text.

- WORD formatted data transfers 16-bit data as two bytes. The :WAVeform:BYTeorder command can be used to specify whether the upper or lower byte is transmitted first. The default (no command sent) is that the upper byte transmitted first.
- BYTE formatted data is transferred as 8-bit bytes.

**Query Syntax** :WAVeform:FORMat?

The :WAVeform:FORMat query returns the current output format for the transfer of waveform data.

**Return Format** <value><NL>

<value> ::= {WORD | BYTE | ASC}

- See Also**
- ["Introduction to :WAVeform Commands"](#) on page 592
  - [":WAVeform:BYTeorder"](#) on page 597
  - [":WAVeform:DATA"](#) on page 599
  - [":WAVeform:PREamble"](#) on page 606

**Example Code** • ["Example Code"](#) on page 611

**:WAVeform:POINts****C** (see [page 750](#))

**Command Syntax** :WAVeform:POINts <# points>

```
<# points> ::= {100 | 250 | 500 | 1000 | <points mode>}
              if waveform points mode is NORMAl

<# points> ::= {100 | 250 | 500 | 1000 | 2000 | 5000 | 10000 | 20000
              | 50000 | 100000 | 200000 | 500000 | 1000000 | 2000000
              | 4000000 | 8000000 | <points mode>}
              if waveform points mode is MAXimum or RAW

<points mode> ::= {NORMAl | MAXimum | RAW}
```

**NOTE**

The <points\_mode> option is deprecated. Use the :WAVeform:POINts:MODE command instead.

The :WAVeform:POINts command sets the number of waveform points to be transferred with the :WAVeform:DATA? query. This value represents the points contained in the waveform selected with the :WAVeform:SOURce command.

For the analog sources, the records that can be transferred depend on the waveform points mode. The maximum number of points returned for math (function) waveforms is determined by the NORMAl waveform points mode. See the :WAVeform:POINts:MODE command (see [page 604](#)) for more information.

Only data visible on the display will be returned.

When the :WAVeform:SOURce is the serial decode bus (SBUS), this command is ignored, and all available serial decode bus data is returned.

**Query Syntax** :WAVeform:POINts?

The :WAVeform:POINts query returns the number of waveform points to be transferred when using the :WAVeform:DATA? query. Setting the points mode will affect what data is transferred (see the :WAVeform:POINts:MODE command (see [page 604](#)) for more information).

When the :WAVeform:SOURce is the serial decode bus (SBUS), this query returns the number of messages that were decoded.

**Return Format** <# points><NL>

```
<# points> ::= {100 | 250 | 500 | 1000 | <maximum # points>}
              if waveform points mode is NORMAl

<# points> ::= {100 | 250 | 500 | 1000 | 2000 | 5000 | 10000 | 20000
              | 50000 | 100000 | 200000 | 500000 | 1000000 | 2000000
              | 4000000 | 8000000 | <maximum # points>}
              if waveform points mode is MAXimum or RAW
```

**NOTE**

If a full screen of data is not displayed, the number of points returned will not be 1000 or an even divisor of it.

---

- See Also**
- ["Introduction to :WAVEform Commands"](#) on page 592
  - [":ACQUIRE:POINTS"](#) on page 184
  - [":WAVEform:DATA"](#) on page 599
  - [":WAVEform:SOURce"](#) on page 611
  - [":WAVEform:VIEW"](#) on page 618
  - [":WAVEform:PREamble"](#) on page 606
  - [":WAVEform:POINTS:MODE"](#) on page 604

**Example Code**

```
' WAVE_POINTS - Specifies the number of points to be transferred  
' using the ":WAVEFORM:DATA?" query.  
myScope.WriteString ":WAVEFORM:POINTS 1000"
```

Example program from the start: ["VISA COM Example in Visual Basic"](#) on page 776

**:WAVeform:POINts:MODE**

**N** (see [page 750](#))

**Command Syntax** :WAVeform:POINts:MODE <points\_mode>

<points\_mode> ::= {NORMal | MAXimum | RAW}

The :WAVeform:POINts:MODE command sets the data record to be transferred with the :WAVeform:DATA? query.

For the analog sources, there are three different records that can be transferred:

- The first is the raw acquisition record. The maximum number of points available in this record is returned by the :ACQuire:POINts? query. The raw acquisition record can only be transferred when the oscilloscope is not running and can only be retrieved from the analog sources.
- The second is referred to as the *measurement record* and is a 1000-point (maximum) representation of the raw acquisition record. The measurement record can be retrieved when :SYSTem:PRECision is OFF, from any source.
- The third is referred to as the *precision analysis record* and is a 10K-point (maximum) representation of the raw acquisition record. The precision analysis record can be retrieved when :SYSTem:PRECision is ON, from analog sources.

If the <points\_mode> is NORMal and :SYSTem:PRECision is OFF, the measurement record is retrieved.

If the <points\_mode> is NORMal and :SYSTem:PRECision is ON, the precision analysis record is retrieved.

If the <points\_mode> is RAW, the raw acquisition record is used. Under some conditions, such as when the oscilloscope is running, this data record is unavailable.

If the <points\_mode> is MAXimum, whichever record contains the maximum amount of points is used. Usually, this is the raw acquisition record. But, if the raw acquisition record is unavailable (for example, when the oscilloscope is running), or if the reconstruction filter ( $\text{Sin}(x)/x$  interpolation) is in use, the measurement record may have more data. If data is being retrieved as the oscilloscope is stopped and as the data displayed is changing, the data being retrieved can switch between the measurement and raw acquisition records.

**Considerations  
for MAXimum or  
RAW data  
retrieval**

- The instrument must be stopped (see the :STOP command (see [page 174](#)) or the :DIGitize command (see [page 146](#)) in the root subsystem) in order to return more than the *measurement record* or *precision analysis record*.
- :TIMEbase:MODE must be set to MAIN.

- `:ACQUIRE:TYPE` must be set to `NORMAL`, `AVERAGE`, or `HRESOLUTION`. If `AVERAGE`, `:ACQUIRE:COUNT` must be set to 1 in order to return more than the *measurement record* or *precision analysis record*.
- `MAXIMUM` or `RAW` will allow up to 8,000,000 points to be returned. The number of points returned will vary as the instrument's configuration is changed. Use the `:WAVEFORM:POINTS? MAXIMUM` query to determine the maximum number of points that can be retrieved at the current settings.

**Query Syntax** `:WAVEFORM:POINTS:MODE?`

The `:WAVEFORM:POINTS:MODE?` query returns the current points mode. Setting the points mode will affect what data is transferred. See the discussion above.

**Return Format** `<points_mode><NL>`

`<points_mode> ::= {NORMAL | MAXIMUM | RAW}`

- See Also**
- "[Introduction to :WAVEFORM Commands](#)" on page 592
  - "[:WAVEFORM:DATA](#)" on page 599
  - "[:ACQUIRE:POINTS](#)" on page 184
  - "[:SYSTEM:PRECISION](#)" on page 424
  - "[:WAVEFORM:VIEW](#)" on page 618
  - "[:WAVEFORM:PREAmble](#)" on page 606
  - "[:WAVEFORM:POINTS](#)" on page 602
  - "[:TIMEbase:MODE](#)" on page 431
  - "[:ACQUIRE:TYPE](#)" on page 191
  - "[:ACQUIRE:COUNT](#)" on page 181

**:WAVeform:PREamble**

**C** (see [page 750](#))

**Query Syntax** :WAVeform:PREamble?

The :WAVeform:PREamble query requests the preamble information for the selected waveform source. The preamble data contains information concerning the vertical and horizontal scaling of the data of the corresponding channel.

**Return Format** <preamble\_block><NL>

```
<preamble_block> ::= <format 16-bit NR1>,
                    <type 16-bit NR1>,
                    <points 32-bit NR1>,
                    <count 32-bit NR1>,
                    <xincrement 64-bit floating point NR3>,
                    <xorigin 64-bit floating point NR3>,
                    <xreference 32-bit NR1>,
                    <yincrement 32-bit floating point NR3>,
                    <yorigin 32-bit floating point NR3>,
                    <yreference 32-bit NR1>
```

<format> ::= 0 for BYTE format, 1 for WORD format, 4 for ASCII format;  
an integer in NR1 format (format set by :WAVeform:FORMat).

<type> ::= 2 for AVERage type, 0 for NORMAl type, 1 for PEAK detect  
type; an integer in NR1 format (type set by :ACQuire:TYPE).

<count> ::= Average count or 1 if PEAK or NORMAl; an integer in NR1  
format (count set by :ACQuire:COUNT).

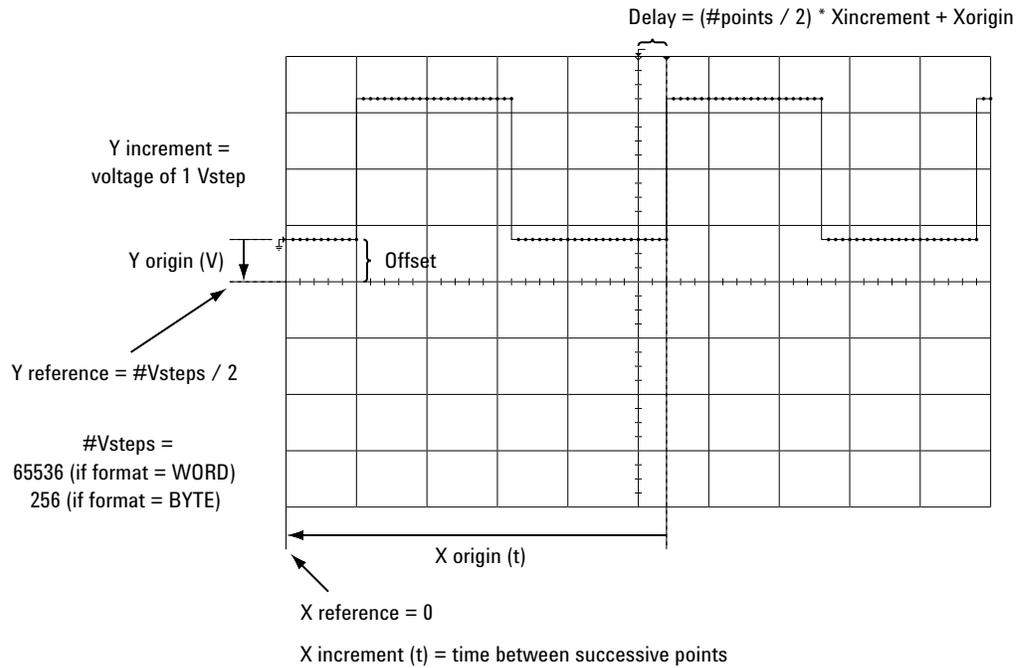

- See Also**
- ["Introduction to :WAVEform Commands"](#) on page 592
  - [":ACQUIRE:COUNT"](#) on page 181
  - [":ACQUIRE:POINTS"](#) on page 184
  - [":ACQUIRE:TYPE"](#) on page 191
  - [":DIGITIZE"](#) on page 146
  - [":WAVEform:COUNT"](#) on page 598
  - [":WAVEform:DATA"](#) on page 599
  - [":WAVEform:FORMat"](#) on page 601
  - [":WAVEform:POINTS"](#) on page 602
  - [":WAVEform:TYPE"](#) on page 616
  - [":WAVEform:XINcrement"](#) on page 619
  - [":WAVEform:XORigin"](#) on page 620
  - [":WAVEform:XREFERence"](#) on page 621
  - [":WAVEform:YINcrement"](#) on page 622
  - [":WAVEform:YORigin"](#) on page 623
  - [":WAVEform:YREFERence"](#) on page 624

**Example Code**

```
' GET_PREAMBLE - The preamble block contains all of the current
' WAVEFORM settings. It is returned in the form <preamble_block><NL>
' where <preamble_block> is:
'   FORMAT          : int16 - 0 = BYTE, 1 = WORD, 4 = ASCII.
```

## 5 Commands by Subsystem

```
' TYPE          : int16 - 0 = NORMAL, 1 = PEAK DETECT, 2 = AVERAGE
' POINTS       : int32 - number of data points transferred.
' COUNT        : int32 - 1 and is always 1.
' XINCREMENT   : float64 - time difference between data points.
' XORIGIN      : float64 - always the first data point in memory.
' XREFERENCE   : int32 - specifies the data point associated with
'              : x-origin.
' YINCREMENT   : float32 - voltage diff between data points.
' YORIGIN      : float32 - value is the voltage at center screen.
' YREFERENCE   : int32 - specifies the data point where y-origin
'              : occurs.
Dim Preamble()
Dim intFormat As Integer
Dim intType As Integer
Dim lngPoints As Long
Dim lngCount As Long
Dim dblXIncrement As Double
Dim dblXOrigin As Double
Dim lngXReference As Long
Dim sngYIncrement As Single
Dim sngYOrigin As Single
Dim lngYReference As Long
Dim strOutput As String

myScope.WriteString ":WAVEFORM:PREAMBLE?" ' Query for the preamble.
Preamble() = myScope.ReadList ' Read preamble information.
intFormat = Preamble(0)
intType = Preamble(1)
lngPoints = Preamble(2)
lngCount = Preamble(3)
dblXIncrement = Preamble(4)
dblXOrigin = Preamble(5)
lngXReference = Preamble(6)
sngYIncrement = Preamble(7)
sngYOrigin = Preamble(8)
lngYReference = Preamble(9)
```

Example program from the start: ["VISA COM Example in Visual Basic"](#) on page 776

**:WAVeform:SEGMented:COUNT**

**N** (see [page 750](#))

**Query Syntax** :WAVeform:SEGMented:COUNT?

**NOTE**

This command is available when the segmented memory option (Option SGM) is enabled.

The :WAVeform:SEGMented:COUNT query returns the number of memory segments in the acquired data. You can use the :WAVeform:SEGMented:COUNT? query while segments are being acquired (although :DIGitize blocks subsequent queries until the full segmented acquisition is complete).

The segmented memory acquisition mode is enabled with the :ACQUIRE:MODE command. The number of segments to acquire is set using the :ACQUIRE:SEGMented:COUNT command, and data is acquired using the :DIGitize, :SINGLE, or :RUN commands.

**Return Format** <count> ::= an integer from 2 to 250 in NR1 format (count set by :ACQUIRE:SEGMented:COUNT).

- See Also**
- [":ACQUIRE:MODE"](#) on page 183
  - [":ACQUIRE:SEGMented:COUNT"](#) on page 186
  - [":DIGitize"](#) on page 146
  - [":SINGLE"](#) on page 172
  - [":RUN"](#) on page 170
  - ["Introduction to :WAVeform Commands"](#) on page 592

**Example Code** • ["Example Code"](#) on page 187

## **:WAVeform:SEGmented:TTAG**

**N** (see [page 750](#))

**Query Syntax** :WAVeform:SEGmented:TTAG?

**NOTE**

This command is available when the segmented memory option (Option SGM) is enabled.

---

The :WAVeform:SEGmented:TTAG? query returns the time tag of the currently selected segmented memory index. The index is selected using the :ACQUIRE:SEGmented:INDEX command.

**Return Format** <time\_tag> ::= in NR3 format

- See Also**
- [":ACQUIRE:SEGmented:INDEX"](#) on page 187
  - ["Introduction to :WAVeform Commands"](#) on page 592

**Example Code** • ["Example Code"](#) on page 187

**:WAVeform:SOURce**

**C** (see [page 750](#))

**Command Syntax** :WAVeform:SOURce <source>

<source> ::= {CHANnel<n> | FUNCTION | MATH | SBUS}

<n> ::= {1 | 2 | 3 | 4} for the four channel oscilloscope models

<n> ::= {1 | 2} for the two channel oscilloscope models

The :WAVeform:SOURce command selects the analog channel, function, or serial decode bus to be used as the source for the :WAVeform commands.

Function capabilities include add, subtract, multiply; integrate, differentiate, and FFT (Fast Fourier Transform) operations.

When the :WAVeform:SOURce is the serial decode bus (SBUS), ASCii is the only waveform format allowed.

**Query Syntax** :WAVeform:SOURce?

The :WAVeform:SOURce? query returns the currently selected source for the WAVeform commands.

**NOTE**

MATH is an alias for FUNCtion. The :WAVeform:SOURce? query returns FUNC if the source is FUNCtion or MATH.

**Return Format** <source><NL>

<source> ::= {CHAN<n> | FUNC | SBUS}

<n> ::= {1 | 2 | 3 | 4} for the four channel oscilloscope models

<n> ::= {1 | 2} for the two channel oscilloscope models

- See Also**
- ["Introduction to :WAVeform Commands"](#) on page 592
  - [":DIGitize"](#) on page 146
  - [":WAVeform:FORMat"](#) on page 601
  - [":WAVeform:BYTeorder"](#) on page 597
  - [":WAVeform:DATA"](#) on page 599
  - [":WAVeform:PREamble"](#) on page 606

**Example Code**

```
' WAVEFORM_DATA - To obtain waveform data, you must specify the
' WAVEFORM parameters for the waveform data prior to sending the
' ":WAVEFORM:DATA?" query. Once these parameters have been sent,
' the waveform data and the preamble can be read.
'
' WAVE_SOURCE - Selects the channel to be used as the source for
' the waveform commands.
myScope.WriteString ":WAVEFORM:SOURCE CHAN1"
```

## 5 Commands by Subsystem

```
' WAVE_POINTS - Specifies the number of points to be transferred
' using the ":WAVEFORM:DATA?" query.
myScope.WriteString ":WAVEFORM:POINTS 1000"

' WAVE_FORMAT - Sets the data transmission mode for the waveform
' data output. This command controls whether data is formatted in
' a word or byte format when sent from the oscilloscope.
Dim lngVSteps As Long
Dim intBytesPerData As Integer

' Data in range 0 to 65535.
myScope.WriteString ":WAVEFORM:FORMAT WORD"
lngVSteps = 65536
intBytesPerData = 2

' Data in range 0 to 255.
myScope.WriteString ":WAVEFORM:FORMAT BYTE"
lngVSteps = 256
intBytesPerData = 1

' GET_PREAMBLE - The preamble block contains all of the current
' WAVEFORM settings. It is returned in the form <preamble_block><NL>
' where <preamble_block> is:
'   FORMAT       : int16 - 0 = BYTE, 1 = WORD, 4 = ASCII.
'   TYPE         : int16 - 0 = NORMAL, 1 = PEAK DETECT, 2 = AVERAGE
'   POINTS      : int32 - number of data points transferred.
'   COUNT       : int32 - 1 and is always 1.
'   XINCREMENT  : float64 - time difference between data points.
'   XORIGIN     : float64 - always the first data point in memory.
'   XREFERENCE  : int32 - specifies the data point associated with
'                   x-origin.
'   YINCREMENT  : float32 - voltage diff between data points.
'   YORIGIN     : float32 - value is the voltage at center screen.
'   YREFERENCE  : int32 - specifies the data point where y-origin
'                   occurs.
Dim Preamble()
Dim intFormat As Integer
Dim intType As Integer
Dim lngPoints As Long
Dim lngCount As Long
Dim dblXIncrement As Double
Dim dblXOrigin As Double
Dim lngXReference As Long
Dim sngYIncrement As Single
Dim sngYOrigin As Single
Dim lngYReference As Long
Dim strOutput As String

myScope.WriteString ":WAVEFORM:PREAMBLE?" ' Query for the preamble.
Preamble() = myScope.ReadList ' Read preamble information.
intFormat = Preamble(0)
intType = Preamble(1)
lngPoints = Preamble(2)
lngCount = Preamble(3)
dblXIncrement = Preamble(4)
dblXOrigin = Preamble(5)
```

```

lngXReference = Preamble(6)
sngYIncrement = Preamble(7)
sngYOrigin = Preamble(8)
lngYReference = Preamble(9)
strOutput = ""
'strOutput = strOutput + "Format = " + CStr(intFormat) + vbCrLf
'strOutput = strOutput + "Type = " + CStr(intType) + vbCrLf
'strOutput = strOutput + "Points = " + CStr(lngPoints) + vbCrLf
'strOutput = strOutput + "Count = " + CStr(lngCount) + vbCrLf
'strOutput = strOutput + "X increment = " + _
'      FormatNumber(dblXIncrement * 1000000) + " us" + vbCrLf
'strOutput = strOutput + "X origin = " + _
'      FormatNumber(dblXOrigin * 1000000) + " us" + vbCrLf
'strOutput = strOutput + "X reference = " + _
'      CStr(lngXReference) + vbCrLf
'strOutput = strOutput + "Y increment = " + _
'      FormatNumber(sngYIncrement * 1000) + " mV" + vbCrLf
'strOutput = strOutput + "Y origin = " + _
'      FormatNumber(sngYOrigin) + " V" + vbCrLf
'strOutput = strOutput + "Y reference = " + _
'      CStr(lngYReference) + vbCrLf
strOutput = strOutput + "Volts/Div = " + _
'      FormatNumber(lngVSteps * sngYIncrement / 8) + _
'      " V" + vbCrLf
strOutput = strOutput + "Offset = " + _
'      FormatNumber((lngVSteps / 2 - lngYReference) * _
'      sngYIncrement + sngYOrigin) + " V" + vbCrLf
strOutput = strOutput + "Sec/Div = " + _
'      FormatNumber(lngPoints * dblXIncrement / 10 * _
'      1000000) + " us" + vbCrLf
strOutput = strOutput + "Delay = " + _
'      FormatNumber(((lngPoints / 2 - lngXReference) * _
'      dblXIncrement + dblXOrigin) * 1000000) + " us" + vbCrLf

' QUERY_WAVE_DATA - Outputs waveform data that is stored in a buffer.

' Query the oscilloscope for the waveform data.
myScope.WriteString ":WAV:DATA?"

' READ_WAVE_DATA - The wave data consists of two parts: the header,
' and the actual waveform data followed by a new line (NL) character.
' The query data has the following format:
'
'      <header><waveform_data><NL>
'
' Where:
'      <header> = #800001000 (This is an example header)
' The "#8" may be stripped off of the header and the remaining
' numbers are the size, in bytes, of the waveform data block. The
' size can vary depending on the number of points acquired for the
' waveform. You can then read that number of bytes from the
' oscilloscope and the terminating NL character.
'
Dim lngI As Long
Dim lngDataValue As Long

' Unsigned integer bytes.

```

## 5 Commands by Subsystem

```
varQueryResult = myScope.ReadIEEEBlock(BinaryType_UI1)

For lngI = 0 To UBound(varQueryResult) _
    Step (UBound(varQueryResult) / 20) ' 20 points.
    If intBytesPerData = 2 Then
        lngDataValue = varQueryResult(lngI) * 256 _
            + varQueryResult(lngI + 1) ' 16-bit value.
    Else
        lngDataValue = varQueryResult(lngI) ' 8-bit value.
    End If
    strOutput = strOutput + "Data point " + _
        CStr(lngI / intBytesPerData) + ", " + _
        FormatNumber((lngDataValue - lngYReference) _
            * sngYIncrement + sngYOrigin) + " V, " + _
        FormatNumber(((lngI / intBytesPerData - lngXReference) _
            * sngXIncrement + dblXOrigin) * 1000000) + " us" + vbCrLf
Next lngI
MsgBox "Waveform data:" + vbCrLf + strOutput
```

Example program from the start: ["VISA COM Example in Visual Basic"](#) on page 776

**:WAVeform:SOURce:SUBSource**

**C** (see [page 750](#))

**Command Syntax** :WAVeform:SOURce:SUBSource <subsource>

<subsource> ::= {{NONE | RX} | TX}

If the :WAVeform:SOURce is SBUS (serial decode), more than one data set may be available, and this command lets you choose from the available data sets.

Currently, only UART serial decode lets you get "TX" data. The default, NONE, specifies "RX" data. (RX is an alias for NONE.)

If the :WAVeform:SOURce is not SBUS, or the :SBUS:MODE is not UART, the only valid subsource is NONE.

**Query Syntax** :WAVeform:SOURce:SUBSource?

The :WAVeform:SOURce:SUBSource? query returns the current waveform subsource setting.

**Return Format** <subsource><NL>

<subsource> ::= {NONE | TX}

- See Also**
- ["Introduction to :WAVeform Commands"](#) on page 592
  - [":WAVeform:SOURce"](#) on page 611

### :WAVeform:TYPE

**C** (see [page 750](#))

**Query Syntax** :WAVeform:TYPE?

The :WAVeform:TYPE? query returns the acquisition mode associated with the currently selected waveform. The acquisition mode is set by the :ACQuire:TYPE command.

**Return Format** <mode><NL>

<mode> ::= {NORM | PEAK | AVER | HRES}

- See Also**
- ["Introduction to :WAVeform Commands"](#) on page 592
  - [":ACQuire:TYPE"](#) on page 191
  - [":WAVeform:DATA"](#) on page 599
  - [":WAVeform:PREamble"](#) on page 606
  - [":WAVeform:SOURce"](#) on page 611

**:WAVeform:UNSigned**

**C** (see [page 750](#))

**Command Syntax** :WAVeform:UNSigned <unsigned>  
 <unsigned> ::= {{0 | OFF} | {1 | ON}}

The :WAVeform:UNSigned command turns unsigned mode on or off for the currently selected waveform. Use the WAVeform:UNSigned command to control whether data values are sent as unsigned or signed integers. This command can be used to match the instrument's internal data type to the data type used by the programming language. This command has no effect if the data format is ASCII.

**Query Syntax** :WAVeform:UNSigned?

The :WAVeform:UNSigned? query returns the status of unsigned mode for the currently selected waveform.

**Return Format** <unsigned><NL>  
 <unsigned> ::= {0 | 1}

- See Also**
- ["Introduction to :WAVeform Commands"](#) on page 592
  - [":WAVeform:SOURce"](#) on page 611

## :WAVeform:VIEW

**C** (see [page 750](#))

**Command Syntax** :WAVeform:VIEW <view>  
<view> ::= {MAIN}

The :WAVeform:VIEW command sets the view setting associated with the currently selected waveform. Currently, the only legal value for the view setting is MAIN.

**Query Syntax** :WAVeform:VIEW?

The :WAVeform:VIEW? query returns the view setting associated with the currently selected waveform.

**Return Format** <view><NL>  
<view> ::= {MAIN}

- See Also**
- ["Introduction to :WAVeform Commands"](#) on page 592
  - [":WAVeform:POINTs"](#) on page 602

**:WAVeform:XINCrement****C** (see [page 750](#))**Query Syntax** :WAVeform:XINCrement?

The :WAVeform:XINCrement? query returns the x-increment value for the currently specified source. This value is the time difference between consecutive data points in seconds.

**Return Format** <value><NL>

<value> ::= x-increment in the current preamble in 64-bit floating point NR3 format

- See Also**
- ["Introduction to :WAVeform Commands"](#) on page 592
  - [":WAVeform:PREamble"](#) on page 606

**Example Code**

- ["Example Code"](#) on page 607

## :WAVeform:XORigin

**C** (see [page 750](#))

**Query Syntax** :WAVeform:XORigin?

The :WAVeform:XORigin? query returns the x-origin value for the currently specified source. XORigin is the X-axis value of the data point specified by the :WAVeform:XREFerence value. In this product, that is always the X-axis value of the first data point (XREFerence = 0).

**Return Format** <value><NL>

<value> ::= x-origin value in the current preamble in 64-bit floating point NR3 format

- See Also**
- "[Introduction to :WAVeform Commands](#)" on page 592
  - "[:WAVeform:PREamble](#)" on page 606
  - "[:WAVeform:XREFerence](#)" on page 621

- Example Code**
- "[Example Code](#)" on page 607

## :WAVeform:XREFerence

**C** (see [page 750](#))

**Query Syntax** :WAVeform:XREFerence?

The :WAVeform:XREFerence? query returns the x-reference value for the currently specified source. This value specifies the index of the data point associated with the x-origin data value. In this product, the x-reference point is the first point displayed and XREFerence is always 0.

**Return Format** <value><NL>

<value> ::= x-reference value = 0 in 32-bit NR1 format

- See Also**
- "[Introduction to :WAVeform Commands](#)" on page 592
  - "[:WAVeform:PREamble](#)" on page 606
  - "[:WAVeform:XORigin](#)" on page 620

**Example Code**

- "[Example Code](#)" on page 607

## :WAVeform:YINCrement

**C** (see [page 750](#))

**Query Syntax** :WAVeform:YINCrement?

The :WAVeform:YINCrement? query returns the y-increment value in volts for the currently specified source. This value is the voltage difference between consecutive data values.

**Return Format** <value><NL>

<value> ::= y-increment value in the current preamble in 32-bit floating point NR3 format

- See Also**
- "[Introduction to :WAVeform Commands](#)" on page 592
  - "[:WAVeform:PREamble](#)" on page 606

**Example Code**

- "[Example Code](#)" on page 607

**:WAVeform:YORigin****C** (see [page 750](#))**Query Syntax** :WAVeform:YORigin?

The :WAVeform:YORigin? query returns the y-origin value for the currently specified source. This value is the Y-axis value of the data value specified by the :WAVeform:YREFerence value. For this product, this is the Y-axis value of the center of the screen.

**Return Format** <value><NL>

<value> ::= y-origin in the current preamble in 32-bit floating point NR3 format

- See Also**
- "[Introduction to :WAVeform Commands](#)" on page 592
  - "[:WAVeform:PREamble](#)" on page 606
  - "[:WAVeform:YREFerence](#)" on page 624

- Example Code**
- "[Example Code](#)" on page 607

## :WAVeform:YREFerence

**C** (see [page 750](#))

**Query Syntax** :WAVeform:YREFerence?

The :WAVeform:YREFerence? query returns the y-reference value for the currently specified source. This value specifies the data point value where the y-origin occurs. In this product, this is the data point value of the center of the screen. It is undefined if the format is ASCii.

**Return Format** <value><NL>

<value> ::= y-reference value in the current preamble in 32-bit NR1 format

- See Also**
- ["Introduction to :WAVeform Commands"](#) on page 592
  - [":WAVeform:PREamble"](#) on page 606
  - [":WAVeform:YORigin"](#) on page 623

- Example Code**
- ["Example Code"](#) on page 607

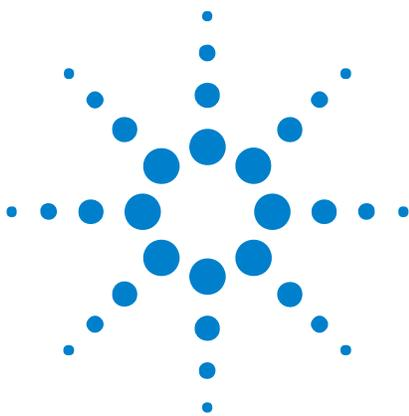

## 6 Commands A-Z

|   |     |
|---|-----|
| A | 625 |
| B | 626 |
| C | 627 |
| D | 629 |
| E | 631 |
| F | 632 |
| G | 633 |
| H | 634 |
| I | 634 |
| L | 635 |
| M | 636 |
| N | 639 |
| O | 639 |
| P | 640 |
| Q | 642 |
| R | 642 |
| S | 643 |
| T | 648 |
| U | 653 |
| V | 654 |
| W | 655 |
| X | 656 |
| Y | 656 |

- A**
- `AALias`, `":ACquire:AALias"` on page 179
  - `":ACquire:AALias"` on page 179
  - `":ACquire:COMplete"` on page 180
  - `":ACquire:COUNt"` on page 181
  - `":ACquire:DAALias"` on page 182
  - `":ACquire:MODE"` on page 183



- ":ACQUIRE:POINTS" on page 184
- ":ACQUIRE:SEGMENTED:ANALYZE" on page 185
- ":ACQUIRE:SEGMENTED:COUNT" on page 186
- ":ACQUIRE:SEGMENTED:INDEX" on page 187
- ":ACQUIRE:SRATE" on page 190
- ":ACQUIRE:TYPE" on page 191
- ADDRESS, ":TRIGGER:IIC:PATTERN:ADDRESS" on page 519
- ":AER (Arm Event Register)" on page 139
- ALIGNMENT, ":TRIGGER:I2S:ALIGNMENT" on page 502
- AMASK Commands:
  - ":MTEST:AMASK:CREATE" on page 342
  - ":MTEST:AMASK:{SAVE | STORE}" on page 693
  - ":MTEST:AMASK:SOURCE" on page 343
  - ":MTEST:AMASK:UNITS" on page 344
  - ":MTEST:AMASK:XDELTA" on page 345
  - ":MTEST:AMASK:YDELTA" on page 346
- ANALYZE, ":ACQUIRE:SEGMENTED:ANALYZE" on page 185
- APRINTER, ":HARDCOPY:APRINTER" on page 263
- AREA Commands:
  - ":HARDCOPY:AREA" on page 262
  - ":SAVE:IMAGE:AREA" on page 381
- ASIZE, ":SBUS:IIC:ASIZE" on page 407
- AUDIO, ":TRIGGER:I2S:AUDIO" on page 503
- ":AUTOSCALE" on page 140
  - ":AUTOSCALE:AMODE" on page 142
  - ":AUTOSCALE:CHANNELS" on page 143
- AUTOSCALE Commands:
  - ":TRIGGER:FLEXRAY:AUTOSCALE" on page 481
  - ":TRIGGER:M1553:AUTOSCALE" on page 541
- AVERAGE Commands:
  - ":MTEST:AVERAGE" on page 694
  - ":MTEST:AVERAGE:COUNT" on page 695
- B** • BASE Commands:
  - ":SBUS:M1553:BASE" on page 409
  - ":SBUS:UART:BASE" on page 413

- ":TRIGger:UART:BASE" on page 572
- BAUDrate Commands:
  - ":TRIGger:CAN:SIGNal:BAUDrate" on page 459
  - ":TRIGger:FLEXray:BAUDrate" on page 482
  - ":TRIGger:LIN:SIGNal:BAUDrate" on page 535
  - ":TRIGger:UART:BAUDrate" on page 573
- BIND, ":MTESt:SCALE:BIND" on page 364
- BITorder Commands:
  - ":SBUS:SPI:BITorder" on page 411
  - ":TRIGger:UART:BITorder" on page 574
- ":BLANk" on page 144
- BURSt, ":TRIGger:UART:BURSt" on page 575
- BWLimit Commands:
  - ":CHANnel<n>:BWLimit" on page 206
  - ":EXTernal:BWLimit" on page 235
- BYTeorder, ":WAVEform:BYTeorder" on page 597
- C**
  - ":CALibrate:DATE" on page 195
  - ":CALibrate:LABEL" on page 196
  - ":CALibrate:OUTPut" on page 197
  - ":CALibrate:START" on page 198
  - ":CALibrate:STATus" on page 199
  - ":CALibrate:SWITCh" on page 200
  - ":CALibrate:TEMPerature" on page 201
  - ":CALibrate:TIME" on page 202
  - CAN Commands:
    - ":SBUS:CAN:COUNT:ERRor" on page 396
    - ":SBUS:CAN:COUNT:OVERload" on page 397
    - ":SBUS:CAN:COUNT:RESet" on page 398
    - ":SBUS:CAN:COUNT:TOTal" on page 399
    - ":SBUS:CAN:COUNT:UTILization" on page 400
    - ":TRIGger:CAN Commands" on page 452
  - CCBASE, ":TRIGger:FLEXray:FRAME:CCBase" on page 486
  - CCRepetition, ":TRIGger:FLEXray:FRAME:CCRepetition" on page 487
  - ":CDISplay" on page 145
  - CENTER, ":FUNCTion:CENTer" on page 246

- CHANnel, ":TRIGger:FLEXray:CHANnel" on page 483
- ":CHANnel:LABel" on page 662
- ":CHANnel2:SKEW" on page 663
- ":CHANnel<n>:BWLimit" on page 206
- ":CHANnel<n>:COUPling" on page 207
- ":CHANnel<n>:DISPlay" on page 208
- ":CHANnel<n>:IMPedance" on page 209
- ":CHANnel<n>:INPut" on page 664
- ":CHANnel<n>:INVert" on page 210
- ":CHANnel<n>:LABel" on page 211
- ":CHANnel<n>:OFFSet" on page 212
- ":CHANnel<n>:PMODE" on page 665
- ":CHANnel<n>:PROBe" on page 213
- ":CHANnel<n>:PROBe:HEAD[:TYPE]" on page 214
- ":CHANnel<n>:PROBe:ID" on page 215
- ":CHANnel<n>:PROBe:SKEW" on page 216
- ":CHANnel<n>:PROBe:STYPe" on page 217
- ":CHANnel<n>:PROTection" on page 218
- ":CHANnel<n>:RANGe" on page 219
- ":CHANnel<n>:SCALe" on page 220
- ":CHANnel<n>:UNITs" on page 221
- ":CHANnel<n>:VERNier" on page 222
- CLear Commands:
  - ":DISPlay:CLear" on page 225
  - ":MEASure:CLear" on page 292
- CLOCk Commands:
  - ":TRIGger:IIC[:SOURce]:CLOCk" on page 522
  - ":TRIGger:I2S:CLOCk:SLOPe" on page 504
  - ":TRIGger:I2S:SOURce:CLOCk" on page 511
  - ":TRIGger:SPI:CLOCk:SLOPe" on page 556
  - ":TRIGger:SPI:CLOCk:TIMeout" on page 557
  - ":TRIGger:SPI:SOURce:CLOCk" on page 561
- "\*CLS (Clear Status)" on page 115
- COMplete, ":ACQuire:COMplete" on page 180

- CONDition, ":HWERegister:CONDition (Hardware Event Condition Register)" on page 150
- CONNect, ":DISPlay:CONNect" on page 666
- COUNT Commands:
  - ":ACQuire:COUNT" on page 181
  - ":ACQuire:SEGmented:COUNT" on page 186
  - ":MTESt:AVERage:COUNT" on page 695
  - ":MTESt:COUNT:FWAVeforms" on page 347
  - ":MTESt:COUNT:RESet" on page 348
  - ":MTESt:COUNT:TIME" on page 349
  - ":MTESt:COUNT:WAVeforms" on page 350
  - ":SBUS:CAN:COUNT:ERRor" on page 396
  - ":SBUS:CAN:COUNT:OVERload" on page 397
  - ":SBUS:CAN:COUNT:RESet" on page 398
  - ":SBUS:CAN:COUNT:TOTal" on page 399
  - ":SBUS:CAN:COUNT:UTILization" on page 400
  - ":SBUS:UART:COUNT:ERRor" on page 414
  - ":SBUS:UART:COUNT:RESet" on page 415
  - ":SBUS:UART:COUNT:RXFRames" on page 416
  - ":SBUS:UART:COUNT:TXFRames" on page 417
  - ":TRIGger:EBURst:COUNT" on page 471
  - ":TRIGger:SEQuence:COUNT" on page 548
  - ":WAVeform:COUNT" on page 598
  - ":WAVeform:SEGmented:COUNT" on page 609
- COUNter, ":MEASure:COUNter" on page 293
- COUPling Commands:
  - ":CHANnel<n>:COUPling" on page 207
  - ":TRIGger[:EDGE]:COUPling" on page 475
- CREate, ":MTESt:AMASK:CREate" on page 342
- D**
  - DAALias, ":ACQuire:DAALias" on page 182
  - DATA Commands:
    - ":DISPlay:DATA" on page 226
    - ":LISTer:DATA" on page 272
    - ":MTESt:DATA" on page 351
    - ":TRIGger:CAN:PATtern:DATA" on page 454

- [":TRIGger:CAN:PATtern:DATA:LENGth"](#) on page 455
- [":TRIGger:I2S:PATtern:DATA"](#) on page 505
- [":TRIGger:I2S:SOURce:DATA"](#) on page 512
- [":TRIGger:IIC:PATtern:DATA"](#) on page 520
- [":TRIGger:IIC:PATtern:DATA2"](#) on page 521
- [":TRIGger:IIC\[:SOURce\]:DATA"](#) on page 523
- [":TRIGger:LIN:PATtern:DATA"](#) on page 530
- [":TRIGger:LIN:PATtern:DATA:LENGth"](#) on page 532
- [":TRIGger:M1553:PATtern:DATA"](#) on page 542
- [":TRIGger:SPI:PATtern:DATA"](#) on page 559
- [":TRIGger:SPI:SOURce:DATA"](#) on page 562
- [":TRIGger:UART:DATA"](#) on page 576
- [":WAVEform:DATA"](#) on page 599
- DATE Commands:
  - [":CALibrate:DATE"](#) on page 195
  - [":SYSTem:DATE"](#) on page 420
- DEFine, [":MEASure:DEFine"](#) on page 294
- DELay Commands:
  - [":MEASure:DELay"](#) on page 297
  - [":TIMEbase:DELay"](#) on page 703
- DELete, [":MTEST:DELete"](#) on page 352
- DESTination, [":HARDcopy:DESTination"](#) on page 672
- DEvice, [":HARDcopy:DEvice"](#) on page 673
- [":DIGitize"](#) on page 146
- DISPlay Commands:
  - [":CHANnel<n>:DISPlay"](#) on page 208
  - [":FUNction:DISPlay"](#) on page 247
  - [":LISTer:DISPlay"](#) on page 273
  - [":SBUS:DISPlay"](#) on page 401
- [":DISPlay:CLEar"](#) on page 225
- [":DISPlay:CONNect"](#) on page 666
- [":DISPlay:DATA"](#) on page 226
- [":DISPlay:LABel"](#) on page 228
- [":DISPlay:LABList"](#) on page 229
- [":DISPlay:PERsistence"](#) on page 230

- ":DISPlay:SOURce" on page 231
  - ":DISPlay:VECTors" on page 232
  - DMINus, ":TRIGger:USB:SOURce:DMINus" on page 586
  - DPLus, ":TRIGger:USB:SOURce:DPLus" on page 587
  - DSP, ":SYSTem:DSP" on page 421
  - DURation, ":TRIGger:DURation Commands" on page 464
  - DUTYcycle, ":MEASure:DUTYcycle" on page 299
- E**
- EBURst, ":TRIGger:EBURst Commands" on page 470
  - EDGE Commands:
    - ":TRIGger[:EDGE] Commands" on page 474
    - ":TRIGger:SEQuence:EDGE" on page 549
  - ENABLE":MTESt:ENABLE" on page 353
  - ":ERASe" on page 667
  - ERRor Commands:
    - ":SBUS:CAN:COUNt:ERRor" on page 396
    - ":SBUS:UART:COUNt:ERRor" on page 414
    - ":SYSTem:ERRor" on page 422
    - ":TRIGger:FLEXray:ERRor:TYPE" on page 484
  - "\*ESE (Standard Event Status Enable)" on page 116
  - "\*ESR (Standard Event Status Register)" on page 118
  - EVENt Commands:
    - ":HWERegister[:EVENt] (Hardware Event Event Register)" on page 152
    - ":MTERegister[:EVENt] (Mask Test Event Event Register)" on page 157
    - ":TRIGger:FLEXray:EVENt:TYPE" on page 485
  - ":EXTErnal:BWLimit" on page 235
  - ":EXTErnal:IMPedance" on page 236
  - ":EXTErnal:INPut" on page 668
  - ":EXTErnal:PMODE" on page 669
  - ":EXTErnal:PROBE" on page 237
  - ":EXTErnal:PROBE:ID" on page 238
  - ":EXTErnal:PROBE:STYPE" on page 239
  - ":EXTErnal:PROTEction" on page 240
  - ":EXTErnal:RANGe" on page 241
  - ":EXTErnal:UNITs" on page 242

- F** • **FACTion** Commands:
  - [":MTESt:RMODe:FACTion:MEASure"](#) on page 357
  - [":MTESt:RMODe:FACTion:PRINt"](#) on page 358
  - [":MTESt:RMODe:FACTion:SAVE"](#) on page 359
  - [":MTESt:RMODe:FACTion:STOP"](#) on page 360
- **FACTors** Commands:
  - [":HARDcopy:FACTors"](#) on page 264
  - [":SAVE:IMAGe:FACTors"](#) on page 382
- **FALLtime**, [":MEASure:FALLtime"](#) on page 300
- **FFEed**, [":HARDcopy:FFEed"](#) on page 265
- **FILEname** Commands:
  - [":HARDcopy:FILEname"](#) on page 674
  - [":RECall:FILEname"](#) on page 372
  - [":SAVE:FILEname"](#) on page 379
- **FIND**, [":TRIGger:SEQuence:FIND"](#) on page 550
- **FLEXray** Commands:
  - [":SBUS:FLEXray:COUNt:NULL"](#) on page 402
  - [":SBUS:FLEXray:COUNt:RESet"](#) on page 403
  - [":SBUS:FLEXray:COUNt:SYNC"](#) on page 404
  - [":SBUS:FLEXray:COUNt:TOTal"](#) on page 405
  - [":TRIGger:FLEXray:AUTosetup"](#) on page 481
  - [":TRIGger:FLEXray:BAUDrate"](#) on page 482
  - [":TRIGger:FLEXray:CHANnel"](#) on page 483
  - [":TRIGger:FLEXray:ERRor:TYPE"](#) on page 484
  - [":TRIGger:FLEXray:EVENT:TYPE"](#) on page 485
  - [":TRIGger:FLEXray:FRAMe:CCBase"](#) on page 486
  - [":TRIGger:FLEXray:FRAMe:CCRepetition"](#) on page 487
  - [":TRIGger:FLEXray:FRAMe:ID"](#) on page 488
  - [":TRIGger:FLEXray:FRAMe:TYPE"](#) on page 489
  - [":TRIGger:FLEXray:SOURce"](#) on page 490
  - [":TRIGger:FLEXray:TRIGger"](#) on page 491
- **FORMat** Commands:
  - [":HARDcopy:FORMat"](#) on page 675
  - [":SAVE:IMAGe:FORMat"](#) on page 383
  - [":SAVE:WAVeform:FORMat"](#) on page 391

- ":TRIGger:I2S:PATtern:FORMat" on page 507
- ":TRIGger:LIN:PATtern:FORMat" on page 533
- ":WAVEform:FORMat" on page 601
- FRAME, ":TRIGger:SPI:SOURce:FRAME" on page 563
- FRAMing Commands:
  - ":SBUS:UART:FRAMing" on page 418
  - ":TRIGger:SPI:FRAMing" on page 558
- FREQuency, ":MEASure:FREQuency" on page 301
- ":FUNctio:n:CENTer" on page 246
- ":FUNctio:n:DISPlay" on page 247
- ":FUNctio:n:GOFT:OPERation" on page 248
- ":FUNctio:n:GOFT:SOURce1" on page 249
- ":FUNctio:n:GOFT:SOURce2" on page 250
- ":FUNctio:n:OFFSet" on page 251
- ":FUNctio:n:OPERation" on page 252
- ":FUNctio:n:RANGe" on page 253
- ":FUNctio:n:REFerence" on page 254
- ":FUNctio:n:SCALE" on page 255
- ":FUNctio:n:SOURce" on page 670
- ":FUNctio:n:SOURce1" on page 256
- ":FUNctio:n:SOURce2" on page 257
- ":FUNctio:n:SPAN" on page 258
- ":FUNctio:n:VIEW" on page 671
- ":FUNctio:n:WINDow" on page 259
- FWAVEforms, ":MTEST:COUNt:FWAVEforms" on page 347
- G**
  - GLITch (Pulse Width), ":TRIGger:GLITCh Commands" on page 492
  - GOFT Commands:
    - ":FUNctio:n:GOFT:OPERation" on page 248
    - ":FUNctio:n:GOFT:SOURce1" on page 249
    - ":FUNctio:n:GOFT:SOURce2" on page 250
  - GRAYscale, ":HARDcopy:GRAYscale" on page 676
  - GREATERthan Commands:
    - ":TRIGger:DURATION:GREATERthan" on page 465
    - ":TRIGger:GLITCh:GREATERthan" on page 493

- H**
  - [":HARDcopy:AREA"](#) on page 262
  - [":HARDcopy:APRinter"](#) on page 263
  - [":HARDcopy:DESTination"](#) on page 672
  - [":HARDcopy:DEVice"](#) on page 673
  - [":HARDcopy:FACTors"](#) on page 264
  - [":HARDcopy:FFEed"](#) on page 265
  - [":HARDcopy:FILEname"](#) on page 674
  - [":HARDcopy:FORMat"](#) on page 675
  - [":HARDcopy:GRAYscale"](#) on page 676
  - [":HARDcopy:IGColors"](#) on page 677
  - [":HARDcopy:INKSaver"](#) on page 266
  - [":HARDcopy:LAYout"](#) on page 267
  - [":HARDcopy:PALette"](#) on page 268
  - [":HARDcopy:PDRiver"](#) on page 678
  - [":HARDcopy:PRINter:LIST"](#) on page 269
  - [":HARDcopy:START"](#) on page 270
  - [HEAD, ":CHANnel<n>:PROBe:HEAD\[:TYPE\]"](#) on page 214
  - [HFReject, ":TRIGger:HFReject"](#) on page 444
  - [HOLDoff, ":TRIGger:HOLDoff"](#) on page 445
  - [":HWEenable \(Hardware Event Enable Register\)"](#) on page 148
  - [":HWERegister:CONDition \(Hardware Event Condition Register\)"](#) on page 150
  - [":HWERegister\[:EVENT\] \(Hardware Event Event Register\)"](#) on page 152
- I**
  - ID Commands:
    - [":TRIGger:CAN:PATtern:ID"](#) on page 456
    - [":TRIGger:CAN:PATtern:ID:MODE"](#) on page 457
    - [":TRIGger:FLEXray:FRAME:ID"](#) on page 488
  - IDLE Commands:
    - [":TRIGger:EBURst:IDLE"](#) on page 472
    - [":TRIGger:UART:IDLE"](#) on page 577
  - ["\\*IDN \(Identification Number\)"](#) on page 120
  - I2S Commands:
    - [":SBUS:I2S:BASE"](#) on page 406
    - [":TRIGger:I2S Commands"](#) on page 500
  - IIC Commands:

- [":SBUS:IIC:ASize"](#) on page 407
- [":TRIGger:IIC Commands"](#) on page 518
- IGCOLORS Commands:
  - [":HARDcopy:IGColors"](#) on page 677
  - [":SAVE:IMAGe:INKSaver"](#) on page 384
- IMAGe Commands:
  - [":RECall:IMAGe\[:START\]"](#) on page 373
  - [":SAVE:IMAGe:AREA"](#) on page 381
  - [":SAVE:IMAGe:FACTors"](#) on page 382
  - [":SAVE:IMAGe:FORMat"](#) on page 383
  - [":SAVE:IMAGe:INKSaver"](#) on page 384
  - [":SAVE:IMAGe:PALette"](#) on page 385
  - [":SAVE:IMAGe\[:START\]"](#) on page 380
- IMPedance Commands:
  - [":CHANnel<n>:IMPedance"](#) on page 209
  - [":EXTernal:IMPedance"](#) on page 236
- INCRement, [":MEASure:STATistics:INCRement"](#) on page 318
- INDEx, [":ACQuire:SEGmented:INDEx"](#) on page 187
- INKSaver, [":HARDcopy:INKSaver"](#) on page 266
- INVert, [":CHANnel<n>:INVert"](#) on page 210
- L**
  - LABEL Commands:
    - [":CALibrate:LABel"](#) on page 196
    - [":CHANnel:LABel"](#) on page 662
    - [":CHANnel<n>:LABel"](#) on page 211
    - [":DISPlay:LABel"](#) on page 228
  - LABList, [":DISPlay:LABList"](#) on page 229
  - LAYout, [":HARDcopy:LAYout"](#) on page 267
  - LENGth Commands:
    - [":SAVE:WAVEform:LENGth"](#) on page 392
    - [":TRIGger:CAN:PATtern:DATA:LENGth"](#) on page 455
    - [":TRIGger:LIN:PATtern:DATA:LENGth"](#) on page 532
  - LESSthan Commands:
    - [":TRIGger:DURation:LESSthan"](#) on page 466
    - [":TRIGger:GLITCh:LESSthan"](#) on page 494
  - LEVEL Commands:

- [":TRIGger\[:EDGE\]:LEVel"](#) on page 476
  - [":TRIGger:GLITCh:LEVel"](#) on page 495
  - LFIfty, [":TRIGger:LFIfty"](#) on page 446
  - LIN Commands:
    - [":SBUS:LIN:PARity"](#) on page 408
    - [":TRIGger:LIN Commands"](#) on page 527
  - LINE, [":TRIGger:TV:LINE"](#) on page 565
  - LIST, [":HARDcopy:PRINter:LIST"](#) on page 269
  - LISTer Commands:
    - [":LISTer:DATA"](#) on page 272
    - [":LISTer:DISPlay"](#) on page 273
    - [":SAVE:LISTer\[:STARt\]"](#) on page 386
  - LOAD, [":MTEST:LOAD"](#) on page 696
  - LOCK Commands:
    - [":MTEST:LOCK"](#) on page 354
    - [":SYSTEM:LOCK"](#) on page 423
    - [":SYSTEM:PROTection:LOCK"](#) on page 425
  - LOWer Commands:
    - [":MEASure:LOWer"](#) on page 679
    - [":TRIGger:M1553:SOURce:LOWer"](#) on page 544
  - ["\\*LRN \(Learn Device Setup\)"](#) on page 121
- M**
- M1553 Commands:
    - [":SBUS:M1553:BASE"](#) on page 409
    - [":TRIGger:M1553 Commands"](#) on page 540
  - [":MARKer:MODE"](#) on page 276
  - [":MARKer:X1Position"](#) on page 277
  - [":MARKer:X1Y1source"](#) on page 278
  - [":MARKer:X2Position"](#) on page 279
  - [":MARKer:X2Y2source"](#) on page 280
  - [":MARKer:XDELta"](#) on page 281
  - [":MARKer:Y1Position"](#) on page 282
  - [":MARKer:Y2Position"](#) on page 283
  - [":MARKer:YDELta"](#) on page 284
  - MASK Commands:
    - [":RECall:MASK\[:STARt\]"](#) on page 374

- [":SAVE:MASK\[:START\]"](#) on page 387
- [":MEASure:CLEar"](#) on page 292
- [":MEASure:COUNter"](#) on page 293
- [":MEASure:DEFine"](#) on page 294
- [":MEASure:DELay"](#) on page 297
- [":MEASure:DUTYcycle"](#) on page 299
- [":MEASure:FALLtime"](#) on page 300
- [":MEASure:FREQuency"](#) on page 301
- [":MEASure:LOWer"](#) on page 679
- [":MEASure:NWIDth"](#) on page 302
- [":MEASure:OVERshoot"](#) on page 303
- [":MEASure:PERiod"](#) on page 305
- [":MEASure:PHASe"](#) on page 306
- [":MEASure:PREShoot"](#) on page 307
- [":MEASure:PWIDth"](#) on page 308
- [":MEASure:RESults"](#) on page 309
- [":MEASure:RISetime"](#) on page 312
- [":MEASure:SCRatch"](#) on page 680
- [":MEASure:SDEVIation"](#) on page 313
- [":MEASure:SHOW"](#) on page 314
- [":MEASure:SOURce"](#) on page 315
- [":MEASure:STATistics"](#) on page 317
- [":MEASure:STATistics:INCRement"](#) on page 318
- [":MEASure:STATistics:RESet"](#) on page 319
- [":MEASure:TDELta"](#) on page 681
- [":MEASure:TEDGE"](#) on page 320
- [":MEASure:THResholds"](#) on page 682
- [":MEASure:TMAX"](#) on page 683
- [":MEASure:TMIN"](#) on page 684
- [":MEASure:TSTArt"](#) on page 685
- [":MEASure:TSTOP"](#) on page 686
- [":MEASure:TVALue"](#) on page 322
- [":MEASure:TVOLT"](#) on page 687
- [":MEASure:UPPer"](#) on page 689
- [":MEASure:VAMPLitude"](#) on page 324

- [":MEASure:VAverage"](#) on page 325
- [":MEASure:VBASe"](#) on page 326
- [":MEASure:VDELta"](#) on page 690
- [":MEASure:VMAX"](#) on page 327
- [":MEASure:VMIN"](#) on page 328
- [":MEASure:VPP"](#) on page 329
- [":MEASure:VRATio"](#) on page 330
- [":MEASure:VRMS"](#) on page 331
- [":MEASure:VSTArt"](#) on page 691
- [":MEASure:VSTOp"](#) on page 692
- [":MEASure:VTIME"](#) on page 332
- [":MEASure:VTOp"](#) on page 333
- [":MEASure:WINDow"](#) on page 334
- [":MEASure:XMAX"](#) on page 335
- [":MEASure:XMIN"](#) on page 336
- [MEASure, ":MTESt:RMODE:FACTion:MEASure"](#) on page 357
- [":MERGe"](#) on page 154
- MODE Commands:
  - [":ACQuire:MODE"](#) on page 183
  - [":MARKer:MODE"](#) on page 276
  - [":SBUS:MODE"](#) on page 410
  - [":TIMEbase:MODE"](#) on page 431
  - [":TRIGger:CAN:PATtern:ID:MODE"](#) on page 457
  - [":TRIGger:MODE"](#) on page 447
  - [":TRIGger:TV:MODE"](#) on page 566
  - [":WAVeform:POINts:MODE"](#) on page 604
- [":MTEenable \(Mask Test Event Enable Register\)"](#) on page 155
- [":MTERegister\[:EVENT\] \(Mask Test Event Event Register\)"](#) on page 157
- [":MTESt:AMASk:CREate"](#) on page 342
- [":MTESt:AMASk:{SAVE | STORE}"](#) on page 693
- [":MTESt:AMASk:SOURce"](#) on page 343
- [":MTESt:AMASk:UNITs"](#) on page 344
- [":MTESt:AMASk:XDELta"](#) on page 345
- [":MTESt:AMASk:YDELta"](#) on page 346
- [":MTESt:AVERage"](#) on page 694

- ":MTESt:AVERage:COUNT" on page 695
  - ":MTESt:COUNT:FWAVEforms" on page 347
  - ":MTESt:COUNT:RESet" on page 348
  - ":MTESt:COUNT:TIME" on page 349
  - ":MTESt:COUNT:WAVEforms" on page 350
  - ":MTESt:DATA" on page 351
  - ":MTESt:DELeTe" on page 352
  - ":MTESt:ENABle" on page 353
  - ":MTESt:LOAD" on page 696
  - ":MTESt:LOCK" on page 354
  - ":MTESt:OUTPut" on page 355
  - ":MTESt:RMODE" on page 356
  - ":MTESt:RMODE:FACTION:MEASure" on page 357
  - ":MTESt:RMODE:FACTION:PRINt" on page 358
  - ":MTESt:RMODE:FACTION:SAVE" on page 359
  - ":MTESt:RMODE:FACTION:STOP" on page 360
  - ":MTESt:RMODE:SIGMa" on page 361
  - ":MTESt:RMODE:TIME" on page 362
  - ":MTESt:RMODE:WAVEforms" on page 363
  - ":MTESt:RUMode" on page 697
  - ":MTESt:RUMode:SOFailure" on page 698
  - ":MTESt:SCALE:BIND" on page 364
  - ":MTESt:SCALE:X1" on page 365
  - ":MTESt:SCALE:XDELta" on page 366
  - ":MTESt:SCALE:Y1" on page 367
  - ":MTESt:SCALE:Y2" on page 368
  - ":MTESt:SOURce" on page 369
  - ":MTESt:{STARt | STOP}" on page 699
  - ":MTESt:TITLe" on page 370
  - ":MTESt:TRIGger:SOURce" on page 700
- N**
- NREJect, ":TRIGger:NREJect" on page 448
  - NWIDth, ":MEASure:NWIDth" on page 302
- O**
- OFFSet Commands:
    - ":CHANnel<n>:OFFSet" on page 212

- ":FUNction:OFFSet" on page 251
- "\*OPC (Operation Complete)" on page 122
- ":OPEE (Operation Status Enable Register)" on page 159
- OPERation Commands:
  - ":FUNction:GOFT:OPERation" on page 248
  - ":FUNction:OPERation" on page 252
- ":OPERegister:CONDition (Operation Status Condition Register)" on page 161
- ":OPERegister[:EVENT] (Operation Status Event Register)" on page 163
- "\*OPT (Option Identification)" on page 123
- OUTPut Commands:
  - ":CALibrate:OUTPut" on page 197
  - ":MTESt:OUTPut" on page 355
- OVERload, ":SBUS:CAN:COUNT:OVERload" on page 397
- OVERshoot, ":MEASure:OVERshoot" on page 303
- ":OVLenable (Overload Event Enable Register)" on page 165
- ":OVLRegister (Overload Event Register)" on page 167
- P**
  - PALette Commands:
    - ":HARDcopy:PALette" on page 268
    - ":SAVE:IMAGe:PALette" on page 385
  - PARity Commands:
    - ":SBUS:LIN:PARity" on page 408
    - ":TRIGger:UART:PARity" on page 578
  - PATTern Commands:
    - ":TRIGger:CAN:PATTern:DATA" on page 454
    - ":TRIGger:CAN:PATTern:DATA:LENGth" on page 455
    - ":TRIGger:CAN:PATTern:ID" on page 456
    - ":TRIGger:CAN:PATTern:ID:MODE" on page 457
    - ":TRIGger:DURation:PATTern" on page 467
    - ":TRIGger:I2S:PATTern:DATA" on page 505
    - ":TRIGger:I2S:PATTern:FORMat" on page 507
    - ":TRIGger:IIC:PATTern:ADDRes" on page 519
    - ":TRIGger:IIC:PATTern:DATA" on page 520
    - ":TRIGger:IIC:PATTern:DATA2" on page 521
    - ":TRIGger:LIN:PATTern:DATA" on page 530

- ":TRIGger:LIN:PATtern:DATA:LENGth" on page 532
- ":TRIGger:LIN:PATtern:FORMat" on page 533
- ":TRIGger:M1553:PATtern:DATA" on page 542
- ":TRIGger:PATtern" on page 449
- ":TRIGger:SEQuence:PATtern" on page 551
- ":TRIGger:SPI:PATtern:DATA" on page 559
- ":TRIGger:SPI:PATtern:WIDTh" on page 560
- PDRiver, ":HARDcopy:PDRiver" on page 678
- PERiod, ":MEASure:PERiod" on page 305
- PERsistence, ":DISPlay:PERsistence" on page 230
- PHASe, ":MEASure:PHASe" on page 306
- PMODE, ":CHANnel<n>:PMODE" on page 665
- POINTs Commands:
  - ":ACQuire:POINTs" on page 184
  - ":WAVEform:POINTs" on page 602
  - ":WAVEform:POINTs:MODE" on page 604
- POLarity Commands:
  - ":TRIGger:GLITch:POLarity" on page 496
  - ":TRIGger:TV:POLarity" on page 567
  - ":TRIGger:UART:POLarity" on page 579
- POSition Commands:
  - ":TIMEbase:POSition" on page 432
  - ":TIMEbase:WINDow:POSition" on page 437
- PREamble, ":WAVEform:PREamble" on page 606
- PRECision, ":SYSTem:PRECision" on page 424
- PREShoot, ":MEASure:PREShoot" on page 307
- PRINt, ":MTEST:RMODE:FACTion:PRINt" on page 358
- ":PRINt" on page 169
- ":PRINt?" on page 701
- PRINter, ":HARDcopy:PRINter:LIST" on page 269
- PROBE Commands:
  - ":CHANnel<n>:PROBe" on page 213
  - ":CHANnel<n>:PROBe:HEAD[:TYPE]" on page 214
  - ":CHANnel<n>:PROBe:ID" on page 215
  - ":CHANnel<n>:PROBe:SKEW" on page 216

- ":CHANnel<n>:PROBe:STYPe" on page 217
- ":EXTeRnal:PROBe" on page 237
- PROTection Commands:
  - ":CHANnel<n>:PROTection" on page 218
  - ":EXTeRnal:PROTection" on page 240
  - ":SYSTem:PROTection:LOCK" on page 425
- Pulse Width (GLITCh), ":TRIGger:GLITCh Commands" on page 492
- PWD Commands:
  - ":RECall:PWD" on page 375
  - ":SAVE:PWD" on page 388
- PWIDth, ":MEASure:PWIDth" on page 308
- Q**
  - QUALifier Commands:
    - ":TRIGger:DURation:QUALifier" on page 468
    - ":TRIGger:GLITCh:QUALifier" on page 497
    - ":TRIGger:IIC:TRIGger:QUALifier" on page 524
    - ":TRIGger:UART:QUALifier" on page 580
- R**
  - RANGe Commands:
    - ":CHANnel<n>:RANGe" on page 219
    - ":EXTeRnal:RANGe" on page 241
    - ":FUNCTion:RANGe" on page 253
    - ":TIMebase:RANGe" on page 433
    - ":TIMebase:WINDow:RANGe" on page 438
    - ":TRIGger:DURation:RANGe" on page 469
    - ":TRIGger:GLITCh:RANGe" on page 498
    - ":TRIGger:I2S:RANGe" on page 508
  - "\*RCL (Recall)" on page 124
  - ":RECall:FILEname" on page 372
  - ":RECall:IMAGe[:STARt]" on page 373
  - ":RECall:MASK[:STARt]" on page 374
  - ":RECall:PWD" on page 375
  - ":RECall:SETup[:STARt]" on page 376
  - REFerence Commands:
    - ":FUNCTion:REFerence" on page 254
    - ":TIMebase:REFerence" on page 434

- REJect, ":TRIGger[:EDGE]:REJect" on page 477
- RESet Commands:
  - ":MEASure:STATistics:RESet" on page 319
  - ":MTESt:COUNt:RESet" on page 348
  - ":SBUS:CAN:COUNt:RESet" on page 398
  - ":SBUS:UART:COUNt:RESet" on page 415
  - ":TRIGger:SEQuence:RESet" on page 552
- RESults, ":MEASure:RESults" on page 309
- RISetime, ":MEASure:RISetime" on page 312
- RMODe Commands:
  - ":MTESt:RMODe" on page 356
  - ":MTESt:RMODe:FACTion:MEASure" on page 357
  - ":MTESt:RMODe:FACTion:PRINT" on page 358
  - ":MTESt:RMODe:FACTion:SAVE" on page 359
  - ":MTESt:RMODe:FACTion:STOP" on page 360
  - ":MTESt:RMODe:SIGMa" on page 361
  - ":MTESt:RMODe:TIME" on page 362
  - ":MTESt:RMODe:WAVEforms" on page 363
- "Root (:)" Commands" on page 136
- "\*RST (Reset)" on page 125
- RTA, ":TRIGger:M1553:RTA" on page 543
- RUMode Commands:
  - ":MTESt:RUMode" on page 697
  - ":MTESt:RUMode:SOFailure" on page 698
- ":RUN" on page 170
- RWIDth, ":TRIGger:I2S:RWIDth" on page 510
- RX, ":TRIGger:UART:SOURce:RX" on page 581
- RXFRames, ":SBUS:UART:COUNt:RXFRames" on page 416
- S**
  - SAMPlEpoint Commands:
    - ":TRIGger:CAN:SAMPlEpoint" on page 458
    - ":TRIGger:LIN:SAMPlEpoint" on page 534
  - "\*SAV (Save)" on page 128
  - SAVe Commands:
    - ":MTESt:AMASK:{SAVE | STORe}" on page 693
    - ":MTESt:RMODe:FACTion:SAVE" on page 359

- [":SAVE:FILENAME"](#) on page 379
- [":SAVE:IMAGE:AREA"](#) on page 381
- [":SAVE:IMAGE:FACTors"](#) on page 382
- [":SAVE:IMAGE:FORMat"](#) on page 383
- [":SAVE:IMAGE:INKSaver"](#) on page 384
- [":SAVE:IMAGE:PALette"](#) on page 385
- [":SAVE:IMAGE\[:START\]"](#) on page 380
- [":SAVE:LISTer\[:START\]"](#) on page 386
- [":SAVE:MASK\[:START\]"](#) on page 387
- [":SAVE:PWD"](#) on page 388
- [":SAVE:SETup\[:START\]"](#) on page 389
- [":SAVE:WAVEform:FORMat"](#) on page 391
- [":SAVE:WAVEform:LENGth"](#) on page 392
- [":SAVE:WAVEform:SEGMENTed"](#) on page 393
- [":SAVE:WAVEform\[:START\]"](#) on page 390
- [":SBUS:CAN:COUNT:ERRor"](#) on page 396
- [":SBUS:CAN:COUNT:OVERload"](#) on page 397
- [":SBUS:CAN:COUNT:RESet"](#) on page 398
- [":SBUS:CAN:COUNT:TOTal"](#) on page 399
- [":SBUS:CAN:COUNT:UTILization"](#) on page 400
- [":SBUS:DISPlay"](#) on page 401
- [":SBUS:FLEXray:COUNT:NULL"](#) on page 402
- [":SBUS:FLEXray:COUNT:RESet"](#) on page 403
- [":SBUS:FLEXray:COUNT:SYNC"](#) on page 404
- [":SBUS:FLEXray:COUNT:TOTal"](#) on page 405
- [":SBUS:I2S:BASE"](#) on page 406
- [":SBUS:IIC:ASIZE"](#) on page 407
- [":SBUS:LIN:PARity"](#) on page 408
- [":SBUS:M1553:BASE"](#) on page 409
- [":SBUS:MODE"](#) on page 410
- [":SBUS:SPI:BITorder"](#) on page 411
- [":SBUS:SPI:WIDTh"](#) on page 412
- [":SBUS:UART:BASE"](#) on page 413
- [":SBUS:UART:COUNT:ERRor"](#) on page 414
- [":SBUS:UART:COUNT:RESet"](#) on page 415

- [":SBUS:UART:COUNt:RXFRames"](#) on page 416
- [":SBUS:UART:COUNt:TXFRames"](#) on page 417
- [":SBUS:UART:FRAMing"](#) on page 418
- SCALe Commands:
  - [":CHANnel<n>:SCALe"](#) on page 220
  - [":FUNction:SCALe"](#) on page 255
  - [":MTESt:SCALe:BINd"](#) on page 364
  - [":MTESt:SCALe:X1"](#) on page 365
  - [":MTESt:SCALe:XDELta"](#) on page 366
  - [":MTESt:SCALe:Y1"](#) on page 367
  - [":MTESt:SCALe:Y2"](#) on page 368
  - [":TIMebase:SCALe"](#) on page 435
  - [":TIMebase:WINDow:SCALe"](#) on page 439
- SCRatch, [":MEASure:SCRatch"](#) on page 680
- SDEVIation, [":MEASure:SDEVIation"](#) on page 313
- [":SERial"](#) on page 171
- SEGMENTed Commands:
  - [":ACQuire:SEGMENTed:ANALyze"](#) on page 185
  - [":ACQuire:SEGMENTed:COUNt"](#) on page 186
  - [":ACQuire:SEGMENTed:INDex"](#) on page 187
  - [":SAVE:WAVEform:SEGMENTed"](#) on page 393
  - [":WAVEform:SEGMENTed:COUNt"](#) on page 609
  - [":WAVEform:SEGMENTed:TTAG"](#) on page 610
- SETup Commands:
  - [":RECall:SETup\[:STARt\]"](#) on page 376
  - [":SAVE:SETup\[:STARt\]"](#) on page 389
  - [":SYSTem:SETup"](#) on page 426
- SEQUence, [":TRIGger:SEQUence Commands"](#) on page 547
- SHOW, [":MEASure:SHOW"](#) on page 314
- SIGMa, [":MTESt:RMODE:SIGMa"](#) on page 361
- SIGNal Commands:
  - [":TRIGger:CAN:SIGNal:BAUDrate"](#) on page 459
  - [":TRIGger:CAN:SIGNal:DEFinition"](#) on page 460
  - [":TRIGger:LIN:SIGNal:BAUDrate"](#) on page 535
  - [":TRIGger:LIN:SIGNal:DEFinition"](#) on page 705

- [":SINGLE"](#) on page 172
- [SKEW, ":CHANnel<n>:PROBe:SKEW"](#) on page 216
- **SLOPe Commands:**
  - [":TRIGger:EBURst:SLOPe"](#) on page 473
  - [":TRIGger\[:EDGE\]:SLOPe"](#) on page 478
  - [":TRIGger:I2S:CLOCK:SLOPe"](#) on page 504
  - [":TRIGger:SPI:CLOCK:SLOPe"](#) on page 556
- [SOFailure, ":MTESt:RUMode:SOFailure"](#) on page 698
- **SOURce Commands:**
  - [":DISPlay:SOURce"](#) on page 231
  - [":FUNCTion:SOURce"](#) on page 670
  - [":MEASure:SOURce"](#) on page 315
  - [":MTESt:AMASk:SOURce"](#) on page 343
  - [":MTESt:SOURce"](#) on page 369
  - [":MTESt:TRIGger:SOURce"](#) on page 700
  - [":TRIGger:CAN:SOURce"](#) on page 461
  - [":TRIGger:FLEXray:SOURce"](#) on page 490
  - [":TRIGger:GLITCh:SOURce"](#) on page 499
  - [":TRIGger:I2S:SOURce:CLOCK"](#) on page 511
  - [":TRIGger:I2S:SOURce:DATA"](#) on page 512
  - [":TRIGger:I2S:SOURce:WSElect"](#) on page 513
  - [":TRIGger:IIC\[:SOURce\]:CLOCK"](#) on page 522
  - [":TRIGger:IIC\[:SOURce\]:DATA"](#) on page 523
  - [":TRIGger:LIN:SOURce"](#) on page 536
  - [":TRIGger:M1553:SOURce:LOWer"](#) on page 544
  - [":TRIGger:M1553:SOURce:UPPer"](#) on page 545
  - [":TRIGger:SPI:SOURce:CLOCK"](#) on page 561
  - [":TRIGger:SPI:SOURce:DATA"](#) on page 562
  - [":TRIGger:SPI:SOURce:FRAME"](#) on page 563
  - [":TRIGger:TV:SOURce"](#) on page 568
  - [":TRIGger:UART:SOURce:RX"](#) on page 581
  - [":TRIGger:UART:SOURce:TX"](#) on page 582
  - [":TRIGger:USB:SOURce:DMINus"](#) on page 586
  - [":TRIGger:USB:SOURce:DPLus"](#) on page 587
  - [":WAVEform:SOURce"](#) on page 611

- [":WAVeform:SOURce:SUBSource"](#) on page 615
- SOURce1 Commands:
  - [":FUNcTion:GOFT:SOURce1"](#) on page 249
  - [":FUNcTion:SOURce1"](#) on page 256
- SOURce2 Commands:
  - [":FUNcTion:GOFT:SOURce2"](#) on page 250
  - [":FUNcTion:SOURce2"](#) on page 257
- SPAN, [":FUNcTion:SPAN"](#) on page 258
- SPEEd, [":TRIGger:USB:SPEEd"](#) on page 588
- SPI Commands:
  - [":SBUS:SPI:BITorder"](#) on page 411
  - [":SBUS:SPI:WIDTh"](#) on page 412
  - [":TRIGger:SPI Commands"](#) on page 555
- SRATe, [":ACQuire:SRATe"](#) on page 190
- ["\\*SRE \(Service Request Enable\)"](#) on page 129
- STANdard Commands:
  - [":TRIGger:LIN:STANdard"](#) on page 537
  - [":TRIGger:TV:STANdard"](#) on page 569
- STARt Commands:
  - [":CALibrate:STARt"](#) on page 198
  - [":HARDcopy:STARt"](#) on page 270
  - [":MTESt:{STARt | STOP}"](#) on page 699
  - [":RECall:IMAGe\[:STARt\]"](#) on page 373
  - [":RECall:MASK\[:STARt\]"](#) on page 374
  - [":RECall:SETup\[:STARt\]"](#) on page 376
  - [":SAVE:IMAGe\[:STARt\]"](#) on page 380
  - [":SAVE:LISTer\[:STARt\]"](#) on page 386
  - [":SAVE:MASK\[:STARt\]"](#) on page 387
  - [":SAVE:SETup\[:STARt\]"](#) on page 389
  - [":SAVE:WAVeform\[:STARt\]"](#) on page 390
- STATistics Commands:
  - [":MEASure:STATistics"](#) on page 317
  - [":MEASure:STATistics:INCRement"](#) on page 318
  - [":MEASure:STATistics:RESet"](#) on page 319
- STATus Commands:

- ":CALibrate:STATus" on page 199
  - ":STATus" on page 173
  - "\*STB (Read Status Byte)" on page 131
  - STOP Commands:
    - ":MTESt:RMODe:FACTion:STOP" on page 360
    - ":MTESt:{START | STOP}" on page 699
  - ":STOP" on page 174
  - STORe, ":MTESt:AMASK:{SAVE | STORe}" on page 693
  - SUBSource, ":WAVEform:SOURce:SUBSource" on page 615
  - SWEep, ":TRIGger:SWEep" on page 451
  - SWITCh, ":CALibrate:SWITCh" on page 200
  - SYNCbreak, ":TRIGger:LIN:SYNCbreak" on page 538
  - ":SYSTem:DATE" on page 420
  - ":SYSTem:DSP" on page 421
  - ":SYSTem:ERRor" on page 422
  - ":SYSTem:LOCK" on page 423
  - ":SYSTem:PRECision" on page 424
  - ":SYSTem:SETup" on page 426
  - ":SYSTem:TIME" on page 428
- T**
- TDELta, ":MEASure:TDELta" on page 681
  - TEDGe, ":MEASure:TEDGe" on page 320
  - TEMPerature, ":CALibrate:TEMPerature" on page 201
  - ":TER (Trigger Event Register)" on page 175
  - THResholds, ":MEASure:THResholds" on page 682
  - TIME Commands:
    - ":CALibrate:TIME" on page 202
    - ":MTESt:COUNt:TIME" on page 349
    - ":MTESt:RMODe:TIME" on page 362
    - ":SYSTem:TIME" on page 428
  - ":TIMEbase:DELay" on page 703
  - ":TIMEbase:MODE" on page 431
  - ":TIMEbase:POSition" on page 432
  - ":TIMEbase:RANGe" on page 433
  - ":TIMEbase:REFerence" on page 434
  - ":TIMEbase:SCALE" on page 435

- [":TIMEbase:VERNier"](#) on page 436
- [":TIMEbase:WINDow:POSition"](#) on page 437
- [":TIMEbase:WINDow:RANGe"](#) on page 438
- [":TIMEbase:WINDow:SCALe"](#) on page 439
- [TIMEout, ":TRIGger:SPI:CLOCK:TIMEout"](#) on page 557
- [TIMER, ":TRIGger:SEQuence:TIMER"](#) on page 553
- [TITLE, ":MTEST:TITLE"](#) on page 370
- [TMAX, ":MEASure:TMAX"](#) on page 683
- [TMIN, ":MEASure:TMIN"](#) on page 684
- [TOTAL, ":SBUS:CAN:COUNT:TOTAL"](#) on page 399
- ["\\*TRG \(Trigger\)"](#) on page 133
- **TRIGger Commands:**
  - [":MTEST:TRIGger:SOURce"](#) on page 700
  - [":TRIGger:CAN:TRIGger"](#) on page 462
  - [":TRIGger:I2S:TRIGger"](#) on page 514
  - [":TRIGger:IIC:TRIGger:QUALifier"](#) on page 524
  - [":TRIGger:IIC:TRIGger\[:TYPE\]"](#) on page 525
  - [":TRIGger:LIN:TRIGger"](#) on page 539
  - [":TRIGger:SEQuence:TRIGger"](#) on page 554
  - [":TRIGger:USB:TRIGger"](#) on page 589
- [":TRIGger:HFReject"](#) on page 444
- [":TRIGger:HOLDoff"](#) on page 445
- [":TRIGger:LFIFty"](#) on page 446
- [":TRIGger:MODE"](#) on page 447
- [":TRIGger:NREJect"](#) on page 448
- [":TRIGger:PATtern"](#) on page 449
- [":TRIGger:SWEep"](#) on page 451
- [":TRIGger:CAN:ACKnowledge"](#) on page 704
- [":TRIGger:CAN:PATtern:DATA"](#) on page 454
- [":TRIGger:CAN:PATtern:DATA:LENGth"](#) on page 455
- [":TRIGger:CAN:PATtern:ID"](#) on page 456
- [":TRIGger:CAN:PATtern:ID:MODE"](#) on page 457
- [":TRIGger:CAN:SAMPlepoint"](#) on page 458
- [":TRIGger:CAN:SIGNal:BAUDrate"](#) on page 459
- [":TRIGger:CAN:SIGNal:DEFinition"](#) on page 460

- [":TRIGger:CAN:SOURce"](#) on page 461
- [":TRIGger:CAN:TRIGger"](#) on page 462
- [":TRIGger:DURation:GREaterthan"](#) on page 465
- [":TRIGger:DURation:LESSthan"](#) on page 466
- [":TRIGger:DURation:PATtern"](#) on page 467
- [":TRIGger:DURation:QUALifier"](#) on page 468
- [":TRIGger:DURation:RANGe"](#) on page 469
- [":TRIGger\[:EDGE\]:COUpling"](#) on page 475
- [":TRIGger\[:EDGE\]:LEVel"](#) on page 476
- [":TRIGger\[:EDGE\]:REJect"](#) on page 477
- [":TRIGger\[:EDGE\]:SLOPe"](#) on page 478
- [":TRIGger\[:EDGE\]:SOURce"](#) on page 479
- [":TRIGger:FLEXray:AUTOsetup"](#) on page 481
- [":TRIGger:FLEXray:BAUDrate"](#) on page 482
- [":TRIGger:FLEXray:CHANnel"](#) on page 483
- [":TRIGger:FLEXray:ERRor:TYPE"](#) on page 484
- [":TRIGger:FLEXray:EVENT:TYPE"](#) on page 485
- [":TRIGger:FLEXray:FRAMe:CCBase"](#) on page 486
- [":TRIGger:FLEXray:FRAMe:CCRepetition"](#) on page 487
- [":TRIGger:FLEXray:FRAMe:ID"](#) on page 488
- [":TRIGger:FLEXray:FRAMe:TYPE"](#) on page 489
- [":TRIGger:FLEXray:SOURce"](#) on page 490
- [":TRIGger:FLEXray:TRIGger"](#) on page 491
- [":TRIGger:GLITch:GREaterthan"](#) on page 493
- [":TRIGger:GLITch:LESSthan"](#) on page 494
- [":TRIGger:GLITch:LEVel"](#) on page 495
- [":TRIGger:GLITch:POLarity"](#) on page 496
- [":TRIGger:GLITch:QUALifier"](#) on page 497
- [":TRIGger:GLITch:RANGe"](#) on page 498
- [":TRIGger:GLITch:SOURce"](#) on page 499
- [":TRIGger:HFReject"](#) on page 444
- [":TRIGger:HOLDoff"](#) on page 445
- [":TRIGger:I2S:ALIGnment"](#) on page 502
- [":TRIGger:I2S:AUDio"](#) on page 503
- [":TRIGger:I2S:CLOCK:SLOPe"](#) on page 504

- [":TRIGger:I2S:PATtern:DATA"](#) on page 505
- [":TRIGger:I2S:PATtern:FORMat"](#) on page 507
- [":TRIGger:I2S:RANGe"](#) on page 508
- [":TRIGger:I2S:RWIDth"](#) on page 510
- [":TRIGger:I2S:SOURce:CLOCK"](#) on page 511
- [":TRIGger:I2S:SOURce:DATA"](#) on page 512
- [":TRIGger:I2S:SOURce:WSElect"](#) on page 513
- [":TRIGger:I2S:TRIGger"](#) on page 514
- [":TRIGger:I2S:TWIDth"](#) on page 516
- [":TRIGger:I2S:WSLow"](#) on page 517
- [":TRIGger:IIC:PATtern:ADDRes"](#) on page 519
- [":TRIGger:IIC:PATtern:DATA"](#) on page 520
- [":TRIGger:IIC:PATtern:DATA2"](#) on page 521
- [":TRIGger:IIC\[:SOURce\]:CLOCK"](#) on page 522
- [":TRIGger:IIC\[:SOURce\]:DATA"](#) on page 523
- [":TRIGger:IIC:TRIGger:QUALifier"](#) on page 524
- [":TRIGger:IIC:TRIGger\[:TYPE\]"](#) on page 525
- [":TRIGger:LIN:ID"](#) on page 529
- [":TRIGger:LIN:PATtern:DATA"](#) on page 530
- [":TRIGger:LIN:PATtern:DATA:LENGth"](#) on page 532
- [":TRIGger:LIN:PATtern:FORMat"](#) on page 533
- [":TRIGger:LIN:SAMPlepoint"](#) on page 534
- [":TRIGger:LIN:SIGNal:BAUDrate"](#) on page 535
- [":TRIGger:LIN:SIGNal:DEFinition"](#) on page 705
- [":TRIGger:LIN:SOURce"](#) on page 536
- [":TRIGger:LIN:STANdard"](#) on page 537
- [":TRIGger:LIN:SYNCbreak"](#) on page 538
- [":TRIGger:LIN:TRIGger"](#) on page 539
- [":TRIGger:M1553:AUTOsetup"](#) on page 541
- [":TRIGger:M1553:PATtern:DATA"](#) on page 542
- [":TRIGger:M1553:RTA"](#) on page 543
- [":TRIGger:M1553:SOURce:LOWer"](#) on page 544
- [":TRIGger:M1553:SOURce:UPPer"](#) on page 545
- [":TRIGger:M1553:TYPE"](#) on page 546
- [":TRIGger:MODE"](#) on page 447

- `":TRIGger:NREJect"` on page 448
- `":TRIGger:PATtern"` on page 449
- `":TRIGger:SEquence:COUNT"` on page 548
- `":TRIGger:SEquence:EDGE"` on page 549
- `":TRIGger:SEquence:FIND"` on page 550
- `":TRIGger:SEquence:PATtern"` on page 551
- `":TRIGger:SEquence:RESet"` on page 552
- `":TRIGger:SEquence:TIMer"` on page 553
- `":TRIGger:SEquence:TRIGger"` on page 554
- `":TRIGger:SPI:CLOCK:SLOPe"` on page 556
- `":TRIGger:SPI:CLOCK:TIMEout"` on page 557
- `":TRIGger:SPI:FRAMing"` on page 558
- `":TRIGger:SPI:PATtern:DATA"` on page 559
- `":TRIGger:SPI:PATtern:WIDTh"` on page 560
- `":TRIGger:SPI:SOURce:CLOCK"` on page 561
- `":TRIGger:SPI:SOURce:DATA"` on page 562
- `":TRIGger:SPI:SOURce:FRAMe"` on page 563
- `":TRIGger:SWEep"` on page 451
- `":TRIGger:TV:LINE"` on page 565
- `":TRIGger:TV:MODE"` on page 566
- `":TRIGger:TV:POLarity"` on page 567
- `":TRIGger:TV:SOURce"` on page 568
- `":TRIGger:TV:STANdard"` on page 569
- `":TRIGger:TV:TVMode"` on page 706
- `":TRIGger:UART:BASE"` on page 572
- `":TRIGger:UART:BAUDrate"` on page 573
- `":TRIGger:UART:BITOrder"` on page 574
- `":TRIGger:UART:BURSt"` on page 575
- `":TRIGger:UART:DATA"` on page 576
- `":TRIGger:UART:IDLE"` on page 577
- `":TRIGger:UART:PARity"` on page 578
- `":TRIGger:UART:POLarity"` on page 579
- `":TRIGger:UART:QUALifier"` on page 580
- `":TRIGger:UART:SOURce:RX"` on page 581
- `":TRIGger:UART:SOURce:TX"` on page 582

- [":TRIGger:UART:TYPE"](#) on page 583
- [":TRIGger:UART:WIDTh"](#) on page 584
- [":TRIGger:USB:SOURce:DMINus"](#) on page 586
- [":TRIGger:USB:SOURce:DPLus"](#) on page 587
- [":TRIGger:USB:SPEed"](#) on page 588
- [":TRIGger:USB:TRIGger"](#) on page 589
- ["\\*TST \(Self Test\)"](#) on page 134
- TSTArt, [":MEASure:TSTArt"](#) on page 685
- TSTOp, [":MEASure:TSTOp"](#) on page 686
- TTAG, [":WAVEform:SEGmented:TTAG"](#) on page 610
- TV, [":TRIGger:TV Commands"](#) on page 564
- TVALue, [":MEASure:TVALue"](#) on page 322
- TVOLt, [":MEASure:TVOLt"](#) on page 687
- TWIDth, [":TRIGger:I2S:TWIDth"](#) on page 516
- TX, [":TRIGger:UART:SOURce:TX"](#) on page 582
- TXFRames, [":SBUS:UART:COUNt:TXFRames"](#) on page 417
- TYPE Commands:
  - [":ACQuire:TYPE"](#) on page 191
  - [":CHANnel<n>:PROBe:HEAD\[:TYPE\]"](#) on page 214
  - [":WAVEform:TYPE"](#) on page 616
  - [":TRIGger:FLEXray:ERRor:TYPE"](#) on page 484
  - [":TRIGger:FLEXray:EVENT:TYPE"](#) on page 485
  - [":TRIGger:FLEXray:FRAMe:TYPE"](#) on page 489
  - [":TRIGger:IIC:TRIGger\[:TYPE\]"](#) on page 525
  - [":TRIGger:M1553:TYPE"](#) on page 546
  - [":TRIGger:UART:TYPE"](#) on page 583

- U**
- UART Commands:
    - [":SBUS:UART:BASE"](#) on page 413
    - [":SBUS:UART:COUNt:ERRor"](#) on page 414
    - [":SBUS:UART:COUNt:RESet"](#) on page 415
    - [":SBUS:UART:COUNt:RXFRames"](#) on page 416
    - [":SBUS:UART:COUNt:TXFRames"](#) on page 417
    - [":SBUS:UART:FRAMing"](#) on page 418
    - [":TRIGger:UART:BASE"](#) on page 572
    - [":TRIGger:UART:BAUDrate"](#) on page 573

- ":TRIGger:UART:BITOrder" on page 574
- ":TRIGger:UART:BURSt" on page 575
- ":TRIGger:UART:DATA" on page 576
- ":TRIGger:UART:IDLE" on page 577
- ":TRIGger:UART:PARity" on page 578
- ":TRIGger:UART:POLarity" on page 579
- ":TRIGger:UART:QUALifier" on page 580
- ":TRIGger:UART:SOURce:RX" on page 581
- ":TRIGger:UART:SOURce:TX" on page 582
- ":TRIGger:UART:TYPE" on page 583
- ":TRIGger:UART:WIDTh" on page 584
- UNITs Commands:
  - ":CHANnel<n>:UNITs" on page 221
  - ":EXTernal:UNITs" on page 242
  - ":MTESt:AMASk:UNITs" on page 344
- UNSigned, ":WAVEform:UNSigned" on page 617
- UPPer Commands:
  - ":MEASure:UPPer" on page 689
  - ":TRIGger:M1553:SOURce:UPPer" on page 545
- USB, ":TRIGger:USB Commands" on page 585
- UTILization, ":SBUS:CAN:COUNt:UTILization" on page 400
- V**
  - VAMPLitude, ":MEASure:VAMPLitude" on page 324
  - VAVerage, ":MEASure:VAVerage" on page 325
  - VBASe, ":MEASure:VBASe" on page 326
  - VDELta, ":MEASure:VDELta" on page 690
  - VECTors, ":DISPlay:VECTors" on page 232
  - VERNier, ":CHANnel<n>:VERNier" on page 222
  - ":VIEW" on page 176
  - VMAX, ":MEASure:VMAX" on page 327
  - VMIN, ":MEASure:VMIN" on page 328
  - VPP, ":MEASure:VPP" on page 329
  - VRATio, ":MEASure:VRATio" on page 330
  - VRMS, ":MEASure:VRMS" on page 331
  - VSTArt, ":MEASure:VSTArt" on page 691
  - VSTOp, ":MEASure:VSTOp" on page 692

- VTIME, ":MEASure:VTIME" on page 332
- VTOP, ":MEASure:VTOP" on page 333
- W**
  - "\*"WAI (Wait To Continue)" on page 135
  - WAVEform Commands:
    - ":SAVE:WAVEform:FORMat" on page 391
    - ":SAVE:WAVEform:LENGth" on page 392
    - ":SAVE:WAVEform[:STARt]" on page 390
  - ":WAVEform:BYTeorder" on page 597
  - ":WAVEform:COUNt" on page 598
  - ":WAVEform:DATA" on page 599
  - ":WAVEform:FORMat" on page 601
  - ":WAVEform:POINts" on page 602
  - ":WAVEform:POINts:MODE" on page 604
  - ":WAVEform:PREAmble" on page 606
  - ":WAVEform:SEGMENTed:COUNt" on page 609
  - ":WAVEform:SEGMENTed:TTAG" on page 610
  - ":WAVEform:SOURce" on page 611
  - ":WAVEform:SOURce:SUBSource" on page 615
  - ":WAVEform:TYPE" on page 616
  - ":WAVEform:UNSigned" on page 617
  - ":WAVEform:VIEW" on page 618
  - ":WAVEform:XINCrement" on page 619
  - ":WAVEform:XORigin" on page 620
  - ":WAVEform:XREFerence" on page 621
  - ":WAVEform:YINCrement" on page 622
  - ":WAVEform:YORigin" on page 623
  - ":WAVEform:YREFerence" on page 624
  - WAVEforms Commands:
    - ":MTESt:COUNt:WAVEforms" on page 350
    - ":MTESt:RMODE:WAVEforms" on page 363
  - WIDTh Commands:
    - ":SBUS:SPI:WIDTh" on page 412
    - ":TRIGger:SPI:PATTern:WIDTh" on page 560
    - ":TRIGger:UART:WIDTh" on page 584
  - WINDow Commands:

- [":FUNCTION:WINDOW"](#) on page 259
  - [":TIMEbase:WINDOW:POSITION"](#) on page 437
  - [":TIMEbase:WINDOW:RANGE"](#) on page 438
  - [":TIMEbase:WINDOW:SCALE"](#) on page 439
  - [":MEASure:WINDOW"](#) on page 334
  - WSElect, [":TRIGger:I2S:SOURce:WSElect"](#) on page 513
  - WSLow, [":TRIGger:I2S:WSLow"](#) on page 517
- X**
- X1, [":MTEST:SCALE:X1"](#) on page 365
  - X1Position, [":MARKer:X1Position"](#) on page 277
  - X1Y1source, [":MARKer:X1Y1source"](#) on page 278
  - X2Position, [":MARKer:X2Position"](#) on page 279
  - X2Y2source, [":MARKer:X2Y2source"](#) on page 280
  - XDELta Commands:
    - [":MARKer:XDELta"](#) on page 281
    - [":MTEST:AMASK:XDELta"](#) on page 345
    - [":MTEST:SCALE:XDELta"](#) on page 366
  - XINCrement, [":WAVEform:XINCrement"](#) on page 619
  - XMAX, [":MEASure:XMAX"](#) on page 335
  - XMIN, [":MEASure:XMIN"](#) on page 336
  - XORigin, [":WAVEform:XORigin"](#) on page 620
  - XREFerence, [":WAVEform:XREFerence"](#) on page 621
- Y**
- Y1, [":MTEST:SCALE:Y1"](#) on page 367
  - Y1Position, [":MARKer:Y1Position"](#) on page 282
  - Y2, [":MTEST:SCALE:Y2"](#) on page 368
  - Y2Position, [":MARKer:Y2Position"](#) on page 283
  - YDELta Commands:
    - [":MARKer:YDELta"](#) on page 284
    - [":MTEST:AMASK:YDELta"](#) on page 346
  - YINCrement, [":WAVEform:YINCrement"](#) on page 622
  - YORigin, [":WAVEform:YORigin"](#) on page 623
  - YREFerence, [":WAVEform:YREFerence"](#) on page 624

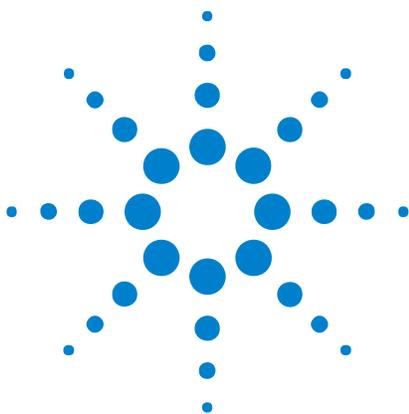

## 7 Obsolete and Discontinued Commands

Obsolete commands are older forms of commands that are provided to reduce customer rework for existing systems and programs (see "Obsolete Commands" on page 750).

| Obsolete Command                                  | Current Command Equivalent                             | Behavior Differences |
|---|--|----------------------|
| ANALog<n>:BWLimit                                 | :CHANnel<n>:BWLimit (see <a href="#">page 206</a> )    |                      |
| ANALog<n>:COUPling                                | :CHANnel<n>:COUPling (see <a href="#">page 207</a> )   |                      |
| ANALog<n>:INVert                                  | :CHANnel<n>:INVert (see <a href="#">page 210</a> )     |                      |
| ANALog<n>:LABel                                   | :CHANnel<n>:LABel (see <a href="#">page 211</a> )      |                      |
| ANALog<n>:OFFSet                                  | :CHANnel<n>:OFFSet (see <a href="#">page 212</a> )     |                      |
| ANALog<n>:PROBe                                   | :CHANnel<n>:PROBe (see <a href="#">page 213</a> )      |                      |
| ANALog<n>:PMODE                                   | none   |                      |
| ANALog<n>:RANGe                                   | :CHANnel<n>:RANGe (see <a href="#">page 219</a> )      |                      |
| :CHANnel:LABel (see <a href="#">page 662</a> )    | :CHANnel<n>:LABel (see <a href="#">page 211</a> )      |                      |
| :CHANnel2:SKEW (see <a href="#">page 663</a> )    | :CHANnel<n>:PROBe:SKEW (see <a href="#">page 216</a> ) |                      |
| :CHANnel<n>:INPut (see <a href="#">page 664</a> ) | :CHANnel<n>:IMPedance (see <a href="#">page 209</a> )  |                      |
| :CHANnel<n>:PMODE (see <a href="#">page 665</a> ) | none   |                      |
| :DISPlay:CONNect (see <a href="#">page 666</a> )  | :DISPlay:VECTors (see <a href="#">page 232</a> )       |                      |
| :ERASe (see <a href="#">page 667</a> )            | :CDISplay (see <a href="#">page 145</a> )              |                      |



## 7 Obsolete and Discontinued Commands

| Obsolete Command                                      | Current Command Equivalent  | Behavior Differences   |
|---|---|--|
| :EXtErnal:INPut (see <a href="#">page 668</a> )       | :EXtErnal:IMPedance (see <a href="#">page 236</a> )   |  |
| :EXtErnal:PMODE (see <a href="#">page 669</a> )       | none  |  |
| FUNcTion1, FUNcTion2                                  | :FUNcTion Commands (see <a href="#">page 243</a> )  | ADD not included   |
| :FUNcTion:SOURce (see <a href="#">page 670</a> )      | :FUNcTion:SOURce1 (see <a href="#">page 256</a> )   | Obsolete command has ADD, SUBTract, and MULTiply parameters; current command has GOFT parameter. |
| :FUNcTion:VIEW (see <a href="#">page 671</a> )        | :FUNcTion:DISPlay (see <a href="#">page 247</a> )   |  |
| :HARDcopy:DESTination (see <a href="#">page 672</a> ) | :HARDcopy:FIleName (see <a href="#">page 674</a> )  |  |
| :HARDcopy:DEVice (see <a href="#">page 673</a> )      | :HARDcopy:FORMat (see <a href="#">page 675</a> )  | PLOTter, THINkjet not supported; TIF, BMP, CSV, SEIko added                                      |
| :HARDcopy:FIleName (see <a href="#">page 674</a> )    | :RECall:FIleName (see <a href="#">page 372</a> )<br>:SAVE:FIleName (see <a href="#">page 372</a> )  |  |
| :HARDcopy:FORMat (see <a href="#">page 675</a> )      | :HARDcopy:APRinter (see <a href="#">page 263</a> )<br>:SAVE:IMAGe:FORMat (see <a href="#">page 383</a> )<br>:SAVE:WAVEform:FORMat (see <a href="#">page 391</a> ) |  |
| :HARDcopy:GRAYscale (see <a href="#">page 676</a> )   | :HARDcopy:PALette (see <a href="#">page 268</a> )   |  |
| :HARDcopy:IGColors (see <a href="#">page 677</a> )    | :HARDcopy:INKSaver (see <a href="#">page 266</a> )  |  |
| :HARDcopy:PDRiver (see <a href="#">page 678</a> )     | :HARDcopy:APRinter (see <a href="#">page 263</a> )  |  |
| :MEASure:LOWer (see <a href="#">page 679</a> )        | :MEASure:DEFine:THResholds (see <a href="#">page 294</a> )  | MEASure:DEFine:THResholds can define absolute values or percentage                               |
| :MEASure:SCRatch (see <a href="#">page 680</a> )      | :MEASure:CLEar (see <a href="#">page 292</a> )  |  |
| :MEASure:TDELta (see <a href="#">page 681</a> )       | :MARKer:XDELta (see <a href="#">page 281</a> )  |  |

| Obsolete Command  | Current Command Equivalent  | Behavior Differences  |
|---|---|---|
| :MEASure:THResholds (see <a href="#">page 682</a> )         | :MEASure:DEFine:THResholds (see <a href="#">page 294</a> )                    | MEASure:DEFine:THResholds can define absolute values or percentage                  |
| :MEASure:TMAX (see <a href="#">page 683</a> )               | :MEASure:XMAX (see <a href="#">page 335</a> )                                 |   |
| :MEASure:TMIN (see <a href="#">page 684</a> )               | :MEASure:XMIN (see <a href="#">page 336</a> )                                 |   |
| :MEASure:TStArt (see <a href="#">page 685</a> )             | :MARKer:X1Position (see <a href="#">page 277</a> )                            |   |
| :MEASure:TStOp (see <a href="#">page 686</a> )              | :MARKer:X2Position (see <a href="#">page 279</a> )                            |   |
| :MEASure:TVOlt (see <a href="#">page 687</a> )              | :MEASure:TVALue (see <a href="#">page 322</a> )                               | TVALue measures additional values such as db, Vs, etc.                              |
| :MEASure:UPPer (see <a href="#">page 689</a> )              | :MEASure:DEFine:THResholds (see <a href="#">page 294</a> )                    | MEASure:DEFine:THResholds can define absolute values or percentage                  |
| :MEASure:VDELta (see <a href="#">page 690</a> )             | :MARKer:YDELta (see <a href="#">page 284</a> )                                |   |
| :MEASure:VStArt (see <a href="#">page 691</a> )             | :MARKer:Y1Position (see <a href="#">page 282</a> )                            |   |
| :MEASure:VStOp (see <a href="#">page 692</a> )              | :MARKer:Y2Position (see <a href="#">page 283</a> )                            |   |
| :MTESt:AMASK:{SAVE   STORe} (see <a href="#">page 693</a> ) | :SAVE:MASK[:StArt] (see <a href="#">page 387</a> )                            |   |
| :MTESt:AVERage (see <a href="#">page 694</a> )              | :ACQuire:TYPE AVERage (see <a href="#">page 191</a> )                         |   |
| :MTESt:AVERage:COUNt (see <a href="#">page 695</a> )        | :ACQuire:COUNt (see <a href="#">page 181</a> )                                |   |
| :MTESt:LOAD (see <a href="#">page 696</a> )                 | :RECall:MASK[:StArt] (see <a href="#">page 374</a> )                          |   |
| :MTESt:RUMode (see <a href="#">page 697</a> )               | :MTESt:RMODE (see <a href="#">page 356</a> )                                  |   |
| :MTESt:RUMode:SOFailure (see <a href="#">page 698</a> )     | :MTESt:RMODE:FACTION:STOP (see <a href="#">page 360</a> )                     |   |
| :MTESt:{StArt   StOp} (see <a href="#">page 699</a> )       | :RUN (see <a href="#">page 170</a> ) or :STOP (see <a href="#">page 174</a> ) |   |
| :MTESt:TRIGger:SOURce (see <a href="#">page 700</a> )       | :TRIGger Commands (see <a href="#">page 440</a> )                             | There are various commands for setting the source with different types of triggers. |

## 7 Obsolete and Discontinued Commands

| Obsolete Command  | Current Command Equivalent   | Behavior Differences   |
|---|--|--|
| :PRINt? (see <a href="#">page 701</a> )                         | :DISPlay:DATA? (see <a href="#">page 226</a> )   |  |
| :TIMebase:DELay (see <a href="#">page 703</a> )                 | :TIMebase:POSition (see <a href="#">page 432</a> ) or<br>:TIMebase:WINDow:POSition (see <a href="#">page 437</a> ) | TIMebase:POSition is position value of main time base;<br>TIMebase:WINDow:POSition is position value of zoomed (delayed) time base window. |
| :TRIGger:CAN:ACKnowledge (see <a href="#">page 704</a> )        | none   |  |
| :TRIGger:LIN:SIGNal:DEFinitio n (see <a href="#">page 705</a> ) | none   |  |
| :TRIGger:TV:TVMode (see <a href="#">page 706</a> )              | :TRIGger:TV:MODE (see <a href="#">page 566</a> )   |  |

### Discontinued Commands

Discontinued commands are commands that were used by previous oscilloscopes, but are not supported by the InfiniiVision 5000 Series oscilloscopes. Listed below are the Discontinued commands and the nearest equivalent command available (if any).

| Discontinued Command | Current Command Equivalent                                    | Comments  |
|----------------------|---|---|
| ASTore               | :DISPlay:PERSistence INFinite (see <a href="#">page 230</a> ) |   |
| CHANnel:MATH         | :FUNCTion:OPERation (see <a href="#">page 252</a> )           | ADD not included  |
| CHANnel<n>:PROTect   | :CHANnel<n>:PROTectio n (see <a href="#">page 218</a> )       | Previous form of this command was used to enable/disable 50Ω protection. The new command resets a tripped protect and the query returns the status of TRIPed or NORMal. |
| DISPlay:INVerse      | none  |   |
| DISPlay:COLumn       | none  |   |
| DISPlay:FREeze       | none  |   |
| DISPlay:GRID         | none  |   |
| DISPlay:LINE         | none  |   |
| DISPlay:PIXel        | none  |   |
| DISPlay:POSition     | none  |   |
| DISPlay:ROW          | none  |   |

| Discontinued Command       | Current Command Equivalent                       | Comments   |
|----------------------------|--|--|
| DISPlay:TEXT               | none   |  |
| FUNcTion:MOVE              | none   |  |
| FUNcTion:PEAKs             | none   |  |
| HARDcopy:ADDRes            | none   | Only parallel printer port is supported. GPIB printing not supported |
| MASK                       | none   | All commands discontinued, feature not available                     |
| SYSTem:KEY                 | none   |  |
| TEST:ALL                   | *TST (Self Test) (see <a href="#">page 134</a> ) |  |
| TRACE subsystem            | none   | All commands discontinued, feature not available                     |
| TRIGger:ADVanced subsystem |  | Use new GLITCh, PATtern, or TV trigger modes                         |
| TRIGger:TV:FIELD           | :TRIGger:TV:MODE (see <a href="#">page 566</a> ) |  |
| TRIGger:TV:TVHFrej         |  |  |
| TRIGger:TV:VIR             | none   |  |
| VAUToscale                 | none   |  |

**Discontinued Parameters**

Some previous oscilloscope queries returned control setting values of OFF and ON. The InfiniiVision 5000 Series oscilloscopes only return the enumerated values 0 (for off) and 1 (for on).

## :CHANnel:LABel

**O** (see [page 750](#))

**Command Syntax** :CHANnel:LABel <source\_text><string>  
<source\_text> ::= {CHANnel1 | CHANnel2 | DIGital0,...,DIGital15}  
<string> ::= quoted ASCII string

The :CHANnel:LABel command sets the source text to the string that follows. Setting a channel will also result in the name being added to the label list.

**NOTE**

The :CHANnel:LABel command is an obsolete command provided for compatibility to previous oscilloscopes. Use the :CHANnel<n>:LABel command (see [page 211](#)) instead.

---

**Query Syntax** :CHANnel:LABel?

The :CHANnel:LABel? query returns the label associated with a particular analog channel.

**Return Format** <string><NL>  
<string> ::= quoted ASCII string

## :CHANnel2:SKEW

**O** (see [page 750](#))

**Command Syntax** :CHANnel2:SKEW <skew value>  
 <skew value> ::= skew time in NR3 format  
 <skew value> ::= -100 ns to +100 ns

The :CHANnel2:SKEW command sets the skew between channels 1 and 2. The maximum skew is +/- 100 ns. You can use the oscilloscope's analog probe skew control to remove cable delay errors between channel 1 and channel 2.

**NOTE** The :CHANnel2:SKEW command is an obsolete command provided for compatibility to previous oscilloscopes. Use the :CHANnel<n>:PROBe:SKEW command (see [page 216](#)) instead.

**NOTE** This command is only valid for the two channel oscilloscope models.

**Query Syntax** :CHANnel2:SKEW?

The :CHANnel2:SKEW? query returns the current probe skew setting for the selected channel.

**Return Format** <skew value><NL>  
 <skew value> ::= skew value in NR3 format

**See Also** • ["Introduction to :CHANnel<n> Commands"](#) on page 204

### :CHANnel<n>:INPut

**O** (see [page 750](#))

**Command Syntax** :CHANnel<n>:INPut <impedance>  
<impedance> ::= {ONEMeg | FIFTy}  
<n> ::= {1 | 2 | 3 | 4} for the four channel oscilloscope models  
<n> ::= {1 | 2} for the two channel oscilloscope models

The :CHANnel<n>:INPut command selects the input impedance setting for the specified channel. The legal values for this command are ONEMeg (1 M $\Omega$ ) and FIFTy (50 $\Omega$ ).

#### NOTE

The :CHANnel<n>:INPut command is an obsolete command provided for compatibility to previous oscilloscopes. Use the :CHANnel<n>:IMPedance command (see [page 209](#)) instead.

**Query Syntax** :CHANnel<n>:INPut?

The :CHANnel<n>:INPut? query returns the current input impedance setting for the specified channel.

**Return Format** <impedance value><NL>  
<impedance value> ::= {ONEM | FIFT}

## :CHANnel<n>:PMODE

**O** (see [page 750](#))

**Command Syntax** :CHANnel<n>:PMODE <pmode value>  
 <pmode value> ::= {AUTO | MANual}  
 <n> ::= {1 | 2 | 3 | 4} for the four channel oscilloscope models  
 <n> ::= {1 | 2} for the two channel oscilloscope models

The probe sense mode is controlled internally and cannot be set. If a probe with sense is connected to the specified channel, auto sensing is enabled; otherwise, the mode is manual.

If the PMODE sent matches the oscilloscope's setting, the command will be accepted. Otherwise, a setting conflict error is generated.

**NOTE**

The :CHANnel<n>:PMODE command is an obsolete command provided for compatibility to previous oscilloscopes.

**Query Syntax** :CHANnel<n>:PMODE?

The :CHANnel<n>:PMODE? query returns AUT if an autosense probe is attached and MAN otherwise.

**Return Format** <pmode value><NL>  
 <pmode value> ::= {AUT | MAN}

## :DISPlay:CONNect

**O** (see [page 750](#))

**Command Syntax** :DISPlay:CONNect <connect>  
<connect> ::= {{ 1 | ON} | {0 | OFF}}

The :DISPlay:CONNect command turns vectors on and off. When vectors are turned on, the oscilloscope displays lines connecting sampled data points. When vectors are turned off, only the sampled data is displayed.

**NOTE**

The :DISPlay:CONNect command is an obsolete command provided for compatibility to previous oscilloscopes. Use the :DISPlay:VECTors command (see [page 232](#)) instead.

---

**Query Syntax** :DISPlay:CONNect?

The :DISPlay:CONNect? query returns the current state of the vectors setting.

**Return Format** <connect><NL>  
<connect> ::= {1 | 0}

**See Also** • [":DISPlay:VECTors"](#) on [page 232](#)

**:ERASe****O** (see [page 750](#))**Command Syntax** :ERASe

The :ERASe command erases the screen.

**NOTE**

The :ERASe command is an obsolete command provided for compatibility to previous oscilloscopes. Use the :CDISplay command (see [page 145](#)) instead.

---

## :EXternal:INPut

**O** (see [page 750](#))

**Command Syntax** :EXternal:INPut <impedance>  
<impedance> ::= {ONEMeg | FIFTy}

The :EXternal:IMPedance command selects the input impedance setting for the external trigger. The legal values for this command are ONEMeg (1 M $\Omega$ ) and FIFTy (50 $\Omega$ ).

**NOTE**

The :EXternal:INPut command is an obsolete command provided for compatibility to previous oscilloscopes. Use the :EXternal:IMPedance command (see [page 236](#)) instead.

**Query Syntax** :EXternal:INPut?

The :EXternal:INPut? query returns the current input impedance setting for the external trigger.

**Return Format** <impedance value><NL>  
<impedance value> ::= {ONEM | FIFT}

- See Also**
- ["Introduction to :EXternal Trigger Commands"](#) on page 233
  - ["Introduction to :TRIGger Commands"](#) on page 440
  - [":CHANnel<n>:IMPedance"](#) on page 209

**:EXternal:PMODE**

**O** (see [page 750](#))

**Command Syntax** :EXternal:PMODE <pmode value>

<pmode value> ::= {AUTO | MANual}

The probe sense mode is controlled internally and cannot be set. If a probe with sense is connected to the specified channel, auto sensing is enabled; otherwise, the mode is manual.

If the pmode sent matches the oscilloscope's setting, the command will be accepted. Otherwise, a setting conflict error is generated.

**NOTE**

The :EXternal:PMODE command is an obsolete command provided for compatibility to previous oscilloscopes.

**Query Syntax** :EXternal:PMODE?

The :EXternal:PMODE? query returns AUT if an autosense probe is attached and MAN otherwise.

**Return Format** <pmode value><NL>

<pmode value> ::= {AUT | MAN}

**:FUNCTION:SOURce**

**O** (see [page 750](#))

**Command Syntax** :FUNCTION:SOURce <value>  
 <value> ::= {CHANnel<n> | ADD | SUBTract | MULTiply}  
 <n> ::= {1 | 2 | 3 | 4} for the four channel oscilloscope models  
 <n> ::= {1 | 2} for the two channel oscilloscope models

The :FUNCTION:SOURce command is only used when an FFT (Fast Fourier Transform), DIFF, or INT operation is selected (see the:FUNCTION:OPERation command for more information about selecting an operation). The :FUNCTION:SOURce command selects the source for function operations. Choose CHANnel<n>, or ADD, SUBT, or MULT to specify the desired source for function DIFFerentiate, INTegrate, and FFT operations specified by the :FUNCTION:OPERation command.

**NOTE**

The :FUNCTION:SOURce command is an obsolete command provided for compatibility to previous oscilloscopes. Use the :FUNCTION:SOURce1 command (see [page 256](#)) instead.

**Query Syntax** :FUNCTION:SOURce?

The :FUNCTION:SOURce? query returns the current source for function operations.

**Return Format** <value><NL>  
 <value> ::= {CHAN<n> | ADD | SUBT | MULT}  
 <n> ::= {1 | 2 | 3 | 4} for the four channel oscilloscope models  
 <n> ::= {1 | 2} for the two channel oscilloscope models

- See Also**
- "[Introduction to :FUNCTION Commands](#)" on page 245
  - "[:FUNCTION:OPERation](#)" on page 252

## :FUNCTION:VIEW

**O** (see [page 750](#))

**Command Syntax** :FUNCTION:VIEW <view>  
 <view> ::= {{1 | ON} | {0 | OFF}}

The :FUNCTION:VIEW command turns the selected function on or off. When ON is selected, the function performs as specified using the other FUNCTION commands. When OFF is selected, function is neither calculated nor displayed.

**NOTE** The :FUNCTION:VIEW command is provided for backward compatibility to previous oscilloscopes. Use the :FUNCTION:DISPLAY command (see [page 247](#)) instead.

**Query Syntax** :FUNCTION:VIEW?

The :FUNCTION:VIEW? query returns the current state of the selected function.

**Return Format** <view><NL>  
 <view> ::= {1 | 0}

## :HARDcopy:DESTination

**O** (see [page 750](#))

**Command Syntax** :HARDcopy:DESTination <destination>  
<destination> ::= {CENTronics | FLOppy}

The :HARDcopy:DESTination command sets the hardcopy destination.

### NOTE

The :HARDcopy:DESTination command is an obsolete command provided for compatibility to previous oscilloscopes. Use the :HARDcopy:FILEname command (see [page 674](#)) instead.

**Query Syntax** :HARDcopy:DESTination?

The :HARDcopy:DESTination? query returns the selected hardcopy destination.

**Return Format** <destination><NL>  
<destination> ::= {CENT | FLOP}

- See Also**
- ["Introduction to :HARDcopy Commands"](#) on page 261
  - [":HARDcopy:FORMat"](#) on page 675

## :HARDcopy:DEvice

**O** (see [page 750](#))

**Command Syntax** :HARDcopy:DEvice <device>  
 <device> ::= {TIFF | GIF | BMP | LASerjet | EPSON | DESKjet  
 | BWDeskjet | SEIKo}

The HARDcopy:DEvice command sets the hardcopy device type.

**NOTE**

BWDeskjet option refers to the monochrome Deskjet printer.

**NOTE**

The :HARDcopy:DEvice command is an obsolete command provided for compatibility to previous oscilloscopes. Use the :HARDcopy:FORMat command (see [page 675](#)) instead.

**Query Syntax** :HARDcopy:DEvice?

The :HARDcopy:DEvice? query returns the selected hardcopy device type.

**Return Format** <device><NL>  
 <device> ::= {TIFF | GIF | BMP | LAS | EPS | DESK | BWD | SEIK}

## :HARDcopy:FILENAME

**O** (see [page 750](#))

**Command Syntax** :HARDcopy:FILENAME <string>  
<string> ::= quoted ASCII string

The HARDcopy:FILENAME command sets the output filename for those print formats whose output is a file.

### NOTE

The :HARDcopy:FILENAME command is an obsolete command provided for compatibility to previous oscilloscopes. Use the :SAVE:FILENAME command (see [page 379](#)) and :RECall:FILENAME command (see [page 372](#)) instead.

**Query Syntax** :HARDcopy:FILENAME?

The :HARDcopy:FILENAME? query returns the current hardcopy output filename.

**Return Format** <string><NL>  
<string> ::= quoted ASCII string

- See Also**
- "[Introduction to :HARDcopy Commands](#)" on page 261
  - "[:HARDcopy:FORMat](#)" on page 675

## :HARDcopy:FORMat

**O** (see [page 750](#))

**Command Syntax** :HARDcopy:FORMat <format>

```
<format> ::= {BMP[24bit] | BMP8bit | PNG | CSV | ASCiixy | BINary
              | PRINter0 | PRINter1}
```

The HARDcopy:FORMat command sets the hardcopy format type.

PRINter0 and PRINter1 are only valid when printers are connected to the oscilloscope's USB ports. (The first printer connected/identified is PRINter0 and the second is PRINter1.)

### NOTE

The :HARDcopy:FORMat command is an obsolete command provided for compatibility to previous oscilloscopes. Use the :SAVE:IMAGE:FORMat (see [page 383](#)), :SAVE:WAVEform:FORMat (see [page 391](#)), and :HARDcopy:APRinter (see [page 263](#)) commands instead.

**Query Syntax** :HARDcopy:FORMat?

The :HARDcopy:FORMat? query returns the selected hardcopy format type.

**Return Format** <format><NL>

```
<format> ::= {BMP | BMP8 | PNG | CSV | ASC | BIN | PRIN0 | PRIN1}
```

**See Also** • ["Introduction to :HARDcopy Commands"](#) on page 261

## :HARDcopy:GRAYscale

**O** (see [page 750](#))

**Command Syntax** :HARDcopy:GRAYscale <gray>  
<gray> ::= {{OFF | 0} | {ON | 1}}

The :HARDcopy:GRAYscale command controls whether grayscaling is performed in the hardcopy dump.

### NOTE

The :HARDcopy:GRAYscale command is an obsolete command provided for compatibility to previous oscilloscopes. Use the :HARDcopy:PALETTE command (see [page 268](#)) instead. (":HARDcopy:GRAYscale ON" is the same as ":HARDcopy:PALETTE GRAYscale" and ":HARDcopy:GRAYscale OFF" is the same as ":HARDcopy:PALETTE COLor".)

**Query Syntax** :HARDcopy:GRAYscale?

The :HARDcopy:GRAYscale? query returns a flag indicating whether grayscaling is performed in the hardcopy dump.

**Return Format** <gray><NL>  
<gray> ::= {0 | 1}

**See Also** • ["Introduction to :HARDcopy Commands"](#) on page 261

## :HARDcopy:IGColors

**O** (see [page 750](#))

**Command Syntax** :HARDcopy:IGColors <value>  
 <value> ::= {{OFF | 0} | {ON | 1}}

The HARDcopy:IGColors command controls whether the graticule colors are inverted or not.

**NOTE**

The :HARDcopy:IGColors command is an obsolete command provided for compatibility to previous oscilloscopes. Use the :HARDcopy:INKSaver (see [page 266](#)) command instead.

**Query Syntax** :HARDcopy:IGColors?

The :HARDcopy:IGColors? query returns a flag indicating whether graticule colors are inverted or not.

**Return Format** <value><NL>  
 <value> ::= {0 | 1}

**See Also** • ["Introduction to :HARDcopy Commands"](#) on page 261

**:HARDcopy:PDRiver**

**O** (see [page 750](#))

**Command Syntax** :HARDcopy:PDRiver <driver>

```
<driver> ::= {AP2Xxx | AP21xx | {AP2560 | AP25} | {DJ350 | DJ35} |
             DJ6xx | {DJ630 | DJ63} | DJ6Special | DJ6Photo |
             DJ8Special | DJ8xx | DJ9Vip | OJPRokx50 | DJ9xx | GVIP |
             DJ55xx | {PS470 | PS47} {PS100 | PS10} | CLASer |
             MLASer | LJFastraster | POSTscript}
```

The HARDcopy:PDRiver command sets the hardcopy printer driver used for the selected printer.

If the correct driver for the selected printer can be identified, it will be selected and cannot be changed.

**NOTE**

The :HARDcopy:PDRiver command is an obsolete command provided for compatibility to previous oscilloscopes. Use the :HARDcopy:APRinter (see [page 263](#)) command instead.

**Query Syntax** :HARDcopy:PDRiver?

The :HARDcopy:PDRiver? query returns the selected hardcopy printer driver.

**Return Format** <driver><NL>

```
<driver> ::= {AP2X | AP21 | AP25 | DJ35 | DJ6 | DJ63 | DJ6S | DJ6P |
             DJ8S | DJ8 | DJ9V | OJPR | DJ9 | GVIP | DJ55 | PS10 |
             PS47 | CLAS | MLAS | LJF | POST}
```

- See Also**
- "Introduction to :HARDcopy Commands" on page 261
  - ":HARDcopy:FORMat" on page 675

## :MEASure:LOWer

**O** (see [page 750](#))

**Command Syntax** :MEASure:LOWer <voltage>

The :MEASure:LOWer command sets the lower measurement threshold value. This value and the UPPER value represent absolute values when the thresholds are ABSolute and percentage when the thresholds are PERCent as defined by the :MEASure:DEFine THResholds command.

**NOTE**

The :MEASure:LOWer command is obsolete and is provided for backward compatibility to previous oscilloscopes. Use the :MEASure:DEFine THResholds command (see [page 294](#)) instead.

**Query Syntax** :MEASure:LOWer?

The :MEASure:LOWer? query returns the current lower threshold level.

**Return Format** <voltage><NL>

<voltage> ::= the user-defined lower threshold in volts in NR3 format

- See Also**
- ["Introduction to :MEASure Commands"](#) on page 290
  - [":MEASure:THResholds"](#) on page 682
  - [":MEASure:UPPer"](#) on page 689

## :MEASure:SCRatch

**O** (see [page 750](#))

**Command Syntax** :MEASure:SCRatch

The :MEASure:SCRatch command clears all selected measurements and markers from the screen.

**NOTE**

The :MEASure:SCRatch command is obsolete and is provided for backward compatibility to previous oscilloscopes. Use the :MEASure:CLEar command (see [page 292](#)) instead.

---

## :MEASure:TDELta

**O** (see [page 750](#))

**Query Syntax** :MEASure:TDELta?

The :MEASure:TDELta? query returns the time difference between the Tstop marker (X2 cursor) and the Tstart marker (X1 cursor).

$Tdelta = Tstop - Tstart$

Tstart is the time at the start marker (X1 cursor) and Tstop is the time at the stop marker (X2 cursor). No measurement is made when the :MEASure:TDELta? query is received by the oscilloscope. The delta time value that is output is the current value. This is the same value as the front-panel cursors delta X value.

**NOTE**

The :MEASure:TDELta command is an obsolete command provided for compatibility to previous oscilloscopes. Use the :MARKer:XDELta command (see [page 281](#)) instead.

**Return Format** <value><NL>

<value> ::= time difference between start and stop markers in NR3 format

- See Also**
- "[Introduction to :MARKer Commands](#)" on page 275
  - "[Introduction to :MEASure Commands](#)" on page 290
  - "[:MARKer:X1Position](#)" on page 277
  - "[:MARKer:X2Position](#)" on page 279
  - "[:MARKer:XDELta](#)" on page 281
  - "[:MEASure:TSTArt](#)" on page 685
  - "[:MEASure:TSTOp](#)" on page 686

## :MEASure:THResholds

**O** (see [page 750](#))

**Command Syntax** :MEASure:THResholds {T1090 | T2080 | VOLTage}

The :MEASure:THResholds command selects the thresholds used when making time measurements.

### NOTE

The :MEASure:THResholds command is obsolete and is provided for backward compatibility to previous oscilloscopes. Use the :MEASure:DEFine THResholds command (see [page 294](#)) instead.

**Query Syntax** :MEASure:THResholds?

The :MEASure:THResholds? query returns the current thresholds selected when making time measurements.

**Return Format** {T1090 | T2080 | VOLTage}<NL>

{T1090} uses the 10% and 90% levels of the selected waveform.

{T2080} uses the 20% and 80% levels of the selected waveform.

{VOLTage} uses the upper and lower voltage thresholds set by the UPPER and LOWER commands on the selected waveform.

- See Also**
- ["Introduction to :MEASure Commands"](#) on [page 290](#)
  - [":MEASure:LOWer"](#) on [page 679](#)
  - [":MEASure:UPPer"](#) on [page 689](#)

## :MEASure:TMAX

**O** (see [page 750](#))

**Command Syntax** :MEASure:TMAX [<source>]

<source> ::= {CHANnel<n> | FUNCTION | MATH}

<n> ::= {1 | 2 | 3 | 4} for the four channel oscilloscope models

<n> ::= {1 | 2} for the two channel oscilloscope models

The :MEASure:TMAX command installs a screen measurement and starts an X-at-Max-Y measurement on the selected waveform. If the optional source is specified, the current source is modified.

**NOTE**

The :MEASure:TMAX command is obsolete and is provided for backward compatibility to previous oscilloscopes. Use the :MEASure:XMAX command (see [page 335](#)) instead.

**Query Syntax** :MEASure:TMAX? [<source>]

The :MEASure:TMAX? query returns the horizontal axis value at which the maximum vertical value occurs on the current source. If the optional source is specified, the current source is modified. If all channels are off, the query returns 9.9E+37.

**Return Format** <value><NL>

<value> ::= time at maximum in NR3 format

- See Also**
- ["Introduction to :MEASure Commands"](#) on page 290
  - [":MEASure:TMIN"](#) on page 684
  - [":MEASure:XMAX"](#) on page 335
  - [":MEASure:XMIN"](#) on page 336

**:MEASure:TMIN**

**O** (see [page 750](#))

**Command Syntax** :MEASure:TMIN [<source>]

<source> ::= {CHANnel<n> | FUNCTION | MATH}

<n> ::= {1 | 2 | 3 | 4} for the four channel oscilloscope models

<n> ::= {1 | 2} for the two channel oscilloscope models

The :MEASure:TMIN command installs a screen measurement and starts an X-at-Min-Y measurement on the selected waveform. If the optional source is specified, the current source is modified.

**NOTE**

The :MEASure:TMIN command is obsolete and is provided for backward compatibility to previous oscilloscopes. Use the :MEASure:XMIN command (see [page 336](#)) instead.

**Query Syntax** :MEASure:TMIN? [<source>]

The :MEASure:TMIN? query returns the horizontal axis value at which the minimum vertical value occurs on the current source. If the optional source is specified, the current source is modified. If all channels are off, the query returns 9.9E+37.

**Return Format** <value><NL>

<value> ::= time at minimum in NR3 format

- See Also**
- "[Introduction to :MEASure Commands](#)" on page 290
  - "[:MEASure:TMAX](#)" on page 683
  - "[:MEASure:XMAX](#)" on page 335
  - "[:MEASure:XMIN](#)" on page 336

## :MEASure:TSTArt

**O** (see [page 750](#))

**Command Syntax** :MEASure:TSTArt <value> [suffix]  
 <value> ::= time at the start marker in seconds  
 [suffix] ::= {s | ms | us | ns | ps}

The :MEASure:TSTArt command moves the start marker (X1 cursor) to the specified time with respect to the trigger time.

**NOTE**

The short form of this command, TSTA, does not follow the defined Long Form to Short Form Truncation Rules (see [page 752](#)). The normal short form "TST" would be the same for both TSTArt and TSTOp, so sending TST for the TSTArt command produces an error.

**NOTE**

The :MEASure:TSTArt command is an obsolete command provided for compatibility to previous oscilloscopes. Use the :MARKer:X1Position command (see [page 277](#)) instead.

**Query Syntax** :MEASure:TSTArt?

The :MEASure:TSTArt? query returns the time at the start marker (X1 cursor).

**Return Format** <value><NL>  
 <value> ::= time at the start marker in NR3 format

- See Also**
- ["Introduction to :MARKer Commands"](#) on page 275
  - ["Introduction to :MEASure Commands"](#) on page 290
  - [":MARKer:X1Position"](#) on page 277
  - [":MARKer:X2Position"](#) on page 279
  - [":MARKer:XDELta"](#) on page 281
  - [":MEASure:TDELta"](#) on page 681
  - [":MEASure:TSTOP"](#) on page 686

## :MEASure:TSTOp

**O** (see [page 750](#))

**Command Syntax** :MEASure:TSTOp <value> [suffix]  
<value> ::= time at the stop marker in seconds  
[suffix] ::= {s | ms | us | ns | ps}

The :MEASure:TSTOp command moves the stop marker (X2 cursor) to the specified time with respect to the trigger time.

### NOTE

The short form of this command, TSTO, does not follow the defined Long Form to Short Form Truncation Rules (see [page 752](#)). The normal short form "TST" would be the same for both TSTArt and TSTOp, so sending TST for the TSTOp command produces an error.

### NOTE

The :MEASure:TSTOp command is an obsolete command provided for compatibility to previous oscilloscopes. Use the :MARKer:X2Position command (see [page 279](#)) instead.

**Query Syntax** :MEASure:TSTOp?

The :MEASure:TSTOp? query returns the time at the stop marker (X2 cursor).

**Return Format** <value><NL>  
<value> ::= time at the stop marker in NR3 format

- See Also**
- "[Introduction to :MARKer Commands](#)" on page 275
  - "[Introduction to :MEASure Commands](#)" on page 290
  - "[:MARKer:X1Position](#)" on page 277
  - "[:MARKer:X2Position](#)" on page 279
  - "[:MARKer:XDELta](#)" on page 281
  - "[:MEASure:TDELta](#)" on page 681
  - "[:MEASure:TSTArt](#)" on page 685

## :MEASure:TVOLt

**O** (see [page 750](#))

**Query Syntax** :MEASure:TVOLt? <value>, [<slope>]<occurrence>[,<source>]

<value> ::= the voltage level that the waveform must cross.

<slope> ::= direction of the waveform. A rising slope is indicated by a plus sign (+). A falling edge is indicated by a minus sign (-).

<occurrence> ::= the transition to be reported. If the occurrence number is one, the first crossing is reported. If the number is two, the second crossing is reported, etc.

<source> ::= {CHANnel<n> | FUNCTION | MATH}

<n> ::= {1 | 2 | 3 | 4} for the four channel oscilloscope models

<n> ::= {1 | 2} for the two channel oscilloscope models

When the :MEASure:TVOLt? query is sent, the displayed signal is searched for the specified voltage level and transition. The time interval between the trigger event and this defined occurrence is returned as the response to the query.

The specified voltage can be negative or positive. To specify a negative voltage, use a minus sign (-). The sign of the slope selects a rising (+) or falling (-) edge. If no sign is specified for the slope, it is assumed to be the rising edge.

The magnitude of the occurrence defines the occurrence to be reported. For example, +3 returns the time for the third time the waveform crosses the specified voltage level in the positive direction. Once this voltage crossing is found, the oscilloscope reports the time at that crossing in seconds, with the trigger point (time zero) as the reference.

If the specified crossing cannot be found, the oscilloscope reports +9.9E+37. This value is returned if the waveform does not cross the specified voltage, or if the waveform does not cross the specified voltage for the specified number of times in the direction specified.

If the optional source parameter is specified, the current source is modified.

### NOTE

The :MEASure:TVOLt command is obsolete and is provided for backward compatibility to previous oscilloscopes. Use the :MEASure:TVALue command (see [page 322](#)) instead.

**Return Format** <value><NL>

## 7 Obsolete and Discontinued Commands

<value> ::= time in seconds of the specified voltage crossing  
in NR3 format

**:MEASure:UPPer**

**O** (see [page 750](#))

**Command Syntax** :MEASure:UPPer <value>

The :MEASure:UPPer command sets the upper measurement threshold value. This value and the LOWer value represent absolute values when the thresholds are ABSolute and percentage when the thresholds are PERCent as defined by the :MEASure:DEFine THResholds command.

**NOTE**

The :MEASure:UPPer command is obsolete and is provided for backward compatibility to previous oscilloscopes. Use the :MEASure:DEFine THResholds command (see [page 294](#)) instead.

**Query Syntax** :MEASure:UPPer?

The :MEASure:UPPer? query returns the current upper threshold level.

**Return Format** <value><NL>

<value> ::= the user-defined upper threshold in NR3 format

- See Also**
- "[Introduction to :MEASure Commands](#)" on page 290
  - "[:MEASure:LOWer](#)" on page 679
  - "[:MEASure:THResholds](#)" on page 682

**:MEASure:VDELta**

**O** (see [page 750](#))

**Query Syntax** :MEASure:VDELta?

The :MEASure:VDELta? query returns the voltage difference between vertical marker 1 (Y1 cursor) and vertical marker 2 (Y2 cursor). No measurement is made when the :MEASure:VDELta? query is received by the oscilloscope. The delta value that is returned is the current value. This is the same value as the front-panel cursors delta Y value.

VDELta = value at marker 2 - value at marker 1

**NOTE**

The :MEASure:VDELta command is an obsolete command provided for compatibility to previous oscilloscopes. Use the :MARKer:YDELta command (see [page 284](#)) instead.

**Return Format** <value><NL>

<value> ::= delta V value in NR1 format

- See Also**
- "[Introduction to :MARKer Commands](#)" on page 275
  - "[Introduction to :MEASure Commands](#)" on page 290
  - "[:MARKer:Y1Position](#)" on page 282
  - "[:MARKer:Y2Position](#)" on page 283
  - "[:MARKer:YDELta](#)" on page 284
  - "[:MEASure:TDELta](#)" on page 681
  - "[:MEASure:TSTArt](#)" on page 685

## :MEASure:VSTArt

**O** (see [page 750](#))

**Command Syntax** :MEASure:VSTArt <vstart\_argument>

<vstart\_argument> ::= value for vertical marker 1

The :MEASure:VSTArt command moves the vertical marker (Y1 cursor) to the specified value corresponding to the selected source. The source can be selected by the MARKer:X1Y1source command.

### NOTE

The short form of this command, VSTA, does not follow the defined Long Form to Short Form Truncation Rules (see [page 752](#)). The normal short form, VST, would be the same for both VSTArt and VSTOp, so sending VST for the VSTArt command produces an error.

### NOTE

The :MEASure:VSTArt command is an obsolete command provided for compatibility to previous oscilloscopes. Use the :MARKer:Y1Position command (see [page 282](#)) instead.

**Query Syntax** :MEASure:VSTArt?

The :MEASure:VSTArt? query returns the current value of the Y1 cursor.

**Return Format** <value><NL>

<value> ::= voltage at voltage marker 1 in NR3 format

### See Also

- "[Introduction to :MARKer Commands](#)" on page 275
- "[Introduction to :MEASure Commands](#)" on page 290
- "[:MARKer:Y1Position](#)" on page 282
- "[:MARKer:Y2Position](#)" on page 283
- "[:MARKer:YDELta](#)" on page 284
- "[:MARKer:X1Y1source](#)" on page 278
- "[:MEASure:SOURce](#)" on page 315
- "[:MEASure:TDELta](#)" on page 681
- "[:MEASure:TSTArt](#)" on page 685

**:MEASure:VSTOp**

**O** (see [page 750](#))

**Command Syntax** :MEASure:VSTOp <vstop\_argument>  
 <vstop\_argument> ::= value for Y2 cursor

The :MEASure:VSTOp command moves the vertical marker 2 (Y2 cursor) to the specified value corresponding to the selected source. The source can be selected by the MARKer:X2Y2source command.

**NOTE**

The short form of this command, VSTO, does not follow the defined Long Form to Short Form Truncation Rules (see [page 752](#)). The normal short form, VST, would be the same for both VSTArt and VSTOp, so sending VST for the VSTOp command produces an error.

**NOTE**

The :MEASure:VSTOp command is an obsolete command provided for compatibility to previous oscilloscopes. Use the :MARKer:Y2Position command (see [page 283](#)) instead.

**Query Syntax** :MEASure:VSTOp?

The :MEASure:VSTOp? query returns the current value of the Y2 cursor.

**Return Format** <value><NL>  
 <value> ::= value of the Y2 cursor in NR3 format

- See Also**
- "[Introduction to :MARKer Commands](#)" on page 275
  - "[Introduction to :MEASure Commands](#)" on page 290
  - "[:MARKer:Y1Position](#)" on page 282
  - "[:MARKer:Y2Position](#)" on page 283
  - "[:MARKer:YDELta](#)" on page 284
  - "[:MARKer:X2Y2source](#)" on page 280
  - "[:MEASure:SOURce](#)" on page 315
  - "[:MEASure:TDELta](#)" on page 681
  - "[:MEASure:TSTArt](#)" on page 685

**:MTESt:AMASk:{SAVE | STORe}**

**O** (see [page 750](#))

**Command Syntax** :MTESt:AMASk:{SAVE | STORe} "<filename>"

The :MTESt:AMASk:SAVE command saves the automask generated mask to a file. If an automask has not been generated, an error occurs.

The <filename> parameter is an MS-DOS compatible name of the file, a maximum of 254 characters long (including the path name, if used). The filename assumes the present working directory if a path does not precede the file name.

**NOTE**

The :MTESt:AMASk:{SAVE | STORe} command is obsolete and is provided for backward compatibility to previous oscilloscopes. Use the :SAVE:MASK[:STARt] command (see [page 387](#)) instead.

**See Also** • "Introduction to :MTESt Commands" on page 339

## :MTESt:AVERage

**O** (see [page 750](#))

**Command Syntax** :MTESt:AVERage <on\_off>  
<on\_off> ::= {{1 | ON} | {0 | OFF}}

The :MTESt:AVERage command enables or disables averaging. When ON, the oscilloscope acquires multiple data values for each time bucket, and averages them. When OFF, averaging is disabled. To set the number of averages, use the :MTESt:AVERage:COUNT command described next.

### NOTE

The :MTESt:AVERage command is obsolete and is provided for backward compatibility to previous oscilloscopes. Use the :ACQUIRE:TYPE AVERage command (see [page 191](#)) instead.

**Query Syntax** :MTESt:AVERage?

The :MTESt:AVERage? query returns the current setting for averaging.

**Return Format** <on\_off><NL>  
<on\_off> ::= {1 | 0}

- See Also**
- "[Introduction to :MTESt Commands](#)" on page 339
  - "[:MTESt:AVERage:COUNT](#)" on page 695

## :MTESt:AVERAge:COUNT

**O** (see [page 750](#))

**Command Syntax** :MTESt:AVERAge:COUNT <count>

<count> ::= an integer from 2 to 65536 in NR1 format

The :MTESt:AVERAge:COUNT command sets the number of averages for the waveforms. With the AVERAge acquisition type, the :MTESt:AVERAge:COUNT command specifies the number of data values to be averaged for each time bucket before the acquisition is considered complete for that time bucket.

### NOTE

The :MTESt:AVERAge:COUNT command is obsolete and is provided for backward compatibility to previous oscilloscopes. Use the :ACQuire:COUNT command (see [page 181](#)) instead.

**Query Syntax** :MTESt:AVERAge:COUNT?

The :MTESt:AVERAge:COUNT? query returns the currently selected count value.

**Return Format** <count><NL>

<count> ::= an integer from 2 to 65536 in NR1 format

- See Also**
- "Introduction to :MTESt Commands" on page 339
  - ":MTESt:AVERAge" on page 694

## :MTEST:LOAD

**O** (see [page 750](#))

**Command Syntax** :MTEST:LOAD "<filename>"

The :MTEST:LOAD command loads the specified mask file.

The <filename> parameter is an MS-DOS compatible name of the file, a maximum of 254 characters long (including the path name, if used).

### NOTE

The :MTEST:LOAD command is obsolete and is provided for backward compatibility to previous oscilloscopes. Use the :RECall:MASK[:START] command (see [page 374](#)) instead.

- See Also**
- "Introduction to :MTEST Commands" on page 339
  - ":MTEST:AMASK:{SAVE | STORE}" on page 693

## :MTEST:RUMode

**O** (see [page 750](#))

**Command Syntax** :MTEST:RUMode {FORever | TIME,<seconds> | {WAVeforms,<wfm\_count>}}

<seconds> ::= from 1 to 86400 in NR3 format

<wfm\_count> ::= number of waveforms in NR1 format  
from 1 to 1,000,000,000

The :MTEST:RUMode command determines the termination conditions for the mask test. The choices are FORever, TIME, or WAVeforms.

- FORever – runs the Mask Test until the test is turned off.
- TIME – sets the amount of time in seconds that a mask test will run before it terminates. The <seconds> parameter is a real number from 1 to 86400 seconds.
- WAVeforms – sets the maximum number of waveforms that are required before the mask test terminates. The <wfm\_count> parameter indicates the number of waveforms that are to be acquired; it is an integer from 1 to 1,000,000,000.

### NOTE

The :MTEST:RUMode command is obsolete and is provided for backward compatibility to previous oscilloscopes. Use the :MTEST:RMODE command (see [page 356](#)) instead.

**Query Syntax** :MTEST:RUMode?

The :MTEST:RUMode? query returns the currently selected termination condition and value.

**Return Format** {FOR | TIME,<seconds> | {WAV,<wfm\_count>}}<NL>

<seconds> ::= from 1 to 86400 in NR3 format

<wfm\_count> ::= number of waveforms in NR1 format  
from 1 to 1,000,000,000

- See Also**
- ["Introduction to :MTEST Commands"](#) on page 339
  - [":MTEST:RUMode:SOFailure"](#) on page 698

## :MTESt:RUMode:SOFailure

**O** (see [page 750](#))

**Command Syntax** :MTESt:RUMode:SOFailure <on\_off>  
<on\_off> ::= {{1 | ON} | {0 | OFF}}

The :MTESt:RUMode:SOFailure command enables or disables the Stop On Failure run until criteria. When a mask test is run and a mask violation is detected, the mask test is stopped and the acquisition system is stopped.

### NOTE

The :MTESt:RUMode:SOFailure command is obsolete and is provided for backward compatibility to previous oscilloscopes. Use the :MTESt:RMODE:FACTion:STOP command (see [page 360](#)) instead.

**Query Syntax** :MTESt:RUMode:SOFailure?

The :MTESt:RUMode:SOFailure? query returns the current state of the Stop on Failure control.

**Return Format** <on\_off><NL>  
<on\_off> ::= {1 | 0}

- See Also**
- "[Introduction to :MTESt Commands](#)" on [page 339](#)
  - "[:MTESt:RUMode](#)" on [page 697](#)

**:MTEST:{START | STOP}**

**O** (see [page 750](#))

**Command Syntax** :MTEST:{START | STOP}

The :MTEST:{START | STOP} command starts or stops the acquisition system.

**NOTE**

The :MTEST:START and :MTEST:STOP commands are obsolete and are provided for backward compatibility to previous oscilloscopes. Use the :RUN command (see [page 170](#)) and :STOP command (see [page 174](#)) instead.

**See Also** • "Introduction to :MTEST Commands" on page 339

## :MTESt:TRIGger:SOURce

**O** (see [page 750](#))

**Command Syntax** :MTESt:TRIGger:SOURce <source>

<source> ::= CHANnel<n>

<n> ::= {1 | 2 | 3 | 4} for the four channel oscilloscope models

<n> ::= {1 | 2} for the two channel oscilloscope models

The :MTESt:TRIGger:SOURce command sets the channel to use as the trigger.

### NOTE

The :MTESt:TRIGger:SOURce command is obsolete and is provided for backward compatibility to previous oscilloscopes. Use the trigger source commands (see [page 440](#)) instead.

**Query Syntax** :MTESt:TRIGger:SOURce?

The :MTESt:TRIGger:SOURce? query returns the currently selected trigger source.

**Return Format** <source> ::= CHAN<n>

<n> ::= {1 | 2 | 3 | 4} for the four channel oscilloscope models

<n> ::= {1 | 2} for the two channel oscilloscope models

**See Also** • ["Introduction to :MTESt Commands"](#) on page 339

## :PRINt?

**O** (see [page 750](#))

### Query Syntax

:PRINt? [<options>]

<options> ::= [<print option>][,...,<print option>]

<print option> ::= {COLor | GRAYscale | BMP8bit | BMP}

The :PRINt? query pulls image data back over the bus for storage.

### NOTE

The :PRINT command is an obsolete command provided for compatibility to previous oscilloscopes. Use the :DISPlay:DATA command (see [page 226](#)) instead.

| Print Option | :PRINt command   | :PRINt? query                          | Query Default |
|--------------|--|--|---------------|
| COLor        | Sets palette=COLor   |  |               |
| GRAYscale    | Sets palette=GRAYscale   |  | palette=COLor |
| PRINter0,1   | Causes the USB printer #0,1 to be selected as destination (if connected) | Not used                               | N/A           |
| BMP8bit      | Sets print format to 8-bit BMP   | Selects 8-bit BMP formatting for query | N/A           |
| BMP          | Sets print format to BMP   | Selects BMP formatting for query       | N/A           |
| FACTors      | Selects outputting of additional settings information for :PRINT         | Not used                               | N/A           |
| NOFactors    | Deselects outputting of additional settings information for :PRINT       | Not used                               | N/A           |

| Old Print Option: | Is Now:   |
|-------------------|-----------|
| HIRes             | COLor     |
| LORes             | GRAYscale |
| PARallel          | PRINter0  |

## 7 Obsolete and Discontinued Commands

| Old Print Option: | Is Now: |
|-------------------|---------|
| DISK              | invalid |
| PCL               | invalid |

### NOTE

The PRINT? query is not a core command.

- See Also**
- ["Introduction to Root \(: \) Commands"](#) on page 138
  - ["Introduction to :HARDcopy Commands"](#) on page 261
  - [":HARDcopy:FORMat"](#) on page 675
  - [":HARDcopy:FACTors"](#) on page 264
  - [":HARDcopy:GRAYscale"](#) on page 676
  - [":DISPlay:DATA"](#) on page 226

## :TIMEbase:DElAy

**O** (see [page 750](#))

**Command Syntax** :TIMEbase:DElAy <delay\_value>

<delay\_value> ::= time in seconds from trigger to the delay reference point on the screen.

The valid range for delay settings depends on the time/division setting for the main time base.

The :TIMEbase:DElAy command sets the main time base delay. This delay is the time between the trigger event and the delay reference point on the screen. The delay reference point is set with the :TIMEbase:REfERENCE command (see [page 434](#)).

### NOTE

The :TIMEbase:DElAy command is obsolete and is provided for backward compatibility to previous oscilloscopes. Use the :TIMEbase:POSition command (see [page 432](#)) instead.

**Query Syntax** :TIMEbase:DElAy?

The :TIMEbase:DElAy query returns the current delay value.

**Return Format** <delay\_value><NL>

<delay\_value> ::= time from trigger to display reference in seconds in NR3 format.

**Example Code**

```
' TIMEBASE_DELAY - Sets the time base delay. This delay
' is the internal time between the trigger event and the
' onscreen delay reference point.

' Set time base delay to 0.0.
myScope.WriteString ":TIMEBASE:DELAY 0.0"
```

Example program from the start: "[VISA COM Example in Visual Basic](#)" on [page 776](#)

## :TRIGger:CAN:ACKnowledge

**O** (see [page 750](#))

**Command Syntax** :TRIGger:CAN:ACKnowledge <value>  
<value> ::= {0 | OFF}

This command was used with the N2758A CAN trigger module for 54620/54640 Series mixed-signal oscilloscopes. The InfiniiVision 5000 Series oscilloscopes do not support the N2758A CAN trigger module.

**Query Syntax** :TRIGger:CAN:ACKnowledge?

The :TRIGger:CAN:ACKnowledge? query returns the current CAN acknowledge setting.

**Return Format** <value><NL>

<value> ::= 0

- See Also**
- "[Introduction to :TRIGger Commands](#)" on page 440
  - "[:TRIGger:MODE](#)" on page 447
  - "[:TRIGger:CAN:TRIGger](#)" on page 462

## :TRIGger:LIN:SIGNal:DEFinition

**O** (see [page 750](#))

**Command Syntax** :TRIGger:LIN:SIGNal:DEFinition <value>  
 <value> ::= {LIN | RX | TX}

The :TRIGger:LIN:SIGNal:DEFinition command sets the LIN signal type. These signals can be set to:

Dominant low signals:

- LIN – the actual LIN single-end bus signal line.
- RX – the Receive signal from the LIN bus transceiver.
- TX – the Transmit signal to the LIN bus transceiver.

**NOTE**

With InfiniiVision 5000 Series oscilloscope software version 5.00 or greater, this command is available, but the only legal value is LIN.

**Query Syntax** :TRIGger:LIN:SIGNal:DEFinition?

The :TRIGger:LIN:SIGNal:DEFinition? query returns the current LIN signal type.

**Return Format** <value><NL>  
 <value> ::= LIN

- See Also**
- ["Introduction to :TRIGger Commands"](#) on page 440
  - [":TRIGger:MODE"](#) on page 447
  - [":TRIGger:LIN:SIGNal:BAUDrate"](#) on page 535
  - [":TRIGger:LIN:SOURce"](#) on page 536

**:TRIGger:TV:TVMode**

**O** (see [page 750](#))

**Command Syntax** :TRIGger:TV:TVMode <mode>

```
<mode> ::= {FIEld1 | FIEld2 | AFIElds | ALINes | LINE | VERTical
           | LFIeld1 | LFIeld2 | LALTernate | LVERTical}
```

The :TRIGger:TV:MODE command selects the TV trigger mode and field. The LVERTical parameter is only available when :TRIGger:TV:STANdard is GENERic. The LALTernate parameter is not available when :TRIGger:TV:STANdard is GENERic (see [page 569](#)).

Old forms for <mode> are accepted:

| <mode>     | Old Forms Accepted |
|------------|--------------------|
| FIEld1     | F1                 |
| FIEld2     | F2                 |
| AFIEld     | ALLFields, ALLFLDS |
| ALINes     | ALLLines           |
| LFIeld1    | LINEF1, LINEFIELD1 |
| LFIeld2    | LINEF2, LINEFIELD2 |
| LALTernate | LINEAlt            |
| LVERTical  | LINEVert           |

**NOTE**

The :TRIGger:TV:TVMode command is an obsolete command provided for compatibility to previous oscilloscopes. Use the :TRIGger:TV:MODE command (see [page 566](#)) instead.

**Query Syntax** :TRIGger:TV:TVMode?

The :TRIGger:TV:TVMode? query returns the TV trigger mode.

**Return Format** <value><NL>

```
<value> ::= {FIE1 | FIE2 | AFI | ALIN | LINE | VERT | LFI1 | LFI2
           | LALT | LVER}
```

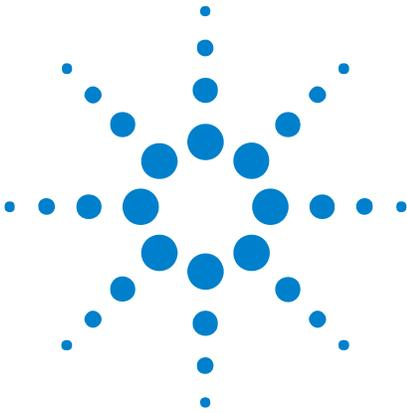

## 8 Error Messages

**-440, Query UNTERMINATED after indefinite response**

**-430, Query DEADLOCKED**

**-420, Query UNTERMINATED**

**-410, Query INTERRUPTED**

**-400, Query error**

**-340, Calibration failed**

**-330, Self-test failed**

**-321, Out of memory**

**-320, Storage fault**

**-315, Configuration memory lost**



**-314, Save/recall memory lost**

**-313, Calibration memory lost**

**-311, Memory error**

**-310, System error**

**-300, Device specific error**

**-278, Macro header not found**

**-277, Macro redefinition not allowed**

**-276, Macro recursion error**

**-273, Illegal macro label**

**-272, Macro execution error**

**-258, Media protected**

**-257, File name error**

**-256, File name not found**

**-255, Directory full**

**-254, Media full**

**-253, Corrupt media**

**-252, Missing media**

**-251, Missing mass storage**

**-250, Mass storage error**

**-241, Hardware missing**

This message can occur when a feature is unavailable or unlicensed.

For example, serial bus decode commands (which require a four-channel oscilloscope) are unavailable on two-channel oscilloscopes, and some serial bus decode commands are only available on four-channel oscilloscopes when the AMS (automotive serial decode) or LSS (low-speed serial decode) options are licensed.

**-240, Hardware error**

**-231, Data questionable**

**-230, Data corrupt or stale**

**-224, Illegal parameter value**

**-223, Too much data**

**-222, Data out of range**

**-221, Settings conflict**

**-220, Parameter error**

**-200, Execution error**

**-183, Invalid inside macro definition**

**-181, Invalid outside macro definition**

**-178, Expression data not allowed**

**-171, Invalid expression**

**-170, Expression error**

**-168, Block data not allowed**

**-161, Invalid block data**

**-158, String data not allowed**

- 151, Invalid string data
- 150, String data error
- 148, Character data not allowed
- 138, Suffix not allowed
- 134, Suffix too long
- 131, Invalid suffix
- 128, Numeric data not allowed
- 124, Too many digits
- 123, Exponent too large
- 121, Invalid character in number
- 120, Numeric data error
- 114, Header suffix out of range
- 113, Undefined header

**-112, Program mnemonic too long**

**-109, Missing parameter**

**-108, Parameter not allowed**

**-105, GET not allowed**

**-104, Data type error**

**-103, Invalid separator**

**-102, Syntax error**

**-101, Invalid character**

**-100, Command error**

**+10, Software Fault Occurred**

**+100, File Exists**

**+101, End-Of-File Found**

**+102, Read Error**

**+103, Write Error****+104, Illegal Operation****+105, Print Canceled****+106, Print Initialization Failed****+107, Invalid Trace File****+108, Compression Error****+109, No Data For Operation**

A remote operation wants some information, but there is no information available. For example, you may request a stored TIFF image using the :DISPlay:DATA? query, but there may be no image stored.

**+112, Unknown File Type****+113, Directory Not Supported**

## 8 Error Messages

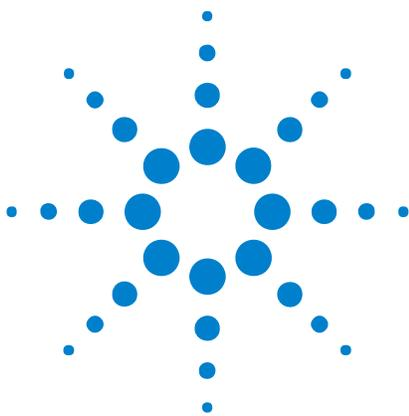

## 9 Status Reporting

|   |     |
|---|-----|
| Status Reporting Data Structures                              | 718 |
| Status Byte Register (STB)                                    | 721 |
| Service Request Enable Register (SRE)                         | 723 |
| Trigger Event Register (TER)                                  | 724 |
| Output Queue  | 725 |
| Message Queue   | 726 |
| (Standard) Event Status Register (ESR)                        | 727 |
| (Standard) Event Status Enable Register (ESE)                 | 728 |
| Error Queue   | 729 |
| Operation Status Event Register (:OPERRegister[:EVENTt])      | 730 |
| Operation Status Condition Register (:OPERRegister:CONDition) | 731 |
| Arm Event Register (AER)                                      | 732 |
| Overload Event Register (:OVLRegister)                        | 733 |
| Hardware Event Event Register (:HWERegister[:EVENTt])         | 734 |
| Hardware Event Condition Register (:HWERegister:CONDition)    | 735 |
| Mask Test Event Event Register (:MTERegister[:EVENTt])        | 736 |
| Clearing Registers and Queues                                 | 737 |
| Status Reporting Decision Chart                               | 738 |

IEEE 488.2 defines data structures, commands, and common bit definitions for status reporting (for example, the Status Byte Register and the Standard Event Status Register). There are also instrument-defined structures and bits (for example, the Operation Status Event Register and the Overload Event Register).

An overview of the oscilloscope's status reporting structure is shown in the following block diagram. The status reporting structure allows monitoring specified events in the oscilloscope. The ability to monitor and report these events allows determination of such things as the status of an operation, the availability and reliability of the measured data, and more.



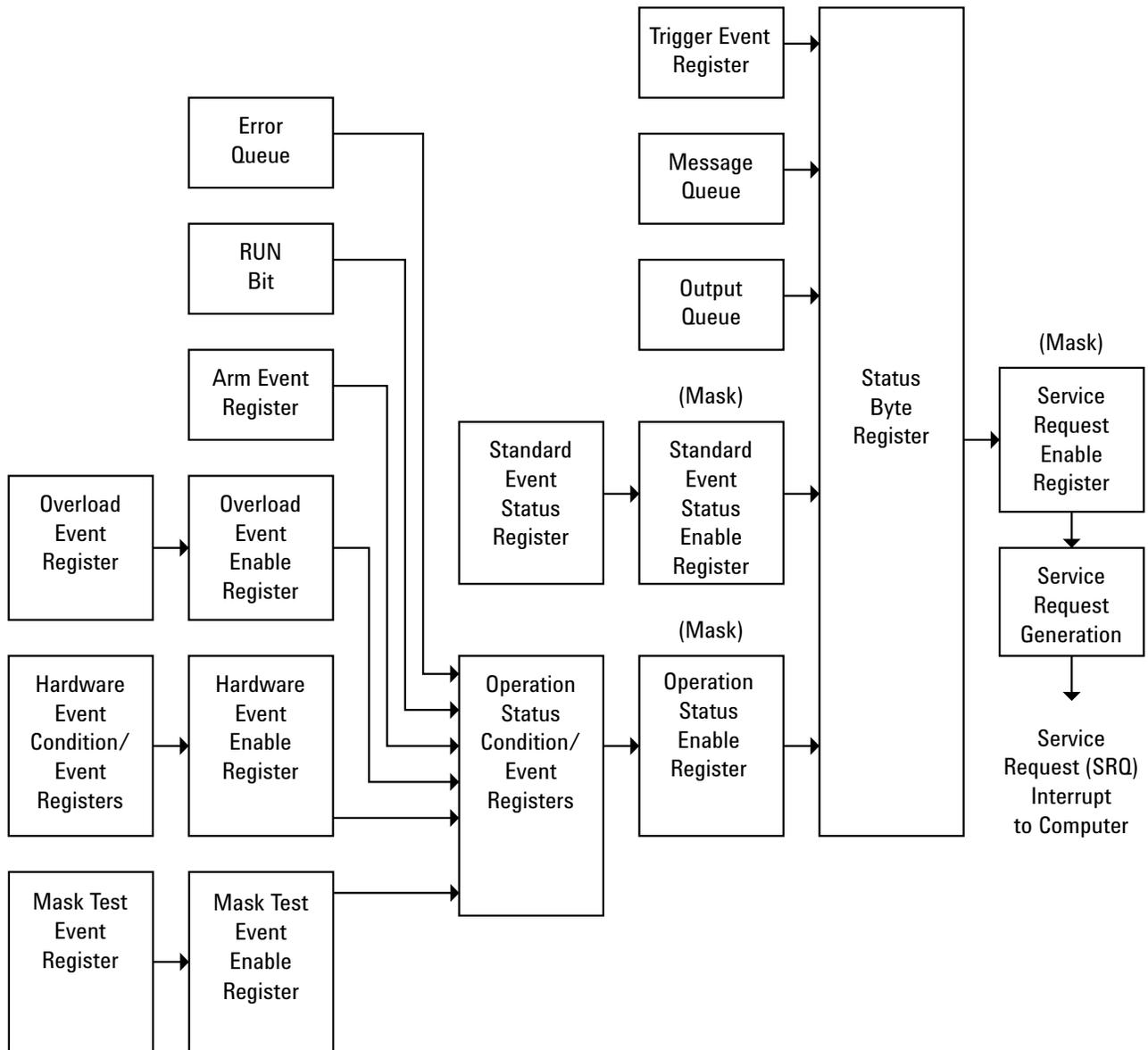

- To monitor an event, first clear the event; then, enable the event. All of the events are cleared when you initialize the instrument.
- To allow a service request (SRQ) interrupt to an external controller, enable at least one bit in the Status Byte Register (by setting, or unmasking, the bit in the Service Request Enable register).

The Status Byte Register, the Standard Event Status Register group, and the Output Queue are defined as the Standard Status Data Structure Model in IEEE 488.2-1987.

The bits in the status byte act as summary bits for the data structures residing behind them. In the case of queues, the summary bit is set if the queue is not empty. For registers, the summary bit is set if any enabled bit in the event register is set. The events are enabled with the corresponding event enable register. Events captured by an event register remain set until the register is read or cleared. Registers are read with their associated commands. The \*CLS command clears all event registers and all queues except the output queue. If you send \*CLS immediately after a program message terminator, the output queue is also cleared.

## Status Reporting Data Structures

The following figure shows how the status register bits are masked and logically OR'ed to generate service requests (SRQ) on particular events.

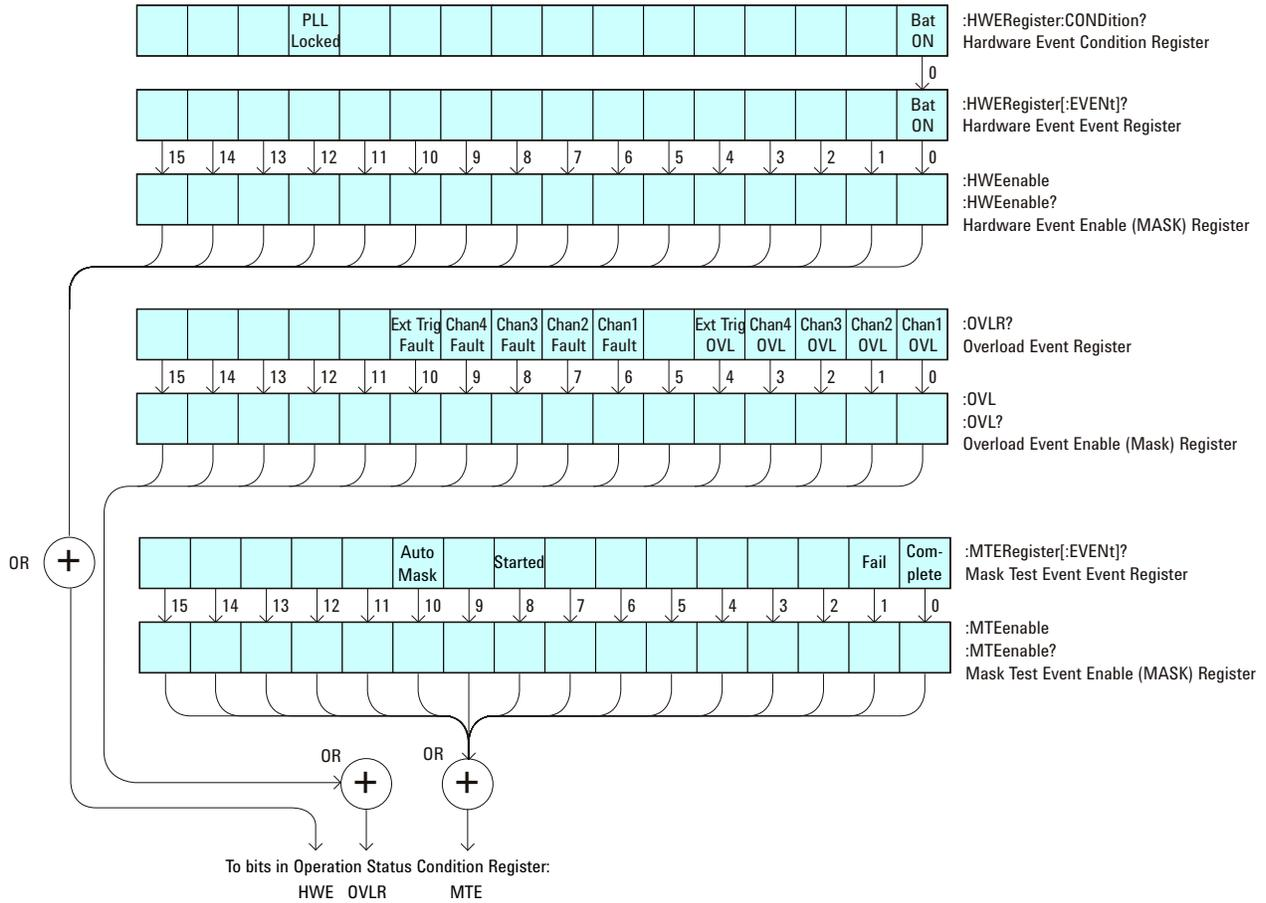

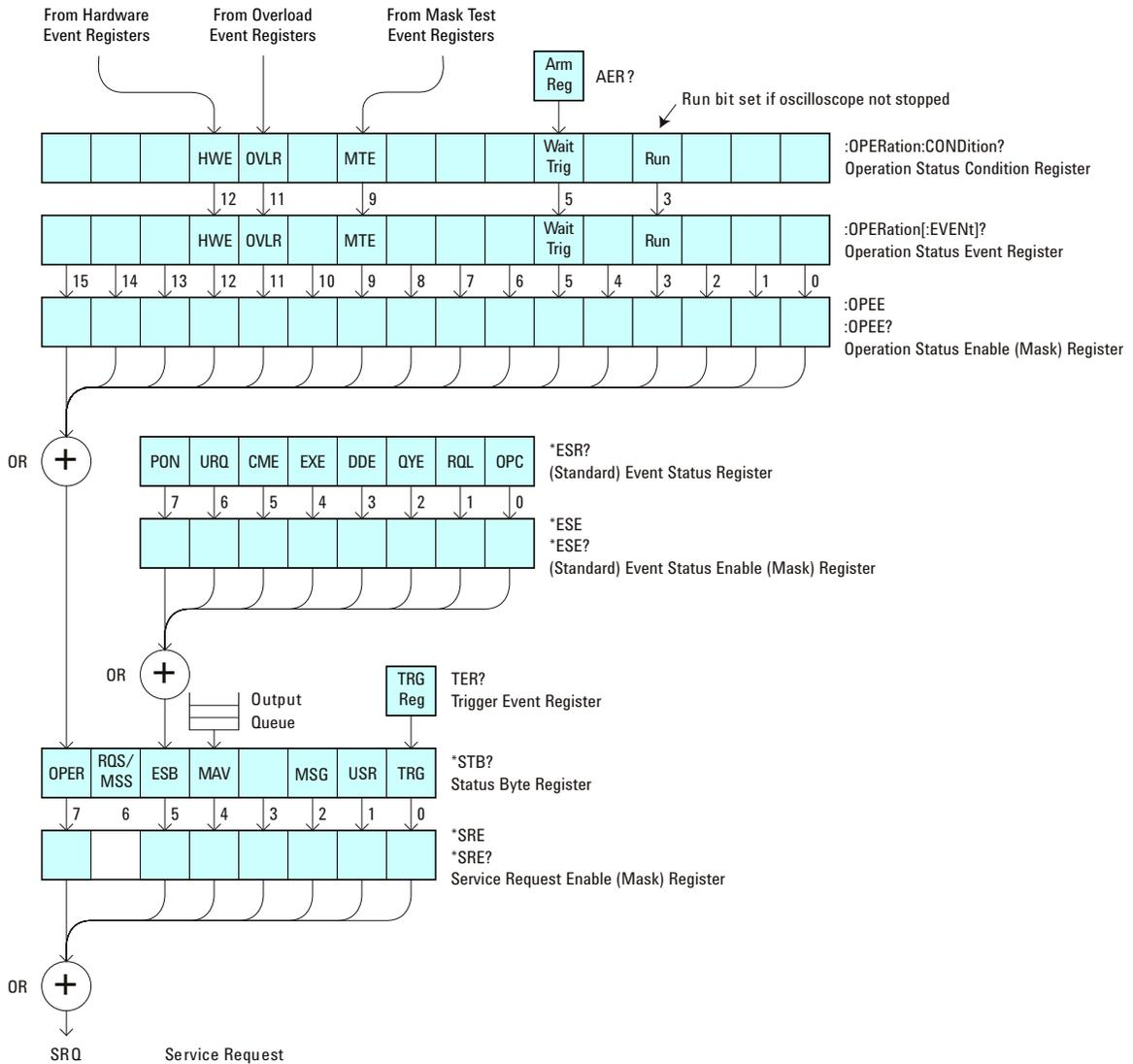

The status register bits are described in more detail in the following tables:

- [Table 41](#)
- [Table 39](#)
- [Table 49](#)
- [Table 50](#)
- [Table 52](#)
- [Table 44](#)
- [Table 45](#)
- [Table 47](#)

The status registers picture above shows how the different status reporting data structures work together. To make it possible for any of the Standard Event Status Register bits to generate a summary bit, the bits must be enabled. These bits are enabled by using the \*ESE common command to set the corresponding bit in the Standard Event Status Enable Register.

To generate a service request (SRQ) interrupt to an external controller, at least one bit in the Status Byte Register must be enabled. These bits are enabled by using the \*SRE common command to set the corresponding bit in the Service Request Enable Register. These enabled bits can then set RQS and MSS (bit 6) in the Status Byte Register.

## Status Byte Register (STB)

The Status Byte Register is the summary-level register in the status reporting structure. It contains summary bits that monitor activity in the other status registers and queues. The Status Byte Register is a live register. That is, its summary bits are set and cleared by the presence and absence of a summary bit from other event registers or queues.

If the Status Byte Register is to be used with the Service Request Enable Register to set bit 6 (RQS/MSS) and to generate an SRQ, at least one of the summary bits must be enabled, then set. Also, event bits in all other status registers must be specifically enabled to generate the summary bit that sets the associated summary bit in the Status Byte Register.

The Status Byte Register can be read using either the \*STB? Common Command or the programming interface serial poll command. Both commands return the decimal-weighted sum of all set bits in the register. The difference between the two methods is that the serial poll command reads bit 6 as the Request Service (RQS) bit and clears the bit which clears the SRQ interrupt. The \*STB? command reads bit 6 as the Master Summary Status (MSS) and does not clear the bit or have any affect on the SRQ interrupt. The value returned is the total bit weights of all of the bits that are set at the present time.

The use of bit 6 can be confusing. This bit was defined to cover all possible computer interfaces, including a computer that could not do a serial poll. The important point to remember is that, if you are using an SRQ interrupt to an external computer, the serial poll command clears bit 6. Clearing bit 6 allows the oscilloscope to generate another SRQ interrupt when another enabled event occurs.

No other bits in the Status Byte Register are cleared by either the \*STB? query or the serial poll, except the Message Available bit (bit 4). If there are no other messages in the Output Queue, bit 4 (MAV) can be cleared as a result of reading the response to the \*STB? command.

If bit 4 (weight = 16) and bit 5 (weight = 32) are set, the program prints the sum of the two weights. Since these bits were not enabled to generate an SRQ, bit 6 (weight = 64) is not set.

The following example uses the \*STB? query to read the contents of the oscilloscope's Status Byte Register.

```
myScope.WriteString "*STB?"
varQueryResult = myScope.ReadNumber
MsgBox "Status Byte Register, Read: 0x" + Hex(varQueryResult)
```

The next program prints 0xD1 and clears bit 6 (RQS) and bit 4 (MAV) of the Status Byte Register. The difference in the output value between this example and the previous one is the value of bit 6 (weight = 64). Bit 6 is set when the first enabled summary bit is set and is cleared when the Status Byte Register is read by the serial poll command.

**Example** The following example uses the resource session object's ReadSTB method to read the contents of the oscilloscope's Status Byte Register.

```
varQueryResult = myScope.IO.ReadSTB
MsgBox "Status Byte Register, Serial Poll: 0x" + Hex(varQueryResult)
```

### NOTE

**Use Serial Polling to Read Status Byte Register.** Serial polling is the preferred method to read the contents of the Status Byte Register because it resets bit 6 and allows the next enabled event that occurs to generate a new SRQ interrupt.

---

## Service Request Enable Register (SRE)

Setting the Service Request Enable Register bits enable corresponding bits in the Status Byte Register. These enabled bits can then set RQS and MSS (bit 6) in the Status Byte Register.

Bits are set in the Service Request Enable Register using the \*SRE command and the bits that are set are read with the \*SRE? query.

**Example** The following example sets bit 4 (MAV) and bit 5 (ESB) in the Service Request Enable Register.

```
myScope.WriteString "*SRE " + CStr(CInt("&H30"))
```

This example uses the decimal parameter value of 48, the string returned by CStr(CInt("&H30")), to enable the oscilloscope to generate an SRQ interrupt under the following conditions:

- When one or more bytes in the Output Queue set bit 4 (MAV).
- When an enabled event in the Standard Event Status Register generates a summary bit that sets bit 5 (ESB).

## Trigger Event Register (TER)

This register sets the TRG bit in the status byte when a trigger event occurs.

The TER event register stays set until it is cleared by reading the register or using the \*CLS command. If your application needs to detect multiple triggers, the TER event register must be cleared after each one.

If you are using the Service Request to interrupt a program or controller operation, you must clear the event register each time the trigger bit is set.

## Output Queue

The output queue stores the oscilloscope-to-controller responses that are generated by certain instrument commands and queries. The output queue generates the Message Available summary bit when the output queue contains one or more bytes. This summary bit sets the MAV bit (bit 4) in the Status Byte Register.

When using the Agilent VISA COM library, the output queue may be read with the FormattedIO488 object's ReadString, ReadNumber, ReadList, or ReadIEEEBlock methods.

## Message Queue

The message queue contains the text of the last message written to the advisory line on the screen of the oscilloscope. The length of the oscilloscope's message queue is 1. Note that messages sent with the :SYSTem:DSP command do not set the MSG status bit in the Status Byte Register.

## (Standard) Event Status Register (ESR)

The (Standard) Event Status Register (ESR) monitors the following oscilloscope status events:

- PON - Power On
- URQ - User Request
- CME - Command Error
- EXE - Execution Error
- DDE - Device Dependent Error
- QYE - Query Error
- RQC - Request Control
- OPC - Operation Complete

When one of these events occur, the event sets the corresponding bit in the register. If the bits are enabled in the Standard Event Status Enable Register, the bits set in this register generate a summary bit to set bit 5 (ESB) in the Status Byte Register.

You can read the contents of the Standard Event Status Register and clear the register by sending the \*ESR? query. The value returned is the total bit weights of all of the bits that are set at the present time.

**Example** The following example uses the \*ESR query to read the contents of the Standard Event Status Register.

```
myScope.WriteString "*ESR?"
varQueryResult = myScope.ReadNumber
MsgBox "Standard Event Status Register: 0x" + Hex(varQueryResult)
```

If bit 4 (weight = 16) and bit 5 (weight = 32) are set, the program prints the sum of the two weights.

## (Standard) Event Status Enable Register (ESE)

To allow any of the (Standard) Event Status Register (ESR) bits to generate a summary bit, you must first enable that bit. Enable the bit by using the \*ESE (Event Status Enable) common command to set the corresponding bit in the (Standard) Event Status Enable Register (ESE).

Set bits are read with the \*ESE? query.

**Example** Suppose your application requires an interrupt whenever any type of error occurs. The error related bits in the (Standard) Event Status Register are bits 2 through 5 (hexadecimal value 0x3C). Therefore, you can enable any of these bits to generate the summary bit by sending:

```
myScope.WriteString "*ESE " + CStr(CInt("&H3C"))
```

Whenever an error occurs, it sets one of these bits in the (Standard) Event Status Register. Because all the error related bits are enabled, a summary bit is generated to set bit 5 (ESB) in the Status Byte Register.

If bit 5 (ESB) in the Status Byte Register is enabled (via the \*SRE command), an SRQ service request interrupt is sent to the controller PC.

### NOTE

**Disabled (Standard) Event Status Register bits respond but do not generate a summary bit.** (Standard) Event Status Register bits that are not enabled still respond to their corresponding conditions (that is, they are set if the corresponding event occurs). However, because they are not enabled, they do not generate a summary bit to the Status Byte Register.

## Error Queue

As errors are detected, they are placed in an error queue. This queue is first in, first out. If the error queue overflows, the last error in the queue is replaced with error 350, Queue overflow. Any time the queue overflows, the least recent errors remain in the queue, and the most recent error is discarded. The length of the oscilloscope's error queue is 30 (29 positions for the error messages, and 1 position for the Queue overflow message).

The error queue is read with the `:SYSTEM:ERROR?` query. Executing this query reads and removes the oldest error from the head of the queue, which opens a position at the tail of the queue for a new error. When all the errors have been read from the queue, subsequent error queries return "0, No error".

The error queue is cleared when:

- the instrument is powered up,
- the instrument receives the `*CLS` common command, or
- the last item is read from the error queue.

## Operation Status Event Register (:OPERRegister[:EVENTt])

The Operation Status Event Register register hosts these bits:

| Name          | Location | Description   |
|---------------|----------|---|
| RUN bit       | bit 3    | Is set whenever the instrument goes from a stop state to a single or running state. |
| WAIT TRIG bit | bit 5    | Is set by the Trigger Armed Event Register and indicates that the trigger is armed. |
| MTE bit       | bit 9    | Comes from the Mask Test Event Registers.   |
| OVLRL bit     | bit 11   | Is set whenever a 50Ω input overload occurs.  |
| HWE bit       | bit 12   | Comes from the Hardware Event Registers.  |

If any of these bits are set, the OPER bit (bit 7) of the Status Byte Register is set. The Operation Status Event Register is read and cleared with the :OPERRegister[:EVENTt]? query. The register output is enabled or disabled using the mask value supplied with the OPEE command.

## Operation Status Condition Register (:OPERRegister:CONDition)

The Operation Status Condition Register register hosts these bits:

| Name          | Location | Description   |
|---------------|----------|---|
| RUN bit       | bit 3    | Is set whenever the instrument is not stopped.                                      |
| WAIT TRIG bit | bit 5    | Is set by the Trigger Armed Event Register and indicates that the trigger is armed. |
| MTE bit       | bit 9    | Comes from the Mask Test Event Registers.   |
| OVL R bit     | bit 11   | Is set whenever a 50 $\Omega$ input overload occurs.                                |
| HWE bit       | bit 12   | Comes from the Hardware Event Registers.  |

The :OPERRegister:CONDition? query returns the value of the Operation Status Condition Register.

## Arm Event Register (AER)

This register sets bit 5 (Wait Trig bit) in the Operation Status Register and the OPER bit (bit 7) in the Status Byte Register when the instrument becomes armed.

The ARM event register stays set until it is cleared by reading the register with the AER? query or using the \*CLS command. If your application needs to detect multiple triggers, the ARM event register must be cleared after each one.

If you are using the Service Request to interrupt a program or controller operation when the trigger bit is set, then you must clear the event register after each time it has been set.

## Overload Event Register (:OVLRegister)

The Overload Event Register register hosts these bits:

| Name                   | Location | Description                                      |
|------------------------|----------|--|
| Channel 1 OVL          | bit 0    | Overload has occurred on Channel 1 input.        |
| Channel 2 OVL          | bit 1    | Overload has occurred on Channel 2 input.        |
| Channel 3 OVL          | bit 2    | Overload has occurred on Channel 3 input.        |
| Channel 4 OVL          | bit 3    | Overload has occurred on Channel 4 input.        |
| External Trigger OVL   | bit 4    | Overload has occurred on External Trigger input. |
| Channel 1 Fault        | bit 6    | Fault has occurred on Channel 1 input.           |
| Channel 2 Fault        | bit 7    | Fault has occurred on Channel 2 input.           |
| Channel 3 Fault        | bit 8    | Fault has occurred on Channel 3 input.           |
| Channel 4 Fault        | bit 9    | Fault has occurred on Channel 4 input.           |
| External Trigger Fault | bit 10   | Fault has occurred on External Trigger input.    |

## Hardware Event Event Register (:HWERegister[:EVENTt])

This register hosts the PLL LOCKED bit (bit 12).

- The PLL LOCKED bit (bit 12) is for internal use and is not intended for general use.

## Hardware Event Condition Register (:HWERegister:CONDition)

This register hosts the PLL LOCKED bit (bit 12).

- The :HWERegister:CONDition? query returns the value of the Hardware Event Condition Register.
- The PLL LOCKED bit (bit 12) is for internal use and is not intended for general use.

## Mask Test Event Event Register (:MTERegister[:EVENT])

The Mask Test Event Event Register register hosts these bits:

| Name      | Location | Description                                  |
|-----------|----------|--|
| Complete  | bit 0    | Is set when the mask test is complete.       |
| Fail      | bit 1    | Is set when there is a mask test failure.    |
| Started   | bit 8    | Is set when mask testing is started.         |
| Auto Mask | bit 10   | Is set when auto mask creation is completed. |

The :MTERegister[:EVENT]? query returns the value of, and clears, the Mask Test Event Event Register.

## Clearing Registers and Queues

The \*CLS common command clears all event registers and all queues except the output queue. If \*CLS is sent immediately after a program message terminator, the output queue is also cleared.

## Status Reporting Decision Chart

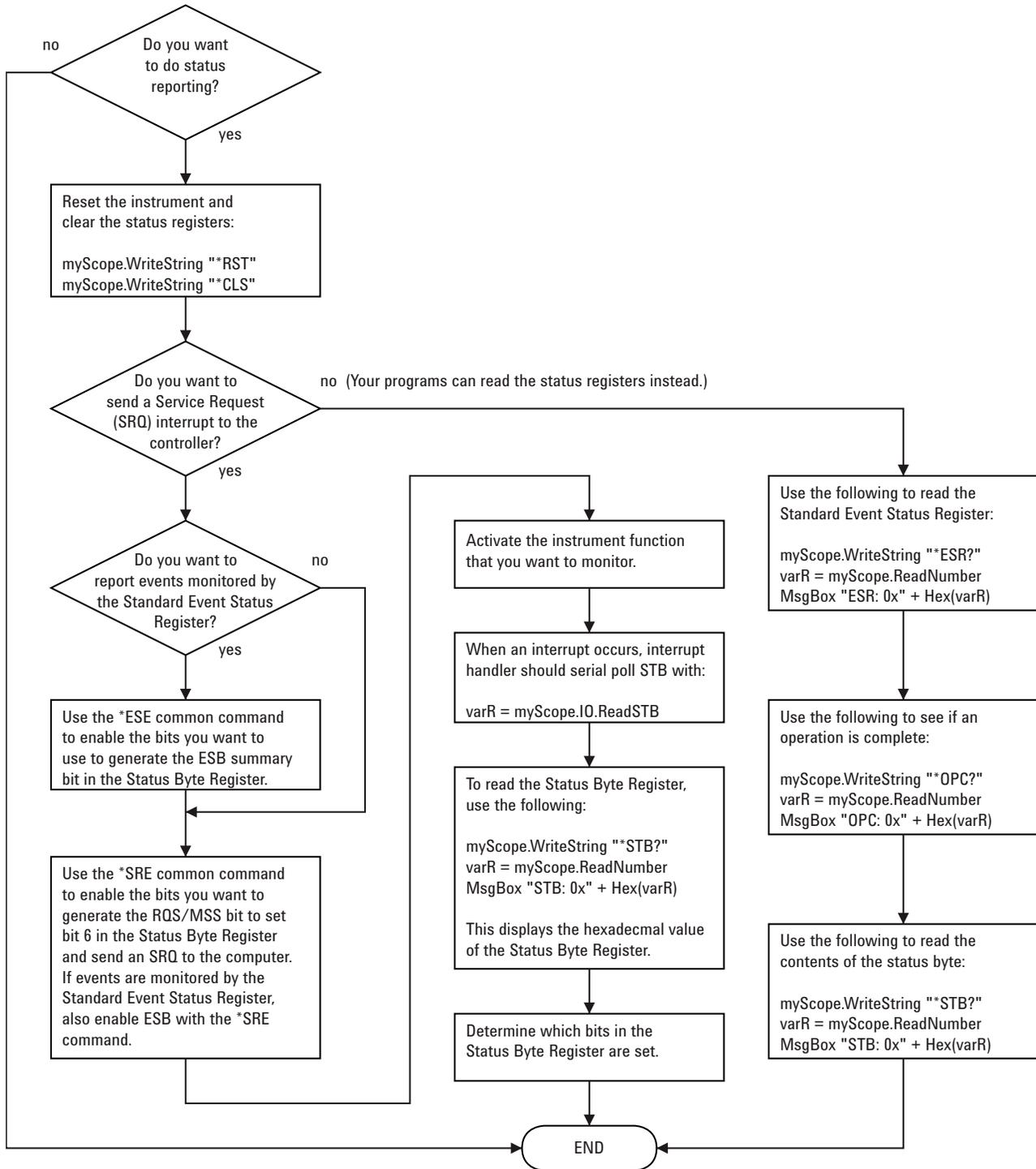

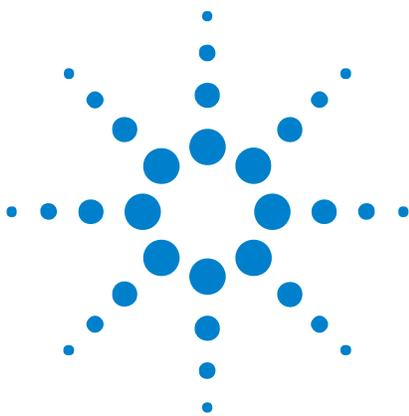

## 10 Synchronizing Acquisitions

- Synchronization in the Programming Flow [740](#)
- Blocking Synchronization [741](#)
- Polling Synchronization With Timeout [742](#)
- Synchronizing with a Single-Shot Device Under Test (DUT) [744](#)
- Synchronization with an Averaging Acquisition [746](#)

When remotely controlling an oscilloscope with programming commands, it is often necessary to know when the oscilloscope has finished the previous operation and is ready for the next command. The most common example is when an acquisition is started using the `:DIGitize`, `:RUN`, or `:SINGLE` commands. Before a measurement result can be queried, the acquisition must complete. Too often fixed delays are used to accomplish this wait, but fixed delays often use excessive time or the time may not be long enough. A better solution is to use synchronous commands and status to know when the oscilloscope is ready for the next request.



## Synchronization in the Programming Flow

Most remote programming follows these three general steps:

- 1 Set up the oscilloscope and device under test (see [page 740](#)).
- 2 Acquire a waveform (see [page 740](#)).
- 3 Retrieve results (see [page 740](#)).

### Set Up the Oscilloscope

Before making changes to the oscilloscope setup, it is best to make sure it is stopped using the :STOP command followed by the \*OPC? query.

#### NOTE

It is not necessary to use \*OPC?, hard coded waits, or status checking when setting up the oscilloscope. After the oscilloscope is configured, it is ready for an acquisition.

### Acquire a Waveform

When acquiring a waveform there are two possible methods used to wait for the acquisition to complete. These methods are blocking and polling. The table below details when each method should be chosen and why.

|                               | Blocking Wait   | Polling Wait   |
|-------------------------------|---|--|
| <b>Use When</b>               | You know the oscilloscope <i>will</i> trigger based on the oscilloscope setup and device under test.          | You know the oscilloscope <i>may or may not</i> trigger on the oscilloscope setup and device under test. |
| <b>Advantages</b>             | No need for polling.<br>Fastest method.   | Remote interface will not timeout<br>No need for device clear if no trigger.                             |
| <b>Disadvantages</b>          | Remote interface may timeout.<br>Device clear only way to get control of oscilloscope if there is no trigger. | Slower method.<br>Requires polling loop.<br>Requires known maximum wait time.                            |
| <b>Implementation Details</b> | See " <a href="#">Blocking Synchronization</a> " on page 741.   | See " <a href="#">Polling Synchronization With Timeout</a> " on page 742.                                |

### Retrieve Results

Once the acquisition is complete, it is safe to retrieve measurements and statistics.

## Blocking Synchronization

Use the :DIGitize command to start the acquisition. This blocks subsequent queries until the acquisition and processing is complete. For example:

```
'
' Synchronizing acquisition using blocking.
' =====

Option Explicit

Public myMgr As VisaComLib.ResourceManager
Public myScope As VisaComLib.FormattedIO488
Public varQueryResult As Variant
Public strQueryResult As String

Sub Main()

    On Error GoTo VisaComError

    ' Create the VISA COM I/O resource.
    Set myMgr = New VisaComLib.ResourceManager
    Set myScope = New VisaComLib.FormattedIO488
    Set myScope.IO = myMgr.Open("TCPIP0::130.29.69.12::inst0::INSTR")
    myScope.IO.Clear ' Clear the interface.

    ' Set up.
    ' -----
    myScope.WriteString ":TRIGger:MODE EDGE"
    myScope.WriteString ":TRIGger:EDGE:LEVel 2"
    myScope.WriteString ":TIMEbase:SCALe 5e-8"

    ' Acquire.
    ' -----
    myScope.WriteString ":DIGitize"

    ' Get results.
    ' -----
    myScope.WriteString ":MEASure:RISetime"
    myScope.WriteString ":MEASure:RISetime?"
    varQueryResult = myScope.ReadNumber ' Read risetime.
    Debug.Print "Risetime: " + _
        FormatNumber(varQueryResult * 1000000000, 1) + " ns"

    Exit Sub

VisaComError:
    MsgBox "VISA COM Error:" + vbCrLf + Err.Description

End Sub
```

## Polling Synchronization With Timeout

This example requires a timeout value so the operation can abort if an acquisition does not occur within the timeout period:

```
'
' Synchronizing acquisition using polling.
' =====

Option Explicit

Public myMgr As VisaComLib.ResourceManager
Public myScope As VisaComLib.FormattedIO488
Public varQueryResult As Variant
Public strQueryResult As String

Private Declare Sub Sleep Lib "kernel32" (ByVal dwMilliseconds As Long)

Sub Main()

    On Error GoTo VisaComError

    ' Create the VISA COM I/O resource.
    Set myMgr = New VisaComLib.ResourceManager
    Set myScope = New VisaComLib.FormattedIO488
    Set myScope.IO = myMgr.Open("TCPIP0::130.29.69.12::inst0::INSTR")
    myScope.IO.Clear    ' Clear the interface.

    ' Set up.
    ' -----
    ' Set up the trigger and horizontal scale.
    myScope.WriteString ":TRIGger:MODE EDGE"
    myScope.WriteString ":TRIGger:EDGE:LEVel 2"
    myScope.WriteString ":TIMEbase:SCALE 5e-8"

    ' Stop acquisitions and wait for the operation to complete.
    myScope.WriteString ":STOP"
    myScope.WriteString "*OPC?"
    strQueryResult = myScope.ReadString

    ' Acquire.
    ' -----
    ' Start a single acquisition.
    myScope.WriteString ":SINGLE"

    ' Oscilloscope is armed and ready, enable DUT here.
    Debug.Print "Oscilloscope is armed and ready, enable DUT."

    ' Look for RUN bit = stopped (acquisition complete).
    Dim lngTimeout As Long    ' Max millisecs to wait for single-shot.
    Dim lngElapsed As Long
    lngTimeout = 10000    ' 10 seconds.
    lngElapsed = 0

    Do While lngElapsed <= lngTimeout
```

```

myScope.WriteString ":OPERRegister:CONDition?"
varQueryResult = myScope.ReadNumber
' Mask RUN bit (bit 3, &H8).
If (varQueryResult And &H8) = 0 Then
    Exit Do
Else
    Sleep 100 ' Small wait to prevent excessive queries.
    lngElapsed = lngElapsed + 100
End If
Loop

' Get results.
' -----
If lngElapsed < lngTimeout Then
    myScope.WriteString ":MEASure:RISetime"
    myScope.WriteString ":MEASure:RISetime?"
    varQueryResult = myScope.ReadNumber ' Read risetime.
    Debug.Print "Risetime: " + _
        FormatNumber(varQueryResult * 1000000000, 1) + " ns"
Else
    Debug.Print "Timeout waiting for single-shot trigger."
End If

Exit Sub

VisaComError:
    MsgBox "VISA COM Error:" + vbCrLf + Err.Description

End Sub

```

## Synchronizing with a Single-Shot Device Under Test (DUT)

The examples in ["Blocking Synchronization"](#) on page 741 and ["Polling Synchronization With Timeout"](#) on page 742 assume the DUT is continually running and therefore the oscilloscope will have more than one opportunity to trigger. With a single shot DUT, there is only one opportunity for the oscilloscope to trigger, so it is necessary for the oscilloscope to be armed and ready before the DUT is enabled.

### NOTE

The blocking :DIGitize command cannot be used for a single shot DUT because once the :DIGitize command is issued, the oscilloscope is blocked from any further commands until the acquisition is complete.

This example is the same ["Polling Synchronization With Timeout"](#) on page 742 with the addition of checking for the armed event status.

```
'
' Synchronizing single-shot acquisition using polling.
' =====

Option Explicit

Public myMgr As VisaComLib.ResourceManager
Public myScope As VisaComLib.FormattedIO488
Public varQueryResult As Variant
Public strQueryResult As String

Private Declare Sub Sleep Lib "kernel32" (ByVal dwMilliseconds As Long)

Sub Main()

    On Error GoTo VisaComError

    ' Create the VISA COM I/O resource.
    Set myMgr = New VisaComLib.ResourceManager
    Set myScope = New VisaComLib.FormattedIO488
    Set myScope.IO = myMgr.Open("TCPIP0::130.29.69.12::inst0::INSTR")
    myScope.IO.Clear ' Clear the interface.

    ' Set up.
    ' -----

    ' Set up the trigger and horizontal scale.
    myScope.WriteString ":TRIGger:MODE EDGE"
    myScope.WriteString ":TRIGger:EDGE:LEVel 2"
    myScope.WriteString ":TIMEbase:SCALE 5e-8"

    ' Stop acquisitions and wait for the operation to complete.
    myScope.WriteString ":STOP"
    myScope.WriteString "*OPC?"
    strQueryResult = myScope.ReadString

    ' Acquire.
```

```

' -----
' Start a single acquisition.
myScope.WriteString ":SINGLE"

' Wait until the trigger system is armed.
Do
  Sleep 100 ' Small wait to prevent excessive queries.
  myScope.WriteString ":AER?"
  varQueryResult = myScope.ReadNumber
Loop Until varQueryResult = 1

' Oscilloscope is armed and ready, enable DUT here.
Debug.Print "Oscilloscope is armed and ready, enable DUT."

' Now, look for RUN bit = stopped (acquisition complete).
Dim lngTimeout As Long ' Max millisecs to wait for single-shot.
Dim lngElapsed As Long
lngTimeout = 10000 ' 10 seconds.
lngElapsed = 0

Do While lngElapsed <= lngTimeout
  myScope.WriteString ":OPERRegister:CONdITION?"
  varQueryResult = myScope.ReadNumber
  ' Mask RUN bit (bit 3, &H8).
  If (varQueryResult And &H8) = 0 Then
    Exit Do
  Else
    Sleep 100 ' Small wait to prevent excessive queries.
    lngElapsed = lngElapsed + 100
  End If
Loop

' Get results.
' -----
If lngElapsed < lngTimeout Then
  myScope.WriteString ":MEASure:RISetime"
  myScope.WriteString ":MEASure:RISetime?"
  varQueryResult = myScope.ReadNumber ' Read risetime.
  Debug.Print "Risetime: " + _
    FormatNumber(varQueryResult * 1000000000, 1) + " ns"
Else
  Debug.Print "Timeout waiting for single-shot trigger."
End If

Exit Sub

VisaComError:
  MsgBox "VISA COM Error:" + vbCrLf + Err.Description

End Sub

```

## Synchronization with an Averaging Acquisition

When averaging, it is necessary to know when the average count has been reached. The :SINGLe command does not average.

If it is known that a trigger will occur, a :DIGitize will acquire the complete number of averages, but if the number of averages is large, a timeout on the connection can occur.

The example below polls during the :DIGitize to prevent a timeout on the connection.

```
'
' Synchronizing in averaging acquisition mode.
' =====

Option Explicit

Public myMgr As VisaComLib.ResourceManager
Public myScope As VisaComLib.FormattedIO488
Public varQueryResult As Variant
Public strQueryResult As String

Private Declare Sub Sleep Lib "kernel32" (ByVal dwMilliseconds As Long)

Sub Main()

    On Error GoTo VisaComError

    ' Create the VISA COM I/O resource.
    Set myMgr = New VisaComLib.ResourceManager
    Set myScope = New VisaComLib.FormattedIO488
    Set myScope.IO = myMgr.Open("TCPIP0::130.29.69.12::inst0::INSTR")
    myScope.IO.Clear ' Clear the interface.
    myScope.IO.Timeout = 5000

    ' Set up.
    ' -----
    ' Set up the trigger and horizontal scale.
    myScope.WriteString ":TRIGger:SWEEp NORMal"
    myScope.WriteString ":TRIGger:MODE EDGE"
    myScope.WriteString ":TRIGger:EDGE:LEVel 2"
    myScope.WriteString ":TIMEbase:SCALE 5e-8"

    ' Stop acquisitions and wait for the operation to complete.
    myScope.WriteString ":STOP"
    myScope.WriteString "*OPC?"
    strQueryResult = myScope.ReadString

    ' Set up average acquisition mode.
    Dim lngAverages As Long
    lngAverages = 256
    myScope.WriteString ":ACQuire:COUNT " + CStr(lngAverages)
    myScope.WriteString ":ACQuire:TYPE AVERAge"
```

```

' Save *ESE (Standard Event Status Enable register) mask
' (so it can be restored later).
Dim varInitialESE As Variant
myScope.WriteString "*ESE?"
varInitialESE = myScope.ReadNumber

' Set *ESE mask to allow only OPC (Operation Complete) bit.
myScope.WriteString "*ESE " + CStr(CInt("&H01"))

' Acquire using :DIGitize. Set up OPC bit to be set when the
' operation is complete.
' -----
myScope.WriteString ":DIGitize"
myScope.WriteString "*OPC"

' Assume the oscilloscope will trigger, if not put a check here.

' Wait until OPC becomes true (bit 5 of Status Byte register, STB,
' from Standard Event Status register, ESR, is set). STB can be
' read during :DIGitize without generating a timeout.
Do
Sleep 4000 ' Poll more often than the timeout setting.
varQueryResult = myScope.IO.ReadSTB
Loop While (varQueryResult And &H20) = 0

' Clear ESR and restore previously saved *ESE mask.
myScope.WriteString "*ESR?" ' Clear ESR by reading it.
varQueryResult = myScope.ReadNumber
myScope.WriteString "*ESE " + CStr(varInitialESE)

' Get results.
' -----
myScope.WriteString ":WAVEform:COUNT?"
varQueryResult = myScope.ReadNumber
Debug.Print "Averaged waveforms: " + CStr(varQueryResult)

myScope.WriteString ":MEASure:RISetime"
myScope.WriteString ":MEASure:RISetime?"
varQueryResult = myScope.ReadNumber ' Read risetime.
Debug.Print "Risetime: " + _
FormatNumber(varQueryResult * 1000000000, 1) + " ns"

Exit Sub

VisaComError:
MsgBox "VISA COM Error:" + vbCrLf + Err.Description

End Sub

```

## 10 Synchronizing Acquisitions

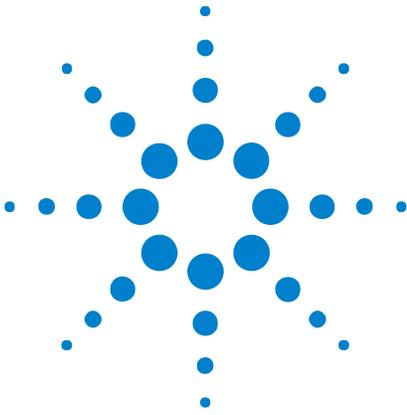

# 11

## More About Oscilloscope Commands

- Command Classifications [750](#)
- Valid Command/Query Strings [751](#)
- Query Return Values [772](#)
- All Oscilloscope Commands Are Sequential [773](#)



## Command Classifications

To help you use existing programs with your oscilloscope, or use current programs with the next generation of Agilent InfiniiVision oscilloscopes, commands are classified by the following categories:

- "Core Commands" on page 750
- "Non-Core Commands" on page 750
- "Obsolete Commands" on page 750

### **C** Core Commands

Core commands are a common set of commands that provide basic oscilloscope functionality on this oscilloscope and future Agilent InfiniiVision oscilloscopes. Core commands are unlikely to be modified in the future. If you restrict your programs to core commands, the programs should work across product offerings in the future, assuming appropriate programming methods are employed.

### **N** Non-Core Commands

Non-core commands are commands that provide specific features, but are not universal across all Agilent InfiniiVision oscilloscope models. Non-core commands may be modified or deleted in the future. With a command structure as complex as the one for your oscilloscope, some evolution over time is inevitable. Agilent's intent is to continue to expand command subsystems, such as the rich and evolving trigger feature set.

### **O** Obsolete Commands

Obsolete commands are older forms of commands that are provided to reduce customer rework for existing systems and programs. Generally, these commands are mapped onto some of the Core and Non-core commands, but may not strictly have the same behavior as the new command. None of the obsolete commands are guaranteed to remain functional in future products. New systems and programs should use the Core (and Non-core) commands. Obsolete commands are listed in:

- [Chapter 7](#), "Obsolete and Discontinued Commands," starting on page 657
- As well as: [Chapter 6](#), "Commands A-Z," starting on page 625

## Valid Command/Query Strings

- "Program Message Syntax" on page 751
- "Command Tree" on page 755
- "Duplicate Mnemonics" on page 769
- "Tree Traversal Rules and Multiple Commands" on page 769

### Program Message Syntax

To program the instrument remotely, you must understand the command format and structure expected by the instrument. The IEEE 488.2 syntax rules govern how individual elements such as headers, separators, program data, and terminators may be grouped together to form complete instructions. Syntax definitions are also given to show how query responses are formatted. The following figure shows the main syntactical parts of a typical program statement.

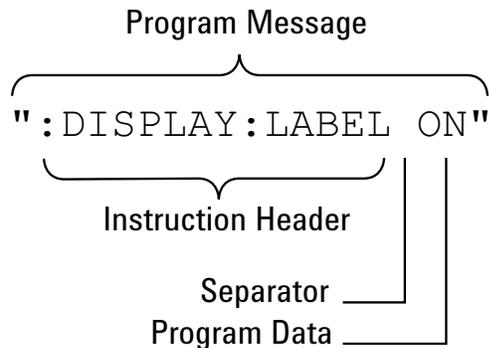

Instructions (both commands and queries) normally appear as a string embedded in a statement of your host language, such as Visual Basic or C/C++. The only time a parameter is not meant to be expressed as a string is when the instruction's syntax definition specifies <block data>, such as <learn string>. There are only a few instructions that use block data.

Program messages can have long or short form commands (and data in some cases – see "Long Form to Short Form Truncation Rules" on page 752), and upper and/or lower case ASCII characters may be used. (Query responses, however, are always returned in upper case.)

Instructions are composed of two main parts:

- The header, which specifies the command or query to be sent.
- The program data, which provide additional information needed to clarify the meaning of the instruction.

**Instruction Header** The instruction header is one or more mnemonics separated by colons (:) that represent the operation to be performed by the instrument. The "Command Tree" on page 755 illustrates how all the mnemonics can be joined together to form a complete header.

":DISPlay:LABel ON" is a command. Queries are indicated by adding a question mark (?) to the end of the header, for example, ":DISPlay:LABel?". Many instructions can be used as either commands or queries, depending on whether or not you have included the question mark. The command and query forms of an instruction usually have different program data. Many queries do not use any program data.

There are three types of headers:

- "Simple Command Headers" on page 753
- "Compound Command Headers" on page 753
- "Common Command Headers" on page 754

**White Space (Separator)** White space is used to separate the instruction header from the program data. If the instruction does not require any program data parameters, you do not need to include any white space. White space is defined as one or more space characters. ASCII defines a space to be character 32 (in decimal).

**Program Data** Program data are used to clarify the meaning of the command or query. They provide necessary information, such as whether a function should be on or off, or which waveform is to be displayed. Each instruction's syntax definition shows the program data, as well as the values they accept. "Program Data Syntax Rules" on page 754 describes all of the general rules about acceptable values.

When there is more than one data parameter, they are separated by commas(.). Spaces can be added around the commas to improve readability.

**Program Message Terminator** The program instructions within a data message are executed after the program message terminator is received. The terminator may be either an NL (New Line) character, an EOI (End-Or-Identify) asserted in the programming interface, or a combination of the two. Asserting the EOI sets the EOI control line low on the last byte of the data message. The NL character is an ASCII linefeed (decimal 10).

### NOTE

**New Line Terminator Functions.** The NL (New Line) terminator has the same function as an EOS (End Of String) and EOT (End Of Text) terminator.

### Long Form to Short Form Truncation Rules

To get the short form of a command/keyword:

- When the command/keyword is longer than four characters, use the first four characters of the command/keyword unless the fourth character is a vowel; when the fourth character is a vowel, use the first three characters of the command/keyword.
- When the command/keyword is four or fewer characters, use all of the characters.

| Long Form | Short form |
|-----------|------------|
| RANGe     | RANG       |
| PATTerN   | PATT       |
| TIMebase  | TIM        |
| DELay     | DEL        |
| TYPE      | TYPE       |

In the oscilloscope programmer's documentation, the short form of a command is indicated by uppercase characters.

Programs written in long form are easily read and are almost self-documenting. The short form syntax conserves the amount of controller memory needed for program storage and reduces I/O activity.

### Simple Command Headers

Simple command headers contain a single mnemonic. :AUToscale and :DIGitize are examples of simple command headers typically used in the oscilloscope. The syntax is:

```
<program mnemonic><terminator>
```

Simple command headers must occur at the beginning of a program message; if not, they must be preceded by a colon.

When program data must be included with the simple command header (for example, :DIGitize CHANnel1), white space is added to separate the data from the header. The syntax is:

```
<program mnemonic><separator><program data><terminator>
```

### Compound Command Headers

Compound command headers are a combination of two or more program mnemonics. The first mnemonic selects the subsystem, and the second mnemonic selects the function within that subsystem. The mnemonics within the compound message are separated by colons. For example, to execute a single function within a subsystem:

```
:<subsystem>:<function><separator><program data><terminator>
```

For example, :CHANnel1:BWLimit ON

### Common Command Headers

Common command headers control IEEE 488.2 functions within the instrument (such as clear status). Their syntax is:

```
*<command header><terminator>
```

No space or separator is allowed between the asterisk (\*) and the command header. \*CLS is an example of a common command header.

### Program Data Syntax Rules

Program data is used to convey a parameter information related to the command header. At least one space must separate the command header or query header from the program data.

```
<program mnemonic><separator><data><terminator>
```

When a program mnemonic or query has multiple program data, a comma separates sequential program data.

```
<program mnemonic><separator><data>,<data><terminator>
```

For example, :MEASure:DELay CHANnel1,CHANnel2 has two program data: CHANnel1 and CHANnel2.

Two main types of program data are used in commands: character and numeric.

#### Character Program Data

Character program data is used to convey parameter information as alpha or alphanumeric strings. For example, the :TIMEbase:MODE command can be set to normal, zoomed (delayed), XY, or ROLL. The character program data in this case may be MAIN, WINDOW, XY, or ROLL. The command :TIMEbase:MODE WINDOW sets the time base mode to zoomed.

The available mnemonics for character program data are always included with the command's syntax definition.

When sending commands, you may either the long form or short form (if one exists). Uppercase and lowercase letters may be mixed freely.

When receiving query responses, uppercase letters are used exclusively.

#### Numeric Program Data

Some command headers require program data to be expressed numerically. For example, :TIMEbase:RANGE requires the desired full scale range to be expressed numerically.

For numeric program data, you have the option of using exponential notation or using suffix multipliers to indicate the numeric value. The following numbers are all equal:

28 = 0.28E2 = 280e-1 = 28000m = 0.028K = 28e-3K.

When a syntax definition specifies that a number is an integer, that means that the number should be whole. Any fractional part will be ignored, truncating the number. Numeric data parameters accept fractional values are called real numbers.

All numbers must be strings of ASCII characters. Thus, when sending the number 9, you would send a byte representing the ASCII code for the character 9 (which is 57). A three-digit number like 102 would take up three bytes (ASCII codes 49, 48, and 50). This is handled automatically when you include the entire instruction in a string.

## Command Tree

The command tree shows all of the commands and the relationships of the commands to each other. The IEEE 488.2 common commands are not listed as part of the command tree because they do not affect the position of the parser within the tree. When a program message terminator (<NL>, linefeed-ASCII decimal 10) or a leading colon (:) is sent to the instrument, the parser is set to the root of the command tree.

- **:(root)**
  - :ACQuire (see [page 177](#))
    - :AALias (see [page 179](#))
    - :COMPLete (see [page 180](#))
    - :COUNT (see [page 181](#))
    - :DAALias (see [page 182](#))
    - :MODE (see [page 183](#))
    - :POINTs (see [page 184](#))
    - :SEGMENTed
      - :ANALyze (see [page 185](#))
      - :COUNT (see [page 186](#))
      - :INDEX (see [page 187](#))
    - :SRATE (see [page 190](#))
    - :TYPE (see [page 191](#))
  - :AER (Arm Event Register) (see [page 139](#))
  - :AUToscale (see [page 140](#))
    - :AMODE (see [page 142](#))
    - :CHANnels (see [page 143](#))
  - :BLANK (see [page 144](#))
  - :CALibrate (see [page 193](#))
    - :DATE (see [page 195](#))
    - :LABEL (see [page 196](#))

- :OUTPut (see [page 197](#))
- :STARt (see [page 198](#))
- :STATus (see [page 199](#))
- :SWITch (see [page 200](#))
- :TEMPerature (see [page 201](#))
- :TIME (see [page 202](#))
- :CDISplay (see [page 145](#))
- :CHANnel<n> (see [page 203](#))
  - :BWLimit (see [page 206](#))
  - :COUPling (see [page 207](#))
  - :DISPlay (see [page 208](#))
  - :IMPedance (see [page 209](#))
  - :INVert (see [page 210](#))
  - :LABel (see [page 211](#))
  - :OFFSet (see [page 212](#))
  - :PROBe (see [page 213](#))
    - :HEAD[:TYPE] (see [page 214](#))
    - :ID (see [page 215](#))
    - :SKEW (see [page 216](#))
    - :STYPe (see [page 217](#))
  - :PROTection (see [page 218](#))
  - :RANGe (see [page 219](#))
  - :SCALE (see [page 220](#))
  - :UNITs (see [page 221](#))
  - :VERNier (see [page 222](#))
- :DIGitize (see [page 146](#))
- :DISPlay (see [page 223](#))
  - :CLEar (see [page 225](#))
  - :DATA (see [page 226](#))
  - :LABel (see [page 228](#))
  - :LABList (see [page 229](#))
  - :PERSiStence (see [page 230](#))
  - :SOURce (see [page 231](#))
  - :VECTors (see [page 232](#))
- :EXTernal (see [page 233](#))

- :BWLimit (see [page 235](#))
- :IMPedance (see [page 236](#))
- :PROBe (see [page 237](#))
  - :ID (see [page 238](#))
  - :STYPe (see [page 239](#))
- :PROTection (see [page 240](#))
- :RANGe (see [page 241](#))
- :UNITs (see [page 242](#))
- :FUNCTion (see [page 243](#))
  - :CENTer (see [page 246](#))
  - :DISPlay (see [page 247](#))
  - :GOFT
    - :OPERation (see [page 248](#))
    - :SOURce1 (see [page 249](#))
    - :SOURce2 (see [page 250](#))
  - :OFFSet (see [page 251](#))
  - :OPERation (see [page 252](#))
  - :RANGe (see [page 253](#))
  - :REFerence (see [page 254](#))
  - :SCALE (see [page 255](#))
  - :SOURce1 (see [page 256](#))
  - :SOURce2 (see [page 257](#))
  - :SPAN (see [page 258](#))
  - :WINDow (see [page 259](#))
- :HARDcopy (see [page 260](#))
  - :AREA (see [page 262](#))
  - :APRinter (see [page 263](#))
  - :FACTors (see [page 264](#))
  - :FFEed (see [page 265](#))
  - :INKSaver (see [page 266](#))
  - :LAYout (see [page 267](#))
  - :PALette (see [page 268](#))
  - [:PRINter]
    - :LIST (see [page 269](#))
  - [:STARt] (see [page 270](#))

- :HWEenable (Hardware Event Enable Register) (see [page 148](#))
- :HWERegister
  - :CONDition (Hardware Event Condition Register) (see [page 150](#))
  - [:EVENT] (Hardware Event Event Register) (see [page 152](#))
- :LISTer (see [page 271](#))
  - :DATA (see [page 272](#))
  - :DISPlay (see [page 273](#))
- :MARKer (see [page 274](#))
  - :MODE (see [page 276](#))
  - :X1Position (see [page 277](#))
  - :X1Y1source (see [page 278](#))
  - :X2Position (see [page 279](#))
  - :X2Y2source (see [page 280](#))
  - :XDELta (see [page 281](#))
  - :Y1Position (see [page 282](#))
  - :Y2Position (see [page 283](#))
  - :YDELta (see [page 284](#))
- :MEASure (see [page 285](#))
  - :CLEar (see [page 292](#))
  - :COUNter (see [page 293](#))
  - :DEFine (see [page 294](#))
  - :DELay (see [page 297](#))
  - :DUTYcycle (see [page 299](#))
  - :FALLtime (see [page 300](#))
  - :FREQuency (see [page 301](#))
  - :NWIDth (see [page 302](#))
  - :OVERshoot (see [page 303](#))
  - :PERiod (see [page 305](#))
  - :PHASe (see [page 306](#))
  - :PREShoot (see [page 307](#))
  - :PWIDth (see [page 308](#))
  - :RISetime (see [page 312](#))
  - :RESults (see [page 309](#))
  - :SDEViation (see [page 313](#))
  - :SHOW (see [page 314](#))

- :SOURce (see [page 315](#))
- :STATistics (see [page 317](#))
  - :INCRement (see [page 318](#))
  - :RESet (see [page 319](#))
- :TEDGe (see [page 320](#))
- :TVALue (see [page 322](#))
- :VAMPLitude (see [page 324](#))
- :VAverage (see [page 325](#))
- :VBASe (see [page 326](#))
- :VMAX (see [page 327](#))
- :VMIN (see [page 328](#))
- :VPP (see [page 329](#))
- :VRATio (see [page 330](#))
- :VRMS (see [page 331](#))
- :VTIME (see [page 332](#))
- :VTOP (see [page 333](#))
- :WINDow (see [page 334](#))
- :XMAX (see [page 335](#))
- :XMIN (see [page 336](#))
- :MERGe (see [page 154](#))
- :MTEenable (Mask Test Event Enable Register) (see [page 155](#))
- :MTERegister[:EVENT] (Mask Test Event Event Register) (see [page 157](#))
- :MTEST (see [page 337](#))
  - :AMASk
    - :CREate (see [page 342](#))
    - :SOURCe (see [page 343](#))
    - :UNITs (see [page 344](#))
    - :XDELta (see [page 345](#))
    - :YDELta (see [page 346](#))
  - :COUNt
    - :FWAVEforms (see [page 347](#))
    - :RESet (see [page 348](#))
    - :TIME (see [page 349](#))
    - :WAVEforms (see [page 350](#))
- :DATA (see [page 351](#))

- :DELEte (see [page 352](#))
- :ENABle (see [page 353](#))
- :LOCK (see [page 354](#))
- :OUTPut (see [page 355](#))
- :RMODE (see [page 356](#))
  - :FACTion
    - :MEASure (see [page 357](#))
    - :PRINt (see [page 358](#))
    - :SAVE (see [page 359](#))
    - :STOP (see [page 360](#))
  - :SIGMa (see [page 361](#))
  - :TIME (see [page 362](#))
  - :WAVEforms (see [page 363](#))
- :SCALe
  - :BIND (see [page 364](#))
  - :X1 (see [page 365](#))
  - :XDELta (see [page 366](#))
  - :Y1 (see [page 367](#))
  - :Y2 (see [page 368](#))
- :SOURce (see [page 369](#))
- :TITLe (see [page 370](#))
- :OPEE (Operation Status Enable Register) (see [page 159](#))
- :OPERegister
  - :CONDition (Operation Status Condition Register) (see [page 161](#))
  - [:EVENT] (Operation Status Event Register) (see [page 163](#))
- :OVLenable (Overload Event Enable Register) (see [page 165](#))
- :OVLRegister (Overload Event Register) (see [page 167](#))
- :RECall
  - :FILename (see [page 372](#))
  - :IMAGe (see [page 373](#))
    - [:START] (see [page 373](#))
  - :MASK (see [page 374](#))
    - [:START] (see [page 374](#))
  - :PWD (see [page 375](#))
  - :SETup (see [page 376](#))

- [:START] (see [page 376](#))
- :RUN (see [page 170](#))
- :SAVE
  - :FILEname (see [page 379](#))
  - :IMAGe (see [page 380](#))
    - [:START] (see [page 380](#))
    - :AREa (see [page 381](#))
    - :FACTors (see [page 382](#))
    - :FORMat (see [page 383](#))
    - :IGColors (see [page 384](#))
    - :PALette (see [page 385](#))
  - :LISTer (see [page 386](#))
    - [:START] (see [page 386](#))
  - :MASK (see [page 387](#))
    - [:START] (see [page 387](#))
  - :PWD (see [page 388](#))
  - :SETup (see [page 389](#))
    - [:START] (see [page 389](#))
  - :WAVEform (see [page 390](#))
    - [:START] (see [page 390](#))
    - :FORMat (see [page 391](#))
    - :LENGth (see [page 392](#))
    - :SEGmented (see [page 393](#))
- :SBUS (see [page 394](#))
  - :CAN
    - :COUNT
      - :ERRor (see [page 396](#))
      - :OVERload (see [page 397](#))
      - :RESet (see [page 398](#))
      - :TOTal (see [page 399](#))
      - :UTILization (see [page 400](#))
  - :DISPlay (see [page 401](#))
  - :FLEXray
    - :COUNT
      - :NULL? (see [page 402](#))

## 11 More About Oscilloscope Commands

- :RESet (see [page 403](#))
- :SYNC? (see [page 404](#))
- :TOTal? (see [page 405](#))
- :I2S
  - :BASE (see [page 406](#))
- :IIC
  - :ASIZe (see [page 407](#))
- :LIN
  - :PARity (see [page 408](#))
- :M1553
  - :BASE (see [page 409](#))
- :MODE (see [page 410](#))
- :SPI
  - :BITorder (see [page 411](#))
  - :WIDTh (see [page 412](#))
- :UART
  - :BASE (see [page 413](#))
  - :COUNT
    - :ERRor (see [page 414](#))
    - :RESet (see [page 415](#))
    - :RXFRames (see [page 416](#))
    - :TXFRames (see [page 417](#))
  - :FRAMing (see [page 418](#))
- :SERial (see [page 171](#))
- :SINGle (see [page 172](#))
- :STATus (see [page 173](#))
- :STOP (see [page 174](#))
- :SYSTem (see [page 419](#))
  - :DATE (see [page 420](#))
  - :DSP (see [page 421](#))
  - :ERRor (see [page 422](#))
  - :LOCK (see [page 423](#))
  - :PRECision (see [page 424](#))
- :PROTection
  - :LOCK (see [page 407](#))

- :SETup (see [page 426](#))
- :TIME (see [page 428](#))
- :TER (Trigger Event Register) (see [page 175](#))
- :TIMEbase (see [page 429](#))
  - :MODE (see [page 431](#))
  - :POSition (see [page 432](#))
  - :RANGe (see [page 433](#))
  - :REFerence (see [page 434](#))
  - :SCALE (see [page 435](#))
  - :VERNier (see [page 436](#))
  - :WINDow
    - :POSition (see [page 437](#))
    - :RANGe (see [page 438](#))
    - :SCALE (see [page 439](#))
- :TRIGger (see [page 440](#))
  - :HFReject (see [page 444](#))
  - :HOLDoff (see [page 445](#))
  - :LFIFTy (see [page 446](#))
  - :MODE (see [page 447](#))
  - :NREJect (see [page 448](#))
  - :PATTern (see [page 449](#))
  - :SWEep (see [page 451](#))
  - :CAN (see [page 452](#))
    - :ACKnowledge (see [page 704](#))
    - :PATTern
      - :DATA (see [page 454](#))
        - :LENGth (see [page 455](#))
      - :ID (see [page 456](#))
        - :MODE (see [page 457](#))
    - :SAMPlepoint (see [page 458](#))
    - :SIGNal
      - :BAUDrate (see [page 459](#))
      - :DEFinition (see [page 460](#))
    - :SOURce (see [page 461](#))
    - :TRIGger (see [page 462](#))

- :DURation (see [page 464](#))
  - :GREaterthan (see [page 465](#))
  - :LESSthan (see [page 466](#))
  - :PATtern (see [page 467](#))
  - :QUALifier (see [page 468](#))
  - :RANGe (see [page 469](#))
- :EBURst (see [page 470](#))
  - :COUNT (see [page 471](#))
  - :IDLE (see [page 472](#))
  - :SLOPe (see [page 473](#))
- [:EDGE] (see [page 474](#))
  - :COUPling (see [page 475](#))
  - :LEVel (see [page 476](#))
  - :REJect (see [page 477](#))
  - :SLOPe (see [page 478](#))
  - :SOURce (see [page 479](#))
- :FLEXray (see [page 480](#))
  - :AUToset (see [page 481](#))
  - :BAUDrate (see [page 482](#))
  - :CHANnel (see [page 483](#))
  - :ERRor
    - :TYPE (see [page 484](#))
  - :EVENT
    - :TYPE (see [page 485](#))
  - :FRAMe
    - :CCBase (see [page 486](#))
    - :CCRepetition (see [page 487](#))
    - :ID (see [page 488](#))
    - :TYPE (see [page 489](#))
  - :SOURce (see [page 490](#))
  - :TRIGger (see [page 491](#))
- :GLITch (see [page 492](#))
  - :GREaterthan (see [page 493](#))
  - :LESSthan (see [page 494](#))
  - :LEVel (see [page 495](#))

- :POLarity (see [page 496](#))
- :QUALifier (see [page 497](#))
- :RANGe (see [page 498](#))
- :SOURce (see [page 499](#))
- :HFReject (see [page 444](#))
- :HOLDoff (see [page 445](#))
- :I2S (see [page 500](#))
  - :ALIGNment (see [page 502](#))
  - :AUDio (see [page 503](#))
  - :CLOCK
    - :SLOPe (see [page 504](#))
  - :PATTERn
    - :DATA (see [page 505](#))
    - :FORMat (see [page 507](#))
  - :RANGe (see [page 508](#))
  - :RWIDth (see [page 510](#))
  - :SOURce
    - :CLOCK (see [page 511](#))
    - :DATA (see [page 512](#))
    - :WSElect (see [page 513](#))
  - :TRIGger (see [page 514](#))
  - :TWIDth (see [page 516](#))
  - :WSLow (see [page 517](#))
- :IIC (see [page 518](#))
  - :PATTERn
    - :ADDRESS (see [page 519](#))
    - :DATA (see [page 520](#))
    - :DATA2 (see [page 521](#))
  - :SOURce
    - :CLOCK (see [page 522](#))
    - :DATA (see [page 523](#))
  - :TRIGger
    - :QUALifier (see [page 524](#))
    - [:TYPE] (see [page 525](#))
- :LIN (see [page 527](#))

- :ID (see [page 529](#))
- :PATTern
  - :DATA (see [page 530](#))
    - :LENGth (see [page 532](#))
  - :FORMat (see [page 533](#))
- :SAMPlEpoint (see [page 534](#))
- :SIGNal
  - :BAUDrate (see [page 535](#))
  - :DEFinition (see [page 705](#))
- :SOURce (see [page 536](#))
- :STANdard (see [page 537](#))
- :SYNCbreak (see [page 538](#))
- :TRIGger (see [page 539](#))
- :M1553 (see [page 540](#))
  - :AUTosetup (see [page 541](#))
  - :PATTern
    - :DATA (see [page 542](#))
  - :RTA (see [page 543](#))
  - :SOURce
    - :LOWer (see [page 544](#))
    - :UPPer (see [page 545](#))
  - :TYPE (see [page 546](#))
- :MODE (see [page 447](#))
- :NREJect (see [page 448](#))
- :PATTern (see [page 449](#))
- :SEQuence (see [page 547](#))
  - :COUNT (see [page 548](#))
  - :EDGE (see [page 549](#))
  - :FIND (see [page 550](#))
  - :PATTern (see [page 551](#))
  - :RESet (see [page 552](#))
  - :TIMer (see [page 553](#))
  - :TRIGger (see [page 554](#))
- :SPI (see [page 555](#))
  - :CLOCK

- :SLOPe (see [page 556](#))
- :TIMEout (see [page 557](#))
- :FRAMing (see [page 558](#))
- :PATtern
  - :DATA (see [page 559](#))
  - :WIDTh (see [page 560](#))
- :SOURce
  - :CLOCK (see [page 561](#))
  - :DATA (see [page 562](#))
  - :FRAMe (see [page 563](#))
- :SWEep (see [page 451](#))
- :TV (see [page 564](#))
  - :LINE (see [page 565](#))
  - :MODE (see [page 566](#))
  - :POLarity (see [page 567](#))
  - :SOURce (see [page 568](#))
  - :STANdard (see [page 569](#))
  - :TVMode (see [page 706](#))
- :UART (see [page 570](#))
  - :BASE (see [page 572](#))
  - :BAUDrate (see [page 573](#))
  - :BITorder (see [page 574](#))
  - :BURSt (see [page 575](#))
  - :DATA (see [page 576](#))
  - :IDLE (see [page 577](#))
  - :PARity (see [page 578](#))
  - :QUALifier (see [page 580](#))
  - :POLarity (see [page 579](#))
  - :SOURce
    - :RX (see [page 581](#))
    - :TX (see [page 582](#))
  - :TYPE (see [page 583](#))
  - :WIDTh (see [page 584](#))
- :USB (see [page 585](#))
  - :SOURce

## 11 More About Oscilloscope Commands

- :DMINus (see [page 586](#))
- :DPLus (see [page 587](#))
- :SPEed (see [page 588](#))
- :TRIGger (see [page 589](#))
- :VIEW (see [page 176](#))
- :WAVEform (see [page 590](#))
  - :BYTeorder (see [page 597](#))
  - :COUNT (see [page 598](#))
  - :DATA (see [page 599](#))
  - :FORMat (see [page 601](#))
  - :POINTs (see [page 602](#))
    - :MODE (see [page 604](#))
  - :PREamble (see [page 606](#))
  - :SEGmented
    - :COUNT (see [page 609](#))
    - :TTAG (see [page 610](#))
  - :SOURce (see [page 611](#))
    - :SUBSource (see [page 615](#))
  - :TYPE (see [page 616](#))
  - :UNSigned (see [page 617](#))
  - :VIEW (see [page 618](#))
  - :XINCrement (see [page 619](#))
  - :XORigin (see [page 620](#))
  - :XREFerence (see [page 621](#))
  - :YINCrement (see [page 622](#))
  - :YORigin (see [page 623](#))
  - :YREFerence (see [page 624](#))

### Common Commands (IEEE 488.2)

- \*CLS (see [page 115](#))
- \*ESE (see [page 116](#))
- \*ESR (see [page 118](#))
- \*IDN (see [page 120](#))
- \*LRN (see [page 121](#))
- \*OPC (see [page 122](#))
- \*OPT (see [page 123](#))
- \*RCL (see [page 124](#))

- \*RST (see [page 125](#))
- \*SAV (see [page 128](#))
- \*SRE (see [page 129](#))
- \*STB (see [page 131](#))
- \*TRG (see [page 133](#))
- \*TST (see [page 134](#))
- \*WAI (see [page 135](#))

## Duplicate Mnemonics

Identical function mnemonics can be used in more than one subsystem. For example, the function mnemonic RANGe may be used to change the vertical range or to change the horizontal range:

```
:CHANnel1:RANGe .4
```

Sets the vertical range of channel 1 to 0.4 volts full scale.

```
:TIMEbase:RANGe 1
```

Sets the horizontal time base to 1 second full scale.

:CHANnel1 and :TIMEbase are subsystem selectors and determine which range is being modified.

## Tree Traversal Rules and Multiple Commands

Command headers are created by traversing down the Command Tree (see [page 755](#)). A legal command header would be :TIMEbase:RANGe. This is referred to as a *compound header*. A compound header is a header made of two or more mnemonics separated by colons. The mnemonic created contains no spaces.

The following rules apply to traversing the tree:

- A leading colon (<NL> or EOI true on the last byte) places the parser at the root of the command tree. A leading colon is a colon that is the first character of a program header. Executing a subsystem command lets you access that subsystem until a leading colon or a program message terminator (<NL>) or EOI true is found.
- In the command tree, use the last mnemonic in the compound header as the reference point (for example, RANGe). Then find the last colon above that mnemonic (TIMEbase:). That is the point where the parser resides. Any command below that point can be sent within the current program message without sending the mnemonics which appear above them (for example, POSition).

The output statements in the examples are written using the Agilent VISA COM library in Visual Basic. The quoted string is placed on the bus, followed by a carriage return and linefeed (CRLF).

To execute more than one function within the same subsystem, separate the functions with a semicolon (;):

```
:<subsystem>:<function><separator><data>;<function><separator><data><terminator>
```

For example:

```
myScope.WriteString ":TIMEbase:RANGe 0.5;POSition 0"
```

### NOTE

The colon between TIMEbase and RANGe is necessary because TIMEbase:RANGe is a compound command. The semicolon between the RANGe command and the POSition command is the required program message unit separator. The POSition command does not need TIMEbase preceding it because the TIMEbase:RANGe command sets the parser to the TIMEbase node in the tree.

### Example 2: Program Message Terminator Sets Parser Back to Root

```
myScope.WriteString ":TIMEbase:REFerence CENTER;POSition 0.00001"
```

or

```
myScope.WriteString ":TIMEbase:REFerence CENTER"  
myScope.WriteString ":TIMEbase:POSition 0.00001"
```

### NOTE

In the first line of example 2, the subsystem selector is implied for the POSition command in the compound command. The POSition command must be in the same program message as the REFerence command because the program message terminator places the parser back at the root of the command tree.

A second way to send these commands is by placing TIMEbase: before the POSition command as shown in the second part of example 2. The space after POSition is required.

### Example 3: Selecting Multiple Subsystems

You can send multiple program commands and program queries for different subsystems on the same line by separating each command with a semicolon. The colon following the semicolon enables you to enter a new subsystem. For example:

```
<program mnemonic><data>;:<program mnemonic><data><terminator>
```

For example:

```
myScope.WriteString ":TIMEbase:REFerence CENTER;:DISPlay:VECTors ON"
```

### NOTE

The leading colon before DISPlay:VECTors ON tells the parser to go back to the root of the command tree. The parser can then see the DISPlay:VECTors ON command. The space between REFerence and CENTER is required; so is the space between VECTors and ON.

Multiple commands may be any combination of compound and simple commands.

## Query Return Values

Command headers immediately followed by a question mark (?) are queries. Queries are used to get results of measurements made by the instrument or to find out how the instrument is currently configured.

After receiving a query, the instrument interrogates the requested function and places the answer in its output queue. The answer remains in the output queue until it is read or another command is issued.

When read, the answer is transmitted across the bus to the designated listener (typically a controller). For example, the query :TIMEbase:RANGe? places the current time base setting in the output queue. When using the Agilent VISA COM library in Visual Basic, the controller statements:

```
Dim strQueryResult As String
myScope.WriteString ":TIMEbase:RANGe?"
strQueryResult = myScope.ReadString
```

pass the value across the bus to the controller and place it in the variable strQueryResult.

### NOTE

**Read Query Results Before Sending Another Command.** Sending another command or query before reading the result of a query clears the output buffer (the current response) and places a Query INTERRUPTED error in the error queue.

### Infinity Representation

The representation of infinity is +9.9E+37. This is also the value returned when a measurement cannot be made.

## All Oscilloscope Commands Are Sequential

IEEE 488.2 makes the distinction between sequential and overlapped commands:

- *Sequential commands* finish their task before the execution of the next command starts.
- *Overlapped commands* run concurrently. Commands following an overlapped command may be started before the overlapped command is completed.

All of the oscilloscope commands are sequential.

## 11 More About Oscilloscope Commands

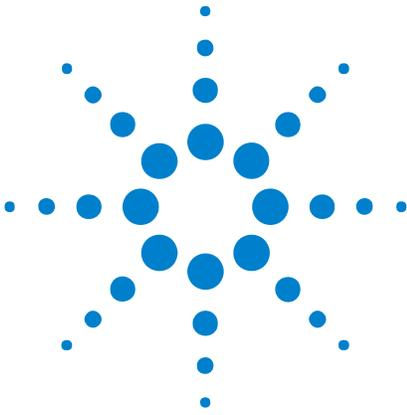

## 12 Programming Examples

VISA COM Examples [776](#)

VISA Examples [809](#)

SICL Examples [855](#)

Example programs are ASCII text files that can be cut from the help file and pasted into your favorite text editor.



## VISA COM Examples

- ["VISA COM Example in Visual Basic"](#) on page 776
- ["VISA COM Example in C#"](#) on page 786
- ["VISA COM Example in Visual Basic .NET"](#) on page 798

### VISA COM Example in Visual Basic

To run this example in Visual Basic for Applications (VBA):

- 1 Start the application that provides Visual Basic for Applications (for example, Microsoft Excel).
- 2 Press ALT+F11 to launch the Visual Basic editor.
- 3 Reference the Agilent VISA COM library:
  - a Choose **Tools>References...** from the main menu.
  - b In the References dialog, check the "VISA COM 3.0 Type Library".
  - c Click **OK**.
- 4 Choose **Insert>Module**.
- 5 Cut-and-paste the code that follows into the editor.
- 6 Edit the program to use the VISA address of your oscilloscope, and save the changes.
- 7 Run the program.

```
'
' Agilent VISA COM Example in Visual Basic
' -----
' This program illustrates most of the commonly used programming
' features of your Agilent oscilloscopes.
' -----

Option Explicit

Public myMgr As VisaComLib.ResourceManager
Public myScope As VisaComLib.FormattedIO488
Public varQueryResult As Variant
Public strQueryResult As String

'
' MAIN PROGRAM
' -----
' This example shows the fundamental parts of a program (initialize,
' capture, analyze).
'
' The commands sent to the oscilloscope are written in both long and
' short form. Both forms are acceptable.
'
' The input signal is the probe compensation signal from the front
' panel of the oscilloscope connected to channel 1.
```

```

'
' If you are using a different signal or different channels, these
' commands may not work as explained in the comments.
' -----

Sub Main()

    On Error GoTo VisaComError

    ' Create the VISA COM I/O resource.
    Set myMgr = New VisaComLib.ResourceManager
    Set myScope = New VisaComLib.FormattedIO488

    ' GPIB.
    'Set myScope.IO = myMgr.Open("GPIB0::7::INSTR")

    ' LAN.
    'Set myScope.IO = myMgr.Open("TCPIP0::a-mso6102-90541::inst0::INSTR")

    ' USB.
    Set myScope.IO = myMgr.Open("USB0::2391::5970::30D3090541::0::INSTR")

    ' Initialize - Initialization will start the program with the
    ' oscilloscope in a known state.
    Initialize

    ' Capture - After initialization, you must make waveform data
    ' available to analyze. To do this, capture the data using the
    ' DIGITIZE command.
    Capture

    ' Analyze - Once the waveform has been captured, it can be analyzed.
    ' There are many parts of a waveform to analyze. This example shows
    ' some of the possible ways to analyze various parts of a waveform.
    Analyze

    Exit Sub

VisaComError:
    MsgBox "VISA COM Error:" + vbCrLf + Err.Description

End Sub

'
' Initialize
' -----
' Initialize will start the program with the oscilloscope in a known
' state. This is required because some uninitialized conditions could
' cause the program to fail or not perform as expected.
'
' In this example, we initialize the following:
' - Oscilloscope
' - Channel 1 range
' - Display Grid
' - Timebase reference, range, and delay
' - Trigger mode and type
'

```

## 12 Programming Examples

```
' There are also some additional initialization commands, which are
' not used, but shown for reference.
' -----

Private Sub Initialize()

    On Error GoTo VisaComError

    ' Clear the interface.
    myScope.IO.Clear

    ' RESET - This command puts the oscilloscope into a known state.
    ' This statement is very important for programs to work as expected.
    ' Most of the following initialization commands are initialized by
    ' *RST. It is not necessary to reinitialize them unless the default
    ' setting is not suitable for your application.
    myScope.WriteString "*RST" ' Reset the oscilloscope to the defaults.

    ' AUTOSCALE - This command evaluates all the input signals and sets
    ' the correct conditions to display all of the active signals.

    ' Same as pressing the Autoscale key.
    myScope.WriteString ":AUTOSCALE"

    ' CHANNEL_PROBE - Sets the probe attenuation factor for the selected
    ' channel. The probe attenuation factor may be set from 0.1 to 1000.
    myScope.WriteString ":CHAN1:PROBE 10" ' Set Probe to 10:1.

    ' CHANNEL_RANGE - Sets the full scale vertical range in volts. The
    ' range value is 8 times the volts per division.

    ' Set the vertical range to 8 volts.
    myScope.WriteString ":CHANNEL1:RANGE 8"

    ' TIME_RANGE - Sets the full scale horizontal time in seconds. The
    ' range value is 10 times the time per division.

    ' Set the time range to 0.002 seconds.
    myScope.WriteString ":TIM:RANG 2e-3"

    ' TIME_REFERENCE - Possible values are LEFT and CENTER.
    ' - LEFT sets the display reference on time division from the left.
    ' - CENTER sets the display reference to the center of the screen.

    ' Set reference to center.
    myScope.WriteString ":TIMEBASE:REFERENCE CENTER"

    ' TRIGGER_TV_SOURCE - Selects the channel that actually produces the
    ' TV trigger. Any channel can be selected.
    myScope.WriteString ":TRIGGER:TV:SOURCE CHANNEL1"

    ' TRIGGER_MODE - Set the trigger mode to EDGE, GLITCh, PATtern, CAN,
    ' DURATION, IIC, LIN, SEQuence, SPI, TV, or USB.

    ' Set the trigger mode to EDGE.
    myScope.WriteString ":TRIGGER:MODE EDGE"
```

```

' TRIGGER_EDGE_SLOPE - Sets the slope of the edge for the trigger.

' Set the slope to positive.
myScope.WriteString ":TRIGGER:EDGE:SLOPE POSITIVE"

' The following commands are not executed and are shown for reference
' purposes only. To execute these commands, uncomment them.

' RUN_STOP - (not executed in this example)
' - RUN starts the acquisition of data for the active waveform
'   display.
' - STOP stops the data acquisition and turns off AUTOSTORE.
' myScope.WriteString ":RUN"      ' Start data acquisition.
' myScope.WriteString ":STOP"    ' Stop the data acquisition.

' VIEW_BLANK - (not executed in this example)
' - VIEW turns on (starts displaying) a channel or pixel memory.
' - BLANK turns off (stops displaying) a channel or pixel memory.
' myScope.WriteString ":BLANK CHANNEL1"  ' Turn channel 1 off.
' myScope.WriteString ":VIEW CHANNEL1"   ' Turn channel 1 on.

' TIMEBASE_MODE - (not executed in this example)
' Set the time base mode to MAIN, DELAYED, XY, or ROLL.

' Set time base mode to main.
' myScope.WriteString ":TIMEBASE:MODE MAIN"

Exit Sub

VisaComError:
  MsgBox "VISA COM Error:" + vbCrLf + Err.Description

End Sub

'
' Capture
' -----
' We will capture the waveform using the digitize command.
' -----

Private Sub Capture()

  On Error GoTo VisaComError

  ' ACQUIRE_TYPE - Sets the acquisition mode, which can be NORMAL,
  ' PEAK, or AVERAGE.
  myScope.WriteString ":ACQUIRE:TYPE NORMAL"

  ' ACQUIRE_COMPLETE - Specifies the minimum completion criteria for
  ' an acquisition. The parameter determines the percentage of time
  ' buckets needed to be "full" before an acquisition is considered
  ' to be complete.
  myScope.WriteString ":ACQUIRE:COMPLETE 100"

  ' DIGITIZE - Used to acquire the waveform data for transfer over
  ' the interface. Sending this command causes an acquisition to
  ' take place with the resulting data being placed in the buffer.

```

```

'
' NOTE! The DIGITIZE command is highly recommended for triggering
' modes other than SINGLE. This ensures that sufficient data is
' available for measurement. If DIGITIZE is used with single mode,
' the completion criteria may never be met. The number of points
' gathered in Single mode is related to the sweep speed, memory
' depth, and maximum sample rate. For example, take an oscilloscope
' with a 1000-point memory, a sweep speed of 10 us/div (100 us
' total time across the screen), and a 20 MSa/s maximum sample rate.
' 1000 divided by 100 us equals 10 MSa/s. Because this number is
' less than or equal to the maximum sample rate, the full 1000 points
' will be digitized in a single acquisition. Now, use 1 us/div
' (10 us across the screen). 1000 divided by 10 us equals 100 MSa/s;
' because this is greater than the maximum sample rate by 5 times,
' only 400 points (or 1/5 the points) can be gathered on a single
' trigger. Keep in mind when the oscilloscope is running,
' communication with the computer interrupts data acquisition.
' Setting up the oscilloscope over the bus causes the data buffers
' to be cleared and internal hardware to be reconfigured. If a
' measurement is immediately requested, there may have not been
' enough time for the data acquisition process to collect data,
' and the results may not be accurate. An error value of 9.9E+37
' may be returned over the bus in this situation.
'
myScope.WriteString ":DIGITIZE CHAN1"

Exit Sub

VisaComError:
    MsgBox "VISA COM Error:" + vbCrLf + Err.Description

End Sub

'
' Analyze
' -----
' In analyze, we will do the following:
' - Save the system setup to a file and restore it.
' - Save the waveform data to a file on the computer.
' - Make single channel measurements.
' - Save the oscilloscope display to a file that can be sent to a
'   printer.
' -----

Private Sub Analyze()

    On Error GoTo VisaComError

    ' SAVE_SYSTEM_SETUP - The :SYSTEM:SETUP? query returns a program
    ' message that contains the current state of the instrument. Its
    ' format is a definite-length binary block, for example,
    '   #800002204<setup string><NL>
    ' where the setup string is 2204 bytes in length.
    myScope.WriteString ":SYSTEM:SETUP?"
    varQueryResult = myScope.ReadIEEEBlock(BinaryType_UI1)
    CheckForInstrumentErrors ' After reading query results.
    ' Output setup string to a file:

```

```

Dim strPath As String
strPath = "c:\scope\config\setup.dat"
Close #1 ' If #1 is open, close it.
' Open file for output.
Open strPath For Binary Access Write Lock Write As #1
Put #1, , varQueryResult ' Write data.
Close #1 ' Close file.

' IMAGE_TRANSFER - In this example, we will query for the image data
' with ":DISPLAY:DATA?", read the data, and then save it to a file.
Dim byteData() As Byte
myScope.IO.Timeout = 15000
myScope.WriteString ":DISPLAY:DATA? BMP, SCREEN, COLOR"
byteData = myScope.ReadIEEEBlock(BinaryType_UI1)
' Output display data to a file:
strPath = "c:\scope\data\screen.bmp"
' Remove file if it exists.
If Len(Dir(strPath)) Then
    Kill strPath
End If
Close #1 ' If #1 is open, close it.
' Open file for output.
Open strPath For Binary Access Write Lock Write As #1
Put #1, , byteData ' Write data.
Close #1 ' Close file.
myScope.IO.Timeout = 5000

' RESTORE_SYSTEM_SETUP - Read the setup string from a file and write
' it back to the oscilloscope.
Dim varSetupString As Variant
strPath = "c:\scope\config\setup.dat"
Open strPath For Binary Access Read As #1 ' Open file for input.
Get #1, , varSetupString ' Read data.
Close #1 ' Close file.
' Write setup string back to oscilloscope using ":SYSTEM:SETUP"
' command:
myScope.WriteIEEEBlock ":SYSTEM:SETUP ", varSetupString
CheckForInstrumentErrors

' MEASURE - The commands in the MEASURE subsystem are used to make
' measurements on displayed waveforms.

' Source to measure.
myScope.WriteString ":MEASURE:SOURCE CHANNEL1"

' Query for frequency.
myScope.WriteString ":MEASURE:FREQUENCY?"
varQueryResult = myScope.ReadNumber ' Read frequency.
MsgBox "Frequency:" + vbCrLf + _
    FormatNumber(varQueryResult / 1000, 4) + " kHz"

' Query for duty cycle.
myScope.WriteString ":MEASURE:DUTYCYCLE?"
varQueryResult = myScope.ReadNumber ' Read duty cycle.
MsgBox "Duty cycle:" + vbCrLf + _
    FormatNumber(varQueryResult, 3) + "%"

```

```

' Query for risetime.
myScope.WriteString ":MEASURE:RISETIME?"
varQueryResult = myScope.ReadNumber ' Read risetime.
MsgBox "Risetime:" + vbCrLf + _
    FormatNumber(varQueryResult * 1000000, 4) + " us"

' Query for Peak to Peak voltage.
myScope.WriteString ":MEASURE:VPP?"
varQueryResult = myScope.ReadNumber ' Read VPP.
MsgBox "Peak to peak voltage:" + vbCrLf + _
    FormatNumber(varQueryResult, 4) + " V"

' Query for Vmax.
myScope.WriteString ":MEASURE:VMAX?"
varQueryResult = myScope.ReadNumber ' Read Vmax.
MsgBox "Maximum voltage:" + vbCrLf + _
    FormatNumber(varQueryResult, 4) + " V"

' WAVEFORM_DATA - To obtain waveform data, you must specify the
' WAVEFORM parameters for the waveform data prior to sending the
' ":WAVEFORM:DATA?" query. Once these parameters have been sent,
' the waveform data and the preamble can be read.
'
' WAVE_SOURCE - Selects the channel to be used as the source for
' the waveform commands.
myScope.WriteString ":WAVEFORM:SOURCE CHAN1"

' WAVE_POINTS - Specifies the number of points to be transferred
' using the ":WAVEFORM:DATA?" query.
myScope.WriteString ":WAVEFORM:POINTS 1000"

' WAVE_FORMAT - Sets the data transmission mode for the waveform
' data output. This command controls whether data is formatted in
' a word or byte format when sent from the oscilloscope.
Dim lngVSteps As Long
Dim intBytesPerData As Integer

' Data in range 0 to 65535.
myScope.WriteString ":WAVEFORM:FORMAT WORD"
lngVSteps = 65536
intBytesPerData = 2

' With WORD format, use most significant byte first order.
myScope.WriteString ":WAVEform:BYTorder MSBFirst"

' Data in range 0 to 255.
myScope.WriteString ":WAVEFORM:FORMAT BYTE"
lngVSteps = 256
intBytesPerData = 1

' GET_PREAMBLE - The preamble block contains all of the current
' WAVEFORM settings. It is returned in the form <preamble_block><NL>
' where <preamble_block> is:
'   FORMAT      : int16 - 0 = BYTE, 1 = WORD, 4 = ASCII.
'   TYPE        : int16 - 0 = NORMAL, 1 = PEAK DETECT, 2 = AVERAGE.
'   POINTS      : int32 - number of data points transferred.
'   COUNT       : int32 - 1 and is always 1.

```

```

'      XINCREMENT      : float64 - time difference between data points.
'      XORIGIN         : float64 - always the first data point in memory.
'      XREFERENCE      : int32 - specifies the data point associated with
'                      x-origin.
'      YINCREMENT      : float32 - voltage difference between data points.
'      YORIGIN         : float32 - value is the voltage at center screen.
'      YREFERENCE      : int32 - specifies the data point where y-origin
'                      occurs.
Dim Preamble()
Dim intFormat As Integer
Dim intType As Integer
Dim lngPoints As Long
Dim lngCount As Long
Dim dblXIncrement As Double
Dim dblXOrigin As Double
Dim lngXReference As Long
Dim sngYIncrement As Single
Dim sngYOrigin As Single
Dim lngYReference As Long
Dim strOutput As String

myScope.WriteString ":WAVEFORM:PREAmble?" ' Query for the preamble.
Preamble() = myScope.ReadList ' Read preamble information.
intFormat = Preamble(0)
intType = Preamble(1)
lngPoints = Preamble(2)
lngCount = Preamble(3)
dblXIncrement = Preamble(4)
dblXOrigin = Preamble(5)
lngXReference = Preamble(6)
sngYIncrement = Preamble(7)
sngYOrigin = Preamble(8)
lngYReference = Preamble(9)
strOutput = ""
'strOutput = strOutput + "Format = " + CStr(intFormat) + vbCrLf
'strOutput = strOutput + "Type = " + CStr(intType) + vbCrLf
'strOutput = strOutput + "Points = " + CStr(lngPoints) + vbCrLf
'strOutput = strOutput + "Count = " + CStr(lngCount) + vbCrLf
'strOutput = strOutput + "X increment = " + _
'      FormatNumber(dblXIncrement * 1000000) + _
'      " us" + vbCrLf
'strOutput = strOutput + "X origin = " + _
'      FormatNumber(dblXOrigin * 1000000) + _
'      " us" + vbCrLf
'strOutput = strOutput + "X reference = " + _
'      CStr(lngXReference) + vbCrLf
'strOutput = strOutput + "Y increment = " + _
'      FormatNumber(sngYIncrement * 1000) + _
'      " mV" + vbCrLf
'strOutput = strOutput + "Y origin = " + _
'      FormatNumber(sngYOrigin) + " V" + vbCrLf
'strOutput = strOutput + "Y reference = " + _
'      CStr(lngYReference) + vbCrLf
strOutput = strOutput + "Volts/Div = " + _
'      FormatNumber(lngVSteps * sngYIncrement / 8) + _
'      " V" + vbCrLf
strOutput = strOutput + "Offset = " + _

```

## 12 Programming Examples

```
        FormatNumber(sngYOrigin) + " V" + vbCrLf
strOutput = strOutput + "Sec/Div = " + _
        FormatNumber(lngPoints * dblXIncrement / 10 * _
        1000000) + " us" + vbCrLf
strOutput = strOutput + "Delay = " + _
        FormatNumber(((lngPoints / 2) * _
        dblXIncrement + dblXOrigin) * 1000000) + " us" + vbCrLf

' QUERY_WAVE_DATA - Outputs waveform data that is stored in a buffer.

' Query the oscilloscope for the waveform data.
myScope.WriteString ":WAV:DATA?"

' READ_WAVE_DATA - The wave data consists of two parts: the header,
' and the actual waveform data followed by a new line (NL) character.
' The query data has the following format:
'
'     <header><waveform_data><NL>
'
' Where:
'     <header> = #800001000 (This is an example header)
' The "#8" may be stripped off of the header and the remaining
' numbers are the size, in bytes, of the waveform data block. The
' size can vary depending on the number of points acquired for the
' waveform. You can then read that number of bytes from the
' oscilloscope and the terminating NL character.
'
Dim lngI As Long
Dim lngDataValue As Long

' Unsigned integer bytes.
varQueryResult = myScope.ReadIEEEBlock(BinaryType_UI1)
For lngI = 0 To UBound(varQueryResult) _
    Step (UBound(varQueryResult) / 20) ' 20 points.
    If intBytesPerData = 2 Then
        lngDataValue = varQueryResult(lngI) * 256 + _
            varQueryResult(lngI + 1) ' 16-bit value.
    Else
        lngDataValue = varQueryResult(lngI) ' 8-bit value.
    End If
    strOutput = strOutput + "Data point " + _
        CStr(lngI / intBytesPerData) + ", " + _
        FormatNumber((lngDataValue - lngYReference) * sngYIncrement + _
        sngYOrigin) + " V, " + _
        FormatNumber(((lngI / intBytesPerData - lngXReference) * _
        dblXIncrement + dblXOrigin) * 1000000) + " us" + vbCrLf
Next lngI
MsgBox "Waveform data:" + vbCrLf + strOutput

' Make a delay measurement between channel 1 and 2.
Dim dblChan1Edge1 As Double
Dim dblChan2Edge1 As Double
Dim dblChan1Edge2 As Double
Dim dblDelay As Double
Dim dblPeriod As Double
Dim dblPhase As Double
```

```

' Query time at 1st rising edge on ch1.
myScope.WriteString ":MEASURE:TEDGE? +1, CHAN1"

' Read time at edge 1 on ch 1.
dblChan1Edge1 = myScope.ReadNumber

' Query time at 1st rising edge on ch2.
myScope.WriteString ":MEASURE:TEDGE? +1, CHAN2"

' Read time at edge 1 on ch 2.
dblChan2Edge1 = myScope.ReadNumber

' Calculate delay time between ch1 and ch2.
dblDelay = dblChan2Edge1 - dblChan1Edge1

' Write calculated delay time to screen.
MsgBox "Delay = " + vbCrLf + CStr(dblDelay)

' Make a phase difference measurement between channel 1 and 2.

' Query time at 1st rising edge on ch1.
myScope.WriteString ":MEASURE:TEDGE? +2, CHAN1"

' Read time at edge 2 on ch 1.
dblChan1Edge2 = myScope.ReadNumber

' Calculate period of ch 1.
dblPeriod = dblChan1Edge2 - dblChan1Edge1

' Calculate phase difference between ch1 and ch2.
dblPhase = (dblDelay / dblPeriod) * 360
MsgBox "Phase = " + vbCrLf + CStr(dblPhase)

Exit Sub

VisaComError:
MsgBox "VISA COM Error:" + vbCrLf + Err.Description

End Sub

Private Sub CheckForInstrumentErrors()

On Error GoTo VisaComError

Dim strErrVal As String
Dim strOut As String

myScope.WriteString "SYSTEM:ERROR?" ' Query any errors data.
strErrVal = myScope.ReadString ' Read: Errnum,"Error String".
While Val(strErrVal) <> 0 ' End if find: 0,"No Error".
strOut = strOut + "INST Error: " + strErrVal
myScope.WriteString ":SYSTEM:ERROR?" ' Request error message.
strErrVal = myScope.ReadString ' Read error message.
Wend

If Not strOut = "" Then
MsgBox strOut, vbExclamation, "INST Error Messages"

```

```
        myScope.FlushWrite (False)
        myScope.FlushRead

    End If

    Exit Sub

VisaComError:
    MsgBox "VISA COM Error: " + vbCrLf + Err.Description

End Sub
```

### VISA COM Example in C#

To compile and run this example in Microsoft Visual Studio 2005:

- 1 Open Visual Studio.
- 2 Create a new Visual C#, Windows, Console Application project.
- 3 Cut-and-paste the code that follows into the C# source file.
- 4 Edit the program to use the VISA address of your oscilloscope.
- 5 Add a reference to the VISA COM 3.0 Type Library:
  - a Right-click the project you wish to modify (not the solution) in the Solution Explorer window of the Microsoft Visual Studio environment.
  - b Choose **Add Reference...**
  - c In the Add Reference dialog, select the **COM** tab.
  - d Select **VISA COM 3.0 Type Library**; then click **OK**.
- 6 Build and run the program.

For more information, see the VISA COM Help that comes with Agilent IO Libraries Suite 15.

```
/*
 * Agilent VISA COM Example in C#
 * -----
 * This program illustrates most of the commonly used programming
 * features of your Agilent oscilloscopes.
 * -----
 */

using System;
using System.IO;
using System.Text;
using Ivi.Visa.Interop;
using System.Runtime.InteropServices;

namespace InfiniiVision
{
    class VisaComInstrumentApp
    {
```

```

private static VisaComInstrument myScope;

public static void Main(string[] args)
{
    try
    {
        myScope = new
            VisaComInstrument("USB0::2391::5957::MY47250010::0::INSTR");

        Initialize();

        /* The extras function contains miscellaneous commands that
         * do not need to be executed for the proper operation of
         * this example. The commands in the extras function are
         * shown for reference purposes only.
         */
        // Extra(); // Uncomment to execute the extra function.
        Capture();
        Analyze();
    }
    catch (System.ApplicationException err)
    {
        Console.WriteLine("*** VISA Error Message : " + err.Message);
    }
    catch (System.SystemException err)
    {
        Console.WriteLine("*** System Error Message : " + err.Message);
    }
    catch (System.Exception err)
    {
        System.Diagnostics.Debug.Fail("Unexpected Error");
        Console.WriteLine("*** Unexpected Error : " + err.Message);
    }
    finally
    {
        myScope.Close();
    }
}

/*
 * Initialize()
 * -----
 * This function initializes both the interface and the
 * oscilloscope to a known state.
 */
private static void Initialize()
{
    string strResults;

    /* RESET - This command puts the oscilloscope into a known
     * state. This statement is very important for programs to
     * work as expected. Most of the following initialization
     * commands are initialized by *RST. It is not necessary to
     * reinitialize them unless the default setting is not suitable
     * for your application.
     */
    myScope.DoCommand("*RST"); // Reset the to the defaults.
}

```

## 12 Programming Examples

```
myScope.DoCommand("*CLS"); // Clear the status data structures.

/* IDN - Ask for the device's *IDN string.
 */
strResults = myScope.DoQueryString("*IDN?");

// Display results.
Console.WriteLine("Result is: {0}", strResults);

/* AUTOSCALE - This command evaluates all the input signals
 * and sets the correct conditions to display all of the
 * active signals.
 */
myScope.DoCommand(":AUToscale");

/* CHANNEL_PROBE - Sets the probe attenuation factor for the
 * selected channel. The probe attenuation factor may be from
 * 0.1 to 1000.
 */
myScope.DoCommand(":CHANnel1:PROBe 10");

/* CHANNEL_RANGE - Sets the full scale vertical range in volts.
 * The range value is eight times the volts per division.
 */
myScope.DoCommand(":CHANnel1:RANGe 8");

/* TIME_RANGE - Sets the full scale horizontal time in seconds.
 * The range value is ten times the time per division.
 */
myScope.DoCommand(":TIMebase:RANGe 2e-3");

/* TIME_REFERENCE - Possible values are LEFT and CENTER:
 * - LEFT sets the display reference one time division from
 * the left.
 * - CENTER sets the display reference to the center of the
 * screen.
 */
myScope.DoCommand(":TIMebase:REFerence CENTER");

/* TRIGGER_SOURCE - Selects the channel that actually produces
 * the TV trigger. Any channel can be selected.
 */
myScope.DoCommand(":TRIGger:TV:SOURCe CHANnel1");

/* TRIGGER_MODE - Set the trigger mode to, EDGE, GLITCh,
 * PATtern, CAN, DURation, IIC, LIN, SEQuence, SPI, TV,
 * UART, or USB.
 */
myScope.DoCommand(":TRIGger:MODE EDGE");

/* TRIGGER_EDGE_SLOPE - Set the slope of the edge for the
 * trigger to either POSITIVE or NEGATIVE.
 */
myScope.DoCommand(":TRIGger:EDGE:SLOPe POSitive");
}

/*
```

```

* Extra()
* -----
* The commands in this function are not executed and are shown
* for reference purposes only. To execute these commands, call
* this function from main.
*/
private static void Extra()
{
    /* RUN_STOP (not executed in this example):
    * - RUN starts the acquisition of data for the active
    *   waveform display.
    * - STOP stops the data acquisition and turns off AUTOSTORE.
    */
    myScope.DoCommand(":RUN");
    myScope.DoCommand(":STOP");

    /* VIEW_BLANK (not executed in this example):
    * - VIEW turns on (starts displaying) an active channel or
    *   pixel memory.
    * - BLANK turns off (stops displaying) a specified channel or
    *   pixel memory.
    */
    myScope.DoCommand(":BLANK CHANnel1");
    myScope.DoCommand(":VIEW CHANnel1");

    /* TIME_MODE (not executed in this example) - Set the time base
    * mode to MAIN, DELAYED, XY or ROLL.
    */
    myScope.DoCommand(":TIMEbase:MODE MAIN");
}

/*
* Capture()
* -----
* This function prepares the scope for data acquisition and then
* uses the DIGITIZE MACRO to capture some data.
*/
private static void Capture()
{
    /* AQUIRE_TYPE - Sets the acquisition mode. There are three
    * acquisition types NORMAL, PEAK, or AVERAGE.
    */
    myScope.DoCommand(":ACquire:TYPE NORMal");

    /* AQUIRE_COMPLETE - Specifies the minimum completion criteria
    * for an acquisition. The parameter determines the percentage
    * of time buckets needed to be "full" before an acquisition is
    * considered to be complete.
    */
    myScope.DoCommand(":ACquire:COMplete 100");

    /* DIGITIZE - Used to acquire the waveform data for transfer
    * over the interface. Sending this command causes an
    * acquisition to take place with the resulting data being
    * placed in the buffer.
    */
}

```

```

/* NOTE! The use of the DIGITIZE command is highly recommended
 * as it will ensure that sufficient data is available for
 * measurement. Keep in mind when the oscilloscope is running,
 * communication with the computer interrupts data acquisition.
 * Setting up the oscilloscope over the bus causes the data
 * buffers to be cleared and internal hardware to be
 * reconfigured.
 * If a measurement is immediately requested there may not have
 * been enough time for the data acquisition process to collect
 * data and the results may not be accurate. An error value of
 * 9.9E+37 may be returned over the bus in this situation.
 */
myScope.DoCommand(":DIGitize CHANnel1");
}

/*
 * Analyze()
 * -----
 * In this example we will do the following:
 * - Save the system setup to a file for restoration at a later
 *   time.
 * - Save the oscilloscope display to a file which can be
 *   printed.
 * - Make single channel measurements.
 */
private static void Analyze()
{
    byte[] ResultsArray; // Results array.
    int nBytes; // Number of bytes returned from instrument.

    /* SAVE_SYSTEM_SETUP - The :SYSTEM:SETup? query returns a
     * program message that contains the current state of the
     * instrument. Its format is a definite-length binary block,
     * for example,
     * #800002204<setup string><NL>
     * where the setup string is 2204 bytes in length.
     */
    Console.WriteLine("Saving oscilloscope setup to " +
        "c:\\scope\\config\\setup.dat");
    if (File.Exists("c:\\scope\\config\\setup.dat"))
        File.Delete("c:\\scope\\config\\setup.dat");

    // Query and read setup string.
    ResultsArray = myScope.DoQueryIEEEBlock(":SYSTEM:SETup?");
    nBytes = ResultsArray.Length;
    Console.WriteLine("Read oscilloscope setup ({0} bytes).",
        nBytes);

    // Write setup string to file.
    File.WriteAllBytes("c:\\scope\\config\\setup.dat",
        ResultsArray);
    Console.WriteLine("Wrote setup string ({0} bytes) to file.",
        nBytes);

    /* RESTORE_SYSTEM_SETUP - Uploads a previously saved setup
     * string to the oscilloscope.
     */
}

```

```

byte[] dataArray;

// Read setup string from file.
dataArray = File.ReadAllBytes("c:\\scope\\config\\setup.dat");
Console.WriteLine("Read setup string ({0} bytes) from file.",
    dataArray.Length);

// Restore setup string.
myScope.DoCommandIIEEEBlock(":SYSTem:SETup", dataArray);
Console.WriteLine("Restored setup string.");

/* IMAGE_TRANSFER - In this example, we query for the screen
 * data with the ":DISPLAY:DATA?" query. The .png format
 * data is saved to a file in the local file system.
 */
Console.WriteLine("Transferring screen image to " +
    "c:\\scope\\data\\screen.png");
if (File.Exists("c:\\scope\\data\\screen.png"))
    File.Delete("c:\\scope\\data\\screen.png");

// Increase I/O timeout to fifteen seconds.
myScope.SetTimeoutSeconds(15);

// Get the screen data in PNG format.
ResultsArray = myScope.DoQueryIIEEEBlock(
    ":DISPlay:DATA? PNG, SCReen, COLOr");
nBytes = ResultsArray.Length;
Console.WriteLine("Read screen image ({0} bytes).", nBytes);

// Store the screen data in a file.
File.WriteAllBytes("c:\\scope\\data\\screen.png",
    ResultsArray);
Console.WriteLine("Wrote screen image ({0} bytes) to file.",
    nBytes);

// Return I/O timeout to five seconds.
myScope.SetTimeoutSeconds(5);

/* MEASURE - The commands in the MEASURE subsystem are used to
 * make measurements on displayed waveforms.
 */

// Set source to measure.
myScope.DoCommand(":MEASure:SOURce CHANnel1");

// Query for frequency.
double fResults;
fResults = myScope.DoQueryValue(":MEASure:FREQuency?");
Console.WriteLine("The frequency is: {0:F4} kHz",
    fResults / 1000);

// Query for peak to peak voltage.
fResults = myScope.DoQueryValue(":MEASure:VPP?");
Console.WriteLine("The peak to peak voltage is: {0:F2} V",
    fResults);

/* WAVEFORM_DATA - Get waveform data from oscilloscope. To

```

```

* obtain waveform data, you must specify the WAVEFORM
* parameters for the waveform data prior to sending the
* ":WAVEFORM:DATA?" query.
*
* Once these parameters have been sent, the
* ":WAVEFORM:PREAMBLE?" query provides information concerning
* the vertical and horizontal scaling of the waveform data.
*
* With the preamble information you can then use the
* ":WAVEFORM:DATA?" query and read the data block in the
* correct format.
*/

/* WAVE_FORMAT - Sets the data transmission mode for waveform
* data output. This command controls how the data is
* formatted when sent from the oscilloscope and can be set
* to WORD or BYTE format.
*/

// Set waveform format to BYTE.
myScope.DoCommand(":WAVEform:FORMat BYTE");

/* WAVE_POINTS - Sets the number of points to be transferred.
* The number of time points available is returned by the
* "ACQUIRE:POINTS?" query. This can be set to any binary
* fraction of the total time points available.
*/
myScope.DoCommand(":WAVEform:POINTs 1000");

/* GET_PREAMBLE - The preamble contains all of the current
* WAVEFORM settings returned in the form <preamble block><NL>
* where the <preamble block> is:
*   FORMAT      : int16 - 0 = BYTE, 1 = WORD, 4 = ASCII.
*   TYPE        : int16 - 0 = NORMAL, 1 = PEAK DETECT,
*               2 = AVERAGE.
*   POINTS      : int32 - number of data points transferred.
*   COUNT       : int32 - 1 and is always 1.
*   XINCREMENT  : float64 - time difference between data
*                       points.
*   XORIGIN     : float64 - always the first data point in
*                       memory.
*   XREFERENCE  : int32 - specifies the data point associated
*                       with the x-origin.
*   YINCREMENT  : float32 - voltage difference between data
*                       points.
*   YORIGIN     : float32 - value of the voltage at center
*                       screen.
*   YREFERENCE  : int32 - data point where y-origin occurs.
*/
Console.WriteLine("Reading preamble.");
double[] fResultsArray;
fResultsArray = myScope.DoQueryValues(":WAVEform:PREAmble?");

double fFormat = fResultsArray[0];
Console.WriteLine("Preamble FORMat: {0:e}", fFormat);

double fType = fResultsArray[1];

```

```

Console.WriteLine("Preamble TYPE: {0:e}", fType);

double fPoints = fResultsArray[2];
Console.WriteLine("Preamble POINTs: {0:e}", fPoints);

double fCount = fResultsArray[3];
Console.WriteLine("Preamble COUNT: {0:e}", fCount);

double fXincrement = fResultsArray[4];
Console.WriteLine("Preamble XINCrement: {0:e}", fXincrement);

double fXorigin = fResultsArray[5];
Console.WriteLine("Preamble XORigin: {0:e}", fXorigin);

double fXreference = fResultsArray[6];
Console.WriteLine("Preamble XREFerence: {0:e}", fXreference);

double fYincrement = fResultsArray[7];
Console.WriteLine("Preamble YINCrement: {0:e}", fYincrement);

double fYorigin = fResultsArray[8];
Console.WriteLine("Preamble YORigin: {0:e}", fYorigin);

double fYreference = fResultsArray[9];
Console.WriteLine("Preamble YREFerence: {0:e}", fYreference);

/* QUERY_WAVE_DATA - Outputs waveform records to the controller
 * over the interface that is stored in a buffer previously
 * specified with the ":WAVEform:SOURce" command.
 */

/* READ_WAVE_DATA - The wave data consists of two parts: the
 * header, and the actual waveform data followed by a
 * New Line (NL) character. The query data has the following
 * format:
 *
 * <header><waveform data block><NL>
 *
 * Where:
 *
 * <header> = #800002048 (this is an example header)
 *
 * The "#8" may be stripped off of the header and the remaining
 * numbers are the size, in bytes, of the waveform data block.
 * The size can vary depending on the number of points acquired
 * for the waveform which can be set using the
 * ":WAVEFORM:POINTS" command. You may then read that number
 * of bytes from the oscilloscope; then, read the following NL
 * character to terminate the query.
 */

// Read waveform data.
ResultsArray = myScope.DoQueryIEEEBlock(":WAVEform:DATA?");
nBytes = ResultsArray.Length;
Console.WriteLine("Read waveform data ({0} bytes).", nBytes);

// Make some calculations from the preamble data.

```

```

double fVdiv = 32 * fYincrement;
double fOffset = fYorigin;
double fSdiv = fPoints * fXincrement / 10;
double fDelay = (fPoints / 2) * fXincrement + fXorigin;

// Print them out...
Console.WriteLine("Scope Settings for Channel 1:");
Console.WriteLine("Volts per Division = {0:f}", fVdiv);
Console.WriteLine("Offset = {0:f}", fOffset);
Console.WriteLine("Seconds per Division = {0:e}", fSdiv);
Console.WriteLine("Delay = {0:e}", fDelay);

// Print the waveform voltage at selected points:
for (int i = 0; i < nBytes; i = i + (nBytes / 20))
{
    Console.WriteLine("Data point {0:d} = {1:f6} Volts at "
        + "{2:f10} Seconds", i,
        ((float)ResultsArray[i] - fYreference) * fYincrement +
        fYorigin,
        ((float)i - fXreference) * fXincrement + fXorigin);
}

/* SAVE_WAVE_DATA - saves the waveform data to a CSV format
 * file named "waveform.csv".
 */
if (File.Exists("c:\\scope\\data\\waveform.csv"))
    File.Delete("c:\\scope\\data\\waveform.csv");

StreamWriter writer =
    File.CreateText("c:\\scope\\data\\waveform.csv");
for (int i = 0; i < nBytes; i++)
{
    writer.WriteLine("{0:E}, {1:f6}",
        ((float)i - fXreference) * fXincrement + fXorigin,
        ((float)ResultsArray[i] - fYreference) * fYincrement +
        fYorigin);
}
writer.Close();
Console.WriteLine("Waveform data ({0} points) written to " +
    "c:\\scope\\data\\waveform.csv.", nBytes);
}
}

class VisaComInstrument
{
    private ResourceManagerClass m_ResourceManager;
    private FormattedIO488Class m_IoObject;
    private string m_strVisaAddress;

    // Constructor.
    public VisaComInstrument(string strVisaAddress)
    {
        // Save VISA address in member variable.
        m_strVisaAddress = strVisaAddress;

        // Open the default VISA COM IO object.
        OpenIo();
    }
}

```

```

        // Clear the interface.
        m_IoObject.IO.Clear();
    }

    public void DoCommand(string strCommand)
    {
        // Send the command.
        m_IoObject.WriteString(strCommand, true);

        // Check for instrument errors.
        CheckForInstrumentErrors(strCommand);
    }

    public string DoQueryString(string strQuery)
    {
        // Send the query.
        m_IoObject.WriteString(strQuery, true);

        // Get the result string.
        string strResults;
        strResults = m_IoObject.ReadString();

        // Check for instrument errors.
        CheckForInstrumentErrors(strQuery);

        // Return results string.
        return strResults;
    }

    public double DoQueryValue(string strQuery)
    {
        // Send the query.
        m_IoObject.WriteString(strQuery, true);

        // Get the result number.
        double fResult;
        fResult = (double)m_IoObject.ReadNumber(
            IEEEASCIIType.ASCIIType_R8, true);

        // Check for instrument errors.
        CheckForInstrumentErrors(strQuery);

        // Return result number.
        return fResult;
    }

    public double[] DoQueryValues(string strQuery)
    {
        // Send the query.
        m_IoObject.WriteString(strQuery, true);

        // Get the result numbers.
        double[] fResultsArray;
        fResultsArray = (double[])m_IoObject.ReadList(
            IEEEASCIIType.ASCIIType_R8, ",;");
    }

```

## 12 Programming Examples

```
// Check for instrument errors.
CheckForInstrumentErrors(strQuery);

// Return result numbers.
return fResultsArray;
}

public byte[] DoQueryIEEEBlock(string strQuery)
{
    // Send the query.
    m_IoObject.WriteString(strQuery, true);

    // Get the results array.
    byte[] ResultsArray;
    ResultsArray = (byte[])m_IoObject.ReadIEEEBlock(
        IEEEBinaryType.BinaryType_UI1, false, true);

    // Check for instrument errors.
    CheckForInstrumentErrors(strQuery);

    // Return results array.
    return ResultsArray;
}

public void DoCommandIEEEBlock(string strCommand,
    byte[] DataArray)
{
    // Send the command.
    m_IoObject.WriteIEEEBlock(strCommand, DataArray, true);

    // Check for instrument errors.
    CheckForInstrumentErrors(strCommand);
}

private void CheckForInstrumentErrors(string strCommand)
{
    string strInstrumentError;
    bool bFirstError = true;

    // Repeat until all errors are displayed.
    do
    {
        // Send the ":SYSTEM:ERROR?" query, and get the result string.
        m_IoObject.WriteString(":SYSTEM:ERROR?", true);
        strInstrumentError = m_IoObject.ReadString();

        // If there is an error, print it.
        if (strInstrumentError.ToString() != "+0,\nNo error\n\n")
        {
            if (bFirstError)
            {
                // Print the command that caused the error.
                Console.WriteLine("ERROR(s) for command '{0}': ",
                    strCommand);
                bFirstError = false;
            }
            Console.Write(strInstrumentError);
        }
    }
}
```

```

    }
    } while (strInstrumentError.ToString() != "+0,\\"No error\\"\\n");
}

private void OpenIo()
{
    m_ResourceManager = new ResourceManagerClass();
    m_IoObject = new FormattedIO488Class();

    // Open the default VISA COM IO object.
    try
    {
        m_IoObject.IO =
            (IMessage)m_ResourceManager.Open(m_strVisaAddress,
            AccessMode.NO_LOCK, 0, "");
    }
    catch (Exception e)
    {
        Console.WriteLine("An error occurred: {0}", e.Message);
    }
}

public void SetTimeoutSeconds(int nSeconds)
{
    m_IoObject.IO.Timeout = nSeconds * 1000;
}

public void Close()
{
    try
    {
        m_IoObject.IO.Close();
    }
    catch {}

    try
    {
        Marshal.ReleaseComObject(m_IoObject);
    }
    catch {}

    try
    {
        Marshal.ReleaseComObject(m_ResourceManager);
    }
    catch {}
}
}
}

```

## VISA COM Example in Visual Basic .NET

To compile and run this example in Microsoft Visual Studio 2005:

- 1 Open Visual Studio.
- 2 Create a new Visual Basic, Windows, Console Application project.
- 3 Cut-and-paste the code that follows into the C# source file.
- 4 Edit the program to use the VISA address of your oscilloscope.
- 5 Add a reference to the VISA COM 3.0 Type Library:
  - a Right-click the project you wish to modify (not the solution) in the Solution Explorer window of the Microsoft Visual Studio environment.
  - b Choose **Add Reference...**
  - c In the Add Reference dialog, select the **COM** tab.
  - d Select **VISA COM 3.0 Type Library**; then click **OK**.
  - e Right-click the project you wish to modify (not the solution) in the Solution Explorer window of the Microsoft Visual Studio environment and choose **Properties**; then, select "InfiniiVision.VisaComInstrumentApp" as the **Startup object**.
- 6 Build and run the program.

For more information, see the VISA COM Help that comes with Agilent IO Libraries Suite 15.

```
'
' Agilent VISA COM Example in Visual Basic .NET
' -----
' This program illustrates most of the commonly used programming
' features of your Agilent oscilloscopes.
' -----

Imports System
Imports System.IO
Imports System.Text
Imports Ivi.Visa.Interop
Imports System.Runtime.InteropServices

Namespace InfiniiVision
  Class VisaComInstrumentApp
    Private Shared myScope As VisaComInstrument

    Public Shared Sub Main(ByVal args As String())
      Try
        myScope = New _
          VisaComInstrument("USB0::2391::5957::MY47250010::0::INSTR")

        Initialize()

        ' The extras function contains miscellaneous commands that
```

```

' do not need to be executed for the proper operation of
' this example. The commands in the extras function are
' shown for reference purposes only.

' Extra(); // Uncomment to execute the extra function.
Capture()
Analyze()
Catch err As System.ApplicationException
    Console.WriteLine("*** VISA Error Message : " + err.Message)
Catch err As System.SystemException
    Console.WriteLine("*** System Error Message : " + err.Message)
Catch err As System.Exception
    System.Diagnostics.Debug.Fail("Unexpected Error")
    Console.WriteLine("*** Unexpected Error : " + err.Message)
Finally
    myScope.Close()
End Try
End Sub

' Initialize()
' -----
' This function initializes both the interface and the
' oscilloscope to a known state.

Private Shared Sub Initialize()
    Dim strResults As String

    ' RESET - This command puts the oscilloscope into a known
    ' state. This statement is very important for programs to
    ' work as expected. Most of the following initialization
    ' commands are initialized by *RST. It is not necessary to
    ' reinitialize them unless the default setting is not suitable
    ' for your application.

    ' Reset to the defaults.
    myScope.DoCommand("*RST")

    ' Clear the status data structures.
    myScope.DoCommand("*CLS")

    ' IDN - Ask for the device's *IDN string.
    strResults = myScope.DoQueryString("*IDN?")

    ' Display results.
    Console.WriteLine("Result is: {0}", strResults)

    ' AUTOSCALE - This command evaluates all the input signals
    ' and sets the correct conditions to display all of the
    ' active signals.
    myScope.DoCommand(":AUToscale")

    ' CHANNEL_PROBE - Sets the probe attenuation factor for the
    ' selected channel. The probe attenuation factor may be from
    ' 0.1 to 1000.
    myScope.DoCommand(":CHANnel1:PROBe 10")

    ' CHANNEL_RANGE - Sets the full scale vertical range in volts.

```

## 12 Programming Examples

```
' The range value is eight times the volts per division.
myScope.DoCommand(":CHANnel1:RANGe 8")

' TIME_RANGE - Sets the full scale horizontal time in seconds.
' The range value is ten times the time per division.
myScope.DoCommand(":TIMebase:RANGe 2e-3")

' TIME_REFERENCE - Possible values are LEFT and CENTER:
' - LEFT sets the display reference one time division from
'   the left.
' - CENTER sets the display reference to the center of the
'   screen.
myScope.DoCommand(":TIMebase:REFerence CENTER")

' TRIGGER_SOURCE - Selects the channel that actually produces
' the TV trigger. Any channel can be selected.
myScope.DoCommand(":TRIGger:TV:SOURCe CHANnel1")

' TRIGGER_MODE - Set the trigger mode to, EDGE, GLITCh,
' PATtern, CAN, DURation, IIC, LIN, SEQuence, SPI, TV,
' UART, or USB.
myScope.DoCommand(":TRIGger:MODE EDGE")

' TRIGGER_EDGE_SLOPE - Set the slope of the edge for the
' trigger to either POSITIVE or NEGATIVE.
myScope.DoCommand(":TRIGger:EDGE:SLOPe POSitive")

End Sub

'
' Extra()
' -----
' The commands in this function are not executed and are shown
' for reference purposes only. To execute these commands, call
' this function from main.
'

Private Shared Sub Extra()
' RUN_STOP (not executed in this example):
' - RUN starts the acquisition of data for the active
'   waveform display.
' - STOP stops the data acquisition and turns off AUTOSTORE.
'

myScope.DoCommand(":RUN")
myScope.DoCommand(":STOP")

' VIEW_BLANK (not executed in this example):
' - VIEW turns on (starts displaying) an active channel or
'   pixel memory.
' - BLANK turns off (stops displaying) a specified channel or
'   pixel memory.
'

myScope.DoCommand(":BLANk CHANnel1")
myScope.DoCommand(":VIEW CHANnel1")
```

```

' TIME_MODE (not executed in this example) - Set the time base
' mode to MAIN, DELAYED, XY or ROLL.
'
myScope.DoCommand(":TIMEbase:MODE MAIN")
End Sub

' Capture()
' -----
' This function prepares the scope for data acquisition and then
' uses the DIGITIZE MACRO to capture some data.

Private Shared Sub Capture()
' ACQUIRE_TYPE - Sets the acquisition mode. There are three
' acquisition types NORMAL, PEAK, or AVERAGE.
myScope.DoCommand(":ACquire:TYPE NORMal")

' ACQUIRE_COMPLETE - Specifies the minimum completion criteria
' for an acquisition. The parameter determines the percentage
' of time buckets needed to be "full" before an acquisition is
' considered to be complete.
myScope.DoCommand(":ACquire:COMplete 100")

' DIGITIZE - Used to acquire the waveform data for transfer
' over the interface. Sending this command causes an
' acquisition to take place with the resulting data being
' placed in the buffer.

' NOTE! The use of the DIGITIZE command is highly recommended
' as it will ensure that sufficient data is available for
' measurement. Keep in mind when the oscilloscope is running,
' communication with the computer interrupts data acquisition.
' Setting up the oscilloscope over the bus causes the data
' buffers to be cleared and internal hardware to be
' reconfigured.
' If a measurement is immediately requested there may not have
' been enough time for the data acquisition process to collect
' data and the results may not be accurate. An error value of
' 9.9E+37 may be returned over the bus in this situation.
myScope.DoCommand(":DIGitize CHANnel1")

End Sub

' Analyze()
' -----
' In this example we will do the following:
' - Save the system setup to a file for restoration at a later
'   time.
' - Save the oscilloscope display to a file which can be
'   printed.
' - Make single channel measurements.

Private Shared Sub Analyze()
' Results array.
Dim ResultsArray As Byte()

' Number of bytes returned from instrument.

```

```

Dim nBytes As Integer

' SAVE_SYSTEM_SETUP - The :SYSTEM:SETup? query returns a
' program message that contains the current state of the
' instrument. Its format is a definite-length binary block,
' for example,
'   #800002204<setup string><NL>
' where the setup string is 2204 bytes in length.
Console.WriteLine("Saving oscilloscope setup to " + _
    "c:\scope\config\setup.dat")
If File.Exists("c:\scope\config\setup.dat") Then
    File.Delete("c:\scope\config\setup.dat")
End If

' Query and read setup string.
ResultsArray = myScope.DoQueryIEEEBlock(":SYSTEM:SETup?")
nBytes = ResultsArray.Length
Console.WriteLine("Read oscilloscope setup ({0} bytes).", nBytes)

' Write setup string to file.
File.WriteAllBytes("c:\scope\config\setup.dat", ResultsArray)
Console.WriteLine("Wrote setup string ({0} bytes) to file.", _
    nBytes)

' RESTORE_SYSTEM_SETUP - Uploads a previously saved setup
' string to the oscilloscope.
Dim dataArray As Byte()

' Read setup string from file.
dataArray = File.ReadAllBytes("c:\scope\config\setup.dat")
Console.WriteLine("Read setup string ({0} bytes) from file.", _
    dataArray.Length)

' Restore setup string.
myScope.DoCommandIEEEBlock(":SYSTEM:SETup", dataArray)
Console.WriteLine("Restored setup string.")

' IMAGE_TRANSFER - In this example, we query for the screen
' data with the ":DISPLAY:DATA?" query. The .png format
' data is saved to a file in the local file system.
Console.WriteLine("Transferring screen image to " + _
    "c:\scope\data\screen.png")
If File.Exists("c:\scope\data\screen.png") Then
    File.Delete("c:\scope\data\screen.png")
End If

' Increase I/O timeout to fifteen seconds.
myScope.SetTimeoutSeconds(15)

' Get the screen data in PNG format.
ResultsArray = _
    myScope.DoQueryIEEEBlock(":DISPlay:DATA? PNG, SCREen, COLOr")
nBytes = ResultsArray.Length
Console.WriteLine("Read screen image ({0} bytes).", nBytes)

' Store the screen data in a file.
File.WriteAllBytes("c:\scope\data\screen.png", ResultsArray)

```

```

Console.WriteLine("Wrote screen image ({0} bytes) to file.", _
    nBytes)

' Return I/O timeout to five seconds.
myScope.SetTimeoutSeconds(5)

' MEASURE - The commands in the MEASURE subsystem are used to
' make measurements on displayed waveforms.

' Set source to measure.
myScope.DoCommand(":MEASure:SOURce CHANnel1")

' Query for frequency.
Dim fResults As Double
fResults = myScope.DoQueryValue(":MEASure:FREQuency?")
Console.WriteLine("The frequency is: {0:F4} kHz", _
    fResults / 1000)

' Query for peak to peak voltage.
fResults = myScope.DoQueryValue(":MEASure:VPP?")
Console.WriteLine("The peak to peak voltage is: {0:F2} V", _
    fResults)

' WAVEFORM_DATA - Get waveform data from oscilloscope. To
' obtain waveform data, you must specify the WAVEFORM
' parameters for the waveform data prior to sending the
' ":WAVEFORM:DATA?" query.
'
' Once these parameters have been sent, the
' ":WAVEFORM:PREAMBLE?" query provides information concerning
' the vertical and horizontal scaling of the waveform data.
'
' With the preamble information you can then use the
' ":WAVEFORM:DATA?" query and read the data block in the
' correct format.

' WAVE_FORMAT - Sets the data transmission mode for waveform
' data output. This command controls how the data is
' formatted when sent from the oscilloscope and can be set
' to WORD or BYTE format.

' Set waveform format to BYTE.
myScope.DoCommand(":WAVEform:FORMat BYTE")

' WAVE_POINTS - Sets the number of points to be transferred.
' The number of time points available is returned by the
' "ACQUIRE:POINTS?" query. This can be set to any binary
' fraction of the total time points available.
myScope.DoCommand(":WAVEform:POINTs 1000")

' GET_PREAMBLE - The preamble contains all of the current
' WAVEFORM settings returned in the form <preamble block><NL>
' where the <preamble block> is:
'   FORMAT      : int16 - 0 = BYTE, 1 = WORD, 4 = ASCII.
'   TYPE        : int16 - 0 = NORMAL, 1 = PEAK DETECT,
'               :             2 = AVERAGE.
'   POINTS      : int32 - number of data points transferred.

```

```

'   COUNT      : int32 - 1 and is always 1.
'   XINCREMENT : float64 - time difference between data
'                   points.
'   XORIGIN    : float64 - always the first data point in
'                   memory.
'   XREFERENCE : int32 - specifies the data point associated
'                   with the x-origin.
'   YINCREMENT : float32 - voltage difference between data
'                   points.
'   YORIGIN    : float32 - value of the voltage at center
'                   screen.
'   YREFERENCE : int32 - data point where y-origin occurs.

Console.WriteLine("Reading preamble.")
Dim fResultsArray As Double()
fResultsArray = myScope.DoQueryValues(":WAVEform:PREamble?")

Dim fFormat As Double = fResultsArray(0)
Console.WriteLine("Preamble FORMat: {0:e}", fFormat)

Dim fType As Double = fResultsArray(1)
Console.WriteLine("Preamble TYPE: {0:e}", fType)

Dim fPoints As Double = fResultsArray(2)
Console.WriteLine("Preamble POINTs: {0:e}", fPoints)

Dim fCount As Double = fResultsArray(3)
Console.WriteLine("Preamble COUNT: {0:e}", fCount)

Dim fXincrement As Double = fResultsArray(4)
Console.WriteLine("Preamble XINCrement: {0:e}", fXincrement)

Dim fXorigin As Double = fResultsArray(5)
Console.WriteLine("Preamble XORigin: {0:e}", fXorigin)

Dim fXreference As Double = fResultsArray(6)
Console.WriteLine("Preamble XREFerence: {0:e}", fXreference)

Dim fYincrement As Double = fResultsArray(7)
Console.WriteLine("Preamble YINCrement: {0:e}", fYincrement)

Dim fYorigin As Double = fResultsArray(8)
Console.WriteLine("Preamble YORigin: {0:e}", fYorigin)

Dim fYreference As Double = fResultsArray(9)
Console.WriteLine("Preamble YREFerence: {0:e}", fYreference)

' QUERY_WAVE_DATA - Outputs waveform records to the controller
' over the interface that is stored in a buffer previously
' specified with the ":WAVEform:SOURce" command.

' READ_WAVE_DATA - The wave data consists of two parts: the
' header, and the actual waveform data followed by a
' New Line (NL) character. The query data has the following
' format:
'
'   <header><waveform data block><NL>

```

```

'
' Where:
'
' <header> = #800002048      (this is an example header)
'
' The "#8" may be stripped off of the header and the remaining
' numbers are the size, in bytes, of the waveform data block.
' The size can vary depending on the number of points acquired
' for the waveform which can be set using the
' ":WAVEFORM:POINTS" command. You may then read that number
' of bytes from the oscilloscope; then, read the following NL
' character to terminate the query.

' Read waveform data.
ResultsArray = myScope.DoQueryIEEEBlock(":WAVEform:DATA?")
nBytes = ResultsArray.Length
Console.WriteLine("Read waveform data ({0} bytes).", nBytes)

' Make some calculations from the preamble data.
Dim fVdiv As Double = 32 * fYincrement
Dim fOffset As Double = fYorigin
Dim fSdiv As Double = fPoints * fXincrement / 10
Dim fDelay As Double = (fPoints / 2) * fXincrement + fXorigin

' Print them out...
Console.WriteLine("Scope Settings for Channel 1:")
Console.WriteLine("Volts per Division = {0:f}", fVdiv)
Console.WriteLine("Offset = {0:f}", fOffset)
Console.WriteLine("Seconds per Division = {0:e}", fSdiv)
Console.WriteLine("Delay = {0:e}", fDelay)

' Print the waveform voltage at selected points:
Dim i As Integer = 0
While i < nBytes
    Console.WriteLine("Data point {0:d} = {1:f6} Volts at " + _
        "{2:f10} Seconds", i, _
        (CSng(ResultsArray(i)) - fYreference) * fYincrement + _
        fYorigin, (CSng(i) - fXreference) * fXincrement + fXorigin)
    i = i + (nBytes / 20)
End While

' SAVE_WAVE_DATA - saves the waveform data to a CSV format
' file named "waveform.csv".
If File.Exists("c:\scope\data\waveform.csv") Then
    File.Delete("c:\scope\data\waveform.csv")
End If

Dim writer As StreamWriter = _
    File.CreateText("c:\scope\data\waveform.csv")
For index As Integer = 0 To nBytes - 1
    writer.WriteLine("{0:E}, {1:f6}", _
        (CSng(index) - fXreference) * fXincrement + fXorigin, _
        (CSng(ResultsArray(index)) - fYreference) * fYincrement _
        + fYorigin)
Next
writer.Close()
Console.WriteLine("Waveform data ({0} points) written to " + _

```

## 12 Programming Examples

```
        "c:\scope\data\waveform.csv.", nBytes)
    End Sub
End Class

Class VisaComInstrument
    Private m_ResourceManager As ResourceManagerClass
    Private m_IoObject As FormattedIO488Class
    Private m_strVisaAddress As String

    ' Constructor.
    Public Sub New(ByVal strVisaAddress As String)
        ' Save VISA address in member variable.
        m_strVisaAddress = strVisaAddress

        ' Open the default VISA COM IO object.
        OpenIo()

        ' Clear the interface.
        m_IoObject.IO.Clear()
    End Sub

    Public Sub DoCommand(ByVal strCommand As String)
        ' Send the command.
        m_IoObject.WriteString(strCommand, True)

        ' Check for instrument errors.
        CheckForInstrumentErrors(strCommand)
    End Sub

    Public Function DoQueryString(ByVal strQuery As String) As String
        ' Send the query.
        m_IoObject.WriteString(strQuery, True)

        ' Get the result string.
        Dim strResults As String
        strResults = m_IoObject.ReadString()

        ' Check for instrument errors.
        CheckForInstrumentErrors(strQuery)

        ' Return results string.
        Return strResults
    End Function

    Public Function DoQueryValue(ByVal strQuery As String) As Double
        ' Send the query.
        m_IoObject.WriteString(strQuery, True)

        ' Get the result number.
        Dim fResult As Double
        fResult = _
            Cdbl(m_IoObject.ReadNumber(IEEEASCIIType.ASCIIType_R8, True))

        ' Check for instrument errors.
        CheckForInstrumentErrors(strQuery)

        ' Return result number.
    End Function
End Class
```

```

    Return fResult
End Function

Public Function DoQueryValues(ByVal strQuery As String) As Double()
    ' Send the query.
    m_IoObject.WriteString(strQuery, True)

    ' Get the result numbers.
    Dim fResultsArray As Double()
    fResultsArray = _
        m_IoObject.ReadList(IEEEASCIIType.ASCIIType_R8, ",;")

    ' Check for instrument errors.
    CheckForInstrumentErrors(strQuery)

    ' Return result numbers.
    Return fResultsArray
End Function

Public _
    Function DoQueryIEEEBlock(ByVal strQuery As String) As Byte()
    ' Send the query.
    m_IoObject.WriteString(strQuery, True)

    ' Get the results array.
    Dim ResultsArray As Byte()
    ResultsArray = _
        m_IoObject.ReadIEEEBlock(IEEEBinaryType.BinaryType_UI1, _
            False, True)

    ' Check for instrument errors.
    CheckForInstrumentErrors(strQuery)

    ' Return results array.
    Return ResultsArray
End Function

Public _
    Sub DoCommandIEEEBlock(ByVal strCommand As String, _
        ByVal dataArray As Byte())
    ' Send the command.
    m_IoObject.WriteIEEEBlock(strCommand, dataArray, True)

    ' Check for instrument errors.
    CheckForInstrumentErrors(strCommand)
End Sub

Private Sub CheckForInstrumentErrors(ByVal strCommand As String)
    Dim strInstrumentError As String
    Dim bFirstError As Boolean = True

    ' Repeat until all errors are displayed.
    Do
        ' Send the ":SYSTem:ERRor?" query, and get the result string.
        m_IoObject.WriteString(":SYSTem:ERRor?", True)
        strInstrumentError = m_IoObject.ReadString()
    
```

## 12 Programming Examples

```
' If there is an error, print it.
If strInstrumentError.ToString() <> "+0,"No error"" " _
    & Chr(10) & "" Then
    If bFirstError Then
        ' Print the command that caused the error.
        Console.WriteLine("ERROR(s) for command '{0}': ", _
            strCommand)
        bFirstError = False
    End If
    Console.Write(strInstrumentError)
End If
Loop While strInstrumentError.ToString() <> "+0,"No error"" " _
    & Chr(10) & ""
End Sub

Private Sub OpenIo()
    m_ResourceManager = New ResourceManagerClass()
    m_IoObject = New FormattedIO488Class()

    ' Open the default VISA COM IO object.
    Try
        m_IoObject.IO = _
            DirectCast(m_ResourceManager.Open(m_strVisaAddress, _
                AccessMode.NO_LOCK, 0, ""), IMessage)
    Catch e As Exception
        Console.WriteLine("An error occurred: {0}", e.Message)
    End Try
End Sub

Public Sub SetTimeoutSeconds(ByVal nSeconds As Integer)
    m_IoObject.IO.Timeout = nSeconds * 1000
End Sub

Public Sub Close()
    Try
        m_IoObject.IO.Close()
    Catch
    End Try

    Try
        Marshal.ReleaseComObject(m_IoObject)
    Catch
    End Try

    Try
        Marshal.ReleaseComObject(m_ResourceManager)
    Catch
    End Try
End Sub
End Class
End Namespace
```

## VISA Examples

- "VISA Example in C" on page 809
- "VISA Example in Visual Basic" on page 818
- "VISA Example in C#" on page 828
- "VISA Example in Visual Basic .NET" on page 841

### VISA Example in C

To compile and run this example in Microsoft Visual Studio 2005:

- 1 Open Visual Studio.
- 2 Create a new Visual C++, Win32, Win32 Console Application project.
- 3 In the Win32 Application Wizard, click **Next >**. Then, check **Empty project**, and click **Finish**.
- 4 Cut-and-paste the code that follows into a file named "example.c" in the project directory.
- 5 In Visual Studio 2005, right-click the Source Files folder, choose **Add > Add Existing Item...**, select the example.c file, and click **Add**.
- 6 Edit the program to use the VISA address of your oscilloscope.
- 7 Choose **Project > Properties...** In the Property Pages dialog, update these project settings:
  - a Under Configuration Properties, Linker, Input, add "visa32.lib" to the Additional Dependencies field.
  - b Under Configuration Properties, C/C++, Code Generation, select Multi-threaded DLL for the Runtime Library field.
  - c Click **OK** to close the Property Pages dialog.
- 8 Add the include files and library files search paths:
  - a Choose **Tools > Options...**
  - b In the Options dialog, select **VC++ Directories** under Projects and Solutions.
  - c Show directories for **Include files**, and add the include directory (for example, Program Files\VISA\winnt\include).
  - d Show directories for **Library files**, and add the library files directory (for example, Program Files\VISA\winnt\lib\msc).
  - e Click **OK** to close the Options dialog.
- 9 Build and run the program.

```
/*
 * Agilent VISA Example in C
 * -----
```

## 12 Programming Examples

```
* This program illustrates most of the commonly-used programming
* features of your Agilent oscilloscope.
* This program is to be built as a WIN32 console application.
* Edit the RESOURCE line to specify the address of the
* applicable device.
*/

#include <stdio.h>           /* For printf(). */
#include <visa.h>           /* Agilent VISA routines. */

/* GPIB */
/* #define RESOURCE "GPIB0::7::INSTR" */

/* LAN */
/* #define RESOURCE "TCPIP0::a-mso6102-90541::inst0::INSTR" */

/* USB */
#define RESOURCE "USB0::2391::5970::30D3090541::0::INSTR"

#define WAVE_DATA_SIZE 5000
#define TIMEOUT        5000
#define SETUP_STR_SIZE 3000
#define IMG_SIZE       300000

/* Function prototypes */
void initialize(void);      /* Initialize the oscilloscope. */
void extra(void);          /* Miscellaneous commands not executed,
                           shown for reference purposes. */
void capture(void);        /* Digitize data from oscilloscope. */
void analyze(void);        /* Make some measurements. */
void get_waveform(void);   /* Download waveform data from
                           oscilloscope. */
void save_waveform(void);  /* Save waveform data to a file. */
void retrieve_waveform(void); /* Load waveform data from a file. */

/* Global variables */
ViSession defaultRM, vi;   /* Device session ID. */
char buf[256] = { 0 };     /* Buffer for IDN string. */
unsigned char waveform_data[WAVE_DATA_SIZE]; /* Array for waveform
                                                data. */
double preamble[10];       /* Array for preamble. */

void main(void)
{
    /* Open session. */
    viOpenDefaultRM(&defaultRM);
    viOpen(defaultRM, RESOURCE, VI_NULL, VI_NULL, &vi);
    printf ("Oscilloscope session initialized!\n");

    /* Clear the interface. */
    viClear(vi);

    initialize();

    /* The extras function contains miscellaneous commands that do not
     * need to be executed for the proper operation of this example.
     */
}
```

```

    * The commands in the extras function are shown for reference
    * purposes only.
    */
/* extra(); */ /* <-- Uncomment to execute the extra function */

capture();

analyze();

/* Close session */
viClose(vi);
viClose(defaultRM);
printf ("Program execution is complete...\n");
}

/*
 * initialize
 * -----
 * This function initializes both the interface and the oscilloscope
 * to a known state.
 */

void initialize (void)
{
    /* RESET - This command puts the oscilloscope in a known state.
     * Without this command, the oscilloscope settings are unknown.
     * This command is very important for program control.
     *
     * Many of the following initialization commands are initialized
     * by this command. It is not necessary to reinitialize them
     * unless you want to change the default setting.
     */
    viPrintf(vi, "*RST\n");

    /* Write the *IDN? string and send an EOI indicator, then read
     * the response into buf.
     */
    viQueryf(vi, "*IDN?\n", "%t", buf);
    printf("%s\n", buf);
    /*
     *
     * AUTOSCALE - This command evaluates all the input signals and
     * sets the correct conditions to display all of the active signals.
     */
    viPrintf(vi, ":AUTOSCALE\n");

    /* CHANNEL_PROBE - Sets the probe attenuation factor for the
     * selected channel. The probe attenuation factor may be from
     * 0.1 to 1000.
     */
    viPrintf(vi, ":CHAN1:PROBE 10\n");

    /* CHANNEL_RANGE - Sets the full scale vertical range in volts.
     * The range value is eight times the volts per division.
     */
    viPrintf(vi, ":CHANNEL1:RANGE 8\n");

    /* TIME_RANGE - Sets the full scale horizontal time in seconds.

```

## 12 Programming Examples

```
    * The range value is ten times the time per division.
    */
viPrintf(vi, ":TIM:RANG 2e-3\n");

/* TIME_REFERENCE - Possible values are LEFT and CENTER:
 * - LEFT sets the display reference one time division from the
 *   left.
 * - CENTER sets the display reference to the center of the screen.
 */
viPrintf(vi, ":TIMEBASE:REFERENCE CENTER\n");

/* TRIGGER_SOURCE - Selects the channel that actually produces the
 * TV trigger. Any channel can be selected.
 */
viPrintf(vi, ":TRIGGER:TV:SOURCE CHANNEL1\n");

/* TRIGGER_MODE - Set the trigger mode to, EDGE, GLITCh, PATtern,
 * CAN, DURation, IIC, LIN, SEQuence, SPI, TV, or USB.
 */
viPrintf(vi, ":TRIGGER:MODE EDGE\n");

/* TRIGGER_EDGE_SLOPE - Set the slope of the edge for the trigger
 * to either POSITIVE or NEGATIVE.
 */
viPrintf(vi, ":TRIGGER:EDGE:SLOPE POSITIVE\n");
}

/*
 * extra
 * -----
 * The commands in this function are not executed and are shown for
 * reference purposes only. To execute these commands, call this
 * function from main.
 */

void extra (void)
{
    /* RUN_STOP (not executed in this example):
     * - RUN starts the acquisition of data for the active waveform
     *   display.
     * - STOP stops the data acquisition and turns off AUTOSTORE.
     */
viPrintf(vi, ":RUN\n");
viPrintf(vi, ":STOP\n");

    /* VIEW_BLANK (not executed in this example):
     * - VIEW turns on (starts displaying) an active channel or pixel
     *   memory.
     * - BLANK turns off (stops displaying) a specified channel or
     *   pixel memory.
     */
viPrintf(vi, ":BLANK CHANNEL1\n");
viPrintf(vi, ":VIEW CHANNEL1\n");

    /* TIME_MODE (not executed in this example) - Set the time base
     * mode to MAIN, DELAYED, XY or ROLL.
     */
}
```

```

    viPrintf(vi, ":TIMEBASE:MODE MAIN\n");
}

/*
 * capture
 * -----
 * This function prepares the scope for data acquisition and then
 * uses the DIGITIZE MACRO to capture some data.
 */

void capture (void)
{
    /* ACQUIRE_TYPE - Sets the acquisition mode. There are three
     * acquisition types NORMAL, PEAK, or AVERAGE.
     */
    viPrintf(vi, ":ACQUIRE:TYPE NORMAL\n");

    /* ACQUIRE_COMPLETE - Specifies the minimum completion criteria
     * for an acquisition. The parameter determines the percentage
     * of time buckets needed to be "full" before an acquisition is
     * considered to be complete.
     */
    viPrintf(vi, ":ACQUIRE:COMPLETE 100\n");

    /* DIGITIZE - Used to acquire the waveform data for transfer over
     * the interface. Sending this command causes an acquisition to
     * take place with the resulting data being placed in the buffer.
     */

    /* NOTE! The use of the DIGITIZE command is highly recommended
     * as it will ensure that sufficient data is available for
     * measurement. Keep in mind when the oscilloscope is running,
     * communication with the computer interrupts data acquisition.
     * Setting up the oscilloscope over the bus causes the data
     * buffers to be cleared and internal hardware to be reconfigured.
     * If a measurement is immediately requested there may not have
     * been enough time for the data acquisition process to collect
     * data and the results may not be accurate. An error value of
     * 9.9E+37 may be returned over the bus in this situation.
     */
    viPrintf(vi, ":DIGITIZE CHAN1\n");
}

/*
 * analyze
 * -----
 * In this example we will do the following:
 * - Save the system setup to a file for restoration at a later time.
 * - Save the oscilloscope display to a file which can be printed.
 * - Make single channel measurements.
 */

void analyze (void)
{
    double frequency, vpp;          /* Measurements. */
    double vdiv, off, sdiv, delay; /* Values calculated from preamble
                                     data. */

```

```

int i;                                /* Loop counter. */
unsigned char setup_string[SETUP_STR_SIZE]; /* Array for setup
                                           string. */

int setup_size;
FILE *fp;
unsigned char image_data[IMG_SIZE]; /* Array for image data. */
int img_size;

/* SAVE_SYSTEM_SETUP - The :SYSTEM:SETUP? query returns a program
 * message that contains the current state of the instrument. Its
 * format is a definite-length binary block, for example,
 * #800002204<setup string><NL>
 * where the setup string is 2204 bytes in length.
 */
setup_size = SETUP_STR_SIZE;
/* Query and read setup string. */
viQueryf(vi, ":SYSTEM:SETUP?\n", "%#b\n", &setup_size, setup_string);
printf("Read setup string query (%d bytes).\n", setup_size);
/* Write setup string to file. */
fp = fopen ("c:\\scope\\config\\setup.dat", "wb");
setup_size = fwrite(setup_string, sizeof(unsigned char), setup_size,
                    fp);
fclose (fp);
printf("Wrote setup string (%d bytes) to file.\n", setup_size);

/* RESTORE_SYSTEM_SETUP - Uploads a previously saved setup string
 * to the oscilloscope.
 */
/* Read setup string from file. */
fp = fopen ("c:\\scope\\config\\setup.dat", "rb");
setup_size = fread (setup_string, sizeof(unsigned char),
                    SETUP_STR_SIZE, fp);
fclose (fp);
printf("Read setup string (%d bytes) from file.\n", setup_size);
/* Restore setup string. */
viPrintf(vi, ":SYSTEM:SETUP #8%08d", setup_size);
viBufWrite(vi, setup_string, setup_size, &setup_size);
viPrintf(vi, "\n");
printf("Restored setup string (%d bytes).\n", setup_size);

/* IMAGE_TRANSFER - In this example we will query for the image
 * data with ":DISPLAY:DATA?" to read the data and save the data
 * to the file "image.dat" which you can then send to a printer.
 */
viSetAttribute(vi, VI_ATTR_TMO_VALUE, 30000);
printf("Transferring image to c:\\scope\\data\\screen.bmp\n");
img_size = IMG_SIZE;
viQueryf(vi, ":DISPLAY:DATA? BMP8bit, SCREEN, COLOR\n", "%#b\n",
          &img_size, image_data);
printf("Read display data query (%d bytes).\n", img_size);
/* Write image data to file. */
fp = fopen ("c:\\scope\\data\\screen.bmp", "wb");
img_size = fwrite(image_data, sizeof(unsigned char), img_size, fp);
fclose (fp);
printf("Wrote image data (%d bytes) to file.\n", img_size);
viSetAttribute(vi, VI_ATTR_TMO_VALUE, 5000);

```

```

/* MEASURE - The commands in the MEASURE subsystem are used to
 * make measurements on displayed waveforms.
 */

/* Set source to measure. */
viPrintf(vi, ":MEASURE:SOURCE CHANNEL1\n");

/* Query for frequency. */
viQueryf(vi, ":MEASURE:FREQUENCY?\n", "%lf", &frequency);
printf("The frequency is: %.4f kHz\n", frequency / 1000);

/* Query for peak to peak voltage. */
viQueryf(vi, ":MEASURE:VPP?\n", "%lf", &vpp);
printf("The peak to peak voltage is: %.2f V\n", vpp);

/* WAVEFORM_DATA - Get waveform data from oscilloscope.
 */
get_waveform();

/* Make some calculations from the preamble data. */
vdiv = 32 * preamble [7];
off = preamble [8];
sdiv = preamble [2] * preamble [4] / 10;
delay = (preamble [2] / 2) * preamble [4] + preamble [5];

/* Print them out... */
printf ("Scope Settings for Channel 1:\n");
printf ("Volts per Division = %f\n", vdiv);
printf ("Offset = %f\n", off);
printf ("Seconds per Division = %f\n", sdiv);
printf ("Delay = %f\n", delay);

/* print out the waveform voltage at selected points */
for (i = 0; i < 1000; i = i + 50)
    printf ("Data Point %4d = %6.2f Volts at %10f Seconds\n", i,
        ((float)waveform_data[i] - preamble[9]) * preamble[7] +
        preamble[8],
        ((float)i - preamble[6]) * preamble[4] + preamble[5]);

save_waveform();          /* Save waveform data to disk. */
retrieve_waveform();      /* Load waveform data from disk. */
}

/*
 * get_waveform
 * -----
 * This function transfers the data displayed on the oscilloscope to
 * the computer for storage, plotting, or further analysis.
 */

void get_waveform (void)
{
    int waveform_size;

    /* WAVEFORM_DATA - To obtain waveform data, you must specify the
     * WAVEFORM parameters for the waveform data prior to sending the
     * ":WAVEFORM:DATA?" query.

```

```

*
* Once these parameters have been sent, the ":WAVEFORM:PREAMBLE?"
* query provides information concerning the vertical and horizontal
* scaling of the waveform data.
*
* With the preamble information you can then use the
* ":WAVEFORM:DATA?" query and read the data block in the
* correct format.
*/

/* WAVE_FORMAT - Sets the data transmission mode for waveform data
* output. This command controls how the data is formatted when
* sent from the oscilloscope and can be set to WORD or BYTE format.
*/

/* Set waveform format to BYTE. */
viPrintf(vi, ":WAVEFORM:FORMAT BYTE\n");

/* WAVE_POINTS - Sets the number of points to be transferred.
* The number of time points available is returned by the
* "ACQUIRE:POINTS?" query. This can be set to any binary
* fraction of the total time points available.
*/
viPrintf(vi, ":WAVEFORM:POINTS 1000\n");

/* GET_PREAMBLE - The preamble contains all of the current WAVEFORM
* settings returned in the form <preamble block><NL> where the
* <preamble block> is:
*   FORMAT      : int16 - 0 = BYTE, 1 = WORD, 4 = ASCII.
*   TYPE        : int16 - 0 = NORMAL, 1 = PEAK DETECT, 2 = AVERAGE.
*   POINTS      : int32 - number of data points transferred.
*   COUNT       : int32 - 1 and is always 1.
*   XINCREMENT  : float64 - time difference between data points.
*   XORIGIN     : float64 - always the first data point in memory.
*   XREFERENCE  : int32 - specifies the data point associated
*                   with the x-origin.
*   YINCREMENT  : float32 - voltage difference between data points.
*   YORIGIN     : float32 - value of the voltage at center screen.
*   YREFERENCE  : int32 - data point where y-origin occurs.
*/
printf("Reading preamble\n");
viQueryf(vi, ":WAVEFORM:PREAMBLE?\n", "%,10lf\n", preamble);
/*
printf("Preamble FORMAT: %e\n", preamble[0]);
printf("Preamble TYPE: %e\n", preamble[1]);
printf("Preamble POINTS: %e\n", preamble[2]);
printf("Preamble COUNT: %e\n", preamble[3]);
printf("Preamble XINCREMENT: %e\n", preamble[4]);
printf("Preamble XORIGIN: %e\n", preamble[5]);
printf("Preamble XREFERENCE: %e\n", preamble[6]);
printf("Preamble YINCREMENT: %e\n", preamble[7]);
printf("Preamble YORIGIN: %e\n", preamble[8]);
printf("Preamble YREFERENCE: %e\n", preamble[9]);
*/

/* QUERY_WAVE_DATA - Outputs waveform records to the controller
* over the interface that is stored in a buffer previously

```

```

    * specified with the ":WAVEFORM:SOURCE" command.
    */
viPrintf(vi, ":WAVEFORM:DATA?\n"); /* Query waveform data. */

/* READ_WAVE_DATA - The wave data consists of two parts: the header,
 * and the actual waveform data followed by an New Line (NL)
 * character. The query data has the following format:
 *
 * <header><waveform data block><NL>
 *
 * Where:
 *
 * <header> = #800002048 (this is an example header)
 *
 * The "#8" may be stripped off of the header and the remaining
 * numbers are the size, in bytes, of the waveform data block.
 * The size can vary depending on the number of points acquired
 * for the waveform which can be set using the ":WAVEFORM:POINTS"
 * command. You may then read that number of bytes from the
 * oscilloscope; then, read the following NL character to
 * terminate the query.
 */
waveform_size = WAVE_DATA_SIZE;
/* Read waveform data. */
viScanf(vi, "%#b\n", &waveform_size, waveform_data);
if ( waveform_size == WAVE_DATA_SIZE )
{
    printf("Waveform data buffer full: ");
    printf("May not have received all points.\n");
}
else
{
    printf("Reading waveform data... size = %d\n", waveform_size);
}
}

/*
 * save_waveform
 * -----
 * This function saves the waveform data from the get_waveform
 * function to disk. The data is saved to a file called "wave.dat".
 */

void save_waveform(void)
{
    FILE *fp;

    fp = fopen("c:\\scope\\data\\wave.dat", "wb");
    /* Write preamble. */
    fwrite(preamble, sizeof(preamble[0]), 10, fp);
    /* Write actually waveform data. */
    fwrite(waveform_data, sizeof(waveform_data[0]), (int)preamble[2],
           fp);
    fclose(fp);
}

/*

```

```

* retrieve_waveform
* -----
* This function retrieves previously saved waveform data from a
* file called "wave.dat".
*/

void retrieve_waveform(void)
{
    FILE *fp;

    fp = fopen("c:\\scope\\data\\wave.dat", "rb");
    /* Read preamble. */
    fread(preamble, sizeof(preamble[0]), 10, fp);
    /* Read the waveform data. */
    fread(waveform_data, sizeof(waveform_data[0]), (int)preamble[2],
          fp);
    fclose(fp);
}

```

### VISA Example in Visual Basic

To run this example in Visual Basic for Applications:

- 1 Start the application that provides Visual Basic for Applications (for example, Microsoft Excel).
- 2 Press ALT+F11 to launch the Visual Basic editor.
- 3 Add the visa32.bas file to your project:
  - a Choose **File>Import File...**
  - b Navigate to the header file, visa32.bas (installed with Agilent IO Libraries Suite and found in the Program Files\VISA\winnt\include directory), select it, and click **Open**.
- 4 Choose **Insert>Module**.
- 5 Cut-and-paste the code that follows into the editor.
- 6 Edit the program to use the VISA address of your oscilloscope, and save the changes.
- 7 Run the program.

```

'
' Agilent VISA Example in Visual Basic
' -----
' This program illustrates a few commonly-used programming
' features of your Agilent oscilloscope.
' -----

Option Explicit

Public err As Long ' Error returned by VISA function calls.
Public drm As Long ' Session to Default Resource Manager.
Public vi As Long ' Session to instrument.

```

```

' Declare variables to hold numeric values returned by
' viVScanf/viVQueryf.
Public dblQueryResult As Double
Public Const ByteArraySize = 5000000
Public retCount As Long
Public byteArray(ByteArraySize) As Byte
Public paramsArray(2) As Long
Public Const DblArraySize = 20
Public dblArray(DblArraySize) As Double

' Declare fixed length string variable to hold string value returned
' by viVScanf/viVQueryf.
Public strQueryResult As String * 200

' For Sleep subroutine.
Private Declare Sub Sleep Lib "kernel32" (ByVal dwMilliseconds As Long)

'
' Main Program
' -----

Sub Main()

    ' Open the default resource manager session.
    err = viOpenDefaultRM(drm)
    If (err <> VI_SUCCESS) Then HandleVISAError drm

    ' Open the session using the oscilloscope's VISA address.
    err = viOpen(drm, _
        "USB0::2391::5970::30D3090541::0::INSTR", 0, 15000, vi)
    If (err <> VI_SUCCESS) Then HandleVISAError drm

    ' Initialize - start from a known state.
    Initialize

    ' Capture data.
    Capture

    ' Analyze the captured waveform.
    Analyze

    ' Close the vi session and the resource manager session.
    err = viClose(vi)
    err = viClose(drm)

End Sub

'
' Initialize the oscilloscope to a known state.
' -----

Private Sub Initialize()

    ' Clear the interface.
    err = viClear(vi)
    If Not (err = VI_SUCCESS) Then HandleVISAError vi

```

## 12 Programming Examples

```
' Get and display the device's *IDN? string.
strQueryResult = DoQueryString("*IDN?")
MsgBox "*IDN? string: " + strQueryResult, vbOKOnly, "*IDN? Result"

' Clear status and load the default setup.
DoCommand "*CLS"
DoCommand "*RST"

End Sub

'
' Capture the waveform.
' -----

Private Sub Capture()

' Set probe attenuation factor (from 0.1 to 1000).
' -----
DoCommand ":CHANnel1:PROBe 10"
Debug.Print "Channel 1 probe attenuation factor: " + _
    DoQueryString(":CHANnel1:PROBe?")

' Use auto-scale to automatically configure oscilloscope.
' -----
DoCommand ":AUToscale"

' Set the trigger mode to EDGE.
DoCommand ":TRIGger:MODE EDGE"
Debug.Print "Trigger mode: " + _
    DoQueryString(":TRIGger:MODE?")

' Set EDGE trigger parameters.
DoCommand ":TRIGger:EDGE:SOURCe CHANnel1"
Debug.Print "Trigger edge source: " + _
    DoQueryString(":TRIGger:EDGE:SOURce?")

DoCommand ":TRIGger:EDGE:LEVel 1.5"
Debug.Print "Trigger edge level: " + _
    DoQueryString(":TRIGger:EDGE:LEVel?")

DoCommand ":TRIGger:EDGE:SLOPe POSitive"
Debug.Print "Trigger edge slope: " + _
    DoQueryString(":TRIGger:EDGE:SLOPe?")

' Save oscilloscope configuration.
' -----
Dim lngSetupStringSize As Long
lngSetupStringSize = DoQueryIIEEEBlock_Bytes(":SYSTem:SETup?")
Debug.Print "Setup bytes saved: " + CStr(lngSetupStringSize)

' Output setup string to a file:
Dim strPath As String
strPath = "c:\scope\config\setup.dat"
If Len(Dir(strPath)) Then
    Kill strPath ' Remove file if it exists.
End If
```

```

' Open file for output.
Dim hFile As Long
hFile = FreeFile
Open strPath For Binary Access Write Lock Write As hFile
Dim lngI As Long
For lngI = 0 To lngSetupStringSize - 1
  Put hFile, , byteArray(lngI) ' Write data.
Next lngI
Close hFile ' Close file.

' Change settings with individual commands:
' -----

' Set vertical scale and offset.
DoCommand ":CHANnel1:SCALE 0.05"
Debug.Print "Channel 1 vertical scale: " + _
  DoQueryString(":CHANnel1:SCALE?")

DoCommand ":CHANnel1:OFFSet -1.5"
Debug.Print "Channel 1 vertical offset: " + _
  DoQueryString(":CHANnel1:OFFSet?")

' Set horizontal scale and offset.
DoCommand ":TIMEbase:SCALE 0.0002"
Debug.Print "Timebase scale: " + _
  DoQueryString(":TIMEbase:SCALE?")

DoCommand ":TIMEbase:POSition 0.0"
Debug.Print "Timebase position: " + _
  DoQueryString(":TIMEbase:POSition?")

' Set the acquisition type to NORMAL.
DoCommand ":ACQuire:TYPE NORMAL"
Debug.Print "Acquire type: " + _
  DoQueryString(":ACQuire:TYPE?")

' Or, configure by loading a previously saved setup.
' -----
strPath = "c:\scope\config\setup.dat"
Open strPath For Binary Access Read As hFile ' Open file for input.
Dim lngSetupFileSize As Long
lngSetupFileSize = LOF(hFile) ' Length of file.
Get hFile, , byteArray ' Read data.
Close hFile ' Close file.
' Write learn string back to oscilloscope using ":SYSTEM:SETup"
' command:
Dim lngRestored As Long
lngRestored = DoCommandIEEEBlock(":SYSTEM:SETup", lngSetupFileSize)
Debug.Print "Setup bytes restored: " + CStr(lngRestored)

' Capture data using :DIGitize.
' -----
DoCommand ":DIGitize"

End Sub

```

## 12 Programming Examples

```
' Analyze the captured waveform.
' -----

Private Sub Analyze()

    ' Make a couple of measurements.
    ' -----
    DoCommand ":MEASure:SOURce CHANnel1"
    Debug.Print "Measure source: " + _
        DoQueryString(":MEASure:SOURce?")

    DoCommand ":MEASure:VAMPlitude"
    dblQueryResult = DoQueryNumber(":MEASure:VAMPlitude?")
    MsgBox "Vertial amplitude:" + vbCrLf + _
        FormatNumber(dblQueryResult, 4) + " V"

    DoCommand ":MEASure:FREQuency"
    dblQueryResult = DoQueryNumber(":MEASure:FREQuency?")
    MsgBox "Frequency:" + vbCrLf + _
        FormatNumber(dblQueryResult / 1000, 4) + " kHz"

    ' Download the screen image.
    ' -----
    ' Get screen image.
    Dim lngBlockSize As Long
    lngBlockSize = _
        DoQueryIEEEBlock_Bytes(":DISPlay:DATA? PNG, SCREEN, COLOR")
    Debug.Print "Screen image bytes: " + CStr(lngBlockSize)

    ' Save screen image to a file:
    Dim strPath As String
    strPath = "c:\scope\data\screen.png"
    If Len(Dir(strPath)) Then
        Kill strPath ' Remove file if it exists.
    End If
    Dim hFile As Long
    hFile = FreeFile
    Open strPath For Binary Access Write Lock Write As hFile
    Dim lngI As Long
    For lngI = 0 To lngBlockSize - 1
        Put hFile, , byteArray(lngI) ' Write data.
    Next lngI
    Close hFile ' Close file.
    MsgBox "Screen image written to " + strPath

    ' Download waveform data.
    ' -----

    ' Set the waveform points mode.
    DoCommand ":WAVEform:POINts:MODE RAW"
    Debug.Print "Waveform points mode: " + _
        DoQueryString(":WAVEform:POINts:MODE?")

    ' Set the desired number of waveform points.
    DoCommand ":WAVEform:POINts 1000"
```

```

Debug.Print "Waveform points desired: " + _
    DoQueryString(":WAVEform:POINTs?")

' Set the waveform source.
DoCommand ":WAVEform:SOURce CHANnel1"
Debug.Print "Waveform source: " + _
    DoQueryString(":WAVEform:SOURce?")

' Choose the format of the data returned (WORD, BYTE, ASCII):
DoCommand ":WAVEform:FORMat BYTE"
Debug.Print "Waveform format: " + _
    DoQueryString(":WAVEform:FORMat?")

' Display the waveform settings:
Dim intFormat As Integer
Dim intType As Integer
Dim lngPoints As Long
Dim lngCount As Long
Dim dblXIncrement As Double
Dim dblXOrigin As Double
Dim lngXReference As Long
Dim sngYIncrement As Single
Dim sngYOrigin As Single
Dim lngYReference As Long
Dim strOutput As String

Dim lngNumNumbers As Long
lngNumNumbers = DoQueryNumbers(":WAVEform:PREAmble?")

intFormat = dblArray(0)
intType = dblArray(1)
lngPoints = dblArray(2)
lngCount = dblArray(3)
dblXIncrement = dblArray(4)
dblXOrigin = dblArray(5)
lngXReference = dblArray(6)
sngYIncrement = dblArray(7)
sngYOrigin = dblArray(8)
lngYReference = dblArray(9)

If intFormat = 0 Then
    Debug.Print "Waveform format: BYTE"
ElseIf intFormat = 1 Then
    Debug.Print "Waveform format: WORD"
ElseIf intFormat = 4 Then
    Debug.Print "Waveform format: ASCii"
End If

If intType = 0 Then
    Debug.Print "Acquisition type: NORMAL"
ElseIf intType = 1 Then
    Debug.Print "Acquisition type: PEAK"
ElseIf intType = 2 Then
    Debug.Print "Acquisition type: AVERAGE"
End If

Debug.Print "Waveform points desired: " + _

```

## 12 Programming Examples

```
        FormatNumber(lngPoints, 0)

Debug.Print "Waveform average count: " + _
    FormatNumber(lngCount, 0)

Debug.Print "Waveform X increment: " + _
    Format(dblXIncrement, "Scientific")

Debug.Print "Waveform X origin: " + _
    Format(dblXOrigin, "Scientific")

Debug.Print "Waveform X reference: " + _
    FormatNumber(lngXReference, 0)

Debug.Print "Waveform Y increment: " + _
    Format(sngYIncrement, "Scientific")

Debug.Print "Waveform Y origin: " + _
    Format(sngYOrigin, "Scientific")

Debug.Print "Waveform Y reference: " + _
    FormatNumber(lngYReference, 0)

' Get the waveform data
Dim lngNumBytes As Long
lngNumBytes = DoQueryIEEEBlock_Bytes(":WAVEform:DATA?")
Debug.Print "Number of data values: " + CStr(lngNumBytes)

' Set up output file:
strPath = "c:\scope\data\waveform_data.csv"

' Open file for output.
Open strPath For Output Access Write Lock Write As hFile

' Output waveform data in CSV format.
Dim lngDataValue As Long

For lngI = 0 To lngNumBytes - 1
    lngDataValue = CLng(byteArray(lngI))

    ' Write time value, voltage value.
    Print #hFile, _
        Format((lngI - lngXReference) * dblXIncrement + _
            dblXOrigin, "Scientific") + ", " + _
        FormatNumber((lngDataValue - lngYReference) * _
            sngYIncrement + sngYOrigin)

Next lngI

' Close output file.
Close hFile ' Close file.
MsgBox "Waveform format BYTE data written to " + _
    "c:\scope\data\waveform_data.csv."

End Sub

Private Sub DoCommand(command As String)
```

```

err = viVPrintf(vi, command + vbLf, 0)
If (err <> VI_SUCCESS) Then HandleVISAError vi

CheckInstrumentErrors

End Sub

Private Function DoCommandIEEEBlock(command As String, _
    lngBlockSize As Long)

retCount = lngBlockSize

Dim strCommandAndLength As String
strCommandAndLength = command + " %#" + _
    Format(lngBlockSize) + "b"

err = viVPrintf(vi, strCommandAndLength + vbLf, paramsArray(1))
If (err <> VI_SUCCESS) Then HandleVISAError vi

DoCommandIEEEBlock = retCount

CheckInstrumentErrors

End Function

Private Function DoQueryString(query As String) As String

Dim strResult As String * 200

err = viVPrintf(vi, query + vbLf, 0)
If (err <> VI_SUCCESS) Then HandleVISAError vi

err = viVScanf(vi, "%t", strResult)
If (err <> VI_SUCCESS) Then HandleVISAError vi

DoQueryString = strResult

CheckInstrumentErrors

End Function

Private Function DoQueryNumber(query As String) As Variant

Dim dblResult As Double

err = viVPrintf(vi, query + vbLf, 0)
If (err <> VI_SUCCESS) Then HandleVISAError vi

err = viVScanf(vi, "%lf" + vbLf, VarPtr(dblResult))
If (err <> VI_SUCCESS) Then HandleVISAError vi

DoQueryNumber = dblResult

CheckInstrumentErrors

End Function

```

## 12 Programming Examples

```
Private Function DoQueryNumbers(query As String) As Long

    Dim dblResult As Double

    ' Send query.
    err = viVPrintf(vi, query + vbLf, 0)
    If (err <> VI_SUCCESS) Then HandleVISAError vi

    ' Set up paramsArray for multiple parameter query returning array.
    paramsArray(0) = VarPtr(retCount)
    paramsArray(1) = VarPtr(dblArray(0))

    ' Set retCount to max number of elements array can hold.
    retCount = DblArraySize

    ' Read numbers.
    err = viVScanf(vi, "%,#lf" + vbLf, paramsArray(0))
    If (err <> VI_SUCCESS) Then HandleVISAError vi

    ' retCount is now actual number of values returned by query.
    DoQueryNumbers = retCount

    CheckInstrumentErrors

End Function
```

```
Private Function DoQueryIEEEBlock_Bytes(query As String) As Long

    ' Send query.
    err = viVPrintf(vi, query + vbLf, 0)
    If (err <> VI_SUCCESS) Then HandleVISAError vi

    ' Set up paramsArray for multiple parameter query returning array.
    paramsArray(0) = VarPtr(retCount)
    paramsArray(1) = VarPtr(byteArray(0))

    ' Set retCount to max number of elements array can hold.
    retCount = ByteArraySize

    ' Get unsigned integer bytes.
    Sleep 2000 ' Delay before reading data.
    err = viVScanf(vi, "%#b" + vbLf, paramsArray(0))
    If (err <> VI_SUCCESS) Then HandleVISAError vi

    err = viFlush(vi, VI_READ_BUF)
    If (err <> VI_SUCCESS) Then HandleVISAError vi

    err = viFlush(vi, VI_WRITE_BUF)
    If (err <> VI_SUCCESS) Then HandleVISAError vi

    ' retCount is now actual number of bytes returned by query.
    DoQueryIEEEBlock_Bytes = retCount

    CheckInstrumentErrors

End Function
```

```

Private Sub CheckInstrumentErrors()

    On Error GoTo ErrorHandler

    Dim strErrVal As String * 200
    Dim strOut As String

    err = viVPrintf(vi, ":SYSTem:ERRor?" + vbLf, 0) ' Query any errors.
    If (err <> VI_SUCCESS) Then HandleVISAError vi

    err = viVScanf(vi, "%t", strErrVal) ' Read: Errnum,"Error String".
    If (err <> VI_SUCCESS) Then HandleVISAError vi

    While Val(strErrVal) <> 0 ' End if find: 0,"No Error".
        strOut = strOut + "INST Error: " + strErrVal

        err = viVPrintf(vi, ":SYSTem:ERRor?" + vbLf, 0) ' Request error.
        If (err <> VI_SUCCESS) Then HandleVISAError vi

        err = viVScanf(vi, "%t", strErrVal) ' Read error message.
        If (err <> VI_SUCCESS) Then HandleVISAError vi

    Wend

    If Not strOut = "" Then
        MsgBox strOut, vbExclamation, "INST Error Messages"

        err = viFlush(vi, VI_READ_BUF)
        If (err <> VI_SUCCESS) Then HandleVISAError vi

        err = viFlush(vi, VI_WRITE_BUF)
        If (err <> VI_SUCCESS) Then HandleVISAError vi

    End If

    Exit Sub

ErrorHandler:

    MsgBox "*** Error : " + Error, vbExclamation
    End

End Sub

Private Sub HandleVISAError(session As Long)

    Dim strVisaErr As String * 200
    Call viStatusDesc(session, err, strVisaErr)
    MsgBox "*** VISA Error : " + strVisaErr, vbExclamation

    ' If the error is not a warning, close the session.
    If err < VI_SUCCESS Then
        If session <> 0 Then Call viClose(session)
        End
    End If

```

End Sub

### VISA Example in C#

To compile and run this example in Microsoft Visual Studio 2005:

- 1 Open Visual Studio.
- 2 Create a new Visual C#, Windows, Console Application project.
- 3 Cut-and-paste the code that follows into the C# source file.
- 4 Edit the program to use the VISA address of your oscilloscope.
- 5 Add Agilent's VISA header file to your project:
  - a Right-click the project you wish to modify (not the solution) in the Solution Explorer window of the Microsoft Visual Studio environment.
  - b Click **Add** and then click **Add Existing Item...**
  - c Navigate to the header file, visa32.cs (installed with Agilent IO Libraries Suite and found in the Program Files\VISA\winnt\include directory), select it, but *do not click the Open button*.
  - d Click the down arrow to the right of the **Add** button, and choose **Add as Link**.

You should now see the file underneath your project in the Solution Explorer. It will have a little arrow icon in its lower left corner, indicating that it is a link.

- 6 Build and run the program.

For more information, see the tutorial on using VISA in Microsoft .NET in the VISA Help that comes with Agilent IO Libraries Suite 15.

```
/*
 * Agilent VISA Example in C#
 * -----
 * This program illustrates most of the commonly used programming
 * features of your Agilent oscilloscopes.
 * -----
 */

using System;
using System.IO;
using System.Text;

namespace InfiniiVision
{
    class VisaInstrumentApp
    {
        private static VisaInstrument oscp;

        public static void Main(string[] args)
```

```

{
    try
    {
        oscp = new
            VisaInstrument("USB0::2391::5957::MY47250010::0::INSTR");

        Initialize();

        /* The extras function contains miscellaneous commands that
         * do not need to be executed for the proper operation of
         * this example. The commands in the extras function are
         * shown for reference purposes only.
         */
        // Extra(); // Uncomment to execute the extra function.
        Capture();
        Analyze();
    }
    catch (System.ApplicationException err)
    {
        Console.WriteLine("*** VISA Error Message : " + err.Message);
    }
    catch (System.SystemException err)
    {
        Console.WriteLine("*** System Error Message : " + err.Message);
    }
    catch (System.Exception err)
    {
        System.Diagnostics.Debug.Fail("Unexpected Error");
        Console.WriteLine("*** Unexpected Error : " + err.Message);
    }
    finally
    {
        oscp.Close();
    }
}

/*
 * Initialize()
 * -----
 * This function initializes both the interface and the
 * oscilloscope to a known state.
 */
private static void Initialize()
{
    StringBuilder strResults;

    /* RESET - This command puts the oscilloscope into a known
     * state. This statement is very important for programs to
     * work as expected. Most of the following initialization
     * commands are initialized by *RST. It is not necessary to
     * reinitialize them unless the default setting is not suitable
     * for your application.
     */
    oscp.DoCommand("*RST"); // Reset the to the defaults.
    oscp.DoCommand("*CLS"); // Clear the status data structures.

    /* IDN - Ask for the device's *IDN string.

```

## 12 Programming Examples

```
    */
    strResults = oscp.DoQueryString("*IDN?");

    // Display results.
    Console.WriteLine("Result is: {0}", strResults);

    /* AUTOSCALE - This command evaluates all the input signals
     * and sets the correct conditions to display all of the
     * active signals.
     */
    oscp.DoCommand(":AUToscale");

    /* CHANNEL_PROBE - Sets the probe attenuation factor for the
     * selected channel. The probe attenuation factor may be from
     * 0.1 to 1000.
     */
    oscp.DoCommand(":CHANnel1:PROBe 10");

    /* CHANNEL_RANGE - Sets the full scale vertical range in volts.
     * The range value is eight times the volts per division.
     */
    oscp.DoCommand(":CHANnel1:RANGE 8");

    /* TIME_RANGE - Sets the full scale horizontal time in seconds.
     * The range value is ten times the time per division.
     */
    oscp.DoCommand(":TIMEbase:RANGE 2e-3");

    /* TIME_REFERENCE - Possible values are LEFT and CENTER:
     * - LEFT sets the display reference one time division from
     *   the left.
     * - CENTER sets the display reference to the center of the
     *   screen.
     */
    oscp.DoCommand(":TIMEbase:REFerence CENTER");

    /* TRIGGER_SOURCE - Selects the channel that actually produces
     * the TV trigger. Any channel can be selected.
     */
    oscp.DoCommand(":TRIGger:TV:SOURCe CHANnel1");

    /* TRIGGER_MODE - Set the trigger mode to, EDGE, GLITCh,
     * PATTern, CAN, DURation, IIC, LIN, SEQUence, SPI, TV,
     * UART, or USB.
     */
    oscp.DoCommand(":TRIGger:MODE EDGE");

    /* TRIGGER_EDGE_SLOPE - Set the slope of the edge for the
     * trigger to either POSITIVE or NEGATIVE.
     */
    oscp.DoCommand(":TRIGger:EDGE:SLOPe POSitive");
}

/*
 * Extra()
 * -----
 * The commands in this function are not executed and are shown
 */
```

```

* for reference purposes only. To execute these commands, call
* this function from main.
*/
private static void Extra()
{
    /* RUN_STOP (not executed in this example):
    * - RUN starts the acquisition of data for the active
    *   waveform display.
    * - STOP stops the data acquisition and turns off AUTOSTORE.
    */
    oscp.DoCommand(":RUN");
    oscp.DoCommand(":STOP");

    /* VIEW_BLANK (not executed in this example):
    * - VIEW turns on (starts displaying) an active channel or
    *   pixel memory.
    * - BLANK turns off (stops displaying) a specified channel or
    *   pixel memory.
    */
    oscp.DoCommand(":BLANK CHANnel1");
    oscp.DoCommand(":VIEW CHANnel1");

    /* TIME_MODE (not executed in this example) - Set the time base
    * mode to MAIN, DELAYED, XY or ROLL.
    */
    oscp.DoCommand(":TIMEbase:MODE MAIN");
}

/*
* Capture()
* -----
* This function prepares the scope for data acquisition and then
* uses the DIGITIZE MACRO to capture some data.
*/
private static void Capture()
{
    /* ACQUIRE_TYPE - Sets the acquisition mode. There are three
    * acquisition types NORMAL, PEAK, or AVERAGE.
    */
    oscp.DoCommand(":ACquire:TYPE NORMal");

    /* ACQUIRE_COMPLETE - Specifies the minimum completion criteria
    * for an acquisition. The parameter determines the percentage
    * of time buckets needed to be "full" before an acquisition is
    * considered to be complete.
    */
    oscp.DoCommand(":ACquire:COMPLETE 100");

    /* DIGITIZE - Used to acquire the waveform data for transfer
    * over the interface. Sending this command causes an
    * acquisition to take place with the resulting data being
    * placed in the buffer.
    */

    /* NOTE! The use of the DIGITIZE command is highly recommended
    * as it will ensure that sufficient data is available for
    * measurement. Keep in mind when the oscilloscope is running,

```

```

    * communication with the computer interrupts data acquisition.
    * Setting up the oscilloscope over the bus causes the data
    * buffers to be cleared and internal hardware to be
    * reconfigured.
    * If a measurement is immediately requested there may not have
    * been enough time for the data acquisition process to collect
    * data and the results may not be accurate. An error value of
    * 9.9E+37 may be returned over the bus in this situation.
    */
    oscp.DoCommand(":DIGitize CHANnel1");
}

/*
 * Analyze()
 * -----
 * In this example we will do the following:
 * - Save the system setup to a file for restoration at a later
 *   time.
 * - Save the oscilloscope display to a file which can be
 *   printed.
 * - Make single channel measurements.
 */
private static void Analyze()
{
    byte[] ResultsArray; // Results array.
    int nLength; // Number of bytes returned from instrument.

    /* SAVE_SYSTEM_SETUP - The :SYSTEM:SETup? query returns a
     * program message that contains the current state of the
     * instrument. Its format is a definite-length binary block,
     * for example,
     * #800002204<setup string><NL>
     * where the setup string is 2204 bytes in length.
     */
    Console.WriteLine("Saving oscilloscope setup to " +
        "c:\\scope\\config\\setup.dat");
    if (File.Exists("c:\\scope\\config\\setup.dat"))
        File.Delete("c:\\scope\\config\\setup.dat");

    // Query and read setup string.
    nLength = oscp.DoQueryIEEEBlock(":SYSTEM:SETup?",
        out ResultsArray);
    Console.WriteLine("Read oscilloscope setup ({0} bytes).",
        nLength);

    // Write setup string to file.
    File.WriteAllBytes("c:\\scope\\config\\setup.dat",
        ResultsArray);
    Console.WriteLine("Wrote setup string ({0} bytes) to file.",
        nLength);

    /* RESTORE_SYSTEM_SETUP - Uploads a previously saved setup
     * string to the oscilloscope.
     */
    byte[] DataArray;
    int nBytesWritten;

```

```

// Read setup string from file.
dataArray = File.ReadAllBytes("c:\\scope\\config\\setup.dat");
Console.WriteLine("Read setup string ({0} bytes) from file.",
    dataArray.Length);

// Restore setup string.
nBytesWritten = oscp.DoCommandIEEEBlock(":SYSTem:SETup",
    dataArray);
Console.WriteLine("Restored setup string ({0} bytes).",
    nBytesWritten);

/* IMAGE_TRANSFER - In this example, we query for the screen
 * data with the ":DISPLAY:DATA?" query. The .png format
 * data is saved to a file in the local file system.
 */
Console.WriteLine("Transferring screen image to " +
    "c:\\scope\\data\\screen.png");
if (File.Exists("c:\\scope\\data\\screen.png"))
    File.Delete("c:\\scope\\data\\screen.png");

// Increase I/O timeout to fifteen seconds.
oscp.SetTimeoutSeconds(15);

// Get the screen data in PNG format.
nLength = oscp.DoQueryIEEEBlock(
    ":DISPlay:DATA? PNG, SCReen, COLOr", out ResultsArray);
Console.WriteLine("Read screen image ({0} bytes).", nLength);

// Store the screen data in a file.
File.WriteAllBytes("c:\\scope\\data\\screen.png",
    ResultsArray);
Console.WriteLine("Wrote screen image ({0} bytes) to file.",
    nLength);

// Return I/O timeout to five seconds.
oscp.SetTimeoutSeconds(5);

/* MEASURE - The commands in the MEASURE subsystem are used to
 * make measurements on displayed waveforms.
 */

// Set source to measure.
oscp.DoCommand(":MEASure:SOURce CHANnel1");

// Query for frequency.
double fResults;
fResults = oscp.DoQueryValue(":MEASure:FREQuency?");
Console.WriteLine("The frequency is: {0:F4} kHz",
    fResults / 1000);

// Query for peak to peak voltage.
fResults = oscp.DoQueryValue(":MEASure:VPP?");
Console.WriteLine("The peak to peak voltage is: {0:F2} V",
    fResults);

/* WAVEFORM_DATA - Get waveform data from oscilloscope. To
 * obtain waveform data, you must specify the WAVEFORM

```

```

* parameters for the waveform data prior to sending the
* ":WAVEFORM:DATA?" query.
*
* Once these parameters have been sent, the
* ":WAVEFORM:PREAMBLE?" query provides information concerning
* the vertical and horizontal scaling of the waveform data.
*
* With the preamble information you can then use the
* ":WAVEFORM:DATA?" query and read the data block in the
* correct format.
*/

/* WAVE_FORMAT - Sets the data transmission mode for waveform
* data output. This command controls how the data is
* formatted when sent from the oscilloscope and can be set
* to WORD or BYTE format.
*/

// Set waveform format to BYTE.
oscp.DoCommand(":WAVEform:FORMat BYTE");

/* WAVE_POINTS - Sets the number of points to be transferred.
* The number of time points available is returned by the
* "ACQUIRE:POINTS?" query. This can be set to any binary
* fraction of the total time points available.
*/
oscp.DoCommand(":WAVEform:POINTs 1000");

/* GET_PREAMBLE - The preamble contains all of the current
* WAVEFORM settings returned in the form <preamble block><NL>
* where the <preamble block> is:
*   FORMAT      : int16 - 0 = BYTE, 1 = WORD, 4 = ASCII.
*   TYPE        : int16 - 0 = NORMAL, 1 = PEAK DETECT,
*                2 = AVERAGE.
*   POINTS      : int32 - number of data points transferred.
*   COUNT       : int32 - 1 and is always 1.
*   XINCREMENT  : float64 - time difference between data
*                        points.
*   XORIGIN     : float64 - always the first data point in
*                        memory.
*   XREFERENCE  : int32 - specifies the data point associated
*                        with the x-origin.
*   YINCREMENT  : float32 - voltage difference between data
*                        points.
*   YORIGIN     : float32 - value of the voltage at center
*                        screen.
*   YREFERENCE  : int32 - data point where y-origin occurs.
*/
Console.WriteLine("Reading preamble.");
double[] fResultsArray;
fResultsArray = oscp.DoQueryValues(":WAVEform:PREAmble?");

double fFormat = fResultsArray[0];
Console.WriteLine("Preamble FORMat: {0:e}", fFormat);

double fType = fResultsArray[1];
Console.WriteLine("Preamble TYPE: {0:e}", fType);

```

```

double fPoints = fResultsArray[2];
Console.WriteLine("Preamble POINTs: {0:e}", fPoints);

double fCount = fResultsArray[3];
Console.WriteLine("Preamble COUNT: {0:e}", fCount);

double fXincrement = fResultsArray[4];
Console.WriteLine("Preamble XINCrement: {0:e}", fXincrement);

double fXorigin = fResultsArray[5];
Console.WriteLine("Preamble XORigin: {0:e}", fXorigin);

double fXreference = fResultsArray[6];
Console.WriteLine("Preamble XREFerence: {0:e}", fXreference);

double fYincrement = fResultsArray[7];
Console.WriteLine("Preamble YINCrement: {0:e}", fYincrement);

double fYorigin = fResultsArray[8];
Console.WriteLine("Preamble YORigin: {0:e}", fYorigin);

double fYreference = fResultsArray[9];
Console.WriteLine("Preamble YREFerence: {0:e}", fYreference);

/* QUERY_WAVE_DATA - Outputs waveform records to the controller
 * over the interface that is stored in a buffer previously
 * specified with the ":WAVEform:SOURce" command.
 */

/* READ_WAVE_DATA - The wave data consists of two parts: the
 * header, and the actual waveform data followed by a
 * New Line (NL) character. The query data has the following
 * format:
 *
 * <header><waveform data block><NL>
 *
 * Where:
 *
 * <header> = #800002048 (this is an example header)
 *
 * The "#8" may be stripped off of the header and the remaining
 * numbers are the size, in bytes, of the waveform data block.
 * The size can vary depending on the number of points acquired
 * for the waveform which can be set using the
 * ":WAVEFORM:POINTS" command. You may then read that number
 * of bytes from the oscilloscope; then, read the following NL
 * character to terminate the query.
 */

// Read waveform data.
nLength = oscp.DoQueryIEEEBlock(":WAVEform:DATA?",
    out ResultsArray);
Console.WriteLine("Read waveform data ({0} bytes).", nLength);

// Make some calculations from the preamble data.
double fVdiv = 32 * fYincrement;

```

## 12 Programming Examples

```
double fOffset = fYorigin;
double fSdiv = fPoints * fXincrement / 10;
double fDelay = (fPoints / 2) * fXincrement + fXorigin;

// Print them out...
Console.WriteLine("Scope Settings for Channel 1:");
Console.WriteLine("Volts per Division = {0:f}", fVdiv);
Console.WriteLine("Offset = {0:f}", fOffset);
Console.WriteLine("Seconds per Division = {0:e}", fSdiv);
Console.WriteLine("Delay = {0:e}", fDelay);

// Print the waveform voltage at selected points:
for (int i = 0; i < 1000; i = i + 50)
    Console.WriteLine("Data point {0:d} = {1:f2} Volts at "
        + "{2:f10} Seconds", i,
        ((float)ResultsArray[i] - fYreference) * fYincrement +
        fYorigin,
        ((float)i - fXreference) * fXincrement + fXorigin);

/* SAVE_WAVE_DATA - saves the waveform data to a CSV format
 * file named "waveform.csv".
 */
if (File.Exists("c:\\scope\\data\\waveform.csv"))
    File.Delete("c:\\scope\\data\\waveform.csv");

StreamWriter writer =
    File.CreateText("c:\\scope\\data\\waveform.csv");
for (int i = 0; i < 1000; i++)
    writer.WriteLine("{0:E}, {1:f6}",
        ((float)i - fXreference) * fXincrement + fXorigin,
        ((float)ResultsArray[i] - fYreference) * fYincrement +
        fYorigin);
writer.Close();
}
}

class VisaInstrument
{
    private int m_nResourceManager;
    private int m_nSession;
    private string m_strVisaAddress;

    // Constructor.
    public VisaInstrument(string strVisaAddress)
    {
        // Save VISA address in member variable.
        m_strVisaAddress = strVisaAddress;

        // Open the default VISA resource manager.
        OpenResourceManager();

        // Open a VISA resource session.
        OpenSession();

        // Clear the interface.
        int nViStatus;
        nViStatus = visa32.viClear(m_nSession);
    }
}
```

```

}

public void DoCommand(string strCommand)
{
    // Send the command.
    VisaSendCommandOrQuery(strCommand);

    // Check for instrument errors (another command and result).
    CheckForInstrumentErrors(strCommand);
}

public int DoCommandIEEEBlock(string strCommand,
    byte[] DataArray)
{
    // Send the command to the device.
    string strCommandAndLength;
    int nViStatus, nLength, nBytesWritten;

    nLength = DataArray.Length;
    strCommandAndLength = String.Format("{0} #8{1:D8}",
        strCommand, nLength);

    // Write first part of command to formatted I/O write buffer.
    nViStatus = visa32.viPrintf(m_nSession, strCommandAndLength);
    CheckVisaStatus(nViStatus);

    // Write the data to the formatted I/O write buffer.
    nViStatus = visa32.viBufWrite(m_nSession, DataArray, nLength,
        out nBytesWritten);
    CheckVisaStatus(nViStatus);

    // Write command termination character.
    nViStatus = visa32.viPrintf(m_nSession, "\n");
    CheckVisaStatus(nViStatus);

    // Check for instrument errors (another command and result).
    CheckForInstrumentErrors(strCommand);

    return nBytesWritten;
}

public StringBuilder DoQueryString(string strQuery)
{
    // Send the query.
    VisaSendCommandOrQuery(strQuery);

    // Get the result string.
    StringBuilder strResults = new StringBuilder(1000);
    strResults = VisaGetResultString();

    // Check for instrument errors (another command and result).
    CheckForInstrumentErrors(strQuery);

    // Return string results.
    return strResults;
}

```

```
public double DoQueryValue(string strQuery)
{
    // Send the query.
    VisaSendCommandOrQuery(strQuery);

    // Get the result string.
    double fResults;
    fResults = VisaGetResultValue();

    // Check for instrument errors (another command and result).
    CheckForInstrumentErrors(strQuery);

    // Return string results.
    return fResults;
}

public double[] DoQueryValues(string strQuery)
{
    // Send the query.
    VisaSendCommandOrQuery(strQuery);

    // Get the result string.
    double[] fResultsArray;
    fResultsArray = VisaGetResultValues();

    // Check for instrument errors (another command and result).
    CheckForInstrumentErrors(strQuery);

    // Return string results.
    return fResultsArray;
}

public int DoQueryIEEEBlock(string strQuery,
    out byte[] ResultsArray)
{
    // Send the query.
    VisaSendCommandOrQuery(strQuery);

    // Get the result string.
    int length; // Number of bytes returned from instrument.
    length = VisaGetResultIEEEBlock(out ResultsArray);

    // Check for instrument errors (another command and result).
    CheckForInstrumentErrors(strQuery);

    // Return string results.
    return length;
}

private void CheckForInstrumentErrors(string strCommand)
{
    // Check for instrument errors.
    StringBuilder strInstrumentError = new StringBuilder(1000);
    bool bFirstError = true;
    do
    {
        VisaSendCommandOrQuery(":SYSTem:ERRor?");
```

```

        strInstrumentError = VisaGetResultString();

        if (strInstrumentError.ToString() != "+0,\"No error\"\\n")
        {
            if (bFirstError)
            {
                Console.WriteLine("ERROR(s) for command '{0}': ",
                    strCommand);
                bFirstError = false;
            }
            Console.Write(strInstrumentError);
        }
    } while (strInstrumentError.ToString() != "+0,\"No error\"\\n");
}

private void VisaSendCommandOrQuery(string strCommandOrQuery)
{
    // Send command or query to the device.
    string strWithNewline;
    strWithNewline = String.Format("{0}\\n", strCommandOrQuery);
    int nViStatus;
    nViStatus = visa32.viPrintf(m_nSession, strWithNewline);
    CheckVisaStatus(nViStatus);
}

private StringBuilder VisaGetResultString()
{
    StringBuilder strResults = new StringBuilder(1000);

    // Read return value string from the device.
    int nViStatus;
    nViStatus = visa32.viScanf(m_nSession, "%1000t", strResults);
    CheckVisaStatus(nViStatus);

    return strResults;
}

private double VisaGetResultValue()
{
    double fResults = 0;

    // Read return value string from the device.
    int nViStatus;
    nViStatus = visa32.viScanf(m_nSession, "%lf", out fResults);
    CheckVisaStatus(nViStatus);

    return fResults;
}

private double[] VisaGetResultValues()
{
    double[] fResultsArray;
    fResultsArray = new double[10];

    // Read return value string from the device.
    int nViStatus;
    nViStatus = visa32.viScanf(m_nSession, "%,10lf\\n",

```

## 12 Programming Examples

```
        fResultsArray);
    CheckVisaStatus(nViStatus);

    return fResultsArray;
}

private int VisaGetResultIEEEBlock(out byte[] ResultsArray)
{
    // Results array, big enough to hold a PNG.
    ResultsArray = new byte[300000];
    int length;    // Number of bytes returned from instrument.

    // Set the default number of bytes that will be contained in
    // the ResultsArray to 300,000 (300kB).
    length = 300000;

    // Read return value string from the device.
    int nViStatus;
    nViStatus = visa32.viScanf(m_nSession, "%#b", ref length,
        ResultsArray);
    CheckVisaStatus(nViStatus);

    // Write and read buffers need to be flushed after IEEE block?
    nViStatus = visa32.viFlush(m_nSession, visa32.VI_WRITE_BUF);
    CheckVisaStatus(nViStatus);
    nViStatus = visa32.viFlush(m_nSession, visa32.VI_READ_BUF);
    CheckVisaStatus(nViStatus);

    return length;
}

private void OpenResourceManager()
{
    int nViStatus;
    nViStatus =
        visa32.viOpenDefaultRM(out this.m_nResourceManager);
    if (nViStatus < visa32.VI_SUCCESS)
        throw new
            ApplicationException("Failed to open Resource Manager");
}

private void OpenSession()
{
    int nViStatus;
    nViStatus = visa32.viOpen(this.m_nResourceManager,
        this.m_strVisaAddress, visa32.VI_NO_LOCK,
        visa32.VI_TMO_IMMEDIATE, out this.m_nSession);
    CheckVisaStatus(nViStatus);
}

public void SetTimeoutSeconds(int nSeconds)
{
    int nViStatus;
    nViStatus = visa32.viSetAttribute(this.m_nSession,
        visa32.VI_ATTR_TMO_VALUE, nSeconds * 1000);
    CheckVisaStatus(nViStatus);
}
```

```

public void CheckVisaStatus(int nViStatus)
{
    // If VISA error, throw exception.
    if (nViStatus < visa32.VI_SUCCESS)
    {
        StringBuilder strError = new StringBuilder(256);
        visa32.viStatusDesc(this.m_nResourceManager, nViStatus,
            strError);
        throw new ApplicationException(strError.ToString());
    }
}

public void Close()
{
    if (m_nSession != 0)
        visa32.viClose(m_nSession);
    if (m_nResourceManager != 0)
        visa32.viClose(m_nResourceManager);
}
}
}

```

## VISA Example in Visual Basic .NET

To compile and run this example in Microsoft Visual Studio 2005:

- 1 Open Visual Studio.
- 2 Create a new Visual Basic, Windows, Console Application project.
- 3 Cut-and-paste the code that follows into the Visual Basic .NET source file.
- 4 Edit the program to use the VISA address of your oscilloscope.
- 5 Add Agilent's VISA header file to your project:
  - a Right-click the project you wish to modify (not the solution) in the Solution Explorer window of the Microsoft Visual Studio environment.
  - b Choose **Add** and then choose **Add Existing Item...**
  - c Navigate to the header file, visa32.vb (installed with Agilent IO Libraries Suite and found in the Program Files\VISA\winnt\include directory), select it, but *do not click the Open button*.
  - d Click the down arrow to the right of the **Add** button, and choose **Add as Link**.

You should now see the file underneath your project in the Solution Explorer. It will have a little arrow icon in its lower left corner, indicating that it is a link.

- e Right-click the project again and choose **Properties**; then, select "InfiniiVision.VisaInstrumentApp" as the **Startup object**.

## 6 Build and run the program.

For more information, see the tutorial on using VISA in Microsoft .NET in the VISA Help that comes with Agilent IO Libraries Suite 15.

```

'
' Agilent VISA Example in Visual Basic .NET
' -----
' This program illustrates most of the commonly-used programming
' features of your Agilent oscilloscope.
' -----

Imports System
Imports System.IO
Imports System.Text

Namespace InfiniiVision
  Class VisaInstrumentApp
    Private Shared oscp As VisaInstrument

    Public Shared Sub Main(ByVal args As String())
      Try
        oscp = _
          New VisaInstrument("USB0::2391::5957::MY47250010::0::INSTR")

        Initialize()

        ' The extras function contains miscellaneous commands that
        ' do not need to be executed for the proper operation of
        ' this example. The commands in the extras function are
        ' shown for reference purposes only.

        ' Extra() ' Uncomment to execute the extra function.
        Capture()
        Analyze()
      Catch err As System.ApplicationException
        MsgBox("*** Error : " & err.Message, vbExclamation, _
          "VISA Error Message")
        Exit Sub
      Catch err As System.SystemException
        MsgBox("*** Error : " & err.Message, vbExclamation, _
          "System Error Message")
        Exit Sub
      Catch err As System.Exception
        Debug.Fail("Unexpected Error")
        MsgBox("*** Error : " & err.Message, vbExclamation, _
          "Unexpected Error")
        Exit Sub
      Finally
        oscp.Close()
      End Try
    End Sub

    ' Initialize()
    ' -----
    ' This function initializes both the interface and the
    ' oscilloscope to a known state.

```

```

Private Shared Sub Initialize()
    Dim strResults As StringBuilder

    ' RESET - This command puts the oscilloscope into a known
    ' state. This statement is very important for programs to
    ' work as expected. Most of the following initialization
    ' commands are initialized by *RST. It is not necessary to
    ' reinitialize them unless the default setting is not suitable
    ' for your application.

    ' Reset the to the defaults.
    oscp.DoCommand("*RST")
    ' Clear the status data structures.
    oscp.DoCommand("*CLS")

    ' IDN - Ask for the device's *IDN string.
    strResults = oscp.DoQueryString("*IDN?")
    ' Display results.
    Console.WriteLine("Result is: {0}", strResults)

    ' AUTOSCALE - This command evaluates all the input signals
    ' and sets the correct conditions to display all of the
    ' active signals.
    oscp.DoCommand(":AUToscale")

    ' CHANNEL_PROBE - Sets the probe attenuation factor for the
    ' selected channel. The probe attenuation factor may be from
    ' 0.1 to 1000.
    oscp.DoCommand(":CHANnel1:PROBe 10")

    ' CHANNEL_RANGE - Sets the full scale vertical range in volts.
    ' The range value is eight times the volts per division.
    oscp.DoCommand(":CHANnel1:RANGe 8")

    ' TIME_RANGE - Sets the full scale horizontal time in seconds.
    ' The range value is ten times the time per division.
    oscp.DoCommand(":TIMEbase:RANGe 2e-3")

    ' TIME_REFERENCE - Possible values are LEFT and CENTER:
    ' - LEFT sets the display reference one time division from
    ' the left.
    ' - CENTER sets the display reference to the center of the
    ' screen.
    oscp.DoCommand(":TIMEbase:REFerence CENTer")

    ' TRIGGER_SOURCE - Selects the channel that actually produces
    ' the TV trigger. Any channel can be selected.
    oscp.DoCommand(":TRIGger:TV:SOURCe CHANnel1")

    ' TRIGGER_MODE - Set the trigger mode to, EDGE, GLITCh,
    ' PATTern, CAN, DURation, IIC, LIN, SEQuence, SPI, TV,
    ' UART, or USB.
    oscp.DoCommand(":TRIGger:MODE EDGE")

    ' TRIGGER_EDGE_SLOPE - Set the slope of the edge for the
    ' trigger to either POSITIVE or NEGATIVE.

```

## 12 Programming Examples

```
    oscp.DoCommand(":TRIGger:EDGE:SLOPe POSitive")

End Sub

' Extra()
' -----
' The commands in this function are not executed and are shown
' for reference purposes only. To execute these commands, call
' this function from main.

Private Shared Sub Extra()

    ' RUN_STOP (not executed in this example):
    ' - RUN starts the acquisition of data for the active
    '   waveform display.
    ' - STOP stops the data acquisition and turns off AUTOSTORE.
    oscp.DoCommand(":RUN")
    oscp.DoCommand(":STOP")

    ' VIEW_BLANK (not executed in this example):
    ' - VIEW turns on (starts displaying) an active channel or
    '   pixel memory.
    ' - BLANK turns off (stops displaying) a specified channel or
    '   pixel memory.
    oscp.DoCommand(":BLANK CHANnel1")
    oscp.DoCommand(":VIEW CHANnel1")

    ' TIME_MODE (not executed in this example) - Set the time base
    ' mode to MAIN, DELAYED, XY or ROLL.
    oscp.DoCommand(":TIMEbase:MODE MAIN")

End Sub

' Capture()
' -----
' This function prepares the scope for data acquisition and then
' uses the DIGITIZE MACRO to capture some data.

Private Shared Sub Capture()

    ' ACQUIRE_TYPE - Sets the acquisition mode. There are three
    ' acquisition types NORMAL, PEAK, or AVERAGE.
    oscp.DoCommand(":ACQuire:TYPE NORMal")

    ' ACQUIRE_COMPLETE - Specifies the minimum completion criteria
    ' for an acquisition. The parameter determines the percentage
    ' of time buckets needed to be "full" before an acquisition is
    ' considered to be complete.
    oscp.DoCommand(":ACQuire:COMplete 100")

    ' DIGITIZE - Used to acquire the waveform data for transfer
    ' over the interface. Sending this command causes an
    ' acquisition to take place with the resulting data being
    ' placed in the buffer.

    ' NOTE! The use of the DIGITIZE command is highly recommended
```

```

' as it will ensure that sufficient data is available for
' measurement. Keep in mind when the oscilloscope is running,
' communication with the computer interrupts data acquisition.
' Setting up the oscilloscope over the bus causes the data
' buffers to be cleared and internal hardware to be
' reconfigured.
' If a measurement is immediately requested there may not have
' been enough time for the data acquisition process to collect
' data and the results may not be accurate. An error value of
' 9.9E+37 may be returned over the bus in this situation.
'
'
oscp.DoCommand(":DIGitize CHANnel1")
End Sub

' Analyze()
' -----
' In this example we will do the following:
' - Save the system setup to a file for restoration at a later
'   time.
' - Save the oscilloscope display to a file which can be
'   printed.
' - Make single channel measurements.

Private Shared Sub Analyze()

' Results array.
Dim ResultsArray As Byte()
' Number of bytes returned from instrument.
Dim nLength As Integer

' SAVE_SYSTEM_SETUP - The :SYSTEM:SETup? query returns a
' program message that contains the current state of the
' instrument. Its format is a definite-length binary block,
' for example,
' #800002204<setup string><NL>
' where the setup string is 2204 bytes in length.
Console.WriteLine("Saving oscilloscope setup to " & _
    + "c:\scope\config\setup.dat")
If File.Exists("c:\scope\config\setup.dat") Then
    File.Delete("c:\scope\config\setup.dat")
End If

' Query and read setup string.
nLength = oscp.DoQueryIEEEBlock(":SYSTEM:SETup?", ResultsArray)
Console.WriteLine("Read oscilloscope setup ({0} bytes).", _
    nLength)

' Write setup string to file.
File.WriteAllBytes("c:\scope\config\setup.dat", ResultsArray)
Console.WriteLine("Wrote setup string ({0} bytes) to file.", _
    nLength)

' RESTORE_SYSTEM_SETUP - Uploads a previously saved setup
' string to the oscilloscope.
Dim dataArray As Byte()
Dim nBytesWritten As Integer

```

```

' Read setup string from file.
dataArray = File.ReadAllBytes("c:\scope\config\setup.dat")
Console.WriteLine("Read setup string ({0} bytes) from file.", _
    dataArray.Length)

' Restore setup string.
nBytesWritten = oscp.DoCommandIEEEBlock(":SYSTem:SETup", _
    dataArray)
Console.WriteLine("Restored setup string ({0} bytes).", _
    nBytesWritten)

' IMAGE_TRANSFER - In this example, we query for the screen
' data with the ":DISPLAY:DATA?" query. The .png format
' data is saved to a file in the local file system.
Console.WriteLine("Transferring screen image to " _
    + "c:\scope\data\screen.png")
If File.Exists("c:\scope\data\screen.png") Then
    File.Delete("c:\scope\data\screen.png")
End If

' Increase I/O timeout to fifteen seconds.
oscp.SetTimeoutSeconds(15)

' Get the screen data in PNG format.
nLength = _
    oscp.DoQueryIEEEBlock(":DISPlay:DATA? PNG, SCReen, COLor", _
        resultsArray)
Console.WriteLine("Read screen image ({0} bytes).", nLength)

' Store the screen data in a file.
File.WriteAllBytes("c:\scope\data\screen.png", resultsArray)
Console.WriteLine("Wrote screen image ({0} bytes) to file.", _
    nLength)

' Return I/O timeout to five seconds.
oscp.SetTimeoutSeconds(5)

' MEASURE - The commands in the MEASURE subsystem are used to
' make measurements on displayed waveforms.

' Set source to measure.
oscp.DoCommand(":MEASure:SOURce CHANnel1")

' Query for frequency.
Dim fResults As Double
fResults = oscp.DoQueryValue(":MEASure:FREQuency?")
Console.WriteLine("The frequency is: {0:F4} kHz", _
    fResults / 1000)

' Query for peak to peak voltage.
fResults = oscp.DoQueryValue(":MEASure:VPP?")
Console.WriteLine("The peak to peak voltage is: {0:F2} V", _
    fResults)

' WAVEFORM_DATA - Get waveform data from oscilloscope. To
' obtain waveform data, you must specify the WAVEFORM

```

```

' parameters for the waveform data prior to sending the
' ":WAVEFORM:DATA?" query.
'
' Once these parameters have been sent, the
' ":WAVEFORM:PREAMBLE?" query provides information concerning
' the vertical and horizontal scaling of the waveform data.
'
' With the preamble information you can then use the
' ":WAVEFORM:DATA?" query and read the data block in the
' correct format.

' WAVE_FORMAT - Sets the data transmission mode for waveform
' data output. This command controls how the data is
' formatted when sent from the oscilloscope and can be set
' to WORD or BYTE format.

' Set waveform format to BYTE.
oscp.DoCommand(":WAVEform:FORMat BYTE")

' WAVE_POINTS - Sets the number of points to be transferred.
' The number of time points available is returned by the
' "ACQUIRE:POINTS?" query. This can be set to any binary
' fraction of the total time points available.
oscp.DoCommand(":WAVEform:POINTs 1000")

' GET_PREAMBLE - The preamble contains all of the current
' WAVEFORM settings returned in the form <preamble block><NL>
' where the <preamble block> is:
'   FORMAT      : int16 - 0 = BYTE, 1 = WORD, 4 = ASCII.
'   TYPE        : int16 - 0 = NORMAL, 1 = PEAK DETECT,
'                 2 = AVERAGE.
'   POINTS      : int32 - number of data points transferred.
'   COUNT       : int32 - 1 and is always 1.
'   XINCREMENT  : float64 - time difference between data
'                         points.
'   XORIGIN     : float64 - always the first data point in
'                         memory.
'   XREFERENCE  : int32 - specifies the data point associated
'                         with the x-origin.
'   YINCREMENT  : float32 - voltage difference between data
'                         points.
'   YORIGIN     : float32 - value of the voltage at center
'                         screen.
'   YREFERENCE  : int32 - data point where y-origin occurs.
Console.WriteLine("Reading preamble.")
Dim fResultsArray As Double()
fResultsArray = oscp.DoQueryValues(":WAVEform:PREAmble?")

Dim fFormat As Double = fResultsArray(0)
Console.WriteLine("Preamble FORMat: {0:e}", fFormat)

Dim fType As Double = fResultsArray(1)
Console.WriteLine("Preamble TYPE: {0:e}", fType)

Dim fPoints As Double = fResultsArray(2)
Console.WriteLine("Preamble POINTs: {0:e}", fPoints)

```

## 12 Programming Examples

```
Dim fCount As Double = fResultsArray(3)
Console.WriteLine("Preamble COUNT: {0:e}", fCount)

Dim fXincrement As Double = fResultsArray(4)
Console.WriteLine("Preamble XINCrement: {0:e}", fXincrement)

Dim fXorigin As Double = fResultsArray(5)
Console.WriteLine("Preamble XORigin: {0:e}", fXorigin)

Dim fXreference As Double = fResultsArray(6)
Console.WriteLine("Preamble XREFerence: {0:e}", fXreference)

Dim fYincrement As Double = fResultsArray(7)
Console.WriteLine("Preamble YINCrement: {0:e}", fYincrement)

Dim fYorigin As Double = fResultsArray(8)
Console.WriteLine("Preamble YORigin: {0:e}", fYorigin)

Dim fYreference As Double = fResultsArray(9)
Console.WriteLine("Preamble YREFerence: {0:e}", fYreference)

' QUERY_WAVE_DATA - Outputs waveform records to the controller
' over the interface that is stored in a buffer previously
' specified with the ":WAVEform:SOURce" command.

' READ_WAVE_DATA - The wave data consists of two parts: the
' header, and the actual waveform data followed by a
' New Line (NL) character. The query data has the following
' format:
'
'     <header><waveform data block><NL>
'
' Where:
'
'     <header> = #800002048      (this is an example header)
'
' The "#8" may be stripped off of the header and the remaining
' numbers are the size, in bytes, of the waveform data block.
' The size can vary depending on the number of points acquired
' for the waveform which can be set using the
' ":WAVEFORM:POINTS" command. You may then read that number
' of bytes from the oscilloscope; then, read the following NL
' character to terminate the query.

' Read waveform data.
nLength = oscp.DoQueryIEEEBlock(":WAVEform:DATA?", ResultsArray)
Console.WriteLine("Read waveform data ({0} bytes).", nLength)

' Make some calculations from the preamble data.
Dim fVdiv As Double = 32 * fYincrement
Dim fOffset As Double = fYorigin
Dim fSdiv As Double = fPoints * fXincrement / 10
Dim fDelay As Double = (fPoints / 2) * fXincrement + fXorigin

' Print them out...
Console.WriteLine("Scope Settings for Channel 1:")
Console.WriteLine("Volts per Division = {0:f}", fVdiv)
```

```

Console.WriteLine("Offset = {0:f}", fOffset)
Console.WriteLine("Seconds per Division = {0:e}", fSdiv)
Console.WriteLine("Delay = {0:e}", fDelay)

' Print the waveform voltage at selected points:
Dim i As Integer = 0
While i < 1000
    Console.WriteLine("Data point {0:d} = {1:f2} Volts at " + _
        "{2:f10} Seconds", i, _
        (CSng(ResultsArray(i)) - fYreference) * fYincrement + _
        fYorigin, _
        (CSng(i) - fXreference) * fXincrement + fXorigin)
    i = i + 50
End While

' SAVE_WAVE_DATA - saves the waveform data to a CSV format
' file named "waveform.csv".
If File.Exists("c:\scope\data\waveform.csv") Then
    File.Delete("c:\scope\data\waveform.csv")
End If

Dim writer As StreamWriter = _
    File.CreateText("c:\scope\data\waveform.csv")
For index As Integer = 0 To 999
    writer.WriteLine("{0:E}, {1:f6}", _
        (CSng(index) - fXreference) * fXincrement + fXorigin, _
        (CSng(ResultsArray(index)) - fYreference) * fYincrement _
        + fYorigin)
Next
writer.Close()
End Sub
End Class

Class VisaInstrument
Private m_nResourceManager As Integer
Private m_nSession As Integer
Private m_strVisaAddress As String

' Constructor.
Public Sub New(ByVal strVisaAddress As String)
    ' Save VISA address in member variable.
    m_strVisaAddress = strVisaAddress

    ' Open the default VISA resource manager.
    OpenResourceManager()

    ' Open a VISA resource session.
    OpenSession()

    ' Clear the interface.
    Dim nViStatus As Integer
    nViStatus = visa32.viClear(m_nSession)
End Sub

Public Sub DoCommand(ByVal strCommand As String)
    ' Send the command.
    VisaSendCommandOrQuery(strCommand)

```

## 12 Programming Examples

```
' Check for instrument errors (another command and result).
CheckForInstrumentErrors(strCommand)
End Sub

Public Function DoCommandIEEEBlock(ByVal strCommand As String, _
    ByVal dataArray As Byte()) As Integer
    ' Send the command to the device.
    Dim strCommandAndLength As String
    Dim nViStatus As Integer
    Dim nLength As Integer
    Dim nBytesWritten As Integer

    nLength = dataArray.Length
    strCommandAndLength = [String].Format("{0} #8{1:D8}", _
        strCommand, nLength)

    ' Write first part of command to formatted I/O write buffer.
    nViStatus = visa32.viPrintf(m_nSession, strCommandAndLength)
    CheckVisaStatus(nViStatus)

    ' Write the data to the formatted I/O write buffer.
    nViStatus = visa32.viBufWrite(m_nSession, dataArray, nLength, _
        nBytesWritten)
    CheckVisaStatus(nViStatus)

    ' Write command termination character.
    nViStatus = visa32.viPrintf(m_nSession, "" & Chr(10) & "")
    CheckVisaStatus(nViStatus)

    ' Check for instrument errors (another command and result).
    CheckForInstrumentErrors(strCommand)

    Return nBytesWritten
End Function

Public Function DoQueryString(ByVal strQuery As String) _
    As StringBuilder
    ' Send the query.
    VisaSendCommandOrQuery(strQuery)

    ' Get the result string.
    Dim strResults As New StringBuilder(1000)
    strResults = VisaGetResultString()

    ' Check for instrument errors (another command and result).
    CheckForInstrumentErrors(strQuery)

    ' Return string results.
    Return strResults
End Function

Public Function DoQueryValue(ByVal strQuery As String) As Double
    ' Send the query.
    VisaSendCommandOrQuery(strQuery)

    ' Get the result string.
```

```

Dim fResults As Double
fResults = VisaGetResultValue()

' Check for instrument errors (another command and result).
CheckForInstrumentErrors(strQuery)

' Return string results.
Return fResults
End Function

Public Function DoQueryValues(ByVal strQuery As String) As Double()
' Send the query.
VisaSendCommandOrQuery(strQuery)

' Get the result string.
Dim fResultsArray As Double()
fResultsArray = VisaGetResultValues()

' Check for instrument errors (another command and result).
CheckForInstrumentErrors(strQuery)

' Return string results.
Return fResultsArray
End Function

Public Function DoQueryIEEEBlock(ByVal strQuery As String, _
    ByRef ResultsArray As Byte()) As Integer
' Send the query.
VisaSendCommandOrQuery(strQuery)

' Get the result string.
Dim length As Integer
' Number of bytes returned from instrument.
length = VisaGetResultIEEEBlock(ResultsArray)

' Check for instrument errors (another command and result).
CheckForInstrumentErrors(strQuery)

' Return string results.
Return length
End Function

Private Sub CheckForInstrumentErrors(ByVal strCommand As String)
' Check for instrument errors.
Dim strInstrumentError As New StringBuilder(1000)
Dim bFirstError As Boolean = True
Do
    VisaSendCommandOrQuery(":SYSTem:ERRor?")
    strInstrumentError = VisaGetResultString()

    If strInstrumentError.ToString() <> _
        "+0,""No error"" & Chr(10) & "" Then
        If bFirstError Then
            Console.WriteLine("ERROR(s) for command '{0}': ", _
                strCommand)
            bFirstError = False
        End If
    End If
End Sub

```

```

        Console.Write(strInstrumentError)
    End If
    Loop While strInstrumentError.ToString() <> _
        "+0,""No error"" & Chr(10) & ""
End Sub

Private Sub VisaSendCommandOrQuery(ByVal strCommandOrQuery _
    As String)
    ' Send command or query to the device.
    Dim strWithNewline As String
    strWithNewline = [String].Format("{0}" & Chr(10) & "", _
        strCommandOrQuery)
    Dim nViStatus As Integer
    nViStatus = visa32.viPrintf(m_nSession, strWithNewline)
    CheckVisaStatus(nViStatus)
End Sub

Private Function VisaGetResultString() As StringBuilder
    Dim strResults As New StringBuilder(1000)

    ' Read return value string from the device.
    Dim nViStatus As Integer
    nViStatus = visa32.viScanf(m_nSession, "%1000t", strResults)
    CheckVisaStatus(nViStatus)

    Return strResults
End Function

Private Function VisaGetResultValue() As Double
    Dim fResults As Double = 0

    ' Read return value string from the device.
    Dim nViStatus As Integer
    nViStatus = visa32.viScanf(m_nSession, "%lf", fResults)
    CheckVisaStatus(nViStatus)

    Return fResults
End Function

Private Function VisaGetResultValues() As Double()
    Dim fResultsArray As Double()
    fResultsArray = New Double(9) {}

    ' Read return value string from the device.
    Dim nViStatus As Integer
    nViStatus = visa32.viScanf(m_nSession, _
        "%,10lf" & Chr(10) & "", fResultsArray)
    CheckVisaStatus(nViStatus)

    Return fResultsArray
End Function

Private Function VisaGetResultIEEEBlock(ByRef ResultsArray _
    As Byte()) As Integer
    ' Results array, big enough to hold a PNG.
    ResultsArray = New Byte(299999) {}
    Dim length As Integer

```

```

' Number of bytes returned from instrument.
' Set the default number of bytes that will be contained in
' the ResultsArray to 300,000 (300kB).
length = 300000

' Read return value string from the device.
Dim nViStatus As Integer
nViStatus = visa32.viScanf(m_nSession, "%#b", length, _
    ResultsArray)
CheckVisaStatus(nViStatus)

' Write and read buffers need to be flushed after IEEE block?
nViStatus = visa32.viFlush(m_nSession, visa32.VI_WRITE_BUF)
CheckVisaStatus(nViStatus)
nViStatus = visa32.viFlush(m_nSession, visa32.VI_READ_BUF)
CheckVisaStatus(nViStatus)

Return length
End Function

Private Sub OpenResourceManager()
Dim nViStatus As Integer
nViStatus = visa32.viOpenDefaultRM(Me.m_nResourceManager)
If nViStatus < visa32.VI_SUCCESS Then
    Throw New _
        ApplicationException("Failed to open Resource Manager")
End If
End Sub

Private Sub OpenSession()
Dim nViStatus As Integer
nViStatus = visa32.viOpen(Me.m_nResourceManager, _
    Me.m_strVisaAddress, visa32.VI_NO_LOCK, _
    visa32.VI_TMO_IMMEDIATE, Me.m_nSession)
CheckVisaStatus(nViStatus)
End Sub

Public Sub SetTimeoutSeconds(ByVal nSeconds As Integer)
Dim nViStatus As Integer
nViStatus = visa32.viSetAttribute(Me.m_nSession, _
    visa32.VI_ATTR_TMO_VALUE, nSeconds * 1000)
CheckVisaStatus(nViStatus)
End Sub

Public Sub CheckVisaStatus(ByVal nViStatus As Integer)
' If VISA error, throw exception.
If nViStatus < visa32.VI_SUCCESS Then
    Dim strError As New StringBuilder(256)
    visa32.viStatusDesc(Me.m_nResourceManager, nViStatus, strError)
    Throw New ApplicationException(strError.ToString())
End If
End Sub

Public Sub Close()
If m_nSession <> 0 Then
    visa32.viClose(m_nSession)
End If

```

## 12 Programming Examples

```
    If m_nResourceManager <> 0 Then
        visa32.viClose(m_nResourceManager)
    End If
End Sub
End Class
End Namespace
```

## SICL Examples

- "SICL Example in C" on page 855
- "SICL Example in Visual Basic" on page 864

### SICL Example in C

To compile and run this example in Microsoft Visual Studio 2005:

- 1 Open Visual Studio.
- 2 Create a new Visual C++, Win32, Win32 Console Application project.
- 3 In the Win32 Application Wizard, click **Next >**. Then, check **Empty project**, and click **Finish**.
- 4 Cut-and-paste the code that follows into a file named "example.c" in the project directory.
- 5 In Visual Studio 2005, right-click the Source Files folder, choose **Add > Add Existing Item...**, select the example.c file, and click **Add**.
- 6 Edit the program to use the SICL address of your oscilloscope.
- 7 Choose **Project > Properties...** In the Property Pages dialog, update these project settings:
  - a Under Configuration Properties, Linker, Input, add "sicl32.lib" to the Additional Dependencies field.
  - b Under Configuration Properties, C/C++, Code Generation, select Multi-threaded DLL for the Runtime Library field.
  - c Click **OK** to close the Property Pages dialog.
- 8 Add the include files and library files search paths:
  - a Choose **Tools > Options...**
  - b In the Options dialog, select **VC++ Directories** under Projects and Solutions.
  - c Show directories for **Include files**, and add the include directory (for example, Program Files\Agilent\ IO Libraries Suite\include).
  - d Show directories for **Library files**, and add the library files directory (for example, Program Files\Agilent\IO Libraries Suite\lib).
  - e Click **OK** to close the Options dialog.
- 9 Build and run the program.

```

/*
 * Agilent SICL Example in C
 * -----
 * This program illustrates most of the commonly-used programming
 * features of your Agilent oscilloscope.
 * This program is to be built as a WIN32 console application.

```

## 12 Programming Examples

```
* Edit the DEVICE_ADDRESS line to specify the address of the
* applicable device.
*/

#include <stdio.h>           /* For printf(). */
#include "sicl.h"           /* SICL routines. */

/* #define DEVICE_ADDRESS "gpib0,7" */           /* GPIB */
/* #define DEVICE_ADDRESS "lan[a-mso6102-90541]:inst0" */ /* LAN */
#define DEVICE_ADDRESS "usb0[2391::5970::30D3090541::0]" /* USB */

#define WAVE_DATA_SIZE 5000
#define TIMEOUT 5000
#define SETUP_STR_SIZE 3000
#define IMG_SIZE 300000

/* Function prototypes */
void initialize(void);      /* Initialize the oscilloscope. */
void extra(void);          /* Miscellaneous commands not executed,
                           shown for reference purposes. */
void capture(void);        /* Digitize data from oscilloscope. */
void analyze(void);        /* Make some measurements. */
void get_waveform(void);   /* Download waveform data from
                           oscilloscope. */
void save_waveform(void);  /* Save waveform data to a file. */
void retrieve_waveform(void); /* Load waveform data from a file. */

/* Global variables */
INST id;                   /* Device session ID. */
char buf[256] = { 0 };     /* Buffer for IDN string. */

/* Array for waveform data. */
unsigned char waveform_data[WAVE_DATA_SIZE];
double preamble[10];       /* Array for preamble. */

void main(void)
{
    /* Install a default SICL error handler that logs an error message
    * and exits. On Windows 98SE or Windows Me, view messages with
    * the SICL Message Viewer. For Windows 2000 or XP, use the Event
    * Viewer.
    */
    ionerror(I_ERROR_EXIT);

    /* Open a device session using the DEVICE_ADDRESS */
    id = iopen(DEVICE_ADDRESS);

    if (id == 0)
    {
        printf ("Oscilloscope iopen failed!\n");
    }
    else
    {
        printf ("Oscilloscope session initialized!\n");

        /* Set the I/O timeout value for this session to 5 seconds. */
        itimeout(id, TIMEOUT);
    }
}
```

```

        /* Clear the interface. */
        iclear(id);
        iremote(id);
    }

    initialize();

    /* The extras function contains miscellaneous commands that do not
    * need to be executed for the proper operation of this example.
    * The commands in the extras function are shown for reference
    * purposes only.
    */
    /* extra(); */ /* <-- Uncomment to execute the extra function */

    capture();

    analyze();

    /* Close the device session to the instrument. */
    iclose(id);
    printf ("Program execution is complete...\n");

    /* For WIN16 programs, call _siclcleanup before exiting to release
    * resources allocated by SICL for this application. This call is
    * a no-op for WIN32 programs.
    */
    _siclcleanup();
}

/*
 * initialize
 * -----
 * This function initializes both the interface and the oscilloscope
 * to a known state.
 */

void initialize (void)
{
    /* RESET - This command puts the oscilloscope in a known state.
    * Without this command, the oscilloscope settings are unknown.
    * This command is very important for program control.
    *
    * Many of the following initialization commands are initialized
    * by this command. It is not necessary to reinitialize them
    * unless you want to change the default setting.
    */
    fprintf(id, "RST\n");

    /* Write the *IDN? string and send an EOI indicator, then read
    * the response into buf.
    */
    ipromptf(id, "*IDN?\n", "%t", buf);
    printf("%s\n", buf);

    /* AUTOSCALE - This command evaluates all the input signals and
    * sets the correct conditions to display all of the active signals.
    */

```

## 12 Programming Examples

```
    */
    fprintf(id, ":AUTOSCALE\n");

    /* CHANNEL_PROBE - Sets the probe attenuation factor for the
     * selected channel. The probe attenuation factor may be from
     * 0.1 to 1000.
     */
    fprintf(id, ":CHAN1:PROBE 10\n");

    /* CHANNEL_RANGE - Sets the full scale vertical range in volts.
     * The range value is eight times the volts per division.
     */
    fprintf(id, ":CHANNEL1:RANGE 8\n");

    /* TIME_RANGE - Sets the full scale horizontal time in seconds.
     * The range value is ten times the time per division.
     */
    fprintf(id, ":TIM:RANG 2e-3\n");

    /* TIME_REFERENCE - Possible values are LEFT and CENTER:
     * - LEFT sets the display reference one time division from the
     * left.
     * - CENTER sets the display reference to the center of the screen.
     */
    fprintf(id, ":TIMEBASE:REFERENCE CENTER\n");

    /* TRIGGER_SOURCE - Selects the channel that actually produces the
     * TV trigger. Any channel can be selected.
     */
    fprintf(id, ":TRIGGER:TV:SOURCE CHANNEL1\n");

    /* TRIGGER_MODE - Set the trigger mode to, EDGE, GLITCh, PATtern,
     * CAN, DURation, IIC, LIN, SEQuence, SPI, TV, or USB.
     */
    fprintf(id, ":TRIGGER:MODE EDGE\n");

    /* TRIGGER_EDGE_SLOPE - Set the slope of the edge for the trigger
     * to either POSITIVE or NEGATIVE.
     */
    fprintf(id, ":TRIGGER:EDGE:SLOPE POSITIVE\n");
}

/*
 * extra
 * -----
 * The commands in this function are not executed and are shown for
 * reference purposes only. To execute these commands, call this
 * function from main.
 */

void extra (void)
{
    /* RUN_STOP (not executed in this example):
     * - RUN starts the acquisition of data for the active waveform
     * display.
     * - STOP stops the data acquisition and turns off AUTOSTORE.
     */
}
```

```

iprintf(id, ":RUN\n");
iprintf(id, ":STOP\n");

/* VIEW_BLANK (not executed in this example):
 * - VIEW turns on (starts displaying) an active channel or pixel
 *   memory.
 * - BLANK turns off (stops displaying) a specified channel or
 *   pixel memory.
 */
iprintf(id, ":BLANK CHANNEL1\n");
iprintf(id, ":VIEW CHANNEL1\n");

/* TIME_MODE (not executed in this example) - Set the time base
 * mode to MAIN, DELAYED, XY or ROLL.
 */
iprintf(id, ":TIMEBASE:MODE MAIN\n");
}

/*
 * capture
 * -----
 * This function prepares the scope for data acquisition and then
 * uses the DIGITIZE MACRO to capture some data.
 */

void capture (void)
{
    /* ACQUIRE_TYPE - Sets the acquisition mode. There are three
     * acquisition types NORMAL, PEAK, or AVERAGE.
     */
    iprintf(id, ":ACQUIRE:TYPE NORMAL\n");

    /* ACQUIRE_COMPLETE - Specifies the minimum completion criteria
     * for an acquisition. The parameter determines the percentage
     * of time buckets needed to be "full" before an acquisition is
     * considered to be complete.
     */
    iprintf(id, ":ACQUIRE:COMPLETE 100\n");

    /* DIGITIZE - Used to acquire the waveform data for transfer over
     * the interface. Sending this command causes an acquisition to
     * take place with the resulting data being placed in the buffer.
     */

    /* NOTE! The use of the DIGITIZE command is highly recommended
     * as it will ensure that sufficient data is available for
     * measurement. Keep in mind when the oscilloscope is running,
     * communication with the computer interrupts data acquisition.
     * Setting up the oscilloscope over the bus causes the data
     * buffers to be cleared and internal hardware to be reconfigured.
     * If a measurement is immediately requested there may not have
     * been enough time for the data acquisition process to collect
     * data and the results may not be accurate. An error value of
     * 9.9E+37 may be returned over the bus in this situation.
     */
    iprintf(id, ":DIGITIZE CHAN1\n");
}

```

```

/*
 * analyze
 * -----
 * In this example we will do the following:
 * - Save the system setup to a file for restoration at a later time.
 * - Save the oscilloscope display to a file which can be printed.
 * - Make single channel measurements.
 */

void analyze (void)
{
    double frequency, vpp;           /* Measurements. */
    double vdiv, off, sdiv, delay;   /* Calculated from preamble data. */
    int i;                           /* Loop counter. */
    /* Array for setup string. */
    unsigned char setup_string[SETUP_STR_SIZE];
    int setup_size;
    FILE *fp;
    unsigned char image_data[IMG_SIZE]; /* Array for image data. */
    int img_size;

    /* SAVE_SYSTEM_SETUP - The :SYSTEM:SETUP? query returns a program
     * message that contains the current state of the instrument. Its
     * format is a definite-length binary block, for example,
     * #800002204<setup string><NL>
     * where the setup string is 2204 bytes in length.
     */
    setup_size = SETUP_STR_SIZE;
    /* Query and read setup string. */
    ipromptf(id, ":SYSTEM:SETUP?\n", "%#b\n", &setup_size, setup_string);
    printf("Read setup string query (%d bytes).\n", setup_size);
    /* Write setup string to file. */
    fp = fopen ("c:\\scope\\config\\setup.dat", "wb");
    setup_size = fwrite(setup_string, sizeof(unsigned char), setup_size,
        fp);
    fclose (fp);
    printf("Wrote setup string (%d bytes) to file.\n", setup_size);

    /* RESTORE_SYSTEM_SETUP - Uploads a previously saved setup string
     * to the oscilloscope.
     */
    /* Read setup string from file. */
    fp = fopen ("c:\\scope\\config\\setup.dat", "rb");
    setup_size = fread (setup_string, sizeof(unsigned char),
        SETUP_STR_SIZE, fp);
    fclose (fp);
    printf("Read setup string (%d bytes) from file.\n", setup_size);
    /* Restore setup string. */
    iprintf(id, ":SYSTEM:SETUP #8%08d", setup_size);
    ifwrite(id, setup_string, setup_size, 1, &setup_size);
    printf("Restored setup string (%d bytes).\n", setup_size);

    /* IMAGE_TRANSFER - In this example we will query for the image
     * data with ":DISPLAY:DATA?" to read the data and save the data
     * to the file "image.dat" which you can then send to a printer.
     */
}

```

```

ittimeout(id, 30000);
printf("Transferring image to c:\\scope\\data\\screen.bmp\\n");
img_size = IMG_SIZE;
ipromptf(id, ":DISPLAY:DATA? BMP8bit, SCREEN, COLOR\\n", "%#b\\n",
    &img_size, image_data);
printf("Read display data query (%d bytes).\\n", img_size);
/* Write image data to file. */
fp = fopen ("c:\\scope\\data\\screen.bmp", "wb");
img_size = fwrite(image_data, sizeof(unsigned char), img_size, fp);
fclose (fp);
printf("Wrote image data (%d bytes) to file.\\n", img_size);
ittimeout(id, 5000);

/* MEASURE - The commands in the MEASURE subsystem are used to
 * make measurements on displayed waveforms.
 */

/* Set source to measure. */
iprintf(id, ":MEASURE:SOURCE CHANNEL1\\n");

/* Query for frequency. */
ipromptf(id, ":MEASURE:FREQUENCY?\\n", "%lf", &frequency);
printf("The frequency is: %.4f kHz\\n", frequency / 1000);

/* Query for peak to peak voltage. */
ipromptf(id, ":MEASURE:VPP?\\n", "%lf", &vpp);
printf("The peak to peak voltage is: %.2f V\\n", vpp);

/* WAVEFORM_DATA - Get waveform data from oscilloscope.
 */
get_waveform();

/* Make some calculations from the preamble data. */
vdiv = 32 * preamble [7];
off = preamble [8];
sdiv = preamble [2] * preamble [4] / 10;
delay = (preamble [2] / 2) * preamble [4] + preamble [5];

/* Print them out... */
printf ("Scope Settings for Channel 1:\\n");
printf ("Volts per Division = %f\\n", vdiv);
printf ("Offset = %f\\n", off);
printf ("Seconds per Division = %f\\n", sdiv);
printf ("Delay = %f\\n", delay);

/* print out the waveform voltage at selected points */
for (i = 0; i < 1000; i = i + 50)
    printf ("Data Point %4d = %6.2f Volts at %10f Seconds\\n", i,
        ((float)waveform_data[i] - preamble[9]) * preamble[7] +
        preamble[8],
        ((float)i - preamble[6]) * preamble[4] + preamble[5]);

save_waveform();          /* Save waveform data to disk. */
retrieve_waveform();      /* Load waveform data from disk. */
}

/*

```

## 12 Programming Examples

```
* get_waveform
* -----
* This function transfers the data displayed on the oscilloscope to
* the computer for storage, plotting, or further analysis.
*/

void get_waveform (void)
{
    int waveform_size;

    /* WAVEFORM_DATA - To obtain waveform data, you must specify the
     * WAVEFORM parameters for the waveform data prior to sending the
     * ":WAVEFORM:DATA?" query.
     *
     * Once these parameters have been sent, the ":WAVEFORM:PREAMBLE?"
     * query provides information concerning the vertical and horizontal
     * scaling of the waveform data.
     *
     * With the preamble information you can then use the
     * ":WAVEFORM:DATA?" query and read the data block in the
     * correct format.
     */

    /* WAVE_FORMAT - Sets the data transmission mode for waveform data
     * output. This command controls how the data is formatted when
     * sent from the oscilloscope and can be set to WORD or BYTE format.
     */

    /* Set waveform format to BYTE. */
    fprintf(id, ":WAVEFORM:FORMAT BYTE\n");

    /* WAVE_POINTS - Sets the number of points to be transferred.
     * The number of time points available is returned by the
     * "ACQUIRE:POINTS?" query. This can be set to any binary
     * fraction of the total time points available.
     */
    fprintf(id, ":WAVEFORM:POINTS 1000\n");

    /* GET_PREAMBLE - The preamble contains all of the current WAVEFORM
     * settings returned in the form <preamble block><NL> where the
     * <preamble block> is:
     *
     * FORMAT      : int16 - 0 = BYTE, 1 = WORD, 4 = ASCII.
     * TYPE        : int16 - 0 = NORMAL, 1 = PEAK DETECT, 2 = AVERAGE.
     * POINTS      : int32 - number of data points transferred.
     * COUNT       : int32 - 1 and is always 1.
     * XINCREMENT  : float64 - time difference between data points.
     * XORIGIN     : float64 - always the first data point in memory.
     * XREFERENCE  : int32 - specifies the data point associated
     *                   with the x-origin.
     * YINCREMENT  : float32 - voltage difference between data points.
     * YORIGIN     : float32 - value of the voltage at center screen.
     * YREFERENCE  : int32 - data point where y-origin occurs.
     */
    printf("Reading preamble\n");
    ipromptf(id, ":WAVEFORM:PREAMBLE?\n", "%,10lf\n", preamble);
    /*
    printf("Preamble FORMAT: %e\n", preamble[0]);
    */
}
```

```

printf("Preamble TYPE: %e\n", preamble[1]);
printf("Preamble POINTS: %e\n", preamble[2]);
printf("Preamble COUNT: %e\n", preamble[3]);
printf("Preamble XINCREMENT: %e\n", preamble[4]);
printf("Preamble XORIGIN: %e\n", preamble[5]);
printf("Preamble XREFERENCE: %e\n", preamble[6]);
printf("Preamble YINCREMENT: %e\n", preamble[7]);
printf("Preamble YORIGIN: %e\n", preamble[8]);
printf("Preamble YREFERENCE: %e\n", preamble[9]);
*/

/* QUERY_WAVE_DATA - Outputs waveform records to the controller
 * over the interface that is stored in a buffer previously
 * specified with the ":WAVEFORM:SOURCE" command.
 */
iprintf(id, ":WAVEFORM:DATA?\n"); /* Query waveform data. */

/* READ_WAVE_DATA - The wave data consists of two parts: the header,
 * and the actual waveform data followed by an New Line (NL)
 * character. The query data has the following format:
 *
 * <header><waveform data block><NL>
 *
 * Where:
 *
 * <header> = #800002048 (this is an example header)
 *
 * The "#8" may be stripped off of the header and the remaining
 * numbers are the size, in bytes, of the waveform data block.
 * The size can vary depending on the number of points acquired
 * for the waveform which can be set using the ":WAVEFORM:POINTS"
 * command. You may then read that number of bytes from the
 * oscilloscope; then, read the following NL character to
 * terminate the query.
 */
waveform_size = WAVE_DATA_SIZE;
/* Read waveform data. */
iscanf(id, "%#b\n", &waveform_size, waveform_data);
if ( waveform_size == WAVE_DATA_SIZE )
{
    printf("Waveform data buffer full: ");
    printf("May not have received all points.\n");
}
else
{
    printf("Reading waveform data... size = %d\n", waveform_size);
}
}

/*
 * save_waveform
 * -----
 * This function saves the waveform data from the get_waveform
 * function to disk. The data is saved to a file called "wave.dat".
 */

void save_waveform(void)

```

```
{
    FILE *fp;

    fp = fopen("c:\\scope\\data\\wave.dat", "wb");
    /* Write preamble. */
    fwrite(preamble, sizeof(preamble[0]), 10, fp);
    /* Write actually waveform data. */
    fwrite(waveform_data, sizeof(waveform_data[0]),
           (int)preamble[2], fp);
    fclose (fp);
}

/*
 * retrieve_waveform
 * -----
 * This function retrieves previously saved waveform data from a
 * file called "wave.dat".
 */

void retrieve_waveform(void)
{
    FILE *fp;

    fp = fopen("c:\\scope\\data\\wave.dat", "rb");
    /* Read preamble. */
    fread (preamble, sizeof(preamble[0]), 10, fp);
    /* Read the waveform data. */
    fread (waveform_data, sizeof(waveform_data[0]),
           (int)preamble[2], fp);
    fclose (fp);
}
```

### SICL Example in Visual Basic

To run this example in Visual Basic for Applications:

- 1 Start the application that provides Visual Basic for Applications (for example, Microsoft Excel).
- 2 Press ALT+F11 to launch the Visual Basic editor.
- 3 Add the sicl32.bas file to your project:
  - a Choose **File>Import File...**
  - b Navigate to the header file, sicl32.bas (installed with Agilent IO Libraries Suite and found in the Program Files\Agilent\IO Libraries Suite\include directory), select it, and click **Open**.
- 4 Choose **Insert>Module**.
- 5 Cut-and-paste the code that follows into the editor.
- 6 Edit the program to use the SICL address of your oscilloscope, and save the changes.
- 7 Run the program.

```

'
' Agilent SICL Example in Visual Basic
' -----
' This program illustrates a few commonly-used programming
' features of your Agilent oscilloscope.
' -----

Option Explicit

Public id As Integer ' Session to instrument.

' Declare variables to hold numeric values returned by
' ivscanf/ifread.
Public dblQueryResult As Double
Public Const ByteArraySize = 5000000
Public retCount As Long
Public byteArray(ByteArraySize) As Byte

' Declare fixed length string variable to hold string value returned
' by ivscanf.
Public strQueryResult As String * 200

'
' Main Program
' -----

Sub Main()

    On Error GoTo ErrorHandler

    ' Open a device session using the SICL_ADDRESS.
    id = iopen("lan[130.29.69.12]:inst0")
    Call itimeout(id, 5000)

    ' Initialize - start from a known state.
    Initialize

    ' Capture data.
    Capture

    ' Analyze the captured waveform.
    Analyze

    ' Close the vi session and the resource manager session.
    Call iclose(id)

    Exit Sub

ErrorHandler:

    MsgBox "*** Error : " + Error, vbExclamation
    End

End Sub

'
' Initialize the oscilloscope to a known state.

```

## 12 Programming Examples

```
' -----  
  
Private Sub Initialize()  
  
    On Error GoTo ErrorHandler  
  
    ' Clear the interface.  
    Call iclear(id)  
  
    ' Get and display the device's *IDN? string.  
    strQueryResult = DoQueryString("*IDN?")  
    MsgBox "Result is: " + RTrim(strQueryResult), vbOKOnly, "*IDN? Result"  
  
    ' Clear status and load the default setup.  
    DoCommand "*CLS"  
    DoCommand "*RST"  
  
    Exit Sub  
  
ErrorHandler:  
  
    MsgBox "*** Error : " + Error, vbExclamation  
    End  
  
End Sub  
  
'  
' Capture the waveform.  
' -----  
  
Private Sub Capture()  
  
    On Error GoTo ErrorHandler  
  
    ' Use auto-scale to automatically configure oscilloscope.  
    ' -----  
    DoCommand ":AUToscale"  
  
    ' Save oscilloscope configuration.  
    ' -----  
    Dim lngSetupStringSize As Long  
    lngSetupStringSize = DoQueryIEEEBlock_Bytes(":SYSTem:SETup?")  
    Debug.Print "Setup bytes saved: " + CStr(lngSetupStringSize)  
  
    ' Output setup string to a file:  
    Dim strPath As String  
    strPath = "c:\scope\config\setup.dat"  
  
    ' Open file for output.  
    Dim hFile As Long  
    hFile = FreeFile  
    Open strPath For Binary Access Write Lock Write As hFile  
    Dim lngI As Long  
    For lngI = 0 To lngSetupStringSize - 1  
        Put hFile, , byteArray(lngI) ' Write data.  
    Next lngI  
    Close hFile ' Close file.
```

```

' Or, configure the settings with individual commands:
' -----

' Set trigger mode and input source.
DoCommand ":TRIGger:MODE EDGE"
Debug.Print "Trigger mode: " + _
    DoQueryString(":TRIGger:MODE?")

' Set EDGE trigger parameters.
DoCommand ":TRIGger:EDGE:SOURCe CHANnel1"
Debug.Print "Trigger edge source: " + _
    DoQueryString(":TRIGger:EDGE:SOURce?")

DoCommand ":TRIGger:EDGE:LEVel 1.5"
Debug.Print "Trigger edge level: " + _
    DoQueryString(":TRIGger:EDGE:LEVel?")

DoCommand ":TRIGger:EDGE:SLOPe POSitive"
Debug.Print "Trigger edge slope: " + _
    DoQueryString(":TRIGger:EDGE:SLOPe?")

' Set vertical scale and offset.
DoCommand ":CHANnel1:SCALe 0.5"
Debug.Print "Channel 1 vertical scale: " + _
    DoQueryString(":CHANnel1:SCALe?")

DoCommand ":CHANnel1:OFFSet 1.5"
Debug.Print "Channel 1 vertical offset: " + _
    DoQueryString(":CHANnel1:OFFSet?")

' Set horizontal scale and offset.
DoCommand ":TIMEbase:SCALe 0.0002"
Debug.Print "Timebase scale: " + _
    DoQueryString(":TIMEbase:SCALe?")

DoCommand ":TIMEbase:POSition 0.0"
Debug.Print "Timebase position: " + _
    DoQueryString(":TIMEbase:POSition?")

' Set the acquisition type (NORMAL, PEAK, AVERage, or HRESolution).
DoCommand ":ACQuire:TYPE NORMAL"
Debug.Print "Acquire type: " + _
    DoQueryString(":ACQuire:TYPE?")

' Or, configure by loading a previously saved setup.
' -----
strPath = "c:\scope\config\setup.dat"
Open strPath For Binary Access Read As hFile ' Open file for input.
Dim lngSetupFileSize As Long
lngSetupFileSize = LOF(hFile) ' Length of file.
Get hFile, , byteArray ' Read data.
Close hFile ' Close file.
' Write learn string back to oscilloscope using ":SYSTem:SETup"
' command:
Dim lngRestored As Long
lngRestored = DoCommandIEEEBlock(":SYSTem:SETup", lngSetupFileSize)

```

## 12 Programming Examples

```
Debug.Print "Setup bytes restored: " + CStr(lngRestored)

' Acquire data.
' -----
DoCommand ":DIGitize"

Exit Sub

ErrorHandler:

MsgBox "*** Error : " + Error, vbExclamation
End

End Sub

'
' Analyze the captured waveform.
' -----

Private Sub Analyze()

On Error GoTo ErrorHandler

' Make a couple of measurements.
' -----
DoCommand ":MEASure:SOURce CHANnel1"
Debug.Print "Measure source: " + _
    DoQueryString(":MEASure:SOURce?")

DoCommand ":MEASure:VAMPlitude"
dblQueryResult = DoQueryNumber(":MEASure:VAMPlitude?")
MsgBox "Vertical amplitude:" + vbCrLf + _
    FormatNumber(dblQueryResult, 4) + " V"

DoCommand ":MEASure:FREQuency"
dblQueryResult = DoQueryNumber(":MEASure:FREQuency?")
MsgBox "Frequency:" + vbCrLf + _
    FormatNumber(dblQueryResult / 1000, 4) + " kHz"

' Download the screen image.
' -----
' Get screen image.
Dim lngBlockSize As Long
lngBlockSize = _
    DoQueryIEEEBlock_Bytes(":DISPlay:DATA? PNG, SCReen, COLOr")
Debug.Print "Image IEEEBlock bytes: " + CStr(lngBlockSize)

' Save screen image to a file:
Dim strPath As String
strPath = "c:\scope\data\screen.png"
Dim hFile As Long
hFile = FreeFile
Open strPath For Binary Access Write Lock Write As hFile
Dim lngI As Long
For lngI = 10 To lngBlockSize - 1 ' Skip past 10-byte header.
    Put hFile, , byteArray(lngI) ' Write data.
Next lngI
```

```

Close hFile ' Close file.
MsgBox "Screen image written to " + strPath

' Download waveform data.
' -----
Dim lngPoints As Long
Dim dblXIncrement As Double
Dim dblXOrigin As Double
Dim dblYIncrement As Double
Dim dblYOrigin As Double
Dim dblYReference As Double

' Set the waveform source.
DoCommand ":WAVEform:SOURce CHANnel1"
Debug.Print "Waveform source: " + _
    DoQueryString(":WAVEform:SOURce?")

' Get the number of waveform points:
' How do you get max depth like when saving CSV from front panel?
dblQueryResult = DoQueryNumber(":WAVEform:POINTs?")
lngPoints = dblQueryResult
Debug.Print "Waveform points, channel 1: " + _
    CStr(lngPoints)

' Display the waveform settings:
dblXIncrement = DoQueryNumber(":WAVEform:XINCrement?")
Debug.Print "Waveform X increment, channel 1: " + _
    Format(dblXIncrement, "Scientific")
dblXOrigin = DoQueryNumber(":WAVEform:XORigin?")
Debug.Print "Waveform X origin, channel 1: " + _
    Format(dblXOrigin, "Scientific")

dblYIncrement = DoQueryNumber(":WAVEform:YINCrement?")
Debug.Print "Waveform Y increment, channel 1: " + _
    Format(dblYIncrement, "Scientific")
dblYOrigin = DoQueryNumber(":WAVEform:YORigin?")
Debug.Print "Waveform Y origin, channel 1: " + _
    Format(dblYOrigin, "Scientific")
dblYReference = DoQueryNumber(":WAVEform:YREFerence?")
Debug.Print "Waveform Y reference, channel 1: " + _
    Format(dblYReference, "Scientific")

' Choose the format of the data returned (WORD, BYTE, ASCII):
DoCommand ":WAVEform:FORMat BYTE"
Debug.Print "Waveform format: " + _
    DoQueryString(":WAVEform:FORMat?")
' Data in range 0 to 255.
Dim lngVSteps As Long
Dim intBytesPerData As Integer
lngVSteps = 256
intBytesPerData = 1

' Get the waveform data
Dim lngNumBytes As Long
lngNumBytes = DoQueryIEEEBlock_Bytes(":WAVEform:DATA?")
Debug.Print "Waveform data IEEEBlock bytes: " + CStr(lngNumBytes)

```

## 12 Programming Examples

```
' Set up output file:
strPath = "c:\scope\data\waveform_data.csv"

' Open file for output.
Open strPath For Output Access Write Lock Write As hFile

' Output waveform data in CSV format.
Dim lngDataValue As Long

For lngI = 10 To lngNumBytes - 2 ' Skip past 10-byte header.
  lngDataValue = CLng(byteArray(lngI))

  ' Write time value, voltage value.
  Print #hFile, _
    Format(dblXOrigin + lngI * dblXIncrement, "Scientific") + _
    ", " + _
    FormatNumber((lngDataValue - dblyReference) * dblyIncrement + _
    dblyOrigin)

Next lngI

' Close output file.
Close hFile ' Close file.
MsgBox "Waveform format BYTE data written to " + _
  "c:\scope\data\waveform_data.csv."

Exit Sub

ErrorHandler:

  MsgBox "*** Error : " + Error, vbExclamation
End

End Sub

Private Sub DoCommand(command As String)

  On Error GoTo ErrorHandler

  Call ivprintf(id, command + vbLf)
  CheckForInstrumentErrors command

  Exit Sub

ErrorHandler:

  MsgBox "*** Error : " + Error, vbExclamation
End

End Sub

Private Function DoCommandIEEEBlock(command As String, _
  lngBlockSize As Long)

  On Error GoTo ErrorHandler

  ' Send command part.
```

```

Call ivprintf(id, command + " ")
' Write definite-length block bytes.
Call ifwrite(id, byteArray(), lngBlockSize, vbNull, retCount)
' retCount is now actual number of bytes written.
CheckForInstrumentErrors command
DoCommandIEEEBlock = retCount

```

```
Exit Function
```

```
ErrorHandler:
```

```
MsgBox "*** Error : " + Error, vbExclamation
End
```

```
End Function
```

```
Private Function DoQueryString(query As String) As String
```

```
Dim actual As Long
```

```
On Error GoTo ErrorHandler
```

```
Dim ret_val As Integer
```

```
Dim strResult As String * 200
```

```
Call ivprintf(id, query + vbLf)
Call ivscanf(id, "%200t", strResult)
CheckForInstrumentErrors query
DoQueryString = strResult

```

```
Exit Function
```

```
ErrorHandler:
```

```
MsgBox "*** Error : " + Error, vbExclamation
End
```

```
End Function
```

```
Private Function DoQueryNumber(query As String) As Double
```

```
On Error GoTo ErrorHandler
```

```
Dim dblResult As Double
```

```
Call ivprintf(id, query + vbLf)
Call ivscanf(id, "%lf" + vbLf, dblResult)
CheckForInstrumentErrors query
DoQueryNumber = dblResult

```

```
Exit Function
```

```
ErrorHandler:
```

```
MsgBox "*** Error : " + Error, vbExclamation
End
```

## 12 Programming Examples

```
End Function

Private Function DoQueryIEEEBlock_Bytes(query As String) As Long

    On Error GoTo ErrorHandler

    ' Send query.
    Call ivprintf(id, query + vbCrLf)
    ' Read definite-length block bytes.
    Call ifread(id, byteArray(), ByVal byteArraySize, ByVal retCount)
    ' retCount is now actual number of bytes returned by read.
    CheckForInstrumentErrors query
    DoQueryIEEEBlock_Bytes = retCount

Exit Function

ErrorHandler:

    MsgBox "*** Error : " + Error, vbExclamation
End

End Function

Private Sub CheckForInstrumentErrors(strCmdOrQuery As String)

    On Error GoTo ErrorHandler

    Dim strErrVal As String * 200
    Dim strOut As String

    Do
        Call ivprintf(id, "SYSTEM:ERROR?" + vbCrLf) ' Request error message.
        Call ivscanf(id, "%200t", strErrVal) ' Read: Errno,"Error String".
        If Val(strErrVal) <> 0 Then
            strOut = strOut + "INST Error: " + RTrim(strErrVal) + vbCrLf
        End If
    Loop While Val(strErrVal) <> 0 ' End if find: 0,"No Error".

    If Not strOut = "" Then
        MsgBox strOut, vbExclamation, "INST Error Messages, " + _
            strCmdOrQuery
        Call iflush(id, I_BUF_DISCARD_READ Or I_BUF_DISCARD_WRITE)
    End If

Exit Sub

ErrorHandler:

    MsgBox "*** Error: " + Error, vbExclamation

End Sub
```

# Index

## Symbols

+9.9E+37, infinity representation, 772  
+9.9E+37, measurement error, 290

## Numerics

0 (zero) values in waveform data, 599  
1 (one) values in waveform data, 599  
50% trigger level, 446  
82350A GPIB interface, 4

## A

AC coupling, trigger edge, 475  
AC input coupling for specified channel, 207  
acknowledge, 704  
ACQuire commands, 177  
acquire data, 146, 191  
acquire mode on autoscale, 142  
acquire reset conditions, 125  
acquire sample rate, 190  
ACQuire subsystem, 53  
acquired data points, 184  
acquisition anti-alias control, 179  
acquisition count, 181  
acquisition mode, 177, 183, 616  
acquisition type, 177, 191  
acquisition types, 592  
active printer, 263  
add function, 611  
add math function, 252  
add math function as g(t) source, 248  
address field size, IIC serial decode, 407  
address, IIC trigger pattern, 519  
Addresses softkey, 40  
AER (Arm Event Register), 139, 161, 163, 732  
Agilent Connection Expert, 41  
Agilent Interactive IO application, 45  
Agilent IO Control icon, 41  
Agilent IO Libraries Suite, 4, 37, 50, 52  
Agilent IO Libraries Suite, installing, 38  
ALB waveform data format, 391  
alignment, I2S trigger, 502  
ALL segments waveform save option, 393  
alphabetical list of commands, 625  
AMASk commands, 626  
amplitude, vertical, 324  
analog channel coupling, 207  
analog channel display, 208  
analog channel impedance, 209  
analog channel input, 664  
analog channel inversion, 210

analog channel labels, 211, 229  
analog channel offset, 212  
analog channel protection lock, 425  
analog channel range, 219  
analog channel scale, 220  
analog channel source for glitch, 499  
analog channel units, 221  
analog probe attenuation, 213  
analog probe head type, 214  
analog probe sensing, 665  
analog probe skew, 216, 663  
analyzing captured data, 49  
angle brackets, 107  
annotate channels, 211  
anti-alias control, 179  
AREA commands, 626  
area for hardcopy print, 262  
area for saved image, 381  
Arm Event Register (AER), 139, 161, 163, 732  
ASCII format, 601  
ASCII format for data transfer, 595  
ASCII string, quoted, 107  
ASCiixy waveform data format, 391  
assign channel names, 211  
attenuation factor (external trigger) probe, 237  
attenuation for oscilloscope probe, 213  
audio channel, I2S trigger, 503  
AUT option for probe sense, 665, 669  
auto setup for M1553 trigger, 541  
auto trigger sweep mode, 440  
automask create, 342  
automask source, 343  
automask units, 344  
automatic measurements constants, 213  
automatic probe type detection, 665, 669  
Automation-Ready CD, 38  
autoscale, 140  
autoscale acquire mode, 142  
autoscale channels, 143  
AUToscale command, 52  
AUTosetup commands, 626  
autosetup for FLEXray trigger, 481  
AVERage commands, 626  
average value measurement, 325  
averaging acquisition type, 178, 594  
averaging, synchronizing with, 746

## B

bandwidth filter limits, 235  
bandwidth filter limits to 20 MHz, 206  
BASE commands, 626  
base value measurement, 326

base, I2S serial decode, 406  
base, MIL-STD 1553 serial decode, 409  
base, UART trigger, 572  
basic instrument functions, 113  
baud rate, 459, 535, 573  
BAUDrate commands, 627  
begin acquisition, 146, 170, 172  
BHARris window for minimal spectral leakage, 259  
binary block data, 107, 426, 599  
BINary waveform data format, 391  
bind levels for masks, 364  
bit order, 574  
bit order, SPI decode, 411  
bit weights, 118  
bitmap display, 226  
BITorder commands, 627  
bits in Service Request Enable Register, 130  
bits in Standard Event Status Enable Register, 117  
bits in Status Byte Register, 132  
blank, 144  
block data, 107, 121, 226, 426  
block response data, 56  
blocking synchronization, 741  
blocking wait, 740  
BMP (bitmap) hardcopy format, 675  
braces, 106  
built-in measurements, 49  
burst, minimum time before next, 472  
button disable, 423  
BWLimit commands, 627  
byte format for data transfer, 596, 601  
BYTeorder, 597

## C

C, SICL library example, 855  
C, VISA library example, 809  
C#, VISA COM example, 786  
C#, VISA example, 828  
CAL PROTECT switch, 193, 200  
calculating preshoot of waveform, 307  
calculating the waveform overshoot, 303  
calibrate, 195, 196, 200, 202  
CALibrate commands, 193  
calibrate date, 195  
calibrate introduction, 193  
calibrate label, 196  
calibrate output, 197  
calibrate start, 198  
calibrate status, 199  
calibrate switch, 200

## Index

calibrate temperature, 201  
calibrate time, 202  
CAN, 454  
CAN acknowledge, 458, 704  
CAN baud rate, 459  
CAN commands, 627  
CAN frame counters, reset, 398  
CAN id pattern, 456  
CAN signal definition, 460  
CAN source, 461  
CAN trigger, 455, 462  
CAN trigger commands, 452  
CAN trigger pattern id mode, 457  
CAN triggering, 441  
capture data, 146  
capturing data, 48  
CDISplay, 145  
center frequency set, 245, 246  
center of screen, 624  
center reference, 434  
center screen, vertical value at, 251, 254  
channel, 176, 211  
channel coupling, 207  
channel display, 208  
channel input impedance, 209  
channel inversion, 210  
channel label, 211, 662  
channel labels, 228, 229  
channel overload, 218  
channel probe ID, 238  
channel protection, 218  
channel reset conditions, 125  
channel selected to produce trigger, 499, 568  
channel signal type, 217  
channel skew for oscilloscope probe, 216, 663  
channel status, 173  
channel vernier, 222  
channel, stop displaying, 144  
CHANnel<n> commands, 203, 204  
channels to autoscale, 143  
channels, how autoscale affects, 140  
characters to display, 421  
classes of input signals, 259  
classifications, command, 750  
clear, 225  
CLEAR commands, 628  
clear display, 145  
clear markers, 292, 680  
clear measurement, 292, 680  
clear message queue, 115  
Clear method, 51  
clear screen, 667  
clear status, 115  
clear waveform area, 223  
clipped high waveform data value, 599  
clipped low waveform data value, 599  
clock, 522, 556, 557, 561  
CLOCK commands, 628  
clock slope, I2S, 504  
CLOCK source, I2S, 511  
CLS (Clear Status), 115  
CME (Command Error) status bit, 117, 119

code, :ACQUIRE:COMPLETE, 180  
code, :ACQUIRE:SEGMENTED, 187  
code, :ACQUIRE:TYPE, 192  
code, :AUTOSCALE, 141  
code, :CHANNEL<n>:LABEL, 211  
code, :CHANNEL<n>:PROBE, 213  
code, :CHANNEL<n>:RANGE, 219  
code, :DIGITIZE, 146  
code, :DISPLAY:DATA, 227  
code, :DISPLAY:LABEL, 228  
code, :MEASURE:PERIOD, 315  
code, :MEASURE:RESULTS, 309  
code, :MEASURE:TEDGE, 321  
code, :MTEST, 339  
code, :RUN/STOP, 170  
code, :SYSTEM:SETUP, 426  
code, :TIMEBASE:DELAY, 703  
code, :TIMEBASE:MODE, 431  
code, :TIMEBASE:RANGE, 433  
code, :TIMEBASE:REFERENCE, 434  
code, :TRIGGER:MODE, 447  
code, :TRIGGER:SLOPE, 478  
code, :TRIGGER:SOURCE, 479  
code, :VIEW and :BLANK, 176  
code, :WAVEFORM, 611  
code, :WAVEFORM:DATA, 599  
code, :WAVEFORM:POINTS, 603  
code, :WAVEFORM:PREAmble, 607  
code, :WAVEFORM:SEGMENTED, 187  
code, \*RST, 127  
code, SICL library example in C, 855  
code, SICL library example in Visual Basic, 864  
code, VISA COM library example in C#, 786  
code, VISA COM library example in Visual Basic, 776  
code, VISA COM library example in Visual Basic .NET, 798  
code, VISA library example in C, 809  
code, VISA library example in C#, 828  
code, VISA library example in Visual Basic, 818  
code, VISA library example in Visual Basic .NET, 841  
colon, root commands prefixed by, 138  
color palette for hardcopy, 268  
color palette for image, 385  
Comma Separated Values (CSV) hardcopy format, 675  
Comma Separated Values (CSV) waveform data format, 391  
command classifications, 750  
command errors detected in Standard Event Status, 119  
command header, 752  
command headers, common, 754  
command headers, compound, 753  
command headers, simple, 753  
command strings, valid, 751  
command tree, 755  
commands by subsystem, 109  
commands in alphabetical order, 625  
commands quick reference, 61  
commands sent over interface, 113

commands, more about, 749  
commands, obsolete and discontinued, 657  
common (\*) commands, 110, 111, 113  
common command headers, 754  
completion criteria for an acquisition, 180, 181  
compound command headers, 753  
compound header, 769  
computer control examples, 775  
conditions for external trigger, 233  
conditions, reset, 125  
configurations, oscilloscope, 121, 124, 128, 426  
Configure softkey, 40  
connect oscilloscope, 39  
connect sampled data points, 666  
constants for making automatic measurements, 213  
constants for scaling display factors, 213  
constants for setting trigger levels, 213  
Control softkey, 39, 40  
controller initialization, 48  
copy display, 169  
core commands, 750  
count, 548, 598  
COUNT commands, 629  
count values, 181  
count, Nth edge of burst, 471  
counter, 293  
coupling, 475  
COUPLING commands, 629  
coupling for channels, 207  
create automask, 342  
CSV (Comma Separated Values) hardcopy format, 675  
CSV (Comma Separated Values) waveform data format, 391  
current oscilloscope configuration, 121, 124, 128, 426  
current probe, 221, 242  
CURRENT segment waveform save option, 393  
cursor mode, 276  
cursor position, 277, 279, 281, 282, 284  
cursor readout, 681, 685, 686  
cursor reset conditions, 125  
cursor source, 278, 280  
cursor time, 681, 685, 686  
cursors track measurements, 314  
cursors, how autoscale affects, 140  
cursors, X1, X2, Y1, Y2, 275  
cycle count base, FLEXray frame trigger, 486  
cycle count repetition, FLEXray frame trigger, 487  
cycle measured, 299  
cycle time, 305

## D

D- source, 586  
D+ source, 587  
data, 454, 520, 523, 559, 562, 599  
data 2, 521  
data acquisition types, 592

DATA commands, 629  
 data conversion, 594  
 data displayed, 226  
 data format for transfer, 595  
 data output order, 597  
 data pattern length, 455, 532  
 data pattern width, 560  
 data point index, 621  
 data points, 184  
 data record, deep analysis, 424  
 data record, measurement, 424, 604  
 data record, precision analysis, 604  
 data record, raw acquisition, 604  
 data required to fill time buckets, 180  
 DATA source, I2S, 512  
 data structures, status reporting, 718  
 data transfer, 226  
 data, erasing, 145  
 data, saving and recalling, 223  
 DATE commands, 630  
 date, calibration, 195  
 date, system, 420  
 dB versus frequency, 245  
 DC coupling for edge trigger, 475  
 DC input coupling for specified channel, 207  
 dc RMS measured on waveform, 331  
 DDE (Device Dependent Error) status bit, 117, 119  
 decision chart, status reporting, 738  
 deep analysis record, 424  
 default conditions, 125  
 define channel labels, 211  
 define glitch trigger, 497  
 define measurement, 295  
 define measurement source, 315  
 define trigger, 449, 465, 466, 467, 469, 498, 549  
 defined as, 106  
 definite-length block query response, 56  
 definite-length block response data, 107  
 DELay commands, 630  
 delay measured to calculate phase, 306  
 delay measurement, 295  
 delay measurements, 320  
 delay parameters for measurement, 297  
 delay, how autoscale affects, 140  
 delayed time base, 431  
 delayed time base mode, how autoscale affects, 140  
 delayed window horizontal scale, 439  
 delete mask, 352  
 delta time, 681  
 delta voltage measurement, 690  
 delta X cursor, 275  
 delta Y cursor, 275  
 DeskJet, 673  
 destination, 231  
 detecting probe types, 665, 669  
 device for hardcopy, 673  
 device-defined error queue clear, 115  
 differential probe heads, 214  
 differential signal type, 217, 239

differentiate math function, 182, 245, 252, 611  
 DIFFerentiate source for function, 257, 670  
 digitize channels, 146  
 DIGitize command, 49, 53, 593  
 digits, 107  
 disable anti-alias mode, 182  
 disable front panel, 423  
 disable function, 671  
 disabling calibration, 200  
 disabling channel display, 208  
 disabling status register bits, 116, 129  
 discontinued and obsolete commands, 657  
 display clear, 225  
 DISPlay commands, 223, 630  
 display commands introduction, 223  
 display connect, 666  
 display data, 226  
 display date, 420  
 display factors scaling, 213  
 display for channels, 208  
 display frequency span, 258  
 display measurements, 290, 314  
 display persistence, 230  
 display reference, 432, 434  
 display reset conditions, 125  
 display serial number, 171  
 display source, 231  
 display vectors, 232  
 display, clearing, 145  
 display, lister, 273  
 display, oscilloscope, 230, 231, 232, 247, 421  
 display, serial decode bus, 401  
 displaying a baseline, 451  
 displaying unsynchronized signal, 451  
 DNS IP, 39  
 domain, 39  
 Domain softkey, 40  
 driver, printer, 678  
 duplicate mnemonics, 769  
 duration, 465, 466, 469  
 duration for glitch trigger, 493, 494, 498  
 duration pattern, 467  
 duration qualifier, trigger, 465, 466, 468  
 DURation trigger commands, 464  
 duration triggering, 441  
 duty cycle measurement, 49, 290, 299

## E

EBURst trigger commands, 470  
 edge, 549  
 EDGE commands, 631  
 edge counter, 548  
 edge counter, Nth edge of burst, 471  
 edge coupling, 475  
 edge define, 449, 549  
 edge fall time, 300  
 edge parameter for delay measurement, 297  
 edge preshoot measured, 307  
 edge rise time, 312  
 edge slope, 478  
 edge source, 479  
 EDGE trigger commands, 474  
 edge triggering, 441  
 edges in measurement, 295  
 elapsed time in mask test, 349  
 ellipsis, 107  
 enable channel labels, 228  
 enabling calibration, 200  
 enabling channel display, 208  
 enabling status register bits, 116, 129  
 end of string (EOS) terminator, 752  
 end of text (EOT) terminator, 752  
 end or identify (EOI), 752  
 enter pattern, 449  
 EOI (end or identify), 752  
 EOS (end of string) terminator, 752  
 EOT (end of text) terminator, 752  
 Epson, 673  
 equivalent-time acquisition mode, 178, 183  
 erase data, 145, 225  
 erase functions, 145  
 erase measurements, 680  
 erase screen, 667  
 ERRor commands, 631  
 error frame count (CAN), 396  
 error frame count (UART), 414  
 error messages, 422, 707  
 error number, 422  
 error queue, 422, 729  
 error, measurement, 290  
 ESB (Event Status Bit), 130, 132  
 ESE (Standard Event Status Enable Register), 116, 728  
 ESR (Standard Event Status Register), 118, 727  
 EVENt commands, 631  
 event status conditions occurred, 132  
 Event Status Enable Register (ESE), 116, 728  
 Event Status Register (ESR), 118, 175, 727  
 example code, :ACQuire:COMPLete, 180  
 example code, :ACQuire:SEGMented, 187  
 example code, :ACQuire:TYPE, 192  
 example code, :AUToscale, 141  
 example code, :CHANnel<n>:LABel, 211  
 example code, :CHANnel<n>:PROBe, 213  
 example code, :CHANnel<n>:RANGe, 219  
 example code, :DIGitize, 146  
 example code, :DISPlay:DATA, 227  
 example code, :DISPlay:LABel, 228  
 example code, :MEASure:PERiod, 315  
 example code, :MEASure:RESults, 309  
 example code, :MEASure:TEDGe, 321  
 example code, :MTESt, 339  
 example code, :RUN/:STOP, 170  
 example code, :SYSTem:SETup, 426  
 example code, :TIMebase:DELay, 703  
 example code, :TIMebase:MODE, 431  
 example code, :TIMebase:RANGe, 433  
 example code, :TIMebase:REFerence, 434  
 example code, :TRIGger:MODE, 447  
 example code, :TRIGger:SLOPe, 478  
 example code, :TRIGger:SOURce, 479  
 example code, :VIEW and :BLANK, 176  
 example code, :WAVeform, 611

## Index

example code, :WAVEform:DATA, 599  
example code, :WAVEform:POINts, 603  
example code, :WAVEform:PREamble, 607  
example code, :WAVEform:SEGmented, 187  
example code, \*RST, 127  
example programs, 4, 775  
EXE (Execution Error) status bit, 117, 119  
execution error detected in Standard Event Status, 119  
exponential notation, 106  
external glitch trigger source, 499  
external range, 241  
external trigger, 233, 236, 237, 479, 668  
EXternal trigger commands, 233  
external trigger input impedance, 236, 668  
EXternal trigger level, 476  
external trigger overload, 240  
external trigger probe attenuation factor, 237  
external trigger probe ID, 238  
external trigger probe sensing, 669  
external trigger protection, 240  
external trigger signal type, 239  
EXternal trigger source, 479  
external trigger units, 242

## F

FACTion commands, 632  
FACTors commands, 632  
fail (mask test) output, 355  
failed waveforms in mask test, 347  
failure, self test, 134  
fall time measurement, 290, 300  
falling edge, 449, 549  
Fast Fourier Transform (FFT) functions, 245, 246, 257, 258, 259, 670  
FF values in waveform data, 599  
FFT (Fast Fourier Transform) functions, 245, 246, 257, 258, 259, 670  
FFT (Fast Fourier Transform) operation, 252, 611  
FFT math function, 182  
fifty ohm impedance, disable setting, 425  
fifty percent trigger level, 446  
FILENAME commands, 632  
filename for hardcopy, 674  
filename for recall, 372  
filename for save, 379  
filter for frequency reject, 477  
filter for high frequency reject, 444  
filter for noise reject, 448  
filter used to limit bandwidth, 206, 235  
filters to Fast Fourier Transforms, 259  
find stage in sequence trigger, 550  
fine horizontal adjustment (vernier), 436  
fine vertical adjustment (vernier), 222  
finish pending device operations, 122  
first point displayed, 621  
FLATop window for amplitude measurements, 259  
FLEXray commands, 632  
FlexRay frame counters, reset, 403

FLEXray source, 490  
FLEXray trigger, 491  
FLEXray trigger autoseup, 481  
FLEXray trigger commands, 480  
format, 601, 606  
FORMat commands, 632  
format for block data, 121  
format for generic video, 565, 569  
format for hardcopy, 672, 675  
format for image, 383  
format for waveform data, 391  
FormattedIO488 object, 51  
formfeed for hardcopy, 261, 265  
formulas for data conversion, 594  
frame, 563  
frame counters (CAN), error, 396  
frame counters (CAN), overload, 397  
frame counters (CAN), reset, 398  
frame counters (CAN), total, 399  
frame counters (FlexRay), null, 402, 404  
frame counters (FlexRay), reset, 403  
frame counters (FlexRay), total, 405  
frame counters (UART), error, 414  
frame counters (UART), reset, 415  
frame counters (UART), Rx frames, 416  
frame counters (UART), Tx frames, 417  
frame ID, FLEXray frame trigger, 488  
frame type, FLEXray frame trigger, 489  
framing, 558  
FRAMing commands, 633  
frequency measurement, 49, 290, 301  
frequency resolution, 259  
frequency span of display, 258  
frequency versus dB, 245  
front panel mode, 451  
front panel Single key, 172  
front panel Stop key, 174  
front-panel lock, 423  
full-scale horizontal time, 433, 438  
full-scale vertical axis defined, 253  
function, 176, 246, 247, 251, 252, 253, 254, 255, 257, 258, 259, 670, 671  
FUNCTION commands, 243  
function memory, 173  
function turned on or off, 671  
functions, 611  
functions, erasing, 145

## G

g(t) source, first input channel, 249  
g(t) source, math operation, 248  
g(t) source, second input channel, 250  
gateway IP, 39  
general trigger commands, 443  
GENeric, 565, 569  
generic video format, 565, 569  
glitch duration, 498  
glitch qualifier, 497  
glitch source, 499  
GLITCh trigger commands, 492  
glitch trigger duration, 493

glitch trigger polarity, 496  
glitch trigger source, 493  
GOFT commands, 633  
GPIB interface, 39, 40  
graphics, 226  
graticule area for hardcopy print, 262  
graticule area for saved image, 381  
graticule colors, invert for hardcopy, 266, 677  
graticule colors, invert for image, 384  
graticule data, 226  
grayscale palette for hardcopy, 268  
grayscale palette for image, 385  
grayscale on hardcopy, 676  
greater than qualifier, 497  
greater than time, 465, 469, 493, 498  
GREaterthan commands, 633

## H

HANNing window for frequency resolution, 259  
hardcopy, 169, 261  
HARDcopy commands, 260  
hardcopy device, 673  
hardcopy factors, 264, 382  
hardcopy filename, 674  
hardcopy format, 672, 675  
hardcopy formfeed, 265  
hardcopy grayscale, 676  
hardcopy invert graticule colors, 266, 677  
hardcopy layout, 267  
hardcopy palette, 268  
hardcopy print, area, 262  
hardcopy printer driver, 678  
hardware event condition register, 150  
Hardware Event Condition Register (:HWERegister:CONDition), 150  
Hardware Event Condition Register (:OPERRegister:CONDition), 735  
Hardware Event Enable Register (HWEenable), 148  
hardware event event register, 152  
Hardware Event Event Register (:HWERegister[:EVENT]), 152, 734  
head type, probe, 214  
header, 752  
high resolution acquisition type, 594  
high-frequency reject filter, 444, 477  
high-resolution acquisition type, 178  
hold until operation complete, 122  
holdoff time, 445  
holes in waveform data, 599  
horizontal adjustment, fine (vernier), 436  
horizontal position, 437  
horizontal scale, 435, 439  
horizontal scaling, 606  
horizontal time, 433, 438, 681  
hostname, 39  
HWEenable (Hardware Event Enable Register), 148  
HWERegister:CONDition (Hardware Event Condition Register), 150, 735

HWERegister[:EVENT] (Hardware Event Event Register), 152, 734

## I

I/O softkey, 39, 40  
 I1080L50HZ, 565, 569  
 I1080L60HZ, 565, 569  
 I2S alignment, 502  
 I2S audio channel, 503  
 I2S clock slope, 504  
 I2S CLOCK source, 511  
 I2S commands, 634  
 I2S DATA source, 512  
 I2S pattern data, 505  
 I2S pattern format, 507  
 I2S range, 508  
 I2S receiver width, 510  
 I2S serial decode base, 406  
 I2S transmit word size, 516  
 I2S trigger commands, 500  
 I2S trigger operator, 514  
 I2S triggering, 441  
 I2S word select (WS) low, 517  
 I2S word select (WS) source, 513  
 ID commands, 634  
 id mode, 457  
 identification number, 120  
 identification of options, 123  
 identifier, 456  
 identifier, LIN, 529  
 idle, 472  
 IDLE commands, 634  
 idle until operation complete, 122  
 IDN (Identification Number), 120  
 IEEE 488.2 standard, 113  
 IGCOLORS commands, 635  
 IIC address, 519  
 IIC clock, 522  
 IIC commands, 634  
 IIC data, 520, 523  
 IIC data 2, 521  
 IIC serial decode address field size, 407  
 IIC trigger commands, 518  
 IIC trigger qualifier, 524  
 IIC trigger type, 525  
 IIC triggering, 441  
 IMAGE commands, 635  
 image format, 383  
 image invert graticule colors, 384  
 image memory, 173, 231  
 image palette, 385  
 image, recall, 373  
 image, save, 380  
 image, save with inksaver, 384  
 impedance, 209  
 IMPedance commands, 635  
 impedance for external trigger input, 236, 668  
 infinity representation, 772  
 initialization, 48, 51  
 initialize, 125  
 initialize label list, 229

initiate acquisition, 146  
 inksaver, save image with, 384  
 input, 236, 668  
 input coupling for channels, 207  
 input impedance for channels, 209, 664  
 input impedance for external trigger, 236, 668  
 input inversion for specified channel, 210  
 insert label, 211  
 installed options identified, 123  
 instruction header, 752  
 instrument number, 120  
 instrument options identified, 123  
 instrument requests service, 132  
 instrument serial number, 171  
 instrument settings, 261  
 instrument status, 58  
 instrument type, 120  
 integrate math function, 245, 252, 611  
 INTEGRATE source for function, 257, 670  
 INTERN files, 231  
 internal low-pass filter, 206, 235  
 introduction to :ACQUIRE commands, 177  
 introduction to :CALIBRATE commands, 193  
 introduction to :CHANnel<n> commands, 204  
 introduction to :DISPLAY commands, 223  
 introduction to :EXTERNAL commands, 233  
 introduction to :FUNCTION commands, 245  
 introduction to :HARDcopy commands, 261  
 introduction to :LISTer commands, 271  
 introduction to :MARKer commands, 275  
 introduction to :MEASURE commands, 290  
 introduction to :RECALL commands, 371  
 introduction to :SAVE commands, 378  
 introduction to :SBUS commands, 395  
 introduction to :SYSTEM commands, 419  
 introduction to :TIMebase commands, 429  
 introduction to :TRIGGER commands, 440  
 introduction to :WAVEform commands, 592  
 introduction to common (\*) commands, 113  
 introduction to root (:): commands, 138  
 invert graticule colors for hardcopy, 266, 677  
 invert graticule colors for image, 384  
 inverted masks, bind levels, 364  
 inverting input for channels, 210  
 IO library, referencing, 50  
 IP address, 39  
 IP Options softkey, 40

## K

key disable, 423  
 key press detected in Standard Event Status Register, 119  
 knob disable, 423  
 known state, 125

## L

label, 662  
 LABEL commands, 635  
 label list, 211, 229

labels, 211, 228, 229  
 labels to store calibration information, 196  
 labels, specifying, 223  
 LAN interface, 39, 42  
 LAN Settings softkey, 40  
 landscape layout for hardcopy, 267  
 language for program examples, 47  
 LaserJet, 673  
 layout for hardcopy, 267  
 leakage into peak spectrum, 259  
 learn string, 121, 426  
 least significant byte first, 597  
 left reference, 434  
 legal values for channel offset, 212  
 legal values for frequency span, 258  
 legal values for offset, 251, 254  
 LENGTH commands, 635  
 length for waveform data, 392  
 less than qualifier, 497  
 less than time, 466, 469, 494, 498  
 LESSthan commands, 635  
 LEVEL commands, 635, 636  
 level for trigger voltage, 476, 495  
 LF coupling, 475  
 license information, 123  
 limits for line number, 565  
 LIN acknowledge, 534  
 LIN baud rate, 535  
 LIN identifier, 529  
 LIN pattern data, 530  
 LIN pattern format, 533  
 LIN serial decode bus parity bits, 408  
 LIN source, 536  
 LIN standard, 537  
 LIN sync break, 538  
 LIN trigger, 532, 539  
 LIN trigger commands, 527  
 LIN trigger definition, 705  
 LIN triggering, 441  
 line glitch trigger source, 499  
 line number for TV trigger, 565  
 line terminator, 106  
 LINE trigger level, 476  
 LINE trigger source, 479  
 list of channel labels, 229  
 LISTer commands, 271, 636  
 lister display, 273  
 load utilization (CAN), 400  
 local lockout, 423  
 lock, 423  
 LOCK commands, 636  
 lock mask to signal, 354  
 lock, analog channel protection, 425  
 lockout message, 423  
 long form, 752  
 LOWER commands, 636  
 lower threshold, 305  
 lower threshold channel, M1553 trigger, 544  
 lower threshold voltage for measurement, 679  
 lowercase characters in commands, 751  
 low-frequency reject filter, 477

## Index

low-pass filter used to limit bandwidth, [206](#), [235](#)

LRN (Learn Device Setup), [121](#)  
lsbfirst, [597](#)

## M

M1553 commands, [636](#)  
M1553 trigger commands, [540](#)  
M1553 trigger type, [546](#)  
magnitude of occurrence, [322](#)  
main sweep range, [437](#)  
main time base, [703](#)  
main time base mode, [431](#)  
making measurements, [290](#)  
MAN option for probe sense, [665](#), [669](#)  
manual cursor mode, [276](#)  
MARKer commands, [274](#)  
marker mode, [282](#)  
marker position, [283](#)  
marker readout, [685](#), [686](#)  
marker set for voltage measurement, [691](#), [692](#)  
marker sets start time, [682](#)  
marker time, [681](#)  
markers for delta voltage measurement, [690](#)  
markers track measurements, [314](#)  
markers, command overview, [275](#)  
markers, mode, [276](#)  
markers, time at start, [686](#)  
markers, time at stop, [685](#)  
markers, X delta, [281](#)  
markers, X1 position, [277](#)  
markers, X1Y1 source, [278](#)  
markers, X2 position, [279](#)  
markers, X2Y2 source, [280](#)  
markers, Y delta, [284](#)  
markers, Y1 position, [282](#)  
markers, Y2 position, [283](#)  
mask, [116](#), [129](#), [449](#), [467](#)  
MASK commands, [636](#)  
mask statistics, reset, [348](#)  
mask test commands, [337](#)  
Mask Test Event Enable Register (MTEenable), [155](#)  
mask test event register, [157](#)  
Mask Test Event Event Register (:MTERegister[:EVENT]), [157](#), [736](#)  
mask test output, [355](#)  
mask test run mode, [356](#)  
mask test termination conditions, [356](#)  
mask test, enable/disable, [353](#)  
mask, delete, [352](#)  
mask, get as binary block data, [351](#)  
mask, load from binary block data, [351](#)  
mask, lock to signal, [354](#)  
mask, recall, [374](#)  
mask, save, [386](#), [387](#)  
masks, bind levels, [364](#)  
master summary status bit, [132](#)  
math function, stop displaying, [144](#)  
math operations, [245](#)  
MAV (Message Available), [115](#), [130](#), [132](#)

maximum duration, [465](#), [466](#), [494](#)  
maximum position, [432](#)  
maximum range for zoomed window, [438](#)  
maximum scale for zoomed window, [439](#)  
maximum vertical value measurement, [327](#)  
maximum vertical value, time of, [335](#), [683](#)  
MEASure commands, [285](#)  
measure mask test failures, [357](#)  
measure overshoot, [303](#)  
measure period, [305](#)  
measure phase between channels, [306](#)  
measure preshoot, [307](#)  
measure start voltage, [691](#)  
measure stop voltage, [692](#)  
measure value at a specified time, [332](#)  
measure value at top of waveform, [333](#)  
measurement error, [290](#)  
measurement record, [424](#), [604](#)  
measurement setup, [290](#), [315](#)  
measurement source, [315](#)  
measurement statistics results, [309](#)  
measurement window for zoomed time base, [334](#)  
measurements, average value, [325](#)  
measurements, base value, [326](#)  
measurements, built-in, [49](#)  
measurements, clear, [292](#), [680](#)  
measurements, command overview, [290](#)  
measurements, counter, [293](#)  
measurements, dc RMS, [331](#)  
measurements, definition setup, [295](#)  
measurements, delay, [297](#)  
measurements, duty cycle, [299](#)  
measurements, fall time, [300](#)  
measurements, frequency, [301](#)  
measurements, how autoscale affects, [140](#)  
measurements, lower threshold level, [679](#)  
measurements, maximum vertical value, [327](#)  
measurements, maximum vertical value, time of, [335](#), [683](#)  
measurements, minimum vertical value, [328](#)  
measurements, minimum vertical value, time of, [336](#), [684](#)  
measurements, overshoot, [303](#)  
measurements, period, [305](#)  
measurements, phase, [306](#)  
measurements, preshoot, [307](#)  
measurements, pulse width, negative, [302](#)  
measurements, pulse width, positive, [308](#)  
measurements, ratio of AC RMS values, [330](#)  
measurements, resetting, [145](#)  
measurements, rise time, [312](#)  
measurements, show, [314](#)  
measurements, source channel, [315](#)  
measurements, standard deviation, [313](#)  
measurements, start marker time, [685](#)  
measurements, stop marker time, [686](#)  
measurements, thresholds, [682](#)  
measurements, time between start and stop markers, [681](#)  
measurements, time between trigger and edge, [320](#)

measurements, time between trigger and vertical value, [322](#)  
measurements, time between trigger and voltage level, [687](#)  
measurements, upper threshold value, [689](#)  
measurements, vertical amplitude, [324](#)  
measurements, vertical peak-to-peak, [329](#)  
measurements, voltage difference, [690](#)  
memory setup, [128](#), [426](#)  
merge, [154](#)  
message available bit, [132](#)  
message available bit clear, [115](#)  
message displayed, [132](#)  
message error, [707](#)  
message queue, [726](#)  
messages ready, [132](#)  
midpoint of thresholds, [305](#)  
MIL-STD 1553 serial decode base, [409](#)  
MIL-STD 1553 triggering, [441](#)  
minimum duration, [465](#), [466](#), [469](#), [493](#)  
minimum vertical value measurement, [328](#)  
minimum vertical value, time of, [336](#), [684](#)  
mnemonics, duplicate, [769](#)  
mode, [183](#), [191](#), [276](#), [431](#), [566](#)  
MODE commands, [638](#)  
mode, serial decode, [410](#)  
model number, [120](#)  
models, oscilloscope, [3](#)  
modes for triggering, [447](#)  
Modify softkey, [40](#)  
monochrome palette for image, [385](#)  
most significant byte first, [597](#)  
move, [245](#)  
move cursors, [685](#), [686](#)  
msbfirst, [597](#)  
MSG (Message), [130](#), [132](#)  
MSS (Master Summary Status), [132](#)  
MTEenable (Mask Test Event Enable Register), [155](#)  
MTERegister[:EVENT] (Mask Test Event Event Register), [157](#), [736](#)  
MTESt commands, [337](#)  
multiple commands, [769](#)  
multiple queries, [57](#)  
multiply math function, [245](#), [252](#), [611](#)  
multiply math function as g(t) source, [248](#)

## N

name channels, [211](#)  
name list, [229](#)  
negative glitch trigger polarity, [496](#)  
negative pulse width, [302](#)  
negative pulse width measurement, [49](#)  
negative slope, [478](#), [556](#)  
negative slope, Nth edge in burst, [473](#)  
negative TV trigger polarity, [567](#)  
new line (NL) terminator, [106](#), [752](#)  
NL (new line) terminator, [106](#), [752](#)  
noise reject filter, [448](#)  
non-core commands, [750](#)  
non-interlaced GENeric mode, [569](#)

non-volatile memory, label list, 229  
 normal acquisition type, 177, 593  
 normal trigger sweep mode, 440  
 notices, 2  
 NR1 number format, 106  
 NR3 number format, 106  
 Nth edge burst triggering, 441  
 Nth edge in a burst idle, 472  
 Nth edge in burst slope, 473  
 Nth edge of burst counter, 471  
 NTSC, 565, 569  
 null frame count (FlexRay), 402  
 NULL string, 421  
 number format, 106  
 number of points, 184, 602, 604  
 number of time buckets, 602, 604  
 numeric variables, 56  
 numeric variables, reading query results into multiple, 58  
 nwidth, 302

## O

obsolete and discontinued commands, 657  
 obsolete commands, 750  
 occurrence reported by magnitude, 687  
 offset, 245  
 OFFSet commands, 639  
 offset value for channel voltage, 212  
 offset value for selected function, 251, 254  
 one values in waveform data, 599  
 OPC (Operation Complete) command, 122  
 OPC (Operation Complete) status bit, 117, 119  
 OPEE (Operation Status Enable Register), 159  
 Open method, 51  
 operating configuration, 121, 426  
 operating state, 128  
 OPERation commands, 640  
 operation complete, 122  
 operation status condition register, 161  
 Operation Status Condition Register (:OPERRegister:CONDition), 161, 731  
 operation status conditions occurred, 132  
 Operation Status Enable Register (OPEE), 159  
 operation status event register, 163  
 Operation Status Event Register (:OPERRegister[:EVENT]), 163, 730  
 operation, math, 245  
 operations for function, 252  
 OPERRegister:CONDition (Operation Status Condition Register), 161, 731  
 OPERRegister[:EVENT] (Operation Status Event Register), 163, 730  
 OPT (Option Identification), 123  
 optional syntax terms, 106  
 options, 123  
 order of output, 597  
 oscilloscope connection, opening, 51  
 oscilloscope connection, verifying, 41  
 oscilloscope external trigger, 233  
 oscilloscope models, 3  
 oscilloscope rate, 190  
 oscilloscope, connecting, 39  
 oscilloscope, initialization, 48  
 oscilloscope, operation, 4  
 oscilloscope, program structure, 48  
 oscilloscope, setting up, 39  
 oscilloscope, setup, 52  
 OUTPut commands, 640  
 output messages ready, 132  
 output queue, 122, 725  
 output queue clear, 115  
 output sequence, 597  
 output, mask test, 355  
 overlapped commands, 773  
 overload, 218, 240  
 Overload Event Enable Register (OVL), 165  
 Overload Event Register (:OVLRegister), 733  
 Overload Event Register (OVLr), 167  
 overload frame count (CAN), 397  
 overload protection, 165, 167  
 overshoot of waveform, 303  
 overvoltage, 218, 240  
 OVL (Overload Event Enable Register), 165  
 OVLr (Overload Event Register), 167  
 OVLr bit, 152, 161, 163  
 OVLRegister (Overload Event Register), 733

## P

P1080L24HZ, 565, 569  
 P1080L25HZ, 565, 569  
 P1080L50HZ, 569  
 P1080L60HZ, 542, 569  
 P480L60HZ, 565, 569  
 P720L60HZ, 565, 569  
 PAL, 565, 569  
 PALette commands, 640  
 palette for hardcopy, 268  
 palette for image, 385  
 PAL-M, 565, 569  
 parameters for delay measurement, 297  
 parametric measurements, 290  
 parity, 578  
 parity bits, LIN serial decode bus, 408  
 PARity commands, 640  
 parser, 138, 769  
 pass (mask test) output, 355  
 pass, self test, 134  
 path information, recall, 375  
 path information, save, 388  
 pattern, 449, 454, 456, 467, 519, 520, 521, 551, 559  
 pattern and edge, 449  
 PATtern commands, 640  
 pattern data, I2S, 505  
 pattern data, LIN, 530  
 pattern duration, 465, 466, 493, 494  
 pattern format, I2S, 507  
 pattern format, LIN, 533  
 pattern length, 455, 532  
 pattern trigger, 449  
 pattern triggering, 441  
 pattern width, 560  
 peak data, 594  
 peak detect, 191  
 peak detect acquisition type, 178, 594  
 peaks, 245  
 peak-to-peak vertical value measurement, 329  
 pending operations, 122  
 percent of waveform overshoot, 303  
 percent thresholds, 295  
 period measured to calculate phase, 306  
 period measurement, 49, 290, 305  
 persistence, waveform, 223, 230  
 phase measured between channels, 306  
 phase measurements, 320  
 pixel memory, 231  
 pixel memory, saving display to, 154  
 PLL Locked bit, 150, 161  
 pod, 611  
 points, 184, 602, 604  
 POINts commands, 641  
 points in waveform data, 593  
 polarity, 567, 579  
 POLarity commands, 641  
 polarity for glitch trigger, 496  
 polling synchronization with timeout, 742  
 polling wait, 740  
 PON (Power On) status bit, 117, 119  
 portrait layout for hardcopy, 267  
 position, 279, 432, 437  
 POSition commands, 641  
 position cursors, 685, 686  
 position in zoomed view, 437  
 positive glitch trigger polarity, 496  
 positive pulse width, 308  
 positive pulse width measurement, 49  
 positive slope, 478, 556  
 positive slope, Nth edge in burst, 473  
 positive TV trigger polarity, 567  
 positive width, 308  
 preamble data, 606  
 preamble metadata, 592  
 precision analysis, 424  
 precision analysis record, 604  
 present working directory, recall operations, 375  
 present working directory, save operations, 388  
 preset conditions, 125  
 preshoot measured on waveform, 307  
 previously stored configuration, 124  
 print command, 169  
 print job, start, 270  
 print mask test failures, 358  
 print query, 701  
 printer, 673  
 printer driver for hardcopy, 678  
 printer hardcopy format, 675  
 printer, active, 263  
 printing, 261  
 printing in grayscale, 676  
 probe, 476  
 probe attenuation affects channel voltage range, 219  
 probe attenuation factor (external trigger), 237

## Index

probe attenuation factor for selected channel, 213  
PROBe commands, 641  
probe head type, 214  
probe ID, 215, 238  
probe sense for oscilloscope, 665, 669  
probe skew value, 216, 663  
process sigma, mask test run, 361  
program data, 752  
program data syntax rules, 754  
program initialization, 48  
program message, 51, 113  
program message syntax, 751  
program message terminator, 752  
program structure, 48  
programming examples, 4, 775  
protecting against calibration, 200  
protection, 165, 167, 218, 240  
PROTection commands, 642  
protection lock, 425  
pulse width, 302, 308  
pulse width duration trigger, 493, 494, 498  
pulse width measurement, 49, 290  
pulse width trigger, 448  
pulse width trigger level, 495  
pulse width triggering, 441  
PVD commands, 642  
pwidth, 308

## Q

qualifier, 498  
QUALifier commands, 642  
qualifier, trigger duration, 465, 466, 468  
queries, multiple, 57  
query error detected in Standard Event Status, 119  
query responses, block data, 56  
query responses, reading, 55  
query results, reading into numeric variables, 56  
query results, reading into string variables, 56  
query return values, 772  
query setup, 261, 275, 290, 426  
query subsystem, 245  
querying setup, 205  
querying the subsystem, 442  
queues, clearing, 737  
quick reference, commands, 61  
quoted ASCII string, 107  
QYE (Query Error) status bit, 117, 119

## R

range, 245, 438  
RANGe commands, 642  
range for channels, 219  
range for duration trigger, 469  
range for external trigger, 241  
range for full-scale vertical axis, 253  
range for glitch trigger, 498

range for time base, 433  
range of offset values, 212  
range qualifier, 497  
range, I2S, 508  
ranges, value, 107  
rate, 190  
ratio of AC RMS values measured between channels, 330  
raw acquisition record, 604  
RCL (Recall), 124  
read configuration, 121  
read trace memory, 226  
ReadIIEEEBlock method, 51, 55, 57  
ReadList method, 51, 55  
ReadNumber method, 51, 55  
readout, 681  
ReadString method, 51, 55  
real-time acquisition mode, 178, 183  
recall, 124, 371, 426  
RECall commands, 371  
recall filename, 372  
recall image, 373  
recall mask, 374  
recall path information, 375  
recall setup, 376  
recalling and saving data, 223  
receiver width, I2S, 510  
RECTangular window for transient signals, 259  
reference, 245, 434  
REFeRence commands, 642  
reference for time base, 703  
registers, 118, 124, 128, 139, 148, 150, 152, 155, 157, 159, 161, 163, 165, 167  
registers, clearing, 737  
reject filter, 477  
reject high frequency, 444  
reject noise, 448  
remote control examples, 775  
Remote Terminal Address (RTA), M1553 trigger, 543  
remove cursor information, 276  
remove labels, 228  
remove message from display, 421  
reorder channels, 140  
repetitive acquisitions, 170  
report errors, 422  
report transition, 320, 322  
reporting status, 715  
reporting the setup, 442  
request service, 132  
Request-for-OPC flag clear, 115  
reset, 125, 552  
RESet commands, 643  
reset conditions, 125  
reset mask statistics, 348  
reset measurements, 145, 225  
resolution of printed copy, 676  
resource session object, 51  
ResourceManager object, 51  
restore configurations, 121, 124, 128, 426  
restore labels, 228  
restore setup, 124

return values, query, 772  
returning acquisition type, 191  
returning number of data points, 184  
right reference, 434  
rise time measurement, 290  
rise time of positive edge, 312  
rising edge, 449, 549  
RMODe commands, 643  
RMS value measurement, 331  
roll time base mode, 431  
root (:) commands, 136, 138  
root level commands, 110  
RQL (Request Control) status bit, 117, 119  
RQS (Request Service), 132  
RS-232/UART triggering, 442  
RST (Reset), 125  
rules, tree traversal, 769  
rules, truncation, 752  
RUMode commands, 643  
run, 133, 170  
Run bit, 161, 163  
run mode, mask test, 356  
running configuration, 128, 426  
Rx frame count (UART), 416  
Rx source, 581

## S

sample rate, 190  
sampled data, 666  
sampled data points, 599  
SAMPlEpoint commands, 643  
SAV (Save), 128  
save, 128, 378  
SAVE commands, 377, 643  
save filename, 379  
save image, 380  
save image with inksaver, 384  
save mask, 386, 387  
save mask test failures, 359  
save path information, 388  
save setup, 389  
SAVE TO INTERN, 154  
save waveform data, 390  
save waveforms to pixel memory, 154  
saved image, area, 381  
saving and recalling data, 223  
SBUS commands, 394  
scale, 255, 435, 439  
SCALE commands, 645  
scale factors output on hardcopy, 264, 382  
scale for channels, 220  
scale units for channels, 221  
scale units for external trigger, 242  
scaling display factors, 213  
SCPI commands, 59  
scratch measurements, 680  
screen area for hardcopy print, 262  
screen area for saved image, 381  
screen data, 226  
SECAM, 565, 569  
seconds per division, 435

- SEGmented commands, 645
  - segmented waveform save option, 393
  - segments, analyze, 185
  - segments, count of waveform, 609
  - segments, setting number of memory, 186
  - segments, setting the index, 187
  - segments, time tag, 610
  - select measurement channel, 315
  - self-test, 134
  - sensing a channel probe, 665
  - sensing an external trigger probe, 669
  - sensitivity of oscilloscope input, 213
  - sequence, 550, 551, 552
  - sequence trigger, 554
  - SEquence trigger commands, 547
  - sequence triggering, 442
  - sequencer edge counter, 548
  - sequencer timer, 553
  - sequential commands, 773
  - serial clock, 522, 561
  - serial data, 523, 562
  - serial decode bus, 395
  - serial decode bus display, 401
  - serial decode mode, 410
  - serial frame, 563
  - serial number, 171
  - service request, 132
  - Service Request Enable Register (SRE), 130, 723
  - set, 125
  - set center frequency, 246
  - set conditions, 140
  - set cursors, 685, 686
  - set date, 420
  - set delay, 140
  - set thresholds, 140
  - set time, 428
  - set time/div, 140
  - set up oscilloscope, 39
  - setting display, 247
  - setting external trigger level, 233
  - setting impedance for channels, 209
  - setting inversion for channels, 210
  - settings, 124, 128
  - settings, instrument, 261
  - setup, 178, 205, 223, 245, 261, 426
  - SETup commands, 645
  - setup configuration, 124, 128, 426
  - setup defaults, 125
  - setup memory, 124
  - setup reported, 442
  - setup, recall, 376
  - setup, save, 389
  - short form, 3, 752
  - show channel labels, 228
  - show measurements, 290, 314
  - SICL example in C, 855
  - SICL example in Visual Basic, 864
  - SICL examples, 855
  - sigma, mask test run, 361
  - SIGNal commands, 645
  - signal type, 217, 239
  - signed data, 595
  - simple command headers, 753
  - single acquisition, 172
  - single-ended probe heads, 214
  - single-ended signal type, 217, 239
  - single-shot DUT, synchronizing with, 744
  - skew, 216, 663
  - slope, 478, 556
  - slope (direction) of waveform, 687
  - SLOPe commands, 646
  - slope not valid in TV trigger mode, 478
  - slope of edge, 549
  - slope parameter for delay measurement, 297
  - slope, Nth edge in burst, 473
  - smoothing acquisition type, 594
  - software version, 120
  - source, 231, 245, 315, 461, 536, 611
  - SOURce commands, 646
  - source for function, 256, 257, 670
  - source for trigger, 479
  - source for TV trigger, 568
  - source, automask, 343
  - source, FLEXray, 490
  - source, mask test, 369
  - SOURce1 commands, 647
  - SOURce2 commands, 647
  - span, 245
  - span of frequency on display, 258
  - specify measurement, 315
  - SPI, 556, 557, 559
  - SPI commands, 647
  - SPI decode bit order, 411
  - SPI decode word width, 412
  - SPI trigger, 558, 560
  - SPI trigger clock, 561
  - SPI trigger commands, 555
  - SPI trigger data, 562
  - SPI trigger frame, 563
  - SPI triggering, 442
  - square root math function, 252
  - SRE (Service Request Enable Register), 130, 723
  - SRQ (Service Request interrupt), 148, 155, 159
  - STANDARD commands, 647
  - standard deviation measured on waveform, 313
  - Standard Event Status Enable Register (ESE), 116, 728
  - Standard Event Status Register (ESR), 118, 727
  - standard for video, 569
  - standard, LIN, 537
  - start acquisition, 133, 146, 170, 172
  - start and stop edges, 295
  - STARt commands, 647
  - start cursor, 685
  - start measurement, 290
  - start print job, 270
  - start time, 498, 685
  - start time marker, 682
  - state memory, 128
  - state of instrument, 121, 426
  - STATistics commands, 647
  - statistics increment, 318
  - statistics reset, 319
  - statistics results, 309
  - statistics, type of, 317
  - status, 131, 173, 175
  - Status Byte Register (STB), 129, 131, 132, 721
  - STATus commands, 647
  - status data structure clear, 115
  - status registers, 58
  - status reporting, 715
  - STB (Status Byte Register), 129, 131, 132, 721
  - step size for frequency span, 258
  - stop, 146, 174
  - stop acquisition, 174
  - STOP commands, 648
  - stop cursor, 686
  - stop displaying channel, 144
  - stop displaying math function, 144
  - stop displaying pod, 144
  - stop on mask test failure, 360
  - stop time, 498, 686
  - storage, 128
  - store instrument setup, 121, 128
  - store setup, 128
  - store waveforms to pixel memory, 154
  - storing calibration information, 196
  - string variables, 56
  - string variables, reading multiple query results into, 57
  - string variables, reading query results into multiple, 57
  - string, quoted ASCII, 107
  - subnet mask, 39
  - subsource, waveform source, 615
  - subsystem commands, 110, 769
  - subtract math function, 245, 252, 611
  - subtract math function as g(t) source, 248
  - sweep mode, trigger, 440, 451
  - sweep speed set to fast to measure fall time, 300
  - sweep speed set to fast to measure rise time, 312
  - switch disable, 423
  - switch, calibration protect, 200
  - sync break, LIN, 538
  - sync frame count (FlexRay), 404
  - syntax elements, 106
  - syntax rules, program data, 754
  - syntax, optional terms, 106
  - syntax, program message, 751
  - SYSTem commands, 419
  - system commands, 420, 421, 422, 423, 426, 428
  - system commands introduction, 419
- ## T
- tdelta, 681
  - tedge, 320
  - telnet ports 5024 and 5025, 599
  - Telnet sockets, 59
  - temporary message, 421

- TER (Trigger Event Register), 175, 724
- termination conditions, mask test, 356
- test sigma, mask test run, 361
- test, self, 134
- text, writing to display, 421
- threshold voltage (lower) for measurement, 679
- threshold voltage (upper) for measurement, 689
- thresholds, 295, 682
- thresholds used to measure period, 305
- thresholds, how autoscale affects, 140
- TIFF image format, 383
- time base, 431, 432, 433, 434, 435, 703
- time base commands introduction, 429
- time base reset conditions, 125
- time base window, 437, 438, 439
- time between points, 681
- time buckets, 180, 181
- TIME commands, 648
- time delay, 703
- time delta, 681
- time difference between data points, 619
- time duration, 465, 466, 469, 498
- time holdoff for trigger, 445
- time interval, 320, 322, 681
- time interval between trigger and occurrence, 687
- time marker sets start time, 682
- time per division, 433
- time record, 259
- time specified, 332
- time, calibration, 202
- time, mask test run, 362
- time, start marker, 685
- time, stop marker, 686
- time, system, 428
- time/div, how autoscale affects, 140
- time-at-max measurement, 683
- time-at-min measurement, 684
- TIMEbase commands, 429
- timebase vernier, 436
- TIMEbase:MODE, 54
- time-ordered label list, 229
- timeout, 557
- timer, 553
- timing measurement, 290
- title channels, 211
- title, mask test, 370
- tolerance, automask, 345, 346
- top of waveform value measured, 333
- total frame count (CAN), 399
- total frame count (FlexRay), 405
- total waveforms in mask test, 350
- trace memories, how autoscale affects, 140
- trace memory, 173, 176
- trace memory data, 226
- track measurements, 314
- trademarks, 2
- transfer instrument state, 121, 426
- transmit, 226
- transmit word size, I2S, 516
- tree traversal rules, 769
- tree, command, 755
- TRG (Trigger), 130, 132, 133
- TRIG OUT BNC, 197
- trigger (external) input impedance, 236, 668
- trigger armed event register, 161, 163
- trigger burst, UART, 575
- TRIGger CAN commands, 452
- trigger channel source, 499, 568
- TRIGger commands, 440, 649
- TRIGger commands, general, 443
- trigger data, UART, 576
- trigger duration, 465, 466
- TRIGger DURation commands, 464
- TRIGger EBUrst commands, 470
- trigger edge, 549
- TRIGger EDGE commands, 474
- trigger edge coupling, 475
- trigger edge slope, 478
- trigger event bit, 175
- Trigger Event Register (TER), 724
- TRIGger FLEXray commands, 480
- TRIGger GLITch commands, 492
- trigger holdoff, 445
- TRIGger I2S commands, 500
- trigger idle, UART, 577
- TRIGger IIC commands, 518
- trigger level constants, 213
- trigger level voltage, 476
- trigger level, 50%, 446
- TRIGger LIN commands, 527
- TRIGger M1553 commands, 540
- trigger occurred, 132
- trigger pattern, 449, 467
- trigger qualifier, 468
- trigger qualifier, UART, 580
- trigger reset conditions, 125
- TRIGger SEquence commands, 547
- trigger SPI clock slope, 556
- TRIGger SPI commands, 555
- trigger status bit, 175
- trigger sweep mode, 440
- TRIGger TV commands, 564
- trigger type, UART, 583
- TRIGger UART commands, 570
- TRIGger USB commands, 585
- trigger, CAN, 462
- trigger, CAN acknowledge, 704
- trigger, CAN pattern data, 454
- trigger, CAN pattern data length, 455
- trigger, CAN pattern ID, 456
- trigger, CAN pattern ID mode, 457
- trigger, CAN sample point, 458
- trigger, CAN signal baudrate, 459
- trigger, CAN signal definition, 460
- trigger, CAN source, 461
- trigger, duration greater than, 465
- trigger, duration less than, 466
- trigger, duration pattern, 467
- trigger, duration qualifier, 468
- trigger, duration range, 469
- trigger, edge coupling, 475
- trigger, edge level, 476
- trigger, edge reject, 477
- trigger, edge slope, 478
- trigger, edge source, 479
- trigger, FLEXray, 491
- trigger, FLEXray autoseup, 481
- trigger, FLEXray error, 484
- trigger, FLEXray event, 485
- trigger, FLEXray source, 490
- trigger, glitch greater than, 493
- trigger, glitch less than, 494
- trigger, glitch level, 495
- trigger, glitch polarity, 496
- trigger, glitch qualifier, 497
- trigger, glitch range, 498
- trigger, glitch source, 499
- trigger, high frequency reject filter, 444
- trigger, holdoff, 445
- trigger, I2S, 514
- trigger, I2S alignment, 502
- trigger, I2S audio channel, 503
- trigger, I2S clock slope, 504
- trigger, I2S CLOCksource, 511
- trigger, I2S DATA source, 512
- trigger, I2S pattern data, 505
- trigger, I2S pattern format, 507
- trigger, I2S range, 508
- trigger, I2S receiver width, 510
- trigger, I2S transmit word size, 516
- trigger, I2S word select (WS) low, 517
- trigger, I2S word select (WS) source, 513
- trigger, IIC clock source, 522
- trigger, IIC data source, 523
- trigger, IIC pattern address, 519
- trigger, IIC pattern data, 520
- trigger, IIC pattern data 2, 521
- trigger, IIC qualifier, 524
- trigger, IIC signal baudrate, 535
- trigger, IIC type, 525
- trigger, LIN, 539
- trigger, LIN pattern data, 530
- trigger, LIN pattern data length, 532
- trigger, LIN pattern format, 533
- trigger, LIN sample point, 534
- trigger, LIN signal definition, 705
- trigger, LIN source, 536
- trigger, mode, 447
- trigger, noise reject filter, 448
- trigger, Nth edge in burst slope, 473
- trigger, Nth edge of burst count, 471
- trigger, pattern, 449
- trigger, sequence, 554
- trigger, sequence count, 548
- trigger, sequence edge, 549
- trigger, sequence find, 550
- trigger, sequence pattern, 551
- trigger, sequence reset, 552
- trigger, sequence timer, 553
- trigger, SPI clock slope, 556
- trigger, SPI clock source, 561
- trigger, SPI clock timeout, 557
- trigger, SPI data source, 562

trigger, SPI frame source, [563](#)  
 trigger, SPI framing, [558](#)  
 trigger, SPI pattern data, [559](#)  
 trigger, SPI pattern width, [560](#)  
 trigger, sweep, [451](#)  
 trigger, TV line, [565](#)  
 trigger, TV mode, [566, 706](#)  
 trigger, TV polarity, [567](#)  
 trigger, TV source, [568](#)  
 trigger, TV standard, [569](#)  
 trigger, UART base, [572](#)  
 trigger, UART baudrate, [573](#)  
 trigger, UART bit order, [574](#)  
 trigger, UART parity, [578](#)  
 trigger, UART polarity, [579](#)  
 trigger, UART Rx source, [581](#)  
 trigger, UART Tx source, [582](#)  
 trigger, UART width, [584](#)  
 trigger, USB, [589](#)  
 trigger, USB D- source, [586](#)  
 trigger, USB D+ source, [587](#)  
 trigger, USB speed, [588](#)  
 truncation rules, [752](#)  
 TST (Self Test), [134](#)  
 tstart, [685](#)  
 tstop, [686](#)  
 turn function on or off, [671](#)  
 turn off channel, [144](#)  
 turn off channel labels, [228](#)  
 turn off cursors, [140](#)  
 turn off digital pod, [144](#)  
 turn off math function, [144](#)  
 turn off measurements, [140](#)  
 turn off trace memories, [140](#)  
 turn off zoomed time base mode, [140](#)  
 turn on channel labels, [228](#)  
 turn on channels, [140](#)  
 turning channel display on and off, [208](#)  
 turning off/on function calculation, [247](#)  
 turning vectors on or off, [666](#)  
 TV mode, [566, 706](#)  
 TV trigger commands, [564](#)  
 TV trigger line number setting, [565](#)  
 TV trigger mode, [568](#)  
 TV trigger polarity, [567](#)  
 TV trigger standard setting, [569](#)  
 TV triggering, [442](#)  
 tvmode, [706](#)  
 Tx data, UART, [615](#)  
 Tx frame count (UART), [417](#)  
 Tx source, [582](#)  
 type, [191, 616](#)  
 TYPE commands, [653](#)

## U

UART base, [572](#)  
 UART baud rate, [573](#)  
 UART bit order, [574](#)  
 UART commands, [653](#)  
 UART frame counters, reset, [415](#)  
 UART parity, [578](#)

UART polarity, [579](#)  
 UART Rx source, [581](#)  
 UART trigger burst, [575](#)  
 UART trigger commands, [570](#)  
 UART trigger data, [576](#)  
 UART trigger idle, [577](#)  
 UART trigger qualifier, [580](#)  
 UART trigger type, [583](#)  
 UART Tx data, [615](#)  
 UART Tx source, [582](#)  
 UART width, [584](#)  
 UART/RS-232 triggering, [442](#)  
 UNITs commands, [654](#)  
 units per division, [220, 221, 242, 435](#)  
 units per division (vertical) for function, [220, 255](#)  
 units, automask, [344](#)  
 unsigned data, [595](#)  
 unsigned mode, [617](#)  
 update rate, waveform, [424](#)  
 UPPer commands, [654](#)  
 upper threshold, [305](#)  
 upper threshold channel, M1553 trigger, [545](#)  
 upper threshold voltage for measurement, [689](#)  
 uppercase characters in commands, [751](#)  
 URQ (User Request) status bit, [117, 119](#)  
 USB (Device) interface, [39](#)  
 USB source, [586, 587](#)  
 USB speed, [588](#)  
 USB trigger, [589](#)  
 USB trigger commands, [585](#)  
 USB triggering, [442](#)  
 user defined channel labels, [211](#)  
 user event conditions occurred, [132](#)  
 User's Guide, [4](#)  
 USR (User Event bit), [130, 132](#)  
 Utility button, [39, 40](#)  
 utilization, CAN bus, [400](#)

## V

valid command strings, [751](#)  
 valid pattern time, [465, 466](#)  
 value, [322](#)  
 value measured at base of waveform, [326](#)  
 value measured at specified time, [332](#)  
 value measured at top of waveform, [333](#)  
 value ranges, [107](#)  
 values required to fill time buckets, [181](#)  
 VBA, [50, 776](#)  
 vectors, [232](#)  
 vectors turned on or off, [666](#)  
 vectors, turning on or off, [223](#)  
 vernier, channel, [222](#)  
 vernier, horizontal, [436](#)  
 vertical adjustment, fine (vernier), [222](#)  
 vertical amplitude measurement, [324](#)  
 vertical axis defined by RANGe, [253](#)  
 vertical axis range for channels, [219](#)  
 vertical offset for channels, [212](#)  
 vertical peak-to-peak measured on waveform, [329](#)

vertical scale, [220, 255](#)  
 vertical scaling, [606](#)  
 vertical value at center screen, [251, 254](#)  
 vertical value maximum measured on waveform, [327](#)  
 vertical value measurements to calculate overshoot, [303](#)  
 vertical value minimum measured on waveform, [328](#)  
 video line to trigger on, [565](#)  
 video standard selection, [569](#)  
 view, [176, 245, 618](#)  
 view turns function on or off, [671](#)  
 VISA COM example in C#, [786](#)  
 VISA COM example in Visual Basic, [776](#)  
 VISA COM example in Visual Basic .NET, [798](#)  
 VISA example in C, [809](#)  
 VISA example in C#, [828](#)  
 VISA example in Visual Basic, [818](#)  
 VISA example in Visual Basic .NET, [841](#)  
 VISA examples, [776, 809](#)  
 Visual Basic .NET, VISA COM example, [798](#)  
 Visual Basic .NET, VISA example, [841](#)  
 Visual Basic 6.0, [51](#)  
 Visual Basic for Applications, [50, 776](#)  
 Visual Basic, SICL library example, [864](#)  
 Visual Basic, VISA COM example, [776](#)  
 Visual Basic, VISA example, [818](#)  
 voltage crossing reported or not found, [687](#)  
 voltage difference between data points, [622](#)  
 voltage difference measured, [690](#)  
 voltage level for active trigger, [476](#)  
 voltage marker used to measure waveform, [691, 692](#)  
 voltage offset value for channels, [212](#)  
 voltage probe, [221, 242](#)  
 voltage ranges for channels, [219](#)  
 voltage ranges for external trigger, [241](#)  
 voltage threshold, [295](#)

## W

WAI (Wait To Continue), [135](#)  
 wait, [135](#)  
 wait for operation complete, [122](#)  
 Wait Trig bit, [161, 163](#)  
 waveform base value measured, [326](#)  
 WAVEform command, [49](#)  
 WAVEform commands, [590, 655](#)  
 waveform data, [592](#)  
 waveform data format, [391](#)  
 waveform data length, [392](#)  
 waveform data, save, [390](#)  
 waveform introduction, [592](#)  
 waveform maximum vertical value measured, [327](#)  
 waveform minimum vertical value measured, [328](#)  
 waveform must cross voltage level to be an occurrence, [687](#)  
 WAVEform parameters, [54](#)

## Index

- waveform peak-to-peak vertical value measured, [329](#)
- waveform period, [305](#)
- waveform persistence, [223](#)
- waveform RMS value measured, [331](#)
- waveform save option for segments, [393](#)
- waveform source channels, [611](#)
- waveform source subsource, [615](#)
- waveform standard deviation value measured, [313](#)
- waveform update rate, [424](#)
- waveform vertical amplitude, [324](#)
- waveform voltage measured at marker, [691](#), [692](#)
- waveform, byte order, [597](#)
- waveform, count, [598](#)
- waveform, data, [599](#)
- waveform, format, [601](#)
- waveform, points, [602](#), [604](#)
- waveform, preamble, [606](#)
- waveform, source, [611](#)
- waveform, type, [616](#)
- waveform, unsigned, [617](#)
- waveform, view, [618](#)
- waveform, X increment, [619](#)
- waveform, X origin, [620](#)
- waveform, X reference, [621](#)
- waveform, Y increment, [622](#)
- waveform, Y origin, [623](#)
- waveform, Y reference, [624](#)
- WAVeform:FORMat, [54](#)
- WAVeforms commands, [655](#)
- waveforms, mask test run, [363](#)
- Web control, [59](#)
- what's new, [21](#)
- width, [498](#), [584](#)
- WIDTh commands, [655](#)
- window, [437](#), [438](#), [439](#)
- WINDow commands, [655](#)
- window time, [433](#)
- window time base mode, [431](#)
- windows, [259](#)
- windows as filters to Fast Fourier Transforms, [259](#)
- windows for Fast Fourier Transform functions, [259](#)
- word format, [601](#)
- word format for data transfer, [596](#)
- word select (WS) low, I2S trigger, [517](#)
- word select (WS) source, I2S, [513](#)
- word width, SPI decode, [412](#)
- write text to display, [421](#)
- write trace memory, [226](#)
- WriteEEEBlock method, [51](#), [57](#)
- WriteList method, [51](#)
- WriteNumber method, [51](#)
- WriteString method, [51](#)

## X

- X axis markers, [275](#)
- X delta, [281](#)

- X delta, mask scaling, [366](#)
- X1 and X2 cursor value difference, [281](#)
- X1 cursor, [275](#), [277](#), [278](#)
- X1, mask scaling, [365](#)
- X2 cursor, [275](#), [279](#), [280](#)
- X-axis functions, [429](#)
- XDELta commands, [656](#)
- X-increment, [619](#)
- X-of-max measurement, [335](#)
- X-of-min measurement, [336](#)
- X-origin, [620](#)
- X-reference, [621](#)
- X-Y mode, [429](#), [431](#)

## Y

- Y axis markers, [275](#)
- Y1 and Y2 cursor value difference, [284](#)
- Y1 cursor, [275](#), [278](#), [282](#), [284](#)
- Y1, mask scaling, [367](#)
- Y2 cursor, [275](#), [280](#), [283](#), [284](#)
- Y2, mask scaling, [368](#)
- Y-axis value, [623](#)
- YDELta commands, [656](#)
- Y-increment, [622](#)
- Y-origin, [623](#), [624](#)
- Y-reference, [624](#)

## Z

- zero values in waveform data, [599](#)
- zoomed time base, [431](#)
- zoomed time base mode, how autoscale affects, [140](#)
- zoomed time base, measurement window, [334](#)
- zoomed window horizontal scale, [439](#)