

Agilent E5070B/E5071B ENA Series RF Network Analyzers

VBA Programmer's Guide

Ninth Edition

FIRMWARE REVISIONS

This manual applies directly to instruments that have the firmware revision A.08.10.

For additional information about firmware revisions, see Appendix A.



Manufacturing No. E5070-90413

June 2007

Notices

The information contained in this document is subject to change without notice.

This document contains proprietary information that is protected by copyright. All rights are reserved. No part of this document may be photocopied, reproduced, or translated to another language without the prior written consent of Agilent Technologies.

Microsoft®, MS-DOS®, Windows®, Visual C++®, Visual Basic®, VBA® and Excel® are registered

UNIX is a registered trademark in U.S. and other countries, licensed exclusively through X/Open Company Limited.

Portions ©Copyright 1996, Microsoft Corporation. All rights reserved.

© Copyright 2002, 2003, 2004, 2005, 2006, 2007 Agilent Technologies

Manual Printing History

The manual's printing date and part number indicate its current edition. The printing date changes when a new edition is printed (minor corrections and updates that are incorporated at reprint do not cause the date to change). The manual part number changes when extensive technical changes are incorporated.

August 2002	First Edition (part number: E5070-90033)
March 2003	Second Edition (part number: E5070-90043, changes for firmware version A.03.50)
January 2004	Third Edition (part number: E5070-90053, changes for firmware version A.03.60)
August 2004	Fourth Edition (part number: E5070-90063, changes for firmware version A.04.00)
May 2005	Fifth Edition (part number: E5070-90073, changes for firmware version A.05.00)
November 2005	Sixth Edition (part number: E5070-90083, changes for firmware version A.06.00)
May 2006	Seventh Edition (part number: E5070-90093, changes for firmware version A.06.50)
February 2007	Eighth Edition (part number: E5070-90403, changes for firmware version A.08.00)
June 2007	Ninth Edition (part number: E5070-90413, changes for firmware version A.08.10)

Typeface Conventions

Sample (bold)	Boldface type is used when a term is defined or emphasized.
<i>Sample (Italic)</i>	Italic type is used for emphasis and for titles of manuals and other publications.
[Sample]	Indicates the hardkey whose key label is “Sample”.
[Sample] - Item	Indicates a series of key operations in which you press the [Sample] key, make the item called “Item” on the displayed menu blink by using the [↓] or in other ways, and then press the [Enter] key.

Sample Program Disk

A VBA sample program disk (Agilent part number: E5070-180x1) is furnished with this manual. The disk contains the sample programs used in this manual.

The customer shall have the personal, non-transferable rights to use, copy, or modify SAMPLE PROGRAMS in this manual for the customer’s internal operations. The customer shall use the SAMPLE PROGRAMS solely and exclusively for their own purposes and shall not license, lease, market, or distribute the SAMPLE PROGRAMS or modification of any part thereof.

Agilent Technologies shall not be liable for the quality, performance, or behavior of the SAMPLE PROGRAMS. Agilent Technologies especially disclaims any responsibility for the operation of the SAMPLE PROGRAMS to be uninterrupted or error-free. The SAMPLE PROGRAMS are provided AS IS.

AGILENT TECHNOLOGIES DISCLAIMS ANY IMPLIED WARRANTY OF MERCHANTABILITY AND FITNESS FOR A PARTICULAR PURPOSE.

Agilent Technologies shall not be liable for any infringement of any patent, trademark, copyright, or other proprietary right by the SAMPLE PROGRAMS or their use. Agilent Technologies does not warrant that the SAMPLE PROGRAMS are free from infringements of such rights of third parties. However, Agilent Technologies will not knowingly infringe or deliver software that infringes the patent, trademark, copyright, or other proprietary right of a third party.

E5070B/E5071B Documentation Map

The following manuals are available for the E5070B/E5071B.

- ***User's Guide (Part Number: E5070-904x0, attached to option ABA)***

This manual describes most of the basic information necessary to use the E5070B/E5071B. It provides a function overview, detailed operation procedure for each function (from preparation for measurement to analysis of measurement results), measurement examples, specifications, and supplemental information. For programming guidance on performing automatic measurement with the E5070B/E5071B, please see the *Programming Manual*.

- ***Installation and Quick Start Guide (Part Number: E5070-900x1, attached to option ABA)***

This manual describes installation after it is delivered and the basic operation procedures for applications and analysis. Refer to this manual when you use the E5070B/E5071B for the first time.

- ***Programmer's Guide (Part Number: E5070-900x2, attached to option ABA)***

This manual provides programming information for performing automatic measurement with the E5070B/E5071B. It includes an outline of remote control, procedures for detecting measurement start (trigger) and end (sweep end), application programming examples, command reference, and related information.

- ***VBA Programmer's Guide (Part Number: E5070-900x3, attached to option ABA)***

This manual describes programming information for performing automatic measurement with internal controller. It includes an outline of VBA programming, some sample programming examples, a COM object reference, and related information.

NOTE

The number position shown by "x" in the part numbers above indicates the edition number. This convention is applied to each manual, CD-ROM (for manuals), and sample programs disk issued.

1. Making Effective Use of This Manual	
Contents of This Manual	22
How To Use This Manual	24
Looking Up COM Objects	24
Using Sample Programs	24
2. Introduction to VBA Programming	
Introduction of the E5070B/E5071B Macro Function	28
An Overview of a Control System Based on the Macro Function	29
Implementing a Control System	29
Control Methods	30
Overview of E5070B/E5071B COM Object	31
About COM Object	31
Using COM Object to Control the E5070B/E5071B	31
Major Control Difference between COM Object and SCPI Command	32
3. Operation Basics of the E5070B/E5071B's VBA	
Displaying Visual Basic Editor	34
Initial Screen of Visual Basic Editor	34
Closing Visual Basic Editor	36
Switching to the E5070B/E5071B Measurement Screen	36
Making a Preparation Before Coding	37
A Project and Three Types of Module	37
Displaying a Code Window	38
Coding a VBA Program	42
User Interface Elements of a Code Window	42
Creating a Simple VBA Program	43
Auto-complete Feature	45
Saving a VBA program	46
Saving a Project	46
Saving a Module (Exporting)	47
Loading a VBA Program	49
Loading a Project	49
Loading a Module (Importing)	50
Running a VBA Program	52
Running a previous loaded VBA program	52
Loading and executing program in batch process	54
Stopping a VBA Program	55
Stopping with the Dialog Box Appeared	55
Abruptly Terminating the VBA Program	56
Errors and Debugging	57
Types of Error	57
Using a Debug Tool	58
Printing Output Values in the Echo Window	63
Entering Values Output to the Echo Window	63
Opening the Echo Window	63
Clearing Values Output in the Echo Window	63
Using VBA Online Help	64

Contents

Accessing VBA Online Help	64
Uses Advanced Techniques	66
Accessing a List of E5070B/E5071B COM Objects	66
Using Automatic Library References	67
4. Controlling the E5070B/E5071B	
Detecting the End of Measurement	70
Using the Status Register	70
Using the SCPI.TRIGger.SEQUENCE.SINGLE Object	73
Reading/Writing Measurement Data	75
Executing a Procedure with a Softkey (User Menu Function)	80
Preparation for Using the User Menu Function	80
How to Use the User Menu Function	81
Simple Example	82
Using a User Defined Variable	85
5. Controlling Peripherals	
Overview	88
Preparation	88
Programming with VISA	89
STEP 1. Starting Up VISA System	90
STEP 2. Connection	90
STEP 3. Communication	91
STEP 4. Disconnection	92
Example Program to Read Out the Product Information of Peripheral (Instrument)	93
6. Application Programs	
Basic Measurement (measuring a band-pass filter)	96
Overview of the program	96
Description of the program	96
Measuring a Multi-port Device	104
Overview of the program	104
Description of the program	106
Measurement Using E5091A (measuring FEM)	118
Executing Power Calibration	126
Program overview	126
Program description	127
Connecting Hard Disk of External PC (shared folder)	132
Using VBA program	132
Description of operation in VBA program	133
7. COM Object Reference	
COM Object Model	136
Application Objects	136
SCPI Objects	137
COM Object List	138
List by Function	138
List by Front Panel Key	160

COM Object Tree	178
Notational Rules of COM Objects	196
Object Type	196
Syntax	196
Description	196
Variable	197
Examples	197
Related Objects	197
Equivalent Key	197
Application Objects	198
ECHO	198
NAME	199
Parse	200
Prompt	201
UserMenu.Item(Key_id).Caption	202
UserMenu.Item(Key_id).Enabled	203
UserMenu_OnPress(ByVal Key_id As Long)	204
UserMenu.PRESet	204
UserMenu.Press(Key_id)	205
UserMenu.Show	205
VBAVersion	206
WaitOnSRQ	207
SCPI Objects	208
SCPI.ABORT	208
SCPI.CALCulate(Ch).FSIMulator.BALun.CZConversion. BPORT(Bpt).IMAGinary	209
SCPI.CALCulate(Ch).FSIMulator.BALun.CZConversion. BPORT(Bpt).REAL	211
SCPI.CALCulate(Ch).FSIMulator.BALun.CZConversion. BPORT(Bpt).Z0.R	212
SCPI.CALCulate(Ch).FSIMulator.BALun.CZConversion. STATE	213
SCPI.CALCulate(Ch).FSIMulator.BALun.DEVice	214
SCPI.CALCulate(Ch).FSIMulator.BALun.DMCircuit. BPORT(Bpt).PARAmeters.C	215
SCPI.CALCulate(Ch).FSIMulator.BALun.DMCircuit. BPORT(Bpt).PARAmeters.G	216
SCPI.CALCulate(Ch).FSIMulator.BALun.DMCircuit. BPORT(Bpt).PARAmeters.L	217
SCPI.CALCulate(Ch).FSIMulator.BALun.DMCircuit. BPORT(Bpt).PARAmeters.R	218
SCPI.CALCulate(Ch).FSIMulator.BALun.DMCircuit. BPORT(Bpt).TYPE	219
SCPI.CALCulate(Ch).FSIMulator.BALun.DMCircuit. BPORT(Bpt).USER.FILEname	220
SCPI.CALCulate(Ch).FSIMulator.BALun.DMCircuit. STATE	221
SCPI.CALCulate(Ch).FSIMulator.BALun.DZConversion. BPORT(Bpt).IMAGinary	222
SCPI.CALCulate(Ch).FSIMulator.BALun.DZConversion. BPORT(Bpt).REAL	223
SCPI.CALCulate(Ch).FSIMulator.BALun.DZConversion. BPORT(Bpt).Z0.R	224
SCPI.CALCulate(Ch).FSIMulator.BALun.DZConversion. STATE	225
SCPI.CALCulate(Ch).FSIMulator.BALun.PARAmeter(Tr).BBALanced.DEFIne	226
SCPI.CALCulate(Ch).FSIMulator.BALun.PARAmeter(Tr). SBALanced.DEFIne	227
SCPI.CALCulate(Ch).FSIMulator.BALun.PARAmeter(Tr). SSBALanced.DEFIne	228
SCPI.CALCulate(Ch).FSIMulator.BALun.PARAmeter(Tr). STATE	229
SCPI.CALCulate(Ch).FSIMulator.BALun.TOPology. BBALanced.PPORTs	230
SCPI.CALCulate(Ch).FSIMulator.BALun.TOPology. PROPerTy.STATE	231
SCPI.CALCulate(Ch).FSIMulator.BALun.TOPology. SBALanced.PPORTs	232
SCPI.CALCulate(Ch).FSIMulator.BALun.TOPology. SSBALanced.PPORTs	233
SCPI.CALCulate(Ch).FSIMulator.EMBed.NETWork(Nwk). FILEname	234

SCPI.CALCulate(Ch).FSIMulator.EMBed.NETWork(Nwk).TYPE	235
SCPI.CALCulate(Ch).FSIMulator.EMBed.STATe	236
SCPI.CALCulate(Ch).FSIMulator.EMBed.TOPology.A.PORTs	237
SCPI.CALCulate(Ch).FSIMulator.EMBed.TOPology.B.PORTs	238
SCPI.CALCulate(Ch).FSIMulator.EMBed.TOPology.C.PORTs	239
SCPI.CALCulate(Ch).FSIMulator.EMBed.TYPE	240
SCPI.CALCulate(Ch).FSIMulator.SENDEd.DEEMbed.PORT(Pt).TYPE	241
SCPI.CALCulate(Ch).FSIMulator.SENDEd.DEEMbed.PORT(Pt).USER.FILename	243
SCPI.CALCulate(Ch).FSIMulator.SENDEd.DEEMbed.STATe	244
SCPI.CALCulate(Ch).FSIMulator.SENDEd.PMCircuit.PORT(Pt).PARAmeters.C	245
SCPI.CALCulate(Ch).FSIMulator.SENDEd.PMCircuit.PORT(Pt).PARAmeters.G	246
SCPI.CALCulate(Ch).FSIMulator.SENDEd.PMCircuit.PORT(Pt).PARAmeters.L	247
SCPI.CALCulate(Ch).FSIMulator.SENDEd.PMCircuit.PORT(Pt).PARAmeters.R	248
SCPI.CALCulate(Ch).FSIMulator.SENDEd.PMCircuit.PORT(Pt).TYPE	249
SCPI.CALCulate(Ch).FSIMulator.SENDEd.PMCircuit.PORT(Pt).USER.FILename	250
SCPI.CALCulate(Ch).FSIMulator.SENDEd.PMCircuit.STATe	251
SCPI.CALCulate(Ch).FSIMulator.SENDEd.ZCONversion.PORT(Pt).IMAGinary	252
SCPI.CALCulate(Ch).FSIMulator.SENDEd.ZCONversion.PORT(Pt).REAL	253
SCPI.CALCulate(Ch).FSIMulator.SENDEd.ZCONversion.PORT(Pt).Z0.R	254
SCPI.CALCulate(Ch).FSIMulator.SENDEd.ZCONversion.STATe	255
SCPI.CALCulate(Ch).FSIMulator.STATe	256
SCPI.CALCulate(Ch).PARAmeter.COUNT	257
SCPI.CALCulate(Ch).PARAmeter(Tr).DEFine	258
SCPI.CALCulate(Ch).PARAmeter(Tr).SELect	259
SCPI.CALCulate(Ch).PARAmeter(Tr).SPORT	260
SCPI.CALCulate(Ch).SELectEd.BLIMit.DB	261
SCPI.CALCulate(Ch).SELectEd.BLIMit.DISPlay.MARKer	262
SCPI.CALCulate(Ch).SELectEd.BLIMit.DISPlay.VALue	263
SCPI.CALCulate(Ch).SELectEd.BLIMit.FAIL	264
SCPI.CALCulate(Ch).SELectEd.BLIMit.MAXimum	265
SCPI.CALCulate(Ch).SELectEd.BLIMit.MINimum	266
SCPI.CALCulate(Ch).SELectEd.BLIMit.REPort.DATA	267
SCPI.CALCulate(Ch).SELectEd.BLIMit.STATe	268
SCPI.CALCulate(Ch).SELectEd.CONVersion.FUNcTion	269
SCPI.CALCulate(Ch).SELectEd.CONVersion.STATe	270
SCPI.CALCulate(Ch).SELectEd.CORRection.EDELay.MEDIum	271
SCPI.CALCulate(Ch).SELectEd.CORRection.EDELay.TIME	272
SCPI.CALCulate(Ch).SELectEd.CORRection.EDELay.WGCutoff	273
SCPI.CALCulate(Ch).SELectEd.CORRection.OFFSet.PHASE	274
SCPI.CALCulate(Ch).SELectEd.DATA.FDATA	275
SCPI.CALCulate(Ch).SELectEd.DATA.FMEMory	276
SCPI.CALCulate(Ch).SELectEd.DATA.SDATA	277
SCPI.CALCulate(Ch).SELectEd.DATA.SMEMory	278
SCPI.CALCulate(Ch).SELectEd.EQUation.STATe	279
SCPI.CALCulate(Ch).SELectEd.EQUation.TEXT	280
SCPI.CALCulate(Ch).SELectEd.EQUation.VALid	281
SCPI.CALCulate(Ch).SELectEd.FILTer.GATE.TIME.CENTer	282
SCPI.CALCulate(Ch).SELectEd.FILTer.GATE.TIME.SHAPe	283
SCPI.CALCulate(Ch).SELectEd.FILTer.GATE.TIME.SPAN	284

SCPI.CALCulate(Ch).SElected.FILTer.GATE.TIME. START	285
SCPI.CALCulate(Ch).SElected.FILTer.GATE.TIME. STAtE	286
SCPI.CALCulate(Ch).SElected.FILTer.GATE.TIME. STOP	287
SCPI.CALCulate(Ch).SElected.FILTer.GATE.TIME. TYPE	288
SCPI.CALCulate(Ch).SElected.FORMat	289
SCPI.CALCulate(Ch).SElected.FUNcTion.DAtA	290
SCPI.CALCulate(Ch).SElected.FUNcTion.DOMain.COUPle	291
SCPI.CALCulate(Ch).SElected.FUNcTion.DOMain.STARt	292
SCPI.CALCulate(Ch).SElected.FUNcTion.DOMain.STAtE	293
SCPI.CALCulate(Ch).SElected.FUNcTion.DOMain.STOP	294
SCPI.CALCulate(Ch).SElected.FUNcTion.EXECute	295
SCPI.CALCulate(Ch).SElected.FUNcTion.PEXcursion	296
SCPI.CALCulate(Ch).SElected.FUNcTion.POINts	297
SCPI.CALCulate(Ch).SElected.FUNcTion.PPOLarity	298
SCPI.CALCulate(Ch).SElected.FUNcTion.TARGet	299
SCPI.CALCulate(Ch).SElected.FUNcTion.TTRansiTion	300
SCPI.CALCulate(Ch).SElected.FUNcTion.TYPE	301
SCPI.CALCulate(Ch).SElected.LIMit.DAtA	302
SCPI.CALCulate(Ch).SElected.LIMit.DISPlay.STAtE	304
SCPI.CALCulate(Ch).SElected.LIMit.FAIL	305
SCPI.CALCulate(Ch).SElected.LIMit.OFFSet.AMPLitude	306
SCPI.CALCulate(Ch).SElected.LIMit.OFFSet.MARKer	307
SCPI.CALCulate(Ch).SElected.LIMit.OFFSet.STIMulus	308
SCPI.CALCulate(Ch).SElected.LIMit.REPort.ALL	309
SCPI.CALCulate(Ch).SElected.LIMit.REPort.DAtA	310
SCPI.CALCulate(Ch).SElected.LIMit.REPort.POINts	311
SCPI.CALCulate(Ch).SElected.LIMit.STAtE	312
SCPI.CALCulate(Ch).SElected.MARKer(Mk).ACTivate	313
SCPI.CALCulate(Ch).SElected.MARKer(Mk).BWiDth. DAtA	314
SCPI.CALCulate(Ch).SElected.MARKer.BWiDth.STAtE	315
SCPI.CALCulate(Ch).SElected.MARKer(Mk).BWiDth. THReshold	316
SCPI.CALCulate(Ch).SElected.MARKer.COUPle	317
SCPI.CALCulate(Ch).SElected.MARKer(Mk).DISCrete	318
SCPI.CALCulate(Ch).SElected.MARKer.FUNcTion. DOMain.COUPle	319
SCPI.CALCulate(Ch).SElected.MARKer.FUNcTion. DOMain.STARt	320
SCPI.CALCulate(Ch).SElected.MARKer.FUNcTion. DOMain.STAtE	321
SCPI.CALCulate(Ch).SElected.MARKer.FUNcTion. DOMain.STOP	322
SCPI.CALCulate(Ch).SElected.MARKer(Mk).FUNcTion. EXECute	323
SCPI.CALCulate(Ch).SElected.MARKer(Mk).FUNcTion. PEXcursion	324
SCPI.CALCulate(Ch).SElected.MARKer(Mk).FUNcTion. PPOLarity	325
SCPI.CALCulate(Ch).SElected.MARKer(Mk).FUNcTion. TARGet	326
SCPI.CALCulate(Ch).SElected.MARKer(Mk).FUNcTion. TRACking	327
SCPI.CALCulate(Ch).SElected.MARKer(Mk).FUNcTion. TTRansiTion	328
SCPI.CALCulate(Ch).SElected.MARKer(Mk).FUNcTion. TYPE	329
SCPI.CALCulate(Ch).SElected.MARKer(Mk).NOTCh. DAtA	331
SCPI.CALCulate(Ch).SElected.MARKer.MARKer(Mk).NOTCh.STAtE	332
SCPI.CALCulate(Ch).SElected.MARKer(Mk).NOTCh. THReshold	333
SCPI.CALCulate(Ch).SElected.MARKer.MARKer(Mk).REFerence. STAtE	334
SCPI.CALCulate(Ch).SElected.MARKer(Mk).SET	335

SCPI.CALCulate(Ch).SElected.MARKer(Mk).STATE.	336
SCPI.CALCulate(Ch).SElected.MARKer(Mk).X	337
SCPI.CALCulate(Ch).SElected.MARKer(Mk).Y	338
SCPI.CALCulate(Ch).SElected.MATH.FUNcTION	339
SCPI.CALCulate(Ch).SElected.MATH.MEMorize	340
SCPI.CALCulate(Ch).SElected.MIXer.XAXis.	341
SCPI.CALCulate(Ch).SElected.MSStatistIcs.DATa	342
SCPI.CALCulate(Ch).SElected.MSStatistIcs.STATe.	343
SCPI.CALCulate(Ch).SElected.OFFset.XAXis	344
SCPI.CALCulate(Ch).SElected.RLIMit.DATa	345
SCPI.CALCulate(Ch).SElected.RLIMit.DISPlay.LINE	347
SCPI.CALCulate(Ch).SElected.RLIMit.DISPlay.SELect	348
SCPI.CALCulate(Ch).SElected.RLIMit.DISPlay.VALue.	349
SCPI.CALCulate(Ch).SElected.RLIMit.FAIL	350
SCPI.CALCulate(Ch).SElected.RLIMit.REPort.DATa	351
SCPI.CALCulate(Ch).SElected.RLIMit.STATe	352
SCPI.CALCulate(Ch).SElected.SMOothing.APERTure	353
SCPI.CALCulate(Ch).SElected.SMOothing.STATe.	354
SCPI.CALCulate(Ch).SElected.TRANsform.TIME. cENTer	355
SCPI.CALCulate(Ch).SElected.TRANsform.TIME. IMPulse.WIDTh	356
SCPI.CALCulate(Ch).SElected.TRANsform.TIME. KBESsel	357
SCPI.CALCulate(Ch).SElected.TRANsform.TIME. LPFRequency	358
SCPI.CALCulate(Ch).SElected.TRANsform.TIME.SPAN	359
SCPI.CALCulate(Ch).SElected.TRANsform.TIME.STARt.	360
SCPI.CALCulate(Ch).SElected.TRANsform.TIME.STATe.	361
SCPI.CALCulate(Ch).SElected.TRANsform.TIME.STEP.RTIME	362
SCPI.CALCulate(Ch).SElected.TRANsform.TIME. STIMulus	363
SCPI.CALCulate(Ch).SElected.TRANsform.TIME.STOP	364
SCPI.CALCulate(Ch).SElected.TRANsform.TIME.TYPE	365
SCPI.CONTRol.HANDler.A.DATa	366
SCPI.CONTRol.HANDler.B.DATa	367
SCPI.CONTRol.HANDler.C.DATa	368
SCPI.CONTRol.HANDler.C.MODE.	369
SCPI.CONTRol.HANDler.D.DATa	370
SCPI.CONTRol.HANDler.D.MODE.	371
SCPI.CONTRol.HANDler.E.DATa	372
SCPI.CONTRol.HANDler.EXTension.INDEX.STATe.	373
SCPI.CONTRol.HANDler.EXTension.RTRigger.STATe	374
SCPI.CONTRol.HANDler.F.DATa	375
SCPI.CONTRol.HANDler.OUTPUT(Num).DATa.	376
SCPI.DISPlay.ANNotation.FREQuency.STATe.	377
SCPI.DISPlay.CCLear	377
SCPI.DISPlay.CLOCK	378
SCPI.DISPlay.COLOr(Dnum).BACK.	379
SCPI.DISPlay.COLOr(Dnum).GRATicule(Gnum)	380
SCPI.DISPlay.COLOr(Dnum).LIMit(Lnum)	381
SCPI.DISPlay.COLOr(Dnum).RESet	382
SCPI.DISPlay.COLOr(Dnum).TRACe(Tr).DATa	383
SCPI.DISPlay.COLOr(Dnum).TRACe(Tr).MEMory.	384

SCPI.DISPlay.ECHO.CLEAr	385
SCPI.DISPlay.ECHO.DATA	385
SCPI.DISPlay.ENABLE	386
SCPI.DISPlay.FSIGn	387
SCPI.DISPlay.IMAGe	388
SCPI.DISPlay.MAXimize	389
SCPI.DISPlay.SKEY.STATe	390
SCPI.DISPlay.SPLit	391
SCPI.DISPlay.TABLe.STATe	393
SCPI.DISPlay.TABLe.TYPE	394
SCPI.DISPlay.UPDate.IMMediate	395
SCPI.DISPlay.WINDow(Ch).ACTivate	395
SCPI.DISPlay.WINDow(Ch).ANNotation.MARKer.ALIgn. STATe	396
SCPI.DISPlay.WINDow(Ch).ANNotation.MARKer.SINGle. STATe	397
SCPI.DISPlay.WINDow(Ch).LABel	398
SCPI.DISPlay.WINDow(Ch).MAXimize	399
SCPI.DISPlay.WINDow(Ch).SPLit	400
SCPI.DISPlay.WINDow(Ch).TITLe.DATA	401
SCPI.DISPlay.WINDow(Ch).TITLe.STATe	402
SCPI.DISPlay.WINDow(Ch).TRACe(Tr).ANNotation.MARKer.POSition.X	403
SCPI.DISPlay.WINDow(Ch).TRACe(Tr).ANNotation.MARKer.POSition.Y	404
SCPI.DISPlay.WINDow(Ch).TRACe(Tr).MEMory. STATe	405
SCPI.DISPlay.WINDow(Ch).TRACe(Tr).STATe	406
SCPI.DISPlay.WINDow(Ch).TRACe(Tr).Y.SCALe.AUTO	406
SCPI.DISPlay.WINDow(Ch).TRACe(Tr).Y.SCALe. PDIVision	407
SCPI.DISPlay.WINDow(Ch).TRACe(Tr).Y.SCALe.RLEVel	408
SCPI.DISPlay.WINDow(Ch).TRACe(Tr).Y.SCALe. RPOsition	409
SCPI.DISPlay.WINDow(Ch).X.SPACing	410
SCPI.DISPlay.WINDow(Ch).Y.SCALe.DIVisions	411
SCPI.FORMat.BORDer	412
SCPI.FORMat.DATA	413
SCPI.HCOPy.ABORt	415
SCPI.HCOPy.IMAGe	415
SCPI.HCOPy.IMMediate	416
SCPI.IEEE4882.CLS	417
SCPI.IEEE4882.ESE	418
SCPI.IEEE4882.ESR	419
SCPI.IEEE4882.IDN	419
SCPI.IEEE4882.OPC	420
SCPI.IEEE4882.OPT	421
SCPI.IEEE4882.RST	421
SCPI.IEEE4882.SRE	422
SCPI.IEEE4882.STB	423
SCPI.IEEE4882.TRG	423
SCPI.IEEE4882.WAI	423
SCPI.INITiate(Ch).CONTinuous	424
SCPI.INITiate(Ch).IMMediate	425
SCPI.MMEMory.CATalog(Dir)	426
SCPI.MMEMory.COPIY	427

SCPI.MMEMemory.DELEte	428
SCPI.MMEMemory.LOAD.ASCFactor	429
SCPI.MMEMemory.LOAD.BSCFactor	430
SCPI.MMEMemory.LOAD.CHANnel.STATe	431
SCPI.MMEMemory.LOAD.CKIT(Ckit)	432
SCPI.MMEMemory.LOAD.LIMit	433
SCPI.MMEMemory.LOAD.PLOSs(Pt)	434
SCPI.MMEMemory.LOAD.RLIMit	435
SCPI.MMEMemory.LOAD.SEGMent	436
SCPI.MMEMemory.LOAD.STATe	437
SCPI.MMEMemory.MDIRectory	438
SCPI.MMEMemory.STORe.ASCFactor	439
SCPI.MMEMemory.STORe.BSCFactor	440
SCPI.MMEMemory.STORe.CHANnel.CLEAr	441
SCPI.MMEMemory.STORe.CHANnel.STATe	441
SCPI.MMEMemory.STORe.CKIT(Ckit)	442
SCPI.MMEMemory.STORe.FDATa	443
SCPI.MMEMemory.STORe.IMAGe	444
SCPI.MMEMemory.STORe.LIMit	445
SCPI.MMEMemory.STORe.PLOSs(Pt)	446
SCPI.MMEMemory.STORe.RLIMit	447
SCPI.MMEMemory.STORe.SALL	448
SCPI.MMEMemory.STORe.SEGMent	449
SCPI.MMEMemory.STORe.SNP.DATA	450
SCPI.MMEMemory.STORe.SNP.FORMat	451
SCPI.MMEMemory.STORe.SNP.TYPE.S1P	452
SCPI.MMEMemory.STORe.SNP.TYPE.S2P	453
SCPI.MMEMemory.STORe.SNP.TYPE.S3P	454
SCPI.MMEMemory.STORe.SNP.TYPE.S4P	455
SCPI.MMEMemory.STORe.STATe	456
SCPI.MMEMemory.STORe.STYPE	457
SCPI.OUTPut.STATe	458
SCPI.PROGram.VARiable.ARRay(Vnum).DATA	459
SCPI.PROGram.VARiable.ARRay(Vnum).SIZE	461
SCPI.PROGram.VARiable.DOUBle(Vnum).DATA	462
SCPI.PROGram.VARiable.LONG(Vnum).DATA	463
SCPI.PROGram.VARiable.STRing(Vnum).DATA	464
SCPI.SENSE(Ch).AVERAge.CLEAr	465
SCPI.SENSE(Ch).AVERAge.COUNT	465
SCPI.SENSE(Ch).AVERAge.STATe	466
SCPI.SENSE(Ch).BANDwidth.RESolution	467
SCPI.SENSE(Ch).BWIDTH.RESolution	468
SCPI.SENSE(Ch).CORRection.CLEAr	469
SCPI.SENSE(Ch).CORRection.COEFFicient.DATA	470
SCPI.SENSE(Ch).CORRection.COEFFicient.METHod.ERESponse	472
SCPI.SENSE(Ch).CORRection.COEFFicient.METHod.RESponse.OPEN	473
SCPI.SENSE(Ch).CORRection.COEFFicient.METHod.RESponse.SHORT	473
SCPI.SENSE(Ch).CORRection.COEFFicient.METHod.RESponse.THRU	474
SCPI.SENSE(Ch).CORRection.COEFFicient.METHod.SOLT1	475

SCPI.SENSE(Ch).CORRection.COEFFicient.METHod.SOLT2	476
SCPI.SENSE(Ch).CORRection.COEFFicient.METHod.SOLT3	477
SCPI.SENSE(Ch).CORRection.COEFFicient.METHod.SOLT4	478
SCPI.SENSE(Ch).CORRection.COEFFicient.SAVE	479
SCPI.SENSE(Ch).CORRection.COLLect.ACQUIRE.ISOLation	480
SCPI.SENSE(Ch).CORRection.COLLect.ACQUIRE.LOAD	481
SCPI.SENSE(Ch).CORRection.COLLect.ACQUIRE.OPEN	482
SCPI.SENSE(Ch).CORRection.COLLect.ACQUIRE.SHORT	482
SCPI.SENSE(Ch).CORRection.COLLect.ACQUIRE.SUBClass	483
SCPI.SENSE(Ch).CORRection.COLLect.ACQUIRE.THRU	484
SCPI.SENSE(Ch).CORRection.COLLect.ACQUIRE.TRLLine	485
SCPI.SENSE(Ch).CORRection.COLLect.ACQUIRE.TRLReflect	486
SCPI.SENSE(Ch).CORRection.COLLect.ACQUIRE.TRLThru	487
SCPI.SENSE(Ch).CORRection.COLLect.ADApter(Pt).LENGth	488
SCPI.SENSE(Ch).CORRection.COLLect.CKIT.LABel	489
SCPI.SENSE(Ch).CORRection.COLLect.CKIT.ORDer.LOAD(Cpt)	490
SCPI.SENSE(Ch).CORRection.COLLect.CKIT.ORDer.OPEN(Cpt)	492
SCPI.SENSE(Ch).CORRection.COLLect.CKIT.ORDer.SELect	493
SCPI.SENSE(Ch).CORRection.COLLect.CKIT.ORDer.SHORT(Cpt)	494
SCPI.SENSE(Ch).CORRection.COLLect.CKIT.ORDer.THRU(Cpt_m,Cpt_n)	495
SCPI.SENSE(Ch).CORRection.COLLect.CKIT.ORDer.TRLLine(Cpt_m,Cpt_n)	497
SCPI.SENSE(Ch).CORRection.COLLect.CKIT.ORDer.TRLReflect	498
SCPI.SENSE(Ch).CORRection.COLLect.CKIT.ORDer.TRLThru(Cpt_m,Cpt_n)	499
SCPI.SENSE(Ch).CORRection.COLLect.CKIT.RESet	500
SCPI.SENSE(Ch).CORRection.COLLect.CKIT.SELect	500
SCPI.SENSE(Ch).CORRection.COLLect.CKIT.STAN(Std).ARBitrary	502
SCPI.SENSE(Ch).CORRection.COLLect.CKIT.STAN(Std).C0	503
SCPI.SENSE(Ch).CORRection.COLLect.CKIT.STAN(Std).C1	504
SCPI.SENSE(Ch).CORRection.COLLect.CKIT.STAN(Std).C2	505
SCPI.SENSE(Ch).CORRection.COLLect.CKIT.STAN(Std).C3	506
SCPI.SENSE(Ch).CORRection.COLLect.CKIT.STAN(Std).CHARacter	507
SCPI.SENSE(Ch).CORRection.COLLect.CKIT.STAN(Std).DELay	508
SCPI.SENSE(Ch).CORRection.COLLect.CKIT.STAN(Std).FMAXimum	509
SCPI.SENSE(Ch).CORRection.COLLect.CKIT.STAN(Std).FMINimum	510
SCPI.SENSE(Ch).CORRection.COLLect.CKIT.STAN(Std).L0	511
SCPI.SENSE(Ch).CORRection.COLLect.CKIT.STAN(Std).L1	512
SCPI.SENSE(Ch).CORRection.COLLect.CKIT.STAN(Std).L2	513
SCPI.SENSE(Ch).CORRection.COLLect.CKIT.STAN(Std).L3	514
SCPI.SENSE(Ch).CORRection.COLLect.CKIT.STAN(Std).LABel	515
SCPI.SENSE(Ch).CORRection.COLLect.CKIT.STAN(Std).LOSS	516
SCPI.SENSE(Ch).CORRection.COLLect.CKIT.STAN(Std).TYPE	517
SCPI.SENSE(Ch).CORRection.COLLect.CKIT.STAN(Std).Z0	518
SCPI.SENSE(Ch).CORRection.COLLect.CKIT.TRLoption.IMPedance	519
SCPI.SENSE(Ch).CORRection.COLLect.CKIT.TRLoption.RPLane	520
SCPI.SENSE(Ch).CORRection.COLLect.CLEAR	521
SCPI.SENSE(Ch).CORRection.COLLect.ECAL.CCHeck.ACQUIRE	522
SCPI.SENSE(Ch).CORRection.COLLect.ECAL.ERESponse	523
SCPI.SENSE(Ch).CORRection.COLLect.ECAL.ISOLation.STATE	524
SCPI.SENSE(Ch).CORRection.COLLect.ECAL.ORientation.STATE	525

SCPI.SENSE(Ch).CORRection.COLLEct.ECAL.PATH(Cpt)	526
SCPI.SENSE(Ch).CORRection.COLLEct.ECAL.SOLT1	527
SCPI.SENSE(Ch).CORRection.COLLEct.ECAL.SOLT2	528
SCPI.SENSE(Ch).CORRection.COLLEct.ECAL.SOLT3	529
SCPI.SENSE(Ch).CORRection.COLLEct.ECAL.SOLT4	530
SCPI.SENSE(Ch).CORRection.COLLEct.ECAL.THRU	531
SCPI.SENSE(Ch).CORRection.COLLEct.ECAL.UCHar	532
SCPI.SENSE(Ch).CORRection.COLLEct.ECAL.UTHRu.STATe	533
SCPI.SENSE(Ch).CORRection.COLLEct.METHod.ADApTer.REMOval	534
SCPI.SENSE(Ch).CORRection.COLLEct.METHod.ERESpOse	535
SCPI.SENSE(Ch).CORRection.COLLEct.METHod. RESpOse.OPEN	536
SCPI.SENSE(Ch).CORRection.COLLEct.METHod. RESpOse.SHORt	536
SCPI.SENSE(Ch).CORRection.COLLEct.METHod. RESpOse.THRU	537
SCPI.SENSE(Ch).CORRection.COLLEct.METHod. SOLT1	537
SCPI.SENSE(Ch).CORRection.COLLEct.METHod. SOLT2	538
SCPI.SENSE(Ch).CORRection.COLLEct.METHod. SOLT3	539
SCPI.SENSE(Ch).CORRection.COLLEct.METHod. SOLT4	540
SCPI.SENSE(Ch).CORRection.COLLEct.METHod.TRL2	541
SCPI.SENSE(Ch).CORRection.COLLEct.METHod.TRL3	542
SCPI.SENSE(Ch).CORRection.COLLEct.METHod.TRL4	543
SCPI.SENSE(Ch).CORRection.COLLEct.METHod.TYPE	544
SCPI.SENSE(Ch).CORRection.COLLEct.PARTIal.SAVE	545
SCPI.SENSE(Ch).CORRection.COLLEct.SAVE	546
SCPI.SENSE(Ch).CORRection.COLLEct.SIMPlIed.SAVE	547
SCPI.SENSE(Ch).CORRection.EXTension.AUTO.CONFIg	548
SCPI.SENSE(Ch).CORRection.EXTension.AUTO.DCOFFset	549
SCPI.SENSE(Ch).CORRection.EXTension.AUTO.LOSS	550
SCPI.SENSE(Ch).CORRection.EXTension.AUTO.MEASure	551
SCPI.SENSE(Ch).CORRection.EXTension.AUTO.PORT(Pt)	552
SCPI.SENSE(Ch).CORRection.EXTension.AUTO.RESEt	553
SCPI.SENSE(Ch).CORRection.EXTension.AUTO.STARt	554
SCPI.SENSE(Ch).CORRection.EXTension.AUTO.STOP	555
SCPI.SENSE(Ch).CORRection.EXTension.PORT(Pt). FREQuency(Fq)	556
SCPI.SENSE(Ch).CORRection.EXTension.PORT(Pt). INCLude(II).STATe	558
SCPI.SENSE(Ch).CORRection.EXTension.PORT(Pt).LDC	560
SCPI.SENSE(Ch).CORRection.EXTension.PORT(Pt) .LOSS(Loss)	561
SCPI.SENSE(Ch).CORRection.EXTension.PORT(Pt).TIME	563
SCPI.SENSE(Ch).CORRection.EXTension.STATe	564
SCPI.SENSE(Ch).CORRection.IMPedance.INPut.MAGNItude	565
SCPI.SENSE(Ch).CORRection.OFFSet.CLEar	566
SCPI.SENSE(Ch).CORRection.OFFSet.COLLEct.ACQuire.LOAD	567
SCPI.SENSE(Ch).CORRection.OFFSet.COLLEct.ACQuire.OPEN	568
SCPI.SENSE(Ch).CORRection.OFFSet.COLLEct.ACQuire.PMETer	569
SCPI.SENSE(Ch).CORRection.OFFSet.COLLEct.ACQuire.SHORt	571
SCPI.SENSE(Ch).CORRection.OFFSet.COLLEct.ACQuire.THRU	572
SCPI.SENSE(Ch).CORRection.OFFSet.COLLEct.CLEar	573
SCPI.SENSE(Ch).CORRection.OFFSet.COLLEct.ECAL.SMIX2	574
SCPI.SENSE(Ch).CORRection.OFFSet.COLLEct.ECAL.SOLT1	575
SCPI.SENSE(Ch).CORRection.OFFSet.COLLEct.METHod.SMIX2	576

SCPI.SENSE(Ch).CORRection.OFFSet.COLLECT.METHod.SOLT1	577
SCPI.SENSE(Ch).CORRection.OFFSet.COLLECT.SAVE	578
SCPI.SENSE(Ch).CORRection.PROPerTy	579
SCPI.SENSE(Ch).CORRection.RECEiver(Pt).COLLECT.ACQUIRE	580
SCPI.SENSE(Ch).CORRection.RECEiver(Pt).STATE	581
SCPI.SENSE(Ch).CORRection.RVELOCITY.COAX	582
SCPI.SENSE(Ch).CORRection.STATE	583
SCPI.SENSE(Ch).CORRection.TRIGger.FREE.STATE	584
SCPI.SENSE(Ch).CORRection.TYPE(Tr)	585
SCPI.SENSE(Ch).FREQuency.CENTer	587
SCPI.SENSE(Ch).FREQuency.CW	588
SCPI.SENSE(Ch).FREQuency.DATA	589
SCPI.SENSE(Ch).FREQuency.FIXed	590
SCPI.SENSE(Ch).FREQuency.SPAN	591
SCPI.SENSE(Ch).FREQuency.STARt	592
SCPI.SENSE(Ch).FREQuency.STOP	593
SCPI.SENSE.MULTIplexer.CATalog	594
SCPI.SENSE(Ch).MULTIplexer(Id).COUNT	595
SCPI.SENSE(Ch).MULTIplexer(Id).DISPlay.STATE	596
SCPI.SENSE.MULTIplexer(Id).INCount	597
SCPI.SENSE.MULTIplexer(Id).NAME	598
SCPI.SENSE(Ch).MULTIplexer(Id).OUTPut.DATA	599
SCPI.SENSE(Ch).MULTIplexer(Id).PORT(Pt).CATalog	600
SCPI.SENSE(Ch).MULTIplexer(Id).PORT(Pt).SElect	601
SCPI.SENSE(Ch).MULTIplexer(Id).STATE	603
SCPI.SENSE(Ch).MULTIplexer(Id).TSET9.OUTPut.DATA	604
SCPI.SENSE(Ch).MULTIplexer(Id).TSET9.PORT1	605
SCPI.SENSE(Ch).MULTIplexer(Id).TSET9.PORT2	606
SCPI.SENSE(Ch).MULTIplexer(Id).TSET9.PORT3	607
SCPI.SENSE(Ch).MULTIplexer(Id).TSET9.PORT4	608
SCPI.SENSE(Ch).OFFSet.ASPurious	609
SCPI.SENSE(Ch).OFFSet.LOCal.CONTRol.STATE	610
SCPI.SENSE(Ch).OFFSet.LOCal.FREQuency.DATA	611
SCPI.SENSE(Ch).OFFSet.LOCal.FREQuency.DIVisor	612
SCPI.SENSE(Ch).OFFSet.LOCal.FREQuency.MULTIplier	613
SCPI.SENSE(Ch).OFFSet.LOCal.FREQuency.OFFSet	614
SCPI.SENSE(Ch).OFFSet.LOCal.FREQuency.STARt	615
SCPI.SENSE(Ch).OFFSet.LOCal.FREQuency.STOP	616
SCPI.SENSE(Ch).OFFSet.LOCal.POWER.LEVel.IMMEdiate.AMPLitude	617
SCPI.SENSE(Ch).OFFSet.LOCal.POWER.LEVel.SLOPe.DATA	618
SCPI.SENSE(Ch).OFFSet.LOCal.POWER.LEVel.SLOPe.STATE	619
SCPI.SENSE(Ch).OFFSet.LOCal.STATE	620
SCPI.SENSE(Ch).OFFSet.PORT(Pt).FREQuency.DATA	621
SCPI.SENSE(Ch).OFFSet.PORT(Pt).FREQuency.DIVisor	622
SCPI.SENSE(Ch).OFFSet.PORT(Pt).FREQuency.MULTIplier	623
SCPI.SENSE(Ch).OFFSet.PORT(Pt).FREQuency.OFFSet	624
SCPI.SENSE(Ch).OFFSet.PORT(Pt).FREQuency.STARt	625
SCPI.SENSE(Ch).OFFSet.PORT(Pt).FREQuency.STOP	626
SCPI.SENSE(Ch).OFFSet.STATE	627

SCPI.SENSE(Ch).ROSCillator.SOURce	628
SCPI.SENSE(Ch).SEGMENT.DATA	629
SCPI.SENSE(Ch).SEGMENT.SWEep.POINTs	631
SCPI.SENSE(Ch).SEGMENT.SWEep.TIME.DATA	631
SCPI.SENSE(Ch).SWEep.ASPurious	632
SCPI.SENSE(Ch).SWEep.DELay	633
SCPI.SENSE(Ch).SWEep.GENERation	634
SCPI.SENSE(Ch).SWEep.POINTs	635
SCPI.SENSE(Ch).SWEep.TIME.AUTO	636
SCPI.SENSE(Ch).SWEep.TIME.DATA	637
SCPI.SENSE(Ch).SWEep.TYPE	638
SCPI.SERVICE.CHANnel.ACTive	639
SCPI.SERVICE.CHANnel.COUNT	639
SCPI.SERVICE.CHANnel(Ch).TRACe.ACTive	640
SCPI.SERVICE.CHANnel.TRACe.COUNT	640
SCPI.SERVICE.PORT.COUNT	641
SCPI.SERVICE.SREvision	641
SCPI.SERVICE.SWEep.FREQuency.MAXimum	642
SCPI.SERVICE.SWEep.FREQuency.MINimum	642
SCPI.SERVICE.SWEep.POINTs	643
SCPI.SOURCE(Ch).POWER.ATTenuation.DATA	644
SCPI.SOURCE(Ch).POWER.ATTenuation.AUTO	645
SCPI.SOURCE(Ch).POWER.CENTer	647
SCPI.SOURCE(Ch).POWER.LEVel.IMMEDIATE. AMPLitude	648
SCPI.SOURCE(Ch).POWER.LEVel.SLOPe.DATA	649
SCPI.SOURCE(Ch).POWER.LEVel.SLOPe.STATe	650
SCPI.SOURCE(Ch).POWER.PORT(Pt).CORRection. COLLECT.ACQUIRE	651
SCPI.SOURCE(Ch).POWER.PORT.CORRection.COLLECT. ASENSor.RCFactor	652
SCPI.SOURCE(Ch).POWER.PORT(Pt).CORRection. COLLECT.AVERAge.COUNT	653
SCPI.SOURCE(Ch).POWER.PORT.CORRection.COLLECT. BSENSor.RCFactor	654
SCPI.SOURCE(Ch).POWER.PORT.CORRection.COLLECT. NTOLerance	655
SCPI.SOURCE(Ch).POWER.PORT.CORRection.COLLECT. TABLE.ASENSor.DATA	656
SCPI.SOURCE(Ch).POWER.PORT.CORRection.COLLECT. TABLE.BSENSor.DATA	657
SCPI.SOURCE(Ch).POWER.PORT(Pt).CORRection. COLLECT.TABLE.LOSS.DATA	658
SCPI.SOURCE(Ch).POWER.PORT(Pt).CORRection. COLLECT.TABLE.LOSS.STATe	659
SCPI.SOURCE(Ch).POWER.PORT(Pt).CORRection.DATA	660
SCPI.SOURCE(Ch).POWER.PORT(Pt).CORRection.STATe	661
SCPI.SOURCE(Ch).POWER.PORT.COUPLE	662
SCPI.SOURCE(Ch).POWER.PORT(Pt).LEVel.IMMEDIATE. AMPLitude	663
SCPI.SOURCE(Ch).POWER.SPAN	664
SCPI.SOURCE(Ch).POWER.START	665
SCPI.SOURCE(Ch).POWER.STOP	666
SCPI.STATUS.OPERation.CONDITION	667
SCPI.STATUS.OPERation.ENABLE	667
SCPI.STATUS.OPERation.EVENT	668
SCPI.STATUS.OPERation.NTRANSition	668
SCPI.STATUS.OPERation.PTRANSition	669
SCPI.STATUS.PRESet	669
SCPI.STATUS.QUESTIONable.BLIMIT.CHANnel(Ch).CONDITION	670

SCPI.STATUS.QUEStionable.BLIMit.CHANnel(Ch).ECHannel.CONDition	671
SCPI.STATUS.QUEStionable.BLIMit.CHANnel(Ch).ECHannel.ENABLE	672
SCPI.STATUS.QUEStionable.BLIMit.CHANnel(Ch).ECHannel.EVENT	673
SCPI.STATUS.QUEStionable.BLIMit.CHANnel(Ch).ECHannel.NTRansition	674
SCPI.STATUS.QUEStionable.BLIMit.CHANnel(Ch).ECHannel.PTRansition	675
SCPI.STATUS.QUEStionable.BLIMit.CHANnel(Ch).ENABLE	676
SCPI.STATUS.QUEStionable.BLIMit.CHANnel(Ch).EVENT	677
SCPI.STATUS.QUEStionable.BLIMit.CHANnel(Ch).NTRansition	678
SCPI.STATUS.QUEStionable.BLIMit.CHANnel(Ch).PTRansition	679
SCPI.STATUS.QUEStionable.BLIMit.CONDition	680
SCPI.STATUS.QUEStionable.BLIMit.ELIMit.CONDition.	680
SCPI.STATUS.QUEStionable.BLIMit.ELIMit.ENABLE	681
SCPI.STATUS.QUEStionable.BLIMit.ELIMit.EVENT	681
SCPI.STATUS.QUEStionable.BLIMit.ELIMit.NTRansition.	682
SCPI.STATUS.QUEStionable.BLIMit.ELIMit.PTRansition	683
SCPI.STATUS.QUEStionable.BLIMit.ENABLE.	684
SCPI.STATUS.QUEStionable.BLIMit.EVENTt.	684
SCPI.STATUS.QUEStionable.BLIMit.NTRansition	685
SCPI.STATUS.QUEStionable.BLIMit.PTRansition.	686
SCPI.STATUS.QUEStionable.CONDition.	687
SCPI.STATUS.QUEStionable.ENABLE	688
SCPI.STATUS.QUEStionable.EVENT	689
SCPI.STATUS.QUEStionable.LIMit.CHANnel(Ch). CONDition.	689
SCPI.STATUS.QUEStionable.LIMit.CHANnel(Ch). ECHannel.CONDition	690
SCPI.STATUS.QUEStionable.LIMit.CHANnel(Ch). ECHannel.ENABLE	691
SCPI.STATUS.QUEStionable.LIMit.CHANnel(Ch). ECHannel.EVENT	692
SCPI.STATUS.QUEStionable.LIMit.CHANnel(Ch). ECHannel.NTRansition	693
SCPI.STATUS.QUEStionable.LIMit.CHANnel(Ch). ECHannel.PTRansition	694
SCPI.STATUS.QUEStionable.LIMit.CHANnel(Ch).ENABLE.	695
SCPI.STATUS.QUEStionable.LIMit.CHANnel(Ch).EVENTt.	696
SCPI.STATUS.QUEStionable.LIMit.CHANnel(Ch). NTRansition.	697
SCPI.STATUS.QUEStionable.LIMit.CHANnel(Ch). PTRansition	698
SCPI.STATUS.QUEStionable.LIMit.CONDition	699
SCPI.STATUS.QUEStionable.LIMit.ELIMit.CONDition	699
SCPI.STATUS.QUEStionable.LIMit.ELIMit.ENABLE	700
SCPI.STATUS.QUEStionable.LIMit.ELIMit.EVENT	700
SCPI.STATUS.QUEStionable.LIMit.ELIMit.NTRansition	701
SCPI.STATUS.QUEStionable.LIMit.ELIMit.PTRansition	702
SCPI.STATUS.QUEStionable.LIMit.ENABLE	703
SCPI.STATUS.QUEStionable.LIMit.EVENTt	703
SCPI.STATUS.QUEStionable.LIMit.NTRansition	704
SCPI.STATUS.QUEStionable.LIMit.PTRansition	705
SCPI.STATUS.QUEStionable.NTRansition.	706
SCPI.STATUS.QUEStionable.PTRansition	707
SCPI.STATUS.QUEStionable.RLIMit.CHANnel(Ch).CONDition	708
SCPI.STATUS.QUEStionable.RLIMit.CHANnel(Ch).ECHannel.CONDition	709
SCPI.STATUS.QUEStionable.RLIMit.CHANnel(Ch).ECHannel.ENABLE	710
SCPI.STATUS.QUEStionable.RLIMit.CHANnel(Ch).ECHannel.EVENT	711
SCPI.STATUS.QUEStionable.RLIMit.CHANnel(Ch).ECHannel.NTRansition	712

SCPI.STATus.QUEStionable.RLIMit.CHANnel(Ch).ECHannel.PTRansition	713
SCPI.STATus.QUEStionable.RLIMit.CHANnel(Ch).ENABLE	714
SCPI.STATus.QUEStionable.RLIMit.CHANnel(Ch).EVENT	715
SCPI.STATus.QUEStionable.RLIMit.CHANnel(Ch).NTRansition	716
SCPI.STATus.QUEStionable.RLIMit.CHANnel(Ch).PTRansition	717
SCPI.STATus.QUEStionable.RLIMit.CONDition	718
SCPI.STATus.QUEStionable.RLIMit.ELIMit.CONDition	718
SCPI.STATus.QUEStionable.RLIMit.ELIMit.ENABLE	719
SCPI.STATus.QUEStionable.RLIMit.ELIMit.EVENTt	719
SCPI.STATus.QUEStionable.RLIMit.ELIMit.NTRansition	720
SCPI.STATus.QUEStionable.RLIMit.ELIMit.PTRansition	721
SCPI.STATus.QUEStionable.RLIMit.ENABLE	722
SCPI.STATus.QUEStionable.RLIMit.EVENT	722
SCPI.STATus.QUEStionable.RLIMit.NTRansition	723
SCPI.STATus.QUEStionable.RLIMit.PTRansition	724
SCPI.SYSTem.BACKlight	725
SCPI.SYSTem.BEEPer.COMPLete.IMMEdiate	726
SCPI.SYSTem.BEEPer.COMPLete.STATe	726
SCPI.SYSTem.BEEPer.WARNing.IMMEdiate	727
SCPI.SYSTem.BEEPer.WARNing.STATe	727
SCPI.SYSTem.COMMunicate.GPIB.PMETer.ADDRess	728
SCPI.SYSTem.COMMunicate.GPIB.SGENerator.ADDRess	729
SCPI.SYSTem.COMMunicate.GPIB.SGENerator.CCOMmand.FREQuency	730
SCPI.SYSTem.COMMunicate.GPIB.SGENerator.CCOMmand.POWER	731
SCPI.SYSTem.COMMunicate.GPIB.SGENerator.CCOMmand.PRESet	732
SCPI.SYSTem.COMMunicate.GPIB.SGENerator.CCOMmand.RFON	733
SCPI.SYSTem.COMMunicate.GPIB.SGENerator.DWELL	734
SCPI.SYSTem.COMMunicate.GPIB.SGENerator.TYPE	735
SCPI.SYSTem.CORRection.STATe	736
SCPI.SYSTem.DATE	737
SCPI.SYSTem.ERRor	738
SCPI.SYSTem.ISPC.PORT	739
SCPI.SYSTem.ISPC.STAT	740
SCPI.SYSTem.KLOCK.KBD	741
SCPI.SYSTem.KLOCK.MOUSE	742
SCPI.SYSTem.POFF	742
SCPI.SYSTem.PRESet	743
SCPI.SYSTem.SECurity.LEVel	744
SCPI.SYSTem.SERVice	745
SCPI.SYSTem.TEMPerature.HIGH	746
SCPI.SYSTem.TEMPerature.STATe	747
SCPI.SYSTem.TIME	748
SCPI.SYSTem.UPReset	749
SCPI.TRIGger.SEQuence.AVERAge	750
SCPI.TRIGger.SEQuence.EXTernal.DELay	751
SCPI.TRIGger.SEQuence.EXTernal.LLATency.STATe	752
SCPI.TRIGger.SEQuence.IMMEdiate	753
SCPI.TRIGger.SEQuence.POINt	754
SCPI.TRIGger.SEQuence.SCOPE	755

SCPI.TRIGger.SEQuence.SINGle	756
SCPI.TRIGger.SEQuence.SOURce	757
8. Waveform Analysis Library	
Ripple Analysis Library	760
Flow of Programming Using the Ripple Analysis Library	760
Condition Setting Before Using the Ripple Analysis Library	760
List of the Ripple Analysis Library	761
Simple Use Example	762
Procedure Reference	763
FirstLeftGap(Chan)	763
FirstLeftInterval(Chan)	764
FirstRightGap(Chan)	765
FirstRightInterval(Chan)	766
GapMean(Chan)	767
MaxEnvelopeGap(Chan)	768
MaxGap(Chan)	769
MaxLeftGap(Chan)	770
MaxPeakToPeak(Chan)	771
MaxRightGap(Chan)	772
MaxRipplePoint(Chan,Stim)	773
MaxRippleValue(Chan)	774
Pole(Chan,D,LeftStim,LeftValue,RightStim,RightValue)	775
9. Complex Operation Library	
Complex operation library	778
Data of the complex type	778
List of procedures	778
Procedure Reference	779
ComplexAbs(x)	779
ComplexAdd(x,y)	779
ComplexArg(x)	779
ComplexConj(x)	780
ComplexCos(x)	780
ComplexCosh(x)	780
ComplexDiv(x,y)	780
ComplexExp(x)	781
ComplexLog(x)	781
ComplexLog10(x)	781
ComplexMul(x,y)	781
ComplexNorm(x)	782
ComplexPolar(x,y)	782
ComplexSet(x,y)	782
ComplexSetArray(x)	783
ComplexSin(x)	783
ComplexSinh(x)	783
ComplexSqrt(x)	784
ComplexSub(x,y)	784

Contents

Sample Program	785
A. Manual Changes	
Manual Changes	788
Change 10	789
Change 9	789
Change 8	790
Change 7	790
Change 6	793
Change 5	793
Change 4	796
Change 3	798
Change 2	798
Change 1	799

1 Making Effective Use of This Manual

This chapter provides an overview of this manual as well as useful information to help you navigate through the manual. It also briefly describes how to use this manual, focusing on how you can look up particular COM object.

Contents of This Manual

This is a VBA programming guide with Agilent E5070B/E5071B.

This guide describes programming method mainly aiming at learning how to write a program that controls the E5070B/E5071B using COM objects, focusing on the macro function of the E5070B/E5071B and sample usage with the built-in VBA.

Controlling the E5070B/E5071B using an external controller is not covered by this guide; it is described in *Programmer's Guide*. For remote control using an external controller, see *Programmer's Guide*.

Description in this guide assumes that the reader has learned manual operation of the E5070B/E5071B. Thus, this guide does not describe each feature of the E5070B/E5071B in detail. For detailed information on each feature, see *User's Guide*.

The chapter-by-chapter contents of this manual are as follows.

Chapter 1, "Making Effective Use of This Manual."

This chapter provides an overview of this manual as well as useful information to help you navigate through the manual. It also briefly describes how to use this manual, focusing on how you can look up particular COM object.

Chapter 2, "Introduction to VBA Programming."

This chapter introduces you to the E5070B/E5071B's VBA macro function, describes how you can implement your system using the VBA macro function, and provides an overview of the COM objects that come with the E5070B/E5071B.

Chapter 3, "Operation Basics of the E5070B/E5071B's VBA."

This chapter provides descriptive information on basic operations for creating VBA programs within the E5070B/E5071B's VBA environment; topics include launching Visual Basic Editor, creating, saving, and running VBA programs, and so on.

Chapter 4, "Controlling the E5070B/E5071B."

This chapter describes how to use the E5070B/E5071B's VBA to control the E5070B/E5071B itself.

Chapter 5, "Controlling Peripherals."

This chapter explains how to control peripherals connected to the E5070B/E5071B with GPIB by using the software (VISA library) installed in the E5070B/E5071B.

Chapter 6, "Application Programs."

This chapter describes sample programs (VBA programs) based on actual measurement examples.

Chapter 7, "COM Object Reference."

This chapter describes the COM object model of the Agilent E5070B/E5071B and the COM object reference in alphabetical order. If you want to look up COM objects by their function, see "COM object list by function."

Chapter 8, “Waveform Analysis Library.”

This chapter describes how to use the ripple analysis library and the procedures in the ripple analysis library.

Chapter 9, “Complex Operation Library.”

This chapter describes the complex operation library.

Appendix A, “Manual Changes.”

This appendix contains the information required to adapt this manual to versions or configurations of the E5070B/E5071B manufactured earlier than the current printing date of this manual.

How To Use This Manual

Chapter 3 provides the basic operation of VBA when coding VBA programs, and Chapter 4 provides the description of controlling the E5070B/E5071B and sample program examples that you can use to develop your custom programs. For more information on individual COM object, see Chapter 7, “COM Object Reference.”

Looking Up COM Objects

Chapter 7, “COM Object Reference.” contains a complete reference of COM objects. You can look up a particular COM object in any of the following ways:

Lookup by Abbreviated COM Object Name

The COM object reference is organized alphabetically according to the abbreviated name used as the title for each COM object’s description.

Lookup by COM Object Function

Table 7-1 on page 138 provides a complete list of COM objects by function and indicates the page numbers where the COM objects appear in the COM object reference.

Lookup by Front panel key

Table 7-2 on page 160 provides a complete list of COM objects that correspond to the front panel key tree and indicates the page numbers where the COM objects appear in the COM object reference.

Using Sample Programs

The manual comes with a sample program disk, which contains the source files of the sample programs described in this manual. The disk is DOS-formatted.

Loading a Sample Program

For the method to load a sample program into the E5070B/E5071B VBA, see Section “Loading a VBA Program” on page 49 in the Chapter 3 “Operation Basics of the E5070B/E5071B’s VBA”.

List of the Sample Programs

Table 1-1 shows the file list contained with the VBA sample program disk. To look up the description of a sample program, see the listings under “Sample program” in the index.

Table 1-1 List of the sample programs

Project	Object names of modules in the project	Module type	Content
apl_bsc.vba	mdlBscMeas	Standard module	Program for the basic measurement of the bandpass filter
apl_fem.vba	mdlFemMeas	Standard module	Application program for the measurement using the E5091A
apl_sys.vba	mdlDupMeas frmDupMeas	Standard module UserForm	Application program for the duplexer measurement
ctrl_ext.vba	mdlVisa Module1 Module2	Standard module Standard module Standard module	Program for reading out the product information of the peripheral
map_drive.vba	Module1 frmMapDrive	Standard module UserForm	Program for connecting a hard disk (a shared folder) of an external PC to the E5070B/E5071B.
meas_sing.vba	mdlSingMeas frmSingMeas	Standard module UserForm	Program for detecting the end of the measurement using SCPI.TRIGger.SEQuence.SINGle object and SCPI.IEEE4882.OPC object.
meas_srq.vba	mdlSrqMeas frmSrqMeas	Standard module UserForm	Program for detecting the end of the measurement through the status register
meas_user.vba	mdlUserMenu	Standard module	Program for utilizing the user menu function (interrupt processing by the assigned softkey)
pow_cal.vba	mdlPowCal Module1 Module2	Standard module Standard module Standard module	Program for performing the power calibration
read_write.vba	mdlReadWrite frmReadWrite	Standard module UserForm	Program for reading / displaying / writing a formatted data array

NOTE

The sample program disk also contains two definition file for controlling peripherals with VISA library, named “visa32.bas” and “vpptype.bas.”

Making Effective Use of This Manual
How To Use This Manual

2

Introduction to VBA Programming

This chapter introduces you to the E5070B/E5071B's VBA macro function, describes how you can implement your system using the VBA macro function, and provides an overview of the COM objects that come with the E5070B/E5071B.

Introduction of the E5070B/E5071B Macro Function

The E5070B/E5071B has a built-in macro function that allows a single instruction to substitute for multiple instructions. You can have the E5070B/E5071B automatically execute your own macro program that contains a series of VBA (Visual Basic for Application) statements. The macro function allows you to run a variety of applications; you can control not only the E5070B/E5071B but also various peripherals from your own macro code.

The VBA is based on the VB (Visual Basic) programming language. Although the VBA is similar to the VB, they are not the same. The VBA is decreased some of the VB's features and added characteristic features for each application. The E5070B/E5071B VBA is added features for controlling the E5070B/E5071B. For details of difference between the VBA and the VB, refer to Microsoft official guides, and various books on VBA.

For information on the basic operating procedures for the E5070B/E5071B's VBA, see Chapter 3, "Operation Basics of the E5070B/E5071B's VBA," on page 33. This manual is not meant to be an in-depth guide to VBA programming basics and the syntax of VBA functions and commands. Such in-depth information is covered in VBA Help, Microsoft official guides, and various books on VBA.

The macro function allows you to control the E5070B/E5071B itself as well as various peripherals. You can do the following:

1. Automate repetitive tasks

You can use the E5070B/E5071B's macro function to combine several processes into one. Automating repetitive tasks provides higher efficiency and eliminates human error. Once you have contained repetitive tasks in Sub procedures, you can later call the procedures from other programs, thus allowing effective reuse of programming assets.

2. Implement a user interface

The E5070B/E5071B VBA supports user forms (see "User Form" on page 37) that simplify creating a visual user interface. User forms guide users through common tasks such as performing measurement and entering data, without requiring familiarity with the E5070B/E5071B, thus minimizing the possibility of human error.

NOTE

When more than 1601 measurement points is set for 1 channel and 4 traces, the E5070B/E5071B VBA macro function may not operate.

An Overview of a Control System Based on the Macro Function

This section describes how you can use the E5070B/E5071B's built-in VBA macro function to implement a system that controls the E5070B/E5071B and peripherals, and what command sets are available for such purposes.

Implementing a Control System

Macro-based control systems are classified into two types: As shown in Figure 2-1, a VBA control system controls the E5070B/E5071B itself while a VBA remote control system controls peripherals. When you use the macro function to control peripherals, you must connect the E5070B/E5071B with the peripherals through USB/GPIB interface, and configure them to communicate over VISA (Virtual Instrument Software Architecture). For information on programming using the VISA library, refer to “Programming with VISA” on page 89.

Figure 2-1 Configuration example of control system using macro environment

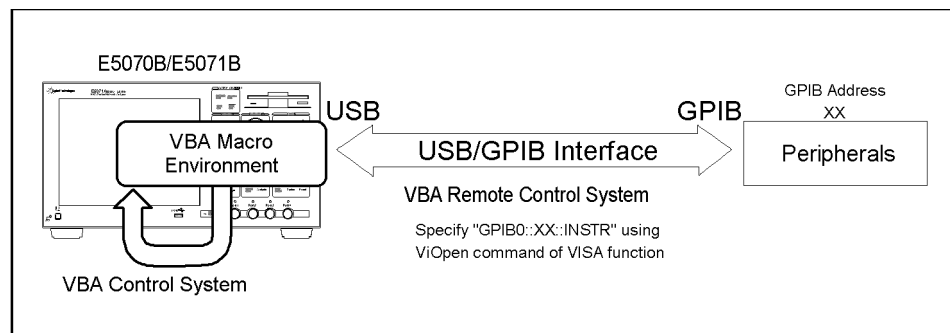

e5070bve013

Required Equipment

1. E5070B/E5071B
2. Peripherals and/or other instruments that serve your purpose
3. USB/GPIB interface

NOTE To use the VBA remote control system, you need to set the USB/GPIB interface correctly. For detail, refer to *User's Guide*.

NOTE Do not connect two or more USB/GPIB interfaces.

Control Methods

The command set you can use differs depending on whether you use the macro function to control the E5070B/E5071B or a peripheral.

Controlling the E5070B/E5071B

When you want to control the E5070B/E5071B itself, you can create a program using COM objects within the E5070B/E5071B VBA environment. COM objects that come with the E5070B/E5071B include seven objects specific to the COM interface and COM objects that correspond to SCPI commands.

For information on using E5070B/E5071B's COM objects, see Chapter 7, "COM Object Reference," on page 135. For information on using SCPI commands, see the "SCPI Command Reference" in the *E5070B/E5071B Programmer's Guide*.

Controlling a Peripheral

When you want to control a peripheral, you can create a program using VISA library functions within the E5070B/E5071B VBA environment.

For information on using the VISA library, see Chapter 5, "Controlling Peripherals," on page 87. For a complete description of VISA functions, refer to the VISA library's online help. You can access this online help by double-clicking a file named visa.hlp contained in the CD-ROM (Agilent part No. E5070-905xx).

For information on the GPIB commands available with a particular peripheral, refer to the documentation that comes with the peripheral.

Overview of E5070B/E5071B COM Object

The E5070B/E5071B VBA environment provides COM objects that support controlling the E5070B/E5071B. This section provides an overview of COM objects as well as considerations for using the E5070B/E5071B's COM objects. For more information on the E5070B/E5071B's COM objects and the comparison with SCPI commands, refer to Chapter 7, “COM Object Reference,” on page 135.

The definitions and specifications of COM are beyond the scope of this guide. Such in-depth information is covered in a variety of books on COM.

About COM Object

When you control the E5070B/E5071B through the macro function, you can use COM objects as components of your application. The functionality of the E5070B/E5071B's COM objects is exposed through properties and methods.

Property

A property allows you to read or write a setting or attribute of an object. With the E5070B/E5071B, you can use properties to set or read the settings of the E5070B/E5071B.

You can find properties in the list of object types in Chapter 7, “COM Object Reference,” on page 135.

Method

A method allows you to manipulate an object in a particular way. With the E5070B/E5071B, you can use methods to perform specific tasks.

You can find methods in the list of object types in Chapter 7, “COM Object Reference,” on page 135.

Event

An event means an operation from outside that the program can recognize such as clicking a mouse. The E5070B/E5071B detects events that a specific softkey is pressed using the `UserMenu_OnPress(ByVal Key_id As Long)` on page 204 procedure to execute the assigned procedure.

Using COM Object to Control the E5070B/E5071B

When you want to control the E5070B/E5071B, you can use COM objects alone or in conjunction with SCPI commands and the `Parse` on page 200 object. The latter method is a little slower than the former method because the `Parse` on page 200 object is used to parse the messages of SCPI commands. For instructions on using the E5070B/E5071B's VBA Editor to create a program that uses COM objects, refer to Chapter 3, “Operation Basics of the E5070B/E5071B's VBA,” on page 33.

Major Control Difference between COM Object and SCPI Command

While the control using SCPI commands allows SRQ (Service Request) interrupts through the status reporting mechanism, the control using COM objects does not support SRQ interrupts. Instead of SRQ interrupts, you can use the **WaitOnSRQ** object to suspend the program until the E5070B/E5071B is put into the desired state. For a detailed example of use, see “WaitOnSRQ” on page 207.

3 Operation Basics of the E5070B/E5071B's VBA

This chapter provides descriptive information on basic operations for creating VBA programs within the E5070B/E5071B's VBA environment; topics include launching Visual Basic Editor, creating, saving, and running VBA programs, and so on.

Displaying Visual Basic Editor

This section describes how to launch Visual Basic Editor.

Step 1. From the E5070B/E5071B measurement screen, launch Visual Basic Editor using one of the following methods:

- **[Macro Setup] - VBA Editor**
- Press **[Alt] + [F11]** on the keyboard.

Initial Screen of Visual Basic Editor

When you launch Visual Basic Editor, it displays the initial screen, which contains a number of windows as shown in Figure 3-1. The initial screen provides the following GUI elements:

Figure 3-1 Example of Visual Basic Editor initial screen

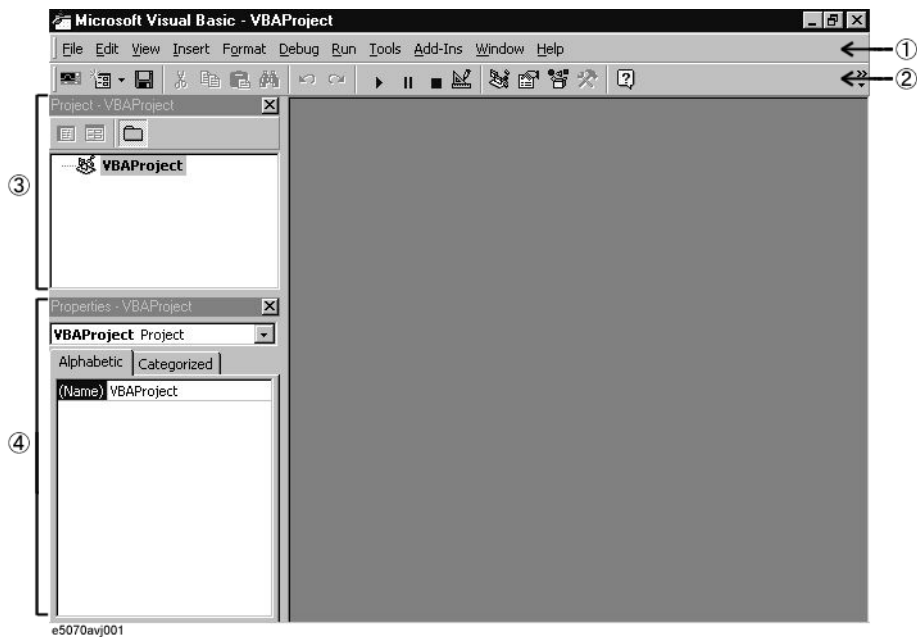

1. Menu Bar

Clicking one of the menu labels brings up the corresponding menu. The menu bar can be used as the primary method to navigate through E5070B/E5071B's VBA environment.

2. Toolbar

The toolbar provides access to commonly used commands via icon buttons; these commands are a subset of the commands accessible from the menu bar. For the description of the buttons on the standard toolbar, see Figure 3-2.

Figure 3-2

Buttons on the standard toolbar

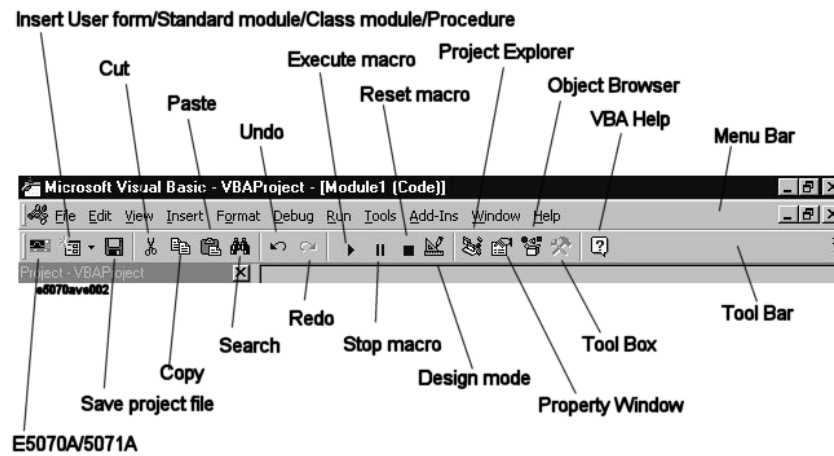

3. Project Explorer

Within the E5070B/E5071B's VBA environment, you can develop your application as a project that consists of a number of files (modules). Project Explorer shows a list of all files (modules) that make up a project. The list also includes files (modules) created or loaded in Visual Basic Editor. For information on modules, refer to “A Project and Three Types of Module” on page 37.

Step 1. To display the project explorer, do one of the following:

- On the **View** menu, click **Project Explorer**.
- Press **[Ctrl] + [R]** on the keyboard.
- On the toolbar, click “Project Explorer” icon (Figure 3-2).

4. Property Window

A property window shows the settings (label, font, color, size, etc.) of a control (such as a command button or text box) placed on the user form. For information on user forms, refer to “User Form” on page 37.

You can also set properties by programming in the code window.

Step 1. To display the project explorer, do one of the following:

- On the **View** menu, click **Properties Window**.
- Press **[F4]** on the keyboard.
- On the toolbar, click “Property Window” icon (Figure 3-2).

Closing Visual Basic Editor

This section describes how to quit Visual Basic Editor.

- Step 1.** Close the Visual Basic Editor using one of the following methods:
- On Visual Basic Editor's **File** menu, click **Close and Return to E5070**.
 - Within Visual Basic Editor, press **[Alt] + [Q]** on the keyboard.
 - **[Macro Setup] - Close Editor**(E5070B/E5071B measurement screen)

NOTE

Whenever you launch Visual Basic Editor, it automatically displays the project files you were working with in the previous session. However, once you turn off the power to the E5070B/E5071B, the project files kept in memory will be lost; therefore, it is strongly recommended to save your VBA programs before you turn off the power.

Switching to the E5070B/E5071B Measurement Screen

You can switch to the E5070B/E5071B measurement screen without closing Visual Basic Editor.

- Step 1.** To switch to the E5070B/E5071B measurement screen, do one of the following:
- On the **View** menu, click **E5070**.
 - Press **[Alt] + [F11]** on the keyboard.
 - On the toolbar, click “E5070B/E5071B” icon (Figure 3-2).
 - Press the **[Focus]** key on the E5070B/E5071B front panel.

Making a Preparation Before Coding

A Project and Three Types of Module

Project Explorer (Figure 3-1) displays a list of files (modules) that are used in the E5070B/E5071B VBA. This section describes a project composed of a number of files (modules) and three types of modules (“user form”, “standard,” and “class”). Each type of module serves its own purposes as described below.

Project

When you develop an application within the E5070B/E5071B's VBA environment, you use a number of VBA program files (modules), and manage them as one project. The project is saved with the file extension “.vba”.

User Form

A user form contains controls such as buttons and text boxes. You can code event-driven procedures that are invoked when a particular event occurs on a particular control, thereby creating a user interface. The user form is saved with the file extension “.frm”.

Standard module

A standard module contains a collection of one or more procedures (subprograms enclosed between Sub and End Sub). One typical use of a standard module is to contain shared subroutines and globally called functions. The standard module is saved with the file extension “.bas”.

Class Module

A class module contains both data and procedures and acts as one object. Once you have created a class module that serves as an object, you can create any number of instances of that object by naming each instance as an object variable. While each procedure must be unique in a standard module, you can have multiple instances of an object created through a class module. The class module is saved with the file extension “.cls”.

Displaying a Code Window

The code windows appear on the Visual Basic Editor by inserting the modules in a project. You can do coding (programming) on this code windows practically.

The E5070B/E5071B's VBA environment does not allow you to manage multiple projects. When the current project is existing in the Visual Basic Editor by loading the saved project file, you can replace the current project with a new project by the following method from the E5070B/E5071B measurement screen.

- **[Macro Setup] - New Project**

NOTE

When you replace the current project with a new project, the message whether or not the current project is saved may appear. If you want to save the project, click **Yes** button to display a dialog box for saving (Figure 3-6 on page 46). For saving the project, see “Saving a Project” on page 46.

Inserting the User Form

Within Visual Basic Editor, do one of the following to add a user form to your project (this brings up such a window as shown in Figure 3-3):

- On the **Insert** menu, click **UserForm**.
- On the toolbar, click “Insert User Form/Standard Module/Class Module/Procedure” icon (Figure 3-2), and click **UserForm**.
- In Project Explorer (Figure 3-1), right-click the “VBAProject” icon, and click **Insert - UserForm**.

NOTE

Adding a user form does not automatically open the code window for that user form. To open the code window, click the “Show Code” icon (Figure 3-3) in Project Explorer (Figure 3-1) or double-click a control placed on the user form.

Figure 3-3

Adding a user form

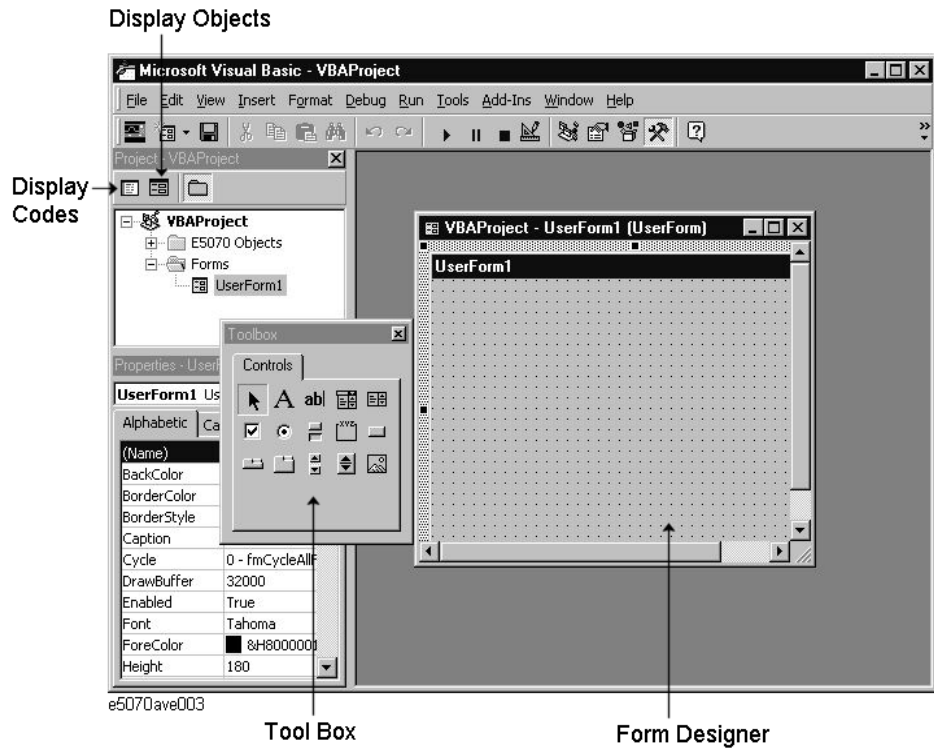

3. Operation Basics of the
E5070B/E5071B's VBA

Inserting the Standard Module

Within Visual Basic Editor, do one of the following to add a standard module to your project (this brings up such a window as shown in Figure 3-4):

- On the **Insert** menu, click **Module**.
- On the toolbar, click “Insert User Form/Standard Module/Class Module/Procedure” icon (Figure 3-2), and click **Module**.
- In Project Explorer (Figure 3-1), right-click the “VBAProject” icon, and click **Insert - Module**.

Figure 3-4 Adding a standard module/class module

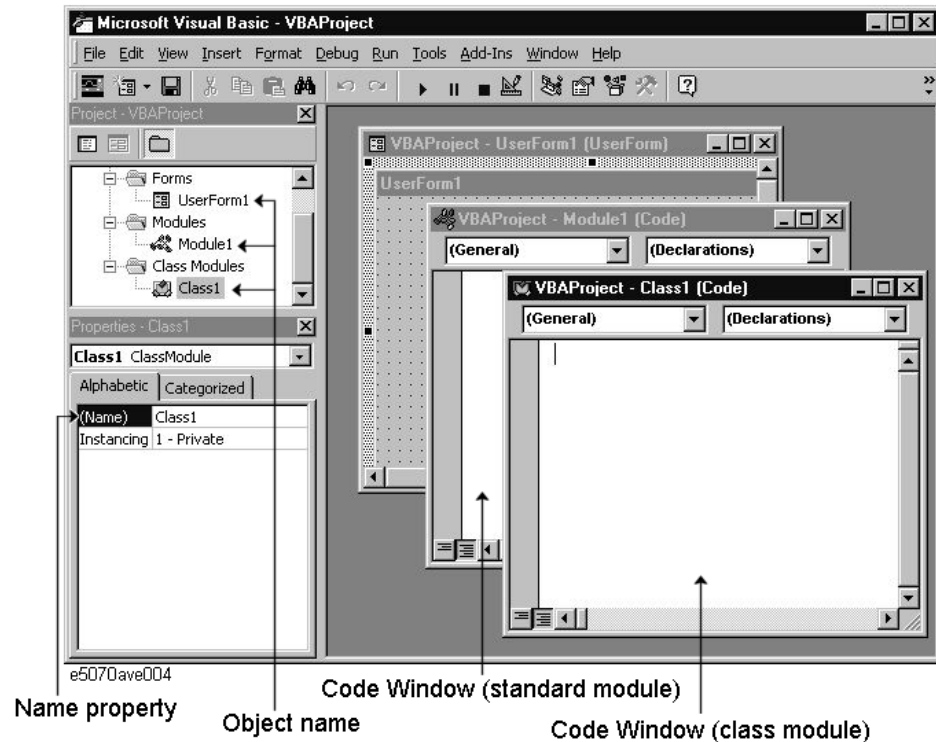

Inserting the Class Module

Within Visual Basic Editor, do one of the following to add a class module to your project (this brings up such a window as shown in Figure 3-4):

- On the **Insert** menu, click **ClassModule**.
- On the toolbar, click “Insert User Form/Standard Module/Class Module/Procedure” icon (Figure 3-2), and click **ClassModule**.
- In Project Explorer (Figure 3-1), right-click the “VBAProject” icon, and click **Insert - ClassModule**.

Deleting Modules

You can delete any unnecessary module from the project within Visual Basic Editor. The following procedure assumes that you want to delete a class module named “Class1”.

- Step 1.** In Project Explorer (Figure 3-1), click the “Class1” class module under the “Class Modules” icon to highlight it.
- Step 2.** Delete the “Class1” class module using one of the following methods:
 - On the **File** menu, click **Remove Class1...**
 - Click the right mouse button, and click **Remove Class1...**
- Step 3.** When you are prompted to confirm whether to export (save) “Class1”, click **No**. Alternatively, you can click **Yes** if you want to save the module.

Coding a VBA Program

This section provides descriptive information on the user interface elements of a code window that lets you code a VBA program, and walks through a sample program (procedure) that finds the maximum value contained in an array so you can gain insight into how to create your own programs.

User Interface Elements of a Code Window

A code window is where you code a VBA program. When you are working with a user form, you can open the code window for that user form by double-clicking a control (such as a button or text box) placed on the form. Similarly, when you are working with a standard or class module, you can open the code window associated with that module by double-clicking the module's icon in Project Explorer (Figure 3-1).

Figure 3-5

Code window for a standard module

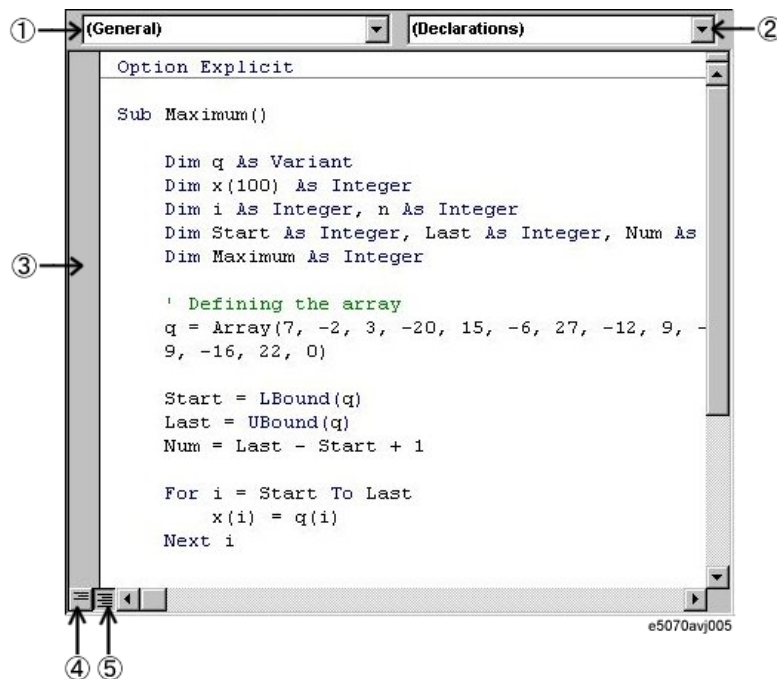

1. Object box

Provides a list of objects currently used within the code window.

2. Procedure box

Provides a list of procedures that reside within the code window. When you are working with a user form, this provides a list of events (actions such as click or double-click).

3. Margin indicator bar

Primarily intended for use when debugging a program.

4. Show Procedure button

Displays only the procedure at the cursor position.

5. Show Module button

Displays the entire program contained in the code window.

Creating a Simple VBA Program

This section walks through a sample program that finds the maximum value contained in an array while breaking down the code into a number of blocks and describing what they do. Line numbers are added for description purpose only, and do not appear in the actual program source code.

Example 3-1

Sample program that finds the maximum value contained in an array

```
10| Option Explicit
20|
30| Sub Maximum()
40|
50|     Dim q As Variant
60|     Dim x(100) As Integer
70|     Dim i As Integer, n As Integer
80|     Dim Start As Integer, Last As Integer, Num As Integer
90|     Dim Maximum As Integer
100|
110|     ' Defining the array
120|     q = Array(7, -2, 3, -20, 15, -6, 27, -12, 9, -5, 18, 23, _
130|         9, -16, 22, 0)
140|
150|     Start = LBound(q)
160|     Last = UBound(q)
170|     Num = Last - Start + 1
180|
190|     For i = Start To Last
200|         x(i) = q(i)
210|     Next i
220|
230|     Maximum = x(Start)
240|
250|     For n = Start + 1 To Last
260|         If x(n) > Maximum Then Maximum = x(n)
270|     Next n
280|
290|     MsgBox Maximum
300|
310| End Sub
```

Operation Basics of the E5070B/E5071B's VBA Coding a VBA Program

Let us break down the code into a number of blocks and see what they do.

Line 10	This instruction mandates explicit declaration of variables.
Lines 30 to 310	The code enclosed between Sub Maximum() and End Sub will be executed within the E5070B/E5071B's macro environment. Thus enclosed code is called a procedure. In this example, "Maximum" is the procedure name.
Lines 50 to 90	These lines declare data types of variables using Dim statements. A statement is the minimum instruction unit based on the syntax. The sample program declares the variable "q" as Variant, and the variables "x(100)", "i", "n", "Start", "Last", "Num", and "Maximum" as Integer. For a complete list of statements and data types supported by VBA, see VBA Online Help.
Line 110	Any text preceded by a comment indicator (') is treated as a comment.
Lines 120 to 130	These lines use VBA's Array function to initialize the array. The q() array contains elements delimited with commas in the ascending order of index numbers (zero-based). A combination of a space and underscore () is used to continue the statement across two or more lines.
Line 150	Stores the starting index number of the q array into the Start variable.
Line 160	Stores the last index number of the q array into the Last variable.
Line 170	Stores the number of elements in the q array into the Num variable.
Lines 190 to 210 and Lines 250 to 270	The code within each For ...Next statement is iterated until the counter reaches the specific number.
Line 200	Stores the contents of the q array (Variant) into the x variable (Integer).
Line 230	Uses the first element of the x array as the tentative maximum value.
Line 260	Compares the tentative maximum value with each of elements that follow; if an element is larger than the tentative maximum value, then that element is used as the tentative maximum value.
Line 290	Uses a message box function to display the maximum value. For a complete list of functions supported by VBA, see VBA Online Help.

NOTE

The sample program in Example 3-1 consists of a single procedure contained in a single module. However, when you deal with procedures and variables across multiple modules, you should be aware of the scope of variables and procedures.

Auto-complete Feature

When you use COM objects in Visual Basic Editor, the editor's auto-complete feature allows you to easily type in keywords without misspelling them.

The following procedure assumes that you are entering the SCPI.INITiate(Ch).CONTInuous on page 424 object.

- Step 1.** In a standard module, type **sub main** and press the **[Enter]** key. **End Sub** is automatically added.
- Step 2.** Typing **scpi** followed by a dot (.) brings up a list of classes under the SCPI class.
- Step 3.** Typing **in** automatically moves focus to **INITiate** in the list box.
- Step 4.** Typing **(** brings up a list of indexes.
- Step 5.** Typing **1).** brings up a list of classes under the INITiate class.
- Step 6.** Typing **c** automatically moves focus to **CONTInuous** in the list box.
- Step 7.** Typing **=** brings up a list box for setting a Boolean value (**True/False**).
- Step 8.** Typing **t** automatically moves focus to **True**.
- Step 9.** Pressing the **[Enter]** key completes the statement: SCPI.INITiate(1).CONTInuous = True.

Saving a VBA program

You can save VBA programs either as one complete project or on a module by module basis.

Saving a Project

When you opt to save your program as one complete project, you can have the files (modules) making up the project into a single package. A project is saved as a .vba file. You can save your program to a project file using one of the following two methods:

Saving a Project from Visual Basic Editor

Step 1. Open the Save As dialog box by doing one of the following:

- On the **File** menu, click **Save xxx.VBA**. "xxx" represents the file name.
- On the toolbar, click "Save Project File" icon (Figure 3-2).
- Press **[Ctrl] + [S]** on the keyboard.

Step 2. The Save As dialog box (Figure 3-6) appears. Specify the file name and location (drive or folder) and click **Save**.

The Save As dialog box has the following user interface elements:

Figure 3-6

Save As dialog box

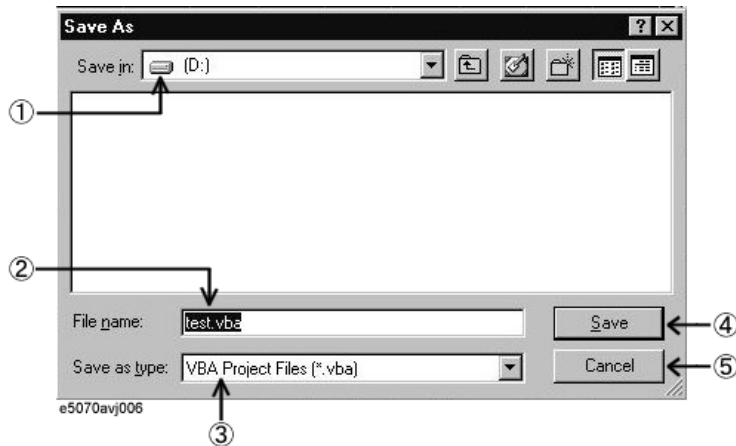

- 1. Save in:** Specify the location (drive or folder) where to save the file.
- 2. File name** Type in the file name.
- 3. Save as type:** Select the type of the file you are saving. Normally, you should select **VBA Project Files [* .vba]**.
- 4. Save:** Clicking this button saves the project.
- 5. Cancel:** Clicking this button closes the Save As dialog box and brings you back to the main screen.

E5070B/E5071B Saving a Project from the E5070B/E5071B Measurement Screen

- Step 1.** Display the E5070B/E5071B measurement screen following the instructions given in “Switching to the E5070B/E5071B Measurement Screen” on page 36.
- Step 2.** Open the Save As dialog box using the following key sequence:
 - **[Macro Setup] - Save Project**
- Step 3.** The Save As dialog box (Figure 3-6) appears. Specify the file name and location (drive or folder) and click **Save**.

Saving a Module (Exporting)

Alternatively, you can save each module (user form, standard, or class) of your VBA program individually. To save a module, you must use Visual Basic Editor. User forms are saved as .frm files, standard modules as .bas files, and class modules as .cls files.

- Step 1.** In Project Explorer (Figure 3-1), click the file name that appears under the desired module icon to highlight it.
- Step 2.** Open the Export File dialog box by doing one of the following:
 - On the **File** menu, click **Export File....**
 - Click the right mouse button, and click **Export File....**
 - Press **[Ctrl] + [E]** on the keyboard.
- Step 3.** The Export File dialog box (Figure 3-7) appears. Specify the file name and location (drive or folder) and click **Save**.

The Export File dialog box has the following user interface elements:

Figure 3-7

Export File dialog box

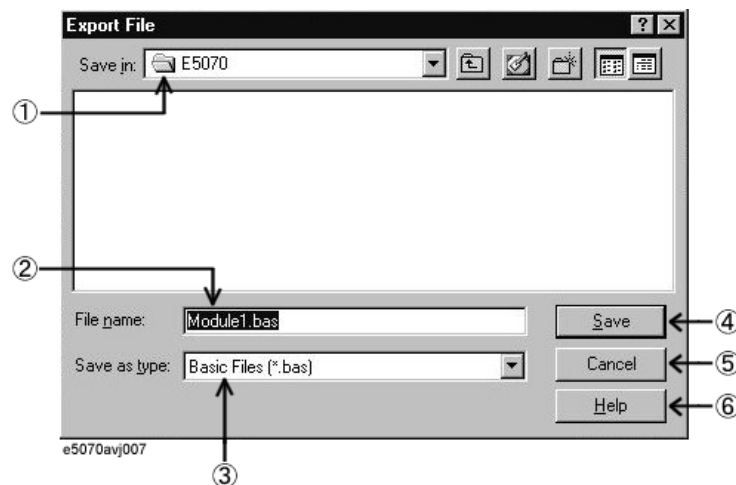

- 1. Save in:** Specify the location (drive or folder) where to save the file.
- 2. File name** Type in the file name.

Saving a VBA program

- 3. Save as type:** Select the type of the module you are saving. The type that corresponds to the module you are saving is selected by default. Normally, you should use the default.
- 4. Save:** Clicking this button saves the module.
- 5. Cancel:** Clicking this button closes the Export File dialog box and brings you back to the main screen.
- 6. Help:** Clicking this button brings up VBA Online Help.

Loading a VBA Program

Once you have saved a project or module file, you can load it later whenever necessary.

Loading a Project

You can load a saved project file either from the E5070B/E5071B measurement screen or by specifying that the project file be automatically loaded when the power is turned on.

Loading a Project from the E5070B/E5071B Measurement Screen

Step 1. Access the Open dialog box using the following key sequence:

- **[Macro Setup] - Load Project**

NOTE

When the another project has already been loaded on the Visual Basic Editor, the message whether or not the current project is saved may appear. If you want to save the project, click **Yes** button to display a dialog box for saving (Figure 3-6 on page 46). For saving the project, see “Saving a Project” on page 46.

Step 2. The Open dialog box (Figure 3-8) appears. Specify the file name and location (drive or folder) of the file you want to load and click **Open**.

The Open dialog box has the following user interface elements:

Figure 3-8

Open dialog box

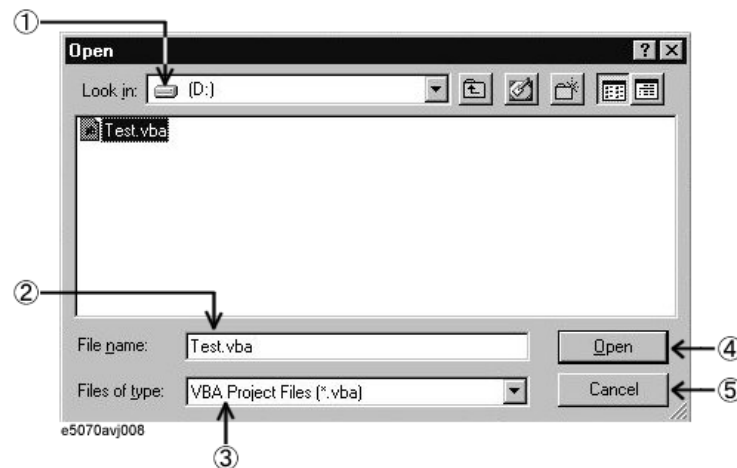

- 1. Look in:** Specify the location (drive or folder) where the project resides.
- 2. File name:** Specify the file name of the project you want to load.
- 3. Files of type:** Select the type of the file you want load. Normally, you should select **VBA Project Files (*.vba)**.
- 4. Open:** Clicking this button loads the project.
- 5. Cancel:** Clicking this button closes the Open dialog box and brings you back to the main screen.

Operation Basics of the E5070B/E5071B's VBA

Loading a VBA Program

Automatically Loading a Project at Power-On

Once you have saved a project file that satisfies the following conditions, the project will be automatically loaded whenever the power is turned ON.

Auto-loaded project	Conditions
Directory where the project resides.	A:\ or D:\
Project file name	autoload.vba ^{*1}

*1. Upper/lower case insensitive.

NOTE

If there is the file named “autoload.vba” in both the A drive and the D drive, the file in the A drive is used.

Loading a Module (Importing)

To load a saved module into a project, you must use Visual Basic Editor.

Step 1. In Project Explorer (Figure 3-1), click the file name that appears under the desired module icon to highlight it.

Step 2. Open the Import File dialog box by doing one of the following:

- On the **File** menu, click **Import File...**
- In Project Explorer (Figure 3-1), right-click the “VBAProject” icon, and click **Import File...**
- Press **[Ctrl] + [M]** on the keyboard.

Step 3. The Import File dialog box (Figure 3-9) appears. Specify the file name and location (drive or folder) of the file (module) you want to load and click **Open**.

The Import File dialog box has the following user interface elements:

Figure 3-9

Import File dialog box

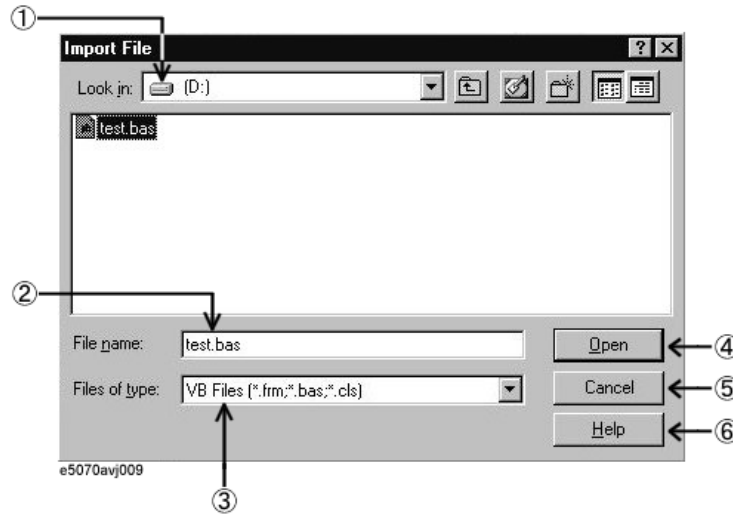

1. **Look in:** Specify the location (drive or folder) where the module resides.
2. **File name:** Specify the file name of the module you want to load.
3. **Files of type:** Select the type of the file you want load. Normally, you should select **VB Files [*.frm;*.bas;*.cls]**.
4. **Open:** Clicking this button loads the module.
5. **Cancel:** Clicking this button closes the Import File dialog box and brings you back to the main screen.
6. **Help:** Clicking this button brings up VBA Online Help.

Running a VBA Program

The E5070B/E5071A provides 2 methods to execute a VBA program: executing a program that you previously loaded and loading and executing a program in a batch process. The execution status of the VBA program is indicated in the instrument status bar, as shown in Figure 3-10. “Run” indicates that the program is running while “Stop” indicates that the program is stopped.

Figure 3-10

Instrument status bar indicating the status of the VBA program



Running a previous loaded VBA program

The E5070B/E5071B allows you to run a previous loaded VBA program using one of the four methods listed below.

Running a Program from Visual Basic Editor

Step 1. Open the Macros dialog (Figure 3-11) box by doing one of the following:

- On the **Run** menu, click **Run Macro**.
- On the **Tools** menu, click **Macros...**
- On the toolbar, click “Run Macro” icon (Figure 3-2).
- Press **[F5]** on the keyboard.

NOTE

Doing the above steps with the cursor positioned within a procedure in the code window immediately runs the program without displaying the Macros dialog box.

Step 2. In the Macros dialog box, select the VBA program (procedure name) you want to run, and click the **Run** button.

The Macros dialog box has the following user interface elements:

Figure 3-11

Macros dialog box

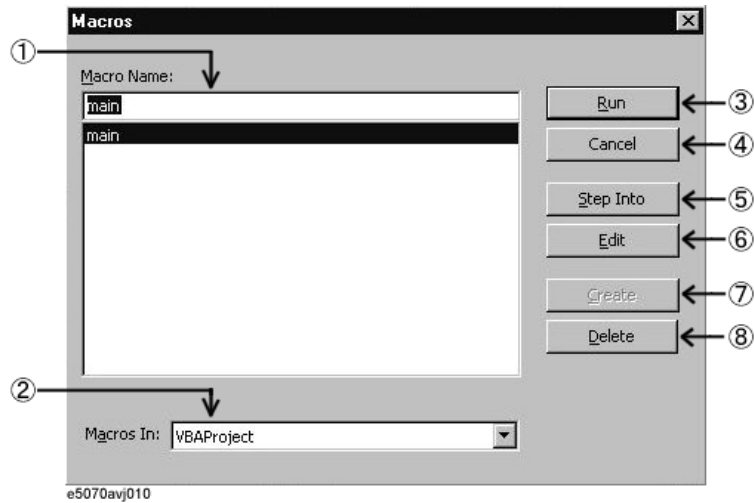

- 1. Macro Name:** Select the VBA program (procedure name) you want to run from the list box so its name appears here.
- 2. Macro In:** Specify the project that contains the VBA program you want to run. Normally, use the default.
- 3. Run:** Clicking this button runs the selected VBA program (procedure).
- 4. Cancel:** Clicking this button closes the Macros dialog box and brings you back to the main screen.
- 5. Step Into:** Clicking this button brings up Visual Basic Editor and put it into step-in mode, where the selected VBA program is run step by step. This mode is primarily intended for use when debugging a VBA program. For more information on step-in mode, see “Debug Toolbar” on page 58.
- 6. Edit:** Displays the code of the selected VBA program. You can use this for re-editing your code.
- 7. Create:** This button is normally dimmed.
- 8. Delete:** Clicking this button deletes the selected VBA program. Take care not to inadvertently delete your VBA program before saving it.

NOTE

The Macros dialog provides access to subprograms (procedures enclosed between Sub and End Sub) created in a standard module.

Operation Basics of the E5070B/E5071B's VBA Running a VBA Program

Running a Program from the E5070B/E5071B Measurement Screen

The E5070B/E5071B allows you to run a program from E5070B/E5071B screen using one of the four methods listed below.

Step 1. Display the E5070B/E5071B measurement screen following the instructions given in “Switching to the E5070B/E5071B Measurement Screen” on page 36.

Step 2. Run the VBA program (procedure) using the following key sequence:

- **[Macro Setup] - Select Macro - Module xxx**

where “**Module**” is the object name (Name property shown in the property window: see Figure 3-4 on page 40) and “**xxx**” is the procedure name.

- Press the **[Macro Run]** key on the E5070B/E5071B front panel. For a program to be run from the measurement screen, its procedure name must be “Main” (subprogram enclosed between Sub Main() and End Sub), and its object name (Name property as displayed in the property window) must be “Module1”.

NOTE

When you are working with the E5070B/E5071B measurement screen, the E5070B/E5071B's macro environment only provides access to those VBA programs that are created as subprograms (enclosed between Sub and End Sub) in a standard module.

Loading and executing program in batch process

NOTE

This feature is available for E5070B/E5071B Rev. 3.5 or later.

This section describes how to load and execute a program (VBA project) in a batch process by pressing the softkey corresponding to the program name.

Step 1. Save the VBA program (VBA project file) into the following folder.

D:\VBA

NOTE

This feature is available only for programs saved in D:\VBA. This feature is not available for programs saved in subfolders of D:\VBA.

NOTE

When copying a VBA program to D:\VBA from another folder, copy all the files necessary to execute the program to appropriate folders. When copying a factory-installed VBA program into D:\VBA, choose only its VBA project file.

Step 2. Press **Macro Setup**

Step 3. Press **Load & Run**.

Step 4. Press the softkey corresponding to the VBA project file name of the program you want to execute. The pressed VBA project is loaded and the program whose procedure name is set to "Main" (subprogram enclosed between Sub Main() and End Sub) and whose object name (Name property as displayed in the property window) is set to "Module" is executed.

NOTE

There is no limit to the number of VBA project files that can be saved in D:\VBA. However, the maximum number of programs that can be displayed as softkeys is 50.

- File names of the VBA projects saved in D:\VBA are displayed as softkeys in alphabetical order.
- The maximum number of characters that can be displayed in a softkey is 12. If a file name has 13 or more characters, "." is added to the 12th character from the beginning of the program name and displayed. In this case a .vba extension is omitted.

Stopping a VBA Program

Stopping with the Dialog Box Appeared

This section describes how to break a procedure during the execution of a VBA program (display a dialog box as shown in Figure 3-12 using forced interrupts).

Step 1. To break the running VBA program, do one of the following:

- On the **Run** menu, click **Break**.
- On the toolbar, click "Break Macro" icon (Figure 3-2).
- Press **[Ctrl] + [Break]** on the keyboard.
- **[Macro Setup] - Stop**(E5070B/E5071B measurement screen)
- Press the **[Macro Break]** key on the E5070B/E5071B front panel.

Step 2. A dialog box as shown in Figure 3-12 is displayed through forced interrupts, and the program is suspended.

Figure 3-12

Dialog box that appears when a VBA program is suspended

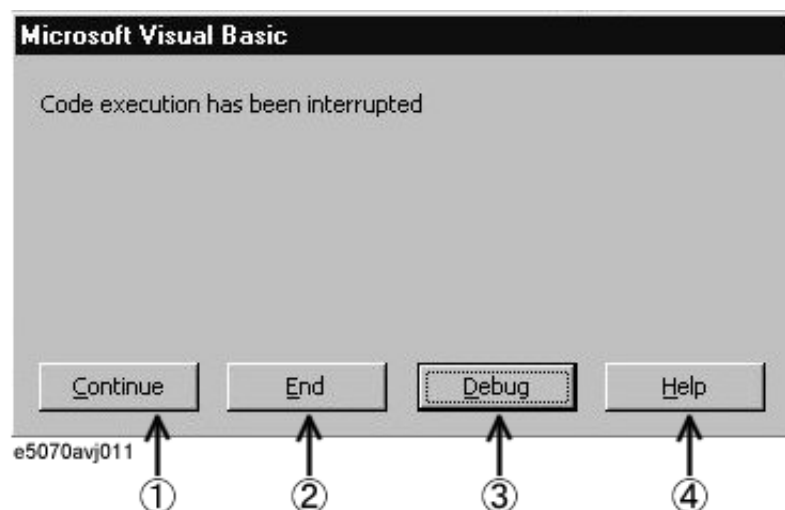

Operation Basics of the E5070B/E5071B's VBA

Stopping a VBA Program

- 1. Continue:** Resumes the execution of the program.
- 2. End:** Terminates the VBA program.
- 3. Debug:** Displays a run-time error.
- 4. Help:** Brings up VBA Online Help.

Abruptly Terminating the VBA Program

This section describes how to abruptly terminate a running procedure. When abruptly terminating the VBA program by the below methods, the “Program interrupted” message is shown in the instrument status bar on the bottom of the LCD display.

Step 1. To terminate the running VBA program, do one of the following:

- On the **Run** menu, click **Reset**.
- On the toolbar, click “Reset Macro” icon (Figure 3-2).
- Insert an *End* statement into your code.

Errors and Debugging

Types of Error

Errors in VBA programs are classified into the following two types:

Syntax errors

A syntax error is generated when Visual Basic Editor detects an invalid statement that violates the Visual Basic syntax rules. For example, misspelled keywords generate syntax errors. An error dialog box appears that indicates the error message, and highlight the invalid statement in red. To get detailed information on the error, click the **HELP** button in the error dialog box to display the help topic on the error. You cannot run the macro until you correct the syntax error.

The E5070B/E5071B VBA environment is by default configured to automatically check for syntax errors, but you can disable the auto syntax check feature using the following steps:

- Step 1.** On the **Tools** menu, click **Options...**
- Step 2.** On the **Editor** tab, clear the **Auto Syntax Check** check box.
- Step 3.** Click the **OK** button.

Run-time Errors

A run-time error is generated when a VBA program attempts to execute an invalid statement at run time. When a run-time error is generated, the program is stopped at the invalid statement, and an error dialog box as shown in Figure 3-12 appears. You can terminate the program by clicking the **END** button in the error dialog box. Also, you can click the **DEBUG** button in the error dialog box to identify the statement that caused the error. In this case, the statement in question is highlighted in yellow.

NOTE

Some run-time errors occur under particular conditions, even though a program run without occurring the errors under normal conditions. For example, the “Target value not found” error that occurs when a program that analyzes the results using the Marker Bandwidth Search feature fail to perform bandwidth search because the marker is not in the appropriate position, the “Ecal module not in RF path” error that occurs when a program that performs calibrations using a ECal module fail to measure the calibration data because the ECal module is not appropriately connected to test ports, and so on. To avoid interruption of the program by these errors, you can handle these errors like lines 730 to 960 in Example 6-1 on page 99.

Using a Debug Tool

The E5070B/E5071B's VBA environment provides a variety of debug tools that help you identify logical errors. Detailed information on using the debug tools is covered in VBA Online Help and books on VBA.

Debug Toolbar

The debug toolbar (Figure 3-13) provides tool buttons that allow you to easily access various debug tools. To display the debug toolbar, do the following:

- Step 1.** On the **View** menu, click **Toolbars - Debug**.

Figure 3-13

Debug toolbar

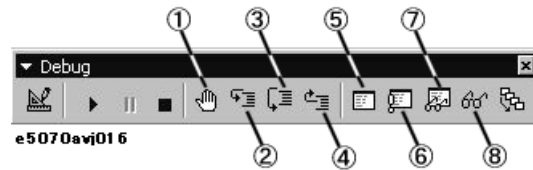

1. Set/clear break points (keyboard: **[F9]**)
Puts a break point at the cursor position or clears an existing break point.
2. Step-in (keyboard: **[F8]**)
Runs the VBA program step by step. If the current program contains a call to another procedure, that procedure is also run step by step.
3. Step-over (keyboard: **[Shift]+[F8]**)
Runs the VBA program step by step. If the current program contains a call to another procedure, that procedure is run as one line.
4. Step-out (keyboard: **[Ctrl]+[Shift]+[F8]**)
Executes the remaining lines of the function where the execution point is currently placed.
5. Local window
Opens the local window that shows the current values of local variables.
6. Immediate window (keyboard: **[Ctrl]+[G]**)
Opens the immediate window that evaluates entered values of variables or expressions.
7. Watch window
Opens the watch window that displays the current value of a specified expression.
8. (keyboard: **[Shift]+[F9]**)
Displays the current value of a specified expression in a dialog box.

Setting a Break Point

By placing a break point at a particular statement in a VBA program, you can automatically suspend the program when it is executed to that statement.

Step 1. When you put a break point at a line, the line is highlighted in amber as shown in Figure 3-14. To set a break point do one of the following:

- Place the cursor at the desired line of code, and click the “Set/clear break points” button (Figure 3-13: 1) on the debug toolbar.
- Click anywhere in the margin indicator bar of the code window.

Figure 3-14

Setting a break point

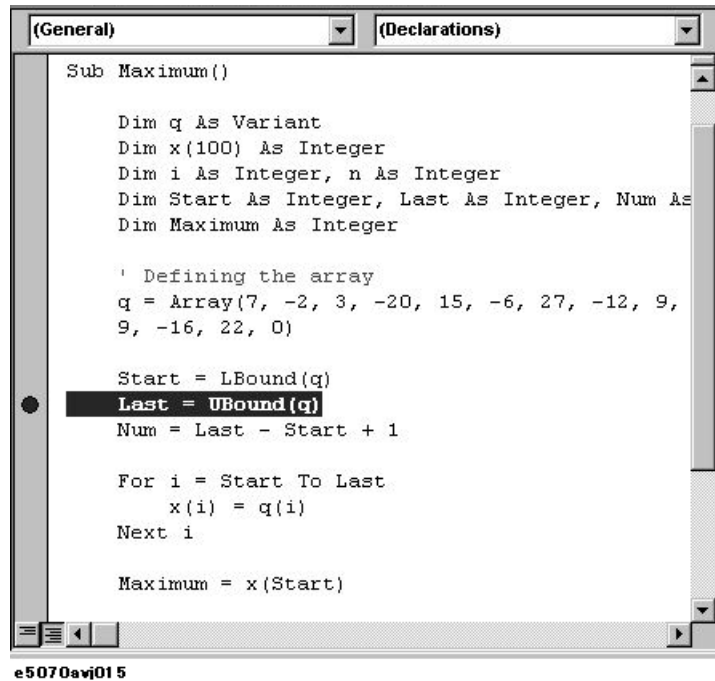

Monitoring Variable or Property Values

With your VBA program suspended, you can use the following debug tool to monitor variables or properties. To do this, you must set a break point, run the VBA program, and suspend it.

Data Hint

When you point to the variable or expression of interest, Data Hint shows the current value as shown in Figure 3-15.

Figure 3-15

Data Hint

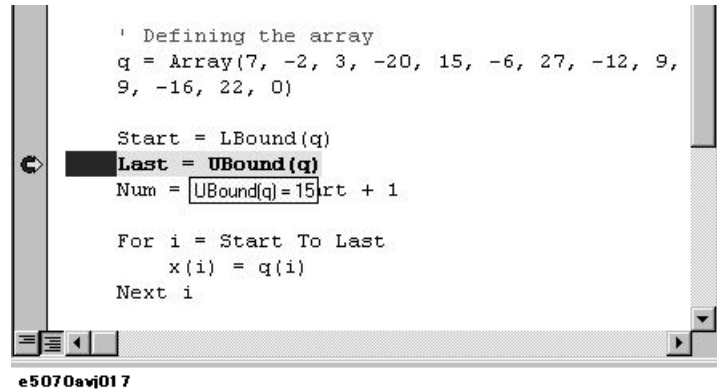

Immediate Window

To display the immediate window, click the “Immediate Window” button (Figure 3-13:6) on the debug toolbar.

In the immediate window, enter a question mark (?) followed by the variable or expression whose value you want to check, and press the Enter key, as shown in Figure 3-16. The current value appears in the line that follows.

Figure 3-16

Immediate window



Watch Window

To display the watch window (Figure 3-17), click the “Watch Window” button (Figure 3-13: 7) on the debug toolbar.

Figure 3-17

Watch window

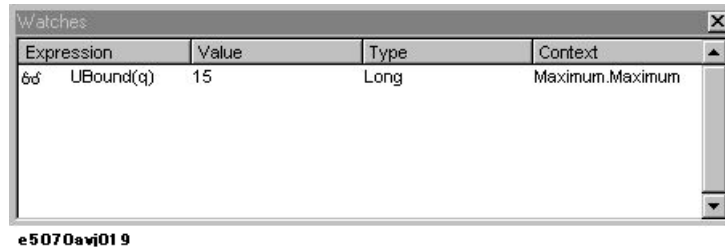

Step 1. To open the Add Watch dialog box (Figure 3-18), do the following:

- On the **Debug** menu, click **Add Watch...**

Step 2. As shown in Figure 3-18, you can specify an expression of interest as a watch expression to always monitor its value.

Step 3. Click the **OK** button.

Figure 3-18

Add Watch dialog box

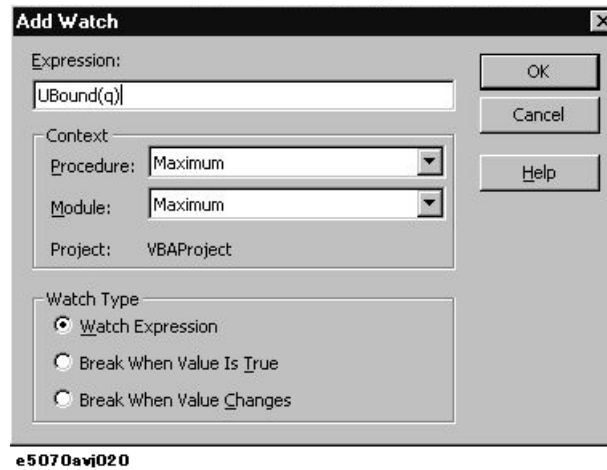

Quick Watch

In the code window, select a variable or expression whose value you want to watch. On the debug toolbar, click the “Quick Watch” button (Figure 3-13:8) to open the Quick Watch dialog box (Figure 3-19). The dialog box displays the current value of your specified variable or expression.

Also, you can click the **Add** button in the Quick Watch dialog box to specify the current expression as a watch expression.

Figure 3-19

Quick watch



e5070avi021

Printing Output Values in the Echo Window

The echo window, which appears in the lower part of the E5070B/E5071B measurement screen, can be used to display a message or the return value (data) of an object.

Entering Values Output to the Echo Window

You can use the COM objects listed below to enter values output to the echo window. For more information on each object, see Chapter 7, “COM Object Reference.”

- ECHO on page 198
- SCPI.DISPLAY.ECHO.DATA on page 385

Opening the Echo Window

You can use the COM objects listed below to open the echo window. For more information on each object, see Chapter 7, “COM Object Reference.”

- SCPI.DISPLAY.TABLE.TYPE on page 394
- SCPI.DISPLAY.TABLE.STATE on page 393

Alternatively, you can also open the echo window using the following key sequence:

- **[Macro Setup] - Echo Window (ON)**

Clearing Values Output in the Echo Window

You can use the COM object shown below to clear values output to the echo window. For more information on this object, see Chapter 7, “COM Object Reference.”

- SCPI.DISPLAY.ECHO.CLEAR on page 385

Alternatively, you can also clear values output to the echo window using the following key sequence:

- **[Macro Setup] - Clear Echo**

Using VBA Online Help

VBA Online Help provides useful topics, such as the VBA terminology or how to use a particular feature. In VBA Online Help, you can find a topic of interest through the Contents or by entering specific keywords.

Accessing VBA Online Help

Step 1. From Visual Basic Editor, do one of the following to access the VBA Online Help screen (Figure 3-20):

- On the **Help** menu, click **Microsoft Visual Basic Help**.
- Press **[F1]** on the keyboard.
- On the toolbar, click “VBA Help” icon (Figure 3-2).

Figure 3-20

VBA Online Help screen

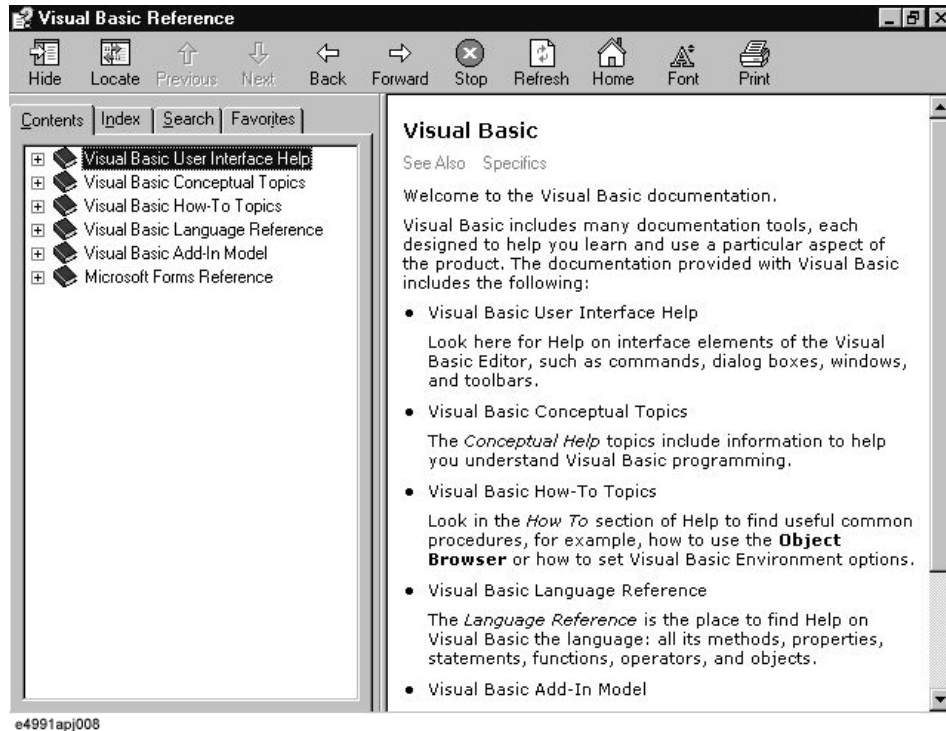

Using the Contents Tab

Step 1. Clicking the **Contents** tab in the VBA Online Help screen brings up the items listed below. The E5070B/E5071B VBA Online Help has a hierarchical table of contents. Click an item to expand it, and then find a topic of interest.

- Visual Basic User Interface Help
- Visual Basic Conceptual Topics
- Visual Basic How-To Topics
- Visual Basic Language Reference
- Visual Basic Add-In Model
- Microsoft Forms Reference

When you need information on using Visual Basic Editor, use User Interface Help and How-To Topics as primary sources of information. Formats of VBA programs are covered in Visual Basic Conceptual Topics. Properties and methods supported by VBA are covered in Visual Basic Language Reference and Visual Basic Add-In Model. Information on using user forms is covered in Microsoft Forms Reference.

Using the Index Tab

Step 1. In the VBA Online Help screen, click the **Index** tab, and enter a keyword(s) into the text box. For example, you may wish to search for “Sub” or “With” when you are writing your own code.

Looking up a Keyword in the Code within Visual Basic Editor

When you want to know the usage or meaning of a keyword contained in a sample program or some other code, you can quickly access the help topic on that keyword by moving the cursor to the keyword and pressing **[F1]**.

Uses Advanced Techniques

Accessing a List of E5070B/E5071B COM Objects

The E5070B/E5071B VBA environment provides COM objects that support controlling the E5070B/E5071B. When you are developing a program using E5070B/E5071B COM objects, you can access a list of E5070B/E5071B COM objects by opening Object Browser within Visual Basic Editor.

Step 1. To open Object Browser, do one of the following:

- On the **View** menu, click **Object Browser**.
- On the toolbar, click “Object Browser” icon (Figure 3-2).

Step 2. Select **E5070Lib** from the Project/Library box to display the E5070B/E5071B library as shown in Figure 3-21.

NOTE

There are some COM objects NOT used in controlling with E5070B/E5071B VBA in the list of the E5070B/E5071B COM objects displayed on the Object Browser. The COM objects NOT used in controlling with E5070B/E5071B VBA are not described in the Chapter 7, “COM Object Reference,” on page 135.

Figure 3-21

How to use Object Browser

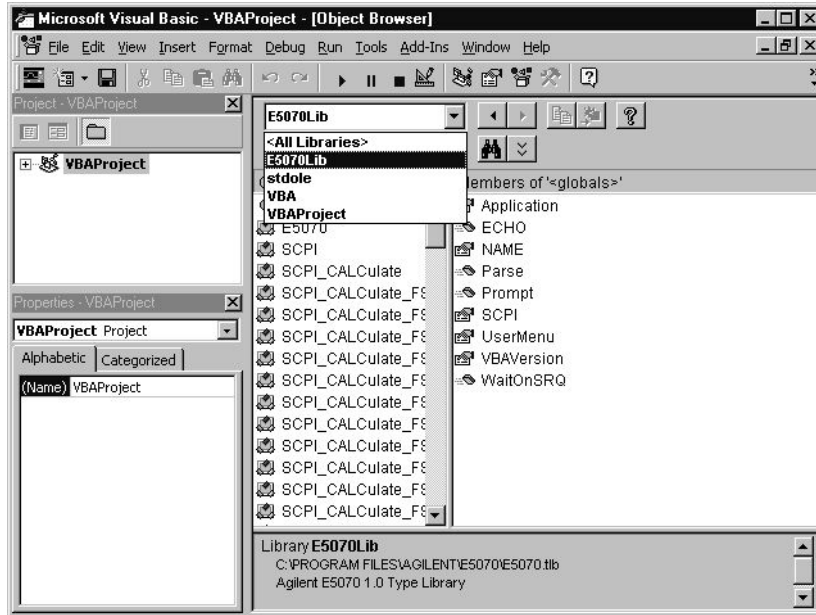

e5070avj042

Using Automatic Library References

For libraries that satisfy the following conditions, the library reference will be automatically set whenever a new project is created and loaded (**[Macro Setup] - New Project**).

Automatically referenced libraries	Conditions
Directory where the library resides.	D:\Agilent
Extensions of libraries	olb, tlb, dll, or ocx

To check the library reference setting, you must use Visual Basic Editor.

Follow these steps to check the library reference setting.

- On the **Tools** menu, click **References...**

NOTE

A project sets the library reference when the project is created. Therefore, if the existing project is loaded, libraries added after the development of the project are not automatically set in the library reference.

Operation Basics of the E5070B/E5071B's VBA
Uses Advanced Techniques

4

Controlling the E5070B/E5071B

This chapter describes how to use the E5070B/E5071B's VBA to control the E5070B/E5071B itself.

Detecting the End of Measurement

This chapter uses sample programs to demonstrate how to trigger the instrument to start a new measurement cycle and how to detect the end of a measurement cycle. The trigger system is responsible for such tasks as detecting the start of a measurement cycle (triggering) and enabling/disabling measurement on each channel. For a detailed description of the trigger system and the concept of triggering, see Chapter “Making a Measurement” in *E5070B/E5071B Programmer's Guide* gives a detailed description.

You can detect the end of measurement by using either the status register or the SCPI.TRIGger.SEQuence.SINGle on page 756 object.

Using the Status Register

The status of the E5070B/E5071B can be detected through the status register. For a complete description of the status report mechanism, including the specifications of each bit of the status register, see Appendix “Status Reporting System” in *E5070B/E5071B Programmer's Guide*.

If your program is based on SPCI commands, you can use SRQ (Service Request) interrupts to detect the end of measurement. For more information, see Section “Waiting for the End of Measurement” in *E5070B/E5071B Programmer's Guide*.

On the other hand, if your program is based on COM objects, SRQ interrupts are not available; instead, you can use the following object to suspend the program until SRQs are generated upon completion of measurement.

- WaitOnSRQ on page 207

The sample program disk contains a sample program, named “meas_srq.vba”, that demonstrates how to use the status register to suspend the program until the end of measurement. This VBA program consists of the following modules:

NOTE

For information on loading VBA programs, see “Loading a VBA Program” on page 49.

Object name	Module type	Content
frmSrqMeas	UserForm	Uses the status register to wait for the end of measurement.
mdlSrqMeas	Standard module	Invokes a UserForm.

NOTE

This sample program correctly runs when the maximum number of channels/traces is set 9 channels/9 traces.

When you run this VBA program, a UserForm as shown in Figure 4-1 appears. For how to use each element in Figure 4-1, see the following description.

Figure 4-1 The UserForm when running the Example 4-1 program

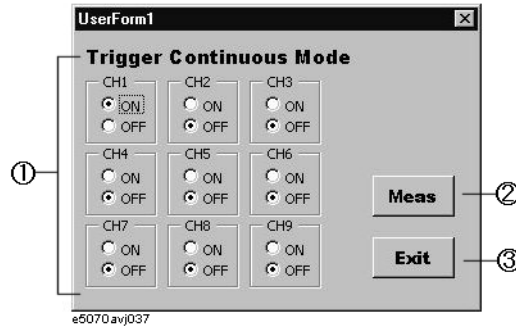

1. The program turns on Continuous Activation mode for each channel and determines whether to enable or disable each channel for measurement.
2. The program triggers the instrument to start a new measurement cycle, waits for the end of measurement, and then displays a message. For detail, see the description of the code window.
3. The program exits, and the UserForm disappears.

In Visual Basic Editor, open the UserForm (object name: frmSrqMeas), and double-click the **Meas** or **Exit** button to bring up the code window. The following is the description of the subprograms associated with the respective buttons.

Procedure called when the user clicks the **Exit** button on the UserForm (lines 10 to 50)

Line 30 Unloads the UserForm from the memory, and terminates the program.

Procedure called when the user clicks the **Meas** button on the UserForm (lines 70 to 390)

Line 110 Hides the UserForm (object name: frmSrqMeas) from the screen.

Line 130 Displays 9 channel windows.

Line 140 Sets the trigger source to "bus".

Lines 160 to 240 These lines turn on or off Continuous Activation mode for each channel depending on whether the corresponding option buttons are on or off. By default, the mode is turned on for channel 1 only.

Lines 260 to 270 These lines configure the instrument so that operation status event register's bit 4 is set to 1 only when operation status condition register's bit 4 is changed from 1 to 0 (negative transition).

Line 280 Enables the operation status event register's bit 4.

Line 290 Enables the status byte register's bit 7.

Line 300 Clears the status byte register and operation status event register.

Line 310 Triggers the instrument to start a measurement cycle.

Line 320 Verifies that the instrument is in a measurement cycle, and suspends the program until the end of measurement. The time-out is set to 100 seconds (maximum value).

Controlling the E5070B/E5071B Detecting the End of Measurement

Lines 330 to 350 These lines display a measurement completion message upon detecting the end of measurement.

Line 370 Displays the UserForm (object name :frmSrqMeas) on the screen.

Example 4-1

Using SRQs to detect the end of measurement (object name: frmSrqMeas)

```
10| Private Sub cmdExit_Click()
20|
30|     Unload Me
40|
50| End Sub
60|
70| Private Sub cmdMeas_Click()
80|
90|     Dim Cond As Boolean
100|
110|     frmSrqMeas.Hide
120|
130|     SCPI.DISPlay.Split = "d123_456_789"
140|     SCPI.TRIGger.SEQuence.Source = "bus"
150|
160|     SCPI.INITiate(1).CONTinuous = optOn1.Value
170|     SCPI.INITiate(2).CONTinuous = optOn2.Value
180|     SCPI.INITiate(3).CONTinuous = optOn3.Value
190|     SCPI.INITiate(4).CONTinuous = optOn4.Value
200|     SCPI.INITiate(5).CONTinuous = optOn5.Value
210|     SCPI.INITiate(6).CONTinuous = optOn6.Value
220|     SCPI.INITiate(7).CONTinuous = optOn7.Value
230|     SCPI.INITiate(8).CONTinuous = optOn8.Value
240|     SCPI.INITiate(9).CONTinuous = optOn9.Value
250|
260|     SCPI.STATus.OPERation.PTRansition = 0
270|     SCPI.STATus.OPERation.NTRansition = 16
280|     SCPI.STATus.OPERation.ENABLE = 16
290|     SCPI.IEEE4882.SRE = 128
300|     SCPI.IEEE4882.CLS
310|     SCPI.IEEE4882.TRG
320|     WaitOnSRQ Cond, 100000
330|     If Cond = True Then
340|         MsgBox "Measurement Completion"
350|     End If
360|
370|     frmSrqMeas.Show
380|
390| End Sub
```

Using the **SCPI.TRIGger.SEQUENCE.SINGLE** Object

When you trigger the instrument by issuing the **SCPI.TRIGger.SEQUENCE.SINGLE** on page 756 object, you can use the **SCPI.IEEE4882.OPC** on page 420 object to suspend the program until the end of measurement.

The sample program disk contains a sample program, named “meas_sing.vba”, that demonstrates how to use the **SCPI.TRIGger.SEQUENCE.SINGLE** on page 756 object to suspend the program until the end of measurement. This VBA program consists of the following modules:

Object name	Module type	Content
frmSingMeas	UserForm	Uses the SCPI.TRIGger.SEQUENCE.SINGLE and SCPI.IEEE4882.OPC objects to suspend the program until the end of measurement.
mdlSingMeas	Standard module	Invokes a UserForm.

NOTE

This sample program correctly runs when the maximum number of channels/traces is set 9 channels/9 traces.

When you run this VBA program, a window as shown in Figure 4-1 appears. For how to use each element, see Figure 4-1 in the previous section.

In Visual Basic Editor, open the UserForm (object name:frmSingMeas), and double-click the **Meas** or **Exit** button to bring up the code window. The following is the description of the subprograms associated with the respective buttons.

Procedure called when the user clicks the **Exit** button on the UserForm (lines 10 to 50)

Line 30 Unloads the UserForm from the memory, and terminates the program.

Procedure called when the user clicks the **Meas** button on the UserForm (lines 70 to 330)

Line 110 Hides the UserForm (object name: frmSingMeas) from the screen.

Line 130 Displays 9 channel windows.

Line 140 Sets the trigger source to "bus".

Lines 160 to 240 These lines turn on or off Continuous Activation mode for each channel depending on whether the corresponding option buttons are on or off. By default, the mode is turned on for channel 1 only.

Line 260 Triggers the instrument to start a measurement cycle.

Line 270 Executes the **SCPI.IEEE4882.OPC** object to suspend the program until the value of 1 is returned indicating the end of measurement.

Line 290 Displays a measurement completion message.

Line 310 Displays the UserForm (object name: frmSingMeas) on the screen.

Controlling the E5070B/E5071B Detecting the End of Measurement

Example 4-2

Using the **SCPI.TRIGger.SEQuence.SINGle** object to suspend the program until the end of measurement (object name:frmSingMeas)

```
10| Private Sub cmdExit_Click()
20|
30|     Unload Me
40|
50| End Sub
60|
70| Private Sub cmdMeas_Click()
80|
90|     Dim Dmy As Long
100|
110|     frmSingMeas.Hide
120|
130|     SCPI.DISPlay.Split = "d123_456_789"
140|     SCPI.TRIGger.SEQuence.Source = "bus"
150|
160|     SCPI.INITiate(1).CONTinuous = optOn1.Value
170|     SCPI.INITiate(2).CONTinuous = optOn2.Value
180|     SCPI.INITiate(3).CONTinuous = optOn3.Value
190|     SCPI.INITiate(4).CONTinuous = optOn4.Value
200|     SCPI.INITiate(5).CONTinuous = optOn5.Value
210|     SCPI.INITiate(6).CONTinuous = optOn6.Value
220|     SCPI.INITiate(7).CONTinuous = optOn7.Value
230|     SCPI.INITiate(8).CONTinuous = optOn8.Value
240|     SCPI.INITiate(9).CONTinuous = optOn9.Value
250|
260|     SCPI.TRIGger.SEQuence.SINGle
270|     Dmy = SCPI.IEEE4882.OPC
280|
290|     MsgBox "Measurement Completion"
300|
310|     frmSingMeas.Show
320|
330| End Sub
```

Reading/Writing Measurement Data

This section describes how to process the E5070B/E5071B's internal data. You can use these internal data arrays: corrected data arrays, corrected memory arrays, formatted data arrays, formatted memory arrays, and stimulus data arrays. For more information on the internal data arrays, see Section “Internal Data Processing” in *E5070B/E5071B Programmer's Guide*.

To read/write a formatted data array, formatted memory array, corrected data array, or corrected memory array use the following objects:

- SCPI.CALCulate(Ch).SELEcted.DATA.FDATA on page 275
- SCPI.CALCulate(Ch).SELEcted.DATA.FMEMORY on page 276
- SCPI.CALCulate(Ch).SELEcted.DATA.SDATA on page 277
- SCPI.CALCulate(Ch).SELEcted.DATA.SMEMORY on page 278

To read a c stimulus data array, use the following objects:

- SCPI.SENSE(Ch).FREQUency.DATA on page 589

The E5070B/E5071B VBA allows you to deal with multiple pieces of data through variables of Variant type. Variant variables can contain any type of data, allowing you to deal with array data without being aware of the number of elements. For example, a formatted data array that includes 5 measurement points is stored as shown in Figure 4-2. Note that a formatted data array always contains 2 data items per measurement point, whichever data format is used. For more information on contained data, see Section “Internal Data Processing” in *E5070B/E5071B Programmer's Guide*; you can find a table that describes the relationship between contained data items and data formats.

Figure 4-2

Example storing data into a Variant variable

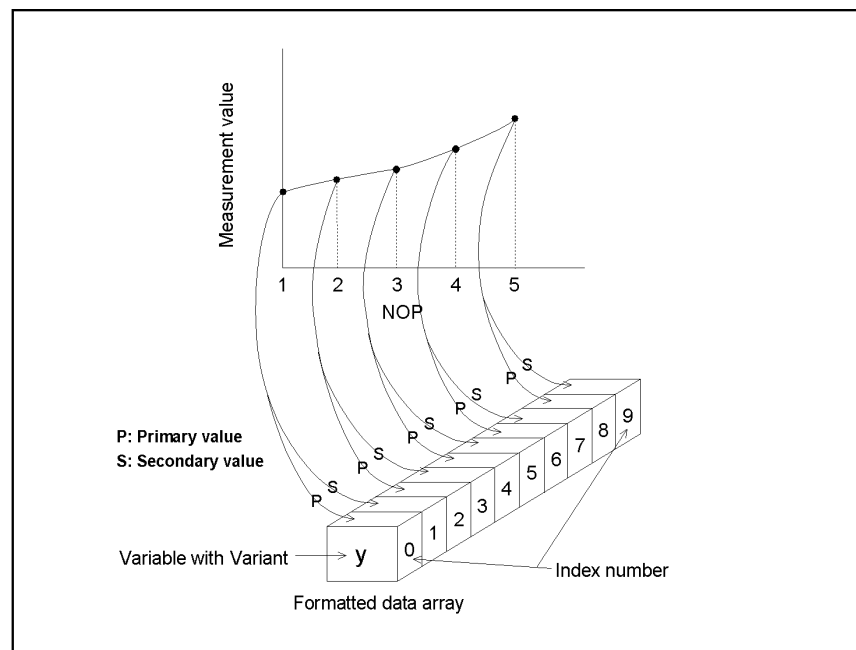

e5070ave038

NOTE

When you use one of the objects listed above, the base index number of the array is always 0 even if the declaration section contains the “Option Base 1” statement, which specifies the use of the base array index of 1.

For example, you may wish to read the formatted data array for a particular trace in its entirety (including all measurement points), display the data in the echo window, and then write the data into another trace. How to implement such a process can be better understood with the aid of a sample program.

The sample program disk contains a sample program, named “read_write.vba”, that demonstrates how to read and write measurement data. This VBA program consists of the following modules:

Object name	Module type	Content
frmReadWrite	UserForm	Reads, displays, and writes a formatted data array.
mdlReadWrite	Standard module	Invokes a UserForm.

NOTE

This sample program correctly runs when the maximum number of channels/traces is set 9 channels/9 traces.

When you run this VBA program, a window as shown in Figure 4-3 appears. For how to use each element in Figure 4-3, see the following description.

Figure 4-3

The UserForm when running the Example 4-3 program

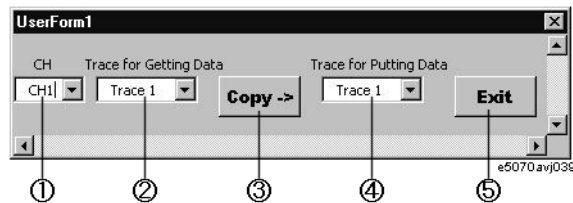

1. The program lets the user specify the channel to be controlled.
2. The program lets the user specify which trace's formatted data array to read (source trace).
3. The program reads the formatted data array for the trace specified by the user, display the measurement results in the echo window, and write the data into the trace specified by the user. For detail, see the description of the code window.
4. The program lets the user specify which trace's formatted data array to overwrite (target trace).
5. The program exits, and the window disappears.

In Visual Basic Editor, open the UserForm (object name: frmReadWrite), and double-click the entire UserForm or the **Copy ->** or **Exit** button to bring up the code window. The following is the description of the subprograms associated with the respective buttons.

Procedure called when the user clicks the **Copy** button on the UserForm (lines 10 to 520)

- Lines 90 to 160 These lines identify the selected items in each list and store them into the variables TrGet, TrPut, and ActCh.
- Lines 180 to 210 If the specified target trace is not displayed, these lines display that trace.
- Lines 230 to 250 These lines make active the specified trace (TrGet: source trace) in the specified channel(ActCh) and hold the sweep.
- Line 260 Reads the number of measurement points for the specified channel (ActCh) and stores that number into the Nop variable.
- Line 280 Reads the formatted data array for the active trace (source trace) and store the data into the FmtData variable.
- Line 290 Reads the stimulus array for the specified channel (ActCh) and stores the data into the Freq variable.
- Line 330 Reads the data format for the active trace (source trace) and store it into the Fmt variable.
- Lines 340 to 350 These lines display the echo window in the lower part of the LCD screen.
- Lines 360 to 470 The lines display, in the echo window, each point along with one measured value (the odd part of the index is always 0) and a frequency if the Fmt is "MLOG", "PHAS", "GDEL", "MLIN", "SWR", "REAL", "IMAG", or "UPH"; or along with two measured values and a frequency if Fmt\$ returns any other string.
- Line 490 Makes active the specified trace (TrPut: target trace) in the specified channel(ActCh).
- Line 500 Writes the formatted data array (FmtData) into the active trace (target trace).

Procedure called when the user clicks the **Exit** button on the UserForm (lines 540 to 580)

- Line 560 Unloads the UserForm from the memory, and terminates the program.

Procedure that initializes the UserForm (lines 600 to 1020)

- Lines 620 to 1000 When the program is launched, these lines add each list item and set the default value for each list.

Example 4-3

Reading/displaying/writing a formatted data array (read_write.frm)

```

10| Private Sub cmdCopy_Click()
20|
30|   Dim X As Integer, Y As Integer, Z As Integer, I As Integer
40|   Dim ActCh As Long, TrGet As Long, TrPut As Long
50|   Dim TrCont As Long, Nop As Long
60|   Dim FmtData As Variant, Freq As Variant
70|   Dim Fmt As String
80|
90|   X = cboCh.ListIndex

```

Controlling the E5070B/E5071B Reading/Writing Measurement Data

```
100|     ActCh = X + 1
110|
120|     Y = cboGet.ListIndex
130|     TrGet = Y + 1
140|
150|     Z = cboPut.ListIndex
160|     TrPut = Z + 1
170|
180|     TrCont = SCPI.CALCulate(ActCh).PARAMeter.Count
190|     If TrCont < TrPut Then
200|         SCPI.CALCulate(ActCh).PARAMeter.Count = TrPut
210|     End If
220|
230|     SCPI.CALCulate(ActCh).PARAMeter(TrGet).SElect
240|     SCPI.INITiate(ActCh).CONTinuous = False
250|     SCPI.ABORT
260|     Nop = SCPI.SENSE(ActCh).SWEep.POINTs
270|
280|     FmtData = SCPI.CALCulate(ActCh).SElected.Data.FDATA
290|     Freq = SCPI.SENSE(ActCh).FREQUENCY.Data
300|
310|     ''Displays the formatted data
320|
330|     Fmt = SCPI.CALCulate(ActCh).SElected.Format
340|     SCPI.DISplay.TABLE.TYPE = "ECHO"
350|     SCPI.DISplay.TABLE.STATE = True
360|     Select Case Fmt
370|         Case "MLOG", "PHAS", "GDEL", "MLIN", "SWR", "REAL",
"IMAG", "UPH"
380|             ECHO "Nop", "Frequency(GHz)", "Data"
390|             For I = 0 To Nop - 1
400|                 ECHO I + 1, Freq(I) / 1000000000#, FmtData(2 * I)
410|             Next I
420|         Case Else
430|             ECHO "Nop", "Frequency(GHz)", "Data1", "Data2"
440|             For I = 0 To Nop - 1
450|                 ECHO I + 1, Freq(I) / 1000000000#, FmtData(2 * I),
FmtData(2 * I + 1)
460|             Next I
470|         End Select
480|
490|     SCPI.CALCulate(ActCh).PARAMeter(TrPut).SElect
500|     SCPI.CALCulate(ActCh).SElected.Data.FDATA = FmtData
510|
520| End Sub
530|
540| Private Sub cmdExit_Click()
550|
560|     Unload Me
570|
580| End Sub
590|
600| Private Sub UserForm_Initialize()
610|
620|     With cboCh
630|         .AddItem "CH1"
640|         .AddItem "CH2"
650|         .AddItem "CH3"
```

```
660|         .AddItem "CH4"  
670|         .AddItem "CH5"  
680|         .AddItem "CH6"  
690|         .AddItem "CH7"  
700|         .AddItem "CH8"  
710|         .AddItem "CH9"  
720|     End With  
730|  
740|     With cboGet  
750|         .AddItem "Trace 1"  
760|         .AddItem "Trace 2"  
770|         .AddItem "Trace 3"  
780|         .AddItem "Trace 4"  
790|         .AddItem "Trace 5"  
800|         .AddItem "Trace 6"  
810|         .AddItem "Trace 7"  
820|         .AddItem "Trace 8"  
830|         .AddItem "Trace 9"  
840|     End With  
850|  
860|     With cboPut  
870|         .AddItem "Trace 1"  
880|         .AddItem "Trace 2"  
890|         .AddItem "Trace 3"  
900|         .AddItem "Trace 4"  
910|         .AddItem "Trace 5"  
920|         .AddItem "Trace 6"  
930|         .AddItem "Trace 7"  
940|         .AddItem "Trace 8"  
950|         .AddItem "Trace 9"  
960|     End With  
970|  
980|     cboCh.ListIndex = 0  
990|     cboGet.ListIndex = 0  
1000|     cboPut.ListIndex = 0  
1010|  
1020| End Sub
```

Executing a Procedure with a Softkey (User Menu Function)

The E5070B/E5071B lets you perform procedures assigned to specific softkeys (**[Macro Setup] - User Menu - Button 1/2/3/4/5/6/7/8/9/10**) without using user forms by an event that the softkey is pressed. This function is called the user menu function.

NOTE You do not have to execute any VBA program when using the user menu function.

Preparation for Using the User Menu Function

Before using the user menu function, perform the following preparation.

Coding of a Procedure Assigned to a Softkey

Follow these steps to create a procedure assigned to a specific softkey in the “UserMenu” object in the “E5070 Objects” folder.

- Step 1.** Double-click the “UserMenu” icon in the “E5070 Objects” folder to open the code window.
- Step 2.** In the object box in the code window, click **UserMenu** as shown below.

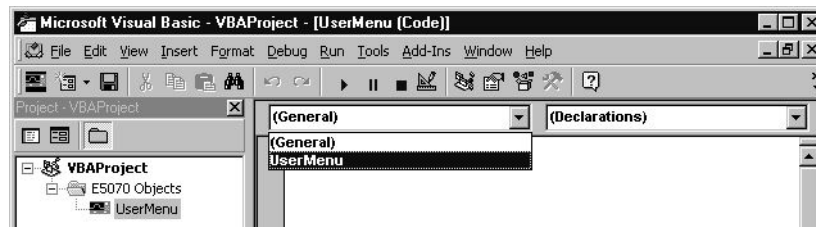

- Step 3.** In the `UserMenu_OnPress(ByVal Key_id As Long)` on page 204 procedure, create a program you want to assign to a specific softkey (specify with the *id* variable). For actual use example, see Line 70 to 430 in the Example 4-5 on page 83.

NOTE During processing an event (during execution of a procedure for a key pressed), another event (an interrupt by a procedure for another softkey pressed) cannot be accepted.

NOTE You cannot save (export) the “UserMenu” object by module basis; save it by project basis.

Settings for Softkey Label and Softkey Enabled/Disabled

When you want to change the softkey labels for the user menu function, use the following COM object. For more information on this object, see Chapter 7, “COM Object Reference.”.

- `UserMenu.Item(Key_id).Caption` on page 202

When you want to set the softkey enabled/disabled for the user menu function, use the following COM object. For more information on this object, see Chapter 7, “COM Object Reference.”.

- `UserMenu.Item(Key_id).Enabled` on page 203

Moreover, when you want to preset the above settings for the user menu function, use the following COM object. For more information on this object, see Chapter 7, “COM Object Reference.”.

- `UserMenu.PRESet` on page 204

NOTE

The above user menu setting is also preset by pressing **[Macro Setup] - Preset User Menu** on the E5070B/E5071B front panel.

How to Use the User Menu Function

To execute a procedure assigned to a softkey, you need to generate an event of pressing the softkey. To generate an event, the manual method and the COM object method are available.

Method by Manual Operation

Step 1. Click the specific softkey as follows:

- **[Macro Setup] - User Menu - Button No.**

"No." represents a button number. You can set the label for "Button No." as you like. For detail, refer to the “Settings for Softkey Label and Softkey Enabled/Disabled.” section.

Method by COM Object

You can use the following COM object to perform the same operation as pressing a specific softkey. For more information on this object, see Chapter 7, “COM Object Reference.”.

- `UserMenu.Press(Key_id)` on page 205

Simple Example

The sample program disk contains a sample program, named “meas_user.vba”, that demonstrates how to use the user menu function. This VBA program consists of the following standard module and the “UserMenu” object.

Object name	Module type	Content
mdlUserMenu	Standard module	Sets the softkey labels and enables interrupts from the softkeys.

The program (object name: mdlUserMenu) is described in detail below:

Line 70	Stores True into the State variable.
Lines 90 to 150	Sets the first to third softkey (<i>id</i> : 1 to 3) enabled, and sets the fourth to tenth softkey (<i>id</i> : 4 to 10) disabled.
Lines 170 to 190	Sets the first softkey label (<i>id</i> : 1) to “Setup” the second softkey label (<i>id</i> : 2) to “Meas” the third softkey label (<i>id</i> : 3) to “Exit”.
Line 210	Displays the buttons for the user menu function in the softkey area.
Lines 230 to 250	Processing repeated until the State variable is True (State = True).
	Line 240: Detects an event that a specific softkey is pressed and enables the interrupt from the event.

Example 4-4

Sample program using user menu (object name: mdlUserMenu)

```
10 | Public State As Boolean
20 |
30 | Sub Main()
40 |
50 |     Dim I As Long, J As Long
60 |
70 |     State = True
80 |
90 |     For I = 1 To 3
100 |         UserMenu.Item(I).Enabled = True
110 |     Next I
120 |
130 |     For J = 4 To 10
140 |         UserMenu.Item(J).Enabled = False
150 |     Next J
160 |
170 |     UserMenu.Item(1).Caption = "Setup"
180 |     UserMenu.Item(2).Caption = "Meas"
190 |     UserMenu.Item(3).Caption = "Exit"
200 |
210 |     UserMenu.Show
220 |
230 |     Do While State
240 |         DoEvents
250 |     Loop
260 |
270 | End Sub
```

The procedures of the “UserMenu” object are described below.

Lines 70 to 190 The procedure when the first softkey (*id*: 1) is pressed.

Line 90: Returns the E5070B/E5071B to the preset state.

Lines 110 to 130 For channel 1, sets the sweep start value to 1.73 GHz, the sweep stop value to 1.83 GHz, and the number of measurement points to 51.

Lines 150 to 170 After aborting the measurement, sets the trigger source to the bus trigger and turns on the continuous trigger startup mode for channel 1.

Line 190: Displays the buttons for the user menu function in the softkey area.

Lines 210 to 320 The procedure when the second softkey (*id*: 2) is pressed.

Lines 230 to 240 Generates a trigger to start a single sweep and waits until the measurement finishes (1 is read out with the **SCPI.IEEE4882.OPC** object).

Line 260: Retrieves the number of points in channel 1 and stores that number into the Nop variable.

Lines 280 to 290 Specifies trace 1 of channel 1 to the active trace, retrieves the formatted data array, and stores the data into the FmtData variable.

Lines 310 to 320 Displays the echo window in the lower part of the LCD screen.

Lines 340 to 360: Displays 2 measurement data values (primary value and secondary value) for each measurement point in the echo window.

Lines 380 to 430 The procedure when the third softkey (*id*: 3) is pressed.

Line 400: Displays a program closing message.

Line 410: Stores False into the sta variable to terminate the main program.

Example 4-5

Sample program using user menu (“UserMenu” object)

```
10| Private Sub UserMenu_OnPress(ByVal id As Long)
20|
30| Dim I As Integer
40| Dim Nop As Long, Dmy As Long
50| Dim FmtData As Variant
60|
70| If id = 1 Then
80|
90|     SCPI.SYSem.PRESet
100|
110|     SCPI.SENSE(1).FREQuency.STARt = 1730000000#
120|     SCPI.SENSE(1).FREQuency.STOP = 1830000000#
130|     SCPI.SENSE(1).SWEep.POINTs = 51
140|
150|     SCPI.ABORT
```

Controlling the E5070B/E5071B Executing a Procedure with a Softkey (User Menu Function)

```
160|         SCPI.TRIGger.SEQuence.Source = "BUS"  
170|         SCPI.INITiate(1).CONTinuous = True  
180|  
190|         UserMenu.Show  
200|  
210|     ElseIf id = 2 Then  
220|  
230|         SCPI.TRIGger.SEQuence.SINGle  
240|         Dmy = SCPI.IEEE4882.OPC  
250|  
260|         Nop = SCPI.SENSE(1).SWEep.POINTs  
270|  
280|         SCPI.CALCulate(1).PARAmeter(1).SElect  
290|         FmtData = SCPI.CALCulate(1).SElected.DATA.FDATA  
300|  
310|         SCPI.DISPlay.TABLE.TYPE = "ECHO"  
320|         SCPI.DISPlay.TABLE.State = True  
330|  
340|         For I = 1 To Nop - 1  
350|             ECHO FmtData(2 * I - 2), FmtData(2 * I - 1)  
360|         Next I  
370|  
380|     ElseIf id = 3 Then  
390|  
400|         MsgBox "Program ended!"  
410|         State = False  
420|  
430|     End If  
440|  
450| End Sub
```

Using a User Defined Variable

The E5070B/E5071B has an area that the user can set any value. These areas are divided depending on the data type. Up to ten (1 to 10) areas can be used for each command.

For example, after setting the value (data) obtained using VBA of the E5070B/E5071B to the user defined variable, the value can be obtained by using the external controller.

NOTE

Turning off the power of the instrument initializes the user defined variables, while executing preset does not initialize them.

- SCPI.PROGram.VARiable.ARRay(Vnum).DATA on page 459
- SCPI.PROGram.VARiable.ARRay(Vnum).SIZE on page 461
- SCPI.PROGram.VARiable.DOUBLE(Vnum).DATA on page 462
- SCPI.PROGram.VARiable.LONG(Vnum).DATA on page 463
- SCPI.PROGram.VARiable.STRING(Vnum).DATA on page 464

NOTE

These commands do not refer to or change the results within the E5070B/E5071B.

Controlling the E5070B/E5071B
Using a User Defined Variable

5

Controlling Peripherals

This chapter explains how to control peripherals connected to the E5070B/E5071B with GPIB by using the software (VISA library) installed in the E5070B/E5071B.

Overview

The E5070B/E5071B macro function (E5070B/E5071B VBA) can be used not only to automate measurements but also to control external measurement instruments connected via USB/GPIB interface cable by acting as a self-contained system controller (see “An Overview of a Control System Based on the Macro Function” on page 29).

The E5070B/E5071B macro function (E5070B/E5071B VBA) performs communications via the COM interface when controlling the E5070B/E5071B itself, but it communicates via VISA (Virtual Instrument Software Architecture) when controlling external measurement instruments.

To control peripherals connected to the E5070B/E5071B via USB/GPIB interface cable, the following preparation is required.

Preparation

Importing Definition Files

To use the VISA library in the E5070B/E5071B macro (E5070B/E5071B VBA), you need to import two definition files into your project with the Visual Basic editor to define the VISA functions and perform other tasks. The definition files are stored on the sample programs disk under the following filenames (for information on importing modules, refer to “Saving a Module (Exporting)” on page 47).

- visa32.bas
- vpptype.bas

Programming with VISA

Figure 5-1 shows the flow of controlling the instrument with VISA. When developing a VISA program in the Visual Basic language, a special programming notice (in the readme text file listed below) must be reviewed.

For details on the use of the VISA library and the programming notice for using the VISA library with the E5070B/E5071B macro (E5070B/E5071B VBA), refer to the following files contained on the CD-ROM (Agilent part number: E5070-905xx).

- visa.hlp (on-line help for the VISA library)
- vbreadme.txt (notes on using the VISA library with VB)

Figure 5-1

Flow of instrument control with VISA

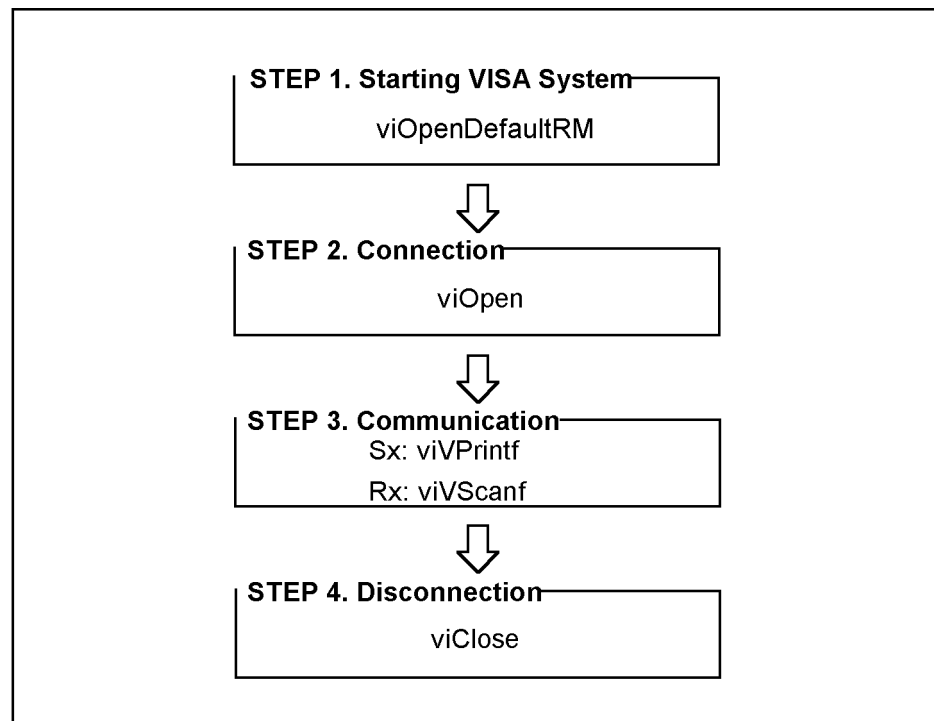

e4991ape033

STEP 1. Starting Up VISA System

The VISA system startup session is processed in Line 90 in Example 5-1. VISA's viOpenDefaultRM function initializes and starts up the VISA system. The viOpenDefaultRM function must be executed before other VISA functions are called, and the parameter of this function is startup information (Defrm in Example 5-1).

Syntax

viOpenDefaultRM(*param*)

Parameter

	<i>(param)</i>
Description	Startup information (output)
Data type	Long integer type

STEP 2. Connection

The connection session is handled in Line 130 in Example 5-1. VISA's viOpen function makes connection with the specified instrument. The viOpen function returns a value so that the VISA functions can apply it to the specified instrument. The parameters of this function are startup information (Defrm in Example 5-1), the address information of the specified instrument ("GPIB0::17::INSTR" in Example 5-1), access mode (0 in Example 5-1), timeout (0 in Example 5-1), and connection information (Equip in Example 5-1).

Syntax

viOpen(*param1,param2,param3,param4,param5*)

Parameters

	<i>(param1)</i>
Description	Startup information (input)
Data type	Long integer type

	<i>(param2)</i>
Description	Address information of the specified instrument (input)
Data type	Character string type
Syntax	GPIB[<i>board</i>] ^{*1} :: <i>primary address</i> ^{*2} ::INSTR

*1. GPIB0 for the E5070B/E5071B.

*2. The GPIB address of the instrument controlled by the E5070B/E5071B.

	<i>(param3)</i>
Description	Access mode (Enter 0)

	<i>(param4)</i>
Description	Timeout (Enter 0)

	<i>(param5)</i>
Description	Connection information (output)
Data type	Long integer type

STEP 3. Communication

The communication session is conducted in Line 170 in Example 5-1. VISA's viVPrintf function sends a program message (GPIB command) to the specified instrument. The parameters of this function are connection information (Equip in Example 5-1), the program message ("*IDN?" in Example 5-1), and the variable to be formatted (0 in Example 5-1).

NOTE

To input/output GPIB commands, the viVPrintf function and the viVScanf function are mainly used, but other VISA functions are also available. For more information, refer to visa.hlp (online help for the VISA library).

Syntax

viVPrintf(*param1,param2,param3*)

Parameters

	<i>(param1)</i>
Description	Connection information (input)
Data type	Long integer type

	<i>(param2)</i>
Description	Program message (input)*1
Data type	Character string type

*1. When sending a program message of the GPIB command, a message terminator is required at the end of the message (Chr\$(10) in Example 5-1).

	<i>(param3)</i>
Description	A variable to be formatted*1
Data type	Specified data type

*1. If not applicable, enter 0.

Controlling Peripherals Programming with VISA

The receiving session is controlled in Line 210 in Example 5-1. VISA's viVScanf function receives the result from the specified instrument and stores it in the output variable. The parameters of this function are connection information (Equip in Example 5-1), the format parameter for the output variable (%t in Example 5-1), and the output variable (Prod in Example 5-1).

Syntax

`viVScanf(param1,param2,param3)`

Parameters

	<i>(param1)</i>
Description	Connection information (input)
Data type	Long integer type

	<i>(param2)</i>
Description	Format parameter for the output variable
Data type	Character string type

	<i>(param3)</i>
Description	Output variable (output)
Data type	Character string type

STEP 4. Disconnection

The disconnection session is handled in Line 280 in Example 5-1. VISA's viClose function disconnects communication and terminates the VISA system. The parameter of this function is startup information (Defrm in Example 5-1).

Syntax

`viClose(param)`

Parameter

	<i>(param)</i>
Description	Startup information (input)
Data type	Long integer type

Example Program to Read Out the Product Information of Peripheral (Instrument)

Here is a sample program to control instruments connected through USB/GPIB interface cable using the E5070B/E5071B as the system controller. The sample program disk contains a sample program, named “ctrl_ext.vba”, that reads out the product information of external instrument connected via GPIB. This VBA program consists of the following modules.

Object name	Module type	Content
mdlVisa	Standard module	Reads out the product information of external instrument.
Module1 Module2	Standard module	Two definition files to use VISA library

NOTE

When you control peripherals from E5070B/E5071B VBA, use the GPIB commands provided for the instrument to communicate over VISA. On the other hand, when you control the E5070B/E5071B itself from E5070B/E5071B VBA, use the COM objects provided for the E5070B/E5071B to communicate.

Lines 90 to 100	Initializes and starts up the VISA system and outputs the startup information to the Defrm variable. During this process, if an error occurs, the program goes to the error handling routine (Lines 320 to 360).
Lines 130 to 140	Establishes the connection to the external instrument (GPIB address: 17) connected via GPIB and outputs the connection information to the Equip variable. During this process, if an error occurs, the program goes to the error handling routine (Lines 320 to 360).
Lines 170 to 180	Queries the product information of the external instrument connected via USB/GPIB interface cable using VISA. During this process, if an error occurs, the program goes to the error handling routine (Lines 320 to 360).
Lines 210 to 250	Retrieves the product information through VISA and outputs it into the Prod variable. Displays the read-out result in the message box. During this process, if an error occurs, the program goes to the error handling routine (Lines 320 to 360).
Line 280	Breaks the communication and terminates the VISA system.
Lines 320 to 360	If an error occurs in a VISA function, displays the detail of the error and terminates the program.

Controlling Peripherals Programming with VISA

Example 5-1

Sample program to read out the product information

```
10| Sub Main()
20|
30|     Dim status As Long           'VISA function status return
code
40|     Dim Defrm As Long           'Session to Default Resource
Manager
50|     Dim Equip As Long           'Session to instrument
60|     Dim Prod As String * 100    'String to receive the result
70|
80|     ' Initializes the VISA system.
90|     status = viOpenDefaultRM(Defrm)
100|    If (status <> VI_SUCCESS) Then GoTo VisaErrorHandler
110|
120|    ' Opens the session to the specified instrument.
130|    status = viOpen(Defrm, "GPIB0::17::INSTR", 0, 0, Equip)
140|    If (status <> VI_SUCCESS) Then GoTo VisaErrorHandler
150|
160|    ' Asks for the instrument's product information.
170|    status = viVPrintf(Equip, "*IDN?" & Chr$(10), 0)
180|    If (status <> VI_SUCCESS) Then GoTo VisaErrorHandler
190|
200|    ' Reads the result.
210|    status = viVScanf(Equip, "%t", Prod)
220|    If (status <> VI_SUCCESS) Then GoTo VisaErrorHandler
230|
240|    ' Displays the result.
250|    MsgBox Prod
260|
270|    ' Closes the resource manager session (which closes
everything)
280|    Call viClose(Defrm)
290|
300|    GoTo Prog_end
310|
320| VisaErrorHandler:
330|     Dim VisaErr As String * 200
340|     Call viStatusDesc(Defrm, status, VisaErr)
350|     MsgBox "Error : " & VisaErr, vbExclamation
360|     Exit Sub
370|
380| Prog_end:
390|
400|     End Sub
```

6 **Application Programs**

This chapter describes sample programs (VBA programs) based on actual measurement examples.

Basic Measurement (measuring a band-pass filter)

Example 6-1 shows a sample program (VBA program) that demonstrates how to perform the basic measurement of the band-pass filter. You can find the source file of this program, named “apl_bsc.vba”, on the sample program disk. This VBA program consists of the following standard module.

Object name	Module type	Content
mdlBscMeas	Standard module	Performs basic measurement of band-pass filter

Overview of the program

The sample program performs full 2-port calibration using the 85032F calibration kit, measures a band-pass filter (center frequency: 947.5 MHz), and calculates and displays its bandwidth, insertion loss, and so on. This measurement is the same as “Example of measuring a band-pass filter” in *Installation/Quick Start Guide* of the E5070B/E5071B. Therefore, for information on the flow of the measurement, the connection of the standard, and so on, refer to the description in *Installation/Quick Start Guide*.

Description of the program

When you run this VBA program, reset is performed, the measurement conditions are automatically set, and the message “Perform the full 2-port calibration” is displayed. To perform the full 2-port calibration, click the **Yes** button; to skip it, click the **No** button.

To perform the calibration, follow the onscreen messages to connect each standard of the Agilent 85032F calibration kit to the specified port and then click the **OK** button to measure the calibration data. Click the **Cancel** button to return to the beginning of the calibration. You cannot skip the isolation calibration. When the calibration data measurement for all standards is complete, the message “All calibration data completion” is displayed, and the calibration coefficient is calculated.

NOTE

When you cancel the calibration data measurement before completing the measurement of necessary calibration data, the settings condition may not be returned to its former state.

Then, the message “Connect DUT, and then press [Macro Setup]-Continue button.” is displayed in the instrument status bar in the lower part of the LCD display. Connect a DUT and perform **[Macro Setup] - Continue**. After the measurement, the search result is displayed in the echo window, as shown in Figure 6-1. If no bandwidth search target is found, only the result of the insertion loss obtained with the marker is displayed.

Figure 6-1 Example of display after executing the program in Example 6-1

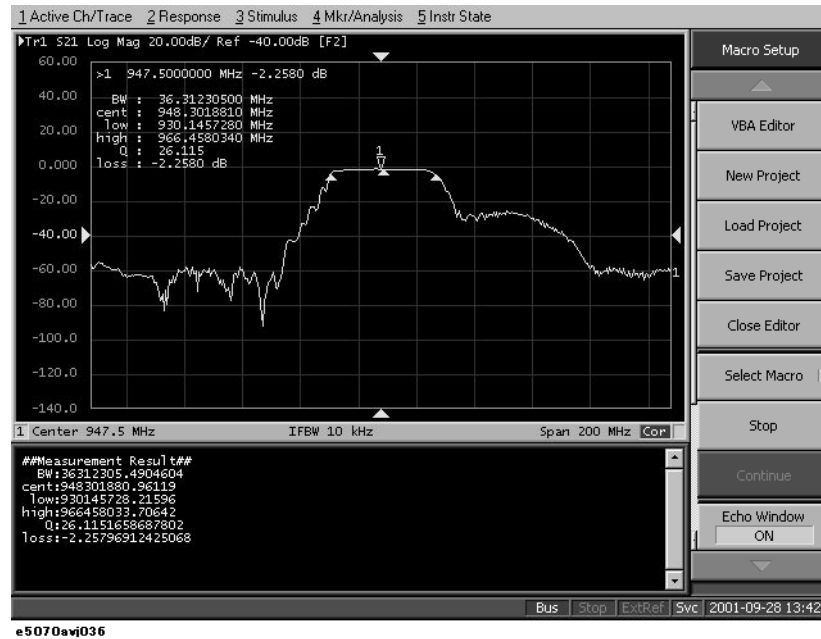

The basic measurement program (object name: mdlBscMeas) is described in detail below. Line numbers are added for description purpose only and do not appear in the actual program source code.

- Lines 120 to 160 Store the sweep center value (947.5 MHz), the sweep span value (200 MHz), the number of measurement points (401), the IF bandwidth (10 kHz), and the power level (-10 dBm) into the variables Center, Span, Nop, IfBw, and Pow, respectively.
- Lines 170 to 210 Store the number of traces (1), the measurement parameter (S21), the data format (log amplitude), the calibration kit number (4: 85032F), and the save file name (State08.sta) into the variables, NumTrac, Par, Fmt, CalKit, and File, respectively.
- Line 250 Returns the E5070B/E5071B to the preset state.
- Lines 290 to 300 For channel 1, turn on the continuous trigger startup mode to On and set the trigger source to the bus trigger.
- Lines 320 to 360 For channel 1, set the sweep center value to the Center variable, the sweep span value to the Span variable, the number of measurement points to the Nop variable, the IF bandwidth to the IfBw variable, and the power level to the Pow variable.
- Lines 380 to 410 For channel 1, set the number of traces to the NumTrac variable, the measurement parameter to the Par variable, and the data format to the Fmt variable.
- Line 450 Stores the calibration kit number for channel 1 into the CalKit variable.
- Line 460 Stores 1 and 2 into the Port variable that indicates ports used for the full 2-port calibration.
- Line 480 Calls the Calib_Solt procedure (lines 1200 to 2130). For information

Application Programs

Basic Measurement (measuring a band-pass filter)

- on the Calib_Solt procedure, see the description later.
- Lines 520 to 530 Save the instrument setting and the calibration coefficient into a file whose name is specified with the File variable.
- Line 580 Displays a message that prompts you to connect a DUT (Device Under Test) in the instrument status bar in the lower part of the LCD display and waits for the operation of **[Macro Setup] - Continue** after the connection.
- Lines 620 to 630 Generate a trigger to start a single sweep and wait until the measurement finishes (1 is read out with the **SCPI.IEEE4882.OPC** object).
- Line 650 For trace 1 of channel 1, executes auto scale to set the optimum scale.
- Lines 690 to 710 Display marker 1 and move it so that the stimulus value becomes equal to the value of the Center variable. Then, these lines read out the response value of marker 1 and store it into the MkrVal variable.
- Line 730 Enables the error handling routine starting from Bw_Err (lines 890 to 950). If a runtime error occurs, the program goes to the error handling routine.
- Lines 750 to 770 Set the bandwidth definition value to -3 dB and the bandwidth search result display to on, read out the bandwidth search result (bandwidth, center frequency, Q value, and insertion loss), and store it into the BwData variable.
- Lines 790 to 840 Based on the bandwidth search result, these lines store the bandwidth to the Bw variable, the center frequency to the Cent variable, the Q value to the Qfac variable, and the insertion loss to the Loss variable. Then, the program goes to the processing starting from Skip_Bw_Err.
- Lines 880 to 960 Define a runtime error handler. These lines read out and display the error number and error message of the error that occurred and store 0 to the Bw, Cent, and Qfac variables and the response value of marker 1 (MkrVal(0) variable) to the Loss variable. Then, the program finishes the error handling and proceeds to the next processing.
- Lines 1000 to 1010 Calculate the 2 (higher and lower) cutoff frequencies from the values in the Bw and Cent variables and store them into the CutLow and CutHigh variables.
- Lines 1030 to 1110 Display the search result (the values of the Bw, Cent, CutLow, CutHigh, Qfac, and Loss variables) in the echo window.
- Lines 1130 to 1160 Display the message asking whether you want to perform measurement again. Click the **Yes** button to return to the DUT connection section. Click the **No** button to terminate the program.
- Procedure: Calib_Solt (lines 1200 to 2130).
- Lines 1260 to 1300 Display the message that prompts for the execution of the full n-port calibration (specified with the SoltType variable). Click the **Cancel** button to cancel the calibration.
- Lines 1320 to 1410 Set the calibration type to the full n-port calibration for the port specified with the Port variable.
- Lines 1450 to 1520 Display the message that prompts for connecting the open standard to

the specified port. These lines start the measurement of the open calibration data initiated by clicking the **OK** button after the connection and wait for the completion of the measurement. Click the **Cancel** button to return to the beginning of the calibration.

Lines 1540 to 1610 Display the message that prompts for connecting the short standard to the specified port. These lines start the measurement of the short calibration data initiated by clicking the **OK** button after the connection and wait for the completion of the measurement. Click the **Cancel** button to return to the beginning of the calibration.

Lines 1630 to 1700 Display the message that prompts for connecting the load standard to the specified port. These lines start the measurement of the load calibration data initiated by clicking the **OK** button after the connection and wait for the completion of the measurement. Click the **Cancel** button to return to the beginning of the calibration.

Lines 1750 to 1840 Display the message that prompts for connecting the thru standard between the specified ports. These lines start the measurement of the thru calibration data initiated by clicking the **OK** button after the connection and wait for the completion of the measurement. Click the **Cancel** button to return to the beginning of the calibration.

Lines 1880 to 2060 When the calibration type is not the 1-port calibration (a value other than 1 is specified for the SoltType variable, displays the message asking you whether you want to measure the isolation calibration data. When the **Yes** button is clicked, displays the message that prompts for connecting the load standard to the specified two ports (specified with the Port(I-1) and Port(J-1) variables). These lines start the measurement of the isolation calibration data initiated by clicking the **OK** button after the connection and wait for the completion of the measurement. Click the **Cancel** button to return to the beginning of the calibration.

Lines 2080 to 2090 Calculate the calibration coefficients from the measured calibration data and turn on the error correction function. Then, these lines display a calibration completion message.

Example 6-1

Measuring a band-pass filter (object name: mdlBscMeas)

```

10| Sub Main()
20|
30| Dim Par As String, Fmt As String, File As String
40| Dim Center As Double, Span As Double, IfBw As Double, Pow
As Double
50| Dim Bw As Double, Cent As Double
60| Dim CutLow As Double, CutHigh As Double
70| Dim Qfac As Double, Loss As Double
80| Dim MkrVal As Variant, BwData As Variant
90| Dim Nop As Long, NumTrac As Long, CalKit As Long, Buff As
Long
100| Dim Port As Variant, Error As Variant
110|
120| Center = 947500000#           'Center freq           : 947.5 MHz
130| Span = 200000000#           'Span freq           : 200 MHz
140| Nop = 401                   'Number of points    : 401
150| IfBw = 10000#               'IF bandwidth        : 10 kHz
160| Pow = -10                   'Power level         : -10dBm

```

Application Programs

Basic Measurement (measuring a band-pass filter)

```
170| NumTrac = 1                'Number of traces      : 1
180| Par = "S21"               'Meas. parameter   : S21
190| Fmt = "MLOG"             'Data format       : Log Mag
200| CalKit = 4                'Calibration kit   : 85032F
210| File = "State08.sta"     'Saved file name   : State08.sta
220|
230| '''Presetting the E5070B/E5071B
240|
250| SCPI.SYSTem.PRESet
260|
270| '''Setting measurement conditions
280|
290| SCPI.INITiate(1).CONTinuous = True
300| SCPI.TRIGger.SEQuence.Source = "BUS"
310|
320| SCPI.SENSE(1).FREQuency.Center = Center
330| SCPI.SENSE(1).FREQuency.Span = Span
340| SCPI.SENSE(1).SWEep.POINTs = Nop
350| SCPI.SENSE(1).BANDwidth.RESolution = IfBw
360| SCPI.Source(1).POWer.LEVel.IMMEDIATE.AMPLitude = Pow
370|
380| SCPI.CALCulate(1).PARAmeter.Count = NumTrac
390| SCPI.CALCulate(1).PARAmeter(1).DEFine = Par
400| SCPI.CALCulate(1).PARAmeter(1).Select
410| SCPI.CALCulate(1).SELected.Format = Fmt
420|
430| '''Performing full 2-port calibration
440|
450| SCPI.SENSE(1).CORRection.COLLect.CKIT.Select = CalKit
460| Port = Array(1, 2)
470|
480| Calib_Solt 1, 2, Port
490|
500| '''Saving state & cal data
510|
520| SCPI.MMEMory.STORe.STYPE = "CST"
530| SCPI.MMEMory.STORe.STATe = File
540|
550| '''Connecting DUT
560|
570| Meas_Start:
580| Prompt ("Connect DUT, and then press [Macro Setup]-Continue
button.")
590|
600| '''Performing single sweep
610|
620| SCPI.TRIGger.SEQuence.SINGle
630| Dmy = SCPI.IEEE4882.OPC
640|
650| SCPI.DISPlay.WINDow(1).TRACe(1).Y.SCALE.AUTO
660|
670| '''Analyzing the results
680|
690| SCPI.CALCulate(1).SELected.MARKer(1).STATe = True
700| SCPI.CALCulate(1).SELected.MARKer(1).X = Center
710| MkrVal = SCPI.CALCulate(1).SELected.MARKer(1).Y
720|
730| On Error GoTo Bw_Err
```



```

740|
750| SCPI.CALCulate(1).SElected.MARKer(1).BWIDth.THReshold = -3
760| SCPI.CALCulate(1).SElected.MARKer(1).BWIDth.STAte = True
770| BwData = SCPI.CALCulate(1).SElected.MARKer(1).BWIDth.DATA
780|
790| Bw = BwData(0)
800| Cent = BwData(1)
810| Qfac = BwData(2)
820| Loss = BwData(3)
830|
840| GoTo Skip_Bw_Err
850|
860| Bw_Err:
870|
880| Error = SCPI.SYSTem.Error
890| MsgBox "Error No:" & Error(0) & " , Description:" & Error(
1)
900|
910| Bw = 0
920| Cent = 0
930| Qfac = 0
940| Loss = MkrVal(0)
950|
960| Resume Skip_Bw_Err
970|
980| Skip_Bw_Err:
990|
1000| CutLow = Cent - Bw / 2
1010| CutHigh = Cent + Bw / 2
1020|
1030| ECHO "##Measurement Result##"
1040| ECHO " BW:" & Bw
1050| ECHO "cent:" & Cent
1060| ECHO " low:" & CutLow
1070| ECHO "high:" & CutHigh
1080| ECHO " Q:" & Qfac
1090| ECHO "loss:" & Loss
1100| SCPI.DISPlay.TABLe.TYPE = "ECHO"
1110| SCPI.DISPlay.TABLe.STAte = True
1120|
1130| Buff = MsgBox("Do you make another measurement?", vbYesNo,
"Bandpass fileter measurement")
1140| If Buff = vbYes Then
1150|     GoTo Meas_Start
1160| End If
1170|
1180| End Sub
1190|
1200| Private Sub Calib_Solt(Chan As Long, SoltType As Long, Port
As Variant)
1210|
1220|     Dim Dmy As Long, I As Long, J As Long, Buff As Long
1230|
1240| Cal_Start:
1250|
1260| Buff = MsgBox("Perform the full " & SoltType & "-port cali
bration.", vbOKCancel, "Full" & SoltType & "-port calibration")
1270|

```

Application Programs

Basic Measurement (measuring a band-pass filter)

```
1280|     If Buff = vbCancel Then
1290|         GoTo Cal_Skip
1300|     End If
1310|
1320|     Select Case SoltType
1330|         Case 1
1340|             SCPI.SENSE(Chan).CORREction.COLLECT.METHOD.SOLT1 =
Port(0)
1350|         Case 2
1360|             SCPI.SENSE(Chan).CORREction.COLLECT.METHOD.SOLT2 =
Port
1370|         Case 3
1380|             SCPI.SENSE(Chan).CORREction.COLLECT.METHOD.SOLT3 =
Port
1390|         Case 4
1400|             SCPI.SENSE(Chan).CORREction.COLLECT.METHOD.SOLT4 =
Port
1410|     End Select
1420|
1430|     For I = 1 To SoltType
1440|
1450|         Buff = MsgBox("Connect the Open standard to Port " & CS
tr(Port(I - 1)) & ".", _
1460|             vbOKCancel, "Full" & SoltType & "-port
calibration")
1470|         If Buff = vbOK Then
1480|             SCPI.SENSE(Chan).CORREction.COLLECT.ACQUIRE.OPEN =
Port(I - 1)
1490|             Dmy = SCPI.IEEE4882.OPC
1500|         Else
1510|             GoTo Cal_Start
1520|         End If
1530|
1540|         Buff = MsgBox("Connect the Short standard to Port " &
CStr(Port(I - 1)) & ".", _
1550|             vbOKCancel, "Full" & SoltType & "-port
calibration")
1560|         If Buff = vbOK Then
1570|             SCPI.SENSE(Chan).CORREction.COLLECT.ACQUIRE.Short =
Port(I - 1)
1580|             Dmy = SCPI.IEEE4882.OPC
1590|         Else
1600|             GoTo Cal_Start
1610|         End If
1620|
1630|         Buff = MsgBox("Connect the Load standard to Port " &
CStr(Port(I - 1)) & ".", _
1640|             vbOKCancel, "Full" & SoltType & "-port
calibration")
1650|         If Buff = vbOK Then
1660|             SCPI.SENSE(Chan).CORREction.COLLECT.ACQUIRE.Load =
Port(I - 1)
1670|             Dmy = SCPI.IEEE4882.OPC
1680|         Else
1690|             GoTo Cal_Start
1700|         End If
1710|     Next I
1720|
```

```

1730|   For I = 1 To SoltType - 1
1740|       For J = I + 1 To SoltType
1750|           Buff = MsgBox("Connect the Thru standard between Por
t " & CStr(Port(I - 1)) & _
1760|               " and Port " & CStr(Port(J - 1))
& ".", vbOKCancel, "Full" & SoltType & "-port calibration")
1770|           If Buff = vbOK Then
1780|
SCPI.SENSE(Chan).CORrection.COLlect.ACquire.THru = Array(Port(I - 1
), Port(J - 1))
1790|               Dmy = SCPI.IEEE4882.OPC
1800|
SCPI.SENSE(Chan).CORrection.COLlect.ACquire.THru = Array(Port(J - 1
), Port(I - 1))
1810|               Dmy = SCPI.IEEE4882.OPC
1820|           Else
1830|               GoTo Cal_Start
1840|           End If
1850|       Next J
1860|   Next I
1870|
1880|   If SoltType <> 1 Then
1890|       Buff = MsgBox("Do you measure the Isolation (Optional
?)", vbYesNo, "Full" & SoltType & "-port calibration")
1900|       If Buff = vbYes Then
1910|           For I = 1 To SoltType - 1
1920|               For J = I + 1 To SoltType
1930|                   Buff = MsgBox("Connect the Load standard to
Port " & Port(I - 1) & " and Port " & Port(J - 1) & ".", _
1940|                       vbOKCancel, "Full" & Solt
Type & "-port calibration")
1950|                   If Buff = vbOK Then
1960|
SCPI.SENSE(Chan).CORrection.COLlect.ACquire.ISOLation = Array(Port(
I - 1), Port(J - 1))
1970|                       Dmy = SCPI.IEEE4882.OPC
1980|
SCPI.SENSE(Chan).CORrection.COLlect.ACquire.ISOLation = Array(Port(
J - 1), Port(I - 1))
1990|                       Dmy = SCPI.IEEE4882.OPC
2000|                   Else
2010|                       GoTo Cal_Start
2020|                   End If
2030|               Next J
2040|           Next I
2050|       End If
2060|   End If
2070|
2080|   SCPI.SENSE(1).CORrection.COLlect.SAVE
2090|   MsgBox "All calibration data completion."
2100|
2110| Cal_Skip:
2120|
2130| End Sub

```

Measuring a Multi-port Device

Example 6-2 shows a sample program (VBA program) that demonstrates how to measure a (3-terminal) duplexer. You can find the source file of this program, named “apl_sys.vba”, on the sample program disk. This VBA program consists of the following modules:

NOTE

For the E5070B/E5071B with Option 213 or 214 (2-port S-parameter test set), a runtime error occurs because there are parameters that it cannot measure.

Object name	Module type	Description
frmDupRes	User form	Displays the analysis result
mdlDupMeas	Standard module	Performs duplexer measurement

Overview of the program

The program performs full 3-port calibration using the 85032F calibration kit, measures a (3-terminal) duplexer, and calculates and displays the limit test result, insertion loss, and band-pass ripple. Figure 6-2 shows the simple flow of the (3-terminal) duplexer measurement program.

Figure 6-2

Flow of duplexer measurement

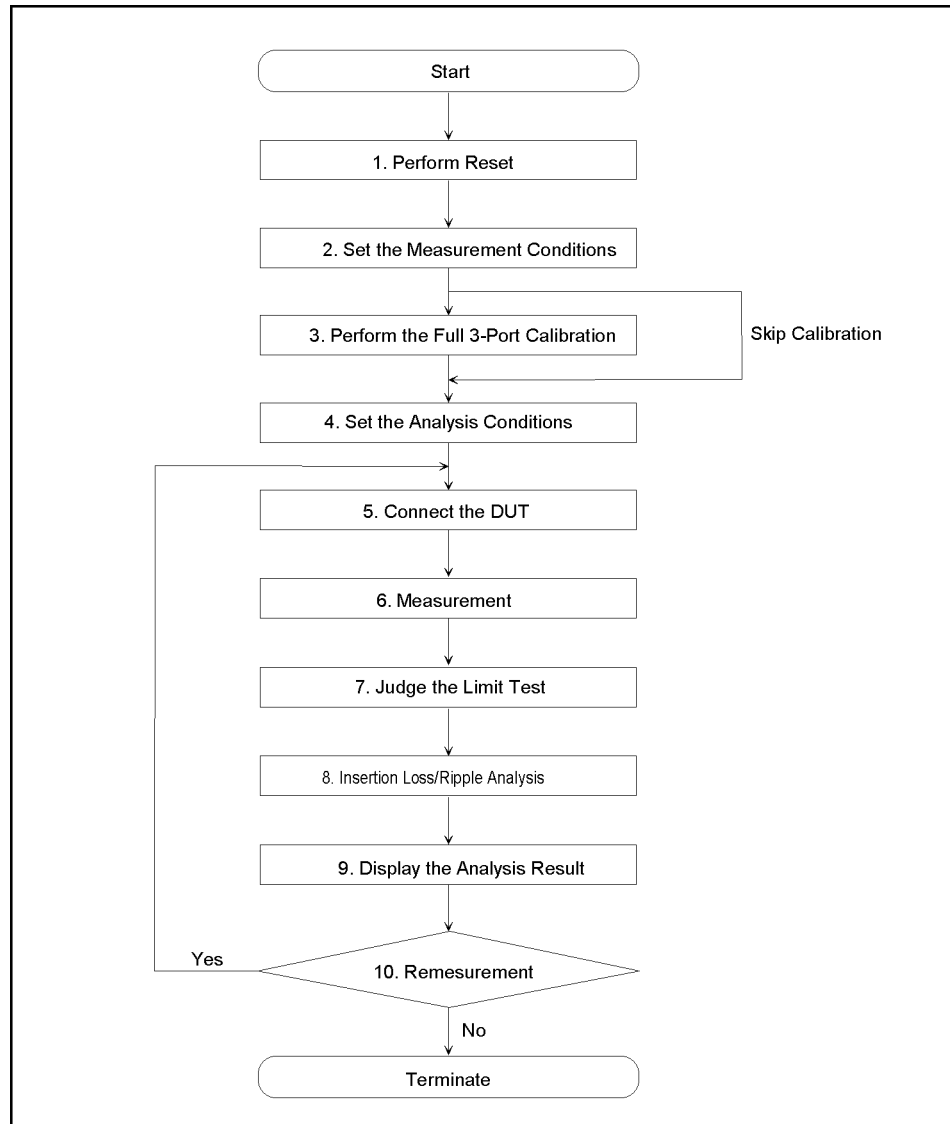

e5070ave035

Description of the program

When you run this VBA program, reset is performed, the measurement conditions are set, and the message “Perform the full 3-port calibration” is displayed. To perform the full 3-port calibration, click the **Yes** button; to skip it, click the **No** button.

To perform the calibration, follow the onscreen messages to connect each standard of the Agilent 85032F calibration kit to the specified port and then click the **OK** button to measure the calibration data. Click the **Cancel** button to return to the beginning of the calibration. You cannot skip the isolation calibration. When the calibration data measurement for all standards is complete, the message “All calibration data completion” is displayed, and the calibration coefficient is calculated.

NOTE

When you cancel the calibration data measurement before completing the measurement of necessary calibration data, the settings condition may not be returned to its former state.

Then, the limit line is set and the setting required for the limit test judgment is performed.

The message “Set the DUT between test cables.” is displayed. Connect the DUT (duplexer) between the test cables and click the **Yes** button. The limit line is set and a single sweep is executed. Then, for both trace 1 (Tx: S13) and trace 2 (Rx: S21), the Pass/Fail judgment of the limit test and the insertion loss and ripple analysis result within the pass band (Figure 6-3) are displayed.

Click the **Exit** button on the user form to display the analysis result (Figure 6-3). The message prompting for remeasurement is displayed. To perform remeasurement, click the **Yes** button; to terminate the program, click the **No** button. The details of the program within the user form for displaying the analysis result (object name: frmDupRes) are not described here.

Figure 6-3

Display of the execution result of the program of Example 6-2

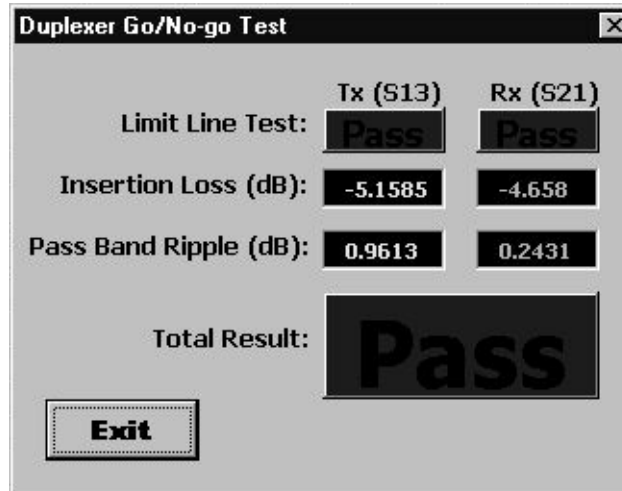

e5070avj041

The duplexer measurement program (object name: mdlDupMeas) is described in detail below. Line numbers are added for description purpose only and do not appear in the actual program source code.

- Line 90 Stores the calibration kit number (4: 85032F) into the CalKit variable.
- Line 110 Turns off display update. Turning off display update shortens drawing time and object processing time.
- Line 140 Returns the E5070B/E5071B to the preset state.
- Lines 170 to 180 For channel 1, these lines turn the continuous trigger startup mode to On and sets the trigger source to the bus trigger.
- Line 200 Calls the Setup_Parameter procedure (lines 910 to 1140). For information on the Setup_Parameter procedure, see the description later.
- Line 220 Calls the Setup_Segment procedure (lines 1160 to 1530). For information on the Setup_Segment procedure, see the description later.
- Line 250 Stores the calibration kit number for channel 1 into the CalKit variable.
- Line 260 Stores 1, 2, and 3 into the Port variable that indicates the ports used for the full 3-port calibration.
- Line 280 Calls the Calib_Solt procedure (lines 1550 to 2420). For information on the Calib_Solt procedure, see the description in Example 6-1, “Measuring a band-pass filter (object name: mdlBscMeas),” on page 99.
- Line 310 Calls the Setup_Limitline procedure (lines 2420 to 3180). For information on the Setup_Limitline procedure, see the description later.
- Line 330 Calls the Setup_Register procedure (lines 3200 to 3260). For information on the Setup_Register procedure, see the description later.
- Line 380 Displays the message that prompts for connecting a DUT (Device Under Test) and waits for the **OK** button to be clicked after the connection.
- Line 410 Clears the questionable limit status event register and questionable limit channel 1 status event register.
- Lines 420 to 430 Generate a trigger to start a single sweep and wait until the measurement finishes (1 is read out with the **SCPI.IEEE4882.OPC** object).
- Lines 450 to 460 For traces 1 and 2, these lines executes the auto scale to set the optimum scale.
- Lines 490 to 500 Read out the value of the questionable limit status event register and store the AND of the read-out value and 2 (the value in which only bit 1 is 1) into the Test_Ch1 variable.
- Lines 510 to 530 Read out the value of the questionable limit channel 1 status event register and store the AND of the read-out value and 2 (the value in which only bit 1 is 1) into the Test_Tr1 variable and the AND of the read-out value and 4 (the value in which only bit 2 is 1) into the

Application Programs

Measuring a Multi-port Device

Test_Tr2 variable.

- Lines 560 to 610 Specify trace 1 as the active trace and set the analysis range (start point: 1.85 GHz and stop point: 1.91 GHz). Then these lines sets the polarity of the peak search (both the positive peak and the negative peak) and the lower limit of the peak excursion value (0).
- Lines 620 to 640 Search for the minimum value within the analysis range and store the analysis result into the IlossTx variables.
- Line 650 Uses the ripple analysis function to store the maximum value of the response differences between the positive peaks and the negative peaks within the analysis range into the RipTx variables.
- Lines 670 to 720 Specify trace 2 as the active trace and set the analysis range (start point: 1.93 GHz and stop point: 1.99 GHz). Then these lines set the polarity of the peak search (both the positive peak and the negative peak) and the lower limit of the peak excursion value (0).
- Lines 730 to 750 Search for the minimum value within the analysis range and store the analysis result into the IlossRx variables.
- Line 760 Uses the ripple analysis function to store the maximum value of the response differences between the positive peaks and the negative peaks within the analysis range into the RipRx variables.
- Line 790 Calls the Display_Update procedure (lines 3280 to 3620). For information on the Display_Update procedure, see the description later.
- Line 810 Displays the user form (object name: frmDupRes) on the screen to display the analysis result.
- Lines 830 to 870 Display the message asking whether you want to perform measurement again. Click the **Yes** button to return to the DUT connection section. Click the **No** button to terminate the program.

Procedure: Setup_Parameter (lines 910 to 1140).

- Lines 970 to 1020 Store the channel layout (“D1”: 1-channel display), graph layout (“D1_2”: upper/lower 2 part split display), measurement parameter of trace 1 (S13), measurement parameter of trace 2 (S21), data format of trace 1 (MLOG), and data format of trace 2 (MLOG) into the ChDisp, TracDisp, Par(0), Par(1), Fmt(0), and Fmt(1) variables, respectively.
- Lines 1040 to 1060 Set the number of traces for channel 1 to 2, the channel layout to the ChDisp variable, and the graph layout for channel 1 to the TracDisp variable.
- Lines 1080 to 1120 Set the measurement parameter for trace 1 to the Par(0) variable, the data format for trace 1 to the Fmt(0) variable, the measurement parameter for trace 2 to the Par(1) variable, and the data format for trace 2 to the Fmt(1) variable.

Procedure: Setup_Segment (lines 1160 to 1530).

- Lines 1200 to 1260 Store the conditions for channel 1's segment table setting into the SegmData(0) to SegmData(6) variables. The settings are as follows. Stimulus setting mode: start/stop value. IF bandwidth setting for each segment: off. Power setting for each segment: off. Sweep delay time setting for each segment: off. Sweep time setting for each segment:

off. Number of segments: 5.

Lines 1280 to 1470 Store the sweep start value, the sweep stop value, and the number of measurement points for channel 1's segments 1 through 5 into the SegmData(7) to SegmData(21) variables, respectively.

Line 1490 Sets channel 1's segment table to the SegmData variable.

Line 1500 Sets channel 1's sweep type to "segment".

Line 1510 Sets the channel 1 graph's horizontal axis display method to the order base (the axis on which the measurement point numbers are placed evenly in the order of measurement).

Procedure: Calib_Solt (lines 1550 to 2420).

See Lines 1200 to 2130 of Example 6-1 on page 99.

Procedure: Setup_Limitline (lines 2440 to 3180).

Line 2490 Stores the number of lines (5) in trace 1 limit table into the LimDataS13(0) variable.

Lines 2500 to 2790 Store the settings in trace 1 limit table into the LimDataS13(1) to LimDataS13(25) variables.

Line 2820 Stores the number of lines (4) in trace 2 limit table into the LimDataS21(0) variable.

Lines 2830 to 3060 Store the settings in trace 2 limit table into the LimDataS21(1) to LimDataS21(20) variables.

Lines 3080 to 3110 Specify trace 1 as the active trace, store trace 1's limit line into the LimDataS13 variable, and display it. Then, these lines turn on the limit test function for trace 1.

Lines 3130 to 3160 Specify trace 2 as the active trace, store trace 2's limit line into the LimDataS21 variable, and display it. Then, these lines turn on the limit test function for trace 2.

Procedure: Setup_Register (lines 3200 to 3260).

Lines 3220 to 3230 Set the instrument so that the questionable limit channel status event register's bits 1 and 2 are set to 1 only when the questionable limit channel status register's bits 1 and 2 are changed from 0 to 1 (positive transition).

Line 3240 Enables the questionable limit channel status event register's bits 1 and 2.

Application Programs

Measuring a Multi-port Device

Procedure: Display_Update (lines 3280 to 3620).

Line 3300 Updates the display on the LCD screen once.

Lines 3320 to 3380 When trace 1's limit test result is Fail (Test_Tr1 = 2), these lines display Tx(S13) "Limit test result: Fail" on the user form (object name: frmDupRes) against a red background. On the other hand, when trace 1's limit test result is Pass (Test_Tr1 ≠ 2), they display Tx(S13) "Limit test result: Pass" on the user form (object name: frmDupRes) against a blue background.

Lines 3400 to 3460 When trace 2's limit test result is Fail (Test_Tr2 = 4), these lines display Rx(S21) "Limit test result: Fail" on the user form (object name: frmDupRes) against a red background. On the other hand, when trace 1's limit test result is Pass (Test_Tr2 ≠ 4), they display Rx(S21) "Limit test result: Pass" on the user form (object name: frmDupRes) against a blue background.

Lines 3480 to 3540 When channel 1's limit test result is Fail (Test_Ch1 = 2), these lines display "Overall limit test result: Fail" on the user form (object name: frmDupRes) against a red background. On the other hand, when channel 1's limit test result is Pass (Test_Ch1 ≠ 2), they display "Overall limit test result: Pass" on the user form (object name: frmDupRes) against a blue background.

Lines 3560 to 3600 Display the analysis results for traces 1 and 2 (insertion loss and band-pass ripple) as Tx(S13) and Rx(S21), respectively, on the user form (object name: frmDupRes).

Example 6-2

Duplexer measurement (object name: mdlDupMeas)

```
10| Sub Main()
20|
30| Dim CalKit As Long, Dmy As Long, Rgst As Long, I As Long,
Buff As Long
40| Dim Test_Ch1 As Integer, Test_Tr1 As Integer, Test_Tr2 As
Integer
50| Dim IlossTx As Variant, IlossRx As Variant
60| Dim RipTx As Double, RipRx As Double
70| Dim Port As Variant
80|
90| CalKit = 4                    'Calibration kit        :85032F
100|
110| SCPI.DISPlay.ENABLE = False
120|
130| '''Presetting the E5070B/E5071B
140| SCPI.SYSTem.PRESet
150|
160| '''Setting measurement conditions
170| SCPI.INITiate(1).CONTinuous = True
180| SCPI.TRIGger.SEQuence.Source = "BUS"
190|
200| Setup_Parameter
210|
220| Setup_Segment
230|
240| '''Full 3-port calibration
250| SCPI.SENSE(1).CORRection.COLLect.CKIT.Select = CalKit
```

```

260|   Port = Array(1, 2, 3)
270|
280|   Calib_Solt 1, 3, Port
290|
300|   '''Setting analysis conditions
310|   Setup_Limitline
320|
330|   Setup_Register
340|
350| Meas_Start:
360|
370|   '''Connecting DUT
380|   MsgBox "Connect DUT between test cables."
390|
400|   '''Performing single sweep
410|   SCPI.IEEE4882.CLS
420|   SCPI.TRIGger.SEQuence.SINGLE
430|   Dmy = SCPI.IEEE4882.OPC
440|
450|   SCPI.DISPlay.WINDow(1).TRACe(1).Y.SCALE.AUTO
460|   SCPI.DISPlay.WINDow(1).TRACe(2).Y.SCALE.AUTO
470|
480|   '''Judging limit test
490|   Rgst = SCPI.STATus.QUEStionable.LIMit.EVENT
500|   Test_Ch1 = CInt(Rgst And 2)
510|   Rgst = SCPI.STATus.QUEStionable.LIMit.CHANnel(1).EVENT
520|   Test_Tr1 = CInt(Rgst And 2)
530|   Test_Tr2 = CInt(Rgst And 4)
540|
550|   '''Analyzing insertion loss/bandpass ripple
560|   SCPI.CALCulate(1).PARAmeter(1).Select
570|   SCPI.CALCulate(1).SElected.FUNcTion.DOMain.START =
185000000#
580|   SCPI.CALCulate(1).SElected.FUNcTion.DOMain.STOP =
191000000#
590|   SCPI.CALCulate(1).SElected.FUNcTion.DOMain.STATe = True
600|   SCPI.CALCulate(1).SElected.FUNcTion.PPOLarity = "both"
610|   SCPI.CALCulate(1).SElected.FUNcTion.PEXCursion = 0
620|   SCPI.CALCulate(1).SElected.FUNcTion.TYPE = "MIN"
630|   SCPI.CALCulate(1).SElected.FUNcTion.EXECute
640|   IlossTx = SCPI.CALCulate(1).SElected.FUNcTion.DATA
650|   RipTx = MaxPeakToPeak(1)
660|
670|   SCPI.CALCulate(1).PARAmeter(2).Select
680|   SCPI.CALCulate(1).SElected.FUNcTion.DOMain.START =
193000000#
690|   SCPI.CALCulate(1).SElected.FUNcTion.DOMain.STOP =
199000000#
700|   SCPI.CALCulate(1).SElected.FUNcTion.DOMain.STATe = True
710|   SCPI.CALCulate(1).SElected.FUNcTion.PPOLarity = "both"
720|   SCPI.CALCulate(1).SElected.FUNcTion.PEXCursion = 0
730|   SCPI.CALCulate(1).SElected.FUNcTion.TYPE = "MIN"
740|   SCPI.CALCulate(1).SElected.FUNcTion.EXECute
750|   IlossRx = SCPI.CALCulate(1).SElected.FUNcTion.DATA
760|   RipRx = MaxPeakToPeak(1)
770|
780|   '''Displaying the results
790|   Display_Update Test_Tr1, Test_Tr2, Test_Ch1, IlossTx,

```

Application Programs

Measuring a Multi-port Device

```
IlossRx, RipTx, RipRx
800|
810|     frmDupRes.Show
820|
830|     Buff = MsgBox("Do you make another measurement?", vbYesNo,
"Duplexer Measurement")
840|
850|     If Buff = vbYes Then
860|         GoTo Meas_Start
870|     End If
880|
890| End Sub
900|
910| Private Sub Setup_Parameter()
920|
930|     Dim I As Long
940|     Dim ChDisp As String, TracDisp As String
950|     Dim Par(1) As String, Fmt(1) As String
960|
970|     ChDisp = "D1"
980|     TracDisp = "D1_2"
990|     Par(0) = "S13"
1000|    Par(1) = "S21"
1010|    Fmt(0) = "MLOG"
1020|    Fmt(1) = "MLOG"
1030|
1040|    SCPI.CALCulate(1).PARAMeter.Count = 2
1050|    SCPI.DISPlay.Split = ChDisp
1060|    SCPI.DISPlay.WINDOW(1).Split = TracDisp
1070|
1080|    For I = 1 To 2
1090|        SCPI.CALCulate(1).PARAMeter(I).DEFine = Par(I - 1)
1100|        SCPI.CALCulate(1).PARAMeter(I).SElect
1110|        SCPI.CALCulate(1).SElected.Format = Fmt(I - 1)
1120|    Next I
1130|
1140| End Sub
1150|
1160| Private Sub Setup_Segment()
1170|
1180|     Dim SegmData(21) As Variant
1190|
1200|     SegmData(0) = 5                'Anytime 5 is set at seg
ment settings
1210|     SegmData(1) = 0                'Allows stimulus range
to be set using Start/Stop frequency
1220|     SegmData(2) = 0                'Not allows IF bandwidth
to be set
1230|     SegmData(3) = 0                'Not allows power to be
set
1240|     SegmData(4) = 0                'Not allows delay time
to be set
1250|     SegmData(5) = 0                'Not allows sweep time
to be set
1260|     SegmData(6) = 5                'Number of segments
1270|
1280|     '''Segment 1
1290|     SegmData(7) = 1730000000#      'Start frequency
```

```

1300| SegmData(8) = 1830000000#           'Stop frequency
1310| SegmData(9) = 50                   'Number of points
1320|   ''Segment 2
1330| SegmData(10) = 1830000000#          'Start frequency
1340| SegmData(11) = 2030000000#          'Stop frequency
1350| SegmData(12) = 400                 'Number of points
1360|   ''Segment 3
1370| SegmData(13) = 2030000000#          'Start frequency
1380| SegmData(14) = 2130000000#          'Stop frequency
1390| SegmData(15) = 50                   'Number of points
1400|   ''Segment 4
1410| SegmData(16) = 3650000000#          'Start frequency
1420| SegmData(17) = 4030000000#          'Stop frequency
1430| SegmData(18) = 38                   'Number of points
1440|   ''Segment 5
1450| SegmData(19) = 5500000000#          'Start frequency
1460| SegmData(20) = 6020000000#          'Stop frequency
1470| SegmData(21) = 52                   'Number of points
1480|
1490| SCPI.SENSE(1).SEGMENT.DATA = SegmData
1500| SCPI.SENSE(1).SWEep.TYPE = "SEGM"
1510| SCPI.DISPlay.WINDow(1).X.SPACing = "OBAS"
1520|
1530| End Sub
1540|
1550| Private Sub Calib_Solt(Chan As Long, SoltType As Long, Port As
Variant)
1560|
1570|     Dim Dmy As Long, I As Long, J As Long, Buff As Long
1580|
1590| Cal_Start:
1600|
1610|     Buff = MsgBox("Perform the full " & SoltType & "-port calib
ration.", vbOKCancel, "Full" & SoltType & "-port calibration")
1620|     If Buff = vbCancel Then
1630|         GoTo Cal_Skip
1640|     End If
1650|
1660|     Select Case SoltType
1670|     Case 1
1680|         SCPI.SENSE(Chan).CORRection.COLLeCt.METHod.SOLT1 =
Port(0)
1690|     Case 2
1700|         SCPI.SENSE(Chan).CORRection.COLLeCt.METHod.SOLT2 =
Port
1710|     Case 3
1720|         SCPI.SENSE(Chan).CORRection.COLLeCt.METHod.SOLT3 =
Port
1730|     Case 4
1740|         SCPI.SENSE(Chan).CORRection.COLLeCt.METHod.SOLT4 =
Port
1750|     End Select
1760|
1770|     For I = 1 To SoltType
1780|
1790|         Buff = MsgBox("Connect the Open standard to Port " & CS
tr(Port(I - 1)) & ".", vbOKCancel, "Full" & SoltType & "-port calibr
ation")

```

Application Programs

Measuring a Multi-port Device

```
1800|         If Buff = vbOK Then
1810|             SCPI.SENSE(Chan).CORREction.COLLECT.ACQUIRE.OPEN =
Port(I - 1)
1820|             Dmy = SCPI.IEEE4882.OPC
1830|         Else
1840|             GoTo Cal_Start
1850|         End If
1860|
1870|         Buff = MsgBox("Connect the Short standard to Port " & C
Str(Port(I - 1)) & ".", vbOKCancel, "Full" & SoltType & "-port calib
ration")
1880|         If Buff = vbOK Then
1890|             SCPI.SENSE(Chan).CORREction.COLLECT.ACQUIRE.Short =
Port(I - 1)
1900|             Dmy = SCPI.IEEE4882.OPC
1910|         Else
1920|             GoTo Cal_Start
1930|         End If
1940|
1950|         Buff = MsgBox("Connect the Load standard to Port " & CS
tr(Port(I - 1)) & ".", vbOKCancel, "Full" & SoltType & "-port calibr
ation")
1960|         If Buff = vbOK Then
1970|             SCPI.SENSE(Chan).CORREction.COLLECT.ACQUIRE.Load =
Port(I - 1)
1980|             Dmy = SCPI.IEEE4882.OPC
1990|         Else
2000|             GoTo Cal_Start
2010|         End If
2020|     Next I
2030|
2040|     For I = 1 To SoltType - 1
2050|         For J = I + 1 To SoltType
2060|             Buff = MsgBox("Connect the Thru standard between Por
t " & CStr(Port(I - 1)) & " and Port " & CStr(Port(J - 1)) & ".", vb
OKCancel, "Full" & SoltType & "-port calibration")
2070|             If Buff = vbOK Then
2080|
SCPI.SENSE(Chan).CORREction.COLLECT.ACQUIRE.THURU = Array(Port(I -
1), Port(J - 1))
2090|                 Dmy = SCPI.IEEE4882.OPC
2100|
SCPI.SENSE(Chan).CORREction.COLLECT.ACQUIRE.THURU = Array(Port(J -
1), Port(I - 1))
2110|                 Dmy = SCPI.IEEE4882.OPC
2120|             Else
2130|                 GoTo Cal_Start
2140|             End If
2150|         Next J
2160|     Next I
2170|
2180|     If SoltType <> 1 Then
2190|         Buff = MsgBox("Do you measure the Isolation (Optional)?
", vbYesNo, "Full" & SoltType & "-port calibration")
2200|         If Buff = vbYes Then
2210|             For I = 1 To SoltType - 1
2220|                 For J = I + 1 To SoltType
2230|                     Buff = MsgBox("Connect the Load standard to
```

```

Port " & Port(I - 1) & " and Port " & Port(J - 1) & ". ", vbOKCancel,
"Full" & SoltType & "-port calibration")
2240|         If Buff = vbOK Then
2250|
SCPI.SENSE(Chan).CORRection.COLlect.ACquire.ISOLation = Array(Port(
I - 1), Port(J - 1))
2260|                 Dmy = SCPI.IEEE4882.OPC
2270|
SCPI.SENSE(Chan).CORRection.COLlect.ACquire.ISOLation = Array(Port(
J - 1), Port(I - 1))
2280|                 Dmy = SCPI.IEEE4882.OPC
2290|                 Else
2300|                 GoTo Cal_Start
2310|                 End If
2320|         Next J
2330|     Next I
2340| End If
2350| End If
2360|
2370|     SCPI.SENSE(1).CORRection.COLlect.SAVE
2380|     MsgBox "All calibration data completion."
2390|
2400| Cal_Skip:
2410|
2420| End Sub
2430|
2440| Private Sub Setup_Limitline()
2450|
2460|     Dim LimDataS13(25) As Variant, LimDataS21(20) As Variant
2470|
2480|     '''Limit line for S13
2490|     LimDataS13(0) = 5           'Number of segment
2500|     '''Limit_line 1
2510|     LimDataS13(1) = 1         'Maximum
2520|     LimDataS13(2) = 1730000000# 'Beginning of stimulus
2530|     LimDataS13(3) = 1930000000# 'End of stimulus
2540|     LimDataS13(4) = 0         'Beginning of response
2550|     LimDataS13(5) = 0         'End of response
2560|     '''Limit_line 2
2570|     LimDataS13(6) = 2         'Minimum
2580|     LimDataS13(7) = 1850000000# 'Beginning of stimulus
2590|     LimDataS13(8) = 1910000000# 'End of stimulus
2600|     LimDataS13(9) = -8       'Beginning of response
2610|     LimDataS13(10) = -8      'End of response
2620|     '''Limit_line 3
2630|     LimDataS13(11) = 1       'Maximum
2640|     LimDataS13(12) = 1930000000# 'Beginning of stimulus
2650|     LimDataS13(13) = 1990000000# 'End of stimulus
2660|     LimDataS13(14) = -35     'Beginning of response
2670|     LimDataS13(15) = -35     'End of response
2680|     '''Limit_line 4
2690|     LimDataS13(16) = 1       'Maximum
2700|     LimDataS13(17) = 1990000000# 'Beginning of stimulus
2710|     LimDataS13(18) = 2130000000# 'End of stimulus
2720|     LimDataS13(19) = -40     'Beginning of response
2730|     LimDataS13(20) = -40     'End of response
2740|     '''Limit_line 5
2750|     LimDataS13(21) = 1       'Maximum

```

Application Programs

Measuring a Multi-port Device

```

2760|     LimDataS13(22) = 2130000000#     'Beginning of stimulus
2770|     LimDataS13(23) = 6020000000#     'End of stimulus
2780|     LimDataS13(24) = -20             'Beginning of response
2790|     LimDataS13(25) = -20             'End of response
2800|
2810|     '''Limit line for S21
2820|     LimDataS21(0) = 4                 'Number of segment
2830|     '''Limit_line 1
2840|     LimDataS21(1) = 1                 'Maximum
2850|     LimDataS21(2) = 1730000000#     'Beginning of stimulus
2860|     LimDataS21(3) = 1850000000#     'End of stimulus
2870|     LimDataS21(4) = -40              'Beginning of response
2880|     LimDataS21(5) = -40              'End of response
2890|     '''Limit_line 2
2900|     LimDataS21(6) = 1                 'Maximum
2910|     LimDataS21(7) = 1850000000#     'Beginning of stimulus
2920|     LimDataS21(8) = 1910000000#     'End of stimulus
2930|     LimDataS21(9) = -40              'Beginning of response
2940|     LimDataS21(10) = -40             'End of response
2950|     '''Limit_line 3
2960|     LimDataS21(11) = 1                'Maximum
2970|     LimDataS21(12) = 1910000000#    'Beginning of stimulus
2980|     LimDataS21(13) = 6020000000#    'End of stimulus
2990|     LimDataS21(14) = 0                'Beginning of response
3000|     LimDataS21(15) = 0                'End of response
3010|     '''Limit_line 4
3020|     LimDataS21(16) = 2                'Minimum
3030|     LimDataS21(17) = 1930000000#    'Beginning of stimulus
3040|     LimDataS21(18) = 1990000000#    'End of stimulus
3050|     LimDataS21(19) = -10              'Beginning of response
3060|     LimDataS21(20) = -10             'End of response
3070|
3080|     SCPI.CALCulate(1).PARAMeter(1).Select
3090|     SCPI.CALCulate(1).SElected.LIMit.DATA = LimDataS13
3100|     SCPI.CALCulate(1).SElected.LIMit.DISPlay.STATE = True
3110|     SCPI.CALCulate(1).SElected.LIMit.STATE = True
3120|
3130|     SCPI.CALCulate(1).PARAMeter(2).Select
3140|     SCPI.CALCulate(1).SElected.LIMit.DATA = LimDataS21
3150|     SCPI.CALCulate(1).SElected.LIMit.DISPlay.STATE = True
3160|     SCPI.CALCulate(1).SElected.LIMit.STATE = True
3170|
3180| End Sub
3190|
3200| Private Sub Setup_Register()
3210|
3220|     SCPI.STATus.QUEStionable.LIMit.CHANnel(1).PTRansition = 6
3230|     SCPI.STATus.QUEStionable.LIMit.CHANnel(1).NTRansition = 0
3240|     SCPI.STATus.QUEStionable.LIMit.CHANnel(1).ENABLE = 6
3250|
3260| End Sub
3270|
3280| Sub Display_Update(Test_Tr1 As Integer, Test_Tr2 As Integer,
Test_Ch1 As Integer, IlossTx As Variant, IlossRx As Variant, RipTx
As Variant, RipRx As Variant)
3290|
3300|     SCPI.DISPlay.UPDate.IMMediate
3310|

```



```

3320|   If Test_Tr1 = 2 Then
3330|       frmDupRes.lblJudgeS13.BackColor = RGB(255, 0, 0)
3340|       frmDupRes.lblJudgeS13.Caption = "Fail"
3350|   Else
3360|       frmDupRes.lblJudgeS13.BackColor = RGB(0, 0, 255)
3370|       frmDupRes.lblJudgeS13.Caption = "Pass"
3380|   End If
3390|
3400|   If Test_Tr2 = 4 Then
3410|       frmDupRes.lblJudgeS21.BackColor = RGB(255, 0, 0)
3420|       frmDupRes.lblJudgeS21.Caption = "Fail"
3430|   Else
3440|       frmDupRes.lblJudgeS21.BackColor = RGB(0, 0, 255)
3450|       frmDupRes.lblJudgeS21.Caption = "Pass"
3460|   End If
3470|
3480|   If Test_Ch1 = 2 Then
3490|       frmDupRes.lblResult.BackColor = RGB(255, 0, 0)
3500|       frmDupRes.lblResult.Caption = "Fail"
3510|   Else
3520|       frmDupRes.lblResult.BackColor = RGB(0, 0, 255)
3530|       frmDupRes.lblResult.Caption = "Pass"
3540|   End If
3550|
3560|       frmDupRes.txtIlossS13.Text = Format(IlossTx(0), "0.####
3570|       ")
3580|       frmDupRes.txtIlossS21.Text = Format(IlossRx(0), "0.####
3590|       ")
3600|       frmDupRes.txtRipS13.Text = Format(RipTx, "0.####")
3610|       frmDupRes.txtRipS21.Text = Format(RipRx, "0.####")
3620| End Sub

```

Measurement Using E5091A (measuring FEM)

Example 6-3 shows front end module (FEM) measurement as a sample program of measurement using the E5091A. You can find the source file of this program, named apl_fem.vba, on the sample program disk.

NOTE If the E5070B/E5071B does not have Option 413 or 414 (4-port S parameter test set), a runtime error occurs because there are parameters that it cannot measure.

NOTE This VBA program cannot control the E5091A-016, the multiport test set.

Object name	Module type	Description
mdlFemMeas	Standard module	Performs measurement of FEM

This program calibrates each channel using the ECal module and then measures the transmission characteristics EGSM:Tx-Antenna (channel 1), EGSM:Antenna-Rx (channel 2), GSM1800:Tx-Antenna (channel 3), and GSM1800:Antenna-Rx (channel 4) of the 6-port dual-band FEM as shown in the below figure.

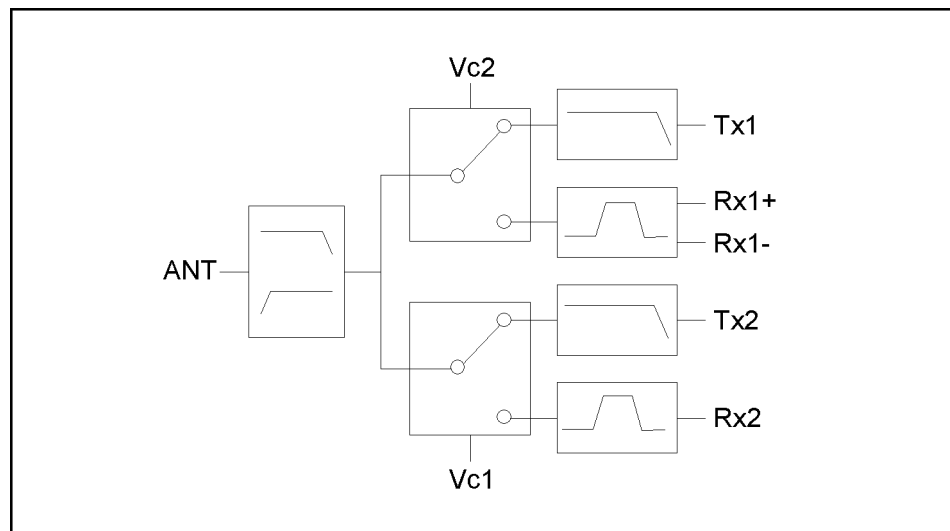

e5070bu073

When you start the program, “Connect A and T1 to ECal Module” is displayed. Connect the cables from A and T1 of the E5091A to the ECal module and then press the **OK** key to calibrate channel 1. If trouble occurs due to a problem in the connection to the ECal module, an error message is displayed. You can execute calibration again by clicking the **Retry** button. If you want to abort the program, click the **Cancel** button. For channels 2 to 4, execute the calibration in the same way.

When calibration is complete, “Set DUT” is displayed. Connect the DUT (FEM) and the E5091A as shown below and click the **OK** button to start measurement.

FEM		E5091A
Antenna		A
EGSM	Tx	T1
	Rx+	R1+
	Rx-	R1-
GSM1800	Tx	T2
	Rx	R2+
Vc1		Control Line 1
Vc2		Control Line 2

Figure 6-4 shows a sample display of the LCD screen after the program exits execution.

Figure 6-4

Example of display after execution of program in Example 6-3

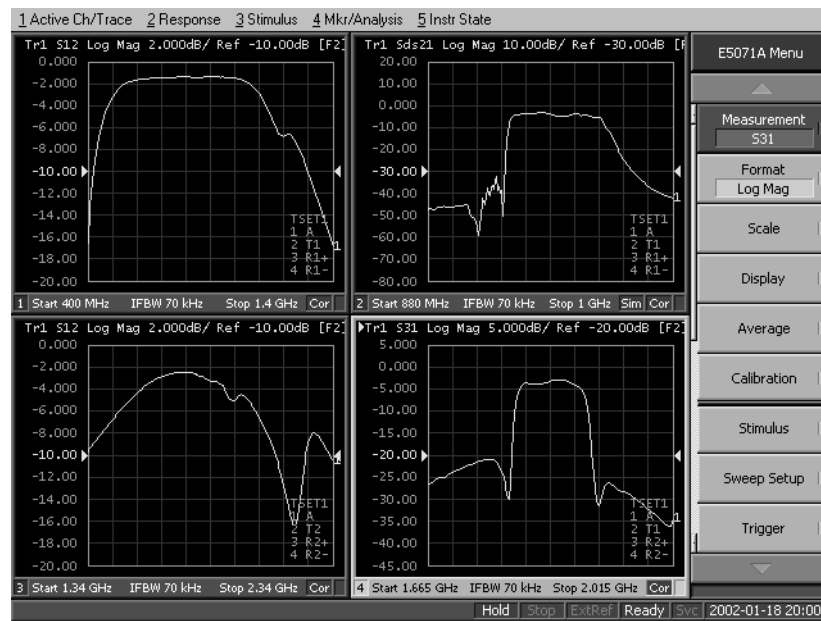

Application Programs

Measurement Using E5091A (measuring FEM)

The FEM measurement program (object name: mdlFemMeas) is described in detail below. Line numbers are added for description purpose only and do not appear in the actual program source code.

Lines 140 to 330 Set the ports assigned to Port 1 to Port 4 of the E5091A and the control line setting (table below) into the variables.

Channel number	Port 1	Port 2	Port 3	Port 4	Control Lines
1	A	T1	R1+	R1-	0 (00000000)
2	A	T1	R1+	R1-	2 (00000010)
3	A	T2	R2+	R2-	0 (00000000)
4	A	T2	R2+	R2-	1 (00000001)

Lines 340 to 660 Set the settings required for the measurement conditions in the table below to the variables.

Channel number	Sweep range		Number of points	Number of traces	Measurement parameter
	Start	Stop			
1	400 MHz	1.4 GHz	51	1	S12
2	880 MHz	1 GHz	101	1	Sds21
3	1.34 GHz	2.34 GHz	201	1	S12
4	1.665 GHz	2.015 GHz	101	1	S31

Channel number	Fixture simulator		Title
	ON/OFF	Topology	
1	OFF	—	[EGSM] Tx-Antenna
2	ON	SE:1, Bal:3,4	[EGSM] Antenna-Rx
3	OFF	—	[GSM1800] Antenna-Rx
4	OFF	—	[GSM1800] Tx-Antenna

Line 710 Puts the instrument into preset state.

Line 720 Allocates the windows to the upper left, upper right, lower left, and lower right.

Lines 740 to 1020 Repeat the following for channels 1 to 4, where Ch is the channel number.

Lines 780 to 810: For the E5091A whose ID is 1, set the port assigned to port 1 to Port1(Ch-1), the port assigned to port 2 to Port2(Ch-1), the Port assigned to port 3 to Port3(Ch-1), and the port assigned to port 4 to Port4(Ch-1).

Line 820: Sets the control line of the E5091A whose ID is 1 to Clines(Ch-1).

Lines 860 to 890: Set the sweep start value to Freq_star(Ch-1), the sweep stop value to Freq_stop(Ch-1), the number of points to Nop(Ch-1), and the number of traces to N_tr(Ch-1).

Lines 910 to 950: If the fixture simulator function is ON (Fsim(Ch-1) is True), these lines set the fixture simulator function to ON, the device type to Dev(Ch-1), the port assignment to Tpl(Ch-1), the balance-unbalance conversion to ON, and the

measurement parameter (mix mode S-parameter) to Trc(Ch-1).

Line 970: If the fixture simulator function is OFF (Fsim(i) is False), sets the measurement parameter (S-parameter) to Trc(Ch-1).

Lines 990 to 1010: Set the title label to Ttl(Ch-1), the title display to ON, and the continuous startup mode to ON.

- Line 1040 Sets the trigger source to “Bus.”
- Lines 1050 to 1060 For the E5091A whose ID is 1, set the property display to ON and the control to ON.
- Lines 1100 to 1120 Recall the Function procedure: ECal_solt (Lines 1410 to 1770) to execute the calibration of channel 1 with the ECal module (full 2-port calibration of ports A and T1). If the calibration is not completed correctly, these lines abort the program. For information on the Function procedure: ECal_solt, see the description later.
- Lines 1130 to 1210 Execute the calibration of channels 2 to 4 in the same way.
- Line 1260 Displays the message that prompts for connecting a DUT (Device Under Test) and waits for the **OK** button to be clicked after the connection.
- Lines 1280 to 1290 Generate a trigger to start a single sweep and wait until the measurement finishes (1 is read out with the **SCPI.IEEE4882.OPC** object).
- Lines 1310 to 1330 Execute auto scale for trace 1 of channels 1 to 4.
- Line 1350 Displays the message asking whether you want to perform measurement again.
- Line 1360 If the **Yes** button is clicked, returns to the DUT connection section.
- Function procedure: ECal_solt (lines 1410 to 1770).
- Line 1460 Clears the error queue.
- Lines 1460 to 1480 Display the message that prompts for connecting the Tset_Port of the E5091A to the ECal module and wait for the **OK** button to be clicked after the connection.
- Line 1500 Enables the error handling routine starting from Ecal_Err (lines 1670 to 1740). If a runtime error occurs, the program goes to the error handling routine.
- Line 1540 If solt is 1, executes the ECal command that performs 1-port calibration on port Ana_port(0) of channel Ch.
- Line 1560 If solt is 2, executes the ECal command that performs full 2-port calibration on port Ana_port of channel Ch.
- Line 1580 If solt is 3, executes the ECal command that performs full 3-port calibration on port Ana_port of channel Ch.
- Line 1600 If solt is 4, executes the ECal command that performs full 4-port calibration on port Ana_port of channel Ch.
- Line 1630 Sets the return value of ECal_solt to 0.
- Lines 1670 to 1740 Define a runtime error handler.

Application Programs

Measurement Using E5091A (measuring FEM)

Lines 780 to 810: For the E5091A whose ID is 1, these lines set the port assigned to port 1 to Port1(Ch-1), the port assigned to port 2 to Port2(Ch-1), the Port assigned to port 3 to Port3(Ch-1), and the port assigned to port 4 to Port4(Ch-1).

Line 1670: Retrieves the error number and error message from the error queue.

Line 1680: Displays the error message.

Line 1700: When the **Retry** button is clicked, the program disables the error handler routine and then returns to the connection part and repeats ECal.

Lines 1720 to 1730: When the **Cancel** button is clicked, the program sets the return value of ECal_solt to the error number and disables the error handler routine.

Example 6-3

Measurement of FEM (object name: mdlFemMeas)

```
10 Sub Main()
20
30 Dim Port1(3) As String, Port2(3) As String
40 Dim Port3(3) As String, Port4(3) As String
50 Dim Trc(3) As String, Fsim(3) As Boolean, Dev(3) As String
60 Dim Tpl(3) As Variant, Ttl(3) As String, Inp_char As String
70 Dim Freq_star(3) As Double, Freq_stop(3) As Double
80 Dim CLines(3) As Long, Nop(3) As Long, N_tr(3) As Long
90 Dim Ch As Long, Res As Long, Buff As Long, Dmy As Long
100 Dim AnaPort As Variant
110 '
120 ' E5091A Setup
130 '
140 Port1(0) = "A" ' [Ch1] Port1: A
150 Port2(0) = "T1" ' Port2: T1
160 Port3(0) = "R1" ' Port3: R1+
170 Port4(0) = "R1" ' Port4: R1-
180 CLines(0) = 0 ' Control Lines: 0
190 Port1(1) = "A" ' [Ch2] Port1: A
200 Port2(1) = "T1" ' Port2: T1
210 Port3(1) = "R1" ' Port3: R1+
220 Port4(1) = "R1" ' Port3: R1-
230 CLines(1) = 2 ' Control Lines: 2 (Line1:HIGH)
240 Port1(2) = "A" ' [Ch3] Port1: A
250 Port2(2) = "T2" ' Port2: T2
260 Port3(2) = "R2" ' Port3: R2+
270 Port4(2) = "R2" ' Port4: R2- (Dummy)
280 CLines(2) = 0 ' Control Lines: 2 (Line1:HIGH)
290 Port1(3) = "A" ' [Ch4] Port1: A
300 Port2(3) = "T2" ' Port2: T2
310 Port3(3) = "R2" ' Port3: R2+
320 Port4(3) = "R2" ' Port4: R2- (Dummy)
330 CLines(3) = 1 ' Control Lines: 1 (Line0:HIGH)
340 '
350 ' Measurement Condition
360 ' [Ch1]
370 Freq_star(0) = 400000000# ' Start frequency : 400 MHz
380 Freq_stop(0) = 1400000000# ' Stop frequency : 1.4 GHz
390 Nop(0) = 51 ' Number of points : 51
400 N_tr(0) = 1 ' Number of traces : 1
410 Fsim(0) = False ' Fixture Simulator : OFF
420 Trc(0) = "S12" ' Meas. parameter : S12
430 Ttl(0) = "[EGSM] Tx-Antenna" ' Title
```

```

440| ' [Ch2]
450| Freq_star(1) = 880000000# ' Start frequency : 880 MHz
460| Freq_stop(1) = 1000000000# ' Stop frequency : 1 GHz
470| Nop(1) = 101 ' Number of points : 101
480| N_tr(1) = 1 ' Number of traces : 1
490| Fsim(1) = True ' Fixture Simulator : ON
500| Dev(1) = "SBAL" ' Bal. Device Type : SE-Bal
510| Tpl(1) = Array(1, 3, 4) ' Topology : SE:1, Bal:3-4
520| Trc(1) = "SDS21" ' Meas. parameter : Sds21
530| Ttl(1) = "[EGSM] Antenna-Rx" ' Title
540| ' [Ch3]
550| Freq_star(2) = 1340000000# ' Start frequency : 1.34 GHz
560| Freq_stop(2) = 2340000000# ' Stop frequency : 2.34 GHz
570| Nop(2) = 201 ' Number of points : 201
580| N_tr(2) = 1 ' Number of traces : 1
590| Fsim(2) = False ' Fixture Simulator : OFF
600| Trc(2) = "S12" ' Meas. parameter : S12
610| Ttl(2) = "[GSM1800] Tx-Antenna" ' Title
620| ' [Ch4]
630| Freq_star(3) = 1665000000# ' Start frequency : 1.665 GHz
640| Freq_stop(3) = 2015000000# ' Stop frequency : 2.015 GHz
650| Nop(3) = 101 ' Number of points : 101
660| N_tr(3) = 1 ' Number of traces : 1
670| Fsim(3) = False ' Fixture Simulator : OFF
680| Trc(3) = "S31" ' Meas. parameter : S31
690| Ttl(3) = "[GSM1800] Antenna-Rx" ' Title
700|
710| SCPI.SYSTem.PRESet
720| SCPI.DISPlay.Split = "D12_34"
730|
740| For Ch = 1 To 4
750| '
760| ' E5091A Setup
770| '
780| SCPI.SENSE(Ch).MULTiplexer(1).TSET9.Port1 = Port1(Ch - 1)
790| SCPI.SENSE(Ch).MULTiplexer(1).TSET9.Port2 = Port2(Ch - 1)
800| SCPI.SENSE(Ch).MULTiplexer(1).TSET9.Port3 = Port3(Ch - 1)
810| SCPI.SENSE(Ch).MULTiplexer(1).TSET9.Port4 = Port4(Ch - 1)
820| SCPI.SENSE(Ch).MULTiplexer(1).TSET9.OUTPUT.DATA = CLines(Ch -
1)
830| '
840| ' Measurement Condition
850| '
860| SCPI.SENSE(Ch).FREQuency.STARt = Freq_star(Ch - 1)
870| SCPI.SENSE(Ch).FREQuency.STOP = Freq_stop(Ch - 1)
880| SCPI.SENSE(Ch).SWEep.POINTs = Nop(Ch - 1)
890| SCPI.CALCulate(Ch).PARAMeter.Count = N_tr(Ch - 1)
900| If Fsim(Ch - 1) = True Then
910| SCPI.CALCulate(Ch).FSIMulator.STATe = True
920| SCPI.CALCulate(Ch).FSIMulator.BALun.DEVice = Dev(Ch - 1)
930| SCPI.CALCulate(Ch).FSIMulator.BALun.TOPology.SBALanced.PPOR
ts = Tpl(Ch - 1)
940| SCPI.CALCulate(Ch).FSIMulator.BALun.PARAMeter(1).STATe = Tr
ue
950| SCPI.CALCulate(Ch).FSIMulator.BALun.PARAMeter(1).SBALanced.
DEFine = Trc(Ch - 1)
960| Else
970| SCPI.CALCulate(Ch).PARAMeter(1).DEFine = Trc(Ch - 1)
980| End If
990| SCPI.DISPlay.WINDow(Ch).TITLE.DATA = Ttl(Ch - 1)
1000| SCPI.DISPlay.WINDow(Ch).TITLE.STATe = True
1010| SCPI.INITiate(Ch).CONTinuous = True
1020| Next Ch
1030|

```

Application Programs

Measurement Using E5091A (measuring FEM)

```
1040 | SCPI.TRIGger.SEquence.Source = "BUS"
1050 | SCPI.SENSE.MULTiplexer(1).DISPlay.STATE = True
1060 | SCPI.SENSE.MULTiplexer(1).STATE = True
1070 | '
1080 | ' Calibration
1090 | '
1100 | AnaPort = Array(1, 2)
1110 | Res = ECal_Solt(1, 2, AnaPort, "A and T1")
1120 | If Res <> 0 Then GoTo Prg_end
1130 | AnaPort = Array(1, 3, 4)
1140 | Res = ECal_Solt(2, 3, AnaPort, "A, R1+ and R1-")
1150 | If Res <> 0 Then GoTo Prg_end
1160 | AnaPort = Array(1, 2)
1170 | Res = ECal_Solt(3, 2, AnaPort, "A and T2")
1180 | If Res <> 0 Then GoTo Prg_end
1190 | AnaPort = Array(1, 3)
1200 | Res = ECal_Solt(4, 2, AnaPort, "A and R2+")
1210 | If Res <> 0 Then GoTo Prg_end
1220 | '
1230 | ' Measurement
1240 | '
1250 | Meas_Start:
1260 |   MsgBox "Connect DUT.", vbOKOnly, "Measurement"
1270 |
1280 |   SCPI.TRIGger.SEquence.SINGLE
1290 |   Dmy = SCPI.IEEE4882.OPC
1300 |
1310 |   For Ch = 1 To 4
1320 |     SCPI.DISPlay.WINDow(Ch).TRACe(1).Y.SCALe.AUTO
1330 |   Next Ch
1340 |
1350 |   Buff = MsgBox("Do you make another measurement?", vbYesNo)
1360 |   If Buff = vbYes Then GoTo Meas_Start
1370 |
1380 | Prg_end:
1390 | End Sub
1400 |
1410 | Function ECal_Solt(Ch As Long, Solt As Long, AnaPort As Variant,
TsetPort As String) As Long
1420 |   Dim Err_info As Variant
1430 |   Dim Buff As Long
1440 |
1450 |   Ecal_start:
1460 |     SCPI.IEEE4882.CLS
1470 |
1480 |     MsgBox "Connect " + TsetPort + " to ECal Module."
1490 |
1500 |     On Error GoTo Ecal_err
1510 |
1520 |     Select Case Solt
1530 |       Case 1
1540 |         SCPI.SENSE(Ch).CORRection.COLLect.ECAL.SOLT1 = AnaPort(0)
1550 |       Case 2
1560 |         SCPI.SENSE(Ch).CORRection.COLLect.ECAL.SOLT2 = AnaPort
1570 |       Case 3
1580 |         SCPI.SENSE(Ch).CORRection.COLLect.ECAL.SOLT3 = AnaPort
1590 |       Case 4
1600 |         SCPI.SENSE(Ch).CORRection.COLLect.ECAL.SOLT4 = AnaPort
1610 |     End Select
1620 |
1630 |     ECal_Solt = 0
1640 |     GoTo Ecal_end
1650 |
1660 | Ecal_err:
```



```
1670| Err_info = SCPI.SYSem.Error
1680| Buff = MsgBox("Error: " + Err_info(1), vbRetryCancel)
1690| If Buff = vbRetry Then
1700|     Resume Ecal_start
1710| Else
1720|     ECal_Solt = Err_info(0)
1730|     Resume Ecal_end
1740| End If
1750|
1760| Ecal_end:
1770| End Function
```

Executing Power Calibration

Example 6-4 shows a sample program (VBA program) for executing power calibration using the E4418B power meter and the E4412A power sensor. You can find the source file of this program, named pow_cal.vba, on the sample program disk. This VBA program consists of the following modules:

Object name	Module type	Description
mdlPowCal	Standard module	Executes power calibration
Module1 Module2	Standard module	Definition files for using VISA library

Program overview

The program connects the E5070B/E5071B and the E4418B (GPIB address: 13) through the USB/GPIB interface as shown in Figure 6-5. Then, the program executes the zero adjustment and calibration of the power sensor (E4412A) connected to the power meter (E4418B) as necessary. Finally, it executes the power calibration of the E5070B/E5071B and saves the obtained power calibration data array into a file.

Figure 6-5

Connection between E5070B/E5071B and power meter

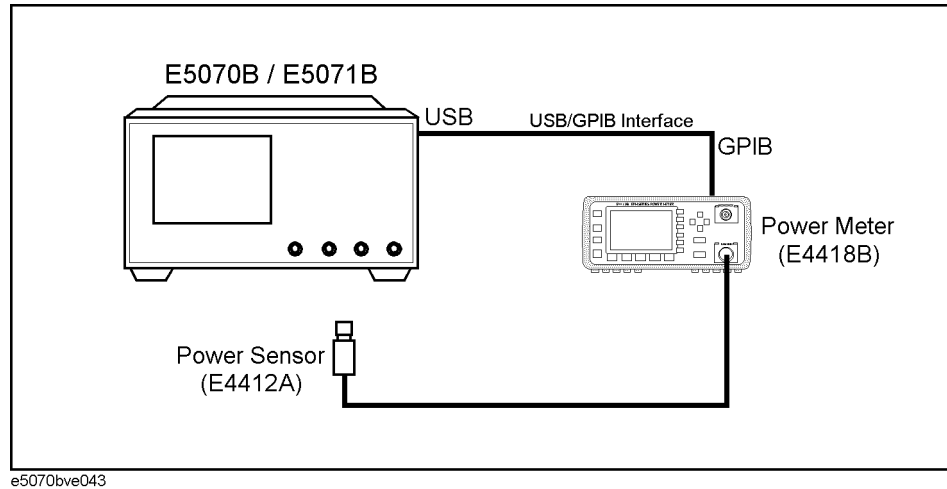

Program description

When you run this VBA program, reset is performed, the GPIB address of the power meter to be controlled and the measurement conditions of the E5070B/E5071B are set, and the message “Do you perform zeroing and calibrating the power meter on channel A?” is displayed. If you want to execute the zero adjustment and the calibration of the power sensor, click the **Yes** button; to skip them, click the **No** button.

If you want to execute the zero adjustment and calibration of the power sensor, follow the displayed messages to connect the power sensor connected to the A channel of the power meter to the POWER RF port of the power meter and click the **OK** button. When the zero adjustment and calibration of the power sensor is complete, the message “Zeroing and calibrating the power sensor is complete” is displayed.

When a message that prompts you to connect the power sensor to port 1 of the E5070B/E5071B is displayed, make the connection and then click the **OK** button. The power calibration data measurement is executed immediately and the obtained power calibration data array is saved in a file named “CORR_DATA.”

The power calibration execution program (object name: mdlPowCal) is described in detail below. Line numbers are added for description purpose only and do not appear in the actual program source code.

- Lines 100 to 150 Assign the sweep type (power sweep), the number of points (41), the power range (-20 to +12 dBm), the sweep start value (-20 dBm), the sweep stop value (-10 dBm), and the fixed frequency (1 GHz) to the Swp_type, Nop, Pow_rang, Start_p, Stop_p, and Cw_freq variables, respectively.
- Lines 160 to 170 Assign the number of power calibration data measurements for each measurement point (4) and the limit value of the power calibration data array (10 dBm) into the Num_avg and Limit variables, respectively.
- Line 200 Returns the E5070B/E5071B to the preset state.
- Line 230 Sets the power meter's GPIB address (13) in the E5070B/E5071B.
- Lines 260 to 310 For channel 1, these lines assign the sweep type to the Swp_type variable, the number of points to the Nop variable, the power range to the Pow_rang variable, the sweep start value to the Start_p variable, the sweep stop value to the Stop_p variable, and the fixed frequency to the Cw_freq variable.
- Lines 340 to 370 Display a message asking whether to execute the zero adjustment and calibration of the power sensor. If the **Yes** button is clicked, these lines call the procedure: Control_PowerMeter (Line 900 to Line 1340). For information on the Control_PowerMeter procedure, see the description later. On the other hand, if the **No** button is clicked, the program skips the zero adjustment and calibration of the power sensor.
- Lines 410 to 420 Clear the error queue. Then, these lines prompt you to connect the power sensor to port 1 of the E5070B/E5071B and wait for the **OK** button to be clicked after the connection.

Application Programs

Executing Power Calibration

- Lines 450 to 470 For port 1 of channel 1, these lines set the number of power calibration data measurements for each measurement point to the Num_avg variable and then start the measurement of the power calibration data and wait for the completion of the measurement.
- Line 500 Reads out an error that has occurred in the E5070B/E5071B during the measurement of the power calibration data and sets it in the Err variable.
- Lines 510 to 590 If no error has occurred, these lines read out the power calibration data array and set it in the Corr_data variable. In addition, the program uses the Limit_Test function to check whether the read out power calibration data array exceeds the specified limit value. If the limit value is exceeded, the return value of the Limit_Test function, False, is returned. Then, a message is displayed asking whether to perform the power calibration again. Click the **Yes** button to return to the start of the power calibration data measurement. Click the **No** button to terminate the program. For information on the Limit_Test function (Line 1360 to Line 1530), see the description later.
- Lines 610 to 660 If an error occurs, display an error message and a message asking whether to execute the power calibration again. Click the **Yes** button to return to the start of the power calibration data measurement. Click the **No** button to terminate the program.
- Lines 690 to 790 Write the read out power calibration data array into a file named "CORR_DATA." Then, these lines display a message that saving into a file has been successfully completed.
- Procedure: Control_PowerMeter (lines 900 to 1340).
- Lines 990 to 1000 Initialize and start up the VISA system and output the startup information to the Defrm variable. During this process, if an error occurs, the program goes to the error handling routine (Lines 1260 to 1300).
- Lines 1030 to 1040 Establish the connection to the power meter in use (GPIB address: 13) and output the connection information to the E4418 variable. During this process, if an error occurs, the program goes to the error handling routine (Lines 1260 to 1300).
- Lines 1070 to 1090 Return the power meter to the preset state through VISA and clear the status byte register and the standard event status register. Then, these lines enable the standard event status register's bit 0.
- Line 1100 Prompts you to connect the power sensor to the POWER REF port of the power meter and waits for the **OK** button to be clicked after the connection.
- Lines 1110 to 1120 Execute the zero adjustment and calibration of the power sensor through VISA. These lines make the setting so that 1 is set to bit 0 of the standard event status register when all pending operations are completed.

- Lines 1130 to 1190 Retrieve the value of the status byte register through VISA and set it into the Rgst variable. These lines set the AND of the read-out value and 32 (the value in which only bit 5 is 1) into the Rslt variable and display a message that the zero adjustment and calibration of the power sensor is completed when Rslt becomes 1 (when the zero adjustment and calibration of the power sensor is completed).
- Line 1220 Breaks the communication and terminates the VISA system.
- Lines 1260 to 1300 If an error occurs in a VISA function, these lines display the details of the error and terminate the program.
- Function: Limit_Test (Lines 1360 to 1530)
- Lines 1420 to 1470 If the absolute value of the read out power calibration data array exceeds the specified limit value, these lines turn off the power calibration function and return the value of False. Otherwise, the value of True is returned.

Example 6-4

Measurement of power calibration (object name: mdlPowCal)

```

10| Sub Main()
20|
30|     Dim Swp_type As String, File As String
40|     Dim Start_p As Double, Stop_p As Double, Cw_freq As Double, Limit As Double
50|     Dim Nop As Long, Pow_rang As Long, Num_avg As Long, Data_size As Long, Buff As Long, Dmy As Long
60|     Dim Corr_data As Variant, Err As Variant
70|     Dim Verifier As Boolean
80|     Dim FileNo As Integer, I As Integer
90|
100|     Swp_type = "POW"           'Sweep type           : POWER
110|     Nop = 41                  'Number of points      : 41
120|     Pow_rang = 0              'Power range           : -20 to +12
dBm
130|     Start_p = -20#           'Start power           : -20 dBm
140|     Stop_p = -10#            'Stop power            : -10 dBm
150|     Cw_freq = 1000000000#    'CW frequency          : 1 GHz
160|     Num_avg = 4              'Number of averaging   : 4
170|     Limit = 10#             'limit for corrected data : 10 dBm
180|
190|     '''Presetting the E5070/71B
200|     SCPI.SYSTem.PRESet
210|
220|     '''Setting GPIB address of the power meter to E5070/71B
230|     SCPI.SYSTem.COMMunicate.GPIB.PMETER.address = 13
240|
250|     '''Setting measurement conditions
260|     SCPI.SENSE(1).SWEep.TYPE = Swp_type
270|     SCPI.SENSE(1).SWEep.POINTs = Nop
280|     SCPI.Source(1).POWER.ATTenuation.DATA = Pow_rang
290|     SCPI.Source(1).POWER.STARt = Start_p
300|     SCPI.Source(1).POWER.STOP = Stop_p
310|     SCPI.SENSE(1).FREQuency.CW = Cw_freq
320|
330|     '''Performing a calibration in the power meter
340|     Buff = MsgBox("Do you perform zeroing and calibrating the power sensor?", vbYesNo, "Power meter calibration")
350|     If Buff = vbYes Then
360|         Control_PowerMeter
370|     End If

```

Application Programs

Executing Power Calibration

```
380|
390| Meas_Start:
400|   '''Connecting the power sensor to the port 1 in the E5070/71B
410|   SCPI.IEEE4882.CLS
420|   MsgBox "Set the power sensor connected to the port 1 in the E507
0/71B.", vbOKOnly, "Power meter calibration"
430|
440|   '''Performing power calibration measurement
450|   SCPI.Source(1).POWER.PORT(1).CORRection.COLLEct.AVERAge.count =
Num_avg
460|   SCPI.Source(1).POWER.PORT(1).CORRection.COLLEct.ACQuire = "ASEN
"
470|   Dmy = SCPI.IEEE4882.OPC
480|
490|   '''Error handling at power meter calibration
500|   Err = SCPI.SYSTem.Error
510|   If Err(0) = 0 Then
520|     Corr_data = SCPI.Source(1).POWER.PORT(1).CORRection.DATA
530|     Verifier = Limit_Test(Nop, Limit, Corr_data)
540|     If Verifier = False Then
550|       Buff = MsgBox("Do you perform the power meter calibration me
asurement again?", vbYesNo, "Power meter calibration")
560|       If Buff = vbYes Then GoTo Meas_Start
570|       If Buff = vbNo Then GoTo Prog_Stop
580|     End If
590|     MsgBox "Power meter calibration measurement is complete.", vbO
KOnly, "Power meter calibration"
600|
610|   Else
620|     MsgBox "Error: " & Err(1)
630|     Buff = MsgBox("Do you perform the power meter calibration meas
urement again?", vbYesNo, "Power meter calibration")
640|     If Buff = vbYes Then GoTo Meas_Start
650|     If Buff = vbNo Then GoTo Prog_Stop
660|   End If
670|
680|   '''Installing the corrected data to a file
690|   FileNo = FreeFile
700|   File = "CORR_DATA"
710|
720|   Open File For Output As FileNo
730|
740|   For I = 0 To Nop - 1
750|     Write #FileNo, Val(Corr_data(I))
760|   Next I
770|   Close #FileNo
780|
790|   MsgBox "Installing the corrected data to the file is DONE.", vbO
KOnly, "Power meter calibration"
800|
810|   GoTo Prog_End
820|
830| Prog_Stop:
840|   MsgBox "Program Interruption", vbOKOnly, "Power meter calibratio
n"
850|
860| Prog_End:
870|
880| End Sub
890|
900| Private Sub Control_PowerMeter()
910|
920|   Dim Status As Long           'VISA function status return
930|   Dim Defrm As Long           'Session to default resource code
```

```

940| Dim E4418 As Long           'Session to power meter
950| Dim Rslt As Integer
960| Dim Rgst As String * 10
970|
980|   ''Initializing the VISA system
990|   Status = viOpenDefaultRM(Defrm)
1000|   If (Status <> VI_SUCCESS) Then GoTo VisaErrorHandler
1010|
1020|   ''Opening the session to the power meter
1030|   Status = viOpen(Defrm, "GPIB0::13::INSTR", 0, 0, E4418)
1040|   If (Status <> VI_SUCCESS) Then GoTo VisaErrorHandler
1050|
1060|   ''Zeroing and calibrating the power meter
1070|   Status = viVPrintf(E4418, "SYST:PRES" & Chr$(10), 0)
1080|   Status = viVPrintf(E4418, "*CLS" & Chr$(10), 0)
1090|   Status = viVPrintf(E4418, "*ESE 1" & Chr$(10), 0)
1100|   MsgBox "Set the power sensor connected to the POWER REF port in
the power meter.", vbOKOnly, "Power meter calibration"
1110|   Status = viVPrintf(E4418, "CAL1:ALL" & Chr$(10), 0)
1120|   Status = viVPrintf(E4418, "*OPC" & Chr$(10), 0)
1130|   Do While Rslt = 0
1140|     Status = viVPrintf(E4418, "*STB?" & Chr$(10), 0)
1150|     Status = viVScanf(E4418, "%t", Rgst)
1160|     Rslt = CInt(CInt(Rgst) And 32)
1170|   Loop
1180|
1190|   MsgBox "Zeroing and Calibrating the power sensor is complete.",
vbOKOnly, "Power meter calibration"
1200|
1210|   ''Closing the resource manager session
1220|   Call viClose(Defrm)
1230|
1240|   GoTo Prog_End
1250|
1260| VisaErrorHandler:
1270|   Dim VisaErr As String * 200
1280|   Call viStatusDesc(Defrm, Status, VisaErr)
1290|   MsgBox "Error : " & VisaErr, vbExclamation
1300|   End
1310|
1320| Prog_End:
1330|
1340| End Sub
1350|
1360| Function Limit_Test(Nop As Long, Limit As Double, Corr_data As Var
iant) As Boolean
1370|
1380|   Dim I As Integer
1390|
1400|   For I = 0 To Nop - 1
1410|
1420|     If Abs(Corr_data(I)) > Limit Then
1430|       SCPI.Source(1).POWER.PORT(1).CORREction.STATE = False
1440|       MsgBox "The corrected data is out of limit!", vbExclamation,
"Power meter calibration"
1450|       Limit_Test = False
1460|       Exit Function
1470|     End If
1480|
1490|   Next I
1500|
1510|   Limit_Test = True
1520|
1530| End Function

```

Connecting Hard Disk of External PC (shared folder)

Example 6-5 shows a sample program (VBA program) that demonstrates how to connect a hard disk (a shared folder) of an external PC to the E5070B/E5071B. You can find the source file of this program, named “map_drive.vba”, on the sample program disk. This VBA program consists of the following modules:

Object name	Module type	Description
frmMapDrive	User form	Connects or disconnects a hard disk
Module1	Standard module	Displays frmMapDrive

Using VBA program

Step 1. Load the map_drive.vba and press [**Macro Run**]. The following macro appears.

Figure 6-6

Shared folder connection macro

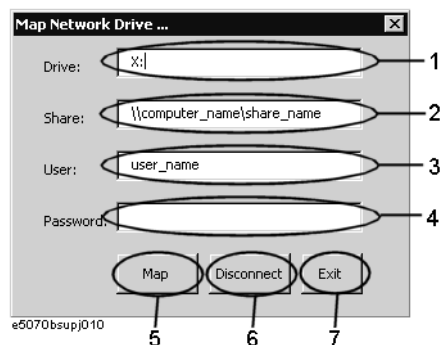

Step 2. Connecting (Mapping)

Enter the drive letter for the shared folder (1 in Figure 6-6), the share name of the shared folder (2 in Figure 6-6), the user name (3 in Figure 6-6) and the password (4 in Figure 6-6) in the external PC. Then click the **Map** button (5 in Figure 6-6).

NOTE

Consult your network administrator and enter the settings in the same way as done in the Windows 2000® PC operating system. If you enter an incorrect setting, an error occurs and the program is interrupted.

Disconnecting

Enter the drive letter for the shared folder (1 in Figure 6-6) and then click the **Disconnect** button (6 in Figure 6-6).

Step 3. Click the **Exit** button (7 in Figure 6-6) to exit from the program.

Description of operation in VBA program

The program (object name: frmMapDrive) is described in detail below:

Sub CommandButton1_Click

This procedure is called when the user clicks the **Map** button. It checks whether the drive letter is used by using the IsDriveNameInUse procedure. Then the procedure connects the shared folder using the MapDrive procedure if the drive letter is not used or otherwise displays a message to show the drive letter is used.

Sub CommandButton2_Click

This procedure is called when the user clicks the **Disconnect** button. The procedure disconnects the shared folder by using the DisconnectDrive procedure.

Function IsDriveNameInUse

This procedure checks if the txtDrive.Text (the drive letter specified by 1 in Figure 6-6) is used.

Sub MapDrive

This procedure connects the shared folder as the txtDrive.Text (the drive letter specified by 1 in Figure 6-6) drive by using the parameters: txtShare.Text (the share name specified by 2 in Figure 6-6), txtUser.Text (the user name specified by 3 in Figure 6-6), and txtPasswd.Text (the password specified by 4 in Figure 6-6).

Sub DisconnectDrive

This procedure disconnects the txtDrive.Text (the drive letter specified by 1 in Figure 6-6) drive.

Sub CommandButton3_Click

This procedure is called when the user clicks the **Exit** button. This procedure ends the program.

Example 6-5**Connecting the hard disk of an external PC (Object name: frmMapDrive)**

```
Private Sub CommandButton1_Click()  
    If Not IsDriveNameInUse Then  
        Call MapDrive  
    Else  
        MsgBox "Drive "" & txtDrive.Text & "" is Already used", vb  
Critical  
        End If  
    End Sub  
  
Private Sub CommandButton2_Click()  
    Call DisconnectDrive  
End Sub  
  
Private Function IsDriveNameInUse() As Boolean  
    Set fso = CreateObject("Scripting.FileSystemObject")  
    IsDriveNameInUse = fso.DriveExists(txtDrive.Text)  
End Function  
  
Private Sub MapDrive()  
    Set network = CreateObject("wscript.network")  
    Call network.MapNetworkDrive(txtDrive.Text, txtShare.Text, vbFal  
se, txtUser.Text, txtPasswd.Text)  
End Sub  
  
Private Sub DisconnectDrive()  
    Set network = CreateObject("wscript.network")  
    network.RemoveNetworkDrive txtDrive.Text  
End Sub  
  
Private Sub CommandButton3_Click()  
    Unload Me  
End Sub
```

7**COM Object Reference**

This chapter describes the COM object model of the Agilent E5070B/E5071B and the COM object reference in alphabetical order. If you want to look up COM objects by their function, see “COM object list by function.”

COM Object Model

The COM objects provided for the E5070B/E5071B are structured hierarchically as shown in Figure 7-1.

Figure 7-1

E5070B/E5071B COM object model

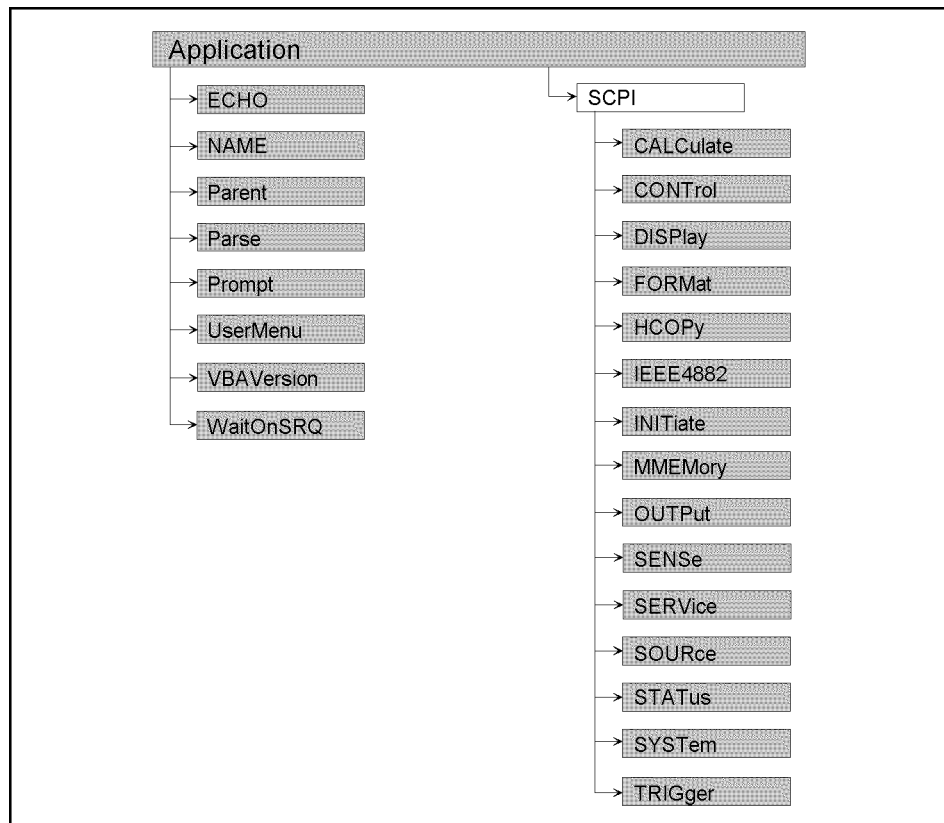

e5070bvj012

Application Objects

The Application objects are at the top of the hierarchy of the E5070B/E5071B COM object model. They consist of 7 objects dedicated to the COM interface and SCPI objects corresponding to SCPI commands. For information on the basic use of the 7 objects dedicated to the COM interface, see “Application Objects” on page 136.

SCPI Objects

The SCPI objects are created to realize the SCPI commands of the E5070B/E5071B with the COM interface. For information on the basic use of the SCPI objects, see “SCPI Objects” on page 137.

The conversion rules from the SCPI commands when writing SCPI object messages are as follows:

- SCPI. must be at the beginning. Notice that the IEEE common commands start with SCPI.IEEE4882. and "*" is omitted.
- Replace colons (:) used as the hierarchical separator symbol with dots (.).
- The number written in the object message is specified with ().
- You cannot omit the command message in the syntax.

SCPI command	COM object
OUTPUT 717;":SOUR1:POW -10"	→ SCPI.SOURce(1).POWer.LEVel.IMMediate.AMPLitude = -10
OUTPUT 717;":SENS1:CORR:COLL:METH:TYPE?" ENTER 717;A\$	→ A = SCPI.SENSE(1).CORRection.COLLection.METHod:TYPE
OUTPUT 717;":*CLS"	→ SCPI.IEEE4882.CLS

COM Object List

List by Function

Table 7-1 shows the COM object list by function.

Table 7-1 E5070B/E5071B COM objects by function

Function	Item to be set/executed			COM Object	
Measurement Conditions	Preset			SCPI.IEEE4882.RST on page 421 SCPI.SYSem.PRESet on page 743 SCPI.SYSem.UPReset on page 749	
	Selects active channel.			SCPI.DISPlay.WINDow(Ch).ACTivate on page 395	
	Checks active channel.			SCPI.SERVice.CHANnel.ACTive on page 639	
	Selects active trace.			SCPI.CALCulate(Ch).PARAmeter(Tr).SELEct on page 259	
	Checks active trace.			SCPI.SERVice.CHANnel(Ch).TRACe.ACTive on page 640	
	Number of traces			SCPI.CALCulate(Ch).PARAmeter.COUNt on page 257	
	Measurement parameter			SCPI.CALCulate(Ch).PARAmeter(Tr).DEFine on page 258	
	Data format			SCPI.CALCulate(Ch).SELEcted.FORMat on page 289	
	On/Off of the stimulus signal output			SCPI.OUTPut.STATe on page 458	
	Power level	Power level for all port		SCPI.SOURce(Ch).POWER.LEVel.IMMEDIATE. AMPLitude on page 648	
		Power level for each port		SCPI.SOURce(Ch).POWER.PORT(Pt).LEVel.IMMEDIATE. AMPLitude on page 663	
		On/Off of port coupling		SCPI.SOURce(Ch).POWER.PORT.COUPle on page 662	
	Power range			SCPI.SOURce(Ch).POWER.ATTenuation.DATA on page 644	
	Auto Power Range set function On/Off			SCPI.SOURce(Ch).POWER.ATTenuation.AUTO on page 645	
	Power slope	On/Off		SCPI.SOURce(Ch).POWER.LEVel.SLOPe.STATe on page 650	
		Coefficient		SCPI.SOURce(Ch).POWER.LEVel.SLOPe.DATA on page 649	
	Fixed frequency (CW frequency)			SCPI.SENSE(Ch).FREQuency.CW on page 588 SCPI.SENSE(Ch).FREQuency.FIXed on page 590	
	Sweep	Range	Frequency sweep	Start	SCPI.SENSE(Ch).FREQuency.STARt on page 592
				Stop	SCPI.SENSE(Ch).FREQuency.STOP on page 593
				Center	SCPI.SENSE(Ch).FREQuency.CENTer on page 587
Span				SCPI.SENSE(Ch).FREQuency.SPAN on page 591	
Power sweep			Start	SCPI.SOURce(Ch).POWER.STARt on page 665	
			Stop	SCPI.SOURce(Ch).POWER.STOP on page 666	
			Center	SCPI.SOURce(Ch).POWER.CENTer on page 647	
		Span	SCPI.SOURce(Ch).POWER.SPAN on page 664		
Number of measurement points			SCPI.SENSE(Ch).SWEep.POINts on page 635		
Time		Turns on/off the automatic setting.		SCPI.SENSE(Ch).SWEep.TIME.AUTO on page 636	
		Sets sweep time.		SCPI.SENSE(Ch).SWEep.TIME.DATA on page 637	
Delay time			SCPI.SENSE(Ch).SWEep.DELay on page 633		
Type			SCPI.SENSE(Ch).SWEep.TYPE on page 638		
sweep mode			SCPI.SENSE(Ch).SWEep.GENERation on page 634		

Table 7-1 E5070B/E5071B COM objects by function

Function	Item to be set/executed		COM Object	
Measurement Conditions (Continued)	Segment sweep	Edits the table.	SCPI.SENSE(Ch).SEGMENT.DATA on page 629	
		Reads total number of measurement points.	SCPI.SENSE(Ch).SEGMENT.SWEEP.POINTS on page 631	
		Reads total sweep time.	SCPI.SENSE(Ch).SEGMENT.SWEEP.TIME.DATA on page 631	
		Horizontal axis display type (Frequency base/Order base)	SCPI.DISPLAY.WINDOW(Ch).X.SPACING on page 410	
	IF bandwidth		SCPI.SENSE(Ch).BANDWIDTH.RESOLUTION on page 467 SCPI.SENSE(Ch).BANDWIDTH.RESOLUTION on page 468	
	Averaging	On/Off	SCPI.SENSE(Ch).AVERAGE.STATE on page 466	
		Averaging counts	SCPI.SENSE(Ch).AVERAGE.COUNT on page 465	
		Clears the counts.	SCPI.SENSE(Ch).AVERAGE.CLEAR on page 465	
	Smoothing	On/Off	SCPI.CALCULATE(Ch).SELECTED.SMOOTHING.STATE on page 354	
		Smoothing aperture	SCPI.CALCULATE(Ch).SELECTED.SMOOTHING.APERTURE on page 353	
	Absolute	Setting the measurement parameter	SCPI.CALCULATE(Ch).PARAMETER(Tr).DEFINE on page 258	
		Selecting the stimulus port	SCPI.CALCULATE(Ch).PARAMETER(Tr).SPORT on page 260	
	Setting the x-axis frequency	In case of the frequency offset is ON	SCPI.CALCULATE(Ch).SELECTED.MIXER.XAXIS on page 341	
		In case of the frequency offset is OFF	SCPI.CALCULATE(Ch).SELECTED.OFFSET.XAXIS on page 344	
	ON/OFF of the avoid spurious		SCPI.SENSE(Ch).OFFSET.ASPURIOUS on page 609	
	External signal source	On/OFF of control		SCPI.SENSE(Ch).OFFSET.LOCAL.CONTROL.STATE on page 610
		Reading out the frequency data		SCPI.SENSE(Ch).OFFSET.LOCAL.FREQUENCY.DATA on page 611
		Setting the frequency	ON/OFF of the frequency offset	SCPI.SENSE(Ch).OFFSET.LOCAL.STATE on page 620
			Multiplier	SCPI.SENSE(Ch).OFFSET.LOCAL.FREQUENCY.MULTIPLIER on page 613
			Divisor	SCPI.SENSE(Ch).OFFSET.LOCAL.FREQUENCY.DIVISOR on page 612
			Offset	SCPI.SENSE(Ch).OFFSET.PORT(Pt).FREQUENCY.OFFSET on page 624
			Start	SCPI.SENSE(Ch).OFFSET.LOCAL.FREQUENCY.START on page 615
			Stop	SCPI.SENSE(Ch).OFFSET.LOCAL.FREQUENCY.STOP on page 616
Setting the power		Power level	SCPI.SENSE(Ch).OFFSET.LOCAL.POWER.LEVEL.IMMEDIATE.AMPLITUDE on page 617	
	Power slope	SCPI.SENSE(Ch).OFFSET.LOCAL.POWER.LEVEL.SLOPE.DATA on page 618		
	ON/OFF of the power slope	SCPI.SENSE(Ch).OFFSET.LOCAL.POWER.LEVEL.SLOPE.STATE on page 619		

COM Object Reference
List by Function

Table 7-1 E5070B/E5071B COM objects by function

Function	Item to be set/executed		COM Object
Measurement Conditions (Continued)	Frequency offset	ON/OFF of the frequency offset	SCPI.SENSE(Ch).OFFSET.STATe on page 627
		Reading out the frequency data of ports	
	Setting the frequency	Multiplier	SCPI.SENSE(Ch).OFFSET.PORT(Pt).FREQUENCY.MULTIPLIER on page 623
		Divisor	SCPI.SENSE(Ch).OFFSET.PORT(Pt).FREQUENCY.DIVISOR on page 622
		Offset	SCPI.SENSE(Ch).OFFSET.PORT(Pt).FREQUENCY.OFFSET on page 624
		Start	SCPI.SENSE(Ch).OFFSET.PORT(Pt).FREQUENCY.START on page 625
		Stop	SCPI.SENSE(Ch).OFFSET.PORT(Pt).FREQUENCY.STOP on page 626

Table 7-1 E5070B/E5071B COM objects by function

Function	Item to be set/executed	COM Object	
Display	Window (Channel) allocation	SCPI.DISPlay.SPLit on page 391	
	Selects active channel.	SCPI.DISPlay.WINDow(Ch).ACTivate on page 395	
	Checks active channel.	SCPI.SERvice.CHANnel.ACTive on page 639	
	Maximizes active channel's window.	SCPI.DISPlay.MAXimize on page 389	
	Number of traces to be displayed	SCPI.CALCulate(Ch).PARAmeter.COUNT on page 257	
	Measurement parameter	SCPI.CALCulate(Ch).PARAmeter(Tr).DEFine on page 258	
	Data format	SCPI.CALCulate(Ch).SELected.FORMat on page 289	
	Graph (Trace) allocation	SCPI.DISPlay.WINDow(Ch).SPLit on page 400	
	Selects active trace.	SCPI.CALCulate(Ch).PARAmeter(Tr).SELect on page 259	
	Checks active trace.	SCPI.SERvice.CHANnel(Ch).TRACe.ACTive on page 640	
	Maximizes active trace's graph.	SCPI.DISPlay.WINDow(Ch).MAXimize on page 399	
	Turns on/off the backlight.	SCPI.SYSTem.BACKlight on page 725	
	Turns on/off the display update.	SCPI.DISPlay.ENABLE on page 386	
	Updates the display once when the update is off.	SCPI.DISPlay.UPDate.IMMEDIATE on page 395	
	Clears the display of error message.	SCPI.DISPlay.CCLear on page 377	
	Data trace	Turn on/off the display.	SCPI.DISPlay.WINDow(Ch).TRACe(Tr).STATe on page 406
		Calculated data	SCPI.CALCulate(Ch).SELected.MATH.FUNcTION on page 339
	Memory trace	Turns on/off the display.	SCPI.DISPlay.WINDow(Ch).TRACe(Tr).MEMory. STATe on page 405
		Copy the measurement data	SCPI.CALCulate(Ch).SELected.MATH.MEMorize on page 340
		Turns on/off the display of division label.	SCPI.DISPlay.WINDow(Ch).LABel on page 398
		Turns on/off the clock display.	SCPI.DISPlay.CLOCK on page 378
		Turns on/off the frequency display.	SCPI.DISPlay.ANNotation.FREQUency. STATe on page 377
		Turns on/off the display in softkey area.	SCPI.DISPlay.SKEY.STATE on page 390
	Title display	On/Off	SCPI.DISPlay.WINDow(Ch).TITLe. STATe on page 402
		Enters title label.	SCPI.DISPlay.WINDow(Ch).TITLe.DATA on page 401
	Table display	On/Off	SCPI.DISPlay.TABLe. STATe on page 393
		Selects table type.	SCPI.DISPlay.TABLe.TYPE on page 394
	ECHO Window	Outputs data.	ECHO on page 198 SCPI.DISPlay.ECHO.DATA on page 385
		Clears data.	SCPI.DISPlay.ECHO.CLEAr on page 385
		Display type (Normal/Inverted)	SCPI.DISPlay.IMAGe on page 388
	Equation Editor	On/Off	SCPI.CALCulate(Ch).SELected.EQUation. STATe on page 279
		Sets equation and equation label	SCPI.CALCulate(Ch).SELected.EQUation.TEXT on page 280
		Valid/Invalid measurement data specified by equation	SCPI.CALCulate(Ch).SELected.EQUation.VALid on page 281

COM Object Reference
List by Function

Table 7-1 E5070B/E5071B COM objects by function

Function	Item to be set/executed	COM Object		
Display (Continued)	Display color	Data trace	SCPI.DISPlay.COLOr(Dnum).TRACe(Tr).DATA on page 383	
		Memory trace	SCPI.DISPlay.COLOr(Dnum).TRACe(Tr).MEMoRY on page 384	
		Graph	SCPI.DISPlay.COLOr(Dnum).GRATicule(Gnum) on page 380	
		Limit test	SCPI.DISPlay.COLOr(Dnum).LIMit(Lnum) on page 381	
		Background	SCPI.DISPlay.COLOr(Dnum).BACK on page 379	
		Reset	SCPI.DISPlay.COLOr(Dnum).RESet on page 382	
	Horizontal axis display type at segment sweep (Frequency base/Order base)		SCPI.DISPlay.WINDow(Ch).X.SPACing on page 410	
	Electrical delay time		SCPI.CALCulate(Ch).SELEcted.CORRection.EDElay. TIME on page 272	
	Velocity factor		SCPI.SENSE(Ch).CORRection.RVELOCITY.COAX on page 582	
	Phase offset		SCPI.CALCulate(Ch).SELEcted.CORRection.OFFSet. PHASE on page 274	
	Scale	Executes auto scale.		SCPI.DISPlay.WINDow(Ch).TRACe(Tr).Y.SCALE.AUTO on page 406
		Number of division		SCPI.DISPlay.WINDow(Ch).Y.SCALE.DIVisions on page 411
		Scale value per division		SCPI.DISPlay.WINDow(Ch).TRACe(Tr).Y.SCALE. PDIVision on page 407
		Reference scale line's position		SCPI.DISPlay.WINDow(Ch).TRACe(Tr).Y.SCALE. RPOStion on page 409
		Reference scale line's value		SCPI.DISPlay.WINDow(Ch).TRACe(Tr).Y.SCALE.RLEVel on page 408
Full scale value (data format: smith chart/polar chart)		SCPI.DISPlay.WINDow(Ch).TRACe(Tr).Y.SCALE. PDIVision on page 407		
Calibration	On/Off		SCPI.SENSE(Ch).CORRection.STATe on page 583	
	Selects calibration kit.		SCPI.SENSE(Ch).CORRection.COLLEct.CKIT.SELEct on page 500	
	Selects calibration type.	Response calibration (Open)		SCPI.SENSE(Ch).CORRection.COLLEct.METHod. RESPonSe.OPEN on page 536
		Response calibration (Short)		SCPI.SENSE(Ch).CORRection.COLLEct.METHod. RESPonSe.SHORT on page 536
		Response calibration (Thru)		SCPI.SENSE(Ch).CORRection.COLLEct.METHod. RESPonSe.THRU on page 537
		1-port calibration		SCPI.SENSE(Ch).CORRection.COLLEct.METHod. SOLT1 on page 537
		Full 2-port calibration		SCPI.SENSE(Ch).CORRection.COLLEct.METHod. SOLT2 on page 538
		Full 3-port calibration		SCPI.SENSE(Ch).CORRection.COLLEct.METHod. SOLT3 on page 539
		Full 4-port calibration		SCPI.SENSE(Ch).CORRection.COLLEct.METHod. SOLT4 on page 540
		Enhanced response calibration		SCPI.SENSE(Ch).CORRection.COLLEct.METHod.ERESponse on page 535
		Specified 2-port TRL calibration		SCPI.SENSE(Ch).CORRection.COLLEct.METHod.TRL2 on page 541
		Specified 3-port TRL calibration		SCPI.SENSE(Ch).CORRection.COLLEct.METHod.TRL3 on page 542
	Specified 4-port TRL calibration		SCPI.SENSE(Ch).CORRection.COLLEct.METHod.TRL4 on page 543	
	Reads the calibration type.		SCPI.SENSE(Ch).CORRection.COLLEct.METHod.TYPE on page 544	

Table 7-1 E5070B/E5071B COM objects by function

Function	Item to be set/executed	COM Object	
Calibration (Continued)	Reads calibration type applied for specified trace.	SCPI.SENSE(Ch).CORRection.TYPE(Tr) on page 585	
	Turns on/off the display of calibration property.	SCPI.SENSE(Ch).CORRection.PROPErty on page 579	
	Setting the subclass of the standard for the calibration	SCPI.SENSE(Ch).CORRection.COLLEct.ACQure.SUBClass on page 483	
	Measuring the THRU standard of the calibration kit	SCPI.SENSE(Ch).CORRection.COLLEct.ACQure.TRLThru on page 487	
	Selecting the standard used for the specified two ports	SCPI.SENSE(Ch).CORRection.COLLEct.CKIT.ORDER.TRLThru(Cpt_m,Cpt_n) on page 499	
	Executing the reflection measurement of the TRL calibration for the selected calibration kit.	SCPI.SENSE(Ch).CORRection.COLLEct.ACQure.TRLReflect on page 486	
	Selecting the standard for the measurement	SCPI.SENSE(Ch).CORRection.COLLEct.CKIT.ORDER.TRLReflect on page 498	
	Executing the line measurement of the TRL calibration for the selected calibration kit.	SCPI.SENSE(Ch).CORRection.COLLEct.ACQure.TRLReflect on page 486	
	Selecting the standard used for the specified two ports	SCPI.SENSE(Ch).CORRection.COLLEct.CKIT.ORDER.TRLLine(Cpt_m,Cpt_n) on page 497	
	Setting the multiple calibration kit	SCPI.SENSE(Ch).CORRection.COLLEct.CKIT.ORDER.SELect on page 493	
	Selecting the reference impedance for the TRL calibration	SCPI.SENSE(Ch).CORRection.COLLEct.CKIT.TRLOption.IMPedance on page 519	
	Selecting the measurement data to calculate the reference plane for the calibration	SCPI.SENSE(Ch).CORRection.COLLEct.CKIT.TRLOption.RPLane on page 520	
	Measures calibration data.	Open standard	SCPI.SENSE(Ch).CORRection.COLLEct.ACQure.OPEN on page 482
		Short standard	SCPI.SENSE(Ch).CORRection.COLLEct.ACQure.SHORt on page 482
		Load standard	SCPI.SENSE(Ch).CORRection.COLLEct.ACQure.LOAD on page 481
		Thru standard	SCPI.SENSE(Ch).CORRection.COLLEct.ACQure.THRU on page 484
		Isolation	SCPI.SENSE(Ch).CORRection.COLLEct.ACQure.ISOLation on page 480
	Calculates calibration coefficient	SCPI.SENSE(Ch).CORRection.COLLEct.SAVE on page 546	
	Clearing the calibration data (measured values of standards)	SCPI.SENSE(Ch).CORRection.COLLEct.CLEar on page 521	
	Clearing the calibration coefficients	SCPI.SENSE(Ch).CORRection.CLEar on page 469	
Selects trigger source at calibration	SCPI.SENSE(Ch).CORRection.TRIGger.FREE.STATe on page 584		

COM Object Reference
List by Function

Table 7-1 E5070B/E5071B COM objects by function

Function	Item to be set/executed		COM Object	
Calibration (Continued)	Defines calibrati on kit.	Reset	SCPI.SENSE(Ch).CORRection.COLLEct.CKIT.RESet on page 500	
		Calibration kit label		SCPI.SENSE(Ch).CORRection.COLLEct.CKIT.LABel on page 489
	Defines standards.	Label	SCPI.SENSE(Ch).CORRection.COLLEct.CKIT.STAN(Std).LABel on page 515	
		Standard type	SCPI.SENSE(Ch).CORRection.COLLEct.CKIT.STAN(Std).TYPE on page 517	
		C0	SCPI.SENSE(Ch).CORRection.COLLEct.CKIT.STAN(Std).C0 on page 503	
		C1	SCPI.SENSE(Ch).CORRection.COLLEct.CKIT.STAN(Std).C1 on page 504	
		C2	SCPI.SENSE(Ch).CORRection.COLLEct.CKIT.STAN(Std).C2 on page 505	
		C3	SCPI.SENSE(Ch).CORRection.COLLEct.CKIT.STAN(Std).C3 on page 506	
		L0	SCPI.SENSE(Ch).CORRection.COLLEct.CKIT.STAN(Std).L0 on page 511	
		L1	SCPI.SENSE(Ch).CORRection.COLLEct.CKIT.STAN(Std).L1 on page 512	
		L2	SCPI.SENSE(Ch).CORRection.COLLEct.CKIT.STAN(Std).L2 on page 513	
		L3	SCPI.SENSE(Ch).CORRection.COLLEct.CKIT.STAN(Std).L3 on page 514	
		Offset delay	SCPI.SENSE(Ch).CORRection.COLLEct.CKIT.STAN(Std).DELay on page 508	
		Offset loss	SCPI.SENSE(Ch).CORRection.COLLEct.CKIT.STAN(Std).LOSS on page 516	
		Offset Z0	SCPI.SENSE(Ch).CORRection.COLLEct.CKIT.STAN(Std).Z0 on page 518	
	Arbitrary impedance	SCPI.SENSE(Ch).CORRection.COLLEct.CKIT.STAN(Std).ARBITrary on page 502		
	Defines calibrati on kit.	Specifies calibration class.	Open	SCPI.SENSE(Ch).CORRection.COLLEct.CKIT.ORDer.OPEN(Cpt) on page 492
			Short	SCPI.SENSE(Ch).CORRection.COLLEct.CKIT.ORDer.SHORT(Cpt) on page 494
			Load	SCPI.SENSE(Ch).CORRection.COLLEct.CKIT.ORDer.LOAD(Cpt) on page 490
			Thru	SCPI.SENSE(Ch).CORRection.COLLEct.CKIT.ORDer.THRU(Cpt_m,Cpt_n) on page 495

Table 7-1 E5070B/E5071B COM objects by function

Function	Item to be set/executed	COM Object	
Calibration (Continued)	ECAL	Executes 1-port calibration.	SCPI.SENSE(Ch).CORRection.COLLECT.ECAL.SOLT1 on page 527
		Executes 2-port calibration.	SCPI.SENSE(Ch).CORRection.COLLECT.ECAL.SOLT2 on page 528
		Executes 3-port calibration.	SCPI.SENSE(Ch).CORRection.COLLECT.ECAL.SOLT3 on page 529
		Executes 4-port calibration.	SCPI.SENSE(Ch).CORRection.COLLECT.ECAL.SOLT4 on page 530
		Executes response calibration (Thru).	SCPI.SENSE(Ch).CORRection.COLLECT.ECAL.THRU on page 531
		Executes enhanced response calibration.	SCPI.SENSE(Ch).CORRection.COLLECT.ECAL.ERESponse on page 523
		Turns On/Off the Isolation measurement.	SCPI.SENSE(Ch).CORRection.COLLECT.ECAL.ISOLation.STATe on page 524
		Selects the characterization (factory/user1-5).	SCPI.SENSE(Ch).CORRection.COLLECT.ECAL.UCHar on page 532
		Executes the confidence check of the applied calibration coefficients.	SCPI.SENSE(Ch).CORRection.COLLECT.ECAL.UCHar on page 532
		Port connection	SCPI.SENSE(Ch).CORRection.COLLECT.ECAL.PATH(Cpt) on page 526
		ON/OFF the auto-detect function	SCPI.SENSE(Ch).CORRection.COLLECT.ECAL.ORientation.STATe on page 525
	Overwrite of partial overwrite		SCPI.SENSE(Ch).CORRection.COLLECT.PARTial.SAVE on page 545
	Port extension	On/Off	SCPI.SENSE(Ch).CORRection.EXTension.STATe on page 564
		Correction value	SCPI.SENSE(Ch).CORRection.EXTension.PORT(Pt).TIME on page 563
	DC loss	Correction value	SCPI.SENSE(Ch).CORRection.EXTension.PORT(Pt).LDC on page 560
	Loss value	Correction value	SCPI.SENSE(Ch).CORRection.EXTension.PORT(Pt).LOSS(Loss) on page 561
		Frequency	SCPI.SENSE(Ch).CORRection.EXTension.PORT(Pt).FREQuency(Fq) on page 556
		ON/OFF	SCPI.SENSE(Ch).CORRection.EXTension.PORT(Pt).INCLude(I).STATe on page 558
	Auto port extension	Frequency	SCPI.SENSE(Ch).CORRection.EXTension.AUTO.CONFig on page 548
		ON/OFF loss correction	SCPI.SENSE(Ch).CORRection.EXTension.AUTO.LOSS on page 550
		ON/OFF DC offset	SCPI.SENSE(Ch).CORRection.EXTension.AUTO.DCOFFset on page 549
		Measuring the OPEN/SHORT standard	SCPI.SENSE(Ch).CORRection.EXTension.AUTO.MEASure on page 551
		ON/OFF the specified port	SCPI.SENSE(Ch).CORRection.EXTension.AUTO.PORT(Pt) on page 552
		Delete the finished measurement data	SCPI.SENSE(Ch).CORRection.EXTension.AUTO.RESet on page 553
		Start frequency	SCPI.SENSE(Ch).CORRection.EXTension.AUTO.STARt on page 554
		Stop frequency	SCPI.SENSE(Ch).CORRection.EXTension.AUTO.STOP on page 555
	Velocity factor		SCPI.SENSE(Ch).CORRection.RVELocity.COAX on page 582

COM Object Reference
List by Function

Table 7-1 E5070B/E5071B COM objects by function

Function	Item to be set/executed		COM Object	
Power calibration	Set Z0		SCPI.SENSE(Ch).CORREction.IMPedance.INPUt.MAGNitude on page 565	
	On/Off		SCPI.SOURce(Ch).POWer.PORT(Pt).CORREction.STATe on page 661	
	Power calibration data	Measurement	SCPI.SOURce(Ch).POWer.PORT(Pt).CORREction.COLLEct.ACQuire on page 651	
		Number of power measurements at one measurement point	SCPI.SOURce(Ch).POWer.PORT(Pt).CORREction.COLLEct.AVERAge.COUNt on page 653	
		Reading out/writing	SCPI.SOURce(Ch).POWer.PORT(Pt).CORREction.DATA on page 660	
	Power sensor calibration factor settings	Reference calibration factor	Channel A	SCPI.SOURce.POWer.PORT.CORREction.COLLEct.ASEnsor.RCFactor on page 652
			Channel B	SCPI.SOURce.POWer.PORT.CORREction.COLLEct.BSEnsor.RCFactor on page 654
		Calibration factor table	Channel A	SCPI.SOURce.POWer.PORT.CORREction.COLLEct.TABLe.ASEnsor.DATA on page 656
			Channel B	SCPI.SOURce.POWer.PORT.CORREction.COLLEct.TABLe.BSEnsor.DATA on page 657
	Loss compensation	ON/OFF	SCPI.SOURce(Ch).POWer.PORT(Pt).CORREction.COLLEct.TABLe.LOSS.STATe on page 659	
		Settings the Loss compensation table	SCPI.SOURce(Ch).POWer.PORT(Pt).CORREction.COLLEct.TABLe.LOSS.DATA on page 658	
	Settings the power meter GPIB address		SCPI.SYSTem.COMMunicate.GPIB.PMETer.ADDRess on page 728	
	Settings the tolerance of power calibration		SCPI.SOURce.POWer.PORT.CORREction.COLLEct.NTOLerance on page 655	
Scalar-mixer calibration	Clearing the calibration data		SCPI.SENSE(Ch).CORREction.OFFSet.COLLEct.CLEar on page 573	
	Clearing the calibration coefficients		SCPI.SENSE(Ch).CORREction.OFFSet.CLEar on page 566	
	Calculating the calibration coefficients		SCPI.SENSE(Ch).CORREction.OFFSet.COLLEct.SAVE on page 578	
	Measuring the calibration data	Open standard	SCPI.SENSE(Ch).CORREction.OFFSet.COLLEct.ACQuire.OPEN on page 568	
		Short standard	SCPI.SENSE(Ch).CORREction.OFFSet.COLLEct.ACQuire.SHORt on page 571	
		Load standard	SCPI.SENSE(Ch).CORREction.OFFSet.COLLEct.ACQuire.LOAD on page 567	
		Thru standard	SCPI.SENSE(Ch).CORREction.OFFSet.COLLEct.ACQuire.THURU on page 572	
		Power calibration	SCPI.SENSE(Ch).CORREction.OFFSet.COLLEct.ACQuire.PMETer on page 569	
	Specifying the ports	2-port (SMIX2)	SCPI.SENSE(Ch).CORREction.OFFSet.COLLEct.METHod.SMIX2 on page 576	
		1-port (SOLT1)	SCPI.SENSE(Ch).CORREction.OFFSet.COLLEct.METHod.SOLT1 on page 577	
	ECal	Executing the scalar-mixer calibration (SMIX2)	SCPI.SENSE(Ch).CORREction.OFFSet.COLLEct.ECAL.SMIX2 on page 574	
		Executing the 1-port calibration (SOLT1)	SCPI.SENSE(Ch).CORREction.OFFSet.COLLEct.ECAL.SOLT1 on page 575	

Table 7-1 E5070B/E5071B COM objects by function

Function	Item to be set/executed		COM Object	
Receiver Calibration	ON/OFF		SCPI.SENSE(Ch).CORREction.RECEiver(Pt).STATE on page 581	
	Calculating the calibration coefficients		SCPI.SENSE(Ch).CORREction.RECEiver(Pt).COLLect.ACQUIre on page 580	
Measurement	Aborts the sweep.		SCPI.ABORT on page 208	
	Trigger system (Trigger mode)	Single trigger (Single)	SCPI.INITiate(Ch).IMMEDIATE on page 425	
		Turns on/off continuous mode (Continuous/Hold)	SCPI.INITiate(Ch).CONTinuous on page 424	
	Triggers when trigger source is BUS		SCPI.IEEE4882.TRG on page 423	
	Triggers at any settings for trigger source		SCPI.TRIGger.SEQUence.IMMEDIATE on page 753	
	Triggers at any settings for trigger source		SCPI.TRIGger.SEQUence.SINGLE on page 756	
	Selects trigger source		SCPI.TRIGger.SEQUence.SOURce on page 757	
	ON/OFF of the point trigger		SCPI.TRIGger.SEQUence.POINt on page 754	
	Low latency external trigger	trigger delay time	SCPI.TRIGger.SEQUence.EXTERNAL.DELay on page 751	
		Turns on/off low latency external trigger	SCPI.TRIGger.SEQUence.EXTERNAL.LLATency.STATE on page 752	
	ON/OFF of the averaging trigger		SCPI.TRIGger.SEQUence.AVERage on page 750	
	Selects the channel to be triggered		SCPI.TRIGger.SEQUence.SCOPE on page 755	
	Reads/Writes the data	Data transfer format	Format	SCPI.FORMAT.DATA on page 413
			Byte order	SCPI.FORMAT.BORDER on page 412
Reads/Writes the formatted trace data.		SCPI.CALCulate(Ch).SELEcted.DATA.FDATA on page 275		
Reads/Writes the formatted memory data.		SCPI.CALCulate(Ch).SELEcted.DATA.FMEMORY on page 276		
Reads/Writes the corrected trace data.		SCPI.CALCulate(Ch).SELEcted.DATA.SDATA on page 277		
Reads/Writes the corrected memory data.		SCPI.CALCulate(Ch).SELEcted.DATA.SMEMORY on page 278		
Reads the stimulus (frequency) data.		SCPI.SENSE(Ch).FREQUency.DATA on page 589		
Reads/Writes the power calibration data.		SCPI.SOURce(Ch).POWER.PORT(Pt).CORREction.DATA on page 660		
Calibration coefficient array data		Enabling the calibration coefficient array data		SCPI.SENSE(Ch).CORREction.COEFFicient.SAVE on page 479
		Reading out/Writing		SCPI.SENSE(Ch).CORREction.COEFFicient.DATA on page 470
		Selecting the calibration type at the reading out/writing the data array	Enhanced response calibration	SCPI.SENSE(Ch).CORREction.COEFFicient.METHod.ERESponse on page 472
			Response calibration (open)	SCPI.SENSE(Ch).CORREction.COEFFicient.METHod.RESPonse.OPEN on page 473
			Response calibration (short)	SCPI.SENSE(Ch).CORREction.COEFFicient.METHod.RESPonse.SHORT on page 473
			Response calibration (thru)	SCPI.SENSE(Ch).CORREction.COEFFicient.METHod.RESPonse.THURU on page 474
			1-port calibration	SCPI.SENSE(Ch).CORREction.COEFFicient.METHod.SOLT1 on page 475
			full 2-port calibration	SCPI.SENSE(Ch).CORREction.COEFFicient.METHod.SOLT2 on page 476
			full 3-port calibration	SCPI.SENSE(Ch).CORREction.COEFFicient.METHod.SOLT3 on page 477
	full 4-port calibration		SCPI.SENSE(Ch).CORREction.COEFFicient.METHod.SOLT4 on page 478	

Table 7-1 E5070B/E5071B COM objects by function

Function	Item to be set/executed	COM Object	
Limit test	On/Off of the limit test	SCPI.CALCulate(Ch).SElected.LIMit.STATe on page 312	
	Turns on/off the display of limit line.	SCPI.CALCulate(Ch).SElected.LIMit.DISPlay.STATe on page 304	
	Turns on/off the “Fail” display on the LCD screen.	SCPI.DISPlay.FSIGN on page 387	
	Edits limit line table.	SCPI.CALCulate(Ch).SElected.LIMit.DATA on page 302	
	Offset	Setting the marker value at the offset along the Y-axis	SCPI.CALCulate(Ch).SElected.LIMit.OFFSet.MARKer on page 307
		Along the X-axis	SCPI.CALCulate(Ch).SElected.LIMit.OFFSet.STIMulus on page 308
		Along the Y-axis	SCPI.CALCulate(Ch).SElected.LIMit.OFFSet.AMPLitude on page 306
	Reads test result.	Test results for each trace	SCPI.CALCulate(Ch).SElected.LIMit.FAIL on page 305
		Frequency value at measurement points failed	SCPI.CALCulate(Ch).SElected.LIMit.REPort.DATA on page 310
		Number of measurement points failed	SCPI.CALCulate(Ch).SElected.LIMit.REPort.POINts on page 311
Points information		SCPI.CALCulate(Ch).SElected.LIMit.REPort.ALL on page 309	
Ripple test	On/Off of the ripple test	SCPI.CALCulate(Ch).SElected.RLIMit.STATe on page 352	
	On/Off of the ripple limit line display	SCPI.CALCulate(Ch).SElected.RLIMit.DISPlay.LINE on page 347	
	Turns on/off the “Fail” display on the LCD screen.	SCPI.DISPlay.FSIGN on page 387	
	Ripple limit line editing	SCPI.CALCulate(Ch).SElected.RLIMit.DATA on page 345	
	On/Off of the ripple value display and selecting the type of ripple value	SCPI.CALCulate(Ch).SElected.RLIMit.DISPlay.VALue on page 349	
	Selecting the ripple limit line number to display the ripple value	SCPI.CALCulate(Ch).SElected.RLIMit.DISPlay.SELect on page 348	
	Reading out the results of each ripple limit lines	SCPI.CALCulate(Ch).SElected.RLIMit.REPort.DATA on page 351	
	Reading out the results of the ripple test (pass/fail)	SCPI.CALCulate(Ch).SElected.RLIMit.FAIL on page 350	
Bandwidth test	On/Off of the bandwidth test	SCPI.CALCulate(Ch).SElected.BLIMit.STATe on page 268	
	On/Off of the bandwidth display	SCPI.CALCulate(Ch).SElected.BLIMit.DISPlay.VALue on page 263	
	Turns on/off the “Fail” display on the LCD screen.	SCPI.DISPlay.FSIGN on page 387	
	On/Off of the marker display	SCPI.CALCulate(Ch).SElected.BLIMit.DISPlay.MARKer on page 262	
	Specifying the upper limit value for the test	SCPI.CALCulate(Ch).SElected.BLIMit.MAXimum on page 265	
	Specifying the lower limit value for the test	SCPI.CALCulate(Ch).SElected.BLIMit.MINimum on page 266	
	Specifying the bandwidth threshold value (attenuation from the peak)	SCPI.CALCulate(Ch).SElected.BLIMit.DB on page 261	
	Reading the bandwidth value	SCPI.CALCulate(Ch).SElected.BLIMit.REPort.DATA on page 267	
	Reading the results (pass/fail)	SCPI.CALCulate(Ch).SElected.BLIMit.FAIL on page 264	

Table 7-1 E5070B/E5071B COM objects by function

Function	Item to be set/executed	COM Object			
Marker	Selects active marker.	SCPI.CALCulate(Ch).SElected.MARKer(Mk).ACTivate on page 313			
	Turns on/off the marker.	SCPI.CALCulate(Ch).SElected.MARKer(Mk).STATe on page 336			
	Turns on/off marker coupling function.	SCPI.CALCulate(Ch).SElected.MARKer.COUPle on page 317			
	Movement mode (Continuous/Discrete)	SCPI.CALCulate(Ch).SElected.MARKer(Mk).DISCrete on page 318			
	Turns on/off reference marker mode.	SCPI.CALCulate(Ch).SElected.MARKer.REFERence. STATe on page 334			
	Reads marker value.	Response value	SCPI.CALCulate(Ch).SElected.MARKer(Mk).Y on page 338		
		Stimulus value	SCPI.CALCulate(Ch).SElected.MARKer(Mk).X on page 337		
	Sets marker stimulus value.				
	Marker search	Executes search	SCPI.CALCulate(Ch).SElected.MARKer(Mk).FUNctIon. EXECute on page 323		
		Search type	SCPI.CALCulate(Ch).SElected.MARKer(Mk).FUNctIon. TYPE on page 329		
		Search range	On/Off of the range coupling between traces	SCPI.CALCulate(Ch).SElected.MARKer.FUNctIon. DOMain.COUPle on page 319	
			Partial Search	On/Off	SCPI.CALCulate(Ch).SElected.MARKer.FUNctIon. DOMain.STATe on page 321
				Start	SCPI.CALCulate(Ch).SElected.MARKer.FUNctIon. DOMain.STARt on page 320
				Stop	SCPI.CALCulate(Ch).SElected.MARKer.FUNctIon. DOMain.STOP on page 322
		Peak definition	Lower limit of peak excursion value	SCPI.CALCulate(Ch).SElected.MARKer(Mk).FUNctIon. PEXCursion on page 324	
			Polarity	SCPI.CALCulate(Ch).SElected.MARKer(Mk).FUNctIon. PPOLarity on page 325	
		Target definition	Target value	SCPI.CALCulate(Ch).SElected.MARKer(Mk).FUNctIon. TARGeT on page 326	
			Polarity	SCPI.CALCulate(Ch).SElected.MARKer(Mk).FUNctIon. TTRansition on page 328	
		Turns on/off tracking function.	SCPI.CALCulate(Ch).SElected.MARKer(Mk).FUNctIon. TRACKing on page 327		
		Bandwidth search	Turns on/off the results display.	SCPI.CALCulate(Ch).SElected.MARKer.BWIDth.STATe on page 315	
			Bandwidth definition value	SCPI.CALCulate(Ch).SElected.MARKer(Mk).BWIDth. THReshold on page 316	
Reads the result.	SCPI.CALCulate(Ch).SElected.MARKer(Mk).BWIDth. DATA on page 314				
Sets the start/stop/center/scale reference/electrical delay value using a marker	SCPI.CALCulate(Ch).SElected.MARKer(Mk).SET on page 335				
Statistical analysis for the trace	Turns on/off the result display.	SCPI.CALCulate(Ch).SElected.MSTATistics.STATe on page 343			
	Reads the result.	SCPI.CALCulate(Ch).SElected.MSTATistics.DATA on page 342			
Display position of marker information		SCPI.DISPlay.WINDow(Ch).TRACe(Tr).ANNotation.MARKer.POSition.X on page 403			
		SCPI.DISPlay.WINDow(Ch).TRACe(Tr).ANNotation.MARKer.POSition.Y on page 404			
Display setting of marker information of each trace		SCPI.DISPlay.WINDow(Ch).ANNotation.MARKer.ALIGN. STATe on page 396			

COM Object Reference
List by Function

Table 7-1 E5070B/E5071B COM objects by function

Function	Item to be set/executed		COM Object	
Marker (Continued)	Setting the display contents of marker information		SCPI.DISPlay.WINDow(Ch).ANNOtation.MARKer.SINGLE.STATE on page 397	
Analysis	Executes analysis		SCPI.CALCulate(Ch).SElected.FUNcTion.EXECute on page 295	
	Analysis type		SCPI.CALCulate(Ch).SElected.FUNcTion.TYPE on page 301	
	Range	On/Off of the range coupling between traces		SCPI.CALCulate(Ch).SElected.FUNcTion.DOMain.COUPle on page 291
		Partial range	On/Off	SCPI.CALCulate(Ch).SElected.FUNcTion.DOMain.STATe on page 293
			Start	SCPI.CALCulate(Ch).SElected.FUNcTion.DOMain.STARt on page 292
			Stop	SCPI.CALCulate(Ch).SElected.FUNcTion.DOMain.STOP on page 294
	Peak definition		Lower limit of peak excursion value	SCPI.CALCulate(Ch).SElected.FUNcTion.PEXCursion on page 296
			Polarity	SCPI.CALCulate(Ch).SElected.FUNcTion.PPOLarity on page 298
	Target definition		Target value	SCPI.CALCulate(Ch).SElected.FUNcTion.TARGET on page 299
			Polarity	SCPI.CALCulate(Ch).SElected.FUNcTion.TTRransition on page 300
	Reads analysis result		Data for analysis	SCPI.CALCulate(Ch).SElected.FUNcTion.DATA on page 290
			Number of data for analysis	SCPI.CALCulate(Ch).SElected.FUNcTion.POINts on page 297
	Fixture simulator	Turns on/off fixture simulator function.		SCPI.CALCulate(Ch).FSIMulator.STATE on page 256
Topology		Balanced device type	SCPI.CALCulate(Ch).FSIMulator.BALun.DEVice on page 214	
		Port assignment	Unbalance-Balance	SCPI.CALCulate(Ch).FSIMulator.BALun.TOPology.SBALanced.PPORTs on page 232
			Balance-Balance	SCPI.CALCulate(Ch).FSIMulator.BALun.TOPology.BBALanced.PPORTs on page 230
			Unbalance-Unbalance-Balance	SCPI.CALCulate(Ch).FSIMulator.BALun.TOPology.SSBALanced.PPORTs on page 233
On/Off of the property display		SCPI.CALCulate(Ch).FSIMulator.BALun.TOPology.PROPERty.STATE on page 231		
Balance/Unbalance conversion function		On/Off		SCPI.CALCulate(Ch).FSIMulator.BALun.PARAmeter(Tr).STATE on page 229
		Measurement parameter	Unbalance-Balance	SCPI.CALCulate(Ch).FSIMulator.BALun.PARAmeter(Tr).SBALanced.DEFIne on page 227
			Balance-Balance	SCPI.CALCulate(Ch).FSIMulator.BALun.PARAmeter(Tr).BBALanced.DEFIne on page 226
			Unbalance-Unbalance-Balance	SCPI.CALCulate(Ch).FSIMulator.BALun.PARAmeter(Tr).SSBALanced.DEFIne on page 228

Table 7-1 E5070B/E5071B COM objects by function

Function	Item to be set/executed		COM Object		
Fixture simulator (Continued)	Matching circuit embedding function	On/Off	SCPI.CALCulate(Ch).FSIMulator.SENDEd.PMCircuit. STATE on page 251		
		Circuit type	SCPI.CALCulate(Ch).FSIMulator.SENDEd.PMCircuit. PORT(Pt).TYPE on page 249		
		Circuit constant	C	SCPI.CALCulate(Ch).FSIMulator.SENDEd.PMCircuit. PORT(Pt).PARAMeters.C on page 245	
			G	SCPI.CALCulate(Ch).FSIMulator.SENDEd.PMCircuit. PORT(Pt).PARAMeters.G on page 246	
			L	SCPI.CALCulate(Ch).FSIMulator.SENDEd.PMCircuit. PORT(Pt).PARAMeters.L on page 247	
			R	SCPI.CALCulate(Ch).FSIMulator.SENDEd.PMCircuit. PORT(Pt).PARAMeters.R on page 248	
		User file	SCPI.CALCulate(Ch).FSIMulator.SENDEd.PMCircuit. PORT(Pt).USER.FILEname on page 250		
	Port impedance conversion function	On/Off	SCPI.CALCulate(Ch).FSIMulator.SENDEd.ZCONversion. STATE on page 255		
		Z0	SCPI.CALCulate(Ch).FSIMulator.SENDEd.ZCONversion. PORT(Pt).Z0.R on page 254		
		Imaginary part	SCPI.CALCulate(Ch).FSIMulator.SENDEd.ZCONversion. PORT(Pt).IMAGinary on page 252		
		Real part	SCPI.CALCulate(Ch).FSIMulator.SENDEd.ZCONversion. PORT(Pt).REAL on page 253		
	Network de-embedding function	On/Off	SCPI.CALCulate(Ch).FSIMulator.SENDEd.DEEMbed. STATE on page 244		
		Type	SCPI.CALCulate(Ch).FSIMulator.SENDEd.DEEMbed. PORT(Pt).TYPE on page 241		
		User file	SCPI.CALCulate(Ch).FSIMulator.SENDEd.DEEMbed. PORT(Pt).USER.FILEname on page 243		
	4-port network embedding/ de-embedding function	On/Off	SCPI.CALCulate(Ch).FSIMulator.EMBed.STATE on page 236		
		Topology	Type	SCPI.CALCulate(Ch).FSIMulator.EMBed.TYPE on page 240	
			Port assignm-ent	A	SCPI.CALCulate(Ch).FSIMulator.EMBed.TOPology.A. PORTs on page 237
				B	SCPI.CALCulate(Ch).FSIMulator.EMBed.TOPology.B. PORTs on page 238
		C		SCPI.CALCulate(Ch).FSIMulator.EMBed.TOPology.C. PORTs on page 239	
		Network	Type	SCPI.CALCulate(Ch).FSIMulator.EMBed.NETWork(Nwk). TYPE on page 235	
File			SCPI.CALCulate(Ch).FSIMulator.EMBed.NETWork(Nwk). FILEname on page 234		

Table 7-1 E5070B/E5071B COM objects by function

Function	Item to be set/executed		COM Object	
Fixture simulator (Continued)	Differential matching circuit embedding function	On/Off	SCPI.CALCulate(Ch).FSIMulator.BALun.DMCircuit. STATE on page 221	
		Circuit type		SCPI.CALCulate(Ch).FSIMulator.BALun.DMCircuit. BPORT(Bpt).TYPE on page 219
		Circuit constant	C	SCPI.CALCulate(Ch).FSIMulator.BALun.DMCircuit. BPORT(Bpt).PARAmeters.C on page 215
			G	SCPI.CALCulate(Ch).FSIMulator.BALun.DMCircuit. BPORT(Bpt).PARAmeters.G on page 216
			L	SCPI.CALCulate(Ch).FSIMulator.BALun.DMCircuit. BPORT(Bpt).PARAmeters.L on page 217
			R	SCPI.CALCulate(Ch).FSIMulator.BALun.DMCircuit. BPORT(Bpt).PARAmeters.R on page 218
	User file		SCPI.CALCulate(Ch).FSIMulator.BALun.DMCircuit. BPORT(Bpt).USER.FILEname on page 220	
	Differential port impedance conversion function	On/Off	SCPI.CALCulate(Ch).FSIMulator.BALun.DZConversion. STATE on page 225	
		Z0	SCPI.CALCulate(Ch).FSIMulator.BALun.DZConversion. BPORT(Bpt).Z0.R on page 224	
		Imaginary part		SCPI.CALCulate(Ch).FSIMulator.BALun.DZConversion. BPORT(Bpt).IMAGinary on page 222
		Real part		SCPI.CALCulate(Ch).FSIMulator.BALun.DZConversion. BPORT(Bpt).REAL on page 223
	Common port impedance conversion function	On/Off	SCPI.CALCulate(Ch).FSIMulator.BALun.CZConversion. STATE on page 213	
		Z0	SCPI.CALCulate(Ch).FSIMulator.BALun.CZConversion. BPORT(Bpt).Z0.R on page 212	
		Imaginary part		SCPI.CALCulate(Ch).FSIMulator.BALun.CZConversion. BPORT(Bpt).IMAGinary on page 209
		Real part		SCPI.CALCulate(Ch).FSIMulator.BALun.CZConversion. BPORT(Bpt).REAL on page 211
Time domain	Transform	On/Off	SCPI.CALCulate(Ch).SElected.TRANSform.TIME.STATE on page 361	
		Transform type		SCPI.CALCulate(Ch).SElected.TRANSform.TIME.TYPE on page 365
		Stimulus type		SCPI.CALCulate(Ch).SElected.TRANSform.TIME. STIMulus on page 363
		Changes the frequency range to match with the low-pass type		SCPI.CALCulate(Ch).SElected.TRANSform.TIME. LPFRequency on page 358
		Window setup	β	SCPI.CALCulate(Ch).SElected.TRANSform.TIME. KBESsel on page 357
			Impulse width	SCPI.CALCulate(Ch).SElected.TRANSform.TIME. IMPulse.WIDTH on page 356
			Rise time of step signal	SCPI.CALCulate(Ch).SElected.TRANSform.TIME. STEP.RTIM e on page 362
		Display range after time domain transformation	Start	SCPI.CALCulate(Ch).SElected.TRANSform.TIME.START on page 360
			Stop	SCPI.CALCulate(Ch).SElected.TRANSform.TIME.STOP on page 364
			Center	SCPI.CALCulate(Ch).SElected.TRANSform.TIME. CENTer on page 355
Span	SCPI.CALCulate(Ch).SElected.TRANSform.TIME.SPAN on page 359			

Table 7-1 E5070B/E5071B COM objects by function

Function	Item to be set/executed		COM Object
Time domain (Continued)	Gating	On/Off	SCPI.CALCulate(Ch).SElected.FILTer.GATE.TIME.STATe on page 286
		Gate type	SCPI.CALCulate(Ch).SElected.FILTer.GATE.TIME.TYPE on page 288
		Gate shape	SCPI.CALCulate(Ch).SElected.FILTer.GATE.TIME.SHAPe on page 283
	Display range after time domain transformation	Start	SCPI.CALCulate(Ch).SElected.FILTer.GATE.TIME.STARt on page 285
		Stop	SCPI.CALCulate(Ch).SElected.FILTer.GATE.TIME.STOP on page 287
		Center	SCPI.CALCulate(Ch).SElected.FILTer.GATE.TIME.CENTer on page 282
		Span	SCPI.CALCulate(Ch).SElected.FILTer.GATE.TIME.SPAN on page 284
Parameter conversion	On/Off		SCPI.CALCulate(Ch).SElected.CONVersion.STATe on page 270
	Selects the conversion parameter.		SCPI.CALCulate(Ch).SElected.CONVersion.FUNcTION on page 269
Handler I/O control	Outputs data using port A.		SCPI.CONTRol.HANDler.A.DATA on page 366
	Outputs data using port B.		SCPI.CONTRol.HANDler.B.DATA on page 367
	Port C	Inputs/Outputs data.	SCPI.CONTRol.HANDler.C.DATA on page 368
		Selects input/output mode.	SCPI.CONTRol.HANDler.C.MODE on page 369
	Port D	Inputs/Outputs data.	SCPI.CONTRol.HANDler.D.DATA on page 370
		Selects input/output mode.	SCPI.CONTRol.HANDler.D.MODE on page 371
	Inputs/outputs data using port E (port C + port D)		SCPI.CONTRol.HANDler.E.DATA on page 372
	Outputs data using port F (port A + port B)		SCPI.CONTRol.HANDler.F.DATA on page 375
	Sets/Reads OUTPUT1 and OUTPUT2		SCPI.CONTRol.HANDler.OUTPUT(Num).DATA on page 376
	Turns on/off INDEX signal.		SCPI.CONTRol.HANDler.EXTension.INDEX.STATe on page 373
	Turns on/off READY FOR TRIGGER signal.		SCPI.CONTRol.HANDler.EXTension.RTRigger.STATe on page 374
E5091A control	Displaying the name of test set.		SCPI.SENSE.MULTiplexer.CATalog on page 594
	Selecting the name of test set.		SCPI.SENSE.MULTiplexer(Id).NAME on page 598
	On/Off of control		SCPI.SENSE(Ch).MULTiplexer(Id).STATe on page 603
	On/Off of the E5091A property display		SCPI.SENSE(Ch).MULTiplexer(Id).DISPlay.STATe on page 596
	Reads number of port.		SCPI.SENSE(Ch).MULTiplexer(Id).COUNT on page 595
	Reading out the input port number		SCPI.SENSE.MULTiplexer(Id).INCount on page 597
	Reading out the assigning port number.		SCPI.SENSE(Ch).MULTiplexer(Id).PORT(Pt).CATalog on page 600
	Assigns the port.	Selecting a assgning port.	SCPI.SENSE(Ch).MULTiplexer(Id).PORT(Pt).SElect on page 601
		Port 1	SCPI.SENSE(Ch).MULTiplexer(Id).TSET9.PORT1 on page 605
		Port 2	SCPI.SENSE(Ch).MULTiplexer(Id).TSET9.PORT2 on page 606
		Port 3	SCPI.SENSE(Ch).MULTiplexer(Id).TSET9.PORT3 on page 607
		Port 4	SCPI.SENSE(Ch).MULTiplexer(Id).TSET9.PORT4 on page 608
	Sets control lines.		SCPI.SENSE(Ch).MULTiplexer(Id).OUTPUT.DATA on page 599 SCPI.SENSE(Ch).MULTiplexer(Id).TSET9.OUTPUT.DATA on page 604

Table 7-1 E5070B/E5071B COM objects by function

Function	Item to be set/executed		COM Object	
File operation	Save	Instrument Setting	Entire state (file)	SCPI.MMEMemory.STORe.STATe on page 456
			State for each channel (register)	SCPI.MMEMemory.STORe.CHANnel.STATe on page 441
			Selects contents	SCPI.MMEMemory.STORe.STYPe on page 457
			Selects target channels/traces	SCPI.MMEMemory.STORe.SALL on page 448
		Formatted trace data		SCPI.MMEMemory.STORe.FDATa on page 443
		Display image on the LCD screen		SCPI.MMEMemory.STORe.IMAGe on page 444
		Segment sweep table		SCPI.MMEMemory.STORe.SEGMent on page 449
		Power sensor calibration factor table	Channel A	SCPI.MMEMemory.STORe.ASCFactor on page 439
			Channel B	SCPI.MMEMemory.STORe.BSCFactor on page 440
		Loss compensation table		SCPI.MMEMemory.STORe.PLOSs(Pt) on page 446
		Limit line table		SCPI.MMEMemory.STORe.LIMit on page 445
		Ripple limit		SCPI.MMEMemory.STORe.RLIMit on page 447
		Cal kit definition table		SCPI.MMEMemory.STORe.CKIT(Ckit) on page 442
		Touchstone file format	File format	SCPI.MMEMemory.STORe.SNP.FORMat on page 451
	Select port 1		SCPI.MMEMemory.STORe.SNP.TYPE.S1P on page 452	
	Selects port 2		SCPI.MMEMemory.STORe.SNP.TYPE.S2P on page 453	
	Selects port 3		SCPI.MMEMemory.STORe.SNP.TYPE.S3P on page 454	
	Selects port 4		SCPI.MMEMemory.STORe.SNP.TYPE.S4P on page 455	
	Save		SCPI.MMEMemory.STORe.SNP.DATA on page 450	
	Recall	Instrument setting	Entire state (file)	SCPI.MMEMemory.LOAD.STATE on page 437
			State for each channel (register)	SCPI.MMEMemory.LOAD.CHANnel.STATE on page 431
		Power sensor calibration factor table	Channel A	SCPI.MMEMemory.LOAD.ASCFactor on page 429
			Channel B	SCPI.MMEMemory.LOAD.BSCFactor on page 430
		Loss compensation table		SCPI.MMEMemory.LOAD.PLOSs(Pt) on page 434
		Segment sweep table		SCPI.MMEMemory.LOAD.SEGMent on page 436
		Limit line table		SCPI.MMEMemory.LOAD.LIMit on page 433
		Ripple limit		SCPI.MMEMemory.LOAD.RLIMit on page 435
		Cal kit definition table		SCPI.MMEMemory.LOAD.CKIT(Ckit) on page 432
		Clears registers.		SCPI.MMEMemory.STORe.CHANnel.CLEAr on page 441
		Creates directory (folder).		SCPI.MMEMemory.MDIRectory on page 438
		Capes file.		SCPI.MMEMemory.COPY on page 427
	Deletes file or directory.		SCPI.MMEMemory.DELeTe on page 428	
	Reads list of files in the directory.		SCPI.MMEMemory.CATalog(Dir) on page 426	

Table 7-1 E5070B/E5071B COM objects by function

Function	Item to be set/executed	COM Object	
Status report system	Clears register.	SCPI.IEEE4882.CLS on page 417	
	Reads status byte register.	SCPI.IEEE4882.STB on page 423	
	Sets service request enable register.	SCPI.IEEE4882.SRE on page 422	
	Standard event status register	Reads register value.	SCPI.IEEE4882.ESR on page 419
		Sets enable register value.	SCPI.IEEE4882.ESE on page 418
		Sets OPC bit on operation termination.	SCPI.IEEE4882.OPC on page 420
	Operation status register	Reset	SCPI.STATus.PRESet on page 669
		Reads conditional register value.	SCPI.STATus.OPERation.CONDition on page 667
		Sets enable register value.	SCPI.STATus.OPERation.ENABLE on page 667
		Reads event register value.	SCPI.STATus.OPERation.EVENT on page 668
		Sets positive transition filter value.	SCPI.STATus.OPERation.PTRansition on page 669
		Sets negative transition filter value.	SCPI.STATus.OPERation.NTRansition on page 668
	Questionable status register	Reset	SCPI.STATus.PRESet on page 669
		Reads conditional register value.	SCPI.STATus.QUEStionable.CONDition on page 687
		Sets enable register value.	SCPI.STATus.QUEStionable.ENABLE on page 688
		Reads event register value.	SCPI.STATus.QUEStionable.EVENT on page 689
		Sets positive transition filter value.	SCPI.STATus.QUEStionable.PTRansition on page 707
		Sets negative transition filter value.	SCPI.STATus.QUEStionable.NTRansition on page 706
	Questionable limit status register	Reset	SCPI.STATus.PRESet on page 669
		Reads conditional register value.	SCPI.STATus.QUEStionable.LIMit.CONDition on page 699
		Sets enable register value.	SCPI.STATus.QUEStionable.LIMit.ENABLE on page 703
		Reads event register value.	SCPI.STATus.QUEStionable.LIMit.EVENT on page 703
		Sets positive transition filter value.	SCPI.STATus.QUEStionable.LIMit.PTRansition on page 705
		Sets negative transition filter value.	SCPI.STATus.QUEStionable.LIMit.NTRansition on page 704
	Questionable limit extra status register	Reset	SCPI.STATus.PRESet on page 669
		Reads conditional register value.	SCPI.STATus.QUEStionable.LIMit.ELIMit.CONDition on page 699
		Sets enable register value.	SCPI.STATus.QUEStionable.LIMit.ELIMit.ENABLE on page 700
		Reads event register value.	SCPI.STATus.QUEStionable.LIMit.ELIMit.EVENT on page 700
		Sets positive transition filter value.	SCPI.STATus.QUEStionable.LIMit.ELIMit.PTRansition on page 702
		Sets negative transition filter value.	SCPI.STATus.QUEStionable.LIMit.ELIMit.NTRansition on page 701
Questionable limit channel{1-16} status register	Reset	SCPI.STATus.PRESet on page 669	
	Reads conditional register value.	SCPI.STATus.QUEStionable.LIMit.CHANnel(Ch). CONDition on page 689	
	Sets enable register value.	SCPI.STATus.QUEStionable.LIMit.CHANnel(Ch).ENABLE on page 695	
	Reads event register value.	SCPI.STATus.QUEStionable.LIMit.CHANnel(Ch).EVENT on page 696	
	Sets positive transition filter value.	SCPI.STATus.QUEStionable.LIMit.CHANnel(Ch). PTRansition on page 698	
	Sets negative transition filter value.	SCPI.STATus.QUEStionable.LIMit.CHANnel(Ch). NTRansition on page 697	

COM Object Reference
List by Function

Table 7-1 E5070B/E5071B COM objects by function

Function	Item to be set/executed	COM Object	
Status report system (Continued)	Questionable limit channel{1-16} extra status register	Reset	SCPI.STATus.PRESet on page 669
		Reads conditional register value.	SCPI.STATus.QUEStionable.LIMit.CHANnel(Ch).ECHannel.CONDition on page 690
		Sets enable register value.	SCPI.STATus.QUEStionable.LIMit.CHANnel(Ch).ECHannel.ENABLE on page 691
		Reads event register value.	SCPI.STATus.QUEStionable.LIMit.CHANnel(Ch).ECHannel.EVENT on page 692
		Sets positive transition filter value.	SCPI.STATus.QUEStionable.LIMit.CHANnel(Ch).ECHannel.PTRansition on page 694
		Sets negative transition filter value.	SCPI.STATus.QUEStionable.LIMit.CHANnel(Ch).ECHannel.NTRansition on page 693
	Questionable ripple limit status register	Reset	SCPI.STATus.PRESet on page 669
		Reads conditional register value.	SCPI.STATus.QUEStionable.RLIMit.CONDition on page 718
		Sets enable register value.	SCPI.STATus.QUEStionable.RLIMit.ENABLE on page 722
		Reads event register value.	SCPI.STATus.QUEStionable.RLIMit.EVENT on page 722
		Sets positive transition filter value.	SCPI.STATus.QUEStionable.RLIMit.PTRansition on page 724
	Questionable ripple limit extra status register	Reset	SCPI.STATus.PRESet on page 669
		Reads conditional register value.	SCPI.STATus.QUEStionable.RLIMit.ELIMit.CONDition on page 718
		Sets enable register value.	SCPI.STATus.QUEStionable.RLIMit.ELIMit.ENABLE on page 719
		Reads event register value.	SCPI.STATus.QUEStionable.RLIMit.ELIMit.EVENT on page 719
		Sets positive transition filter value.	SCPI.STATus.QUEStionable.RLIMit.ELIMit.PTRansition on page 721
	Questionable ripple limit channel{1-16} status register	Reset	SCPI.STATus.PRESet on page 669
		Reads conditional register value.	SCPI.STATus.QUEStionable.RLIMit.CHANnel(Ch).CONDition on page 708
		Sets enable register value.	SCPI.STATus.QUEStionable.RLIMit.CHANnel(Ch).ENABLE on page 714
		Reads event register value.	SCPI.STATus.QUEStionable.RLIMit.CHANnel(Ch).EVENT on page 715
		Sets positive transition filter value.	SCPI.STATus.QUEStionable.RLIMit.CHANnel(Ch).PTRansition on page 717
		Sets negative transition filter value.	SCPI.STATus.QUEStionable.RLIMit.CHANnel(Ch).NTRansition on page 716
	Questionable ripple limit channel{1-16} extra status register	Reset	SCPI.STATus.PRESet on page 669
		Reads conditional register value.	SCPI.STATus.QUEStionable.RLIMit.CHANnel(Ch).ECHannel.CONDition on page 709
Sets enable register value.		SCPI.STATus.QUEStionable.RLIMit.CHANnel(Ch).ECHannel.ENABLE on page 710	
Reads event register value.		SCPI.STATus.QUEStionable.RLIMit.CHANnel(Ch).ECHannel.EVENT on page 711	
Sets positive transition filter value.		SCPI.STATus.QUEStionable.RLIMit.CHANnel(Ch).ECHannel.PTRansition on page 713	
Sets negative transition filter value.		SCPI.STATus.QUEStionable.RLIMit.CHANnel(Ch).ECHannel.NTRansition on page 712	

Table 7-1 E5070B/E5071B COM objects by function

Function	Item to be set/executed	COM Object	
Status report system (Continued)	Questionable bandwidth limit status register	Reset	SCPI.STATus.PRESet on page 669
		Reads conditional register value.	SCPI.STATus.QUEStionable.BLIMit.CONDition on page 680
		Sets enable register value.	SCPI.STATus.QUEStionable.BLIMit.ENABLE on page 684
		Reads event register value.	SCPI.STATus.QUEStionable.BLIMit.EVENT on page 684
		Sets positive transition filter value.	SCPI.STATus.QUEStionable.BLIMit.PTRansition on page 686
		Sets negative transition filter value.	SCPI.STATus.QUEStionable.BLIMit.NTRansition on page 685
	Questionable bandwidth limit extra status register	Reset	SCPI.STATus.PRESet on page 669
		Reads conditional register value.	SCPI.STATus.QUEStionable.BLIMit.ELIMit.CONDition on page 680
		Sets enable register value.	SCPI.STATus.QUEStionable.BLIMit.ELIMit.ENABLE on page 681
		Reads event register value.	SCPI.STATus.QUEStionable.BLIMit.ELIMit.EVENT on page 681
		Sets positive transition filter value.	SCPI.STATus.QUEStionable.BLIMit.ELIMit.PTRansition on page 683
		Sets negative transition filter value.	SCPI.STATus.QUEStionable.BLIMit.ELIMit.NTRansition on page 682
	Questionable bandwidth limit channel{1-16} status register	Reset	SCPI.STATus.PRESet on page 669
		Reads conditional register value.	SCPI.STATus.QUEStionable.BLIMit.CHANnel(Ch).CONDition on page 670
		Sets enable register value.	SCPI.STATus.QUEStionable.BLIMit.CHANnel(Ch).ENABLE on page 676
		Reads event register value.	SCPI.STATus.QUEStionable.BLIMit.CHANnel(Ch).EVENT on page 677
		Sets positive transition filter value.	SCPI.STATus.QUEStionable.BLIMit.CHANnel(Ch).PTRansition on page 679
		Sets negative transition filter value.	SCPI.STATus.QUEStionable.BLIMit.CHANnel(Ch).NTRansition on page 678
	Questionable bandwidth limit channel{1-16} extra status register	Reset	SCPI.STATus.PRESet on page 669
		Reads conditional register value.	SCPI.STATus.QUEStionable.BLIMit.CHANnel(Ch).ECHannel.CONDition on page 671
		Sets enable register value.	SCPI.STATus.QUEStionable.BLIMit.CHANnel(Ch).ECHannel.ENABLE on page 672
		Reads event register value.	SCPI.STATus.QUEStionable.BLIMit.CHANnel(Ch).ECHannel.EVENT on page 673
		Sets positive transition filter value.	SCPI.STATus.QUEStionable.BLIMit.CHANnel(Ch).ECHannel.PTRansition on page 675
		Sets negative transition filter value.	SCPI.STATus.QUEStionable.BLIMit.CHANnel(Ch).ECHannel.NTRansition on page 674
VBA Macro	User menu function	Preset	UserMenu.PRESet on page 204
		Label name	UserMenu.Item(Key_id).Caption on page 202
		Softkey enabled/disabled	UserMenu.Item(Key_id).Enabled on page 203
		Event processing	UserMenu_OnPress(ByVal Key_id As Long) on page 204
		Show the softkey	UserMenu.Show on page 205
	Reads VBA application name.	NAME on page 199	
	Reads VBA version.	VBAVersion on page 206	
	Control through SCPI commands	Parse on page 200	
	Waits for clicking [Macro Setup] - Continue button.	Prompt on page 201	
	Waits for returning 1 at RQS/MSS bit (status register).	WaitOnSRQ on page 207	

COM Object Reference
List by Function

Table 7-1 E5070B/E5071B COM objects by function

Function	Item to be set/executed		COM Object	
Print	Outputs print.		SCPI.HCOPy.IMMEdiate on page 416	
	Aborts printing.		SCPI.HCOPy.ABORt on page 415	
	Selects print mode.		SCPI.HCOPy.IMAGe on page 415	
Operations	Disables front panel/keyboard operations.		SCPI.SYSTem.KLOCK.KBD on page 741	
	Disables mouse/touch screen operations.		SCPI.SYSTem.KLOCK.MOUSe on page 742	
Beeper	For operation completion	On/Off	SCPI.SYSTem.BEEPer.COMPLete.STATe on page 726	
		Makes beep sound.	SCPI.SYSTem.BEEPer.COMPLete.IMMEdiate on page 726	
	For warning/limit test result	On/Off	SCPI.SYSTem.BEEPer.WARning.STATe on page 727	
		Makes beep sound.	SCPI.SYSTem.BEEPer.WARning.IMMEdiate on page 727	
Internal clock	Date		SCPI.SYSTem.DATE on page 737	
	Time		SCPI.SYSTem.TIME on page 748	
External Signal Source	Setting the GPIB address		SCPI.SYSTem.COMMunicate.GPIB.SGENerator.ADDRes on page 729	
	Setting the type of the external signal source		SCPI.SYSTem.COMMunicate.GPIB.SGENerator.TYPE on page 735	
	Setting the GPIB commands when type 1 (custom commands) is chosen	Setting the frequency		SCPI.SYSTem.COMMunicate.GPIB.SGENerator.CCOMmand.FREQuency on page 730
		Setting the power level		SCPI.SYSTem.COMMunicate.GPIB.SGENerator.CCOMmand.POWer on page 731
		Setting the preset		SCPI.SYSTem.COMMunicate.GPIB.SGENerator.CCOMmand.PRESet on page 732
		Setting the RF power ON		SCPI.SYSTem.COMMunicate.GPIB.SGENerator.CCOMmand.RFON on page 733
	Setting the waiting time after setting the frequency and power level to the external signal source		SCPI.SYSTem.COMMunicate.GPIB.SGENerator.DWELL on page 734	

Table 7-1 E5070B/E5071B COM objects by function

Function	Item to be set/executed	COM Object	
Others	Shutdown	SCPI.SYSTem.POFF on page 742	
	Reads the upper limits of the number of channels.	SCPI.SERVice.CHANnel.COUNT on page 639	
	Reads the upper limits of the number of traces.	SCPI.SERVice.CHANnel.TRACe.COUNT on page 640	
	Reads the number of test ports.	SCPI.SERVice.PORT.COUNT on page 641	
	Reads System version.	SCPI.SERVice.SREVision on page 641	
	Reads product information.	SCPI.IEEE4882.IDN on page 419	
	Reads options installed.	SCPI.IEEE4882.OPT on page 421	
	Waits for object execution.	SCPI.IEEE4882.WAI on page 423	
	Returns 1 when completing object execution.	SCPI.IEEE4882.OPC on page 420	
	Reads error message occurred.	SCPI.SYSTem.ERRor on page 738	
	Confirms whether external reference signal is inputted or not.	SCPI.SENSE(CH).ROSCillator.SOURce on page 628	
	Turns on/off the spurious avoid mode.	SCPI.SENSE(CH).SWEep.ASPurious on page 632	
	Turns on/off the system correction.	SCPI.SYSTem.CORRection.STATe on page 736	
	Confirms whether warm-up is enough or not.	SCPI.SYSTem.TEMPerature.STATe on page 747	
	Turns on/off the high temperature mode.	SCPI.SYSTem.TEMPerature.HIGH on page 746	
	Confirms whether service mode or not.	SCPI.SYSTem.SERVice on page 745	
	Sets the power meter GPIB address.	SCPI.SYSTem.COMMunicate.GPIB.PMETer.ADDRESS on page 728	
	Initial Source Port selection feature	SCPI.SYSTem.ISPC.PORT on page 739	
	Initial Source Port Control feature ON/OFF	SCPI.SYSTem.ISPC.STAT on page 740	
	Frequency blank display feature ON/OFF and Setting/Reading the security level	SCPI.SYSTem.SECurity.LEVl on page 744	
	User defined variables	Sets/reads array type	SCPI.PROGram.VARiable.ARRay(Vnum).DATA on page 459
		Sets the size of array type data	SCPI.PROGram.VARiable.ARRay(Vnum).SIZE on page 461
		Sets/reads the double precision floating point type	SCPI.PROGram.VARiable.DOUBLE(Vnum).DATA on page 462
Sets/reads the long integer type		SCPI.PROGram.VARiable.LONG(Vnum).DATA on page 463	
Sets/reads the character string type		SCPI.PROGram.VARiable.STRing(Vnum).DATA on page 464	

List by Front Panel Key

Table 7-2 shows the COM objects that correspond to the front panel keys (in alphabetical order).

Table 7-2 Front panel key tree vs. COM objects correspondence table

Front panel key (Operation)			Corresponding COM object		
[Analysis]	Bandwidth Limit	BW Display	SCPI.CALCulate(Ch).SElected.BLIMit.DISPlay.VALue on page 263		
		BW Marker	SCPI.CALCulate(Ch).SElected.BLIMit.DISPlay.MARKer on page 262		
		BW Test	SCPI.CALCulate(Ch).SElected.BLIMit.STATE on page 268		
		Fail Sign	SCPI.DISPlay.FSIGN on page 387		
		Max Bandwidth	SCPI.CALCulate(Ch).SElected.BLIMit.MAXimum on page 265		
		Min Bandwidth	SCPI.CALCulate(Ch).SElected.BLIMit.MINimum on page 266		
		N DB Points	SCPI.CALCulate(Ch).SElected.BLIMit.DB on page 261		
	Conversion	Conversion	SCPI.CALCulate(Ch).SElected.CONVersion.STATE on page 270		
		Function	SCPI.CALCulate(Ch).SElected.CONVersion.FUNCTION on page 269		
	Fixture Simulator	BalUn		SCPI.CALCulate(Ch).FSIMulator.BALun.PARAmeter(Tr). STATE on page 229	
		Balun OFF All Traces		N/A	
		Balun ON All Traces		N/A	
		Cmn ZConversion	Cmn ZConversion		SCPI.CALCulate(Ch).FSIMulator.BALun.CZConversion. STATE on page 213
			Port n (bal) Imag		SCPI.CALCulate(Ch).FSIMulator.BALun.CZConversion. BPORT(Bpt).IMAGinary on page 209
			Port n (bal) Real		SCPI.CALCulate(Ch).FSIMulator.BALun.CZConversion. BPORT(Bpt).REAL on page 211
				SCPI.CALCulate(Ch).FSIMulator.BALun.CZConversion. BPORT(Bpt).Z0.R on page 212	
		De-Embedding	De- Embedding		SCPI.CALCulate(Ch).FSIMulator.SENDEd.DEEMbed. STATE on page 244
			Select Port		SCPI.CALCulate(Ch).FSIMulator.SENDEd.DEEMbed. PORT(Pt).TYPE on page 241
			Select Type		
	User File		SCPI.CALCulate(Ch).FSIMulator.SENDEd.DEEMbed. PORT(Pt).USER.FILename on page 243		
	De-Embedding S4P	De-Embedding S4P		SCPI.CALCulate(Ch).FSIMulator.EMBed.STATE on page 236	
		Topology	Ports	SCPI.CALCulate(Ch).FSIMulator.EMBed.TOPology.A. PORTS on page 237 SCPI.CALCulate(Ch).FSIMulator.EMBed.TOPology.B. PORTS on page 238 SCPI.CALCulate(Ch).FSIMulator.EMBed.TOPology.C. PORTS on page 239	
			Select Topology		SCPI.CALCulate(Ch).FSIMulator.EMBed.TYPE on page 240
			Type (nwk1/2)		SCPI.CALCulate(Ch).FSIMulator.EMBed.NETWork(Nwk). TYPE on page 235
		User File (nwk1/2)		SCPI.CALCulate(Ch).FSIMulator.EMBed.NETWork(Nwk). FILename on page 234	

Table 7-2 Front panel key tree vs. COM objects correspondence table

Front panel key (Operation)			Corresponding COM object		
[Analysis] (Continued)	Fixture Simulator (Continued)	Diff Matching	C	SCPI.CALCulate(Ch).FSIMulator.BALun.DMCircuit. BPORT(Bpt).PARAmeters.C on page 215	
			Diff Matching	SCPI.CALCulate(Ch).FSIMulator.BALun.DMCircuit. STATE on page 221	
			G	SCPI.CALCulate(Ch).FSIMulator.BALun.DMCircuit. BPORT(Bpt).PARAmeters.G on page 216	
			L	SCPI.CALCulate(Ch).FSIMulator.BALun.DMCircuit. BPORT(Bpt).PARAmeters.L on page 217	
			R	SCPI.CALCulate(Ch).FSIMulator.BALun.DMCircuit. BPORT(Bpt).PARAmeters.R on page 218	
			Select Bal Port	SCPI.CALCulate(Ch).FSIMulator.BALun.DMCircuit. BPORT(Bpt).TYPE on page 219	
			Select Circuit		
			User File	SCPI.CALCulate(Ch).FSIMulator.BALun.DMCircuit. BPORT(Bpt).USER.FILename on page 220	
		Diff ZConversion	Diff ZConversion	SCPI.CALCulate(Ch).FSIMulator.BALun.DZConversion. STATE on page 225	
			Port n (bal)	SCPI.CALCulate(Ch).FSIMulator.BALun.DZConversion. BPORT(Bpt).Z0.R on page 224	
		Measurement			SCPI.CALCulate(Ch).PARAmeter(Tr).DEFine on page 258 SCPI.CALCulate(Ch).FSIMulator.BALun.PARAmeter(Tr). SBALanced.DEFine on page 227 SCPI.CALCulate(Ch).FSIMulator.BALun.PARAmeter(Tr).BBALanced.DE Fine on page 226 SCPI.CALCulate(Ch).FSIMulator.BALun.PARAmeter(Tr). SSBALanced.DEFine on page 228
		Fixture Simulator			SCPI.CALCulate(Ch).FSIMulator.STATE on page 256
		Port Matching	C	C	SCPI.CALCulate(Ch).FSIMulator.SENDEd.PMCircuit. PORT(Pt).PARAmeters.C on page 245
				G	SCPI.CALCulate(Ch).FSIMulator.SENDEd.PMCircuit. PORT(Pt).PARAmeters.G on page 246
				L	SCPI.CALCulate(Ch).FSIMulator.SENDEd.PMCircuit. PORT(Pt).PARAmeters.L on page 247
				Port Matching	SCPI.CALCulate(Ch).FSIMulator.SENDEd.PMCircuit. STATE on page 251
				R	SCPI.CALCulate(Ch).FSIMulator.SENDEd.PMCircuit. PORT(Pt).PARAmeters.R on page 248
				Select Port	SCPI.CALCulate(Ch).FSIMulator.SENDEd.PMCircuit. PORT(Pt).TYPE on page 249
				Select Circuit	
				User File	SCPI.CALCulate(Ch).FSIMulator.SENDEd.PMCircuit. PORT(Pt).USER.FILename on page 250
		Port ZConversion	Port ZConversion	SCPI.CALCulate(Ch).FSIMulator.SENDEd.ZCONversion. STATE on page 255	
			Port n Z0	SCPI.CALCulate(Ch).FSIMulator.SENDEd.ZCONversion. PORT(Pt).Z0.R on page 254	

Table 7-2 Front panel key tree vs. COM objects correspondence table

Front panel key (Operation)				Corresponding COM object
[Analysis] (Continued)	Fixture Simulator (Continued)	Topology	Device	SCPI.CALCulate(Ch).FSIMulator.BALun.DEVice on page 214
			Port n (se) Port n (bal)	SCPI.CALCulate(Ch).FSIMulator.BALun.TOPology. SSBalanced.PPORts on page 233 SCPI.CALCulate(Ch).FSIMulator.BALun.TOPology. SBALanced.PPORts on page 232 SCPI.CALCulate(Ch).FSIMulator.BALun.TOPology. BBALanced.PPORts on page 230
			Property	SCPI.CALCulate(Ch).FSIMulator.BALun.TOPology. PROPerTy.STATe on page 231
	Gating		Center	SCPI.CALCulate(Ch).SElected.FILTer.GATE.TIME. CENTER on page 282
			Gating	SCPI.CALCulate(Ch).SElected.FILTer.GATE.TIME. STATE on page 286
			Shape	SCPI.CALCulate(Ch).SElected.FILTer.GATE.TIME. SHAPe on page 283
			Span	SCPI.CALCulate(Ch).SElected.FILTer.GATE.TIME. SPAN on page 284
			Start	SCPI.CALCulate(Ch).SElected.FILTer.GATE.TIME. START on page 285
			Stop	SCPI.CALCulate(Ch).SElected.FILTer.GATE.TIME. STOP on page 287
			Type	SCPI.CALCulate(Ch).SElected.FILTer.GATE.TIME. TYPE on page 288
	Limit Test	Edit Limit Line	Add / Delete / Clear Limit Table	SCPI.CALCulate(Ch).SElected.LIMit.DATA on page 302
			Export to CSV File	SCPI.MMEMory.STORe.LIMit on page 445
			Import from CSV File	SCPI.MMEMory.LOAD.LIMit on page 433
		Fail Sign	SCPI.DISPlay.FSIGn on page 387	
		Limit Line	SCPI.CALCulate(Ch).SElected.LIMit.DISPlay.STATe on page 304	
		Limit Line Offsets	Amplitude Offset	SCPI.CALCulate(Ch).SElected.LIMit.OFFSet.AMPLitude on page 306
			Marker -> Amplitude Offset	SCPI.CALCulate(Ch).SElected.LIMit.OFFSet.MARKer on page 307
			Stimulus Offset	SCPI.CALCulate(Ch).SElected.LIMit.OFFSet.STIMulus on page 308
		Limit Test	SCPI.CALCulate(Ch).SElected.LIMit.STATe on page 312	
	Ripple Limit	Edit Ripple Limit	Add / Delete / Clear Ripple Limit Table	SCPI.CALCulate(Ch).SElected.RLIMit.DATA on page 345
			Export to CSV File	SCPI.MMEMory.STORe.RLIMit on page 447
			Import from CSV File	SCPI.MMEMory.LOAD.RLIMit on page 435
		Fail Sign	SCPI.DISPlay.FSIGn on page 387	
Ripple Limit		SCPI.CALCulate(Ch).SElected.RLIMit.DISPlay.LINE on page 347		
Ripple Limit Test		SCPI.CALCulate(Ch).SElected.RLIMit.STATe on page 352		
Ripple Value		SCPI.CALCulate(Ch).SElected.RLIMit.DISPlay.VALue on page 349		
Ripple Band		SCPI.CALCulate(Ch).SElected.RLIMit.DISPlay.SELect on page 348		

Table 7-2 Front panel key tree vs. COM objects correspondence table

Front panel key (Operation)			Corresponding COM object	
[Analysis] (Continued)	Transform	Center	SCPI.CALCulate(Ch).SElected.TRANSform.TIME. CENTER on page 355	
		Set Freq Low Pass	SCPI.CALCulate(Ch).SElected.TRANSform.TIME. LPFRequency on page 358	
		Span	SCPI.CALCulate(Ch).SElected.TRANSform.TIME.SPAN on page 359	
		Start	SCPI.CALCulate(Ch).SElected.TRANSform.TIME.START on page 360	
		Stop	SCPI.CALCulate(Ch).SElected.TRANSform.TIME.STOP on page 364	
		Transform	SCPI.CALCulate(Ch).SElected.TRANSform.TIME.TYPE on page 365 SCPI.CALCulate(Ch).SElected.TRANSform.TIME.STATE on page 361	
		Type	SCPI.CALCulate(Ch).SElected.TRANSform.TIME. STIMulus on page 363	
		Window	Impulse Width	SCPI.CALCulate(Ch).SElected.TRANSform.TIME. IMPulse.WIDTH on page 356
			Kaiser Beta	SCPI.CALCulate(Ch).SElected.TRANSform.TIME. KBESsel on page 357
			Maximum	
Minimum				
Normal				
	Step Rise	SCPI.CALCulate(Ch).SElected.TRANSform.TIME.STEP.RTIME on page 362		
[Avg]	Ave Trigger		SCPI.TRIGger.SEquence.AVERAge on page 750	
	Averaging		SCPI.SENSE(Ch).AVERAge.STATE on page 466	
	Averaging Restart		SCPI.SENSE(Ch).AVERAge.CLEAR on page 465	
	Avg Factor		SCPI.SENSE(Ch).AVERAge.COUNT on page 465	
	Smo Aperture		SCPI.CALCulate(Ch).SElected.SMOothing.APERTure on page 353	
	Smoothing		SCPI.CALCulate(Ch).SElected.SMOothing.STATE on page 354	
	IF Bandwidth		SCPI.SENSE(Ch).BANDwidth.RESolution on page 467 SCPI.SENSE(Ch).BWIDTH.RESolution on page 468	
[Cal]	Cal Kit		SCPI.SENSE(Ch).CORRection.COLlect.CKIT.SELECT on page 500	
	Cal Trigger Source		SCPI.SENSE(Ch).CORRection.TRIGger.FREE.STATE on page 584	
	Calibrate	1-Port Cal	Cancel OK	SCPI.SENSE(Ch).CORRection.COLlect.CLEAR on page 521
			Done	SCPI.SENSE(Ch).CORRection.COLlect.SAVE on page 546
			Load	SCPI.SENSE(Ch).CORRection.COLlect.ACQUIRE.LOAD on page 481
			Open	SCPI.SENSE(Ch).CORRection.COLlect.ACQUIRE.OPEN on page 482
			Select Port	SCPI.SENSE(Ch).CORRection.COLlect.METHOD. SOLT1 on page 537
			Short	SCPI.SENSE(Ch).CORRection.COLlect.ACQUIRE. SHORT on page 482
	2-Port Cal	3-Port Cal	Cancel OK	SCPI.SENSE(Ch).CORRection.COLlect.CLEAR on page 521
			Done	SCPI.SENSE(Ch).CORRection.COLlect.SAVE on page 546
	3-Port Cal	4-Port Cal	Isolation (Optional)	SCPI.SENSE(Ch).CORRection.COLlect.ACQUIRE. ISOLation on page 480
			Overwrite	SCPI.SENSE(Ch).CORRection.COLlect.PARTIAL.SAVE on page 545
	Reflection	Port n Load	Port n Load	SCPI.SENSE(Ch).CORRection.COLlect.ACQUIRE.LOAD on page 481
			Port n Open	SCPI.SENSE(Ch).CORRection.COLlect.ACQUIRE.OPEN on page 482
			Port n Short	SCPI.SENSE(Ch).CORRection.COLlect.ACQUIRE. SHORT on page 482
	Select Ports	(2-Port Cal)	SCPI.SENSE(Ch).CORRection.COLlect.METHOD. SOLT2 on page 538	
		(3-Port Cal)	SCPI.SENSE(Ch).CORRection.COLlect.METHOD. SOLT3 on page 539	
(4-Port Cal)		SCPI.SENSE(Ch).CORRection.COLlect.METHOD. SOLT4 on page 540		
Transmission		SCPI.SENSE(Ch).CORRection.COLlect.ACQUIRE.THROUGH on page 484		

COM Object Reference
List by Front Panel Key

Table 7-2 Front panel key tree vs. COM objects correspondence table

Front panel key (Operation)			Corresponding COM object			
[Cal] (Continued)	Calibrate (Continued)	2-Port TRL	Cancel	OK	SCPI.SENSE(Ch).CORRection.COLLECT.CLEAr on page 521	
			Done		SCPI.SENSE(Ch).CORRection.COLLECT.SAVE on page 546	
		3-Port TRL	Line/Match		SCPI.SENSE(Ch).CORRection.COLLECT.ACQUIRE.TRLLine on page 485	
			Reflect	Port x Reflect	SCPI.SENSE(Ch).CORRection.COLLECT.ACQUIRE. TRLReflect on page 486	
		4-Port TRL	Select Ports	(2-Port TRL)		SCPI.SENSE(Ch).CORRection.COLLECT.METHod.TRL2 on page 541
				(3-Port TRL)		SCPI.SENSE(Ch).CORRection.COLLECT.METHod.TRL3 on page 542
				(4-Port TRL)		SCPI.SENSE(Ch).CORRection.COLLECT.METHod.TRL4 on page 543
			Thru/Line		SCPI.SENSE(Ch).CORRection.COLLECT.ACQUIRE.TRLThru on page 487	
		Adapter Removal	Adapter Length		SCPI.SENSE(Ch).CORRection.COLLECT.ADAPter(Pt).LENGth on page 488	
			Cal Kit		SCPI.SENSE(Ch).CORRection.COLLECT.CKIT.SELect on page 500	
	Cancel		OK	SCPI.SENSE(Ch).CORRection.COLLECT.CLEAr on page 521		
	Done		SCPI.SENSE(Ch).CORRection.COLLECT.SAVE on page 546			
	Load		SCPI.SENSE(Ch).CORRection.COLLECT.ACQUIRE.LOAD on page 481			
	Open		SCPI.SENSE(Ch).CORRection.COLLECT.ACQUIRE.OPEN on page 482			
	Select Port		SCPI.SENSE(Ch).CORRection.COLLECT.METHod.ERESponse on page 535			
	Short		SCPI.SENSE(Ch).CORRection.COLLECT.ACQUIRE. SHORt on page 482			
	Enhanced Response	Cancel	OK	SCPI.SENSE(Ch).CORRection.COLLECT.CLEAr on page 521		
		Done		SCPI.SENSE(Ch).CORRection.COLLECT.SAVE on page 546		
		Isolation (Optional)		SCPI.SENSE(Ch).CORRection.COLLECT.ACQUIRE. ISOLation on page 480		
		Load		SCPI.SENSE(Ch).CORRection.COLLECT.ACQUIRE.LOAD on page 481		
		Open		SCPI.SENSE(Ch).CORRection.COLLECT.ACQUIRE.OPEN on page 482		
		Select Port		SCPI.SENSE(Ch).CORRection.COLLECT.METHod.ERESponse on page 535		
		Short		SCPI.SENSE(Ch).CORRection.COLLECT.ACQUIRE. SHORt on page 482		
		Thru		SCPI.SENSE(Ch).CORRection.COLLECT.ACQUIRE.THRU on page 484		
	Response (Open)	Cancel	OK	SCPI.SENSE(Ch).CORRection.COLLECT.CLEAr on page 521		
		Done		SCPI.SENSE(Ch).CORRection.COLLECT.SAVE on page 546		
		Load (Optional)		SCPI.SENSE(Ch).CORRection.COLLECT.ACQUIRE.LOAD on page 481		
		Open		SCPI.SENSE(Ch).CORRection.COLLECT.ACQUIRE.OPEN on page 482		
		Select Port		SCPI.SENSE(Ch).CORRection.COLLECT.METHod. RESPonse.OPEN on page 536		
	Response (Short)	Cancel	OK	SCPI.SENSE(Ch).CORRection.COLLECT.CLEAr on page 521		
		Done		SCPI.SENSE(Ch).CORRection.COLLECT.SAVE on page 546		
		Load (Optional)		SCPI.SENSE(Ch).CORRection.COLLECT.ACQUIRE.LOAD on page 481		
		Select Port		SCPI.SENSE(Ch).CORRection.COLLECT.METHod. RESPonse.SHORt on page 536		
		Short		SCPI.SENSE(Ch).CORRection.COLLECT.ACQUIRE. SHORt on page 482		

Table 7-2 Front panel key tree vs. COM objects correspondence table

Front panel key (Operation)				Corresponding COM object		
[Cal] (Continued)	Calibrate (Continued)	Response (Thru)	Cancel	OK	SCPI.SENSE(Ch).CORREction.COLLECT.CLEAR on page 521	
			Done		SCPI.SENSE(Ch).CORREction.COLLECT.SAVE on page 546	
			Isolation (Optional)		SCPI.SENSE(Ch).CORREction.COLLECT.ACQUIRE. ISOLation on page 480	
			Select Ports		SCPI.SENSE(Ch).CORREction.COLLECT.METHOD. RESPONSE.THRU on page 537	
			Thru		SCPI.SENSE(Ch).CORREction.COLLECT.ACQUIRE.THRU on page 484	
	Clear	OK		SCPI.SENSE(Ch).CORREction.CLEAR on page 469		
	Correction				SCPI.SENSE(Ch).CORREction.STATE on page 583	
	ECal	1-Port Cal		SCPI.SENSE(Ch).CORREction.COLLECT.ECAL.SOLT1 on page 527		
		2-Port Cal		SCPI.SENSE(Ch).CORREction.COLLECT.ECAL.SOLT2 on page 528		
		3-Port Cal		SCPI.SENSE(Ch).CORREction.COLLECT.ECAL.SOLT3 on page 529		
		4-Port Cal		SCPI.SENSE(Ch).CORREction.COLLECT.ECAL.SOLT4 on page 530		
		Characterization				SCPI.SENSE(Ch).CORREction.COLLECT.ECAL.UCHAR on page 532
		Characterization Info				N/A
		Confidence Check				SCPI.SENSE(Ch).CORREction.COLLECT.ECAL.CHECK. ACQUIRE on page 522
		Enhanced Response				SCPI.SENSE(Ch).CORREction.COLLECT.ECAL.ERESPONSE on page 523
Isolation				SCPI.SENSE(Ch).CORREction.COLLECT.ECAL.ISOLation.STATE on page 524		
Orientation				SCPI.SENSE(Ch).CORREction.COLLECT.ECAL.ORIENTATION .STATE on page 525		
	Port n	Port n	SCPI.SENSE(Ch).CORREction.COLLECT.ECAL.PATH(Cpt) on page 526			
Thru Cal				SCPI.SENSE(Ch).CORREction.COLLECT.ECAL.THRU on page 531		
Unknown Thru				SCPI.SENSE(Ch).CORREction.COLLECT.ECAL.UTHRU.STATE on page 533		

COM Object Reference
List by Front Panel Key

Table 7-2 Front panel key tree vs. COM objects correspondence table

Front panel key (Operation)			Corresponding COM object				
[Cal] (Continued)	Mixer/Converter Calibration	Clear	OK		SCPI.SENSE(Ch).CORRection.OFFSet.CLEar on page 566		
		Scalar Cal (Manual)	Cancel	OK		SCPI.SENSE(Ch).CORRection.OFFSet.COLLEct.CLEar on page 573	
			Done			SCPI.SENSE(Ch).CORRection.OFFSet.COLLEct.SAVE on page 578	
			Power Meter	Port x @ Freq y			SCPI.SENSE(Ch).CORRection.OFFSet.COLLEct.ACQUIRE.PMETer on page 569
				Use Sensor			SCPI.SENSE(Ch).CORRection.OFFSet.COLLEct.ACQUIRE.PMETer on page 569
			Reflect ion	Port x @ Freq y (Broadband)			SCPI.SENSE(Ch).CORRection.OFFSet.COLLEct.ACQUIRE.LOAD on page 567
				Port x @ Freq y (Open)			SCPI.SENSE(Ch).CORRection.OFFSet.COLLEct.ACQUIRE.OPEN on page 568
				Port x @ Freq y (Short)			SCPI.SENSE(Ch).CORRection.OFFSet.COLLEct.ACQUIRE.SHORT on page 571
			Select Ports	2-1 (fwd)			SCPI.SENSE(Ch).CORRection.OFFSet.COLLEct.METHod.SMIX2 on page 576
				Port 1			SCPI.SENSE(Ch).CORRection.OFFSet.COLLEct.METHod.SOLT1 on page 577
			Trans mission	Thru x-y @ Freq z (Thru)			SCPI.SENSE(Ch).CORRection.OFFSet.COLLEct.ACQUIRE.THRU on page 572
		Scalar Cal (ECal)	Cancel	OK		SCPI.SENSE(Ch).CORRection.OFFSet.COLLEct.CLEar on page 573	
			Ecal & Done				SCPI.SENSE(Ch).CORRection.OFFSet.COLLEct.ECAL.SMIX2 on page 574 SCPI.SENSE(Ch).CORRection.OFFSet.COLLEct.ECAL.SOLT1 on page 575
			Power Meter	Port x @ Freq y			N/A
	Use Sensor					N/A	
	Select Ports		2-1 (fwd)			N/A	
			Port 1			N/A	

Table 7-2 Front panel key tree vs. COM objects correspondence table

Front panel key (Operation)				Corresponding COM object			
[Cal] (Continued)	Modify Cal Kit	Define STDs	1. XXXX to 21. XXXX	Arb. Impedance	SCPI.SENSE(Ch).CORREction.COLLECT.CKIT.STAN(Std).ARBITrary on page 502		
				C0	SCPI.SENSE(Ch).CORREction.COLLECT.CKIT.STAN(Std).C0 on page 503		
				C1	SCPI.SENSE(Ch).CORREction.COLLECT.CKIT.STAN(Std).C1 on page 504		
				C2	SCPI.SENSE(Ch).CORREction.COLLECT.CKIT.STAN(Std).C2 on page 505		
				C3	SCPI.SENSE(Ch).CORREction.COLLECT.CKIT.STAN(Std).C3 on page 506		
				L0	SCPI.SENSE(Ch).CORREction.COLLECT.CKIT.STAN(Std).L0 on page 511		
				L1	SCPI.SENSE(Ch).CORREction.COLLECT.CKIT.STAN(Std).L1 on page 512		
				L2	SCPI.SENSE(Ch).CORREction.COLLECT.CKIT.STAN(Std).L2 on page 513		
				L3	SCPI.SENSE(Ch).CORREction.COLLECT.CKIT.STAN(Std).L3 on page 514		
				Label	SCPI.SENSE(Ch).CORREction.COLLECT.CKIT.STAN(Std).LABel on page 515		
				Min. Frequency	SCPI.SENSE(Ch).CORREction.COLLECT.CKIT.STAN(Std).FMINimum on page 510		
				Max. Frequency	SCPI.SENSE(Ch).CORREction.COLLECT.CKIT.STAN(Std).FMAXimum on page 509		
				Media	SCPI.SENSE(Ch).CORREction.COLLECT.CKIT.STAN(Std).CHARacter on page 507		
				Offset Delay	SCPI.SENSE(Ch).CORREction.COLLECT.CKIT.STAN(Std).DELay on page 508		
				Offset Loss	SCPI.SENSE(Ch).CORREction.COLLECT.CKIT.STAN(Std).LOSS on page 516		
				Offset Z0	SCPI.SENSE(Ch).CORREction.COLLECT.CKIT.STAN(Std).Z0 on page 518		
				STD Type	SCPI.SENSE(Ch).CORREction.COLLECT.CKIT.STAN(Std).TYPE on page 517		
					Export Cal Kit...		SCPI.MMEMory.STORE.CKIT(Ckit) on page 442
					Import Cal Kit...		SCPI.MMEMory.LOAD.CKIT(Ckit) on page 432
					Label Kit		SCPI.SENSE(Ch).CORREction.COLLECT.CKIT.LABel on page 489
	Specify CLSs		Load	SCPI.SENSE(Ch).CORREction.COLLECT.CKIT.ORDer. LOAD(Cpt) on page 490			
			Open	SCPI.SENSE(Ch).CORREction.COLLECT.CKIT.ORDer. OPEN(Cpt) on page 492			
			Short	SCPI.SENSE(Ch).CORREction.COLLECT.CKIT.ORDer. SHORt(Cpt) on page 494			
			Sub Class	SCPI.SENSE(Ch).CORREction.COLLECT.CKIT.ORDer. SELEct on page 493			
			Thru	SCPI.SENSE(Ch).CORREction.COLLECT.CKIT.ORDer. THRU(Cpt_m,Cpt_n) on page 495			
			TRL Line/Match	SCPI.SENSE(Ch).CORREction.COLLECT.CKIT.ORDer. TRLLine(Cpt_m,Cpt_n) on page 497			
			TRL Reflect	SCPI.SENSE(Ch).CORREction.COLLECT.CKIT.ORDer. TRLReflect on page 498			
			TRL Thru	SCPI.SENSE(Ch).CORREction.COLLECT.CKIT.ORDer. TRLThru(Cpt_m,Cpt_n) on page 499			

Table 7-2 Front panel key tree vs. COM objects correspondence table

Front panel key (Operation)			Corresponding COM object			
[Cal] (Continued)	Port Extensio ns	Auto Port Extensi on	Adjust Mismatch		SCPI.SENSE(Ch).CORRection.EXTension.AUTO.DCOFset on page 549	
			Include Loss		SCPI.SENSE(Ch).CORRection.EXTension.AUTO.LOSS on page 550	
			Measu re OPEN	All		SCPI.SENSE(Ch).CORRection.EXTension.AUTO.MEASure on page 551
				Port 1		
				Port 2		
				Port 3		
				Port 4		
			Measu re Short	All		SCPI.SENSE(Ch).CORRection.EXTension.AUTO.MEASure on page 551
				Port 1		
				Port 2		
				Port 3		
				Port 4		
			Metho d	Active Marker		SCPI.SENSE(Ch).CORRection.EXTension.AUTO.CONFig on page 548
				Current Span		
				User Span		
				User Span Start		SCPI.SENSE(Ch).CORRection.EXTension.AUTO.START on page 554
				User Span Stop		SCPI.SENSE(Ch).CORRection.EXTension.AUTO.STOP on page 555
		Select Ports	Port 1		SCPI.SENSE(Ch).CORRection.EXTension.AUTO.PORT(Pt) on page 552	
			Port 2			
			Port 3			
			Port 4			
		Extension Port 1			SCPI.SENSE(Ch).CORRection.EXTension.PORT(Pt).TIME on page 563	
		Extension Port 2				
		Extension Port 3				
		Extension Port 4				
		Extensions			SCPI.SENSE(Ch).CORRection.EXTension.STATE on page 564	
		Loss	Freq1		SCPI.SENSE(Ch).CORRection.EXTension.PORT(Pt).FREQUENCY(Fq) on page 556	
Freq2						
Loss at DC			SCPI.SENSE(Ch).CORRection.EXTension.PORT(Pt).LDC on page 560			
Loss1			SCPI.SENSE(Ch).CORRection.EXTension.PORT(Pt).LOSS(Loss) on page 561			
Loss2						
Select Port	Port 1		N/A			
	Port 2					
	Port 3					
	Port 4					

Table 7-2 Front panel key tree vs. COM objects correspondence table

Front panel key (Operation)		Corresponding COM object			
[Cal] (Continued)	Power Calibration	Abort		SCPI.ABORT on page 208	
		Correction		SCPI.SOURCE(Ch).POWER.PORT(Pt).CORREction.STATE on page 661	
		Loss Compen	Add / Delete / Clear Loss Table		SCPI.SOURCE(Ch).POWER.PORT(Pt).CORREction. COLLect.TABLE.LOSS.DATA on page 658
			Compensation		SCPI.SOURCE(Ch).POWER.PORT(Pt).CORREction. COLLect.TABLE.LOSS.STATE on page 659
			Export to CSV File		SCPI.MMEMory.STORE.PLOSS(Pt) on page 446
			Import from CSV File		SCPI.MMEMory.LOAD.PLOSS(Pt) on page 434
		Num of Readings		SCPI.SOURCE(Ch).POWER.PORT(Pt).CORREction. COLLect.AVERAge.COUNT on page 653	
		Select Port		N/A	
		Sensor A Settings	Add / Delete / Clear Factor Table		SCPI.SOURCE.POWER.PORT.CORREction.COLLect. TABLE.ASENSOR.DATA on page 656
			Export to CSV File		SCPI.MMEMory.STORE.ASCFactor on page 439
			Import from CSV File		SCPI.MMEMory.LOAD.ASCFactor on page 429
			Ref Cal Factor		SCPI.SOURCE.POWER.PORT.CORREction.COLLect.ASENSOR.RCFactor on page 652
		Sensor B Settings	Add / Delete / Clear Factor Table		SCPI.SOURCE.POWER.PORT.CORREction.COLLect. TABLE.BSENSOR.DATA on page 657
			Export to CSV File		SCPI.MMEMory.STORE.BSCFactor on page 440
			Import from CSV File		SCPI.MMEMory.LOAD.BSCFactor on page 430
	Ref Cal Factor		SCPI.SOURCE.POWER.PORT.CORREction.COLLect.BSENSOR.RCFactor on page 654		
	Take Cal Sweep		SCPI.SOURCE(Ch).POWER.PORT(Pt).CORREction. COLLect.ACQUIRE on page 651		
	Tolerance		SCPI.SOURCE.POWER.PORT.CORREction.COLLect. NTOLerance on page 655		
	Use Sensor		N/A		
	Property		SCPI.SENSE(Ch).CORREction.PROPERty on page 579		
	Receiver Calibration	Correction		SCPI.SENSE(Ch).CORREction.RECEiver(Pt).STATE on page 581	
		Select Port		SCPI.SENSE(Ch).CORREction.RECEiver(Pt).COLLect.ACQUIRE on page 580	
		Source Port			
Take Cal Sweep					
Set Z0		SCPI.SENSE(Ch).CORREction.IMPedance.INPut.MAGNitude on page 565			
Velocity Factor		SCPI.SENSE(Ch).CORREction.RVELOCITY.COAX on page 582			
[Center]		SCPI.SENSE(Ch).FREQUENCY.CENTer on page 587 SCPI.SOURCE(Ch).POWER.CENTer on page 647			
[Channel Prev]		SCPI.DISPlay.WINDow(Ch).ACTivate on page 395			
[Channel Max]		SCPI.DISPlay.MAXimize on page 389			
[Channel Next]		SCPI.DISPlay.WINDow(Ch).ACTivate on page 395			

Table 7-2 Front panel key tree vs. COM objects correspondence table

Front panel key (Operation)		Corresponding COM object
[Display]	Allocate Channels	SCPI.DISPlay.SPLit on page 391
	Allocate Traces	SCPI.DISPlay.WINDow(Ch).SPLit on page 400
	Data - > Mem	SCPI.CALCulate(Ch).SELected.MATH.MEMorize on page 340
	Data Math	SCPI.CALCulate(Ch).SELected.MATH.FUNcTION on page 339
	Display	SCPI.DISPlay.WINDow(Ch).TRACe(Tr).STATe on page 406 SCPI.DISPlay.WINDow(Ch).TRACe(Tr).MEMory. STATe on page 405
	Edit Title Label	SCPI.DISPlay.WINDow(Ch).TITLe.DATA on page 401
	Equation	SCPI.CALCulate(Ch).SELected.EQUation.STATe on page 279
	Equation Editor	SCPI.CALCulate(Ch).SELected.EQUation.TEXT on page 280
	Frequency	SCPI.DISPlay.ANNotation.FREQUency.STATe on page 377
	Graticule Label	SCPI.DISPlay.WINDow(Ch).LABel on page 398
	Invert Color	SCPI.DISPlay.IMAGe on page 388
	Num of Traces	SCPI.CALCulate(Ch).PARAmeter.COUNT on page 257
	Title Label	SCPI.DISPlay.WINDow(Ch).TITLe.STATe on page 402
	Update	SCPI.DISPlay.ENABLE on page 386
[Format]	SCPI.CALCulate(Ch).SELected.FORMat on page 289	
[Macro Break]	N/A	
[Macro Run]	N/A	
[Macro Setup]	Clear Echo	SCPI.DISPlay.ECHO.CLEar on page 385
	Close Editor	N/A
	Continue	N/A
	Echo Window	SCPI.DISPlay.TABLe.STATe on page 393 SCPI.DISPlay.TABLe.TYPE on page 394
	Load & Run	N/A
	Load Project	N/A
	New Project	N/A
	Preset User Menu	UserMenu.PRESet on page 204
	Save Project	N/A
	Select Macro	N/A
	Stop	N/A
	User Menu	UserMenu.Press(Key_id) on page 205
	VBA Editor	N/A

Table 7-2 Front panel key tree vs. COM objects correspondence table

Front panel key (Operation)		Corresponding COM object	
[Marker]	Clear Marker Menu	SCPI.CALCulate(Ch).SElected.MARKer(Mk).STATE on page 336	
	Marker 1 to Marker 4	SCPI.CALCulate(Ch).SElected.MARKer(Mk).STATE on page 336 SCPI.CALCulate(Ch).SElected.MARKer(Mk).ACTivate on page 313 SCPI.CALCulate(Ch).SElected.MARKer(Mk).X on page 337	
	Marker - > Ref Marker	N/A	
	More Markers	Marker 5 to Marker 9	SCPI.CALCulate(Ch).SElected.MARKer(Mk).STATE on page 336 SCPI.CALCulate(Ch).SElected.MARKer(Mk).ACTivate on page 313 SCPI.CALCulate(Ch).SElected.MARKer(Mk).X on page 337
	Ref Marker	SCPI.CALCulate(Ch).SElected.MARKer(Mk).STATE on page 336 SCPI.CALCulate(Ch).SElected.MARKer(Mk).ACTivate on page 313 SCPI.CALCulate(Ch).SElected.MARKer(Mk).X on page 337 SCPI.CALCulate(Ch).SElected.MARKer.REFerence. STATE on page 334	
	Ref Marker Mode	SCPI.CALCulate(Ch).SElected.MARKer.REFerence. STATE on page 334	
	Annotati on Options	Active Only	SCPI.DISPlay.WINDow(Ch).ANNotation.MARKer.SINGle. STATE on page 397
		Align	SCPI.DISPlay.WINDow(Ch).ANNotation.MARKer.ALIGn. STATE on page 396
		Marker Info X Pos	SCPI.DISPlay.WINDow(Ch).TRACe(Tr).ANNotation.MARKer.POSition.X on page 403
		Marker Info Y Pos	SCPI.DISPlay.WINDow(Ch).TRACe(Tr).ANNotation.MARKer.POSition.Y on page 404
[Marker Func]	Couple	SCPI.CALCulate(Ch).SElected.MARKer.COUPle on page 317	
	Discrete	SCPI.CALCulate(Ch).SElected.MARKer(Mk).DISCrete on page 318	
	Marker Table	SCPI.DISPlay.TABLe.STATE on page 393 SCPI.DISPlay.TABLe.TYPE on page 394	
	Marker - > Center	SCPI.CALCulate(Ch).SElected.MARKer(Mk).SET on page 335	
	Marker - > Delay		
	Marker - > Reference		
	Marker - > Start		
	Marker - > Stop		
Statistics	SCPI.CALCulate(Ch).SElected.MSTatistics.STATE on page 343 SCPI.CALCulate(Ch).SElected.MSTatistics.DATA on page 342		

COM Object Reference
List by Front Panel Key

Table 7-2 Front panel key tree vs. COM objects correspondence table

Front panel key (Operation)		Corresponding COM object	
[Marker Search]	Bandwidth	SCPI.CALCulate(Ch).SElected.MARKer.BWIDth.STATE on page 315 SCPI.CALCulate(Ch).SElected.MARKer(Mk).BWIDth. DATA on page 314	
	Bandwidth Value	SCPI.CALCulate(Ch).SElected.MARKer(Mk).BWIDth. THReshold on page 316	
	Max	SCPI.CALCulate(Ch).SElected.MARKer(Mk).FUNctIon. TYPE on page 329	
	Min	SCPI.CALCulate(Ch).SElected.MARKer(Mk).FUNctIon. EXECute on page 323	
	Notch	SCPI.CALCulate(Ch).SElected.MARKer.NOTCh.STATE on page 332 SCPI.CALCulate(Ch).SElected.MARKer(Mk).NOTCh. DATA on page 331	
	Notch Value	SCPI.CALCulate(Ch).SElected.MARKer(Mk).NOTCh. THReshold on page 333	
	Peak	Peak Excursion	SCPI.CALCulate(Ch).SElected.MARKer(Mk).FUNctIon. PEXCursion on page 324
		Peak Polarity	SCPI.CALCulate(Ch).SElected.MARKer(Mk).FUNctIon. PPOLarity on page 325
		Search Left	SCPI.CALCulate(Ch).SElected.MARKer(Mk).FUNctIon. TYPE on page 329
		Search Peak	SCPI.CALCulate(Ch).SElected.MARKer(Mk).FUNctIon. EXECute on page 323
		Search Right	SCPI.CALCulate(Ch).SElected.MARKer(Mk).FUNctIon. EXECute on page 323
	Search Range	Couple	SCPI.CALCulate(Ch).SElected.MARKer.FUNctIon. DOMain.COUPle on page 319
		Search Range	SCPI.CALCulate(Ch).SElected.MARKer.FUNctIon. DOMain.STARt on page 321
		Start	SCPI.CALCulate(Ch).SElected.MARKer.FUNctIon. DOMain.STARt on page 320
		Stop	SCPI.CALCulate(Ch).SElected.MARKer.FUNctIon. DOMain.STOP on page 322
	Target	Search Left	SCPI.CALCulate(Ch).SElected.MARKer(Mk).FUNctIon. TYPE on page 329
		Search Right	SCPI.CALCulate(Ch).SElected.MARKer(Mk).FUNctIon. EXECute on page 323
		Search Target	SCPI.CALCulate(Ch).SElected.MARKer(Mk).FUNctIon. EXECute on page 323
		Target Transition	SCPI.CALCulate(Ch).SElected.MARKer(Mk).FUNctIon. TTRansiion on page 328
		Target Value	SCPI.CALCulate(Ch).SElected.MARKer(Mk).FUNctIon. TARGeT on page 326
Tracking		SCPI.CALCulate(Ch).SElected.MARKer(Mk).FUNctIon. TRACKing on page 327	
[Meas]	S11 to S44 (SSS11 to SMRR2)	SCPI.CALCulate(Ch).PARAmeter(Tr).DEFine on page 258 SCPI.CALCulate(Ch).FSIMulator.BALun.PARAmeter(Tr).SBALanced.DEFinE on page 227 SCPI.CALCulate(Ch).FSIMulator.BALun.PARAmeter(Tr).BBALanced.DEFinE on page 226 SCPI.CALCulate(Ch).FSIMulator.BALun.PARAmeter(Tr).SSBALanced.DEFinE on page 228	
	Absolute A(1) to R4(4)	SCPI.CALCulate(Ch).PARAmeter(Tr).DEFine on page 258 SCPI.CALCulate(Ch).PARAmeter(Tr).SElect on page 259 SCPI.CALCulate(Ch).PARAmeter(Tr).SPORt on page 260	
[Preset]	OK	SCPI.SYSTem.PRESet on page 743	

Table 7-2 Front panel key tree vs. COM objects correspondence table

Front panel key (Operation)		Corresponding COM object	
[Save/ Recall]	Channel/Trace	SCPI.MMEMory.STORe.SALL on page 448	
	Explorer	N/A	
	Recall by File Name	SCPI.MMEMory.LOAd.STATe on page 437	
	Recall Channel	SCPI.MMEMory.LOAd.CHANnel.STATe on page 431	
	Recall State	SCPI.MMEMory.LOAd.STATe on page 437	
	Save Channel	Clear States	SCPI.MMEMory.STORe.CHANnel.CLEAr on page 441
		State A - State D	SCPI.MMEMory.STORe.CHANnel.STATe on page 441
	Save Snp	Snp Format	SCPI.MMEMory.STORe.SNP.FORMat on page 451
		S1p	SCPI.MMEMory.STORe.SNP.TYPE.S1P on page 452
			SCPI.MMEMory.STORe.SNP.DATA on page 450
		S2p	SCPI.MMEMory.STORe.SNP.TYPE.S2P on page 453
			SCPI.MMEMory.STORe.SNP.DATA on page 450
	S3p	SCPI.MMEMory.STORe.SNP.TYPE.S3P on page 454 SCPI.MMEMory.STORe.SNP.DATA on page 450	
	S4p	SCPI.MMEMory.STORe.SNP.TYPE.S4P on page 455	
SCPI.MMEMory.STORe.SNP.DATA on page 450			
Save State	SCPI.MMEMory.STORe.STATe on page 456		
Save Trace Data	SCPI.MMEMory.STORe.FDATA on page 443		
Save Type	SCPI.MMEMory.STORe.STYPE on page 457		
[Scale]	Auto Scale	SCPI.DISPlay.WINDow(Ch).TRACe(Tr).Y.SCALe.AUTO on page 406	
	Auto Scale All	N/A	
	Divisions	SCPI.DISPlay.WINDow(Ch).Y.SCALe.DIVisions on page 411	
	Electrical Delay	Electrical Delay	SCPI.CALCulate(Ch).SELected.CORRection.EDELay. TIME on page 272
		Cutoff Frequency	SCPI.CALCulate(Ch).SELected.CORRection.EDELay. WGCutoff on page 273
		Media	SCPI.CALCulate(Ch).SELected.CORRection.EDELay. MEDIUM on page 271
	Marker -> Reference	SCPI.CALCulate(Ch).SELected.MARKer(Mk).SET on page 335	
	Phase Offset	SCPI.CALCulate(Ch).SELected.CORRection.OFFSet. PHASe on page 274	
	Reference Position	SCPI.DISPlay.WINDow(Ch).TRACe(Tr).Y.SCALe. RPOSITION on page 409	
	Reference Value	SCPI.DISPlay.WINDow(Ch).TRACe(Tr).Y.SCALe. RLEVEL on page 408	
Scale/Div	SCPI.DISPlay.WINDow(Ch).TRACe(Tr).Y.SCALe. PDIVision on page 407		
[Softkey On/Off]	SCPI.DISPlay.SKEY.STATE on page 390		
[Span]	SCPI.SENSE(Ch).FREQUency.SPAN on page 591		
	SCPI.SOURce(Ch).POWER.SPAN on page 664		
[Start]	SCPI.SENSE(Ch).FREQUency.START on page 592		
	SCPI.SOURce(Ch).POWER.START on page 665		
[Stop]	SCPI.SENSE(Ch).FREQUency.STOP on page 593		
	SCPI.SOURce(Ch).POWER.STOP on page 666		

Table 7-2 Front panel key tree vs. COM objects correspondence table

Front panel key (Operation)		Corresponding COM object		
[Sweep Setup]	Edit Segment Table		SCPI.SENSE(Ch).SEGMENT.DATA on page 629	
	Edit Segment Table	Export to CSV File	SCPI.MMEmory.STORE.SEGMENT on page 449	
		Import from CSV File	SCPI.MMEmory.LOAD.SEGMENT on page 436	
	Frequency Offset	Avoid Spurious		SCPI.SENSE(Ch).OFFSET.ASPURIOUS on page 609
		External Source	Control	SCPI.SENSE(Ch).OFFSET.LOCAL.CONTROL.STATE on page 610
			Divisor	SCPI.SENSE(Ch).OFFSET.LOCAL.FREQUENCY.DIVISOR on page 612
			LO Frequency	SCPI.SENSE(Ch).OFFSET.LOCAL.STATE on page 620
			Multiplier	SCPI.SENSE(Ch).OFFSET.LOCAL.FREQUENCY.MULTIPLIER on page 613
			Offset	SCPI.SENSE(Ch).OFFSET.LOCAL.FREQUENCY.OFFSET on page 614
			Control	N/A
			Start	SCPI.SENSE(Ch).OFFSET.LOCAL.FREQUENCY.START on page 615
			Stop	SCPI.SENSE(Ch).OFFSET.LOCAL.FREQUENCY.STOP on page 616
			Power	SCPI.SENSE(Ch).OFFSET.LOCAL.POWER.LEVEL.IMMEDIATE.AMPLITUDE on page 617
			Slope[x dB/GHz]	SCPI.SENSE(Ch).OFFSET.LOCAL.POWER.LEVEL.SLOPE.DATA on page 618
		Slope[ON/OFF]	SCPI.SENSE(Ch).OFFSET.LOCAL.POWER.LEVEL.SLOPE.STATE on page 619	
		Frequency Offset		SCPI.SENSE(Ch).OFFSET.STATE on page 627
		Port 1 to Port 4	Divisor	SCPI.SENSE(Ch).OFFSET.PORT(Pt).FREQUENCY.DIVISOR on page 622
			Multiplier	SCPI.SENSE(Ch).OFFSET.PORT(Pt).FREQUENCY.MULTIPLIER on page 623
	Offset		SCPI.SENSE(Ch).OFFSET.PORT(Pt).FREQUENCY.OFFSET on page 624	
	Start		SCPI.SENSE(Ch).OFFSET.PORT(Pt).FREQUENCY.START on page 625	
	Stop		SCPI.SENSE(Ch).OFFSET.PORT(Pt).FREQUENCY.STOP on page 626	
	X-Axis		SCPI.CALCULATE(Ch).SELECTED.MIXER.XAXIS on page 341 SCPI.CALCULATE(Ch).SELECTED.OFFSET.XAXIS on page 344	
	Points		SCPI.SENSE(Ch).SWEPT.POINTS on page 635	
	Power	CW Freq		SCPI.SENSE(Ch).FREQUENCY.CW on page 588 SCPI.SENSE(Ch).FREQUENCY.FIXED on page 590
		Port Couple		SCPI.SOURCE(Ch).POWER.PORT.COUPLE on page 662
		Port Power		SCPI.SOURCE(Ch).POWER.PORT(Pt).LEVEL.IMMEDIATE.AMPLITUDE on page 663
		Power		SCPI.SOURCE(Ch).POWER.LEVEL.IMMEDIATE.AMPLITUDE on page 648
		Power Ranges		SCPI.SOURCE(Ch).POWER.ATTENUATION.DATA on page 644
		Auto Range		SCPI.SOURCE(Ch).POWER.ATTENUATION.AUTO on page 645
		RF Out		SCPI.OUTPUT.STATE on page 458
		Slope [ON/OFF]		SCPI.SOURCE(Ch).POWER.LEVEL.SLOPE.STATE on page 650
		Slope [xx dB/GHz]		SCPI.SOURCE(Ch).POWER.LEVEL.SLOPE.DATA on page 649
Segment Display		SCPI.DISPLAY.WINDOW(Ch).X.SPACING on page 410		
Sweep Delay		SCPI.SENSE(Ch).SWEPT.DELAY on page 633		
Sweep Mode		SCPI.SENSE(Ch).SWEPT.GENERATION on page 634		
Sweep Time		SCPI.SENSE(Ch).SWEPT.TIME.DATA on page 637 SCPI.SENSE(Ch).SWEPT.TIME.AUTO on page 636		
Sweep Type		SCPI.SENSE(Ch).SWEPT.TYPE on page 638		

Table 7-2 Front panel key tree vs. COM objects correspondence table

Front panel key (Operation)		Corresponding COM object	
[System]	Abort Printing	SCPI.HCOPy.ABORt on page 415	
	Backlight	SCPI.SYSTem.BACKlight on page 725	
	Dump Screen Image	SCPI.MMEMory.STORe.IMAGe on page 444	
E5091A Setup	Control Lines	SCPI.SENSE(Ch).MULTiplexer(Id).TSET9.OUTPut.DATA on page 604	
	E5091A Control	SCPI.SENSE(Ch).MULTiplexer(Id).STATe on page 603	
	E5091A Property	SCPI.SENSE(Ch).MULTiplexer(Id).DISPlay.STATe on page 596	
	Port 1	SCPI.SENSE(Ch).MULTiplexer(Id).TSET9.PORT1 on page 605	
	Port 2	SCPI.SENSE(Ch).MULTiplexer(Id).TSET9.PORT2 on page 606	
	Port 3	SCPI.SENSE(Ch).MULTiplexer(Id).TSET9.PORT3 on page 607	
	Port 4	SCPI.SENSE(Ch).MULTiplexer(Id).TSET9.PORT4 on page 608	
	Select ID	N/A	
		Firmware Revision	SCPI.IEEE4882.IDN on page 419
	Invert Image	SCPI.HCOPy.IMAGe on page 415	
Misc Setup	Beeper	Beep Complete	SCPI.SYSTem.BEEPPer.COMPLete.STATe on page 726
		Beep Warning	SCPI.SYSTem.BEEPPer.WARNing.STATe on page 727
		Test Beep Complete	SCPI.SYSTem.BEEPPer.COMPLete.IMMEdiate on page 726
		Test Beep Warning	SCPI.SYSTem.BEEPPer.WARNing.IMMEdiate on page 727
		Channel/Trace Setup	N/A
	Clock Setup	Set Date and Time	SCPI.SYSTem.DATE on page 737 SCPI.SYSTem.TIME on page 748
		Show Clock	SCPI.DISPlay.CLOCK on page 378
		Color Setup	SCPI.DISPlay.COLor(Dnum).TRACe(Tr).DATA on page 383 SCPI.DISPlay.COLor(Dnum).TRACe(Tr).MEMory on page 384 SCPI.DISPlay.COLor(Dnum).GRATicule(Gnum) on page 380 SCPI.DISPlay.COLor(Dnum).LIMit(Lnum) on page 381 SCPI.DISPlay.COLor(Dnum).BACK on page 379 SCPI.DISPlay.COLor(Dnum).RESet on page 382
		Control Panel...	N/A

COM Object Reference
List by Front Panel Key

Table 7-2 Front panel key tree vs. COM objects correspondence table

Front panel key (Operation)				Corresponding COM object		
[System] (Continued)	Misc Setup (Continued)	GPIB Setup	Power Meter Address		SCPI.SYSTem.COMMunicate.GPIB.PMETer.ADDRes on page 728	
			Signal Generator Address	Address		SCPI.SYSTem.COMMunicate.GPIB.SGENerator.ADDRes on page 729
				Custom Commands	Set Frequency	SCPI.SYSTem.COMMunicate.GPIB.SGENerator.CCOMmand.FREQUen cy on page 730
					Preset	SCPI.SYSTem.COMMunicate.GPIB.SGENerator.CCOMmand.PRESet on page 732
				Set Power Level	SCPI.SYSTem.COMMunicate.GPIB.SGENerator.CCOMmand.POWer on page 731	
				Turn RF Out ON	SCPI.SYSTem.COMMunicate.GPIB.SGENerator.CCOMmand.RFON on page 733	
			8643A,8644B,8664A,8665A/B		SCPI.SYSTem.COMMunicate.GPIB.SGENerator.TYPE on page 735	
			8648A/B/C/D,ESG/PSG Series			
			Switching Time		SCPI.SYSTem.COMMunicate.GPIB.SGENerator.DWELL on page 734	
			System Controller Configuration		N/A	
		Talker/Listener Address		N/A		
		Key Lock	Front Panel & Keyboard Lock		SCPI.SYSTem.KLOCK.KBD on page 741	
			Touch Screen & Mouse Lock		SCPI.SYSTem.KLOCK.MOUSe on page 742	
	Network Setup		N/A			
	Preset Setup	Confirm		N/A		
		State	Factory	N/A		
			User			
	Multiport Test Set Setup	Test Set 1	Control		SCPI.SENSE(Ch).MULTiplexer(Id).STATe on page 603	
			Control Lines		SCPI.SENSE(Ch).MULTiplexer(Id).OUTPut.DATA on page 599 SCPI.SENSE(Ch).MULTiplexer(Id).TSET9.OUTPut.DATA on page 604	
			Port 1	SCPI.SENSE(Ch).MULTiplexer(Id).PORT(Pt).SELEct on page 601		
			Port 2			
			Port 3			
			Port 4			
Port 5*1						
Port 6*1						
Port 7*1						
Property			SCPI.SENSE(Ch).MULTiplexer(Id).DISPlay.STATe on page 596			
Select Test Set		SCPI.SENSE.MULTiplexer(Id).NAME on page 598				
Test Set 2		Displays the model selected for test set 2.				
Print		SCPI.HCOPy.IMMEDIATE on page 416				
Printer Setup		N/A				

Table 7-2 Front panel key tree vs. COM objects correspondence table

Front panel key (Operation)		Corresponding COM object	
[System] (Continued)	Service Menu	Avoid Spurious	SCPI.SENSE(Ch).SWEep.ASPurious on page 632
		Channel/Trace Setup	N/A
		Enable Options	N/A
		High Temperature	SCPI.SYSTem.TEMPerature.HIGH on page 746
		Init Src Port	SCPI.SYSTem.ISPC.PORT on page 739
		Init Src Ctrl	SCPI.SYSTem.ISPC.STAT on page 740
		Security Level	SCPI.SYSTem.SECurity.LEVEL on page 744
		Service Functions	N/A
		System Correction	SCPI.SYSTem.CORREction.STATe on page 736
		Test Menu	Adjust Touch Screen
	Display		N/A
	Front Panel		N/A
	Power On Test		N/A
	Restart Firmware	N/A	
Update Firmware	N/A		
[Trace Prev]		SCPI.CALCulate(Ch).PARAmeter(Tr).SELEct on page 259	
[Trace Max]		SCPI.DISPlay.WINDow(Ch).MAXimize on page 399	
[Trace Next]		SCPI.CALCulate(Ch).PARAmeter(Tr).SELEct on page 259	
[Trigger]	Continuous	SCPI.INITiate(Ch).CONTInuous on page 424	
	Continuous Disp Channels	N/A	
	Ext Trig Delay	SCPI.TRIGger.SEQuence.EXTernal.DELay on page 751	
	Hold	SCPI.ABORt on page 208 SCPI.INITiate(Ch).CONTInuous on page 424	
	Hold All Channels	N/A	
	Low Latency	SCPI.TRIGger.SEQuence.EXTernal.LLATency.STATe on page 752	
	Restart	SCPI.ABORt on page 208	
	Single	SCPI.ABORt on page 208 SCPI.INITiate(Ch).CONTInuous on page 424 SCPI.INITiate(Ch).IMMEDIATE on page 425	
	Trigger Event	SCPI.TRIGger.SEQuence.POINt on page 754	
	Trigger Scope	SCPI.TRIGger.SEQuence.SCOPE on page 755	
	Trigger Source	SCPI.TRIGger.SEQuence.SOURce on page 757	
	Trigger	SCPI.TRIGger.SEQuence.IMMEDIATE on page 753	

*1.E5091A-016 only

COM Object Tree

Table 7-3 shows the COM object tree of the E5070B/E5071B.

Table 7-3 E5070B/E5071B COM object tree

Object	Object type	Note
ECHO	Method	[No read]
NAME	Property(Data Type:String)	[Read only]
Parse	Method	
Prompt	Method	[No read]
UserMenu		
.Item(<i>Key_id</i>)		
.Caption	Property(Data Type:String)	
.Enabled	Property(Data Type:Boolean)	
_OnPress(ByVal <i>Key_id</i> As Long)	Event	
.PRESet	Method	[No read]
.Press(<i>Key_id</i>)	Method	[No read]
.Show	Method	[No read]
VBAVersion	Property(Data Type:String)	[Read only]
WaitOnSRQ	Method	[No read]
SCPI		
.ABORT	Method	[No read]
.CALCulate(<i>Ch</i>)		
.FSIMulator		
.BALun		
.CZConversion		
.BPORT(<i>Bprt</i>)		
.IMAGinary	Property(Data Type:Double)	
.REAL	Property(Data Type:Double)	
.Z0		
.R	Property(Data Type:Double)	
.STATe	Property(Data Type:Boolean)	
.DEVice	Property(Data Type:String)	
.DMCircuit		
.BPORT(<i>Bprt</i>)		
.PARAmeters		
.C	Property(Data Type:Double)	
.G	Property(Data Type:Double)	
.L	Property(Data Type:Double)	
.R	Property(Data Type:Double)	
.TYPE	Property(Data Type:String)	
.USER		
.FILEname	Property(Data Type:String)	
.STATe	Property(Data Type:Boolean)	
.DZConversion		
.BPORT(<i>Bprt</i>)		
.IMAGinary	Property(Data Type:Double)	
.REAL	Property(Data Type:Double)	
.Z0		
.R	Property(Data Type:Double)	
.STATe	Property(Data Type:Boolean)	
.PARAmeter(<i>Tr</i>)		
.BBALanced		
.DEFine	Property(Data Type:String)	
.SBALanced		
.DEFine	Property(Data Type:String)	

Table 7-3 E5070B/E5071B COM object tree

Object	Object type	Note
SCPI		
.CALCulate(<i>Ch</i>)		
.FSIMulator		
.BALun		
.PARAmeter(<i>Tr</i>)		
.SSBalanced		
.DEFINE	Property(Data Type:String)	
.STATE	Property(Data Type:Boolean)	
.TOPology		
.BBALanced		
.PPORTs	Property(Data Type:Variant)	
.PROPErty		
.STATE	Property(Data Type:Boolean)	
.SBALanced		
.PPORTs	Property(Data Type:Variant)	
.SSBalanced		
.PPORTs	Property(Data Type:Variant)	
.EMBed		
.NETWork(<i>Nwk</i>)		
.FILename	Property(Data Type:String)	
.TYPE	Property(Data Type:String)	
.STATE	Property(Data Type:Boolean)	
.TOPology		
.A		
.PORTs	Property(Data Type:Variant)	
.B		
.PORTs	Property(Data Type:Variant)	
.C		
.PORTs	Property(Data Type:Variant)	
.TYPE	Property(Data Type:String)	
.SENDed		
.DEEMbed		
.PORT(<i>Pr</i>)		
.TYPE	Property(Data Type:String)	
.USER		
.FILename	Property(Data Type:String)	
.STATE	Property(Data Type:Boolean)	
.PMCircuit		
.PORT(<i>Pr</i>)		
.PARAmeters		
.C	Property(Data Type:Double)	
.G	Property(Data Type:Double)	
.L	Property(Data Type:Double)	
.R	Property(Data Type:Double)	
.TYPE	Property(Data Type:String)	
.USER		
.FILename	Property(Data Type:String)	
.STATE	Property(Data Type:Boolean)	

Table 7-3 E5070B/E5071B COM object tree

Object	Object type	Note
SCPI		
.CALCulate(<i>Ch</i>)		
.FSIMulator		
.SENDEd		
.ZCONversion		
.PORT(<i>Pr</i>)		
.IMAGinary	Property(Data Type:Double)	
.REAL	Property(Data Type:Double)	
.Z0		
.R	Property(Data Type:Double)	
.STATe	Property(Data Type:Boolean)	
.STATe	Property(Data Type:Boolean)	
.PARAmeter(<i>Tr</i>)		
.COUNt	Property(Data Type:Long)	
.DEFine	Property(Data Type:String)	
.SELect	Method	[No read]
.SPORt	Property(Data Type:Long)	
.SELected		
.BLIMit		
.DB	Property(Data Type:Double)	
.DISPLay		
.MARKer	Property(Data Type:Boolean)	
.VALue	Property(Data Type:Boolean)	
.FAIL	Property(Data Type:Boolean)	[Read only]
.MAXimum	Property(Data Type:Double)	
.MINimum	Property(Data Type:Double)	
.REPORt		
.DATA	Property(Data Type:Double)	[Read only]
.STATe	Property(Data Type:Boolean)	
.CONVersion		
.FUNcTION	Property(Data Type:String)	
.STATe	Property(Data Type:Boolean)	
.CORREction		
.EDELay		
.MEDIum	Property(Data Type:String)	
.TIME	Property(Data Type:Double)	
.WGCutoff	Property(Data Type:Double)	
.OFFSet		
.PHASE	Property(Data Type:Double)	
.DATA		
.FDATa	Property(Data Type:Variant)	
.FMEMory	Property(Data Type:Variant)	
.SDATa	Property(Data Type:Variant)	
.SMEMory	Property(Data Type:Variant)	
.EQUation		
.STATe	Property(Data Type:Boolean)	
.TEXT	Property(Data Type:String)	
.VALid	Property(Data Type:Boolean)	[Read only]

Table 7-3 E5070B/E5071B COM object tree

Object	Object type	Note
SCPI		
.CALCulate(<i>Ch</i>)		
.SELEcted		
.FILTer		
.GATE		
.TIME		
.CENTer	Property(Data Type:Double)	
.SHAPe	Property(Data Type:String)	
.SPAN	Property(Data Type:Double)	
.STARt	Property(Data Type:Double)	
.STATe	Property(Data Type:Boolean)	
.STOP	Property(Data Type:Double)	
.TYPE	Property(Data Type:String)	
.FORMat	Property(Data Type:String)	
.FUNcTion		
.DATA	Property(Data Type:Variant)	[Read only]
.DOMain		
.COUPle	Property(Data Type:Boolean)	
.STARt	Property(Data Type:Double)	
.STATe	Property(Data Type:Boolean)	
.STOP	Property(Data Type:Double)	
.EXECute	Method	[No read]
.PEXCursion	Property(Data Type:Double)	
.POINts	Property(Data Type:Long)	[Read only]
.PPOLarity	Property(Data Type:String)	
.TARGet	Property(Data Type:Double)	
.TTRansition	Property(Data Type:String)	
.TYPE	Property(Data Type:String)	
.LIMit		
.DATA	Property(Data Type:Variant)	
.DISPlay		
.STATe	Property(Data Type:Boolean)	
.FAIL	Property(Data Type:Boolean)	[Read only]
.OFFSet		
.AMPLitude	Property(Data Type:Double)	
.MARKer	Method	[No read]
.STIMulus	Property(Data Type:Double)	
.REPort		
.ALL	Property(Data Type:Variant)	[Read only]
.DATA	Property(Data Type:Variant)	[Read only]
.POINts	Property(Data Type:Long)	[Read only]
.STATe	Property(Data Type:Boolean)	
.MARKer(<i>Mk</i>)		
.ACTivate	Method	[No read]
.BWIDth		
.DATA	Property(Data Type:Variant)	[Read only]
.STATe	Property(Data Type:Boolean)	
.THReshold	Property(Data Type:Double)	
.COUPle	Property(Data Type:Boolean)	
.DISCrete	Property(Data Type:Boolean)	

Table 7-3 E5070B/E5071B COM object tree

Object	Object type	Note
SCPI		
.CALCulate(<i>Ch</i>)		
.SELEcted		
.MARKer(<i>Mk</i>)		
.FUNcTION		
.EXECute	Method	[No read]
.DOMain		
.COUPle	Property(Data Type:Boolean)	
.STARt	Property(Data Type:Double)	
.STATe	Property(Data Type:Boolean)	
.STOP	Property(Data Type:Double)	
.PEXCursion	Property(Data Type:Double)	
.PPOLarity	Property(Data Type:String)	
.TARGet	Property(Data Type:Double)	
.TRACKing	Property(Data Type:Boolean)	
.TTRansition	Property(Data Type:String)	
.TYPE	Property(Data Type:String)	
.NOTCh		
.DATA	Property(Data Type:Variant)	[Read only]
.STATe	Property(Data Type:Boolean)	
.THReshold	Property(Data Type:Double)	
.REFerence		
.STATe	Property(Data Type:Boolean)	
.SET	Property(Data Type:String)	
.STATe	Property(Data Type:Boolean)	
.X	Property(Data Type:Double)	
.Y	Property(Data Type:Variant)	[Read only]
.MATH		
.FUNcTION	Property(Data Type:String)	
.MEMorize	Method	[No read]
.MIXer		
.XAXis	Property(Data Type:String)	
.MSTATistics		
.DATA	Property(Data Type:Variant)	[Read only]
.STATe	Property(Data Type:Boolean)	
.OFFSet		
.XAXis	Property(Data Type:String)	
.RLIMit		
.DATA	Property(Data Type:Variant)	
.DISPlay		
.LINE	Property(Data Type:Boolean)	
.SELect	Property(Data Type:Long)	
.VALue	Property(Data Type:String)	
.FAIL	Property(Data Type:Boolean)	[Read only]
.REPort		
.DATA	Property(Data Type:Variant)	[Read only]
.STATe	Property(Data Type:Boolean)	
.SMOothing		
.APERture	Property(Data Type:Double)	
.STATe	Property(Data Type:Boolean)	

Table 7-3 E5070B/E5071B COM object tree

Object	Object type	Note
SCPI		
.CALCulate(<i>Ch</i>)		
.SELEcted		
.TRANSform		
.TIME		
.CENTER	Property(Data Type:Double)	
.IMPulse		
.WIDTH	Property(Data Type:Double)	
.KBESsel	Property(Data Type:Double)	
.LPFRequency	Method	[No read]
.SPAN	Property(Data Type:Double)	
.STARt	Property(Data Type:Double)	
.STATe	Property(Data Type:Boolean)	
.STEP		
.RTIME	Property(Data Type:Double)	
.STIMulus	Property(Data Type:String)	
.STOP	Property(Data Type:Double)	
.TYPE	Property(Data Type:String)	
.CONTRol		
.HANDler		
.A		
.DATA	Property(Data Type:Long)	[No read]
.B		
.DATA	Property(Data Type:Long)	[No read]
.C		
.DATA	Property(Data Type:Long)	
.MODE	Property(Data Type:String)	
.D		
.DATA	Property(Data Type:Long)	
.MODE	Property(Data Type:String)	
.E		
.DATA	Property(Data Type:Long)	
.EXTension		
.INDex		
.STATe	Property(Data Type:Boolean)	
.RTRigger		
.STATe	Property(Data Type:Boolean)	
.F		
.DATA	Property(Data Type:Long)	[No read]
.OUTPut(<i>Num</i>)		
.DATA	Property(Data Type:Long)	
.DISPlay		
.ANNotation		
.FREQuency		
.STATe	Property(Data Type:Boolean)	
.CCLear	Method	[No read]
.CLOCK	Property(Data Type:Boolean)	
.COLor(<i>Dnum</i>)		
.BACK	Property(Data Type:Variant)	
.GRATICule(<i>Gnum</i>)	Property(Data Type:Variant)	
.LIMit(<i>Lnum</i>)	Property(Data Type:Variant)	
.RESet	Method	[No read]
.TRACe(<i>Tr</i>)		
.DATA	Property(Data Type:Variant)	
.MEMory	Property(Data Type:Variant)	

Table 7-3 E5070B/E5071B COM object tree

Object	Object type	Note
SCPI		
.DISPlay		
.ECHO		
.CLEAr	Method	[No read]
.DATA	Property(Data Type:String)	[No read]
.ENABLE	Property(Data Type:Boolean)	
.FSIGn	Property(Data Type:Boolean)	
.IMAGe	Property(Data Type:String)	
.MAXimize	Property(Data Type:Boolean)	
.SKEY		
.STATe	Property(Data Type:Boolean)	
.SPLit	Property(Data Type:String)	
.TABLe		
.STATe	Property(Data Type:Boolean)	
.TYPE	Property(Data Type:String)	
.UPDate		
.IMMediate	Method	[No read]
.WINDow(<i>Ch</i>)		
.ACTivate	Method	[No read]
.ANNotation		
.Marker		
.ALIGn		
.STATe	Property(Data Type:Boolean)	
.SINGLE		
.STATe	Property(Data Type:Boolean)	
.LABel	Property(Data Type:Boolean)	
.MAXimize	Property(Data Type:Boolean)	
.SPLit	Property(Data Type:String)	
.TITLe		
.DATA	Property(Data Type:String)	
.STATe	Property(Data Type:Boolean)	
.TRACe(<i>Tr</i>)		
.ANNotation		
.MARKer		
.POSition		
.X	Property(Data Type:Double)	
.Y	Property(Data Type:Double)	
.MEMory		
.STATe	Property(Data Type:Boolean)	
.STATe	Property(Data Type:Boolean)	
.Y		
.SCALe		
.AUTO	Method	[No read]
.PDIVision	Property(Data Type:Double)	
.RLEVel	Property(Data Type:Double)	
.RPOSition	Property(Data Type:Long)	
.X		
.SPACing	Property(Data Type:String)	
.Y		
.SCALe		
.DIVisions	Property(Data Type:Long)	

Table 7-3 E5070B/E5071B COM object tree

Object	Object type	Note
SCPI		
.FORMat		
.BORDer	Property(Data Type:String)	
.DATA	Property(Data Type:String)	
.HCOPy		
.ABORt	Method	[No read]
.IMAGe	Property(Data Type:String)	
.IMMediate	Method	[No read]
.IEEE4882		
.CLS	Method	[No read]
.ESE	Property(Data Type:Long)	
.ESR	Property(Data Type:Long)	[Read only]
.IDN	Property(Data Type:String)	[Read only]
.OPC	Property(Data Type:Long)	
.OPT	Property(Data Type:String)	[Read only]
.RST	Method	[No read]
.SRE	Property(Data Type:Long)	
.STB	Property(Data Type:Long)	[Read only]
.TRG	Method	[No read]
.WAI	Method	[No read]
.INITiate(<i>Ch</i>)		
.CONTInuous	Property(Data Type:Boolean)	
.IMMediate	Method	[No read]
.MMEMory		
.CATalog(<i>Dir</i>)	Property(Data Type:String)	[Read only]
.COPY	Property(Data Type:Variant)	[No read]
.DELete	Property(Data Type:String)	[No read]
.LOAD		
.ASCFactor	Property(Data Type:String)	[No read]
.BSCFactor	Property(Data Type:String)	[No read]
.CAHNnel		
.STATe	Property(Data Type:String)	[No read]
.CKIT(<i>ckit</i>)	Property(Data Type:String)	[No read]
.LIMit	Property(Data Type:String)	[No read]
.PLOSs	Property(Data Type:String)	[No read]
.RLIMit	Property(Data Type:String)	[No read]
.SEGMent	Property(Data Type:String)	[No read]
.STATe	Property(Data Type:String)	[No read]
.MDIRectory	Property(Data Type:String)	[No read]
.STORe		
.ASCFactor	Property(Data Type:String)	[No read]
.BSCFactor	Property(Data Type:String)	[No read]
.CAHNnel		
.CLEar	Method	[No read]
.STATe	Property(Data Type:String)	[No read]
.CKIT(<i>ckit</i>)	Property(Data Type:String)	[No read]
.FDATa	Property(Data Type:String)	[No read]
.IMAGe	Property(Data Type:String)	[No read]
.LIMit	Property(Data Type:String)	[No read]
.PLOSs	Property(Data Type:String)	[No read]
.RLIMit	Property(Data Type:String)	[No read]
.SALL	Property(Data Type:Boolean)	
.SEGMent	Property(Data Type:String)	[No read]

Table 7-3 E5070B/E5071B COM object tree

Object	Object type	Note
SCPI		
.MMEMory		
.STORe		
.SNP		
.DATA	Property(Data Type:String)	[No read]
.FORMat	Property(Data Type:String)	
.TYPE		
.S1P	Property(Data Type:Long)	
.S2P	Property(Data Type:Long)	
.S3P	Property(Data Type:Long)	
.S4P	Property(Data Type:Long)	
.STATe	Property(Data Type:String)	[No read]
.STYPe	Property(Data Type:String)	
.OUTPut		
.STATe	Property(Data Type:Boolean)	
.PROGram		
.VARiable		
.ARRay (<i>Vnum</i>)		
.DATA	Property(Data Type:Variant)	
.SIZE	Property(Data Type:Long)	
.DOUBle (<i>Vnum</i>)		
.DATA	Property(Data Type:Double)	
.LONG (<i>Vnum</i>)		
.DATA	Property(Data Type:Long)	
.STRing (<i>Vnum</i>)		
.DATA	Property(Data Type:String)	
.SENSE(<i>Ch</i>)		
.AVERage		
.CLEar	Method	[No read]
.COUNt	Property(Data Type:Long)	
.STATe	Property(Data Type:Boolean)	
.BANDwidth		
.RESolution	Property(Data Type:Double)	
.BWIDth		
.RESolution	Property(Data Type:Double)	
.CORRection		
.CLEar	Method	[No read]
.COEFFicient		
.DATA	Property(Data Type:Variant)	
.METHod		
.ERESponse	Property(Data Type:Variant)	[No read]
.RESPOse		
.OPEN	Property(Data Type:Long)	[No read]
.SHORt	Property(Data Type:Long)	[No read]
.THRU	Property(Data Type:Variant)	[No read]
.SOLT1	Property(Data Type:Long)	[No read]
.SOLT2	Property(Data Type:Variant)	[No read]
.SOLT3	Property(Data Type:Variant)	[No read]
.SOLT4	Property(Data Type:Variant)	[No read]
.SAVE	Method	[No read]

Table 7-3 E5070B/E5071B COM object tree

Object	Object type	Note
SCPI		
.SENSE(<i>Ch</i>)		
.CORRection		
.COLLEct		
.ACQuire		
.ISOLation	Property(Data Type:Variant)	[No read]
.LOAD	Property(Data Type:Long)	[No read]
.OPEN	Property(Data Type:Long)	[No read]
.SHORt	Property(Data Type:Long)	[No read]
.SUBClass	Property(Data Type:Long)	
.THRU	Property(Data Type:Variant)	[No read]
.TRLLine	Property(Data Type:Long)	[No read]
.TRLReflect	Property(Data Type:Long)	[No read]
.TRLThru	Property(Data Type:Long)	[No read]
.ADATter (<i>Pt</i>)		
.LENGth	Property(Data Type:Double)	
.CKIT		
.LABel	Property(Data Type:String)	
.ORDer		
.LOAD(<i>Cpt</i>)	Property(Data Type:Long)	
.OPEN(<i>Cpt</i>)	Property(Data Type:Long)	
.SELect	Property(Data Type:Long)	
.SHORt(<i>Cpt</i>)	Property(Data Type:Long)	
.THRU(<i>Cpt_m,Cpt_n</i>)	Property(Data Type:Long)	
.TRLLine(<i>Cpt_m,Cpt_n</i>)	Property(Data Type:Long)	
)		
.TRLReflect	Property(Data Type:Long)	
.TRLThru(<i>Cpt_m,Cpt_n</i>)	Property(Data Type:Long)	
)		
.RESet	Method	[No read]
.SELect	Property(Data Type:Long)	
.STAN(<i>Std</i>)		
.ARBItrary	Property(Data Type:Double)	
.C0	Property(Data Type:Double)	
.C1	Property(Data Type:Double)	
.C2	Property(Data Type:Double)	
.C3	Property(Data Type:Double)	
.CHARacter	Property(Data Type:String)	
.DELay	Property(Data Type:Double)	
.FMAXimum	Property(Data Type:Double)	
.FMINimum	Property(Data Type:Double)	
.L0	Property(Data Type:Double)	
.L1	Property(Data Type:Double)	
.L2	Property(Data Type:Double)	
.L3	Property(Data Type:Double)	
.LABel	Property(Data Type:String)	
.LOSS	Property(Data Type:Double)	
.TYPE	Property(Data Type:String)	
.Z0	Property(Data Type:Double)	
.TRLOption		
.IMPedance	Property(Data Type:String)	
.RPLane	Property(Data Type:String)	
.CLEar	Method	[No read]

7. COM Object Reference

Table 7-3 E5070B/E5071B COM object tree

Object	Object type	Note
SCPI		
.SENSE(<i>Ch</i>)		
.CORRection		
.COLLect		
.ECAL		
.CCHeck		
.ACQUIRE	Method	[No read]
.ERESponse	Property(Data Type:Variant)	[No read]
.ISOLation		
.STATe	Property(Data Type:Boolean)	
.ORIentation		
.STATe	Property(Data Type:Boolean)	
.PATH(<i>Cpt</i>)	Property(Data Type:Long)	
.SOLT1	Property(Data Type:Long)	[No read]
.SOLT2	Property(Data Type:Variant)	[No read]
.SOLT3	Property(Data Type:Variant)	[No read]
.SOLT4	Property(Data Type:Variant)	[No read]
.THRU	Property(Data Type:Variant)	[No read]
.UCHar	Property(Data Type:String)	
.UTHRU		
.STATe	Property(Data Type:Boolean)	
.METHod		
.ADAPter		
.REMOval	Property(Data Type:Long)	[No read]
.ERESponse	Property(Data Type:Variant)	[No read]
.RESPOuse		
.OPEN	Property(Data Type:Long)	[No read]
.SHORt	Property(Data Type:Long)	[No read]
.THRU	Property(Data Type:Variant)	[No read]
.SOLT1	Property(Data Type:Long)	[No read]
.SOLT2	Property(Data Type:Variant)	[No read]
.SOLT3	Property(Data Type:Variant)	[No read]
.SOLT4	Property(Data Type:Variant)	[No read]
.TRL2	Property(Data Type:Variant)	
.TRL3	Property(Data Type:Variant)	
.TRL4	Property(Data Type:Variant)	
.TYPE	Property(Data Type:String)	[Read only]
.PARTial		
.SAVE	Method	[No read]
.SAVE	Method	[No read]
.SIMPlified		
.SAVE	Method	[No read]
.EXTension		
.AUTO		
.CONFig	Property(Data Type:String)	
.DCOFFset	Property(Data Type:Boolean)	
.LOSS	Property(Data Type:Boolean)	
.MEASure	Property(Data Type:String)	
.PORT(<i>Pt</i>)	Property(Data Type:Boolean)	
.RESet	Method	[No read]
.STARt	Property(Data Type:Double)	
.STOP	Property(Data Type:Double)	

Table 7-3 E5070B/E5071B COM object tree

Object	Object type	Note
SCPI		
.SENSE(<i>Ch</i>)		
.CORRection		
.EXTension		
.PORT(<i>Pt</i>)		
.FREQuency	Property(Data Type:Double)	
.INCLude	Property(Data Type:Boolean)	
.LDC	Property(Data Type:Double)	
.LOSS(<i>Loss</i>)	Property(Data Type:Double)	
.TIME	Property(Data Type:Double)	
.STATe	Property(Data Type:Boolean)	
.IMPedance.INPut.MAGNitude		
.OFFSet		
.CLEar	Method	[No read]
.COLLect		
.ACQuire		
.LOAD	Property(Data Type:Variant)	[No read]
.OPEN	Property(Data Type:Variant)	[No read]
.PMETer	Property(Data Type:Variant)	[No read]
.SHORt	Property(Data Type:Variant)	[No read]
.THRU	Property(Data Type:Variant)	[No read]
.CLEar	Method	[No read]
.ECAL		
.SMIX2	Property(Data Type:Variant)	[No read]
.SOLT1	Property(Data Type:Long)	[No read]
.METHod		
.SMIX2	Property(Data Type:Variant)	[No read]
.SOLT1	Property(Data Type:Long)	[No read]
.SAVE	Method	[No read]
.PROPerTy	Property(Data Type:Boolean)	
.RECEiver(<i>Pt</i>)		
.COLLect		
.ACQuire	Property(Data Type:Long)	[No read]
.STATe	Property(Data Type:Variant)	
.RVELocity		
.COAX	Property(Data Type:Double)	
.STATe	Property(Data Type:Boolean)	
.TRIGger		
.SOURce	Property(Data Type:String)	
.TYPE(<i>Tr</i>)	Property(Data Type:Variant)	[Read only]
.FREQuency		
.CENTer	Property(Data Type:Double)	
.CW	Property(Data Type:Double)	
.DATA	Property(Data Type:Variant)	[Read only]
.FIXed	Property(Data Type:Double)	
.SPAN	Property(Data Type:Double)	
.STARt	Property(Data Type:Double)	
.STOP	Property(Data Type:Double)	
.MULTiplexer(<i>Id</i>)		
.CATalog	Property(Data Type:String)	[Read only]
.COUNT	Property(Data Type:Long)	[Read only]
.DISPlay		
.STATe	Property(Data Type:Boolean)	
.INCount	Property(Data Type:Long)	[Read only]
.NAME	Property(Data Type:String)	

7. COM Object Reference

Table 7-3 E5070B/E5071B COM object tree

Object	Object type	Note
SCPI		
.SENSE(<i>Ch</i>)		
.MULTIplexer(<i>Id</i>)		
.OUTPUT		
.DATA	Property(Data Type:Long)	
.PORT(<i>Pt</i>)		
.CATALOG	Property(Data Type:String)	[Read only]
.SELECT	Property(Data Type:String)	
.STATE	Property(Data Type:Boolean)	
.TSET9		
.OUTPUT		
.DATA	Property(Data Type:Long)	
.PORT1	Property(Data Type:String)	
.PORT2	Property(Data Type:String)	
.PORT3	Property(Data Type:String)	
.PORT4	Property(Data Type:String)	
.OFFSet		
.ASPurious	Property(Data Type:Boolean)	
.LOCal		
.CONTrol		
.STATE	Property(Data Type:Boolean)	
.FREQuency		
.DATA	Property(Data Type:Variant)	[Read only]
.DIVisor	Property(Data Type:Double)	
.MULTi;lier	Property(Data Type:Double)	
.OFFSet	Property(Data Type:Double)	
.STARt	Property(Data Type:Double)	
.STOP	Property(Data Type:Double)	
.POWer		
.LEVel		
.IMMediate		
.AMPLitude	Property(Data Type:Double)	
.SLOPe		
.DATA	Property(Data Type:Double)	
.STATE	Property(Data Type:Boolean)	
.STATE	Property(Data Type:Boolean)	
.PORT(<i>Pt</i>)		
.FREQuency		
.DATA	Property(Data Type:Variant)	[Read only]
.DIVisor	Property(Data Type:Double)	
.MULTi;lier	Property(Data Type:Double)	
.OFFSet	Property(Data Type:Double)	
.STARt	Property(Data Type:Double)	
.STOP	Property(Data Type:Double)	
.STATE	Property(Data Type:Boolean)	
.ROSCillator		
.SOURce	Property(Data Type:String)	[Read only]
.SEGMent		
.DATA	Property(Data Type:Variant)	
.SWEep		
.POINts	Property(Data Type:Long)	[Read only]
.TIME		
.DATA	Property(Data Type:Double)	[Read only]

Table 7-3 E5070B/E5071B COM object tree

Object	Object type	Note
SCPI		
.SENSE(<i>Ch</i>)		
.SWEep		
.ASPurious	Property(Data Type:Boolean)	
.DELay	Property(Data Type:Double)	
.GENeration	Property(Data Type:String)	
.POINts	Property(Data Type:Long)	
.TIME		
.AUTO	Property(Data Type:Boolean)	
.DATA	Property(Data Type:Double)	
.TYPE	Property(Data Type:String)	
.SERvice		
.CHANnel(<i>Ch</i>)		
.ACTive	Property(Data Type:Long)	[Read only]
.COUNt	Property(Data Type:Long)	[Read only]
.TRACe		
.ACTive	Property(Data Type:Long)	[Read only]
.COUNt	Property(Data Type:Long)	[Read only]
.PORT		
.COUNt	Property(Data Type:Long)	[Read only]
.SREvision	Property(Data Type:Long)	[Read only]
.SWEep		
.FREquency		
.MAXimum	Property(Data Type:Double)	[Read only]
.MINimum	Property(Data Type:Double)	[Read only]
.POINts	Property(Data Type:Long)	[Read only]
.SOURce(<i>Ch</i>)		
.POWER		
.ATTenuation		
.DATA	Property(Data Type:Long)	
.CENTer	Property(Data Type:Double)	
.LEVel		
.IMMediate		
.AMPLitude	Property(Data Type:Double)	
.SLOPe		
.DATA	Property(Data Type:Double)	
.STATe	Property(Data Type:Boolean)	

7. COM Object Reference

Table 7-3 E5070B/E5071B COM object tree

Object	Object type	Note
SCPI		
.SOURce(<i>Ch</i>)		
.POWER		
.PORT(<i>Pr</i>)		
.CORRection		
.COLLect		
.ACQuire	Property(Data Type:String)	[No read]
.ASEnsor		
.RCFactor	Property(Data Type:Double)	
.AVERage		
.COUNt	Property(Data Type:Long)	
.BSEnsor		
.RCFactor	Property(Data Type:Double)	
.NTOLerance	Property(Data Type:Long)	
.TABLe		
.ASEnsor		
.DATA	Property(Data Type:Variant)	
.BSEnsor		
.DATA	Property(Data Type:Variant)	
.LOSS		
.DATA	Property(Data Type:Variant)	
.STATe	Property(Data Type:Boolean)	
.DATA	Property(Data Type:Variant)	
.STATe	Property(Data Type:Boolean)	
.COUPle	Property(Data Type:Boolean)	
.LEVel		
.IMMediate		
.AMPLitude	Property(Data Type:Double)	
.SPAN	Property(Data Type:Double)	
.STARt	Property(Data Type:Double)	
.STOP	Property(Data Type:Double)	
.STATus		
.OPERation		
.CONDItion	Property(Data Type:Long)	[Read only]
.ENABLE	Property(Data Type:Long)	
.EVENT	Property(Data Type:Long)	[Read only]
.NTRansition	Property(Data Type:Long)	
.PTRansition	Property(Data Type:Long)	
.PRESet	Method	[No read]
.QUEStionable		
.BLIMit		
.CHANnel(<i>Ch</i>)		
.CONDItion	Property(Data Type:Long)	[Read only]
.ECHannel		
.CONDItion	Property(Data Type:Long)	[Read only]
.ENABLE	Property(Data Type:Long)	
.EVENT	Property(Data Type:Long)	[Read only]
.NTRansition	Property(Data Type:Long)	
.PTRansition	Property(Data Type:Long)	
.ENABLE	Property(Data Type:Long)	
.EVENT	Property(Data Type:Long)	[Read only]
.NTRansition	Property(Data Type:Long)	
.PTRansition	Property(Data Type:Long)	
.CONDItion	Property(Data Type:Long)	[Read only]

Table 7-3 E5070B/E5071B COM object tree

Object	Object type	Note
SCPI		
.STATUS		
.QUEStionable		
.BLIMit		
.ELIMit		
.CONDItion	Property(Data Type:Long)	[Read only]
.ENABLE	Property(Data Type:Long)	
.EVENT	Property(Data Type:Long)	[Read only]
.NTRansition	Property(Data Type:Long)	
.PTRansition	Property(Data Type:Long)	
.ENABLE	Property(Data Type:Long)	
.EVENT	Property(Data Type:Long)	[Read only]
.NTRansition	Property(Data Type:Long)	
.PTRansition	Property(Data Type:Long)	
.CONDItion	Property(Data Type:Long)	[Read only]
.ENABLE	Property(Data Type:Long)	
.EVENT	Property(Data Type:Long)	[Read only]
.LIMit		
.CHANnel(<i>Ch</i>)		
.CONDItion	Property(Data Type:Long)	[Read only]
.ECHannel		
.CONDItion	Property(Data Type:Long)	[Read only]
.ENABLE	Property(Data Type:Long)	
.EVENT	Property(Data Type:Long)	[Read only]
.NTRansition	Property(Data Type:Long)	
.PTRansition	Property(Data Type:Long)	
.ENABLE	Property(Data Type:Long)	
.EVENT	Property(Data Type:Long)	[Read only]
.NTRansition	Property(Data Type:Long)	
.PTRansition	Property(Data Type:Long)	
.CONDItion	Property(Data Type:Long)	[Read only]
.ELIMit		
.CONDItion	Property(Data Type:Long)	[Read only]
.ENABLE	Property(Data Type:Long)	
.EVENT	Property(Data Type:Long)	[Read only]
.NTRansition	Property(Data Type:Long)	
.PTRansition	Property(Data Type:Long)	
.ENABLE	Property(Data Type:Long)	
.EVENT	Property(Data Type:Long)	[Read only]
.NTRansition	Property(Data Type:Long)	
.PTRansition	Property(Data Type:Long)	
.NTRansition	Property(Data Type:Long)	
.PTRansition	Property(Data Type:Long)	

Table 7-3 E5070B/E5071B COM object tree

Object	Object type	Note
SCPI		
.STATUS		
.QUEStionable		
.RLIMit		
.CHANnel(<i>Ch</i>)		
.CONDition	Property(Data Type:Long)	[Read only]
.ECHannel		
.CONDition	Property(Data Type:Long)	[Read only]
.ENABLE	Property(Data Type:Long)	
.EVENT	Property(Data Type:Long)	[Read only]
.NTRansition	Property(Data Type:Long)	
.PTRansition	Property(Data Type:Long)	
.ENABLE	Property(Data Type:Long)	
.EVENT	Property(Data Type:Long)	[Read only]
.NTRansition	Property(Data Type:Long)	
.PTRansition	Property(Data Type:Long)	
.CONDition	Property(Data Type:Long)	[Read only]
.ELIMit		
.CONDition	Property(Data Type:Long)	[Read only]
.ENABLE	Property(Data Type:Long)	
.EVENT	Property(Data Type:Long)	[Read only]
.NTRansition	Property(Data Type:Long)	
.PTRansition	Property(Data Type:Long)	
.ENABLE	Property(Data Type:Long)	
.EVENT	Property(Data Type:Long)	[Read only]
.NTRansition	Property(Data Type:Long)	
.PTRansition	Property(Data Type:Long)	
.SYSTEM		
.BACKlight	Property(Data Type:Boolean)	
.BEEPer		
.COMPLete		
.IMMEdiate	Method	[No read]
.STATe	Property(Data Type:Boolean)	
.WARNing		
.IMMEdiate	Method	[No read]
.STATe	Property(Data Type:Boolean)	
.COMMunicate		
.GPIB		
.PMETer		
.ADDRess	Property(Data Type:Long)	
.SGENerator		
.ADDRess	Property(Data Type:Long)	
.CCOMmand		
.FREQuency	Property(Data Type:String)	
.POWER	Property(Data Type:String)	
.PRESet	Property(Data Type:String)	
.RFON	Property(Data Type:String)	
.DWELl	Property(Data Type:Double)	
.TYPE	Property(Data Type:Long)	
.CORRection		
.STATe	Property(Data Type:Boolean)	

Table 7-3 E5070B/E5071B COM object tree

Object	Object type	Note
SCPI		
.SYSTem		
.DATE	Property(Data Type:Variant)	
.ERRor	Property(Data Type:Variant)	[Read only]
:ISPControl		
:PORT		
:STATe		
.KLOCK		
.KBD	Property(Data Type:Boolean)	
.MOUSe	Property(Data Type:Boolean)	
.POFF	Method	[No read]
.PRESet	Method	[No read]
.SECurity		
.LEVeL	Property(Data Type:String)	
.SERvice	Property(Data Type:Boolean)	[Read only]
.TEMPerature		
.HIGH	Property(Data Type:Boolean)	
.STATe	Property(Data Type:Boolean)	[Read only]
.TIME	Property(Data Type:Variant)	
UPReset	Method	[No read]
.TRIGger		
.SEQuence		
.AVERage	Property(Data Type:Boolean)	
.EXTernal		
.DELay	Property(Data Type:Double)	
.LLATency		
.STATe	Property(Data Type:Boolean)	
.IMMediate	Method	[No read]
.POINt	Property(Data Type:Boolean)	
.SCOPE	Property(Data Type:String)	
.SINGle	Method	[No read]
.SOURce	Property(Data Type:String)	

Notational Rules of COM Objects

This section describes the rules for the description of the COM objects in this chapter.

Object Type

Part with heading “Object type” describes the type of the E5070B/E5071B COM object. The E5070B/E5071B provides properties and methods as the types of COM objects. In the E5070B/E5071B COM objects, COM objects to set (send)/read (return) the state of the E5070B/E5071B using variables are defined as property and ones to prompt some kind of processing as method.

Syntax

Part with heading “Syntax” describes the syntax to send a COM object from the E5070B/E5071B VBA to the E5070B/E5071B. The syntax consists of the object part and the set/read part, with an equal “=” inserted between them. Variables are indicated by italicized letters. Variables with () are indices. For indices with () having their preset values, you can omit “(variable),” and, if omitted, the preset values are automatically set.

There are the following 3 types of syntax for coding using objects.

"Object (property) = *variable*": to set the stat of the E5070B/E5071B.

variable=object (property): to read the stat of the E5070B/E5071B.

"Object (method)": to make the E5070B/E5071B perform some processing.

Description

Part with heading “Description” describes how to use the COM object or the operation when executed. COM objects used only to read the state of the E5070B/E5071B are indicated with “Read only” and ones used only to set the state of the E5070B/E5071B “No read.”

Variable

Part with heading “Variable” describes necessary variables when using the object. It gives the description, data type, allowable range, preset value, unit, resolution, and notes for *variable* (*italic*) shown in the syntax.

Variables declared as the string data type (String) are case insensitive. For variables of the string type that indicate arguments (written as *Param* in the syntax), you can omit lower-case letters.

The data types of the E5070B/E5071B COM objects include 5 types as shown in Table 7-4. Before using variables, declare the data type of each variable. If you do not declare the data type of a variable, it is automatically dealt as the variant type.

Table 7-4 Data type

Data type	Name	Consumed memory	Range
Long	Long integer type	4 bytes	-2,147,483,648 to 2,147,483,647
Double	Double precision floating point type	8 bytes	For a negative value: -1.79769313486232E+308 to -4.94065645841247E-324 For a positive value: -1.79769313486232E+308 to -4.94065645841247E-324
Boolean	Boolean type	2 bytes	-1 (True) or 0 (False)
String	Character string type *1	1 byte/alphan umeric character	Up to approximately 2 billion characters
Variant	Variant type	16 bytes	No limitation

*1. For a fixed length string, declare the number of characters.

Examples

Part with heading “Examples” describes a simple example of how to use the object for coding with E5070B/E5071B VBA.

Related Objects

Part with heading “Related objects” describes related objects when using the object.

Equivalent Key

Part with heading “Equivalent key” shows the operational procedure of the front panel keys that has the same effect as this object.

[Key] Indicates that you press the key named Key.

[Key] - Item Indicates a series of key operation in which you press the **[Key]** key, move the focus to the button called Item on the displayed menu using the [←↓] key and so on, and then press the **[Enter]** key.

Application Objects

The Application objects are at the top of the hierarchy of the E5070B/E5071B COM object model. They consist of 7 objects dedicated to the E5070B/E5071B COM interface and SCPI objects corresponding to SCPI commands. This section describes the objects dedicated to the E5070B/E5071B COM interface.

ECHO

Object type	Method						
Syntax	ECHO <i>V1,V2,..,V10</i> ECHO <i>SCPI object</i>						
Description	<p>Provides display in the echo window. (No read)</p> <p>There is the following difference from the display with the SCPI.DISPLAY.ECHO.DATA object.</p> <ul style="list-style-type: none"> • Up to 10 data items can be displayed. • Data is displayed as the declared data type without a cast. <table border="1" style="width: 100%; border-collapse: collapse;"> <tr> <td style="width: 30%;"></td> <td><i>V1,V2,..,V10</i></td> </tr> <tr> <td>Description</td> <td>Data you want to display in the echo window.</td> </tr> <tr> <td>Data type</td> <td>Variant type (Variant)</td> </tr> </table>		<i>V1,V2,..,V10</i>	Description	Data you want to display in the echo window.	Data type	Variant type (Variant)
	<i>V1,V2,..,V10</i>						
Description	Data you want to display in the echo window.						
Data type	Variant type (Variant)						
Examples	<pre>Dim Nop As Long Dim i As Integer Dim Fdata As Variant Nop = SCPI.SENSE(1).SWEep.POINTs Fdata = SCPI.CALCulate(1).SElected.DATA.FDATA ECHO "Test Results" For i=1 to Nop ECHO i, Fdata(2*i-2), Fdata(2*i-1) Next i ECHO SCPI.SYSTEM.ERROR</pre>						
Related objects	SCPI.DISPLAY.ECHO.DATA on page 385						
Equivalent key	No equivalent key is available on the front panel.						

NAME

Object type Property

Syntax *App* = NAME

Description Reads out the application name of VBA. “E5070B” or “E5071B” is always read out. (Read only)

Variable

	<i>App</i>
Description	Application name
Data type	Character string type (String)

Examples

```
Dim Inst As String
Inst = NAME
ECHO Inst
```

Equivalent key No equivalent key is available on the front panel.

Parse

Object type Method

Syntax `Parse(Scpi)`

Return = `Parse(Scpi?)`

Description Executes an SCPI command of the E5070B/E5071B. For information on the SCPI commands, see Chapter “SCPI Command Reference” in the *E5070B/E5071B Programmer’s Guide*.

The **Parse** object is a little slower in the execution speed than the COM object which has the same function as the SCPI command because it must parse the message string of the SCPI command.

Variable

	<i>Scpi</i>
Description	SCPI command
Data type	Character string type (String)

	<i>Return</i>
Description	Response (query) of the SCPI command
Data type	Character string type (String)

Examples

```
Dim Start As String
Parse(":SENS1:FREQ:STAR 100E6")
Start = Parse(":SENS1:FREQ:STAR?")
```

```
Dim TtlLbl As String
Parse(":DISP:WIND1:TITL:DATA \"filter\"")
TtlLbl = Parse(":DISP:WIND1:TITL:DATA?")
```

```
Dim Fmt As String
Parse(":CALC1:PAR2:SEL")
Parse(":CALC1:FORM SMIT")
Fmt = Parse(":CALC1:FORM?")
```

```
Dim BckLght As String
Parse(":SYST:BACK OFF")
BckLght = Parse(":SYST:BACK?")
```

Equivalent key No equivalent key is available on the front panel.

Prompt

Object type	Method
Syntax	Prompt(<i>Mes</i>)
Description	Displays the message you specify on the instrument status bar (at the bottom of the LCD display) and suspends the program until the [Macro Setup] - Continue button is pressed. (No read)

NOTE When using this object, execute the program with the Visual Basic closed since you need to press the **[Macro Setup] - Continue**. For more information, see “Running a Program from the E5070B/E5071B Measurement Screen” on page 54. If you need to abort the program, see “Stopping with the Dialog Box Appeared” on page 55.

Variable

	<i>Mes</i>
Description	Message
Data type	Character string type (String)

Examples Prompt("Connect DUT, and then press [Continue]")

Equivalent key No equivalent key is available on the front panel.

UserMenu.Item(Key_id).Caption

Object type	Property
Syntax	UserMenu.Item(<i>Key_id</i>).Caption = <i>Lbl</i> <i>Lbl</i> = UserMenu.Item(<i>Key_id</i>).Caption
Description	Sets the label name of the user menu function softkeys 1 to 10 (<i>Key_id</i>).

Variable

Table 7-5

Variable (*Key_id*)

	<i>Key_id</i>
Description	Softkey number for the user menu function
Data type	Long integer type (Long)
Range	1 to 10
Note	You cannot omit this because it does not have a preset value. If the specified variable is out of the valid setting range, an error occurs when executed.

	<i>Lbl</i>
Description	Softkey label name for the user menu function
Data type	Character string type (String)
Preset value	Varies depending on the specified softkey number.

Examples

```
Dim KeyLbl As String  
UserMenu.Item(1).Caption = "Meas"  
KeyLbl = UserMenu.Item(1).Caption
```

Equivalent key No equivalent key is available on the front panel.

UserMenu.Item(Key_id).Enabled

- Object type** Property
- Syntax** UserMenu.Item(Key_id).Enabled = Status
 Status = UserMenu.Item(Key_id).Enabled
- Description** Makes the user menu function softkeys 1 to 10 (Key_id) enabled/disabled. The softkey label enabled is displayed with the grey color and its softkey cannot be pressed.
- Variable**

	Status
Description	Enabled/disabled for the user menu function softkey
Data type	Boolean type (Boolean)
Range	Select from the following. <ul style="list-style-type: none"> •True or -1 Makes the softkey enabled. •False or 0 Makes the softkey enabled.
Preset value	True or -1

For information on the variable (Key_id), see Table 7-5, “Variable (Key_id),” on page 202.

- Examples**
- ```
Dim KeyEna As Boolean
UserMenu.Item(10).Enabled = False
KeyEna = UserMenu.Item(10).Enabled
```
- Related objects** UserMenu.Press(Key\_id) on page 205
- Equivalent key** No equivalent key is available on the front panel.

**UserMenu\_OnPress(ByVal *Key\_id* As Long)**

|                |                                                                                                                                                                                                                                                                       |
|----------------|-----------------------------------------------------------------------------------------------------------------------------------------------------------------------------------------------------------------------------------------------------------------------|
| Object type    | Event                                                                                                                                                                                                                                                                 |
| Description    | Executes the processing when one of the user menu function softkeys 1 to 10 ( <i>Key_id</i> ) is pressed. Write the processing in the “UserMenu” object. For more information on its use, see “Executing a Procedure with a Softkey (User Menu Function)” on page 80. |
| Variable       | For information on the variable ( <i>Key_id</i> ), see Table 7-5, “Variable (Key_id),” on page 202.                                                                                                                                                                   |
| Examples       | <pre>Private Sub UserMenu_OnPress(ByVal id As Long)   If id = 1 Then     MsgBox "Button 1 was pressed."   ElseIf id = 10 Then     MsgBox "Button 10 was pressed."   End If End Sub</pre>                                                                              |
| Equivalent key | No equivalent key is available on the front panel.                                                                                                                                                                                                                    |

**UserMenu.PRESet**

|                 |                                                                                            |
|-----------------|--------------------------------------------------------------------------------------------|
| Object type     | Method                                                                                     |
| Syntax          | UserMenu.PRESet                                                                            |
| Description     | Presets the label name and enabled/disabled settings for the user menu softkeys. (No read) |
| Examples        | UserMenu.PRESet                                                                            |
| Related objects | UserMenu.Item(Key_id).Caption on page 202<br>UserMenu.Item(Key_id).Enabled on page 203     |
| Equivalent key  | <b>[Macro Setup] - Preset User Menu</b>                                                    |



## UserMenu.Press(*Key\_id*)

|                 |                                                                                                                                                 |
|-----------------|-------------------------------------------------------------------------------------------------------------------------------------------------|
| Object type     | Method                                                                                                                                          |
| Syntax          | UserMenu.Press( <i>Key_id</i> )                                                                                                                 |
| Description     | Presses one of the user menu function softkeys 1 to 10 ( <i>id</i> ). (No read)                                                                 |
| Variable        | For information on the variable ( <i>Key_id</i> ), see Table 7-5, “Variable (Key_id),” on page 202.                                             |
| Examples        | UserMenu.Press(1)                                                                                                                               |
| Related objects | UserMenu.Item(Key_id).Enabled on page 203                                                                                                       |
| Equivalent key  | <b>[Macro Setup] - User Menu - Button 1   Button 2   Button 3   Button 4   Button 5   Button 6   Button 7   Button 8   Button 9   Button 10</b> |

## UserMenu.Show

|                |                                                                         |
|----------------|-------------------------------------------------------------------------|
| Object type    | Method                                                                  |
| Syntax         | UserMenu.Show                                                           |
| Description    | Displays the user menu function softkeys in the softkey area. (No read) |
| Examples       | UserMenu.Show                                                           |
| Equivalent key | <b>[Macro Setup] - User Menu</b>                                        |

## VBAVersion

|             |                                                                                      |
|-------------|--------------------------------------------------------------------------------------|
| Object type | Property                                                                             |
| Syntax      | <i>Vers</i> = VBAVersion                                                             |
| Description | Reads out the version information of VBA installed in the E5070B/E5071B. (Read only) |
| Variable    |                                                                                      |

|             |                                |
|-------------|--------------------------------|
|             | <i>Vers</i>                    |
| Description | VBA version information        |
| Data type   | Character string type (String) |

Examples

```
Dim Version As String
Version = VBAVersion
ECHO Version
```

Equivalent key From the **Help** menu of the Visual Basic editor, click **About Microsoft Visual Basic...**

## WaitOnSRQ

|             |                                                                                                                                                                                                                                                                            |
|-------------|----------------------------------------------------------------------------------------------------------------------------------------------------------------------------------------------------------------------------------------------------------------------------|
| Object type | Method                                                                                                                                                                                                                                                                     |
| Syntax      | WaitOnSRQ <i>Status, Timeout</i>                                                                                                                                                                                                                                           |
| Description | Suspends the program for specified time until the RQS/MSS bit (bit 6) of the status byte register changes to 1. For information on the structure of the status register, see Appendix “Status Reporting System” in the <i>E5070B/E5071B Programmer’s Guide</i> . (No read) |
| Variable    |                                                                                                                                                                                                                                                                            |

|             | <i>Status</i>                                                                                                                                                                                                                                                                                 |
|-------------|-----------------------------------------------------------------------------------------------------------------------------------------------------------------------------------------------------------------------------------------------------------------------------------------------|
| Description | State of the RQS/MSS bit (read only)                                                                                                                                                                                                                                                          |
| Data type   | Boolean type (Boolean)                                                                                                                                                                                                                                                                        |
| Range       | One of the following is returned.<br><ul style="list-style-type: none"> <li>• True or -1                      1 has been received within the specified time.</li> <li>• False or 0                      1 has not been received within the specified time due to timeout or abort.</li> </ul> |

|              | <i>Timeout</i>                                                                                                                                                                                               |
|--------------|--------------------------------------------------------------------------------------------------------------------------------------------------------------------------------------------------------------|
| Description  | Timeout time                                                                                                                                                                                                 |
| Data type    | Long integer type (Long)                                                                                                                                                                                     |
| Range        | 0 to 2,147,483,647                                                                                                                                                                                           |
| Preset value | -1 (infinity)                                                                                                                                                                                                |
| Unit         | ms (millisecond)                                                                                                                                                                                             |
| Note         | If the specified variable is out of the allowable setup range, the minimum value (if the lower limit of the range is not reached) or the maximum value (if the upper limit of the range is exceeded) is set. |

**Examples**

```

Dim Stat As Boolean
SCPI.IEEE4882.CLS
SCPI.STATUS.OPERation.PTRansition = 0
SCPI.STATUS.OPERation.NTRansition = 16
SCPI.STATUS.OPERation.ENABLE = 16
SCPI.IEEE4882.SRE = 128
SCPI.TRIGger.SEQuence.SOURce = "bus"
SCPI.INITiate(1).CONTinuous = True
SCPI.TRIGger.SEQuence.IMMEDIATE
WaitOnSRQ Stat, 10000
If Stat = True Then
 MsgBox "Done"
End If

```

**Equivalent key** No equivalent key is available on the front panel.

## SCPI Objects

SCPI objects are a collection of the COM interface having one-on-one correspondence with the SCPI commands. This section describes the SCPI objects provided for the E5070B/E5071B.

### SCPI.ABORT

|                 |                                                                                                                                                                                                                                                                                                                                                                                                                                               |
|-----------------|-----------------------------------------------------------------------------------------------------------------------------------------------------------------------------------------------------------------------------------------------------------------------------------------------------------------------------------------------------------------------------------------------------------------------------------------------|
| Object type     | Method                                                                                                                                                                                                                                                                                                                                                                                                                                        |
| Syntax          | SCPI.ABORT                                                                                                                                                                                                                                                                                                                                                                                                                                    |
| Description     | <p>Aborts the measurement and changes the trigger sequence for all channels to idle state.</p> <p>The channels for which the continuous startup mode is set to ON (setting to start up the trigger system continuously) change into the startup state immediately after the change to the idle state.</p> <p>For details about the trigger system, see Section “Trigger System” in the <i>E5070B/E5071B Programmer’s Guide</i>. (No read)</p> |
| Examples        | SCPI . ABORT                                                                                                                                                                                                                                                                                                                                                                                                                                  |
| Related objects | SCPI.INITiate(Ch).IMMEDIATE on page 425<br>SCPI.INITiate(Ch).CONTinuous on page 424                                                                                                                                                                                                                                                                                                                                                           |
| Equivalent key  | <b>[Trigger] - Restart</b>                                                                                                                                                                                                                                                                                                                                                                                                                    |

## **SCPI.CALCulate(Ch).FSIMulator.BALun.CZConversion. BPORT(Bpt).IMAGinary**

|             |                                                                                                                                                                              |
|-------------|------------------------------------------------------------------------------------------------------------------------------------------------------------------------------|
| Object type | Property                                                                                                                                                                     |
| Syntax      | SCPI.CALCulate(Ch).FSIMulator.BALun.CZConversion.BPORT(Bpt).IMAGinary = <i>Value</i><br><i>Value</i> = SCPI.CALCulate(Ch).FSIMulator.BALun.CZConversion.BPORT(Bpt).IMAGinary |
| Description | For balance ports 1 and 2 ( <i>Bpt</i> ) of channels 1 to 16 ( <i>Ch</i> ), sets the impedance value (imaginary part) for the common port impedance conversion function.     |
| Variable    |                                                                                                                                                                              |

**Table 7-6**

### **Variable (*Ch*)**

|              | <i>Ch</i>                                                                                     |
|--------------|-----------------------------------------------------------------------------------------------|
| Description  | Channel number                                                                                |
| Data type    | Long integer type (Long)                                                                      |
| Range        | 1 to 16                                                                                       |
| Preset value | 1                                                                                             |
| Note         | If the specified variable is out of the allowable setup range, an error occurs when executed. |

**Table 7-7**

### **Variable (*Bpt*)**

|              | <i>Bpt</i>                                                                                    |
|--------------|-----------------------------------------------------------------------------------------------|
| Description  | Balance port number*1                                                                         |
| Data type    | Long integer type (Long)                                                                      |
| Range        | 1 to 2                                                                                        |
| Preset value | 1                                                                                             |
| Note         | If the specified variable is out of the allowable setup range, an error occurs when executed. |

\*1. Specify the balance ports assigned with the SCPI.CALCulate(Ch).FSIMulator.BALun.TOPology. BBALanced.PPORTs object, the SCPI.CALCulate(Ch).FSIMulator.BALun.TOPology. SBALanced.PPORTs object, and the SCPI.CALCulate(Ch).FSIMulator.BALun.TOPology. SSBALanced.PPORTs object on the order base. For more information on assigning the balance ports, see Figure 7-2 on page 214.

## COM Object Reference

### SCPI.CALCulate(Ch).FSIMulator.BALun.CZConversion. BPORT(Bpt).IMAGinary

|              | <i>Value</i>                                                                                                                                                                                                 |
|--------------|--------------------------------------------------------------------------------------------------------------------------------------------------------------------------------------------------------------|
| Description  | Impedance value (imaginary part) for the common port impedance conversion function                                                                                                                           |
| Data type    | Double precision floating point type (Double)                                                                                                                                                                |
| Range        | -1E+18 to 1E+18                                                                                                                                                                                              |
| Preset value | 0                                                                                                                                                                                                            |
| Unit         | $\Omega$ (ohm)                                                                                                                                                                                               |
| Note         | If the specified variable is out of the allowable setup range, the minimum value (if the lower limit of the range is not reached) or the maximum value (if the upper limit of the range is exceeded) is set. |

#### Examples

```
Dim CImag As Double
SCPI.CALCulate(1).FSIMulator.BALun.CZConversion.BPORT(1).IMAGinary
= 1E5
CImag =
SCPI.CALCulate(1).FSIMulator.BALun.CZConversion.BPORT(1).IMAGinary
```

#### Related objects

SCPI.CALCulate(Ch).FSIMulator.BALun.CZConversion. BPORT(Bpt).REAL on page 211

SCPI.CALCulate(Ch).FSIMulator.BALun.CZConversion. BPORT(Bpt).Z0.R on page 212

SCPI.CALCulate(Ch).FSIMulator.BALun.CZConversion. STATE on page 213

SCPI.CALCulate(Ch).FSIMulator.STATE on page 256

#### Equivalent key

**[Analysis] - Fixture Simulator - Cmn ZConversion - Port1(bal) ImagPort2(bal) ImagPort3(bal) Imag**

## SCPI.CALCulate(*Ch*).FSIMulator.BALun.CZConversion.BPORT(*Bpt*).REAL

|             |                                                                                                                                                                                                        |
|-------------|--------------------------------------------------------------------------------------------------------------------------------------------------------------------------------------------------------|
| Object type | Property                                                                                                                                                                                               |
| Syntax      | SCPI.CALCulate( <i>Ch</i> ).FSIMulator.BALun.CZConversion.BPORT( <i>Bpt</i> ).REAL = <i>Value</i><br><i>Value</i> = SCPI.CALCulate( <i>Ch</i> ).FSIMulator.BALun.CZConversion.BPORT( <i>Bpt</i> ).REAL |
| Description | For balance ports 1 and 2 ( <i>Bpt</i> ) of channels 1 to 16 ( <i>Ch</i> ), sets the impedance value (real part) for the common port impedance conversion function.                                    |

**NOTE** This command performs in the same way as “SCPI.CALCulate(Ch).FSIMulator.BALun.CZConversion.BPORT(Bpt).Z0.R” on page 212

### Variable

|              | <i>Value</i>                                                                                                                                                                                                 |
|--------------|--------------------------------------------------------------------------------------------------------------------------------------------------------------------------------------------------------------|
| Description  | Impedance value (real part) for the common port impedance conversion function                                                                                                                                |
| Data type    | Double precision floating point type (Double)                                                                                                                                                                |
| Range        | 1E-3 to 1E7                                                                                                                                                                                                  |
| Preset value | 25                                                                                                                                                                                                           |
| Unit         | $\Omega$ (ohm)                                                                                                                                                                                               |
| Resolution   | 0.001                                                                                                                                                                                                        |
| Note         | If the specified variable is out of the allowable setup range, the minimum value (if the lower limit of the range is not reached) or the maximum value (if the upper limit of the range is exceeded) is set. |

**Examples**

```
Dim CReal As Double
SCPI.CALCulate(1).FSIMulator.BALun.CZConversion.BPORT(1).REAL = 30
CReal =
SCPI.CALCulate(1).FSIMulator.BALun.CZConversion.BPORT(1).REAL
```

**Related objects**

SCPI.CALCulate(Ch).FSIMulator.BALun.CZConversion.BPORT(Bpt).IMAGinary on page 209

SCPI.CALCulate(Ch).FSIMulator.BALun.CZConversion.BPORT(Bpt).Z0.R on page 212

SCPI.CALCulate(Ch).FSIMulator.BALun.CZConversion.STATe on page 213

SCPI.CALCulate(Ch).FSIMulator.STATe on page 256

**Equivalent key** [Analysis] - Fixture Simulator - Cmn ZConversion - Port1(bal) Real|Port2(bal) Real|Port3(bal) Real

**SCPI.CALCulate(Ch).FSIMulator.BALun.CZConversion. BPORT(Bpt).Z0.R**

|             |                                                                                                                                                                    |
|-------------|--------------------------------------------------------------------------------------------------------------------------------------------------------------------|
| Object type | Property                                                                                                                                                           |
| Syntax      | SCPI.CALCulate(Ch).FSIMulator.BALun.CZConversion.BPORT(Bpt).Z0.R = <i>Value</i><br><i>Value</i> = SCPI.CALCulate(Ch).FSIMulator.BALun.CZConversion.BPORT(Bpt).Z0.R |
| Description | For balance ports 1 and 2 ( <i>Bpt</i> ) of channels 1 to 16 ( <i>Ch</i> ), sets the impedance value for the common port impedance conversion function.            |

---

**CAUTION** This command clears setting value of “SCPI.CALCulate(Ch).FSIMulator.BALun.CZConversion. BPORT(Bpt).IMAGinary” on page 209

---

## Variable

|              | <i>Value</i>                                                                                                                                                                                                 |
|--------------|--------------------------------------------------------------------------------------------------------------------------------------------------------------------------------------------------------------|
| Description  | Impedance value for the common port impedance conversion function                                                                                                                                            |
| Data type    | Double precision floating point type (Double)                                                                                                                                                                |
| Range        | 1E-3 to 1E7                                                                                                                                                                                                  |
| Preset value | 25                                                                                                                                                                                                           |
| Unit         | $\Omega$ (ohm)                                                                                                                                                                                               |
| Resolution   | 0.001                                                                                                                                                                                                        |
| Note         | If the specified variable is out of the allowable setup range, the minimum value (if the lower limit of the range is not reached) or the maximum value (if the upper limit of the range is exceeded) is set. |

**Examples**

```
Dim CZ0 As Double
SCPI.CALCulate(1).FSIMulator.BALun.CZConversion.BPORT(1).Z0.R = 30
CZ0 = SCPI.CALCulate(1).FSIMulator.BALun.CZConversion.BPORT(1).Z0.R
```

**Related objects**

SCPI.CALCulate(Ch).FSIMulator.BALun.CZConversion. BPORT(Bpt).IMAGinary on page 209

SCPI.CALCulate(Ch).FSIMulator.BALun.CZConversion. BPORT(Bpt).REAL on page 211

SCPI.CALCulate(Ch).FSIMulator.BALun.CZConversion. STATE on page 213

SCPI.CALCulate(Ch).FSIMulator.STATE on page 256

**Equivalent key** **[Analysis] - Fixture Simulator - Cmn ZConversion - Port1(bal) Real|Port2(bal) Real|Port3(bal) Real**



**SCPI.CALCulate(Ch).FSIMulator.BALun.CZConversion. STATE**

|             |                                                                                                                                                                    |
|-------------|--------------------------------------------------------------------------------------------------------------------------------------------------------------------|
| Object type | Property                                                                                                                                                           |
| Syntax      | SCPI.CALCulate(Ch).FSIMulator.BALun.CZConversion.STATE = <i>Status</i><br><i>Status</i> = SCPI.CALCulate(Ch).FSIMulator.BALun.CZConversion.STATE                   |
| Description | For all the balance ports of channels 1 to 16 ( <i>Ch</i> ), turns ON/OFF the common port impedance conversion function when the fixture simulator function is ON. |
| Variable    |                                                                                                                                                                    |

|              |                                                                                                                                                                                                                                                                               |
|--------------|-------------------------------------------------------------------------------------------------------------------------------------------------------------------------------------------------------------------------------------------------------------------------------|
|              | <i>Status</i>                                                                                                                                                                                                                                                                 |
| Description  | ON/OFF of the common port impedance conversion function                                                                                                                                                                                                                       |
| Data type    | Boolean type (Boolean)                                                                                                                                                                                                                                                        |
| Range        | Select from the following.<br><ul style="list-style-type: none"> <li>• True or -1                      Turns ON the common port impedance conversion function.</li> <li>• False or 0                      Turns OFF the common port impedance conversion function.</li> </ul> |
| Preset value | False or 0                                                                                                                                                                                                                                                                    |

For information on the variable (*Ch*), see Table 7-6, “Variable (Ch),” on page 209.

|                 |                                                                                                                                                                                                                                                                                                         |
|-----------------|---------------------------------------------------------------------------------------------------------------------------------------------------------------------------------------------------------------------------------------------------------------------------------------------------------|
| Examples        | Dim ComZcon As Boolean<br>SCPI.CALCulate(1).FSIMulator.BALun.CZConversion.STATE = True<br>ComZcon = SCPI.CALCulate(1).FSIMulator.BALun.CZConversion.STATE                                                                                                                                               |
| Related objects | SCPI.CALCulate(Ch).FSIMulator.BALun.CZConversion. BPORT(Bpt).IMAGinary on page 209<br>SCPI.CALCulate(Ch).FSIMulator.BALun.CZConversion. BPORT(Bpt).REAL on page 211<br>SCPI.CALCulate(Ch).FSIMulator.BALun.CZConversion. BPORT(Bpt).Z0.R on page 212<br>SCPI.CALCulate(Ch).FSIMulator.STATE on page 256 |
| Equivalent key  | <b>[Analysis] - Fixture Simulator - Cmn ZConversion - Cmn ZConversion</b>                                                                                                                                                                                                                               |

## SCPI.CALCulate(*Ch*).FSIMulator.BALun.DEVice

Object type Property  
 Syntax SCPI.CALCulate(*Ch*).FSIMulator.BALun.DEVice = *Param*  
*Param* = SCPI.CALCulate(*Ch*).FSIMulator.BALun.DEVice  
 Description For channels 1 to 16 (*Ch*), selects the balance device type of the fixture simulator function.

**Figure 7-2 Balance device type**

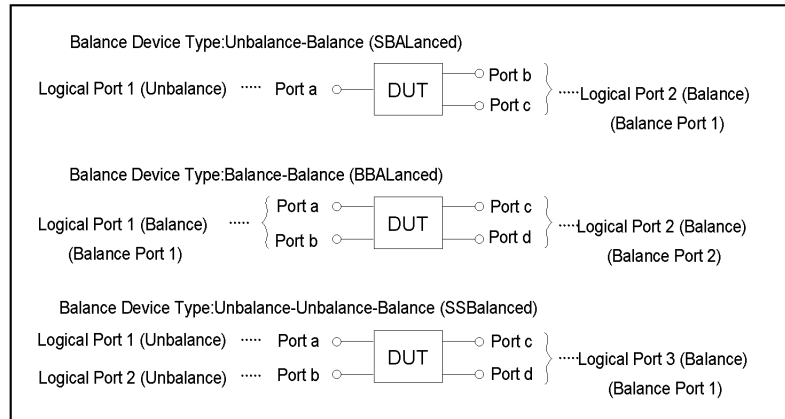

e5070ape019

Variable

|              | <i>Param</i>                                                                                                                                                                                                                                                                    |
|--------------|---------------------------------------------------------------------------------------------------------------------------------------------------------------------------------------------------------------------------------------------------------------------------------|
| Description  | Balance device type (See Figure 7-2)                                                                                                                                                                                                                                            |
| Data type    | Character string type (String)                                                                                                                                                                                                                                                  |
| Range        | Select from the following. <ul style="list-style-type: none"> <li>•"SBALanced" Specifies the unbalance-balance (3 ports).</li> <li>•"BBALanced" Specifies the balance-balance (4 ports).</li> <li>•"SSBALanced" Specifies the unbalance-unbalance-balance (4 ports).</li> </ul> |
| Preset value | "SBALanced"                                                                                                                                                                                                                                                                     |

For information on the variable (*Ch*), see Table 7-6, “Variable (Ch),” on page 209.

Examples

```
Dim BalDev As String
SCPI.CALCulate(1).FSIMulator.BALun.DEVice = "bbal"
BalDev = SCPI.CALCulate(1).FSIMulator.BALun.DEVice
```

Related objects

SCPI.CALCulate(*Ch*).FSIMulator.BALun.TOPology. BBALanced.PPORTs on page 230  
 SCPI.CALCulate(*Ch*).FSIMulator.BALun.TOPology. SBALanced.PPORTs on page 232  
 SCPI.CALCulate(*Ch*).FSIMulator.BALun.TOPology. SSBALanced.PPORTs on page 233

Equivalent key

**[Analysis] - Fixture Simulator - Topology - Device**

## SCPI.CALCulate(*Ch*).FSIMulator.BALun.DMCircuit. BPORT(*Bpt*).PARAMeters.C

**Object type** Property

**Syntax** SCPI.CALCulate(*Ch*).FSIMulator.BALun.DMCircuit.BPORT(*Bpt*).PARAMeters.C = *Value*  
*Value* = SCPI.CALCulate(*Ch*).FSIMulator.BALun.DMCircuit.BPORT(*Bpt*).PARAMeters.C

**Description** For balance port 1 and balance port 2 (*Bpt*) of channel 1 to 9 (*Ch*), sets the C value of the differential matching circuit consisting of shunt L and shunt C (PLPC is specified with the SCPI.CALCulate(Ch).FSIMulator.BALun.DMCircuit. BPORT(Bpt).TYPE object).

**Variable**

|              | <i>Value</i>                                                                                                                                                                                                 |
|--------------|--------------------------------------------------------------------------------------------------------------------------------------------------------------------------------------------------------------|
| Description  | C value of the differential matching circuit                                                                                                                                                                 |
| Data type    | Double precision floating point type (Double)                                                                                                                                                                |
| Range        | -1E18 to 1E18                                                                                                                                                                                                |
| Preset value | 0                                                                                                                                                                                                            |
| Unit         | F (farad)                                                                                                                                                                                                    |
| Resolution   | 1E-18                                                                                                                                                                                                        |
| Note         | If the specified variable is out of the allowable setup range, the minimum value (if the lower limit of the range is not reached) or the maximum value (if the upper limit of the range is exceeded) is set. |

For information on the variable (*Ch*) and the variable (*Bpt*), see Table 7-6, “Variable (Ch),” on page 209 and Table 7-7, “Variable (Bpt),” on page 209, respectively.

**Examples**

```
Dim DmcC As Double
SCPI.CALCulate(1).FSIMulator.BALun.DMCircuit.BPORT(1).PARAMeters.C = 12E-12
DmcC = SCPI.CALCulate(1).FSIMulator.BALun.DMCircuit.BPORT(1).PARAMeters.C
```

**Related objects**

SCPI.CALCulate(Ch).FSIMulator.BALun.DMCircuit. BPORT(Bpt).PARAMeters.G on page 216

SCPI.CALCulate(Ch).FSIMulator.BALun.DMCircuit. BPORT(Bpt).PARAMeters.L on page 217

SCPI.CALCulate(Ch).FSIMulator.BALun.DMCircuit. BPORT(Bpt).PARAMeters.R on page 218

SCPI.CALCulate(Ch).FSIMulator.BALun.DMCircuit. BPORT(Bpt).TYPE on page 219

SCPI.CALCulate(Ch).FSIMulator.BALun.DMCircuit. STAtE on page 221

**Equivalent key** **[Analysis] - Fixture Simulator - Diff Matching - C**

**SCPI.CALCulate(Ch).FSIMulator.BALun.DMCircuit.  
 BPORT(Bpt).PARAMeters.G**

**Object type** Property

**Syntax** SCPI.CALCulate(Ch).FSIMulator.BALun.DMCircuit.BPORT(Bpt).PARAMeters.G = *Value*  
*Value* = SCPI.CALCulate(Ch).FSIMulator.BALun.DMCircuit.BPORT(Bpt).PARAMeters.G

**Description** For balance port 1 and balance port 2 (*Bpt*) of channel 1 to 9 (*Ch*), sets the G value of the differential matching circuit consisting of shunt L and shunt C (PLPC is specified with the SCPI.CALCulate(Ch).FSIMulator.BALun.DMCircuit. BPORT(Bpt).TYPE object).

**Variable**

|              | <i>Value</i>                                                                                                                                                                                                 |
|--------------|--------------------------------------------------------------------------------------------------------------------------------------------------------------------------------------------------------------|
| Description  | G value of the differential matching circuit                                                                                                                                                                 |
| Data type    | Double precision floating point type (Double)                                                                                                                                                                |
| Range        | -1E18 to 1E18                                                                                                                                                                                                |
| Preset value | 0                                                                                                                                                                                                            |
| Unit         | S (siemens)                                                                                                                                                                                                  |
| Resolution   | 1E-18                                                                                                                                                                                                        |
| Note         | If the specified variable is out of the allowable setup range, the minimum value (if the lower limit of the range is not reached) or the maximum value (if the upper limit of the range is exceeded) is set. |

For information on the variable (*Ch*) and the variable (*Bpt*), see Table 7-6, “Variable (Ch),” on page 209 and Table 7-7, “Variable (Bpt),” on page 209, respectively.

**Examples**

```
Dim DmcG As Double
SCPI.CALCulate(1).FSIMulator.BALun.DMCircuit.BPORT(1).PARAMeters.G = 12E-12
DmcG = SCPI.CALCulate(1).FSIMulator.BALun.DMCircuit.BPORT(1).PARAMeters.G
```

**Related objects**

SCPI.CALCulate(Ch).FSIMulator.BALun.DMCircuit. BPORT(Bpt).PARAMeters.C on page 215

SCPI.CALCulate(Ch).FSIMulator.BALun.DMCircuit. BPORT(Bpt).PARAMeters.L on page 217

SCPI.CALCulate(Ch).FSIMulator.BALun.DMCircuit. BPORT(Bpt).PARAMeters.R on page 218

SCPI.CALCulate(Ch).FSIMulator.BALun.DMCircuit. BPORT(Bpt).TYPE on page 219

SCPI.CALCulate(Ch).FSIMulator.BALun.DMCircuit. STATE on page 221

**Equivalent key** **[Analysis] - Fixture Simulator - Diff Matching - G**

## SCPI.CALCulate(*Ch*).FSIMulator.BALun.DMCircuit. BPORT(*Bpt*).PARAmeters.L

**Object type** Property

**Syntax** SCPI.CALCulate(*Ch*).FSIMulator.BALun.DMCircuit.BPORT(*Bpt*).PARAmeters.L = *Value*  
*Value* = SCPI.CALCulate(*Ch*).FSIMulator.BALun.DMCircuit.BPORT(*Bpt*).PARAmeters.L

**Description** For balance port 1 and balance port 2 (*Bpt*) of channel 1 to 9 (*Ch*), sets the L value of the differential matching circuit consisting of shunt L and shunt C (PLPC is specified with the SCPI.CALCulate(Ch).FSIMulator.BALun.DMCircuit. BPORT(Bpt).TYPE object).

**Variable**

|              | <i>Value</i>                                                                                                                                                                                                 |
|--------------|--------------------------------------------------------------------------------------------------------------------------------------------------------------------------------------------------------------|
| Description  | L value of the differential matching circuit                                                                                                                                                                 |
| Data type    | Double precision floating point type (Double)                                                                                                                                                                |
| Range        | -1E18 to 1E18                                                                                                                                                                                                |
| Preset value | 0                                                                                                                                                                                                            |
| Unit         | H (henry)                                                                                                                                                                                                    |
| Resolution   | 1E-18                                                                                                                                                                                                        |
| Note         | If the specified variable is out of the allowable setup range, the minimum value (if the lower limit of the range is not reached) or the maximum value (if the upper limit of the range is exceeded) is set. |

For information on the variable (*Ch*) and the variable (*Bpt*), see Table 7-6, “Variable (Ch),” on page 209 and Table 7-7, “Variable (Bpt),” on page 209, respectively.

**Examples**

```
Dim DmcL As Double
SCPI.CALCulate(1).FSIMulator.BALun.DMCircuit.BPORT(1).PARAmeters.L
= 12E-12
DmcL =
SCPI.CALCulate(1).FSIMulator.BALun.DMCircuit.BPORT(1).PARAmeters.L
```

**Related objects**

SCPI.CALCulate(Ch).FSIMulator.BALun.DMCircuit. BPORT(Bpt).PARAmeters.C on page 215

SCPI.CALCulate(Ch).FSIMulator.BALun.DMCircuit. BPORT(Bpt).PARAmeters.G on page 216

SCPI.CALCulate(Ch).FSIMulator.BALun.DMCircuit. BPORT(Bpt).PARAmeters.R on page 218

SCPI.CALCulate(Ch).FSIMulator.BALun.DMCircuit. BPORT(Bpt).TYPE on page 219

SCPI.CALCulate(Ch).FSIMulator.BALun.DMCircuit. STATE on page 221

**Equivalent key** **[Analysis] - Fixture Simulator - Diff Matching - L**

**SCPI.CALCulate(Ch).FSIMulator.BALun.DMCircuit.  
 BPORT(Bpt).PARAMeters.R**

**Object type** Property

**Syntax** SCPI.CALCulate(Ch).FSIMulator.BALun.DMCircuit.BPORT(Bpt).PARAMeters.R = *Value*  
*Value* = SCPI.CALCulate(Ch).FSIMulator.BALun.DMCircuit.BPORT(Bpt).PARAMeters.R

**Description** For balance port 1 and balance port 2 (*Bpt*) of channel 1 to 9 (*Ch*), sets the R value of the differential matching circuit consisting of shunt L and shunt C (PLPC is specified with the SCPI.CALCulate(Ch).FSIMulator.BALun.DMCircuit. BPORT(Bpt).TYPE object).

**Variable**

|              | <i>Value</i>                                                                                                                                                                                                 |
|--------------|--------------------------------------------------------------------------------------------------------------------------------------------------------------------------------------------------------------|
| Description  | R value of the differential matching circuit                                                                                                                                                                 |
| Data type    | Double precision floating point type (Double)                                                                                                                                                                |
| Range        | -1E18 to 1E18                                                                                                                                                                                                |
| Preset value | 0                                                                                                                                                                                                            |
| Unit         | $\Omega$ (ohm)                                                                                                                                                                                               |
| Resolution   | 1E-18                                                                                                                                                                                                        |
| Note         | If the specified variable is out of the allowable setup range, the minimum value (if the lower limit of the range is not reached) or the maximum value (if the upper limit of the range is exceeded) is set. |

For information on the variable (*Ch*) and the variable (*Bpt*), see Table 7-6, “Variable (Ch),” on page 209 and Table 7-7, “Variable (Bpt),” on page 209, respectively.

**Examples**

```
Dim DmcR As Double
SCPI.CALCulate(1).FSIMulator.BALun.DMCircuit.BPORT(1).PARAMeters.R = 12E-12
DmcR = SCPI.CALCulate(1).FSIMulator.BALun.DMCircuit.BPORT(1).PARAMeters.R
```

**Related objects**

SCPI.CALCulate(Ch).FSIMulator.BALun.DMCircuit. BPORT(Bpt).PARAMeters.C on page 215

SCPI.CALCulate(Ch).FSIMulator.BALun.DMCircuit. BPORT(Bpt).PARAMeters.G on page 216

SCPI.CALCulate(Ch).FSIMulator.BALun.DMCircuit. BPORT(Bpt).PARAMeters.L on page 217

SCPI.CALCulate(Ch).FSIMulator.BALun.DMCircuit. BPORT(Bpt).TYPE on page 219

SCPI.CALCulate(Ch).FSIMulator.BALun.DMCircuit. STATE on page 221

**Equivalent key** [Analysis] - Fixture Simulator - Diff Matching - R

## SCPI.CALCulate(Ch).FSIMulator.BALun.DMCircuit. BPORT(Bpt).TYPE

|             |                                                                                                                                                                                                                                                                                            |
|-------------|--------------------------------------------------------------------------------------------------------------------------------------------------------------------------------------------------------------------------------------------------------------------------------------------|
| Object type | Property                                                                                                                                                                                                                                                                                   |
| Syntax      | SCPI.CALCulate(Ch).FSIMulator.BALun.DMCircuit.BPORT(Bpt).TYPE = <i>Param</i><br><i>Param</i> = SCPI.CALCulate(Ch).FSIMulator.BALun.DMCircuit.BPORT(Bpt).TYPE                                                                                                                               |
| Description | For balance ports 1 and 2 ( <i>Bpt</i> ) of channels 1 to 16 ( <i>Ch</i> ), selects the type of the differential matching circuit. For information on the model of the differential matching circuit, see Section “Evaluating Balanced Devices” in the <i>E5070B/E5071B User’s Guide</i> . |

### Variable

|              | <i>Param</i>                                                                                                                                                                                                                                                                                                                       |
|--------------|------------------------------------------------------------------------------------------------------------------------------------------------------------------------------------------------------------------------------------------------------------------------------------------------------------------------------------|
| Description  | Type of the differential matching circuit                                                                                                                                                                                                                                                                                          |
| Data type    | Character string type (String)                                                                                                                                                                                                                                                                                                     |
| Range        | Select from the following.<br><ul style="list-style-type: none"> <li>•"NONE"                      Specifies no-circuit.</li> <li>•"PLPC"                      Specifies the circuit that consists of shunt L and shunt C.</li> <li>•"USER"                      Specifies the user-defined circuit<sup>*1</sup>.</li> </ul>        |
| Preset value | "NONE"                                                                                                                                                                                                                                                                                                                             |
| Note         | If you want to select the user-defined circuit, you must specify the 2-port touchstone file in which the proper information on the user-defined circuit is saved in advance. If you do not specify the appropriate file and you select the user-defined circuit, an error occurs when executed and NONE is automatically selected. |

\*1. The information on the circuit is read out from the 2-port touchstone file specified with the SCPI.CALCulate(Ch).FSIMulator.BALun.DMCircuit. BPORT(Bpt).USER.FILEname object.

For information on the variable (*Ch*) and the variable (*Bpt*), see Table 7-6, “Variable (Ch),” on page 209 and Table 7-7, “Variable (Bpt),” on page 209, respectively.

### Examples

```
Dim CirType As String
SCPI.CALCulate(1).FSIMulator.BALun.DMCircuit.BPORT(1).TYPE = "plpc"
CirType = SCPI.CALCulate(1).FSIMulator.BALun.DMCircuit.BPORT(1).TYPE
```

### Related objects

SCPI.CALCulate(Ch).FSIMulator.BALun.DMCircuit. BPORT(Bpt).PARAMeters.C on page 215

SCPI.CALCulate(Ch).FSIMulator.BALun.DMCircuit. BPORT(Bpt).PARAMeters.G on page 216

SCPI.CALCulate(Ch).FSIMulator.BALun.DMCircuit. BPORT(Bpt).PARAMeters.L on page 217

SCPI.CALCulate(Ch).FSIMulator.BALun.DMCircuit. BPORT(Bpt).PARAMeters.R on page 218

SCPI.CALCulate(Ch).FSIMulator.BALun.DMCircuit. BPORT(Bpt).USER.FILEname on page 220

SCPI.CALCulate(Ch).FSIMulator.BALun.DMCircuit. STATE on page 221

### Equivalent key

**[Analysis] - Fixture Simulator - Diff Matching - Select Circuit**

## SCPI.CALCulate(*Ch*).FSIMulator.BALun.DMCircuit. BPORT(*Bpt*).USER.FILename

**Object type** Property

**Syntax** SCPI.CALCulate(*Ch*).FSIMulator.BALun.DMCircuit.BPORT(*Bpt*).USER.FILename = *File*  
*File* = SCPI.CALCulate(*Ch*).FSIMulator.BALun.DMCircuit.BPORT(*Bpt*).USER.FILename

**Description** For balance ports 1 and 2 (*Bpt*) of channels 1 to 16 (*Ch*), specifies the file in which the information on the user-defined differential matching circuit is saved (2-port touchstone file with the .s2p extension).

Specify the file name with the extension. If you want to specify a file on the floppy disk drive, you need to add "A:" at the beginning of the file name. When you use directory names (folder names) and file name, separate them with "\" (back slash), or "/" (slash).

Even if the specified file does not exist, no error occurs when you execute this object. However, when you set the type of the differential matching circuit to the user-defined circuit with the SCPI.CALCulate(Ch).FSIMulator.BALun.DMCircuit.

BPORT(Bpt).TYPE object, an error occurs when executed.

### Variable

|              | <i>File</i>                                                                         |
|--------------|-------------------------------------------------------------------------------------|
| Description  | 2-port touchstone file name (extension: .s2p) for the differential matching circuit |
| Data type    | Character string type (String)                                                      |
| Range        | 254 characters or less                                                              |
| Preset value | ""                                                                                  |

For information on the variable (*Ch*) and the variable (*Bpt*), see Table 7-6, "Variable (Ch)," on page 209 and Table 7-7, "Variable (Bpt)," on page 209, respectively.

**Examples**

```
Dim DmcUser As String
SCPI.CALCulate(1).FSIMulator.BALun.DMCircuit.BPORT(1).USER.FILename = "dmc.s2p"
DmcUser = SCPI.CALCulate(1).FSIMulator.BALun.DMCircuit.BPORT(1).USER.FILename
SCPI.CALCulate(1).FSIMulator.BALun.DMCircuit.BPORT(1).TYPE = "user"
```

**Related objects** SCPI.CALCulate(Ch).FSIMulator.BALun.DMCircuit. BPORT(Bpt).TYPE on page 219  
SCPI.CALCulate(Ch).FSIMulator.BALun.DMCircuit. STATE on page 221

**Equivalent key** **[Analysis] - Fixture Simulator - Diff Matching - User File**



## SCPI.CALCulate(Ch).FSIMulator.BALun.DMCircuit. STATE

**Object type** Property

**Syntax** SCPI.CALCulate(Ch).FSIMulator.BALun.DMCircuit.STATE = *Status*  
*Status* = SCPI.CALCulate(Ch).FSIMulator.BALun.DMCircuit.STATE

**Description** For all the balance ports of channels 1 to 16 (*Ch*), turns ON/OFF the differential matching circuit embedding function when the fixture simulator function is ON.

**Variable**

|              | <i>Status</i>                                                                                                                                                                                                                                                                               |
|--------------|---------------------------------------------------------------------------------------------------------------------------------------------------------------------------------------------------------------------------------------------------------------------------------------------|
| Description  | ON/OFF of the differential matching circuit embedding function                                                                                                                                                                                                                              |
| Data type    | Boolean type (Boolean)                                                                                                                                                                                                                                                                      |
| Range        | Select from the following.<br><ul style="list-style-type: none"> <li>• True or -1                      Turns ON the differential matching circuit embedding function.</li> <li>• False or 0                      Turns OFF the differential matching circuit embedding function.</li> </ul> |
| Preset value | False or 0                                                                                                                                                                                                                                                                                  |

For information on the variable (*Ch*), see Table 7-6, “Variable (Ch),” on page 209.

**Examples**

```
Dim DifMch As Boolean
SCPI.CALCulate(1).FSIMulator.BALun.DMCircuit.STATE = True
DifMch = SCPI.CALCulate(1).FSIMulator.BALun.DMCircuit.STATE
```

**Related objects**

SCPI.CALCulate(Ch).FSIMulator.BALun.DMCircuit. BPORT(Bpt).PARAMeters.C on page 215

SCPI.CALCulate(Ch).FSIMulator.BALun.DMCircuit. BPORT(Bpt).PARAMeters.G on page 216

SCPI.CALCulate(Ch).FSIMulator.BALun.DMCircuit. BPORT(Bpt).PARAMeters.L on page 217

SCPI.CALCulate(Ch).FSIMulator.BALun.DMCircuit. BPORT(Bpt).PARAMeters.R on page 218

SCPI.CALCulate(Ch).FSIMulator.BALun.DMCircuit. BPORT(Bpt).USER.FILEname on page 220

SCPI.CALCulate(Ch).FSIMulator.BALun.DMCircuit. BPORT(Bpt).TYPE on page 219

SCPI.CALCulate(Ch).FSIMulator.BALun.PARAmeter(Tr). STATE on page 229

SCPI.CALCulate(Ch).FSIMulator.STATE on page 256

**Equivalent key** **[Analysis] - Fixture Simulator - Diff Matching - Diff Matching**

**SCPI.CALCulate(Ch).FSIMulator.BALun.DZConversion.  
BPORT(Bpt).IMAGinary**

|             |                                                                                                                                                                                |
|-------------|--------------------------------------------------------------------------------------------------------------------------------------------------------------------------------|
| Object type | Property                                                                                                                                                                       |
| Syntax      | SCPI.CALCulate(Ch).FSIMulator.BALun.DZConversion.BPORT(Bpt).IMAGinary = <i>Value</i><br><i>Value</i> = SCPI.CALCulate(Ch).FSIMulator.BALun.DZConversion.BPORT(Bpt).IMAGinary   |
| Description | For balance ports 1 and 2 ( <i>Bpt</i> ) of channels 1 to 16 ( <i>Ch</i> ), sets the impedance value (imaginary part) for the differential port impedance conversion function. |
| Variable    |                                                                                                                                                                                |

|              | <i>Value</i>                                                                                                                                                                                                 |
|--------------|--------------------------------------------------------------------------------------------------------------------------------------------------------------------------------------------------------------|
| Description  | Impedance value (imaginary part) for the differential port impedance conversion function                                                                                                                     |
| Data type    | Double precision floating point type (Double)                                                                                                                                                                |
| Range        | -1E+18 to 1E+18                                                                                                                                                                                              |
| Preset value | 0                                                                                                                                                                                                            |
| Unit         | $\Omega$ (ohm)                                                                                                                                                                                               |
| Note         | If the specified variable is out of the allowable setup range, the minimum value (if the lower limit of the range is not reached) or the maximum value (if the upper limit of the range is exceeded) is set. |

For information on the variable (*Ch*) and the variable (*Bpt*), see Table 7-6, “Variable (Ch),” on page 209 and Table 7-7, “Variable (Bpt),” on page 209, respectively.

|          |                                                                                                                                                                                    |
|----------|------------------------------------------------------------------------------------------------------------------------------------------------------------------------------------|
| Examples | <pre>Dim DImag As Double SCPI.CALCulate(1).FSIMulator.BALun.DZConversion.BPORT(1).IMAGinary = 200 DImag = SCPI.CALCulate(1).FSIMulator.BALun.DZConversion.BPORT(1).IMAGinary</pre> |
|----------|------------------------------------------------------------------------------------------------------------------------------------------------------------------------------------|

|                 |                                                                                                                                                                                                                                                                                                             |
|-----------------|-------------------------------------------------------------------------------------------------------------------------------------------------------------------------------------------------------------------------------------------------------------------------------------------------------------|
| Related objects | <p>SCPI.CALCulate(Ch).FSIMulator.BALun.DZConversion. BPORT(Bpt).REAL on page 223</p> <p>SCPI.CALCulate(Ch).FSIMulator.BALun.DZConversion. BPORT(Bpt).Z0.R on page 224</p> <p>SCPI.CALCulate(Ch).FSIMulator.BALun.DZConversion. STATE on page 225</p> <p>SCPI.CALCulate(Ch).FSIMulator.STATE on page 256</p> |
|-----------------|-------------------------------------------------------------------------------------------------------------------------------------------------------------------------------------------------------------------------------------------------------------------------------------------------------------|

|                |                                                                                                            |
|----------------|------------------------------------------------------------------------------------------------------------|
| Equivalent key | <b>[Analysis] - Fixture Simulator - Diff ZConversion - Port1(bal) Imag Port2(bal) Imag Port3(bal) Imag</b> |
|----------------|------------------------------------------------------------------------------------------------------------|

**SCPI.CALCulate(Ch).FSIMulator.BALun.DZConversion.  
BPORT(Bpt).REAL**

|             |                                                                                                                                                                           |
|-------------|---------------------------------------------------------------------------------------------------------------------------------------------------------------------------|
| Object type | Property                                                                                                                                                                  |
| Syntax      | SCPI.CALCulate(Ch).FSIMulator.BALun.DZConversion.BPORT(Bpt).REAL = <i>Value</i><br><i>Value</i> = SCPI.CALCulate(Ch).FSIMulator.BALun.DZConversion.BPORT(Bpt).REAL        |
| Description | For balance ports 1 and 2 ( <i>Bpt</i> ) of channels 1 to 16 ( <i>Ch</i> ), sets the impedance value (real part) for the differential port impedance conversion function. |

**NOTE** This command performs in the same way as “SCPI.CALCulate(Ch).FSIMulator.BALun.DZConversion. BPORT(Bpt).Z0.R” on page 224

## Variable

|              | <i>Value</i>                                                                                                                                                                                                 |
|--------------|--------------------------------------------------------------------------------------------------------------------------------------------------------------------------------------------------------------|
| Description  | Impedance value (real part) for the differential port impedance conversion function                                                                                                                          |
| Data type    | Double precision floating point type (Double)                                                                                                                                                                |
| Range        | 1E-3 to 1E7                                                                                                                                                                                                  |
| Preset value | 100                                                                                                                                                                                                          |
| Unit         | $\Omega$ (ohm)                                                                                                                                                                                               |
| Resolution   | 0.001                                                                                                                                                                                                        |
| Note         | If the specified variable is out of the allowable setup range, the minimum value (if the lower limit of the range is not reached) or the maximum value (if the upper limit of the range is exceeded) is set. |

For information on the variable (*Ch*) and the variable (*Bpt*), see Table 7-6, “Variable (Ch),” on page 209 and Table 7-7, “Variable (Bpt),” on page 209, respectively.

**Examples**

```
Dim DReal As Double
SCPI.CALCulate(1).FSIMulator.BALun.DZConversion.BPORT(1).REAL = 200
DReal =
SCPI.CALCulate(1).FSIMulator.BALun.DZConversion.BPORT(1).REAL
```

**Related objects**

SCPI.CALCulate(Ch).FSIMulator.BALun.DZConversion. BPORT(Bpt).IMAGinary on page 222

SCPI.CALCulate(Ch).FSIMulator.BALun.DZConversion. BPORT(Bpt).Z0.R on page 224

SCPI.CALCulate(Ch).FSIMulator.BALun.DZConversion. STATE on page 225

SCPI.CALCulate(Ch).FSIMulator.STATE on page 256

**Equivalent key** **[Analysis] - Fixture Simulator - Diff ZConversion - Port1(bal) Real|Port2(bal) Real|Port3(bal) Real**

**SCPI.CALCulate(Ch).FSIMulator.BALun.DZConversion. BPORT(Bpt).Z0.R**

|             |                                                                                                                                                                    |
|-------------|--------------------------------------------------------------------------------------------------------------------------------------------------------------------|
| Object type | Property                                                                                                                                                           |
| Syntax      | SCPI.CALCulate(Ch).FSIMulator.BALun.DZConversion.BPORT(Bpt).Z0.R = <i>Value</i><br><i>Value</i> = SCPI.CALCulate(Ch).FSIMulator.BALun.DZConversion.BPORT(Bpt).Z0.R |
| Description | For balance ports 1 and 2 ( <i>Bpt</i> ) of channels 1 to 16 ( <i>Ch</i> ), sets the impedance value for the differential port impedance conversion function.      |

---

**CAUTION** This command clears setting value of “SCPI.CALCulate(Ch).FSIMulator.BALun.DZConversion. BPORT(Bpt).IMAGinary” on page 222

---

## Variable

|              | <i>Value</i>                                                                                                                                                                                                 |
|--------------|--------------------------------------------------------------------------------------------------------------------------------------------------------------------------------------------------------------|
| Description  | Impedance value for the differential port impedance conversion function                                                                                                                                      |
| Data type    | Double precision floating point type (Double)                                                                                                                                                                |
| Range        | 1E-3 to 1E7                                                                                                                                                                                                  |
| Preset value | 100                                                                                                                                                                                                          |
| Unit         | $\Omega$ (ohm)                                                                                                                                                                                               |
| Resolution   | 0.001                                                                                                                                                                                                        |
| Note         | If the specified variable is out of the allowable setup range, the minimum value (if the lower limit of the range is not reached) or the maximum value (if the upper limit of the range is exceeded) is set. |

For information on the variable (*Ch*) and the variable (*Bpt*), see Table 7-6, “Variable (Ch),” on page 209 and Table 7-7, “Variable (Bpt),” on page 209, respectively.

|                 |                                                                                                                                                                                                                                                                                               |
|-----------------|-----------------------------------------------------------------------------------------------------------------------------------------------------------------------------------------------------------------------------------------------------------------------------------------------|
| Examples        | Dim DZ0 As Double<br>SCPI.CALCulate(1).FSIMulator.BALun.DZConversion.BPORT(1).Z0.R = 200<br>DZ0 = SCPI.CALCulate(1).FSIMulator.BALun.DZConversion.BPORT(1).Z0.R                                                                                                                               |
| Related objects | SCPI.CALCulate(Ch).FSIMulator.BALun.DZConversion. BPORT(Bpt).IMAGinary on page 222<br>SCPI.CALCulate(Ch).FSIMulator.BALun.DZConversion. BPORT(Bpt).REAL on page 223<br>SCPI.CALCulate(Ch).FSIMulator.BALun.DZConversion. STATE on page 225<br>SCPI.CALCulate(Ch).FSIMulator.STATE on page 256 |
| Equivalent key  | <b>[Analysis] - Fixture Simulator - Diff ZConversion - Port1(bal) Real Port2(bal) Real Port3(bal) Real</b>                                                                                                                                                                                    |

## SCPI.CALCulate(*Ch*).FSIMulator.BALun.DZConversion. STATE

|             |                                                                                                                                                                          |
|-------------|--------------------------------------------------------------------------------------------------------------------------------------------------------------------------|
| Object type | Property                                                                                                                                                                 |
| Syntax      | SCPI.CALCulate( <i>Ch</i> ).FSIMulator.BALun.DZConversion.STATE = <i>Status</i><br><i>Status</i> = SCPI.CALCulate( <i>Ch</i> ).FSIMulator.BALun.DZConversion.STATE       |
| Description | For all the balance ports of channels 1 to 16 ( <i>Ch</i> ), turns ON/OFF the differential port impedance conversion function when the fixture simulator function is ON. |
| Variable    |                                                                                                                                                                          |

|              | <i>Status</i>                                                                                                                                                                                                                                                                             |
|--------------|-------------------------------------------------------------------------------------------------------------------------------------------------------------------------------------------------------------------------------------------------------------------------------------------|
| Description  | ON/OFF of the differential port impedance conversion function                                                                                                                                                                                                                             |
| Data type    | Boolean type (Boolean)                                                                                                                                                                                                                                                                    |
| Range        | Select from the following.<br><ul style="list-style-type: none"> <li>• True or -1                      Turns ON the differential port impedance conversion function.</li> <li>• False or 0                      Turns OFF the differential port impedance conversion function.</li> </ul> |
| Preset value | False or 0                                                                                                                                                                                                                                                                                |

For information on the variable (*Ch*), see Table 7-6, “Variable (*Ch*),” on page 209.

|                 |                                                                                                                                                                                                                                                                                                                                                                             |
|-----------------|-----------------------------------------------------------------------------------------------------------------------------------------------------------------------------------------------------------------------------------------------------------------------------------------------------------------------------------------------------------------------------|
| Examples        | <pre>Dim DifZcon As Boolean SCPI.CALCulate(1).FSIMulator.BALun.DZConversion.STATE = True DifZcon = SCPI.CALCulate(1).FSIMulator.BALun.DZConversion.STATE</pre>                                                                                                                                                                                                              |
| Related objects | <p>SCPI.CALCulate(<i>Ch</i>).FSIMulator.BALun.DZConversion. BPORT(<i>Bpt</i>).IMAGinary on page 222</p> <p>SCPI.CALCulate(<i>Ch</i>).FSIMulator.BALun.DZConversion. BPORT(<i>Bpt</i>).REAL on page 223</p> <p>SCPI.CALCulate(<i>Ch</i>).FSIMulator.BALun.DZConversion. BPORT(<i>Bpt</i>).Z0.R on page 224</p> <p>SCPI.CALCulate(<i>Ch</i>).FSIMulator.STATE on page 256</p> |
| Equivalent key  | <b>[Analysis] - Fixture Simulator - Diff ZConversion - Diff ZConversion</b>                                                                                                                                                                                                                                                                                                 |

**SCPI.CALCulate(Ch).FSIMulator.BALun.PARAmeter(Tr).BBALanced.DEFINE**

|             |                                                                                                                                                                        |
|-------------|------------------------------------------------------------------------------------------------------------------------------------------------------------------------|
| Object type | Property                                                                                                                                                               |
| Syntax      | SCPI.CALCulate(Ch).FSIMulator.BALun.PARAmeter(Tr).BBALanced.DEFINE = <i>Param</i><br><i>Param</i> = SCPI.CALCulate(Ch).FSIMulator.BALun.PARAmeter(Tr).BBALanced.DEFINE |
| Description | For traces 1 to 16 ( <i>Tr</i> ) of channels 1 to 16 ( <i>Ch</i> ), sets the measurement parameter when the balance device type is "balance-balance."                  |

## Variable

|              | <i>Param</i>                                                                                                                                                                                                                                                                                                                                                                                                                                                                                                                                                                                                                                                                                                                                                                                                                                                                                                                                                                                                                                                                       |
|--------------|------------------------------------------------------------------------------------------------------------------------------------------------------------------------------------------------------------------------------------------------------------------------------------------------------------------------------------------------------------------------------------------------------------------------------------------------------------------------------------------------------------------------------------------------------------------------------------------------------------------------------------------------------------------------------------------------------------------------------------------------------------------------------------------------------------------------------------------------------------------------------------------------------------------------------------------------------------------------------------------------------------------------------------------------------------------------------------|
| Description  | Measurement parameter                                                                                                                                                                                                                                                                                                                                                                                                                                                                                                                                                                                                                                                                                                                                                                                                                                                                                                                                                                                                                                                              |
| Data type    | Character string type (String)                                                                                                                                                                                                                                                                                                                                                                                                                                                                                                                                                                                                                                                                                                                                                                                                                                                                                                                                                                                                                                                     |
| Range        | Select from the following.<br><ul style="list-style-type: none"> <li>•"SDD11"                Specifies Sdd11.</li> <li>•"SDD21"                Specifies Sdd21.</li> <li>•"SDD12"                Specifies Sdd12.</li> <li>•"SDD22"                Specifies Sdd22.</li> <li>•"SCD11"                Specifies Scd11.</li> <li>•"SCD21"                Specifies Scd21.</li> <li>•"SCD12"                Specifies Scd12.</li> <li>•"SCD22"                Specifies Scd22.</li> <li>•"SDC11"                Specifies Sdc11.</li> <li>•"SDC21"                Specifies Sdc21.</li> <li>•"SDC12"                Specifies Sdc12.</li> <li>•"SDC22"                Specifies Sdc22.</li> <li>•"SCC11"                Specifies Scc11.</li> <li>•"SCC21"                Specifies Scc21.</li> <li>•"SCC12"                Specifies Scc12.</li> <li>•"SCC22"                Specifies Scc22.</li> <li>•"IMB1"                 Specifies Imbalance1.</li> <li>•"IMB2"                 Specifies Imbalance2.</li> <li>•"CMRR"                 Specifies CMRR (Sdd21/Sc21).</li> </ul> |
| Preset value | "SDD11"                                                                                                                                                                                                                                                                                                                                                                                                                                                                                                                                                                                                                                                                                                                                                                                                                                                                                                                                                                                                                                                                            |

For information on the variable (*Ch*) and the variable (*Tr*), see Table 7-6, "Variable (Ch)," on page 209 and Table 7-10, "Variable (Tr)," on page 259, respectively.

## Examples

```
Dim BbalPara As String
SCPI.CALCulate(1).FSIMulator.BALun.DEVICE = "bbal"
SCPI.CALCulate(1).FSIMulator.BALun.PARAmeter(1).BBALanced.DEFINE = "sdd21"
BbalPara = SCPI.CALCulate(1).FSIMulator.BALun.PARAmeter(1).BBALanced.DEFINE
```

## Related objects

SCPI.CALCulate(Ch).FSIMulator.BALun.DEVICE on page 214

## Equivalent key

**[Analysis] - Fixture Simulator|[Meas] - Sdd11|Sdd21|Sdd12|Sdd22|Scd11|Scd21|Scd12|Scd22|Sdc11| Sdc21|Sdc12|Sdc22|Scc11|Scc21|Scc12|Scc22|Imbalance1|Imbalance2|Sdd21|Scc21**

## SCPI.CALCulate(*Ch*).FSIMulator.BALun.PARAmeter(*Tr*).SBALanced.DEFIne

|             |                                                                                                                                                                                                            |
|-------------|------------------------------------------------------------------------------------------------------------------------------------------------------------------------------------------------------------|
| Object type | Property                                                                                                                                                                                                   |
| Syntax      | SCPI.CALCulate( <i>Ch</i> ).FSIMulator.BALun.PARAmeter( <i>Tr</i> ).SBALanced.DEFIne = <i>Param</i><br><i>Param</i> = SCPI.CALCulate( <i>Ch</i> ).FSIMulator.BALun.PARAmeter( <i>Tr</i> ).SBALanced.DEFIne |
| Description | For traces 1 to 16 ( <i>Tr</i> ) of channels 1 to 16 ( <i>Ch</i> ), sets the measurement parameter when the balance device type is "balance-balance."                                                      |

### Variable

|              | <i>Param</i>                                                                                                                                                                                                                                                                                                                                                                                                                                                                                                                                                                                                                                                                                                      |
|--------------|-------------------------------------------------------------------------------------------------------------------------------------------------------------------------------------------------------------------------------------------------------------------------------------------------------------------------------------------------------------------------------------------------------------------------------------------------------------------------------------------------------------------------------------------------------------------------------------------------------------------------------------------------------------------------------------------------------------------|
| Description  | Measurement parameter                                                                                                                                                                                                                                                                                                                                                                                                                                                                                                                                                                                                                                                                                             |
| Data type    | Character string type (String)                                                                                                                                                                                                                                                                                                                                                                                                                                                                                                                                                                                                                                                                                    |
| Range        | Select from the following. <ul style="list-style-type: none"> <li>•"SSS11"                Specifies Sss11.</li> <li>•"SDS21"               Specifies Sds21.</li> <li>•"SSD12"               Specifies Ssd12.</li> <li>•"SCS21"               Specifies Scs21.</li> <li>•"SSC12"               Specifies Ssc12.</li> <li>•"SDD22"               Specifies Sdd22.</li> <li>•"SCD22"               Specifies Scd22.</li> <li>•"SDC22"               Specifies Sdc22.</li> <li>•"SCC22"               Specifies Scc22.</li> <li>•"IMB"                   Specifies Imbalance.</li> <li>•"CMRR"                Specifies CMRR (Sds21/Scs21).</li> <li>•"CMRR2"               Specifies CMRR2 (Ssd12/Scs12).</li> </ul> |
| Preset value | "SSS11"                                                                                                                                                                                                                                                                                                                                                                                                                                                                                                                                                                                                                                                                                                           |

For information on the variable (*Ch*) and the variable (*Tr*), see Table 7-6, "Variable (Ch)," on page 209 and Table 7-10, "Variable (Tr)," on page 259, respectively.

### Examples

```
Dim SbalPara As String
SCPI.CALCulate(1).FSIMulator.BALun.DEVICE = "sbal"
SCPI.CALCulate(1).FSIMulator.BALun.PARAmeter(1).SBALanced.DEFIne = "scs21"
SbalPara = SCPI.CALCulate(1).FSIMulator.BALun.PARAmeter(1).SBALanced.DEFIne
```

### Related objects

SCPI.CALCulate(Ch).FSIMulator.BALun.DEVICE on page 214

### Equivalent key

**[Analysis] - Fixture Simulator|[Meas] - Sss11|Sds21|Ssd12|Scs21|Ssc12|Sdd22|Scd22|Sdc22|Scc22|Imbalance|Sds21/Scs21|Ssd12/Scs12**

## SCPI.CALCulate(*Ch*).FSIMulator.BALun.PARAmeter(*Tr*).SSBalanced.DEFine

|             |                                                                                                                                                                                                              |
|-------------|--------------------------------------------------------------------------------------------------------------------------------------------------------------------------------------------------------------|
| Object type | Property                                                                                                                                                                                                     |
| Syntax      | SCPI.CALCulate( <i>Ch</i> ).FSIMulator.BALun.PARAmeter( <i>Tr</i> ).SSBalanced.DEFine = <i>Param</i><br><i>Param</i> = SCPI.CALCulate( <i>Ch</i> ).FSIMulator.BALun.PARAmeter( <i>Tr</i> ).SSBalanced.DEFine |
| Description | For traces 1 to 16 ( <i>Tr</i> ) of channels 1 to 16 ( <i>Ch</i> ), sets the measurement parameter when the balance device type is "unbalance-unbalance-balance."                                            |

### Variable

|              | <i>Param</i>                                                                                                                                                                                                                                                                                                                                                                                                                                                                                                                                                                                                                                                                                                                                                                                                                                                                                                                                                                                                                                                                                                                                                                                                                                                                                                                                             |
|--------------|----------------------------------------------------------------------------------------------------------------------------------------------------------------------------------------------------------------------------------------------------------------------------------------------------------------------------------------------------------------------------------------------------------------------------------------------------------------------------------------------------------------------------------------------------------------------------------------------------------------------------------------------------------------------------------------------------------------------------------------------------------------------------------------------------------------------------------------------------------------------------------------------------------------------------------------------------------------------------------------------------------------------------------------------------------------------------------------------------------------------------------------------------------------------------------------------------------------------------------------------------------------------------------------------------------------------------------------------------------|
| Description  | Measurement parameter                                                                                                                                                                                                                                                                                                                                                                                                                                                                                                                                                                                                                                                                                                                                                                                                                                                                                                                                                                                                                                                                                                                                                                                                                                                                                                                                    |
| Data type    | Character string type (String)                                                                                                                                                                                                                                                                                                                                                                                                                                                                                                                                                                                                                                                                                                                                                                                                                                                                                                                                                                                                                                                                                                                                                                                                                                                                                                                           |
| Range        | Select from the following.<br><ul style="list-style-type: none"> <li>•"SSS11"                    Specifies Sss11.</li> <li>•"SSS21"                    Specifies Sss21.</li> <li>•"SSS12"                    Specifies Sss12.</li> <li>•"SSS22"                    Specifies Sss22.</li> <li>•"SDS31"                    Specifies Sds31.</li> <li>•"SDS32"                    Specifies Sds32.</li> <li>•"SSD13"                    Specifies Ssd13.</li> <li>•"SSD23"                    Specifies Ssd23.</li> <li>•"SCS31"                    Specifies Scs31.</li> <li>•"SCS32"                    Specifies Scs32.</li> <li>•"SSC13"                    Specifies Ssc13.</li> <li>•"SSC23"                    Specifies Ssc23.</li> <li>•"SDD33"                    Specifies Sdd33.</li> <li>•"SCD33"                    Specifies Scd33.</li> <li>•"SDC33"                    Specifies Sdc33.</li> <li>•"SCC33"                    Specifies Scc33.</li> <li>•"IMB1"                     Specifies Imbalance1.</li> <li>•"IMB2"                     Specifies Imbalance2.</li> <li>•"IMB3"                     Specifies Imbalance3.</li> <li>•"IMB4"                     Specifies Imbalance4.</li> <li>•"CMRR1"                   Specifies CMRR ( Sds31/Scs31).</li> <li>•"CMRR2"                   Specifies CMRR ( Sds32/Scs32).</li> </ul> |
| Preset value | "SSS11"                                                                                                                                                                                                                                                                                                                                                                                                                                                                                                                                                                                                                                                                                                                                                                                                                                                                                                                                                                                                                                                                                                                                                                                                                                                                                                                                                  |

For information on the variable (*Ch*) and the variable (*Tr*), see Table 7-6, "Variable (Ch)," on page 209 and Table 7-10, "Variable (Tr)," on page 259, respectively.

### Examples

```
Dim SsbPara As String
SCPI.CALCulate(1).FSIMulator.BALun.DEVice = "ssb"
SCPI.CALCulate(1).FSIMulator.BALun.PARAmeter(1).SSBalanced.DEFine = "sds31"
SsbPara = SCPI.CALCulate(1).FSIMulator.BALun.PARAmeter(1).SSBalanced.DEFine
```

Related objects      SCPI.CALCulate(Ch).FSIMulator.BALun.DEVice on page 214



Equivalent key **[Analysis] - Fixture Simulator** | **[Meas] - Sss11|Sss21|Sss12|Sss22|Sds31|Sds32|Ssd13|Ssd23|Scs31|Scs32|Ssc13|Ssc23|Sdd33|Scd33|Sdc33|Scc33|Imbalance1|Imbalance2|Imbalance3|Imbalance4|Sds31|Scs31|Sds32|Scs32**

## SCPI.CALCulate(*Ch*).FSIMulator.BALun.PARAmeter(*Tr*). STATE

Object type Property

Syntax SCPI.CALCulate(*Ch*).FSIMulator.BALun.PARAmeter(*Tr*).STATE = *Status*  
*Status* = SCPI.CALCulate(*Ch*).FSIMulator.BALun.PARAmeter(*Tr*).STATE

Description For traces 1 and 9 (*Tr*) of channels 1 to 16 (*Ch*), turns ON/OFF the balance-unbalance conversion function when the fixture simulator function is ON.

Variable

|              |                                                                                                                                                                                                                                                                       |
|--------------|-----------------------------------------------------------------------------------------------------------------------------------------------------------------------------------------------------------------------------------------------------------------------|
|              | <i>Status</i>                                                                                                                                                                                                                                                         |
| Description  | ON/OFF of the balance-unbalance conversion function                                                                                                                                                                                                                   |
| Data type    | Boolean type (Boolean)                                                                                                                                                                                                                                                |
| Range        | Select from the following.<br><ul style="list-style-type: none"> <li>• True or -1                      Turns ON the balance-unbalance conversion function.</li> <li>• False or 0                      Turns OFF the balance-unbalance conversion function.</li> </ul> |
| Preset value | False or 0                                                                                                                                                                                                                                                            |

For information on the variable (*Ch*) and the variable (*Tr*), see Table 7-6, “Variable (Ch),” on page 209 and Table 7-10, “Variable (Tr),” on page 259, respectively.

Examples 

```
Dim BalMode As Boolean
SCPI.CALCulate(1).FSIMulator.BALun.PARAmeter(1).STATE = True
BalMode = SCPI.CALCulate(1).FSIMulator.BALun.PARAmeter(1).STATE
```

Related objects SCPI.CALCulate(Ch).FSIMulator.STATE on page 256

Equivalent key **[Analysis] - Fixture Simulator - BalUn**

## SCPI.CALCulate(*Ch*).FSIMulator.BALun.TOPology.BBALanced.PPORTs

Object type Property

Syntax SCPI.CALCulate(*Ch*).FSIMulator.BALun.TOPology.BBALanced.PPORTs = *Ports*  
*Ports* = SCPI.CALCulate(*Ch*).FSIMulator.BALun.TOPology.BBALanced.PPORTs

Description For channels 1 to 16 (*Ch*), assigns each port when the balance device type is "balance-balance."

To set the balance device type to "balance-balance," specify BBAL with the SCPI.CALCulate(*Ch*).FSIMulator.BALun.DEVICE object.

Variable

|              | <i>Ports</i>                                                                                                                                                                                                                                                                                                                                                                                                                                                                     |
|--------------|----------------------------------------------------------------------------------------------------------------------------------------------------------------------------------------------------------------------------------------------------------------------------------------------------------------------------------------------------------------------------------------------------------------------------------------------------------------------------------|
| Description  | Indicates 4-element array data (port number). <ul style="list-style-type: none"> <li>• <i>Ports</i>(0) Port number assigned to port a in Figure 7-2 on page 214.</li> <li>• <i>Ports</i>(1) Port number assigned to port b in Figure 7-2 on page 214.</li> <li>• <i>Ports</i>(2) Port number assigned to port c in Figure 7-2 on page 214.</li> <li>• <i>Ports</i>(3) Port number assigned to port d in Figure 7-2 on page 214.</li> </ul> The index of the array starts from 0. |
| Data type    | Variant type (Variant)                                                                                                                                                                                                                                                                                                                                                                                                                                                           |
| Range        | 1 to 4                                                                                                                                                                                                                                                                                                                                                                                                                                                                           |
| Preset value | Ports(0):1 / Ports(1):2 / Ports(2):3 / Ports(3):4                                                                                                                                                                                                                                                                                                                                                                                                                                |
| Resolution   | 1                                                                                                                                                                                                                                                                                                                                                                                                                                                                                |
| Note         | If the specified variable is out of the allowable setup range, an error occurs when executed. If you specify the same port number to 2 or more port numbers, an error occurs when executed.                                                                                                                                                                                                                                                                                      |

For information on the variable (*Ch*), see Table 7-6, "Variable (*Ch*)," on page 209.

Examples

```
Dim BbalPort As Variant
SCPI.CALCulate(1).FSIMulator.BALun.DEVICE = "bbal"
SCPI.CALCulate(1).FSIMulator.BALun.TOPology.BBALanced.PPORTs = Array(3,4,1,2)
BbalPort = SCPI.CALCulate(1).FSIMulator.BALun.TOPology.BBALanced.PPORTs
```

```
Dim BbalPort(3) As Variant
Dim Ref As Variant
BbalPort(0) = 3
BbalPort(1) = 4
BbalPort(2) = 1
BbalPort(3) = 2
SCPI.CALCulate(1).FSIMulator.BALun.DEVICE = "bbal"
SCPI.CALCulate(1).FSIMulator.BALun.TOPology.BBALanced.PPORTs = BbalPort
Ref = SCPI.CALCulate(1).FSIMulator.BALun.TOPology.BBALanced.PPORTs
```

Related objects SCPI.CALCulate(*Ch*).FSIMulator.BALun.DEVICE on page 214

Equivalent key **[Analysis] - Fixture Simulator - Topology - Port1(bal)**  
**[Analysis] - Fixture Simulator - Topology - Port2(bal)**

**NOTE** When performing the operation from the front panel, set each port separately.

## **SCPI.CALCulate(*Ch*).FSIMulator.BALun.TOPology.PROPerTy.STATe**

|             |                                                                                                                                                                              |
|-------------|------------------------------------------------------------------------------------------------------------------------------------------------------------------------------|
| Object type | Property                                                                                                                                                                     |
| Syntax      | SCPI.CALCulate( <i>Ch</i> ).FSIMulator.BALun.TOPology.PROPerTy.STATe = <i>Status</i><br><i>Status</i> = SCPI.CALCulate( <i>Ch</i> ).FSIMulator.BALun.TOPology.PROPerTy.STATe |
| Description | For channels 1 to 16 ( <i>Ch</i> ), turns on/off the property display for the topology setting when using the balance-unbalance conversion.                                  |
| Variable    |                                                                                                                                                                              |

|              |                                                                                                                                                                                                                           |
|--------------|---------------------------------------------------------------------------------------------------------------------------------------------------------------------------------------------------------------------------|
|              | <i>Status</i>                                                                                                                                                                                                             |
| Description  | On/off of the property display of the topology setting                                                                                                                                                                    |
| Data type    | Boolean type (Boolean)                                                                                                                                                                                                    |
| Range        | Select from the following.<br><ul style="list-style-type: none"> <li>•True or -1                      Turns on the property display.</li> <li>•False or 0                      Turns off the property display.</li> </ul> |
| Preset value | False or 0                                                                                                                                                                                                                |

For information on the variable (*Ch*), refer to Table 7-6, “Variable (Ch),” on page 209.

|          |                                                                                                                                                                     |
|----------|---------------------------------------------------------------------------------------------------------------------------------------------------------------------|
| Examples | Dim TopProp As Boolean<br>SCPI.CALCulate(1).FSIMulator.BALun.TOPology.PROPerTy.STATe = True<br>TopProp = SCPI.CALCulate(1).FSIMulator.BALun.TOPology.PROPerTy.STATe |
|----------|---------------------------------------------------------------------------------------------------------------------------------------------------------------------|

|                |                                                             |
|----------------|-------------------------------------------------------------|
| Equivalent key | <b>[Analysis] - Fixture Simulator - Topology - Property</b> |
|----------------|-------------------------------------------------------------|

## SCPI.CALCulate(*Ch*).FSIMulator.BALun.TOPology.SBALanced.PPORts

- Object type** Property
- Syntax** SCPI.CALCulate(*Ch*).FSIMulator.BALun.TOPology.SBALanced.PPORts = *Ports*  
*Ports* = SCPI.CALCulate(*Ch*).FSIMulator.BALun.TOPology.SBALanced.PPORts
- Description** For channels 1 to 16 (*Ch*), assigns each port when the balance device type is "unbalance-balance."  
 To set the balance device type to "unbalance-balance," specify SBAL with the SCPI.CALCulate(*Ch*).FSIMulator.BALun.DEVice object.

**Variable**

|              | <i>Ports</i>                                                                                                                                                                                                                                                                                                                                                                                   |
|--------------|------------------------------------------------------------------------------------------------------------------------------------------------------------------------------------------------------------------------------------------------------------------------------------------------------------------------------------------------------------------------------------------------|
| Description  | Indicates 3-element array data (port number).<br><ul style="list-style-type: none"> <li>• <i>Ports(0)</i> Port number assigned to port a in Figure 7-2 on page 214.</li> <li>• <i>Ports(1)</i> Port number assigned to port b in Figure 7-2 on page 214.</li> <li>• <i>Ports(2)</i> Port number assigned to port c in Figure 7-2 on page 214.</li> </ul> The index of the array starts from 0. |
| Data type    | Variant type (Variant)                                                                                                                                                                                                                                                                                                                                                                         |
| Range        | 1 to 4                                                                                                                                                                                                                                                                                                                                                                                         |
| Preset value | Ports(0):1 / Ports(1):2 / Ports(2):3                                                                                                                                                                                                                                                                                                                                                           |
| Resolution   | 1                                                                                                                                                                                                                                                                                                                                                                                              |
| Note         | If the specified variable is out of the allowable setup range, the minimum value (if the lower limit of the range is not reached) or the maximum value (if the upper limit of the range is exceeded) is set. If you specify the same port number to 2 or more port numbers, an error occurs when executed.                                                                                     |

For information on the variable (*Ch*), see Table 7-6, “Variable (Ch),” on page 209.

- Examples**
- ```
Dim SbalPort As Variant
SCPI.CALCulate(1).FSIMulator.BALun.DEVice = "sbal"
SCPI.CALCulate(1).FSIMulator.BALun.TOPology.SBALanced.PPORts = Array(1,3,4)
SbalPort = SCPI.CALCulate(1).FSIMulator.BALun.TOPology.BBALanced.PPORts
```

- Related objects** SCPI.CALCulate(*Ch*).FSIMulator.BALun.DEVice on page 214

- Equivalent key** **[Analysis] - Fixture Simulator - Topology - Port1(se)**
[Analysis] - Fixture Simulator - Topology - Port2(bal)

NOTE When performing the operation from the front panel, set each port separately.

SCPI.CALCulate(*Ch*).FSIMulator.BALun.TOPology.SSBalanced.PPORts

Object type	Property
Syntax	SCPI.CALCulate(<i>Ch</i>).FSIMulator.BALun.TOPology.SSBalanced.PPORts = <i>Ports</i> <i>Ports</i> = SCPI.CALCulate(<i>Ch</i>).FSIMulator.BALun.TOPology.SSBalanced.PPORts
Description	For channels 1 to 16 (<i>Ch</i>), assigns each port when the balance device type is "unbalance-unbalance-balance." To set the balance device type to "unbalance-unbalance-balance," specify SSB with the SCPI.CALCulate(<i>Ch</i>).FSIMulator.BALun.DEVICE object.

Variable

	<i>Ports</i>
Description	Indicates 4-element array data (port number). <ul style="list-style-type: none"> • <i>Ports</i>(0) Port number assigned to port a in Figure 7-2 on page 214. • <i>Ports</i>(1) Port number assigned to port b in Figure 7-2 on page 214. • <i>Ports</i>(2) Port number assigned to port c in Figure 7-2 on page 214. • <i>Ports</i>(3) Port number assigned to port d in Figure 7-2 on page 214. The index of the array starts from 0.
Data type	Variant type (Variant)
Range	1 to 4
Preset value	<i>Ports</i> (0):1 / <i>Ports</i> (1):2 / <i>Ports</i> (2):3 / <i>Ports</i> (3):4
Resolution	1
Note	If the specified variable is out of the allowable setup range, the minimum value (if the lower limit of the range is not reached) or the maximum value (if the upper limit of the range is exceeded) is set. If you specify the same port number to 2 or more port numbers, an error occurs when executed.

For information on the variable (*Ch*), see Table 7-6, “Variable (Ch),” on page 209.

Examples

```
Dim SsbPort As Variant
SCPI.CALCulate(1).FSIMulator.BALun.DEVICE = "ssb"
SCPI.CALCulate(1).FSIMulator.BALun.TOPology.SSBalanced.PPORts = Array(1,4,2,3)
SsbPort = SCPI.CALCulate(1).FSIMulator.BALun.TOPology.SSBalanced.PPORts
```

Related objects

SCPI.CALCulate(*Ch*).FSIMulator.BALun.DEVICE on page 214

Equivalent key

[Analysis] - Fixture Simulator - Topology - Port1(se)
[Analysis] - Fixture Simulator - Topology - Port2(se)
[Analysis] - Fixture Simulator - Topology - Port3(bal)

NOTE

When performing the operation from the front panel, set each port separately.

SCPI.CALCulate(Ch).FSIMulator.EMBed.NETWork(Nwk).FILename

Object type	Property
Syntax	SCPI.CALCulate(Ch).FSIMulator.EMBed.NETWork(Nwk).FILename = <i>File</i> <i>File</i> = SCPI.CALCulate(Ch).FSIMulator.EMBed.NETWork(Nwk).FILename
Description	<p>For channels 1 to 16 (<i>Ch</i>), specifies a file in which the information of networks 1 to 2 (<i>Nwk</i>) you want to embed/de-embed using the 4-port network embedding/de-embedding feature is saved (4-port touchstone file with the ".s4p" extension).</p> <p>Specify the file name with the extension. If you want to specify a file on the floppy disk drive, you need to add "A:" at the beginning of the file name. When you use directory names (folder names) and file name, separate them with "\" (back slash) or "/" (slash).</p> <p>For information on network numbers, refer to Figure 7-3 on page 240.</p>

NOTE This function is available with the firmware version 3.50 or greater.

Variable

Table 7-8**Variable (*Nwk*)**

	<i>Nwk</i>
Description	Number of network
Data type	Long integer type (Long)
Range	1 to 2
Preset value	1
Note	If the specified variable is out of the allowable setup range, an error occurs when executed.

	<i>File</i>
Description	4-port touchstone file name (extension: .s4p) for the 4-port network embedding/de-embedding feature
Data type	Character string type (String)
Range	254 characters or less
Preset value	""
Note	When the processing type is set to NONE, even if the specified file does not exist, no error occurs when you execute this object. However, when you set the processing type to embedding/de-embedding with the SCPI.CALCulate(Ch).FSIMulator.EMBed.NETWork(Nwk).TYPE object, an error occurs.

For information on the variable (*Ch*), refer to Table 7-6, "Variable (Ch)," on page 209.

Examples

```
Dim Emb As String
SCPI.CALCulate(1).FSIMulator.EMBed.NETWork(1).FILename = "network.s4p"
Emb = SCPI.CALCulate(1).FSIMulator.EMBed.NETWork(1).FILename
```

Related objects

SCPI.CALCulate(Ch).FSIMulator.EMBed.NETWork(Nwk).TYPE on page 235
SCPI.CALCulate(Ch).FSIMulator.EMBed.STATE on page 236

Equivalent key

[Analysis] - Fixture Simulator - De-Embedding S4P - Topology - User File (nwk1)|User File (nwk2)

SCPI.CALCulate(*Ch*).FSIMulator.EMBed.NETWork(*Nwk*). **TYPE**

Object type	Property
Syntax	SCPI.CALCulate(<i>Ch</i>).FSIMulator.EMBed.NETWork(<i>Nwk</i>).TYPE = <i>File</i> <i>File</i> = SCPI.CALCulate(<i>Ch</i>).FSIMulator.EMBed.NETWork(<i>Nwk</i>).TYPE
Description	For the 4-port network embedding/de-embedding feature for channels 1 to 16 (<i>Ch</i>), selects the processing type for networks 1 and 2 (<i>Nwk</i>).

NOTE This function is available with the firmware version 3.50 or greater.

Variable

	<i>Param</i>
Description	Processing type
Data type	Character string type (String)
Range	Select from the following. <ul style="list-style-type: none"> •"NONE" Specifies no-processing. •"EMBed" Specifies embedding. •"DEEMbed" Specifies de-embedding.
Preset value	"NONE"
Note	Before selecting embedding/de-embedding, use the SCPI.CALCulate(<i>Ch</i>).FSIMulator.EMBed.NETWork(<i>Nwk</i>).FILENAME object to specify the 4-port touchstone file in which the information on the network is saved. If you do not specify the appropriate file and you select embedding/de-embedding, a runtime error occurs and NONE is automatically selected.

For information on the variable (*Ch*) and the variable (*Nwk*), refer to Table 7-6, "Variable (*Ch*)," on page 209 and Table 7-8, "Variable (*Nwk*)," on page 234, respectively.

Examples

```
Dim EmbType As String
SCPI.CALCulate(1).FSIMulator.EMBed.NETWork(1).FILENAME = "network.s4p"
SCPI.CALCulate(1).FSIMulator.EMBed.NETWork(1).TYPE = "deem"
EmbType = SCPI.CALCulate(1).FSIMulator.EMBed.NETWork(1).TYPE
```

Related objects SCPI.CALCulate(*Ch*).FSIMulator.EMBed.NETWork(*Nwk*).FILENAME on page 234
 SCPI.CALCulate(*Ch*).FSIMulator.EMBed.STATe on page 236

Equivalent key **[Analysis] - Fixture Simulator - De-Embedding S4P - Topology - Type (nwk1)|Type (nwk2) - None|Embed|De-Embed**

SCPI.CALCulate(Ch).FSIMulator.EMBed.STATe

Object type	Property
Syntax	SCPI.CALCulate(Ch).FSIMulator.EMBed.STATe = <i>Status</i> <i>Status</i> = SCPI.CALCulate(Ch).FSIMulator.EMBed.STATe
Description	For channels 1 to 16 (<i>Ch</i>), turns ON/OFF the 4-port network embedding/de-embedding feature when the fixture simulator feature is ON.

NOTE This function is available with the firmware version 3.50 or greater.

Variable

	<i>Status</i>
Description	Turns ON/OFF the 4-port network embedding/de-embedding feature.
Data type	Boolean type (Boolean)
Range	Select from the following. <ul style="list-style-type: none"> • True or -1 Turns ON the 4-port network embedding/de-embedding feature. • False or 0 Turns OFF the 4-port network embedding/de-embedding feature.
Preset value	False or 0

For information on the variable (*Ch*), refer to Table 7-6, “Variable (Ch),” on page 209.

Examples

```
Dim Emb As Boolean
SCPI.CALCulate(1).FSIMulator.EMBed.STATe = True
Emb = SCPI.CALCulate(1).FSIMulator.EMBed.STATe
```

Related objects

SCPI.CALCulate(Ch).FSIMulator.EMBed.NETWork(Nwk). FILEname on page 234
SCPI.CALCulate(Ch).FSIMulator.EMBed.NETWork(Nwk). TYPE on page 235
SCPI.CALCulate(Ch).FSIMulator.STATe on page 256

Equivalent key **[Analysis] - Fixture Simulator - De-Embedding S4P - De-Embedding S4P**

SCPI.CALCulate(*Ch*).FSIMulator.EMBed.TOPology.A. PORTs

Object type Property

Syntax SCPI.CALCulate(*Ch*).FSIMulator.EMBed.TOPology.A.PORTs = *Ports*
Ports = SCPI.CALCulate(*Ch*).FSIMulator.EMBed.TOPology.A.PORTs

Description For the 4-port network embedding/de-embedding feature for channels 1 to 16 (*Ch*), specifies test port assignment when the connection type (Topology) is set to A.
 For information on the connection type (Topology), refer to Figure 7-3 on page 240.

NOTE This function is available with the firmware version 3.50 or greater.

Variable

	<i>Ports</i>
Description	Indicates 2-element array data (port numbers). <ul style="list-style-type: none"> • <i>Ports(0)</i> Port number assigned to port a in Figure 7-3. • <i>Ports(1)</i> Port number assigned to port b in Figure 7-3. The index of the array starts from 0.
Data type	Variant type (Variant)
Range	1 to 4
Preset value	Ports(0):1 / Ports(1):2
Resolution	1
Note	If the specified variable is out of the allowable setting range, an error occurs when executed. If you specify an identical port number to multiple ports, a runtime error occurs.

For information on the variable (*Ch*), refer to Table 7-6, “Variable (Ch),” on page 209.

Examples

```
Dim EnbPort As Variant
SCPI.CALCulate(1).FSIMulator.ENBed.TYPE = "a"
SCPI.CALCulate(1).FSIMulator.ENBed.TOPology.A.PORTs = Array(2,1)
EnbPort = SCPI.CALCulate(1).FSIMulator.ENBed.TOPology.A.PORTs
```

Related objects SCPI.CALCulate(Ch).FSIMulator.EMBed.TYPE on page 240

Equivalent key **[Analysis] - Fixture Simulator - De-Embedding S4P - Topology - Ports - 1-2|1-3|1-4|2-1|2-3|2-4|3-1|3-2|3-4|4-1|4-2|4-3**

SCPI.CALCulate(*Ch*).FSIMulator.EMBed.TOPology.B. PORTs

Object type	Property
Syntax	SCPI.CALCulate(<i>Ch</i>).FSIMulator.EMBed.TOPology.B.PORTs = <i>Ports</i> <i>Ports</i> = SCPI.CALCulate(<i>Ch</i>).FSIMulator.EMBed.TOPology.B.PORTs
Description	For the 4-port network embedding/de-embedding feature for channels 1 to 16 (<i>Ch</i>), specifies test port assignment when the connection type (Topology) is set to B. For information on the connection type (Topology), refer to Figure 7-3 on page 240.

NOTE This function is available with the firmware version 3.50 or greater.

Variable

	<i>Ports</i>
Description	Indicates 3-element array data (port numbers). <ul style="list-style-type: none"> • <i>Ports(0)</i> Port number assigned to port a in Figure 7-3. • <i>Ports(1)</i> Port number assigned to port b in Figure 7-3. • <i>Ports(2)</i> Port number assigned to port c in Figure 7-3. The index of the array starts from 0.
Data type	Variant type (Variant)
Range	1 to 4
Preset value	Ports(0):1 / Ports(1):2 / Ports(2):3
Resolution	1
Note	If the specified variable is out of the allowable setting range, an error occurs when executed. If you specify an identical port number to multiple ports, a runtime error occurs.

For information on the variable (*Ch*), refer to Table 7-6, “Variable (Ch),” on page 209.

Examples

```
Dim EnbPort As Variant
SCPI.CALCulate(1).FSIMulator.ENBed.TYPE = "b"
SCPI.CALCulate(1).FSIMulator.ENBed.TOPology.B.PORTs = Array(1,3,2)
EnbPort = SCPI.CALCulate(1).FSIMulator.ENBed.TOPology.B.PORTs
```

Related objects SCPI.CALCulate(*Ch*).FSIMulator.EMBed.TYPE on page 240

Equivalent key **[Analysis] - Fixture Simulator - De-Embedding S4P - Topology - Ports -**
1-2-3|1-2-4|1-3-2|1-3-4|1-4-2|1-4-3|2-1-3|2-1-4|2-3-1|2-3-4|2-4-1|2-4-3|
3-1-2|3-1-4|3-2-1|3-2-4|3-4-1|3-4-2|4-1-2|4-1-3|4-2-1|4-2-3|4-3-1|4-3-2

SCPI.CALCulate(*Ch*).FSIMulator.EMBed.TOPology.C. PORTs

Object type	Property
Syntax	SCPI.CALCulate(<i>Ch</i>).FSIMulator.EMBed.TOPology.C.PORTs = <i>Ports</i> <i>Ports</i> = SCPI.CALCulate(<i>Ch</i>).FSIMulator.EMBed.TOPology.C.PORTs
Description	For the 4-port network embedding/de-embedding feature for channels 1 to 16 (<i>Ch</i>), specifies test port assignment when the connection type (Topology) is set to C. For information on the connection type (Topology), refer to Figure 7-3 on page 240.

NOTE This function is available with the firmware version 3.50 or greater.

Variable

	<i>Ports</i>
Description	Indicates 4-element array data (port numbers). <ul style="list-style-type: none"> • <i>Ports</i>(0) Port number assigned to port a in Figure 7-3. • <i>Ports</i>(1) Port number assigned to port b in Figure 7-3. • <i>Ports</i>(2) Port number assigned to port c in Figure 7-3. • <i>Ports</i>(3) Port number assigned to port d in Figure 7-3. The index of the array starts from 0.
Data type	Variant type (Variant)
Range	1 to 4
Preset value	Ports(0):1 / Ports(1):2 / Ports(2):3 / Ports(3):4
Resolution	1
Note	If the specified variable is out of the allowable setting range, an error occurs when executed. If you specify an identical port number to multiple ports, a runtime error occurs.

For information on the variable (*Ch*), refer to Table 7-6, “Variable (Ch),” on page 209.

Examples

```
Dim EnbPort As Variant
SCPI.CALCulate(1).FSIMulator.ENBed.TYPE = "c"
SCPI.CALCulate(1).FSIMulator.ENBed.TOPology.C.PORTs = Array(1,4,2,3)
EnbPort = SCPI.CALCulate(1).FSIMulator.ENBed.TOPology.C.PORTs
```

Related objects SCPI.CALCulate(Ch).FSIMulator.EMBed.TYPE on page 240

Equivalent key **[Analysis] - Fixture Simulator - De-Embedding S4P - Topology - Ports -**
 1-2-3-4|1-2-4-3|1-3-2-4|1-3-4-2|1-4-2-3|1-4-3-2|2-1-3-4|2-1-4-3|2-3-1-4|2-3-4-1|
 2-4-1-3|2-4-3-1|3-1-2-4|3-1-4-2|3-2-1-4|3-2-4-1|3-4-1-2|3-4-2-1|4-1-2-3|4-1-3-2|
 4-2-1-3|4-2-3-1|4-3-1-2|4-3-2-1

SCPI.CALCulate(Ch).FSIMulator.EMBed.TYPE

Object type	Property
Syntax	SCPI.CALCulate(Ch).FSIMulator.EMBed.TYPE = <i>File</i> <i>File</i> = SCPI.CALCulate(Ch).FSIMulator.EMBed.TYPE
Description	For the 4-port network embedding/de-embedding feature for channels 1 to 16 (<i>Ch</i>), selects a connection type (Topology).

NOTE This function is available with the firmware version 3.50 or greater.

Figure 7-3

Connection type

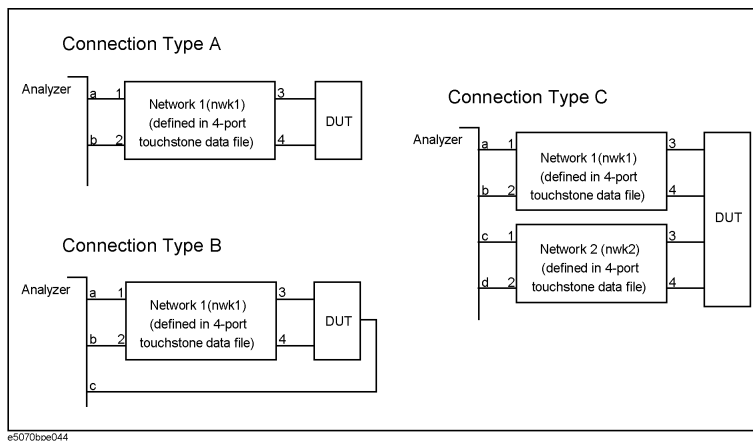

Variable

	<i>Param</i>
Description	Connection type (refer to Figure 7-3)
Data type	Character string type (String)
Range	Select from the following. <ul style="list-style-type: none"> • "A" Specifies connection type A. • "B" Specifies connection type B. • "C" Specifies connection type C.
Preset value	"A"

(For information on *Ch*, refer to Table 7-6, “Variable (Ch),” on page 209.

Examples

```
Dim EmbType As String
SCPI.CALCulate(1).FSIMulator.EMBed.TYPE = "b"
EmbType = SCPI.CALCulate(1).FSIMulator.EMBed.TYPE
```

Related objects

- SCPI.CALCulate(Ch).FSIMulator.EMBed.TOPology.A. PORTs on page 237
- SCPI.CALCulate(Ch).FSIMulator.EMBed.TOPology.B. PORTs on page 238
- SCPI.CALCulate(Ch).FSIMulator.EMBed.TOPology.C. PORTs on page 239

Equivalent key

[Analysis] - Fixture Simulator - De-Embedding S4P - Topology - Select Topology - A|B|C

**SCPI.CALCulate(Ch).FSIMulator.SENDEd.DEEMbed.
PORT(Pt).TYPE**

Object type	Property
Syntax	SCPI.CALCulate(Ch).FSIMulator.SENDEd.DEEMbed.PORT(Pt).TYPE = <i>Param</i> <i>Param</i> = SCPI.CALCulate(Ch).FSIMulator.SENDEd.DEEMbed.PORT(Pt).TYPE
Description	For ports 1 and 4 (<i>Pt</i>) of channels 1 to 16 (<i>Ch</i>), selects the type of the network de-embedding.

Variable

Table 7-9**Variable (*Pt*)**

	<i>Pt</i>
Description	Port number
Data type	Long integer type (Long)
Range	1 to 4
Preset value	1
Note	If the specified variable is out of the allowable setup range, an error occurs when executed.

	<i>Param</i>
Description	Type of the network de-embedding
Data type	Character string type (String)
Range	Select from the following. <ul style="list-style-type: none"> •"NONE" Specifies no network de-embedding. •"USER" Specifies the user-defined network de-embedding*1.
Preset value	"NONE"
Note	If you want to select the user-defined network de-embedding, you must specify the 2-port touchstone file in which the information on the user-defined network is saved in advance. If you do not specify the appropriate file and you select the user-defined network de-embedding, an error occurs when executed and NONE is automatically selected.

*1. The information on the network is read out from the 2-port touchstone file specified with the SCPI.CALCulate(Ch).FSIMulator.SENDEd.DEEMbed. PORT(Pt).USER.FILEname object.

For information on the variable (*Ch*), see Table 7-6, "Variable (Ch)," on page 209.

Examples

```
Dim DeemType As String
SCPI.CALCulate(1).FSIMulator.SENDEd.DEEMbed.PORT(1).USER.FILEname = "network.s2p"
SCPI.CALCulate(1).FSIMulator.SENDEd.DEEMbed.PORT(1).TYPE = "user"
DeemType = SCPI.CALCulate(1).FSIMulator.SENDEd.DEEMbed.PORT(1).TYPE
```

Related objects

SCPI.CALCulate(Ch).FSIMulator.SENDEd.DEEMbed. PORT(Pt).USER.FILEname on page 243

SCPI.CALCulate(Ch).FSIMulator.SENDEd.DEEMbed. STATE on page 244

SCPI.SENSE(Ch).CORREction.COLLEct.ECAL.ORIentation .STATE on page 525

COM Object Reference

SCPI.CALCulate(Ch).FSIMulator.SENDeD.DEEMbed. PORT(Pt).TYPE

Equivalent key

[Analysis] - Fixture Simulator - De-Embedding - Select Type

SCPI.CALCulate(Ch).FSIMulator.SENDEd.DEEMbed. PORT(Pt).USER.FILename

Object type Property

Syntax SCPI.CALCulate(Ch).FSIMulator.SENDEd.DEEMbed.PORT(Pt).USER.FILename = *File*
File = SCPI.CALCulate(Ch).FSIMulator.SENDEd.DEEMbed.PORT(Pt).USER.FILename

Description For ports 1 and 4 (*Pt*) of channels 1 to 16 (*Ch*), specifies the file in which the information on the user-defined network for the network de-embedding function is saved (2-port touchstone file with the .s2p extension).

Specify the file name with the extension. If you want to specify a file on the floppy disk drive, you need to add "A:" at the beginning of the file name. When you use directory names (folder names) and file name, separate them with "\" (back slash), or "/" (slash).

Even if the specified file does not exist, no error occurs when you execute this object. However, when you set the type of the network de-embedding to the user-defined network with the SCPI.CALCulate(Ch).FSIMulator.SENDEd.DEEMbed. PORT(Pt).TYPE object, an error occurs.

Variable

	<i>File</i>
Description	2-port touchstone file name (extension: .s2p) for the network de-embedding function
Data type	Character string type (String)
Range	254 characters or less
Preset value	""

For information on the variable (*Ch*) and the variable (*Pt*), see Table 7-6, "Variable (Ch)," on page 209 and Table 7-9, "Variable (Pt)," on page 241, respectively.

Examples

```
Dim DeemUser As String
SCPI.CALCulate(1).FSIMulator.SENDEd.DEEMbed.PORT(1).USER.FILename = "network.s2p"
DeemUser = SCPI.CALCulate(1).FSIMulator.SENDEd.DEEMbed.PORT(1).USER.FILename
SCPI.CALCulate(1).FSIMulator.SENDEd.DEEMbed.PORT(1).TYPE = "user"
```

Related objects SCPI.CALCulate(Ch).FSIMulator.SENDEd.DEEMbed. PORT(Pt).TYPE on page 241
 SCPI.CALCulate(Ch).FSIMulator.SENDEd.DEEMbed. STATE on page 244

Equivalent key **[Analysis] - Fixture Simulator - De-Embedding - User File**

SCPI.CALCulate(Ch).FSIMulator.SENDEd.DEEMbed. STATE

Object type	Property
Syntax	SCPI.CALCulate(Ch).FSIMulator.SENDEd.DEEMbed. STATE = <i>Status</i> <i>Status</i> = SCPI.CALCulate(Ch).FSIMulator.SENDEd.DEEMbed. STATE
Description	For all the ports of channel 1 to 9 (<i>Ch</i>), turns ON/OFF the network de-embedding function when the fixture simulator function is ON.
Variable	

	<i>Status</i>
Description	ON/OFF of the network de-embedding function
Data type	Boolean type (Boolean)
Range	Select from the following. <ul style="list-style-type: none"> • True or -1 Turns ON the network de-embedding function. • False or 0 Turns OFF the network de-embedding function.
Preset value	False or 0

For information on the variable (*Ch*), see Table 7-6, “Variable (Ch),” on page 209.

Examples	Dim Deemb As Boolean SCPI.CALCulate(1).FSIMulator.SENDEd.DEEMbed. STATE = True Deemb = SCPI.CALCulate(1).FSIMulator.SENDEd.DEEMbed. STATE
Related objects	SCPI.CALCulate(Ch).FSIMulator.SENDEd.DEEMbed. PORT(Pt).USER.FILEname on page 243 SCPI.CALCulate(Ch).FSIMulator.SENDEd.DEEMbed. PORT(Pt).TYPE on page 241 SCPI.CALCulate(Ch).FSIMulator. STATE on page 256
Equivalent key	[Analysis] - Fixture Simulator - De-Embedding - De-Embedding

SCPI.CALCulate(Ch).FSIMulator.SENDEd.PMCircuit. PORT(Pt).PARAmeters.C

Object type Property

Syntax SCPI.CALCulate(Ch).FSIMulator.SENDEd.PMCircuit.PORT(Pt).PARAmeters.C = *Value*
Value = SCPI.CALCulate(Ch).FSIMulator.SENDEd.PMCircuit.PORT(Pt).PARAmeters.C

Description For ports 1 and 4 (*Pt*) of channels 1 to 16 (*Ch*), sets the C value of the matching circuit specified with the SCPI.CALCulate(Ch).FSIMulator.SENDEd.PMCircuit.PORT(Pt).TYPE object.

Variable

	<i>Value</i>
Description	C value of the matching circuit
Data type	Double precision floating point type (Double)
Range	-1E18 to 1E18
Preset value	0
Unit	F (farad)
Resolution	1E-18
Note	If the specified variable is out of the allowable setup range, the minimum value (if the lower limit of the range is not reached) or the maximum value (if the upper limit of the range is exceeded) is set.

For information on the variable (*Ch*) and the variable (*Pt*), see Table 7-6, “Variable (Ch),” on page 209 and Table 7-9, “Variable (Pt),” on page 241, respectively.

Examples

```
Dim PmcC As Double
SCPI.CALCulate(1).FSIMulator.SENDEd.PMCircuit.PORT(1).PARAmeters.C = 12E-12
PmcC = SCPI.CALCulate(1).FSIMulator.SENDEd.PMCircuit.PORT(1).PARAmeters.C
```

Related objects

SCPI.CALCulate(Ch).FSIMulator.SENDEd.PMCircuit. PORT(Pt).TYPE on page 249

SCPI.CALCulate(Ch).FSIMulator.SENDEd.PMCircuit. PORT(Pt).PARAmeters.G on page 246

SCPI.CALCulate(Ch).FSIMulator.SENDEd.PMCircuit. PORT(Pt).PARAmeters.L on page 247

SCPI.CALCulate(Ch).FSIMulator.SENDEd.PMCircuit. PORT(Pt).PARAmeters.R on page 248

SCPI.CALCulate(Ch).FSIMulator.SENDEd.PMCircuit. STATE on page 251

Equivalent key **[Analysis] - Fixture Simulator - Port Matching - C**

**SCPI.CALCulate(Ch).FSIMulator.SENDEd.PMCircuit.
 PORT(Pt).PARAmeters.G**

Object type Property

Syntax SCPI.CALCulate(Ch).FSIMulator.SENDEd.PMCircuit.PORT(Pt).PARAmeters.G = *Value*
Value = SCPI.CALCulate(Ch).FSIMulator.SENDEd.PMCircuit.PORT(Pt).PARAmeters.G

Description For ports 1 and 4 (*Pt*) of channels 1 to 16 (*Ch*), sets the G value of the matching circuit specified with the SCPI.CALCulate(Ch).FSIMulator.SENDEd.PMCircuit.PORT(Pt).TYPE object.

Variable

	<i>Value</i>
Description	G value of the matching circuit
Data type	Double precision floating point type (Double)
Range	-1E18 to 1E18
Preset value	0
Unit	S (siemens)
Resolution	1E-18
Note	If the specified variable is out of the allowable setup range, the minimum value (if the lower limit of the range is not reached) or the maximum value (if the upper limit of the range is exceeded) is set.

For information on the variable (*Ch*) and the variable (*Pt*), see Table 7-6, “Variable (Ch),” on page 209 and Table 7-9, “Variable (Pt),” on page 241, respectively.

Examples

```
Dim PmcG As Double
SCPI.CALCulate(1).FSIMulator.SENDEd.PMCircuit.PORT(1).PARAmeters.G = 12E-12
PmcG = SCPI.CALCulate(1).FSIMulator.SENDEd.PMCircuit.PORT(1).PARAmeters.G
```

Related objects

SCPI.CALCulate(Ch).FSIMulator.SENDEd.PMCircuit. PORT(Pt).TYPE on page 249

SCPI.CALCulate(Ch).FSIMulator.SENDEd.PMCircuit. PORT(Pt).PARAmeters.C on page 245

SCPI.CALCulate(Ch).FSIMulator.SENDEd.PMCircuit. PORT(Pt).PARAmeters.L on page 247

SCPI.CALCulate(Ch).FSIMulator.SENDEd.PMCircuit. PORT(Pt).PARAmeters.R on page 248

SCPI.CALCulate(Ch).FSIMulator.SENDEd.PMCircuit. STATE on page 251

Equivalent key

[Analysis] - Fixture Simulator - Port Matching - G

**SCPI.CALCulate(Ch).FSIMulator.SENDEd.PMCircuit.
PORT(Pt).PARAmeters.L**

Object type	Property
Syntax	SCPI.CALCulate(Ch).FSIMulator.SENDEd.PMCircuit.PORT(Pt).PARAmeters.L = <i>Value</i> <i>Value</i> = SCPI.CALCulate(Ch).FSIMulator.SENDEd.PMCircuit.PORT(Pt).PARAmeters.L
Description	For ports 1 and 4 (<i>Pt</i>) of channels 1 to 16 (<i>Ch</i>), sets the L value of the matching circuit specified with the SCPI.CALCulate(Ch).FSIMulator.SENDEd.PMCircuit.PORT(Pt).TYPE object.

Variable

	<i>Value</i>
Description	L value of the matching circuit
Data type	Double precision floating point type (Double)
Range	-1E18 to 1E18
Preset value	0
Unit	H (henry)
Resolution	1E-18
Note	If the specified variable is out of the allowable setup range, the minimum value (if the lower limit of the range is not reached) or the maximum value (if the upper limit of the range is exceeded) is set.

For information on the variable (*Ch*) and the variable (*Pt*), see Table 7-6, “Variable (Ch),” on page 209 and Table 7-9, “Variable (Pt),” on page 241, respectively.

Examples

```
Dim PmcL As Double
SCPI.CALCulate(1).FSIMulator.SENDEd.PMCircuit.PORT(1).PARAmeters.L = 12E-12
PmcL = SCPI.CALCulate(1).FSIMulator.SENDEd.PMCircuit.PORT(1).PARAmeters.L
```

Related objects

SCPI.CALCulate(Ch).FSIMulator.SENDEd.PMCircuit. PORT(Pt).TYPE on page 249
 SCPI.CALCulate(Ch).FSIMulator.SENDEd.PMCircuit. PORT(Pt).PARAmeters.C on page 245
 SCPI.CALCulate(Ch).FSIMulator.SENDEd.PMCircuit. PORT(Pt).PARAmeters.G on page 246
 SCPI.CALCulate(Ch).FSIMulator.SENDEd.PMCircuit. PORT(Pt).PARAmeters.R on page 248
 SCPI.CALCulate(Ch).FSIMulator.SENDEd.PMCircuit. STATE on page 251

Equivalent key

[Analysis] - Fixture Simulator - Port Matching - L

**SCPI.CALCulate(Ch).FSIMulator.SENDEd.PMCircuit.
 PORT(Pt).PARAmeters.R**

Object type Property

Syntax SCPI.CALCulate(Ch).FSIMulator.SENDEd.PMCircuit.PORT(Pt).PARAmeters.R = *Value*
Value = SCPI.CALCulate(Ch).FSIMulator.SENDEd.PMCircuit.PORT(Pt).PARAmeters.R

Description For ports 1 and 4 (*Pt*) of channels 1 to 16 (*Ch*), sets the R value of the matching circuit specified with the SCPI.CALCulate(Ch).FSIMulator.SENDEd.PMCircuit.PORT(Pt).TYPE object.

Variable

	<i>Value</i>
Description	R value of the matching circuit
Data type	Double precision floating point type (Double)
Range	-1E18 to 1E18
Preset value	0
Unit	Ω (ohm)
Resolution	1E-18
Note	If the specified variable is out of the allowable setup range, the minimum value (if the lower limit of the range is not reached) or the maximum value (if the upper limit of the range is exceeded) is set.

For information on the variable (*Ch*) and the variable (*Pt*), see Table 7-6, “Variable (Ch),” on page 209 and Table 7-9, “Variable (Pt),” on page 241, respectively.

Examples

```
Dim PmcR As Double
SCPI.CALCulate(1).FSIMulator.SENDEd.PMCircuit.PORT(1).PARAmeters.R = 12E-12
PmcR = SCPI.CALCulate(1).FSIMulator.SENDEd.PMCircuit.PORT(1).PARAmeters.R
```

Related objects

SCPI.CALCulate(Ch).FSIMulator.SENDEd.PMCircuit. PORT(Pt).TYPE on page 249

SCPI.CALCulate(Ch).FSIMulator.SENDEd.PMCircuit. PORT(Pt).PARAmeters.C on page 245

SCPI.CALCulate(Ch).FSIMulator.SENDEd.PMCircuit. PORT(Pt).PARAmeters.G on page 246

SCPI.CALCulate(Ch).FSIMulator.SENDEd.PMCircuit. PORT(Pt).PARAmeters.L on page 247

SCPI.CALCulate(Ch).FSIMulator.SENDEd.PMCircuit. STAtE on page 251

Equivalent key

[Analysis] - Fixture Simulator - Port Matching - R

SCPI.CALCulate(Ch).FSIMulator.SENDEd.PMCircuit. PORT(Pt).TYPE

Object type	Property
Syntax	SCPI.CALCulate(Ch).FSIMulator.SENDEd.PMCircuit.PORT(Pt).TYPE = <i>Param</i> <i>Param</i> = SCPI.CALCulate(Ch).FSIMulator.SENDEd.PMCircuit.PORT(Pt).TYPE
Description	For ports 1 and 4 (<i>Pt</i>) of channels 1 to 16 (<i>Ch</i>), selects the type of the matching circuit. For information on the model of the matching circuit, see Section “Determining Characteristics After Adding a Matching Circuit” in the <i>E5070B/E5071B User’s Guide</i> .

Variable

	<i>Param</i>
Description	Type of the matching circuit
Data type	Character string type (String)
Range	Select from the following. <ul style="list-style-type: none"> •"NONE" Specifies no-circuit. •"SLPC" Specifies the circuit that consists of series L and shunt C. •"PCSL" Specifies the circuit that consists of shunt C and series L. •"PLSC" Specifies the circuit that consists of shunt L and series C. •"SCPL" Specifies the circuit that consists of series C and shunt L. •"PLPC" Specifies the circuit that consists of shunt L and shunt C. •"USER" Specifies the user-defined circuit^{*1}.
Preset value	"NONE"
Note	If you want to select the user-defined circuit, you must specify the 2-port touchstone file in which the proper information on the user-defined circuit is saved in advance. If you do not specify the appropriate file and you select the user-defined circuit, an error occurs when executed and NONE is automatically selected.

*1. The information on the circuit is read out from the 2-port touchstone file specified with the SCPI.CALCulate(Ch).FSIMulator.SENDEd.PMCircuit. PORT(Pt).USER.FILEname object.

For information on the variable (*Ch*) and the variable (*Pt*), see Table 7-6, “Variable (Ch),” on page 209 and Table 7-9, “Variable (Pt),” on page 241, respectively.

Examples	<pre>Dim CirType As String SCPI.CALCulate(1).FSIMulator.SENDEd.PMCircuit.PORT(1).TYPE = "slpc" CirType = SCPI.CALCulate(1).FSIMulator.SENDEd.PMCircuit.PORT(1).TYPE</pre>
Related objects	<p>SCPI.CALCulate(Ch).FSIMulator.SENDEd.PMCircuit. PORT(Pt).PARAMeters.C on page 245</p> <p>SCPI.CALCulate(Ch).FSIMulator.SENDEd.PMCircuit. PORT(Pt).PARAMeters.G on page 246</p> <p>SCPI.CALCulate(Ch).FSIMulator.SENDEd.PMCircuit. PORT(Pt).PARAMeters.L on page 247</p> <p>SCPI.CALCulate(Ch).FSIMulator.SENDEd.PMCircuit. PORT(Pt).PARAMeters.R on page 248</p> <p>SCPI.CALCulate(Ch).FSIMulator.SENDEd.PMCircuit. PORT(Pt).USER.FILEname on page 250</p> <p>SCPI.CALCulate(Ch).FSIMulator.SENDEd.PMCircuit. STATE on page 251</p>
Equivalent key	[Analysis] - Fixture Simulator - Port Matching - Select Circuit

**SCPI.CALCulate(Ch).FSIMulator.SENDEd.PMCircuit.
PORT(Pt).USER.FILename**

Object type	Property
Syntax	SCPI.CALCulate(Ch).FSIMulator.SENDEd.PMCircuit.PORT(Pt).USER.FILename = <i>File</i> <i>File</i> = SCPI.CALCulate(Ch).FSIMulator.SENDEd.PMCircuit.PORT(Pt).USER.FILename
Description	<p>For ports 1 and 4 (<i>Pt</i>) of channels 1 to 16 (<i>Ch</i>), specifies the file in which the information on the user-defined matching circuit is saved (2-port touchstone file).</p> <p>Specify the file name with the extension. If you want to specify a file on the floppy disk drive, you need to add "A:" at the beginning of the file name. When you use directory names (folder names) and file name, separate them with "\" (back slash), or "/" (slash).</p> <p>Even if the specified file does not exist, no error occurs when you execute this object. However, when you set the type of the matching circuit to the user-defined circuit with the SCPI.CALCulate(Ch).FSIMulator.SENDEd.PMCircuit. PORT(Pt).TYPE object, an error occurs.</p>

Variable

	<i>File</i>
Description	2-port touchstone file name (extension: .s2p) for the matching circuit
Data type	Character string type (String)
Range	254 characters or less
Preset value	""

For information on the variable (*Ch*) and the variable (*Pt*), see Table 7-6, "Variable (Ch)," on page 209 and Table 7-9, "Variable (Pt)," on page 241, respectively.

Examples	<pre>Dim PmcUser As String SCPI.CALCulate(1).FSIMulator.SENDEd.PMCircuit.PORT(1).USER.FILename = "match.s2p" PmcUser = SCPI.CALCulate(1).FSIMulator.SENDEd.PMCircuit.PORT(1).USER.FILename SCPI.CALCulate(1).FSIMulator.SENDEd.PMCircuit.PORT(1).TYPE = "user"</pre>
Related objects	<p>SCPI.CALCulate(Ch).FSIMulator.SENDEd.PMCircuit. PORT(Pt).TYPE on page 249</p> <p>SCPI.CALCulate(Ch).FSIMulator.SENDEd.PMCircuit. STATE on page 251</p>
Equivalent key	[Analysis] - Fixture Simulator - Port Matching - User File

SCPI.CALCulate(*Ch*).FSIMulator.SENDEd.PMCircuit. STATE

Object type	Property
Syntax	SCPI.CALCulate(<i>Ch</i>).FSIMulator.SENDEd.PMCircuit.STATE = <i>Status</i> <i>Status</i> = SCPI.CALCulate(<i>Ch</i>).FSIMulator.SENDEd.PMCircuit.STATE
Description	For all the ports of channel 1 to 9 (<i>Ch</i>), turns ON/OFF the matching circuit embedding function when the fixture simulator function is ON.
Variable	

	<i>Status</i>
Description	ON/OFF of the matching circuit embedding function
Data type	Boolean type (Boolean)
Range	Select from the following. <ul style="list-style-type: none"> • True or -1 Turns ON the matching circuit embedding function. • False or 0 Turns OFF the matching circuit embedding function.
Preset value	False or 0

For information on the variable (*Ch*), see Table 7-6, “Variable (Ch),” on page 209.

Examples

```
Dim Pmcir As Boolean
SCPI.CALCulate(1).FSIMulator.SENDEd.PMCircuit.STATE = True
Pmcir = SCPI.CALCulate(1).FSIMulator.SENDEd.PMCircuit.STATE
```

Related objects

SCPI.CALCulate(Ch).FSIMulator.SENDEd.PMCircuit. PORT(Pt).TYPE on page 249

SCPI.CALCulate(Ch).FSIMulator.SENDEd.PMCircuit. PORT(Pt).PARAMeters.C on page 245

SCPI.CALCulate(Ch).FSIMulator.SENDEd.PMCircuit. PORT(Pt).PARAMeters.G on page 246

SCPI.CALCulate(Ch).FSIMulator.SENDEd.PMCircuit. PORT(Pt).PARAMeters.L on page 247

SCPI.CALCulate(Ch).FSIMulator.SENDEd.PMCircuit. PORT(Pt).PARAMeters.R on page 248

SCPI.CALCulate(Ch).FSIMulator.SENDEd.PMCircuit. PORT(Pt).USER.FILEname on page 250

SCPI.CALCulate(Ch).FSIMulator.STATE on page 256

Equivalent key **[Analysis] - Fixture Simulator - Port Matching - Port Matching**

**SCPI.CALCulate(Ch).FSIMulator.SENDEd.ZCONversion.
PORT(Pt).IMAGinary**

Object type	Property
Syntax	SCPI.CALCulate(Ch).FSIMulator.SENDEd.ZCONversion.PORT(Pt).IMAGinary = <i>Value</i> <i>Value</i> = SCPI.CALCulate(Ch).FSIMulator.SENDEd.ZCONversion.PORT(Pt).IMAGinary
Description	For ports 1 and 4 (<i>Pt</i>) of channels 1 to 16 (<i>Ch</i>), sets the impedance value (imaginary part) for the port impedance conversion function.

Variable

	<i>Value</i>
Description	Impedance value (imaginary part) for the port impedance conversion function
Data type	Double precision floating point type (Double)
Range	-1E+18 to 1E+18
Preset value	0
Unit	Ω (ohm)
Note	If the specified variable is out of the allowable setup range, the minimum value (if the lower limit of the range is not reached) or the maximum value (if the upper limit of the range is exceeded) is set.

For information on the variable (*Ch*) and the variable (*Pt*), see Table 7-6, “Variable (Ch),” on page 209 and Table 7-9, “Variable (Pt),” on page 241, respectively.

Examples	<pre>Dim ZImag As Double SCPI.CALCulate(1).FSIMulator.SENDEd.ZCONversion.PORT(1).IMAGinary = -9.2E10 ZImag = SCPI.CALCulate(1).FSIMulator.SENDEd.ZCONversion.PORT(1).IMAGinary</pre>
----------	--

Related objects	<p>SCPI.CALCulate(Ch).FSIMulator.SENDEd.ZCONversion. PORT(Pt).REAL on page 253</p> <p>SCPI.CALCulate(Ch).FSIMulator.SENDEd.ZCONversion. PORT(Pt).Z0.R on page 254</p> <p>SCPI.CALCulate(Ch).FSIMulator.SENDEd.ZCONversion. STATE on page 255</p>
-----------------	--

Equivalent key	<p>SCPI.CALCulate(Ch).FSIMulator.STATE on page 256</p> <p>[Analysis] - Fixture Simulator - Port ZConversion - Port1 Z0 Imag Port2 Z0 Imag Port3 Z0 Imag Port4 Z0 Imag</p>
----------------	--

SCPI.CALCulate(Ch).FSIMulator.SENDEd.ZCONversion. PORT(Pt).REAL

Object type	Property
Syntax	SCPI.CALCulate(Ch).FSIMulator.SENDEd.ZCONversion.PORT(Pt).REAL = <i>Value</i> <i>Value</i> = SCPI.CALCulate(Ch).FSIMulator.SENDEd.ZCONversion.PORT(Pt).REAL
Description	For ports 1 and 4 (<i>Pt</i>) of channels 1 to 16 (<i>Ch</i>), sets the impedance value (real part) for the port impedance conversion function.

NOTE This command performs in the same way as “SCPI.CALCulate(Ch).FSIMulator.SENDEd.ZCONversion. PORT(Pt).Z0.R” on page 254

Variable

	<i>Value</i>
Description	Impedance value (real part) for the port impedance conversion function
Data type	Double precision floating point type (Double)
Range	0.001 to 1E7
Preset value	50
Unit	Ω (ohm)
Resolution	0.001
Note	If the specified variable is out of the allowable setup range, the minimum value (if the lower limit of the range is not reached) or the maximum value (if the upper limit of the range is exceeded) is set.

For information on the variable (*Ch*) and the variable (*Pt*), see Table 7-6, “Variable (Ch),” on page 209 and Table 7-9, “Variable (Pt),” on page 241, respectively.

Examples	Dim ZReal As Double SCPI.CALCulate(1).FSIMulator.SENDEd.ZCONversion.PORT(1).REAL = 3.7E5 ZReal = SCPI.CALCulate(1).FSIMulator.SENDEd.ZCONversion.PORT(1).REAL
Related objects	SCPI.CALCulate(Ch).FSIMulator.SENDEd.ZCONversion. PORT(Pt).IMAGinary on page 252 SCPI.CALCulate(Ch).FSIMulator.SENDEd.ZCONversion. PORT(Pt).Z0.R on page 254 SCPI.CALCulate(Ch).FSIMulator.SENDEd.ZCONversion. STATE on page 255
Equivalent key	SCPI.CALCulate(Ch).FSIMulator.STATE on page 256 [Analysis] - Fixture Simulator - Port ZConversion - Port1 Z0 Real Port2 Z0 Real Port3 Z0 Real Port4 Z0 Real

SCPI.CALCulate(*Ch*).FSIMulator.SENDEd.ZCONversion. PORT(*Pt*).Z0.R

Object type	Property
Syntax	SCPI.CALCulate(<i>Ch</i>).FSIMulator.SENDEd.ZCONversion.PORT(<i>Pt</i>).Z0.R = <i>Value</i> <i>Value</i> = SCPI.CALCulate(<i>Ch</i>).FSIMulator.SENDEd.ZCONversion.PORT(<i>Pt</i>).Z0.R
Description	For ports 1 and 4 (<i>Pt</i>) of channels 1 to 16 (<i>Ch</i>), sets the impedance value for the port impedance conversion function.

CAUTION This command clears setting value of “SCPI.CALCulate(Ch).FSIMulator.SENDEd.ZCONversion. PORT(Pt).IMAGinary” on page 252

Variable

	<i>Value</i>
Description	Impedance value for the port impedance conversion function
Data type	Double precision floating point type (Double)
Range	0.001 to 1E7
Preset value	50
Unit	Ω (ohm)
Resolution	0.001
Note	If the specified variable is out of the allowable setup range, the minimum value (if the lower limit of the range is not reached) or the maximum value (if the upper limit of the range is exceeded) is set.

For information on the variable (*Ch*) and the variable (*Pt*), see Table 7-6, “Variable (Ch),” on page 209 and Table 7-9, “Variable (Pt),” on page 241, respectively.

Examples	Dim ZconR As Double SCPI.CALCulate(1).FSIMulator.SENDEd.ZCONversion.PORT(1).Z0.R = 75 ZconR = SCPI.CALCulate(1).FSIMulator.SENDEd.ZCONversion.PORT(1).Z0.R
Related objects	SCPI.CALCulate(Ch).FSIMulator.SENDEd.ZCONversion. PORT(Pt).IMAGinary on page 252 SCPI.CALCulate(Ch).FSIMulator.SENDEd.ZCONversion. PORT(Pt).REAL on page 253 SCPI.CALCulate(Ch).FSIMulator.SENDEd.ZCONversion. STATE on page 255 SCPI.CALCulate(Ch).FSIMulator.STATE on page 256
Equivalent key	[Analysis] - Fixture Simulator - Port ZConversion - Port1 Z0 Real Port2 Z0 Real Port3 Z0 Real Port4 Z0 Real

SCPI.CALCulate(*Ch*).FSIMulator.SENDEd.ZCONversion. STATE

- Object type** Property
- Syntax** SCPI.CALCulate(*Ch*).FSIMulator.SENDEd.ZCONversion.STATE = *Status*
Status = SCPI.CALCulate(*Ch*).FSIMulator.SENDEd.ZCONversion.STATE
- Description** For all the ports of channel 1 to 9 (*Ch*), turns ON/OFF the port impedance conversion function when the fixture simulator function is ON.
- Variable**

	<i>Status</i>
Description	ON/OFF of the port impedance conversion function
Data type	Boolean type (Boolean)
Range	Select from the following. <ul style="list-style-type: none"> • True or -1 Turns ON the port impedance conversion function. • False or 0 Turns OFF the port impedance conversion function.
Preset value	False or 0

For information on the variable (*Ch*), see Table 7-6, “Variable (Ch),” on page 209.

- Examples**

```
Dim Zcon As Boolean
SCPI.CALCulate(1).FSIMulator.SENDEd.ZCONversion.STATE = True
Zcon = SCPI.CALCulate(1).FSIMulator.SENDEd.ZCONversion.STATE
```
- Related objects**
 SCPI.CALCulate(Ch).FSIMulator.SENDEd.ZCONversion. PORT(Pt).IMAGinary on page 252
 SCPI.CALCulate(Ch).FSIMulator.SENDEd.ZCONversion. PORT(Pt).REAL on page 253
 SCPI.CALCulate(Ch).FSIMulator.SENDEd.ZCONversion. PORT(Pt).Z0.R on page 254
 SCPI.CALCulate(Ch).FSIMulator.STATE on page 256
- Equivalent key** **[Analysis] - Fixture Simulator - Port ZConversion - Port ZConversion**

SCPI.CALCulate(Ch).FSIMulator.STATe

Object type	Property
Syntax	SCPI.CALCulate(Ch).FSIMulator.STATe = <i>Status</i> <i>Status</i> = SCPI.CALCulate(Ch).FSIMulator.STATe
Description	Turns ON/OFF the fixture simulator function of channels 1 to 16 (<i>Ch</i>).
Variable	

	<i>Status</i>
Description	ON/OFF of the fixture simulator function
Data type	Boolean type (Boolean)
Range	Select from the following. •True or -1 Turns ON the fixture simulator function. •False or 0 Turns OFF the fixture simulator function.
Preset value	False or 0

For information on the variable (*Ch*), see Table 7-6, “Variable (Ch),” on page 209.

Examples	<pre>Dim FxtSim As Boolean SCPI.CALCulate(1).FSIMulator.STATe = True FxtSim = SCPI.CALCulate(1).FSIMulator.STATe</pre>
----------	--

Equivalent key	[Analysis] - Fixture Simulator - Fixture Simulator
----------------	---

SCPI.CALCulate(*Ch*).PARAmeter.COUNT

- Object type Property
- Syntax SCPI.CALCulate(*Ch*).PARAmeter.COUNT = *Value*
Value = SCPI.CALCulate(*Ch*).PARAmeter.COUNT
- Description Sets the number of traces of channels 1 to 16 (*Ch*).
- Variable

	<i>Value</i>
Description	Number of traces
Data type	Long integer type (Long)
Range	Varies depending on the upper limit setting for the channel/trace number.
Preset value	1
Note	If the specified variable is out of the allowable setup range, the minimum value (if the lower limit of the range is not reached) or the maximum value (if the upper limit of the range is exceeded) is set.

For information on the variable (*Ch*), see Table 7-6, “Variable (Ch),” on page 209.

- Examples Dim TraceNum As Long
SCPI.CALCulate(1).PARAmeter.COUNT = 4
TraceNum = SCPI.CALCulate(1).PARAmeter.COUNT
- Equivalent key **[Display] - Num of Traces**

SCPI.CALCulate(*Ch*).PARAmeter(*Tr*).DEFine

Object type	Property
Syntax	SCPI.CALCulate(<i>Ch</i>).PARAmeter(<i>Tr</i>).DEFine = <i>Param</i> <i>Param</i> = SCPI.CALCulate(<i>Ch</i>).PARAmeter(<i>Tr</i>).DEFine
Description	For channels 1 to 16 (<i>Ch</i>), sets the measurement parameter of traces 1 to 16 (<i>Tr</i>).
Variable	

	<i>Param</i>
Description	Measurement parameter
Data type	Character string type (String)
Range	Select from the following. <ul style="list-style-type: none"> •"S11" Specifies S11. •"S21" Specifies S21. •"S31" Specifies S31. •"S41" Specifies S41. •"S12" Specifies S12. •"S22" Specifies S22. •"S32" Specifies S32. •"S42" Specifies S42. •"S13" Specifies S13. •"S23" Specifies S23. •"S33" Specifies S33. •"S43" Specifies S43. •"S14" Specifies S14. •"S24" Specifies S24. •"S34" Specifies S34. •"S44" Specifies S44. •"A" Specifies A. •"B" Specifies B. •"C" Specifies C. •"D" Specifies D. •"R1" Specifies R1. •"R2" Specifies R2. •"R3" Specifies R3. •"R4" Specifies R4.
Preset value	"S11"

For information on the variable (*Ch*) and the variable (*Tr*), see Table 7-6, “Variable (Ch),” on page 209 and Table 7-10, “Variable (Tr),” on page 259, respectively.

Examples

```
Dim MeasPara As String
SCPI.CALCulate(1).PARAmeter(1).DEFine = "s21"
MeasPara = SCPI.CALCulate(1).PARAmeter(1).DEFine
```

Equivalent key **[Meas] - S11|S21|S31|S41|S12|S22|S32|S42|S13|S23|S33|S43|S14|S24|S34|S44|A|B|C|D|R1|R2|R3|R4**

SCPI.CALCulate(*Ch*).PARAmeter(*Tr*).SElect

Object type Method

Syntax SCPI.CALCulate(*Ch*).PARAmeter(*Tr*).SElect

Description Sets traces 1 to 16 (*Tr*) of channels 1 to 16 (*Ch*) to the active trace.
 You can set only a trace displayed to the active trace. If this object is used to set a trace not displayed to the active trace, an error occurs when executed and the object is ignored. (No read)

Variable

Table 7-10 Variable (*Tr*)

	<i>Tr</i>
Description	Trace number
Data type	Long integer type (Long)
Range	1 to 16
Preset value	1
Note	If the specified variable is out of the allowable setup range, an error occurs when executed.

For information on the variable (*Ch*), see Table 7-6, “Variable (Ch),” on page 209.

Examples SCPI.CALCulate(2).PARAmeter(2).SElect

Related objects SCPI.CALCulate(Ch).SElected.CORRection.EDELay. MEDium on page 271
 SCPI.CALCulate(Ch).SElected.CORRection.EDELay. TIME on page 272
 SCPI.CALCulate(Ch).SElected.CORRection.EDELay. WGCutoff on page 273
 SCPI.DISPlay.WINDow(Ch).ACTivate on page 395
 SCPI.SENSE(Ch).CORRection.EXTension.AUTO.DCOffset on page 549

Equivalent key **[Trace Prev] / [Trace Next]**

SCPI.CALCulate(*Ch*).PARAmeter(*Tr*).SPORT

Type of object	Property
Syntax	SCPI.CALCulate(<i>Ch</i>).PARAmeter(<i>Tr</i>).SPORT = <i>Value</i> <i>Value</i> = SCPI.CALCulate(<i>Ch</i>).PARAmeter(<i>Tr</i>).SPORT
Description	For traces 1 to 16 (<i>Tr</i>) of channels 1 to 16 (<i>Ch</i>), sets the output port used for absolute measurement.
Variable	

	<i>Value</i>
Description	Setting of the output port
Data type	Long integer type (Long)
Range	1 to 4
Preset value	1
Note	You need to set the measurement parameter for absolute measurement with the "SCPI.CALCulate(Ch).PARAmeter(Tr).DEFine" on page 258 command.

For information on the variable (*Ch*), refer to Table 7-6, "Variable (Ch)," on page 209.

For information on the variable (*Tr*), refer to Table 7-10, "Variable (Tr)," on page 259.

Example of use	<pre>Dim Sport As Long SCPI.CALCulate(1).PARAmeter(1).DEFine = "B" SCPI.CALCulate(1).PARAmeter(1).SPORT = 4 Sport = SCPI.CALCulate(1).PARAmeter(1).SPORT</pre>
----------------	--

Related objects	SCPI.CALCulate(Ch).PARAmeter(Tr).DEFine on page 258
-----------------	---

Equivalent key	[Meas] - Absolute - A(1)~A(4)...D(1)~D(4)...R1(1)~R1(4)...R4(1)~R4(4)
----------------	--

SCPI.CALCulate(*Ch*).SElected.BLIMit.DB

Object type Property

Syntax SCPI.CALCulate(*Ch*).SElected.BLIMit.DB = *Value*
Value = SCPI.CALCulate(*Ch*).SElected.BLIMit.DB

Description For channel 1 to channel 16 (specified with the SCPI.CALCulate(*Ch*).PARAmeter(*Tr*).SElect command), sets the bandwidth threshold value (attenuation from the peak) of the bandwidth test.

Variable

	<i>Value</i>
Description	Bandwidth N dB points.
Data type	Double precision floating point type (Double)
Range	0 to 5E8
Preset value	0
Unit	dB

For information on the variable (*Ch*), see Table 7-6, “Variable (*Ch*),” on page 209.

Examples

```
Dim BLimDB As Double
SCPI.CALCulate(1).SElected.BLIMit.DB = 3
BLimDB = SCPI.CALCulate(1).SElected.BLIMit.DB
```

Related objects SCPI.CALCulate(*Ch*).PARAmeter(*Tr*).SElect on page 259
 SCPI.CALCulate(*Ch*).SElected.BLIMit.STATe on page 268

Equivalent key **[Analysis] - Bandwidth Limit - N dB Points**

SCPI.CALCulate(*Ch*).SElected.BLIMit.DISPlay.MARKer

Object type Property

Syntax SCPI.CALCulate(*Ch*).SElected.BLIMit.DISPlay.MARKer = *Status*
Status = SCPI.CALCulate(*Ch*).SElected.BLIMit.DISPlay.MARKer

Description For the active trace of channel 1 to channel 16 (specified with the SCPI.CALCulate(*Ch*).PARAMeter(*Tr*).SElect command), turns ON/OFF the marker display of the bandwidth test.

Variable

	<i>Status</i>
Description	ON/OFF of the bandwidth marker.
Data type	Boolean type (Boolean)
Range	Select from the following. <ul style="list-style-type: none"> •True or -1 Turns ON the bandwidth marker. •False or 0 Turns OFF the bandwidth marker.
Preset value	False or 0

For information on the variable (*Ch*), see Table 7-6, “Variable (*Ch*),” on page 209.

Examples Dim BLimMk As Boolean
SCPI.CALCulate(1).PARAMeter(1).SElect
SCPI.CALCulate(1).SElected.BLIMit.DISPlay.MARKer = True
BLimMk = SCPI.CALCulate(1).SElected.BLIMit.DISPlay.MARKer

Related objects SCPI.CALCulate(*Ch*).PARAMeter(*Tr*).SElect on page 259
SCPI.CALCulate(*Ch*).SElected.BLIMit.STATe on page 268
SCPI.CALCulate(*Ch*).SElected.BLIMit.DISPlay.VALue on page 263

Equivalent key **[Analysis] - Bandwidth Limit - BW Marker**

SCPI.CALCulate(*Ch*).SElected.BLIMit.DISPlay.VALue

Object type Property

Syntax SCPI.CALCulate(*CH*).SElected.BLIMit.DISPlay.VALue = *Status*
Status = SCPI.CALCulate(*Ch*).SElected.BLIMit.DISPlay.VALue

Description For the active trace of channel 1 to channel 16 (specified with the SCPI.CALCulate(*Ch*).PARAmeter(*Tr*).SElect command), turns ON/OFF the bandwidth value display of the bandwidth test.

Variable

	<i>Status</i>
Description	ON/OFF of the bandwidth display of the bandwidth test.
Data type	Boolean type (Boolean)
Range	Select from the following. <ul style="list-style-type: none"> •True or -1 Turns ON the bandwidth display. •False or 0 Turns OFF the bandwidth display.
Preset value	False or 0

For information on the variable (*Ch*), see Table 7-6, “Variable (Ch),” on page 209.

Examples

```
Dim BLimVal As Boolean
SCPI.CALCulate(1).PARAmeter(1).SElectSCPI.CALCulate(1).SElected.BLI
Mit.DISPlay.VALue = True
BLimVal = SCPI.CALCulate(1).SElected.BLIMit.DISPlay.VALue
```

Related objects

SCPI.CALCulate(*Ch*).PARAmeter(*Tr*).SElect on page 259

SCPI.CALCulate(*Ch*).SElected.BLIMit.STATe on page 268

SCPI.CALCulate(*Ch*).SElected.BLIMit.DISPlay.MARKer on page 262

Equivalent key **[Analysis] - Bandwidth Limit - BW Display**

SCPI.CALCulate(*Ch*).SElected.BLIMit.FAIL

Object type	Property
Syntax	<i>Status</i> = SCPI.CALCulate(<i>Ch</i>).SElected.BLIMit.FAIL
Description	For the active trace of channel 1 to channel 16 (specified with the SCPI.CALCulate(<i>Ch</i>).PARAMeter(<i>Tr</i>).SElect command), reads out the bandwidth limit test result. (Read only)
Variable	

	<i>Status</i>
Description	The bandwidth limit test result
Data type	Boolean type (Boolean)
Range	Select from the following. <ul style="list-style-type: none"> •True or -1 Turns ON the bandwidth limit test result is FAIL. •False or 0 Turns OFF the bandwidth limit test result is PASS.
Note	When the bandwidth limit test if set to OFF, False or 0 is always read out.

For information on the variable (*Ch*), see Table 7-6, “Variable (Ch),” on page 209.

Examples	<pre>Dim Result As Boolean SCPI.CALCulate(1).PARAMeter(1).SElect SCPI.CALCulate(1).SElected.BLIMit.STATe = True Result = SCPI.CALCulate(1).SElected.BLIMit.FAIL</pre>
Related objects	<p>SCPI.CALCulate(<i>Ch</i>).PARAMeter(<i>Tr</i>).SElect on page 259</p> <p>SCPI.CALCulate(<i>Ch</i>).SElected.BLIMit.STATe on page 268</p>
Equivalent key	No equivalent key is available on the front panel.

SCPI.CALCulate(*Ch*).SElected.BLIMit.MAXimum

Object type Property

Syntax `SCPI.CALCulate(Ch).SElected.BLIMit.MAXimum = Value`
Value = `SCPI.CALCulate(Ch).SElected.BLIMit.MAXimum`

Description For channel 1 to channel 16 (specified with the `SCPI.CALCulate(Ch).PARAmeter(Tr).SElect` command), sets the upper limit value of the bandwidth test.

Variable

	<i>Value</i>
Description	Maximum bandwidth
Data type	Double precision floating point type (Double)
Range	0 to 1E12
Preset value	0
Unit	Hz (hertz), dBm or second

For information on the variable (*Ch*), see Table 7-6, “Variable (Ch),” on page 209.

Examples

```
Dim BLimMax As Double
SCPI.CALCulate(1).SElected.BLIMit.MAXimum = 1E9
BLimMax = SCPI.CALCulate(1).SElected.BLIMit.MAXimum
```

Related objects

`SCPI.CALCulate(Ch).PARAmeter(Tr).SElect` on page 259
`SCPI.CALCulate(Ch).SElected.BLIMit.STATe` on page 268
`SCPI.CALCulate(Ch).SElected.BLIMit.MINimum` on page 266

Equivalent key

[Analysis] - Bandwidth Limit - Max Bandwidth

SCPI.CALCulate(*Ch*).SElected.BLIMit.MINimum

Object type Property

Syntax SCPI.CALCulate(*Ch*).SElected.BLIMit.MINimum = *Value*
Value = SCPI.CALCulate(*Ch*).SElected.BLIMit.MINimum

Description For channel 1 to channel 16 (specified with the SCPI.CALCulate(Ch).PARAMeter(Tr).SElect command), sets the lower limit value of the bandwidth test.

Variable

	<i>Value</i>
Description	Minimum bandwidth
Data type	Double precision floating point type (Double)
Range	0 to 1E12
Preset value	0
Unit	Hz (hertz), dBm or second

For information on the variable (*Ch*), see Table 7-6, “Variable (Ch),” on page 209.

Examples

```
Dim BLimMin As Double
SCPI.CALCulate(1).SElected.BLIMit.MINimum = 1E6
BLimMin = SCPI.CALCulate(1).SElected.BLIMit.MINimum
```

Related objects SCPI.CALCulate(Ch).PARAMeter(Tr).SElect on page 259
SCPI.CALCulate(Ch).SElected.BLIMit.STATe on page 268
SCPI.CALCulate(Ch).SElected.BLIMit.MAXimum on page 265

Equivalent key **[Analysis] - Bandwidth Limit - Min Bandwidth**

SCPI.CALCulate(*Ch*).SElected.BLIMit.REPort.DATA

- Object type** Property
- Syntax** `Data = SCPI.CALCulate(Ch).SElected.BLIMit.REPort.DATA`
- Description** For the active trace of channel 1 to channel 16 (specified with the SCPI.CALCulate(*Ch*).PARAmeter(*Tr*).SElect command), reads out the bandwidth value of the bandwidth test.

Variable

	<i>Data</i>
Description	The bandwidth value of the bandwidth
Data type	Double precision floating point type (Double)

For information on the variable (*Ch*), see Table 7-6, “Variable (*Ch*),” on page 209.

- Examples**
- ```
Dim BWData As Double
SCPI.CALCulate(1).PARAmeter(1).SElect
BWData = SCPI.CALCulate(1).SElected.BLIMit.REPort.DATA
```
- Related objects**
- SCPI.CALCulate(*Ch*).PARAmeter(*Tr*).SElect on page 259
  - SCPI.CALCulate(*Ch*).SElected.BLIMit.STAtE on page 268
- Equivalent key** No equivalent key is available on the front panel.

## SCPI.CALCulate(*Ch*).SElected.BLIMit.STATe

**Object type** Property

**Syntax** SCPI.CALCulate(*Ch*).SElected.BLIMit.STATe = *Status*  
*Status* = SCPI.CALCulate(*Ch*).SElected.BLIMit.STATe

**Description** For the active trace of channel 1 to channel 16 (specified with the SCPI.CALCulate(*Ch*).PARAMeter(*Tr*).SElect command), turns ON/OFF the bandwidth test function.

**Variable**

|              |                                                                                                                                                                                                                                         |
|--------------|-----------------------------------------------------------------------------------------------------------------------------------------------------------------------------------------------------------------------------------------|
|              | <i>Status</i>                                                                                                                                                                                                                           |
| Description  | ON/OFF the bandwidth test function.                                                                                                                                                                                                     |
| Data type    | Boolean type (Boolean)                                                                                                                                                                                                                  |
| Range        | Select from the following.<br><ul style="list-style-type: none"> <li>•True or -1                      Turns ON the bandwidth test function.</li> <li>•False or 0                      Turns OFF the bandwidth test function.</li> </ul> |
| Preset value | False or 0                                                                                                                                                                                                                              |

For information on the variable (*Ch*), see Table 7-6, “Variable (Ch),” on page 209.

**Examples**

```
Dim BLimTest As Boolean
SCPI.CALCulate(1).PARAMeter(1).SElect
SCPI.CALCulate(1).SElected.BLIMit.STATe = True
BLimTest = SCPI.CALCulate(1).SElected.BLIMit.STATe
```

**Related objects**

- SCPI.CALCulate(*Ch*).PARAMeter(*Tr*).SElect on page 259
- SCPI.CALCulate(*Ch*).SElected.BLIMit.DB on page 261
- SCPI.CALCulate(*Ch*).SElected.BLIMit.DISPlay.MARKer on page 262
- SCPI.CALCulate(*Ch*).SElected.BLIMit.DISPlay.VALue on page 263
- SCPI.CALCulate(*Ch*).SElected.BLIMit.FAIL on page 264
- SCPI.CALCulate(*Ch*).SElected.BLIMit.MAXimum on page 265
- SCPI.CALCulate(*Ch*).SElected.BLIMit.MINimum on page 266
- SCPI.CALCulate(*Ch*).SElected.BLIMit.REPort.DATA on page 267

**Equivalent key** **[Analysis] - Bandwidth Limit - BW Test**



## SCPI.CALCulate(*Ch*).SElected.CONVersion.FUNCTION

**Object type** Property

**Syntax** SCPI.CALCulate(*Ch*).SElected.CONVersion.FUNCTION = *Param*  
*Param* = SCPI.CALCulate(*Ch*).SElected.CONVersion.FUNCTION

**Description** For the active trace of channels 1 to 16 (*Ch*), select the parameter after conversion using the parameter conversion function.

**Variable**

|              | <i>Param</i>                                                                                                                                                                                                                                                                                                                                                                                                                                                                                                                                                                                                                                                                                                                                   |
|--------------|------------------------------------------------------------------------------------------------------------------------------------------------------------------------------------------------------------------------------------------------------------------------------------------------------------------------------------------------------------------------------------------------------------------------------------------------------------------------------------------------------------------------------------------------------------------------------------------------------------------------------------------------------------------------------------------------------------------------------------------------|
| Description  | The parameter after conversion                                                                                                                                                                                                                                                                                                                                                                                                                                                                                                                                                                                                                                                                                                                 |
| Data type    | Character string type (String)                                                                                                                                                                                                                                                                                                                                                                                                                                                                                                                                                                                                                                                                                                                 |
| Range        | Select from the following. <ul style="list-style-type: none"> <li>•"ZREFlection" Specifies the equivalent impedance in reflection measurement.</li> <li>•"ZTRansmit" Specifies the equivalent impedance(series) in transmission measurement.</li> <li>•"YREFlection" Specifies the equivalent admittance in reflection measurement.</li> <li>•"YTRansmit" Specifies the equivalent admittance(series) in transmission measurement.</li> <li>•"INVersion" Specifies the inverse S-parameter.</li> <li>•"ZTSHunt" Specifies the equivalent impedance(shunt) in transmission measurement.</li> <li>•"YTSHunt" Specifies the equivalent admittance(shunt) in transmission measurement.</li> <li>•"CONJugation" Specifies the conjugate.</li> </ul> |
| Preset value | "ZREFlection"                                                                                                                                                                                                                                                                                                                                                                                                                                                                                                                                                                                                                                                                                                                                  |

For information on the variable (*Ch*), see Table 7-6, "Variable (Ch)," on page 209.

**Examples**

```
Dim Func As String
SCPI.CALCulate(1).PARAMeter(1).SElect
SCPI.CALCulate(1).SElected.CONVersion.FUNCTION = "ztr"
Func = SCPI.CALCulate(1).SElected.CONVersion.FUNCTION
```

**Related objects** SCPI.CALCulate(Ch).SElected.CONVersion.STATe on page 270  
SCPI.CALCulate(Ch).PARAMeter(Tr).SElect on page 259  
SCPI.SENSE(Ch).CORRection.EXTension.AUTO.DCOFFset on page 549

**Equivalent key** **[Analysis] - Conversion - Z:Reflection|Z:Transmission|Y:Reflection|Y:Transmission|1/S|Z:Trans-Shunt|Y:Trans-Shunt|Conjugation**

## SCPI.CALCulate(*Ch*).SElected.CONVersion.STATe

|             |                                                                                                                                                |
|-------------|------------------------------------------------------------------------------------------------------------------------------------------------|
| Object type | Property                                                                                                                                       |
| Syntax      | SCPI.CALCulate( <i>Ch</i> ).SElected.CONVersion.STATe = <i>Status</i><br><i>Status</i> = SCPI.CALCulate( <i>Ch</i> ).SElected.CONVersion.STATe |
| Description | For the active trace of channels 1 to 16 ( <i>Ch</i> ), turns ON/OFF the parameter conversion function.                                        |
| Variable    |                                                                                                                                                |

|              |                                                                                                                                                                                                                                                     |
|--------------|-----------------------------------------------------------------------------------------------------------------------------------------------------------------------------------------------------------------------------------------------------|
|              | <i>Status</i>                                                                                                                                                                                                                                       |
| Description  | ON/OFF of the parameter conversion function                                                                                                                                                                                                         |
| Data type    | Boolean type (Boolean)                                                                                                                                                                                                                              |
| Range        | Select from the following.<br><ul style="list-style-type: none"> <li>•True or -1                      Turns ON the parameter conversion function.</li> <li>•False or 0                      Turns OFF the parameter conversion function.</li> </ul> |
| Preset value | False or 0                                                                                                                                                                                                                                          |

For information on the variable (*Ch*), see Table 7-6, “Variable (Ch),” on page 209.

|                 |                                                                                                                                                                            |
|-----------------|----------------------------------------------------------------------------------------------------------------------------------------------------------------------------|
| Examples        | <pre>Dim Conv As Boolean SCPI.CALCulate(1).PARAMeter(1).SElect SCPI.CALCulate(1).SElected.CONVersion.STATe = True Conv = SCPI.CALCulate(1).SElected.CONVersion.STATe</pre> |
| Related objects | SCPI.CALCulate( <i>Ch</i> ).SElected.CONVersion.FUNcTION on page 269<br>SCPI.CALCulate( <i>Ch</i> ).PARAMeter( <i>Tr</i> ).SElect on page 259                              |
| Equivalent key  | <b>[Analysis] - Conversion - Conversion</b>                                                                                                                                |

## **SCPI.CALCulate(*Ch*).SElected.CORRection.EDElay. MEDium**

|             |                                                                                                                                                              |
|-------------|--------------------------------------------------------------------------------------------------------------------------------------------------------------|
| Object type | Property                                                                                                                                                     |
| Syntax      | SCPI.CALCulate( <i>Ch</i> ).SElected.CORRection.EDElay.MEDium = <i>Param</i><br><i>Param</i> = SCPI.CALCulate( <i>Ch</i> ).SElected.CORRection.EDElay.MEDium |
| Description | For calculating the electrical delay time of Channel 1 to 16 ( <i>Ch</i> ), select the media type.                                                           |
| Variable    |                                                                                                                                                              |

|              | <i>Param</i>                                                                                                                                                                                                     |
|--------------|------------------------------------------------------------------------------------------------------------------------------------------------------------------------------------------------------------------|
| Description  | Select the media type for calculating the electrical delay time.                                                                                                                                                 |
| Data type    | Character string type (String)                                                                                                                                                                                   |
| Range        | Select from the following.<br><ul style="list-style-type: none"> <li>•"COAXial"                 Selects coaxial as a media type.</li> <li>•"WAVeguide"             Selects waveguide as a media type.</li> </ul> |
| Preset value | "COAXial"                                                                                                                                                                                                        |

For information on the variable (*Ch*), see Table 7-6, "Variable (Ch)," on page 209.

|                 |                                                                                                                                                                                               |
|-----------------|-----------------------------------------------------------------------------------------------------------------------------------------------------------------------------------------------|
| Examples        | Dim EdelMed As String<br>SCPI.CALCulate(1).SElected.CORRection.EDElay.MEDium = "WAVeguide"<br>EdelMed = SCPI.CALCulate(1).SElected.CORRection.EDElay.MEDium                                   |
| Related objects | SCPI.CALCulate(Ch).PARAmeter(Tr).SElect on page 259<br>SCPI.CALCulate(Ch).SElected.CORRection.EDElay. TIME on page 272<br>SCPI.CALCulate(Ch).SElected.CORRection.EDElay. WGCutoff on page 273 |
| Equivalent key  | <b>[Scale] - Electrical Delay - Media</b>                                                                                                                                                     |

**SCPI.CALCulate(Ch).SElected.CORRection.EDElay.TIME**

|             |                                                                                                                                        |
|-------------|----------------------------------------------------------------------------------------------------------------------------------------|
| Object type | Property                                                                                                                               |
| Syntax      | SCPI.CALCulate(Ch).SElected.CORRection.EDElay.TIME = <i>Value</i><br><i>Value</i> = SCPI.CALCulate(Ch).SElected.CORRection.EDElay.TIME |
| Description | Sets the electrical delay time of the active trace of channels 1 to 16 ( <i>Ch</i> ).                                                  |
| Variable    |                                                                                                                                        |

|              | <i>Value</i>                                                                                                                                                                                                 |
|--------------|--------------------------------------------------------------------------------------------------------------------------------------------------------------------------------------------------------------|
| Description  | Electrical delay time                                                                                                                                                                                        |
| Data type    | Double precision floating point type (Double)                                                                                                                                                                |
| Range        | -10 to 10                                                                                                                                                                                                    |
| Preset value | 0                                                                                                                                                                                                            |
| Unit         | s (second)                                                                                                                                                                                                   |
| Note         | If the specified variable is out of the allowable setup range, the minimum value (if the lower limit of the range is not reached) or the maximum value (if the upper limit of the range is exceeded) is set. |

For information on the variable (*Ch*), see Table 7-6, “Variable (Ch),” on page 209.

**Examples**

```
Dim Edel As Double
SCPI.CALCulate(1).PARAMeter(1).SElect
SCPI.CALCulate(1).SElected.CORRection.EDElay.TIME = 0.2
Edel = SCPI.CALCulate(1).SElected.CORRection.EDElay.TIME
```

**Related objects**

SCPI.CALCulate(Ch).PARAMeter(Tr).SElect on page 259

SCPI.CALCulate(Ch).SElected.CORRection.EDElay.MEDium on page 271

SCPI.CALCulate(Ch).SElected.CORRection.EDElay.WGCutoff on page 273

**Equivalent key**     **[Scale] - Electrical Delay**

## SCPI.CALCulate(*Ch*).SElected.CORRection.EDElay.WGCutoff

Object type      Property

Syntax            SCPI.CALCulate(*Ch*).SElected.CORRection.EDElay.WGCutoff = *Value*  
*Value* = SCPI.CALCulate(*Ch*).SElected.CORRection.EDElay.WGCutoff

Description      Sets the electrical delay time of the active trace of channels 1 to 16 (*Ch*).

Variable

|              | <i>Value</i>                                                                                                                                                                                                 |
|--------------|--------------------------------------------------------------------------------------------------------------------------------------------------------------------------------------------------------------|
| Description  | Cut-off frequency                                                                                                                                                                                            |
| Data type    | Double precision floating point type (Double)                                                                                                                                                                |
| Range        | 3E5 to 3.0E9 (for E5070B)<br>3E5 to 8.5E9 (for E5071B)                                                                                                                                                       |
| Preset value | 3E5                                                                                                                                                                                                          |
| Unit         | s (second)                                                                                                                                                                                                   |
| Note         | If the specified variable is out of the allowable setup range, the minimum value (if the lower limit of the range is not reached) or the maximum value (if the upper limit of the range is exceeded) is set. |

For information on the variable (*Ch*), see Table 7-6, “Variable (Ch),” on page 209.

Examples            Dim EdelWgc As Double  
SCPI.CALCulate(1).SElected.CORRection.EDElay.WGCutoff = 1E9  
Edel = SCPI.CALCulate(1).SElected.CORRection.EDElay.WGCutoff

Related objects    SCPI.CALCulate(Ch).PARAmeter(Tr).SElect on page 259  
SCPI.CALCulate(Ch).SElected.CORRection.EDElay. MEDIUM on page 271  
SCPI.CALCulate(Ch).SElected.CORRection.EDElay. TIME on page 272

Equivalent key      **[Scale] - Electrical Delay - Cutoff Frequency**

**SCPI.CALCulate(*Ch*).SElected.CORRection.OFFSet.PHASE**

|             |                                                                                                                                                            |
|-------------|------------------------------------------------------------------------------------------------------------------------------------------------------------|
| Object type | Property                                                                                                                                                   |
| Syntax      | SCPI.CALCulate( <i>Ch</i> ).SElected.CORRection.OFFSet.PHASE = <i>Value</i><br><i>Value</i> = SCPI.CALCulate( <i>Ch</i> ).SElected.CORRection.OFFSet.PHASE |
| Description | Sets the phase offset of the active trace of channels 1 to 16 ( <i>Ch</i> ).                                                                               |
| Variable    |                                                                                                                                                            |

|              | <i>Value</i>                                                                                                                                                                                                 |
|--------------|--------------------------------------------------------------------------------------------------------------------------------------------------------------------------------------------------------------|
| Description  | Phase offset                                                                                                                                                                                                 |
| Data type    | Double precision floating point type (Double)                                                                                                                                                                |
| Range        | -360 to 360                                                                                                                                                                                                  |
| Preset value | 0                                                                                                                                                                                                            |
| Unit         | ° (degree)                                                                                                                                                                                                   |
| Note         | If the specified variable is out of the allowable setup range, the minimum value (if the lower limit of the range is not reached) or the maximum value (if the upper limit of the range is exceeded) is set. |

For information on the variable (*Ch*), see Table 7-6, “Variable (Ch),” on page 209.

|                 |                                                                                                                                                                                          |
|-----------------|------------------------------------------------------------------------------------------------------------------------------------------------------------------------------------------|
| Examples        | Dim Offset As Double<br>SCPI.CALCulate(2).PARAMeter(1).SElect<br>SCPI.CALCulate(2).SElected.CORRection.OFFSet.PHASE = 2.5<br>Offset = SCPI.CALCulate(2).SElected.CORRection.OFFSet.PHASE |
| Related objects | SCPI.CALCulate(Ch).PARAMeter(Tr).SElect on page 259                                                                                                                                      |
| Equivalent key  | <b>[Scale] - Phase Offset</b>                                                                                                                                                            |

## SCPI.CALCulate(Ch).SElected.DATA.FDATA

Object type Property

Syntax `SCPI.CALCulate(Ch).SElected.DATA.FDATA = Data`  
`Data = SCPI.CALCulate(Ch).SElected.DATA.FDATA`

Description For the active trace of channels 1 to 16 (*Ch*), sets/reads out the formatted data array. The array data element varies in the data format (specified with the `SCPI.CALCulate(Ch).SElected.FORMAT` object). For more information on the formatted data array, see Section “Internal Data Processing” in the *E5070B/E5071B Programmer’s Guide*.

**NOTE** If valid data is not calculated because of the invalid measurement, “1.#QNB” is read out.

Variable

|             | <i>Data</i>                                                                                                                                                                                                                                                                                                                                                                                                                                                                           |
|-------------|---------------------------------------------------------------------------------------------------------------------------------------------------------------------------------------------------------------------------------------------------------------------------------------------------------------------------------------------------------------------------------------------------------------------------------------------------------------------------------------|
| Description | <p>Indicates the array data (formatted data array) of NOP (number of measurement points)×2. Where n is an integer between 1 and NOP.</p> <ul style="list-style-type: none"> <li>• <i>Data(n×2-2)</i> Data (primary value) at the n-th measurement point.</li> <li>• <i>Data(n×2-1)</i> Data (secondary value) at the n-th measurement point. Always 0 when the data format is not the Smith chart format or the polar format.</li> </ul> <p>The index of the array starts from 0.</p> |
| Data type   | Variant type (Variant)                                                                                                                                                                                                                                                                                                                                                                                                                                                                |
| Note        | If there is no array data of NOP (number of measurement point)×2 when setting a formatted data array, an error occurs when executed and the object is ignored.                                                                                                                                                                                                                                                                                                                        |

For information on the variable (*Ch*), see Table 7-6, “Variable (Ch),” on page 209.

Examples

```
Dim FmtData As Variant
SCPI.SENSE(1).SWEp.POINTs = 201
SCPI.CALCulate(1).PARAMeter(1).SElect
FmtData = SCPI.CALCulate(1).SElected.DATA.FDATA
SCPI.CALCulate(1).PARAMeter(2).SElect
SCPI.CALCulate(1).SElected.DATA.FDATA = FmtData
```

Related objects

- SCPI.CALCulate(Ch).PARAMeter(Tr).SElect on page 259
- SCPI.SENSE(Ch).SWEp.POINTs on page 635
- SCPI.CALCulate(Ch).SElected.FORMAT on page 289
- SCPI.CALCulate(Ch).SElected.DATA.FMEMORY on page 276
- SCPI.CALCulate(Ch).SElected.DATA.SDATA on page 277

Equivalent key No equivalent key is available on the front panel.

## SCPI.CALCulate(*Ch*).SElected.DATA.FMEMory

Object type Property

Syntax SCPI.CALCulate(*Ch*).SElected.DATA.FMEMory = *Data*  
*Data* = SCPI.CALCulate(*Ch*).SElected.DATA.FMEMory

Description For the active trace of channels 1 to 16 (*Ch*), sets/reads out the formatted memory array. The array data element varies in the data format (specified with the SCPI.CALCulate(*Ch*).SElected.FORMAT object). For more information on the formatted memory array, see Section “Internal Data Processing” in the *E5070B/E5071B Programmer’s Guide*.

**NOTE** If valid data is not calculated because of the invalid measurement, “1.#QNB” is read out.

Variable

|             | <i>Data</i>                                                                                                                                                                                                                                                                                                                                                                                                                                                                                           |
|-------------|-------------------------------------------------------------------------------------------------------------------------------------------------------------------------------------------------------------------------------------------------------------------------------------------------------------------------------------------------------------------------------------------------------------------------------------------------------------------------------------------------------|
| Description | <p>Indicates the array data (formatted memory array) of NOP (number of measurement points)×2. Where n is an integer between 1 and NOP.</p> <ul style="list-style-type: none"> <li>• <i>Data</i>(<i>n</i>×2-2) Data (primary value) at the n-th measurement point.</li> <li>• <i>Data</i>(<i>n</i>×2-1) Data (secondary value) at the n-th measurement point. Always 0 when the data format is not the Smith chart format or the polar format.</li> </ul> <p>The index of the array starts from 0.</p> |
| Data type   | Variant type (Variant)                                                                                                                                                                                                                                                                                                                                                                                                                                                                                |
| Note        | If there is no array data of NOP (number of measurement point)×2 when setting a formatted memory array, an error occurs when executed and the object is ignored.                                                                                                                                                                                                                                                                                                                                      |

For information on the variable (*Ch*), see Table 7-6, “Variable (Ch),” on page 209.

Examples

```
Dim FmtMem As Variant
SCPI.SENSE(1).SWEp.POINTs = 201
SCPI.CALCulate(1).PARAMeter(1).SElect
FmtMem = SCPI.CALCulate(1).SElected.DATA.FMEMory
SCPI.CALCulate(1).PARAMeter(2).SElect
SCPI.CALCulate(1).SElected.DATA.FMEMory = FmtMem
```

Related objects

SCPI.CALCulate(*Ch*).PARAMeter(*Tr*).SElect on page 259

SCPI.SENSE(*Ch*).SWEp.POINTs on page 635

SCPI.CALCulate(*Ch*).SElected.FORMAT on page 289

SCPI.CALCulate(*Ch*).SElected.DATA.FDATA on page 275

SCPI.CALCulate(*Ch*).SElected.DATA.SMEMory on page 278

Equivalent key No equivalent key is available on the front panel.



## SCPI.CALCulate(Ch).SElected.DATA.SDATA

|             |                                                                                                                                                                                                                                            |
|-------------|--------------------------------------------------------------------------------------------------------------------------------------------------------------------------------------------------------------------------------------------|
| Object type | Property                                                                                                                                                                                                                                   |
| Syntax      | <p>SCPI.CALCulate(Ch).SElected.DATA.SDATA = <i>Data</i></p> <p><i>Data</i> = SCPI.CALCulate(Ch).SElected.DATA.SDATA</p>                                                                                                                    |
| Description | For the active trace of channels 1 to 16 ( <i>Ch</i> ), sets/reads out the corrected data array. For more information on the corrected data array, see Section “Internal Data Processing” in the <i>E5070B/E5071B Programmer’s Guide</i> . |

**NOTE** If valid data is not calculated because of the invalid measurement, “1.#QNB” is read out.

### Variable

|             | <i>Data</i>                                                                                                                                                                                                                                                                                                                                                                                                                                                                     |
|-------------|---------------------------------------------------------------------------------------------------------------------------------------------------------------------------------------------------------------------------------------------------------------------------------------------------------------------------------------------------------------------------------------------------------------------------------------------------------------------------------|
| Description | <p>Indicates the array data (corrected data array) of NOP (number of measurement points)×2. Where n is an integer between 1 and NOP.</p> <ul style="list-style-type: none"> <li>• <i>Data</i>(<i>n</i>×2-2)            Real part of the data (complex number) at the n-th measurement point.</li> <li>• <i>Data</i>(<i>n</i>×2-1)            Imaginary part of the data (complex number) at the n-th measurement point.</li> </ul> <p>The index of the array starts from 0.</p> |
| Data type   | Variant type (Variant)                                                                                                                                                                                                                                                                                                                                                                                                                                                          |
| Note        | If there is no array data of NOP (number of measurement point)×2 when setting a corrected data array, an error occurs when executed and the object is ignored.                                                                                                                                                                                                                                                                                                                  |

For information on the variable (*Ch*), see Table 7-6, “Variable (Ch),” on page 209.

**Examples**

```
Dim CorData As Variant
SCPI.SENSE(1).SWEep.POINTs = 201
CorData = SCPI.CALCulate(1).SElected.DATA.SDATA
SCPI.SENSE(2).SWEep.POINTs = 201
SCPI.CALCulate(2).SElected.DATA.SDATA = CorData
```

**Related objects**

- SCPI.CALCulate(Ch).PARAmeter(Tr).SElect on page 259
- SCPI.SENSE(Ch).SWEep.POINTs on page 635
- SCPI.CALCulate(Ch).SElected.DATA.SMEMory on page 278
- SCPI.CALCulate(Ch).SElected.DATA.FDATA on page 275

**Equivalent key** No equivalent key is available on the front panel.

## SCPI.CALCulate(*Ch*).SElected.DATA.SMEMory

|             |                                                                                                                                                                                                                                                |
|-------------|------------------------------------------------------------------------------------------------------------------------------------------------------------------------------------------------------------------------------------------------|
| Object type | Property                                                                                                                                                                                                                                       |
| Syntax      | SCPI.CALCulate( <i>Ch</i> ).SElected.DATA.SMEMory = <i>Data</i><br><i>Data</i> = SCPI.CALCulate( <i>Ch</i> ).SElected.DATA.SMEMory                                                                                                             |
| Description | For the active trace of channels 1 to 16 ( <i>Ch</i> ), sets/reads out the corrected memory array. For more information on the corrected memory array, see Section “Internal Data Processing” in the <i>E5070B/E5071B Programmer’s Guide</i> . |

---

**NOTE** If valid data is not calculated because of the invalid measurement, “1.#QNB” is read out.

### Variable

|             | <i>Data</i>                                                                                                                                                                                                                                                                                                                                                                                                                                          |
|-------------|------------------------------------------------------------------------------------------------------------------------------------------------------------------------------------------------------------------------------------------------------------------------------------------------------------------------------------------------------------------------------------------------------------------------------------------------------|
| Description | Indicates the array data (corrected memory array) of NOP (number of measurement points)×2. Where n is an integer between 1 and NOP. <ul style="list-style-type: none"> <li>• <i>Data</i>(<i>n</i>×2-2) Real part of the data (complex number) at the n-th measurement point.</li> <li>• <i>Data</i>(<i>n</i>×2-1) Imaginary part of the data (complex number) at the n-th measurement point.</li> </ul> <p>The index of the array starts from 0.</p> |
| Data type   | Variant type (Variant)                                                                                                                                                                                                                                                                                                                                                                                                                               |
| Note        | If there is no array data of NOP (number of measurement point)×2 when setting a corrected memory array, an error occurs when executed and the object is ignored.                                                                                                                                                                                                                                                                                     |

For information on the variable (*Ch*), see Table 7-6, “Variable (Ch),” on page 209.

**Examples**

```
Dim CorMem As Variant
SCPI.SENSE(1).SWEp.POINTs = 201
CorMem = SCPI.CALCulate(1).SElected.DATA.SMEMory
SCPI.SENSE(2).SWEp.POINTs = 201
SCPI.CALCulate(1).SElected.DATA.SMEMory = CorMem
```

**Related objects**

- SCPI.CALCulate(Ch).PARAmeter(Tr).SElect on page 259
- SCPI.SENSE(Ch).SWEp.POINTs on page 635
- SCPI.CALCulate(Ch).SElected.DATA.SDATa on page 277
- SCPI.CALCulate(Ch).SElected.DATA.FMEMory on page 276

**Equivalent key** No equivalent key is available on the front panel.

## SCPI.CALCulate(*Ch*).SElected.EQUation.STATe

**Object type** Property

**Syntax** SCPI.CALCulate(*Ch*).SElected.EQUation.STATe = *Status*  
*Status* = SCPI.CALCulate(*Ch*).SElected.EQUation.STATe

**Description** For the active trace of channels 1 to 16 (*Ch*), turns ON/OFF the calculation function of the equation editor.

**Variable**

|              |                                                                                                                                                                                                                                                                                   |
|--------------|-----------------------------------------------------------------------------------------------------------------------------------------------------------------------------------------------------------------------------------------------------------------------------------|
|              | <i>Status</i>                                                                                                                                                                                                                                                                     |
| Description  | ON/OFF of the calculation function of the equation editor.                                                                                                                                                                                                                        |
| Data type    | Boolean type (Boolean)                                                                                                                                                                                                                                                            |
| Range        | Select from the following.<br><ul style="list-style-type: none"> <li>• True or -1                      Turns on the calculation function of the equation editor.</li> <li>• False or 0                      Turns off the calculation function of the equation editor.</li> </ul> |
| Preset value | False or 0                                                                                                                                                                                                                                                                        |

For information on the variable (*Ch*), see Table 7-6, “Variable (Ch),” on page 209.

**Examples**

```
Dim Equation As Boolean
SCPI.CALCulate(1).SElected.EQUation.STATe = True
Equation = SCPI.CALCulate(1).SElected.EQUation.STATe
```

**Related objects** SCPI.CALCulate(Ch).SElected.EQUation.TEXT on page 280  
SCPI.CALCulate(Ch).SElected.EQUation.VALid on page 281

**Equivalent key** **[Display] - Equation**

## SCPI.CALCulate(*Ch*).SElected.EQUation.TEXT

|             |                                                                                                                                                                   |
|-------------|-------------------------------------------------------------------------------------------------------------------------------------------------------------------|
| Object type | Property                                                                                                                                                          |
| Syntax      | SCPI.CALCulate( <i>Ch</i> ).SElected.EQUation.TEXT = <i>Lbl</i><br><i>Lbl</i> = SCPI.CALCulate( <i>Ch</i> ).SElected.EQUation.TEXT                                |
| Description | For the active trace of channels 1 to 16 ( <i>Ch</i> ), specifies the equation and equation label used in the equation editor. The equation label can be omitted. |
| Variable    |                                                                                                                                                                   |

|             |                                                     |
|-------------|-----------------------------------------------------|
|             | <i>Lbl</i>                                          |
| Description | Equation and equation label in the equation editor. |
| Data type   | Character string type (String)                      |
| Range       | 254 characters or less                              |
| Note        | " "                                                 |

For information on the variable (*Ch*), see Table 7-6, "Variable (Ch)," on page 209.

|                 |                                                                                                                                                 |
|-----------------|-------------------------------------------------------------------------------------------------------------------------------------------------|
| Examples        | <pre>Dim EquLbl As String SCPI.CALCulate(1).SElected.EQUation.TEXT = "MyTr=S21/(1/S11)" EquLbl = SCPI.CALCulate(1).SElected.EQUation.TEXT</pre> |
| Related objects | SCPI.CALCulate(Ch).SElected.EQUation.STATe on page 279<br>SCPI.CALCulate(Ch).SElected.EQUation.VALid on page 281                                |
| Equivalent key  | <b>[Display]</b> - <b>Equation Editor...</b>                                                                                                    |

## SCPI.CALCulate(*Ch*).SElected.EQUation.VALid

|             |                                                                                                                                                                  |
|-------------|------------------------------------------------------------------------------------------------------------------------------------------------------------------|
| Object type | Property                                                                                                                                                         |
| Syntax      | <i>Status</i> = SCPI.CALCulate( <i>Ch</i> ).SElected.EQUation.VALid                                                                                              |
| Description | For the active trace of channels 1 to 16 ( <i>Ch</i> ), reads out whether data specified by the equation in the equation editor is valid or invalid. (Read only) |

**NOTE** This command cannot read out errors of the equation and equation label.

### Variable

|              |                                                                                                                                                                                                                                          |
|--------------|------------------------------------------------------------------------------------------------------------------------------------------------------------------------------------------------------------------------------------------|
|              | <i>Status</i>                                                                                                                                                                                                                            |
| Description  | Valid/Invalid of data specified by the equation                                                                                                                                                                                          |
| Data type    | Boolean type (Boolean)                                                                                                                                                                                                                   |
| Range        | Select from the following.<br><ul style="list-style-type: none"> <li>• True or -1                      Specified measurement data is valid.</li> <li>• False or 0                      Specified measurement data is invalid.</li> </ul> |
| Preset value | False or 0                                                                                                                                                                                                                               |

For information on the variable (*Ch*), see Table 7-6, “Variable (Ch),” on page 209.

|                 |                                                                                                                 |
|-----------------|-----------------------------------------------------------------------------------------------------------------|
| Examples        | <pre>Dim EquVal As Boolean EquVal = SCPI.CALCulate(1).SElected.EQUation.VALid</pre>                             |
| Related objects | SCPI.CALCulate(Ch).SElected.EQUation.STATe on page 279<br>SCPI.CALCulate(Ch).SElected.EQUation.TEXT on page 280 |
| Equivalent key  | No equivalent key is available on the front panel.                                                              |

**SCPI.CALCulate(Ch).SElected.FILTer.GATE.TIME. CENTER**

Object type Property

Syntax SCPI.CALCulate(Ch).SElected.FILTer.GATE.TIME.CENTER = *Value*  
*Value* = SCPI.CALCulate(Ch).SElected.FILTer.GATE.TIME.CENTER

Description For the active trace of channels 1 to 16 (*Ch*), sets the center value of the gate used for the gating function of the time domain function.

Variable

|              | <i>Value</i>                                                                                                                                                                                                 |
|--------------|--------------------------------------------------------------------------------------------------------------------------------------------------------------------------------------------------------------|
| Description  | The center value of the gate                                                                                                                                                                                 |
| Data type    | Double precision floating point type (Double)                                                                                                                                                                |
| Range        | Varies depending on the frequency span and the number of points.                                                                                                                                             |
| Preset value | 0                                                                                                                                                                                                            |
| Unit         | s (second)                                                                                                                                                                                                   |
| Note         | If the specified variable is out of the allowable setup range, the minimum value (if the lower limit of the range is not reached) or the maximum value (if the upper limit of the range is exceeded) is set. |

For information on the variable (*Ch*), see Table 7-6, “Variable (Ch),” on page 209.

Examples

```
Dim FilCent As Double
SCPI.CALCulate(1).PARAMeter(1).SElect
SCPI.CALCulate(1).SElected.FILTer.GATE.TIME.CENTER = 1E-8
FilCent = SCPI.CALCulate(1).SElected.FILTer.GATE.TIME.CENTER
```

Related objects

SCPI.CALCulate(Ch).SElected.FILTer.GATE.TIME. SPAN on page 284  
 SCPI.CALCulate(Ch).SElected.FILTer.GATE.TIME. STATE on page 286  
 SCPI.CALCulate(Ch).PARAMeter(Tr).SElect on page 259

Equivalent key

**[Analysis] - Gating - Center**

## SCPI.CALCulate(*Ch*).SElected.FILTer.GATE.TIME. SHAPe

**Object type** Property

**Syntax** SCPI.CALCulate(*Ch*).SElected.FILTer.GATE.TIME.SHAPe = *Param*  
*Param* = SCPI.CALCulate(*Ch*).SElected.FILTer.GATE.TIME.SHAPe

**Description** For the active trace of channels 1 to 16 (*Ch*), selects the shape of the gate used for the gating function of the time domain function.

**Variable**

|              | <i>Param</i>                                                                                                                                                                                                                                                                                                        |
|--------------|---------------------------------------------------------------------------------------------------------------------------------------------------------------------------------------------------------------------------------------------------------------------------------------------------------------------|
| Description  | The shape of the gate                                                                                                                                                                                                                                                                                               |
| Data type    | Character string type (String)                                                                                                                                                                                                                                                                                      |
| Range        | Select from the following.<br><ul style="list-style-type: none"> <li>•"MAXimum"            Specifies the maximum shape.</li> <li>•"WIDE"                Specifies the wide shape.</li> <li>•"NORMal"             Specifies the normal shape.</li> <li>•"MINimum"            Specifies the minimum shape.</li> </ul> |
| Preset value | "NORMal"                                                                                                                                                                                                                                                                                                            |

For information on the variable (*Ch*), see Table 7-6, "Variable (Ch)," on page 209.

**Examples**

```
Dim FilShape As String
SCPI.CALCulate(1).PARAmeter(1).SElect
SCPI.CALCulate(1).SElected.FILTer.GATE.TIME.SHAPe = "wide"
FilShape = SCPI.CALCulate(1).SElected.FILTer.GATE.TIME.SHAPe
```

**Related objects**

SCPI.CALCulate(Ch).SElected.FILTer.GATE.TIME. TYPE on page 288  
SCPI.CALCulate(Ch).SElected.FILTer.GATE.TIME. STAtE on page 286  
SCPI.CALCulate(Ch).PARAmeter(Tr).SElect on page 259

**Equivalent key** **[Analysis] - Gating - Shape - Maximum|Wide|Normal|Minimum**

**SCPI.CALCulate(Ch).SElected.FILTer.GATE.TIME.SPAN**

Object type Property

Syntax SCPI.CALCulate(Ch).SElected.FILTer.GATE.TIME.SPAN = *Value**Value* = SCPI.CALCulate(Ch).SElected.FILTer.GATE.TIME.SPANDescription For the active trace of channels 1 to 16 (*Ch*), sets the span value of the gate used for the gating function of the time domain function.

Variable

|              | <i>Value</i>                                                                                                                                                                                                 |
|--------------|--------------------------------------------------------------------------------------------------------------------------------------------------------------------------------------------------------------|
| Description  | The span value of the gate                                                                                                                                                                                   |
| Data type    | Double precision floating point type (Double)                                                                                                                                                                |
| Range        | Varies depending on the frequency span and the number of points.                                                                                                                                             |
| Preset value | 2E-8                                                                                                                                                                                                         |
| Unit         | s (second)                                                                                                                                                                                                   |
| Note         | If the specified variable is out of the allowable setup range, the minimum value (if the lower limit of the range is not reached) or the maximum value (if the upper limit of the range is exceeded) is set. |

For information on the variable (*Ch*), see Table 7-6, “Variable (Ch),” on page 209.

Examples

```
Dim FilStar As Double
SCPI.CALCulate(1).PARAMeter(1).SElect
SCPI.CALCulate(1).SElected.FILTer.GATE.TIME.SPAN = 1E-8
FilStar = SCPI.CALCulate(1).SElected.FILTer.GATE.TIME.SPAN
```

Related objects SCPI.CALCulate(Ch).SElected.FILTer.GATE.TIME.CENTer on page 282

SCPI.CALCulate(Ch).SElected.FILTer.GATE.TIME.STATE on page 286

SCPI.CALCulate(Ch).PARAMeter(Tr).SElect on page 259

Equivalent key **[Analysis] - Gating - Span**



## SCPI.CALCulate(*Ch*).SElected.FILTer.GATE.TIME. START

- Object type** Property
- Syntax** SCPI.CALCulate(*Ch*).SElected.FILTer.GATE.TIME.START = *Value*  
*Value* = SCPI.CALCulate(*Ch*).SElected.FILTer.GATE.TIME.START
- Description** For the active trace of channels 1 to 16 (*Ch*), sets the start value of the gate used for the gating function of the time domain function.
- Variable**

|              | <i>Value</i>                                                                                                                                                                                                 |
|--------------|--------------------------------------------------------------------------------------------------------------------------------------------------------------------------------------------------------------|
| Description  | The start value of the gate                                                                                                                                                                                  |
| Data type    | Double precision floating point type (Double)                                                                                                                                                                |
| Range        | Varies depending on the frequency span and the number of points.                                                                                                                                             |
| Preset value | -1E-8                                                                                                                                                                                                        |
| Unit         | s (second)                                                                                                                                                                                                   |
| Note         | If the specified variable is out of the allowable setup range, the minimum value (if the lower limit of the range is not reached) or the maximum value (if the upper limit of the range is exceeded) is set. |

For information on the variable (*Ch*), see Table 7-6, “Variable (Ch),” on page 209.

- Examples**
- ```
Dim FilCent As Double
SCPI.CALCulate(1).PARAMeter(1).SElect
SCPI.CALCulate(1).SElected.FILTer.GATE.TIME.START = 0
FilCent = SCPI.CALCulate(1).SElected.FILTer.GATE.TIME.START
```
- Related objects**
- SCPI.CALCulate(Ch).SElected.FILTer.GATE.TIME. STOP on page 287
 - SCPI.CALCulate(Ch).SElected.FILTer.GATE.TIME. STATE on page 286
 - SCPI.CALCulate(Ch).PARAMeter(Tr).SElect on page 259
- Equivalent key** **[Analysis] - Gating - Start**

SCPI.CALCulate(*Ch*).SElected.FILTer.GATE.TIME. STATE

Object type	Property
Syntax	SCPI.CALCulate(<i>Ch</i>).SElected.FILTer.GATE.TIME.STATE = <i>Status</i> <i>Status</i> = SCPI.CALCulate(<i>Ch</i>).SElected.FILTer.GATE.TIME.STATE
Description	<p>For the active trace of channels 1 to 16 (<i>Ch</i>), turns ON/OFF the gating function of the time domain function.</p> <p>You can turn ON the gating function only when the sweep type is the linear sweep and the number of points is 3 or more. If you execute this object to try to turn ON the gating function when the sweep type is other than the linear sweep or the number of points is less than 3, an error occurs and the object is ignored.</p> <p>When the sweep type is the power sweep, you cannot turn on the gating function. If you execute this object trying to turn on the gating function during the power sweep, an error occurs and the object is ignored.</p>

Variable

	<i>Status</i>
Description	ON/OFF of the gating function
Data type	Boolean type (Boolean)
Range	Select from the following. <ul style="list-style-type: none"> •True or -1 Turns ON the gating function. •False or 0 Turns OFF the gating function.
Preset value	False or 0

For information on the variable (*Ch*), see Table 7-6, “Variable (Ch),” on page 209.

Examples

```
Dim Gating As Boolean
SCPI.CALCulate(1).PARAMeter(1).SElect
SCPI.CALCulate(1).SElected.FILTer.GATE.TIME.STATE = True
Gating = SCPI.CALCulate(1).SElected.FILTer.GATE.TIME.STATE
```

Related objects

SCPI.CALCulate(Ch).PARAmeter(Tr).SElect on page 259
 SCPI.SENSE(Ch).SWEep.TYPE on page 638
 SCPI.SENSE(Ch).SWEep.POINts on page 635

Equivalent key **[Analysis] - Gating - Gating**

SCPI.CALCulate(*Ch*).SElected.FILTer.GATE.TIME. STOP

Object type Property

Syntax SCPI.CALCulate(*Ch*).SElected.FILTer.GATE.TIME.STOP = *Value*
Value = SCPI.CALCulate(*Ch*).SElected.FILTer.GATE.TIME.STOP

Description For the active trace of channels 1 to 16 (*Ch*), sets the stop value of the gate used for the gating function of the time domain function.

Variable

	<i>Value</i>
Description	The stop value of the gate
Data type	Double precision floating point type (Double)
Range	Varies depending on the frequency span and the number of points.
Preset value	1E-8
Unit	s (second)
Note	If the specified variable is out of the allowable setup range, the minimum value (if the lower limit of the range is not reached) or the maximum value (if the upper limit of the range is exceeded) is set.

For information on the variable (*Ch*), see Table 7-6, “Variable (Ch),” on page 209.

Examples Dim FilStop As Double
SCPI.CALCulate(1).PARAMeter(1).SElect
SCPI.CALCulate(1).SElected.FILTer.GATE.TIME.STOP = 2E-8
FilStop = SCPI.CALCulate(1).SElected.FILTer.GATE.TIME.STOP

Related objects SCPI.CALCulate(Ch).SElected.FILTer.GATE.TIME. START on page 285
SCPI.CALCulate(Ch).SElected.FILTer.GATE.TIME. STATE on page 286
SCPI.CALCulate(Ch).PARAMeter(Tr).SElect on page 259

Equivalent key **[Analysis] - Gating - Stop**

SCPI.CALCulate(Ch).SElected.FILTer.GATE.TIME. TYPE

Object type	Property
Syntax	SCPI.CALCulate(Ch).SElected.FILTer.GATE.TIME.TYPE = <i>Param</i> <i>Param</i> = SCPI.CALCulate(Ch).SElected.FILTer.GATE.TIME.TYPE
Description	For the active trace of channels 1 to 16 (<i>Ch</i>), selects the gate type used for the gating function of the time domain function.
Variable	

	<i>Param</i>
Description	The gate type
Data type	Character string type (String)
Range	Select from the following. <ul style="list-style-type: none"> •"BPASs" Specifies the band-pass type. •"NOTCh" Specifies the notch type.
Preset value	"BPASs"

For information on the variable (*Ch*), see Table 7-6, "Variable (Ch)," on page 209.

Examples	<pre>Dim FilType As String SCPI.CALCulate(1).PARAMeter(1).SElect SCPI.CALCulate(1).SElected.FILTer.GATE.TIME.SHAPE = "notc" FilType = SCPI.CALCulate(1).SElected.FILTer.GATE.TIME.SHAPE</pre>
Related objects	<p>SCPI.CALCulate(Ch).SElected.FILTer.GATE.TIME. SHAPE on page 283</p> <p>SCPI.CALCulate(Ch).SElected.FILTer.GATE.TIME. STATE on page 286</p> <p>SCPI.CALCulate(Ch).PARAmeter(Tr).SElect on page 259</p>
Equivalent key	[Analysis] - Gating - Type

SCPI.CALCulate(*Ch*).SElected.FORMAT

Object type	Property
Syntax	SCPI.CALCulate(<i>Ch</i>).SElected.FORMAT = <i>Param</i> <i>Param</i> = SCPI.CALCulate(<i>Ch</i>).SElected.FORMAT
Description	Selects the data format of the active trace of channels 1 to 16 (<i>Ch</i>).
Variable	

	<i>Param</i>
Description	Data format
Data type	Character string type (String)
Range	Select from the following. <ul style="list-style-type: none"> •"MLOGarithmic" Specifies the log magnitude format. •"PHASe" Specifies the phase format. •"GDELay" Specifies the group delay format. •"SLINear" Specifies the Smith chart format (Lin/Phase). •"SLOGarithmic" Specifies the Smith chart format (Log/Phase). •"SCOMplex" Specifies the Smith chart format (Re/Im). •"SMITH" Specifies the Smith chart format (R+jX). •"SADMittance" Specifies the Smith chart format (G+jB). •"PLINear" Specifies the polar format (Lin/Phase). •"PLOGarithmic" Specifies the polar format (Log/Phase). •"POLar" Specifies the polar format (Re/Im). •"MLINear" Specifies the linear magnitude format. •"SWR" Specifies the SWR format. •"REAL" Specifies the real format. •"IMAGinary" Specifies the imaginary format. •"UPHase" Specifies the expanded phase format. •"PPHase" Specifies the positive phase format.
Preset value	"MLOGarithmic"

For information on the variable (*Ch*), see Table 7-6, "Variable (Ch)," on page 209.

Examples	<pre>Dim Fmt As String SCPI.CALCulate(1).PARAMeter(1).SElect SCPI.CALCulate(1).SElected.FORMAT = "smit" Fmt = SCPI.CALCulate(1).SElected.FORMAT</pre>
Related objects	SCPI.CALCulate(Ch).PARAMeter(Tr).SElect on page 259
Equivalent key	<p>[Format] - Log Mag Phase Group Delay Lin Mag SWR Real Imaginary Expand Phase Positive Phase</p> <p>[Format] - Smith - Lin/Phase Log/Phase Real/Imag R+jX G+jB</p> <p>[Format] - Polor - Lin/Phase Log/Phase Real/Imag</p>

SCPI.CALCulate(Ch).SElected.FUNCtion.DATA

Object type	Property
Syntax	<i>Data</i> = SCPI.CALCulate(Ch).SElected.FUNCtion.DATA
Description	For the active trace of channels 1 to 16 (<i>Ch</i>), reads out the analysis result of the SCPI.CALCulate(Ch).SElected.FUNCtion.EXECute object. (Read only)
Variable	

	<i>Data</i>
Description	<p>Indicates the array data (analysis result) of N (number of data pairs)×2. N (number of data pairs) can be read out with the SCPI.CALCulate(Ch).SElected.FUNCtion.POINts object. Where n is an integer between 1 and N.</p> <ul style="list-style-type: none"> • <i>Data(n×2-2)</i> Response value or analysis result of the searched n-th measurement point. • <i>Data(n×2-1)</i> Stimulus value of the searched n-th measurement point. Always 0 for the analysis of the mean value*1, the standard deviation*1, and the difference between the maximum value and the minimum value*1. <p>The index of the array starts from 0.</p>
Data type	Variant type (Variant)

*1. To specify the type of the analysis, use the SCPI.CALCulate(Ch).SElected.FUNCtion.TYPE object.

For information on the variable (*Ch*), see Table 7-6, “Variable (Ch),” on page 209.

Examples

```
Dim AnaData As Variant
SCPI.CALCulate(1).PARAMeter(1).SElect
SCPI.CALCulate(1).SElected.FUNCtion.TYPE = "mean"
SCPI.CALCulate(1).SElected.FUNCtion.EXECute
AnaData = SCPI.CALCulate(1).SElected.FUNCtion.DATA
```

Related objects

- SCPI.CALCulate(Ch).PARAMeter(Tr).SElect on page 259
- SCPI.CALCulate(Ch).SElected.FUNCtion.TYPE on page 301
- SCPI.CALCulate(Ch).SElected.FUNCtion.EXECute on page 295
- SCPI.CALCulate(Ch).SElected.FUNCtion.POINts on page 297

Equivalent key No equivalent key is available on the front panel.

SCPI.CALCulate(Ch).SElected.FUNcTion.DOMain.COUPle

Object type Property

Syntax SCPI.CALCulate(Ch).SElected.FUNcTion.DOMain.COUPle = *Status*
Status = SCPI.CALCulate(Ch).SElected.FUNcTion.DOMain.COUPle

Description For channels 1 to 16 (*Ch*), specifies whether to set the coupling of the analysis range of the SCPI.CALCulate(Ch).SElected.FUNcTion.EXECute object for all traces.

Variable

	<i>Status</i>
Description	On/off of the trace coupling of the analysis range.
Data type	Boolean type (Boolean)
Range	Select from the following. <ul style="list-style-type: none"> • True or -1 Specifies the analysis range with the trace coupling. • False or 0 Specifies the analysis range for each trace.
Preset value	True or -1

For information on the variable (*Ch*), refer to Table 7-6, “Variable (Ch),” on page 209.

Examples

```
Dim TrCpl As Boolean
SCPI.CALCulate(1).SElected.FUNcTion.DOMain.COUPle = False
TrCpl = SCPI.CALCulate(1).SElected.FUNcTion.DOMain.COUPle
```

Related objects SCPI.CALCulate(Ch).SElected.FUNcTion.EXECute on page 295

Equivalent key No equivalent key is available on the front panel.

SCPI.CALCulate(*Ch*).SElected.FUNcTion.DOMain.START

Object type	Property
Syntax	SCPI.CALCulate(<i>Ch</i>).SElected.FUNcTion.DOMain.START = <i>Value</i> <i>Value</i> = SCPI.CALCulate(<i>Ch</i>).SElected.FUNcTion.DOMain.START
Description	For channels 1 to 16 (<i>Ch</i>), sets the start value of the analysis range of the SCPI.CALCulate(<i>Ch</i>).SElected.FUNcTion.EXECute object. When the trace coupling is off, the active trace is the target to be set.
Variable	

	<i>Value</i>
Description	Start value of the analysis range
Data type	Double precision floating point type (Double)
Preset value	0
Unit	Hz (hertz), dBm or s (second)

For information on the variable (*Ch*), see Table 7-6, “Variable (Ch),” on page 209.

Examples	<pre>Dim AnaStar As Double SCPI.CALCulate(1).SElected.FUNcTion.DOMain.START = 1.5E9 AnaStar = SCPI.CALCulate(1).SElected.FUNcTion.DOMain.START</pre>
Related objects	<p>SCPI.CALCulate(<i>Ch</i>).SElected.FUNcTion.DOMain.STOP on page 294</p> <p>SCPI.CALCulate(<i>Ch</i>).SElected.FUNcTion.DOMain.STATe on page 293</p> <p>SCPI.CALCulate(<i>Ch</i>).SElected.FUNcTion.DOMain.COUPle on page 291</p> <p>SCPI.CALCulate(<i>Ch</i>).SElected.FUNcTion.EXECute on page 295</p>
Equivalent key	No equivalent key is available on the front panel.

SCPI.CALCulate(Ch).SElected.FUNcTion.DOMain.STATe

Object type Property

Syntax SCPI.CALCulate(Ch).SElected.FUNcTion.DOMain.STATe = *Status*
Status = SCPI.CALCulate(Ch).SElected.FUNcTion.DOMain.STATe

Description For channels 1 to 16 (*Ch*), sets whether to use an arbitrary range when executing the analysis with the SCPI.CALCulate(Ch).SElected.FUNcTion.EXECute object.
 When the trace coupling is off, the active trace is the target to be set.

Variable

	<i>Status</i>
Description	Selection of the analysis range
Data type	Boolean type (Boolean)
Range	Select from the following. <ul style="list-style-type: none"> • True or -1 Specifies an arbitrary range ^{*1}. • False or 0 Specifies the entire sweep range.
Preset value	False or 0

*1. Specify with the SCPI.CALCulate(Ch).SElected.FUNcTion.DOMain.START object and the SCPI.CALCulate(Ch).SElected.FUNcTion.DOMain.STOP object.

For information on the variable (*Ch*), see Table 7-6, “Variable (Ch),” on page 209.

Examples

```
Dim AnaRnge As Boolean
SCPI.CALCulate(1).SElected.FUNcTion.DOMain.START = 1.5E9
SCPI.CALCulate(1).SElected.FUNcTion.DOMain.STOP = 1.8E9
SCPI.CALCulate(1).SElected.FUNcTion.DOMain.STATe = True
AnaRnge = SCPI.CALCulate(1).SElected.FUNcTion.DOMain.STATe
```

Related objects

- SCPI.CALCulate(Ch).SElected.FUNcTion.DOMain.START on page 292
- SCPI.CALCulate(Ch).SElected.FUNcTion.DOMain.STOP on page 294
- SCPI.CALCulate(Ch).SElected.FUNcTion.DOMain.COUPle on page 291
- SCPI.CALCulate(Ch).SElected.FUNcTion.EXECute on page 295

Equivalent key No equivalent key is available on the front panel.

SCPI.CALCulate(*Ch*).SElected.FUNcTion.DOMain.STOP

Object type	Property
Syntax	SCPI.CALCulate(<i>Ch</i>).SElected.FUNcTion.DOMain.STOP = <i>Value</i> <i>Value</i> = SCPI.CALCulate(<i>Ch</i>).SElected.FUNcTion.DOMain.STOP
Description	For channels 1 to 16 (<i>Ch</i>), sets the stop value of the analysis range of the SCPI.CALCulate(<i>Ch</i>).SElected.FUNcTion.EXECute object. When the trace coupling is off, the active trace is the target to be set.
Variable	

	<i>Value</i>
Description	Stop value of the analysis range
Data type	Double precision floating point type (Double)
Preset value	0
Unit	Hz (hertz), dBm or s (second)

For information on the variable (*Ch*), see Table 7-6, “Variable (Ch),” on page 209.

Examples	<pre>Dim AnaStop As Double SCPI.CALCulate(1).SElected.FUNcTion.DOMain.STOP = 1.8E9 AnaStop = SCPI.CALCulate(1).SElected.FUNcTion.DOMain.STOP</pre>
Related objects	<p>SCPI.CALCulate(<i>Ch</i>).SElected.FUNcTion.DOMain.STARt on page 292</p> <p>SCPI.CALCulate(<i>Ch</i>).SElected.FUNcTion.DOMain.STATe on page 293</p> <p>SCPI.CALCulate(<i>Ch</i>).SElected.FUNcTion.DOMain.COUPle on page 291</p> <p>SCPI.CALCulate(<i>Ch</i>).SElected.FUNcTion.EXECute on page 295</p>
Equivalent key	No equivalent key is available on the front panel.

SCPI.CALCulate(*Ch*).SElected.FUNcTion.EXECute

Object type	Method
Syntax	SCPI.CALCulate(<i>Ch</i>).SElected.FUNcTion.EXECute
Description	For the active trace of channels 1 to 16 (<i>Ch</i>), executes the analysis specified with the SCPI.CALCulate(<i>Ch</i>).SElected.FUNcTion.TYPE object. (No read)
Variable	For information on the variable (<i>Ch</i>), see Table 7-6, “Variable (<i>Ch</i>),” on page 209.
Examples	<pre>SCPI.CALCulate(1).PARAMeter(1).SElect SCPI.CALCulate(1).SElected.FUNcTion.EXECute</pre>
Related objects	SCPI.CALCulate(<i>Ch</i>).PARAmeter(<i>Tr</i>).SElect on page 259 SCPI.CALCulate(<i>Ch</i>).SElected.FUNcTion.TYPE on page 301 SCPI.CALCulate(<i>Ch</i>).SElected.FUNcTion.DOMain.STATe on page 293
Equivalent key	No equivalent key is available on the front panel.

SCPI.CALCulate(*Ch*).SElected.FUNction.PEXCursion

Object type Property

Syntax SCPI.CALCulate(*Ch*).SElected.FUNction.PEXCursion = *Value*
Value = SCPI.CALCulate(*Ch*).SElected.FUNction.PEXCursion

Description For the active trace of channels 1 to 16 (*Ch*), sets the lower limit of peak excursion value (the minimum value of the difference relative to the right and left adjacent measurement points) when executing the peak search with the SCPI.CALCulate(*Ch*).SElected.FUNction.EXECute object. For information on the peak excursion value, see Section “Searching for the Peak” in the *E5070B/E5071B User’s Guide*.

Variable

	<i>Value</i>
Description	Lower limit of peak excursion value
Data type	Double precision floating point type (Double)
Range	0 to 5E8
Preset value	3
Unit	Varies depending on the data format. <ul style="list-style-type: none"> • Log magnitude (MLOG) : dB (decibel) • Phase (PHAS), Expanded phase (UPH) or Positive phase (PPH) : ° (degree) • Group delay (GDEL) : s (second) • Others : No unit
Note	If the specified variable is out of the allowable setup range, the minimum value (if the lower limit of the range is not reached) or the maximum value (if the upper limit of the range is exceeded) is set.

For information on the variable (*Ch*), see Table 7-6, “Variable (Ch),” on page 209.

Examples

```
Dim PeakExc As Double
SCPI.CALCulate(1).PARAMeter(1).SElect
SCPI.CALCulate(1).SElected.FUNction.TYPE = "peak"
SCPI.CALCulate(1).SElected.FUNction.PEXCursion = 1.5
PeakExc = SCPI.CALCulate(1).SElected.FUNction.PEXCursion
```

Related objects SCPI.CALCulate(*Ch*).PARAMeter(*Tr*).SElect on page 259
SCPI.CALCulate(*Ch*).SElected.FUNction.TYPE on page 301
SCPI.CALCulate(*Ch*).SElected.FUNction.PPOLarity on page 298
SCPI.CALCulate(*Ch*).SElected.FUNction.EXECute on page 295

Equivalent key No equivalent key is available on the front panel.

SCPI.CALCulate(*Ch*).SElected.FUNcTion.POINts

Object type Property

Syntax *Value* = SCPI.CALCulate(*Ch*).SElected.FUNcTion.POINts

Description For the active trace of channels 1 to 16 (*Ch*), reads out the number of data pairs of the analysis result of the SCPI.CALCulate(Ch).SElected.FUNcTion.EXECute object.

For the analysis of the mean value or the search of the maximum value, 1 is always read out; for the search of all peaks or the search of all targets, the total number of searched measurement points is read out. (Read only)

Variable

	<i>Value</i>
Description	Number of analyzed data pairs
Data type	Long integer type (Long)

For information on the variable (*Ch*), see Table 7-6, “Variable (Ch),” on page 209.

Examples

```
Dim AnaPoin As Long
SCPI.CALCulate(1).PARAmeter(1).SElect
SCPI.CALCulate(1).SElected.FUNcTion.TYPE = "ape"
SCPI.CALCulate(1).SElected.FUNcTion.EXECute
AnaPoin = SCPI.CALCulate(1).SElected.FUNcTion.POINts
```

Related objects

SCPI.CALCulate(Ch).PARAmeter(Tr).SElect on page 259
 SCPI.CALCulate(Ch).SElected.FUNcTion.EXECute on page 295
 SCPI.CALCulate(Ch).SElected.FUNcTion.DATA on page 290

Equivalent key

No equivalent key is available on the front panel.

SCPI.CALCulate(*Ch*).SElected.FUNcTion.PPOLarity

Object type Property

Syntax SCPI.CALCulate(*Ch*).SElected.FUNcTion.PPOLarity = *Param*
Param = SCPI.CALCulate(*Ch*).SElected.FUNcTion.PPOLarity

Description For the active trace of channels 1 to 16 (*Ch*), selects the polarity when performing the peak search with the SCPI.CALCulate(*Ch*).SElected.FUNcTion.EXECute object.

Variable

	<i>Param</i>
Description	Polarity for peak search
Data type	Character string type (String)
Range	Select from the following. <ul style="list-style-type: none"> •"POSitive" Specifies the positive peak. •"NEGative" Specifies the negative peak. •"BOTH" Specifies both the positive peak and the negative peak.
Preset value	"POSitive"

For information on the variable (*Ch*), see Table 7-6, "Variable (Ch)," on page 209.

Examples

```
Dim PeakPol As String
SCPI.CALCulate(1).PARAMeter(1).SElect
SCPI.CALCulate(1).SElected.FUNcTion.TYPE = "peak"
SCPI.CALCulate(1).SElected.FUNcTion.PPOLarity = "both"
PeakPol = SCPI.CALCulate(1).SElected.FUNcTion.PPOLarity
```

Related objects

SCPI.CALCulate(*Ch*).PARAMeter(*Tr*).SElect on page 259

SCPI.CALCulate(*Ch*).SElected.FUNcTion.TYPE on page 301

SCPI.CALCulate(*Ch*).SElected.FUNcTion.PEXCursion on page 296

SCPI.CALCulate(*Ch*).SElected.FUNcTion.EXECute on page 295

Equivalent key No equivalent key is available on the front panel.

SCPI.CALCulate(*Ch*).SElected.FUNction.TARGet

Object type	Property
Syntax	SCPI.CALCulate(<i>Ch</i>).SElected.FUNction.TARGet = <i>Value</i> <i>Value</i> = SCPI.CALCulate(<i>Ch</i>).SElected.FUNction.TARGet
Description	For the active trace of channels 1 to 16 (<i>Ch</i>), selects the target value when performing the target search with the SCPI.CALCulate(<i>Ch</i>).SElected.FUNction.EXECute object.
Variable	

	<i>Value</i>
Description	Target value
Data type	Double precision floating point type (Double)
Range	-5E8 to 5E8
Preset value	0
Unit	Varies depending on the data format. <ul style="list-style-type: none"> Log magnitude (MLOG) : dB (decibel) Phase (PHAS), Expanded phase (UPH) or Positive phase (PPH) : ° (degree) Group delay (GDEL) : s (second) Others : No unit
Note	If the specified variable is out of the allowable setup range, the minimum value (if the lower limit of the range is not reached) or the maximum value (if the upper limit of the range is exceeded) is set.

For information on the variable (*Ch*), see Table 7-6, “Variable (Ch),” on page 209.

Examples	<pre>Dim TargVal As Double SCPI.CALCulate(1).PARAMeter(1).SElect SCPI.CALCulate(1).SElected.FUNction.TYPE = "atar" SCPI.CALCulate(1).SElected.FUNction.TARGet = -12.5 TargVal = SCPI.CALCulate(1).SElected.FUNction.TARGet</pre>
Related objects	<p>SCPI.CALCulate(<i>Ch</i>).PARAMeter(<i>Tr</i>).SElect on page 259</p> <p>SCPI.CALCulate(<i>Ch</i>).SElected.FUNction.TYPE on page 301</p> <p>SCPI.CALCulate(<i>Ch</i>).SElected.FUNction.TTRansition on page 300</p> <p>SCPI.CALCulate(<i>Ch</i>).SElected.FUNction.EXECute on page 295</p>
Equivalent key	No equivalent key is available on the front panel.

SCPI.CALCulate(*Ch*).SElected.FUNcTion.TTRansition

Object type Property

Syntax SCPI.CALCulate(*Ch*).SElected.FUNcTion.TTRansition = *Param*
Param = SCPI.CALCulate(*Ch*).SElected.FUNcTion.TTRansition

Description For the active trace of channels 1 to 16 (*Ch*), selects the transition type when performing the target search with the SCPI.CALCulate(*Ch*).SElected.FUNcTion.EXECute object. For more information on the transition type, see Section “Searching for the Target Value” in the *E5070B/E5071B User’s Guide*.

Variable

	<i>Param</i>
Description	Transition type for search
Data type	Character string type (String)
Range	Select from the following. <ul style="list-style-type: none"> •"POSitive" Specifies the positive transition. •"NEGative" Specifies the negative transition. •"BOTH" Specifies both the positive transition and the negative transition.
Preset value	"BOTH"

For information on the variable (*Ch*), see Table 7-6, “Variable (Ch),” on page 209.

Examples

```
Dim TargTran As String
SCPI.CALCulate(1).PARAMeter(1).SElect
SCPI.CALCulate(1).SElected.FUNcTion.TYPE = "atar"
SCPI.CALCulate(1).SElected.FUNcTion.TTRansition = "pos"
TargTran = SCPI.CALCulate(1).SElected.FUNcTion.TTRansition
```

Related objects

SCPI.CALCulate(*Ch*).PARAMeter(*Tr*).SElect on page 259

SCPI.CALCulate(*Ch*).SElected.FUNcTion.TYPE on page 301

SCPI.CALCulate(*Ch*).SElected.FUNcTion.TARGET on page 299

SCPI.CALCulate(*Ch*).SElected.FUNcTion.EXECute on page 295

Equivalent key No equivalent key is available on the front panel.

SCPI.CALCulate(Ch).SElected.FUNCTION.TYPE

Object type Property
Syntax SCPI.CALCulate(Ch).SElected.FUNCTION.TYPE = *Param*
Param = SCPI.CALCulate(Ch).SElected.FUNCTION.TYPE
Description For the active trace of channels 1 to 16 (*Ch*), selects the type of analysis.
Variable

	<i>Param</i>
Description	Analysis type
Data type	Character string type (String)
Range	Select from the following. <ul style="list-style-type: none"> •"PTPeak" Specifies the analysis of the difference between the maximum value and the minimum value (Peak to Peak). •"STDEV" Specifies the analysis of the standard deviation. •"MEAN" Specifies the analysis of the mean value. •"MAXimum" Specifies the search for the maximum value. •"MINimum" Specifies the search for the minimum value. •"PEAK" Specifies the search for the peak*¹. •"APEak" Specifies the search for all peaks*¹. •"ATARget" Specifies the search for all targets*².
Preset value	"PTPeak"

*1. To specify the conditions of the peak, use the SCPI.CALCu-
late(Ch).SElected.FUNCTION.PEXCursion object and the SCPI.CALCu-
late(Ch).SElected.FUNCTION.PPOLarity object.

*2. To specify the conditions of the target, use the SCPI.CALCu-
late(Ch).SElected.FUNCTION.TARGET object and the SCPI.CALCu-
late(Ch).SElected.FUNCTION.TTRansition object.

For information on the variable (*Ch*), see Table 7-6, "Variable (Ch)," on page 209.

Examples

```
Dim AnaType As String
SCPI.CALCulate(1).PARAMeter(1).SElect
SCPI.CALCulate(1).SElected.FUNCTION.TYPE = "atar"
AnaType = SCPI.CALCulate(1).SElected.FUNCTION.TYPE
```

Related objects

- SCPI.CALCulate(Ch).PARAMeter(Tr).SElect on page 259
- SCPI.CALCulate(Ch).SElected.FUNCTION.PEXCursion on page 296
- SCPI.CALCulate(Ch).SElected.FUNCTION.PPOLarity on page 298
- SCPI.CALCulate(Ch).SElected.FUNCTION.TARGET on page 299
- SCPI.CALCulate(Ch).SElected.FUNCTION.TTRansition on page 300
- SCPI.CALCulate(Ch).SElected.FUNCTION.EXECute on page 295

Equivalent key No equivalent key is available on the front panel.

SCPI.CALCulate(Ch).SElected.LIMit.DATA

Object type	Property
Syntax	SCPI.CALCulate(Ch).SElected.LIMit.DATA = <i>Data</i> <i>Data</i> = SCPI.CALCulate(Ch).SElected.LIMit.DATA
Description	For the active trace of channels 1 to 16 (<i>Ch</i>), sets the limit table for the limit test.
Variable	

	<i>Data</i>
Description	<p>Indicates the array data (for limit line) of 1 + Num (number of limit lines)×5. Where n is an integer between 1 and Num.</p> <ul style="list-style-type: none"> • <i>Data</i>(0) The number of limit lines you want to set. Specify an integer ranging 0 to 100. When the number of limit lines is set to 0 (clears the limit table), the variable <i>Data</i> is only required with <i>Data</i>(0). • <i>Data</i>(<i>n</i>×5-4) The type of the n-th line. Specify an integer 0 to 2 as follows. 0: OFF 1: Upper limit line 2: Lower limit line • <i>Data</i>(<i>n</i>×5-3) The value on the horizontal axis (frequency/power/time) of the start point of the n-th line. • <i>Data</i>(<i>n</i>×5-2) The value on the horizontal axis (frequency/power/time) of the end point of the n-th line. • <i>Data</i>(<i>n</i>×5-1) The value on the vertical axis of the start point of the n-th line. • <i>Data</i>(<i>n</i>×5) The value on the vertical axis of the end point of the n-th line. <p>The index of the array starts from 0.</p>
Data type	Variant type (Variant)
Note	<p>If there is no array data of 1+Num (number of set lines)×5 when setting a formatted memory array, an error occurs when executed and the object is ignored. For <i>Data</i>(<i>n</i>×5-4) in the array data, if you specify an integer other than 0, 1 or 2, an error occurs when executed. For <i>Data</i>(<i>n</i>×5-3), <i>Data</i>(<i>n</i>×5-2), <i>Data</i>(<i>n</i>×5-1), and <i>Data</i>(<i>n</i>×5) in the array data, if the specified value is out of the allowable setup range, the minimum value (if the lower limit of the range is not reached) or the maximum value (if the upper limit of the range is exceeded) is set.</p>

For information on the variable (*Ch*), see Table 7-6, “Variable (Ch),” on page 209.

Examples	<pre>Dim LimData As Variant SCPI.CALCulate(1).PARAMeter(1).SElect SCPI.CALCulate(1).SElected.LIMit.DATA = Array(1,1,1e6,1e9,0,0) LimData = SCPI.CALCulate(1).SElected.LIMit.DATA SCPI.CALCulate(1).PARAMeter(1).SElect SCPI.CALCulate(1).SElected.LIMit.DATA = Array(0) 'Clear Limit Table</pre>
----------	---

```
Dim LimData(5) As Variant
Dim Ref As Variant
LimData(0) = 1
LimData(1) = 1
LimData(2) = 1e6
LimData(3) = 1e9
LimData(4) = 0
LimData(5) = 0
SCPI.CALCulate(1).PARAMeter(1).SElect
SCPI.CALCulate(1).SElected.LIMit.DATA = LimData
Ref = SCPI.CALCulate(1).SElected.LIMit.DATA

Dim LimData(0) As Variant
LimData(0) = 0
SCPI.CALCulate(1).PARAMeter(1).SElect
SCPI.CALCulate(1).SElected.LIMit.DATA = LimData 'Clear Limit Table
```

- Related objects
- SCPI.CALCulate(Ch).PARAMeter(Tr).SElect on page 259
 - SCPI.CALCulate(Ch).SElected.LIMit.STATe on page 312
 - SCPI.CALCulate(Ch).SElected.LIMit.DISPlay.STATe on page 304
- Equivalent key
- [Analysis] - Limit Test - Edit Limit Line**

SCPI.CALCulate(*Ch*).SElected.LIMit.DISPlay.STATe

Object type	Property
Syntax	SCPI.CALCulate(<i>Ch</i>).SElected.LIMit.DISPlay.STATe = <i>Status</i> <i>Status</i> = SCPI.CALCulate(<i>Ch</i>).SElected.LIMit.DISPlay.STATe
Description	For the active trace of channels 1 to 16 (<i>Ch</i>), turns ON/OFF the limit line display.
Variable	

	<i>Status</i>
Description	Limit line display
Data type	Boolean type (Boolean)
Range	Select from the following. <ul style="list-style-type: none"> •True or -1 Turns ON the limit line display. •False or 0 Turns OFF the limit line display.
Preset value	False or 0

For information on the variable (*Ch*), see Table 7-6, “Variable (Ch),” on page 209.

Examples

```
Dim LimDisp As Boolean
SCPI.CALCulate(1).PARAMeter(1).SElect
SCPI.CALCulate(1).SElected.LIMit = True
LimDisp = SCPI.CALCulate(1).SElected.LIMit.DISPlay.STATe
```

Related objects

SCPI.CALCulate(Ch).PARAMeter(Tr).SElect on page 259
SCPI.CALCulate(Ch).SElected.LIMit.STATe on page 312

Equivalent key **[Analysis] - Limit Test - Limit Line**

SCPI.CALCulate(*Ch*).SElected.LIMit.FAIL

Object type	Property
Syntax	<i>Status</i> = SCPI.CALCulate(<i>Ch</i>).SElected.LIMit.FAIL
Description	For the active trace of channels 1 to 16 (<i>Ch</i>), reads out the limit test result. (Read only)
Variable	

	<i>Status</i>
Description	Limit test result
Data type	Boolean type (Boolean)
Range	Select from the following. <ul style="list-style-type: none"> • True or -1 The limit test result is FAIL. • False or 0 The limit test result is PASS.
Note	When the limit test is set to OFF, False or 0 is always read out.

For information on the variable (*Ch*), see Table 7-6, “Variable (Ch),” on page 209.

Examples	<pre>Dim Result As Boolean SCPI.CALCulate(1).PARAMeter(1).SElect SCPI.CALCulate(1).SElected.LIMit.STATe = True Result = SCPI.CALCulate(1).SElected.LIMit.FAIL</pre>
Related objects	<p>SCPI.CALCulate(Ch).PARAMeter(Tr).SElect on page 259</p> <p>SCPI.CALCulate(Ch).SElected.LIMit.STATe on page 312</p>
Equivalent key	No equivalent key is available on the front panel.

SCPI.CALCulate(*Ch*).SElected.LIMit.OFFSet.AMPLitude

- Object type** Property
- Syntax** SCPI.CALCulate(*Ch*).SElected.LIMit.OFFSet.AMPLitude = *Value*
Value = SCPI.CALCulate(*Ch*).SElected.LIMit.OFFSet.AMPLitude
- Description** For channel 1 to channel 16 (specified with the SCPI.CALCulate(*Ch*).PARAmeter(*Tr*).SElect command), sets the limit line amplitude offset.
 The setting of the limit line doesn't change even if the offset value is changed.

Variable

	<i>Value</i>
Description	The limit line amplitude offset
Data type	Double precision floating point type (Double)
Range	-5E8 to 5E8
Preset value	0
Unit	dB

For information on the variable (*Ch*), see Table 7-6, “Variable (Ch),” on page 209.

- Examples**

```
Dim LimOffset As Double
SCPI.CALCulate(1).SElected.LIMit.OFFSet.AMPLitude = -10
LimOffset = SCPI.CALCulate(1).SElected.LIMit.OFFSet.AMPLitude
```
- Related objects** SCPI.CALCulate(*Ch*).SElected.LIMit.STATe on page 312
 SCPI.CALCulate(*Ch*).SElected.LIMit.OFFSet.MARKer on page 307
 SCPI.CALCulate(*Ch*).SElected.LIMit.OFFSet.STIMulus on page 308
- Equivalent key** **[Analysis] - Limit Test - Limit Line Offsets - Amplitude Offset**

SCPI.CALCulate(*Ch*).SElected.LIMit.OFFSet.MARKer

Object type	Method
Syntax	SCPI.CALCulate(<i>Ch</i>).SElected.LIMit.OFFSet.MARKer
Description	<p>For channel 1 to channel 16 (specified with the SCPI.CALCulate(Ch).PARAmeter(Tr).SElect command), sets the active marker value to amplitude offset using the limit line.</p> <p>The setting of the limit line does not change even if the offset value is changed.</p> <p>When the markers are not displayed, this command does not operate.</p>
Variable	For information on the variable (<i>Ch</i>), see Table 7-6, “Variable (Ch),” on page 209.
Examples	<pre>SCPI.CALCulate(1).PARAmeter(1).SElect SCPI.CALCulate(1).SElected.LIMit.OFFSet.MARKer</pre>
Related objects	<p>SCPI.CALCulate(Ch).SElected.LIMit.STATe on page 312</p> <p>SCPI.CALCulate(Ch).SElected.LIMit.OFFSet.AMPLitude on page 306</p> <p>SCPI.CALCulate(Ch).SElected.LIMit.OFFSet.STIMulus on page 308</p>
Equivalent key	[Analysis] - Limit Test - Limit Line Offsets - Marker -> Amplitude Offset

SCPI.CALCulate(*Ch*).SElected.LIMit.OFFSet.STIMulus

Object type Property

Syntax SCPI.CALCulate(*Ch*).SElected.LIMit.OFFSet.STIMulus = *Value*
Value = SCPI.CALCulate(*Ch*).SElected.LIMit.OFFSet.STIMulus

Description For channel 1 to channel 16 (specified with the SCPI.CALCulate(*Ch*).PARAmeter(*Tr*).SElect command), sets the stimulus offset of the limit line.
 The setting of the limit line doesn't change even if the offset value is changed.

Variable

	<i>Value</i>
Description	The stimulus offset of the limit line
Data type	Double precision floating point type (Double)
Range	-1E12 to 1E12
Preset value	0
Unit	Hz (hertz), dBm or second

For information on the variable (*Ch*), see Table 7-6, “Variable (Ch),” on page 209.

Examples

```
Dim LimOffset As Double
SCPI.CALCulate(1).SElected.LIMit.OFFSet.STIMulus = 1E9
LimOffset = SCPI.CALCulate(1).SElected.LIMit.OFFSet.STIMulus
```

Related objects SCPI.CALCulate(*Ch*).SElected.LIMit.STATe on page 312
 SCPI.CALCulate(*Ch*).SElected.LIMit.OFFSet.AMPLitude on page 306
 SCPI.CALCulate(*Ch*).SElected.LIMit.OFFSet.MARKer on page 307

Equivalent key **[Analysis] - Limit Test - Limit Line Offsets - Stimulus Offset**

SCPI.CALCulate(*Ch*).SElected.LIMit.REPort.ALL

Object type Property

Syntax Data = SCPI.CALCulate(*Ch*).SElected.LIMit.REPort.ALL

Description For the active trace of channel 1 to channel 16 (specified with the SCPI.CALCulate(Ch).PARAMeter(Tr).SElect command), reads out the bandwidth test results (stimulus value, limit test result, upper limit value, lower limit value of all measurement points). (Read only)

Variable

	<i>Data</i>
Description	<p>Indicates the array data (for limit line) of NOP (number of measurement points)×4. Where n is an integer between 1 and NOP.</p> <ul style="list-style-type: none"> • <i>Data</i>(<i>n</i>×4-3) The stimulus value for the measurement point. • <i>Data</i>(<i>n</i>×4-2) The limit test result. Specify an integer -1 to 1 as follows. -1: No limit 0: Fail 1: Pass • <i>Data</i>(<i>n</i>×4-1) The upper limit value at the measurement point. (If there is no limit at this point, reads out the 0.) • <i>Data</i>(<i>n</i>×4) The lower limit value at the measurement point. (If there is no limit at this point, reads out the 0.) <p>The index of the array starts from 0.</p>
Data type	Variant type (Variant)

For information on the variable (*Ch*), see Table 7-6, “Variable (Ch),” on page 209.

Examples

```
Dim LimData As Variant
SCPI.CALCulate(1).PARAMeter(1).SElect
LimData = SCPI.CALCulate(1).SElected.LIMit.REPort.ALL
```

Related objects

SCPI.CALCulate(Ch).PARAMeter(Tr).SElect on page 259

SCPI.CALCulate(Ch).SElected.LIMit.STATe on page 312

SCPI.CALCulate(Ch).SElected.LIMit.REPort.DATA on page 310

SCPI.CALCulate(Ch).SElected.LIMit.REPort.POINts on page 311

Equivalent key No equivalent key is available on the front panel.

SCPI.CALCulate(Ch).SElected.LIMit.REPort.DATA

Object type	Property
Syntax	<i>Data</i> = SCPI.CALCulate(Ch).SElected.LIMit.REPort.DATA
Description	For the active trace of channels 1 to 16 (<i>Ch</i>), reads out the stimulus values (frequency, power level or time) at all the measurement points that failed the limit test. (Read only)
Variable	

	<i>Data</i>
Description	Indicates the array data for failed measurement points (can be read out with the SCPI.CALCulate(Ch).SElected.LIMit.REPort.POINts object).
Data type	Variant type (Variant)

For information on the variable (*Ch*), see Table 7-6, “Variable (Ch),” on page 209.

Examples	<pre>Dim FailData As Variant SCPI.CALCulate(1).PARAMeter(1).SElect SCPI.CALCulate(1).SElected.LIMit.STATe = True FailData = SCPI.CALCulate(1).SElected.LIMit.REPort.DATA</pre>
Related objects	SCPI.CALCulate(Ch).PARAMeter(Tr).SElect on page 259 SCPI.CALCulate(Ch).SElected.LIMit.REPort.POINts on page 311 SCPI.CALCulate(Ch).SElected.LIMit.STATe on page 312
Equivalent key	No equivalent key is available on the front panel.

SCPI.CALCulate(*Ch*).SElected.LIMit.REPort.POINts

- Object type** Property
- Syntax** *Value* = SCPI.CALCulate(*Ch*).SElected.LIMit.REPort.POINts
- Description** For the active trace of channels 1 to 16 (*Ch*), reads out the number of the measurement points that failed the limit test. (Read only)

Variable

	<i>Value</i>
Description	Number of measurement points that failed
Data type	Long integer type (Long)

For information on the variable (*Ch*), see Table 7-6, “Variable (Ch),” on page 209.

- Examples**
- ```
Dim FailPoin As Long
SCPI.CALCulate(1).PARAMeter(1).SElect
SCPI.CALCulate(1).SElected.LIMit.STATE = True
FailPoin = SCPI.CALCulate(1).SElected.LIMit.REPort.POINts
```

- Related objects** SCPI.CALCulate(Ch).PARAMeter(Tr).SElect on page 259  
 SCPI.CALCulate(Ch).SElected.LIMit.STATE on page 312
- Equivalent key** No equivalent key is available on the front panel.

## SCPI.CALCulate(*Ch*).SElected.LIMit.STATe

|             |                                                                                                                                      |
|-------------|--------------------------------------------------------------------------------------------------------------------------------------|
| Object type | Property                                                                                                                             |
| Syntax      | SCPI.CALCulate( <i>Ch</i> ).SElected.LIMit.STATe = <i>Status</i><br><i>Status</i> = SCPI.CALCulate( <i>Ch</i> ).SElected.LIMit.STATe |
| Description | For the active trace of channels 1 to 16 ( <i>Ch</i> ), turns ON/OFF the limit line function.                                        |
| Variable    |                                                                                                                                      |

|              |                                                                                                                                                                                                                                 |
|--------------|---------------------------------------------------------------------------------------------------------------------------------------------------------------------------------------------------------------------------------|
|              | <i>Status</i>                                                                                                                                                                                                                   |
| Description  | ON/OFF of the limit test function                                                                                                                                                                                               |
| Data type    | Boolean type (Boolean)                                                                                                                                                                                                          |
| Range        | Select from the following.<br><ul style="list-style-type: none"> <li>•True or -1                      Turns ON the limit test function.</li> <li>•False or 0                      Turns OFF the limit test function.</li> </ul> |
| Preset value | False or 0                                                                                                                                                                                                                      |

For information on the variable (*Ch*), see Table 7-6, “Variable (Ch),” on page 209.

|                 |                                                                                                                                                                        |
|-----------------|------------------------------------------------------------------------------------------------------------------------------------------------------------------------|
| Examples        | <pre>Dim LimTest As Boolean SCPI.CALCulate(1).PARAMeter(1).SElect SCPI.CALCulate(1).SElected.LIMit.STATe = True LimTest = SCPI.CALCulate(1).SElected.LIMit.STATe</pre> |
| Related objects | <p>SCPI.CALCulate(Ch).PARAMeter(Tr).SElect on page 259</p> <p>SCPI.CALCulate(Ch).SElected.LIMit.DISPlay.STATe on page 304</p> <p>SCPI.DISPlay.FSIGN on page 387</p>    |
| Equivalent key  | <b>[Analysis] - Limit Test - Limit Test</b>                                                                                                                            |

## SCPI.CALCulate(*Ch*).SElected.MARKer(*Mk*).ACTivate

|             |                                                                                                                                                                |
|-------------|----------------------------------------------------------------------------------------------------------------------------------------------------------------|
| Object type | Method                                                                                                                                                         |
| Syntax      | SCPI.CALCulate( <i>Ch</i> ).SElected.MARKer( <i>Mk</i> ).ACTivate                                                                                              |
| Description | For the active trace of channels 1 to 16 ( <i>Ch</i> ), sets marker 1 to 9 ( <i>Mk</i> ) and reference marker ( <i>Mk</i> :10) to the active marker. (No read) |

---

**NOTE** If you set a marker not displayed to the active marker, the marker display is automatically set to ON.

---

Variable

**Table 7-11**

### Variable (*Mk*)

|              | <i>Mk</i>                                                                                     |
|--------------|-----------------------------------------------------------------------------------------------|
| Description  | Marker number                                                                                 |
| Data type    | Long integer type (Long)                                                                      |
| Range        | 1 to 10<br>Notice that 10 is for the reference marker.                                        |
| Preset value | 1                                                                                             |
| Note         | If the specified variable is out of the allowable setup range, an error occurs when executed. |

For information on the variable (*Ch*), see Table 7-6, “Variable (Ch),” on page 209.

**Examples**  
 SCPI.CALCulate(1).PARAMeter(1).SElect  
 SCPI.CALCulate(1).SElected.MARKer(1).ACTivate

**Related objects**  
 SCPI.CALCulate(Ch).PARAMeter(Tr).SElect on page 259  
 SCPI.DISPlay.WINDow(Ch).ACTivate on page 395

**Equivalent key**  
**[Marker] - Marker 1|Marker 2|Marker 3|Marker 4|Ref Marker**  
**[Marker] - More Markers - Marker 5|Marker 6|Marker 7|Marker 8|Marker 9**

**SCPI.CALCulate(Ch).SElected.MARKer(Mk).BWIDth. DATA**

Object type Property

Syntax *Data* = SCPI.CALCulate(Ch).SElected.MARKer(Mk).BWIDth.DATA

Description For the active trace of channels 1 to 16 (*Ch*), reads out the bandwidth search result of marker 1 to 9 (*Mk*) and reference marker (*Mk*:10).

If the bandwidth search is impossible, an error occurs when executed and the object is ignored. (Read only)

Variable

|             | <i>Data</i>                                                                                                                                                                                                                                                                                                                                                                                                                                            |
|-------------|--------------------------------------------------------------------------------------------------------------------------------------------------------------------------------------------------------------------------------------------------------------------------------------------------------------------------------------------------------------------------------------------------------------------------------------------------------|
| Description | <p>Indicates 4-element array data (bandwidth search result).</p> <ul style="list-style-type: none"> <li>• <i>Data</i>(0)                      The bandwidth.</li> <li>• <i>Data</i>(1)                      Center point frequency of the 2 cutoff frequency points.</li> <li>• <i>Data</i>(2)                      The Q value.</li> <li>• <i>Data</i>(3)                      Insertion loss</li> </ul> <p>The index of the array starts from 0.</p> |
| Data type   | Variant type (Variant)                                                                                                                                                                                                                                                                                                                                                                                                                                 |

For information on the variable (*Ch*) and the variable (*Mk*), see Table 7-6, “Variable (Ch),” on page 209 and Table 7-11, “Variable (Mk),” on page 313, respectively.

Examples

```
Dim BandData As Variant
SCPI.CALCulate(1).PARAMeter(1).SElect
BandData = SCPI.CALCulate(1).SElected.MARKer(1).BWIDth.DATA
```

Related objects

SCPI.CALCulate(Ch).PARAmeter(Tr).SElect on page 259

SCPI.CALCulate(Ch).SElected.MARKer.BWIDth.STATe on page 315

SCPI.CALCulate(Ch).SElected.MARKer(Mk).BWIDth. THReshold on page 316

Equivalent key

No equivalent key is available on the front panel.

## SCPI.CALCulate(*Ch*).SElected.MARKer.BWIDth.STATe

Object type      Property

Syntax            SCPI.CALCulate(*Ch*).SElected.MARKer.BWIDth.STATe = *Status*  
*Status* = SCPI.CALCulate(*Ch*).SElected.MARKer.BWIDth.STATe

Description      For the active trace of channels 1 to 16 (*Ch*), turns ON/OFF the bandwidth search result display.

Variable

|              |                                                                                                                                                                                                                                                           |
|--------------|-----------------------------------------------------------------------------------------------------------------------------------------------------------------------------------------------------------------------------------------------------------|
|              | <i>Status</i>                                                                                                                                                                                                                                             |
| Description  | ON/OFF of the bandwidth search result display                                                                                                                                                                                                             |
| Data type    | Boolean type (Boolean)                                                                                                                                                                                                                                    |
| Range        | Select from the following.<br><ul style="list-style-type: none"> <li>• True or -1                      Turns ON the bandwidth search result display.</li> <li>• False or 0                      Turns OFF the bandwidth search result display.</li> </ul> |
| Preset value | False or 0                                                                                                                                                                                                                                                |

For information on the variable (*Ch*), see Table 7-6, “Variable (Ch),” on page 209.

Examples            Dim BandSrch As Boolean  
SCPI.CALCulate(1).PARAMeter(1).SElect  
SCPI.CALCulate(1).SElected.MARKer.BWIDth.STATe = True  
BandSrch = SCPI.CALCulate(1).SElected.MARKer.BWIDth.STATe

Related objects    SCPI.CALCulate(Ch).PARAMeter(Tr).SElect on page 259  
SCPI.CALCulate(Ch).SElected.MARKer(Mk).BWIDth. DATA on page 314  
SCPI.CALCulate(Ch).SElected.MARKer(Mk).BWIDth. THReshold on page 316

Equivalent key     **[Marker Search] - Bandwidth**

**SCPI.CALCulate(Ch).SElected.MARKer(Mk).BWIDth. THReshold**

Object type Property

Syntax SCPI.CALCulate(Ch).SElected.MARKer(Mk).BWIDth. THReshold = *Value*  
*Value* = SCPI.CALCulate(Ch).SElected.MARKer(Mk).BWIDth. THReshold

Description For the active trace of channels 1 to 16 (*Ch*), sets the bandwidth definition value (the value to define the pass-band of the filter) of marker 1 to 9 (*Mk*) and reference marker (*Mk*:10).

Variable

|              | <i>Value</i>                                                                                                                                                                                                                                                                       |
|--------------|------------------------------------------------------------------------------------------------------------------------------------------------------------------------------------------------------------------------------------------------------------------------------------|
| Description  | Bandwidth definition value (the value to define the pass band of the filter)                                                                                                                                                                                                       |
| Data type    | Double precision floating point type (Double)                                                                                                                                                                                                                                      |
| Range        | -5E8 to 5E8                                                                                                                                                                                                                                                                        |
| Preset value | -3                                                                                                                                                                                                                                                                                 |
| Unit         | Varies depending on the data format. <ul style="list-style-type: none"> <li>• Log magnitude (MLOG): dB (decibel)</li> <li>• Phase (PHAS), Expanded phase (UPH) or Positive phase (PPH): ° (degree)</li> <li>• Group delay (GDEL): s (second)</li> <li>• Others: No unit</li> </ul> |
| Note         | If the specified variable is out of the allowable setup range, the minimum value (if the lower limit of the range is not reached) or the maximum value (if the upper limit of the range is exceeded) is set.                                                                       |

For information on the variable (*Ch*) and the variable (*Mk*), see Table 7-6, “Variable (Ch),” on page 209 and Table 7-11, “Variable (Mk),” on page 313, respectively.

Examples

```
Dim BandVal As Double
SCPI.CALCulate(1).PARAMeter(1).SElect
SCPI.CALCulate(1).SElected.MARKer(1).BWIDth. THReshold = -6
BandVal = SCPI.CALCulate(1).SElected.MARKer(1).BWIDth. THReshold
```

Related objects

SCPI.CALCulate(Ch).PARAMeter(Tr).SElect on page 259

SCPI.CALCulate(Ch).SElected.MARKer.BWIDth.STATE on page 315

Equivalent key

**[Marker Search] - Bandwidth Value**



## SCPI.CALCulate(*Ch*).SElected.MARKer.COUPle

|             |                                                                                                                                          |
|-------------|------------------------------------------------------------------------------------------------------------------------------------------|
| Object type | Property                                                                                                                                 |
| Syntax      | SCPI.CALCulate( <i>Ch</i> ).SElected.MARKer.COUPle = <i>Status</i><br><i>Status</i> = SCPI.CALCulate( <i>Ch</i> ).SElected.MARKer.COUPle |
| Description | For channels 1 to 16 ( <i>Ch</i> ), turns ON/OFF the marker coupling between traces.                                                     |
| Variable    |                                                                                                                                          |

|              |                                                                                                                                                                                                                           |
|--------------|---------------------------------------------------------------------------------------------------------------------------------------------------------------------------------------------------------------------------|
|              | <i>Status</i>                                                                                                                                                                                                             |
| Description  | ON/OFF of the marker coupling between traces                                                                                                                                                                              |
| Data type    | Boolean type (Boolean)                                                                                                                                                                                                    |
| Range        | Select from the following.<br><ul style="list-style-type: none"> <li>• True or -1                      Turns ON the marker coupling.</li> <li>• False or 0                      Turns OFF the marker coupling.</li> </ul> |
| Preset value | True or -1                                                                                                                                                                                                                |

For information on the variable (*Ch*), see Table 7-6, “Variable (Ch),” on page 209.

|                |                                                                                                                                     |
|----------------|-------------------------------------------------------------------------------------------------------------------------------------|
| Examples       | <pre>Dim MkrCpl As Boolean SCPI.CALCulate(1).SElected.MARKer.COUPle = False MkrCpl = SCPI.CALCulate(1).SElected.MARKer.COUPle</pre> |
| Equivalent key | <b>[Marker Fctn] - Couple</b>                                                                                                       |

## SCPI.CALCulate(*Ch*).SElected.MARKer(*Mk*).DISCrete

Object type Property

Syntax SCPI.CALCulate(*Ch*).SElected.MARKer(*Mk*).DISCrete = *Status*  
*Status* = SCPI.CALCulate(*Ch*).SElected.MARKer(*Mk*).DISCrete

Description For the active trace of channels 1 to 16 (*Ch*), turns ON/OFF the discrete mode (mode in which the marker moves only at the measurement points) with marker 1 to 9 (*Mk*) and reference marker (*Mk*:10).

Variable

|              |                                                                                                                                                                                                                     |
|--------------|---------------------------------------------------------------------------------------------------------------------------------------------------------------------------------------------------------------------|
|              | <i>Status</i>                                                                                                                                                                                                       |
| Description  | ON/OFF of the marker discrete mode                                                                                                                                                                                  |
| Data type    | Boolean type (Boolean)                                                                                                                                                                                              |
| Range        | Select from the following.<br><ul style="list-style-type: none"> <li>•True or -1                      Turns ON the discrete mode.</li> <li>•False or 0                      Turns OFF the discrete mode.</li> </ul> |
| Preset value | False or 0                                                                                                                                                                                                          |

For information on the variable (*Ch*), see Table 7-6, “Variable (Ch),” on page 209.

Examples

```
Dim MkrDsc As Boolean
SCPI.CALCulate(1).PARAMeter(1).SElect
SCPI.CALCulate(1).SElected.MARKer(1).DISCrete = True
MkrDsc = SCPI.CALCulate(1).SElected.MARKer(1).DISCrete
```

Related objects SCPI.CALCulate(Ch).PARAmeter(Tr).SElect on page 259

Equivalent key **[Marker Fctn] - Discrete**

## SCPI.CALCulate(*Ch*).SElected.MARKer.FUNcTion. DOMain.COUPle

|             |                                                                                                                                                                          |
|-------------|--------------------------------------------------------------------------------------------------------------------------------------------------------------------------|
| Object type | Property                                                                                                                                                                 |
| Syntax      | SCPI.CALCulate( <i>Ch</i> ).SElected.MARKer.FUNcTion.DOMain.COUPle = <i>Status</i><br><i>Status</i> = SCPI.CALCulate( <i>Ch</i> ).SElected.MARKer.FUNcTion.DOMain.COUPle |
| Description | For channels 1 to 16 ( <i>Ch</i> ), specifies whether to set the coupling of the marker search range for all traces.                                                     |
| Variable    |                                                                                                                                                                          |

|              |                                                                                                                                                                                                                                                             |
|--------------|-------------------------------------------------------------------------------------------------------------------------------------------------------------------------------------------------------------------------------------------------------------|
|              | <i>Status</i>                                                                                                                                                                                                                                               |
| Description  | On/off of the trace coupling of the marker search range.                                                                                                                                                                                                    |
| Data type    | Boolean type (Boolean)                                                                                                                                                                                                                                      |
| Range        | Select from the following.<br><ul style="list-style-type: none"> <li>• True or -1                      Specifies the search range with the trace coupling.</li> <li>• False or 0                      Specifies the search range for each trace.</li> </ul> |
| Preset value | True or -1                                                                                                                                                                                                                                                  |

For information on the variable (*Ch*), refer to Table 7-6, “Variable (Ch),” on page 209.

|                 |                                                                                                                                                                   |
|-----------------|-------------------------------------------------------------------------------------------------------------------------------------------------------------------|
| Examples        | <pre>Dim TrCpl As Boolean SCPI.CALCulate(1).SElected.MARKer.FUNcTion.DOMain.COUPle = False TrCpl = SCPI.CALCulate(1).SElected.MARKer.FUNcTion.DOMain.COUPle</pre> |
| Related objects | SCPI.CALCulate(Ch).SElected.MARKer(Mk).FUNcTion. EXECute on page 323                                                                                              |
| Equivalent key  | <b>[Marker Search] - Search Range - Couple</b>                                                                                                                    |

**SCPI.CALCulate(*Ch*).SElected.MARKer.FUNction.  
DOMain.STARt**

|             |                                                                                                                                                                      |
|-------------|----------------------------------------------------------------------------------------------------------------------------------------------------------------------|
| Object type | Property                                                                                                                                                             |
| Syntax      | SCPI.CALCulate( <i>Ch</i> ).SElected.MARKer.FUNction.DOMain.STARt = <i>Value</i><br><i>Value</i> = SCPI.CALCulate( <i>Ch</i> ).SElected.MARKer.FUNction.DOMain.STARt |
| Description | For channels 1 to 16 ( <i>Ch</i> ), sets the start value of the marker search range.<br>When the trace coupling is off, the active trace is the target to be set.    |

## Variable

|              | <i>Value</i>                                  |
|--------------|-----------------------------------------------|
| Description  | The start value of the search range           |
| Data type    | Double precision floating point type (Double) |
| Preset value | 0                                             |
| Unit         | Hz (hertz), dBm or s (second)                 |

For information on the variable (*Ch*), refer to Table 7-6, “Variable (Ch),” on page 209.

|                 |                                                                                                                                                                                                                                      |
|-----------------|--------------------------------------------------------------------------------------------------------------------------------------------------------------------------------------------------------------------------------------|
| Examples        | <pre>Dim SchStar As Double SCPI.CALCulate(1).SElected.MARKer.FUNction.DOMain.STARt = 1.7E9 SchStar = SCPI.CALCulate(1).SElected.MARKer.FUNction.DOMain.STARt</pre>                                                                   |
| Related objects | <p>SCPI.CALCulate(Ch).SElected.MARKer.FUNction. DOMain.STOP on page 322</p> <p>SCPI.CALCulate(Ch).SElected.MARKer.FUNction. DOMain.STATe on page 321</p> <p>SCPI.CALCulate(Ch).SElected.MARKer(Mk).FUNction. EXECute on page 323</p> |
| Equivalent key  | <b>[Marker Search] - Search Range - Start</b>                                                                                                                                                                                        |

## SCPI.CALCulate(*Ch*).SElected.MARKer.FUNCtion. DOMain.STATe

**Object type** Property

**Syntax** SCPI.CALCulate(*Ch*).SElected.MARKer.FUNCtion.DOMain.STATe = *Status*  
*Status* = SCPI.CALCulate(*Ch*).SElected.MARKer.FUNCtion.DOMain.STATe

**Description** For channels 1 to 16 (*Ch*), sets whether to use an arbitrary range when executing the marker search.  
 When the trace coupling is off, the active trace is the target to be set.

**Variable**

|              |                                                                                                                                                                                                                                           |
|--------------|-------------------------------------------------------------------------------------------------------------------------------------------------------------------------------------------------------------------------------------------|
|              | <i>Status</i>                                                                                                                                                                                                                             |
| Description  | Selects the search range.                                                                                                                                                                                                                 |
| Data type    | Boolean type (Boolean)                                                                                                                                                                                                                    |
| Range        | Select from the following.<br><ul style="list-style-type: none"> <li>• True or -1                      Specifies an arbitrary range<sup>*1</sup>.</li> <li>• False or 0                      Specifies the entire sweep range.</li> </ul> |
| Preset value | False or 0                                                                                                                                                                                                                                |

\*1. Specify with the SCPI.CALCulate(Ch).SElected.MARKer.FUNCtion. DOMain.STARt object and the SCPI.CALCulate(Ch).SElected.MARKer.FUNCtion. DOMain.STOP object.

For information on the variable (*Ch*), refer to Table 7-6, “Variable (Ch),” on page 209.

**Examples**

```
Dim SchRnge As Boolean
SCPI.CALCulate(1).SElected.MARKer.FUNCtion.DOMain.STARt = 1.5E9
SCPI.CALCulate(1).SElected.MARKer.FUNCtion.DOMain.STOP = 1.8E9
SCPI.CALCulate(1).SElected.MARKer.FUNCtion.DOMain.STATe = True
SchRnge = SCPI.CALCulate(1).SElected.MARKer.FUNCtion.DOMain.STATe
```

**Related objects** SCPI.CALCulate(Ch).SElected.MARKer.FUNCtion. DOMain.STARt on page 320  
 SCPI.CALCulate(Ch).SElected.MARKer.FUNCtion. DOMain.STOP on page 322  
 SCPI.CALCulate(Ch).SElected.MARKer(Mk).FUNCtion. EXECute on page 323

**Equivalent key** **[Marker Search] - Search Range - Search Range [ON/OFF]**

**SCPI.CALCulate(*Ch*).SElected.MARKer.FUNcTion.  
DOMain.STOP**

|             |                                                                                                                                                                    |
|-------------|--------------------------------------------------------------------------------------------------------------------------------------------------------------------|
| Object type | Property                                                                                                                                                           |
| Syntax      | SCPI.CALCulate( <i>Ch</i> ).SElected.MARKer.FUNcTion.DOMain.STOP = <i>Value</i><br><i>Value</i> = SCPI.CALCulate( <i>Ch</i> ).SElected.MARKer.FUNcTion.DOMain.STOP |
| Description | For channels 1 to 16 ( <i>Ch</i> ), sets the stop value of the marker search range.<br>When the trace coupling is off, the active trace is the target to be set.   |

## Variable

|              | <i>Value</i>                                  |
|--------------|-----------------------------------------------|
| Description  | Stop value of the search range                |
| Data type    | Double precision floating point type (Double) |
| Preset value | 0                                             |
| Unit         | Hz (hertz), dBm or s (second)                 |

For information on the variable (*Ch*), refer to Table 7-6, “Variable (Ch),” on page 209.

|                 |                                                                                                                                                                                                                                       |
|-----------------|---------------------------------------------------------------------------------------------------------------------------------------------------------------------------------------------------------------------------------------|
| Examples        | <pre>Dim SchStop As Double SCPI.CALCulate(1).SElected.MARKer.FUNcTion.DOMain.STOP = 1.8E9 SchStop = SCPI.CALCulate(1).SElected.MARKer.FUNcTion.DOMain.STOP</pre>                                                                      |
| Related objects | <p>SCPI.CALCulate(Ch).SElected.MARKer.FUNcTion. DOMain.STARt on page 320</p> <p>SCPI.CALCulate(Ch).SElected.MARKer.FUNcTion. DOMain.STATe on page 321</p> <p>SCPI.CALCulate(Ch).SElected.MARKer(Mk).FUNcTion. EXECute on page 323</p> |
| Equivalent key  | <b>[Marker Search] - Search Range - Stop</b>                                                                                                                                                                                          |

## **SCPI.CALCulate(*Ch*).SElected.MARKer(*Mk*).FUNction. EXECute**

|                 |                                                                                                                                                                                                                                                                            |
|-----------------|----------------------------------------------------------------------------------------------------------------------------------------------------------------------------------------------------------------------------------------------------------------------------|
| Object type     | Method                                                                                                                                                                                                                                                                     |
| Syntax          | SCPI.CALCulate( <i>Ch</i> ).SElected.MARKer( <i>Mk</i> ).FUNction.EXECute                                                                                                                                                                                                  |
| Description     | <p>For the active trace of channels 1 to 16 (<i>Ch</i>), executes search with marker 1 to 9 (<i>Mk</i>) and reference marker (<i>Mk</i>:10).</p> <p>To specify the type of the search, use the SCPI.CALCulate(Ch).SElected.MARKer(Mk).FUNction. TYPE object. (No read)</p> |
| Variable        | For information on the variable ( <i>Ch</i> ) and the variable ( <i>Mk</i> ), see Table 7-6, “Variable (Ch),” on page 209 and Table 7-11, “Variable (Mk),” on page 313, respectively.                                                                                      |
| Examples        | <pre>SCPI.CALCulate(1).PARAmeter(1).SElect SCPI.CALCulate(1).SElected.MARKer(1).FUNction.TYPE = "maximum" SCPI.CALCulate(1).SElected.MARKer(1).FUNction.EXECute</pre>                                                                                                      |
| Related objects | <p>SCPI.CALCulate(Ch).PARAmeter(Tr).SElect on page 259</p> <p>SCPI.CALCulate(Ch).SElected.MARKer(Mk).FUNction. TYPE on page 329</p> <p>SCPI.CALCulate(Ch).SElected.MARKer.FUNction. DOMain.STATE on page 321</p>                                                           |
| Equivalent key  | <p><b>[Marker Search] - Max Min</b></p> <p><b>[Marker Search] - Peak - Search Peak Search Left Search Right</b></p> <p><b>[Marker Search] - Target - Search Target Search Left Search Right</b></p>                                                                        |

---

**NOTE** When performing the operation from the front panel, you select the search type and execute the search at the same time.

---

**SCPI.CALCulate(*Ch*).SElected.MARKer(*Mk*).FUNction.  
PEXCursion**

Object type Property

Syntax SCPI.CALCulate(*Ch*).SElected.MARKer(*Mk*).FUNction.PEXCursion = *Value*  
*Value* = SCPI.CALCulate(*Ch*).SElected.MARKer(*Mk*).FUNction.PEXCursion

Description For the active trace of channels 1 to 16 (*Ch*), sets the lower limit of peak excursion value (the minimum value of the difference relative to the right and left adjacent measurement points) when executing the peak search with marker 1 to 9 (*Mk*) and reference marker (*Mk*:10). For information on the peak excursion value, see Section “Searching for the Peak” in the *E5070B/E5071B User’s Guide*.

Variable

|              | <i>Value</i>                                                                                                                                                                                                                                                                       |
|--------------|------------------------------------------------------------------------------------------------------------------------------------------------------------------------------------------------------------------------------------------------------------------------------------|
| Description  | Lower limit of peak excursion value                                                                                                                                                                                                                                                |
| Data type    | Double precision floating point type (Double)                                                                                                                                                                                                                                      |
| Range        | 0 to 5E8                                                                                                                                                                                                                                                                           |
| Preset value | 3                                                                                                                                                                                                                                                                                  |
| Unit         | Varies depending on the data format. <ul style="list-style-type: none"> <li>• Log magnitude (MLOG): dB (decibel)</li> <li>• Phase (PHAS), Expanded phase (UPH) or Positive phase (PPH): ° (degree)</li> <li>• Group delay (GDEL): s (second)</li> <li>• Others: No unit</li> </ul> |
| Note         | If the specified variable is out of the allowable setup range, the minimum value (if the lower limit of the range is not reached) or the maximum value (if the upper limit of the range is exceeded) is set.                                                                       |

For information on the variable (*Ch*) and the variable (*Mk*), see Table 7-6, “Variable (Ch),” on page 209 and Table 7-11, “Variable (Mk),” on page 313, respectively.

Examples

```
Dim PeakExc As Double
SCPI.CALCulate(1).PARAMeter(1).SElect
SCPI.CALCulate(1).SElected.MARKer(1).FUNction.TYPE = "peak"
SCPI.CALCulate(1).SElected.MARKer(1).FUNction.PEXCursion = 0.2
PeakExc = SCPI.CALCulate(1).SElected.MARKer(1).FUNction.PEXCursion
```

Related objects

SCPI.CALCulate(Ch).PARAMeter(Tr).SElect on page 259  
SCPI.CALCulate(Ch).SElected.MARKer(Mk).FUNction. TYPE on page 329  
SCPI.CALCulate(Ch).SElected.MARKer(Mk).FUNction. PPOLarity on page 325

Equivalent key

**[Marker Search] - Peak - Peak Excursion**



## SCPI.CALCulate(*Ch*).SElected.MARKer(*Mk*).FUNction. PPOLarity

- Object type** Property
- Syntax** SCPI.CALCulate(*Ch*).SElected.MARKer(*Mk*).FUNction.PPOLarity = *Param*  
*Param* = SCPI.CALCulate(*Ch*).SElected.MARKer(*Mk*).FUNction.PPOLarity
- Description** For the active trace of channels 1 to 16 (*Ch*), selects the polarity of the peak search with marker 1 to 9 (*Mk*) and reference marker (*Mk*:10).
- Variable**

|              |                                                                                                                                                                                                                                                                                                     |
|--------------|-----------------------------------------------------------------------------------------------------------------------------------------------------------------------------------------------------------------------------------------------------------------------------------------------------|
|              | <i>Param</i>                                                                                                                                                                                                                                                                                        |
| Description  | Polarity for peak search                                                                                                                                                                                                                                                                            |
| Data type    | Character string type (String)                                                                                                                                                                                                                                                                      |
| Range        | Select from the following.<br><ul style="list-style-type: none"> <li>•"POSitive"                Specifies the positive peak.</li> <li>•"NEGative"               Specifies the negative peak.</li> <li>•"BOTH"                    Specifies both the positive peak and the negative peak.</li> </ul> |
| Preset value | "POSitive"                                                                                                                                                                                                                                                                                          |

For information on the variable (*Ch*) and the variable (*Mk*), see Table 7-6, "Variable (Ch)," on page 209 and Table 7-11, "Variable (Mk)," on page 313, respectively.

- Examples**
- ```
Dim PeakPol As String
SCPI.CALCulate(1).PARAmeter(1).SElect
SCPI.CALCulate(1).SElected.MARKer(1).FUNction.TYPE = "peak"
SCPI.CALCulate(1).SElected.MARKer(1).FUNction.PPOLarity = "both"
PeakPol = SCPI.CALCulate(1).SElected.MARKer(1).FUNction.PPOLarity
```
- Related objects**
- SCPI.CALCulate(Ch).PARAmeter(Tr).SElect on page 259
 - SCPI.CALCulate(Ch).SElected.MARKer(Mk).FUNction. TYPE on page 329
 - SCPI.CALCulate(Ch).SElected.MARKer(Mk).FUNction. PEXCursion on page 324
- Equivalent key** **[Marker Search] - Peak - Peak Polarity**

SCPI.CALCulate(*Ch*).SElected.MARKer(*Mk*).FUNction. TARGet

Object type Property

Syntax SCPI.CALCulate(*Ch*).SElected.MARKer(*Mk*).FUNction.TARGet = *Value*
Value = SCPI.CALCulate(*Ch*).SElected.MARKer(*Mk*).FUNction.TARGet

Description For the active trace of channels 1 to 16 (*Ch*), sets the target value to be searched with marker 1 to 9 (*Mk*) and reference marker (*Mk*:10).

Variable

	<i>Value</i>
Description	Target value for target search
Data type	Double precision floating point type (Double)
Range	-5E8 to 5E8
Preset value	0
Unit	Varies depending on the data format. <ul style="list-style-type: none"> Log magnitude (MLOG): dB (decibel) Phase (PHAS), Expanded phase (UPH) or Positive phase (PPH): ° (degree) Group delay (GDEL): s (second) Others: No unit
Note	If the specified variable is out of the allowable setup range, the minimum value (if the lower limit of the range is not reached) or the maximum value (if the upper limit of the range is exceeded) is set.

For information on the variable (*Ch*) and the variable (*Mk*), see Table 7-6, “Variable (Ch),” on page 209 and Table 7-11, “Variable (Mk),” on page 313, respectively.

Examples

```
Dim TargVal As Double
SCPI.CALCulate(1).PARAMeter(1).SElect
SCPI.CALCulate(1).SElected.MARKer(1).FUNction.TARGet = -12.5
TargVal = SCPI.CALCulate(1).SElected.MARKer(1).FUNction.TARGet
```

Related objects SCPI.CALCulate(Ch).PARAMeter(Tr).SElect on page 259
SCPI.CALCulate(Ch).SElected.MARKer(Mk).FUNction. TYPE on page 329
SCPI.CALCulate(Ch).SElected.MARKer(Mk).FUNction. TTRansition on page 328

Equivalent key **[Marker Search] - Target - Target Value**

SCPI.CALCulate(*Ch*).SElected.MARKer(*Mk*).FUNction. TRACking

- Object type** Property
- Syntax** SCPI.CALCulate(*Ch*).SElected.MARKer(*Mk*).FUNction.TRACking = *Status*
Status = SCPI.CALCulate(*Ch*).SElected.MARKer(*Mk*).FUNction.TRACking
- Description** For the active trace of channels 1 to 16 (*Ch*), turns ON/OFF the search tracking (function to repeat search for each sweep) for marker 1 to 9 (*Mk*) and reference marker (*Mk*:10).
- Variable**

	<i>Status</i>
Description	ON/OFF of the marker search tracing
Data type	Boolean type (Boolean)
Range	Select from the following. <ul style="list-style-type: none"> • True or -1 Turns ON the search tracking. • False or 0 Turns OFF the search tracking.
Preset value	False or 0

For information on the variable (*Ch*) and the variable (*Mk*), see Table 7-6, “Variable (Ch),” on page 209 and Table 7-11, “Variable (Mk),” on page 313, respectively.

- Examples**
- ```
Dim SrchTrac As Boolean
SCPI.CALCulate(1).PARAMeter(1).SElect
SCPI.CALCulate(1).SElected.MARKer(1).FUNction.TYPE = "targ"
SCPI.CALCulate(1).SElected.MARKer(1).FUNction.TRACking = True
SrchTrac = SCPI.CALCulate(1).SElected.MARKer(1).FUNction.TRACking
```
- Related objects**
- SCPI.CALCulate(Ch).PARAMeter(Tr).SElect on page 259
  - SCPI.CALCulate(Ch).SElected.MARKer(Mk).FUNction. TYPE on page 329
  - SCPI.CALCulate(Ch).SElected.MARKer(Mk).FUNction. EXECute on page 323
- Equivalent key** **[Marker Search] - Tracking**

**SCPI.CALCulate(Ch).SElected.MARKer(Mk).FUNction. TTRansition**

|             |                                                                                                                                                                                                                                                                                                                     |
|-------------|---------------------------------------------------------------------------------------------------------------------------------------------------------------------------------------------------------------------------------------------------------------------------------------------------------------------|
| Object type | Property                                                                                                                                                                                                                                                                                                            |
| Syntax      | SCPI.CALCulate(Ch).SElected.MARKer(Mk).FUNction.TTRansition = <i>Param</i><br><i>Param</i> = SCPI.CALCulate(Ch).SElected.MARKer(Mk).FUNction.TTRansition                                                                                                                                                            |
| Description | For marker 1 to 9 ( <i>Mk</i> ) and reference marker ( <i>Mk</i> :10) of the active trace of channels 1 to 16 ( <i>Ch</i> ), selects the transition type of the target search. For more information on the transition type, see Section “Searching for the Target Value” in the <i>E5070B/E5071B User’s Guide</i> . |

## Variable

|              | <i>Param</i>                                                                                                                                                                                                                                                                                                                                    |
|--------------|-------------------------------------------------------------------------------------------------------------------------------------------------------------------------------------------------------------------------------------------------------------------------------------------------------------------------------------------------|
| Description  | Transition type for search                                                                                                                                                                                                                                                                                                                      |
| Data type    | Character string type (String)                                                                                                                                                                                                                                                                                                                  |
| Range        | Select from the following. <ul style="list-style-type: none"> <li>•"POSitive"                      Specifies the positive transition.</li> <li>•"NEGative"                      Specifies the negative transition.</li> <li>•"BOTH"                              Specifies both the positive transition and the negative transition.</li> </ul> |
| Preset value | "BOTH"                                                                                                                                                                                                                                                                                                                                          |

For information on the variable (*Ch*) and the variable (*Mk*), see Table 7-6, “Variable (Ch),” on page 209 and Table 7-11, “Variable (Mk),” on page 313, respectively.

**Examples**

```
Dim TargTran As String
SCPI.CALCulate(1).PARAMeter(1).SElect
SCPI.CALCulate(1).SElected.MARKer(1).FUNction.TYPE = "targ"
SCPI.CALCulate(1).SElected.MARKer(1).FUNction.TTRansition = "neg"
TargTran = SCPI.CALCulate(1).SElected.MARKer(1).FUNction.TTRansition
```

**Related objects**

SCPI.CALCulate(Ch).PARAMeter(Tr).SElect on page 259

SCPI.CALCulate(Ch).SElected.MARKer(Mk).FUNction. TYPE on page 329

SCPI.CALCulate(Ch).SElected.MARKer(Mk).FUNction. TARGet on page 326

**Equivalent key**      **[Marker Search] - Target - Target Transition**

## SCPI.CALCulate(*Ch*).SElected.MARKer(*Mk*).FUNction. TYPE

|             |                                                                                                                                                                                    |
|-------------|------------------------------------------------------------------------------------------------------------------------------------------------------------------------------------|
| Object type | Property                                                                                                                                                                           |
| Syntax      | SCPI.CALCulate( <i>Ch</i> ).SElected.MARKer( <i>Mk</i> ).FUNction.TYPE = <i>Param</i><br><br><i>Param</i> = SCPI.CALCulate( <i>Ch</i> ).SElected.MARKer( <i>Mk</i> ).FUNction.TYPE |
| Description | For the active trace of channels 1 to 16 ( <i>Ch</i> ), selects the search type for marker 1 to 9 ( <i>Mk</i> ) and reference marker ( <i>Mk</i> :10).                             |
| Variable    |                                                                                                                                                                                    |

|              | <i>Param</i>                                                                                                                                                                                                                                                                                                                                                                                                                                                                                                                                                                                                                                                                                                                                                                                                                                                      |
|--------------|-------------------------------------------------------------------------------------------------------------------------------------------------------------------------------------------------------------------------------------------------------------------------------------------------------------------------------------------------------------------------------------------------------------------------------------------------------------------------------------------------------------------------------------------------------------------------------------------------------------------------------------------------------------------------------------------------------------------------------------------------------------------------------------------------------------------------------------------------------------------|
| Description  | Search type of marker                                                                                                                                                                                                                                                                                                                                                                                                                                                                                                                                                                                                                                                                                                                                                                                                                                             |
| Data type    | Character string type (String)                                                                                                                                                                                                                                                                                                                                                                                                                                                                                                                                                                                                                                                                                                                                                                                                                                    |
| Range        | <p>Select from the following.</p> <ul style="list-style-type: none"> <li>•"MAXimum"            Sets the search type to the maximum value.</li> <li>•"MINimum"           Sets the search type to the minimum value.</li> <li>•"PEAK"                Sets the search type to the peak search *1.</li> <li>•"LPEak"               Sets the search type to the peak search *1 to the left from the marker position.</li> <li>•"RPEak"               Sets the search type to the peak search *1 to the right from the marker position.</li> <li>•"TARGet"              Sets the search type to the target search *2.</li> <li>•"LTARget"             Sets the search type to the target search *2 to the left from the marker position.</li> <li>•"RTARget"             Sets the search type to the target search *2 to the right from the marker position.</li> </ul> |
| Preset value | "MAXimum"                                                                                                                                                                                                                                                                                                                                                                                                                                                                                                                                                                                                                                                                                                                                                                                                                                                         |

\*1. To specify the conditions of the peak, use the SCPI.CALCulate(*Ch*).SElected.MARKer(*Mk*).FUNction. PEXCursion object and the SCPI.CALCulate(*Ch*).SElected.MARKer(*Mk*).FUNction. PPOLarity object.

\*2. To specify the conditions of the target, use the SCPI.CALCulate(*Ch*).SElected.MARKer(*Mk*).FUNction. TARGet object and the SCPI.CALCulate(*Ch*).SElected.MARKer(*Mk*).FUNction. TTRansition object.

For information on the variable (*Ch*) and the variable (*Mk*), see Table 7-6, "Variable (*Ch*)," on page 209 and Table 7-11, "Variable (*Mk*)," on page 313, respectively.

## Examples

```
Dim SrchType As String
SCPI.CALCulate(1).PARAMeter(1).SElect
SCPI.CALCulate(1).SElected.MARKer(1).FUNction.TYPE = "targ"
SrchType = SCPI.CALCulate(1).SElected.MARKer(1).FUNction.TYPE
```

## Related objects

SCPI.CALCulate(Ch).PARAMeter(Tr).SElect on page 259  
SCPI.CALCulate(Ch).SElected.MARKer(Mk).FUNction. PEXCursion on page 324  
SCPI.CALCulate(Ch).SElected.MARKer(Mk).FUNction. PPOLarity on page 325  
SCPI.CALCulate(Ch).SElected.MARKer(Mk).FUNction. TARGet on page 326  
SCPI.CALCulate(Ch).SElected.MARKer(Mk).FUNction. TTRansition on page 328  
SCPI.CALCulate(Ch).SElected.MARKer(Mk).FUNction. EXECute on page 323

## Equivalent key

**[Marker Search] - Max|Min**

**[Marker Search] - Peak - Search Peak|Search Left|Search Right**

**[Marker Search] - Target - Search Target|Search Left|Search Right**

---

**NOTE**

When performing the operation from the front panel, you select the search type and execute the search at the same time.

---

## SCPI.CALCulate(*Ch*).SElected.MARKer(*Mk*).NOTCh. DATA

**Object type** Property

**Syntax** `Data = SCPI.CALCulate(Ch).SElected.MARKer(Mk).NOTCh.DATA`

**Description** For the active trace of channels 1 to 16 (*Ch*), reads out the notch search result of marker 1 to 9 (*Mk*) and reference marker (*Mk*:10).  
  
If the notch search is impossible, an error occurs when executed and the object is ignored. (Read only)

**Variable**

|             | <i>Data</i>                                                                                                                                                                                                                                                                                                                                                                                                                                 |
|-------------|---------------------------------------------------------------------------------------------------------------------------------------------------------------------------------------------------------------------------------------------------------------------------------------------------------------------------------------------------------------------------------------------------------------------------------------------|
| Description | Indicates 4-element array data (notch search result).<br><br><ul style="list-style-type: none"> <li>• <i>Data</i>(0)                      The bandwidth.</li> <li>• <i>Data</i>(1)                      Center point frequency of the 2 cutoff frequency points.</li> <li>• <i>Data</i>(2)                      The Q value.</li> <li>• <i>Data</i>(3)                      Insertion loss</li> </ul> The index of the array starts from 0. |
| Data type   | Variant type (Variant)                                                                                                                                                                                                                                                                                                                                                                                                                      |

For information on the variable (*Ch*) and the variable (*Mk*), see Table 7-13, “Variable (Ckit),” on page 432 and Table 7-11, “Variable (Mk),” on page 313, respectively.

**Examples**

```
Dim NotchData As Variant
SCPI.CALCulate(1).PARAMeter(1).SElect
NotchData = SCPI.CALCulate(1).SElected.MARKer(1).NOTCh.DATA
```

**Related objects**

SCPI.CALCulate(Ch).PARAMeter(Tr).SElect on page 259

SCPI.CALCulate(Ch).SElected.MARKer.NOTCh.STATe on page 332

SCPI.CALCulate(Ch).SElected.MARKer(Mk).NOTCh. THReshold on page 333

**Equivalent key** No equivalent key is available on the front panel.

## **SCPI.CALCulate(*Ch*).SElected.MARKer.NOTCh.STATe**

|             |                                                                                                                                                    |
|-------------|----------------------------------------------------------------------------------------------------------------------------------------------------|
| Object type | Property                                                                                                                                           |
| Syntax      | SCPI.CALCulate( <i>Ch</i> ).SElected.MARKer.NOTCh.STATe = <i>Status</i><br><i>Status</i> = SCPI.CALCulate( <i>Ch</i> ).SElected.MARKer.NOTCh.STATe |
| Description | For the active trace of channels 1 to 16 ( <i>Ch</i> ), turns ON/OFF the notch search result display.                                              |
| Variable    |                                                                                                                                                    |

|              |                                                                                                                                                                                                                                                 |
|--------------|-------------------------------------------------------------------------------------------------------------------------------------------------------------------------------------------------------------------------------------------------|
|              | <i>Status</i>                                                                                                                                                                                                                                   |
| Description  | ON/OFF of the notch search result display                                                                                                                                                                                                       |
| Data type    | Boolean type (Boolean)                                                                                                                                                                                                                          |
| Range        | Select from the following.<br><ul style="list-style-type: none"> <li>•True or -1                      Turns ON the notch search result display.</li> <li>•False or 0                      Turns OFF the notch search result display.</li> </ul> |
| Preset value | False or 0                                                                                                                                                                                                                                      |

For information on the variable (*Ch*), see Table 7-13, “Variable (Ckit),” on page 432 .

**Examples**

```
Dim NotchMode As Boolean
SCPI.CALCulate(1).PARAMeter(1).SElect
SCPI.CALCulate(1).SElected.MARKer.NOTCh.STATe = True
NotchMode = SCPI.CALCulate(1).SElected.MARKer.NOTCh.STATe
```

**Related objects**

SCPI.CALCulate(Ch).PARAmeter(Tr).SElect on page 259  
SCPI.CALCulate(Ch).SElected.MARKer(Mk).NOTCh. DATA on page 331  
SCPI.CALCulate(Ch).SElected.MARKer(Mk).NOTCh. THReshold on page 333

**Equivalent key**      **[Marker Search] - Notch**



## SCPI.CALCulate(*Ch*).SElected.MARKer(*Mk*).NOTCh. THReshold

|             |                                                                                                                                                                                                                 |
|-------------|-----------------------------------------------------------------------------------------------------------------------------------------------------------------------------------------------------------------|
| Object type | Property                                                                                                                                                                                                        |
| Syntax      | SCPI.CALCulate( <i>Ch</i> ).SElected.MARKer( <i>Mk</i> ).NOTCh. THReshold = <i>Value</i><br><i>Value</i> = SCPI.CALCulate( <i>Ch</i> ).SElected.MARKer( <i>Mk</i> ).NOTCh. THReshold                            |
| Description | For the active trace of channels 1 to 16 ( <i>Ch</i> ), sets the notch definition value (the value to define the pass-band of the filter) of marker 1 to 9 ( <i>Mk</i> ) and reference marker ( <i>Mk</i> :10). |
| Variable    |                                                                                                                                                                                                                 |

|              | <i>Value</i>                                                                                                                                                                                                                                                                       |
|--------------|------------------------------------------------------------------------------------------------------------------------------------------------------------------------------------------------------------------------------------------------------------------------------------|
| Description  | Notch definition value (the value to define the pass band of the filter)                                                                                                                                                                                                           |
| Data type    | Double precision floating point type (Double)                                                                                                                                                                                                                                      |
| Range        | -5E8 to 5E8                                                                                                                                                                                                                                                                        |
| Preset value | -3                                                                                                                                                                                                                                                                                 |
| Unit         | Varies depending on the data format. <ul style="list-style-type: none"> <li>• Log magnitude (MLOG): dB (decibel)</li> <li>• Phase (PHAS), Expanded phase (UPH) or Positive phase (PPH): ° (degree)</li> <li>• Group delay (GDEL): s (second)</li> <li>• Others: No unit</li> </ul> |
| Note         | If the specified variable is out of the allowable setup range, the minimum value (if the lower limit of the range is not reached) or the maximum value (if the upper limit of the range is exceeded) is set.                                                                       |

For information on the variable (*Ch*) and the variable (*Mk*), see Table 7-13, “Variable (Ckit),” on page 432 and Table 7-11, “Variable (Mk),” on page 313, respectively.

|                 |                                                                                                                                                                                                     |
|-----------------|-----------------------------------------------------------------------------------------------------------------------------------------------------------------------------------------------------|
| Examples        | <pre>Dim NotchVal As Double SCPI.CALCulate(1).PARAMeter(1).SElect SCPI.CALCulate(1).SElected.MARKer(1).NOTCh. THReshold = -6 NotchVal = SCPI.CALCulate(1).SElected.MARKer(1).NOTCh. THReshold</pre> |
| Related objects | <p>SCPI.CALCulate(Ch).PARAMeter(Tr).SElect on page 259</p> <p>SCPI.CALCulate(Ch).SElected.MARKer(Mk).NOTCh. DATA on page 331</p> <p>SCPI.CALCulate(Ch).SElected.MARKer.NOTCh.STATE on page 332</p>  |
| Equivalent key  | <b>[Marker Search] - Notch Value</b>                                                                                                                                                                |

**SCPI.CALCulate(Ch).SElected.MARKer.REFerence. STATE**

Object type      Property

Syntax            SCPI.CALCulate(Ch).SElected.MARKer.REFerence.STATE = *Status*  
*Status* = SCPI.CALCulate(Ch).SElected.MARKer.REFerence.STATE

Description      For the active trace of channels 1 to 16 (*Ch*), turns ON/OFF the reference marker mode.

Variable

|              |                                                                                                                                                                                                                                       |
|--------------|---------------------------------------------------------------------------------------------------------------------------------------------------------------------------------------------------------------------------------------|
|              | <i>Status</i>                                                                                                                                                                                                                         |
| Description  | ON/OFF of the reference marker mode                                                                                                                                                                                                   |
| Data type    | Boolean type (Boolean)                                                                                                                                                                                                                |
| Range        | Select from the following.<br><ul style="list-style-type: none"> <li>• True or -1                      Turns ON the reference marker mode.</li> <li>• False or 0                      Turns OFF the reference marker mode.</li> </ul> |
| Preset value | False or 0                                                                                                                                                                                                                            |

For information on the variable (*Ch*), see Table 7-6, “Variable (Ch),” on page 209.

Examples

```
Dim RefMode As Boolean
SCPI.CALCulate(1).PARAMeter(1).SElect
SCPI.CALCulate(1).SElected.MARKer.REFerence.STATE = True
RefMode = SCPI.CALCulate(1).SElected.MARKer.REFerence.STATE
```

Related objects      SCPI.CALCulate(Ch).PARAMeter(Tr).SElect on page 259

Equivalent key      **[Marker] - Ref Marker Mode**

## SCPI.CALCulate(*Ch*).SElected.MARKer(*Mk*).SET

|             |                                                                                                                                                                                                                           |
|-------------|---------------------------------------------------------------------------------------------------------------------------------------------------------------------------------------------------------------------------|
| Object type | Property                                                                                                                                                                                                                  |
| Syntax      | SCPI.CALCulate( <i>Ch</i> ).SElected.MARKer( <i>Mk</i> ).SET = <i>Param</i>                                                                                                                                               |
| Description | For the active trace of channels 1 to 16 ( <i>Ch</i> ), sets the value at the position of marker 1 to 9 ( <i>Mk</i> ) and reference marker ( <i>Mk</i> :10) to the value of the instrument setting item ( <i>Param</i> ). |
| Variable    |                                                                                                                                                                                                                           |

|             | <i>Param</i>                                                                                                                                                                                                                                                                                                                                                                                                                                                                                                                                                                                                                                                                                   |
|-------------|------------------------------------------------------------------------------------------------------------------------------------------------------------------------------------------------------------------------------------------------------------------------------------------------------------------------------------------------------------------------------------------------------------------------------------------------------------------------------------------------------------------------------------------------------------------------------------------------------------------------------------------------------------------------------------------------|
| Description | Instrument setting item                                                                                                                                                                                                                                                                                                                                                                                                                                                                                                                                                                                                                                                                        |
| Data type   | Character string type (String)                                                                                                                                                                                                                                                                                                                                                                                                                                                                                                                                                                                                                                                                 |
| Range       | <p>Select from the following.</p> <ul style="list-style-type: none"> <li>•"START"                Sets the sweep start value to the stimulus value at the marker position.</li> <li>•"STOP"                 Sets the sweep stop value to the stimulus value at the marker position.</li> <li>•"CENTer"              Sets the sweep center value to the stimulus value at the marker position.</li> <li>•"RLEVel"               Sets the reference line value to the response value at the marker position.</li> <li>•"DELay"                Sets the electrical delay time value to the value of the group delay at the marker position (a value smoothed with the aperture of 20%).</li> </ul> |

For information on the variable (*Ch*) and the variable (*Mk*), see Table 7-6, "Variable (Ch)," on page 209 and Table 7-11, "Variable (Mk)," on page 313, respectively.

|                 |                                                                                                                                   |
|-----------------|-----------------------------------------------------------------------------------------------------------------------------------|
| Examples        | <pre>Dim MkrTo As String SCPI.CALCulate(1).PARAMeter(1).SElect SCPI.CALCulate(1).SElected.MARKer(1).SET = "cent"</pre>            |
| Related objects | <p>SCPI.CALCulate(Ch).PARAMeter(Tr).SElect on page 259</p> <p>SCPI.CALCulate(Ch).SElected.MARKer.REFerence. STATE on page 334</p> |
| Equivalent key  | <b>[Marker Fctn] - Marker -&gt; Start Marker -&gt; Stop Marker -&gt; Center Marker -&gt; Reference Marker -&gt; Delay</b>         |

## SCPI.CALCulate(*Ch*).SElected.MARKer(*Mk*).STATE

|             |                                                                                                                                                                  |
|-------------|------------------------------------------------------------------------------------------------------------------------------------------------------------------|
| Object type | Property                                                                                                                                                         |
| Syntax      | SCPI.CALCulate( <i>Ch</i> ).SElected.MARKer( <i>Mk</i> ).STATE = <i>Status</i><br><i>Status</i> = SCPI.CALCulate( <i>Ch</i> ).SElected.MARKer( <i>Mk</i> ).STATE |
| Description | For the active trace of channels 1 to 16 ( <i>Ch</i> ), turns ON/OFF the display of marker 1 to 9 ( <i>Mk</i> ) and reference marker ( <i>Mk</i> :10).           |
| Variable    |                                                                                                                                                                  |

|              |                                                                                                                                                                                                                                     |
|--------------|-------------------------------------------------------------------------------------------------------------------------------------------------------------------------------------------------------------------------------------|
|              | <i>Status</i>                                                                                                                                                                                                                       |
| Description  | ON/OFF of display of markers 1 to 9 and reference marker                                                                                                                                                                            |
| Data type    | Boolean type (Boolean)                                                                                                                                                                                                              |
| Range        | Select from the following.<br><ul style="list-style-type: none"> <li>•True or -1                      Turns ON the display of the marker.</li> <li>•False or 0                      Turns OFF the display of the marker.</li> </ul> |
| Preset value | False or 0                                                                                                                                                                                                                          |

For information on the variable (*Ch*) and the variable (*Mk*), see Table 7-6, “Variable (Ch),” on page 209 and Table 7-11, “Variable (Mk),” on page 313, respectively.

**Examples**

```
Dim Mkr As Boolean
SCPI.CALCulate(1).PARAmeter(2).SElect
SCPI.CALCulate(1).SElected.MARKer(10).STATE = True
Mkr = SCPI.CALCulate(1).SElected.MARKer(10).STATE
```

**Related objects**      SCPI.CALCulate(Ch).PARAmeter(Tr).SElect on page 259

**Equivalent key**      When turning ON the display of the marker  
**[Marker] - Marker 1|Marker 2|Marker 3|Marker 4|Ref Marker**  
**[Marker] - More Markers - Marker 5|Marker 6|Marker 7|Marker 8|Marker 9**

---

**NOTE**                      When performing the operation from the front panel, a marker set to ON is automatically set to the active marker.

When turning OFF the display of the marker  
**[Marker] - Clear Marker Menu - Marker 1|Marker 2|Marker 3|Marker 4|Marker 5|Marker 6|Marker 7|Marker 8|Marker 9|Ref Marker**

## SCPI.CALCulate(Ch).SElected.MARKer(Mk).X

**Object type** Property

**Syntax** SCPI.CALCulate(Ch).SElected.MARKer(Mk).X = *Value*  
*Value* = SCPI.CALCulate(Ch).SElected.MARKer(Mk).X

**Description** For the active trace of channels 1 to 16 (*Ch*), sets the stimulus value for marker 1 to 9 (*Ch*) and reference marker (*Ch*:10).

**Variable**

|              | <i>Value</i>                                                                                                                                                                                                 |
|--------------|--------------------------------------------------------------------------------------------------------------------------------------------------------------------------------------------------------------|
| Description  | Stimulus value of the marker*1                                                                                                                                                                               |
| Data type    | Double precision floating point type (Double)                                                                                                                                                                |
| Range        | Sweep start value to sweep stop value*2                                                                                                                                                                      |
| Preset value | Sweep start value*3                                                                                                                                                                                          |
| Unit         | Hz (hertz), dBm or s (second)                                                                                                                                                                                |
| Note         | If the specified variable is out of the allowable setup range, the minimum value (if the lower limit of the range is not reached) or the maximum value (if the upper limit of the range is exceeded) is set. |

\*1. When the reference marker mode is ON ("True" is specified with the SCPI.CALCulate(Ch).SElected.MARKer.REFerence. STATE object), it is the value relative to the reference marker.

\*2. When the span value of the sweep range is 0, the range is from 0 to sweep time value.

\*3. When the span value of the sweep range is 0, the preset value is 0.

For information on the variable (*Ch*) and the variable (*Mk*), see Table 7-6, "Variable (Ch)," on page 209 and Table 7-11, "Variable (Mk)," on page 313, respectively.

**Examples**

```
Dim MkrX As Double
SCPI.CALCulate(1).PARAMeter(1).SElect
SCPI.CALCulate(1).SElected.MARKer(1).X = 1E9
MkrX = SCPI.CALCulate(1).SElected.MARKer(1).X
```

**Related objects** SCPI.CALCulate(Ch).PARAMeter(Tr).SElect on page 259  
 SCPI.CALCulate(Ch).SElected.MARKer.REFerence. STATE on page 334  
 SCPI.CALCulate(Ch).SElected.MARKer(Mk).Y on page 338

**Equivalent key** **[Marker] - Marker 1|Marker 2|Marker 3|Marker 4|Ref Marker**  
**[Marker] - More Markers - Marker 5|Marker 6|Marker 7|Marker 8|Marker 9**

**NOTE** When performing the operation from the front panel, you turn ON the marker and set the stimulus value at the same time.

## SCPI.CALCulate(*Ch*).SElected.MARKer(*Mk*).Y

**Object type** Property

**Syntax** *Data* = SCPI.CALCulate(*Ch*).SElected.MARKer(*Mk*).Y

**Description** For the active trace of channels 1 to 16 (*Ch*), reads out the response value of marker 1 to 9 (*Mk*) and reference marker (*Mk*:10).  
 When the reference marker mode is ON ("True" is specified with the SCPI.CALCulate(Ch).SElected.MARKer.REFERence.STATE object), the readout value is the value relative to the reference marker. (Read only)

**Variable**

|             | <i>Data</i>                                                                                                                                                                                                                                                                                                                                                                                       |
|-------------|---------------------------------------------------------------------------------------------------------------------------------------------------------------------------------------------------------------------------------------------------------------------------------------------------------------------------------------------------------------------------------------------------|
| Description | Indicates 2-element array data (response value of marker).<br><ul style="list-style-type: none"> <li>• <i>Data</i>(0) Response value (primary value) at the marker position.</li> <li>• <i>Data</i>(1) Response value (secondary value) at the marker position. Always 0 when the data format is not the Smith chart format or the polar format.</li> </ul> The index of the array starts from 0. |
| Data type   | Variant type (Variant)                                                                                                                                                                                                                                                                                                                                                                            |

For information on the variable (*Ch*) and the variable (*Mk*), see Table 7-6, "Variable (Ch)," on page 209 and Table 7-11, "Variable (Mk)," on page 313, respectively.

**Examples**

```
Dim MkrY As Variant
SCPI.CALCulate(1).PARAMeter(1).SElect
MkrY = SCPI.CALCulate(1).SElected.MARKer(1).Y
```

**Related objects** SCPI.CALCulate(Ch).PARAMeter(Tr).SElect on page 259  
 SCPI.CALCulate(Ch).SElected.MARKer.REFERence.STATE on page 334  
 SCPI.CALCulate(Ch).SElected.MARKer(Mk).X on page 337

**Equivalent key** No equivalent key is available on the front panel.

## SCPI.CALCulate(*Ch*).SElected.MATH.FUNcTion

**Object type** Property

**Syntax** SCPI.CALCulate(*Ch*).SElected.MATH.FUNcTion = *Param*  
*Param* = SCPI.CALCulate(*Ch*).SElected.MATH.FUNcTion

**Description** For the active trace of channels 1 to 16 (*Ch*), selects the data trace display method (math method between measurement data and memory trace data).  
 The math result according to this setting is displayed on the data trace.

**Variable**

|              | <i>Param</i>                                                                                                                                                                                                                                                                                                                                                                                                                                                                                                                                          |
|--------------|-------------------------------------------------------------------------------------------------------------------------------------------------------------------------------------------------------------------------------------------------------------------------------------------------------------------------------------------------------------------------------------------------------------------------------------------------------------------------------------------------------------------------------------------------------|
| Description  | Math method between measurement data and memory trace data                                                                                                                                                                                                                                                                                                                                                                                                                                                                                            |
| Data type    | Character string type (String)                                                                                                                                                                                                                                                                                                                                                                                                                                                                                                                        |
| Range        | Select from the following.<br><ul style="list-style-type: none"> <li>•"NORMal"                Specifies <i>Data</i> (no math).</li> <li>•"DIVide"                Specifies <i>Data / Mem</i>.</li> <li>•"MULTiply"             Specifies <i>Data × Mem</i>.</li> <li>•"SUBTract"             Specifies <i>Data - Mem</i>.</li> <li>•"ADD"                    Specifies <i>Data + Mem</i>.</li> </ul> Where <i>Data</i> is the measurement data (corrected data array) and <i>Mem</i> is the data stored in the memory trace (corrected memory array). |
| Preset value | "NORMal"                                                                                                                                                                                                                                                                                                                                                                                                                                                                                                                                              |

For information on the variable (*Ch*), see Table 7-6, “Variable (Ch),” on page 209.

**Examples**

```
Dim MathFunc As String
SCPI.CALCulate(1).PARAmeter(1).SElect
SCPI.CALCulate(1).SElected.MATH.FUNcTion = "div"
MathFunc = SCPI.CALCulate(1).SElected.MATH.FUNcTion
```

**Related objects** SCPI.CALCulate(Ch).PARAmeter(Tr).SElect on page 259

**Equivalent key** **[Display] - Data Math - OFF|Data / Mem|Data \* Mem|Data – Mem|Data + Mem**

## **SCPI.CALCulate(*Ch*).SElected.MATH.MEMorize**

|                 |                                                                                                                                                    |
|-----------------|----------------------------------------------------------------------------------------------------------------------------------------------------|
| Object type     | Method                                                                                                                                             |
| Syntax          | SCPI.CALCulate( <i>Ch</i> ).SElected.MATH.MEMorize                                                                                                 |
| Description     | For the active trace of channels 1 to 16 ( <i>Ch</i> ), copies the measurement data at the execution of this object to the memory trace. (No read) |
| Variable        | For information on the variable ( <i>Ch</i> ), see Table 7-6, “Variable (Ch),” on page 209.                                                        |
| Examples        | SCPI.CALCulate(1).PARAmeter(1).SElect<br>SCPI.CALCulate(1).SElected.MATH.MEMorize                                                                  |
| Related objects | SCPI.CALCulate(Ch).PARAmeter(Tr).SElect on page 259                                                                                                |
| Equivalent key  | <b>[Display] - Data -&gt; Mem</b>                                                                                                                  |



## SCPI.CALCulate(*Ch*).SElected.MIXer.XAXis

- Type of object      Property
- Syntax                *SCPI.CALCulate(Ch).SElected.MIXer.XAXis = Param*  
*Param = SCPI.CALCulate(Ch).SElected.MIXer.XAXis*
- Description         For the active trace of channels 1 to 16 (*Ch*), selects the X-axis frequency when the frequency offset feature is off.
- Variable

|              | <i>Param</i>                                                                                                                                                                                                                                                                                                                                                                          |
|--------------|---------------------------------------------------------------------------------------------------------------------------------------------------------------------------------------------------------------------------------------------------------------------------------------------------------------------------------------------------------------------------------------|
| Description  | Selects the X-axis frequency (frequency offset: off)                                                                                                                                                                                                                                                                                                                                  |
| Data type    | Character string type (String)                                                                                                                                                                                                                                                                                                                                                        |
| Range        | Select from the following.<br><ul style="list-style-type: none"> <li>•"NORMal"                Specifies the normal frequency.</li> <li>•"RFPLo"                Specifies the frequency <math>RF + LO</math>.</li> <li>•"RFMLo"                Specifies the frequency <math>RF - LO</math>.</li> <li>•"LOMRf"                Specifies the frequency <math>LO - RF</math>.</li> </ul> |
| Preset value | "NORMal"                                                                                                                                                                                                                                                                                                                                                                              |

For information on the variable (*Ch*), refer to Table 7-6, "Variable (Ch)," on page 209.

- Example of use      `Dim Xaxis As String`  
`SCPI.SENSE.OFFSet.STATE = False`  
`SCPI.CALCulate(1).SElected.MIXer.XAXis = "RFPLo"`  
`Xaxis = SCPI.CALCulate(1).SElected.MIXer.XAXis`
- Related objects     `SCPI.SENSE(Ch).OFFSet.STATE` on page 627  
`SCPI.CALCulate(Ch).SElected.OFFset.XAXis` on page 344
- Equivalent key      **[Sweep Setup] - Frequency Offset - X-Axis - Normal|RF+LO|RF-LO|LO-RF**

## SCPI.CALCulate(*Ch*).SElected.MStatistics.DATA

**Object type** Property

**Syntax** *Data* = SCPI.CALCulate(*Ch*).SElected.MStatistics.DATA

**Description** Reads out the statistics values (the mean vale, the standard deviation, and the difference between the maximum value and the minimum value) of the active trace of channels 1 to 16 (*Ch*). (Read only)

**Variable**

|             | <i>Data</i>                                                                                                                                                                                                                                                                                                                           |
|-------------|---------------------------------------------------------------------------------------------------------------------------------------------------------------------------------------------------------------------------------------------------------------------------------------------------------------------------------------|
| Description | <p>Indicates 3-element array data (statistics value).</p> <ul style="list-style-type: none"> <li>• <i>Data</i>(0) Mean value</li> <li>• <i>Data</i>(1) Standard deviation</li> <li>• <i>Data</i>(2) Difference between the maximum value and the minimum value (Peak to Peak)</li> </ul> <p>The index of the array starts from 0.</p> |
| Data type   | Variant type (Variant)                                                                                                                                                                                                                                                                                                                |

For information on the variable (*Ch*), see Table 7-6, “Variable (Ch),” on page 209.

**Examples**

```
Dim MstData As Variant
SCPI.CALCulate(1).PARAMeter(1).SElect
MstData = SCPI.CALCulate(1).SElected.MStatistics.DATA
```

**Related objects** SCPI.CALCulate(*Ch*).PARAmeter(*Tr*).SElect on page 259  
 SCPI.CALCulate(*Ch*).SElected.MStatistics.STATe on page 343

**Equivalent key** No equivalent key is available on the front panel.

## SCPI.CALCulate(*Ch*).SElected.MStatistIcs.STATe

**Object type** Property

**Syntax** SCPI.CALCulate(*Ch*).SElected.MStatistIcs.STATe = *Status*  
*Status* = SCPI.CALCulate(*Ch*).SElected.MStatistIcs.STATe

**Description** For the active trace of channels 1 to 16 (*Ch*), turns ON/OFF the statistics values (the mean vale, the standard deviation, and the difference between the maximum value and the minimum value) display.

**Variable**

|              |                                                                                                                                                                                                                                             |
|--------------|---------------------------------------------------------------------------------------------------------------------------------------------------------------------------------------------------------------------------------------------|
|              | <b><i>Status</i></b>                                                                                                                                                                                                                        |
| Description  | ON/OFF of the statistics value display                                                                                                                                                                                                      |
| Data type    | Boolean type (Boolean)                                                                                                                                                                                                                      |
| Range        | Select from the following.<br><ul style="list-style-type: none"> <li>• True or -1                      Turns ON the statistics value display.</li> <li>• False or 0                      Turns OFF the statistics value display.</li> </ul> |
| Preset value | False or 0                                                                                                                                                                                                                                  |

For information on the variable (*Ch*), see Table 7-6, “Variable (Ch),” on page 209.

**Examples**

```
Dim Mst As Boolean
SCPI.CALCulate(1).PARAmeter(1).SElect
SCPI.CALCulate(1).SElected.MStatistIcs.STATe = True
Mst = SCPI.CALCulate(1).SElected.MStatistIcs.STATe
```

**Related objects** SCPI.CALCulate(*Ch*).PARAmeter(*Tr*).SElect on page 259  
SCPI.CALCulate(*Ch*).SElected.MStatistIcs.DATA on page 342

**Equivalent key** **[Marker Fctn] - Statistics**

## SCPI.CALCulate(*Ch*).SElected.OFFset.XAXis

|                |                                                                                                                                      |
|----------------|--------------------------------------------------------------------------------------------------------------------------------------|
| Type of object | Property                                                                                                                             |
| Syntax         | SCPI.CALCulate( <i>Ch</i> ).SElected.OFFset.XAXis = <i>Param</i><br><i>Param</i> = SCPI.CALCulate( <i>Ch</i> ).SElected.OFFset.XAXis |
| Description    | For the active trace of channels 1 to 16 ( <i>Ch</i> ), selects the X-axis frequency when the frequency offset feature is on.        |
| Variable       |                                                                                                                                      |

|              | <i>Param</i>                                                                                                                                                                                                                                                                                                                                                                                 |
|--------------|----------------------------------------------------------------------------------------------------------------------------------------------------------------------------------------------------------------------------------------------------------------------------------------------------------------------------------------------------------------------------------------------|
| Description  | Selects the X-axis frequency (frequency offset: on)                                                                                                                                                                                                                                                                                                                                          |
| Data type    | Character string type (String)                                                                                                                                                                                                                                                                                                                                                               |
| Range        | Select from the following. <ul style="list-style-type: none"> <li>•"BASE"                      Sets the normal frequency.</li> <li>•"STIMulus"                Sets the frequency for the <i>source port</i> for the specified measurement parameter.</li> <li>•"RESPonse"                Sets the frequency for <i>the receiver port for the specified measurement parameter</i>.</li> </ul> |
| Preset value | "RESPonse"                                                                                                                                                                                                                                                                                                                                                                                   |

For information on the variable (*Ch*), refer to Table 7-6, "Variable (Ch)," on page 209.

|                 |                                                                                                                                                                    |
|-----------------|--------------------------------------------------------------------------------------------------------------------------------------------------------------------|
| Example of use  | <pre>Dim Xaxis As String SCPI.SENSE.OFFSet.STATe = True SCPI.CALCulate(1).SElected.OFFset.XAXis = "STIMulus" Xaxis = SCPI.CALCulate(1).SElected.OFFset.XAXis</pre> |
| Related objects | <p>SCPI.SENSE(Ch).OFFSet.STATe on page 627</p> <p>SCPI.CALCulate(Ch).SElected.MIXer.XAXis on page 341</p>                                                          |
| Equivalent key  | <b>[Sweep Setup] - Frequency Offset - X-Axis - Base Stimulus Response</b>                                                                                          |

## SCPI.CALCulate(Ch).SElected.RLIMit.DATA

**Object type** Property

**Syntax** SCPI.CALCulate(Ch).SElected.RLIMit.DATA = *Data*  
*Data* = SCPI.CALCulate(Ch).SElected.RLIMit.DATA

**Description** For the active trace of channel 1 to channel 16 (specified with the SCPI.CALCulate(Ch).PARAMeter(Tr).SElect command), sets the ripple limit table.  
 The data transfer format when this command is executed depends on the setting with the SCPI.FORMat.DATA command.

**Variable**

|             | <i>Status</i>                                                                                                                                                                                                                                                                                                                                                                                                                                                                                                                                                                                                                                                                                                                                                                                                                                                                                                        |
|-------------|----------------------------------------------------------------------------------------------------------------------------------------------------------------------------------------------------------------------------------------------------------------------------------------------------------------------------------------------------------------------------------------------------------------------------------------------------------------------------------------------------------------------------------------------------------------------------------------------------------------------------------------------------------------------------------------------------------------------------------------------------------------------------------------------------------------------------------------------------------------------------------------------------------------------|
| Description | <p>Indicates the array data (for ripple line) of 1 + Num (number of limit lines)×4. Where n is an integer between 1 and Num.</p> <ul style="list-style-type: none"> <li>• <i>Data</i>(0) The number of limit lines you want to set. Specify an integer ranging 0 to 12. When the number of limit lines is set to 0 (clears the limit table), the variable <i>Data</i> is only required with <i>Data</i>(0).</li> <li>• <i>Data</i>(n×4-3) The type of the n-th line. Specify an integer 0 to 1 as follows.<br/>0: OFF<br/>1: ON</li> <li>• <i>Data</i>(n×4-2) The value on the horizontal axis (frequency/power/time) of the start point of the n-th line.</li> <li>• <i>Data</i>(n×4-1) The value on the horizontal axis (frequency/power/time) of the end point of the n-th line.</li> <li>• <i>Data</i>(n×4) The ripple line value (dB) of the n-th line.</li> </ul> <p>The index of the array starts from 0.</p> |
| Data type   | Variant type (Variant)                                                                                                                                                                                                                                                                                                                                                                                                                                                                                                                                                                                                                                                                                                                                                                                                                                                                                               |
| Note        | <p>If there is no array data of 1+Num (number of set lines)×4 when setting a formatted memory array, an error occurs when executed and the object is ignored. For <i>Data</i>(n×4-3) in the array data, if you specify an integer other than 0 or 1, an error occurs when executed. For <i>Data</i>(n×4-2) and <i>Data</i>(n×4-1) in the array data, if the specified value is out of the allowable setup range, the minimum value (if the lower limit of the range is not reached) or the maximum value (if the upper limit of the range is exceeded) is set.</p>                                                                                                                                                                                                                                                                                                                                                   |

For information on the variable (*Ch*), see Table 7-6, “Variable (Ch),” on page 209.

**Examples (1)**

```
Dim RlimData As Variant
SCPI.CALCulate(1).PARAMeter(1).SElect
SCPI.CALCulate(1).SElected.RLIMit.DATA = Array(1,1,1E6,1E9,0)
RlimData = SCPI.CALCulate(1).SElected.RLIMit.DATA

SCPI.CALCulate(1).PARAMeter(1).SElect
SCPI.CALCulate(1).SElected.RLIMit.DATA = Array(0) ''' Clear Ripple
Limit Table
```

**Examples (2)**

```
Dim RlimData(5) As Variant
Dim Ref As Variant
RlimData(0) = 1
```

## COM Object Reference

### SCPI.CALCulate(Ch).SElected.RLIMit.DATA

```
RLimData(1) = 1
RLimData(2) = 1e6
RLimData(3) = 1e9
RLimData(4) = 0
SCPI.CALCulate(1).PARAMeter(1).SElect
SCPI.CALCulate(1).SElected.RLIMit.DATA = RLimData
Ref = SCPI.CALCulate(1).SElected.RLIMit.DATA

Dim RLimData(0) as Variant
RLimData(0) = 0
SCPI.CALCulate(1).PARAMeter(1).SElect
SCPI.CALCulate(1).SElected.RLIMit.DATA = RLimData ''' Clear Ripple
Limit Table
```

Related objects    SCPI.CALCulate(Ch).PARAMeter(Tr).SElect on page 259  
                    SCPI.CALCulate(Ch).SElected.RLIMit.STATe on page 352

Equivalent key    **[Analysis] - Ripple Limit - Edit Ripple Limit - Add**

## SCPI.CALCulate(*Ch*).SElected.RLIMit.DISPlay.LINE

**Object type** Property

**Syntax** SCPI.CALCulate(Ch).SElected.RLIMit.DISPlay.LINE = Status  
 Status = SCPI.CALCulate(Ch).SElected.RLIMit.DISPlay.LINE

**Description** For the active trace of channel 1 to channel 16 (specified with the SCPI.CALCulate(Ch).PARAmeter(Tr).SElect command), turns ON/OFF the ripple limit line display.

**Variable**

|              | <i>Status</i>                                                                                                                                                                                                                               |
|--------------|---------------------------------------------------------------------------------------------------------------------------------------------------------------------------------------------------------------------------------------------|
| Description  | ON/OFF the ripple limit line display.                                                                                                                                                                                                       |
| Data type    | Boolean type (Boolean)                                                                                                                                                                                                                      |
| Range        | Select from the following.<br><ul style="list-style-type: none"> <li>•True or -1                      Turns ON the ripple limit line display.</li> <li>•False or 0                      Turns OFF the ripple limit line display.</li> </ul> |
| Preset value | False or 0                                                                                                                                                                                                                                  |

For information on the variable (*Ch*), see Table 7-6, “Variable (Ch),” on page 209.

**Examples**

```
Dim RLimDisp As Boolean
SCPI.CALCulate(1).SElected.RLIMit.DISPlay.LINE = True
RLimDisp = SCPI.CALCulate(1).SElected.RLIMit.DISPlay.LINE
```

**Related objects**

SCPI.CALCulate(Ch).PARAmeter(Tr).SElect on page 259

SCPI.CALCulate(Ch).SElected.RLIMit.STATe on page 352

SCPI.CALCulate(Ch).SElected.RLIMit.DISPlay.SElect on page 348

SCPI.CALCulate(Ch).SElected.RLIMit.DISPlay.VALue on page 349

**Equivalent key** **[Analysis] - Ripple Limit - Ripple Limit**

## SCPI.CALCulate(*Ch*).SElected.RLIMit.DISPlay.SELect

**Object type** Property

**Syntax** SCPI.CALCulate(Ch).SElected.RLIMit.DISPlay.SELect = Value  
 Value = SCPI.CALCulate(Ch).SElected.RLIMit.DISPlay.SELect

**Description** For channel 1 to channel 16 (specified with the SCPI.CALCulate(Ch).PARAmeter(Tr).SElect command), sets the ripple limit band for ripple value display.

**Variable**

|              | <i>Value</i>             |
|--------------|--------------------------|
| Description  | The ripple limit band.   |
| Data type    | Long integer type (Long) |
| Range        | 1 to 12                  |
| Preset value | 1                        |

For information on the variable (*Ch*), see Table 7-6, “Variable (Ch),” on page 209.

**Examples**

```
Dim RBand As Long
SCPI.CALCulate(1).SElected.RLIMit.DISPlay.SELect = 2
RBand = SCPI.CALCulate(1).SElected.RLIMit.DISPlay.SELect
```

**Related objects**

- SCPI.CALCulate(Ch).PARAmeter(Tr).SElect on page 259
- SCPI.CALCulate(Ch).SElected.RLIMit.STATe on page 352
- SCPI.CALCulate(Ch).SElected.RLIMit.DISPlay.LINE on page 347
- SCPI.CALCulate(Ch).SElected.RLIMit.DISPlay.VALue on page 349

**Equivalent key** **[Analysis] - Ripple Limit - Ripple Band**



## SCPI.CALCulate(*Ch*).SElected.RLIMit.DISPlay.VALue

Object type Property

Syntax SCPI.CALCulate(Ch).SElected.RLIMit.DISPlay.VALue = Param  
 Param = SCPI.CALCulate(Ch).SElected.RLIMit.DISPlay.VALue

Description For the active trace of channel 1 to channel 16 (specified with the SCPI.CALCulate(Ch).PARAmeter(Tr).SElect command), selects the display type of ripple value.

Variable

|              | <i>Param</i>                                                                                                                                                                                                                                    |
|--------------|-------------------------------------------------------------------------------------------------------------------------------------------------------------------------------------------------------------------------------------------------|
| Description  | The displaying type of ripple value.                                                                                                                                                                                                            |
| Data type    | Character string type (String)                                                                                                                                                                                                                  |
| Range        | Select from the following.<br><ul style="list-style-type: none"> <li>•"OFF" Specifies the display off.</li> <li>•"ABSolute" Specifies the absolute value for display type.</li> <li>•"MARgin" Specifies the margin for display type.</li> </ul> |
| Preset value | "OFF"                                                                                                                                                                                                                                           |

For information on the variable (*Ch*), see Table 7-6, "Variable (Ch)," on page 209.

Examples  

```
Dim RDisp As String
SCPI.CALCulate(1).SElected.RLIMit.DISPlay.VALue = "ABSolute"
RDisp = SCPI.CALCulate(1).SElected.RLIMit.DISPlay.VALue
```

Related objects  
 SCPI.CALCulate(Ch).PARAmeter(Tr).SElect on page 259  
 SCPI.CALCulate(Ch).SElected.RLIMit.STATe on page 352  
 SCPI.CALCulate(Ch).SElected.RLIMit.DISPlay.LINE on page 347  
 SCPI.CALCulate(Ch).SElected.RLIMit.DISPlay.SElect on page 348

Equivalent key **[Analysis] - Ripple Limit - Ripple Value - OFF|Absolute|Margin**

## **SCPI.CALCulate(Ch).SElected.RLIMit.FAIL**

**Object type** Property

**Syntax** *Status* = SCPI.CALCulate(Ch).SElected.RLIMit.FAIL

**Description** For the active trace of channel 1 to channel 16 (specified with the SCPI.CALCulate(Ch).PARAMeter(Tr).SElect command), reads out the ripple test result. (Read only)

**Variable**

|             | <i>Status</i>                                                                                                                                                                         |
|-------------|---------------------------------------------------------------------------------------------------------------------------------------------------------------------------------------|
| Description | The ripple test result                                                                                                                                                                |
| Data type   | Boolean type (Boolean)                                                                                                                                                                |
| Range       | Select from the following.<br>•True or -1                      Turns ON the ripple test result is FAIL.<br>•False or 0                      Turns OFF the ripple test result is FAIL. |
| Note        | When the ripple test if set to OFF, False or 0 is always read out.                                                                                                                    |

For information on the variable (*Ch*), see Table 7-6, “Variable (Ch),” on page 209.

**Examples**

```
Dim Result As Boolean
Result = SCPI.CALCulate(1).SElected.RLIMit.FAIL
```

**Related objects** SCPI.CALCulate(Ch).PARAMeter(Tr).SElect on page 259  
SCPI.CALCulate(Ch).SElected.RLIMit.STATe on page 352

**Equivalent key** No equivalent key is available on the front panel.

## SCPI.CALCulate(*Ch*).SElected.RLIMit.REPort.DATA

**Object type** Property

**Syntax** `Data = SCPI.CALCulate(Ch).SElected.RLIMit.REPort.DATA`

**Description** For the active trace of channel 1 to channel 16 (specified with the SCPI.CALCulate(Ch).PARAMeter(Tr).SElect command), reads out the ripple value of the ripple test.  
 The data transfer format when this command is executed depends on the setting with the SCPI.FORMAT.DATA command.(Read only)

**Variable**

|             | <i>Status</i>                                                                                                                                                                                                                                                                                                                                                                                                                                                                                                                                                                                                                             |
|-------------|-------------------------------------------------------------------------------------------------------------------------------------------------------------------------------------------------------------------------------------------------------------------------------------------------------------------------------------------------------------------------------------------------------------------------------------------------------------------------------------------------------------------------------------------------------------------------------------------------------------------------------------------|
| Description | <p>Indicates the array data (for ripple line) of 1 + Num (number of limit lines)×3. Where n is an integer between 1 and 12.</p> <ul style="list-style-type: none"> <li>• <i>Data(0)</i>                      Number of ripple limit line.</li> <li>• <i>Data(n×3-2)</i>                  Number of ripple limit bands.</li> <li>• <i>Data(n×3-1)</i>                  Ripple value.</li> <li>• <i>Data(n×3)</i>                      Results of ripple test.<br/>                     Select from the following.<br/>                     0:PASS<br/>                     1:FAIL.</li> </ul> <p>The index of the array starts from 0.</p> |
| Data type   | Variant type (Variant)                                                                                                                                                                                                                                                                                                                                                                                                                                                                                                                                                                                                                    |

For information on the variable (*Ch*), see Table 7-6, “Variable (Ch),” on page 209.

**Examples**

```
Dim RData As Variant
SCPI.CALCulate(1).PARAMeter(1).SElect
RData = SCPI.CALCulate(1).SElected.RLIMit.REPort.DATA
```

**Related objects** SCPI.CALCulate(Ch).PARAMeter(Tr).SElect on page 259  
 SCPI.CALCulate(Ch).SElected.RLIMit.STATe on page 352

**Equivalent key** No equivalent key is available on the front panel.

## SCPI.CALCulate(*Ch*).SElected.RLIMit.STATe

**Object type** Property

**Syntax** SCPI.CALCulate(*Ch*).SElected.RLIMit.STATe = *Status*  
*Status* = SCPI.CALCulate(*Ch*).SElected.RLIMit.STATe

**Description** For the active trace of channel 1 to channel 16 (specified with the SCPI.CALCulate(Ch).PARAMeter(Tr).SElect command), turns ON/OFF the ripple test function.

**Variable**

|              |                                                                                                                                                                                                                                   |
|--------------|-----------------------------------------------------------------------------------------------------------------------------------------------------------------------------------------------------------------------------------|
|              | <i>Status</i>                                                                                                                                                                                                                     |
| Description  | ON/OFF the ripple test function                                                                                                                                                                                                   |
| Data type    | Boolean type (Boolean)                                                                                                                                                                                                            |
| Range        | Select from the following.<br><ul style="list-style-type: none"> <li>•True or -1                      Turns ON the ripple test function.</li> <li>•False or 0                      Turns OFF the ripple test function.</li> </ul> |
| Preset value | False or 0                                                                                                                                                                                                                        |

For information on the variable (*Ch*), see Table 7-6, “Variable (Ch),” on page 209.

**Examples**

```
Dim RLimTest As Boolean
SCPI.CALCulate(1).PARAMeter(1).SElect
SCPI.CALCulate(1).SElected.RLIMit.STATe = True
RLimTest = SCPI.CALCulate(1).SElected.RLIMit.STATe
```

**Related objects**

SCPI.CALCulate(Ch).PARAMeter(Tr).SElect on page 259

SCPI.CALCulate(Ch).SElected.RLIMit.DATA on page 345

SCPI.CALCulate(Ch).SElected.RLIMit.DISPlay.LINE on page 347

SCPI.CALCulate(Ch).SElected.RLIMit.DISPlay.SElect on page 348

SCPI.CALCulate(Ch).SElected.RLIMit.DISPlay.VALue on page 349

SCPI.CALCulate(Ch).SElected.RLIMit.FAIL on page 350

SCPI.CALCulate(Ch).SElected.RLIMit.REPort.DATA on page 351

**Equivalent key** **[Analysis] - Ripple Limit - Ripple Limit Test**

## SCPI.CALCulate(Ch).SElected.SMOothing.APERture

- Object type** Property
- Syntax** SCPI.CALCulate(Ch).SElected.SMOothing.APERture = *Value*  
*Value* = SCPI.CALCulate(Ch).SElected.SMOothing.APERture
- Description** Sets the smoothing aperture (percentage to the sweep span value) of the active trace of channels 1 to 16 (*Ch*).
- Variable**

|              | <i>Value</i>                                                                                                                                                                                                 |
|--------------|--------------------------------------------------------------------------------------------------------------------------------------------------------------------------------------------------------------|
| Description  | Smoothing aperture                                                                                                                                                                                           |
| Data type    | Double precision floating point type (Double)                                                                                                                                                                |
| Range        | 0.05 to 25                                                                                                                                                                                                   |
| Preset value | 1.5                                                                                                                                                                                                          |
| Unit         | % (percent)                                                                                                                                                                                                  |
| Note         | If the specified variable is out of the allowable setup range, the minimum value (if the lower limit of the range is not reached) or the maximum value (if the upper limit of the range is exceeded) is set. |

For information on the variable (*Ch*), see Table 7-6, “Variable (Ch),” on page 209.

- Examples**
- ```
Dim SmoAper As Double
SCPI.CALCulate(1).PARAMeter(1).SElect
SCPI.CALCulate(1).SElected.SMOothing.APERture = 2.5
SmoAper = SCPI.CALCulate(1).SElected.SMOothing.APERture
```
- Related objects** SCPI.CALCulate(Ch).PARAMeter(Tr).SElect on page 259
SCPI.CALCulate(Ch).SElected.SMOothing.STATe on page 354
- Equivalent key** **[Avg] - Smo Aperture**

SCPI.CALCulate(*Ch*).SElected.SMOothing.STATe

Object type	Property
Syntax	SCPI.CALCulate(<i>Ch</i>).SElected.SMOothing.STATe = <i>Status</i> <i>Status</i> = SCPI.CALCulate(<i>Ch</i>).SElected.SMOothing.STATe
Description	For the active trace of channels 1 to 16 (<i>Ch</i>), turns ON/OFF the smoothing.
Variable	

	<i>Status</i>
Description	ON/OFF of the smoothing
Data type	Boolean type (Boolean)
Range	Select from the following. <ul style="list-style-type: none"> •True or -1 Turns ON the smoothing. •False or 0 Turns OFF the smoothing.
Preset value	False or 0

For information on the variable (*Ch*), see Table 7-6, “Variable (Ch),” on page 209.

Examples	<pre>Dim Smo As Boolean SCPI.CALCulate(1).PARAmeter(1).SElect SCPI.CALCulate(1).SElected.SMOothing.STATe = True Smo = SCPI.CALCulate(1).SElected.SMOothing.STATe</pre>
Related objects	<p>SCPI.CALCulate(Ch).PARAmeter(Tr).SElect on page 259</p> <p>SCPI.CALCulate(Ch).SElected.SMOothing.APERTure on page 353</p>
Equivalent key	[Avg] - Smoothing

SCPI.CALCulate(*Ch*).SELEcted.TRANSform.TIME. CENTER

Object type	Property
Syntax	SCPI.CALCulate(<i>Ch</i>).SELEcted.TRANSform.TIME.CENTER = <i>Value</i> <i>Value</i> = SCPI.CALCulate(<i>Ch</i>).SELEcted.TRANSform.TIME.CENTER
Description	For the active trace of channels 1 to 16 (<i>Ch</i>), selects the center value used for the transformation function of the time domain function.
Variable	

	<i>Value</i>
Description	Center value
Data type	Double precision floating point type (Double)
Range	Varies depending on the frequency span and the number of points.
Preset value	0
Unit	s (second)
Note	If the specified variable is out of the allowable setup range, the minimum value (if the lower limit of the range is not reached) or the maximum value (if the upper limit of the range is exceeded) is set.

For information on the variable (*Ch*), see Table 7-6, “Variable (Ch),” on page 209.

Examples	Dim Cent As Double SCPI.CALCulate(1).PARAmeter(1).SELEct SCPI.CALCulate(1).SELEcted.TRANSform.TIME.CENTER = 1E-8 Cent = SCPI.CALCulate(1).SELEcted.TRANSform.TIME.CENTER
Related objects	SCPI.CALCulate(Ch).SELEcted.TRANSform.TIME.SPAN on page 359 SCPI.CALCulate(Ch).SELEcted.TRANSform.TIME.STATe on page 361 SCPI.CALCulate(Ch).PARAmeter(Tr).SELEct on page 259
Equivalent key	[Analysis] - Transform - Center

SCPI.CALCulate(Ch).SELEcted.TRANSform.TIME.IMPulse.WIDTH

Object type Property

Syntax SCPI.CALCulate(Ch).SELEcted.TRANSform.TIME.IMPulse.WIDTH = *Value*
Value = SCPI.CALCulate(Ch).SELEcted.TRANSform.TIME.IMPulse.WIDTH

Description For the active trace of channels 1 to 16 (*Ch*), sets the shape of the Kayser Bessel window using the impulse width used for the transformation function of the time domain function.

Variable

	<i>Value</i>
Description	Impulse width
Data type	Double precision floating point type (Double)
Range	Varies depending on the frequency span and transformation type.
Preset value	Varies depending on the frequency span and transformation type.
Unit	s (second)
Note	If the specified variable is out of the allowable setup range, the minimum value (if the lower limit of the range is not reached) or the maximum value (if the upper limit of the range is exceeded) is set.

For information on the variable (*Ch*), see Table 7-6, “Variable (Ch),” on page 209.

Examples

```
Dim ImpWid As Double
SCPI.CALCulate(1).PARAMeter(1).SELEct
SCPI.CALCulate(1).SELEcted.TRANSform.TIME.IMPulse.WIDTH = 1E-10
ImpWid = SCPI.CALCulate(1).SELEcted.TRANSform.TIME.IMPulse.WIDTH
```

Related objects

SCPI.CALCulate(Ch).SELEcted.TRANSform.TIME.KBESsel on page 357
 SCPI.CALCulate(Ch).SELEcted.TRANSform.TIME.STEP.RTIME on page 362
 SCPI.CALCulate(Ch).SELEcted.TRANSform.TIME.STATe on page 361
 SCPI.CALCulate(Ch).PARAMeter(Tr).SELEct on page 259

Equivalent key

[Analysis] - Transform - Center

SCPI.CALCulate(*Ch*).SElected.TRANSform.TIME. KBESsel

- Object type** Property
- Syntax** SCPI.CALCulate(*Ch*).SElected.TRANSform.TIME.KBESsel = *Value*
Value = SCPI.CALCulate(*Ch*).SElected.TRANSform.TIME.KBESsel
- Description** For the active trace of channels 1 to 16 (*Ch*), sets the shape of the Kayser Bessel window using β used for the transformation function of the time domain function.
- Variable**

	<i>Value</i>
Description	The value of β
Data type	Double precision floating point type (Double)
Range	0 to 13
Preset value	6
Note	If the specified variable is out of the allowable setup range, the minimum value (if the lower limit of the range is not reached) or the maximum value (if the upper limit of the range is exceeded) is set.

For information on the variable (*Ch*), see Table 7-6, “Variable (Ch),” on page 209.

- Examples**
- ```
Dim Beta As Double
SCPI.CALCulate(1).PARAMeter(1).SElect
SCPI.CALCulate(1).SElected.TRANSform.TIME.KBESsel = 3
Beta = SCPI.CALCulate(1).SElected.TRANSform.TIME.KBESsel
```
- Related objects**
- SCPI.CALCulate(Ch).SElected.TRANSform.TIME. IMPulse.WIDTH on page 356
  - SCPI.CALCulate(Ch).SElected.TRANSform.TIME.STEP.RTIME on page 362
  - SCPI.CALCulate(Ch).SElected.TRANSform.TIME.STATE on page 361
  - SCPI.CALCulate(Ch).PARAMeter(Tr).SElect on page 259
- Equivalent key** **[Analysis] - Transform - Center**

## SCPI.CALCulate(*Ch*).SElected.TRANSform.TIME.LPFRequency

|                 |                                                                                                                                                                                                          |
|-----------------|----------------------------------------------------------------------------------------------------------------------------------------------------------------------------------------------------------|
| Object type     | Method                                                                                                                                                                                                   |
| Syntax          | SCPI.CALCulate( <i>Ch</i> ).SElected.TRANSform.TIME.LPFRequency = <i>Value</i>                                                                                                                           |
| Description     | For the active trace of channels 1 to 16 ( <i>Ch</i> ), changes the frequency range to match with the low-pass type transformation of the transformation function of the time domain function. (No read) |
| Variable        | For information on the variable ( <i>Ch</i> ), see Table 7-6, “Variable (Ch),” on page 209.                                                                                                              |
| Examples        | SCPI.CALCulate(1).PARAMeter(1).SElect<br>SCPI.CALCulate(1).SElected.TRANSform.TIME.LPFRequency                                                                                                           |
| Related objects | SCPI.CALCulate(Ch).SElected.TRANSform.TIME.TYPE on page 365<br>SCPI.CALCulate(Ch).SElected.TRANSform.TIME.STATe on page 361<br>SCPI.CALCulate(Ch).PARAMeter(Tr).SElect on page 259                       |
| Equivalent key  | <b>[Analysis] - Transform - Set Freq Low pass</b>                                                                                                                                                        |

## SCPI.CALCulate(*Ch*).SElected.TRANSform.TIME.SPAN

**Object type** Property

**Syntax** SCPI.CALCulate(*Ch*).SElected.TRANSform.TIME.SPAN = *Value*  
*Value* = SCPI.CALCulate(*Ch*).SElected.TRANSform.TIME.SPAN

**Description** For the active trace of channels 1 to 16 (*Ch*), selects the span value used for the transformation function of the time domain function.

**Variable**

|              | <i>Value</i>                                                                                                                                                                                                 |
|--------------|--------------------------------------------------------------------------------------------------------------------------------------------------------------------------------------------------------------|
| Description  | Span value                                                                                                                                                                                                   |
| Data type    | Double precision floating point type (Double)                                                                                                                                                                |
| Range        | Varies depending on the frequency span and the number of points.                                                                                                                                             |
| Preset value | 2E-8                                                                                                                                                                                                         |
| Unit         | s (second)                                                                                                                                                                                                   |
| Note         | If the specified variable is out of the allowable setup range, the minimum value (if the lower limit of the range is not reached) or the maximum value (if the upper limit of the range is exceeded) is set. |

For information on the variable (*Ch*), see Table 7-6, “Variable (*Ch*),” on page 209.

**Examples**

```
Dim Span As Double
SCPI.CALCulate(1).PARAMeter(1).SElect
SCPI.CALCulate(1).SElected.TRANSform.TIME.SPAN = 1E-8
Cent = SCPI.CALCulate(1).SElected.TRANSform.TIME.SPAN
```

**Related objects**

SCPI.CALCulate(*Ch*).SElected.TRANSform.TIME.CENTer on page 355

SCPI.CALCulate(*Ch*).SElected.TRANSform.TIME.STATe on page 361

SCPI.CALCulate(*Ch*).PARAmeter(*Tr*).SElect on page 259

**Equivalent key** **[Analysis] - Transform - Center**

**SCPI.CALCulate(Ch).SElected.TRANSform.TIME.START**

|             |                                                                                                                                                   |
|-------------|---------------------------------------------------------------------------------------------------------------------------------------------------|
| Object type | Property                                                                                                                                          |
| Syntax      | SCPI.CALCulate(Ch).SElected.TRANSform.TIME.START = <i>Value</i><br><i>Value</i> = SCPI.CALCulate(Ch).SElected.TRANSform.TIME.START                |
| Description | For the active trace of channels 1 to 16 ( <i>Ch</i> ), selects the start value used for the transformation function of the time domain function. |
| Variable    |                                                                                                                                                   |

|              | <i>Value</i>                                                                                                                                                                                                 |
|--------------|--------------------------------------------------------------------------------------------------------------------------------------------------------------------------------------------------------------|
| Description  | Start value                                                                                                                                                                                                  |
| Data type    | Double precision floating point type (Double)                                                                                                                                                                |
| Range        | Varies depending on the frequency span and the number of points.                                                                                                                                             |
| Preset value | -1E-8                                                                                                                                                                                                        |
| Unit         | s (second)                                                                                                                                                                                                   |
| Note         | If the specified variable is out of the allowable setup range, the minimum value (if the lower limit of the range is not reached) or the maximum value (if the upper limit of the range is exceeded) is set. |

For information on the variable (*Ch*), see Table 7-6, “Variable (Ch),” on page 209.

|                 |                                                                                                                                                                                                   |
|-----------------|---------------------------------------------------------------------------------------------------------------------------------------------------------------------------------------------------|
| Examples        | <pre>Dim Star As Double SCPI.CALCulate(1).PARAMeter(1).SElect SCPI.CALCulate(1).SElected.TRANSform.TIME.START = 0 Star = SCPI.CALCulate(1).SElected.TRANSform.TIME.START</pre>                    |
| Related objects | <p>SCPI.CALCulate(Ch).SElected.TRANSform.TIME.STOP on page 364</p> <p>SCPI.CALCulate(Ch).SElected.TRANSform.TIME.STATe on page 361</p> <p>SCPI.CALCulate(Ch).PARAMeter(Tr).SElect on page 259</p> |
| Equivalent key  | <b>[Analysis] - Transform - Start</b>                                                                                                                                                             |

## SCPI.CALCulate(Ch).SElected.TRANSform.TIME.STATe

**Object type** Property

**Syntax** SCPI.CALCulate(Ch).SElected.TRANSform.TIME.STATe = *Status*  
*Status* = SCPI.CALCulate(Ch).SElected.TRANSform.TIME.STATe

**Description** For the active trace of channels 1 to 16 (*Ch*), turns ON/OFF the transformation function of the time domain function.

You can enable the transformation function only when the sweep type is the linear sweep and the number of points is 3 or more. If you execute this object to try to enable the transformation function when the sweep type is other than the linear sweep or the number of points is less than 3, an error occurs and the object is ignored.

When the sweep type is the power sweep, you cannot turn on the transformation function. If you execute this object trying to turn on the transformation function during the power sweep, an error occurs and the object is ignored.

**Variable**

|              |                                                                                                                                                                                                                                         |
|--------------|-----------------------------------------------------------------------------------------------------------------------------------------------------------------------------------------------------------------------------------------|
|              | <i>Status</i>                                                                                                                                                                                                                           |
| Description  | ON/OFF of the gating function                                                                                                                                                                                                           |
| Data type    | Boolean type (Boolean)                                                                                                                                                                                                                  |
| Range        | Select from the following.<br><ul style="list-style-type: none"> <li>•True or -1                      Turns ON the transformation function.</li> <li>•False or 0                      Turns OFF the transformation function.</li> </ul> |
| Preset value | False or 0                                                                                                                                                                                                                              |

For information on the variable (*Ch*), see Table 7-6, “Variable (Ch),” on page 209.

**Examples**

```
Dim Trans As Boolean
SCPI.CALCulate(1).PARAMeter(1).SElect
SCPI.CALCulate(1).SElected.TRANSform.TIME.STATe = True
Trans = SCPI.CALCulate(1).SElected.TRANSform.TIME.STATe
```

**Related objects** SCPI.CALCulate(Ch).PARAMeter(Tr).SElect on page 259  
 SCPI.SENSE(Ch).SWEep.TYPE on page 638  
 SCPI.SENSE(Ch).SWEep.POINTs on page 635

**Equivalent key** **[Analysis] - Transform - Transform**

**SCPI.CALCulate(*Ch*).SElected.TRANSform.TIME.STEP.RTime**

Object type Property

Syntax SCPI.CALCulate(*Ch*).SElected.TRANSform.TIME.STEP.RTime = *Value*  
*Value* = SCPI.CALCulate(*Ch*).SElected.TRANSform.TIME.STEP.RTIME

Description For the active trace of channels 1 to 16 (*Ch*), sets the shape of the Kayser Bessel window using the rise time of step signal used for the transformation function of the time domain function.

Variable

|              | <i>Value</i>                                                                                                                                                                                                 |
|--------------|--------------------------------------------------------------------------------------------------------------------------------------------------------------------------------------------------------------|
| Description  | The rise time of step signal                                                                                                                                                                                 |
| Data type    | Double precision floating point type (Double)                                                                                                                                                                |
| Range        | Varies depending on the frequency span.                                                                                                                                                                      |
| Preset value | Varies depending on the frequency span.                                                                                                                                                                      |
| Unit         | s (second)                                                                                                                                                                                                   |
| Note         | If the specified variable is out of the allowable setup range, the minimum value (if the lower limit of the range is not reached) or the maximum value (if the upper limit of the range is exceeded) is set. |

For information on the variable (*Ch*), see Table 7-6, “Variable (Ch),” on page 209.

Examples

```
Dim RTime As Double
SCPI.CALCulate(1).PARAMeter(1).SElect
SCPI.CALCulate(1).SElected.TRANSform.TIME.STEP.RTIME = 1E-10
RTime = SCPI.CALCulate(1).SElected.TRANSform.TIME.STEP.RTIME
```

Related objects

SCPI.CALCulate(*Ch*).SElected.TRANSform.TIME.IMPulse.WIDTH on page 356  
 SCPI.CALCulate(*Ch*).SElected.TRANSform.TIME.KBESsel on page 357  
 SCPI.CALCulate(*Ch*).SElected.TRANSform.TIME.STATE on page 361  
 SCPI.CALCulate(*Ch*).PARAMeter(*Tr*).SElect on page 259

Equivalent key

**[Analysis] - Transform - Center**

## SCPI.CALCulate(*Ch*).SElected.TRANSform.TIME. STIMulus

- Object type** Property
- Syntax** SCPI.CALCulate(*Ch*).SElected.TRANSform.TIME.STIMulus = *Param*  
*Param* = SCPI.CALCulate(*Ch*).SElected.TRANSform.TIME.STIMulus
- Description** For the active trace of channels 1 to 16 (*Ch*), selects the stimulus type used for the transformation function of the time domain function.
- Variable**

|              | <i>Param</i>                                                                                                                                                                                                                       |
|--------------|------------------------------------------------------------------------------------------------------------------------------------------------------------------------------------------------------------------------------------|
| Description  | The stimulus type                                                                                                                                                                                                                  |
| Data type    | Character string type (String)                                                                                                                                                                                                     |
| Range        | Select from the following.<br><ul style="list-style-type: none"> <li>•"IMPulse"                      Specifies the impulse<sup>*1</sup>.</li> <li>•"STEP"                              Specifies the step<sup>*2</sup>.</li> </ul> |
| Preset value | "IMPulse"                                                                                                                                                                                                                          |

\*1. You need to select the transformation type (band-pass or low-pass) with the SCPI.CALCulate(Ch).SElected.TRANSform.TIME.TYPE object.

\*2. You do not need to select the transformation type. Low-pass is selected automatically.

For information on the variable (*Ch*), see Table 7-6, "Variable (Ch)," on page 209.

- Examples**
- ```
Dim StimType As String
SCPI.CALCulate(1).PARAMeter(1).SElect
SCPI.CALCulate(1).SElected.TRANSform.TIME.STIMulus = "step"
StimType = SCPI.CALCulate(1).SElected.TRANSform.TIME.STIMulus
```

- Related objects**
- SCPI.CALCulate(Ch).SElected.TRANSform.TIME.TYPE on page 365
 - SCPI.CALCulate(Ch).SElected.TRANSform.TIME.STATE on page 361
 - SCPI.CALCulate(Ch).PARAMeter(Tr).SElect on page 259

- Equivalent key** **[Analysis] - Transform - Type - Bandpass|Lowpass Step|Lowpass Imp.**

NOTE When performing this operation from the front panel, you select the transformation type at the same time.

SCPI.CALCulate(Ch).SElected.TRANSform.TIME.STOP

Object type	Property
Syntax	SCPI.CALCulate(Ch).SElected.TRANSform.TIME.STOP = <i>Value</i> <i>Value</i> = SCPI.CALCulate(Ch).SElected.TRANSform.TIME.STOP
Description	For the active trace of channels 1 to 16 (<i>Ch</i>), selects the span value used for the transformation function of the time domain function.
Variable	

	<i>Value</i>
Description	Stop value
Data type	Double precision floating point type (Double)
Range	Varies depending on the frequency span and the number of points.
Preset value	1E-8
Unit	s (second)
Note	If the specified variable is out of the allowable setup range, the minimum value (if the lower limit of the range is not reached) or the maximum value (if the upper limit of the range is exceeded) is set.

For information on the variable (*Ch*), see Table 7-6, “Variable (Ch),” on page 209.

Examples	<pre>Dim Span As Double SCPI.CALCulate(1).PARAMeter(1).SElect SCPI.CALCulate(1).SElected.TRANSform.TIME.STOP = 2E-8 Cent = SCPI.CALCulate(1).SElected.TRANSform.TIME.STOP</pre>
Related objects	<p>SCPI.CALCulate(Ch).SElected.TRANSform.TIME.STARt on page 360</p> <p>SCPI.CALCulate(Ch).SElected.TRANSform.TIME.STATe on page 361</p> <p>SCPI.CALCulate(Ch).PARAMeter(Tr).SElect on page 259</p>
Equivalent key	[Analysis] - Transform - Stop

SCPI.CALCulate(*Ch*).SElected.TRANSform.TIME.TYPE

Object type Property

Syntax SCPI.CALCulate(*Ch*).SElected.TRANSform.TIME.TYPE = *Param*
Param = SCPI.CALCulate(*Ch*).SElected.TRANSform.TIME.TYPE

Description For the active trace of channels 1 to 16 (*Ch*), selects the transformation type used for the transformation function of the time domain function.

Variable

	<i>Param</i>
Description	The transformation type
Data type	Character string type (String)
Range	Select from the following. <ul style="list-style-type: none"> •"BPASs" Specifies the band-pass*1. •"LPASs" Specifies the low-pass*2.
Preset value	"BPASs"

*1. You do not need to select the stimulus type. Impulse is selected automatically.
*2. You need to select the stimulus type (impulse or step) with the SCPI.CALCulate(Ch).SElected.TRANSform.TIME. STIMulus object.

For information on the variable (*Ch*), see Table 7-6, "Variable (Ch)," on page 209.

Examples

```
Dim Typ As String
SCPI.CALCulate(1).PARAMeter(1).SElect
SCPI.CALCulate(1).SElected.TRANSform.TIME.SHAPE = "lpas"
Typ = SCPI.CALCulate(1).SElected.TRANSform.TIME.SHAPE
```

Related objects SCPI.CALCulate(Ch).SElected.TRANSform.TIME. STIMulus on page 363
SCPI.CALCulate(Ch).SElected.TRANSform.TIME.STATe on page 361
SCPI.CALCulate(Ch).PARAmeter(Tr).SElect on page 259

Equivalent key **[Analysis] - Transform - Type - Bandpass|Lowpass Step|Lowpass Imp.**

NOTE When performing this operation from the front panel, you select the stimulus type at the same time.

SCPI.CONTrol.HANDler.A.DATA

Object type Property

Syntax SCPI.CONTrol.HANDler.A.DATA = *Value*

Description Outputs port information to output port A (A0 to A7) of the handler I/O. Port information is outputted as 8-bit binary data using A0 as LSB and A7 as MSB. (No read)

For more information on the handler I/O, see Chapter “Communication with External Instruments Using Handler I/O Port” in the *E5070B/E5071B Programmer’s Guide*.

Variable

	<i>Value</i>
Description	Port information (output)
Data type	Long integer type (Long)
Range	0 to 255
Note	If the specified variable is out of the allowable setup range, the minimum value (if the lower limit of the range is not reached) or the maximum value (if the upper limit of the range is exceeded) is set.

Examples SCPI.CONTrol.HANDler.A.DATA = 15

Equivalent key No equivalent key is available on the front panel.

SCPI.CONTRol.HANDler.B.DATA

Object type	Property
Syntax	SCPI.CONTRol.HANDler.B.DATA = <i>Value</i>
Description	Outputs port information to output port B (B0 to B7) of the handler I/O. Port information is outputted as 8-bit binary data using B0 as LSB and B7 as MSB. (No read)

NOTE The bit 6 of the data outputted by this project is ignored when outputting the INDEX signal is turned ON (specifying True with the SCPI.CONTRol.HANDler.EXTension.INDEx.STATe object).

The bit 7 of the data outputted by this project is ignored when outputting the READY FOR TRIGGER signal is turned ON (specifying True with the SCPI.CONTRol.HANDler.EXTension.RTRigger.STATe object).

For more information on the handler I/O, see Chapter “Communication with External Instruments Using Handler I/O Port” in the *E5070B/E5071B Programmer’s Guide*.

Variable

	<i>Value</i>
Description	Port information (output)
Data type	Long integer type (Long)
Range	0 to 255
Note	If the specified variable is out of the allowable setup range, the minimum value (if the lower limit of the range is not reached) or the maximum value (if the upper limit of the range is exceeded) is set.

Examples SCPI.CONTRol.HANDler.B.DATA = 15

Equivalent key No equivalent key is available on the front panel.

SCPI.CONTRol.HANDler.C.DATA

Object type Property

Syntax SCPI.CONTRol.HANDler.C.DATA = *Value*(for output port)
Value = SCPI.CONTRol.HANDler.C.DATA (for input port)

Description When input/output port C of the handler I/O is set to the output port, outputs port information to output port C (C0 to C3).
 When input/output port C of the handler I/O is set to the input port, reads out port information inputted to port C (C0 to C3).
 Port information is inputted/outputted as 4-bit binary data using C0 as LSB and C3 as MSB.
 For more information on the handler I/O, see Chapter “Communication with External Instruments Using Handler I/O Port” in the *E5070B/E5071B Programmer’s Guide*.

Variable

	<i>Value</i>
Description	Port information (output/input)
Data type	Long integer type (Long)
Range	0 to 15
Note	If the specified variable is out of the allowable setup range, the minimum value (if the lower limit of the range is not reached) or the maximum value (if the upper limit of the range is exceeded) is set.

Examples SCPI.CONTRol.HANDler.C.MODE = "outp"
 SCPI.CONTRol.HANDler.C.DATA = 8

```
Dim HdlCinp As Long
SCPI.CONTRol.HANDler.C.MODE = "inp"
HdlCinp = SCPI.CONTRol.HANDler.C.DATA
```

Related objects SCPI.CONTRol.HANDler.C.MODE on page 369

Equivalent key No equivalent key is available on the front panel.

SCPI.CONTRol.HANDler.C.MODE

Object type Property

Syntax SCPI.CONTRol.HANDler.C.MODE = *Param*
Param = SCPI.CONTRol.HANDler.C.MODE

Description Sets the input/output direction of port C of the handler I/O.
 For more information on the handler I/O, see Chapter “Communication with External Instruments Using Handler I/O Port” in the *E5070B/E5071B Programmer’s Guide*.

Variable

	<i>Param</i>
Description	Input/output direction of port C
Data type	Character string type (String)
Range	Select from the following. •"INPut" Sets the port C to input. •"OUTPut" Sets the port C to output.
Preset value	"INPut"

Examples

```
Dim HdlCmode As String
SCPI.CONTRol.HANDler.C.MODE = "outp"
HdlCmode = SCPI.CONTRol.HANDler.C.MODE
```

Related objects SCPI.CONTRol.HANDler.C.DATA on page 368

Equivalent key No equivalent key is available on the front panel.

SCPI.CONTrol.HANDler.D.DATA

Object type	Property
Syntax	SCPI.CONTrol.HANDler.D.DATA = <i>Value</i> (for output port) <i>Value</i> = SCPI.CONTrol.HANDler.D.DATA (for input port)
Description	<p>When input/output port D of the handler I/O is set to the output port, outputs port information to output port D (D0 to D3).</p> <p>When input/output port D of the handler I/O is set to the input port, reads out port information inputted to port D (D0 to D3).</p> <p>Port information is outputted as 4-bit binary data using D0 as LSB and D3 as MSB.</p> <p>For more information on the handler I/O, see Chapter “Communication with External Instruments Using Handler I/O Port” in the <i>E5070B/E5071B Programmer’s Guide</i>.</p>

Variable

	<i>Value</i>
Description	Port information (output/input)
Data type	Long integer type (Long)
Range	0 to 15
Note	If the specified variable is out of the allowable setup range, the minimum value (if the lower limit of the range is not reached) or the maximum value (if the upper limit of the range is exceeded) is set.

Examples

```
SCPI.CONTrol.HANDler.D.MODE = "outp"  
SCPI.CONTrol.HANDler.D.DATA = 8
```

```
Dim HdlDinp As Long  
SCPI.CONTrol.HANDler.D.MODE = "inp"  
HdlDinp = SCPI.CONTrol.HANDler.D.DATA
```

Related objects SCPI.CONTrol.HANDler.D.MODE on page 371

Equivalent key No equivalent key is available on the front panel.

SCPI.CONTRol.HANDler.D.MODE

Object type Property

Syntax `SCPI.CONTRol.HANDler.D.MODE = Param`
Param = SCPI.CONTRol.HANDler.D.MODE

Description Sets the input/output direction of port D of the handler I/O.
 For more information on the handler I/O, see Chapter “Communication with External Instruments Using Handler I/O Port” in the *E5070B/E5071B Programmer’s Guide*.

Variable

	<i>Param</i>
Description	Input/output direction of port D
Data type	Character string type (String)
Range	Select from the following. <ul style="list-style-type: none"> •"INPut" Sets the port D to input. •"OUTPut" Sets the port D to output.
Preset value	"INPut"

Examples `Dim HdlDmode As String`
`SCPI.CONTRol.HANDler.D.MODE = "outp"`
`HdlDmode = SCPI.CONTRol.HANDler.D.MODE`

Related objects SCPI.CONTRol.HANDler.D.DATA on page 370

Equivalent key No equivalent key is available on the front panel.

SCPI.CONTrol.HANDler.E.DATA

Object type Property

Syntax SCPI.CONTrol.HANDler.E.DATA = *Value*(for output)
Value = SCPI.CONTrol.HANDler.E.DATA (for input port)

Description When input/output port E (port C + port D) of the handler I/O is set to the output port, outputs port information to output port E (C0 to D3).
 When input/output port E of the handler I/O is set to the input port, reads out port information inputted to port E (C0 to D3).
 Port information is outputted as 8-bit binary data using C0 as LSB and D3 as MSB.
 For more information on the handler I/O, see Chapter “Communication with External Instruments Using Handler I/O Port” in the *E5070B/E5071B Programmer’s Guide*.

Variable

	<i>Value</i>
Description	Port information (output/input)
Data type	Long integer type (Long)
Range	0 to 255
Note	If the specified variable is out of the allowable setup range, the minimum value (if the lower limit of the range is not reached) or the maximum value (if the upper limit of the range is exceeded) is set.

Examples

```
SCPI.CONTrol.HANDler.C.MODE = "outp"
SCPI.CONTrol.HANDler.D.MODE = "outp"
SCPI.CONTrol.HANDler.E.DATA = 128
```

```
Dim Hdleinp As Long
SCPI.CONTrol.HANDler.C.MODE = "inp"
SCPI.CONTrol.HANDler.D.MODE = "inp"
Hdleinp = SCPI.CONTrol.HANDler.E.DATA
```

Related objects

SCPI.CONTrol.HANDler.C.MODE on page 369
 SCPI.CONTrol.HANDler.D.MODE on page 371
 SCPI.CONTrol.HANDler.C.DATA on page 368
 SCPI.CONTrol.HANDler.D.DATA on page 370

Equivalent key

No equivalent key is available on the front panel.

SCPI.CONTrol.HANDler.EXTension.INDEx.STATe

Object type Property

Syntax SCPI.CONTrol.HANDler.EXTension.INDEx.STATe = *Status*
Status = SCPI.CONTrol.HANDler.EXTension.INDEx.STATe

Description Turns ON/OFF outputting the INDEX signal to B6 of the handler I/O.
 For more information on the handler I/O and the INDEX signal, see Chapter “Communication with External Instruments Using Handler I/O Port” in the *E5070B/E5071B Programmer’s Guide*.

NOTE When you use port B6 as the output port, turn OFF the INDEX signal output. When outputting the INDEX signal is turned ON, the bit 6 of the data outputted by the SCPI.CONTrol.HANDler.B.DATA object (the bit 14 of the data outputted by the SCPI.CONTrol.HANDler.F.DATA object) is ignored.

Variable

	<i>Status</i>
Description	ON/OFF of the INDEX signal output
Data type	Boolean type (Boolean)
Range	Select from the following. <ul style="list-style-type: none"> • True or -1 Turns ON the INDEX signal output. • False or 0 Turns OFF the INDEX signal output.
Preset value	False or 0

Examples

```
Dim Indx As Boolean
SCPI.CONTrol.HANDler.EXTension.INDEx.STATe = True
Indx = SCPI.CONTrol.HANDler.EXTension.INDEx.STATe
```

Related objects SCPI.CONTrol.HANDler.EXTension.RTRigger.STATe on page 374

Equivalent key No equivalent key is available on the front panel.

SCPI.CONTrol.HANDler.EXTension.RTRigger.STATe

Object type	Property
Syntax	SCPI.CONTrol.HANDler.EXTension.RTRigger.STATe = <i>Status</i> <i>Status</i> = SCPI.CONTrol.HANDler.EXTension.RTRigger.STATe
Description	Turns ON/OFF outputting the READY FOR TRIGGER signal to B7 of the handler I/O. For more information on the handler I/O and the INDEX signal, see Chapter “Communication with External Instruments Using Handler I/O Port” in the <i>E5070B/E5071B Programmer’s Guide</i> .

NOTE When you use port B7 as the output port, turn OFF the READY FOR TRIGGER signal output. When outputting the READY FOR TRIGGER signal is turned ON, the bit 7 of the data outputted by the SCPI.CONTrol.HANDler.B.DATA object (the bit 15 of the data outputted by the SCPI.CONTrol.HANDler.F.DATA object) is ignored.

Variable

	<i>Status</i>
Description	ON/OFF of the READY FOR TRIGGER signal output
Data type	Boolean type (Boolean)
Range	Select from the following. <ul style="list-style-type: none"> • True or -1 Turns ON the READY FOR TRIGGER signal output. • False or 0 Turns OFF the READY FOR TRIGGER signal output.
Preset value	False or 0

Examples

```
Dim RdyTrig As Boolean
SCPI.CONTrol.HANDler.EXTension.RTRigger.STATe = True
RdyTrig = SCPI.CONTrol.HANDler.EXTension.RTRigger.STATe
```

Related objects SCPI.CONTrol.HANDler.EXTension.INDEX.STATe on page 373

Equivalent key No equivalent key is available on the front panel.

SCPI.CONTRol.HANDler.F.DATA

Object type Property

Syntax SCPI.CONTRol.HANDler.F.DATA = *Value*

Description Outputs port information to output port F (port A + port B) of the handler I/O. Port information is outputted as 16-bit binary using A0 as LSB and B7 as MSB. (No read)

NOTE The bit 14 of the data outputted by this project is ignored when outputting the INDEX signal is turned ON (specifying True with the SCPI.CONTRol.HANDler.EXTension.INDEx.STATe object).

The bit 15 of the data outputted by this project is ignored when outputting the READY FOR TRIGGER signal is turned ON (specifying True with the SCPI.CONTRol.HANDler.EXTension.RTRigger.STATe object).

For more information on the handler I/O, see Chapter “Communication with External Instruments Using Handler I/O Port” in the *E5070B/E5071B Programmer’s Guide*.

Variable

	<i>Value</i>
Description	Port information (output)
Data type	Long integer type (Long)
Range	0 to 65535
Note	If the specified variable is out of the allowable setup range, the minimum value (if the lower limit of the range is not reached) or the maximum value (if the upper limit of the range is exceeded) is set.

Examples SCPI.CONTRol.HANDler.F.DATA = 511

Related objects SCPI.CONTRol.HANDler.A.DATA on page 366
 SCPI.CONTRol.HANDler.B.DATA on page 367

Equivalent key No equivalent key is available on the front panel.

SCPI.CONTRol.HANDler.OUTPUT(*Num*).DATA

Object type	Property
Syntax	SCPI.CONTRol.HANDler.OUTPUT(<i>Num</i>) = <i>Value</i> <i>Value</i> = SCPI.CONTRol.HANDler.OUTPUT(<i>Num</i>)
Description	Sets HIGH / LOW of OUTPUT1 (<i>Num</i> :1) or OUTPUT2 (<i>Num</i> :2) of the handler I/O. For more information on the handler I/O, see Chapter “Communication with External Instruments Using Handler I/O Port” in the <i>E5070B/E5071B Programmer’s Guide</i> .

Variable

	<i>Num</i>
Description	Number of the OUTPUT terminal
Data type	Long integer type (Long)
Range	1 to 2
Preset value	1
Note	If the specified variable is out of the allowable setup range, an error occurs when executed.

	<i>Value</i>
Description	Polarity (High/Low)
Data type	Long integer type (Long)
Range	Select from the following. <ul style="list-style-type: none"> •1 Specifies LOW. •0 Specifies HIGH.

Examples

```
Dim HdlPol As Long
SCPI.CONTRol.HANDler.OUTPUT(1).DATA = 1
HdlPol = SCPI.CONTRol.HANDler.OUTPUT(1).DATA
```

Equivalent key No equivalent key is available on the front panel.

SCPI.DISPlay.ANNotation.FREQuency.STATe

Object type	Property
Syntax	SCPI.DISPlay.ANNotation.FREQuency.STATe = <i>Status</i> <i>Status</i> = SCPI.DISPlay.ANNotation.FREQuency.STATe
Description	Turns ON/OFF the frequency display on the LCD display.
Variable	

	<i>Status</i>
Description	ON/OFF of the frequency display
Data type	Boolean type (Boolean)
Range	Select from the following. <ul style="list-style-type: none"> • True or -1 Turns ON the frequency display. • False or 0 Turns OFF the frequency display.
Preset value	True or -1

Examples	Dim DispFreq As Boolean SCPI.DISPlay.ANNotation.FREQuency.STATe = False DispFreq = SCPI.DISPlay.ANNotation.FREQuency.STATe
Equivalent key	[Display] - Frequency

SCPI.DISPlay.CCLear

Object type	Method
Syntax	SCPI.DISPlay.CCLear
Description	Clears the error message display on the instrument status bar (at the bottom of the LCD display). (No read)
Examples	SCPI.DISPlay.CCLear
Equivalent key	No equivalent key is available on the front panel.

SCPI.DISPlay.CLOCK

Object type Property

Syntax SCPI.DISPlay.CLOCK = *Status*
Status = SCPI.DISPlay.CLOCK

Description Turns ON/OFF the clock display at the right edge of the instrument status bar (at the bottom of the LCD display).

Variable

	<i>Status</i>
Description	ON/OFF of the clock display
Data type	Boolean type (Boolean)
Range	Select from the following. •True or -1 Turns ON the clock display. •False or 0 Turns OFF the clock display.
Preset value	True or -1

Examples Dim DispTime As Boolean
 SCPI.DISPlay.CLOCK = False
 DispTime = SCPI.DISPlay.CLOCK

Equivalent key **[System] - Misc Setup - Clock Setup - Show Clock**

SCPI.DISPlay.COLOr(Dnum).BACK

Object type Property

Syntax SCPI.DISPlay.COLOr(Dnum).BACK = *Data*
Data = SCPI.DISPlay.COLOr(Dnum).BACK

Description Sets the background color for normal display (*Dnum*: 1) and inverted display (*Dnum*: 2).

Variable

Table 7-12

Variable(*Dnum*)

	<i>Dnum</i>
Description	The number of display mode 1: normal display 2: inverted display
Data type	Long integer type (Long)
Range	1 to 2
Preset value	1
Note	If the specified variable is out of the allowable setup range, an error occurs when executed.

	<i>Data</i>
Description	Indicates 3-element array data. <ul style="list-style-type: none"> • <i>Data</i>(0) Sets amount of red. • <i>Data</i>(1) Sets amount of green. • <i>Data</i>(2) Sets amount of blue. The index of the array starts from 0.
Data type	Variant type (Variant)
Range	<ul style="list-style-type: none"> • <i>Data</i>(0) 0 to 5 • <i>Data</i>(1) 0 to 5 • <i>Data</i>(2) 0 to 5
Resolution	1
Note	If the specified variable is out of the allowable setup range, the minimum value (if the lower limit of the range is not reached) or the maximum value (if the upper limit of the range is exceeded) is set.

Examples

```
Dim BackColor As Variant
SCPI.DISPlay.COLOr(1).BACK = Array(1,2,3)
BackColor = SCPI.DISPlay.COLOr(1).BACK
```

Related objects SCPI.DISPlay.COLOr(Dnum).RESet on page 382

Equivalent key **[System] - Misc Setup - Color Setup - Normal|Invert - Background**

SCPI.DISPLAY.COLOR(Dnum).GRATICULE(Gnum)

Object type

Property

Syntax

SCPI.DISPLAY.COLOR(Dnum).GRATICULE(Gnum) = Data

Data = SCPI.DISPLAY.COLOR(Dnum).GRATICULE(Gnum)

Description

Sets the color of the graticule label and the outer frame line of the graph (*Gnum*: 1) and the color of the grid line of the graph (*Gnum*: 2) for normal display (*Dnum*: 1) and inverted display (*Dnum*: 2).

Variable

	<i>Gnum</i>
Description	The number of item 1: The outer frame line of the graph 2: The color of the grid line of the graph
Data type	Long integer type (Long)
Range	1 to 2
Preset value	1
Note	If the specified variable is out of the allowable setup range, an error occurs when executed.

	<i>Data</i>
Description	Indicates 3-element array data. <ul style="list-style-type: none"> • <i>Data</i>(0) Sets amount of red. • <i>Data</i>(1) Sets amount of green. • <i>Data</i>(2) Sets amount of blue. The index of the array starts from 0.
Data type	Variant type (Variant)
Range	<ul style="list-style-type: none"> • <i>Data</i>(0) 0 to 5 • <i>Data</i>(1) 0 to 5 • <i>Data</i>(2) 0 to 5
Resolution	1
Note	If the specified variable is out of the allowable setup range, the minimum value (if the lower limit of the range is not reached) or the maximum value (if the upper limit of the range is exceeded) is set.

For information on the variable (*Dnum*), see Table 7-12, “Variable(Dnum),” on page 379.

Examples

```
Dim GritColor As Variant
SCPI.DISPLAY.COLOR(1).GRATICULE(1) = Array(1,2,3)
GritColor = SCPI.DISPLAY.COLOR(1).GRATICULE(1)
```

Related objects

SCPI.DISPLAY.COLOR(Dnum).RESET on page 382

Equivalent key

[System] - Misc Setup - Color Setup - Normal|Invert - Graticule Main|Graticule Sub

SCPI.DISPLAY.COLOR(Dnum).LIMIT(Lnum)

Object type	Property
Syntax	SCPI.DISPLAY.COLOR(Dnum).LIMIT(Lnum) = Data Data = SCPI.DISPLAY.COLOR(Dnum).LIMIT(Lnum)
Description	Sets the fail display color used for the limit test result , the bandwidth test result and the ripple test result (<i>Lnum</i> : 1) and the color of the limit line (<i>Lnum</i> : 2) for normal display (<i>Dnum</i> : 1) and inverted display (<i>Dnum</i> : 2).

Variable

	<i>Lnum</i>
Description	The number of item 1: The limit test result 2: The limit line
Data type	Long integer type (Long)
Range	1 to 2
Preset value	1
Note	If the specified variable is out of the allowable setup range, an error occurs when executed.

	<i>Data</i>
Description	Indicates 3-element array data. <ul style="list-style-type: none"> • <i>Data</i>(0) Sets amount of red. • <i>Data</i>(1) Sets amount of green. • <i>Data</i>(2) Sets amount of blue. The index of the array starts from 0.
Data type	Variant type (Variant)
Range	<ul style="list-style-type: none"> • <i>Data</i>(0) 0 to 5 • <i>Data</i>(1) 0 to 5 • <i>Data</i>(2) 0 to 5
Resolution	1
Note	If the specified variable is out of the allowable setup range, the minimum value (if the lower limit of the range is not reached) or the maximum value (if the upper limit of the range is exceeded) is set.

For information on the variable (*Dnum*), see Table 7-12, “Variable(Dnum),” on page 379.

Examples

```
Dim LimColor As Variant
SCPI.DISPLAY.COLOR(1).LIMIT(1) = Array(1,2,3)
LimColor = SCPI.DISPLAY.COLOR(1).LIMIT(1)
```

Related objects SCPI.DISPLAY.COLOR(Dnum).RESET on page 382

Equivalent key **[System] - Misc Setup - Color Setup - Normal|Invert - Limit Fail|Limit Line**

SCPI.DISPlay.COLOr(*Dnum*).RESet

Object type	Method
Syntax	SCPI.DISPlay.COLOr(<i>Dnum</i>).RESet
Description	Resets the display color settings for all the items to the factory preset state for normal display (<i>Dnum</i> : 1) and inverted display (<i>Dnum</i> : 2). (No read)
Variable	For information on the variable (<i>Dnum</i>), see Table 7-12, “Variable(Dnum),” on page 379.
Examples	SCPI.DISPlay.COLOr(1).RESet
Related objects	SCPI.DISPlay.COLOr(Dnum).BACK on page 379 SCPI.DISPlay.COLOr(Dnum).GRATicule(Gnum) on page 380 SCPI.DISPlay.COLOr(Dnum).LIMit(Lnum) on page 381 SCPI.DISPlay.COLOr(Dnum).TRACe(Tr).DATA on page 383 SCPI.DISPlay.COLOr(Dnum).TRACe(Tr).MEMory on page 384
Equivalent key	[System] - Misc Setup - Color Setup - Normal Invert - Reset Color - OK

SCPI.DISPlay.COLOr(Dnum).TRACe(Tr).DATA

Object type Property

Syntax SCPI.DISPlay.COLOr(Dnum).TRACe(Tr).DATA = *Data*
Data = SCPI.DISPlay.COLOr(Dnum).TRACe(Tr).DATA

Description Sets the color of the data trace of traces 1 to 16 (*Tr*) for normal display (*Dnum*: 1) and inverted display (*Dnum*: 2).

Variable

	<i>Data</i>
Description	Indicates 3-element array data. <ul style="list-style-type: none"> • <i>Data</i>(0) Sets amount of red. • <i>Data</i>(1) Sets amount of green. • <i>Data</i>(2) Sets amount of blue. The index of the array starts from 0.
Data type	Variant type (Variant)
Range	<ul style="list-style-type: none"> • <i>Data</i>(0) 0 to 5 • <i>Data</i>(1) 0 to 5 • <i>Data</i>(2) 0 to 5
Resolution	1
Note	If the specified variable is out of the allowable setup range, the minimum value (if the lower limit of the range is not reached) or the maximum value (if the upper limit of the range is exceeded) is set.

For information on the variable (*Dnum*) and the variable (*Tr*), see Table 7-12, “Variable(Dnum),” on page 379 and Table 7-10, “Variable (Tr),” on page 259, respectively.

Examples

```
Dim TrColor As Variant
SCPI.DISPlay.COLOr(1).TRACe(1).DATA = Array(1,2,3)
TrColor = SCPI.DISPlay.COLOr(1).TRACe(1).DATA
```

Related objects SCPI.DISPlay.COLOr(Dnum).RESet on page 382

Equivalent key [System] - Misc Setup - Color Setup - Normal|Invert - Data Trace 1|Data Trace 2|Data Trace 3|Data Trace 4|Data Trace 5|Data Trace 6|Data Trace 7|Data Trace 8|Data Trace 9

SCPI.DISPlay.COLOr(Dnum).TRACe(Tr).MEMory

Object type	Property
Syntax	SCPI.DISPlay.COLOr(Dnum).TRACe(Tr).MEMory = <i>Data</i> <i>Data</i> = SCPI.DISPlay.COLOr(Dnum).TRACe(Tr).MEMory
Description	Sets the color of the memory trace of traces 1 to 16 (<i>Tr</i>) for normal display (<i>Dnum</i> : 1) and inverted display (<i>Dnum</i> : 2).
Variable	

	<i>Data</i>
Description	Indicates 3-element array data. <ul style="list-style-type: none"> • <i>Data</i>(0) Sets amount of red. • <i>Data</i>(1) Sets amount of green. • <i>Data</i>(2) Sets amount of blue. The index of the array starts from 0.
Data type	Variant type (Variant)
Range	<ul style="list-style-type: none"> • <i>Data</i>(0) 0 to 5 • <i>Data</i>(1) 0 to 5 • <i>Data</i>(2) 0 to 5
Resolution	1
Note	If the specified variable is out of the allowable setup range, the minimum value (if the lower limit of the range is not reached) or the maximum value (if the upper limit of the range is exceeded) is set.

For information on the variable (*Dnum*) and the variable (*Tr*), see Table 7-12, “Variable(Dnum),” on page 379 and Table 7-10, “Variable (Tr),” on page 259, respectively.

Examples

```
Dim TrColor As Variant
SCPI.DISPlay.COLOr(1).TRACe(1).MEMory = Array(1,2,3)
TrColor = SCPI.DISPlay.COLOr(1).TRACe(1).MEMory
```

Related objects SCPI.DISPlay.COLOr(Dnum).RESet on page 382

Equivalent key **[System] - Misc Setup - Color Setup - Normal|Invert - Mem Trace 1|Mem Trace 2|
Mem Trace 3|Mem Trace 4|Mem Trace 5|Mem Trace 6|Mem Trace 7|Mem Trace 8|Mem Trace 9**

SCPI.DISPlay.ECHO.CLEAr

Object type	Method
Syntax	SCPI.DISPlay.ECHO.CLEAr
Description	Clears all character strings displayed in the echo window. (No read)
Examples	<code>SCPI.DISPlay.ECHO.CLEAr</code>
Related objects	ECHO on page 198 SCPI.DISPlay.ECHO.DATA on page 385
Equivalent key	[Macro Setup] - Clear Echo

SCPI.DISPlay.ECHO.DATA

Object type	Property
Syntax	SCPI.DISPlay.ECHO.DATA = <i>Cont</i>
Description	Displays a character string in the echo window. (No read) There is the following difference from the display with the ECHO object. <ul style="list-style-type: none"> • Displays a single character string.

Variable

	<i>Cont</i>
Description	String you want to display in the echo window.
Data type	Character string type (String)
Range	254 characters or less

Examples	<code>SCPI.DISPlay.ECHO.DATA = "Test Result"</code> <code>SCPI.DISPlay.TABLE.TYPE = "echo"</code> <code>SCPI.DISPlay.TABLE.STATE = True</code>
Related objects	ECHO on page 198 SCPI.DISPlay.TABLE.TYPE on page 394 SCPI.DISPlay.TABLE.STATE on page 393 SCPI.DISPlay.ECHO.CLEAr on page 385
Equivalent key	No equivalent key is available on the front panel.

SCPI.DISPlay.ENABLE

Object type	Property
Syntax	SCPI.DISPlay.ENABLE = <i>Status</i> <i>Status</i> = SCPI.DISPlay.ENABLE
Description	Turns ON/OFF the display update on the E5070B/E5071B measurement screen.
Variable	

	<i>Status</i>
Description	ON/OFF of the display update of the E5070B/E5071B measurement screen
Data type	Boolean type (Boolean)
Range	Select from the following. •True or -1 Turns ON the display update. •False or 0 Turns OFF the display update.
Preset value	True or -1

Examples

```
Dim DispUpdt As Boolean
SCPI.DISPlay.ENABLE = False
DispUpdt = SCPI.DISPlay.ENABLE
```

Equivalent key **[Display] - Update**

SCPI.DISPlay.FSIGN

Object type	Property
Syntax	SCPI.DISPlay.FSIGN = <i>Status</i> <i>Status</i> = SCPI.DISPlay.FSIGN
Description	Turns ON/OFF the “Fail” display on the LCD screen when the limit test ,bandwidth test and ripple test fails.
Variable	

	<i>Status</i>
Description	ON/OFF of the “Fail” display when the limit test fails
Data type	Boolean type (Boolean)
Range	Select from the following. <ul style="list-style-type: none"> •True or -1 Turns ON the “Fail” display. •False or 0 Turns OFF the “Fail” display.
Preset value	True or -1

On/off of the Fail display cannot be set at each test. When the Fail display of either of test is turned on, the Fail display of other tests turns on, too.

Examples	Dim DispFail As Boolean SCPI.DISPlay.FSIGN = False DispFail = SCPI.DISPlay.FSIGN
Related objects	SCPI.CALCulate(Ch).SElected.LIMit.STATe on page 312 SCPI.CALCulate(Ch).SElected.RLIMit.STATe on page 352 SCPI.CALCulate(Ch).SElected.BLIMit.STATe on page 268
Equivalent key	[Analysis] - Limit Test - Fail Sign [Analysis] - Ripple Limit - Fail Sign [Analysis] - Bandwidth limit - Fail Sign

SCPI.DISPlay.IMAGe

Object type	Property
Syntax	SCPI.DISPlay.IMAGe = <i>Param</i> <i>Param</i> = SCPI.DISPlay.IMAGe
Description	Selects the display type of the LCD display.
Variable	

	<i>Param</i>
Description	Display type of the LCD display
Data type	Character string type (String)
Range	Select from the following. <ul style="list-style-type: none">•"NORMal" Specifies the normal display (background color: black).•"INVert" Specifies the display in which the color of the normal display is inverted (background color: white).
Preset value	"NORMal"

Examples

```
Dim DispImg As String
SCPI.DISPlay.IMAGe = "inv"
DispImg = SCPI.DISPlay.IMAGe
```

Equivalent key **[Display] - Invert Color**

SCPI.DISPlay.MAXimize

Object type Property

Syntax `SCPI.DISPlay.MAXimize = Status`
 `Status = SCPI.DISPlay.MAXimize`

Description Turns ON/OFF the window maximization of the active channel.
 If you turned ON the maximization, only the window of the active channel is maximized on the LCD display and the windows of the other channels are not displayed.

Variable

	<i>Status</i>
Description	ON/OFF of the window maximization
Data type	Boolean type (Boolean)
Range	Select from the following. <ul style="list-style-type: none"> •True or -1 Turns ON the window maximization. •False or 0 Turns OFF the window maximization.
Preset value	False or 0

Examples `Dim ChMax As Boolean`
 `SCPI.DISPlay.SPLit = "d1_2"`
 `SCPI.DISPlay.WINDow(2).ACTivate`
 `SCPI.DISPlay.MAXimize = True`
 `ChMax = SCPI.DISPlay.MAXimize`

Related objects `SCPI.DISPlay.WINDow(Ch).ACTivate` on page 395

Equivalent key **[Channel Max]**

SCPI.DISPlay.SKEY.STATe

Object type	Property
Syntax	SCPI.DISPlay.SKEY.STATe = <i>Status</i> <i>Status</i> = SCPI.DISPlay.SKEY.STATe
Description	Turns ON/OFF the display of the softkey menu bar.
Variable	

	<i>Status</i>
Description	ON/OFF of the softkey menu bar display
Data type	Boolean type (Boolean)
Range	Select from the following. •True or -1 Turns ON the softkey menu bar display. •False or 0 Turns OFF the softkey menu bar display.
Preset value	True or -1

Examples

```
Dim DispSkey As Boolean
SCPI.DISPlay.SKEY.STATe = False
DispSkey = SCPI.DISPlay.SKEY.STATe
```

Equivalent key **[Entry Off]**

SCPI.DISPlay.SPLit

Object type	Property
Syntax	SCPI.DISPlay.SPLit = <i>Param</i> <i>Param</i> = SCPI.DISPlay.SPLit
Description	Sets the layout of the channel windows on the LCD display.
Variable	

	<i>Param</i>
Description	Layout of channel windows
Data type	Character string type (String)
Range	<p>Select from the following.</p> <ul style="list-style-type: none"> •"D1" See Figure 7-4 on page 392. •"D12" See Figure 7-4. •"D1_2" See Figure 7-4. •"D112" See Figure 7-4. •"D1_1_2" See Figure 7-4. •"D123" See Figure 7-4. •"D1_2_3" See Figure 7-4. •"D12_33" See Figure 7-4. •"D11_23" See Figure 7-4. •"D13_23" See Figure 7-4. •"D12_13" See Figure 7-4. •"D1234" See Figure 7-4. •"D1_2_3_4" See Figure 7-4. •"D12_34" See Figure 7-4. •"D123_456" See Figure 7-4. •"D12_34_56" See Figure 7-4. •"D1234_5678" See Figure 7-4. •"D12_34_56_78" See Figure 7-4. •"D123_456_789" See Figure 7-4. •"D123__ABC" See Figure 7-4. •"D1234_9ABC" See Figure 7-4. •"D1234_DEFG" See Figure 7-4.
Preset value	"D1"

Examples

```
Dim ChanAloc As String
SCPI.DISPlay.SPLit = "d12_34"
ChanAloc = SCPI.DISPlay.SPLit
```

Related objects SCPI.DISPlay.WINDOW(Ch).SPLit on page 400

Equivalent key **[Display] - Allocate Channels**

Figure 7-4 Channel/graph window layouts

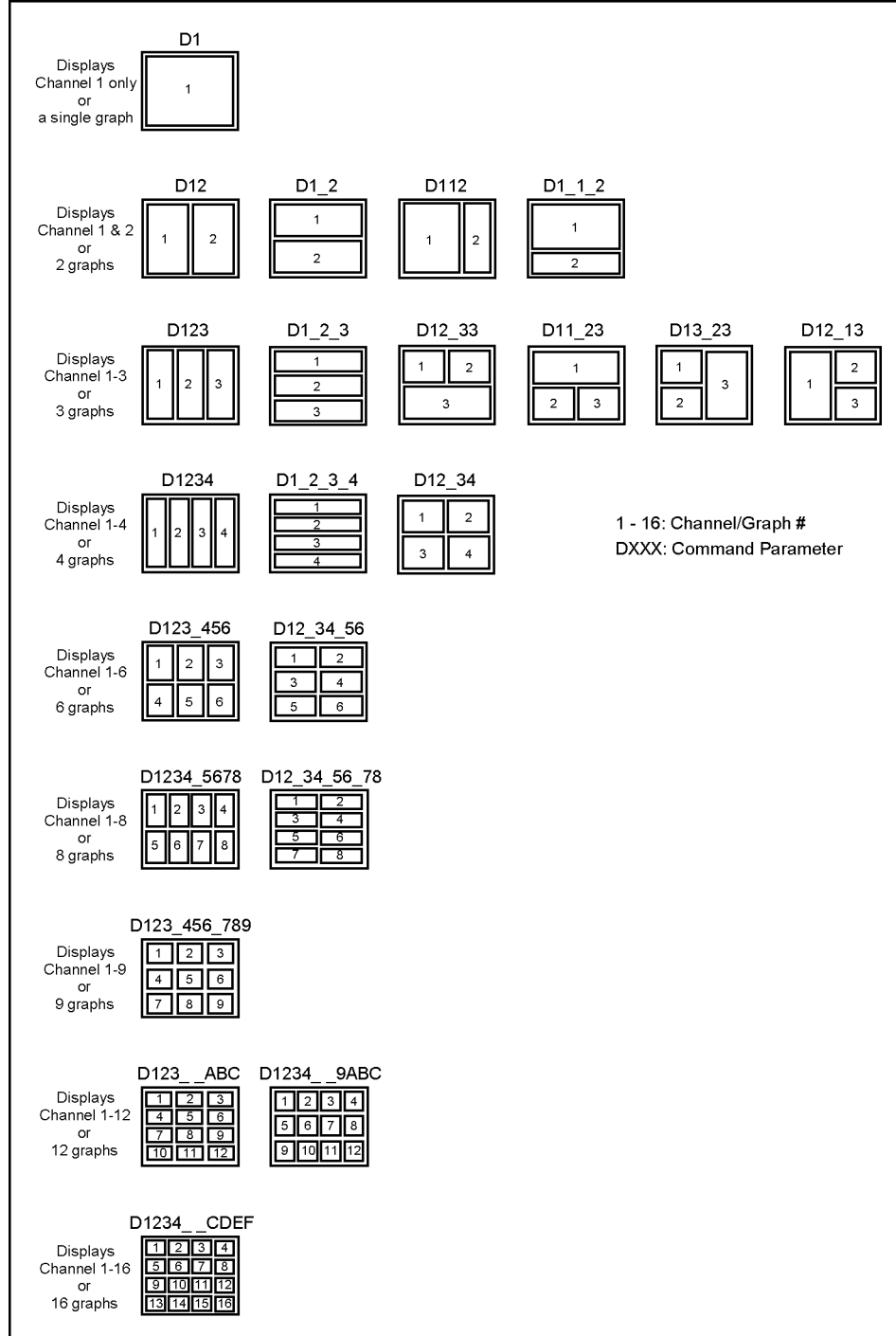

e5070bpe030

SCPI.DISPlay.TABLe.STATe

Object type	Property
Syntax	SCPI.DISPlay.TABLe.STATe = <i>Status</i> <i>Status</i> = SCPI.DISPlay.TABLe.STATe
Description	Turns ON/OFF the display of the window that appears in the lower part of the LCD display (specified with the SCPI.DISPlay.TABLe.TYPE object).
Variable	

	<i>Status</i>
Description	ON/OFF of the display of the window that appears in the lower part of the LCD display
Data type	Boolean type (Boolean)
Range	Select from the following. <ul style="list-style-type: none"> • True or -1 Turns ON the display. • False or 0 Turns OFF the display.
Preset value	False or 0

Examples

```
Dim DispTbl As Boolean
SCPI.DISPlay.TABLe.TYPE = "echo"
SCPI.DISPlay.TABLe.STATe = True
DispTbl = SCPI.DISPlay.TABLe.STATe
```

Related objects SCPI.DISPlay.TABLe.TYPE on page 394

Equivalent key

- [Sweep Setup] - Edit Segment Table**
- [Marker Fctn] - Marker Table**
- [Analysis] - Limit Test - Edit Limit Line**
- [Analysis] - Ripple Limit - Edit Ripple Line**
- [Macro Setup] - Echo Window**
- [Cal] - Power Calibration - Loss Compen**
- [Cal] - Power Calibration - Sensor A Settings | Sensor B Settings**

NOTE When performing the operation from the front panel, you select the type of the window that appears in the lower part of the LCD display and turn ON/OFF the display at the same time.

SCPI.DISPlay.TABLE.TYPE

Object type	Property
Syntax	SCPI.DISPlay.TABLE.TYPE = <i>Param</i> <i>Param</i> = SCPI.DISPlay.TABLE.TYPE
Description	Selects the type of the window that appears in the lower part of the LCD display.
Variable	

	<i>Param</i>
Description	Window type
Data type	Character string type (String)
Range	Select from the following. <ul style="list-style-type: none"> •"MARKer" Specifies the marker table window. •"LIMit" Specifies the limit test table window. •"SEGment" Specifies the segment table window. •"ECHO" Specifies the echo window. •"PLOSs" Specifies the loss compensation table window. •"SCFactor" Specifies the power sensor's calibration factor table window. •"RLIMit" Specifies the ripple test table window.
Preset value	"MARKer"

Examples

```
Dim TblType As String
SCPI.DISPlay.TABLE.TYPE = "echo"
SCPI.DISPlay.TABLE.STATE = True
TblType = SCPI.DISPlay.TABLE.TYPE
```

Related objects SCPI.DISPlay.TABLE.STATE on page 393

Equivalent key

[Sweep Setup] - Edit Segment Table

[Marker Fctn] - Marker Table

[Analysis] - Limit Test - Edit Limit Line

[Analysis] - Ripple Limit - Edit Ripple Line

[Macro Setup] - Echo Window

[Cal] - Power Calibration - Loss Compen

[Cal] - Power Calibration - Sensor A Settings|Sensor B Settings

NOTE When performing the operation from the front panel, you select the type of the window that appears in the lower part of the LCD display and turn ON/OFF the display at the same time.

SCPI.DISPlay.UPDate.IMMEDIATE

Object type	Method
Syntax	SCPI.DISPlay.UPDate.IMMEDIATE
Description	When the display update of the LCD screen is set to OFF (specifying False with the SCPI.DISPlay.ENABLE object), executes the display update once. (No read)
Examples	SCPI.DISPlay.ENABLE = False SCPI.DISPlay.UPDate.IMMEDIATE
Related objects	SCPI.DISPlay.ENABLE on page 386
Equivalent key	No equivalent key is available on the front panel.

SCPI.DISPlay.WINDow(Ch).ACTivate

Object type	Method
Syntax	SCPI.DISPlay.WINDow(<i>Ch</i>).ACTivate
Description	Specifies channels 1 to 16 (<i>Ch</i>) to the active channel. You can set only a channel displayed to the active channel. If this object is used to set a channel not displayed to the active channel, an error occurs when executed and the object is ignored. (No read)
Variable	For information on the variable (<i>Ch</i>), see Table 7-6, “Variable (Ch),” on page 209.
Examples	SCPI.DISPlay.SPLit = "d1_2" SCPI.DISPlay.WINDow(2).ACTivate
Related objects	SCPI.CALCulate(Ch).PARAmeter(Tr).SELEct on page 259
Equivalent key	[Channel Prev] / [Channel Next]

SCPI.DISPLAY.WINDOW(Ch).ANNOTATION.MARKER.ALIGN. STATE

Object type	Method
Syntax	SCPI.DISPLAY.WINDOW(<i>Ch</i>).ANNOTATION.MARKER.ALIGN.STATE = <i>Status</i> <i>Status</i> = SCPI.DISPLAY.WINDOW(<i>Ch</i>).ANNOTATION.MARKER.ALIGN.STATE
Description	For channel 1 to 16 (<i>Ch</i>), turn ON/OFF the mode that align the marker display position of each trace based on trace 1.

Variable

	<i>Status</i>
Description	ON/OFF the mode that align the marker display position of each trace based on trace 1
Data type	Boolean type (Boolean)
Range	Select from the following. <ul style="list-style-type: none"> • True or -1 Turns ON the mode that align marker display position based on trace 1. • False or 0 Turns OFF the alignment.
Preset value	True or -1

For information on the variable (*Ch*), see Table 7-6, “Variable (Ch),” on page 209.

Examples

```
Dim AnnMarkAlign As Boolean
SCPI.DISPLAY.WINDOW(1).ANNOTATION.MARKER.ALIGN.STATE = False
AnnMarkAlign = SCPI.DISPLAY.WINDOW(1).ANNOTATION.MARKER.ALIGN.STATE
```

Related objects

SCPI.DISPLAY.WINDOW(Ch).ANNOTATION.MARKER.SINGLE. STATE on page 397
 SCPI.DISPLAY.WINDOW(Ch).TRACE(Tr).ANNOTATION.MARKER.POSITION.X on page 403
 SCPI.DISPLAY.WINDOW(Ch).TRACE(Tr).ANNOTATION.MARKER.POSITION.Y on page 404

Equivalent key

[Marker Fctn] - Annotation Options - Align

SCPI.DISPlay.WINDow(Ch).ANNOtation.MARKer.SINGle. STATE

Object type Method

Syntax SCPI.DISPlay.WINDow(*Ch*).ANNOtation.MARKer.SINGle.STATE = *Status*
Status = SCPI.DISPlay.WINDow(*Ch*).ANNOtation.MARKer.SINGle.STATE

Description For channel 1 to 16 (*Ch*), turns ON/OFF the display of the marker value of only active traces.
 If you turn off the function, marker values of all traces (markers) are displayed.

Variable

	<i>Status</i>
Description	ON/OFF the display of the marker value of only active
Data type	Boolean type (Boolean)
Range	Select from the following. <ul style="list-style-type: none"> •True or -1 Displays the marker values of only active traces.(ON) •False or 0 Displays the marker values of all traces. (OFF)
Preset value	True or -1

For information on the variable (*Ch*), see Table 7-6, “Variable (Ch),” on page 209.

Examples Dim AnnMarkAlig As Boolean
 SCPI.DISPlay.WINDow(1).ANNOtation.MARKer.SINGle.STATE = False
 AnnMarkAlig = SCPI.DISPlay.WINDow(1).ANNOtation.MARKer.SINGle.STATE

Related objects SCPI.DISPlay.WINDow(Ch).ANNOtation.MARKer.ALIGn. STATE on page 396
 SCPI.DISPlay.WINDow(Ch).TRACe(Tr).ANNOtation.MARKer.POSition.X on page 403
 SCPI.DISPlay.WINDow(Ch).TRACe(Tr).ANNOtation.MARKer.POSition.Y on page 404

Equivalent key **[Marker Fctn] - Annotation Options - Active Only**

SCPI.DISPlay.WINDow(Ch).LAbel

Object type Property

Syntax SCPI.DISPlay.WINDow(Ch).LAbel = *Status*
Status = SCPI.DISPlay.WINDow(Ch).LAbel

Description Turns ON/OFF the graticule label display of the graph of channels 1 to 16 (*Ch*).

Variable

	<i>Status</i>
Description	ON/OFF of the graticule label display of the graph
Data type	Boolean type (Boolean)
Range	Select from the following. •True or -1 Turns ON the graticule label display. •False or 0 Turns OFF the graticule label display.
Preset value	True or -1

For information on the variable (*Ch*), see Table 7-6, “Variable (Ch),” on page 209.

Examples

```
Dim DispGrat As Boolean  
SCPI.DISPlay.WINDow(1).LAbel = False  
DispGrat = SCPI.DISPlay.WINDow(1).LAbel
```

Equivalent key **[Display] - Graticule Label**

SCPI.DISPlay.WINDow(Ch).MAXimize

Object type Property

Syntax SCPI.DISPlay.WINDow(Ch).MAXimize = *Status*
Status = SCPI.DISPlay.WINDow(Ch).MAXimize

Description Turns ON/OFF the maximization of the active trace of channels 1 to 16 (*Ch*).
 If you turned ON the maximization, only the maximized active trace is displayed in the window and the other traces are not displayed.

Variable

	<i>Status</i>
Description	ON/OFF of the maximization of the active trace
Data type	Boolean type (Boolean)
Range	Select from the following. <ul style="list-style-type: none"> • True or -1 Turns ON the maxim display. • False or 0 Turns OFF the maxim display.
Preset value	False or 0

For information on the variable (*Ch*), see Table 7-6, “Variable (Ch),” on page 209.

Examples Dim TracMax As Boolean
 SCPI.CALCulate(1).PARAmeter(2).SElect
 SCPI.DISPlay.WINDow(1).MAXimize = True
 TracMax = SCPI.DISPlay.WINDow(1).MAXimize

Related objects SCPI.CALCulate(Ch).PARAmeter(Tr).SElect on page 259
 SCPI.DISPlay.MAXimize on page 389

Equivalent key **[Trace Max]**

SCPI.DISPlay.WINDow(Ch).SPLit

Object type	Property
Syntax	SCPI.DISPlay.WINDow(Ch).SPLit = <i>Param</i> <i>Param</i> = SCPI.DISPlay.WINDow(Ch).SPLit
Description	Sets the graph layout of channels 1 to 16 (<i>Ch</i>).
Variable	

	<i>Param</i>
Description	Graph layout
Data type	Character string type (String)
Range	Select from the following. <ul style="list-style-type: none"> • "D1" See Figure 7-4 on page 392. • "D12" See Figure 7-4. • "D1_2" See Figure 7-4. • "D112" See Figure 7-4. • "D1_1_2" See Figure 7-4. • "D123" See Figure 7-4. • "D1_2_3" See Figure 7-4. • "D12_33" See Figure 7-4. • "D11_23" See Figure 7-4. • "D13_23" See Figure 7-4. • "D12_13" See Figure 7-4. • "D1234" See Figure 7-4. • "D1_2_3_4" See Figure 7-4. • "D12_34" See Figure 7-4. • "D123_456" See Figure 7-4. • "D12_34_56" See Figure 7-4. • "D1234_5678" See Figure 7-4. • "D12_34_56_78" See Figure 7-4. • "D123_456_789" See Figure 7-4. • "D123__ABC" See Figure 7-4. • "D1234__9ABC" See Figure 7-4. • "D1234__DEFG" See Figure 7-4.
Preset value	"D1"

For information on the variable (*Ch*), see Table 7-6, "Variable (Ch)," on page 209.

Examples

```
Dim TracAloc As String
SCPI.DISPlay.WINDow(1).SPLit = "d1_2"
TracAloc = SCPI.DISPlay.WINDow(1).SPLit
```

Related objects SCPI.DISPlay.SPLit on page 391

Equivalent key **[Display] - Allocate Traces**

SCPI.DISPlay.WINDow(Ch).TITLe.DATA

Object type	Property
Syntax	SCPI.DISPlay.WINDow(Ch).TITLe.DATA = <i>Lbl</i> <i>Lbl</i> = SCPI.DISPlay.WINDow(Ch).TITLe.DATA
Description	Sets the title label displayed in the title area of channels 1 to 16 (<i>Ch</i>).
Variable	

	<i>Lbl</i>
Description	Title label
Data type	Character string type (String)
Range	254 characters or less
Preset value	""

For information on the variable (*Ch*), see Table 7-6, “Variable (Ch),” on page 209.

Examples	<pre>Dim TtlLbl As String SCPI.DISPlay.WINDow(1).TITLe.DATA = "Filter" SCPI.DISPlay.WINDow(1).TITLe.STATe = True TtlLbl = SCPI.DISPlay.WINDow(1).TITLe.DATA</pre>
Related objects	SCPI.DISPlay.WINDow(Ch).TITLe.STATe on page 402
Equivalent key	[Display] - Edit Title Label

SCPI.DISPlay.WINDow(Ch).TITLe.STATe

Object type Property

Syntax SCPI.DISPlay.WINDow(Ch).TITLe.STATe = *Status*
Status = SCPI.DISPlay.WINDow(Ch).TITLe.STATe

Description Turns ON/OFF the title label display in the title area of channels 1 to 16 (*Ch*).

Variable

	<i>Status</i>
Description	ON/OFF of the title label display
Data type	Boolean type (Boolean)
Range	Select from the following. •True or -1 Turns ON the title label display. •False or 0 Turns ON the title label display.
Preset value	False or 0

For information on the variable (*Ch*), see Table 7-6, “Variable (Ch),” on page 209.

Examples Dim DispTtl As Boolean
SCPI.DISPlay.WINDow(1).TITLe.DATA = "Filter"
SCPI.DISPlay.WINDow(1).TITLe.STATe = True
DispTtl = SCPI.DISPlay.WINDow(1).TITLe.STATe

Related objects SCPI.DISPlay.WINDow(Ch).TITLe.DATA on page 401

Equivalent key **[Display] - Title Label**

SCPI.DISPlay.WINDow(Ch).TRACe(Tr).ANNotation.MARKeR.POSition.X

Object type	Property
Syntax	SCPI.DISPlay.WINDow(<i>Ch</i>).TRACe(<i>Tr</i>).ANNotation.MARKeR.POSition.X = <i>Value</i> <i>Value</i> = SCPI.DISPlay.WINDow(<i>Ch</i>).TRACe(<i>Tr</i>).ANNotation.MARKeR.POSition.X
Description	For trace 1 to 16 (<i>Tr</i>) of channel 1 to 16 (<i>Ch</i>), sets the display position of the marker value on the X-axis by a percentage of a width of the display span.
Variable	

	<i>Value</i>
Description	Display position of the marker value on the X-axis.
Data type	Double precision floating point type (Double)
Range	-15 to 100
Preset value	1
Unit	% (percent)
Note	If the specified variable is out of the allowable setup range, the minimum value (if the lower limit of the range is not reached) or the maximum value (if the upper limit of the range is exceeded) is set.

For information on the variable (*Ch*) and the variable (*Tr*), see Table 7-6, “Variable (Ch),” on page 209 and Table 7-10, “Variable (Tr),” on page 259, respectively.

Examples	<pre>Dim AnnMPosX As Double SCPI.DISPlay.WINDow(1).TRACe(1).ANNotation.MARKeR.POSition.X = 15 AnnMPosX = SCPI.DISPlay.WINDow(1).TRACe(1).ANNotation.MARKeR.POSition.X</pre>
Related objects	<p>SCPI.DISPlay.WINDow(Ch).ANNotation.MARKeR.ALIGN. STATE on page 396</p> <p>SCPI.DISPlay.WINDow(Ch).ANNotation.MARKeR.SINGLE. STATE on page 397</p> <p>SCPI.DISPlay.WINDow(Ch).TRACe(Tr).ANNotation.MARKeR.POSition.Y on page 404</p>
Equivalent key	[Marker Fctn] - Annotation Options - Marker Info X Pos

SCPI.DISPLAY.WINDOW(*Ch*).TRACE(*Tr*).ANNOTATION.MARKER.POSITION.Y

Object type	Property
Syntax	SCPI.DISPLAY.WINDOW(<i>Ch</i>).TRACE(<i>Tr</i>).ANNOTATION.MARKER.POSITION.Y = <i>Value</i> <i>Value</i> = SCPI.DISPLAY.WINDOW(<i>Ch</i>).TRACE(<i>Tr</i>).ANNOTATION.MARKER.POSITION.X
Description	For trace 1 to 16 (<i>Tr</i>) of channel 1 to 16 (<i>Ch</i>), sets the display position of the marker value on the X-axis by a percentage of a width of the display span. For trace 1 to 16 (<i>Tr</i>) of channel 1 to 16 (<i>Ch</i>), sets the display position of the marker value on the Y-axis by a percentage of a height of the display span.
Variable	

	<i>Value</i>
Description	Display position of the marker value on the Y-axis.
Data type	Double precision floating point type (Double)
Range	-15 to 100
Preset value	1
Unit	% (percent)
Note	If the specified variable is out of the allowable setup range, the minimum value (if the lower limit of the range is not reached) or the maximum value (if the upper limit of the range is exceeded) is set.

For information on the variable (*Ch*) and the variable (*Tr*), see Table 7-6, “Variable (Ch),” on page 209 and Table 7-10, “Variable (Tr),” on page 259, respectively.

Examples	<pre>Dim AnnMPosY As Double SCPI.DISPLAY.WINDOW(1).TRACE(1).ANNOTATION.MARKER.POSITION.Y = 23 AnnMPosY = SCPI.DISPLAY.WINDOW(1).TRACE(1).ANNOTATION.MARKER.POSITION.Y</pre>
Related objects	<p>SCPI.DISPLAY.WINDOW(Ch).ANNOTATION.MARKER.ALIGN. STATE on page 396</p> <p>SCPI.DISPLAY.WINDOW(Ch).ANNOTATION.MARKER.SINGLE. STATE on page 397</p> <p>SCPI.DISPLAY.WINDOW(Ch).TRACE(Tr).ANNOTATION.MARKER.POSITION.X on page 403</p>
Equivalent key	[Marker Fctn] - Annotation Options - Marker Info X Pos

SCPI.DISPlay.WINDow(Ch).TRACe(Tr).MEMory. STATE

Object type	Property
Syntax	SCPI.DISPlay.WINDow(<i>Ch</i>).TRACe(<i>Tr</i>).MEMory.STATe = <i>Status</i> <i>Status</i> = SCPI.DISPlay.WINDow(<i>Ch</i>).TRACe(<i>Tr</i>).MEMory.STATe
Description	For traces 1 to 16 (<i>Tr</i>) of channels 1 to 16 (<i>Ch</i>), turns ON/OFF the memory trace display.
Variable	

	<i>Status</i>
Description	ON/OFF of the memory trace display
Data type	Boolean type (Boolean)
Range	Select from the following. <ul style="list-style-type: none"> • True or -1 Turns ON the memory trace display. • False or 0 Turns OFF the memory trace display.
Preset value	False or 0

For information on the variable (*Ch*) and the variable (*Tr*), see Table 7-6, “Variable (Ch),” on page 209 and Table 7-10, “Variable (Tr),” on page 259, respectively.

Examples	<pre>Dim DispMem As Boolean SCPI.DISPlay.WINDow(1).TRACe(2).MEMory.STATe = True DispMem = SCPI.DISPlay.WINDow(1).TRACe(2).MEMory.STATe</pre>
Related objects	SCPI.CALCulate(Ch).SELeCted.MATH.MEMorize on page 340 SCPI.DISPlay.WINDow(Ch).TRACe(Tr).STATe on page 406
Equivalent key	[Display] - Display - Mem (when the data trace display is OFF) [Display] - Display - Data & Mem (when the data trace display is ON)

SCPI.DISPlay.WINDow(Ch).TRACe(Tr).STATe

Object type Property
 Syntax SCPI.DISPlay.WINDow(Ch).TRACe(Tr).STATe = *Status*
 Status = SCPI.DISPlay.WINDow(Ch).TRACe(Tr).STATe
 Description For traces 1 to 16 (*Tr*) of channels 1 to 16 (*Ch*), turns ON/OFF the data trace display.
 Variable

	<i>Status</i>
Description	ON/OFF of the data trace display
Data type	Boolean type (Boolean)
Range	Select from the following. <ul style="list-style-type: none"> • True or -1 Turns ON the data trace display. • False or 0 Turns OFF the data trace display.
Preset value	True or -1

For information on the variable (*Ch*) and the variable (*Tr*), see Table 7-6, “Variable (Ch),” on page 209 and Table 7-10, “Variable (Tr),” on page 259, respectively.

Examples Dim DispTrac As Boolean
 SCPI.DISPlay.WINDow(1).TRACe(2).STATe = False
 DispTrac = SCPI.DISPlay.WINDow(1).TRACe(2).STATe
 Related objects SCPI.DISPlay.WINDow(Ch).TRACe(Tr).MEMory. STATe on page 405
 Equivalent key **[Display] - Display - Data** (when the memory trace display is OFF)
 [Display] - Display - Data & Mem (when the memory trace display is ON)

SCPI.DISPlay.WINDow(Ch).TRACe(Tr).Y.SCALe.AUTO

Object type Method
 Syntax SCPI.DISPlay.WINDow(Ch).TRACe(Tr).Y.SCALe.AUTO
 Description For traces 1 to 16 (*Tr*) of channels 1 to 16 (*Ch*), executes the auto scale (function to automatically adjust the value of the reference division line and the scale per division to display the trace appropriately). (No read)
 Variable For information on the variable (*Ch*) and the variable (*Tr*), see Table 7-6, “Variable (Ch),” on page 209 and Table 7-10, “Variable (Tr),” on page 259, respectively.
 Examples SCPI.DISPlay.WINDow(1).TRACe(2).Y.SCALe.AUTO
 Related objects SCPI.DISPlay.WINDow(Ch).TRACe(Tr).Y.SCALe. PDIVision on page 407
 SCPI.DISPlay.WINDow(Ch).TRACe(Tr).Y.SCALe.RLEVel on page 408
 Equivalent key **[Scale] - Auto Scale**

SCPI.DISPlay.WINDow(Ch).TRACe(Tr).Y.SCALe.PDIVision

Object type Property

Syntax SCPI.DISPlay.WINDow(Ch).TRACe(Tr).Y.SCALe.PDIVision = *Value*
Value = SCPI.DISPlay.WINDow(Ch).TRACe(Tr).Y.SCALe.PDIVision

Description For traces 1 to 16 (*Tr*) of channels 1 to 16 (*Ch*), when the data format is not the Smith chart format or the polar format, sets the scale per division. When the data format is the Smith chart format or the polar format, sets the full scale value (the value of the outermost circumference).

Variable

	<i>Value</i>
Description	Scale value
Data type	Double precision floating point type (Double)
Range	1E-18 to 1E8
Preset value	Varies depending the data format. <ul style="list-style-type: none"> • Log magnitude: 10 • Phase, Expanded phase or Positive phase: 90 • Group delay: 1E-8 • Smith chart or Polar or SWR: 1 • Linear magnitude: 0.1 • Real or Imaginary: 0.2
Unit	Varies depending on the data format. <ul style="list-style-type: none"> • Log magnitude: dB (decibel) • Phase, Expanded phase or Positive phase: ° (degree) • Group delay: s (second) • Others: No unit
Note	If the specified variable is out of the allowable setup range, the minimum value (if the lower limit of the range is not reached) or the maximum value (if the upper limit of the range is exceeded) is set.

For information on the variable (*Ch*) and the variable (*Tr*), see Table 7-6, “Variable (Ch),” on page 209 and Table 7-10, “Variable (Tr),” on page 259, respectively.

Examples

```
Dim Pdiv As Double
SCPI.CALCulate(1).PARAMeter(2).SElect
SCPI.CALCulate(1).SElected.FORMat = "gd1"
SCPI.DISPlay.WINDow(1).TRACe(2).Y.SCALe.PDIVision = 1E-9
Pdiv = SCPI.DISPlay.WINDow(1).TRACe(2).Y.SCALe.PDIVision
```

Related objects

SCPI.CALCulate(Ch).SElected.FORMat on page 289
 SCPI.DISPlay.WINDow(Ch).Y.SCALe.DIVisions on page 411
 SCPI.DISPlay.WINDow(Ch).TRACe(Tr).Y.SCALe.RLEVel on page 408
 SCPI.DISPlay.WINDow(Ch).TRACe(Tr).Y.SCALe.RPOsition on page 409

Equivalent key

[Scale] - Scale/Div

SCPI.DISPlay.WINDow(Ch).TRACe(Tr).Y.SCALe.RLEVel

Object type	Property
Syntax	SCPI.DISPlay.WINDow(Ch).TRACe(Tr).Y.SCALe.RLEVel = <i>Value</i> <i>Value</i> = SCPI.DISPlay.WINDow(Ch).TRACe(Tr).Y.SCALe.RLEVel
Description	For traces 1 to 16 (<i>Tr</i>) of channels 1 to 16 (<i>Ch</i>), sets the value of the reference division line.
Variable	

	<i>Value</i>
Description	Value of reference division line
Data type	Double precision floating point type (Double)
Range	-5E8 to 5E8
Preset value	0*1
Unit	Varies depending on the data format. <ul style="list-style-type: none"> Log magnitude (MLOG): dB (decibel) Phase (PHAS), Expanded phase (UPH) or Positive phase (PPH): ° (degree) Group delay (GDEL): s (second) Others: No unit
Note	If the specified variable is out of the allowable setup range, the minimum value (if the lower limit of the range is not reached) or the maximum value (if the upper limit of the range is exceeded) is set.

*1. The preset value is 1 when the data format is SWR.

For information on the variable (*Ch*) and the variable (*Tr*), see Table 7-6, “Variable (Ch),” on page 209 and Table 7-10, “Variable (Tr),” on page 259, respectively.

Examples	<pre>Dim RefLvl As Double SCPI.CALCulate(1).PARAMeter(2).SElect SCPI.CALCulate(1).SElected.FORMat = "phas" SCPI.DISPlay.WINDow(1).TRACe(2).Y.SCALe.RLEVel = 90 Pdiv = SCPI.DISPlay.WINDow(1).TRACe(2).Y.SCALe.RLEVel</pre>
Related objects	<p>SCPI.CALCulate(Ch).SElected.FORMat on page 289</p> <p>SCPI.DISPlay.WINDow(Ch).Y.SCALe.DIVisions on page 411</p> <p>SCPI.DISPlay.WINDow(Ch).TRACe(Tr).Y.SCALe. PDIVision on page 407</p> <p>SCPI.DISPlay.WINDow(Ch).TRACe(Tr).Y.SCALe. RPOSITION on page 409</p>
Equivalent key	[Scale] - Reference Value

SCPI.DISPlay.WINDow(Ch).TRACe(Tr).Y.SCALe.RPOStion

- Object type** Property
- Syntax** SCPI.DISPlay.WINDow(Ch).TRACe(Tr).Y.SCALe.RPOStion = *Value*
Value = SCPI.DISPlay.WINDow(Ch).TRACe(Tr).Y.SCALe.RPOStion
- Description** For traces 1 to 16 (*Tr*) of channels 1 to 16 (*Ch*), specifies the position of a reference division line with its number (an integer assigned starting from 0 from the lowest division).
- Variable**

	<i>Value</i>
Description	Position of reference division line
Data type	Long integer type (Long)
Range	0 to the number of divisions*1
Preset value	5*2
Note	If the specified variable is out of the allowable setup range, the minimum value (if the lower limit of the range is not reached) or the maximum value (if the upper limit of the range is exceeded) is set.

*1. Set with the SCPI.DISPlay.WINDow(Ch).Y.SCALe.DIVisions object.

*2. The preset value is 0 when the data format is linear magnitude or SWR.

For information on the variable (*Ch*) and the variable (*Tr*), see Table 7-6, “Variable (Ch),” on page 209 and Table 7-10, “Variable (Tr),” on page 259, respectively.

- Examples**
- ```
Dim RefPos As Long
SCPI.DISPlay.WINDow(1).TRACe(2).Y.SCALe.RPOStion = 6
RefPos = SCPI.DISPlay.WINDow(1).TRACe(2).Y.SCALe.RPOStion
```
- Related objects**
- SCPI.CALCulate(Ch).SElected.FORMat on page 289
  - SCPI.DISPlay.WINDow(Ch).Y.SCALe.DIVisions on page 411
  - SCPI.DISPlay.WINDow(Ch).TRACe(Tr).Y.SCALe.PDIVision on page 407
  - SCPI.DISPlay.WINDow(Ch).TRACe(Tr).Y.SCALe.RLEVel on page 408
- Equivalent key** **[Scale] - Reference Position**

## SCPI.DISPlay.WINDow(Ch).X.SPACing

|             |                                                                                                            |
|-------------|------------------------------------------------------------------------------------------------------------|
| Object type | Property                                                                                                   |
| Syntax      | SCPI.DISPlay.WINDow(Ch).X.SPACing = <i>Param</i><br><i>Param</i> = SCPI.DISPlay.WINDow(Ch).X.SPACing       |
| Description | Selects the display type of the graph horizontal axis of channels 1 to 16 ( <i>Ch</i> ) for segment sweep. |
| Variable    |                                                                                                            |

|              |                                                                                                                                                                                                                                                                                                                                                                                                                               |
|--------------|-------------------------------------------------------------------------------------------------------------------------------------------------------------------------------------------------------------------------------------------------------------------------------------------------------------------------------------------------------------------------------------------------------------------------------|
|              | <b><i>Param</i></b>                                                                                                                                                                                                                                                                                                                                                                                                           |
| Description  | Horizontal axis display type of the graph for segment sweep                                                                                                                                                                                                                                                                                                                                                                   |
| Data type    | Character string type (String)                                                                                                                                                                                                                                                                                                                                                                                                |
| Range        | Select from the following.<br><ul style="list-style-type: none"> <li>•"LINear"                      Specifies the frequency base (linear frequency axis with the minimum frequency at the left edge and the maximum frequency at the right edge).</li> <li>•"OBASe"                      Specifies the order base (axis in which the measurement point numbers are positioned evenly in the order of measurement).</li> </ul> |
| Preset value | "OBASe"                                                                                                                                                                                                                                                                                                                                                                                                                       |

For information on the variable (*Ch*), see Table 7-6, "Variable (Ch)," on page 209.

**Examples**

```
Dim DispSegm As String
SCPI.SENSE(1).SWEep.TYPE = "segm"
SCPI.DISPlay.WINDow(1).X.SPACing = "obas"
DispSegm = SCPI.DISPlay.WINDow(1).X.SPACing
```

**Related objects**      SCPI.SENSE(Ch).SWEep.TYPE on page 638

**Equivalent key**      **[Sweep Setup] - Segment Display**

## SCPI.DISPlay.WINDow(Ch).Y.SCALe.DIVisions

|             |                                                                                                                      |
|-------------|----------------------------------------------------------------------------------------------------------------------|
| Object type | Property                                                                                                             |
| Syntax      | SCPI.DISPlay.WINDow(Ch).Y.SCALe.DIVisions = <i>Value</i><br><i>Value</i> = SCPI.DISPlay.WINDow(Ch).Y.SCALe.DIVisions |
| Description | For channels 1 to 16 ( <i>Ch</i> ), sets the number of divisions in all the graphs.                                  |
| Variable    |                                                                                                                      |

|              | <i>Value</i>                                                                                                                                                                                                 |
|--------------|--------------------------------------------------------------------------------------------------------------------------------------------------------------------------------------------------------------|
| Description  | Number of divisions of graph                                                                                                                                                                                 |
| Data type    | Long integer type (Long)                                                                                                                                                                                     |
| Range        | 4 to 30                                                                                                                                                                                                      |
| Preset value | 10                                                                                                                                                                                                           |
| Resolution   | 2                                                                                                                                                                                                            |
| Note         | If the specified variable is out of the allowable setup range, the minimum value (if the lower limit of the range is not reached) or the maximum value (if the upper limit of the range is exceeded) is set. |

For information on the variable (*Ch*), see Table 7-6, “Variable (Ch),” on page 209.

|                 |                                                                                                                                                                                                      |
|-----------------|------------------------------------------------------------------------------------------------------------------------------------------------------------------------------------------------------|
| Examples        | Dim Divs As Long<br>SCPI.DISPlay.WINDow(1).Y.SCALe.DIVisions = 12<br>Divs = SCPI.DISPlay.WINDow(1).Y.SCALe.DIVisions                                                                                 |
| Related objects | SCPI.DISPlay.WINDow(Ch).TRACe(Tr).Y.SCALe. PDIVision on page 407<br>SCPI.DISPlay.WINDow(Ch).TRACe(Tr).Y.SCALe.RLEVel on page 408<br>SCPI.DISPlay.WINDow(Ch).TRACe(Tr).Y.SCALe. RPOSition on page 409 |
| Equivalent key  | <b>[Scale] - Divisions</b>                                                                                                                                                                           |

## SCPI.FORMat.BORDER

|             |                                                                                                                                                                              |
|-------------|------------------------------------------------------------------------------------------------------------------------------------------------------------------------------|
| Object type | Property                                                                                                                                                                     |
| Syntax      | SCPI.FORMat.BORDER = <i>Param</i><br><i>Param</i> = SCPI.FORMat.BORDER                                                                                                       |
| Description | When the data transfer format is set to the binary transfer format (specify “REAL” with SCPI.FORMat.DATA object), sets the transfer order of each byte in data (byte order). |

---

**NOTE** This object is NOT used when controlling the E5070B/E5071B using COM objects in the E5070B/E5071B VBA.

---

### Variable

|              | <i>Param</i>                                                                                                                                                                                                                                                                                                                                                    |
|--------------|-----------------------------------------------------------------------------------------------------------------------------------------------------------------------------------------------------------------------------------------------------------------------------------------------------------------------------------------------------------------|
| Description  | Byte order                                                                                                                                                                                                                                                                                                                                                      |
| Data type    | Character string type (String)                                                                                                                                                                                                                                                                                                                                  |
| Range        | Select from the following.<br><ul style="list-style-type: none"><li>•"NORMal"                      Specifies the byte order in which transfer starts from the byte including MSB (Most Significant Bit).</li><li>•"SWAPped"                    Specifies the byte order in which transfer starts from the byte including LSB (Least Significant Bit).</li></ul> |
| Preset value | "NORMal"                                                                                                                                                                                                                                                                                                                                                        |

**Examples**

```
Dim BitOrd As String
SCPI.FORMat.BORDER "swap"
BitOrd = SCPI.FORMat.BORDER
```

**Related objects** SCPI.FORMat.DATA on page 413

**Equivalent key** No equivalent key is available on the front panel.



## SCPI.FORMat.DATA

**Object type** Property

**Syntax** SCPI.FORMat.DATA = *Param*  
*Param* = SCPI.FORMat.DATA

**Description** Use the following SCPI commands to set the format to read the data.

- :CALC{1-16}:DATA:FDAT
- :CALC{1-16}:DATA:FMEM
- :CALC{1-16}:DATA:SDAT?
- :CALC{1-16}:DATA:SMEM?
- :CALC{1-16}:FUNC:DATA?
- :CALC{1-16}:LIM:DATA
- :CALC{1-16}:LIM:REP?
- :CALC{1-16}:LIM:REP:ALL?
- :CALC{1-16}:BLIM:REP?
- :CALC{1-16}:RLIM:DATA?
- :CALC{1-16}:RLIM:REP?
- :SENS{1-16}:FREQ:DATA?
- :SENS{1-16}:SEGM:DATA
- :SOUR:POW:PORT:CORR:COLL:TABL:ASEN:DATA
- :SOUR:POW:PORT:CORR:COLL:TABL:BSEN:DATA
- :SOUR{1-16}:POW:PORT{1-4}:CORR:COLL:TABL:LOSS:DATA
- :SOUR{1-16}:POW:PORT{1-4}:CORR:DATA

---

**NOTE** ASCII transfer format must be specified when controlling the E5070B/E5071B using SCPI commands with the **Parse** object in the E5070B/E5071B VBA.

---

**Variable**

|              | <i>Param</i>                                                                                                                                                                                                                                                                                          |
|--------------|-------------------------------------------------------------------------------------------------------------------------------------------------------------------------------------------------------------------------------------------------------------------------------------------------------|
| Description  | Data transfer format                                                                                                                                                                                                                                                                                  |
| Data type    | Character string type (String)                                                                                                                                                                                                                                                                        |
| Range        | Select from the following.<br><ul style="list-style-type: none"> <li>• "ASCI" Specifies the ASCII transfer format.</li> <li>• "REAL" Specifies the IEEE 64-bit floating point binary transfer format.</li> <li>• "REAL32" Specifies the IEEE 32-bit floating point binary transfer format.</li> </ul> |
| Preset value | "NORMal"                                                                                                                                                                                                                                                                                              |

**Examples**

```
Dim Fmt As String
SCPI.FORMat.DATA = "asc"
Fmt = SCPI.FORMat.DATA
```

**Related objects** SCPI.FORMat.BORDER on page 412  
Parse on page 200

COM Object Reference  
**SCPI.FORMat.DATA**

Equivalent key      No equivalent key is available on the front panel.

## SCPI.HCOPy.ABORT

|                 |                                    |
|-----------------|------------------------------------|
| Object type     | Method                             |
| Syntax          | SCPI.HCOPy.ABORT                   |
| Description     | Aborts the print output. (No read) |
| Examples        | SCPI.HCOPy.ABORT                   |
| Related objects | SCPI.HCOPy.IMMEDIATE on page 416   |
| Equivalent key  | <b>[System] - Abort Printing</b>   |

## SCPI.HCOPy.IMAGe

|             |                                                                    |
|-------------|--------------------------------------------------------------------|
| Object type | Property                                                           |
| Syntax      | SCPI.HCOPy.IMAGe = <i>Param</i><br><i>Param</i> = SCPI.HCOPy.IMAGe |
| Description | Selects the print color for output to the printer.                 |
| Variable    |                                                                    |

|              |                                                                                                                                                                                                                                                                               |
|--------------|-------------------------------------------------------------------------------------------------------------------------------------------------------------------------------------------------------------------------------------------------------------------------------|
|              | <i>Param</i>                                                                                                                                                                                                                                                                  |
| Description  | Print color for output to the printer.                                                                                                                                                                                                                                        |
| Data type    | Character string type (String)                                                                                                                                                                                                                                                |
| Range        | Select from the following.<br><ul style="list-style-type: none"> <li>•"NORMal"                      Specifies printing in close color to the display color.</li> <li>•"INVert"                      Specifies printing in the inverted color of the display color.</li> </ul> |
| Preset value | "INVert"                                                                                                                                                                                                                                                                      |

|                 |                                                                          |
|-----------------|--------------------------------------------------------------------------|
| Examples        | Dim Img As String<br>SCPI.HCOPy.IMAGe = "norm"<br>Img = SCPI.HCOPy.IMAGe |
| Related objects | SCPI.HCOPy.IMMEDIATE on page 416                                         |
| Equivalent key  | <b>[System] - Invert Image</b>                                           |

## SCPI.HCOPy.IMMEDIATE

|                 |                                                                                                                                                                                                                                                                                                                                                                                                                                                                         |
|-----------------|-------------------------------------------------------------------------------------------------------------------------------------------------------------------------------------------------------------------------------------------------------------------------------------------------------------------------------------------------------------------------------------------------------------------------------------------------------------------------|
| Object type     | Method                                                                                                                                                                                                                                                                                                                                                                                                                                                                  |
| Syntax          | SCPI.HCOPy.IMMEDIATE                                                                                                                                                                                                                                                                                                                                                                                                                                                    |
| Description     | Outputs the display image on the LCD display to the printer connected to the E5070B/E5071B. (No read)                                                                                                                                                                                                                                                                                                                                                                   |
| <b>NOTE</b>     | When printing the E5070B/E5071B measurement screen, execute the VBA program with the Visual Basic editor closed. For the method, see “Running a Program from the E5070B/E5071B Measurement Screen” on page 54.                                                                                                                                                                                                                                                          |
| Examples        | <code>SCPI.HCOPy.IMMEDIATE</code>                                                                                                                                                                                                                                                                                                                                                                                                                                       |
| Related objects | SCPI.HCOPy.ABORT on page 415<br>SCPI.HCOPy.IMAGE on page 415                                                                                                                                                                                                                                                                                                                                                                                                            |
| Equivalent key  | <b>[System] - Print</b><br>When performing the operation from the front panel, the image on the LCD display memorized in the volatile memory (clipboard) (the image on the LCD display when the <b>[Capture] ([System])</b> key is pressed) is printed. Notice that, if no image is memorized in the clipboard, in the same way as the SCPI.HCOPy.IMMEDIATE object, the image on the LCD display at the execution is memorized in the clipboard and then it is printed. |

## SCPI.IEEE4882.CLS

|                |                                                                                                                                                                                                                                                                                                                                                                                                                                                                                                                                                                                                                                                                                                                                                                                                                                                                                                                                                                                                                                                                  |
|----------------|------------------------------------------------------------------------------------------------------------------------------------------------------------------------------------------------------------------------------------------------------------------------------------------------------------------------------------------------------------------------------------------------------------------------------------------------------------------------------------------------------------------------------------------------------------------------------------------------------------------------------------------------------------------------------------------------------------------------------------------------------------------------------------------------------------------------------------------------------------------------------------------------------------------------------------------------------------------------------------------------------------------------------------------------------------------|
| Object type    | Method                                                                                                                                                                                                                                                                                                                                                                                                                                                                                                                                                                                                                                                                                                                                                                                                                                                                                                                                                                                                                                                           |
| Syntax         | SCPI.IEEE4882.CLS                                                                                                                                                                                                                                                                                                                                                                                                                                                                                                                                                                                                                                                                                                                                                                                                                                                                                                                                                                                                                                                |
| Description    | <p>Clears the followings. (No read)</p> <ul style="list-style-type: none"><li>• Error Queue</li><li>• Status Byte Register</li><li>• Standard Event Status Register</li><li>• Operation Status Event Register</li><li>• Questionable Status Event Register</li><li>• Questionable Limit Status Event Register</li><li>• Questionable Limit Extra Status Event Register</li><li>• Questionable Limit Channel Status Event Register</li><li>• Questionable Limit Channel Extra Status Event Register</li><li>• Questionable Bandwidth Limit Status Event Register</li><li>• Questionable Bandwidth Limit Extra Status Event Register</li><li>• Questionable Bandwidth Limit Channel Status Event Register</li><li>• Questionable Bandwidth Limit Channel Extra Status Event Register</li><li>• Questionable Ripple Limit Status Event Register</li><li>• Questionable Ripple Limit Extra Status Event Register</li><li>• Questionable Ripple Limit Channel Status Event Register</li><li>• Questionable Ripple Limit Channel Extra Status Event Register</li></ul> |
| Examples       | SCPI.IEEE4882.CLS                                                                                                                                                                                                                                                                                                                                                                                                                                                                                                                                                                                                                                                                                                                                                                                                                                                                                                                                                                                                                                                |
| Equivalent key | No equivalent key is available on the front panel.                                                                                                                                                                                                                                                                                                                                                                                                                                                                                                                                                                                                                                                                                                                                                                                                                                                                                                                                                                                                               |

## SCPI.IEEE4882.ESE

|             |                                                                      |
|-------------|----------------------------------------------------------------------|
| Object type | Property                                                             |
| Syntax      | SCPI.IEEE4882.ESE = <i>Value</i><br><i>Value</i> = SCPI.IEEE4882.ESE |
| Description | Sets the value of the Standard Event Status Enable Register.         |
| Variable    |                                                                      |

|              | <i>Value</i>                                                                                                     |
|--------------|------------------------------------------------------------------------------------------------------------------|
| Description  | Value of the Standard Event Status Enable Register                                                               |
| Data type    | Long integer type (Long)                                                                                         |
| Range        | 0 to 255                                                                                                         |
| Preset value | 0                                                                                                                |
| Note         | If the specified variable is out of the allowable setup range, the result of bitwise AND with 255 (0xff) is set. |

Examples

```
Dim Stat As Long
SCPI.IEEE4882.ESE = 16
Stat = SCPI.IEEE4882.ESE
```

Related objects SCPI.IEEE4882.SRE on page 422

Equivalent key No equivalent key is available on the front panel.

## SCPI.IEEE4882.ESR

**Object type** Property

**Syntax** *Value* = SCPI.IEEE4882.ESR

**Description** Reads out the value of the Standard Event Status Register. Executing this object clears the register value. (Read only)

**Variable**

|             | <i>Value</i>                                |
|-------------|---------------------------------------------|
| Description | Value of the Standard Event Status Register |
| Data type   | Long integer type (Long)                    |

**Examples**

```
Dim Stat As Long
Stat = SCPI.IEEE4882.ESR
```

**Equivalent key** No equivalent key is available on the front panel.

## SCPI.IEEE4882.IDN

**Object type** Property

**Syntax** *Cont* = SCPI.IEEE4882.IDN

**Description** Reads out the product information (manufacturer, model number, serial number, and firmware version number) of the E5070B/E5071B. (Read only)

**Variable**

|             | <i>Cont</i>                                                                                                                                                                                                                                                                                                                                                                |
|-------------|----------------------------------------------------------------------------------------------------------------------------------------------------------------------------------------------------------------------------------------------------------------------------------------------------------------------------------------------------------------------------|
| Description | Product information ("{string 1},{string 2},{string 3},{string 4}") <ul style="list-style-type: none"> <li>• {string 1} Manufacturer. Agilent Technologies is always read out.</li> <li>• {string 2} Model number (example: E5070B).</li> <li>• {string 3} Serial number (example: JP1KI00101).</li> <li>• {string 4} Firmware version number (example: 03.00).</li> </ul> |
| Data type   | Character string type (String)                                                                                                                                                                                                                                                                                                                                             |

**Examples**

```
Dim Who As String
Who = SCPI.IEEE4882.IDN
```

**Equivalent key** **[System] - Firmware Revision**  
**[System] - Service Menu - Enable Options - Serial Number**

## SCPI.IEEE4882.OPC

Object type Property

Syntax (1) SCPI.IEEE4882.OPC = *Dummy*  
(2) *Value* = SCPI.IEEE4882.OPC

Description Case (1):  
Specifies so that 1 is set to OPC bit (bit 0) of the Standard Event Status Register is set to 1 when all of pending operations complete. For information on the structure of the status register, see Appendix “Status Reporting System” in the *E5070B/E5071B Programmer’s Guide*.  
Case (2):  
Specifies so that 1 is read when all of pending operations complete.

Variable Case (2):

|             | <i>Value</i>                                        |
|-------------|-----------------------------------------------------|
| Description | 1 returned when all pending operations are complete |
| Data type   | Long integer type (Long)                            |

Examples Case (1) :  
SCPI.IEEE4882.OPC = 1

Case (2) :  
Dim Dmy As Long  
Dmy = SCPI.IEEE4882.OPC

Related objects SCPI.SENSE(Ch).CORREction.COLLECT.ACQUIRE.ISOLation on page 480  
SCPI.SENSE(Ch).CORREction.COLLECT.ACQUIRE.LOAD on page 481  
SCPI.SENSE(Ch).CORREction.COLLECT.ACQUIRE.OPEN on page 482  
SCPI.SENSE(Ch).CORREction.COLLECT.ACQUIRE.SHORT on page 482  
SCPI.SENSE(Ch).CORREction.COLLECT.ACQUIRE.THROUGH on page 484  
SCPI.TRIGGER.SEQUENCE.SINGLE on page 756

Equivalent key No equivalent key is available on the front panel.



## SCPI.IEEE4882.OPT

|             |                                                                                             |
|-------------|---------------------------------------------------------------------------------------------|
| Object type | Property                                                                                    |
| Syntax      | <i>Cont</i> = SCPI.IEEE4882.OPT                                                             |
| Description | Reads out the identification numbers of options installed in the E5070B/E5071B. (Read only) |

### Variable

|             | <i>Cont</i>                                     |
|-------------|-------------------------------------------------|
| Description | Identification numbers of installed options     |
| Data type   | Character string type (String)                  |
| Note        | If there is no installed option, 0 is read out. |

**Examples**

```
Dim OptNum As String
OptNum = SCPI.IEEE4882.OPT
```

**Equivalent key** No equivalent key is available on the front panel.

## SCPI.IEEE4882.RST

|             |                                                                                                                                                                                                                                                                                                                                                                                                                              |
|-------------|------------------------------------------------------------------------------------------------------------------------------------------------------------------------------------------------------------------------------------------------------------------------------------------------------------------------------------------------------------------------------------------------------------------------------|
| Object type | Method                                                                                                                                                                                                                                                                                                                                                                                                                       |
| Syntax      | SCPI.IEEE4882.RST                                                                                                                                                                                                                                                                                                                                                                                                            |
| Description | <p>Presets the setting state of the E5070B/E5071B. There is the following difference from the setting state preset with the SCPI.SYSTem.PRESet object. For details, see Appendix “List of Default Values” in the <i>E5070B/E5071B User’s Guide</i>. (No read)</p> <ul style="list-style-type: none"> <li>The continuous initiation mode (see the SCPI.INITiate(Ch).CONTinuous object) of channel 1 is set to OFF.</li> </ul> |

**Examples**

```
SCPI.IEEE4882.RST
```

**Related objects**

SCPI.INITiate(Ch).CONTinuous on page 424  
 SCPI.SYSTem.PRESet on page 743  
 SCPI.SYSTem.UPReset on page 749

**Equivalent key** No equivalent key is available on the front panel.

## SCPI.IEEE4882.SRE

|             |                                                                      |
|-------------|----------------------------------------------------------------------|
| Object type | Property                                                             |
| Syntax      | SCPI.IEEE4882.SRE = <i>Value</i><br><i>Value</i> = SCPI.IEEE4882.SRE |
| Description | Sets the value of the Service Request Enable Register.               |
| Variable    |                                                                      |

|              | <i>Value</i>                                                                                                                                         |
|--------------|------------------------------------------------------------------------------------------------------------------------------------------------------|
| Description  | Value of the Service Request Enable Register                                                                                                         |
| Data type    | Long integer type (Long)                                                                                                                             |
| Range        | 0 to 255                                                                                                                                             |
| Preset value | 0                                                                                                                                                    |
| Note         | If the specified variable is out of the allowable setup range, the result of bitwise AND with 255 (0xff) is set. Note that bit 6 cannot be set to 1. |

|                 |                                                                                                                          |
|-----------------|--------------------------------------------------------------------------------------------------------------------------|
| Examples        | <pre>Dim Stat As Long SCPI.IEEE4882.SRE = 8 Stat = SCPI.IEEE4882.SRE</pre>                                               |
| Related objects | SCPI.IEEE4882.ESE on page 418<br>SCPI.STATus.OPERation.ENABLE on page 667<br>SCPI.STATus.QUESTIONable.ENABLE on page 688 |
| Equivalent key  | No equivalent key is available on the front panel.                                                                       |

## SCPI.IEEE4882.STB

- Object type Property
- Syntax *Value* = SCPI.IEEE4882.STB
- Description Reads out the value of the Status Byte Register. (Read only)
- Variable

|             | <i>Value</i>                      |
|-------------|-----------------------------------|
| Description | Value of the Status Byte Register |
| Data type   | Long integer type (Long)          |

- Examples  

```
Dim Stat As Long
Stat = SCPI.IEEE4882.STB
```
- Equivalent key No equivalent key is available on the front panel.

## SCPI.IEEE4882.TRG

- Object type Method
- Syntax SCPI.IEEE4882.TRG
- Description If the trigger source is set to GPIB/LAN (set to BUS with the SCPI.TRIGger.SEQuence.SOURce object), triggers the E5070B/E5071B waiting for trigger. For information on the waiting for trigger state, see Section “Trigger System” in the *E5070B/E5071B Programmer’s Guide*. (No read)
- Examples  

```
SCPI.TRIGger.SEQuence.SOURce = "bus"
SCPI.IEEE4882.TRG
```
- Related objects SCPI.TRIGger.SEQuence.SOURce on page 757
- Equivalent key No equivalent key is available on the front panel.

## SCPI.IEEE4882.WAI

- Object type Method
- Syntax SCPI.IEEE4882.WAI
- Description Waits for the execution of all objects sent before this object to be completed. (No read)
- Examples  

```
SCPI.TRIGger.SEQuence.SOURce = "bus"
SCPI.TRIGger.SEQuence.SINGle
SCPI.IEEE4882.WAI
MsgBox "Done"
```
- Equivalent key No equivalent key is available on the front panel.

## SCPI.INITiate(*Ch*).CONTInuous

**Object type** Property

**Syntax** SCPI.INITiate(*Ch*).CONTInuous = *Status*  
*Status* = SCPI.INITiate(*Ch*).CONTInuous

**Description** Turns ON/OFF of the continuous initiation mode (setting by which the trigger system initiates continuously) of channels 1 to 16 (*Ch*) in the trigger system.  
 For more information on the trigger system, see Section “Trigger System” in the *E5070B/E5071B Programmer’s Guide*.

**Variable**

|              | <i>Status</i>                                                                                                                                                                                                                                 |
|--------------|-----------------------------------------------------------------------------------------------------------------------------------------------------------------------------------------------------------------------------------------------|
| Description  | ON/OFF of the continuous initiation mode                                                                                                                                                                                                      |
| Data type    | Boolean type (Boolean)                                                                                                                                                                                                                        |
| Range        | Select from the following.<br><ul style="list-style-type: none"> <li>•True or -1                      Turns ON the continuous initiation mode.</li> <li>•False or 0                      Turns OFF the continuous initiation mode.</li> </ul> |
| Preset value | Varies depending on [variable ( <i>Ch</i> )] <sup>*1</sup>                                                                                                                                                                                    |

\*1. Only channel 1 is initialized to ON at the execution of the SCPI.SYSTEM.PRESet object; all the channels are initialized to OFF at the execution of the SCPI.IEEE4882.RST object.

For information on the variable (*Ch*), see Table 7-6, “Variable (Ch),” on page 209.

**Examples**

```
Dim ContMode As Boolean
SCPI.INITiate(2).CONTInuous = True
ContMode = SCPI.INITiate(2).CONTInuous
```

**Related objects** SCPI.INITiate(Ch).IMMEDIATE on page 425

**Equivalent key** **[Trigger] - Continuous** (continuous initiation mode ON)  
**[Trigger] - Hold** (continuous initiation mode OFF)

## SCPI.INITiate(Ch).IMMEDIATE

|                 |                                                                                                                                                                                                                                                                                                                                                                                                                                                                                                                                                                                                                                                                                                                                                                                     |
|-----------------|-------------------------------------------------------------------------------------------------------------------------------------------------------------------------------------------------------------------------------------------------------------------------------------------------------------------------------------------------------------------------------------------------------------------------------------------------------------------------------------------------------------------------------------------------------------------------------------------------------------------------------------------------------------------------------------------------------------------------------------------------------------------------------------|
| Object type     | Method                                                                                                                                                                                                                                                                                                                                                                                                                                                                                                                                                                                                                                                                                                                                                                              |
| Syntax          | SCPI.INITiate(Ch).IMMEDIATE                                                                                                                                                                                                                                                                                                                                                                                                                                                                                                                                                                                                                                                                                                                                                         |
| Description     | <p>Changes the state of each channel of channels 1 to 16 (<i>Ch</i>) to the initiation state in the trigger system.</p> <p>When this object is executed for a channel in the idle state in the trigger system, it goes into the initiation state immediately. Then, after measurement is executed once, it goes back to the idle state.</p> <p>If this object is executed for a channel that is not in the idle state or a channel for which the continuous initiation mode is set to ON (setting by which the trigger system initiates continuously) in the trigger system, an error occurs when executed and the object is ignored.</p> <p>For more information on the trigger system, see Section “Trigger System” in the <i>E5070B/E5071B Programmer’s Guide</i>. (No read)</p> |
| Variable        | For information on the variable ( <i>Ch</i> ), see Table 7-6, “Variable (Ch),” on page 209.                                                                                                                                                                                                                                                                                                                                                                                                                                                                                                                                                                                                                                                                                         |
| Examples        | <pre>SCPI.INITiate(1).CONTinuous = False SCPI.INITiate(1).IMMEDIATE</pre>                                                                                                                                                                                                                                                                                                                                                                                                                                                                                                                                                                                                                                                                                                           |
| Related objects | SCPI.INITiate(Ch).CONTinuous on page 424                                                                                                                                                                                                                                                                                                                                                                                                                                                                                                                                                                                                                                                                                                                                            |
| Equivalent key  | <b>[Trigger] - Single</b>                                                                                                                                                                                                                                                                                                                                                                                                                                                                                                                                                                                                                                                                                                                                                           |

## SCPI.MMEemory.CATalog(*Dir*)

Object type      Property

Syntax            *Cont* = SCPI.MMEemory.CATalog(*Dir*)

Description      Reads out the following information on the built-in storage device of the E5070B/E5071B.

- Space in use
- Available space
- Name and size of all files (including directories) in the specified directory.

To read out the information in the root directory (folder), specify "\" (backslash). If you want to specify a directory on the floppy disk drive, you need to add "A:" at the beginning of the file name. Separate between directory names (file name) with "\" (back slash), or "/" (slash). (Read only)

### Variable

|             | <i>Cont</i>                                                                                                                                                                                                                                                                                                                                                                                                                                                                                                                                                                                                        |
|-------------|--------------------------------------------------------------------------------------------------------------------------------------------------------------------------------------------------------------------------------------------------------------------------------------------------------------------------------------------------------------------------------------------------------------------------------------------------------------------------------------------------------------------------------------------------------------------------------------------------------------------|
| Description | Directory information ("{A},{B},{Name 1},{Size 1},{Name 2},{Size 2},...,{Name N},{Size N}")<br><br>Where N is the number of all files in the specified directory and n is an integer between 1 and N. <ul style="list-style-type: none"> <li>• {A}                      Space in use of the built-in storage device (byte)*1.</li> <li>• {B}                      Available space of the built-in storage device (byte)*1.</li> <li>• {Name n}                Name of the n-th file (directory).</li> <li>• {Size n}                Size (byte) of the n-th file (directory). Always 0 for directories.</li> </ul> |
| Data type   | Character string type (String)                                                                                                                                                                                                                                                                                                                                                                                                                                                                                                                                                                                     |

\*1. If you specify a directory on the floppy disk drive, it is the capacity of the floppy disk in the drive.

|             | <i>Dir</i>                                            |
|-------------|-------------------------------------------------------|
| Description | Directory name whose information you want to read out |
| Data type   | Character string type (String)                        |
| Range       | 254 characters or less                                |

Examples            `Dim DirCont As String`  
                          `DirCont = SCPI.MMEemory.CATalog("a:\")`

Equivalent key      No equivalent key is available on the front panel.

## SCPI.MMEMory.COPY

Object type Property

Syntax SCPI.MMEMory.COPY = *File*

Description Copies a file.

Specify the file name with the extension. If you want to specify a file on the floppy disk drive, you need to add "A:" at the beginning of the file name. When you use directory names (folder names) and file name, separate them with "\" (back slash), or "/" (slash). (No read)

Variable

|             |                                                                                                                                                                                                                                                |
|-------------|------------------------------------------------------------------------------------------------------------------------------------------------------------------------------------------------------------------------------------------------|
|             | <b><i>File</i></b>                                                                                                                                                                                                                             |
| Description | Indicates 2 file names (copy source and copy destination). <ul style="list-style-type: none"> <li>• <i>File(0)</i> Copy source file name</li> <li>• <i>File(1)</i> Copy destination file name</li> </ul> The index of the array starts from 0. |
| Data type   | Variant type (Variant)                                                                                                                                                                                                                         |
| Range       | 254 characters or less                                                                                                                                                                                                                         |
| Note        | If the specified copy source file does not exist, an error occurs when executed and the object is ignored. Notice that, if a file with the same name as the specified copy destination file name exists, its contents are overwritten.         |

Examples `SCPI.MMEMory.COPY = Array("test/state01.sta", "a:test01.sta")`

```
Dim File(1) As Variant
File(0) = "test/state01.sta"
File(1) = "a:test01.sta"
SCPI.MMEMory.COPY = File
```

Equivalent key **[Save/Recall] - Save State - File Dialog...**

## SCPI.MMEMory.DElete

Object type Property

Syntax SCPI.MMEMory.DElete = *File*

Description Deletes an existing file or directory (folder).

When you delete a directory, all the files and directories in it are deleted.

Specify the file name with the extension. If you want to specify a file or directory on the floppy disk drive, you need to add "A:" at the beginning of its name. When you specify a file (directory) under an existing directory, separate them with "\" (back slash), or "/" (slash).

To delete all files in the directory (folder), specify "\" (backslash). (No read)

Variable

|             |                                                                                                             |
|-------------|-------------------------------------------------------------------------------------------------------------|
|             | <b><i>File</i></b>                                                                                          |
| Description | File name or directory name you want to delete                                                              |
| Data type   | Character string type (String)                                                                              |
| Range       | 254 characters or less                                                                                      |
| Note        | If the specified file or directory does not exist, an error occurs when executed and the object is ignored. |

Examples SCPI.MMEMory.DElete = "a:\"

SCPI.MMEMory.DElete = "test/state01.sta"

Equivalent key **[Save/Recall] - Save State - File Dialog...**



## SCPI.MMEMory.LOAD.ASCFactor

Object type Property

Syntax SCPI.MMEMory.LOAD.ASCFactor = *File*

Description Recalls the file (file with the ".csv" extension saved with the SCPI.MMEMory.STORE.ASCFactor object) you want to specify as the table for the reference calibration coefficient and the calibration coefficient table for power sensor A. Specify the file name with the extension. If you want to specify a file on the floppy disk drive, you need to add "A:" at the beginning of the file name. When you use directory names and file name, separate them with "\" (back slash), or "/" (slash). (No read)

Variable

|             | <i>File</i>                                                                                                                       |
|-------------|-----------------------------------------------------------------------------------------------------------------------------------|
| Description | A file name (extension ".csv") of the reference calibration coefficient and the calibration coefficient table for power sensor A. |
| Data type   | Character string type (String)                                                                                                    |
| Range       | 254 characters or less                                                                                                            |
| Note        | If the specified file does not exist, a runtime error occurs.                                                                     |

Examples SCPI.MMEMory.LOAD.ASCFactor = "a:\sensor01.csv"

SCPI.MMEMory.LOAD.ASCFactor = "test/sensor01.csv"

Related objects SCPI.MMEMory.STORE.ASCFactor on page 439

Equivalent key **[Cal] - Power Calibration - Sensor A Settings - Import from CSV File**

## SCPI.MMEMory.LOAD.BSCFactor

Object type Property

Syntax SCPI.MMEMory.LOAD.BSCFactor = *File*

Description Recalls the file (file with the ".csv" extension saved with the SCPI.MMEMory.STORE.BSCFactor object) you want to specify as the table for the reference calibration coefficient and the calibration coefficient table for power sensor B.

Specify the file name with the extension. If you want to specify a file on the floppy disk drive, you need to add "A:" at the beginning of the file name. When you use directory names and file name, separate them with "\" (back slash), or "/" (slash). (No read)

Variable

|             |                                                                                                                                   |
|-------------|-----------------------------------------------------------------------------------------------------------------------------------|
|             | <i>File</i>                                                                                                                       |
| Description | A file name (extension ".csv") of the reference calibration coefficient and the calibration coefficient table for power sensor B. |
| Data type   | Character string type (String)                                                                                                    |
| Range       | 254 characters or less                                                                                                            |
| Note        | If the specified file does not exist, a runtime error occurs.                                                                     |

Examples SCPI.MMEMory.LOAD.BSCFactor = "a:\sensor01.csv"

SCPI.MMEMory.LOAD.BSCFactor = "test/sensor01.csv"

Related objects SCPI.MMEMory.STORE.BSCFactor on page 440

Equivalent key **[Cal] - Power Calibration - Sensor B Settings - Import from CSV File**

## SCPI.MMEMory.LOAD.CHANnel.STATe

- Object type** Property
- Syntax** SCPI.MMEMory.LOAD.CHANnel.STATe = *Register*
- Description** Recalls the instrument state for an individual channel (saved with the SCPI.MMEMory.STORe.CHANnel.STATe object) from the specified register as the setting of the active channel.  
 It is possible to recall the register from a different channel where it was saved. (No read)

**Variable**

|             |                                                                                                                                                                                                                                                                                                            |
|-------------|------------------------------------------------------------------------------------------------------------------------------------------------------------------------------------------------------------------------------------------------------------------------------------------------------------|
|             | <i>Register</i>                                                                                                                                                                                                                                                                                            |
| Description | Register                                                                                                                                                                                                                                                                                                   |
| Data type   | Character string type (String)                                                                                                                                                                                                                                                                             |
| Range       | Select from the following.<br><ul style="list-style-type: none"> <li>•"A"                      Specifies register A.</li> <li>•"B"                      Specifies register B.</li> <li>•"C"                      Specifies register C.</li> <li>•"D"                      Specifies register D.</li> </ul> |
| Note        | If no instrument state has been saved in the specified register, an error occurs and the object is ignored.                                                                                                                                                                                                |

- Examples** SCPI.MMEMory.LOAD.CHANnel.STATe = "a"
- Related objects** SCPI.MMEMory.STORe.CHANnel.STATe on page 441  
 SCPI.DISPlay.WINDow(Ch).ACTivate on page 395
- Equivalent key** **[Save/Recall] - Recall Channel - A|B|C|D**

## SCPI.MMEMory.LOAD.CKIT(*Ckit*)

**Object type** Property

**Syntax** SCPI.MMEMory.LOAD.CKIT(*Ckit*) = *File*

**Description** Recalls the instrument state for an individual channel (saved with the SCPI.MMEMory.STORe.CHANnel.STATE object) from the specified register as the setting of the active channel.

It is possible to recall the register from a different channel where it was saved. (No read)

**Variable**

**Table 7-13**

### Variable (*Ckit*)

|              | <i>Ckit</i>                                                                                   |
|--------------|-----------------------------------------------------------------------------------------------|
| Description  | Number of calibration kit                                                                     |
| Data type    | Long integer type (Long)                                                                      |
| Range        | 1 to 20                                                                                       |
| Preset value | 1                                                                                             |
| Note         | If the specified variable is out of the allowable setup range, an error occurs when executed. |

|             | <i>File</i>                                                   |
|-------------|---------------------------------------------------------------|
| Description | File name of the definition table of a calibration kit        |
| Data type   | Character string type (String)                                |
| Range       | 254 characters or less                                        |
| Note        | If the specified file does not exist, a runtime error occurs. |

**Examples** SCPI.MMEMory.LOAD.CKIT(1) = "Test1/Ckit01.ckx"

SCPI.MMEMory.LOAD.CKIT(1) = "A:\Ckit01.ckx"

**Related objects** SCPI.MMEMory.STORe.CKIT(Ckit) on page 442

**Equivalent key** [Cal] - Modify Cal Kit - Import Cal Kit...

## SCPI.MMEMory.LOAD.LIMit

**Object type** Property

**Syntax** SCPI.MMEMory.LOAD.LIMit = *File*

**Description** As the limit table for the active trace of the active channel, recalls the specified limit table file (file with the .csv extension saved with the SCPI.MMEMory.STORE.LIMit object).  
 Specify the file name with the extension. If you want to specify a file on the floppy disk drive, you need to add "A:" at the beginning of the file name. When you use directory names and file name, separate them with "\" (back slash), or "/" (slash). (No read)

**Variable**

|             |                                                                                                |
|-------------|------------------------------------------------------------------------------------------------|
|             | <i>File</i>                                                                                    |
| Description | File name of limit table (extension ".csv")                                                    |
| Data type   | Character string type (String)                                                                 |
| Range       | 254 characters or less                                                                         |
| Note        | If the specified file does not exist, an error occurs when executed and the object is ignored. |

**Examples**

```
SCPI.DISPlay.WINDow(1).ACTivate
SCPI.CALCulate(1).PARAmeter(1).SElect
SCPI.MMEMory.LOAD.LIMit = "a:\limit01.csv"

SCPI.DISPlay.WINDow(1).ACTivate
SCPI.CALCulate(1).PARAmeter(1).SElect
SCPI.MMEMory.LOAD.LIMit = "test/limit01.csv"
```

**Related objects** SCPI.DISPlay.WINDow(Ch).ACTivate on page 395  
 SCPI.CALCulate(Ch).PARAmeter(Tr).SElect on page 259  
 SCPI.MMEMory.STORE.LIMit on page 445

**Equivalent key** **[Analysis] - Limit Test - Edit Limit Line - Import from CSV File**

## SCPI.MMEMory.LOAD.PLOSs(Pt)

Object type Property

Syntax SCPI.MMEMory.LOAD.PLOSs(Pt) = *File*

Description For ports 1 to 4 (*Pt*), as the loss compensation table for the active channel, recalls the specified loss compensation table file (a file with the ".csv" extension saved with the SCPI.MMEMory.STORe.PLOSs(Pt) object).

Specify the file name with the extension. If you want to specify a file on the floppy disk drive, you need to add "A:" at the beginning of the file name. When you use directory names and file name, separate them with "\" (back slash), or "/" (slash). (No read)

Variable

|             | <i>File</i>                                                   |
|-------------|---------------------------------------------------------------|
| Description | File name of the loss compensation table (extension ".csv")   |
| Data type   | Character string type (String)                                |
| Range       | 254 characters or less                                        |
| Note        | If the specified file does not exist, a runtime error occurs. |

For information on the variable (*Pt*), refer to Table 7-9, "Variable (Pt)," on page 241.

Examples

```
SCPI.DISPlay.WINDow(1).ACTivate
SCPI.MMEMory.LOAD.PLOSs(1) = "a:\loss01.csv"
```

```
SCPI.DISPlay.WINDow(1).ACTivate
SCPI.MMEMory.LOAD.PLOSs(1) = "test/loss01.csv"
```

Related objects

SCPI.DISPlay.WINDow(Ch).ACTivate on page 395  
 SCPI.MMEMory.STORe.PLOSs(Pt) on page 446

Equivalent key

**[Cal] - Power Calibration - Loss Compen - Import from CSV File**

## SCPI.MMEMory.LOAD.RLIMit

Object type Property

Syntax SCPI.MMEMory.LOAD.RLIMit = *File*

Description As the ripple limit table for the active trace (specified with the SCPI.CALCulate(Ch).PARAmeter(Tr).SELEct command) of the active channel (specified with the SCPI.DISPlay.WINDow(Ch).ACTivate command), recalls the specified ripple limit table file (file with the .csv extension saved with the SCPI.MMEMory.STORE.RLIMit command).

Specify the file name with the extension. If you want to specify a file on the floppy disk drive, you need to add "A:" at the beginning of the file name. When you write directory names and file name, separate them with "/" (slash) or "\" (backslash).

If the specified file does not exist, an error occurs and the command is ignored. (Read only)

Variable

|             |                                                                                                |
|-------------|------------------------------------------------------------------------------------------------|
|             | <i>File</i>                                                                                    |
| Description | File name of the ripple limit table (extension ".csv")                                         |
| Data type   | Character string type (String)                                                                 |
| Range       | 254 characters or less                                                                         |
| Note        | If the specified file does not exist, an error occurs when executed and the object is ignored. |

For information on the variable (*Ch*), see Table 7-6, "Variable (Ch)," on page 209.

Examples (1)  
 SCPI.DISPlay.WINDow(1).ACTive  
 SCPI.CALCulate(1).PARAmeter(1).SELEct  
 SCPI.MMEMory.LOAD.RIMit = "A:\Rlimit01.csv"

Examples (2)  
 SCPI.DISPlay.WINDow(1).ACTive  
 SCPI.CALCulate(1).PARAmeter(1).SELEct  
 SCPI.MMEMory.LOAD.RLIMit = "test/Rlimit01.csv"

Related objects  
 SCPI.DISPlay.WINDow(Ch).ACTivate on page 395  
 SCPI.CALCulate(Ch).PARAmeter(Tr).SELEct on page 259  
 SCPI.MMEMory.STORE.RLIMit on page 447

Equivalent key **[Analysis] - Ripple Limit - Edit Ripple Line - Import from CSV File**

## SCPI.MMEMory.LOAD.SEGMent

- Object type** Property
- Syntax** SCPI.MMEMory.LOAD.SEGMent = *File*
- Description** As the segment sweep table of the active channel, recalls the specified segment sweep table file (file with the .csv extension saved with the SCPI.MMEMory.STORE.SEGMent object).  
Specify the file name with the extension. If you want to specify a file on the floppy disk drive, you need to add "A:" at the beginning of the file name. When you use directory names and file name, separate them with "\" (back slash), or "/" (slash). (No read)

**Variable**

|             |                                                                                                |
|-------------|------------------------------------------------------------------------------------------------|
|             | <i>File</i>                                                                                    |
| Description | File name of segment sweep table (extension ".csv")                                            |
| Data type   | Character string type (String)                                                                 |
| Range       | 254 characters or less                                                                         |
| Note        | If the specified file does not exist, an error occurs when executed and the object is ignored. |

- Examples**
- ```
SCPI.DISPlay.WINDow(1).ACTivate  
SCPI.MMEMory.LOAD.SEGMent = "a:\segm01.csv"
```
- ```
SCPI.DISPlay.WINDow(1).ACTivate
SCPI.MMEMory.LOAD.SEGMent = "test/segm01.csv"
```
- Related objects** SCPI.DISPlay.WINDow(Ch).ACTivate on page 395  
SCPI.MMEMory.STORE.SEGMent on page 449
- Equivalent key** **[Sweep Setup] - Edit Segment Table - Import from CSV File**



## SCPI.MMEMory.LOAD.STATe

**Object type** Property

**Syntax** SCPI.MMEMory.LOAD.STATe = *File*

**Description** Recalls the specified instrument state file (file with the .sta extension saved with the SCPI.MMEMory.STORE.STATe object).

Specify the file name with the extension. If you want to specify a file on the floppy disk drive, you need to add "A:" at the beginning of the file name. When you use directory names and file name, separate them with "\" (back slash), or "/" (slash). (No read)

**Variable**

|             | <i>File</i>                                                                                    |
|-------------|------------------------------------------------------------------------------------------------|
| Description | File name of instrument state (extension ".sta")                                               |
| Data type   | Character string type (String)                                                                 |
| Range       | 254 characters or less                                                                         |
| Note        | If the specified file does not exist, an error occurs when executed and the object is ignored. |

**Examples**

SCPI.MMEMory.LOAD.STATe = "a:\state01.sta"

SCPI.MMEMory.LOAD.STATe = "test/state01.sta"

**Related objects** SCPI.MMEMory.STORE.STATe on page 456

**Equivalent key** **[Save/Recall] - Recall State**

## SCPI.MMEMory.MDIRectory

Object type      Property

Syntax            SCPI.MMEMory.MDIRectory = *File*

Description      Creates a new directory (folder).

If you want to create a directory on the floppy disk drive, you need to add "A:" at the beginning of the directory name. When you create a directory under an existing directory, separate between the directory names with "\" (back slash), or "/" (slash). (No read)

Variable

|             |                                                                                                                                    |
|-------------|------------------------------------------------------------------------------------------------------------------------------------|
|             | <i>File</i>                                                                                                                        |
| Description | Directory name you want to create                                                                                                  |
| Data type   | Character string type (String)                                                                                                     |
| Range       | 254 characters or less                                                                                                             |
| Note        | If a directory with the same name as the specified directory name exists, an error occurs when executed and the object is ignored. |

Examples            SCPI.MMEMory.MDIRectory = "a:\test"

SCPI.MMEMory.MDIRectory = "test"

Equivalent key    **[Save/Recall] - Save State - File Dialog...**

## SCPI.MMEMory.STORE.ASCFactor

**Object type** Property

**Syntax** SCPI.MMEMory.STORE.ASCFactor = *File*

**Description** Saves the reference calibration coefficient and the calibration coefficient table for power sensor A into a CSV file (extension ".csv").

Specify the file name with the extension. If you want to specify a file on the floppy disk drive, you need to add "A:" at the beginning of the file name. When you use directory names and file name, separate them with "\" (back slash), or "/" (slash). (No read)

**Variable**

|             |                                                                                                                                        |
|-------------|----------------------------------------------------------------------------------------------------------------------------------------|
|             | <i>File</i>                                                                                                                            |
| Description | A file name (extension ".csv") to save the reference calibration coefficient and the calibration coefficient table for power sensor A. |
| Data type   | Character string type (String)                                                                                                         |
| Range       | 254 characters or less                                                                                                                 |
| Note        | If a file with the same name as the specified file name exists, its contents are overwritten.                                          |

**Examples** SCPI.MMEMory.STORE.ASCFactor = "a:\sensor01.csv"

SCPI.MMEMory.STORE.ASCFactor = "test/sensor01.csv"

**Related objects** SCPI.MMEMory.LOAD.ASCFactor on page 429

**Equivalent key** **[Cal] - Power Calibration - Sensor A Settings - Export to CSV File**

## SCPI.MMEMory.STORE.BSCFactor

**Object type** Property

**Syntax** SCPI.MMEMory.STORE.BSCFactor = *File*

**Description** Saves the reference calibration coefficient and the calibration coefficient table for power sensor B into a CSV file (extension ".csv").

Specify the file name with the extension. If you want to specify a file on the floppy disk drive, you need to add "A:" at the beginning of the file name. When you use directory names and file name, separate them with "\" (back slash), or "/" (slash). (No read)

**Variable**

|             | <i>File</i>                                                                                                                            |
|-------------|----------------------------------------------------------------------------------------------------------------------------------------|
| Description | A file name (extension ".csv") to save the reference calibration coefficient and the calibration coefficient table for power sensor B. |
| Data type   | Character string type (String)                                                                                                         |
| Range       | 254 characters or less                                                                                                                 |
| Note        | If a file with the same name as the specified file name exists, its contents are overwritten.                                          |

**Examples**

```
SCPI.MMEMory.STORE.BSCFactor = "a:\sensor01.csv"
```

```
SCPI.MMEMory.STORE.BSCFactor = "test/sensor01.csv"
```

**Related objects** SCPI.MMEMory.LOAD.BSCFactor on page 430

**Equivalent key** **[Cal] - Power Calibration - Sensor B Settings - Export to CSV File**

## SCPI.MMEMory.STORe.CHANnel.CLEAr

|                 |                                                                                                                                        |
|-----------------|----------------------------------------------------------------------------------------------------------------------------------------|
| Object type     | Method                                                                                                                                 |
| Syntax          | SCPI.MMEMory.STORe.CHANnel.CLEAr                                                                                                       |
| Description     | Deletes the instrument state for each channel (saved with the SCPI.MMEMory.STORe.CHANnel.STATe object) in all the registers. (No read) |
| Examples        | SCPI.MMEMory.STORe.CHANnel.CLEAr                                                                                                       |
| Related objects | SCPI.MMEMory.STORe.CHANnel.STATe on page 441                                                                                           |
| Equivalent key  | <b>[Save/Recall] - Save Channel - Clear States - OK</b>                                                                                |

## SCPI.MMEMory.STORe.CHANnel.STATe

|             |                                                                                                                                                           |
|-------------|-----------------------------------------------------------------------------------------------------------------------------------------------------------|
| Object type | Property                                                                                                                                                  |
| Syntax      | SCPI.MMEMory.STORe.CHANnel.STATe = <i>Register</i>                                                                                                        |
| Description | Saves the instrument state of the items set for the active channel specific to that channel only into the specified register (volatile memory). (No read) |

### Variable

|             |                                                                                                                                                                                                                                                                                                            |
|-------------|------------------------------------------------------------------------------------------------------------------------------------------------------------------------------------------------------------------------------------------------------------------------------------------------------------|
|             | <i>Register</i>                                                                                                                                                                                                                                                                                            |
| Description | Register                                                                                                                                                                                                                                                                                                   |
| Data type   | Character string type (String)                                                                                                                                                                                                                                                                             |
| Range       | Select from the following.<br><ul style="list-style-type: none"> <li>•"A"                      Specifies register A.</li> <li>•"B"                      Specifies register B.</li> <li>•"C"                      Specifies register C.</li> <li>•"D"                      Specifies register D.</li> </ul> |
| Note        | If an instrument state has been saved already in the specified register, its contents are overwritten.                                                                                                                                                                                                     |

|                 |                                                                                             |
|-----------------|---------------------------------------------------------------------------------------------|
| Examples        | SCPI.MMEMory.STORe.CHANnel.STATe = "a"                                                      |
| Related objects | SCPI.MMEMory.LOAD.CHANnel.STATe on page 431<br>SCPI.DISPlay.WINDow(Ch).ACTivate on page 395 |
| Equivalent key  | <b>[Save/Recall] - Save Channel - A B C D</b>                                               |

## SCPI.MMEMory.STORe.CKIT(*Ckit*)

Object type Property

Syntax SCPI.MMEMory.STORe.CKIT(*Ckit*) = *File*

Description Saves the definition table of the calibration kit to a file.

Specify the file name with the .ckx extension. If you want to specify a file on the floppy disk drive, you need to add "A:" at the beginning of the file name. When you use a directory name and file name, separate them with "/" (slash) or "\" (backslash).

Notice that, if a file with the specified file name exists, its contents are overwritten. (No Read)

Variable

|             | <i>File</i>                                                                                   |
|-------------|-----------------------------------------------------------------------------------------------|
| Description | A file name used to save the definition of the calibration kit.                               |
| Data type   | Character string type (String)                                                                |
| Range       | 254 characters or less                                                                        |
| Note        | If a file with the same name as the specified file name exists, its contents are overwritten. |

For information on the variable (*Ckit*), see Table 7-13, "Variable (Ckit)," on page 432.

Examples SCPI.MMEMory.STORe.CKIT(1) = "a:\Ckit01.ckx"

SCPI.MMEMory.STORe.CKIT(1) = "test/trace01.csv"

Related objects SCPI.MMEMory.LOAD.CKIT(Ckit) on page 432

Equivalent key **[Save/Recall] - Save Trace Data**

## SCPI.MMEMory.STORe.FDATa

**Object type** Property

**Syntax** SCPI.MMEMory.STORe.FDATa = *File*

**Description** For the active trace of the active channel, saves the formatted data array into a file in the CSV format (extension ".csv").

Specify the file name with the extension. If you want to specify a file on the floppy disk drive, you need to add "A:" at the beginning of the file name. When you use directory names and file name, separate them with "\" (back slash), or "/" (slash). (No read)

**Variable**

|             |                                                                                               |
|-------------|-----------------------------------------------------------------------------------------------|
|             | <i>File</i>                                                                                   |
| Description | File name in which you want to save the formatted data array (extension ".csv")               |
| Data type   | Character string type (String)                                                                |
| Range       | 254 characters or less                                                                        |
| Note        | If a file with the same name as the specified file name exists, its contents are overwritten. |

**Examples**

```
SCPI.DISPlay.WINDow(1).ACTivate
SCPI.CALCulate(1).PARAmeter(1).SElect
SCPI.MMEMory.STORe.FDATa = "a:\trace01.csv"
```

```
SCPI.DISPlay.WINDow(1).ACTivate
SCPI.CALCulate(1).PARAmeter(1).SElect
SCPI.MMEMory.STORe.FDATa = "test/trace01.csv"
```

**Related objects**

SCPI.DISPlay.WINDow(Ch).ACTivate on page 395  
 SCPI.CALCulate(Ch).PARAmeter(Tr).SElect on page 259

**Equivalent key**

**[Save/Recall] - Save Trace Data**

## SCPI.MMEMory.STORe.IMAGE

Object type Property

Syntax SCPI.MMEMory.STORe.IMAGE = *File*

Description Saves the display image on the LCD display at the execution of the object into a file in the bitmap (extension ".bmp") or portable network graphics (extension ".png") format. When saving the E5070B/E5071B measurement screen, execute the VBA program with the Visual Basic editor closed. For more information, see "Running a Program from the E5070B/E5071B Measurement Screen" on page 54.

Specify the file name with the extension. If you want to specify a file on the floppy disk drive, you need to add "A:" at the beginning of the file name. When you use directory names and file name, separate them with "\" (back slash), or "/" (slash). (No read)

Variable

|             | <i>File</i>                                                                                           |
|-------------|-------------------------------------------------------------------------------------------------------|
| Description | File name in which you want to save the display image on the LCD display (extension ".bmp" or ".png") |
| Data type   | Character string type (String)                                                                        |
| Range       | 254 characters or less                                                                                |
| Note        | If a file with the same name as the specified file name exists, its contents are overwritten.         |

Examples SCPI.MMEMory.STORe.IMAGE = "a:\image01.bmp"

SCPI.MMEMory.STORe.IMAGE = "test/image01.png"

Equivalent key **[System] - Dump Screen Image**

When performing the operation from the front panel, the image on the LCD display memorized in the volatile memory (clipboard) (the image on the LCD display when the **[Capture] ([System])** key is pressed) is saved. Notice that, if no image is memorized in the clipboard, in the same way as the SCPI.MMEMory.STORe.IMAGE object, the image on the LCD display at the execution is memorized in the clipboard and then it is saved.



## SCPI.MMEMory.STORe.LIMit

**Object type** Property

**Syntax** SCPI.MMEMory.STORe.LIMit = *File*

**Description** Saves the limit table of the active trace of the active channel into a file in the CSV format (extension ".csv").

Specify the file name with the extension. If you want to specify a file on the floppy disk drive, you need to add "A:" at the beginning of the file name. When you use directory names and file name, separate them with "\" (back slash), or "/" (slash). (No read)

**Variable**

|             | <i>File</i>                                                                                   |
|-------------|-----------------------------------------------------------------------------------------------|
| Description | File name to save the limit table (extension ".csv")                                          |
| Data type   | Character string type (String)                                                                |
| Range       | 254 characters or less                                                                        |
| Note        | If a file with the same name as the specified file name exists, its contents are overwritten. |

**Examples**

```
SCPI.DISPlay.WINDow(1).ACTivate
SCPI.CALCulate(1).PARAmeter(1).SElect
SCPI.MMEMory.STORe.LIMit = "a:\limit01.csv"
```

```
SCPI.DISPlay.WINDow(1).ACTivate
SCPI.CALCulate(1).PARAmeter(1).SElect
SCPI.MMEMory.STORe.LIMit = "test/limit01.csv"
```

**Related objects**

SCPI.DISPlay.WINDow(Ch).ACTivate on page 395  
 SCPI.CALCulate(Ch).PARAmeter(Tr).SElect on page 259  
 SCPI.MMEMory.LOAD.LIMit on page 433

**Equivalent key**

**[Analysis] - Limit Test - Edit Limit Line - Export to CSV File**

## SCPI.MMEMory.STORe.PLOSs(Pt)

**Object type** Property

**Syntax** SCPI.MMEMory.STORe.PLOSs(Pt) = *File*

**Description** For ports 1 to 4 (*Pt*), saves the loss compensation table of the active channel into a file in the CSV format (extension ".csv").

Specify the file name with the extension. If you want to specify a file on the floppy disk drive, you need to add "A:" at the beginning of the file name. When you use directory names and file name, separate them with "\" (back slash), or "/" (slash). (No read)

**Variable**

|             | <i>File</i>                                                                                   |
|-------------|-----------------------------------------------------------------------------------------------|
| Description | A file name to save the loss compensation table (extension ".csv")                            |
| Data type   | Character string type (String)                                                                |
| Range       | 254 characters or less                                                                        |
| Note        | If a file with the same name as the specified file name exists, its contents are overwritten. |

For information on the variable (*Pt*), refer to Table 7-9, "Variable (Pt)," on page 241.

**Examples**

```
SCPI.DISPlay.WINDow(1).ACTivate
SCPI.MMEMory.STORe.PLOSs(1) = "a:\loss01.csv"
```

```
SCPI.DISPlay.WINDow(1).ACTivate
SCPI.MMEMory.STORe.PLOSs(1) = "test/loss01.csv"
```

**Related objects** SCPI.DISPlay.WINDow(Ch).ACTivate on page 395  
 SCPI.MMEMory.LOAD.PLOSs(Pt) on page 434

**Equivalent key** **[Cal] - Power Calibration - Loss Compen - Export to CSV File**

## SCPI.MMEMory.STORe.RLIMit

**Object type** Property

**Syntax** SCPI.MMEMory.STORe.RLIMit = *File*

**Description** Saves the ripple limit table of the active trace (specified with the SCPI.CALCulate(Ch).PARAmeter(Tr).SELEct command) of the active channel (specified with the SCPI.DISPlay.WINDow(Ch).ACTivate command) into a file in the CSV format.

Specify the file name with the .sta extension. If you want to specify a file on the floppy disk drive, you need to add "A:" at the beginning of the file name. When you write directory names and file name, separate them with "/" (slash) or "\" (backslash).

Notice that if a file with the specified file name already exists, its contents will be overwritten. (Read only)

**Variable**

|             |                                                                  |
|-------------|------------------------------------------------------------------|
|             | <i>File</i>                                                      |
| Description | File name used to save the ripple limit table (extension ".csv") |
| Data type   | Character string type (String)                                   |
| Range       | 254 characters or less                                           |
| Note        | If the specified file does not exist, a runtime error occurs.    |

For information on the variable (*Ch*), see Table 7-6, "Variable (Ch)," on page 209.

**Examples (1)**

```
SCPI.DISPlay.WINDow(1).ACTivate
SCPI.CALCulate(1).PARAmeter(1).SELEct
SCPI.MMEMory.STORe.RLIMit = "A:\Rlimit01.csv"
```

**Examples (2)**

```
SCPI.DISPlay.WINDow(1).ACTivate
SCPI.CALCulate(1).PARAmeter(1).SELEct
SCPI.MMEMory.STORe.RLIMit = "test/Rlimit01.csv"
```

**Related objects**

SCPI.DISPlay.WINDow(Ch).ACTivate on page 395

SCPI.CALCulate(Ch).PARAmeter(Tr).SELEct on page 259

SCPI.MMEMory.LOAD.RLIMit on page 435

**Equivalent key** **[Analysis] - Ripple Limit - Edit Ripple Line - Export to CSV File**

## SCPI.MMEMory.STORe.SALL

Object type Property

Syntax SCPI.MMEMory.STORe.SALL = *Status*  
*Status* = SCPI.MMEMory.STORe.SALL

Description Selects whether to save the setting of all channels/traces or that of the displayed channels/traces only as the instrument state to be saved.

Variable

|              |                                                                                                                                                                                                                                                                                                                 |
|--------------|-----------------------------------------------------------------------------------------------------------------------------------------------------------------------------------------------------------------------------------------------------------------------------------------------------------------|
|              | <i>Status</i>                                                                                                                                                                                                                                                                                                   |
| Description  | Selecting content to be saved as the instrument state setting.                                                                                                                                                                                                                                                  |
| Data type    | Boolean type (Boolean)                                                                                                                                                                                                                                                                                          |
| Range        | Select from the following. <ul style="list-style-type: none"><li>•True or -1                      Specifies the setting of all channels/traces as the target to be saved.</li><li>•False or 0                      Specifies the setting of displayed channels/traces only as the target to be saved.</li></ul> |
| Preset value | False or 0                                                                                                                                                                                                                                                                                                      |

Examples  

```
Dim Obj As Boolean
SCPI.MMEMory.STORe.SALL = True
Obj = SCPI.MMEMory.STORe.SALL
```

Related objects SCPI.MMEMory.STORe.STATe on page 456

Equivalent key **[Save/Recall] - Channel/Trace**

## SCPI.MMEMemory.STORE.SEGMENT

**Object type** Property

**Syntax** SCPI.MMEMemory.STORE.SEGMENT = *File*

**Description** Saves the segment sweep table of the active channel into a file in the CSV format (extension ".csv").

Specify the file name with the extension. If you want to specify a file on the floppy disk drive, you need to add "A:" at the beginning of the file name. When you use directory names and file name, separate them with "\" (back slash), or "/" (slash). (No read)

**Variable**

|             |                                                                                               |
|-------------|-----------------------------------------------------------------------------------------------|
|             | <i>File</i>                                                                                   |
| Description | File name to save segment sweep table (extension ".csv")                                      |
| Data type   | Character string type (String)                                                                |
| Range       | 254 characters or less                                                                        |
| Note        | If a file with the same name as the specified file name exists, its contents are overwritten. |

**Examples**

```
SCPI.DISPLAY.WINDOW(1).ACTivate
SCPI.MMEMemory.STORE.SEGMENT = "a:\segm01.csv"
```

```
SCPI.DISPLAY.WINDOW(1).ACTivate
SCPI.MMEMemory.STORE.SEGMENT = "test/segm01.csv"
```

**Related objects**

SCPI.DISPLAY.WINDOW(Ch).ACTivate on page 395  
 SCPI.MMEMemory.LOAD.SEGMENT on page 436

**Equivalent key**

**[Sweep Setup] - Edit Segment Table - Export to CSV File**

## SCPI.MMEMory.STORe.SNP.DATA

|             |                                                                                                                                                                                                                                                                                   |
|-------------|-----------------------------------------------------------------------------------------------------------------------------------------------------------------------------------------------------------------------------------------------------------------------------------|
| Object type | Property                                                                                                                                                                                                                                                                          |
| Syntax      | SCPI.MMEMory.STORe.SNP.DATA = <i>File</i>                                                                                                                                                                                                                                         |
| Description | Saves the measurement data for the active channel (specified with the SCPI.DISPlay.WINDow(Ch).ACTivate command) into a file in the touchstone format.<br><br>You need to specify a file format and file type before saving a file. The extension differs depending on file types. |

| <file type>                 | <extension> |
|-----------------------------|-------------|
| When specifying one port    | s1p         |
| When specifying two ports   | s2p         |
| When specifying three ports | s3p         |
| When specifying four ports  | s4p         |

If you want to specify a file on the floppy disk drive, you need to add "A:" at the beginning of the file name. When you use directory names and file name, separate them with "/" (slash) or "\" (back slash).

Note that if a file with the specified file name already exists, its contents are overwritten. (No query)

### Variable

|             | <i>File</i>                                                         |
|-------------|---------------------------------------------------------------------|
| Description | File name you want to use when saving file in the touchstone format |
| Range       | 254 characters or less                                              |

---

**NOTE** When invalid extension is specified, an error message appears and the command is ignored.

---

**Examples**

```
Dim SnpPorts(2) As Variant
SCPI.DISPlay.WINDow(1).ACTivate
SCPI.MMEMory.STORe.SNP.FORMat = "RI"
SnpPorts(0) = 1
SnpPorts(1) = 2
SnpPorts(2) = 4
SCPI.MMEMory.STORe.SNP.TYPE.S3P = SnpPorts
SCPI.MMEMory.STORe.SNP.DATA = "SNP01.s3p"
```

**Related objects**

SCPI.DISPlay.WINDow(Ch).ACTivate on page 395  
 SCPI.MMEMory.STORe.SNP.FORMat on page 451  
 SCPI.MMEMory.STORe.SNP.TYPE.S1P on page 452

SCPI.MMEMory.STORe.SNP.TYPE.S2P on page 453  
 SCPI.MMEMory.STORe.SNP.TYPE.S3P on page 454  
 SCPI.MMEMory.STORe.SNP.TYPE.S4P on page 455

Equivalent key After a file type is specified, a dialog box will appear.

## SCPI.MMEMory.STORe.SNP.FORMat

Object type Property

Syntax SCPI.MMEMory.STORe.SNP.FORMat = *Param*  
*Param* = SCPI.MMEMory.STORe.SNP.FORMat

Description Specifies data format for saving measurement data for the active channel (specified with SCPI.DISPlay.WINDow(Ch).ACTivate command) into a file in the touchstone format.

Variable

|              |                                                                                                                                                                                                                                                                                                                                                                                      |
|--------------|--------------------------------------------------------------------------------------------------------------------------------------------------------------------------------------------------------------------------------------------------------------------------------------------------------------------------------------------------------------------------------------|
|              | <i>Param</i>                                                                                                                                                                                                                                                                                                                                                                         |
| Description  | Touchstone file format                                                                                                                                                                                                                                                                                                                                                               |
| Data type    | Character string type (String)                                                                                                                                                                                                                                                                                                                                                       |
| Range        | Select from the following.<br><ul style="list-style-type: none"> <li>•"AUTO" Specifies data format automatically according to the display format of the active trace.*1</li> <li>•"MA" Specifies data format "log magnitude - angle".</li> <li>•"DB" Specifies data format "linear magnitude - angle".</li> <li>•"RI" Specifies data format "real part - imaginary part".</li> </ul> |
| Preset value | "CState"                                                                                                                                                                                                                                                                                                                                                                             |

\*1. When the display format of the active trace is set to one other than log magnitude format (LogMag), linear magnitude format (LinMag), or real-imaginary number format (Real/Imag), the data format is automatically set to "real part - imaginary part."

Examples  

```
Dim Fmt As String
SCPI.MMEMory.STORe.SNP.FORMat = "MA"
Fmt = SCPI.MMEMory.STORe.SNP.FORMat
```

Related objects SCPI.DISPlay.WINDow(Ch).ACTivate on page 395  
 SCPI.MMEMory.STORe.SNP.DATA on page 450

Equivalent key **[Save/Recall] - Save Snp - Snp Format - AUTO|LogMag/Angle|LinMag/Angle|Real/Imaginary**

## SCPI.MMEMory.STORe.SNP.TYPE.S1P

Object type Property

Syntax SCPI.MMEMory.STORe.SNP.TYPE.S1P = *Port*  
*Port* = SCPI.MMEMory.STORe.SNP.TYPE.S1P

Description Sets specified port to the file type (1 port) when saving measurement data for the active channel (specified with SCPI.DISPlay.WINDow(Ch).ACTivate command) into a file in the touchstone format.

Variable

|             | <i>Port</i> |
|-------------|-------------|
| Description | Port number |
| Range       | 1 to 4      |
| Resolution  | 1           |

Examples  
10 OUTPUT 717; " :MMEM:STOR:SNP:TYPE:S1P 2 "  
20 OUTPUT 717; " :MMEM:STOR:SNP:TYPE:S1P? "  
30 ENTER 717;A\$

Related objects SCPI.DISPlay.WINDow(Ch).ACTivate on page 395  
SCPI.MMEMory.STORe.SNP.DATA on page 450  
SCPI.MMEMory.STORe.SNP.FORMat on page 451

Equivalent key **[Save/Recall] - Save SnP - S1P - 1|2|3<sup>\*1</sup>|4<sup>\*2</sup>**

\*1. Only with Options 313, 314, 413, and 414.

\*2. Only with Options 413 and 414.



## SCPI.MMEMory.STORe.SNP.TYPE.S2P

**Object type** Property

**Syntax** SCPI.MMEMory.STORe.SNP.TYPE.S2P = *Ports*  
*Ports* = SCPI.MMEMory.STORe.SNP.TYPE.S2P

**Description** Sets specified port to the file type (2 port) when saving measurement data for the active channel (specified with SCPI.DISPlay.WINDow(Ch).ACTivate command) into a file in the touchstone format.

**Variable**

|             |                                                                                                                                                                                                                                                               |
|-------------|---------------------------------------------------------------------------------------------------------------------------------------------------------------------------------------------------------------------------------------------------------------|
|             | <b><i>Ports</i></b>                                                                                                                                                                                                                                           |
| Description | Indicates 2-element array data (port number).<br><ul style="list-style-type: none"> <li>• <i>Ports(0)</i> Specifies a port for file type.</li> <li>• <i>Ports(1)</i> Specifies the other port for file type.</li> </ul> The index of the array starts from 0. |
| Data type   | Variant type (Variant)                                                                                                                                                                                                                                        |
| Range       | 1 to 4                                                                                                                                                                                                                                                        |
| Resolution  | 1                                                                                                                                                                                                                                                             |
| Note        | If the specified variable is out of the allowable setup range, an error occurs when it is executed. If you specify the same port number to two ports, an error occurs during execution. The order of the two port numbers to be specified is arbitrary.       |

**Examples**

```
Dim Ports(1) As Long
Ports(0) = 2
Ports(1) = 3
SCPI.MMEMory.STORe.SNP.TYPE.S2P = Ports
Ports = SCPI.MMEMory.STORe.SNP.TYPE.S2P
```

**Related objects** SCPI.DISPlay.WINDow(Ch).ACTivate on page 395  
SCPI.MMEMory.STORe.SNP.DATA on page 450  
SCPI.MMEMory.STORe.SNP.FORMat on page 451

**Equivalent key** **[Save/Recall] - Save Snp - S2p - 1-2|1-3\*1|1-4\*2|2-3\*1|2-4\*2|3-4\*2**

\*1. Only with Options 313, 314, 413, and 414.  
\*2. Only with Options 413 and 414.

## SCPI.MMEMory.STORe.SNP.TYPE.S3P

**Object type** Property

**Syntax** SCPI.MMEMory.STORe.SNP.TYPE.S3P = *Ports*  
*Ports* = SCPI.MMEMory.STORe.SNP.TYPE.S3P

**Description** Sets specified port to the file type (3 port) when saving measurement data for the active channel (specified with SCPI.DISPlay.WINDow(Ch).ACTivate command) into a file in the touchstone format.

**Variable**

|             | <i>Ports</i>                                                                                                                                                                                                                                                                                                  |
|-------------|---------------------------------------------------------------------------------------------------------------------------------------------------------------------------------------------------------------------------------------------------------------------------------------------------------------|
| Description | Indicates 3-element array data (port number). <ul style="list-style-type: none"> <li>• <i>Ports(0)</i> Specifies a port for file type.</li> <li>• <i>Ports(1)</i> Specifies a port for file type.</li> <li>• <i>Ports(2)</i> Specifies a port for file type.</li> </ul> The index of the array starts from 0. |
| Data type   | Variant type (Variant)                                                                                                                                                                                                                                                                                        |
| Range       | 1 to 4                                                                                                                                                                                                                                                                                                        |
| Resolution  | 1                                                                                                                                                                                                                                                                                                             |
| Note        | If the specified variable is out of the allowable setup range, an error occurs when it is executed. If you specify the same port number to two port numbers, an error occurs during execution. The order of the three port numbers to be specified is arbitrary.                                              |

**Examples**

```
Dim Ports(2) As Long
Ports(0) = 2
Ports(1) = 3
Ports(2) = 4
SCPI.MMEMory.STORe.SNP.TYPE.S3P = Ports
Ports = SCPI.MMEMory.STORe.SNP.TYPE.S3P
```

**Related objects** SCPI.DISPlay.WINDow(Ch).ACTivate on page 395  
 SCPI.MMEMory.STORe.SNP.DATA on page 450  
 SCPI.MMEMory.STORe.SNP.FORMat on page 451

**Equivalent key** **[Save/Recall] - Save Snp - S3p**<sup>\*1</sup> - 1-2-3|1-2-4<sup>\*2</sup>|1-3-4<sup>\*2</sup>|2-3-4<sup>\*2</sup>

\*1. Only with Options 313, 314, 413, and 414.  
 \*2. Only with Options 413 and 414.

## SCPI.MMEMory.STORe.SNP.TYPE.S4P

**Object type** Property

**Syntax** SCPI.MMEMory.STORe.SNP.TYPE.S4P = *Ports*  
*Ports* = SCPI.MMEMory.STORe.SNP.TYPE.S4P

**Description** Sets specified port to the file type (4 port) when saving measurement data for the active channel (specified with SCPI.DISPlay.WINDow(Ch).ACTivate command) into a file in the touchstone format.

**Variable**

|             | <i>Ports</i>                                                                                                                                                                                                                                                                                                                                                             |
|-------------|--------------------------------------------------------------------------------------------------------------------------------------------------------------------------------------------------------------------------------------------------------------------------------------------------------------------------------------------------------------------------|
| Description | Indicates 4-element array data (port number). <ul style="list-style-type: none"> <li>• <i>Ports(0)</i> Specifies a port for file type.</li> <li>• <i>Ports(1)</i> Specifies a port for file type.</li> <li>• <i>Ports(2)</i> Specifies a port for file type.</li> <li>• <i>Ports(3)</i> Specifies a port for file type.</li> </ul> The index of the array starts from 0. |
| Data type   | Variant type (Variant)                                                                                                                                                                                                                                                                                                                                                   |
| Range       | 1 to 4                                                                                                                                                                                                                                                                                                                                                                   |
| Resolution  | 1                                                                                                                                                                                                                                                                                                                                                                        |
| Note        | If the specified variable is out of the allowable setup range, an error occurs when it is executed. If you specify the same port number to two port numbers, an error occurs during execution. The order of the four port numbers to be specified is arbitrary.                                                                                                          |

**Examples**

```
Dim Ports(3) As Long
Ports(0) = 1
Ports(1) = 2
Ports(2) = 3
Ports(3) = 4
SCPI.MMEMory.STORe.SNP.TYPE.S4P = Ports
Ports = SCPI.MMEMory.STORe.SNP.TYPE.S4P
```

**Related objects** SCPI.DISPlay.WINDow(Ch).ACTivate on page 395  
 SCPI.MMEMory.STORe.SNP.DATA on page 450  
 SCPI.MMEMory.STORe.SNP.FORMat on page 451

**Equivalent key** **[Save/Recall] - Save Snp - S4p<sup>\*1</sup> - 1-2-3-4**

\*1. Only with Options 413 and 414.

## SCPI.MMEMory.STORe.STATe

|             |                                                                                                                                                                                                                                                                                                                                                                                                                                     |
|-------------|-------------------------------------------------------------------------------------------------------------------------------------------------------------------------------------------------------------------------------------------------------------------------------------------------------------------------------------------------------------------------------------------------------------------------------------|
| Object type | Property                                                                                                                                                                                                                                                                                                                                                                                                                            |
| Syntax      | SCPI.MMEMory.STORe.STATe = <i>File</i>                                                                                                                                                                                                                                                                                                                                                                                              |
| Description | <p>Saves the instrument state (contents to be saved specified with the SCPI.MMEMory.STORe.STYPE object) into a file (file with the .sta extension).</p> <p>Specify the file name with the extension. If you want to specify a file on the floppy disk drive, you need to add "A:" at the beginning of the file name. When you use directory names and file name, separate them with "\" (back slash), or "/" (slash). (No read)</p> |
| <b>NOTE</b> | The instrument setting file saved with the "autorec.sta" file name is automatically recalled when turning on the E5070B/E5071B.                                                                                                                                                                                                                                                                                                     |

Variable

|             | <i>File</i>                                                                                   |
|-------------|-----------------------------------------------------------------------------------------------|
| Description | File name to save the instrument state (extension ".sta")                                     |
| Data type   | Character string type (String)                                                                |
| Range       | 254 characters or less                                                                        |
| Note        | If a file with the same name as the specified file name exists, its contents are overwritten. |

Examples

```
Dim StaType As String
SCPI.MMEMory.STORe.STYPE = "cdst"
SCPI.MMEMory.STORe.STATe = "a:\state01.sta"

Dim StaType As String
SCPI.MMEMory.STORe.STYPE = "cdst"
SCPI.MMEMory.STORe.STATe = "test/state01.sta"
```

|                 |                                                                                        |
|-----------------|----------------------------------------------------------------------------------------|
| Related objects | <p>SCPI.MMEMory.STORe.STYPE on page 457</p> <p>SCPI.MMEMory.LOAD.STATe on page 437</p> |
|-----------------|----------------------------------------------------------------------------------------|

|                |                                   |
|----------------|-----------------------------------|
| Equivalent key | <b>[Save/Recall] - Save State</b> |
|----------------|-----------------------------------|

## SCPI.MMEMory.STORe.STYPE

|             |                                                                                                                   |
|-------------|-------------------------------------------------------------------------------------------------------------------|
| Object type | Property                                                                                                          |
| Syntax      | SCPI.MMEMory.STORe.STYPE = <i>Param</i><br><i>Param</i> = SCPI.MMEMory.STORe.STYPE                                |
| Description | Selects the contents saved when saving the instrument state into a file with the SCPI.MMEMory.STORe.STATe object. |
| Variable    |                                                                                                                   |

|              | <i>Param</i>                                                                                                                                                                                                                                                                                                                                                                                                                                                                                                                                                                                                    |
|--------------|-----------------------------------------------------------------------------------------------------------------------------------------------------------------------------------------------------------------------------------------------------------------------------------------------------------------------------------------------------------------------------------------------------------------------------------------------------------------------------------------------------------------------------------------------------------------------------------------------------------------|
| Description  | Data of instrument state                                                                                                                                                                                                                                                                                                                                                                                                                                                                                                                                                                                        |
| Data type    | Character string type (String)                                                                                                                                                                                                                                                                                                                                                                                                                                                                                                                                                                                  |
| Range        | Select from the following.<br><ul style="list-style-type: none"> <li>•"STATE"                      Specifies the save of the measurement conditions<sup>*1</sup> only.</li> <li>•"CStAtE"                     Specifies the save of the measurement conditions<sup>*1</sup> and the calibration state.</li> <li>•"DStAtE"                     Specifies the save of the measurement conditions<sup>*1</sup> and the formatted data array.</li> <li>•"CDStAtE"                    Specifies the save of the measurement conditions<sup>*1</sup>, the calibration state, and the formatted data array.</li> </ul> |
| Preset value | "CStAtE"                                                                                                                                                                                                                                                                                                                                                                                                                                                                                                                                                                                                        |

\*1. For information on the measurement conditions to be saved, see Appendix "List of Default Values" in the *E5070B/E5071B User's Guide or Programmer's Guide*.

|                 |                                                                                                       |
|-----------------|-------------------------------------------------------------------------------------------------------|
| Examples        | <pre>Dim StaType As String SCPI.MMEMory.STORe.STYPE = "cdst" StaType = SCPI.MMEMory.STORe.STYPE</pre> |
| Related objects | SCPI.MMEMory.STORe.STATe on page 456                                                                  |
| Equivalent key  | <b>[Save/Recall] - Save Type - State Only State &amp; Cal State &amp; Trace All</b>                   |

## SCPI.OUTPUT.STATE

Object type      Property

Syntax            SCPI.OUTPUT.STATE = *Status*  
*Status* = SCPI.OUTPUT.STATE

Description      Turns on/off of the stimulus signal output. You cannot perform measurement until you turn on the stimulus signal output.

Variable

|              |                                                                                                                                                                 |
|--------------|-----------------------------------------------------------------------------------------------------------------------------------------------------------------|
|              | <i>Status</i>                                                                                                                                                   |
| Description  | On/off of the stimulus signal output                                                                                                                            |
| Data type    | Boolean type (Boolean)                                                                                                                                          |
| Range        | Select from the following.<br>•True or -1                      Turns on the stimulus signal.<br>•False or 0                      Turns off the stimulus signal. |
| Preset value | True or -1                                                                                                                                                      |

Examples            Dim Outp As Boolean  
SCPI.OUTPUT.STATE = True  
Outp = SCPI.OUTPUT.STATE

Equivalent key    **[Sweep Setup] - Power - RF Out**

## SCPI.PROGRAM.VARIABLE.ARRAY(VNUM).DATA

|             |                                                                                                                                                                                                                                                            |
|-------------|------------------------------------------------------------------------------------------------------------------------------------------------------------------------------------------------------------------------------------------------------------|
| Object type | Property                                                                                                                                                                                                                                                   |
| Syntax      | SCPI.PROGRAM.VARIABLE.ARRAY(VNUM).DATA = <i>Data</i><br><i>Data</i> = SCPI.PROGRAM.VARIABLE.ARRAY(VNUM).DATA                                                                                                                                               |
| Description | Specifies the array type user defined variable. Up to ten (1-10) areas can be used for the user defined variables.<br><br>You need to specify the size of an array of data (SCPI.PROGRAM.VARIABLE.ARRAY(VNUM).SIZE command) when you execute this command. |

**NOTE** Turning off the power of the instrument initializes the user defined variables, while executing the preset command does not initialize them.

### Variable

|             | <i>Data</i>                                                                                                                                                                                                                                                                                                                          |
|-------------|--------------------------------------------------------------------------------------------------------------------------------------------------------------------------------------------------------------------------------------------------------------------------------------------------------------------------------------|
| Description | "n" is the number obtained from the value specified with the SCPI.PROGRAM.VARIABLE.ARRAY(VNUM).SIZE object.<br><ul style="list-style-type: none"> <li>• <i>Data</i>(0)                      The first array data</li> <li>• <i>Data</i>(n-1)                    The n-th array data</li> </ul> The index of the array starts from 0. |
| Data type   | Variant type (Variant)                                                                                                                                                                                                                                                                                                               |
| Note        | If the data size is not specified, an error occurs when executed.                                                                                                                                                                                                                                                                    |

**Table 7-14**                      **Variable (VNUM)**

|              | <i>Vnum</i>                                                                                   |
|--------------|-----------------------------------------------------------------------------------------------|
| Description  | Array number                                                                                  |
| Data type    | Long integer type (Long)                                                                      |
| Range        | 1 to 10                                                                                       |
| Preset value | 1                                                                                             |
| Note         | If the specified variable is out of the allowable setup range, an error occurs when executed. |

### Examples

```
Dim VnumData As Variant
Dim VnumSize As Long
SCPI.PROGRAM.VARIABLE.ARRAY(1).SIZE = 4
SCPI.PROGRAM.VARIABLE.ARRAY(1).DATA = Array(1.0,2.0,3.0,4.0)
VnumData = PROGRAM.VARIABLE.ARRAY(1).DATA

Dim VnumData1 As Variant
Dim VnumData2 As Variant
Dim VnumSize As Long
VnumData1(0) = 1.0
VnumData1(1) = 2.0
```

## COM Object Reference

### SCPI.PROGRAM.VARIABLE.ARRAY(Vnum).DATA

```
VnumData1(2) = 3.0
```

```
VnumData1(3) = 4.0
```

```
SCPI.PROGRAM.VARIABLE.ARRAY(2).SIZE = 4
```

```
SCPI.PROGRAM.VARIABLE.ARRAY(2).DATA = VnumData1
```

```
VnumData2 = PROGRAM.VARIABLE.ARRAY(2).DATA
```

|                 |                                                                                                                                                                                                                                          |
|-----------------|------------------------------------------------------------------------------------------------------------------------------------------------------------------------------------------------------------------------------------------|
| Related objects | <p>SCPI.PROGRAM.VARIABLE.ARRAY(Vnum).SIZE on page 461</p> <p>SCPI.PROGRAM.VARIABLE.DOUBLE(Vnum).DATA on page 462</p> <p>SCPI.PROGRAM.VARIABLE.LONG(Vnum).DATA on page 463</p> <p>SCPI.PROGRAM.VARIABLE.STRING(Vnum).DATA on page 464</p> |
| Equivalent key  | No equivalent key is available on the front panel.                                                                                                                                                                                       |



## SCPI.PROGRAM.VARIABLE.ARRAY(VNUM).SIZE

|             |                                                                                                                                     |
|-------------|-------------------------------------------------------------------------------------------------------------------------------------|
| Object type | Property                                                                                                                            |
| Syntax      | SCPI.PROGRAM.VARIABLE.ARRAY(VNUM).SIZE = <i>Value</i><br><i>Value</i> = SCPI.PROGRAM.VARIABLE.ARRAY(VNUM).SIZE                      |
| Description | Specifies the data size of the array type user defined variable. Up to ten (1-10) areas can be used for the user defined variables. |

---

**NOTE** Turning off the power of the instrument initializes the user defined variables, while executing the preset command does not initialize them.

---

### Variable

|              | <i>Value</i>             |
|--------------|--------------------------|
| Description  | The value of data size   |
| Data type    | Long integer type (Long) |
| Range        | 1 to 40002               |
| Preset value | 402                      |
| Resolution   | 1                        |

For information on the variable (*Vnum*), see Table 7-14, “Variable (Vnum),” on page 459.

**Examples**

```
Dim VnumSize As Long
SCPI.PROGRAM.VARIABLE.ARRAY(1).SIZE = 32
VnumSize = PROGRAM.VARIABLE.ARRAY(1).SIZE
```

**Related objects** SCPI.PROGRAM.VARIABLE.ARRAY(VNUM).DATA on page 459

**Equivalent key** No equivalent key is available on the front panel.

## SCPI.PROGram.VARiable.DOUBle(Vnum).DATA

|             |                                                                                                                                              |
|-------------|----------------------------------------------------------------------------------------------------------------------------------------------|
| Object type | Property                                                                                                                                     |
| Syntax      | SCPI.PROGram.VARiable.DOUBle(Vnum).DATA = <i>Value</i><br><i>Value</i> = SCPI.PROGram.VARiable.DOUBle(Vnum).DATA                             |
| Description | Specifies the double precision floating point type user defined variable. Up to ten (1-10) areas can be used for the user defined variables. |

---

**NOTE** Turning off the power of the instrument initializes the user defined variables, while executing the preset command does not initialize them.

---

### Variable

|              | <i>Value</i>                                            |
|--------------|---------------------------------------------------------|
| Description  | The value of the double precision floating point type   |
| Data type    | Double precision floating point type (Double)           |
| Range        | Compliant with the double precision floating point type |
| Preset value | 0                                                       |

For information on the variable (*Vnum*), see Table 7-14, “Variable (Vnum),” on page 459.

**Examples**

```
Dim VnumDoub As Double
SCPI.PROGram.VARiable.DOUBle(1).DATA = 1500.23
VnumDoub = PROGram.VARiable.DOUBle(1).DATA
```

**Related objects** SCPI.PROGram.VARiable.LONG(Vnum).DATA on page 463  
SCPI.PROGram.VARiable.STRING(Vnum).DATA on page 464

**Equivalent key** No equivalent key is available on the front panel.

## SCPI.PROGRAM.VARIABLE.LONG(Vnum).DATA

|             |                                                                                                                      |
|-------------|----------------------------------------------------------------------------------------------------------------------|
| Object type | Property                                                                                                             |
| Syntax      | SCPI.PROGRAM.VARIABLE.LONG(Vnum).DATA = <i>Value</i><br><i>Value</i> = SCPI.PROGRAM.VARIABLE.LONG(Vnum).DATA         |
| Description | Specifies the user defined long integer variable. Up to ten (1-10) areas can be used for the user defined variables. |

---

**NOTE** Turning off the power of the instrument initializes the user defined variables, while executing the preset command does not initialize them.

---

### Variable

|              | <i>Value</i>                         |
|--------------|--------------------------------------|
| Description  | The value of the long integer type   |
| Data type    | Long integer type (Long)             |
| Range        | Compliant with the long integer type |
| Preset value | 0                                    |

For information on the variable (*Vnum*), see Table 7-14, “Variable (Vnum),” on page 459.

**Examples**

```
Dim VnumLong As Long
SCPI.PROGRAM.VARIABLE.LONG(1).DATA = 250
VnumLong = PROGRAM.VARIABLE.LONG(1).DATA
```

**Related objects**

SCPI.PROGRAM.VARIABLE.DOUBLE(Vnum).DATA on page 462  
 SCPI.PROGRAM.VARIABLE.STRING(Vnum).DATA on page 464

**Equivalent key** No equivalent key is available on the front panel.

## SCPI.PROGRAM.VARIABLE.STRING(Vnum).DATA

|             |                                                                                                                               |
|-------------|-------------------------------------------------------------------------------------------------------------------------------|
| Object type | Property                                                                                                                      |
| Syntax      | SCPI.PROGRAM.VARIABLE.STRING(Vnum).DATA = <i>Param</i><br><i>Param</i> = SCPI.PROGRAM.VARIABLE.STRING(Vnum).DATA              |
| Description | Specifies the user defined character string type variable. Up to ten (1-10) areas can be used for the user defined variables. |

---

**NOTE** Turning off the power of the instrument initializes the user defined variables, while executing the preset command does not initialize them.

---

### Variable

|              | <i>Param</i>                             |
|--------------|------------------------------------------|
| Description  | The value of the character string type   |
| Data type    | Character string type (String)           |
| Range        | Compliant with the character string type |
| Preset value | " "                                      |

For information on the variable (*Vnum*), see Table 7-14, “Variable (Vnum),” on page 459.

**Examples**

```
Dim VnumStr As String
SCPI.PROGRAM.VARIABLE.STRING(1).DATA = "TEST DATA"
VnumStr = PROGRAM.VARIABLE.STRING(1).DATA
```

**Related objects**

SCPI.PROGRAM.VARIABLE.DOUBLE(Vnum).DATA on page 462  
SCPI.PROGRAM.VARIABLE.LONG(Vnum).DATA on page 463

**Equivalent key** No equivalent key is available on the front panel.

### SCPI.SENSE(*Ch*).AVERAge.CLEAr

|                 |                                                                                                                                                                            |
|-----------------|----------------------------------------------------------------------------------------------------------------------------------------------------------------------------|
| Object type     | Method                                                                                                                                                                     |
| Syntax          | SCPI.SENSE( <i>Ch</i> ).AVERAge.CLEAr                                                                                                                                      |
| Description     | Resets the data count to 0 used for averaging of channels 1 to 16 ( <i>Ch</i> ). Measurement data before the execution of this object is not used for averaging. (No read) |
| Variable        | For information on the variable ( <i>Ch</i> ), see Table 7-6, “Variable (Ch),” on page 209.                                                                                |
| Examples        | SCPI.SENSE(1).AVERAge.CLEAr                                                                                                                                                |
| Related objects | SCPI.SENSE(Ch).AVERAge.COUNT on page 465<br>SCPI.SENSE(Ch).AVERAge.STATe on page 466                                                                                       |
| Equivalent key  | <b>[Avg] - Averaging Restart</b>                                                                                                                                           |

### SCPI.SENSE(*Ch*).AVERAge.COUNT

|             |                                                                                                              |
|-------------|--------------------------------------------------------------------------------------------------------------|
| Object type | Property                                                                                                     |
| Syntax      | SCPI.SENSE( <i>Ch</i> ).AVERAge.COUNT = <i>Value</i><br><i>Value</i> = SCPI.SENSE( <i>Ch</i> ).AVERAge.COUNT |
| Description | Sets the averaging factor of channels 1 to 16 ( <i>Ch</i> ).                                                 |
| Variable    |                                                                                                              |

|              | <i>Value</i>                                                                                                                                                                                                 |
|--------------|--------------------------------------------------------------------------------------------------------------------------------------------------------------------------------------------------------------|
| Description  | Averaging factor                                                                                                                                                                                             |
| Data type    | Long integer type (Long)                                                                                                                                                                                     |
| Range        | 1 to 999                                                                                                                                                                                                     |
| Preset value | 16                                                                                                                                                                                                           |
| Note         | If the specified variable is out of the allowable setup range, the minimum value (if the lower limit of the range is not reached) or the maximum value (if the upper limit of the range is exceeded) is set. |

For information on the variable (*Ch*), see Table 7-6, “Variable (Ch),” on page 209.

|                 |                                                                                               |
|-----------------|-----------------------------------------------------------------------------------------------|
| Examples        | Dim AvgCnt As Long<br>SCPI.SENSE(1).AVERAge.COUNT = 4<br>AvgCnt = SCPI.SENSE(1).AVERAge.COUNT |
| Related objects | SCPI.SENSE(Ch).AVERAge.STATe on page 466<br>SCPI.SENSE(Ch).AVERAge.CLEAr on page 465          |
| Equivalent key  | <b>[Avg] - Avg Factor</b>                                                                     |

## SCPI.SENSE(Ch).AVERAge.STATE

|             |                                                                                              |
|-------------|----------------------------------------------------------------------------------------------|
| Object type | Property                                                                                     |
| Syntax      | SCPI.SENSE(Ch).AVERAge.STATE = <i>Status</i><br><i>Status</i> = SCPI.SENSE(Ch).AVERAge.STATE |
| Description | Turns ON/OFF the averaging function of channels 1 to 16 ( <i>Ch</i> ).                       |
| Variable    |                                                                                              |

|              |                                                                                                                                                                       |
|--------------|-----------------------------------------------------------------------------------------------------------------------------------------------------------------------|
|              | <i>Status</i>                                                                                                                                                         |
| Description  | ON/OFF of the averaging function                                                                                                                                      |
| Data type    | Boolean type (Boolean)                                                                                                                                                |
| Range        | Select from the following.<br>•True or -1                      Turns ON the averaging function.<br>•False or 0                      Turns OFF the averaging function. |
| Preset value | False or 0                                                                                                                                                            |

For information on the variable (*Ch*), see Table 7-6, “Variable (Ch),” on page 209.

|          |                                                                                                    |
|----------|----------------------------------------------------------------------------------------------------|
| Examples | <pre>Dim Avg As Boolean SCPI.SENSE(1).AVERAge.STATE = True Avg = SCPI.SENSE(1).AVERAge.STATE</pre> |
|----------|----------------------------------------------------------------------------------------------------|

|                 |                                                                                      |
|-----------------|--------------------------------------------------------------------------------------|
| Related objects | SCPI.SENSE(Ch).AVERAge.COUNT on page 465<br>SCPI.SENSE(Ch).AVERAge.CLEAr on page 465 |
|-----------------|--------------------------------------------------------------------------------------|

|                |                          |
|----------------|--------------------------|
| Equivalent key | <b>[Avg] - Averaging</b> |
|----------------|--------------------------|

## SCPI.SENSE(Ch).BANDwidth.RESolution

**Object type** Property

**Syntax** SCPI.SENSE(*Ch*).BANDwidth.RESolution = *Value*  
*Value* = SCPI.SENSE(*Ch*).BANDwidth.RESolution

**Description** Sets the IF bandwidth of channels 1 to 16 (*Ch*).  
This object provides the same function as the SCPI.SENSE(Ch).BWIDth.RESolution object.

**Variable**

|              | <i>Value</i>                                                                                                                                                                                                 |
|--------------|--------------------------------------------------------------------------------------------------------------------------------------------------------------------------------------------------------------|
| Description  | IF bandwidth                                                                                                                                                                                                 |
| Data type    | Double precision floating point type (Double)                                                                                                                                                                |
| Range        | 10 to 100000                                                                                                                                                                                                 |
| Preset value | 70000                                                                                                                                                                                                        |
| Unit         | Hz (hertz)                                                                                                                                                                                                   |
| Resolution   | In steps of 1, 1.5, 2, 3, 4, 5, or 7                                                                                                                                                                         |
| Note         | If the specified variable is out of the allowable setup range, the minimum value (if the lower limit of the range is not reached) or the maximum value (if the upper limit of the range is exceeded) is set. |

For information on the variable (*Ch*), see Table 7-6, “Variable (Ch),” on page 209.

**Examples**

```
Dim IfBw As Double
SCPI.SENSE(1).BANDwidth.RESolution = 1.5E3
IfBw = SCPI.SENSE(1).BANDwidth.RESolution
```

**Related objects** SCPI.SENSE(Ch).BWIDth.RESolution on page 468

**Equivalent key** **[Avg] - IF Bandwidth**

## SCPI.SENSE(*Ch*).BWIDth.RESolution

**Object type** Property

**Syntax** SCPI.SENSE(*Ch*).BWIDth.RESolution = *Value*  
*Value* = SCPI.SENSE(*Ch*).BWIDth.RESolution

**Description** Sets the IF bandwidth of channels 1 to 16 (*Ch*).  
This object provides the same function as the SCPI.SENSE(*Ch*).BANDwidth.RESolution object.

**Variable**

|              | <i>Value</i>                                                                                                                                                                                                 |
|--------------|--------------------------------------------------------------------------------------------------------------------------------------------------------------------------------------------------------------|
| Description  | IF bandwidth                                                                                                                                                                                                 |
| Data type    | Double precision floating point type (Double)                                                                                                                                                                |
| Range        | 10 to 100000                                                                                                                                                                                                 |
| Preset value | 70000                                                                                                                                                                                                        |
| Unit         | Hz (hertz)                                                                                                                                                                                                   |
| Resolution   | In steps of 1, 1.5, 2, 3, 4, 5, or 7                                                                                                                                                                         |
| Note         | If the specified variable is out of the allowable setup range, the minimum value (if the lower limit of the range is not reached) or the maximum value (if the upper limit of the range is exceeded) is set. |

For information on the variable (*Ch*), see Table 7-6, “Variable (Ch),” on page 209.

**Examples**

```
Dim IfBw As Double
SCPI.SENSE(1).BWIDth.RESolution = 1.5E3
IfBw = SCPI.SENSE(1).BWIDth.RESolution
```

**Related objects** SCPI.SENSE(*Ch*).BANDwidth.RESolution on page 467

**Equivalent key** **[Avg] - IF Bandwidth**



## SCPI.SENSE(*Ch*).CORRection.CLEAr

|                 |                                                                                                                                      |
|-----------------|--------------------------------------------------------------------------------------------------------------------------------------|
| Type of object  | Method                                                                                                                               |
| Syntax          | SCPI.SENSE( <i>Ch</i> ).CORRection.CLEAr                                                                                             |
| Description     | For channels 1 to 16 ( <i>Ch</i> ), clears the error coefficient for calibration when the frequency offset feature is off. (No read) |
| Variable        | For information on the variable ( <i>Ch</i> ), refer to Table 7-6, “Variable (Ch),” on page 209.                                     |
| Example of use  | SCPI.SENSE(1).CORRection.CLEAr                                                                                                       |
| Related objects | SCPI.SENSE(Ch).OFFSet.STATe on page 627<br>SCPI.SENSE(Ch).CORRection.OFFSet.CLEAr on page 566                                        |
| Equivalent key  | <b>[Cal] - Clear - OK</b>                                                                                                            |

## SCPI.SENSE(*Ch*).CORRection.COEFFicient.DATA

Object type      Property

Syntax            SCPI.SENSE(*Ch*).CORRection.COEFFicient.DATA (*Str*, *Int1* , *Int2*) = Array  
 Array = SCPI.SENSE(*Ch*).CORRection.COEFFicient.DATA (*Str*, *Int1*, *Int2* )

Description      Reads out/write the calibration coefficient data for specified channel.

When the calibration factor is interpolated, the interpolated calibration coefficient array is read. Similarly, when the calibration factor is not interpolated, a non-interpolated calibration coefficient array is read.

After writing the calibration coefficient array, the written value becomes effective only after the (SCPI.SENSE(Ch).CORRection.COEFFicient.SAVE) command is executed.

Variable

|             |                                                                                                                                                                                                                                                                                                                                                                                                                                                  |
|-------------|--------------------------------------------------------------------------------------------------------------------------------------------------------------------------------------------------------------------------------------------------------------------------------------------------------------------------------------------------------------------------------------------------------------------------------------------------|
|             | <b><i>Array</i></b>                                                                                                                                                                                                                                                                                                                                                                                                                              |
| Description | Indicates the array data (corrected data array) of NOP (number of measurement points)×2. Where n is an integer between 1 and NOP.<br><ul style="list-style-type: none"> <li>• <i>Data</i>(<i>n</i>×2-2)      Real part of data (complex number) at the n-th measurement point.</li> <li>• <i>Data</i>(<i>n</i>×2-1)      Imaginary part of data (complex number) at the n-th measurement point.</li> </ul> The index of the array starts from 0. |
| Data type   | Variant type (Variant)                                                                                                                                                                                                                                                                                                                                                                                                                           |

|             |                                                                                                                                                                                                                                                                                                                                                                      |
|-------------|----------------------------------------------------------------------------------------------------------------------------------------------------------------------------------------------------------------------------------------------------------------------------------------------------------------------------------------------------------------------|
|             | <b><i>Str</i></b>                                                                                                                                                                                                                                                                                                                                                    |
| Description | Calibration type                                                                                                                                                                                                                                                                                                                                                     |
| Data type   | Character string type (String)                                                                                                                                                                                                                                                                                                                                       |
| Range       | Select from the following.<br><ul style="list-style-type: none"> <li>• "ES"                  Source match</li> <li>• "ER"                  Reflection tracking</li> <li>• "ED"                  Directivity</li> <li>• "EL"                  Load match</li> <li>• "ET"                  Transmission tracking</li> <li>• "EX"                  Isolation</li> </ul> |

|             |                                                                                                                                                                             |
|-------------|-----------------------------------------------------------------------------------------------------------------------------------------------------------------------------|
|             | <b><i>Int1</i></b>                                                                                                                                                          |
| Description | Response port                                                                                                                                                               |
| Data type   | Integer type (Integer)                                                                                                                                                      |
| Range       | 1 to 4                                                                                                                                                                      |
| Note        | If ES, ER, or ED is used, the response port and the stimulus port must be the same, while EL, ET, or EX is used, the response port and the stimulus port must be different. |

|             |                                                                                                                                                                             |
|-------------|-----------------------------------------------------------------------------------------------------------------------------------------------------------------------------|
|             | <i>Int2</i>                                                                                                                                                                 |
| Description | Stimulus port                                                                                                                                                               |
| Data type   | Integer type (Integer)                                                                                                                                                      |
| Range       | 1 to 4                                                                                                                                                                      |
| Note        | If ES, ER, or ED is used, the response port and the stimulus port must be the same, while EL, ET, or EX is used, the response port and the stimulus port must be different. |

For information on the variable (*Ch*), see Table 7-6, “Variable (Ch),” on page 209.

**Examples**

```
DIM Array(200) As Variant
Array = SCPI.SENS(1).CORRection.COEFficient("EL", 1, 2)
```

**Related objects**

- SCPI.SENSE(Ch).CORRection.COEFficient.METHod.ERESponse on page 472
- SCPI.SENSE(Ch).CORRection.COEFficient.METHod.RESPOse.OPEN on page 473
- SCPI.SENSE(Ch).CORRection.COEFficient.METHod.RESPOse.SHORT on page 473
- SCPI.SENSE(Ch).CORRection.COEFficient.METHod.RESPOse.THRU on page 474
- SCPI.SENSE(Ch).CORRection.COEFficient.METHod.SOLT1 on page 475
- SCPI.SENSE(Ch).CORRection.COEFficient.METHod.SOLT2 on page 476
- SCPI.SENSE(Ch).CORRection.COEFficient.METHod.SOLT3 on page 477
- SCPI.SENSE(Ch).CORRection.COEFficient.METHod.SOLT4 on page 478
- SCPI.SENSE(Ch).CORRection.COEFficient.SAVE on page 479
- SCPI.SENSE(Ch).CORRection.COLLEct.METHod.TRL2 on page 541
- SCPI.SENSE(Ch).CORRection.COLLEct.METHod.TRL3 on page 542
- SCPI.SENSE(Ch).CORRection.COLLEct.METHod.TRL4 on page 543

**Equivalent key**

No equivalent key is available on the front panel.

## **SCPI.SENSE(*Ch*).CORRection.COEFFicient.METHod.ERE Sponse**

**Object type** Property

**Syntax** SCPI.SENSE(*Ch*).CORRection.COEFFicient.METHod.ERESponse = *Ports*

**Description** For channel 1 to channel 16, sets the calibration type to the enhanced response calibration between the two specified ports when the calibration coefficient data array is written with the SCPI.SENSE(Ch).CORRection.COEFFicient.DATA command. (No read)

**Variable**

|                    |                                                                                                                                                                                                                                              |
|--------------------|----------------------------------------------------------------------------------------------------------------------------------------------------------------------------------------------------------------------------------------------|
|                    | <b><i>Ports</i></b>                                                                                                                                                                                                                          |
| <b>Description</b> | Indicates 2-element array data (port number). <ul style="list-style-type: none"> <li>• <i>Ports(0)</i> Specifies the response port.</li> <li>• <i>Ports(1)</i> Specifies the stimulus port.</li> </ul> The index of the array starts from 0. |
| <b>Data type</b>   | Variant type (Variant)                                                                                                                                                                                                                       |
| <b>Range</b>       | 1 to 4                                                                                                                                                                                                                                       |
| <b>Resolution</b>  | 1                                                                                                                                                                                                                                            |
| <b>Note</b>        | For each parameter, you must specify a different port number. If you specify the same port number for 2 or more parameters, an error occurs and the command is ignored.                                                                      |

For information on the variable (*Ch*), see Table 7-6, “Variable (Ch),” on page 209.

**Examples**

```
Dim ERESport(1) As Variant
ERESport(0) = 1
ERESport(1) = 2
SCPI.SENSE(1).CORRection.COEFFicient.METHod.ERESponse = ERESport
```

**Related objects** SCPI.SENSE(Ch).CORRection.COEFFicient.DATA on page 470  
SCPI.SENSE(Ch).CORRection.COEFFicient.SAVE on page 479

**Equivalent key** No equivalent key is available on the front panel.

**SCPI.SENSE(*Ch*).CORREction.COEFFicient.METHod.RESPonse.OPEN**

|                 |                                                                                                                                                                                                                                                         |
|-----------------|---------------------------------------------------------------------------------------------------------------------------------------------------------------------------------------------------------------------------------------------------------|
| Object type     | Property                                                                                                                                                                                                                                                |
| Syntax          | SCPI.SENSE( <i>Ch</i> ).CORREction.COEFFicient.METHod.RESPonse.OPEN = <i>Port</i>                                                                                                                                                                       |
| Description     | For channel 1 to channel 16 , sets the calibration type to the response calibration (open) of the specified port when the calibration coefficient data array is written with the SCPI.SENSE( <i>Ch</i> ).CORREction.COEFFicient.DATA command. (No read) |
| Variable        | For information on the variable ( <i>Ch</i> ) and the variable ( <i>Port</i> ), see Table 7-6, “Variable ( <i>Ch</i> ),” on page 209 and Table 7-16, “Variable ( <i>Port</i> ),” on page 481, respectively.                                             |
| Examples        | SCPI.SENSE(1).CORREction.COEFFicient.METHod.RESPonse.OPEN = 1                                                                                                                                                                                           |
| Related objects | SCPI.SENSE( <i>Ch</i> ).CORREction.COEFFicient.DATA on page 470<br>SCPI.SENSE( <i>Ch</i> ).CORREction.COEFFicient.SAVE on page 479                                                                                                                      |
| Equivalent key  | No equivalent key is available on the front panel.                                                                                                                                                                                                      |

**SCPI.SENSE(*Ch*).CORREction.COEFFicient.METHod.RESPonse.SHORT**

|                 |                                                                                                                                                                                                                                                          |
|-----------------|----------------------------------------------------------------------------------------------------------------------------------------------------------------------------------------------------------------------------------------------------------|
| Object type     | Property                                                                                                                                                                                                                                                 |
| Syntax          | SCPI.SENSE( <i>Ch</i> ).CORREction.COEFFicient.METHod.RESPonse.SHORT = <i>Port</i>                                                                                                                                                                       |
| Description     | For channel 1 to channel 16 , sets the calibration type to the response calibration (short) of the specified port when the calibration coefficient data array is written with the SCPI.SENSE( <i>Ch</i> ).CORREction.COEFFicient.DATA command. (No read) |
| Variable        | For information on the variable ( <i>Ch</i> ) and the variable ( <i>Port</i> ), see Table 7-6, “Variable ( <i>Ch</i> ),” on page 209 and Table 7-16, “Variable ( <i>Port</i> ),” on page 481 and , respectively.                                         |
| Examples        | SCPI.SENSE(1).CORREction.COEFFicient.METHod.RESPonse.SHORT = 1                                                                                                                                                                                           |
| Related objects | SCPI.SENSE( <i>Ch</i> ).CORREction.COEFFicient.DATA on page 470<br>SCPI.SENSE( <i>Ch</i> ).CORREction.COEFFicient.SAVE on page 479                                                                                                                       |
| Equivalent key  | No equivalent key is available on the front panel.                                                                                                                                                                                                       |

**SCPI.SENSE(*Ch*).CORRection.COEFFicient.METHod.RESPonse.THru**

|                 |                                                                                                                                                                                                                                                         |
|-----------------|---------------------------------------------------------------------------------------------------------------------------------------------------------------------------------------------------------------------------------------------------------|
| Object type     | Property                                                                                                                                                                                                                                                |
| Syntax          | SCPI.SENSE( <i>Ch</i> ).CORRection.COEFFicient.METHod.RESPonse.THru = <i>Ports</i>                                                                                                                                                                      |
| Description     | For channel 1 to channel 16, sets the calibration type to the response calibration (open) between the two specified ports when the calibration coefficient data array is written with the SCPI.SENSE(Ch).CORRection.COEFFicient.DATA command. (No read) |
| Variable        | For information on the variable ( <i>Ch</i> ) and the variable ( <i>Port</i> ), see Table 7-6, “Variable (Ch),” on page 209 and Table 7-16, “Variable (Port),” on page 481, respectively.                                                               |
| Examples (1)    | <pre>SCPI.SENSE(1).CORRection.COEFFicient.METHod.RESPonse.THru =<br/>Array(2, 1)</pre>                                                                                                                                                                  |
| Examples (2)    | <pre>Dim ThruPort(1) As Variant<br/>ThruPort(0) = 2<br/>ThruPort(1) = 1<br/>SCPI.SENSE(1).CORRection.COEFFicient.METHod.RESPonse.THru =<br/>ThruPort</pre>                                                                                              |
| Related objects | SCPI.SENSE(Ch).CORRection.COEFFicient.DATA on page 470<br>SCPI.SENSE(Ch).CORRection.COEFFicient.SAVE on page 479                                                                                                                                        |
| Equivalent key  | No equivalent key is available on the front panel.                                                                                                                                                                                                      |

## SCPI.SENSE(*Ch*).CORREction.COEFFicient.METHOD.SOLT1

|                 |                                                                                                                                                                                                                                      |
|-----------------|--------------------------------------------------------------------------------------------------------------------------------------------------------------------------------------------------------------------------------------|
| Object type     | Property                                                                                                                                                                                                                             |
| Syntax          | SCPI.SENSE( <i>Ch</i> ).CORREction.COEFFicient.METHOD.SOLT1 = <i>Port</i>                                                                                                                                                            |
| Description     | For channel 1 to channel 16, sets the calibration type to the 1-port calibration of the specified port when the calibration coefficient data array is written with the SCPI.SENSE(Ch).CORREction.COEFFicient.DATA command. (No read) |
| Variable        | For information on the variable ( <i>Ch</i> ) and the variable ( <i>Port</i> ), see Table 7-6, “Variable (Ch),” on page 209 and Table 7-16, “Variable (Port),” on page 481 and , respectively.                                       |
| Examples        | SCPI.SENSE(1).CORREction.COEFFicient.METHOD.SLOT1 = 1                                                                                                                                                                                |
| Related objects | SCPI.SENSE(Ch).CORREction.COEFFicient.DATA on page 470<br>SCPI.SENSE(Ch).CORREction.COEFFicient.SAVE on page 479                                                                                                                     |
| Equivalent key  | No equivalent key is available on the front panel.                                                                                                                                                                                   |

## **SCPI.SENSE(*Ch*).CORRection.COEFFicient.METHod.SOLT2**

**Object type** Property

**Syntax** SCPI.SENSE(*Ch*).CORRection.COEFFicient.METHod.SOLT2 = *Ports*

**Description** For channel 1 to channel 16, sets the calibration type to full 2-port calibration between the two specified ports when the calibration coefficient data array is written with the SCPI.SENSE(Ch).CORRection.COEFFicient.DATA command. (No read)

**Variable**

|                    |                                                                                                                                                                                                                                                                                        |
|--------------------|----------------------------------------------------------------------------------------------------------------------------------------------------------------------------------------------------------------------------------------------------------------------------------------|
|                    | <b><i>Ports</i></b>                                                                                                                                                                                                                                                                    |
| <b>Description</b> | Indicates 2-element array data (port number). <ul style="list-style-type: none"> <li>• <i>Ports(0)</i> Specifies a port for full 2-port calibration.</li> <li>• <i>Ports(1)</i> Specifies the other port for full 2-port calibration.</li> </ul> The index of the array starts from 0. |
| <b>Data type</b>   | Variant type (Variant)                                                                                                                                                                                                                                                                 |
| <b>Range</b>       | 1 to 4                                                                                                                                                                                                                                                                                 |
| <b>Resolution</b>  | 1                                                                                                                                                                                                                                                                                      |
| <b>Note</b>        | For each parameter, you must specify a different port number. If you specify the same port number for 2 or more parameters, an error occurs and the command is ignored.                                                                                                                |

For information on the variable (*Ch*), see Table 7-6, “Variable (Ch),” on page 209.

**Examples (1)** SCPI.SENSE(1).CORRection.COEFFicient.METHod.SOLT2 = Array(1, 2)

**Examples (2)**

```
Dim CalPort(1) As Variant
CalPort(0) = 1
CalPort(1) = 2
SCPI.SENSE(1).CORRection.COEFFicient.METHod.SOLT2 = CalPort
```

**Related objects** SCPI.SENSE(Ch).CORRection.COEFFicient.DATA on page 470  
SCPI.SENSE(Ch).CORRection.COEFFicient.SAVE on page 479

**Equivalent key** No equivalent key is available on the front panel.



## SCPI.SENSE(*Ch*).CORRection.COEFFicient.METHod.SOLT3

**Object type** Property

**Syntax** SCPI.SENSE(*Ch*).CORRection.COEFFicient.METHod.SOLT3 = *Ports*

**Description** For channel 1 to channel 16, sets the calibration type to full 3-port calibration between the three specified ports when the calibration coefficient data array is written with the SCPI.SENSE(*Ch*).CORRection.COEFFicient.DATA command. (No read)

**Variable**

|             |                                                                                                                                                                                                                                                                                                                                                         |
|-------------|---------------------------------------------------------------------------------------------------------------------------------------------------------------------------------------------------------------------------------------------------------------------------------------------------------------------------------------------------------|
|             | <i>Ports</i>                                                                                                                                                                                                                                                                                                                                            |
| Description | Indicates 3-element array data (port number). <ul style="list-style-type: none"> <li>• <i>Ports(0)</i> Specifies a port for full 3-port calibration.</li> <li>• <i>Ports(1)</i> Specifies a port for full 3-port calibration.</li> <li>• <i>Ports(2)</i> Specifies a port for full 3-port calibration.</li> </ul> The index of the array starts from 0. |
| Data type   | Variant type (Variant)                                                                                                                                                                                                                                                                                                                                  |
| Range       | 1 to 4                                                                                                                                                                                                                                                                                                                                                  |
| Resolution  | 1                                                                                                                                                                                                                                                                                                                                                       |
| Note        | For each parameter, you must specify a different port number. If you specify the same port number for 2 or more parameters, an error occurs and the command is ignored.                                                                                                                                                                                 |

For information on the variable (*Ch*), see Table 7-6, “Variable (*Ch*),” on page 209.

**Examples (1)** SCPI.SENSE(1).CORRection.COEFFicient.METHod.SOLT3 = Array(1, 2, 3)

**Examples (2)**

```
Dim CalPort(2) As Variant
CalPort(0) = 1
CalPort(1) = 2
CalPort(2) = 3
SCPI.SENSE(1).CORRection.COEFFicient.METHod.SOLT3 = CalPort
```

**Related objects** SCPI.SENSE(*Ch*).CORRection.COEFFicient.DATA on page 470  
SCPI.SENSE(*Ch*).CORRection.COEFFicient.SAVE on page 479

**Equivalent key** No equivalent key is available on the front panel.

**SCPI.SENSE(*Ch*).CORRection.COEFFicient.METHod.SOLT4**

|             |                                                                                                                                                                                                                  |
|-------------|------------------------------------------------------------------------------------------------------------------------------------------------------------------------------------------------------------------|
| Object type | Property                                                                                                                                                                                                         |
| Syntax      | SCPI.SENSE( <i>Ch</i> ).CORRection.COEFFicient.METHod.SOLT4 = <i>Ports</i>                                                                                                                                       |
| Description | For channel 1 to channel 16 , sets the calibration type to full 4-port calibration when the calibration coefficient data array is written with the SCPI.SENSE(Ch).CORRection.COEFFicient.DATA command. (No read) |
| Variable    |                                                                                                                                                                                                                  |

|             | <i>Ports</i>                                                                                                                                                                                                                                                                                                                                                                                                                                                                                                         |
|-------------|----------------------------------------------------------------------------------------------------------------------------------------------------------------------------------------------------------------------------------------------------------------------------------------------------------------------------------------------------------------------------------------------------------------------------------------------------------------------------------------------------------------------|
| Description | Indicates 4-element array data (port number). <ul style="list-style-type: none"> <li>• <i>Ports(0)</i>                      Specifies a port for full 4-port calibration.</li> <li>• <i>Ports(1)</i>                      Specifies a port for full 4-port calibration.</li> <li>• <i>Ports(2)</i>                      Specifies a port for full 4-port calibration.</li> <li>• <i>Ports(3)</i>                      Specifies a port for full 4-port calibration.</li> </ul> The index of the array starts from 0. |
| Data type   | Variant type (Variant)                                                                                                                                                                                                                                                                                                                                                                                                                                                                                               |
| Range       | 1 to 4                                                                                                                                                                                                                                                                                                                                                                                                                                                                                                               |
| Resolution  | 1                                                                                                                                                                                                                                                                                                                                                                                                                                                                                                                    |
| Note        | For each parameter, you must specify a different port number. If you specify the same port number for 2 or more parameters, an error occurs and the command is ignored.                                                                                                                                                                                                                                                                                                                                              |

For information on the variable (*Ch*), see Table 7-6, “Variable (Ch),” on page 209.

|                 |                                                                                                                                                              |
|-----------------|--------------------------------------------------------------------------------------------------------------------------------------------------------------|
| Examples (1)    | SCPI.SENSE(1).CORRection.COEFFicient.METHod.SOLT4 = Array(1, 2, 3, 4)                                                                                        |
| Examples (2)    | <pre>Dim CalPort(3) As Variant CalPort(0) = 1 CalPort(1) = 2 CalPort(2) = 3 CalPort(3) = 4 SCPI.SENSE(1).CORRection.COEFFicient.METHod.SLOT4 = CalPort</pre> |
| Related objects | SCPI.SENSE(Ch).CORRection.COEFFicient.DATA on page 470<br>SCPI.SENSE(Ch).CORRection.COEFFicient.SAVE on page 479                                             |
| Equivalent key  | No equivalent key is available on the front panel.                                                                                                           |

## SCPI.SENSE(*Ch*).CORREction.COEFFicient.SAVE

|                 |                                                                                                                                                                                                                                                                                                                                                                                                                                                                                                                                                                                                                                                                                                                                                                                                                                                                               |
|-----------------|-------------------------------------------------------------------------------------------------------------------------------------------------------------------------------------------------------------------------------------------------------------------------------------------------------------------------------------------------------------------------------------------------------------------------------------------------------------------------------------------------------------------------------------------------------------------------------------------------------------------------------------------------------------------------------------------------------------------------------------------------------------------------------------------------------------------------------------------------------------------------------|
| Object type     | Method                                                                                                                                                                                                                                                                                                                                                                                                                                                                                                                                                                                                                                                                                                                                                                                                                                                                        |
| Syntax          | SCPI.SENSE( <i>Ch</i> ).CORREction.COEFFicient.SAVE                                                                                                                                                                                                                                                                                                                                                                                                                                                                                                                                                                                                                                                                                                                                                                                                                           |
| Description     | <p>From the writing calibration data, enables the calibration coefficients depending on the selected calibration type.</p> <p>Enabling the calibration coefficients clears all calibration data regardless of whether the data are used for the calculation and also clears the calibration type selections.</p> <p>If you execute this command before all calibration data needed for calculating the calibration coefficients are written, an error occurs and the command is ignored. (No Read)</p>                                                                                                                                                                                                                                                                                                                                                                        |
| Variable        | For information on the variable ( <i>Ch</i> ), see Table 7-6, “Variable (Ch),” on page 209.                                                                                                                                                                                                                                                                                                                                                                                                                                                                                                                                                                                                                                                                                                                                                                                   |
| Examples        | <pre>Dim Dmy As Long Dim Data(3) as Variant Data(0) = -1.123 Data(1) = 2.456 Data(2) = -2.249 Data(3) = 2.608 SCPI.SENSE(1).CORREction.COEFFicient.METHod.RESPonse.THRU = Array(2, 1) SCPI.SENSE(1).CORREction.COEFFicient("ET", 2, 1) = Data Dmy = SCPI.IEEE4882.OPC SCPI.SENSE(1).CORREction.COEFFicient.SAVE</pre>                                                                                                                                                                                                                                                                                                                                                                                                                                                                                                                                                         |
| Related objects | <p>SCPI.SENSE(Ch).CORREction.COEFFicient.DATA on page 470</p> <p>SCPI.SENSE(Ch).CORREction.COEFFicient.METHod.ERESponse on page 472</p> <p>SCPI.SENSE(Ch).CORREction.COEFFicient.METHod.RESPonse.OPEN on page 473</p> <p>SCPI.SENSE(Ch).CORREction.COEFFicient.METHod.RESPonse.SHORT on page 473</p> <p>SCPI.SENSE(Ch).CORREction.COEFFicient.METHod.RESPonse.THRU on page 474</p> <p>SCPI.SENSE(Ch).CORREction.COEFFicient.METHod.SOLT1 on page 475</p> <p>SCPI.SENSE(Ch).CORREction.COEFFicient.METHod.SOLT2 on page 476</p> <p>SCPI.SENSE(Ch).CORREction.COEFFicient.METHod.SOLT3 on page 477</p> <p>SCPI.SENSE(Ch).CORREction.COEFFicient.METHod.SOLT4 on page 478</p> <p>SCPI.SENSE(Ch).CORREction.COLLEct.METHod.TRL2 on page 541</p> <p>SCPI.SENSE(Ch).CORREction.COLLEct.METHod.TRL3 on page 542</p> <p>SCPI.SENSE(Ch).CORREction.COLLEct.METHod.TRL4 on page 543</p> |
| Equivalent key  | No equivalent key is available on the front panel.                                                                                                                                                                                                                                                                                                                                                                                                                                                                                                                                                                                                                                                                                                                                                                                                                            |

## SCPI.SENSE(*Ch*).CORRection.COLLect.ACQuire.ISOLation

Object type Property  
 Syntax SCPI.SENSE(*Ch*).CORRection.COLLect.ACQuire.ISOLation = *Ports*  
 Description For channels 1 to 16 (*Ch*), measures the calibration data of the isolation from the specified stimulus port to the specified response port. (No read)

Variable

**Table 7-15 Variable (*Ports*)**

|             | <i>Ports</i>                                                                                                                                                                                                                                                  |
|-------------|---------------------------------------------------------------------------------------------------------------------------------------------------------------------------------------------------------------------------------------------------------------|
| Description | Indicates 2-element array data (port number).<br><ul style="list-style-type: none"> <li>• <i>Ports</i>(0) Specifies the response port number.</li> <li>• <i>Ports</i>(1) Specifies the stimulus port number.</li> </ul> The index of the array starts from 0. |
| Data type   | Long integer type (Long)                                                                                                                                                                                                                                      |
| Range       | 1 to 4                                                                                                                                                                                                                                                        |
| Resolution  | 1                                                                                                                                                                                                                                                             |
| Note        | If the specified variable is out of the allowable setup range, an error occurs when executed.<br>If you specify the same port number to 2 port numbers, an error occurs when executed.                                                                        |

For information on the variable (*Ch*), see Table 7-6, “Variable (Ch),” on page 209.

Examples

```
Dim Dmy As Long
SCPI.SENSE(1).CORRection.COLLect.ACQuire.ISOLation = Array(1,2)
Dmy = SCPI.IEEE4882.OPC

Dim IsPort(1) As Variant
Dim Dmy As Long
IsPort(0) = 1
IsPort(1) = 2
SCPI.SENSE(1).CORRection.COLLect.ACQuire.ISOLation = IsPort
Dmy = SCPI.IEEE4882.OPC
```

Related objects SCPI.IEEE4882.OPC on page 420

Equivalent key **[Cal] - Calibrate - Response (Thru) - Isolation (Optional)**  
**[Cal] - Calibrate - n-Port Cal - Isolation (Optional) - Port m-n Isol**

## SCPI.SENSE(*Ch*).CORRection.COLLect.ACQuire.LOAD

|             |                                                                                                                          |
|-------------|--------------------------------------------------------------------------------------------------------------------------|
| Object type | Property                                                                                                                 |
| Syntax      | SCPI.SENSE( <i>Ch</i> ).CORRection.COLLect.ACQuire.LOAD = <i>Port</i>                                                    |
| Description | For channels 1 to 16 ( <i>Ch</i> ), measures the calibration data of the load standard for the specified port. (No read) |
| Variable    |                                                                                                                          |

**Table 7-16**

**Variable (*Port*)**

|             | <i>Port</i>                                                                                   |
|-------------|-----------------------------------------------------------------------------------------------|
| Description | Port number                                                                                   |
| Data type   | Long integer type (Long)                                                                      |
| Range       | 1 to 4                                                                                        |
| Note        | If the specified variable is out of the allowable setup range, an error occurs when executed. |

For information on the variable (*Ch*), see Table 7-6, “Variable (Ch),” on page 209.

**Examples**

```
Dim Dmy As Long
SCPI.SENSE(1).CORRection.COLLect.ACQuire.LOAD = 1
Dmy = SCPI.IEEE4882.OPC
```

**Related objects** SCPI.IEEE4882.OPC on page 420

**Equivalent key**

**[Cal] - Calibrate - Response (Open)|Response (Short) - Load (Optional)**

**[Cal] - Calibrate - 1-Port Cal - Load**

**[Cal] - Calibrate - n-Port Cal - Reflection - Port m Load**

**SCPI.SENSE(Ch).CORRection.COLLect.ACQuire.OPEN**

|                 |                                                                                                                                                                                           |
|-----------------|-------------------------------------------------------------------------------------------------------------------------------------------------------------------------------------------|
| Object type     | Property                                                                                                                                                                                  |
| Syntax          | SCPI.SENSE( <i>Ch</i> ).CORRection.COLLect.ACQuire.OPEN = <i>Port</i>                                                                                                                     |
| Description     | For channels 1 to 16 ( <i>Ch</i> ), measures the calibration data of the open standard for the specified port. (No read)                                                                  |
| Variable        | For information on the variable ( <i>Ch</i> ) and the variable ( <i>Port</i> ), see Table 7-6, “Variable (Ch),” on page 209 and Table 7-16, “Variable (Port),” on page 481, respectively. |
| Examples        | <pre>Dim Dmy As Long SCPI.SENSE(1).CORRection.COLLect.ACQuire.OPEN = 1 Dmy = SCPI.IEEE4882.OPC</pre>                                                                                      |
| Related objects | SCPI.IEEE4882.OPC on page 420                                                                                                                                                             |
| Equivalent key  | <b>[Cal] - Calibrate - Response (Open) 1-Port Cal - Open</b><br><b>[Cal] - Calibrate - n-Port Cal - Reflection - Port m Open</b>                                                          |

**SCPI.SENSE(Ch).CORRection.COLLect.ACQuire.SHORT**

|                 |                                                                                                                                                                                           |
|-----------------|-------------------------------------------------------------------------------------------------------------------------------------------------------------------------------------------|
| Object type     | Property                                                                                                                                                                                  |
| Syntax          | SCPI.SENSE( <i>Ch</i> ).CORRection.COLLect.ACQuire.SHORT = <i>Port</i>                                                                                                                    |
| Description     | For channels 1 to 16 ( <i>Ch</i> ), measures the calibration data of the short standard for the specified port. (No read)                                                                 |
| Variable        | For information on the variable ( <i>Ch</i> ) and the variable ( <i>Port</i> ), see Table 7-6, “Variable (Ch),” on page 209 and Table 7-16, “Variable (Port),” on page 481, respectively. |
| Examples        | <pre>Dim Dmy As Long SCPI.SENSE(1).CORRection.COLLect.ACQuire.SHORT = 1 Dmy = SCPI.IEEE4882.OPC</pre>                                                                                     |
| Related objects | SCPI.IEEE4882.OPC on page 420                                                                                                                                                             |
| Equivalent key  | <b>[Cal] - Calibrate - Response (Short) 1-Port Cal - Short</b><br><b>[Cal] - Calibrate - n-Port Cal - Reflection - Port m Short</b>                                                       |

## **SCPI.SENSE(*Ch*).CORRection.COLLect.ACQuire.SUBClass**

|             |                                                                                                                                                                                                                     |
|-------------|---------------------------------------------------------------------------------------------------------------------------------------------------------------------------------------------------------------------|
| Object type | Property                                                                                                                                                                                                            |
| Syntax      | SCPI.SENSE( <i>Ch</i> ).CORRection.COLLect.ACQuire.SUBClass = <i>Value</i><br><i>Value</i> = SCPI.SENSE( <i>Ch</i> ).CORRection.COLLect.ACQuire.SUBClass                                                            |
| Description | For channels 1 to 16 ( <i>Ch</i> ), measures the calibration data of the short standard for the specified port. (No read)<br><br>For channel 1 to 16 ( <i>Ch</i> ), sets the standard subclass for the calibration. |

### Variable

|              | <i>Value</i>                                                                                                                                                                                                 |
|--------------|--------------------------------------------------------------------------------------------------------------------------------------------------------------------------------------------------------------|
| Description  | The setting number of the standard subclass for the calibration.                                                                                                                                             |
| Data type    | Long integer type (Long)                                                                                                                                                                                     |
| Range        | 1 to 8                                                                                                                                                                                                       |
| Preset value | 25                                                                                                                                                                                                           |
| Unit         | $\Omega$ (ohm)                                                                                                                                                                                               |
| Resolution   | 0.001                                                                                                                                                                                                        |
| Note         | If the specified variable is out of the allowable setup range, the minimum value (if the lower limit of the range is not reached) or the maximum value (if the upper limit of the range is exceeded) is set. |

For information on the variable (*Ch*), refer to Table 7-6, “Variable (Ch),” on page 209.

|          |                                                                                                                                       |
|----------|---------------------------------------------------------------------------------------------------------------------------------------|
| Examples | Dim Subc As Long<br>SCPI.SENSE(1).CORRection.COLLect.ACQuire.SUBClass = 3<br>Subc = SCPI.SENSE(1).CORRection.COLLect.ACQuire.SUBClass |
|----------|---------------------------------------------------------------------------------------------------------------------------------------|

|                |                                                    |
|----------------|----------------------------------------------------|
| Equivalent key | No equivalent key is available on the front panel. |
|----------------|----------------------------------------------------|

**SCPI.SENSE(*Ch*).CORRection.COLLect.ACQuire.THRU**

|                 |                                                                                                                                                                                                                                                                            |
|-----------------|----------------------------------------------------------------------------------------------------------------------------------------------------------------------------------------------------------------------------------------------------------------------------|
| Object type     | Property                                                                                                                                                                                                                                                                   |
| Syntax          | SCPI.SENSE( <i>Ch</i> ).CORRection.COLLect.ACQuire.THRU = <i>Ports</i>                                                                                                                                                                                                     |
| Description     | For channels 1 to 16 ( <i>Ch</i> ), measures the calibration data of the thru standard from the specified stimulus port to the specified response port. (No read)                                                                                                          |
| Variable        | For information on the variable ( <i>Ch</i> ) and the variable ( <i>Ports</i> ), see Table 7-6, “Variable (Ch),” on page 209 and Table 7-15, “Variable (Ports),” on page 480, respectively.                                                                                |
| Examples        | <pre>Dim Dmy As Long SCPI.SENSE(1).CORRection.COLLect.ACQuire.THRU = Array(2,1) Dmy = SCPI.IEEE4882.OPC  Dim ThruPort(1) As Variant Dim Dmy As Long ThruPort(0) = 2 ThruPort(1) = 1 SCPI.SENSE(1).CORRection.COLLect.ACQuire.THRU = ThruPort Dmy = SCPI.IEEE4882.OPC</pre> |
| Related objects | SCPI.IEEE4882.OPC on page 420                                                                                                                                                                                                                                              |
| Equivalent key  | <b>[Cal] - Calibrate - Response (Thru) - Thru</b><br><b>[Cal] - Calibrate - n-Port Cal - Transmission - Port m-n Thru</b>                                                                                                                                                  |



## SCPI.SENSE(*Ch*).CORRection.COLLect.ACQuire.TRLLine

**Object type** Property

**Syntax** SCPI.SENSE(*Ch*).CORRection.COLLect.ACQuire.TRLLine = *Ports*

**Description** For channel 1 to 16 (*Ch*), executes LINE or MATCH measurement of the TRL calibration for the selected calibration kit.  
 (No Read)

**Variable**

|             | <i>Ports</i>                                                                                                                                                                                                                                    |
|-------------|-------------------------------------------------------------------------------------------------------------------------------------------------------------------------------------------------------------------------------------------------|
| Description | Indicates 2-element array data (port number).<br><ul style="list-style-type: none"> <li>• <i>Ports(0)</i> Specifies the response port.</li> <li>• <i>Ports(1)</i> Specifies the stimulus port.</li> </ul> The index of the array starts from 0. |
| Data type   | Variant type (Variant)                                                                                                                                                                                                                          |
| Range       | 1 to 4                                                                                                                                                                                                                                          |
| Resolution  | 1                                                                                                                                                                                                                                               |
| Note        | For each parameter, you must specify a different port number. If you specify the same port number for 2 or more parameters, an error occurs and the command is ignored.                                                                         |

For information on the variable (*Ch*), see Table 7-6, “Variable (Ch),” on page 209.

**Examples**

```
Dim Dmy As Long
SCPI.SENSE(1).CORRection.COLLect.ACQuire.TRLLine = Array(1,2)
Dmy = SCPI.IEEE4882.OPC
```

```
Dim Trll(1) As Variant
Dim Dmy As Long
Trll(0) = 1
Trll(1) = 2
SCPI.SENSE(1).CORRection.COLLect.ACQuire.TRLLine = Trll
Dmy = SCPI.IEEE4882.OPC
```

**Related objects** SCPI.SENSE(*Ch*).CORRection.COLLect.ACQuire. TRLReflect on page 486  
 SCPI.SENSE(*Ch*).CORRection.COLLect.ACQuire.TRLThru on page 487

**Equivalent key** **[Cal] - Calibrate - 2-Port TRL Cal - Line/Match - x-y Line/Match|x-y Fwd (Syx)|x-y Rvs (Sxy)**  
**[Cal] - Calibrate - 3-Port TRL Cal - Line/Match - x-y Line/Match|x-y Fwd (Syx)|x-y Rvs (Sxy)|x-z Line/Match|x-z Fwd (Szx)|x-z Rvs (Sxz)|y-z Line/Match|y-z Fwd (Szy)|y-z Rvs (Syz)**  
**[Cal] - Calibrate - 4-Port TRL Cal - Line/Match - x-y Line/Match|x-y Fwd (Syx)|x-y Rvs (Sxy) - x-z Line/Match|x-z Fwd (Szx)|x-z Rvs (Sxz) - x-w Line/Match|x-w Fwd (Swx)|x-w Rvs (Sxw) - y-z Line/Match|y-z Fwd (Szy)|y-z Rvs (Syz) - y-w Line/Match|y-w Fwd (Swy)|y-w Rvs (Syw) - z-w Line/Match|z-w Fwd (Swz)|z-w Rvs (Szw)**

**SCPI.SENSE(*Ch*).CORRection.COLLect.ACQuire. TRLReflect**

Object type      Property

Syntax            SCPI.SENSE(*Ch*).CORRection.COLLect.ACQuire.TRLReflect = *Port*

Description      For channel 1 to 16 (*Ch*), executes the reflection measurement of the TRL calibration for the selected calibration kit.(No Read)

Variable

|              |                                                                                                                                                                                                              |
|--------------|--------------------------------------------------------------------------------------------------------------------------------------------------------------------------------------------------------------|
|              | <b><i>Port</i></b>                                                                                                                                                                                           |
| Description  | Port number                                                                                                                                                                                                  |
| Data type    | Long integer type (Long)                                                                                                                                                                                     |
| Range        | 1 to 4                                                                                                                                                                                                       |
| Preset value | 1                                                                                                                                                                                                            |
| Note         | If the specified variable is out of the allowable setup range, the minimum value (if the lower limit of the range is not reached) or the maximum value (if the upper limit of the range is exceeded) is set. |

For information on the variable (*Ch*), see Table 7-6, “Variable (Ch),” on page 209.

Examples            Dim Dmy As Long  
 SCPI.SENSE(1).CORRection.COLLect.ACQuire.TRLReflect = 1  
 Dmy = SCPI.IEEE4882.OPC

Related objects    SCPI.SENSE(Ch).CORRection.COLLect.ACQuire.TRLLine on page 485  
 SCPI.SENSE(Ch).CORRection.COLLect.ACQuire.TRLThru on page 487

Equivalent key     **[Cal] - Calibrate - 2-Port TRL Cal - Reflect - Portx Reflect|Porty Reflect**  
**[Cal] - Calibrate - 3-Port TRL Cal - Reflect - Portx Reflect|Porty Reflect|Portz Reflect**  
**[Cal] - Calibrate - 4-Port TRL Cal - Reflect - Portx Reflect|Porty Reflect|Portz Reflect|Portw Reflect**

## SCPI.SENSE(*Ch*).CORRection.COLLeCt.ACQuire.TRLThru

**Object type** Property

**Syntax** SCPI.SENSE(*Ch*).CORRection.COLLeCt.ACQuire.TRLThru = *Ports*

**Description** For channel 1 to 16 (*Ch*), executes the THRU measurement of the TRL calibration for the selected calibration kit.(No Read)

**Variable**

|             |                                                                                                                                                                                                                                              |
|-------------|----------------------------------------------------------------------------------------------------------------------------------------------------------------------------------------------------------------------------------------------|
|             | <i>Ports</i>                                                                                                                                                                                                                                 |
| Description | Indicates 2-element array data (port number). <ul style="list-style-type: none"> <li>• <i>Ports(0)</i> Specifies the response port.</li> <li>• <i>Ports(1)</i> Specifies the stimulus port.</li> </ul> The index of the array starts from 0. |
| Data type   | Variant type (Variant)                                                                                                                                                                                                                       |
| Range       | 1 to 4                                                                                                                                                                                                                                       |
| Resolution  | 1                                                                                                                                                                                                                                            |
| Note        | For each parameter, you must specify a different port number. If you specify the same port number for 2 or more parameters, an error occurs and the command is ignored.                                                                      |

For information on the variable (*Ch*), see Table 7-6, “Variable (Ch),” on page 209.

**Examples**

```
Dim Dmy As Long
SCPI.SENSE(1).CORRection.COLLeCt.ACQuire.TRLThru = Array(1,2)
Dmy = SCPI.IEEE4882.OPC
```

```
Dim Trlt(1) As Variant
Dim Dmy As Long
Trlt(0) = 1
Trlt(1) = 2
SCPI.SENSE(1).CORRection.COLLeCt.ACQuire.TRLThru = Trlt
Dmy = SCPI.IEEE4882.OPC
```

**Related objects** SCPI.SENSE(*Ch*).CORRection.COLLeCt.ACQuire.TRLLine on page 485  
 SCPI.SENSE(*Ch*).CORRection.COLLeCt.ACQuire. TRLReflect on page 486

**Equivalent key** **[Cal] - Calibrate - 2-Port TRL Cal - Thru/Line - Port x-y Thru**  
**[Cal] - Calibrate - 3-Port TRL Cal - Thru/Line - Port x-y Thru|Port x-z Thru|Port y-z Thru**  
**[Cal] - Calibrate - 4-Port TRL Cal - Thru/Line - Port x-y Thru|Port x-z Thru|Port x-w Thru|Port y-z Thru|Port y-w Thru|Port z-w Thru**

**SCPI.SENSE(*Ch*).CORRection.COLLect.ADAPter(*Pt*).LENGth**

|             |                                                                                                                                                                                |
|-------------|--------------------------------------------------------------------------------------------------------------------------------------------------------------------------------|
| Object type | Property                                                                                                                                                                       |
| Syntax      | SCPI.SENSE( <i>Ch</i> ).CORRection.COLLect.ADAPter( <i>Pt</i> ).LENGth = <i>Value</i><br><i>Value</i> = SCPI.SENSE( <i>Ch</i> ).CORRection.COLLect.ADAPter( <i>Pt</i> ).LENGth |
| Description | For channels 1 to 16 ( <i>Ch</i> ) and for the selected port 1 to 4 ( <i>Pt</i> ), sets the approximate length of the adapter.                                                 |

## Variable

|              | <i>Value</i>                                                                       |
|--------------|------------------------------------------------------------------------------------|
| Description  | Adapter length                                                                     |
| Data type    | Double precision floating point type (Double)                                      |
| Range        | -10 to 10                                                                          |
| Preset value | 0 (AUTO)                                                                           |
| Unit         | s (second)                                                                         |
| Note         | Adapter length is positive for adapter removal and negative for adapter insertion. |

For information on the variable (*Ch*), see Table 7-6, “Variable (Ch),” on page 209.

For information on the variable (*Pt*), see Table 7-9, “Variable (Pt),” on page 241.

|          |                                                                                                                                                         |
|----------|---------------------------------------------------------------------------------------------------------------------------------------------------------|
| Examples | <pre>Dim AdapLen As Double SCPI.SENSE(1).CORRection.COLLect.ADAPter(2).LENGth = 0.01 AdapLen = SCPI.SENSE(1).CORRection.COLLect.ADAPter(2).LENGth</pre> |
|----------|---------------------------------------------------------------------------------------------------------------------------------------------------------|

|                 |                                                                      |
|-----------------|----------------------------------------------------------------------|
| Related objects | SCPI.SENSE(Ch).CORRection.COLLect.METHod.ADAPter.REMOval on page 534 |
|-----------------|----------------------------------------------------------------------|

|                |                                                             |
|----------------|-------------------------------------------------------------|
| Equivalent key | <b>[Cal] - Calibrate - Adapter Removal - Adapter Length</b> |
|----------------|-------------------------------------------------------------|

## SCPI.SENSE(*Ch*).CORRection.COLLEct.CKIT.LABel

|             |                                                                                                                                          |
|-------------|------------------------------------------------------------------------------------------------------------------------------------------|
| Object type | Property                                                                                                                                 |
| Syntax      | SCPI.SENSE( <i>Ch</i> ).CORRection.COLLEct.CKIT.LABel = <i>Lbl</i><br><i>Lbl</i> = SCPI.SENSE( <i>Ch</i> ).CORRection.COLLEct.CKIT.LABel |
| Description | Sets a calibration kit name for the calibration kit selected for channels 1 to 16 ( <i>Ch</i> ).                                         |
| Variable    |                                                                                                                                          |

|              |                                                                                                                                                                                                                                                                                                                                         |
|--------------|-----------------------------------------------------------------------------------------------------------------------------------------------------------------------------------------------------------------------------------------------------------------------------------------------------------------------------------------|
|              | <b><i>Lbl</i></b>                                                                                                                                                                                                                                                                                                                       |
| Description  | Calibration kit name                                                                                                                                                                                                                                                                                                                    |
| Data type    | Character string type (String)                                                                                                                                                                                                                                                                                                          |
| Range        | 254 characters or less                                                                                                                                                                                                                                                                                                                  |
| Preset value | Varies depending on the calibration kit number. <ul style="list-style-type: none"> <li>• 1: "85033E"</li> <li>• 2: "85033D"</li> <li>• 3: "85052D"</li> <li>• 4: "85032F"</li> <li>• 5: "85032B"</li> <li>• 6: "85036B/E"</li> <li>• 7: "85031B"</li> <li>• 8: "85050C/D"</li> <li>• 9: "85052C"</li> <li>• 10 to 20: "User"</li> </ul> |

|                 |                                                                                                                                             |
|-----------------|---------------------------------------------------------------------------------------------------------------------------------------------|
| Examples        | <pre>Dim CalLbl As String SCPI.SENSE(1).CORRection.COLLEct.CKIT.LABel = "User 1" CalLbl = SCPI.SENSE(1).CORRection.COLLEct.CKIT.LABel</pre> |
| Related objects | SCPI.SENSE( <i>Ch</i> ).CORRection.COLLEct.CKIT.SELect on page 500                                                                          |
| Equivalent key  | <b>[Cal] - Modify Cal Kit - Label Kit</b>                                                                                                   |

**SCPI.SENSE(*Ch*).CORRection.COLLEct.CKIT.ORDer.LOAD(*Cpt*)**

|             |                                                                                                                                                                                    |
|-------------|------------------------------------------------------------------------------------------------------------------------------------------------------------------------------------|
| Object type | Property                                                                                                                                                                           |
| Syntax      | SCPI.SENSE( <i>Ch</i> ).CORRection.COLLEct.CKIT.ORDer.LOAD( <i>Cpt</i> ) = <i>Value</i><br><i>Value</i> = SCPI.SENSE( <i>Ch</i> ).CORRection.COLLEct.CKIT.ORDer.LOAD( <i>Cpt</i> ) |
| Description | For the calibration kit selected for channels 1 to 16 ( <i>Ch</i> ), selects the standard used for the load measurement of the specified port ( <i>Cpt</i> ).                      |

Variable

**Table 7-17** Variable (*Cpt*)

|             | <i>Cpt</i>                                                                                    |
|-------------|-----------------------------------------------------------------------------------------------|
| Description | Port number                                                                                   |
| Data type   | Long integer type (Long)                                                                      |
| Range       | 1 to 4                                                                                        |
| Note        | If the specified variable is out of the allowable setup range, an error occurs when executed. |

**NOTE**

Since the variable (*Cpt*) has no preset value, you cannot omit it. If you omit the variable (*Cpt*), an error occurs when executed.

|             | <i>Value</i>                                                                                  |
|-------------|-----------------------------------------------------------------------------------------------|
| Description | Standard number                                                                               |
| Data type   | Long integer type (Long)                                                                      |
| Range       | 0 to 21                                                                                       |
| Note        | If the specified variable is out of the allowable setup range, an error occurs when executed. |

For information on the variable (*Ch*), see Table 7-6, “Variable (Ch),” on page 209.

**Examples**

```
Dim StanLoad As Long
SCPI.SENSE(1).CORRection.COLLEct.CKIT.ORDer.LOAD(1) = 10
StanLoad = SCPI.SENSE(1).CORRection.COLLEct.CKIT.ORDer.LOAD(1)
```

**Related objects**

SCPI.SENSE(*Ch*).CORRection.COLLEct.CKIT.SELect on page 500  
 SCPI.SENSE(*Ch*).CORRection.COLLEct.CKIT.ORDer.OPEN(*Cpt*) on page 492  
 SCPI.SENSE(*Ch*).CORRection.COLLEct.CKIT.ORDer.SELect on page 493  
 SCPI.SENSE(*Ch*).CORRection.COLLEct.CKIT.ORDer.SHORt(*Cpt*) on page 494  
 SCPI.SENSE(*Ch*).CORRection.COLLEct.CKIT.ORDer.THRU(*Cpt\_m*,*Cpt\_n*) on page 495  
 SCPI.SENSE(*Ch*).CORRection.COLLEct.CKIT.ORDer.TRLLine(*Cpt\_m*,*Cpt\_n*) on page 497

SCPI.SENSE(Ch).CORRection.COLLEct.CKIT.ORDer. TRLReflect on page 498

SCPI.SENSE(Ch).CORRection.COLLEct.CKIT.ORDer. TRLThru(Cpt\_m,Cpt\_n) on page 499

Equivalent key **[Cal] - Modify Cal Kit - Specify CLSs - Load - Set All|Port 1|Port 2|Port 3|Port 4**

**SCPI.SENSE(*Ch*).CORRection.COLLEct.CKIT.ORDer.  
OPEN(*Cpt*)**

|             |                                                                                                                                                                                    |
|-------------|------------------------------------------------------------------------------------------------------------------------------------------------------------------------------------|
| Object type | Property                                                                                                                                                                           |
| Syntax      | SCPI.SENSE( <i>Ch</i> ).CORRection.COLLEct.CKIT.ORDer.OPEN( <i>Cpt</i> ) = <i>Value</i><br><i>Value</i> = SCPI.SENSE( <i>Ch</i> ).CORRection.COLLEct.CKIT.ORDer.OPEN( <i>Cpt</i> ) |
| Description | For the calibration kit selected for channels 1 to 16 ( <i>Ch</i> ), selects the standard used for the open measurement of the specified port ( <i>Cpt</i> ).                      |
| Variable    |                                                                                                                                                                                    |

|             | <i>Value</i>                                                                                  |
|-------------|-----------------------------------------------------------------------------------------------|
| Description | Standard number                                                                               |
| Data type   | Long integer type (Long)                                                                      |
| Range       | 0 to 21                                                                                       |
| Note        | If the specified variable is out of the allowable setup range, an error occurs when executed. |

For information on the variable (*Ch*) and the variable (*Cpt*), see Table 7-6, “Variable (Ch),” on page 209 and Table 7-17, “Variable (Cpt),” on page 490, respectively.

---

|             |                                                                                                                                                    |
|-------------|----------------------------------------------------------------------------------------------------------------------------------------------------|
| <b>NOTE</b> | Since the variable ( <i>Cpt</i> ) has no preset value, you cannot omit it. If you omit the variable ( <i>Cpt</i> ), an error occurs when executed. |
|-------------|----------------------------------------------------------------------------------------------------------------------------------------------------|

---

|                 |                                                                                                                                                                                                                                                                                                                                                                                                                                                                                                                                                                                                                                                                                 |
|-----------------|---------------------------------------------------------------------------------------------------------------------------------------------------------------------------------------------------------------------------------------------------------------------------------------------------------------------------------------------------------------------------------------------------------------------------------------------------------------------------------------------------------------------------------------------------------------------------------------------------------------------------------------------------------------------------------|
| Examples        | Dim StanOpen As Long<br>SCPI.SENSE(1).CORRection.COLLEct.CKIT.ORDer.OPEN(1) = 10<br>StanOpen = SCPI.SENSE(1).CORRection.COLLEct.CKIT.ORDer.OPEN(1)                                                                                                                                                                                                                                                                                                                                                                                                                                                                                                                              |
| Related objects | SCPI.SENSE(Ch).CORRection.COLLEct.CKIT.SELEct on page 500<br>SCPI.SENSE(Ch).CORRection.COLLEct.CKIT.ORDer. LOAD( <i>Cpt</i> ) on page 490<br>SCPI.SENSE(Ch).CORRection.COLLEct.CKIT.ORDer. SELEct on page 493<br>SCPI.SENSE(Ch).CORRection.COLLEct.CKIT.ORDer. SHORt( <i>Cpt</i> ) on page 494<br>SCPI.SENSE(Ch).CORRection.COLLEct.CKIT.ORDer. THRU( <i>Cpt_m</i> , <i>Cpt_n</i> ) on page 495<br>SCPI.SENSE(Ch).CORRection.COLLEct.CKIT.ORDer. TRLLine( <i>Cpt_m</i> , <i>Cpt_n</i> ) on page 497<br>SCPI.SENSE(Ch).CORRection.COLLEct.CKIT.ORDer. TRLReflect on page 498<br>SCPI.SENSE(Ch).CORRection.COLLEct.CKIT.ORDer. TRLThru( <i>Cpt_m</i> , <i>Cpt_n</i> ) on page 499 |
| Equivalent key  | <b>[Cal] - Modify Cal Kit - Specify CLSs - Open - Port 1 Port 2 Port 3 Port 4</b>                                                                                                                                                                                                                                                                                                                                                                                                                                                                                                                                                                                               |



## **SCPI.SENSE(*Ch*).CORRection.COLLect.CKIT.ORDER. SElect**

**Object type** Property

**Syntax** SCPI.SENSE(*Ch*).CORRection.COLLect.CKIT.ORDER.SElect = *Value*  
*Value* = SCPI.SENSE(*Ch*).CORRection.COLLect.CKIT.ORDER.SElect

**Description** Sets a subclass of the standard for the calibration for channel 1 to 16 (*Ch*).

**Variable**

|             | <i>Value</i>                                                                                  |
|-------------|-----------------------------------------------------------------------------------------------|
| Description | The number of the standard subclass for the calibration.                                      |
| Data type   | Long integer type (Long)                                                                      |
| Range       | 1 to 8                                                                                        |
| Note        | If the specified variable is out of the allowable setup range, an error occurs when executed. |

For information on the variable (*Ch*), see Table 7-6, “Variable (Ch),” on page 209.

**Examples**

```
Dim CKitSel As Long
SCPI.SENSE(1).CORRection.COLLect.CKIT.ORDER.SElect = 3
CKitSel = SCPI.SENSE(1).CORRection.COLLect.CKIT.ORDER.SElect
```

**Related objects**

SCPI.SENSE(*Ch*).CORRection.COLLect.CKIT.SElect on page 500

SCPI.SENSE(*Ch*).CORRection.COLLect.CKIT.ORDER. LOAD(*Cpt*) on page 490

SCPI.SENSE(*Ch*).CORRection.COLLect.CKIT.ORDER. OPEN(*Cpt*) on page 492

SCPI.SENSE(*Ch*).CORRection.COLLect.CKIT.ORDER. SHORt(*Cpt*) on page 494

SCPI.SENSE(*Ch*).CORRection.COLLect.CKIT.ORDER. THRU(*Cpt\_m*,*Cpt\_n*) on page 495

SCPI.SENSE(*Ch*).CORRection.COLLect.CKIT.ORDER. TRLLine(*Cpt\_m*,*Cpt\_n*) on page 497

SCPI.SENSE(*Ch*).CORRection.COLLect.CKIT.ORDER. TRLReflect on page 498

SCPI.SENSE(*Ch*).CORRection.COLLect.CKIT.ORDER. TRLThru(*Cpt\_m*,*Cpt\_n*) on page 499

**Equivalent key** **[Cal] - Modify Cal Kit - Specify CLSs - Sub Class - Sub Class 1|...|Sub Class 8**

**SCPI.SENSE(*Ch*).CORRection.COLLEct.CKIT.ORDer.SHORt(*Cpt*)**

|             |                                                                                                                                                                                      |
|-------------|--------------------------------------------------------------------------------------------------------------------------------------------------------------------------------------|
| Object type | Property                                                                                                                                                                             |
| Syntax      | SCPI.SENSE( <i>Ch</i> ).CORRection.COLLEct.CKIT.ORDer.SHORt( <i>Cpt</i> ) = <i>Value</i><br><i>Value</i> = SCPI.SENSE( <i>Ch</i> ).CORRection.COLLEct.CKIT.ORDer.SHORt( <i>Cpt</i> ) |
| Description | For the calibration kit selected for channels 1 to 16 ( <i>Ch</i> ), selects the standard used for the short measurement of the specified port ( <i>Cpt</i> ).                       |

## Variable

|             | <i>Value</i>                                                                                  |
|-------------|-----------------------------------------------------------------------------------------------|
| Description | Standard number                                                                               |
| Data type   | Long integer type (Long)                                                                      |
| Range       | 1 to 21                                                                                       |
| Note        | If the specified variable is out of the allowable setup range, an error occurs when executed. |

For information on the variable (*Ch*) and the variable (*Cpt*), see Table 7-6, “Variable (Ch),” on page 209 and Table 7-17, “Variable (Cpt),” on page 490, respectively.

**NOTE**

Since the variable (*Cpt*) has no preset value, you cannot omit it. If you omit the variable (*Cpt*), an error occurs when executed.

## Examples

```
Dim StanShor As Long
SCPI.SENSE(1).CORRection.COLLEct.CKIT.ORDer.SHORt(1) = 10
StanShor = SCPI.SENSE(1).CORRection.COLLEct.CKIT.ORDer.SHORt(1)
```

## Related objects

SCPI.SENSE(Ch).CORRection.COLLEct.CKIT.SELEct on page 500  
 SCPI.SENSE(Ch).CORRection.COLLEct.CKIT.ORDer.LOAD(Cpt) on page 490  
 SCPI.SENSE(Ch).CORRection.COLLEct.CKIT.ORDer.OPEN(Cpt) on page 492  
 SCPI.SENSE(Ch).CORRection.COLLEct.CKIT.ORDer.SELEct on page 493  
 SCPI.SENSE(Ch).CORRection.COLLEct.CKIT.ORDer.THRU(Cpt\_m,Cpt\_n) on page 495  
 SCPI.SENSE(Ch).CORRection.COLLEct.CKIT.ORDer.TRLLine(Cpt\_m,Cpt\_n) on page 497  
 SCPI.SENSE(Ch).CORRection.COLLEct.CKIT.ORDer.TRLReflect on page 498  
 SCPI.SENSE(Ch).CORRection.COLLEct.CKIT.ORDer.TRLThru(Cpt\_m,Cpt\_n) on page 499

## Equivalent key

**[Cal] - Modify Cal Kit - Specify CLSs - Short - Port 1|Port 2|Port 3|Port 4**

**SCPI.SENSE(Ch).CORRection.COLLEct.CKIT.ORDer.  
THRU(Cpt\_m,Cpt\_n)**

|             |                                                                                                                                                                                          |
|-------------|------------------------------------------------------------------------------------------------------------------------------------------------------------------------------------------|
| Object type | Property                                                                                                                                                                                 |
| Syntax      | SCPI.SENSE(Ch).CORRection.COLLEct.CKIT.ORDer.THRU(Cpt_m,Cpt_n) = <i>Value</i><br><i>Value</i> = SCPI.SENSE(Ch).CORRection.COLLEct.CKIT.ORDer.THRU(Cpt_m,Cpt_n)                           |
| Description | For the calibration kit selected for channels 1 to 16 ( <i>Ch</i> ), selects the standard used for the thru measurement between the specified 2 ports ( <i>Cpt_m</i> and <i>Cpt_n</i> ). |

Variable

**Table 7-18****Variable (*Cpt\_m*, *Cpt\_n*)**

|             | <i>Cpt_m</i> , <i>Cpt_n</i>                                                                   |
|-------------|-----------------------------------------------------------------------------------------------|
| Description | Port number                                                                                   |
| Data type   | Long integer type (Long)                                                                      |
| Range       | 1 to 4                                                                                        |
| Note        | If the specified variable is out of the allowable setup range, an error occurs when executed. |

**NOTE**

Since the variables (*Cpt\_m* and *Cpt\_n*) have no preset value, you cannot omit them. If you omit the variables (*Cpt\_m* and *Cpt\_n*) or if you specify the same port number to 2 port numbers, an error occurs when executed. Notice that when you specify 2 ports with the variables (*Cpt\_m* and *Cpt\_n*), the order of the 2 port numbers is arbitrary.

|             | <i>Value</i>                                                                                  |
|-------------|-----------------------------------------------------------------------------------------------|
| Description | Standard number                                                                               |
| Data type   | Long integer type (Long)                                                                      |
| Range       | 1 to 21                                                                                       |
| Note        | If the specified variable is out of the allowable setup range, an error occurs when executed. |

For information on the variable (*Ch*), see Table 7-6, “Variable (Ch),” on page 209.

**Examples**

```
Dim StanThru As Long
SCPI.SENSE(1).CORRection.COLLEct.CKIT.ORDer.THRU(1,2) = 10
StanThru = SCPI.SENSE(1).CORRection.COLLEct.CKIT.ORDer.THRU(1,2)
```

**Related objects**

SCPI.SENSE(Ch).CORRection.COLLEct.CKIT.SELect on page 500  
 SCPI.SENSE(Ch).CORRection.COLLEct.CKIT.ORDer. LOAD(Cpt) on page 490  
 SCPI.SENSE(Ch).CORRection.COLLEct.CKIT.ORDer. OPEN(Cpt) on page 492  
 SCPI.SENSE(Ch).CORRection.COLLEct.CKIT.ORDer. SELect on page 493  
 SCPI.SENSE(Ch).CORRection.COLLEct.CKIT.ORDer. SHORT(Cpt) on page 494  
 SCPI.SENSE(Ch).CORRection.COLLEct.CKIT.ORDer. TRLLine(Cpt\_m,Cpt\_n) on

COM Object Reference

**SCPI.SENSE(Ch).CORRection.COLLEct.CKIT.ORDer. THRU(Cpt\_m,Cpt\_n)**

page 497

SCPI.SENSE(Ch).CORRection.COLLEct.CKIT.ORDer. TRLReflect on page 498

SCPI.SENSE(Ch).CORRection.COLLEct.CKIT.ORDer. TRLThru(Cpt\_m,Cpt\_n) on page 499

Equivalent key

**[Cal] - Modify Cal Kit - Specify CLSs - Thru - Port 1-2|Port 1-3|Port 1-4|Port 2-3|Port 2-4|Port 3-4**

**SCPI.SENSE(Ch).CORRection.COLLECT.CKIT.ORDER.  
TRLLine(Cpt\_m,Cpt\_n)**

|             |                                                                                                                                                                                                                                                                                      |
|-------------|--------------------------------------------------------------------------------------------------------------------------------------------------------------------------------------------------------------------------------------------------------------------------------------|
| Object type | Property                                                                                                                                                                                                                                                                             |
| Syntax      | SCPI.SENSE(Ch).CORRection.COLLECT.CKIT.ORDER.TRLLine(Cpt_m,Cpt_n) = <i>Value</i><br><i>Value</i> = SCPI.SENSE(Ch).CORRection.COLLECT.CKIT.ORDER.TRLLine(Cpt_m,Cpt_n)                                                                                                                 |
| Description | For the calibration kit selected for channel 1 to 16 ( <i>Ch</i> ), selects the standard used for the line measurement of TRL calibration between the specified 2 ports ( <i>Cpt_m</i> and <i>Cpt_n</i> ).<br>If the standard number is 0, the standard is invalid for the subclass. |

## Variable

|             | <i>Value</i>                                                                                  |
|-------------|-----------------------------------------------------------------------------------------------|
| Description | Standard number                                                                               |
| Data type   | Long integer type (Long)                                                                      |
| Range       | 0 to 21                                                                                       |
| Note        | If the specified variable is out of the allowable setup range, an error occurs when executed. |

For information on the variable (*Ch*) and the variable (*Cpt\_m* and *Cpt\_n*), see Table 7-6, “Variable (Ch),” on page 209 and Table 7-18, “Variable (Cpt\_m, Cpt\_n),” on page 495, respectively.

|                 |                                                                                                                                                                                                                                                                                                                                                                                                                                                                                                                                                                                                                          |
|-----------------|--------------------------------------------------------------------------------------------------------------------------------------------------------------------------------------------------------------------------------------------------------------------------------------------------------------------------------------------------------------------------------------------------------------------------------------------------------------------------------------------------------------------------------------------------------------------------------------------------------------------------|
| Examples        | <pre>Dim StanTrll As Long SENSE(1).CORRection.COLLECT.CKIT.ORDER.TRLLine(1,2) = 10 StanTrll = SENSE(1).CORRection.COLLECT.CKIT.ORDER.TRLLine(1,2)</pre>                                                                                                                                                                                                                                                                                                                                                                                                                                                                  |
| Related objects | <p>SCPI.SENSE(Ch).CORRection.COLLECT.CKIT.SELECT on page 500</p> <p>SCPI.SENSE(Ch).CORRection.COLLECT.CKIT.ORDER.LOAD(Cpt) on page 490</p> <p>SCPI.SENSE(Ch).CORRection.COLLECT.CKIT.ORDER.OPEN(Cpt) on page 492</p> <p>SCPI.SENSE(Ch).CORRection.COLLECT.CKIT.ORDER.SELECT on page 493</p> <p>SCPI.SENSE(Ch).CORRection.COLLECT.CKIT.ORDER.SHORT(Cpt) on page 494</p> <p>SCPI.SENSE(Ch).CORRection.COLLECT.CKIT.ORDER.THRU(Cpt_m,Cpt_n) on page 495</p> <p>SCPI.SENSE(Ch).CORRection.COLLECT.CKIT.ORDER.TRLReflect on page 498</p> <p>SCPI.SENSE(Ch).CORRection.COLLECT.CKIT.ORDER.TRLThru(Cpt_m,Cpt_n) on page 499</p> |
| Equivalent key  | <b>[Cal] - Modify Cal Kit - Specify CLSs - TRL Line/Match - Set All Port 1-2 Port 1-3 Port 1-4 Port 2-3 Port 2-4 Port 3-4</b>                                                                                                                                                                                                                                                                                                                                                                                                                                                                                            |

**SCPI.SENSE(*Ch*).CORRection.COLLect.CKIT.ORDer.TRLReflect**

**Object type** Property

**Syntax** SCPI.SENSE(*Ch*).CORRection.COLLect.CKIT.ORDer.TRLreflect = *Value*  
*Value* = SCPI.SENSE(*Ch*).CORRection.COLLect.CKIT.ORDer.TRLreflect

**Description** For the calibration kit selected for channel 1 to 16 (*Ch*), selects the standard used for the reflection measurement of the TRL calibration between the specified 2 ports.  
 If the standard number is 0, the standard is invalid for the subclass.

**Variable**

|             | <i>Value</i>                                                                                  |
|-------------|-----------------------------------------------------------------------------------------------|
| Description | Standard number                                                                               |
| Data type   | Long integer type (Long)                                                                      |
| Range       | 0 to 21                                                                                       |
| Note        | If the specified variable is out of the allowable setup range, an error occurs when executed. |

For information on the variable (*Ch*), see Table 7-6, “Variable (Ch),” on page 209.

**Examples**

```
Dim StanTrlr As Long
SENSE(1).CORRection.COLLect.CKIT.ORDer.TRLReflect = 5
StanTrlr = SENSE(1).CORRection.COLLect.CKIT.ORDer.TRLReflect
```

**Related objects**

SCPI.SENSE(Ch).CORRection.COLLect.CKIT.SELect on page 500

SCPI.SENSE(Ch).CORRection.COLLect.CKIT.ORDer.LOAD(Cpt) on page 490

SCPI.SENSE(Ch).CORRection.COLLect.CKIT.ORDer.OPEN(Cpt) on page 492

SCPI.SENSE(Ch).CORRection.COLLect.CKIT.ORDer.SELect on page 493

SCPI.SENSE(Ch).CORRection.COLLect.CKIT.ORDer.SHORT(Cpt) on page 494

SCPI.SENSE(Ch).CORRection.COLLect.CKIT.ORDer.THRU(Cpt\_m,Cpt\_n) on page 495

SCPI.SENSE(Ch).CORRection.COLLect.CKIT.ORDer.TRLLine(Cpt\_m,Cpt\_n) on page 497

SCPI.SENSE(Ch).CORRection.COLLect.CKIT.ORDer.TRLThru(Cpt\_m,Cpt\_n) on page 499

**Equivalent key** **[Ca] - Modify Cal Kit - Specify CLSs - TRL Reflect**

**SCPI.SENSE(Ch).CORRection.COLLect.CKIT.ORDER.TRLThru(Cpt\_m,Cpt\_n)**

|             |                                                                                                                                                                                                                                                                                                                                                                                                                                                              |
|-------------|--------------------------------------------------------------------------------------------------------------------------------------------------------------------------------------------------------------------------------------------------------------------------------------------------------------------------------------------------------------------------------------------------------------------------------------------------------------|
| Object type | Property                                                                                                                                                                                                                                                                                                                                                                                                                                                     |
| Syntax      | SCPI.SENSE(Ch).CORRection.COLLect.CKIT.ORDER.TRLThru(Cpt_m,Cpt_n) = Value<br>Value = SCPI.SENSE(Ch).CORRection.COLLect.CKIT.ORDER.TRLThru(Cpt_m,Cpt_n)                                                                                                                                                                                                                                                                                                       |
| Description | For the calibration kit selected for channel 1 to 16 (Ch), selects the standard used for the line measurement of TRL calibration between the specified 2 ports (Cpt_m and Cpt_n).<br><br>For the calibration kit selected for channel 1 to 16 (Ch), selects the standard used for the THRU measurement of the TRL calibration between the specified 2 ports (Cpt_m and Cpt_n).<br><br>If the standard number is 0, the standard is invalid for the subclass. |

## Variable

|             | <i>Value</i>                                                                                  |
|-------------|-----------------------------------------------------------------------------------------------|
| Description | Standard number                                                                               |
| Data type   | Long integer type (Long)                                                                      |
| Range       | 0 to 21                                                                                       |
| Note        | If the specified variable is out of the allowable setup range, an error occurs when executed. |

For information on the variable (Ch) and the variable (Cpt\_m and Cpt\_n), see Table 7-6, “Variable (Ch),” on page 209 and Table 7-18, “Variable (Cpt\_m, Cpt\_n),” on page 495, respectively.

|                 |                                                                                                                                                                                                                                                                                                                                                                                                                                                                                                                                                                                       |
|-----------------|---------------------------------------------------------------------------------------------------------------------------------------------------------------------------------------------------------------------------------------------------------------------------------------------------------------------------------------------------------------------------------------------------------------------------------------------------------------------------------------------------------------------------------------------------------------------------------------|
| Examples        | Dim StanTrlt As Long<br>SENSe(1).CORRection.COLLect.CKIT.ORDER.TRLThru(1,2) = 3<br>StanTrlt = SENSe(1).CORRection.COLLect.CKIT.ORDER.TRLThru(1,2)                                                                                                                                                                                                                                                                                                                                                                                                                                     |
| Related objects | SCPI.SENSE(Ch).CORRection.COLLect.CKIT.SELECT on page 500<br>SCPI.SENSE(Ch).CORRection.COLLect.CKIT.ORDER.LOAD(Cpt) on page 490<br>SCPI.SENSE(Ch).CORRection.COLLect.CKIT.ORDER.OPEN(Cpt) on page 492<br>SCPI.SENSE(Ch).CORRection.COLLect.CKIT.ORDER.SELECT on page 493<br>SCPI.SENSE(Ch).CORRection.COLLect.CKIT.ORDER.SHORT(Cpt) on page 494<br>SCPI.SENSE(Ch).CORRection.COLLect.CKIT.ORDER.THRU(Cpt_m,Cpt_n) on page 495<br>SCPI.SENSE(Ch).CORRection.COLLect.CKIT.ORDER.TRLLine(Cpt_m,Cpt_n) on page 497<br>SCPI.SENSE(Ch).CORRection.COLLect.CKIT.ORDER.TRLReflect on page 498 |
| Equivalent key  | <b>[Cal] - Modify Cal Kit - Specify CLSs - TRL Thru - Set All Port 1-2 Port 1-3 Port 1-4 Port 2-3 Port 2-4 Port 3-4</b>                                                                                                                                                                                                                                                                                                                                                                                                                                                               |

## **SCPI.SENSE(Ch).CORRection.COLLect.CKIT.RESet**

|                 |                                                                                                                |
|-----------------|----------------------------------------------------------------------------------------------------------------|
| Object type     | Method                                                                                                         |
| Syntax          | SCPI.SENSE( <i>Ch</i> ).CORRection.COLLect.CKIT.RESet                                                          |
| Description     | Resets the calibration kit selected for channels 1 to 16 ( <i>Ch</i> ) to the factory setting state. (No read) |
| Variable        | For information on the variable ( <i>Ch</i> ), see Table 7-6, “Variable (Ch),” on page 209.                    |
| Examples        | SCPI.SENSE(1).CORRection.COLLect.CKIT.RESet                                                                    |
| Related objects | SCPI.SENSE(Ch).CORRection.COLLect.CKIT.SELect on page 500                                                      |
| Equivalent key  | No equivalent key is available on the front panel.                                                             |

## **SCPI.SENSE(Ch).CORRection.COLLect.CKIT.SELect**

|             |                                                                                                                                                |
|-------------|------------------------------------------------------------------------------------------------------------------------------------------------|
| Object type | Property                                                                                                                                       |
| Syntax      | SCPI.SENSE( <i>Ch</i> ).CORRection.COLLect.CKIT.SELect = <i>Value</i><br><i>Value</i> = SCPI.SENSE( <i>Ch</i> ).CORRection.COLLect.CKIT.SELect |
| Description | Selects the calibration kit of channels 1 to 16 ( <i>Ch</i> ).                                                                                 |
| Variable    |                                                                                                                                                |

|              | <i>Value</i>                                                                                  |
|--------------|-----------------------------------------------------------------------------------------------|
| Description  | Number of calibration kit*1                                                                   |
| Data type    | Long integer type (Long)                                                                      |
| Range        | 1 to 10                                                                                       |
| Preset value | 1                                                                                             |
| Note         | If the specified variable is out of the allowable setup range, an error occurs when executed. |

\*1. The numbers of 1 to 10 assigned from the top to the calibration kit names displayed on the softkey labels when performing **[Cal]** - **Cal Kit**.

For information on the variable (*Ch*), see Table 7-6, “Variable (Ch),” on page 209.

|                 |                                                                                                                                                                                                                |
|-----------------|----------------------------------------------------------------------------------------------------------------------------------------------------------------------------------------------------------------|
| Examples        | Dim CalKit As Long<br>SCPI.SENSE(1).CORRection.COLLect.CKIT.SELect = 3<br>CalKit = SCPI.SENSE(1).CORRection.COLLect.CKIT.SELect                                                                                |
| Related objects | SCPI.SENSE(Ch).CORRection.COLLect.CKIT.ORDER. LOAD(Cpt) on page 490<br>SCPI.SENSE(Ch).CORRection.COLLect.CKIT.ORDER. OPEN(Cpt) on page 492<br>SCPI.SENSE(Ch).CORRection.COLLect.CKIT.ORDER. SELect on page 493 |



SCPI.SENSE(Ch).CORRection.COLLEct.CKIT.ORDER. SHORt(Cpt) on page 494

SCPI.SENSE(Ch).CORRection.COLLEct.CKIT.ORDER. THRU(Cpt\_m,Cpt\_n) on page 495

SCPI.SENSE(Ch).CORRection.COLLEct.CKIT.ORDER. TRLLine(Cpt\_m,Cpt\_n) on page 497

SCPI.SENSE(Ch).CORRection.COLLEct.CKIT.ORDER. TRLReflect on page 498

SCPI.SENSE(Ch).CORRection.COLLEct.CKIT.ORDER. TRLThru(Cpt\_m,Cpt\_n) on page 499

SCPI.SENSE(Ch).CORRection.COLLEct.CKIT.STAN(Std).DELay on page 508

Equivalent key

**[Cal]** - Cal Kit

**SCPI.SENSE(*Ch*).CORRection.COLLect.CKIT.STAN(*Std*).ARBitrary**

|             |                                                                                                                                                                                            |
|-------------|--------------------------------------------------------------------------------------------------------------------------------------------------------------------------------------------|
| Object type | Property                                                                                                                                                                                   |
| Syntax      | SCPI.SENSE( <i>Ch</i> ).CORRection.COLLect.CKIT.STAN( <i>Std</i> ).ARBitrary = <i>Value</i><br><i>Value</i> = SCPI.SENSE( <i>Ch</i> ).CORRection.COLLect.CKIT.STAN( <i>Std</i> ).ARBitrary |
| Description | For the calibration kit selected for channels 1 to 16 ( <i>Ch</i> ), sets the value of the arbitrary impedance of the standards 1 to 21 ( <i>Std</i> ).                                    |

Variable

**Table 7-19****Variable (*Std*)**

|              |                                                                                               |
|--------------|-----------------------------------------------------------------------------------------------|
|              | <i>Std</i>                                                                                    |
| Description  | Standard number                                                                               |
| Data type    | Long integer type (Long)                                                                      |
| Range        | 1 to 21                                                                                       |
| Preset value | 1                                                                                             |
| Note         | If the specified variable is out of the allowable setup range, an error occurs when executed. |

|              |                                                                                                                                                                                                              |
|--------------|--------------------------------------------------------------------------------------------------------------------------------------------------------------------------------------------------------------|
|              | <i>Value</i>                                                                                                                                                                                                 |
| Description  | Value of arbitrary impedance                                                                                                                                                                                 |
| Data type    | Double precision floating point type (Double)                                                                                                                                                                |
| Range        | -1E18 to 1E18                                                                                                                                                                                                |
| Preset value | Varies depending on the specified calibration kit and standard.                                                                                                                                              |
| Unit         | $\Omega$ (ohm)                                                                                                                                                                                               |
| Note         | If the specified variable is out of the allowable setup range, the minimum value (if the lower limit of the range is not reached) or the maximum value (if the upper limit of the range is exceeded) is set. |

For information on the variable (*Ch*), see Table 7-6, “Variable (*Ch*),” on page 209.

Examples

```
Dim StanArbt As Double
SCPI.SENSE(1).CORRection.COLLect.CKIT.STAN(5).ARBitrary = 50.5
StanArbt = SCPI.SENSE(1).CORRection.COLLect.CKIT.STAN(5).ARBitrary
```

Related objects

SCPI.SENSE(*Ch*).CORRection.COLLect.CKIT.SELect on page 500

Equivalent key

**[Cal] - Modify Cal Kit - Define STDs - no. name\*<sup>1</sup> - Arb. Impedance**

\*1.no: standard number (1 to 21), name: standard name (variable)

## SCPI.SENSE(*Ch*).CORRection.COLLect.CKIT.STAN(*Std*).C0

**Object type** Property

**Syntax** SCPI.SENSE(*Ch*).CORRection.COLLect.CKIT.STAN(*Std*).C0 = *Value*  
*Value* = SCPI.SENSE(*Ch*).CORRection.COLLect.CKIT.STAN(*Std*).C0

**Description** For the calibration kit selected for channels 1 to 16 (*Ch*), sets the value of the C0 value of the standards 1 to 21 (*Std*).

**Variable**

|              | <i>Value</i>                                                                                                                                                                                                 |
|--------------|--------------------------------------------------------------------------------------------------------------------------------------------------------------------------------------------------------------|
| Description  | C0                                                                                                                                                                                                           |
| Data type    | Double precision floating point type (Double)                                                                                                                                                                |
| Range        | -1E18 to 1E18                                                                                                                                                                                                |
| Preset value | Varies depending on the specified calibration kit and standard.                                                                                                                                              |
| Unit         | fF (femto farad): 1E-15 F (farad)                                                                                                                                                                            |
| Note         | If the specified variable is out of the allowable setup range, the minimum value (if the lower limit of the range is not reached) or the maximum value (if the upper limit of the range is exceeded) is set. |

For information on the variable (*Ch*) and the variable (*Std*), see Table 7-6, “Variable (Ch),” on page 209 and Table 7-19, “Variable (Std),” on page 502, respectively.

**Examples** Dim StanC0 As Double  
 SCPI.SENSE(1).CORRection.COLLect.CKIT.STAN(5).C0 = 12.3  
 StanC0 = SCPI.SENSE(1).CORRection.COLLect.CKIT.STAN(5).C0

**Related objects** SCPI.SENSE(*Ch*).CORRection.COLLect.CKIT.SELect on page 500

**Equivalent key** **[Cal] - Modify Cal Kit - Define STDs - no. name<sup>\*1</sup> - C0**

\*1.no: standard number (1 to 21), name: standard name (variable)

**SCPI.SENSE(*Ch*).CORRection.COLLect.CKIT.STAN(*Std*).C1**

|             |                                                                                                                                                                              |
|-------------|------------------------------------------------------------------------------------------------------------------------------------------------------------------------------|
| Object type | Property                                                                                                                                                                     |
| Syntax      | SCPI.SENSE( <i>Ch</i> ).CORRection.COLLect.CKIT.STAN( <i>Std</i> ).C1 = <i>Value</i><br><i>Value</i> = SCPI.SENSE( <i>Ch</i> ).CORRection.COLLect.CKIT.STAN( <i>Std</i> ).C1 |
| Description | For the calibration kit selected for channels 1 to 16 ( <i>Ch</i> ), sets the value of the C1 value of the standards 1 to 21 ( <i>Std</i> ).                                 |

## Variable

|              | <i>Value</i>                                                                                                                                                                                                 |
|--------------|--------------------------------------------------------------------------------------------------------------------------------------------------------------------------------------------------------------|
| Description  | C1                                                                                                                                                                                                           |
| Data type    | Double precision floating point type (Double)                                                                                                                                                                |
| Range        | -1E18 to 1E18                                                                                                                                                                                                |
| Preset value | Varies depending on the specified calibration kit and standard.                                                                                                                                              |
| Unit         | 1E-27 F/Hz (1E-27 farad / hertz)                                                                                                                                                                             |
| Note         | If the specified variable is out of the allowable setup range, the minimum value (if the lower limit of the range is not reached) or the maximum value (if the upper limit of the range is exceeded) is set. |

For information on the variable (*Ch*) and the variable (*Std*), see Table 7-6, “Variable (Ch),” on page 209 and Table 7-19, “Variable (Std),” on page 502, respectively.

|                 |                                                                                                                                              |
|-----------------|----------------------------------------------------------------------------------------------------------------------------------------------|
| Examples        | Dim StanC1 As Double<br>SCPI.SENSE(1).CORRection.COLLect.CKIT.STAN(5).C1 = 12.3<br>StanC1 = SCPI.SENSE(1).CORRection.COLLect.CKIT.STAN(5).C1 |
| Related objects | SCPI.SENSE(Ch).CORRection.COLLect.CKIT.SELect on page 500                                                                                    |
| Equivalent key  | <b>[Cal] - Modify Cal Kit - Define STDs - no. name<sup>*1</sup> - C1</b>                                                                     |

\*1.no: standard number (1 to 21), name: standard name (variable)

## SCPI.SENSE(*Ch*).CORRection.COLLEct.CKIT.STAN(*Std*).C2

**Object type** Property

**Syntax** SCPI.SENSE(*Ch*).CORRection.COLLEct.CKIT.STAN(*Std*).C2 = *Value*  
*Value* = SCPI.SENSE(*Ch*).CORRection.COLLEct.CKIT.STAN(*Std*).C2

**Description** For the calibration kit selected for channels 1 to 16 (*Ch*), sets the value of the C2 value of the standards 1 to 21 (*Std*).

**Variable**

|              | <i>Value</i>                                                                                                                                                                                                 |
|--------------|--------------------------------------------------------------------------------------------------------------------------------------------------------------------------------------------------------------|
| Description  | C2                                                                                                                                                                                                           |
| Data type    | Double precision floating point type (Double)                                                                                                                                                                |
| Range        | -1E18 to 1E18                                                                                                                                                                                                |
| Preset value | Varies depending on the specified calibration kit and standard.                                                                                                                                              |
| Unit         | 1E-36 F/Hz <sup>2</sup> (1E-36 farad /hertz <sup>2</sup> )                                                                                                                                                   |
| Note         | If the specified variable is out of the allowable setup range, the minimum value (if the lower limit of the range is not reached) or the maximum value (if the upper limit of the range is exceeded) is set. |

For information on the variable (*Ch*) and the variable (*Std*), see Table 7-6, “Variable (Ch),” on page 209 and Table 7-19, “Variable (Std),” on page 502, respectively.

**Examples**

```
Dim StanC2 As Double
SCPI.SENSE(1).CORRection.COLLEct.CKIT.STAN(5).C2 = 12.3
StanC2 = SCPI.SENSE(1).CORRection.COLLEct.CKIT.STAN(5).C2
```

**Related objects** SCPI.SENSE(Ch).CORRection.COLLEct.CKIT.SELect on page 500

**Equivalent key** **[Cal] - Modify Cal Kit - Define STDs - no. name<sup>\*1</sup> - C2**

\*1.no: standard number (1 to 21), name: standard name (variable)

## SCPI.SENSE(*Ch*).CORRection.COLLEct.CKIT.STAN(*Std*).C3

|             |                                                                                                                                                                              |
|-------------|------------------------------------------------------------------------------------------------------------------------------------------------------------------------------|
| Object type | Property                                                                                                                                                                     |
| Syntax      | SCPI.SENSE( <i>Ch</i> ).CORRection.COLLEct.CKIT.STAN( <i>Std</i> ).C3 = <i>Value</i><br><i>Value</i> = SCPI.SENSE( <i>Ch</i> ).CORRection.COLLEct.CKIT.STAN( <i>Std</i> ).C3 |
| Description | For the calibration kit selected for channels 1 to 16 ( <i>Ch</i> ), sets the value of the C3 value of the standards 1 to 21 ( <i>Std</i> ).                                 |

### Variable

|              | <i>Value</i>                                                                                                                                                                                                 |
|--------------|--------------------------------------------------------------------------------------------------------------------------------------------------------------------------------------------------------------|
| Description  | C3                                                                                                                                                                                                           |
| Data type    | Double precision floating point type (Double)                                                                                                                                                                |
| Range        | -1E18 to 1E18                                                                                                                                                                                                |
| Preset value | Varies depending on the specified calibration kit and standard.                                                                                                                                              |
| Unit         | 1E-45 F/Hz <sup>3</sup> (1E-45 farad / hertz <sup>3</sup> )                                                                                                                                                  |
| Note         | If the specified variable is out of the allowable setup range, the minimum value (if the lower limit of the range is not reached) or the maximum value (if the upper limit of the range is exceeded) is set. |

For information on the variable (*Ch*) and the variable (*Std*), see Table 7-6, “Variable (Ch),” on page 209 and Table 7-19, “Variable (Std),” on page 502, respectively.

|                 |                                                                                                                                              |
|-----------------|----------------------------------------------------------------------------------------------------------------------------------------------|
| Examples        | Dim StanC3 As Double<br>SCPI.SENSE(1).CORRection.COLLEct.CKIT.STAN(5).C3 = 12.3<br>StanC3 = SCPI.SENSE(1).CORRection.COLLEct.CKIT.STAN(5).C3 |
| Related objects | SCPI.SENSE(Ch).CORRection.COLLEct.CKIT.SELect on page 500                                                                                    |
| Equivalent key  | <b>[Cal] - Modify Cal Kit - Define STDs - no. name<sup>*1</sup> - C3</b>                                                                     |

\*1.no: standard number (1 to 21), name: standard name (variable)

## SCPI.SENSE(*Ch*).CORRection.COLLect.CKIT.STAN(*Std*). **CHARacter**

**Object type** Property

**Syntax** SCPI.SENSE(*Ch*).CORRection.COLLect.CKIT.STAN(*Std*).CHARacter = *Param*  
*Param* = SCPI.SENSE(*Ch*).CORRection.COLLect.CKIT.STAN(*Std*).CHARacter

**Description** For the calibration kit selected for channels 1 to 16 (*Ch*), sets the value of the C3 value of the standards 1 to 21 (*Std*).  
 For the standard 1 to 21 (*Std*) selected for the channel 1 to 16 (*Ch*), set the media type.

**Variable**

|              | <i>Param</i>                                                                                                                                             |
|--------------|----------------------------------------------------------------------------------------------------------------------------------------------------------|
| Description  | Select media type of standard.                                                                                                                           |
| Data type    | Character string type (String)                                                                                                                           |
| Range        | Select from the following.<br>•"COAXial"               Selects coaxial as the media type.<br>•"WAVeguide"           Selects waveguide as the media type. |
| Preset value | "COAXial"                                                                                                                                                |

For information on the variable (*Ch*) and the variable (*Std*), see Table 7-6, "Variable (Ch)," on page 209 and Table 7-19, "Variable (Std)," on page 502, respectively.

**Examples**

```
Dim StanChar As Double
SCPI.SENSE(1).SENSe.CORRection.COLLect.CKIT.STAN.CHARacter =
"WAVeguide"
StanChar = SCPI.SENSE.CORRection.COLLect.CKIT.STAN.CHARacter
```

**Related objects** SCPI.SENSE(*Ch*).CORRection.COLLect.CKIT.STAN(*Std*).DELay on page 508

**Equivalent key** **[Cal] - Modify Cal Kit - Define STDs - no. name<sup>\*1</sup> - Media**

\*1.no: standard number (1 to 21), name: standard name (variable)

**SCPI.SENSE(*Ch*).CORRection.COLLEct.CKIT.STAN(*Std*).DELay**

|             |                                                                                                                                                                                    |
|-------------|------------------------------------------------------------------------------------------------------------------------------------------------------------------------------------|
| Object type | Property                                                                                                                                                                           |
| Syntax      | SCPI.SENSE( <i>Ch</i> ).CORRection.COLLEct.CKIT.STAN( <i>Std</i> ).DELay = <i>Value</i><br><i>Value</i> = SCPI.SENSE( <i>Ch</i> ).CORRection.COLLEct.CKIT.STAN( <i>Std</i> ).DELay |
| Description | For the calibration kit selected for channels 1 to 16 ( <i>Ch</i> ), sets the value of the offset delay of the standards 1 to 21 ( <i>Std</i> ).                                   |

## Variable

|              | <i>Value</i>                                                                                                                                                                                                 |
|--------------|--------------------------------------------------------------------------------------------------------------------------------------------------------------------------------------------------------------|
| Description  | Offset delay                                                                                                                                                                                                 |
| Data type    | Double precision floating point type (Double)                                                                                                                                                                |
| Range        | -1E18 to 1E18                                                                                                                                                                                                |
| Preset value | Varies depending on the specified calibration kit and standard.                                                                                                                                              |
| Unit         | s (second)                                                                                                                                                                                                   |
| Note         | If the specified variable is out of the allowable setup range, the minimum value (if the lower limit of the range is not reached) or the maximum value (if the upper limit of the range is exceeded) is set. |

For information on the variable (*Ch*) and the variable (*Std*), see Table 7-6, “Variable (Ch),” on page 209 and Table 7-19, “Variable (Std),” on page 502, respectively.

|                 |                                                                                                                                                      |
|-----------------|------------------------------------------------------------------------------------------------------------------------------------------------------|
| Examples        | Dim StanDel As Double<br>SCPI.SENSE(1).CORRection.COLLEct.CKIT.STAN(5).DELay = 12.3<br>StanDel = SCPI.SENSE(1).CORRection.COLLEct.CKIT.STAN(5).DELay |
| Related objects | SCPI.SENSE(Ch).CORRection.COLLEct.CKIT.SELect on page 500<br>SCPI.SENSE(Ch).CORRection.COLLEct.CKIT.STAN(Std).CHARacter on page 507                  |
| Equivalent key  | <b>[Cal] - Modify Cal Kit - Define STDs - no. name<sup>*1</sup> - Offset Delay</b>                                                                   |

\*1.no: standard number (1 to 21), name: standard name (variable)



## **SCPI.SENSE(*Ch*).CORRection.COLLect.CKIT.STAN(*Std*) .FMAXimum**

**Object type** Property

**Syntax** SCPI.SENSE(*Ch*).CORRection.COLLect.CKIT.STAN(*Std*).FMAXimum = *Value*  
*Value* = SCPI.SENSE(*Ch*).CORRection.COLLect.CKIT.STAN(*Std*).FMAXimum

**Description** For the calibration kit selected for channel 1 to 16 (*Ch*), sets the value of the stop frequency of the standard 1 to 21 (*Std*).

---

**NOTE** When media type of standard is "Waveguide", sets the stop frequency of the cutoff frequency.

---

**Variable**

|              | <i>Value</i>                                                                                                                                                                                                 |
|--------------|--------------------------------------------------------------------------------------------------------------------------------------------------------------------------------------------------------------|
| Description  | Stop frequency of the selected standard.                                                                                                                                                                     |
| Data type    | Double precision floating point type (Double)                                                                                                                                                                |
| Range        | 0 to 999E9                                                                                                                                                                                                   |
| Preset value | Varies depending on the specified calibration kit and standard.                                                                                                                                              |
| Unit         | Hz (hertz)                                                                                                                                                                                                   |
| Note         | If the specified variable is out of the allowable setup range, the minimum value (if the lower limit of the range is not reached) or the maximum value (if the upper limit of the range is exceeded) is set. |

For information on the variable (*Ch*) and the variable (*Std*), see Table 7-6, "Variable (Ch)," on page 209 and Table 7-19, "Variable (Std)," on page 502, respectively.

**Examples**

```
Dim StanFMax As Double
SCPI.SENSE(1).CORRection.COLLect.CKIT.STAN(5).FMAXimum = 13.2E9
StanFMax = SCPI.SENSE(1).CORRection.COLLect.CKIT.STAN(5).FMAXimum
```

**Related objects** SCPI.SENSE(*Ch*).CORRection.COLLect.CKIT.STAN(*Std*) .FMINimum on page 510

**Equivalent key** **[Cal] - Modify Cal Kit - Define STDs - no. name<sup>\*1</sup> - Max. Frequency**

---

\*1.no: standard number (1 to 21), name: standard name (variable)

**SCPI.SENSE(*Ch*).CORRection.COLLect.CKIT.STAN(*Std*)  
.FMINimum**

|             |                                                                                                                                                                                                                                                                                    |
|-------------|------------------------------------------------------------------------------------------------------------------------------------------------------------------------------------------------------------------------------------------------------------------------------------|
| Object type | Property                                                                                                                                                                                                                                                                           |
| Syntax      | SCPI.SENSE( <i>Ch</i> ).CORRection.COLLect.CKIT.STAN( <i>Std</i> ).FMINimum = <i>Value</i><br><i>Value</i> = SCPI.SENSE( <i>Ch</i> ).CORRection.COLLect.CKIT.STAN( <i>Std</i> ).FMINimum                                                                                           |
| Description | For the calibration kit selected for channel 1 to 16 ( <i>Ch</i> ), sets the value of the stop frequency of the standard 1 to 21 ( <i>Std</i> ).<br><br>For the standard 1 to 21 ( <i>Std</i> ) selected for channel 1 to 16 ( <i>Ch</i> ), sets the value of the start frequency. |

---

**NOTE** When media type of standard is "Waveguide", sets the stop frequency of the cutoff frequency.

---

## Variable

|              | <i>Value</i>                                                                                                                                                                                                 |
|--------------|--------------------------------------------------------------------------------------------------------------------------------------------------------------------------------------------------------------|
| Description  | Start frequency of the selected standard.                                                                                                                                                                    |
| Data type    | Double precision floating point type (Double)                                                                                                                                                                |
| Range        | 0 to 999E9                                                                                                                                                                                                   |
| Preset value | Varies depending on the specified calibration kit and standard.                                                                                                                                              |
| Unit         | Hz (hertz)                                                                                                                                                                                                   |
| Note         | If the specified variable is out of the allowable setup range, the minimum value (if the lower limit of the range is not reached) or the maximum value (if the upper limit of the range is exceeded) is set. |

For information on the variable (*Ch*) and the variable (*Std*), see Table 7-6, "Variable (Ch)," on page 209 and Table 7-19, "Variable (Std)," on page 502, respectively.

**Examples**

```
Dim StanFMin As Double
SCPI.SENSE(1).CORRection.COLLect.CKIT.STAN(5).FMINimum = 600E6
StanFMax = SCPI.SENSE(1).CORRection.COLLect.CKIT.STAN(5).FMINimum
```

**Related objects** SCPI.SENSE(*Ch*).CORRection.COLLect.CKIT.STAN(*Std*) .FMAXimum on page 509

**Equivalent key** **[Cal] - Modify Cal Kit - Define STDs - no. name<sup>\*1</sup> - Min. Frequency**

---

\*1.no: standard number (1 to 21), name: standard name (variable)

## **SCPI.SENSE(*Ch*).CORRection.COLLect.CKIT.STAN(*Std*).L0**

**Object type** Property

**Syntax** SCPI.SENSE(*Ch*).CORRection.COLLect.CKIT.STAN(*Std*).L0 = *Value*  
*Value* = SCPI.SENSE(*Ch*).CORRection.COLLect.CKIT.STAN(*Std*).L0

**Description** For the calibration kit selected for channels 1 to 16 (*Ch*), sets the value of the L0 value of the standards 1 to 21 (*Std*).

**Variable**

|              | <i>Value</i>                                                                                                                                                                                                 |
|--------------|--------------------------------------------------------------------------------------------------------------------------------------------------------------------------------------------------------------|
| Description  | L0                                                                                                                                                                                                           |
| Data type    | Double precision floating point type (Double)                                                                                                                                                                |
| Range        | -1E18 to 1E18                                                                                                                                                                                                |
| Preset value | Varies depending on the specified calibration kit and standard.                                                                                                                                              |
| Unit         | pH (pico henry)                                                                                                                                                                                              |
| Note         | If the specified variable is out of the allowable setup range, the minimum value (if the lower limit of the range is not reached) or the maximum value (if the upper limit of the range is exceeded) is set. |

For information on the variable (*Ch*) and the variable (*Std*), see Table 7-6, “Variable (Ch),” on page 209 and Table 7-19, “Variable (Std),” on page 502, respectively.

**Examples**

```
Dim StanL0 As Double
SCPI.SENSE(1).CORRection.COLLect.CKIT.STAN(5).L0 = 12.3
StanL0 = SCPI.SENSE(1).CORRection.COLLect.CKIT.STAN(5).L0
```

**Related objects** SCPI.SENSE(*Ch*).CORRection.COLLect.CKIT.SELect on page 500

**Equivalent key** **[Cal] - Modify Cal Kit - Define STDs - no. name<sup>\*1</sup> - L0**

<sup>\*1</sup>no: standard number (1 to 21), name: standard name (variable)

**SCPI.SENSE(*Ch*).CORRection.COLLECT.CKIT.STAN(*Std*).L1**

|             |                                                                                                                                                                              |
|-------------|------------------------------------------------------------------------------------------------------------------------------------------------------------------------------|
| Object type | Property                                                                                                                                                                     |
| Syntax      | SCPI.SENSE( <i>Ch</i> ).CORRection.COLLECT.CKIT.STAN( <i>Std</i> ).L1 = <i>Value</i><br><i>Value</i> = SCPI.SENSE( <i>Ch</i> ).CORRection.COLLECT.CKIT.STAN( <i>Std</i> ).L1 |
| Description | For the calibration kit selected for channels 1 to 16 ( <i>Ch</i> ), sets the value of the L1 value of the standards 1 to 21 ( <i>Std</i> ).                                 |

## Variable

|              | <i>Value</i>                                                                                                                                                                                                 |
|--------------|--------------------------------------------------------------------------------------------------------------------------------------------------------------------------------------------------------------|
| Description  | L1                                                                                                                                                                                                           |
| Data type    | Double precision floating point type (Double)                                                                                                                                                                |
| Range        | -1E18 to 1E18                                                                                                                                                                                                |
| Preset value | Varies depending on the specified calibration kit and standard.                                                                                                                                              |
| Unit         | 1E-24 H/Hz (1E-24 henry / hertz)                                                                                                                                                                             |
| Note         | If the specified variable is out of the allowable setup range, the minimum value (if the lower limit of the range is not reached) or the maximum value (if the upper limit of the range is exceeded) is set. |

For information on the variable (*Ch*) and the variable (*Std*), see Table 7-6, “Variable (Ch),” on page 209 and Table 7-19, “Variable (Std),” on page 502, respectively.

|                 |                                                                                                                                              |
|-----------------|----------------------------------------------------------------------------------------------------------------------------------------------|
| Examples        | Dim StanL1 As Double<br>SCPI.SENSE(1).CORRection.COLLECT.CKIT.STAN(5).L1 = 12.3<br>StanL1 = SCPI.SENSE(1).CORRection.COLLECT.CKIT.STAN(5).L1 |
| Related objects | SCPI.SENSE(Ch).CORRection.COLLECT.CKIT.SELECT on page 500                                                                                    |
| Equivalent key  | <b>[Cal] - Modify Cal Kit - Define STDs - no. name<sup>*1</sup> - L1</b>                                                                     |

\*1.no: standard number (1 to 21), name: standard name (variable)

## **SCPI.SENSE(*Ch*).CORRection.COLLect.CKIT.STAN(*Std*).L2**

**Object type** Property

**Syntax** SCPI.SENSE(*Ch*).CORRection.COLLect.CKIT.STAN(*Std*).L2 = *Value*  
*Value* = SCPI.SENSE(*Ch*).CORRection.COLLect.CKIT.STAN(*Std*).L2

**Description** For the calibration kit selected for channels 1 to 16 (*Ch*), sets the value of the L2 value of the standards 1 to 21 (*Std*).

**Variable**

|              | <i>Value</i>                                                                                                                                                                                                 |
|--------------|--------------------------------------------------------------------------------------------------------------------------------------------------------------------------------------------------------------|
| Description  | L2                                                                                                                                                                                                           |
| Data type    | Double precision floating point type (Double)                                                                                                                                                                |
| Range        | -1E18 to 1E18                                                                                                                                                                                                |
| Preset value | Varies depending on the specified calibration kit and standard.                                                                                                                                              |
| Unit         | 1E-33 H/Hz <sup>2</sup> (1E-33 henry / hertz <sup>2</sup> )                                                                                                                                                  |
| Note         | If the specified variable is out of the allowable setup range, the minimum value (if the lower limit of the range is not reached) or the maximum value (if the upper limit of the range is exceeded) is set. |

For information on the variable (*Ch*) and the variable (*Std*), see Table 7-6, “Variable (Ch),” on page 209 and Table 7-19, “Variable (Std),” on page 502, respectively.

**Examples**

```
Dim StanL2 As Double
SCPI.SENSE(1).CORRection.COLLect.CKIT.STAN(5).L2 = 12.3
StanL2 = SCPI.SENSE(1).CORRection.COLLect.CKIT.STAN(5).L2
```

**Related objects** SCPI.SENSE(*Ch*).CORRection.COLLect.CKIT.SELect on page 500

**Equivalent key** **[Cal] - Modify Cal Kit - Define STDs - no. name<sup>\*1</sup> - L2**

<sup>\*1</sup>no: standard number (1 to 21), name: standard name (variable)

**SCPI.SENSE(*Ch*).CORRection.COLLect.CKIT.STAN(*Std*).L3**

|             |                                                                                                                                                                              |
|-------------|------------------------------------------------------------------------------------------------------------------------------------------------------------------------------|
| Object type | Property                                                                                                                                                                     |
| Syntax      | SCPI.SENSE( <i>Ch</i> ).CORRection.COLLect.CKIT.STAN( <i>Std</i> ).L3 = <i>Value</i><br><i>Value</i> = SCPI.SENSE( <i>Ch</i> ).CORRection.COLLect.CKIT.STAN( <i>Std</i> ).L3 |
| Description | For the calibration kit selected for channels 1 to 16 ( <i>Ch</i> ), sets the value of the L3 value of the standards 1 to 21 ( <i>Std</i> ).                                 |

## Variable

|              | <i>Value</i>                                                                                                                                                                                                 |
|--------------|--------------------------------------------------------------------------------------------------------------------------------------------------------------------------------------------------------------|
| Description  | L3                                                                                                                                                                                                           |
| Data type    | Double precision floating point type (Double)                                                                                                                                                                |
| Range        | -1E18 to 1E18                                                                                                                                                                                                |
| Preset value | Varies depending on the specified calibration kit and standard.                                                                                                                                              |
| Unit         | 1E-42 H/Hz <sup>3</sup> (1E-42 henry / hertz <sup>3</sup> )                                                                                                                                                  |
| Note         | If the specified variable is out of the allowable setup range, the minimum value (if the lower limit of the range is not reached) or the maximum value (if the upper limit of the range is exceeded) is set. |

For information on the variable (*Ch*) and the variable (*Std*), see Table 7-6, “Variable (Ch),” on page 209 and Table 7-19, “Variable (Std),” on page 502, respectively.

|                 |                                                                                                                                              |
|-----------------|----------------------------------------------------------------------------------------------------------------------------------------------|
| Examples        | Dim StanL3 As Double<br>SCPI.SENSE(1).CORRection.COLLect.CKIT.STAN(5).L3 = 12.3<br>StanL3 = SCPI.SENSE(1).CORRection.COLLect.CKIT.STAN(5).L3 |
| Related objects | SCPI.SENSE(Ch).CORRection.COLLect.CKIT.SELect on page 500                                                                                    |
| Equivalent key  | <b>[Cal] - Modify Cal Kit - Define STDs - no. name<sup>*1</sup> - L3</b>                                                                     |

\*1.no: standard number (1 to 21), name: standard name (variable)

**SCPI.SENSE(*Ch*).CORRection.COLLect.CKIT.STAN(*Std*).LAbel**

|             |                                                                                                                                                                                |
|-------------|--------------------------------------------------------------------------------------------------------------------------------------------------------------------------------|
| Object type | Property                                                                                                                                                                       |
| Syntax      | SCPI.SENSE( <i>Ch</i> ).CORRection.COLLect.CKIT.STAN( <i>Std</i> ).LAbel = <i>Lbl</i><br><i>Lbl</i> = SCPI.SENSE( <i>Ch</i> ).CORRection.COLLect.CKIT.STAN( <i>Std</i> ).LAbel |
| Description | For the calibration kit selected for channels 1 to 16 ( <i>Ch</i> ), sets the name of the standards 1 to 21 ( <i>Std</i> ).                                                    |

## Variable

|              |                                                                 |
|--------------|-----------------------------------------------------------------|
|              | <i>Lbl</i>                                                      |
| Description  | Standard name                                                   |
| Data type    | Character string type (String)                                  |
| Range        | 254 characters or less                                          |
| Preset value | Varies depending on the specified calibration kit and standard. |

For information on the variable (*Ch*) and the variable (*Std*), see Table 7-6, “Variable (Ch),” on page 209 and Table 7-19, “Variable (Std),” on page 502, respectively.

|                 |                                                                                                                                                                   |
|-----------------|-------------------------------------------------------------------------------------------------------------------------------------------------------------------|
| Examples        | <pre>Dim StanLbl As Double SCPI.SENSE(1).CORRection.COLLect.CKIT.STAN(5).LAbel = "OPEN 3.5mm" StanLbl = SCPI.SENSE(1).CORRection.COLLect.CKIT.STAN(5).LAbel</pre> |
| Related objects | SCPI.SENSE(Ch).CORRection.COLLect.CKIT.SELect on page 500                                                                                                         |
| Equivalent key  | <b>[Cal] - Modify Cal Kit - Define STDs - no. name<sup>*1</sup> - Label</b>                                                                                       |

\*1.no: standard number (1 to 21), name: standard name (variable)

**SCPI.SENSE(*Ch*).CORRection.COLLect.CKIT.STAN(*Std*).LOSS**

|             |                                                                                                                                                                                  |
|-------------|----------------------------------------------------------------------------------------------------------------------------------------------------------------------------------|
| Object type | Property                                                                                                                                                                         |
| Syntax      | SCPI.SENSE( <i>Ch</i> ).CORRection.COLLect.CKIT.STAN( <i>Std</i> ).LOSS = <i>Value</i><br><i>Value</i> = SCPI.SENSE( <i>Ch</i> ).CORRection.COLLect.CKIT.STAN( <i>Std</i> ).LOSS |
| Description | For the calibration kit selected for channels 1 to 16 ( <i>Ch</i> ), sets the value of the offset loss of the standards 1 to 21 ( <i>Std</i> ).                                  |

## Variable

|              | <i>Value</i>                                                                                                                                                                                                 |
|--------------|--------------------------------------------------------------------------------------------------------------------------------------------------------------------------------------------------------------|
| Description  | Offset loss                                                                                                                                                                                                  |
| Data type    | Double precision floating point type (Double)                                                                                                                                                                |
| Range        | -1E18 to 1E18                                                                                                                                                                                                |
| Preset value | Varies depending on the specified calibration kit and standard.                                                                                                                                              |
| Unit         | $\Omega/s$ (ohm/second)                                                                                                                                                                                      |
| Note         | If the specified variable is out of the allowable setup range, the minimum value (if the lower limit of the range is not reached) or the maximum value (if the upper limit of the range is exceeded) is set. |

For information on the variable (*Ch*) and the variable (*Std*), see Table 7-6, “Variable (Ch),” on page 209 and Table 7-19, “Variable (Std),” on page 502, respectively.

|                 |                                                                                                                                                      |
|-----------------|------------------------------------------------------------------------------------------------------------------------------------------------------|
| Examples        | Dim StanLoss As Double<br>SCPI.SENSE(1).CORRection.COLLect.CKIT.STAN(5).LOSS = 12.3<br>StanLoss = SCPI.SENSE(1).CORRection.COLLect.CKIT.STAN(5).LOSS |
| Related objects | SCPI.SENSE(Ch).CORRection.COLLect.CKIT.SELect on page 500                                                                                            |
| Equivalent key  | <b>[Cal] - Modify Cal Kit - Define STDs - no. name<sup>*1</sup> - Offset Loss</b>                                                                    |

\*1.no: standard number (1 to 21), name: standard name (variable)



## SCPI.SENSE(*Ch*).CORRection.COLLEct.CKIT.STAN(*Std*).TYPE

|             |                                                                                                                                                                                      |
|-------------|--------------------------------------------------------------------------------------------------------------------------------------------------------------------------------------|
| Object type | Property                                                                                                                                                                             |
| Syntax      | SCPI.SENSE( <i>Ch</i> ).CORRection.COLLEct.CKIT.STAN( <i>Std</i> ).TYPE = <i>Param</i><br><br><i>Param</i> = SCPI.SENSE( <i>Ch</i> ).CORRection.COLLEct.CKIT.STAN( <i>Std</i> ).TYPE |
| Description | For the calibration kit selected for channels 1 to 16 ( <i>Ch</i> ), sets the standard type of the standards 1 to 21 ( <i>Std</i> ).                                                 |
| Variable    |                                                                                                                                                                                      |

|              | <i>Param</i>                                                                                                                                                                                                                                                                                                                                                                                                                                                                                                            |
|--------------|-------------------------------------------------------------------------------------------------------------------------------------------------------------------------------------------------------------------------------------------------------------------------------------------------------------------------------------------------------------------------------------------------------------------------------------------------------------------------------------------------------------------------|
| Description  | Standard type                                                                                                                                                                                                                                                                                                                                                                                                                                                                                                           |
| Data type    | Character string type (String)                                                                                                                                                                                                                                                                                                                                                                                                                                                                                          |
| Range        | Select from the following.<br><ul style="list-style-type: none"> <li>•"OPEN"                      Specifies open.</li> <li>•"SHORt"                     Specifies short.</li> <li>•"LOAD"                      Specifies load.</li> <li>•"THRU"                      Specifies thru.</li> <li>•"UTHR"                      Specifies unknown thru.</li> <li>•"ARBI"                      Specifies arbitrary impedance.</li> <li>•"NONE"                      Specifies DUT of which theoretical value is 0.</li> </ul> |
| Preset value | Varies depending on the specified calibration kit and standard.                                                                                                                                                                                                                                                                                                                                                                                                                                                         |

For information on the variable (*Ch*) and the variable (*Std*), see Table 7-6, "Variable (Ch)," on page 209 and Table 7-19, "Variable (Std)," on page 502, respectively.

**Examples**

```
Dim StanType As String
SCPI.SENSE(1).CORRection.COLLEct.CKIT.STAN(5).TYPE = "OPEN"
StanType = SCPI.SENSE(1).CORRection.COLLEct.CKIT.STAN(5).TYPE
```

**Related objects**      SCPI.SENSE(*Ch*).CORRection.COLLEct.CKIT.SELect on page 500

**Equivalent key**      **[Cal] - Modify Cal Kit - Define STDs - no. name<sup>\*1</sup> - STD Type**

<sup>\*1</sup>no: standard number (1 to 21), name: standard name (variable)

**SCPI.SENSE(*Ch*).CORRection.COLLect.CKIT.STAN(*Std*).Z0**

|             |                                                                                                                                                                              |
|-------------|------------------------------------------------------------------------------------------------------------------------------------------------------------------------------|
| Object type | Property                                                                                                                                                                     |
| Syntax      | SCPI.SENSE( <i>Ch</i> ).CORRection.COLLect.CKIT.STAN( <i>Std</i> ).Z0 = <i>Value</i><br><i>Value</i> = SCPI.SENSE( <i>Ch</i> ).CORRection.COLLect.CKIT.STAN( <i>Std</i> ).Z0 |
| Description | For the calibration kit selected for channels 1 to 16 ( <i>Ch</i> ), sets the value of the offset Z0 of the standards 1 to 21 ( <i>Std</i> ).                                |

## Variable

|              | <i>Value</i>                                                                                                                                                                                                 |
|--------------|--------------------------------------------------------------------------------------------------------------------------------------------------------------------------------------------------------------|
| Description  | Offset Z0                                                                                                                                                                                                    |
| Data type    | Double precision floating point type (Double)                                                                                                                                                                |
| Range        | -1E18 to 1E18                                                                                                                                                                                                |
| Preset value | Varies depending on the specified calibration kit and standard.                                                                                                                                              |
| Unit         | $\Omega$ (ohm)                                                                                                                                                                                               |
| Note         | If the specified variable is out of the allowable setup range, the minimum value (if the lower limit of the range is not reached) or the maximum value (if the upper limit of the range is exceeded) is set. |

For information on the variable (*Ch*) and the variable (*Std*), see Table 7-6, “Variable (Ch),” on page 209 and Table 7-19, “Variable (Std),” on page 502, respectively.

|                 |                                                                                                                                            |
|-----------------|--------------------------------------------------------------------------------------------------------------------------------------------|
| Examples        | Dim StanZ0 As Double<br>SCPI.SENSE(1).CORRection.COLLect.CKIT.STAN(5).Z0 = 50<br>StanZ0 = SCPI.SENSE(1).CORRection.COLLect.CKIT.STAN(5).Z0 |
| Related objects | SCPI.SENSE(Ch).CORRection.COLLect.CKIT.SELect on page 500                                                                                  |
| Equivalent key  | <b>[Cal] - Modify Cal Kit - Define STDs - no. name<sup>*1</sup> - Offset Z0</b>                                                            |

\*1.no: standard number (1 to 21), name: standard name (variable)

## **SCPI.SENSE(*Ch*).CORRection.COLLect.CKIT.TRLoption. IMPedance**

**Object type** Property

**Syntax** SCPI.SENSE(*Ch*).CORRection.COLLect.CKIT.TRLoption.IMPedance = *Param*  
*Param* = SCPI.SENSE(*Ch*).CORRection.COLLect.CKIT.TRLoption.IMPedance

**Description** For channel 1 to 16 (*Ch*). selects the reference impedance during the TRL calibration.

**Variable**

|              |                                                                                                                                                                                                                                                                                                                                   |
|--------------|-----------------------------------------------------------------------------------------------------------------------------------------------------------------------------------------------------------------------------------------------------------------------------------------------------------------------------------|
|              | <i>Param</i>                                                                                                                                                                                                                                                                                                                      |
| Description  | Selects the reference impedance during the TRL calibration.                                                                                                                                                                                                                                                                       |
| Data type    | Character string type (String)                                                                                                                                                                                                                                                                                                    |
| Range        | Select from the following.<br><ul style="list-style-type: none"> <li>•"SYSTEM" Calculate the error coefficients by setting the system impedance to the reference impedance.</li> <li>•"LINE" Calculate the error coefficients by setting the characteristic impedance of the line standard to the reference impedance.</li> </ul> |
| Preset value | "SYSTEM"                                                                                                                                                                                                                                                                                                                          |

For information on the variable (*Ch*), see Table 7-6, “Variable (Ch),” on page 209.

**Examples**

```
Dim TrlImp As String
SCPI.SENSE(1).CORRection.COLLect.CKIT.TRLoption.IMPedance = "LINE"
TrlImp = SCPI.SENSE(1).CORRection.COLLect.CKIT.TRLoption.IMPedance
```

**Related objects** SCPI.SENSE(*Ch*).CORRection.COLLect.CKIT.TRLoption. RPLane on page 520

**Equivalent key** **[Cal] - Modify Cal Kit - TRL Option - Impedance**

**SCPI.SENSE(*Ch*).CORRection.COLLect.CKIT.TRLoption.  
RPLane**

Object type Property

Syntax SCPI.SENSE(*Ch*).CORRection.COLLect.CKIT.TRLoption.RPLane = *Param*  
*Param* = SCPI.SENSE(*Ch*).CORRection.COLLect.CKIT.TRLoption.RPLane

Description For channel 1 to 16 (*Ch*), selects the calculation method of the calibration plane.

Variable

|              | <i>Param</i>                                                                                                                                                                                                                                                                                                                        |
|--------------|-------------------------------------------------------------------------------------------------------------------------------------------------------------------------------------------------------------------------------------------------------------------------------------------------------------------------------------|
| Description  | Selects the calculation method of the calibration plane.                                                                                                                                                                                                                                                                            |
| Data type    | Character string type (String)                                                                                                                                                                                                                                                                                                      |
| Range        | Select from the following. <ul style="list-style-type: none"> <li>•"THRU"                      Uses the length of the THRU and LINE standard to calculate the calibration plane.</li> <li>•"REFlect"                      Uses the reflection coefficient of the reflection standard to calculate the calibration plane.</li> </ul> |
| Preset value | "THRU"                                                                                                                                                                                                                                                                                                                              |

For information on the variable (*Ch*), see Table 7-6, "Variable (Ch)," on page 209.

Examples 

```
Dim TrlRpl As String
SCPI.SENSE(1).SENSE(1).CORRection.COLLect.CKIT.TRLoption.RPLane =
"REFlect"
TrlRpl = SCPI.SENSE(1).CORRection.COLLect.CKIT.TRLoption.RPLane
```

Related objects SCPI.SENSE(Ch).CORRection.COLLect.CKIT.TRLoption. IMPedance on page 519

Equivalent key **[Cal] - Modify Cal Kit - TRL Option - Reference Plane**

## SCPI.SENSE(*Ch*).CORRection.COLLect.CLEAr

|                 |                                                                                                                                                                                                                                                                                                                                                                                                                                           |
|-----------------|-------------------------------------------------------------------------------------------------------------------------------------------------------------------------------------------------------------------------------------------------------------------------------------------------------------------------------------------------------------------------------------------------------------------------------------------|
| Type of object  | Method                                                                                                                                                                                                                                                                                                                                                                                                                                    |
| Syntax          | SCPI.SENSE( <i>Ch</i> ).CORRection.COLLect.CLEAr                                                                                                                                                                                                                                                                                                                                                                                          |
| Description     | <p>For channels 1 to 16 (<i>Ch</i>), clears the calibration measurement data when the frequency offset feature is off. (No read)</p> <p>Settings that have been temporarily changed due to measurement for each standard (number of traces, measurement parameters, and so on) return to their original values.</p>                                                                                                                       |
| Variable        | For information on the variable ( <i>Ch</i> ), refer to Table 7-6, “Variable (Ch),” on page 209.                                                                                                                                                                                                                                                                                                                                          |
| Example of use  | SCPI.SENSE(1).CORRection.COLLect.CLEAr                                                                                                                                                                                                                                                                                                                                                                                                    |
| Related objects | SCPI.SENSE(Ch).OFFSet.STATe on page 627                                                                                                                                                                                                                                                                                                                                                                                                   |
| Equivalent key  | <p><b>[Cal] - Calibrate - Responce(Open) - Cancel - OK</b></p> <p><b>[Cal] - Calibrate - Responce(Short) - Cancel - OK</b></p> <p><b>[Cal] - Calibrate - Responce(Thru) - Cancel - OK</b></p> <p><b>[Cal] - Calibrate - 1-Port Cal - Cancel - OK</b></p> <p><b>[Cal] - Calibrate - 2-Port Cal - Cancel - OK</b></p> <p><b>[Cal] - Calibrate - 3-Port Cal - Cancel - OK</b></p> <p><b>[Cal] - Calibrate - 4-Port Cal - Cancel - OK</b></p> |

**SCPI.SENSE(*Ch*).CORRection.COLLect.ECAL.CCHeck.ACQuire**

|                   |                                                                                                                                                                                                                                                                                                                                                                                                                     |
|-------------------|---------------------------------------------------------------------------------------------------------------------------------------------------------------------------------------------------------------------------------------------------------------------------------------------------------------------------------------------------------------------------------------------------------------------|
| Type of object    | Method                                                                                                                                                                                                                                                                                                                                                                                                              |
| Syntax            | SCPI.SENSE( <i>Ch</i> ).CORRection.COLLect.ECAL.CCHeck.ACQuire                                                                                                                                                                                                                                                                                                                                                      |
| Description       | <p>Using ECal (Electronic Calibration), executes the confidence check of the calibration coefficients for channels 1 to 16 (<i>Ch</i>) (sets the data measured with the analyzer and the data stored in ECal so that they can be compared).</p> <p>If you execute this object when the ECal module is not connected or when ports are not connected each other appropriately, a runtime error occurs. (No read)</p> |
| <hr/> <b>NOTE</b> | <hr/> This function is available with the firmware version 3.50 or greater.                                                                                                                                                                                                                                                                                                                                         |
| Variable          | For information on the variable ( <i>Ch</i> ), refer to Table 7-6, “Variable (Ch),” on page 209.                                                                                                                                                                                                                                                                                                                    |
| Example of use    | SCPI.SENSE(1).CORRection.COLLect.ECAL.CCHeck.ACQuire                                                                                                                                                                                                                                                                                                                                                                |
| Equivalent key    | <b>[Cal] - ECal - Confidence Check</b>                                                                                                                                                                                                                                                                                                                                                                              |

## SCPI.SENSE(*Ch*).CORRection.COLLect.ECAL.ERESponse

**Object type** Property

**Syntax** SCPI.SENSE(*Ch*).CORRection.COLLect.ECAL.ERESponse = Eports

**Description** Executes enhanced response calibration between the two specified ports of channel 1 to channel 16 using the ECal (Electrical Calibration) module.

If you execute this command when the ECal module is not connected, an error occurs and the command is ignored. (No read)

**Variable**

|             |                                                                                                                                                                                                                                                   |
|-------------|---------------------------------------------------------------------------------------------------------------------------------------------------------------------------------------------------------------------------------------------------|
|             | <b><i>Eports</i></b>                                                                                                                                                                                                                              |
| Description | Indicates 2-element array data (port number).<br><ul style="list-style-type: none"> <li>• <i>EPorts(0)</i> Specifies the response port.</li> <li>• <i>EPorts(1)</i> Specifies the stimulus port.</li> </ul> The index of the array starts from 0. |
| Data type   | Variant type (Variant)                                                                                                                                                                                                                            |
| Range       | 1 to 4                                                                                                                                                                                                                                            |
| Resolution  | 1                                                                                                                                                                                                                                                 |
| Note        | For each parameter, you must specify a different port number. If you specify the same port number for 2 or more parameters, an error occurs and the command is ignored.                                                                           |

For information on the variable (*Ch*), see Table 7-6, “Variable (Ch),” on page 209.

**Examples**

```
Dim ERESport(1) As Variant
ERESport(0) = 1
ERESport(1) = 2
SCPI.SENSE(1).CORRection.COLLect.ECAL.ERESponse = ERESport
```

**Equivalent key** **[Cal] - ECal - Enhanced Response - 2-1 (S21 S11)3-1 (S31 S11)...3-4 (S34 S44)**

**SCPI.SENSE(*Ch*).CORRection.COLLECT.ECAL.ISOLation.STATE**

|             |                                                                                                                                                                    |
|-------------|--------------------------------------------------------------------------------------------------------------------------------------------------------------------|
| Object type | Property                                                                                                                                                           |
| Syntax      | SCPI.SENSE( <i>Ch</i> ).CORRection.COLLECT.ECAL.ISOLation.STATE = <i>Status</i><br><i>Status</i> = SCPI.SENSE( <i>Ch</i> ).CORRection.COLLECT.ECAL.ISOLation.STATE |
| Description | For channels 1 to 16 ( <i>Ch</i> ), turns ON/OFF the isolation measurement when executing ECal (Electronic Calibration).                                           |

## Variable

|              |                                                                                                                                                                                                                                     |
|--------------|-------------------------------------------------------------------------------------------------------------------------------------------------------------------------------------------------------------------------------------|
|              | <i>Status</i>                                                                                                                                                                                                                       |
| Description  | ON/OFF of the isolation measurement when executing ECal                                                                                                                                                                             |
| Data type    | Boolean type (Boolean)                                                                                                                                                                                                              |
| Range        | Select from the following.<br><ul style="list-style-type: none"> <li>•True or -1                      Turns ON the isolation measurement.</li> <li>•False or 0                      Turns OFF the isolation measurement.</li> </ul> |
| Preset value | False or 0                                                                                                                                                                                                                          |

For information on the variable (*Ch*), see Table 7-6, “Variable (Ch),” on page 209.

## Examples

```
Dim EcalIso As Boolean
SCPI.SENSE(1).CORRection.COLLECT.ECAL.ISOLation.STATE = True
EcalIso = SCPI.SENSE(1).CORRection.COLLECT.ECAL.ISOLation.STATE
```

## Related objects

SCPI.SENSE(Ch).CORRection.COLLECT.ECAL.SOLT1 on page 527  
 SCPI.SENSE(Ch).CORRection.COLLECT.ECAL.SOLT2 on page 528  
 SCPI.SENSE(Ch).CORRection.COLLECT.ECAL.SOLT3 on page 529  
 SCPI.SENSE(Ch).CORRection.COLLECT.ECAL.SOLT4 on page 530

## Equivalent key

**[Cal] - ECal - Isolation**



## SCPI.SENSE(*Ch*).CORRection.COLLect.ECAL.ORIentation .STATe

**Object type** Property

**Syntax** SCPI.SENSE(*Ch*).CORRection.COLLect.ECAL.ORIentation.STATe = *Status*  
*Status* = SCPI.SENSE(*Ch*).CORRection.COLLect.ECAL.ORIentation.STATe

**Description** Turns ON/OFF the ECal auto detect funcion.

**Variable**

|              |                                                                                                                                                                                                                                   |
|--------------|-----------------------------------------------------------------------------------------------------------------------------------------------------------------------------------------------------------------------------------|
|              | <i>Status</i>                                                                                                                                                                                                                     |
| Description  | ON/OFF the ECal auto detect funcion.                                                                                                                                                                                              |
| Data type    | Boolean type (Boolean)                                                                                                                                                                                                            |
| Range        | Select from the following.<br><ul style="list-style-type: none"> <li>• True or -1                      Turns ON the auto detect funcion.</li> <li>• False or 0                      Turns OFF the auto detect funcion.</li> </ul> |
| Preset value | True or -1                                                                                                                                                                                                                        |

For information on the variable (*Ch*), see Table 7-6, “Variable (Ch),” on page 209.

**Examples**

```
Dim EcalOri As Boolean
SCPI.SENSE(1).CORRection.COLLect.ECAL.ORIentation.STATe = True
EcalOri = SCPI.SENSE(1).CORRection.COLLect.ECAL.ORIentation.STATe
```

**Related objects** SCPI.SENSE(*Ch*).CORRection.COLLect.ECAL.PATH(*Cpt*) on page 526  
SCPI.CALCulate(*Ch*).FSIMulator.SENDEd.DEEMbed. PORT(*Pt*).TYPE on page 241

**Equivalent key** **[Cal] - ECal - Orientation**

**SCPI.SENSE(*Ch*).CORRection.COLLEct.ECAL.PATH(*Cpt*)**

Object type

Property

Syntax

SCPI.SENSE.CORRection.COLLEct.ECAL.PATH(*Cpt*) = *Value**Value* = SCPI.SENSE(Ch).CORRection.COLLEct.ECAL.PATH(*Cpt*)

Description

Specify the ECal module n port number which is connected to a specified port.

Variable

|             | <i>Value</i>                                                                                                                                                                                                                                                                                                                                         |
|-------------|------------------------------------------------------------------------------------------------------------------------------------------------------------------------------------------------------------------------------------------------------------------------------------------------------------------------------------------------------|
| Description | Port of ECal module.                                                                                                                                                                                                                                                                                                                                 |
| Data type   | Long integer type (Long)                                                                                                                                                                                                                                                                                                                             |
| Range       | One of the following is read out. <ul style="list-style-type: none"> <li>• 0                    Nothing is connected.</li> <li>• 1                    Port A is connected.</li> <li>• 2                    Port B is connected.</li> <li>• 3                    Port C is connected.</li> <li>• 4                    Port D is connected.</li> </ul> |

For information on the variable (*Cpt*), see Table 7-17, “Variable (*Cpt*),” on page 490.

Examples

```
Dim ECalPort As Long
SCPI.SENSE.CORRection.COLLEct.ECAL.PATH(1) = 3
ECalPort = SCPI.SENSE.CORRection.COLLEct.ECAL.PATH(1)
```

Related objects

SCPI.SENSE(Ch).CORRection.COLLEct.ECAL.ORlentation .STATE on page 525

Equivalent key

No equivalent key is available on the front panel.

## **SCPI.SENSE(*Ch*).CORRection.COLLection.ECAL.SOLT1**

**Object type** Property

**Syntax** SCPI.SENSE(*Ch*).CORRection.COLLection.ECAL.SOLT1 = *Eport*

**Description** Executes 1-port calibration of the specified port of channels 1 to 16 (*Ch*) using the ECal (Electronic Calibration) module.

If you execute this object when the ECal module is not connected, an error occurs when executed and the object is ignored. (No read)

**Variable**

|             |                                                                                               |
|-------------|-----------------------------------------------------------------------------------------------|
|             | <i>Eport</i>                                                                                  |
| Description | Port number                                                                                   |
| Data type   | Long integer type (Long)                                                                      |
| Range       | 1 to 4                                                                                        |
| Note        | If the specified variable is out of the allowable setup range, an error occurs when executed. |

For information on the variable (*Ch*), see Table 7-6, “Variable (Ch),” on page 209.

**Examples** SCPI.SENSE(1).CORRection.COLLection.ECAL.SOLT1 = 1

**Equivalent key** **[Cal] - ECal - 1-Port Cal - Port 1|Port 2|Port 3|Port 4**

## SCPI.SENSE(*Ch*).CORRection.COLLect.ECAL.SOLT2

**Object type** Property

**Syntax** SCPI.SENSE(*Ch*).CORRection.COLLect.ECAL.SOLT2 = *Eports*

**Description** Executes full 2-port calibration between the specified 2 ports of channels 1 to 16 (*Ch*) using the ECal (Electronic Calibration) module.

If you execute this object when the ECal module is not connected, an error occurs when executed and the object is ignored. (No read)

**Variable**

|             |                                                                                                                                                                                                                                                        |
|-------------|--------------------------------------------------------------------------------------------------------------------------------------------------------------------------------------------------------------------------------------------------------|
|             | <i>Eports</i>                                                                                                                                                                                                                                          |
| Description | Indicates 2-element array data (port number).<br><ul style="list-style-type: none"> <li>• <i>EPorts(0)</i></li> <li><i>EPorts(1)</i>                      Specifies the port numbers for 2-port ECal.</li> </ul> The index of the array starts from 0. |
| Data type   | Variant type (Variant)                                                                                                                                                                                                                                 |
| Range       | 1 to 4                                                                                                                                                                                                                                                 |
| Resolution  | 1                                                                                                                                                                                                                                                      |
| Note        | If the specified variable is out of the allowable setup range, an error occurs when executed. If you specify the same port number to 2 port numbers, an error occurs when executed. the order of the 2 port numbers to be specified is arbitrary.      |

For information on the variable (*Ch*), see Table 7-6, “Variable (Ch),” on page 209.

**Examples**

```
SCPI.SENSE(1).CORRection.COLLect.ECAL.SOLT2 = Array(1,2)

Dim EcalPort(1) As Variant
EcalPort(0) = 1
EcalPort(1) = 2
SCPI.SENSE(1).CORRection.COLLect.ECAL.SOLT2 = EcalPort
```

**Equivalent key** **[Cal] - ECal - 2-Port Cal - Port 1-2|Port 1-3|Port 1-4|Port 2-3|Port 2-4|Port 3-4**

## SCPI.SENSE(*Ch*).CORRection.COLLect.ECAL.SOLT3

**Object type**      Property

**Syntax**            SCPI.SENSE(*Ch*).CORRection.COLLect.ECAL.SOLT3 = *Eports*

**Description**        Executes full 3-port calibration between the specified 3 ports of channels 1 to 16 (*Ch*) using the ECal (Electronic Calibration) module.

                          If you execute this object when the 4-port ECal module is not connected, an error occurs when executed and the object is ignored. (No read)

**Variable**

|             |                                                                                                                                                                                                                                                                                                |
|-------------|------------------------------------------------------------------------------------------------------------------------------------------------------------------------------------------------------------------------------------------------------------------------------------------------|
|             | <i>Eports</i>                                                                                                                                                                                                                                                                                  |
| Description | Indicates 3-element array data (port number).<br><ul style="list-style-type: none"> <li>• <i>EPorts(0)</i></li> <li>  <i>EPorts(1)</i></li> <li>  <i>EPorts(2)</i>                                Specifies the port numbers for 3-port ECal.</li> </ul> The index of the array starts from 0. |
| Data type   | Variant type (Variant)                                                                                                                                                                                                                                                                         |
| Range       | 1 to 4                                                                                                                                                                                                                                                                                         |
| Resolution  | 1                                                                                                                                                                                                                                                                                              |
| Note        | If the specified variable is out of the allowable setup range, an error occurs when executed.<br>If you specify the same port number to more than 2 port numbers, an error occurs when executed. the order of the 3 port numbers to be specified is arbitrary.                                 |

For information on the variable (*Ch*), see Table 7-6, “Variable (Ch),” on page 209.

**Examples**            SCPI.SENSE(1).CORRection.COLLect.ECAL.SOLT3 = Array(1,2,3)

```
Dim EcalPort(2) As Variant
EcalPort(0) = 1
EcalPort(1) = 2
EcalPort(2) = 3
SCPI.SENSE(1).CORRection.COLLect.ECAL.SOLT3 = EcalPort
```

**Equivalent key**     **[Cal] - ECal - 3-Port Cal - Port 1-2-3|Port 1-2-4|Port 1-3-4|Port 2-3-4**

**SCPI.SENSE(*Ch*).CORRection.COLLect.ECAL.SOLT4**

|             |                                                                                                                                                                                                                                                                             |
|-------------|-----------------------------------------------------------------------------------------------------------------------------------------------------------------------------------------------------------------------------------------------------------------------------|
| Object type | Property                                                                                                                                                                                                                                                                    |
| Syntax      | SCPI.SENSE( <i>Ch</i> ).CORRection.COLLect.ECAL.SOLT4 = <i>Eports</i>                                                                                                                                                                                                       |
| Description | <p>Executes full 4-port calibration for channels 1 to 16 (<i>Ch</i>) using the ECal (Electronic Calibration) module.</p> <p>If you execute this object when the 4-port ECal module is not connected, an error occurs when executed and the object is ignored. (No read)</p> |

## Variable

|             |                                                                                                                                                                                                                                                                                                                                    |
|-------------|------------------------------------------------------------------------------------------------------------------------------------------------------------------------------------------------------------------------------------------------------------------------------------------------------------------------------------|
|             | <b><i>Eports</i></b>                                                                                                                                                                                                                                                                                                               |
| Description | <p>Indicates 4-element array data (port number).</p> <ul style="list-style-type: none"> <li>• <i>EPorts(0)</i></li> <li><i>EPorts(1)</i></li> <li><i>EPorts(2)</i></li> <li><i>EPorts(3)</i></li> </ul> <p style="text-align: right;">Specifies the port numbers for 4-port ECal.</p> <p>The index of the array starts from 0.</p> |
| Data type   | Variant type (Variant)                                                                                                                                                                                                                                                                                                             |
| Range       | 1 to 4                                                                                                                                                                                                                                                                                                                             |
| Resolution  | 1                                                                                                                                                                                                                                                                                                                                  |
| Note        | <p>If the specified variable is out of the allowable setup range, an error occurs when executed.</p> <p>If you specify the same port number to more than 2 port numbers, an error occurs when executed. the order of the 4 port numbers to be specified is arbitrary.</p>                                                          |

For information on the variable (*Ch*), see Table 7-6, “Variable (Ch),” on page 209.

## Examples

```
SCPI.SENSE(1).CORRection.COLLect.ECAL.SOLT4 = Array(1,2,3,4)
```

```
Dim EcalPort(3) As Variant
EcalPort(0) = 1
EcalPort(1) = 2
EcalPort(2) = 3
EcalPort(3) = 4
SCPI.SENSE(1).CORRection.COLLect.ECAL.SOLT4 = EcalPort
```

Equivalent key **[Cal] - ECal - 4-Port Cal**

## SCPI.SENSE(*Ch*).CORRection.COLLect.ECAL.THru

**Object type** Property

**Syntax** SCPI.SENSE(*Ch*).CORRection.COLLect.ECAL.THru = *Eports*

**Description** Executes response calibration (thru) between the specified 2 ports of channels 1 to 16 (*Ch*) using the ECal (Electronic Calibration) module.

If you execute this object when the ECal module is not connected, an error occurs when executed and the object is ignored. (No read)

**Variable**

|             |                                                                                                                                                                                                                                                                   |
|-------------|-------------------------------------------------------------------------------------------------------------------------------------------------------------------------------------------------------------------------------------------------------------------|
|             | <i>Eports</i>                                                                                                                                                                                                                                                     |
| Description | Indicates 2-element array data (port number). <ul style="list-style-type: none"> <li>• <i>Ports(0)</i> Specifies the response port number.</li> <li>• <i>Ports(1)</i> Specifies the stimulus port number.</li> </ul> <p>The index of the array starts from 0.</p> |
| Data type   | Variant type (Variant)                                                                                                                                                                                                                                            |
| Range       | 1 to 4                                                                                                                                                                                                                                                            |
| Resolution  | 1                                                                                                                                                                                                                                                                 |
| Note        | If the specified variable is out of the allowable setup range, an error occurs when executed. If you specify the same port number to 2 port numbers, an error occurs when executed. the order of the 2 port numbers to be specified is arbitrary.                 |

For information on the variable (*Ch*), see Table 7-6, “Variable (Ch),” on page 209.

**Examples** SCPI.SENSE(1).CORRection.COLLect.ECAL.THru = Array(1,2)

```
Dim EcalPort(1) As Variant
EcalPort(0) = 1
EcalPort(1) = 2
SCPI.SENSE(1).CORRection.COLLect.ECAL.THru = EcalPort
```

**Equivalent key** **[Cal] - ECal - Thru Cal - 2-1 (S21)|3-1 (S31)|4-1 (S41)|1-2 (S12)|3-2 (S32)| 4-2 (S42)| 1-3 (S13)|2-3 (S23)|4-3 (S43)|1-4 (S14)|2-4 (S24)|3-4 (S34)**

## SCPI.SENSE(*Ch*).CORRection.COLLect.ECAL.UCHar

|             |                                                                                                                                                                                                                                                                                                                                                                                                                                                                                                             |
|-------------|-------------------------------------------------------------------------------------------------------------------------------------------------------------------------------------------------------------------------------------------------------------------------------------------------------------------------------------------------------------------------------------------------------------------------------------------------------------------------------------------------------------|
| Object type | Property                                                                                                                                                                                                                                                                                                                                                                                                                                                                                                    |
| Syntax      | SCPI.SENSE( <i>Ch</i> ).CORRection.COLLect.ECAL.UCHar = <i>Param</i>                                                                                                                                                                                                                                                                                                                                                                                                                                        |
| Description | <p>For channels 1 to 16 (<i>Ch</i>), selects the ECal characteristic used when executing the user-defined ECal.</p> <p>The user-defined ECal is a type of ECal that is executed using the characteristic that has been acquired by the user and stored in the memory for ECal. For more information, refer to <i>User's Guide</i>.</p> <p>When the ECal module is not connected or the characteristic is not stored at the specified location number, executing this object will cause a runtime error.</p> |

---

**NOTE** This function is available with the firmware version 3.50 or greater.

### Variable

|              |                                                                                                                                                                                                                                                                                                                                                                                                                                                                                                                                                                                                                                                                                                                                                         |
|--------------|---------------------------------------------------------------------------------------------------------------------------------------------------------------------------------------------------------------------------------------------------------------------------------------------------------------------------------------------------------------------------------------------------------------------------------------------------------------------------------------------------------------------------------------------------------------------------------------------------------------------------------------------------------------------------------------------------------------------------------------------------------|
|              | <i>Param</i>                                                                                                                                                                                                                                                                                                                                                                                                                                                                                                                                                                                                                                                                                                                                            |
| Description  | Characteristic used when executing ECal (user characterization)                                                                                                                                                                                                                                                                                                                                                                                                                                                                                                                                                                                                                                                                                         |
| Data type    | Character string type (String)                                                                                                                                                                                                                                                                                                                                                                                                                                                                                                                                                                                                                                                                                                                          |
| Range        | <p>Select from the following.</p> <ul style="list-style-type: none"> <li>•"CHAR0"                Uses the factory-default characteristic. (Normal ECal)</li> <li>•"CHAR1"                Uses the characteristic stored at location number 1 in the ECal's flash memory.</li> <li>•"CHAR2"                Uses the characteristic stored at location number 2 in the ECal's flash memory.</li> <li>•"CHAR3"                Uses the characteristic stored at location number 3 in the ECal's flash memory.</li> <li>•"CHAR4"                Uses the characteristic stored at location number 4 in the ECal's flash memory.</li> <li>•"CHAR5"                Uses the characteristic stored at location number 5 in the ECal's flash memory.</li> </ul> |
| Preset value | "CHAR0"                                                                                                                                                                                                                                                                                                                                                                                                                                                                                                                                                                                                                                                                                                                                                 |

For information on the variable (*Ch*), refer to Table 7-6, "Variable (Ch)," on page 209.

**Examples**

```
Dim UserChar As String
SCPI.SENSE(1).CORRection.COLLect.ECAL.UCHar = "CHAR2"
UserChar = SCPI.SENSE(1).CORRection.COLLect.ECAL.UCHar
```

**Equivalent key**     **[Ca] - ECal - Characterization - Factory|User1|User2|User3|User4|User5**



## **SCPI.SENSE(*Ch*).CORRection.COLLect.ECAL.UTHRu.STATe**

|             |                                                                                                                                                       |
|-------------|-------------------------------------------------------------------------------------------------------------------------------------------------------|
| Object type | Property                                                                                                                                              |
| Syntax      | SCPI.SENSE( <i>Ch</i> ).CORRection.COLLect.ECAL.UTHRu.STATe = <i>Status</i><br><i>Status</i> = SCPI.SENSE( <i>Ch</i> ).CORRection.COLLect.UTHRu.STATe |
| Description | For channels 1 to 16 ( <i>Ch</i> ), turns ON/OFF the unknown thru calibration when executing Ecal (Electronic Calibration).                           |
| Variable    |                                                                                                                                                       |

|              |                                                                                                                                                                                                                                             |
|--------------|---------------------------------------------------------------------------------------------------------------------------------------------------------------------------------------------------------------------------------------------|
|              | <i>Status</i>                                                                                                                                                                                                                               |
| Description  | ON/OFF of the unknown thru calibration when executing ECal                                                                                                                                                                                  |
| Data type    | Boolean type (Boolean)                                                                                                                                                                                                                      |
| Range        | Select from the following.<br><ul style="list-style-type: none"> <li>• True or -1                      Turns ON the unknown thru calibration.</li> <li>• False or 0                      Turns OFF the unknown thru calibration.</li> </ul> |
| Preset value | False or 0                                                                                                                                                                                                                                  |

For information on the variable (*Ch*), see Table 7-6, “Variable (Ch),” on page 209.

|          |                                                                                                                                                     |
|----------|-----------------------------------------------------------------------------------------------------------------------------------------------------|
| Examples | Dim EcalUthr As Boolean<br>SCPI.SENSE(1).CORRection.COLLect.ECAL.UTHRu.STATe = True<br>EcalUthr = SCPI.SENSE(1).CORRection.COLLect.ECAL.UTHRu.STATe |
|----------|-----------------------------------------------------------------------------------------------------------------------------------------------------|

|                |                                    |
|----------------|------------------------------------|
| Equivalent key | <b>[Cal] - ECal - Unknown Thru</b> |
|----------------|------------------------------------|

**SCPI.SENSE(*Ch*).CORRection.COLLect.METHod.ADAPter.REMOval**

|             |                                                                                              |
|-------------|----------------------------------------------------------------------------------------------|
| Object type | Property                                                                                     |
| Syntax      | SCPI.SENSE( <i>Ch</i> ).CORRection.COLLect.METHod.ADAPter.REMOval = <i>Port</i>              |
| Description | For channel 1 to 16 ( <i>Ch</i> ), sets the specified port of the adapter removal. (No read) |
| Variable    |                                                                                              |

|             | <i>Port</i>                                             |
|-------------|---------------------------------------------------------|
| Description | Port number                                             |
| Data type   | Long integer type (Long)                                |
| Range       | 1 to 4                                                  |
| Resolution  | 1                                                       |
| Note        | You need to execute full n-port calibration in advance. |

For information on the variable (*Ch*), refer to Table 7-6, “Variable (Ch),” on page 209.

|                 |                                                                                    |
|-----------------|------------------------------------------------------------------------------------|
| Examples        | Dim AdapRem As Long<br>SCPI.SENSE(1).CORRection.COLLect.METHod.ADAPter.REMOval = 2 |
| Related objects | SCPI.SENSE(Ch).CORRection.COLLect.ADAPter(Pt).LENGth on page 488                   |
| Equivalent key  | <b>[Cal] - Calibrate - Adapter Removal - Select Port</b>                           |

## **SCPI.SENSE(*Ch*).CORRection.COLLect.METHod.ERESponse**

|             |                                                                                                                                         |
|-------------|-----------------------------------------------------------------------------------------------------------------------------------------|
| Object type | Property                                                                                                                                |
| Syntax      | SCPI.SENSE( <i>Ch</i> ).CORRection.COLLect.METHod.ERESponse = <i>Ports</i>                                                              |
| Description | For channel 1 to channel 16 , sets the calibration type to the enhanced response calibration between the two specified ports. (No read) |
| Variable    |                                                                                                                                         |

|             | <i>Ports</i>                                                                                                                                                                                                                                                                              |
|-------------|-------------------------------------------------------------------------------------------------------------------------------------------------------------------------------------------------------------------------------------------------------------------------------------------|
| Description | Indicates 2-element array data (port number).<br><ul style="list-style-type: none"> <li>• <i>Ports(0)</i>                      Specifies the response port.</li> <li>• <i>Ports(1)</i>                      Specifies the stimulus port.</li> </ul> The index of the array starts from 0. |
| Data type   | Variant type (Variant)                                                                                                                                                                                                                                                                    |
| Range       | 1 to 4                                                                                                                                                                                                                                                                                    |
| Resolution  | 1                                                                                                                                                                                                                                                                                         |
| Note        | For each parameter, you must specify a different port number. If you specify the same port number for 2 or more parameters, an error occurs and the command is ignored.                                                                                                                   |

For information on the variable (*Ch*), see Table 7-6, “Variable (Ch),” on page 209.

|                 |                                                                                                                                    |
|-----------------|------------------------------------------------------------------------------------------------------------------------------------|
| Examples        | <pre>Dim ERESport(1) As Variant ERESport(0) = 1 ERESport(1) = 2 SCPI.SENSE(1).CORRection.COLLect.METHod.ERESponse = ERESport</pre> |
| Related objects | SCPI.SENSE( <i>Ch</i> ).CORRection.COLLect.METHod.TYPE on page 544                                                                 |
| Equivalent key  | <b>[Cal] - Calibrate - Enhanced Response - Select Ports - 2-1 (S21 S11) 3-1 (S31 S11) ... 3-4 (S34 S44)</b>                        |

**SCPI.SENSE(*Ch*).CORRection.COLLect.METHod.  
RESPonse.OPEN**

|                 |                                                                                                                                                                                           |
|-----------------|-------------------------------------------------------------------------------------------------------------------------------------------------------------------------------------------|
| Object type     | Property                                                                                                                                                                                  |
| Syntax          | SCPI.SENSE( <i>Ch</i> ).CORRection.COLLect.METHod.RESPonse.OPEN = <i>Port</i>                                                                                                             |
| Description     | For channels 1 to 16 ( <i>Ch</i> ), sets the calibration type to the response calibration (open) of the specified port. (No read)                                                         |
| Variable        | For information on the variable ( <i>Ch</i> ) and the variable ( <i>Port</i> ), see Table 7-6, “Variable (Ch),” on page 209 and Table 7-16, “Variable (Port),” on page 481, respectively. |
| Examples        | SCPI.SENSE(1).CORRection.COLLect.METHod.RESPonse.OPEN = 1                                                                                                                                 |
| Related objects | SCPI.SENSE(Ch).CORRection.COLLect.METHod.TYPE on page 544                                                                                                                                 |
| Equivalent key  | <b>[Cal] - Calibrate - Response (Open) - Select Port</b>                                                                                                                                  |

**SCPI.SENSE(*Ch*).CORRection.COLLect.METHod.  
RESPonse.SHORT**

|                 |                                                                                                                                                                                           |
|-----------------|-------------------------------------------------------------------------------------------------------------------------------------------------------------------------------------------|
| Object type     | Property                                                                                                                                                                                  |
| Syntax          | SCPI.SENSE( <i>Ch</i> ).CORRection.COLLect.METHod.RESPonse.SHORT = <i>Port</i>                                                                                                            |
| Description     | For channels 1 to 16 ( <i>Ch</i> ), sets the calibration type to the response calibration (short) of the specified port. (No read)                                                        |
| Variable        | For information on the variable ( <i>Ch</i> ) and the variable ( <i>Port</i> ), see Table 7-6, “Variable (Ch),” on page 209 and Table 7-16, “Variable (Port),” on page 481, respectively. |
| Examples        | SCPI.SENSE(1).CORRection.COLLect.METHod.RESPonse.SHORT = 1                                                                                                                                |
| Related objects | SCPI.SENSE(Ch).CORRection.COLLect.METHod.TYPE on page 544                                                                                                                                 |
| Equivalent key  | <b>[Cal] - Calibrate - Response (Short) - Select Port</b>                                                                                                                                 |

## SCPI.SENSE(*Ch*).CORREction.COLLECT.METHOD. RESPONSE.THRU

|                 |                                                                                                                                                                                                                                     |
|-----------------|-------------------------------------------------------------------------------------------------------------------------------------------------------------------------------------------------------------------------------------|
| Object type     | Property                                                                                                                                                                                                                            |
| Syntax          | SCPI.SENSE( <i>Ch</i> ).CORREction.COLLECT.METHOD.RESPONSE.THRU = <i>Ports</i>                                                                                                                                                      |
| Description     | For channels 1 to 16 ( <i>Ch</i> ), sets the calibration type to the response calibration (thru) between the specified 2 ports. (No read)                                                                                           |
| Variable        | For information on the variable ( <i>Ch</i> ) and the variable ( <i>Ports</i> ), see Table 7-6, “Variable ( <i>Ch</i> ),” on page 209 and Table 7-15, “Variable ( <i>Ports</i> ),” on page 480, respectively.                       |
| Examples        | <pre>SCPI.SENSE(1).CORREction.COLLECT.METHOD.RESPONSE.THRU = Array(2,1)</pre><br><pre>Dim ThruPort(1) As Variant<br/>ThruPort(0) = 2<br/>ThruPort(1) = 1<br/>SCPI.SENSE(1).CORREction.COLLECT.METHOD.RESPONSE.THRU = ThruPort</pre> |
| Related objects | SCPI.SENSE( <i>Ch</i> ).CORREction.COLLECT.METHOD.TYPE on page 544                                                                                                                                                                  |
| Equivalent key  | <b>[Cal] - Calibrate - Response (Thru) - Select Ports</b>                                                                                                                                                                           |

## SCPI.SENSE(*Ch*).CORREction.COLLECT.METHOD. SOLT1

|                 |                                                                                                                                                                                                             |
|-----------------|-------------------------------------------------------------------------------------------------------------------------------------------------------------------------------------------------------------|
| Object type     | Property                                                                                                                                                                                                    |
| Syntax          | SCPI.SENSE( <i>Ch</i> ).CORREction.COLLECT.METHOD.SOLT1 = <i>Port</i>                                                                                                                                       |
| Description     | For channels 1 to 16 ( <i>Ch</i> ), sets the calibration type to the 1-port calibration of the specified port. (No read)                                                                                    |
| Variable        | For information on the variable ( <i>Ch</i> ) and the variable ( <i>Port</i> ), see Table 7-6, “Variable ( <i>Ch</i> ),” on page 209 and Table 7-16, “Variable ( <i>Port</i> ),” on page 481, respectively. |
| Examples        | <pre>SCPI.SENSE(1).CORREction.COLLECT.METHOD.SOLT1 = 1</pre>                                                                                                                                                |
| Related objects | SCPI.SENSE( <i>Ch</i> ).CORREction.COLLECT.METHOD.TYPE on page 544                                                                                                                                          |
| Equivalent key  | <b>[Cal] - Calibrate - 1-Port Cal - Select Port</b>                                                                                                                                                         |

## SCPI.SENSE(*Ch*).CORRection.COLLect.METHod. SOLT2

|             |                                                                                                                                       |
|-------------|---------------------------------------------------------------------------------------------------------------------------------------|
| Object type | Property                                                                                                                              |
| Syntax      | SCPI.SENSE( <i>Ch</i> ).CORRection.COLLect.METHod.SOLT2 = <i>Ports</i>                                                                |
| Description | For channels 1 to 16 ( <i>Ch</i> ), sets the calibration type to the full 2-port calibration between the specified 2 ports. (No read) |
| Variable    |                                                                                                                                       |

|             | <i>Ports</i>                                                                                                                                                                                                                                                                                                                        |
|-------------|-------------------------------------------------------------------------------------------------------------------------------------------------------------------------------------------------------------------------------------------------------------------------------------------------------------------------------------|
| Description | Indicates 2-element array data (port number).<br><ul style="list-style-type: none"> <li>• <i>Ports(0)</i>                      Specifies a port for full 2-port calibration.</li> <li>• <i>Ports(1)</i>                      Specifies the other port for full 2-port calibration.</li> </ul> The index of the array starts from 0. |
| Data type   | Variant type (Variant)                                                                                                                                                                                                                                                                                                              |
| Range       | 1 to 4                                                                                                                                                                                                                                                                                                                              |
| Resolution  | 1                                                                                                                                                                                                                                                                                                                                   |
| Note        | If the specified variable is out of the allowable setup range, an error occurs when executed. If you specify the same port number to 2 port numbers, an error occurs when executed. The order of the 2 port numbers to be specified is arbitrary.                                                                                   |

For information on the variable (*Ch*), see Table 7-6, “Variable (Ch),” on page 209.

**Examples**                      SCPI.SENSE(1).CORRection.COLLect.METHod.SOLT2 = Array(1,2)

```
Dim CalPort(1) As Variant
CalPort(0) = 1
CalPort(1) = 2
SCPI.SENSE(1).CORRection.COLLect.METHod.SOLT2 = CalPort
```

**Related objects**            SCPI.SENSE(Ch).CORRection.COLLect.METHod.TYPE on page 544

**Equivalent key**            **[Cal] - Calibrate - 2-Port Cal - Select Ports**

## SCPI.SENSE(*Ch*).CORRection.COLLEct.METHod. SOLT3

|             |                                                                                                                                       |
|-------------|---------------------------------------------------------------------------------------------------------------------------------------|
| Object type | Property                                                                                                                              |
| Syntax      | SCPI.SENSE( <i>Ch</i> ).CORRection.COLLEct.METHod.SOLT3 = <i>Ports</i>                                                                |
| Description | For channels 1 to 16 ( <i>Ch</i> ), sets the calibration type to the full 3-port calibration between the specified 3 ports. (No read) |
| Variable    |                                                                                                                                       |

|             | <i>Ports</i>                                                                                                                                                                                                                                                                                                                                                                                                           |
|-------------|------------------------------------------------------------------------------------------------------------------------------------------------------------------------------------------------------------------------------------------------------------------------------------------------------------------------------------------------------------------------------------------------------------------------|
| Description | Indicates 3-element array data (port number). <ul style="list-style-type: none"> <li>• <i>Ports(0)</i>                      Specifies a port for full 3-port calibration.</li> <li>• <i>Ports(1)</i>                      Specifies a port for full 3-port calibration.</li> <li>• <i>Ports(2)</i>                      Specifies a port for full 3-port calibration.</li> </ul> The index of the array starts from 0. |
| Data type   | Variant type (Variant)                                                                                                                                                                                                                                                                                                                                                                                                 |
| Range       | 1 to 4                                                                                                                                                                                                                                                                                                                                                                                                                 |
| Resolution  | 1                                                                                                                                                                                                                                                                                                                                                                                                                      |
| Note        | If the specified variable is out of the allowable setup range, an error occurs when executed. If you specify the same port number to 2 or more port numbers, an error occurs when executed. The order of the 3 port numbers to be specified is arbitrary.                                                                                                                                                              |

For information on the variable (*Ch*), see Table 7-6, “Variable (Ch),” on page 209.

**Examples**                      SCPI.SENSE(1).CORRection.COLLEct.METHod.SOLT3 = Array(1,2,3)

```
Dim CalPort(2) As Variant
CalPort(0) = 1
CalPort(1) = 2
CalPort(2) = 3
SCPI.SENSE(1).CORRection.COLLEct.METHod.SOLT3 = CalPort
```

**Related objects**            SCPI.SENSE(Ch).CORRection.COLLEct.METHod.TYPE on page 544

**Equivalent key**            **[Cal] - Calibrate - 3-Port Cal - Select Ports**

**SCPI.SENSE(*Ch*).CORRection.COLLect.METHod. SOLT4**

|             |                                                                                                         |
|-------------|---------------------------------------------------------------------------------------------------------|
| Object type | Property                                                                                                |
| Syntax      | SCPI.SENSE( <i>Ch</i> ).CORRection.COLLect.METHod.SOLT4 = <i>Ports</i>                                  |
| Description | For channels 1 to 16 ( <i>Ch</i> ), sets the calibration type to the full 4-port calibration. (No read) |
| Variable    |                                                                                                         |

|             | <i>Ports</i>                                                                                                                                                                                                                                                                                                                                                                                                                                                                                                                |
|-------------|-----------------------------------------------------------------------------------------------------------------------------------------------------------------------------------------------------------------------------------------------------------------------------------------------------------------------------------------------------------------------------------------------------------------------------------------------------------------------------------------------------------------------------|
| Description | Indicates 4-element array data (port number). <ul style="list-style-type: none"> <li>• <i>Ports(0)</i>                      Specifies a port for full 4-port calibration.</li> <li>• <i>Ports(1)</i>                      Specifies a port for full 4-port calibration.</li> <li>• <i>Ports(2)</i>                      Specifies a port for full 4-port calibration.</li> <li>• <i>Ports(3)</i>                      Specifies a port for full 4-port calibration.</li> </ul> <p>The index of the array starts from 0.</p> |
| Data type   | Variant type (Variant)                                                                                                                                                                                                                                                                                                                                                                                                                                                                                                      |
| Range       | 1 to 4                                                                                                                                                                                                                                                                                                                                                                                                                                                                                                                      |
| Resolution  | 1                                                                                                                                                                                                                                                                                                                                                                                                                                                                                                                           |
| Note        | If the specified variable is out of the allowable setup range, an error occurs when executed. If you specify the same port number to 2 or more port numbers, an error occurs when executed. The order of the 4 port numbers to be specified is arbitrary.                                                                                                                                                                                                                                                                   |

For information on the variable (*Ch*), see Table 7-6, “Variable (Ch),” on page 209.

**Examples**                      SCPI.SENSE(1).CORRection.COLLect.METHod.SOLT4 = Array(1,2,3,4)

```
Dim CalPort(3) As Variant
CalPort(0) = 1
CalPort(1) = 2
CalPort(2) = 3
CalPort(3) = 4
SCPI.SENSE(1).CORRection.COLLect.METHod.SOLT4 = CalPort
```

**Related objects**            SCPI.SENSE(*Ch*).CORRection.COLLect.METHod.TYPE on page 544

**Equivalent key**            **[Cal] - Calibrate - 4-Port Cal**



## SCPI.SENSE(Ch).CORRection.COLLect.METHod.TRL2

|             |                                                                                                                              |
|-------------|------------------------------------------------------------------------------------------------------------------------------|
| Object type | Property                                                                                                                     |
| Syntax      | SCPI.SENSE( <i>Ch</i> ).CORRection.COLLect.METHod.TRL2 = <i>Ports</i>                                                        |
| Description | For channel 1 to 16 ( <i>Ch</i> ), sets the calibration type to the TRL calibration between the 2 specified ports. (No Read) |
| Variable    |                                                                                                                              |

|             | <i>Ports</i>                                                                                                                                                                                                                                                                 |
|-------------|------------------------------------------------------------------------------------------------------------------------------------------------------------------------------------------------------------------------------------------------------------------------------|
| Description | Indicates 2-element array data (port number). <ul style="list-style-type: none"> <li>• <i>Ports(0)</i> Specifies a port for TRL 2-port calibration.</li> <li>• <i>Ports(1)</i> Specifies a port for TRL 2-port calibration.</li> </ul> The index of the array starts from 0. |
| Data type   | Variant type (Variant)                                                                                                                                                                                                                                                       |
| Range       | 1 to 4                                                                                                                                                                                                                                                                       |
| Resolution  | 1                                                                                                                                                                                                                                                                            |
| Note        | If the specified variable is out of the allowable setup range, an error occurs when executed. If you specify the same port number to 2 or more port numbers, an error occurs when executed. The order of the 2 port numbers to be specified is arbitrary.                    |

For information on the variable (*Ch*), see Table 7-6, “Variable (Ch),” on page 209.

**Examples** SCPI.SENSE(1).CORRection.COLLect.METHod.TRL2 = Array(1,2)

```
Dim TrlCalPort(1) As Variant
TrlCalPort(0) = 1
TrlCalPort(1) = 2
SCPI.SENSE(1).CORRection.COLLect.METHod.TRL2 = TrlCalPort
```

- Related objects**
- SCPI.SENSE(Ch).CORRection.COEFFicient.DATA on page 470
  - SCPI.SENSE(Ch).CORRection.COEFFicient.SAVE on page 479
  - SCPI.SENSE(Ch).CORRection.COLLect.METHod.TRL3 on page 542
  - SCPI.SENSE(Ch).CORRection.COLLect.METHod.TRL4 on page 543
  - SCPI.SENSE(Ch).CORRection.COLLect.SAVE on page 546
  - SCPI.SENSE(Ch).CORRection.TYPE(Tr) on page 585

**Equivalent key** **[Cal] - Calibrate - 2-Port TRL Cal - Select Ports - 1-2|1-3\*1|1-4\*2|2-3\*1|2-4\*2|3-4\*2**

\*1. Only with Options 313, 314, 413, and 414.  
 \*2. Only with Options 413 and 414.

## SCPI.SENSE(*Ch*).CORRection.COLLect.METHod.TRL3

|             |                                                                                                                              |
|-------------|------------------------------------------------------------------------------------------------------------------------------|
| Object type | Property                                                                                                                     |
| Syntax      | SCPI.SENSE( <i>Ch</i> ).CORRection.COLLect.METHod.TRL3 = <i>Ports</i>                                                        |
| Description | For channel 1 to 16 ( <i>Ch</i> ), sets the calibration type to the TRL calibration between the 3 specified ports. (No Read) |
| Variable    |                                                                                                                              |

|             | <i>Ports</i>                                                                                                                                                                                                                                                                                                                                                                                                        |
|-------------|---------------------------------------------------------------------------------------------------------------------------------------------------------------------------------------------------------------------------------------------------------------------------------------------------------------------------------------------------------------------------------------------------------------------|
| Description | Indicates 3-element array data (port number). <ul style="list-style-type: none"> <li>• <i>Ports(0)</i>                      Specifies a port for TRL 3-port calibration.</li> <li>• <i>Ports(1)</i>                      Specifies a port for TRL 3-port calibration.</li> <li>• <i>Ports(2)</i>                      Specifies a port for TRL 3-port calibration.</li> </ul> The index of the array starts from 0. |
| Data type   | Variant type (Variant)                                                                                                                                                                                                                                                                                                                                                                                              |
| Range       | 1 to 4                                                                                                                                                                                                                                                                                                                                                                                                              |
| Resolution  | 1                                                                                                                                                                                                                                                                                                                                                                                                                   |
| Note        | If the specified variable is out of the allowable setup range, an error occurs when executed. If you specify the same port number to 2 or more port numbers, an error occurs when executed. The order of the 3 port numbers to be specified is arbitrary.                                                                                                                                                           |

For information on the variable (*Ch*), see Table 7-6, “Variable (Ch),” on page 209.

**Examples**                      SCPI.SENSE(1).CORRection.COLLect.METHod.TRL3 = Array(1,2,3)

```
Dim TrlCalPort(2) As Variant
TrlCalPort(0) = 1
TrlCalPort(1) = 2
TrlCalPort(2) = 3
SCPI.SENSE(1).CORRection.COLLect.METHod.TRL3 = TrlCalPort
```

**Related objects**

- SCPI.SENSE(Ch).CORRection.COEFFicient.DATA on page 470
- SCPI.SENSE(Ch).CORRection.COEFFicient.SAVE on page 479
- SCPI.SENSE(Ch).CORRection.COLLect.METHod.TRL2 on page 541
- SCPI.SENSE(Ch).CORRection.COLLect.METHod.TRL4 on page 543
- SCPI.SENSE(Ch).CORRection.COLLect.SAVE on page 546
- SCPI.SENSE(Ch).CORRection.TYPE(Tr) on page 585

**Equivalent key**                      **[Cal]** - Calibrate - 3-Port TRL Cal\*1 - Select Ports - 1-2-3|1-2-4\*2|1-3-4\*2|2-3-4\*2

\*1. Only with Options 313, 314, 413, and 414.  
 \*2. Only with Options 413 and 414.

## SCPI.SENSE(*Ch*).CORRection.COLLECT.METHod.TRL4

|             |                                                                                                                              |
|-------------|------------------------------------------------------------------------------------------------------------------------------|
| Object type | Property                                                                                                                     |
| Syntax      | SCPI.SENSE( <i>Ch</i> ).CCORRection.COLLECT.METHod.TRL4 = <i>Ports</i>                                                       |
| Description | For channel 1 to 16 ( <i>Ch</i> ), sets the calibration type to the TRL calibration between the 4 specified ports. (No Read) |
| Variable    |                                                                                                                              |

|             | <i>Ports</i>                                                                                                                                                                                                                                                                                                                                                                                                                                                                                                     |
|-------------|------------------------------------------------------------------------------------------------------------------------------------------------------------------------------------------------------------------------------------------------------------------------------------------------------------------------------------------------------------------------------------------------------------------------------------------------------------------------------------------------------------------|
| Description | Indicates 4-element array data (port number). <ul style="list-style-type: none"> <li>• <i>Ports(0)</i>                      Specifies a port for TRL 4-port calibration.</li> <li>• <i>Ports(1)</i>                      Specifies a port for TRL 4-port calibration.</li> <li>• <i>Ports(2)</i>                      Specifies a port for TRL 4-port calibration.</li> <li>• <i>Ports(3)</i>                      Specifies a port for TRL 4-port calibration.</li> </ul> The index of the array starts from 0. |
| Data type   | Variant type (Variant)                                                                                                                                                                                                                                                                                                                                                                                                                                                                                           |
| Range       | 1 to 4                                                                                                                                                                                                                                                                                                                                                                                                                                                                                                           |
| Resolution  | 1                                                                                                                                                                                                                                                                                                                                                                                                                                                                                                                |
| Note        | If the specified variable is out of the allowable setup range, an error occurs when executed. If you specify the same port number to 2 or more port numbers, an error occurs when executed. The order of the 4 port numbers to be specified is arbitrary.                                                                                                                                                                                                                                                        |

For information on the variable (*Ch*), see Table 7-6, “Variable (Ch),” on page 209.

**Examples**                      SCPI.SENSE(1).CORRection.COLLECT.METHod.TRL4 = Array(1,2,3,4)

```
Dim TrlCalPort(3) As Variant
TrlCalPort(0) = 1
TrlCalPort(1) = 2
TrlCalPort(2) = 3
TrlCalPort(3) = 4
SCPI.SENSE(1).CORRection.COLLECT.METHod.TRL4 = TrlCalPort
```

- Related objects**
- SCPI.SENSE(Ch).CORRection.COEFFicient.DATA on page 470
  - SCPI.SENSE(Ch).CORRection.COEFFicient.SAVE on page 479
  - SCPI.SENSE(Ch).CORRection.COLLECT.METHod.TRL2 on page 541
  - SCPI.SENSE(Ch).CORRection.COLLECT.METHod.TRL3 on page 542
  - SCPI.SENSE(Ch).CORRection.COLLECT.SAVE on page 546
  - SCPI.SENSE(Ch).CORRection.TYPE(Tr) on page 585

**Equivalent key**                      **[Cal] - Calibrate - 4-Port TRL Cal**<sup>\*1</sup>

## SCPI.SENSE(*Ch*).CORREction.COLLECT.METHOD.TYPE

|             |                                                                                        |
|-------------|----------------------------------------------------------------------------------------|
| Object type | Property                                                                               |
| Syntax      | <i>Param</i> = SCPI.SENSE( <i>Ch</i> ).CORREction.COLLECT.METHOD.TYPE                  |
| Description | Reads out the selected calibration type of channels 1 to 16 ( <i>Ch</i> ). (Read only) |

**NOTE** This object is used to check the selected calibration type for calculating the calibration coefficients. To check the applied calibration type (error correction on), use the SCPI.SENSE(Ch).CORREction.TYPE(Tr) object.

Variable

|             |                                                                                                                                                                                                                                                                                                                                                                                                                                                                                                                                                                                                                                                                                                                                                                                                                                                                                                                                                                                                                                                                                                                                                                   |
|-------------|-------------------------------------------------------------------------------------------------------------------------------------------------------------------------------------------------------------------------------------------------------------------------------------------------------------------------------------------------------------------------------------------------------------------------------------------------------------------------------------------------------------------------------------------------------------------------------------------------------------------------------------------------------------------------------------------------------------------------------------------------------------------------------------------------------------------------------------------------------------------------------------------------------------------------------------------------------------------------------------------------------------------------------------------------------------------------------------------------------------------------------------------------------------------|
|             | <i>Param</i>                                                                                                                                                                                                                                                                                                                                                                                                                                                                                                                                                                                                                                                                                                                                                                                                                                                                                                                                                                                                                                                                                                                                                      |
| Description | Calibration type                                                                                                                                                                                                                                                                                                                                                                                                                                                                                                                                                                                                                                                                                                                                                                                                                                                                                                                                                                                                                                                                                                                                                  |
| Data type   | Character string type (String)                                                                                                                                                                                                                                                                                                                                                                                                                                                                                                                                                                                                                                                                                                                                                                                                                                                                                                                                                                                                                                                                                                                                    |
| Range       | Select from the following.<br><ul style="list-style-type: none"> <li>•"ERES"                   The calibration type is the enhanced response calibration.</li> <li>•"NONE"                   The calibration type is set to nothing.</li> <li>•"RESPO"                  The calibration type is the response calibration (open).</li> <li>•"RESPS"                  The calibration type is the response calibration (short).</li> <li>•"RESPT"                  The calibration type is the response calibration (thru).</li> <li>•"SOLT1"                  The calibration type is the 1-port calibration.</li> <li>•"SOLT2"                  The calibration type is the full 2-port calibration.</li> <li>•"SOLT3"                  The calibration type is the full 3-port calibration.</li> <li>•"SOLT4"                  The calibration type is the full 4-port calibration.</li> <li>•"TRL2"                  The calibration type is the TRL 2-port calibration.</li> <li>•"TRL3"                  The calibration type is the TRL 3-port calibration.</li> <li>•"TRL4"                  The calibration type is the TRL 4-port calibration.</li> </ul> |

For information on the variable (*Ch*), see Table 7-6, "Variable (Ch)," on page 209.

**Examples**                   Dim CalType As String  
                               CalType = SCPI.SENSE(1).CORREction.COLLECT.METHOD.TYPE

**Related objects**        SCPI.SENSE(Ch).CORREction.COLLECT.SAVE on page 546  
                               SCPI.SENSE(Ch).CORREction.TYPE(Tr) on page 585

**Equivalent key**        No equivalent key is available on the front panel.

\*1. Only with Options 413 and 414.

## SCPI.SENSE(*Ch*).CORRection.COLLEct.PARTial.SAVE

|                |                                                                                                                                                                                                                                                                                                                                                                                                                                                                                        |
|----------------|----------------------------------------------------------------------------------------------------------------------------------------------------------------------------------------------------------------------------------------------------------------------------------------------------------------------------------------------------------------------------------------------------------------------------------------------------------------------------------------|
| Object type    | Method                                                                                                                                                                                                                                                                                                                                                                                                                                                                                 |
| Syntax         | SCPI.SENSE( <i>Ch</i> ).CORRection.COLLEct.PARTial.SAVE                                                                                                                                                                                                                                                                                                                                                                                                                                |
| Description    | <p>Used for partial overwrite. From the measured calibration data, recalculates the calibration coefficients depending on the selected calibration type.</p> <p>Calculating the calibration coefficients clears all calibration data regardless of whether they are used for the calculation and also clears the calibration type selections.</p> <p>If you execute partial overwrite before selecting the calibration type, an error occurs and the command is ignored. (No read)</p> |
| Variable       | For information on the variable ( <i>Ch</i> ), see Table 7-6, “Variable (Ch),” on page 209.                                                                                                                                                                                                                                                                                                                                                                                            |
| Examples       | SCPI.SENSE(1).CORRection.COLLEct.PARTial.SAVE                                                                                                                                                                                                                                                                                                                                                                                                                                          |
| Equivalent key | <b>[Cal] - Calibrate - n-Port Cal - Overwrite</b>                                                                                                                                                                                                                                                                                                                                                                                                                                      |

## **SCPI.SENSE(*Ch*).CORRection.COLLect.SAVE**

|                 |                                                                                                                                                                                                                                                                                                                                                                                                                                                                                                                                                                                                                                                                                                           |
|-----------------|-----------------------------------------------------------------------------------------------------------------------------------------------------------------------------------------------------------------------------------------------------------------------------------------------------------------------------------------------------------------------------------------------------------------------------------------------------------------------------------------------------------------------------------------------------------------------------------------------------------------------------------------------------------------------------------------------------------|
| Object type     | Method                                                                                                                                                                                                                                                                                                                                                                                                                                                                                                                                                                                                                                                                                                    |
| Syntax          | SCPI.SENSE( <i>Ch</i> ).CORRection.COLLect.SAVE                                                                                                                                                                                                                                                                                                                                                                                                                                                                                                                                                                                                                                                           |
| Description     | <p>From the measured calibration data, calculates the calibration coefficients depending on the calibration type selection.</p> <p>Calculating the calibration coefficients clears all the measured calibration data whether or not used for the calculation and also clears the calibration type selection.</p> <p>If you execute this object before all necessary calibration data for calculating the calibration coefficients is measured, an error occurs when executed. (No read)</p>                                                                                                                                                                                                               |
| Variable        | For information on the variable ( <i>Ch</i> ), see Table 7-6, “Variable (Ch),” on page 209.                                                                                                                                                                                                                                                                                                                                                                                                                                                                                                                                                                                                               |
| Examples        | <pre>Dim Dmy As Long SCPI.SENSE(1).CORRection.COLLect.METHod.RESPonse.THru = Array(2,1) SCPI.SENSE(1).CORRection.COLLect.ACQuire.THru = Array(2,1) Dmy = SCPI.IEEE4882.OPC SCPI.SENSE(1).CORRection.COLLect.SAVE</pre>                                                                                                                                                                                                                                                                                                                                                                                                                                                                                    |
| Related objects | <p>SCPI.SENSE(Ch).CORRection.COLLect.METHod.RESPonse.OPEN on page 536</p> <p>SCPI.SENSE(Ch).CORRection.COLLect.METHod.RESPonse.SHORt on page 536</p> <p>SCPI.SENSE(Ch).CORRection.COLLect.METHod.RESPonse.THru on page 537</p> <p>SCPI.SENSE(Ch).CORRection.COLLect.METHod.SOLT1 on page 537</p> <p>SCPI.SENSE(Ch).CORRection.COLLect.METHod.SOLT2 on page 538</p> <p>SCPI.SENSE(Ch).CORRection.COLLect.METHod.SOLT3 on page 539</p> <p>SCPI.SENSE(Ch).CORRection.COLLect.METHod.SOLT4 on page 540</p> <p>SCPI.SENSE(Ch).CORRection.COLLect.METHod.TRL2 on page 541</p> <p>SCPI.SENSE(Ch).CORRection.COLLect.METHod.TRL3 on page 542</p> <p>SCPI.SENSE(Ch).CORRection.COLLect.METHod.TRL4 on page 543</p> |
| Equivalent key  | <b>[Cal] - Calibrate - ResponseIn-Port Cal - Done</b>                                                                                                                                                                                                                                                                                                                                                                                                                                                                                                                                                                                                                                                     |

## SCPI.SENSE(*Ch*).CORRection.COLLEct.SIMPLified.SAVE

|                 |                                                                                                                                                                                                                                                                                                                                                                                                                                                                                                                                                                                                                                                                                                                                                                                                                                |
|-----------------|--------------------------------------------------------------------------------------------------------------------------------------------------------------------------------------------------------------------------------------------------------------------------------------------------------------------------------------------------------------------------------------------------------------------------------------------------------------------------------------------------------------------------------------------------------------------------------------------------------------------------------------------------------------------------------------------------------------------------------------------------------------------------------------------------------------------------------|
| Object type     | Method                                                                                                                                                                                                                                                                                                                                                                                                                                                                                                                                                                                                                                                                                                                                                                                                                         |
| Syntax          | SCPI.SENSE( <i>Ch</i> ).CORRection.COLLEct.SIMPLified.SAVE                                                                                                                                                                                                                                                                                                                                                                                                                                                                                                                                                                                                                                                                                                                                                                     |
| Description     | <p>When the full 3/4 port calibration is selected as the calibration type, calculates the calibration coefficients for the simple full 3 port calibration or the simple full 4 port calibration from the measured calibration data.</p> <p>If the response calibration or the 1/2 port calibration is selected as the calibration type, this object provides the same function as the SCPI.SENSE(<i>Ch</i>).CORRection.COLLEct.SAVE object.</p> <p>After the calibration coefficients are calculated, the measured data and the calibration type setting are cleared.</p> <p>If you execute this object before all the necessary calibration data for calculating the calibration coefficients for the simple full 3 port calibration or the simple full 4 port calibration is measured, a runtime error occurs. (No read)</p> |
| <hr/>           |                                                                                                                                                                                                                                                                                                                                                                                                                                                                                                                                                                                                                                                                                                                                                                                                                                |
| <b>NOTE</b>     | This function is available with the firmware version 3.50 or greater.                                                                                                                                                                                                                                                                                                                                                                                                                                                                                                                                                                                                                                                                                                                                                          |
| Variable        | For information on the variable ( <i>Ch</i> ), refer to Table 7-6, “Variable (Ch),” on page 209.                                                                                                                                                                                                                                                                                                                                                                                                                                                                                                                                                                                                                                                                                                                               |
| Examples        | <pre>SCPI.SENSE(1).CORRection.COLLEct.METHod.SOLT3 = Array(1,2,3) SCPI.SENSE(1).CORRection.COLLEct.SIMPLified.SAVE</pre>                                                                                                                                                                                                                                                                                                                                                                                                                                                                                                                                                                                                                                                                                                       |
| Related objects | <p>SCPI.SENSE(<i>Ch</i>).CORRection.COLLEct.METHod. SOLT3 on page 539</p> <p>SCPI.SENSE(<i>Ch</i>).CORRection.COLLEct.METHod. SOLT4 on page 540</p> <p>SCPI.SENSE(<i>Ch</i>).CORRection.COLLEct.METHod.TRL3 on page 542</p> <p>SCPI.SENSE(<i>Ch</i>).CORRection.COLLEct.METHod.TRL4 on page 543</p> <p>SCPI.SENSE(<i>Ch</i>).CORRection.COLLEct.SAVE on page 546</p>                                                                                                                                                                                                                                                                                                                                                                                                                                                           |
| Equivalent key  | <b>[Cal] - Calibrate - n-Port Cal n-Port TRL - Done</b>                                                                                                                                                                                                                                                                                                                                                                                                                                                                                                                                                                                                                                                                                                                                                                        |

## SCPI.SENSE(*Ch*).CORRection.EXTEnsion.AUTO.CONFIg

Object type      Method

Syntax            SCPI.SENSE(*Ch*).CORRection.EXTEnsion.AUTO.CONFIg = *Param*  
*Param* = SCPI.SENSE(*Ch*).CORRection.EXTEnsion.AUTO.CONFIg

Description      For channel 1 to 16 (*Ch*), sets the frequency point to calculate the loss value of the auto port extension.

### Variable

|              | <i>Param</i>                                                                                                                                                                                                                                                                                                                                                                                                       |
|--------------|--------------------------------------------------------------------------------------------------------------------------------------------------------------------------------------------------------------------------------------------------------------------------------------------------------------------------------------------------------------------------------------------------------------------|
| Description  | The frequency point to calculate the loss value of the auto port extension                                                                                                                                                                                                                                                                                                                                         |
| Data type    | Character string type (String)                                                                                                                                                                                                                                                                                                                                                                                     |
| Range        | Select from the following.<br><ul style="list-style-type: none"> <li>•"CSPN"                      Uses the frequency of the current sweep range.</li> <li>•"AMKR"                     Use the frequency of the active marker.*1 This is applied to Loss 1 and Loss 2 is ignored.</li> <li>•"USPN"                     This is executed with the arbitrary specified start frequency and stop frequency.</li> </ul> |
| Preset value | "CSPN"                                                                                                                                                                                                                                                                                                                                                                                                             |

\*1. Even if active marker is set to OFF, it turns on automatically.

For information on the variable (*Ch*), refer to Table 7-6, "Variable (*Ch*)," on page 209.

Examples            

```
Dim Conf As String
SCPI.SENSE(1).CORRection.EXTEnsion.AUTO.CONFIg = "AMKR"
Conf = SCPI.SENSE(1).CORRection.EXTEnsion.AUTO.CONFIg
```

Related objects    SCPI.SENSE(*Ch*).CORRection.EXTEnsion.STATe on page 564  
SCPI.SENSE(*Ch*).CORRection.EXTEnsion.AUTO.DCOFFset on page 549  
SCPI.SENSE(*Ch*).CORRection.EXTEnsion.AUTO.LOSS on page 550  
SCPI.SENSE(*Ch*).CORRection.EXTEnsion.AUTO.MEASure on page 551  
SCPI.SENSE(*Ch*).CORRection.EXTEnsion.AUTO.PORT(*Pt*) on page 552  
SCPI.SENSE(*Ch*).CORRection.EXTEnsion.AUTO.RESet on page 553  
SCPI.SENSE(*Ch*).CORRection.EXTEnsion.AUTO.STARt on page 554  
SCPI.SENSE(*Ch*).CORRection.EXTEnsion.AUTO.STOP on page 555

Equivalent key    **[Ca] - Port Extensions - Auto Port Extension - Method - Current Span|Active Marker|User Span**



**SCPI.SENSE(Ch).CORRection.EXTension.AUTO.DCOffset**

|             |                                                                                                                                        |
|-------------|----------------------------------------------------------------------------------------------------------------------------------------|
| Object type | Method                                                                                                                                 |
| Syntax      | SCPI.SENSE(Ch).CORRection.EXTension.AUTO.DCOffset = <i>Status</i><br><i>Status</i> = SCPI.SENSE(Ch).CORRection.EXTension.AUTO.DCOffset |
| Description | For channel 1 to 16 ( <i>Ch</i> ), enables or disables the usage of DC loss value for the results of the auto port extension .         |
| Variable    |                                                                                                                                        |

|              |                                                                                                                                                                                                                                                      |
|--------------|------------------------------------------------------------------------------------------------------------------------------------------------------------------------------------------------------------------------------------------------------|
|              | <i>Status</i>                                                                                                                                                                                                                                        |
| Description  | ON/OFF the usage of DC loss value for the results of the auto port extension                                                                                                                                                                         |
| Data type    | Boolean type (Boolean)                                                                                                                                                                                                                               |
| Range        | Select from the following.<br><ul style="list-style-type: none"> <li>• True or -1                      Uses the DC loss value for the results.</li> <li>• False or 0                      Does not use the DC loss value for the results.</li> </ul> |
| Preset value | False or 0                                                                                                                                                                                                                                           |

For information on the variable (*Ch*), refer to Table 7-6, “Variable (Ch),” on page 209.

|                 |                                                                                                                                                                                                                                                                                                                                                                                                                                                                                                                                                                                                                                                                              |
|-----------------|------------------------------------------------------------------------------------------------------------------------------------------------------------------------------------------------------------------------------------------------------------------------------------------------------------------------------------------------------------------------------------------------------------------------------------------------------------------------------------------------------------------------------------------------------------------------------------------------------------------------------------------------------------------------------|
| Examples        | <pre>Dim Dcof As Boolean SCPI.SENSE(1).CORRection.EXTension.AUTO.DCOffset = True Dcof = SCPI.SENSE(1).CORRection.EXTension.AUTO.DCOffset</pre>                                                                                                                                                                                                                                                                                                                                                                                                                                                                                                                               |
| Related objects | <p>SCPI.CALCulate(Ch).PARAmeter(Tr).SELEct on page 259</p> <p>SCPI.CALCulate(Ch).SELEcted.CONVersion.FUNcTION on page 269</p> <p>SCPI.SENSE(Ch).CORRection.EXTension.STATe on page 564</p> <p>SCPI.SENSE(Ch).CORRection.EXTension.AUTO.CONFig on page 548</p> <p>SCPI.SENSE(Ch).CORRection.EXTension.AUTO.LOSS on page 550</p> <p>SCPI.SENSE(Ch).CORRection.EXTension.AUTO.MEASure on page 551</p> <p>SCPI.SENSE(Ch).CORRection.EXTension.AUTO.PORT(Pt) on page 552</p> <p>SCPI.SENSE(Ch).CORRection.EXTension.AUTO.RESEt on page 553</p> <p>SCPI.SENSE(Ch).CORRection.EXTension.AUTO.STARt on page 554</p> <p>SCPI.SENSE(Ch).CORRection.EXTension.AUTO.STOP on page 555</p> |
| Equivalent key  | <b>[Cal] - Port Extensions - Auto Port Extension - Adjust Mismatch</b>                                                                                                                                                                                                                                                                                                                                                                                                                                                                                                                                                                                                       |

## SCPI.SENSE(*Ch*).CORRection.EXTeNsion.AUTO.LOSS

**Object type** Method

**Syntax** SCPI.SENSE(*Ch*).CORRection.EXTeNsion.AUTO.LOSS = *Status*  
*Status* = SCPI.SENSE(*Ch*).CORRection.EXTeNsion.AUTO.LOSS

**Description** For channel 1 to 16 (*Ch*), turns ON/OFF the loss compensation for the results of the auto port extension .

**Variable**

|              |                                                                                                                                                                                                                             |
|--------------|-----------------------------------------------------------------------------------------------------------------------------------------------------------------------------------------------------------------------------|
|              | <i>Status</i>                                                                                                                                                                                                               |
| Description  | ON/OFF the loss compensation for the results of the auto port extension                                                                                                                                                     |
| Data type    | Boolean type (Boolean)                                                                                                                                                                                                      |
| Range        | Select from the following.<br><ul style="list-style-type: none"> <li>• True or -1                      Turns on the loss compensation</li> <li>• False or 0                      Turns off the loss compensation</li> </ul> |
| Preset value | False or 0                                                                                                                                                                                                                  |

For information on the variable (*Ch*), refer to Table 7-6, “Variable (*Ch*),” on page 209.

**Examples**

```
Dim AutoLoss As Boolean
SCPI.SENSE(1).CORRection.EXTeNsion.AUTO.LOSS = True
AutoLoss = SCPI.SENSE(1).CORRection.EXTeNsion.AUTO.LOSS
```

**Related objects**

SCPI.SENSE(*Ch*).CORRection.EXTeNsion.AUTO.CONFIg on page 548  
SCPI.SENSE(*Ch*).CORRection.EXTeNsion.AUTO.DCOFFset on page 549  
SCPI.SENSE(*Ch*).CORRection.EXTeNsion.AUTO.MEASure on page 551  
SCPI.SENSE(*Ch*).CORRection.EXTeNsion.AUTO.PORT(*Pt*) on page 552  
SCPI.SENSE(*Ch*).CORRection.EXTeNsion.AUTO.RESEt on page 553  
SCPI.SENSE(*Ch*).CORRection.EXTeNsion.AUTO.STARt on page 554  
SCPI.SENSE(*Ch*).CORRection.EXTeNsion.AUTO.STOP on page 555

**Equivalent key** **[Cal] - Port Extensions - Auto Port Extension - Include Loss**

## **SCPI.SENSE(*Ch*).CORRection.EXTeNsion.AUTOMEASure**

**Object type**      Method

**Syntax**            `SCPI.SENSE(Ch).CORRection.EXTeNsion.AUTOMEASure = Param`  
*Param* = `SCPI.SENSE(Ch).CORRection.EXTeNsion.AUTOMEASure`

**Description**      For channel 1 to 16 (*Ch*), measures the calibration data of the OPEN standard or SHORT standard of the auto port extension.

**Variable**

|              |                                                                                                                                                                                                                                                           |
|--------------|-----------------------------------------------------------------------------------------------------------------------------------------------------------------------------------------------------------------------------------------------------------|
|              | <i>Param</i>                                                                                                                                                                                                                                              |
| Description  | Standard type of the auto port extension                                                                                                                                                                                                                  |
| Data type    | Character string type (String)                                                                                                                                                                                                                            |
| Range        | Select from the following.<br><ul style="list-style-type: none"> <li>•"OPEN"                      Measures the calibration data of the OPEN standard</li> <li>•"SHORT"                     Measures the calibration data of the SHORT standard</li> </ul> |
| Preset value | "SHORT"                                                                                                                                                                                                                                                   |

For information on the variable (*Ch*), refer to Table 7-6, "Variable (Ch)," on page 209.

**Examples**

```
Dim AutoMeas As String
SCPI.SENSE(1).CORRection.EXTeNsion.AUTOMEASure = "OPEN"
AutoLoss = SCPI.SENSE(1).CORRection.EXTeNsion.AUTO.LOSS
```

**Related objects**

SCPI.SENSE(*Ch*).CORRection.EXTeNsion.AUTO.CONFIg on page 548  
SCPI.SENSE(*Ch*).CORRection.EXTeNsion.AUTO.DCOFFset on page 549  
SCPI.SENSE(*Ch*).CORRection.EXTeNsion.AUTO.LOSS on page 550  
SCPI.SENSE(*Ch*).CORRection.EXTeNsion.AUTO.PORT(*Pt*) on page 552  
SCPI.SENSE(*Ch*).CORRection.EXTeNsion.AUTO.RESEt on page 553  
SCPI.SENSE(*Ch*).CORRection.EXTeNsion.AUTO.STARt on page 554  
SCPI.SENSE(*Ch*).CORRection.EXTeNsion.AUTO.STOP on page 555

**Equivalent key**      **[Cal] - Port Extensions - Auto Port Extension - Measure OPEN|Measure Short-All|Port 1|Port 2|Port 3|Port 4**

**SCPI.SENSE(Ch).CORRection.EXTension.AUTO.PORT(Pt)**

|             |                                                                                                                                                                            |
|-------------|----------------------------------------------------------------------------------------------------------------------------------------------------------------------------|
| Object type | Method                                                                                                                                                                     |
| Syntax      | SCPI.SENSE( <i>Ch</i> ).CORRection.EXTension.AUTO.PORT( <i>Pt</i> ) = <i>Status</i><br><i>Status</i> = SCPI.SENSE( <i>Ch</i> ).CORRection.EXTension.AUTO.PORT( <i>Pt</i> ) |
| Description | For channel 1 to 16 ( <i>Ch</i> ), turns ON/OFF the auto port extension.                                                                                                   |
| Variable    |                                                                                                                                                                            |

|              |                                                                                                                                                                                                                                  |
|--------------|----------------------------------------------------------------------------------------------------------------------------------------------------------------------------------------------------------------------------------|
|              | <i>Status</i>                                                                                                                                                                                                                    |
| Description  | On/off of the auto port extension                                                                                                                                                                                                |
| Data type    | Boolean type (Boolean)                                                                                                                                                                                                           |
| Range        | Select from the following.<br><ul style="list-style-type: none"> <li>• True or -1                      Turns ON the auto port extension</li> <li>• False or 0                      Turns OFF the autot port extension</li> </ul> |
| Preset value | True or -1                                                                                                                                                                                                                       |

For information on the variable (*Ch*), refer to Table 7-6, “Variable (Ch),” on page 209.

For information on the variable (*Pt*), refer to Table 7-9, “Variable (Pt),” on page 241.

**Examples**

```
Dim APort As Boolean
SCPI.SENSE(1).CORRection.EXTension.AUTO.PORT(1) = True
APort = SCPI.SENSE(1).CORRection.EXTension.AUTO.PORT(1)
```

**Related objects**

- SCPI.SENSE(Ch).CORRection.EXTension.AUTO.CONFig on page 548
- SCPI.SENSE(Ch).CORRection.EXTension.AUTO.DCOFFset on page 549
- SCPI.SENSE(Ch).CORRection.EXTension.AUTO.LOSS on page 550
- SCPI.SENSE(Ch).CORRection.EXTension.AUTO.MEASure on page 551
- SCPI.SENSE(Ch).CORRection.EXTension.AUTO.RESet on page 553
- SCPI.SENSE(Ch).CORRection.EXTension.AUTO.STARt on page 554
- SCPI.SENSE(Ch).CORRection.EXTension.AUTO.STOP on page 555

**Equivalent key**      **[Cal] - Port Extensions - Auto Port Extension - Select Ports - Port 1|Port 2|Port 3|Port 4**

## **SCPI.SENSE(*Ch*).CORRection.EXTension.AUTO.RESet**

|                 |                                                                                                                                                                                                                                                                                                                                                                                                                                                                                                                |
|-----------------|----------------------------------------------------------------------------------------------------------------------------------------------------------------------------------------------------------------------------------------------------------------------------------------------------------------------------------------------------------------------------------------------------------------------------------------------------------------------------------------------------------------|
| Object type     | Method                                                                                                                                                                                                                                                                                                                                                                                                                                                                                                         |
| Syntax          | SCPI.SENSE( <i>Ch</i> ).CORRection.EXTension.AUTO.RESet                                                                                                                                                                                                                                                                                                                                                                                                                                                        |
| Description     | For channel 1 to 16 ( <i>Ch</i> ), deletes the finished measurement data (OPEN and SHORT).<br>(No Read)                                                                                                                                                                                                                                                                                                                                                                                                        |
| Variable        | For information on the variable ( <i>Ch</i> ), refer to Table 7-6, “Variable (Ch),” on page 209.                                                                                                                                                                                                                                                                                                                                                                                                               |
| Examples        | SCPI.SENSE(1).CORRection.EXTension.AUTO.RESet                                                                                                                                                                                                                                                                                                                                                                                                                                                                  |
| Related objects | SCPI.SENSE(Ch).CORRection.EXTension.STATe on page 564<br>SCPI.SENSE(Ch).CORRection.EXTension.AUTO.CONFig on page 548<br>SCPI.SENSE(Ch).CORRection.EXTension.AUTO.DCOFFset on page 549<br>SCPI.SENSE(Ch).CORRection.EXTension.AUTO.LOSS on page 550<br>SCPI.SENSE(Ch).CORRection.EXTension.AUTO.MEASure on page 551<br>SCPI.SENSE(Ch).CORRection.EXTension.AUTO.PORT(Pt) on page 552<br>SCPI.SENSE(Ch).CORRection.EXTension.AUTO.STARt on page 554<br>SCPI.SENSE(Ch).CORRection.EXTension.AUTO.STOP on page 555 |
| Equivalent key  | No equivalent key is available on the front panel.                                                                                                                                                                                                                                                                                                                                                                                                                                                             |

**SCPI.SENSE(Ch).CORRection.EXTension.AUTO.START**

Object type Method

Syntax SCPI.SENSE(*Ch*).CORRection.EXTension.AUTO.START = *Value**Value* = SCPI.SENSE(*Ch*).CORRection.EXTension.AUTO.STARTDescription For channel 1 to 16 (*Ch*), sets the start frequency within the frequency range of the user specified auto port extension.

Variable

|              | <i>Value</i>                                                                                                                                                                                                 |
|--------------|--------------------------------------------------------------------------------------------------------------------------------------------------------------------------------------------------------------|
| Description  | Start frequency                                                                                                                                                                                              |
| Data type    | Double precision floating point type (Double)                                                                                                                                                                |
| Range        | 3E5 to 3.0E9 (for E5070B)<br>3E5 to 8.5E9 (for E5071B)                                                                                                                                                       |
| Preset value | 3E5                                                                                                                                                                                                          |
| Unit         | Hz (hertz)                                                                                                                                                                                                   |
| Note         | If the specified variable is out of the allowable setup range, the minimum value (if the lower limit of the range is not reached) or the maximum value (if the upper limit of the range is exceeded) is set. |

For information on the variable (*Ch*), refer to Table 7-6, “Variable (Ch),” on page 209.

Examples

```
Dim AStart As Double
SCPI.SENSE(1).CORRection.EXTension.AUTO.START = 1E9
AStart = SCPI.SENSE(1).CORRection.EXTension.AUTO.START
```

Related objects

SCPI.SENSE(*Ch*).CORRection.EXTension.STATE on page 564  
 SCPI.SENSE(*Ch*).CORRection.EXTension.AUTO.CONFig on page 548  
 SCPI.SENSE(*Ch*).CORRection.EXTension.AUTO.DCOFfset on page 549  
 SCPI.SENSE(*Ch*).CORRection.EXTension.AUTO.LOSS on page 550  
 SCPI.SENSE(*Ch*).CORRection.EXTension.AUTO.MEASure on page 551  
 SCPI.SENSE(*Ch*).CORRection.EXTension.AUTO.PORT(Pt) on page 552  
 SCPI.SENSE(*Ch*).CORRection.EXTension.AUTO.RESet on page 553  
 SCPI.SENSE(*Ch*).CORRection.EXTension.AUTO.STOP on page 555

Equivalent key

**[Cal] - Port Extensions - Auto Port Extension - Method - User Span Start**

## SCPI.SENSE(Ch).CORRection.EXTeNsion.AUTOSTOP

|             |                                                                                                                                                  |
|-------------|--------------------------------------------------------------------------------------------------------------------------------------------------|
| Object type | Method                                                                                                                                           |
| Syntax      | SCPI.SENSE( <i>Ch</i> ).CORRection.EXTeNsion.AUTOSTOP = <i>Value</i><br><br><i>Value</i> = SCPI.SENSE( <i>Ch</i> ).CORRection.EXTeNsion.AUTOSTOP |
| Description | For channel 1 to 16 ( <i>Ch</i> ), sets the stop frequency within the frequency range of the user specified auto port extension.                 |
| Variable    |                                                                                                                                                  |

|              | <i>Value</i>                                                                                                                                                                                                 |
|--------------|--------------------------------------------------------------------------------------------------------------------------------------------------------------------------------------------------------------|
| Description  | Stop frequency                                                                                                                                                                                               |
| Data type    | Double precision floating point type (Double)                                                                                                                                                                |
| Range        | 3E5 to 3.0E9 (for E5070B)<br>3E5 to 8.5E9 (for E5071B)                                                                                                                                                       |
| Preset value | 3.0E9 (for E5070B)<br>8.5E9 (for E5071B)                                                                                                                                                                     |
| Unit         | Hz (hertz)                                                                                                                                                                                                   |
| Note         | If the specified variable is out of the allowable setup range, the minimum value (if the lower limit of the range is not reached) or the maximum value (if the upper limit of the range is exceeded) is set. |

For information on the variable (*Ch*), refer to Table 7-6, “Variable (Ch),” on page 209.

|                 |                                                                                                                                                                                                                                                                                                                                                                                                                                                                                                                                             |
|-----------------|---------------------------------------------------------------------------------------------------------------------------------------------------------------------------------------------------------------------------------------------------------------------------------------------------------------------------------------------------------------------------------------------------------------------------------------------------------------------------------------------------------------------------------------------|
| Examples        | <pre>Dim AStop As Double SCPI.SENSE(1).CORRection.EXTeNsion.AUTOSTOP = 250E8 AStop = SCPI.SENSE(1).CORRection.EXTeNsion.STOP.START</pre>                                                                                                                                                                                                                                                                                                                                                                                                    |
| Related objects | <p>SCPI.SENSE(Ch).CORRection.EXTeNsion.STATe on page 564</p> <p>SCPI.SENSE(Ch).CORRection.EXTeNsion.AUTOCOnFig on page 548</p> <p>SCPI.SENSE(Ch).CORRection.EXTeNsion.AUTODCOFFset on page 549</p> <p>SCPI.SENSE(Ch).CORRection.EXTeNsion.AUTOLOSS on page 550</p> <p>SCPI.SENSE(Ch).CORRection.EXTeNsion.AUTOMEASure on page 551</p> <p>SCPI.SENSE(Ch).CORRection.EXTeNsion.AUTOPORT(Pt) on page 552</p> <p>SCPI.SENSE(Ch).CORRection.EXTeNsion.AUTORESet on page 553</p> <p>SCPI.SENSE(Ch).CORRection.EXTeNsion.AUTOSTARt on page 554</p> |
| Equivalent key  | <b>[Cal] - Port Extensions - Auto Port Extension - Method - User Span Stop</b>                                                                                                                                                                                                                                                                                                                                                                                                                                                              |

**SCPI.SENSE(Ch).CORRection.EXTension.PORT(Pt).  
FREQuency(Fq)**

|             |                                                                                                                                                        |
|-------------|--------------------------------------------------------------------------------------------------------------------------------------------------------|
| Object type | Method                                                                                                                                                 |
| Syntax      | SCPI.SENSE(Ch).CORRection.EXTension.PORT(Pt).FREQuency(Fq) = <i>Value</i><br><i>Value</i> = SCPI.SENSE(Ch).CORRection.EXTension.PORT(Pt).FREQuency(Fq) |
| Description | For channel 1 to 16 ( <i>Ch</i> ), sets the stop frequency within the frequency range of the user specified auto port extension.                       |
| Variable    |                                                                                                                                                        |

**Table 7-20** Variable (*Fq*)

|              | <i>Fq</i>                                                                                     |
|--------------|-----------------------------------------------------------------------------------------------|
| Description  | Frequency number                                                                              |
| Data type    | Long integer type (Long)                                                                      |
| Range        | 1 to 2                                                                                        |
| Preset value | 1                                                                                             |
| Note         | If the specified variable is out of the allowable setup range, an error occurs when executed. |

|              | <i>Value</i>                                                                                                                                                                                                 |
|--------------|--------------------------------------------------------------------------------------------------------------------------------------------------------------------------------------------------------------|
| Description  | Frequency                                                                                                                                                                                                    |
| Data type    | Double precision floating point type (Double)                                                                                                                                                                |
| Range        | 3E5 to 3.0E9 (for E5070B)<br>3E5 to 8.5E9 (for E5071B)                                                                                                                                                       |
| Preset value | 0                                                                                                                                                                                                            |
| Unit         | Hz (hertz)                                                                                                                                                                                                   |
| Note         | If the specified variable is out of the allowable setup range, the minimum value (if the lower limit of the range is not reached) or the maximum value (if the upper limit of the range is exceeded) is set. |

For information on the variable (*Ch*) and the variable (*Pt*), see Table 7-6, “Variable (Ch),” on page 209 and Table 7-9, “Variable (Pt),” on page 241, respectively.

**Examples**

```
Dim PortFreq As Double
SCPI.SENSE(1).CORRection.EXTension.PORT(1).FREQuency(1) = 500E6
PortFreq = SCPI.SENSE(1).CORRection.EXTension.PORT(1).FREQuency(1)
```

**Related objects**

SCPI.SENSE(Ch).CORRection.EXTension.STATe on page 564

SCPI.SENSE(Ch).CORRection.EXTension.PORT(Pt). INCLude(II).STATe on page 558

SCPI.SENSE(Ch).CORRection.EXTension.PORT(Pt).LDC on page 560



**SCPI.SENSE(Ch).CORRection.EXTension.PORT(Pt). FREQUency(Fq)**

SCPI.SENSE(Ch).CORRection.EXTension.PORT(Pt) .LOSS(Loss) on page 561

Equivalent key **[Cal] - Port Extensions - Loss - Freq1|Freq2**

**SCPI.SENSE(Ch).CORRection.EXTEnsion.PORT(Pt).  
INCLude(II).STATe**

|             |                                                                                                                                                                      |
|-------------|----------------------------------------------------------------------------------------------------------------------------------------------------------------------|
| Object type | Method                                                                                                                                                               |
| Syntax      | SCPI.SENSE(Ch).CORRection.EXTEnsion.PORT(Pt).INCLude(II).STATe = <i>Status</i><br><br><i>Status</i> = SCPI.SENSE(Ch).CORRection.EXTEnsion.PORT(Pt).INCLude(II).STATe |
| Description | For channel 1 to 16 ( <i>Ch</i> ), turns ON/OFF the set of loss value and frequency value of include 1 to 2 ( <i>II</i> ) of the port 1 to 4 ( <i>Pt</i> ).          |

Variable

**Table 7-21****Variable (II)**

|              |                                                                                               |
|--------------|-----------------------------------------------------------------------------------------------|
|              | <i>II</i>                                                                                     |
| Description  | Include number                                                                                |
| Data type    | Long integer type (Long)                                                                      |
| Range        | 1 to 2                                                                                        |
| Preset value | 1                                                                                             |
| Note         | If the specified variable is out of the allowable setup range, an error occurs when executed. |

|              |                                                                                                                                                                                                                                                       |
|--------------|-------------------------------------------------------------------------------------------------------------------------------------------------------------------------------------------------------------------------------------------------------|
|              | <i>Status</i>                                                                                                                                                                                                                                         |
| Description  | ON/OFF the set of loss value and frequency value.                                                                                                                                                                                                     |
| Data type    | Boolean type (Boolean)                                                                                                                                                                                                                                |
| Range        | Select from the following.<br><ul style="list-style-type: none"> <li>•True or -1                      Turns ON the loss value and frequency value.</li> <li>•False or 0                      Turns OFF the loss value and frequency value.</li> </ul> |
| Preset value | False or 0                                                                                                                                                                                                                                            |

For information on the variable (*Ch*) and the variable (*Pt*), see Table 7-6, “Variable (Ch),” on page 209 and Table 7-9, “Variable (Pt),” on page 241, respectively.

Examples

```
Dim PortIncl As Double
SCPI.SENSE(1).CORRection.EXTEnsion.PORT(1).INCLude(1).STATe = 500E6
PortIncl =
SCPI.SENSE(1).CORRection.EXTEnsion.PORT(1).INCLude(1).STATe
```

Related objects

SCPI.SENSE(Ch).CORRection.EXTEnsion.STATe on page 564  
 SCPI.SENSE(Ch).CORRection.EXTEnsion.PORT(Pt). FREQuency(Fq) on page 556  
 SCPI.SENSE(Ch).CORRection.EXTEnsion.PORT(Pt).LDC on page 560  
 SCPI.SENSE(Ch).CORRection.EXTEnsion.PORT(Pt) .LOSS(Loss) on page 561  
 SCPI.SENSE(Ch).CORRection.EXTEnsion.PORT(Pt).TIME on page 563

Equivalent key      **[Cal] - Port Extensions - Loss - Loss1|Loss2**

**SCPI.SENSE(*Ch*).CORRection.EXTension.PORT(*Pt*).LDC**

Object type Method

Syntax SCPI.SENSE(*Ch*).CORRection.EXTension.PORT(*Pt*).LDC = *Value**Value* = SCPI.SENSE(*Ch*).CORRection.EXTension.PORT(*Pt*).LDCDescription For channel 1 to 16 (*Ch*), sets the DC loss value of the port 1 to 4 (*Pt*).

Variable

|              | <i>Value</i>                                                                                                                                                                                                 |
|--------------|--------------------------------------------------------------------------------------------------------------------------------------------------------------------------------------------------------------|
| Description  | The loss value of DC.                                                                                                                                                                                        |
| Data type    | Double precision floating point type (Double)                                                                                                                                                                |
| Range        | -90 to 90                                                                                                                                                                                                    |
| Preset value | 0                                                                                                                                                                                                            |
| Unit         | dBm                                                                                                                                                                                                          |
| Note         | If the specified variable is out of the allowable setup range, the minimum value (if the lower limit of the range is not reached) or the maximum value (if the upper limit of the range is exceeded) is set. |

For information on the variable (*Ch*) and the variable (*Pt*), see Table 7-6, “Variable (Ch),” on page 209 and Table 7-9, “Variable (Pt),” on page 241, respectively.

Examples

```
Dim PLdc As Double
SCPI.SENSE(1).CORRection.EXTension.PORT(1).LDC = 45
PLdc = SCPI.SENSE(1).CORRection.EXTension.PORT(1).LDC
```

Related objects

SCPI.SENSE(*Ch*).CORRection.EXTension.STATe on page 564SCPI.SENSE(*Ch*).CORRection.EXTension.PORT(*Pt*). FREQuency(*Fq*) on page 556SCPI.SENSE(*Ch*).CORRection.EXTension.PORT(*Pt*). INCLude(*Il*).STATe on page 558SCPI.SENSE(*Ch*).CORRection.EXTension.PORT(*Pt*). .LOSS(*Loss*) on page 561SCPI.SENSE(*Ch*).CORRection.EXTension.PORT(*Pt*). TIME on page 563

Equivalent key

**[Cal] - Port Extensions - Loss - Loss at DC**

## SCPI.SENSE(Ch).CORRection.EXTension.PORT(Pt) .LOSS(Loss)

|             |                                                                                                                                    |
|-------------|------------------------------------------------------------------------------------------------------------------------------------|
| Object type | Method                                                                                                                             |
| Syntax      | SCPI.SENSE(Ch).CORRection.EXTension.PORT(Pt).LOSS(Loss) = Value<br>Value = SCPI.SENSE(Ch).CORRection.EXTension.PORT(Pt).LOSS(Loss) |
| Description | For channel 1 to 16 (Ch), sets the DC loss value of the port 1 to 4 (Pt).                                                          |
| Variable    |                                                                                                                                    |

**Table 7-22** Variable (Loss)

|              | <i>Loss</i>                                                                                   |
|--------------|-----------------------------------------------------------------------------------------------|
| Description  | Loss number                                                                                   |
| Data type    | Long integer type (Long)                                                                      |
| Range        | 1 to 2                                                                                        |
| Preset value | 1                                                                                             |
| Note         | If the specified variable is out of the allowable setup range, an error occurs when executed. |

|              | <i>Value</i>                                                                                                                                                                                                 |
|--------------|--------------------------------------------------------------------------------------------------------------------------------------------------------------------------------------------------------------|
| Description  | The loss value                                                                                                                                                                                               |
| Data type    | Double precision floating point type (Double)                                                                                                                                                                |
| Range        | -90 to 90                                                                                                                                                                                                    |
| Preset value | 0                                                                                                                                                                                                            |
| Unit         | dBm                                                                                                                                                                                                          |
| Note         | If the specified variable is out of the allowable setup range, the minimum value (if the lower limit of the range is not reached) or the maximum value (if the upper limit of the range is exceeded) is set. |

For information on the variable (Ch) and the variable (Pt), see Table 7-6, “Variable (Ch),” on page 209 and Table 7-9, “Variable (Pt),” on page 241, respectively.

**Examples**

```
Dim PLoss As Double
SCPI.SENSE(1).CORRection.EXTension.PORT(1).LOSS(1) = -45
PLoss = SCPI.SENSE(1).CORRection.EXTension.PORT(1).LOSS(1)
```

**Related objects**

- SCPI.SENSE(Ch).CORRection.EXTension.STATE on page 564
- SCPI.SENSE(Ch).CORRection.EXTension.PORT(Pt). FREQUency(Fq) on page 556
- SCPI.SENSE(Ch).CORRection.EXTension.PORT(Pt). INCLude(II).STATE on page 558
- SCPI.SENSE(Ch).CORRection.EXTension.PORT(Pt).LDC on page 560

COM Object Reference

**SCPI.SENSE(Ch).CORRection.EXTension.PORT(Pt) .LOSS(Loss)**

SCPI.SENSE(Ch).CORRection.EXTension.PORT(Pt).TIME on page 563

Equivalent key

**[Cal] - Port Extensions - Loss - Loss1|Loss2**

## SCPI.SENSE(*Ch*).CORRection.EXTension.PORT(*Pt*).TIME

**Object type** Property

**Syntax** SCPI.SENSE(*Ch*).CORRection.EXTension.PORT(*Pt*).TIME = *Value*  
*Value* = SCPI.SENSE(*Ch*).CORRection.EXTension.PORT(*Pt*).TIME

**Description** For channels 1 to 16 (*Ch*), sets the delay time for the port extension of ports 1 and 4 (*Pt*).

**Variable**

|              | <i>Value</i>                                                                                                                                                                                                 |
|--------------|--------------------------------------------------------------------------------------------------------------------------------------------------------------------------------------------------------------|
| Description  | Delay time                                                                                                                                                                                                   |
| Data type    | Double precision floating point type (Double)                                                                                                                                                                |
| Range        | -10 to 10                                                                                                                                                                                                    |
| Preset value | 0                                                                                                                                                                                                            |
| Unit         | s (second)                                                                                                                                                                                                   |
| Note         | If the specified variable is out of the allowable setup range, the minimum value (if the lower limit of the range is not reached) or the maximum value (if the upper limit of the range is exceeded) is set. |

For information on the variable (*Ch*) and the variable (*Pt*), see Table 7-6, “Variable (*Ch*),” on page 209 and Table 7-9, “Variable (*Pt*),” on page 241, respectively.

**Examples**

```
Dim PortExt As Double
SCPI.SENSE(1).CORRection.EXTension.PORT(1).TIME = 1E-3
PortExt = SCPI.SENSE(1).CORRection.EXTension.PORT(1).TIME
```

**Related objects**

SCPI.SENSE(*Ch*).CORRection.EXTension.STATe on page 564

SCPI.SENSE(*Ch*).CORRection.EXTension.PORT(*Pt*). FREQUency(*Fq*) on page 556

SCPI.SENSE(*Ch*).CORRection.EXTension.PORT(*Pt*). INCLude(*Il*).STATe on page 558

SCPI.SENSE(*Ch*).CORRection.EXTension.PORT(*Pt*).LDC on page 560

SCPI.SENSE(*Ch*).CORRection.EXTension.PORT(*Pt*).LOSS(*Loss*) on page 561

**Equivalent key** **[Cal] - Port Extensions - Extension Port N**

## SCPI.SENSE(*Ch*).CORRection.EXTension.STATe

|             |                                                                                                                                          |
|-------------|------------------------------------------------------------------------------------------------------------------------------------------|
| Object type | Property                                                                                                                                 |
| Syntax      | SCPI.SENSE( <i>Ch</i> ).CORRection.EXTension.STATe = <i>Status</i><br><i>Status</i> = SCPI.SENSE( <i>Ch</i> ).CORRection.EXTension.STATe |
| Description | For channels 1 to 16 ( <i>Ch</i> ), turns ON/OFF the port extension.                                                                     |
| Variable    |                                                                                                                                          |

|              |                                                                                                                                                                                                                       |
|--------------|-----------------------------------------------------------------------------------------------------------------------------------------------------------------------------------------------------------------------|
|              | <i>Status</i>                                                                                                                                                                                                         |
| Description  | ON/OFF of the port extension correction                                                                                                                                                                               |
| Data type    | Boolean type (Boolean)                                                                                                                                                                                                |
| Range        | Select from the following.<br><ul style="list-style-type: none"> <li>•True or -1                      Turns ON the port extension.</li> <li>•False or 0                      Turns OFF the port extension.</li> </ul> |
| Preset value | False or 0                                                                                                                                                                                                            |

For information on the variable (*Ch*), see Table 7-6, “Variable (*Ch*),” on page 209.

**Examples**

```
Dim Ext As Boolean
SCPI.SENSE(1).CORRection.EXTension.STATe = True
Ext = SCPI.SENSE(1).CORRection.EXTension.STATe
```

**Related objects**

SCPI.SENSE(*Ch*).CORRection.EXTension.PORT(*Pt*).TIME on page 563  
SCPI.SENSE(*Ch*).CORRection.EXTension.AUTO.DCOFFset on page 549  
SCPI.SENSE(*Ch*).CORRection.EXTension.AUTO.LOSS on page 550  
SCPI.SENSE(*Ch*).CORRection.EXTension.AUTO.MEASure on page 551  
SCPI.SENSE(*Ch*).CORRection.EXTension.AUTO.PORT(*Pt*) on page 552  
SCPI.SENSE(*Ch*).CORRection.EXTension.AUTO.RESet on page 553  
SCPI.SENSE(*Ch*).CORRection.EXTension.PORT(*Pt*). FREQuency(*Fq*) on page 556  
SCPI.SENSE(*Ch*).CORRection.EXTension.PORT(*Pt*). INCLude(*Il*).STATe on page 558  
SCPI.SENSE(*Ch*).CORRection.EXTension.PORT(*Pt*).LDC on page 560  
SCPI.SENSE(*Ch*).CORRection.EXTension.PORT(*Pt*).LOSS(*Loss*) on page 561  
SCPI.SENSE(*Ch*).CORRection.EXTension.PORT(*Pt*).TIME on page 563

**Equivalent key**      **[Cal] - Port Extensions - Extensions**



## **SCPI.SENSE(*Ch*).CORRection.IMPedance.INPut.MAGNitude**

|             |                                                                                                                                                            |
|-------------|------------------------------------------------------------------------------------------------------------------------------------------------------------|
| Object type | Property                                                                                                                                                   |
| Syntax      | SCPI.SENSE( <i>Ch</i> ).CORRection.IMPedance.INPut.MAGNitude = <i>Value</i><br><i>Value</i> = SCPI.SENSE( <i>Ch</i> ).CORRection.IMPedance.INPut.MAGNitude |
| Description | Sets the system characteristic impedance (Z0) value.                                                                                                       |

**NOTE** This object is available with the firmware version 3.01 or greater.

### Variable

|              | <i>Value</i>                                                                                                                                                                                                 |
|--------------|--------------------------------------------------------------------------------------------------------------------------------------------------------------------------------------------------------------|
| Description  | System Z0 value                                                                                                                                                                                              |
| Data type    | Double precision floating point type (Double)                                                                                                                                                                |
| Range        | 1E-3 to 1000                                                                                                                                                                                                 |
| Preset value | 50                                                                                                                                                                                                           |
| Unit         | Ω (ohm)                                                                                                                                                                                                      |
| Resolution   | 0.001                                                                                                                                                                                                        |
| Note         | If the specified variable is out of the allowable setup range, the minimum value (if the lower limit of the range is not reached) or the maximum value (if the upper limit of the range is exceeded) is set. |

**Examples**

```
Dim SysZ0 As Double
SCPI.SENSE.CORRection.IMPedance.INPut.MAGNitude = 75
SysZ0 = SCPI.SENSE.CORRection.IMPedance.INPut.MAGNitude
```

Equivalent key **[Cal] - Set Z0**

## **SCPI.SENSE(*Ch*).CORRection.OFFSet.CLEar**

|                 |                                                                                                                                                                                                                                          |
|-----------------|------------------------------------------------------------------------------------------------------------------------------------------------------------------------------------------------------------------------------------------|
| Type of object  | Method                                                                                                                                                                                                                                   |
| Syntax          | SCPI.SENSE( <i>Ch</i> ).CORRection.OFFSet.CLEar                                                                                                                                                                                          |
| Description     | <p>For channels 1 to 16 (<i>Ch</i>), clears the error coefficient for calibration when the frequency offset feature is on. (No read)</p> <p>This command does not clear the error coefficient when the frequency offset mode is off.</p> |
| Variable        | For information on the variable ( <i>Ch</i> ), refer to Table 7-6, “Variable (Ch),” on page 209.                                                                                                                                         |
| Example of use  | SCPI.SENSE(1).CORRection.OFFSet.CLEar                                                                                                                                                                                                    |
| Related objects | SCPI.SENSE(Ch).OFFSet.STATe on page 627<br>SCPI.SENSE(Ch).CORRection.CLEar on page 469                                                                                                                                                   |
| Equivalent key  | <b>[Cal] - Mixer/Converter Calibration - Clear - OK</b>                                                                                                                                                                                  |

## **SCPI.SENSE(Ch).CORRection.OFFSet.COLLect.ACQure.LOAD**

Type of object      Property

Syntax                SCPI.SENSE(Ch).CORRection.OFFSet.COLLect.ACQure.LOAD = *Ports*

Description         For channels 1 to 16 (*Ch*), measures the calibration data of the load standard of the specified port when the frequency offset feature is on. (No read)

Variable

|             |                                                                                                                                                                                                            |
|-------------|------------------------------------------------------------------------------------------------------------------------------------------------------------------------------------------------------------|
|             | <i>Ports</i>                                                                                                                                                                                               |
| Description | Provides 2-element array data (port).<br>Ports(0): Measurement port number<br>Ports(1): Frequency port number<br>The index of the array starts from 0.                                                     |
| Data type   | Variant type (Variant)                                                                                                                                                                                     |
| Range       | 1 to 4                                                                                                                                                                                                     |
| Note        | The value used as the frequency is the value specified with frequency setting commands "SCPI.SENSE(Ch).OFFSet.PORT(Pt).FREQUENCY and its subcommands" for the port specified by the frequency port number. |

For information on the variable (*Ch*), refer to Table 7-6, "Variable (Ch)," on page 209.

Example of use (1)    SCPI.SENSE(1).CORRection.OFFSet.COLLect.ACQure.LOAD = Array(1,2)

Example of use (2)    Dim Port As Variant  
                           Port(0) = 1  
                           Port(1) = 2  
                           SCPI.SENSE(1).CORRection.OFFSet.COLLect.ACQure.LOAD = Port

Related objects      SCPI.SENSE(Ch).CORRection.OFFSet.COLLect.ACQure.OPEN on page 568  
                           SCPI.SENSE(Ch).CORRection.OFFSet.COLLect.ACQure.SHORT on page 571

Equivalent key        **[Cal] - Mixer/Converter Caribration - Scalar Cal(Manual) - Reflection - PortX@FreqY Broadband**

---

**NOTE**                The values of PortX and FreqY change depending on the selected calibration method and port number.

---

**SCPI.SENSE(*Ch*).CORRection.OFFSet.COLLect.ACQuire.OPEN**

|                |                                                                                                                                                                 |
|----------------|-----------------------------------------------------------------------------------------------------------------------------------------------------------------|
| Type of object | Property                                                                                                                                                        |
| Syntax         | SCPI.SENSE( <i>Ch</i> ).CORRection.OFFSet.COLLect.ACQuire.OPEN = <i>Ports</i>                                                                                   |
| Description    | For channels 1 to 16 ( <i>Ch</i> ), measures the calibration data of the open standard of the specified port when the frequency offset feature is on. (No read) |
| Variable       |                                                                                                                                                                 |

|             |                                                                                                                                                                                                            |
|-------------|------------------------------------------------------------------------------------------------------------------------------------------------------------------------------------------------------------|
|             | <b><i>Ports</i></b>                                                                                                                                                                                        |
| Description | Provides 2-element array data (port).<br>Ports(0): Measurement port number<br>Ports(1): Frequency port number<br>The index of the array starts from 0.                                                     |
| Data type   | Variant type (Variant)                                                                                                                                                                                     |
| Range       | 1 to 4                                                                                                                                                                                                     |
| Note        | The value used as the frequency is the value specified with frequency setting commands "SCPI.SENSE(Ch).OFFSet.PORT(Pt).FREQUENCY and its subcommands" for the port specified by the frequency port number. |

For information on the variable (*Ch*), refer to Table 7-6, "Variable (*Ch*)," on page 209.

|                    |                                                                                                                                         |
|--------------------|-----------------------------------------------------------------------------------------------------------------------------------------|
| Example of use (1) | SCPI.SENSE(1).CORRection.OFFSet.COLLect.ACQuire.OPEN = Array(1,2)                                                                       |
| Example of use (2) | Dim Port As Variant<br>Port(0) = 1<br>Port(1) = 2<br>SCPI.SENSE(1).CORRection.OFFSet.COLLect.ACQuire.OPEN = Port                        |
| Related objects    | SCPI.SENSE(Ch).CORRection.OFFSet.COLLect.ACQuire.LOAD on page 567<br>SCPI.SENSE(Ch).CORRection.OFFSet.COLLect.ACQuire.SHORT on page 571 |
| Equivalent key     | <b>[Cal] - Mixer/Converter Caribration - Scalar Cal(Manual) - Reflection - PortX@FreqY Open</b>                                         |

---

**NOTE** The values of PortX and FreqY change depending on the selected calibration method and port number.

---

## SCPI.SENSE(Ch).CORRection.OFFSet.COLLect.ACQuire.PMETer

|                |                                                                                                                                                                                |
|----------------|--------------------------------------------------------------------------------------------------------------------------------------------------------------------------------|
| Type of object | Property                                                                                                                                                                       |
| Syntax         | SCPI.SENSE(Ch).CORRection.OFFSet.COLLect.ACQuire.PMETer = <i>Params</i>                                                                                                        |
| Description    | For channels 1 to 16 ( <i>Ch</i> ), measures the scalar-mixer calibration data using the power meter for the specified port when the frequency offset feature is on. (No read) |
| Variable       |                                                                                                                                                                                |

|             | <i>Params</i>                                                                                                                                                                                                                                                                                |
|-------------|----------------------------------------------------------------------------------------------------------------------------------------------------------------------------------------------------------------------------------------------------------------------------------------------|
| Description | Provides 3-element array data (port).<br>Params(0): Measurement port number<br>Params(1): Frequency port number<br>Params(2): Power sensor number in use<br>The index of the array starts from 0.                                                                                            |
| Data type   | Variant type (Variant)                                                                                                                                                                                                                                                                       |
| Range       | Measurement port number/frequency port number<br>1 to 4<br>Power sensor number in use <ul style="list-style-type: none"> <li>• "ASENSor": Specifies power sensor A.</li> <li>• "BSENSor": Specifies power sensor B.</li> </ul>                                                               |
| Note        | The value used as the frequency is the value specified with frequency setting commands "SCPI.SENSE(Ch).OFFSet.PORT(Pt).FREQuency and its subcommands" for the port specified by the frequency port number.<br>The setting of the power sensor is common to that for power meter calibration. |

For information on the variable (*Ch*), refer to Table 7-6, "Variable (Ch)," on page 209.

**Example of use (1)** SCPI.SENSE(1).CORRection.OFFSet.COLLect.ACQuire.PMETer = Array(1,2,"ASENSor")

**Example of use (2)**  
 Dim Params As Variant  
 Params(0) = 1  
 Params(1) = 2  
 Params(2) = "ASENSor"  
 SCPI.SENSE(1).CORRection.OFFSet.COLLect.ACQuire.PMETer = Params

COM Object Reference

**SCPI.SENSE(Ch).CORRection.OFFSet.COLLEct.ACQuire.PMETER**

Related objects SCPI.SENSE(Ch).CORRection.OFFSet.COLLEct.ACQuire.LOAD on page 567  
SCPI.SENSE(Ch).CORRection.OFFSet.COLLEct.ACQuire.OPEN on page 568  
SCPI.SENSE(Ch).CORRection.OFFSet.COLLEct.ACQuire.SHORT on page 571

Equivalent key **[Cal] - Mixer/Converter Caribration - Scalar Cal(Manual) - Power Meter - Use Sensor A|Use Sensor B**  
**[Cal] - Mixer/Converter Caribration - Scalar Cal(Manual) - Power Meter - PortX@FreqY**

---

**NOTE** The values of PortX and FreqY change depending on the selected calibration method and port number.

---

## SCPI.SENSE(*Ch*).CORRection.OFFSet.COLLect.ACQuire.SHORt

Type of object      Property

Syntax                SCPI.SENSE(*Ch*).CORRection.OFFSet.COLLect.ACQuire.SHORt = *Ports*

Description         For channels 1 to 16 (*Ch*), measures the calibration data of the short standard of the specified port when the frequency offset feature is on. (No read)

Variable

|             |                                                                                                                                                                                                                              |
|-------------|------------------------------------------------------------------------------------------------------------------------------------------------------------------------------------------------------------------------------|
|             | <i>Ports</i>                                                                                                                                                                                                                 |
| Description | Provides 2-element array data (port).<br>Ports(0): Measurement port number<br>Ports(1): Frequency port number<br>The index of the array starts from 0.                                                                       |
| Data type   | Variant type (Variant)                                                                                                                                                                                                       |
| Range       | 1 to 4                                                                                                                                                                                                                       |
| Note        | The value used as the frequency is the value specified with frequency setting commands "SCPI.SENSE( <i>Ch</i> ).OFFSet.PORT( <i>Pt</i> ).FREQuency and its subcommands" for the port specified by the frequency port number. |

For information on the variable (*Ch*), refer to Table 7-6, "Variable (*Ch*)," on page 209.

Example of use (1)    SCPI.SENSE(1).CORRection.OFFSet.COLLect.ACQuire.SHORt = Array(1,2)

Example of use (2)    Dim Port As Variant  
Port(0) = 1  
Port(1) = 2  
SCPI.SENSE(1).CORRection.OFFSet.COLLect.ACQuire.SHORt = Port

Related objects      SCPI.SENSE(*Ch*).CORRection.OFFSet.COLLect.ACQuire.LOAD on page 567  
SCPI.SENSE(*Ch*).CORRection.OFFSet.COLLect.ACQuire.OPEN on page 568

Equivalent key        **[Cal] - Mixer/Converter Caribration - Scalar Cal(Manual) - Reflection - PortX@FreqY Short**

---

**NOTE**                The values of PortX and FreqY change depending on the selected calibration method and port number.

---

**SCPI.SENSE(*Ch*).CORRection.OFFSet.COLLect.ACQuire.  
THRU**

|                |                                                                                                                                                                 |
|----------------|-----------------------------------------------------------------------------------------------------------------------------------------------------------------|
| Type of object | Property                                                                                                                                                        |
| Syntax         | SCPI.SENSE( <i>Ch</i> ).CORRection.OFFSet.COLLect.ACQuire.THRU = <i>Ports</i>                                                                                   |
| Description    | For channels 1 to 16 ( <i>Ch</i> ), measures the calibration data of the thru standard of the specified port when the frequency offset feature is on. (No read) |
| Variable       |                                                                                                                                                                 |

|             |                                                                                                                                                                                                                       |
|-------------|-----------------------------------------------------------------------------------------------------------------------------------------------------------------------------------------------------------------------|
|             | <i>Ports</i>                                                                                                                                                                                                          |
| Description | Provides 2-element array data (port).<br>Ports(0): Response port number<br>Ports(1): Stimulus port number<br>The index of the array starts from 0.                                                                    |
| Data type   | Variant type (Variant)                                                                                                                                                                                                |
| Range       | 1 to 4                                                                                                                                                                                                                |
| Note        | For example, when THRU 1,2 is specified, S22 and S12 are measured; when THRU 2,1 is specified, S11 and S21 are measured.<br>If you specify the same port number to the 2 port numbers, an error occurs when executed. |

For information on the variable (*Ch*), refer to Table 7-6, “Variable (*Ch*),” on page 209.

|                    |                                                                                                                                                                                                              |
|--------------------|--------------------------------------------------------------------------------------------------------------------------------------------------------------------------------------------------------------|
| Example of use (1) | SCPI.SENSE(1).CORRection.OFFSet.COLLect.ACQuire.THRU = Array(1,2)                                                                                                                                            |
| Example of use (2) | Dim Port As Variant<br>Port(0) = 1<br>Port(1) = 2<br>SCPI.SENSE(1).CORRection.OFFSet.COLLect.ACQuire.THRU = Port                                                                                             |
| Related objects    | SCPI.SENSE(Ch).CORRection.OFFSet.COLLect.ACQuire.LOAD on page 567<br>SCPI.SENSE(Ch).CORRection.OFFSet.COLLect.ACQuire.OPEN on page 568<br>SCPI.SENSE(Ch).CORRection.OFFSet.COLLect.ACQuire.SHORT on page 571 |
| Equivalent key     | <b>[Cal] - Mixer/Converter Caribration - Scalar Cal(Manual) - Transmission - PortX-Y@FreqZ Thru</b>                                                                                                          |

---

**NOTE** The values of PortX-Y and FreqZ change depending on the selected calibration method and port number.

---



## SCPI.SENSE(*Ch*).CORRection.OFFSet.COLLect.CLEAr

|                 |                                                                                                                                                                                                                                                                                                                                                                                      |
|-----------------|--------------------------------------------------------------------------------------------------------------------------------------------------------------------------------------------------------------------------------------------------------------------------------------------------------------------------------------------------------------------------------------|
| Type of object  | Method                                                                                                                                                                                                                                                                                                                                                                               |
| Syntax          | SCPI.SENSE( <i>Ch</i> ).CORRection.OFFSet.COLLect.CLEAr                                                                                                                                                                                                                                                                                                                              |
| Description     | <p>For channels 1 to 16 (<i>Ch</i>), clears the calibration measurement data when the frequency offset feature is on. This command also clears the measurement data of the power meter. (No read)</p> <p>Settings that have been temporarily changed due to measurement for each standard (number of traces, measurement parameters, and so on) return to their original values.</p> |
| Variable        | For information on the variable ( <i>Ch</i> ), refer to Table 7-6, “Variable (Ch),” on page 209.                                                                                                                                                                                                                                                                                     |
| Example of use  | SCPI.SENSE(1).CORRection.OFFSet.COLLect.CLEAr                                                                                                                                                                                                                                                                                                                                        |
| Related objects | SCPI.SENSE(Ch).OFFSet.STATe on page 627<br>SCPI.SENSE(Ch).CORRection.OFFSet.CLEAr on page 566                                                                                                                                                                                                                                                                                        |
| Equivalent key  | <b>[Cal] - Mixer/Converter Calibration - Scalar Cal(Manual) - Cancel - OK</b>                                                                                                                                                                                                                                                                                                        |

**SCPI.SENSE(*Ch*).CORRection.OFFSet.COLLect.ECAL.SMIX2**

|                |                                                                                                                                                                                                                                                                                                                                        |
|----------------|----------------------------------------------------------------------------------------------------------------------------------------------------------------------------------------------------------------------------------------------------------------------------------------------------------------------------------------|
| Type of object | Property                                                                                                                                                                                                                                                                                                                               |
| Syntax         | SCPI.SENSE( <i>Ch</i> ).CORRection.OFFSet.COLLect.ECAL.SMIX2 = <i>Ports</i>                                                                                                                                                                                                                                                            |
| Description    | <p>Executes calibration for the specified 2 ports when the frequency offset feature is on for channels 1 to 16 (<i>Ch</i>) using ECal(Electronic Calibration).</p> <p>If you execute this object when the ECal module is not connected or when ports are not connected each other appropriately, a runtime error occurs. (No read)</p> |

## Variable

|             | <i>Ports</i>                                                                                                                                                                                                                                                                                                        |
|-------------|---------------------------------------------------------------------------------------------------------------------------------------------------------------------------------------------------------------------------------------------------------------------------------------------------------------------|
| Description | <p>Provides 2-element array data (port).</p> <p>Ports(0): Port number 1</p> <p>Ports(1): Port number 2</p> <p>The direction (forward or reverse) is determined by the presence/absence of power meter measurement data instead of port 1 or port 2 specified here.</p> <p>The index of the array starts from 0.</p> |
| Data type   | Variant type (Variant)                                                                                                                                                                                                                                                                                              |
| Range       | 1 to 4                                                                                                                                                                                                                                                                                                              |
| Note        | <p>Before executing this command, the “SCPI.SENSE(Ch).CORRection.OFFSet.COLLect.ACQuire.PMETer” on page 569 command must be executed.</p> <p>If you specify the same port number to the 2 port numbers, an error occurs when executed.</p>                                                                          |

For information on the variable (*Ch*), refer to Table 7-6, “Variable (*Ch*),” on page 209.

Example of use (1) `SCPI.SENSE(1).CORRection.OFFSet.COLLect.ECAL.SMIX2 = Array(1,2)`

Example of use (2) `Dim Port As Variant`  
`Port(0) = 1`  
`Port(1) = 2`  
`SCPI.SENSE(1).CORRection.OFFSet.COLLect.ECAL.SMIX2 = Port`

Related objects `SCPI.SENSE(Ch).OFFSet.STATe` on page 627  
`SCPI.SENSE(Ch).CORRection.OFFSet.COLLect.ACQuire.PMETer` on page 569  
`SCPI.SENSE(Ch).CORRection.OFFSet.COLLect.ECAL.SOLT1` on page 575

Equivalent key **[Cal] - Mixer/Converter Caribration - Scalar Cal(ECal) - ECal & Done**

## **SCPI.SENSE(*Ch*).CORRection.OFFSet.COLLect.ECAL.SOLT1**

Type of object      Property

Syntax                `SCPI.SENSE(Ch).CORRection.OFFSet.COLLect.ECAL.SOLT1 = EPort`

Description         Executes 1-port calibration for the specified port when the frequency offset feature is on for channels 1 to 16 (*Ch*) using ECal(Electronic Calibration).

                          If you execute this object when the ECal module is not connected or when ports are not connected each other appropriately, a runtime error occurs. (No read)

Variable

|             |                                                                                               |
|-------------|-----------------------------------------------------------------------------------------------|
|             | <i>EPort</i>                                                                                  |
| Description | Executes 1-port calibration for frequency offset measurement.                                 |
| Data type   | Long integer type (Long)                                                                      |
| Range       | 1 to 4                                                                                        |
| Note        | If the specified variable is out of the allowable setup range, an error occurs when executed. |

For information on the variable (*Ch*), refer to Table 7-6, “Variable (Ch),” on page 209.

Example of use (1)    `SCPI.SENSE(1).CORRection.OFFSet.COLLect.ECAL.SOLT1 = 1`

Related objects        `SCPI.SENSE(Ch).OFFSet.STATe` on page 627  
                              `SCPI.SENSE(Ch).CORRection.OFFSet.COLLect.ECAL.SMIX2` on page 574

Equivalent key        **[Cal] - Mixer/Converter Caribration - Scalar Cal(ECal) - Select Ports - Port n**  
                              **[Cal] - Mixer/Converter Caribration - Scalar Cal(ECal) - ECal & Done**

**SCPI.SENSE(*Ch*).CORRection.OFFSet.COLLect.METHod.SMIX2**

|                |                                                                                                                                             |
|----------------|---------------------------------------------------------------------------------------------------------------------------------------------|
| Type of object | Property                                                                                                                                    |
| Syntax         | SCPI.SENSE( <i>Ch</i> ).CORRection.OFFSet.COLLect.METHod.SMIX2 = <i>Ports</i>                                                               |
| Description    | Executes 2-port calibration for the specified 2 ports when the frequency offset feature is on for channels 1 to 16 ( <i>Ch</i> ). (No read) |
| Variable       |                                                                                                                                             |

|             | <i>Ports</i>                                                                                                                                                                                                                                                                                                                                                                                                                                                                                                                                                                        |
|-------------|-------------------------------------------------------------------------------------------------------------------------------------------------------------------------------------------------------------------------------------------------------------------------------------------------------------------------------------------------------------------------------------------------------------------------------------------------------------------------------------------------------------------------------------------------------------------------------------|
| Description | <p>Provides 2-element array data (port).</p> <p>Ports(0): Port number 1</p> <p>Ports(1): Port number 2</p> <p>The direction (forward, reverse, or both) is determined depending on the port number specified with the “SCPI.SENSE(Ch).CORRection.OFFSet.COLLect.ACQUIRE.LOAD”, “SCPI.SENSE(Ch).CORRection.OFFSet.COLLect.ACQUIRE.OPEN”, “SCPI.SENSE(Ch).CORRection.OFFSet.COLLect.ACQUIRE.SHORT”, and “SCPI.SENSE(Ch).CORRection.OFFSet.COLLect.ACQUIRE.THROUGH” command instead of port number 1 or port number 2 specified here.</p> <p>The index of the array starts from 0.</p> |
| Data type   | Variant type (Variant)                                                                                                                                                                                                                                                                                                                                                                                                                                                                                                                                                              |
| Range       | 1 to 4                                                                                                                                                                                                                                                                                                                                                                                                                                                                                                                                                                              |
| Note        | If you specify the same port number to the 2 port numbers, an error occurs when executed.                                                                                                                                                                                                                                                                                                                                                                                                                                                                                           |

For information on the variable (*Ch*), refer to Table 7-6, “Variable (Ch),” on page 209.

Example of use (1) `SCPI.SENSE(1).CORRection.OFFSet.COLLect.METHod.SMIX2 = Array(1,2)`

Example of use (2) `Dim Port As Variant  
Port(0) = 1  
Port(1) = 2  
SCPI.SENSE(1).CORRection.OFFSet.COLLect.METHod.SMIX2 = Port`

Related objects

- SCPI.SENSE(Ch).OFFSet.STATe on page 627
- SCPI.SENSE(Ch).CORRection.OFFSet.COLLect.ACQUIRE.LOAD on page 567
- SCPI.SENSE(Ch).CORRection.OFFSet.COLLect.ACQUIRE.OPEN on page 568
- SCPI.SENSE(Ch).CORRection.OFFSet.COLLect.ACQUIRE.SHORT on page 571
- SCPI.SENSE(Ch).CORRection.OFFSet.COLLect.ACQUIRE.THROUGH on page 572

Equivalent key **[Cal] - Mixer/Converter Calibration - Scalar Cal(Manual) - Select Ports - 2-1(fwd)|1-2(rev)|1-2(both)•••**

## **SCPI.SENSE(*Ch*).CORRection.OFFSet.COLLect.METHod.SOLT1**

Type of object      Property

Syntax                `SCPI.SENSE(Ch).CORRection.OFFSet.COLLect.METHod.SOLT1 = Port`

Description         Executes 1-port calibration for the specified port when the frequency offset feature is on for channels 1 to 16 (*Ch*). (No read)

Variable

|             |                                                                                               |
|-------------|-----------------------------------------------------------------------------------------------|
|             | <i>Port</i>                                                                                   |
| Description | Executes 1-port calibration for frequency offset measurement.                                 |
| Data type   | Long integer type (Long)                                                                      |
| Range       | 1 to 4                                                                                        |
| Note        | If the specified variable is out of the allowable setup range, an error occurs when executed. |

For information on the variable (*Ch*), refer to Table 7-6, “Variable (Ch),” on page 209.

Example of use (1)    `SCPI.SENSE(1).CORRection.OFFSet.COLLect.METHod.SOLT1 = 2`

Related objects      `SCPI.SENSE(Ch).OFFSet.STATe` on page 627  
                              `SCPI.SENSE(Ch).CORRection.OFFSet.COLLect.METHod.SMIX2` on page 576

Equivalent key        **[Cal] - Mixer/Converter Caribration - Scalar Cal(Manual) - Select Ports - Port n**

**SCPI.SENSE(*Ch*).CORRection.OFFSet.COLLect.SAVE**

|                 |                                                                                                                                                                                                                                                                                                                                                                                                                                                                                           |
|-----------------|-------------------------------------------------------------------------------------------------------------------------------------------------------------------------------------------------------------------------------------------------------------------------------------------------------------------------------------------------------------------------------------------------------------------------------------------------------------------------------------------|
| Type of object  | Method                                                                                                                                                                                                                                                                                                                                                                                                                                                                                    |
| Syntax          | SCPI.SENSE( <i>Ch</i> ).CORRection.OFFSet.COLLect.SAVE                                                                                                                                                                                                                                                                                                                                                                                                                                    |
| Description     | <p>For channels 1 to 16 (<i>Ch</i>), calculates the calibration coefficient for the selected calibration type from the calibration data measured with the frequency offset feature.</p> <p>After the calibration coefficient is calculated, the measured data and the calibration type setting are cleared.</p> <p>If you execute this object before all necessary calibration data for calculating the calibration coefficient is measured, an error occurs when executed. (No read)</p> |
| Variable        | For information on the variable ( <i>Ch</i> ), refer to Table 7-6, “Variable (Ch),” on page 209.                                                                                                                                                                                                                                                                                                                                                                                          |
| Example of use  | SCPI.SENSE(1).CORRection.OFFSet.COLLect.SAVE                                                                                                                                                                                                                                                                                                                                                                                                                                              |
| Related objects | <p>SCPI.SENSE(Ch).CORRection.OFFSet.COLLect.METHod.SMIX2 on page 576</p> <p>SCPI.SENSE(Ch).CORRection.OFFSet.COLLect.METHod.SOLT1 on page 577</p> <p>SCPI.SENSE(Ch).CORRection.OFFSet.COLLect.ACQUIRE.LOAD on page 567</p> <p>SCPI.SENSE(Ch).CORRection.OFFSet.COLLect.ACQUIRE.OPEN on page 568</p> <p>SCPI.SENSE(Ch).CORRection.OFFSet.COLLect.ACQUIRE.SHORT on page 571</p> <p>SCPI.SENSE(Ch).CORRection.OFFSet.COLLect.ACQUIRE.THROUGH on page 572</p>                                 |
| Equivalent key  | <b>[Cal] - Mixer/Converter Caribration - Scalar Cal(Manual) - Done</b>                                                                                                                                                                                                                                                                                                                                                                                                                    |

## SCPI.SENSE(*Ch*).CORRection.PROPerTy

|             |                                                                                                                            |
|-------------|----------------------------------------------------------------------------------------------------------------------------|
| Object type | Property                                                                                                                   |
| Syntax      | SCPI.SENSE( <i>Ch</i> ).CORRection.PROPerTy = <i>Status</i><br><i>Status</i> = SCPI.SENSE( <i>Ch</i> ).CORRection.PROPerTy |
| Description | For the active trace of channels 1 to 16 ( <i>Ch</i> ), turns ON/OFF the display of the calibration property.              |
| Variable    |                                                                                                                            |

|              |                                                                                                                                                                                                                                                                 |
|--------------|-----------------------------------------------------------------------------------------------------------------------------------------------------------------------------------------------------------------------------------------------------------------|
|              | <i>Status</i>                                                                                                                                                                                                                                                   |
| Description  | ON/OFF of the display of the calibration property                                                                                                                                                                                                               |
| Data type    | Boolean type (Boolean)                                                                                                                                                                                                                                          |
| Range        | Select from the following.<br><ul style="list-style-type: none"> <li>•True or -1                      Turns ON the display of the calibration property.</li> <li>•False or 0                      Turns OFF the display of the calibration property.</li> </ul> |
| Preset value | False or 0                                                                                                                                                                                                                                                      |

For information on the variable (*Ch*), see Table 7-6, “Variable (Ch),” on page 209.

|                |                                                                                                                   |
|----------------|-------------------------------------------------------------------------------------------------------------------|
| Examples       | Dim CalProp As Boolean<br>SCPI.SENSE(1).CORRection.PROPerTy = True<br>CalProp = SCPI.SENSE(1).CORRection.PROPerTy |
| Equivalent key | <b>[Cal] - Property</b>                                                                                           |

**SCPI.SENSE(Ch).CORREction.RECeiver(Pt).COLLect.ACQuire**

|                |                                                                                                                       |
|----------------|-----------------------------------------------------------------------------------------------------------------------|
| Type of object | Property                                                                                                              |
| Syntax         | SCPI.SENSE( <i>Ch</i> ).CORREction.RECeiver( <i>Pt</i> ).COLLect.ACQuire = <i>Src</i>                                 |
| Description    | For measurement ports 1 to 4 ( <i>Pt</i> ) of channels 1 to 16 ( <i>Ch</i> ), executes receiver calibration.(No read) |

Because information of power calibration for both the measurement port and the source port is used for error coefficient calculation, the precision of receiver calibration is improved by executing power calibration for both ports before executing receiver calibration.

## Variable

|             |                                                                                                    |
|-------------|----------------------------------------------------------------------------------------------------|
|             | <i>Src</i>                                                                                         |
| Description | Specifies the source port for receiver correction.                                                 |
| Data type   | Long integer type (Long)                                                                           |
| Range       | 1 to 4                                                                                             |
| Note        | If you specify the same port number as the measurement port number, an error occurs when executed. |

For information on the variable (*Ch*), refer to Table 7-6, “Variable (Ch),” on page 209.

For information on the variable (*Pt*), refer to Table 7-9, “Variable (Pt),” on page 241.

|                 |                                                                                                                                                                                |
|-----------------|--------------------------------------------------------------------------------------------------------------------------------------------------------------------------------|
| Example of use  | SCPI.SENSE(1).CORREction.RECeiver(2).COLLect.ACQuire = 4                                                                                                                       |
| Related objects | SCPI.SENSE(Ch).CORREction.RECeiver(Pt).STATE on page 581                                                                                                                       |
| Equivalent key  | <b>[Cal] - Receiver Calibration - Select Port 1 2 3 4</b><br><b>[Cal] - Receiver Calibration - Source Port 1 2 3 4</b><br><b>[Cal] - Receiver Calibration - Take Cal Sweep</b> |



## SCPI.SENSE(*Ch*).CORRection.RECeiver(*Pt*).STATe

|                |                                                                                                                                                                  |
|----------------|------------------------------------------------------------------------------------------------------------------------------------------------------------------|
| Type of object | Property                                                                                                                                                         |
| Syntax         | SCPI.SENSE( <i>Ch</i> ).CORRection.RECeiver( <i>Pt</i> ).STATe = <i>Status</i><br><i>Status</i> = SCPI.SENSE( <i>Ch</i> ).CORRection.RECeiver( <i>Pt</i> ).STATe |
| Description    | For measurement ports 1 to 4 ( <i>Pt</i> ) of channels 1 to 16 ( <i>Ch</i> ), turns on/off error correction for receiver calibration.                            |
| Variable       |                                                                                                                                                                  |

|              |                                                                                                                                                                                                                                                                     |
|--------------|---------------------------------------------------------------------------------------------------------------------------------------------------------------------------------------------------------------------------------------------------------------------|
|              | <i>Status</i>                                                                                                                                                                                                                                                       |
| Description  | On/off of error correction                                                                                                                                                                                                                                          |
| Data type    | Boolean type (Boolean)                                                                                                                                                                                                                                              |
| Range        | Select from the following.<br><ul style="list-style-type: none"> <li>•True or -1                      Turns on the receiver calibration error correction.</li> <li>•False or 0                      Turns off the receiver calibration error correction.</li> </ul> |
| Preset value | False or 0                                                                                                                                                                                                                                                          |

For information on the variable (*Ch*), refer to Table 7-6, “Variable (Ch),” on page 209.

For information on the variable (*Pt*), refer to Table 7-9, “Variable (Pt),” on page 241.

|                 |                                                                                                                               |
|-----------------|-------------------------------------------------------------------------------------------------------------------------------|
| Example of use  | Dim Corr As Boolean<br>SCPI.SENSE(1).CORRection.RECeiver(1).STATe = True<br>Corr = SCPI.SENSE(1).CORRection.RECeiver(1).STATe |
| Related objects | SCPI.SENSE( <i>Ch</i> ).CORRection.RECeiver( <i>Pt</i> ).COLLect.ACQuire on page 580                                          |
| Equivalent key  | <b>[Cal] - Receiver Calibration - Correction</b>                                                                              |

## SCPI.SENSE(*Ch*).CORRection.RVELOCITY.COAX

|             |                                                                                                                                      |
|-------------|--------------------------------------------------------------------------------------------------------------------------------------|
| Object type | Property                                                                                                                             |
| Syntax      | SCPI.SENSE( <i>Ch</i> ).CORRection.RVELOCITY.COAX = <i>Value</i><br><i>Value</i> = SCPI.SENSE( <i>Ch</i> ).CORRection.RVELOCITY.COAX |
| Description | For channels 1 to 16 ( <i>Ch</i> ), sets the velocity factor.                                                                        |
| Variable    |                                                                                                                                      |

|              | <i>Value</i>                                                                                                                                                                                                 |
|--------------|--------------------------------------------------------------------------------------------------------------------------------------------------------------------------------------------------------------|
| Description  | Velocity factor                                                                                                                                                                                              |
| Data type    | Double precision floating point type (Double)                                                                                                                                                                |
| Range        | 0 to 10                                                                                                                                                                                                      |
| Preset value | 1                                                                                                                                                                                                            |
| Note         | If the specified variable is out of the allowable setup range, the minimum value (if the lower limit of the range is not reached) or the maximum value (if the upper limit of the range is exceeded) is set. |

For information on the variable (*Ch*), see Table 7-6, “Variable (Ch),” on page 209.

**Examples**

```
Dim Vel As Double
SCPI.SENSE(1).CORRection.RVELOCITY.COAX = 0.5
Vel = SCPI.SENSE(1).CORRection.RVELOCITY.COAX
```

**Equivalent key**      **[Cal] - Velocity Factor**

## SCPI.SENSE(*Ch*).CORREction.STATe

Object type      Property

Syntax            SCPI.SENSE(*Ch*).CORREction.STATe = *Status*  
*Status* = SCPI.SENSE(*Ch*).CORREction.STATe

Description      For the active trace of channels 1 to 16 (*Ch*), turns ON/OFF the error correction.

Variable

|              |                                                                                                                                                                                                                             |
|--------------|-----------------------------------------------------------------------------------------------------------------------------------------------------------------------------------------------------------------------------|
|              | <i>Status</i>                                                                                                                                                                                                               |
| Description  | ON/OFF of the error correction                                                                                                                                                                                              |
| Data type    | Boolean type (Boolean)                                                                                                                                                                                                      |
| Range        | Select from the following.<br><ul style="list-style-type: none"> <li>• True or -1                      Turns ON the error correction.</li> <li>• False or 0                      Turns OFF the error correction.</li> </ul> |
| Preset value | False or 0                                                                                                                                                                                                                  |

Examples            Dim Corr As Boolean  
SCPI.SENSE(1).CORREction.STATe = True  
Corr = SCPI.SENSE(1).CORREction.STATe

Equivalent key    **[Cal] - Correction**

**SCPI.SENSE(*Ch*).CORRection.TRIGger.FREE.STATe**

Object type Property

Syntax SCPI.SENSE(*Ch*).CORRection.TRIGger.FREE.STATe = *Status**Status* = SCPI.SENSE(*Ch*).CORRection.TRIGger.FREE.STATe

Description Sets the trigger source for calibration to internal (ON) or to the state of the trigger source (SCPI.TRIGger.SEQuence.SOURce) when measurement is made (OFF).

When you change the trigger source during sweep, the sweep is canceled.

Variable

|              |                                                                                                                                                                                                                                                                                                                                                                              |
|--------------|------------------------------------------------------------------------------------------------------------------------------------------------------------------------------------------------------------------------------------------------------------------------------------------------------------------------------------------------------------------------------|
|              | <i>Status</i>                                                                                                                                                                                                                                                                                                                                                                |
| Description  | ON/OFF of the trigger source at calibration                                                                                                                                                                                                                                                                                                                                  |
| Data type    | Boolean type (Boolean)                                                                                                                                                                                                                                                                                                                                                       |
| Range        | Select from the following. <ul style="list-style-type: none"> <li>• True or -1                      Specifies internal for the trigger source for calibration. This corresponds to the softkey "Internal".</li> <li>• False or 0                      Matches the state of the trigger source when measurement is made. This corresponds to the softkey "System".</li> </ul> |
| Preset value | True or -1                                                                                                                                                                                                                                                                                                                                                                   |

Examples

```
Dim TrigSour As Boolean
SCPI.SENSE(1).CORRection.TRIGger.FREE.STATe = False
TrigSour = SCPI.SENSE(1).CORRection.TRIGger.FREE.STATe
```

Equivalent key

**[Cal] - Cal Trigger Source - Internal|System**

## SCPI.SENSE(Ch).CORREction.TYPE(Tr)

|             |                                                                                                                                                                                                                     |
|-------------|---------------------------------------------------------------------------------------------------------------------------------------------------------------------------------------------------------------------|
| Object type | Properties                                                                                                                                                                                                          |
| Syntax      | <i>Data</i> = SCPI.SENSE( <i>Ch</i> ).CORREction.TYPE( <i>Tr</i> )                                                                                                                                                  |
| Description | For traces 1 to 16 ( <i>Tr</i> ) of channels 1 to 16 ( <i>Ch</i> ), reads out the information (calibration type, port numbers) of the applied calibration coefficients for the actual error correction. (Read only) |
| Variable    |                                                                                                                                                                                                                     |

|             | <i>Data</i>                                                                                                                                                                                                                                                                                                                                                                                                                                                                                                                                                                                                                                                                                                                                                                                                                                                                                                                                   |
|-------------|-----------------------------------------------------------------------------------------------------------------------------------------------------------------------------------------------------------------------------------------------------------------------------------------------------------------------------------------------------------------------------------------------------------------------------------------------------------------------------------------------------------------------------------------------------------------------------------------------------------------------------------------------------------------------------------------------------------------------------------------------------------------------------------------------------------------------------------------------------------------------------------------------------------------------------------------------|
| Description | <p>Indicates 5 array data items (the calibration type and the port information to which the calibration is applied).</p> <ul style="list-style-type: none"> <li>• <i>Data</i>(0)                      The calibration type applied. For detail, refer to the Range section.</li> <li>• <i>Data</i>(1)                      The port number to which the calibration is applied (0 when the calibration type is NONE).</li> <li>• <i>Data</i>(2)                      The port number to which the calibration is applied (0 when the calibration type is not SOLT2, SOLT3, or SOLT4).</li> <li>• <i>Data</i>(3)                      The port number to which the calibration is applied (0 when the calibration type is not SOLT3 or SOLT4).</li> <li>• <i>Data</i>(4)                      The port number to which the calibration is applied (0 when the calibration type is not SOLT4).</li> </ul> <p>The array index starts from 0.</p> |
| Range       | <p>One of the following is read out as <i>Data</i>(0).</p> <ul style="list-style-type: none"> <li>• "ERES"                      The enhanced response calibration is applied.</li> <li>• "NONE"                      Nothing is applied.</li> <li>• "RESPO"                      The response calibration (open) is applied.</li> <li>• "RESPS"                      The response calibration (short) is applied.</li> <li>• "RESPT"                      The response calibration (thru) is applied.</li> <li>• "SMIX2"                      The scalar-mixer calibration is applied.</li> <li>• "SOLT1"                      The 1-port calibration is applied.</li> <li>• "SOLT2"                      The full 2-port calibration is applied.</li> <li>• "SOLT3"                      The full 3-port calibration is applied.</li> <li>• "SOLT4"                      The full 4-port calibration is applied.</li> </ul>                  |
| Data type   | Variant type (Variant)                                                                                                                                                                                                                                                                                                                                                                                                                                                                                                                                                                                                                                                                                                                                                                                                                                                                                                                        |

For information on the variable (*Ch*) and the variable (*Tr*), see Table 7-6, “Variable (Ch),” on page 209 and Table 7-10, “Variable (Tr),” on page 259, respectively.

**Examples**

```
Dim CalType As Variant
CalType = SCPI.SENSE(1).CORREction.TYPE(1)
```

**Related objects**

SCPI.SENSE(Ch).CORREction.COLLEct.METHod.TRL2 on page 541  
 SCPI.SENSE(Ch).CORREction.COLLEct.METHod.TRL3 on page 542

COM Object Reference  
**SCPI.SENSE(Ch).CORRection.TYPE(Tr)**

SCPI.SENSE(Ch).CORRection.COLLEct.METHod.TRL4 on page 543

Equivalent key      No equivalent key is available on the front panel.

## SCPI.SENSE(*Ch*).FREQUENCY.CENTER

|             |                                                                                                                    |
|-------------|--------------------------------------------------------------------------------------------------------------------|
| Object type | Property                                                                                                           |
| Syntax      | SCPI.SENSE( <i>Ch</i> ).FREQUENCY.CENTER = <i>Value</i><br><i>Value</i> = SCPI.SENSE( <i>Ch</i> ).FREQUENCY.CENTER |
| Description | Sets the center value of the sweep range of channels 1 to 16 ( <i>Ch</i> ).                                        |
| Variable    |                                                                                                                    |

|              | <i>Value</i>                                                                                                                                                                                                 |
|--------------|--------------------------------------------------------------------------------------------------------------------------------------------------------------------------------------------------------------|
| Description  | Center value                                                                                                                                                                                                 |
| Data type    | Double precision floating point type (Double)                                                                                                                                                                |
| Range        | 3E5 to 8.5E9                                                                                                                                                                                                 |
| Preset value | 4.25015E9                                                                                                                                                                                                    |
| Unit         | Hz (hertz)                                                                                                                                                                                                   |
| Resolution   | 0.5 or 1                                                                                                                                                                                                     |
| Note         | If the specified variable is out of the allowable setup range, the minimum value (if the lower limit of the range is not reached) or the maximum value (if the upper limit of the range is exceeded) is set. |

For information on the variable (*Ch*), see Table 7-6, “Variable (Ch),” on page 209.

|                 |                                                                                                     |
|-----------------|-----------------------------------------------------------------------------------------------------|
| Examples        | Dim Cntr As Double<br>SCPI.SENSE(1).FREQUENCY.CENTER = 2E9<br>Cntr = SCPI.SENSE(1).FREQUENCY.CENTER |
| Related objects | SCPI.SENSE(Ch).FREQUENCY.SPAN on page 591                                                           |
| Equivalent key  | <b>[Center]</b>                                                                                     |

## SCPI.SENSE(Ch).FREQUENCY.CW

**Object type** Property

**Syntax** SCPI.SENSE(*Ch*).FREQUENCY.CW = *Value*  
*Value* = SCPI.SENSE(*Ch*).FREQUENCY.CW

**Description** Sets the fixed frequency (CW frequency) for the power sweep for channels 1 to 16 (*Ch*). This object provides the same function as the SCPI.SENSE(Ch).FREQUENCY.FIXED object.

**Variable**

|              | <i>Value</i>                                                                                                                                                                                                 |
|--------------|--------------------------------------------------------------------------------------------------------------------------------------------------------------------------------------------------------------|
| Description  | Fixed frequency                                                                                                                                                                                              |
| Data type    | Double precision floating point type (Double)                                                                                                                                                                |
| Range        | 3E5 to 8.5E9                                                                                                                                                                                                 |
| Preset value | 3E5                                                                                                                                                                                                          |
| Unit         | Hz (hertz)                                                                                                                                                                                                   |
| Resolution   | 1                                                                                                                                                                                                            |
| Note         | If the specified variable is out of the allowable setup range, the minimum value (if the lower limit of the range is not reached) or the maximum value (if the upper limit of the range is exceeded) is set. |

For information on the variable (*Ch*), refer to Table 7-6, “Variable (Ch),” on page 209.

**Examples**

```
Dim CwFreq As Double
SCPI.SENSE(1).FREQUENCY.CW = 1E9
CwFreq = SCPI.SENSE(1).FREQUENCY.CW
```

**Related objects** SCPI.SENSE(Ch).FREQUENCY.FIXED on page 590  
 SCPI.SENSE(Ch).SWEep.TYPE on page 638

**Equivalent key** **[Sweep Setup] - Power - CW Freq**



## SCPI.SENSE(*Ch*).FREQUENCY.DATA

|             |                                                                                                    |
|-------------|----------------------------------------------------------------------------------------------------|
| Object type | Property                                                                                           |
| Syntax      | <i>Data</i> = SCPI.SENSE( <i>Ch</i> ).FREQUENCY.DATA                                               |
| Description | Reads out the frequencies at all measurement points of channels 1 to 16 ( <i>Ch</i> ). (Read only) |
| Variable    |                                                                                                    |

|             | <i>Data</i>                                                                                                                                                                                                                                                                                                                     |
|-------------|---------------------------------------------------------------------------------------------------------------------------------------------------------------------------------------------------------------------------------------------------------------------------------------------------------------------------------|
| Description | <p>Indicates the array data (frequency) of NOP (number of measurement points). Where <i>n</i> is an integer between 1 and NOP.</p> <ul style="list-style-type: none"> <li>• <i>Data</i>(<i>n-1</i>)                      Frequency at the <i>n</i>-th measurement point</li> </ul> <p>The index of the array starts from 0.</p> |
| Data type   | Variant type (Variant)                                                                                                                                                                                                                                                                                                          |

For information on the variable (*Ch*), see Table 7-6, “Variable (*Ch*),” on page 209.

|                 |                                                                                                             |
|-----------------|-------------------------------------------------------------------------------------------------------------|
| Examples        | <pre>Dim FreqData As Variant SCPI.SENSE(1).SWEep.POINTs = 201 FreqData = SCPI.SENSE(1).FREQUENCY.DATA</pre> |
| Related objects | SCPI.SENSE( <i>Ch</i> ).SWEep.POINTs on page 635                                                            |
| Equivalent key  | No equivalent key is available on the front panel.                                                          |

## SCPI.SENSE(*Ch*).FREQUENCY.FIXed

|             |                                                                                                                                                                                               |
|-------------|-----------------------------------------------------------------------------------------------------------------------------------------------------------------------------------------------|
| Object type | Property                                                                                                                                                                                      |
| Syntax      | SCPI.SENSE( <i>Ch</i> ).FREQUENCY.FIXed = <i>Value</i><br><i>Value</i> = SCPI.SENSE( <i>Ch</i> ).FREQUENCY.FIXed                                                                              |
| Description | Sets the fixed frequency (CW frequency) for the power sweep for channels 1 to 16 ( <i>Ch</i> ).<br>This object provides the same function as the SCPI.SENSE( <i>Ch</i> ).FREQUENCY.CW object. |

### Variable

|              | <i>Value</i>                                                                                                                                                                                                 |
|--------------|--------------------------------------------------------------------------------------------------------------------------------------------------------------------------------------------------------------|
| Description  | Fixed frequency                                                                                                                                                                                              |
| Data type    | Double precision floating point type (Double)                                                                                                                                                                |
| Range        | 3E5 to 8.5E9                                                                                                                                                                                                 |
| Preset value | 3E5                                                                                                                                                                                                          |
| Unit         | Hz (hertz)                                                                                                                                                                                                   |
| Resolution   | 1                                                                                                                                                                                                            |
| Note         | If the specified variable is out of the allowable setup range, the minimum value (if the lower limit of the range is not reached) or the maximum value (if the upper limit of the range is exceeded) is set. |

For information on the variable (*Ch*), refer to Table 7-6, “Variable (*Ch*),” on page 209.

|                 |                                                                                                            |
|-----------------|------------------------------------------------------------------------------------------------------------|
| Examples        | <pre>Dim CwFreq As Double SCPI.SENSE(1).FREQUENCY.FIXed = 1E9 CwFreq = SCPI.SENSE(1).FREQUENCY.FIXed</pre> |
| Related objects | SCPI.SENSE( <i>Ch</i> ).FREQUENCY.CW on page 588<br>SCPI.SENSE( <i>Ch</i> ).SWEep.TYPE on page 638         |
| Equivalent key  | <b>[Sweep Setup] - Power - CW Freq</b>                                                                     |

## SCPI.SENSE(*Ch*).FREQUENCY.SPAN

|             |                                                                                                                |
|-------------|----------------------------------------------------------------------------------------------------------------|
| Object type | Property                                                                                                       |
| Syntax      | SCPI.SENSE( <i>Ch</i> ).FREQUENCY.SPAN = <i>Value</i><br><i>Value</i> = SCPI.SENSE( <i>Ch</i> ).FREQUENCY.SPAN |
| Description | Sets the span value of the sweep range of channels 1 to 16 ( <i>Ch</i> ).                                      |
| Variable    |                                                                                                                |

|              | <i>Value</i>                                                                                                                                                                                                 |
|--------------|--------------------------------------------------------------------------------------------------------------------------------------------------------------------------------------------------------------|
| Description  | Span value                                                                                                                                                                                                   |
| Data type    | Double precision floating point type (Double)                                                                                                                                                                |
| Range        | 0 to 8.4997E9                                                                                                                                                                                                |
| Preset value | 8.4997E9                                                                                                                                                                                                     |
| Unit         | Hz (hertz)                                                                                                                                                                                                   |
| Resolution   | 1                                                                                                                                                                                                            |
| Note         | If the specified variable is out of the allowable setup range, the minimum value (if the lower limit of the range is not reached) or the maximum value (if the upper limit of the range is exceeded) is set. |

For information on the variable (*Ch*), see Table 7-6, “Variable (Ch),” on page 209.

|                 |                                                                                                 |
|-----------------|-------------------------------------------------------------------------------------------------|
| Examples        | Dim Span As Double<br>SCPI.SENSE(1).FREQUENCY.SPAN = 1E9<br>Span = SCPI.SENSE(1).FREQUENCY.SPAN |
| Related objects | SCPI.SENSE(Ch).FREQUENCY.CENTER on page 587                                                     |
| Equivalent key  | <b>[Span]</b>                                                                                   |

## SCPI.SENSE(*Ch*).FREQUENCY.START

|             |                                                                                                                  |
|-------------|------------------------------------------------------------------------------------------------------------------|
| Object type | Property                                                                                                         |
| Syntax      | SCPI.SENSE( <i>Ch</i> ).FREQUENCY.START = <i>Value</i><br><i>Value</i> = SCPI.SENSE( <i>Ch</i> ).FREQUENCY.START |
| Description | Sets the start value of the sweep range of channels 1 to 16 ( <i>Ch</i> ).                                       |
| Variable    |                                                                                                                  |

|              | <i>Value</i>                                                                                                                                                                                                 |
|--------------|--------------------------------------------------------------------------------------------------------------------------------------------------------------------------------------------------------------|
| Description  | Start value                                                                                                                                                                                                  |
| Data type    | Double precision floating point type (Double)                                                                                                                                                                |
| Range        | 3E5 to 8.5E9                                                                                                                                                                                                 |
| Preset value | 3E5                                                                                                                                                                                                          |
| Unit         | Hz (hertz)                                                                                                                                                                                                   |
| Resolution   | 1                                                                                                                                                                                                            |
| Note         | If the specified variable is out of the allowable setup range, the minimum value (if the lower limit of the range is not reached) or the maximum value (if the upper limit of the range is exceeded) is set. |

For information on the variable (*Ch*), see Table 7-6, “Variable (Ch),” on page 209.

|                 |                                                                                                            |
|-----------------|------------------------------------------------------------------------------------------------------------|
| Examples        | <pre>Dim Start As Double SCPI.SENSE(1).FREQUENCY.START = 100E6 Start = SCPI.SENSE(1).FREQUENCY.START</pre> |
| Related objects | SCPI.SENSE( <i>Ch</i> ).FREQUENCY.STOP on page 593                                                         |
| Equivalent key  | <b>[Start]</b>                                                                                             |

## SCPI.SENSE(*Ch*).FREQUENCY.STOP

|             |                                                                                                                |
|-------------|----------------------------------------------------------------------------------------------------------------|
| Object type | Property                                                                                                       |
| Syntax      | SCPI.SENSE( <i>Ch</i> ).FREQUENCY.STOP = <i>Value</i><br><i>Value</i> = SCPI.SENSE( <i>Ch</i> ).FREQUENCY.STOP |
| Description | Sets the stop value of the sweep range of channels 1 to 16 ( <i>Ch</i> ).                                      |
| Variable    |                                                                                                                |

|              | <i>Value</i>                                                                                                                                                                                                 |
|--------------|--------------------------------------------------------------------------------------------------------------------------------------------------------------------------------------------------------------|
| Description  | Stop value                                                                                                                                                                                                   |
| Data type    | Double precision floating point type (Double)                                                                                                                                                                |
| Range        | 3E5 to 8.5E9                                                                                                                                                                                                 |
| Preset value | 8.5E9                                                                                                                                                                                                        |
| Unit         | Hz (hertz)                                                                                                                                                                                                   |
| Resolution   | 1                                                                                                                                                                                                            |
| Note         | If the specified variable is out of the allowable setup range, the minimum value (if the lower limit of the range is not reached) or the maximum value (if the upper limit of the range is exceeded) is set. |

For information on the variable (*Ch*), see Table 7-6, “Variable (Ch),” on page 209.

|                 |                                                                                               |
|-----------------|-----------------------------------------------------------------------------------------------|
| Examples        | Dim Stp As Double<br>SCPI.SENSE(1).FREQUENCY.STOP = 3E9<br>Stp = SCPI.SENSE(1).FREQUENCY.STOP |
| Related objects | SCPI.SENSE( <i>Ch</i> ).FREQUENCY.START on page 592                                           |
| Equivalent key  | <b>[Stop]</b>                                                                                 |

## **SCPI.SENSE.MULTIplexer.CATalog**

|                 |                                                                               |
|-----------------|-------------------------------------------------------------------------------|
| Object type     | Property                                                                      |
| Syntax          | <i>Param</i> = SCPI.SENSE.MULTIplexer.CATalog                                 |
| Description     | Reads the name of the E5091A test set. (Read only)                            |
| Examples        | <pre>Dim MultCat As String<br/>MultCat = SCPI.SENSE.MULTIplexer.CATalog</pre> |
| Related objects | SCPI.SENSE.MULTIplexer(Id).NAME on page 598                                   |
| Equivalent key  | No equivalent key is available on the front panel.                            |

## SCPI.SENSE(Ch).MULTiplexer(Id).COUNT

|             |                                                                                       |
|-------------|---------------------------------------------------------------------------------------|
| Object type | Property                                                                              |
| Syntax      | <i>Value</i> = SCPI.SENSE(Ch).MULTiplexer(Id).COUNT                                   |
| Description | Reads the number of ports (9 or 16) of the E5091A whose ID is <i>Id</i> . (Read only) |
| Variable    |                                                                                       |

**Table 7-23**

### Variable(*Id*)

|              |                                                                                               |
|--------------|-----------------------------------------------------------------------------------------------|
|              | <i>Id</i>                                                                                     |
| Description  | ID of the E5091A                                                                              |
| Data type    | Long integer type (Long)                                                                      |
| Range        | 1 to 2                                                                                        |
| Preset value | 1                                                                                             |
| Note         | If the specified variable is out of the allowable setup range, an error occurs when executed. |

|             |                                             |
|-------------|---------------------------------------------|
|             | <i>Value</i>                                |
| Description | The number of ports                         |
| Data type   | Long integer type (Long)                    |
| Note        | 0 is read when the E5091A is not connected. |

**Examples**

```
Dim NPort As Long
NPort = SCPI.SENSE.MULTiplexer(1).COUNT
```

**Equivalent key** No equivalent key is available on the front panel.

## SCPI.SENSE(Ch).MULTiplexer(Id).DISPlay.STATe

|             |                                                                                                                              |
|-------------|------------------------------------------------------------------------------------------------------------------------------|
| Object type | Property                                                                                                                     |
| Syntax      | SCPI.SENSE(Ch).MULTiplexer(Id).DISPlay.STATe = <i>Status</i><br><i>Status</i> = SCPI.SENSE(Ch).MULTiplexer(Id).DISPlay.STATe |
| Description | Turns ON/OFF the property display (the state of the port assignment) of the E5091A whose ID is <i>Id</i> .                   |
| Variable    |                                                                                                                              |

|              |                                                                                                                                                                                                                             |
|--------------|-----------------------------------------------------------------------------------------------------------------------------------------------------------------------------------------------------------------------------|
|              | <i>Status</i>                                                                                                                                                                                                               |
| Description  | ON/OFF of the property display                                                                                                                                                                                              |
| Data type    | Boolean type (Boolean)                                                                                                                                                                                                      |
| Range        | Select from the following.<br><ul style="list-style-type: none"> <li>• True or -1                      Turns ON the property display.</li> <li>• False or 0                      Turns OFF the property display.</li> </ul> |
| Preset value | False or 0                                                                                                                                                                                                                  |

For information on the variable (*Id*), see Table 7-23, “Variable(*Id*),” on page 595.

|                 |                                                                                                                                                                                                                                                                                                                                                                                              |
|-----------------|----------------------------------------------------------------------------------------------------------------------------------------------------------------------------------------------------------------------------------------------------------------------------------------------------------------------------------------------------------------------------------------------|
| Examples        | <pre>Dim Prop As Boolean SCPI.SENSE.MULTiplexer(1).DISPlay.STATe = True Prop = SCPI.SENSE.MULTiplexer(1).DISPlay.STATe</pre>                                                                                                                                                                                                                                                                 |
| Related objects | <p>SCPI.SENSE(Ch).MULTiplexer(Id).TSET9.PORT1 on page 605</p> <p>SCPI.SENSE(Ch).MULTiplexer(Id).TSET9.PORT2 on page 606</p> <p>SCPI.SENSE(Ch).MULTiplexer(Id).TSET9.PORT3 on page 607</p> <p>SCPI.SENSE(Ch).MULTiplexer(Id).TSET9.PORT4 on page 608</p> <p>SCPI.SENSE(Ch).MULTiplexer(Id).PORT(Pt).CATalog on page 600</p> <p>SCPI.SENSE(Ch).MULTiplexer(Id).PORT(Pt).SElect on page 601</p> |
| Equivalent key  | <b>[System] - Multiport Test Set Setup - Test Set 1 Test Set 2 - Property</b>                                                                                                                                                                                                                                                                                                                |



## SCPI.SENSE.MULTiplexer(*Id*).INCount

|                 |                                                                                                                                                                                                                                                                          |
|-----------------|--------------------------------------------------------------------------------------------------------------------------------------------------------------------------------------------------------------------------------------------------------------------------|
| Object type     | Property                                                                                                                                                                                                                                                                 |
| Syntax          | <i>Value</i> = SCPI.SENSE.MULTiplexer( <i>Id</i> ).INCount                                                                                                                                                                                                               |
| Description     | The E5091A returns the number of input ports of ID 1 to 2 ( <i>Id</i> ) (Read only)                                                                                                                                                                                      |
| Variable        | For information on the variable ( <i>Id</i> ), see Table 7-23, “Variable( <i>Id</i> ),” on page 595.                                                                                                                                                                     |
| Examples        | <pre>Dim INCount As Long INCount = SCPI.SENSE(1).MULTiplexer(1).INCount</pre>                                                                                                                                                                                            |
| Related objects | SCPI.SENSE(Ch).MULTiplexer( <i>Id</i> ).TSET9.PORT1 on page 605<br>SCPI.SENSE(Ch).MULTiplexer( <i>Id</i> ).TSET9.PORT2 on page 606<br>SCPI.SENSE(Ch).MULTiplexer( <i>Id</i> ).TSET9.PORT3 on page 607<br>SCPI.SENSE(Ch).MULTiplexer( <i>Id</i> ).TSET9.PORT4 on page 608 |
| Equivalent key  | No equivalent key is available on the front panel.                                                                                                                                                                                                                       |

## SCPI.SENSE.MULTIplexer(*Id*).NAME

|             |                                                                                                                    |
|-------------|--------------------------------------------------------------------------------------------------------------------|
| Object type | Property                                                                                                           |
| Syntax      | SCPI.SENSE.MULTIplexer( <i>Id</i> ).NAME = <i>Param</i><br><i>Param</i> = SCPI.SENSE.MULTIplexer( <i>Id</i> ).NAME |
| Description | Specify the name of the E5091A test set.<br>The upper case and lower case are not distinguished.                   |
| Variable    |                                                                                                                    |

|             | <i>Param</i>                                                                                                                                                                                                                                                                                                                                              |
|-------------|-----------------------------------------------------------------------------------------------------------------------------------------------------------------------------------------------------------------------------------------------------------------------------------------------------------------------------------------------------------|
| Description | The name of the E5091A test set                                                                                                                                                                                                                                                                                                                           |
| Data type   | Character string type (String)                                                                                                                                                                                                                                                                                                                            |
| Range       | Select from the following.<br><ul style="list-style-type: none"> <li>•"E5091_9"                      Select the E5091A option 009.</li> <li>•"E5091_13"                    Select the E5091A option 016 for the 13-port device function.</li> <li>•"E5091_16"                    Select the E5091A option 016 for the 16-port device function.</li> </ul> |

For information on the variable (*Id*), see Table 7-23, "Variable(*Id*)," on page 595.

**Examples**

```
Dim MultName As String
SCPI.SENSE.MULTIplexer(1).NAME = "E5091_16"
MultName = SCPI.SENSE.MULTIplexer(1).NAME
```

**Related objects**

SCPI.SENSE.MULTIplexer.CATALOG on page 594  
SCPI.SENSE.MULTIplexer(*Id*).INCount on page 597

**Equivalent key**

**[System] - Multiport Test Set Setup - Test Set 1|Test Set 2 - Select Test Set - E5091\_9|E5091\_13|E5091\_16**

## SCPI.SENSE(Ch).MULTiplexer(Id).OUTPut.DATA

**Object type** Property

**Syntax** SCPI.SENSE(Ch).MULTiplexer(Id).OUTPut.DATA = *Value*  
*Value* = SCPI.SENSE(Ch).MULTiplexer(Id).OUTPut.DATA

**Description** Sets HIGH/LOW of all the control lines of the E5091A whose ID is 1 to 2 (*Id*) when measuring channel 1 to 16 (*Ch*) in the measurement using the E5091A.

To set the control lines, use the values obtained by converting 8-bit binary values expressed HIGH (1) / LOW (0) of individual lines to decimal values, assuming line 1 as LSB and line 8 as MSB.

**Variable**

|              | <i>Value</i>                                                                                                                                                                                                 |
|--------------|--------------------------------------------------------------------------------------------------------------------------------------------------------------------------------------------------------------|
| Description  | Sets/gets control line value                                                                                                                                                                                 |
| Data type    | Long integer type (Long)                                                                                                                                                                                     |
| Range        | 1 to 255                                                                                                                                                                                                     |
| Preset value | 0                                                                                                                                                                                                            |
| Note         | If the specified variable is out of the allowable setup range, the minimum value (if the lower limit of the range is not reached) or the maximum value (if the upper limit of the range is exceeded) is set. |

For information on the variable (*Ch*) and the variable (*Id*), see Table 7-13, “Variable (Ckit),” on page 432 and Table 7-23, “Variable(Id),” on page 595, respectively.

**Examples**

```
Dim OData As Long
SCPI.SENSE.MULTiplexer(1).OUTPut.DATA = "E5091_16"
MultName = SCPI.SENSE.MULTiplexer(1).OUTPut.DATA
```

**Related objects** SCPI.SENSE(Ch).MULTiplexer(Id).STATE on page 603

**Equivalent key** **[System] - Multiport Test Set Setup - Test Set 1|Test Set 2 - Control Lines**

**SCPI.SENSE(Ch).MULTiplexer(Id).PORT(Pt).CATalog**

|                 |                                                                                                                                                                                                                                                                                                                                                                                           |
|-----------------|-------------------------------------------------------------------------------------------------------------------------------------------------------------------------------------------------------------------------------------------------------------------------------------------------------------------------------------------------------------------------------------------|
| Object type     | Property                                                                                                                                                                                                                                                                                                                                                                                  |
| Syntax          | <i>String</i> = SCPI.SENSE.MULTiplexer( <i>Id</i> ).PORT( <i>Pt</i> ).CATalog                                                                                                                                                                                                                                                                                                             |
| Description     | Selects a port assigned to Port 1 to 20 ( <i>Pt</i> ) of the E5091A whose ID is 1 to 2 ( <i>Id</i> ) when measuring channel 1 to 16 ( <i>Ch</i> ) in the measurement using the E5091A.                                                                                                                                                                                                    |
| Variable        | For information on the variable ( <i>Ch</i> ), the variable ( <i>Id</i> ) and the variable ( <i>Pt</i> ), see Table 7-6, “Variable (Ch),” on page 209, Table 7-23, “Variable (Id),” on page 595 and Table 7-9, “Variable (Pt),” on page 241, respectively.                                                                                                                                |
| Examples        | <pre>Dim PortCat As String PortCat = SCPI.SENSE.MULTiplexer(1).PORT(4).CATalog</pre>                                                                                                                                                                                                                                                                                                      |
| Related objects | <p>SCPI.SENSE(Ch).MULTiplexer(Id).TSET9.PORT1 on page 605</p> <p>SCPI.SENSE(Ch).MULTiplexer(Id).TSET9.PORT2 on page 606</p> <p>SCPI.SENSE(Ch).MULTiplexer(Id).TSET9.PORT3 on page 607</p> <p>SCPI.SENSE(Ch).MULTiplexer(Id).TSET9.PORT4 on page 608</p> <p>SCPI.SENSE(Ch).MULTiplexer(Id).DISPlay.STATe on page 596</p> <p>SCPI.SENSE(Ch).MULTiplexer(Id).PORT(Pt).SElect on page 601</p> |
| Equivalent key  | No equivalent key is available on the front panel.                                                                                                                                                                                                                                                                                                                                        |

## SCPI.SENSE(Ch).MULTiplexer(Id).PORT(Pt).SElect

|             |                                                                                                                                                                                         |
|-------------|-----------------------------------------------------------------------------------------------------------------------------------------------------------------------------------------|
| Object type | Property                                                                                                                                                                                |
| Syntax      | SCPI.SENSE.MULTiplexer(Id).PORT(Pt).SElect = <i>String</i><br><i>String</i> = SCPI.SENSE.MULTiplexer(Id).PORT(Pt).SElect                                                                |
| Description | Ses a port name assigned to Port 1 to 20 ( <i>Pt</i> ) of the E5091A whose ID is 1 to 2 ( <i>Id</i> ) when measuring channel 1 to 16 ( <i>Ch</i> ) in the measurement using the E5091A. |
| Variable    | <b>When the E5091A-009 is Connected</b>                                                                                                                                                 |

|              |                                                |            |             |             |
|--------------|------------------------------------------------|------------|-------------|-------------|
|              | <b>String</b>                                  |            |             |             |
| Description  | Sets/gets a port name assigned to Port 1 to 20 |            |             |             |
| Data type    | String type (String)                           |            |             |             |
| Range        | Port 1                                         | Port 2     | Port 3      | Port 4      |
|              | A or T1*1                                      | T1*1 or T2 | R1+,R2+,R3+ | R1-,R2-,R3- |
| Preset value | A                                              | T1         | R1+         | R1-         |

\*1. If port T1 has already been assigned to port 2 when you try to assign port T1 to port 1, port T2 is automatically assigned to port 2. If port T1 has already been assigned to port 1 when you try to assign port T1 to port 2, port A is automatically assigned to port 1.

### When the E5091A-013 is Connected

|              |                                                |             |                 |                 |
|--------------|------------------------------------------------|-------------|-----------------|-----------------|
|              | <b>String</b>                                  |             |                 |                 |
| Description  | Sets/gets a port name assigned to Port 1 to 20 |             |                 |                 |
| Data type    | String type (String)                           |             |                 |                 |
| Range        | Port 1                                         | Port 2      | Port 3          | Port 4          |
|              | A1,T1,T2,T3                                    | T1,T2,T3,T4 | R1+,R2+,R3+,R4+ | R1-,R2-,R3-,R4- |
| Preset value | A                                              | T1          | R1+             | R1-             |

### When the E5091A-016 is Connected

|              |                                                |                          |                 |                 |           |           |           |
|--------------|------------------------------------------------|--------------------------|-----------------|-----------------|-----------|-----------|-----------|
|              | <b>String</b>                                  |                          |                 |                 |           |           |           |
| Description  | Sets/gets a port name assigned to Port 1 to 20 |                          |                 |                 |           |           |           |
| Data type    | String type (String)                           |                          |                 |                 |           |           |           |
| Range        | Port 1                                         | Port 2                   | Port 3          | Port 4          | Port 5    | Port 6    | Port 7    |
|              | A1(A),A2,A3,A4,T1,T2,T3                        | B1(T4),B2,B3,B4,T1,T2,T3 | R1+,R2+,R3+,R4+ | R1-,R2-,R3-,R4- | X1 and X2 | Y1 and Y2 | Z1 and Z2 |
| Preset value | A1                                             | B1                       | R1+             | R1-             | X1        | Y1        | Z1        |

For information on the variable (*Ch*), the variable (*Id*) and the variable (*Pt*), see Table 7-6, “Variable (Ch),” on page 209, Table 7-23, “Variable(Id),” on page 595 and Table 7-9, “Variable (Pt),” on page 241, respectively.

|          |                       |
|----------|-----------------------|
| Examples | Dim PortSel As String |
|----------|-----------------------|

## COM Object Reference

### SCPI.SENSE(Ch).MULTIplexer(Id).PORT(Pt).SELEct

```
SCPI.SENSE.MULTIplexer(1).PORT(4).SELEct = "R2"
PortSel = SCPI.SENSE.MULTIplexer(1).PORT(4).SELEct
```

#### Related objects

SCPI.SENSE(Ch).MULTIplexer(Id).TSET9.PORT1 on page 605

SCPI.SENSE(Ch).MULTIplexer(Id).TSET9.PORT2 on page 606

SCPI.SENSE(Ch).MULTIplexer(Id).TSET9.PORT3 on page 607

SCPI.SENSE(Ch).MULTIplexer(Id).TSET9.PORT4 on page 608

SCPI.SENSE(Ch).MULTIplexer(Id).DISPlay.STATe on page 596

SCPI.SENSE(Ch).MULTIplexer(Id).PORT(Pt).CATalog on page 600

SCPI.SENSE(Ch).MULTIplexer(Id).STATe on page 603

#### Equivalent key

**[System] - Multiport Test Set Setup - Test Set 1|Test Set 2 - Port 1|Port 2|Port 3|Port 4|Port 5|Port 6|Port 7**

## SCPI.SENSE(Ch).MULTiplexer(Id).STATE

|             |                                                                                                                                                                 |
|-------------|-----------------------------------------------------------------------------------------------------------------------------------------------------------------|
| Object type | Property                                                                                                                                                        |
| Syntax      | SCPI.SENSE(Ch).MULTiplexer(Id).STATE = <i>Status</i><br><i>Status</i> = SCPI.SENSE(Ch).MULTiplexer(Id).STATE                                                    |
| Description | Turns ON/OFF the control (switching the internal switch that connects between the ports and changing control line output) of the E5091A whose ID is <i>Id</i> . |
| Variable    |                                                                                                                                                                 |

|              | <i>Status</i>                                                                                                                                                                                                                         |
|--------------|---------------------------------------------------------------------------------------------------------------------------------------------------------------------------------------------------------------------------------------|
| Description  | ON/OFF of the control of the E5091A                                                                                                                                                                                                   |
| Data type    | Boolean type (Boolean)                                                                                                                                                                                                                |
| Range        | Select from the following.<br><ul style="list-style-type: none"> <li>• True or -1                      Turns ON the control of the E5091A.</li> <li>• False or 0                      Turns OFF the control of the E5091A.</li> </ul> |
| Preset value | False or 0                                                                                                                                                                                                                            |

For information on the variable (*Id*), see Table 7-23, “Variable(*Id*),” on page 595.

|                 |                                                                                                                                                                                                                                                                                                                                                                                                                              |
|-----------------|------------------------------------------------------------------------------------------------------------------------------------------------------------------------------------------------------------------------------------------------------------------------------------------------------------------------------------------------------------------------------------------------------------------------------|
| Examples        | Dim Cont As Boolean<br>SCPI.SENSE.MULTiplexer(1).STATE = True<br>Cont = SCPI.SENSE.MULTiplexer(1).STATE                                                                                                                                                                                                                                                                                                                      |
| Related objects | SCPI.SENSE(Ch).MULTiplexer(Id).OUTPut.DATA on page 599<br>SCPI.SENSE(Ch).MULTiplexer(Id).PORT(Pt).SElect on page 601<br>SCPI.SENSE(Ch).MULTiplexer(Id).TSET9.PORT1 on page 605<br>SCPI.SENSE(Ch).MULTiplexer(Id).TSET9.PORT2 on page 606<br>SCPI.SENSE(Ch).MULTiplexer(Id).TSET9.PORT3 on page 607<br>SCPI.SENSE(Ch).MULTiplexer(Id).TSET9.PORT4 on page 608<br>SCPI.SENSE(Ch).MULTiplexer(Id).TSET9.OUTPut.DATA on page 604 |
| Equivalent key  | <b>[System] - Multiport Test Set Setup - Test Set 1 Test Set 2 - Control</b>                                                                                                                                                                                                                                                                                                                                                 |

**SCPI.SENSE(Ch).MULTiplexer(Id).TSET9.OUTPut.DATA**

Object type

Property

Syntax

SCPI.SENSE(Ch).MULTiplexer(Id).TSET9.OUTPut.DATA = *Value**Value* = SCPI.SENSE(Ch).MULTiplexer(Id).TSET9.OUTPut.DATA

Description

Sets the HIGH/LOW of all the control line of the E5091A whose ID is *Id* when measuring channels 1 to 16 (*Ch*) in the measurement using the E5091A.

To set the control lines, use values obtained by converting 8-bit binary values expressed by HIGH (1)/LOW (0) of individual lines to decimal values, assuming line 1 as LSB and line 8 as MSB.

Variable

|              | <i>Value</i>                                                                                                                                                                                                 |
|--------------|--------------------------------------------------------------------------------------------------------------------------------------------------------------------------------------------------------------|
| Description  | Setting value the control line                                                                                                                                                                               |
| Data type    | Long integer type (Long)                                                                                                                                                                                     |
| Range        | 0 to 255                                                                                                                                                                                                     |
| Preset value | 0                                                                                                                                                                                                            |
| Resolution   | 1                                                                                                                                                                                                            |
| Note         | If the specified variable is out of the allowable setup range, the minimum value (if the lower limit of the range is not reached) or the maximum value (if the upper limit of the range is exceeded) is set. |

For information on the variable (*Ch*) and the variable (*Id*), see Table 7-6, “Variable (Ch),” on page 209 and Table 7-23, “Variable(Id),” on page 595, respectively.

Examples

```
Dim C_line As Long
SCPI.SENSE(1).MULTiplexer(1).TSET9.OUTPut.DATA = 5
C_line = SCPI.SENSE(1).MULTiplexer(1).TSET9.OUTPut.DATA
```

Related objects

SCPI.SENSE(Ch).MULTiplexer(Id).STATE on page 603

Equivalent key

**[System] - Multiport Test Set Setup - Test Set 1|Test Set 2 - Control Lines - Line 1|...|Line 8**



## SCPI.SENSE(Ch).MULTiplexer(Id).TSET9.PORT1

Object type Property

Syntax SCPI.SENSE(Ch).MULTiplexer(Id).TSET9.PORT1 = *Param*  
*Param* = SCPI.SENSE(Ch).MULTiplexer(Id).TSET9.PORT1

Description Selects a port assigned to Port 1 of the E5091A whose ID is *Id* when measuring channels 1 to 16 (*Ch*) in the measurement using the E5091A.  
 If the port assigned to Port 2 is T1 and you select T1 as the port assigned to Port 1, the port assigned to Port 2 is changed to T2 automatically.

Variable

|             | <i>Param</i>                                                                                                                                                                                                                      |
|-------------|-----------------------------------------------------------------------------------------------------------------------------------------------------------------------------------------------------------------------------------|
| Description | The port assigned to Port 1                                                                                                                                                                                                       |
| Data type   | Character string type (String)                                                                                                                                                                                                    |
| Range       | Select from the following.<br><ul style="list-style-type: none"> <li>•"A"                      Selects A as the port assigned to Port 1.</li> <li>•"T1"                     Selects T1 as the port assigned to Port 1.</li> </ul> |

For information on the variable (*Ch*) and the variable (*Id*), see Table 7-6, "Variable (Ch)," on page 209 and Table 7-23, "Variable(Id)," on page 595, respectively.

Examples  

```
Dim Port As String
SCPI.SENSE(1).MULTiplexer(1).TSET9.PORT1 = "T1"
Port = SCPI.SENSE(1).MULTiplexer(1).TSET9.PORT1
```

Related objects  
 SCPI.SENSE(Ch).MULTiplexer(Id).STATE on page 603  
 SCPI.SENSE(Ch).MULTiplexer(Id).TSET9.PORT2 on page 606  
 SCPI.SENSE(Ch).MULTiplexer(Id).TSET9.PORT3 on page 607  
 SCPI.SENSE(Ch).MULTiplexer(Id).TSET9.PORT4 on page 608  
 SCPI.SENSE(Ch).MULTiplexer(Id).DISPlay.STATe on page 596  
 SCPI.SENSE(Ch).MULTiplexer(Id).PORT(Pt).CATalog on page 600

Equivalent key **[System] - Multiport Test Set Setup - Test Set 1|Test Set 2 - Port 1 - A|T1**

## SCPI.SENSE(*Ch*).MULTiplexer(*Id*).TSET9.PORT2

**Object type** Property

**Syntax** SCPI.SENSE(*Ch*).MULTiplexer(*Id*).TSET9.PORT2 = *Param*  
*Param* = SCPI.SENSE(*Ch*).MULTiplexer(*Id*).TSET9.PORT2

**Description** Selects a port assigned to Port 2 of the E5091A whose ID is *Id* when measuring channels 1 to 16 (*Ch*) in the measurement using the E5091A.  
 If the port assigned to Port 1 is T1 and you select T1 as the port assigned to Port 2, the port assigned to Port 1 is changed to A automatically.

**Variable**

|             | <i>Param</i>                                                                                                                                                                                                                         |
|-------------|--------------------------------------------------------------------------------------------------------------------------------------------------------------------------------------------------------------------------------------|
| Description | The port assigned to Port 2                                                                                                                                                                                                          |
| Data type   | Character string type (String)                                                                                                                                                                                                       |
| Range       | Select from the following.<br><ul style="list-style-type: none"> <li>•"T1"                      Selects T1 as the port assigned to Port 2.</li> <li>•"T2"                      Selects T2 as the port assigned to Port 2.</li> </ul> |

For information on the variable (*Ch*) and the variable (*Id*), see Table 7-6, “Variable (Ch),” on page 209 and Table 7-23, “Variable(Id),” on page 595, respectively.

**Examples**

```
Dim Port As String
SCPI.SENSE(1).MULTiplexer(1).TSET9.PORT2 = "T2"
Port = SCPI.SENSE(1).MULTiplexer(1).TSET9.PORT2
```

**Related objects**

- SCPI.SENSE(Ch).MULTiplexer(Id).STATE on page 603
- SCPI.SENSE(Ch).MULTiplexer(Id).TSET9.PORT1 on page 605
- SCPI.SENSE(Ch).MULTiplexer(Id).TSET9.PORT3 on page 607
- SCPI.SENSE(Ch).MULTiplexer(Id).TSET9.PORT4 on page 608
- SCPI.SENSE(Ch).MULTiplexer(Id).DISPlay.STATE on page 596
- SCPI.SENSE(Ch).MULTiplexer(Id).PORT(Pt).CATalog on page 600

**Equivalent key** **[System] - Multiport Test Set Setup - Test Set 1|Test Set 2 - Port2 - T1|T2**

## SCPI.SENSE(Ch).MULTiplexer(Id).TSET9.PORT3

**Object type** Property

**Syntax** SCPI.SENSE(Ch).MULTiplexer(Id).TSET9.PORT3 = *Param*  
*Param* = SCPI.SENSE(Ch).MULTiplexer(Id).TSET9.PORT3

**Description** Selects a port assigned to Port 3 of the E5091A whose ID is *Id* when measuring channels 1 to 16 (*Ch*) in the measurement using the E5091A.

**Variable**

|             | <i>Param</i>                                                                                                                                                                                                                                                                                                             |
|-------------|--------------------------------------------------------------------------------------------------------------------------------------------------------------------------------------------------------------------------------------------------------------------------------------------------------------------------|
| Description | The port assigned to Port 3                                                                                                                                                                                                                                                                                              |
| Data type   | Character string type (String)                                                                                                                                                                                                                                                                                           |
| Range       | Select from the following.<br><ul style="list-style-type: none"> <li>•"R1"                      Selects R1+ as the port assigned to Port 3.</li> <li>•"R2"                      Selects R2+ as the port assigned to Port 3.</li> <li>•"R3"                      Selects R3+*1 as the port assigned to Port 3.</li> </ul> |

\*1. For Option 007 (7 ports), R2+.

For information on the variable (*Ch*) and the variable (*Id*), see Table 7-6, "Variable (Ch)," on page 209 and Table 7-23, "Variable(Id)," on page 595, respectively.

**Examples**

```
Dim Port As String
SCPI.SENSE(1).MULTiplexer(1).TSET9.PORT3 = "R2"
Port = SCPI.SENSE(1).MULTiplexer(1).TSET9.PORT3
```

**Related objects**

SCPI.SENSE(Ch).MULTiplexer(Id).STATE on page 603

SCPI.SENSE(Ch).MULTiplexer(Id).TSET9.PORT1 on page 605

SCPI.SENSE(Ch).MULTiplexer(Id).TSET9.PORT2 on page 606

SCPI.SENSE(Ch).MULTiplexer(Id).TSET9.PORT4 on page 608

SCPI.SENSE(Ch).MULTiplexer(Id).DISPlay.STATE on page 596

SCPI.SENSE(Ch).MULTiplexer(Id).PORT(Pt).CATalog on page 600

**Equivalent key** **[System] - Multiport Test Set Setup - Test Set 1|Test Set 2 - Port3 - R1+|R2+|R3+**

## SCPI.SENSE(Ch).MULTiplexer(Id).TSET9.PORT4

|             |                                                                                                                                                          |
|-------------|----------------------------------------------------------------------------------------------------------------------------------------------------------|
| Object type | Property                                                                                                                                                 |
| Syntax      | SCPI.SENSE(Ch).MULTiplexer(Id).TSET9.PORT3 = <i>Param</i><br><i>Param</i> = SCPI.SENSE(Ch).MULTiplexer(Id).TSET9.PORT3                                   |
| Description | Selects a port assigned to Port 4 of the E5091A whose ID is <i>Id</i> when measuring channels 1 to 16 ( <i>Ch</i> ) in the measurement using the E5091A. |
| Variable    |                                                                                                                                                          |

|             | <i>Param</i>                                                                                                                                                                                                                                                                                                                        |
|-------------|-------------------------------------------------------------------------------------------------------------------------------------------------------------------------------------------------------------------------------------------------------------------------------------------------------------------------------------|
| Description | The port assigned to Port 4                                                                                                                                                                                                                                                                                                         |
| Data type   | Character string type (String)                                                                                                                                                                                                                                                                                                      |
| Range       | Select from the following.<br><ul style="list-style-type: none"> <li>•"R1"                      Selects R1- as the port assigned to Port 4.</li> <li>•"R2"                      Selects R2- as the port assigned to Port 4.</li> <li>•"R3"                      Selects R3-<sup>*1</sup> as the port assigned to Port 4.</li> </ul> |

\*1. For Option 007 (7 ports), R2-.

For information on the variable (*Ch*) and the variable (*Id*), see Table 7-6, "Variable (Ch)," on page 209 and Table 7-23, "Variable(Id)," on page 595, respectively.

**Examples**

```
Dim Port As String
SCPI.SENSE(1).MULTiplexer(1).TSET9.PORT4 = "R2"
Port = SCPI.SENSE(1).MULTiplexer(1).TSET9.PORT4
```

**Related objects**

SCPI.SENSE(Ch).MULTiplexer(Id).STATE on page 603  
SCPI.SENSE(Ch).MULTiplexer(Id).TSET9.PORT1 on page 605  
SCPI.SENSE(Ch).MULTiplexer(Id).TSET9.PORT2 on page 606  
SCPI.SENSE(Ch).MULTiplexer(Id).TSET9.PORT3 on page 607  
SCPI.SENSE(Ch).MULTiplexer(Id).DISPLAY.STATE on page 596  
SCPI.SENSE(Ch).MULTiplexer(Id).PORT(Pt).CATalog on page 600

**Equivalent key**      **[System] - Multiport Test Set Setup - Test Set 1|Test Set 2 - Port4 - R1-|R2-|R3-**

## SCPI.SENSE(Ch).OFFSET.ASPurious

Type of object      Property

Syntax                `SCPI.SENSE(Ch).OFFSET.ASPurious = Status`  
*Status* = `SCPI.SENSE(Ch).OFFSET.ASPurious`

Description            For channels 1 to 16 (*Ch*), turns on/off the spurious avoidance mode.  
 When the spurious avoidance is on, measurement is performed avoiding spurious that occurs due to the following signals.

- Source signal and its harmonics
- When the frequency setting for the external signal source is enabled, the set signal and its harmonics.

Variable

|              |                                                                                                                                                                                                                                           |
|--------------|-------------------------------------------------------------------------------------------------------------------------------------------------------------------------------------------------------------------------------------------|
|              | <i>Status</i>                                                                                                                                                                                                                             |
| Description  | On/off of the spurious avoidance mode for frequency offset measurement                                                                                                                                                                    |
| Data type    | Boolean type (Boolean)                                                                                                                                                                                                                    |
| Range        | Select from the following.<br><ul style="list-style-type: none"> <li>• True or -1                      Turns on the spurious avoidance mode.</li> <li>• False or 0                      Turns off the spurious avoidance mode.</li> </ul> |
| Preset value | False or 0                                                                                                                                                                                                                                |

For information on the variable (*Ch*), refer to Table 7-6, “Variable (Ch),” on page 209.

Example of use        `Dim ASpurious As Boolean`  
`SCPI.SENSE(1).OFFSET.ASPurious = False`  
`ASpurious = SCPI.SENSE(1).OFFSET.ASPurious`

Equivalent key        **[Sweep Setup] - Frequency Offset - Avoid Spurious**

## SCPI.SENSE(*Ch*).OFFSET.LOCAL.CONTROL.STATE

|                |                                                                                                                                          |
|----------------|------------------------------------------------------------------------------------------------------------------------------------------|
| Type of object | Property                                                                                                                                 |
| Syntax         | SCPI.SENSE( <i>Ch</i> ).OFFSET.LOCAL.CONTROL.STATE = <i>Status</i><br><i>Status</i> = SCPI.SENSE( <i>Ch</i> ).OFFSET.LOCAL.CONTROL.STATE |
| Description    | For channels 1 to 16 ( <i>Ch</i> ), turns on/off the external signal source control mode.                                                |
| Variable       |                                                                                                                                          |

|              |                                                                                                                                                                                                                                                                   |
|--------------|-------------------------------------------------------------------------------------------------------------------------------------------------------------------------------------------------------------------------------------------------------------------|
|              | <i>Status</i>                                                                                                                                                                                                                                                     |
| Description  | On/off of the external signal source                                                                                                                                                                                                                              |
| Data type    | Boolean type (Boolean)                                                                                                                                                                                                                                            |
| Range        | Select from the following.<br><ul style="list-style-type: none"> <li>• True or -1                      Turns on the external signal source control mode.</li> <li>• False or 0                      Turns off the external signal source control mode.</li> </ul> |
| Preset value | False or 0                                                                                                                                                                                                                                                        |

For information on the variable (*Ch*), refer to Table 7-6, “Variable (Ch),” on page 209.

|                |                                                                                                                              |
|----------------|------------------------------------------------------------------------------------------------------------------------------|
| Example of use | Dim State As Boolean<br>SCPI.SENSE(1).OFFSET.LOCAL.CONTROL.STATE = False<br>State = SCPI.SENSE(1).OFFSET.LOCAL.CONTROL.STATE |
| Equivalent key | <b>[Sweep Setup] - Frequency Offset - External Source - Control</b>                                                          |

## SCPI.SENSE(Ch).OFFSET.LOCAL.FREQUENCY.DATA

Type of object

Syntax

*Data* = SCPI.SENSE(*Ch*).OFFSET.LOCAL.FREQUENCY.DATA

Description

For channels 1 to 16 (*Ch*), acquires the external signal source frequency data. (Read only)

Variable

|             | <i>Data</i>                                                      |
|-------------|------------------------------------------------------------------|
| Description | Reads out the frequencies of all measurement points as an array. |
| Data type   | Variant type (Variant)                                           |

For information on the variable (*Ch*), refer to Table 7-6, “Variable (Ch),” on page 209.

Example of use

```
Dim LoData As Variant
LoData = SCPI.SENSE(1).OFFSET.LOCAL.FREQUENCY.DATA
```

Related objects

SCPI.SENSE(Ch).OFFSET.LOCAL.FREQUENCY.DIVISOR on page 612  
 SCPI.SENSE(Ch).OFFSET.LOCAL.FREQUENCY.MULTIPLIER on page 613  
 SCPI.SENSE(Ch).OFFSET.LOCAL.FREQUENCY.OFFSET on page 614  
 SCPI.SENSE(Ch).OFFSET.LOCAL.FREQUENCY.START on page 615  
 SCPI.SENSE(Ch).OFFSET.LOCAL.FREQUENCY.STOP on page 616

Equivalent key

No equivalent key is available on the front panel.

## SCPI.SENSE(*Ch*).OFFSET.LOCAL.FREQUENCY.DIVISOR

|                |                                                                                                                                                                      |
|----------------|----------------------------------------------------------------------------------------------------------------------------------------------------------------------|
| Type of object | Property                                                                                                                                                             |
| Syntax         | SCPI.SENSE( <i>Ch</i> ).OFFSET.LOCAL.FREQUENCY.DIVISOR = <i>Value</i><br><i>Value</i> = SCPI.SENSE( <i>Ch</i> ).OFFSET.LOCAL.FREQUENCY.DIVISOR                       |
| Description    | For channels 1 to 16 ( <i>Ch</i> ), the external signal source frequency is set by using a divisor value for the basic frequency. This command sets a divisor value. |
| Variable       |                                                                                                                                                                      |

|              | <i>Value</i>                                                                                                                                                                                                 |
|--------------|--------------------------------------------------------------------------------------------------------------------------------------------------------------------------------------------------------------|
| Description  | Setting of a divisor value for the basic frequency                                                                                                                                                           |
| Data type    | Double precision floating point type (Double)                                                                                                                                                                |
| Range        | 1 to 100                                                                                                                                                                                                     |
| Preset value | 1                                                                                                                                                                                                            |
| Note         | If the specified variable is out of the allowable setup range, the minimum value (if the lower limit of the range is not reached) or the maximum value (if the upper limit of the range is exceeded) is set. |

For information on the variable (*Ch*), refer to Table 7-6, “Variable (Ch),” on page 209.

|                 |                                                                                                                                                                                                                                                                                              |
|-----------------|----------------------------------------------------------------------------------------------------------------------------------------------------------------------------------------------------------------------------------------------------------------------------------------------|
| Example of use  | <pre>Dim Divisor As Double SCPI.SENSE(1).OFFSET.LOCAL.FREQUENCY.DIVISOR = 50 Divisor = SCPI.SENSE(1).OFFSET.LOCAL.FREQUENCY.DIVISOR</pre>                                                                                                                                                    |
| Related objects | <p>SCPI.SENSE(<i>Ch</i>).OFFSET.LOCAL.FREQUENCY.MULTIPLIER on page 613</p> <p>SCPI.SENSE(<i>Ch</i>).OFFSET.LOCAL.FREQUENCY.OFFSET on page 614</p> <p>SCPI.SENSE(<i>Ch</i>).OFFSET.LOCAL.FREQUENCY.START on page 615</p> <p>SCPI.SENSE(<i>Ch</i>).OFFSET.LOCAL.FREQUENCY.STOP on page 616</p> |
| Equivalent key  | <b>[Sweep Setup] - Frequency Offset - External Source - Divisor</b>                                                                                                                                                                                                                          |

---

**NOTE** The basic frequency range is set by using “SCPI.SENSE(*Ch*).FREQUENCY.START” on page 592 and “SCPI.SENSE(*Ch*).FREQUENCY.STOP” on page 593.

---



## **SCPI.SENSE(Ch).OFFSET.LOCAL.FREQUENCY.MULTIPLIER**

Type of object      Property

Syntax                `SCPI.SENSE(Ch).OFFSET.LOCAL.FREQUENCY.MULTIPLIER = Value`  
*Value* = `SCPI.SENSE(Ch).OFFSET.LOCAL.FREQUENCY.MULTIPLIER`

Description         For channels 1 to 16 (*Ch*), the external signal source frequency is set by using a multiplier value for the basic frequency. This command sets a multiplier value.

Variable

|              | <i>Value</i>                                                                                                                                                                                                 |
|--------------|--------------------------------------------------------------------------------------------------------------------------------------------------------------------------------------------------------------|
| Description  | Setting of a multiplier value for the basic frequency                                                                                                                                                        |
| Data type    | Double precision floating point type (Double)                                                                                                                                                                |
| Range        | -100 to 100                                                                                                                                                                                                  |
| Preset value | 0                                                                                                                                                                                                            |
| Note         | If the specified variable is out of the allowable setup range, the minimum value (if the lower limit of the range is not reached) or the maximum value (if the upper limit of the range is exceeded) is set. |

For information on the variable (*Ch*), refer to Table 7-6, “Variable (Ch),” on page 209.

Example of use      `Dim Multiplier As Double`  
`SCPI.SENSE(1).OFFSET.LOCAL.FREQUENCY.MULTIPLIER = -10`  
`Multiplier = SCPI.SENSE(1).OFFSET.LOCAL.FREQUENCY.MULTIPLIER`

Related objects     `SCPI.SENSE(Ch).OFFSET.LOCAL.FREQUENCY.DIVISOR` on page 612  
`SCPI.SENSE(Ch).OFFSET.LOCAL.FREQUENCY.OFFSET` on page 614  
`SCPI.SENSE(Ch).OFFSET.LOCAL.FREQUENCY.START` on page 615  
`SCPI.SENSE(Ch).OFFSET.LOCAL.FREQUENCY.STOP` on page 616

Equivalent key      **[Sweep Setup] - Frequency Offset - External Source - Multiplier**

**NOTE**              The basic frequency range is set by using “`SCPI.SENSE(Ch).FREQUENCY.START`” on page 592 and “`SCPI.SENSE(Ch).FREQUENCY.STOP`” on page 593.

## SCPI.SENSE(*Ch*).OFFSET.LOCAL.FREQUENCY.OFFSET

|                |                                                                                                                                                                      |
|----------------|----------------------------------------------------------------------------------------------------------------------------------------------------------------------|
| Type of object | Property                                                                                                                                                             |
| Syntax         | SCPI.SENSE( <i>Ch</i> ).OFFSET.LOCAL.FREQUENCY.OFFSET = <i>Value</i><br><i>Value</i> = SCPI.SENSE( <i>Ch</i> ).OFFSET.LOCAL.FREQUENCY.OFFSET                         |
| Description    | For channels 1 to 16 ( <i>Ch</i> ), the external signal source frequency is set by using an offset value for the basic frequency. This command sets an offset value. |
| Variable       |                                                                                                                                                                      |

|              | <i>Value</i>                                                                                                                                                                                                 |
|--------------|--------------------------------------------------------------------------------------------------------------------------------------------------------------------------------------------------------------|
| Description  | Setting of an offset value for the basic frequency                                                                                                                                                           |
| Data type    | Double precision floating point type (Double)                                                                                                                                                                |
| Range        | -1E12 to 1E12                                                                                                                                                                                                |
| Preset value | 0                                                                                                                                                                                                            |
| Unit         | Hz (hertz)                                                                                                                                                                                                   |
| Resolution   | 1                                                                                                                                                                                                            |
| Note         | If the specified variable is out of the allowable setup range, the minimum value (if the lower limit of the range is not reached) or the maximum value (if the upper limit of the range is exceeded) is set. |

For information on the variable (*Ch*), refer to Table 7-6, “Variable (*Ch*),” on page 209.

|                 |                                                                                                                                                                                                                                                                                    |
|-----------------|------------------------------------------------------------------------------------------------------------------------------------------------------------------------------------------------------------------------------------------------------------------------------------|
| Example of use  | Dim Offset As Double<br>SCPI.SENSE(1).OFFSET.LOCAL.FREQUENCY.OFFSET = -10<br>Offset = SCPI.SENSE(1).OFFSET.LOCAL.FREQUENCY.OFFSET                                                                                                                                                  |
| Related objects | SCPI.SENSE( <i>Ch</i> ).OFFSET.LOCAL.FREQUENCY.DIVISOR on page 612<br>SCPI.SENSE( <i>Ch</i> ).OFFSET.LOCAL.FREQUENCY.MULTIPLIER on page 613<br>SCPI.SENSE( <i>Ch</i> ).OFFSET.LOCAL.FREQUENCY.START on page 615<br>SCPI.SENSE( <i>Ch</i> ).OFFSET.LOCAL.FREQUENCY.STOP on page 616 |
| Equivalent key  | <b>[Sweep Setup] - Frequency Offset - External Source - Offset</b>                                                                                                                                                                                                                 |

---

**NOTE** The basic frequency range is set by using “SCPI.SENSE(*Ch*).FREQUENCY.START” on page 592 and “SCPI.SENSE(*Ch*).FREQUENCY.STOP” on page 593.

---

## SCPI.SENSE(Ch).OFFSET.LOCAL.FREQUENCY.START

|                |                                                                                                                          |
|----------------|--------------------------------------------------------------------------------------------------------------------------|
| Type of object | Property                                                                                                                 |
| Syntax         | SCPI.SENSE(Ch).OFFSET.LOCAL.FREQUENCY.START = <i>Value</i><br><i>Value</i> = SCPI.SENSE(Ch).OFFSET.LOCAL.FREQUENCY.START |
| Description    | For channels 1 to 16 ( <i>Ch</i> ), sets a start value for the external signal source frequency setting.                 |
| Variable       |                                                                                                                          |

|              | <i>Value</i>                                                                                                                                                                                                 |
|--------------|--------------------------------------------------------------------------------------------------------------------------------------------------------------------------------------------------------------|
| Description  | Setting of a start value for the external signal source                                                                                                                                                      |
| Data type    | Double precision floating point type (Double)                                                                                                                                                                |
| Range        | 0 to 1E12                                                                                                                                                                                                    |
| Preset value | 0                                                                                                                                                                                                            |
| Unit         | Hz (hertz)                                                                                                                                                                                                   |
| Resolution   | 1                                                                                                                                                                                                            |
| Note         | If the specified variable is out of the allowable setup range, the minimum value (if the lower limit of the range is not reached) or the maximum value (if the upper limit of the range is exceeded) is set. |

For information on the variable (*Ch*), refer to Table 7-6, “Variable (Ch),” on page 209.

|                 |                                                                                                                                                                                                                                                                    |
|-----------------|--------------------------------------------------------------------------------------------------------------------------------------------------------------------------------------------------------------------------------------------------------------------|
| Example of use  | <pre>Dim Start As Double SCPI.SENSE(1).OFFSET.LOCAL.FREQUENCY.START = 100E6 Start = SCPI.SENSE(1).OFFSET.LOCAL.FREQUENCY.START</pre>                                                                                                                               |
| Related objects | <p>SCPI.SENSE(Ch).OFFSET.LOCAL.FREQUENCY.DIVISOR on page 612</p> <p>SCPI.SENSE(Ch).OFFSET.LOCAL.FREQUENCY.MULTIPLIER on page 613</p> <p>SCPI.SENSE(Ch).OFFSET.LOCAL.FREQUENCY.OFFSET on page 614</p> <p>SCPI.SENSE(Ch).OFFSET.LOCAL.FREQUENCY.STOP on page 616</p> |
| Equivalent key  | <b>[Sweep Setup] - Frequency Offset - External Source - Start</b>                                                                                                                                                                                                  |

## SCPI.SENSE(*Ch*).OFFSET.LOCAL.FREQUENCY.STOP

|                |                                                                                                                                          |
|----------------|------------------------------------------------------------------------------------------------------------------------------------------|
| Type of object | Property                                                                                                                                 |
| Syntax         | SCPI.SENSE( <i>Ch</i> ).OFFSET.LOCAL.FREQUENCY.STOP = <i>Value</i><br><i>Value</i> = SCPI.SENSE( <i>Ch</i> ).OFFSET.LOCAL.FREQUENCY.STOP |
| Description    | For channels 1 to 16 ( <i>Ch</i> ), sets a stop value for the external signal source frequency setting.                                  |
| Variable       |                                                                                                                                          |

|              | <i>Value</i>                                                                                                                                                                                                 |
|--------------|--------------------------------------------------------------------------------------------------------------------------------------------------------------------------------------------------------------|
| Description  | Setting of a stop value for the external signal source                                                                                                                                                       |
| Data type    | Double precision floating point type (Double)                                                                                                                                                                |
| Range        | 0 to 1E12                                                                                                                                                                                                    |
| Preset value | 0                                                                                                                                                                                                            |
| Unit         | Hz (hertz)                                                                                                                                                                                                   |
| Resolution   | 1                                                                                                                                                                                                            |
| Note         | If the specified variable is out of the allowable setup range, the minimum value (if the lower limit of the range is not reached) or the maximum value (if the upper limit of the range is exceeded) is set. |

For information on the variable (*Ch*), refer to Table 7-6, “Variable (*Ch*),” on page 209.

|                 |                                                                                                                                                                                                                                                                                      |
|-----------------|--------------------------------------------------------------------------------------------------------------------------------------------------------------------------------------------------------------------------------------------------------------------------------------|
| Example of use  | Dim Stop As Double<br>SCPI.SENSE(1).OFFSET.LOCAL.FREQUENCY.STOP = 100E6<br>Stop = SCPI.SENSE(1).OFFSET.LOCAL.FREQUENCY.STOP                                                                                                                                                          |
| Related objects | SCPI.SENSE( <i>Ch</i> ).OFFSET.LOCAL.FREQUENCY.DIVISOR on page 612<br>SCPI.SENSE( <i>Ch</i> ).OFFSET.LOCAL.FREQUENCY.MULTIPLIER on page 613<br>SCPI.SENSE( <i>Ch</i> ).OFFSET.LOCAL.FREQUENCY.OFFSET on page 614<br>SCPI.SENSE( <i>Ch</i> ).OFFSET.LOCAL.FREQUENCY.START on page 615 |
| Equivalent key  | <b>[Sweep Setup] - Frequency Offset - External Source - Stop</b>                                                                                                                                                                                                                     |

**SCPI.SENSE(Ch).OFFSET.LOCAL.POWER.LEVEL.IMMEDIATE.AMPLITUDE**

|                |                                                                                                                                                          |
|----------------|----------------------------------------------------------------------------------------------------------------------------------------------------------|
| Type of object | Property                                                                                                                                                 |
| Syntax         | SCPI.SENSE(Ch).OFFSET.LOCAL.POWER.LEVEL.IMMEDIATE.AMPLITUDE = <i>Value</i><br><i>Value</i> = SCPI.SENSE(Ch).OFFSET.LOCAL.POWER.LEVEL.IMMEDIATE.AMPLITUDE |
| Description    | For channels 1 to 16 ( <i>Ch</i> ), sets a power level value for the external signal source power setting.                                               |
| Variable       |                                                                                                                                                          |

|              | <i>Value</i>                                                                                                                                                                                                 |
|--------------|--------------------------------------------------------------------------------------------------------------------------------------------------------------------------------------------------------------|
| Description  | Setting of a power level value for the external signal source                                                                                                                                                |
| Data type    | Double precision floating point type (Double)                                                                                                                                                                |
| Range        | -150 to 30                                                                                                                                                                                                   |
| Preset value | -10                                                                                                                                                                                                          |
| Unit         | dBm                                                                                                                                                                                                          |
| Resolution   | 0.01                                                                                                                                                                                                         |
| Note         | If the specified variable is out of the allowable setup range, the minimum value (if the lower limit of the range is not reached) or the maximum value (if the upper limit of the range is exceeded) is set. |

For information on the variable (*Ch*), refer to Table 7-6, “Variable (Ch),” on page 209.

|                 |                                                                                                                                                               |
|-----------------|---------------------------------------------------------------------------------------------------------------------------------------------------------------|
| Example of use  | Dim Power As Double<br>SCPI.SENSE(1).OFFSET.LOCAL.POWER.LEVEL.IMMEDIATE.AMPLITUDE = -10<br>Power = SCPI.SENSE(1).OFFSET.LOCAL.POWER.LEVEL.IMMEDIATE.AMPLITUDE |
| Related objects | SCPI.SENSE(Ch).OFFSET.LOCAL.POWER.LEVEL.SLOPE.DATA on page 618<br>SCPI.SENSE(Ch).OFFSET.LOCAL.POWER.LEVEL.SLOPE.STATE on page 619                             |
| Equivalent key  | <b>[Sweep Setup] - Frequency Offset - External Source - Power</b>                                                                                             |

**SCPI.SENSE(*Ch*).OFFSET.LOCAL.POWER.LEVEL.SLOPE.DA  
TA**

Type of object Property

Syntax SCPI.SENSE(*Ch*).OFFSET.LOCAL.POWER.LEVEL.SLOPE.DATA = *Value*  
*Value* = SCPI.SENSE(*Ch*).OFFSET.LOCAL.POWER.LEVEL.SLOPE.DATA

Description For channels 1 to 16 (*Ch*), sets a power slope value for the external signal source.

Variable

|              | <i>Value</i>                                                                                                                                                                                                 |
|--------------|--------------------------------------------------------------------------------------------------------------------------------------------------------------------------------------------------------------|
| Description  | Setting of a power slope value for the external signal source                                                                                                                                                |
| Data type    | Double precision floating point type (Double)                                                                                                                                                                |
| Range        | -2 to 2                                                                                                                                                                                                      |
| Preset value | 0                                                                                                                                                                                                            |
| Unit         | dB/GHz                                                                                                                                                                                                       |
| Resolution   | 0.01                                                                                                                                                                                                         |
| Note         | If the specified variable is out of the allowable setup range, the minimum value (if the lower limit of the range is not reached) or the maximum value (if the upper limit of the range is exceeded) is set. |

For information on the variable (*Ch*), refer to Table 7-6, “Variable (Ch),” on page 209.

Example of use Dim Slope As Double  
SCPI.SENSE(1).OFFSET.LOCAL.POWER.LEVEL.SLOPE.DATA = -1  
Slope = SCPI.SENSE(1).OFFSET.LOCAL.POWER.LEVEL.SLOPE.DATA

Related objects SCPI.SENSE(*Ch*).OFFSET.LOCAL.POWER.LEVEL.IMMEDIATE.AMPLITUDE on page 617  
SCPI.SENSE(*Ch*).OFFSET.LOCAL.POWER.LEVEL.SLOPE.STATE on page 619

Equivalent key **[Sweep Setup] - Frequency Offset - External Source - Slope**

## **SCPI.SENSE(Ch).OFFSET.LOCAL.POWER.LEVEL.SLOPE.STATE**

|                |                                                                                                                                            |
|----------------|--------------------------------------------------------------------------------------------------------------------------------------------|
| Type of object | Property                                                                                                                                   |
| Syntax         | SCPI.SENSE(Ch).OFFSET.LOCAL.POWER.LEVEL.SLOPE.STATE = <i>Status</i><br><i>Status</i> = SCPI.SENSE(Ch).OFFSET.LOCAL.POWER.LEVEL.SLOPE.STATE |
| Description    | For channels 1 to 16 ( <i>Ch</i> ), turns on/off the power slope value setting mode for the external signal source.                        |
| Variable       |                                                                                                                                            |

|              | <i>Status</i>                                                                                                                                                                                                               |
|--------------|-----------------------------------------------------------------------------------------------------------------------------------------------------------------------------------------------------------------------------|
| Description  | On/off of the power slope setting for the external signal source                                                                                                                                                            |
| Data type    | Boolean type (Boolean)                                                                                                                                                                                                      |
| Range        | Select from the following.<br><ul style="list-style-type: none"> <li>• True or -1                      Turns on the power slope mode.</li> <li>• False or 0                      Turns off the power slope mode.</li> </ul> |
| Preset value | False or 0                                                                                                                                                                                                                  |

For information on the variable (*Ch*), refer to Table 7-6, “Variable (Ch),” on page 209.

|                 |                                                                                                                                                  |
|-----------------|--------------------------------------------------------------------------------------------------------------------------------------------------|
| Example of use  | Dim State As Boolean<br>SCPI.SENSE(1).OFFSET.LOCAL.POWER.LEVEL.SLOPE.STATE = False<br>State = SCPI.SENSE(1).OFFSET.LOCAL.POWER.LEVEL.SLOPE.STATE |
| Related objects | SCPI.SENSE(Ch).OFFSET.LOCAL.POWER.LEVEL.IMMEDIATE.AMPLITUDE on page 617<br>SCPI.SENSE(Ch).OFFSET.LOCAL.POWER.LEVEL.SLOPE.DATA on page 618        |
| Equivalent key  | <b>[Sweep Setup] - Frequency Offset - External Source - Slope</b>                                                                                |

## SCPI.SENSE(*Ch*).OFFSET.LOCAL.STATE

|                |                                                                                                                                                  |
|----------------|--------------------------------------------------------------------------------------------------------------------------------------------------|
| Type of object | Property                                                                                                                                         |
| Syntax         | SCPI.SENSE( <i>Ch</i> ).OFFSET.LOCAL.STATE = <i>Status</i><br><i>Status</i> = SCPI.SENSE( <i>Ch</i> ).OFFSET.LOCAL.STATE                         |
| Description    | For channels 1 to 16 ( <i>Ch</i> ), turns on/off the external signal source frequency setting mode regardless of on/off of the frequency offset. |
| Variable       |                                                                                                                                                  |

|              |                                                                                                                                                                                                                             |
|--------------|-----------------------------------------------------------------------------------------------------------------------------------------------------------------------------------------------------------------------------|
|              | <i>Status</i>                                                                                                                                                                                                               |
| Description  | On/off of external signal source frequency setting                                                                                                                                                                          |
| Data type    | Boolean type (Boolean)                                                                                                                                                                                                      |
| Range        | Select from the following.<br><ul style="list-style-type: none"> <li>•True or -1                      Turns on the frequency setting.</li> <li>•False or 0                      Turns off the frequency setting.</li> </ul> |
| Preset value | False or 0                                                                                                                                                                                                                  |

For information on the variable (*Ch*), refer to Table 7-6, “Variable (Ch),” on page 209.

|                |                                                                                                              |
|----------------|--------------------------------------------------------------------------------------------------------------|
| Example of use | Dim State As Boolean<br>SCPI.SENSE(1).OFFSET.LOCAL.STATE = False<br>State = SCPI.SENSE(1).OFFSET.LOCAL.STATE |
|----------------|--------------------------------------------------------------------------------------------------------------|

|                |                                                                    |
|----------------|--------------------------------------------------------------------|
| Equivalent key | <b>[Setup] - Frequency Offset - External Source - LO Frequency</b> |
|----------------|--------------------------------------------------------------------|



## **SCPI.SENSE(*Ch*).OFFSET.PORT(*Pt*).FREQUENCY.DATA**

Type of object      Property

Syntax                *Data* = SCPI.SENSE(*Ch*).OFFSET.PORT(*Pt*).FREQUENCY.DATA

Description         For channels 1 to 16 (*Ch*), acquires the frequency data for ports 1 to 4 (*Pt*) when the frequency offset feature is on. (Read only)

Variable

|             | <i>Data</i>                                                      |
|-------------|------------------------------------------------------------------|
| Description | Reads out the frequencies of all measurement points as an array. |
| Data type   | Variant type (Variant)                                           |

For information on the variable (*Ch*), refer to Table 7-6, “Variable (Ch),” on page 209.

For information on the variable (*Pt*), refer to Table 7-9, “Variable (Pt),” on page 241.

Example of use      `Dim Freqdata As Variant`  
`Freqdata = SCPI.SENSE(1).OFFSET.PORT(1).FREQUENCY.DATA`

Related objects     SCPI.SENSE(Ch).OFFSET.PORT(Pt).FREQUENCY.DIVISOR on page 622  
 SCPI.SENSE(Ch).OFFSET.PORT(Pt).FREQUENCY.MULTIPLIER on page 623  
 SCPI.SENSE(Ch).OFFSET.PORT(Pt).FREQUENCY.OFFSET on page 624  
 SCPI.SENSE(Ch).OFFSET.PORT(Pt).FREQUENCY.START on page 625  
 SCPI.SENSE(Ch).OFFSET.PORT(Pt).FREQUENCY.STOP on page 626

Equivalent key      No equivalent key is available on the front panel.

**SCPI.SENSE(Ch).OFFSET.PORT(Pt).FREQUENCY.DIVISOR**

Type of object      Property

Syntax                SCPI.SENSE(Ch).OFFSET.PORT(Pt).FREQUENCY.DIVISOR = *Value*

*Value* = SCPI.SENSE(Ch).OFFSET.PORT(Pt).FREQUENCY.DIVISOR

Description         For channels 1 to 16 (*Ch*), the ports 1 to 4 (*Pt*) frequencies are set by using a divisor value for the basic frequency when the frequency offset feature is on. This command sets a divisor value.

Variable

|              | <i>Value</i>                                                                                                                                                                                                 |
|--------------|--------------------------------------------------------------------------------------------------------------------------------------------------------------------------------------------------------------|
| Description  | Setting of a frequency divisor value for the basic frequency                                                                                                                                                 |
| Data type    | Double precision floating point type (Double)                                                                                                                                                                |
| Range        | 1 to 100                                                                                                                                                                                                     |
| Preset value | 1                                                                                                                                                                                                            |
| Note         | If the specified variable is out of the allowable setup range, the minimum value (if the lower limit of the range is not reached) or the maximum value (if the upper limit of the range is exceeded) is set. |

For information on the variable (*Ch*), refer to Table 7-6, “Variable (Ch),” on page 209.

For information on the variable (*Pt*), refer to Table 7-9, “Variable (Pt),” on page 241.

Example of use

```
Dim Divisor As Double
SCPI.SENSE(1).OFFSET.PORT(1).FREQUENCY.DIVISOR = 50
Divisor = SCPI.SENSE(1).OFFSET.PORT(1).FREQUENCY.DIVISOR
```

Related objects

SCPI.SENSE(Ch).OFFSET.PORT(Pt).FREQUENCY.MULTIPLIER on page 623

SCPI.SENSE(Ch).OFFSET.PORT(Pt).FREQUENCY.OFFSET on page 624

SCPI.SENSE(Ch).OFFSET.PORT(Pt).FREQUENCY.START on page 625

SCPI.SENSE(Ch).OFFSET.PORT(Pt).FREQUENCY.STOP on page 626

Equivalent key

**[Sweep Setup] - Frequency Offset - Port n - Divisor**

**NOTE**

The basic frequency range is set by using “SCPI.SENSE(Ch).FREQUENCY.START” on page 592 and “SCPI.SENSE(Ch).FREQUENCY.STOP” on page 593.

## **SCPI.SENSE(*Ch*).OFFSET.PORT(*Pt*).FREQUENCY.MULTIPLIER**

Type of object Property

Syntax SCPI.SENSE(*Ch*).OFFSET.PORT(*Pt*).FREQUENCY.MULTIPLIER = *Value*  
*Value* = SCPI.SENSE(*Ch*).OFFSET.PORT(*Pt*).FREQUENCY.MULTIPLIER

Description For channels 1 to 16 (*Ch*), the ports 1 to 4 (*Pt*) frequencies are set by using a multiplier value for the basic frequency when the frequency offset feature is on. This command sets a divisor value.

Variable

|              | <i>Value</i>                                                                                                                                                                                                 |
|--------------|--------------------------------------------------------------------------------------------------------------------------------------------------------------------------------------------------------------|
| Description  | Setting of a frequency multiplier value for the basic frequency                                                                                                                                              |
| Data type    | Double precision floating point type (Double)                                                                                                                                                                |
| Range        | -100 to 100                                                                                                                                                                                                  |
| Preset value | 1                                                                                                                                                                                                            |
| Note         | If the specified variable is out of the allowable setup range, the minimum value (if the lower limit of the range is not reached) or the maximum value (if the upper limit of the range is exceeded) is set. |

For information on the variable (*Ch*), refer to Table 7-6, “Variable (Ch),” on page 209.

For information on the variable (*Pt*), refer to Table 7-9, “Variable (Pt),” on page 241.

Example of use  

```
Dim Multiplier As Double
SCPI.SENSE(1).OFFSET.PORT(1).FREQUENCY.MULTIPLIER = -10
Multiplier = SCPI.SENSE(1).OFFSET.PORT(1).FREQUENCY.MULTIPLIER
```

Related objects  
 SCPI.SENSE(Ch).OFFSET.PORT(Pt).FREQUENCY.DIVISOR on page 622  
 SCPI.SENSE(Ch).OFFSET.PORT(Pt).FREQUENCY.OFFSET on page 624  
 SCPI.SENSE(Ch).OFFSET.PORT(Pt).FREQUENCY.START on page 625  
 SCPI.SENSE(Ch).OFFSET.PORT(Pt).FREQUENCY.STOP on page 626

Equivalent key **[Sweep Setup] - Frequency Offset - Port n - Multiplier**

**NOTE** The basic frequency range is set by using “SCPI.SENSE(Ch).FREQUENCY.START” on page 592 and “SCPI.SENSE(Ch).FREQUENCY.STOP” on page 593.

**SCPI.SENSE(Ch).OFFSET.PORT(Pt).FREQUENCY.OFFSET**

|                |                                                                                                                                                                                                                     |
|----------------|---------------------------------------------------------------------------------------------------------------------------------------------------------------------------------------------------------------------|
| Type of object | Property                                                                                                                                                                                                            |
| Syntax         | SCPI.SENSE( <i>Ch</i> ).OFFSET.PORT( <i>Pt</i> ).FREQUENCY.OFFSET = <i>Value</i><br><i>Value</i> = SCPI.SENSE( <i>Ch</i> ).OFFSET.PORT( <i>Pt</i> ).FREQUENCY.OFFSET                                                |
| Description    | For channels 1 to 16 ( <i>Ch</i> ), the ports 1 to 4 ( <i>Pt</i> ) frequencies are set by using an offset value for the basic frequency when the frequency offset feature is on. This command sets an offset value. |

## Variable

|              | <i>Value</i>                                                                                                                                                                                                 |
|--------------|--------------------------------------------------------------------------------------------------------------------------------------------------------------------------------------------------------------|
| Description  | Setting of a frequency offset value for the basic frequency                                                                                                                                                  |
| Data type    | Double precision floating point type (Double)                                                                                                                                                                |
| Range        | -1E12 to 1E12                                                                                                                                                                                                |
| Preset value | 0                                                                                                                                                                                                            |
| Unit         | Hz (hertz)                                                                                                                                                                                                   |
| Resolution   | 1                                                                                                                                                                                                            |
| Note         | If the specified variable is out of the allowable setup range, the minimum value (if the lower limit of the range is not reached) or the maximum value (if the upper limit of the range is exceeded) is set. |

For information on the variable (*Ch*), refer to Table 7-6, “Variable (Ch),” on page 209.

For information on the variable (*Pt*), refer to Table 7-9, “Variable (Pt),” on page 241.

|                 |                                                                                                                                                                                                                                                            |
|-----------------|------------------------------------------------------------------------------------------------------------------------------------------------------------------------------------------------------------------------------------------------------------|
| Example of use  | Dim Offset As Double<br>SCPI.SENSE(1).OFFSET.PORT(1).FREQUENCY.OFFSET = 1E9<br>Offset = SCPI.SENSE(1).OFFSET.PORT(1).FREQUENCY.OFFSET                                                                                                                      |
| Related objects | SCPI.SENSE(Ch).OFFSET.PORT(Pt).FREQUENCY.DIVISOR on page 622<br>SCPI.SENSE(Ch).OFFSET.PORT(Pt).FREQUENCY.MULTIPLIER on page 623<br>SCPI.SENSE(Ch).OFFSET.PORT(Pt).FREQUENCY.START on page 625<br>SCPI.SENSE(Ch).OFFSET.PORT(Pt).FREQUENCY.STOP on page 626 |
| Equivalent key  | <b>[Sweep Setup] - Frequency Offset - Port n - Offset</b>                                                                                                                                                                                                  |

---

**NOTE** The basic frequency range is set by using “SCPI.SENSE(Ch).FREQUENCY.START” on page 592 and “SCPI.SENSE(Ch).FREQUENCY.STOP” on page 593.

---

## SCPI.SENSE(Ch).OFFSET.PORT(Pt).FREQUENCY.START

Type of object      Property

Syntax                SCPI.SENSE(*Ch*).OFFSET.PORT(*Pt*).FREQUENCY.START = *Value*  
*Value* = SCPI.SENSE(*Ch*).OFFSET.PORT(*Pt*).FREQUENCY.START

Description         For channels 1 to 16 (*Ch*), sets a frequency start value for ports 1 to 4 (*Pt*) when the frequency offset feature is on.

Variable

|              | <i>Value</i>                                                                                                                                                                                                 |
|--------------|--------------------------------------------------------------------------------------------------------------------------------------------------------------------------------------------------------------|
| Description  | Setting of a frequency start value                                                                                                                                                                           |
| Data type    | Double precision floating point type (Double)                                                                                                                                                                |
| Range        | 3E5 to 8.5E9 (3E9)                                                                                                                                                                                           |
| Preset value | 3E5                                                                                                                                                                                                          |
| Unit         | Hz (hertz)                                                                                                                                                                                                   |
| Resolution   | 1                                                                                                                                                                                                            |
| Note         | If the specified variable is out of the allowable setup range, the minimum value (if the lower limit of the range is not reached) or the maximum value (if the upper limit of the range is exceeded) is set. |

For information on the variable (*Ch*), refer to Table 7-6, “Variable (Ch),” on page 209.  
 For information on the variable (*Pt*), refer to Table 7-9, “Variable (Pt),” on page 241.

Example of use      Dim Start As Double  
 SCPI.SENSE(1).OFFSET.PORT(1).FREQUENCY.START = 100E6  
 Start = SCPI.SENSE(1).OFFSET.PORT(1).FREQUENCY.START

Related objects     SCPI.SENSE(Ch).OFFSET.PORT(Pt).FREQUENCY.DIVISOR on page 622  
 SCPI.SENSE(Ch).OFFSET.PORT(Pt).FREQUENCY.MULTIPLIER on page 623  
 SCPI.SENSE(Ch).OFFSET.PORT(Pt).FREQUENCY.OFFSET on page 624  
 SCPI.SENSE(Ch).OFFSET.PORT(Pt).FREQUENCY.STOP on page 626

Equivalent key      **[Sweep Setup] - Frequency Offset - Port n - Start**

**SCPI.SENSE(Ch).OFFSET.PORT(Pt).FREQUENCY.STOP**

|                |                                                                                                                                                                  |
|----------------|------------------------------------------------------------------------------------------------------------------------------------------------------------------|
| Type of object | Property                                                                                                                                                         |
| Syntax         | SCPI.SENSE( <i>Ch</i> ).OFFSET.PORT( <i>Pt</i> ).FREQUENCY.STOP = <i>Value</i><br><i>Value</i> = SCPI.SENSE( <i>Ch</i> ).OFFSET.PORT( <i>Pt</i> ).FREQUENCY.STOP |
| Description    | For channels 1 to 16 ( <i>Ch</i> ), sets a frequency stop value for ports 1 to 4 ( <i>Pt</i> ) when the frequency offset feature is on.                          |

## Variable

|              | <i>Value</i>                                                                                                                                                                                                 |
|--------------|--------------------------------------------------------------------------------------------------------------------------------------------------------------------------------------------------------------|
| Description  | Setting of a frequency stop value                                                                                                                                                                            |
| Data type    | Double precision floating point type (Double)                                                                                                                                                                |
| Range        | 3E5 to 8.5E9 (3E9)                                                                                                                                                                                           |
| Preset value | 8.5E9 (3E9)                                                                                                                                                                                                  |
| Unit         | Hz (hertz)                                                                                                                                                                                                   |
| Resolution   | 1                                                                                                                                                                                                            |
| Note         | If the specified variable is out of the allowable setup range, the minimum value (if the lower limit of the range is not reached) or the maximum value (if the upper limit of the range is exceeded) is set. |

For information on the variable (*Ch*), refer to Table 7-6, “Variable (Ch),” on page 209.

For information on the variable (*Pt*), refer to Table 7-9, “Variable (Pt),” on page 241.

|                 |                                                                                                                                                                                                                                                              |
|-----------------|--------------------------------------------------------------------------------------------------------------------------------------------------------------------------------------------------------------------------------------------------------------|
| Example of use  | Dim Stop As Double<br>SCPI.SENSE(1).OFFSET.PORT(1).FREQUENCY.STOP = 100E6<br>Stop = SCPI.SENSE(1).OFFSET.PORT(1).FREQUENCY.STOP                                                                                                                              |
| Related objects | SCPI.SENSE(Ch).OFFSET.PORT(Pt).FREQUENCY.DIVISOR on page 622<br>SCPI.SENSE(Ch).OFFSET.PORT(Pt).FREQUENCY.MULTIPLIER on page 623<br>SCPI.SENSE(Ch).OFFSET.PORT(Pt).FREQUENCY.OFFSET on page 624<br>SCPI.SENSE(Ch).OFFSET.PORT(Pt).FREQUENCY.START on page 625 |
| Equivalent key  | <b>[Sweep Setup] - Frequency Offset - Port n - Stop</b>                                                                                                                                                                                                      |

## SCPI.SENSE(Ch).OFFSET.STATE

Type of object      Property

Syntax                `SCPI.SENSE(Ch).OFFSET.STATE = Status`  
                           `Status = SCPI.SENSE(Ch).OFFSET.STATE`

Description            For channels 1 to 16 (*Ch*), turns on/off the frequency offset.

                          When the frequency offset feature is on, different frequencies can be used for measurement for each port. Frequencies set for each port are used regardless of whether the port is on the stimulus side or response side.

Variable

|              | <i>Status</i>                                                                                                                                                                                                             |
|--------------|---------------------------------------------------------------------------------------------------------------------------------------------------------------------------------------------------------------------------|
| Description  | On/off of the frequency offset                                                                                                                                                                                            |
| Data type    | Boolean type (Boolean)                                                                                                                                                                                                    |
| Range        | Select from the following.<br><ul style="list-style-type: none"> <li>•True or -1                      Turns on the frequency offset.</li> <li>•False or 0                      Turns off the frequency offset.</li> </ul> |
| Preset value | False or 0                                                                                                                                                                                                                |

For information on the variable (*Ch*), refer to Table 7-6, “Variable (Ch),” on page 209.

Example of use        `Dim State As Boolean`  
                           `SCPI.SENSE(1).OFFSET.STATE = False`  
                           `State = SCPI.SENSE(1).OFFSET.STATE`

Equivalent key        **[Sweep Setup] - Frequency Offset - Frequency Offset**

## SCPI.SENSE(*Ch*).ROSCillator.SOURce

|             |                                                                                                                    |
|-------------|--------------------------------------------------------------------------------------------------------------------|
| Object type | Property                                                                                                           |
| Syntax      | <i>Param</i> = SCPI.SENSE( <i>Ch</i> ).ROSCillator.SOURce                                                          |
| Description | Reads out whether the external reference signal is inputted to the Ref In connector on the rear panel. (Read only) |
| Variable    |                                                                                                                    |

|             | <i>Param</i>                                                                                                                                                                                                                                   |
|-------------|------------------------------------------------------------------------------------------------------------------------------------------------------------------------------------------------------------------------------------------------|
| Description | Whether the external reference signal is inputted or not.                                                                                                                                                                                      |
| Data type   | Character string type (String)                                                                                                                                                                                                                 |
| Range       | Select from the following. <ul style="list-style-type: none"><li>•"INTernal"                      The external reference signal is not inputted.</li><li>•"EXTernal"                      The external reference signal is inputted.</li></ul> |

For information on the variable (*Ch*), see Table 7-6, "Variable (Ch)," on page 209.

|          |                                                                     |
|----------|---------------------------------------------------------------------|
| Examples | <pre>Dim Ref As String Ref = SCPI.SENSE(1).ROSCillator.SOURce</pre> |
|----------|---------------------------------------------------------------------|

|                |                                                                            |
|----------------|----------------------------------------------------------------------------|
| Equivalent key | Displayed on the instrument status bar (at the bottom of the LCD display). |
|----------------|----------------------------------------------------------------------------|



## SCPI.SENSE(Ch).SEGMENT.DATA

|             |                                                                                        |
|-------------|----------------------------------------------------------------------------------------|
| Object type | Property                                                                               |
| Syntax      | SCPI.SENSE(Ch).SEGMENT.DATA = <i>Data</i><br><i>Data</i> = SCPI.SENSE(Ch).SEGMENT.DATA |
| Description | Creates the segment sweep table of channels 1 to 16 ( <i>Ch</i> ).                     |
| Variable    |                                                                                        |

|             | <i>Data</i>                                                                                                                                                                                                                                                                                                                                                                                                                                                                                                                                                                                                                                                                                                                                                                                                                                                                                                                                                                                                                                                                                                                                                                                                                                                                                                                                                                                                                                                                                                                                                                                                                                                                                                                                                                                                                                                                                                                                                                                                                                                                                                                                                                                                                                                                                                                                           |
|-------------|-------------------------------------------------------------------------------------------------------------------------------------------------------------------------------------------------------------------------------------------------------------------------------------------------------------------------------------------------------------------------------------------------------------------------------------------------------------------------------------------------------------------------------------------------------------------------------------------------------------------------------------------------------------------------------------------------------------------------------------------------------------------------------------------------------------------------------------------------------------------------------------------------------------------------------------------------------------------------------------------------------------------------------------------------------------------------------------------------------------------------------------------------------------------------------------------------------------------------------------------------------------------------------------------------------------------------------------------------------------------------------------------------------------------------------------------------------------------------------------------------------------------------------------------------------------------------------------------------------------------------------------------------------------------------------------------------------------------------------------------------------------------------------------------------------------------------------------------------------------------------------------------------------------------------------------------------------------------------------------------------------------------------------------------------------------------------------------------------------------------------------------------------------------------------------------------------------------------------------------------------------------------------------------------------------------------------------------------------------|
| Description | <p>Indicates the array data arranged in the following order (for the segment sweep table). Where N is the number of segments (specified with &lt;segm&gt;) and n is an integer between 1 and N.</p> <p><i>Data</i> = {&lt;buf&gt;,&lt;stim&gt;,&lt;ifbw&gt;,&lt;pow&gt;,&lt;del&gt;,&lt;swp&gt;,&lt;time&gt;,&lt;segm&gt;,&lt;star 1&gt;,&lt;stop 1&gt;,&lt;nop 1&gt;,&lt;ifbw 1&gt;,&lt;pow 1&gt;,&lt;del 1&gt;,&lt;swp 1&gt;,&lt;time 1&gt;,...,&lt;star n&gt;,&lt;stop n&gt;,&lt;nop n&gt;,&lt;ifbw n&gt;,&lt;pow n&gt;,&lt;del n&gt;,&lt;swp n&gt;,&lt;time n&gt;,...,&lt;star N&gt;,&lt;stop N&gt;,&lt;nop N&gt;,&lt;ifbw N&gt;,&lt;pow N&gt;,&lt;del N&gt;,&lt;swp N&gt;,&lt;time N&gt;}</p> <p>Each parameter in the above array data is detailed below.</p> <ul style="list-style-type: none"> <li>• &lt;buf&gt; Always specify 5 or 6. You have to specify 6 if you need to set up the sweep mode setting for each segment.</li> <li>• &lt;stim&gt; Stimulus setting mode<br/>0: Specifies with start/stop values<br/>1: Specifies with center/span values</li> <li>• &lt;ifbw&gt; ON/OFF of the IF bandwidth setting for each segment<br/>0: OFF, 1: ON</li> <li>• &lt;pow&gt; ON/OFF of the power setting for each segment<br/>0: OFF, 1: ON</li> <li>• &lt;del&gt; ON/OFF of the sweep delay time setting for each segment<br/>0: OFF, 1: ON</li> <li>• &lt;swp&gt; ON/OFF of the sweep mode setting for each segment<br/>0: OFF, 1: ON<br/>Not necessary when &lt;buf&gt; is 5.</li> <li>• &lt;time&gt; ON/OFF of the sweep time setting for each segment<br/>0: OFF, 1: ON</li> <li>• &lt;segm&gt; Number of segments<br/>Specify an integer ranging 1 to 201.</li> <li>• &lt;star n&gt; Start value/center value of the n-th segment</li> <li>• &lt;stop n&gt; Stop value/span value of the n-th segment</li> <li>• &lt;nop n&gt; Number of measurement points of the n-th segment</li> <li>• &lt;ifbw n&gt; IF bandwidth of the n-th segment Not necessary when the IF bandwidth setting for each segment is OFF (&lt;ifbw&gt;:0).</li> <li>• &lt;pow n&gt; Power of the n-th segment Not necessary when the power setting for each segment is OFF (&lt;pow&gt;:0).</li> <li>• &lt;del n&gt; Sweep delay time of the n-th segment Not necessary when the sweep delay time setting for each segment is OFF (&lt;del&gt;:0).</li> </ul> |

COM Object Reference  
**SCPI.SENSE(Ch).SEGMENT.DATA**

|             | <i>Data</i>                                                                                                                                                                                                                                                                                                                                                                                                                                                                                                                                                                                                                            |
|-------------|----------------------------------------------------------------------------------------------------------------------------------------------------------------------------------------------------------------------------------------------------------------------------------------------------------------------------------------------------------------------------------------------------------------------------------------------------------------------------------------------------------------------------------------------------------------------------------------------------------------------------------------|
| Description | <ul style="list-style-type: none"> <li>• &lt;swp n&gt; Sweep mode of the n-th segment<br/>           0: Stepped mode<br/>           1: Swept mode<br/>           2: Fast stepped mode<br/>           3: Fast swept mode<br/>           Not necessary when &lt;buf&gt; is 5 or the sweep mode setting for each segment is OFF (&lt;del&gt;:0).</li> <li>• &lt;time n&gt; Sweep time of the n-th segment Not necessary when the sweep time setting for each segment is OFF (&lt;time&gt;:0).</li> </ul>                                                                                                                                  |
| Data type   | Variant type (Variant)                                                                                                                                                                                                                                                                                                                                                                                                                                                                                                                                                                                                                 |
| Note        | If there is not the necessary amount of array data for the specified number of segments when setting the segment sweep table, an error occurs when executed and the object is ignored. For <stim>, <ifbw>, <pow>, <del>, <swp>, and <time>, if the specified value is not the allowable integer, an error occurs when executed. For <star n>, <stop n>, <nop n>, <ifbw n>, <pow n>, <del n>, and <time n> in the array data, if the specified value is out of the allowable setup range, the minimum value (if the lower limit of the range is not reached) or the maximum value (if the upper limit of the range is exceeded) is set. |

For information on the variable (*Ch*), see Table 7-6, “Variable (Ch),” on page 209.

**Examples**

```
Dim SegmData As Variant
SCPI.SENSE(1).SEGMENT.DATA = Array(5,0,0,1,0,0,2, _
100E6,1E9,31,0,2E9,3E9,51,-10)
SegmData = SCPI.SENSE(1).SEGMENT.DATA
```

```
Dim SegmData(14) As Variant
Dim Ref As Variant
SegmData(0) = 5
SegmData(1) = 0
SegmData(2) = 0
SegmData(3) = 1
SegmData(4) = 0
SegmData(5) = 0
SegmData(6) = 2
SegmData(7) = 100E6
SegmData(8) = 1E9
SegmData(9) = 31
SegmData(10) = 0
SegmData(11) = 2E9
SegmData(12) = 3E9
SegmData(13) = 51
SegmData(14) = -10
SCPI.SENSE(1).SEGMENT.DATA = SegmData
Ref = SCPI.SENSE(1).SEGMENT.DATA
```

Related objects **SCPI.SENSE(Ch).SWEep.TYPE** on page 638

Equivalent key **[Sweep Setup] - Edit Segment Table**

## SCPI.SENSE(*Ch*).SEGMENT.SWEep.POINTs

**Object type** Property

**Syntax** *Value* = SCPI.SENSE(*Ch*).SEGMENT.SWEep.POINTs

**Description** For the segment sweep table of channels 1 to 16 (*Ch*), reads out the total number of the measurement points of all segments. (Read only)

**Variable**

|             | <i>Value</i>                                       |
|-------------|----------------------------------------------------|
| Description | Total number of measurement points of all segments |
| Data type   | Long integer type (Long)                           |

For information on the variable (*Ch*), see Table 7-6, “Variable (Ch),” on page 209.

**Examples**

```
Dim SegmPoin As Long
SegmPoin = SCPI.SENSE(1).SEGMENT.SWEep.POINTs
```

**Related objects** SCPI.SENSE(*Ch*).SEGMENT.DATA on page 629

**Equivalent key** No equivalent key is available on the front panel.

## SCPI.SENSE(*Ch*).SEGMENT.SWEep.TIME.DATA

**Object type** Property

**Syntax** *Value* = SCPI.SENSE(*Ch*).SEGMENT.SWEep.TIME.DATA

**Description** For the segment sweep table of channels 1 to 16 (*Ch*), reads out the total sweep time (including sweep delay time) of all segments. (Read only)

**Variable**

|             | <i>Value</i>                                  |
|-------------|-----------------------------------------------|
| Description | Total sweep time of all segments              |
| Data type   | Double precision floating point type (Double) |

For information on the variable (*Ch*), see Table 7-6, “Variable (Ch),” on page 209.

**Examples**

```
Dim SegmTime As Double
SegmTime = SCPI.SENSE(1).SEGMENT.SWEep.TIME.DATA
```

**Related objects** SCPI.SENSE(*Ch*).SEGMENT.DATA on page 629

**Equivalent key** No equivalent key is available on the front panel.

## SCPI.SENSE(Ch).SWEep.ASPurious

|             |                                                                                                  |
|-------------|--------------------------------------------------------------------------------------------------|
| Object type | Property                                                                                         |
| Syntax      | SCPI.SENSE(Ch).SWEep.ASPurious = <i>Status</i><br><i>Status</i> = SCPI.SENSE(Ch).SWEep.ASPurious |
| Description | Turns ON/OFF the spurious avoidance mode of channels 1 to 16 ( <i>Ch</i> ).                      |
| Variable    |                                                                                                  |

|              |                                                                                                                                                                                 |
|--------------|---------------------------------------------------------------------------------------------------------------------------------------------------------------------------------|
|              | <i>Status</i>                                                                                                                                                                   |
| Description  | ON/OFF of the spurious avoidance mode                                                                                                                                           |
| Data type    | Boolean type (Boolean)                                                                                                                                                          |
| Range        | Select from the following.<br>•True or -1                      Turns ON the spurious avoidance mode.<br>•False or 0                      Turns OFF the spurious avoidance mode. |
| Preset value | True or -1                                                                                                                                                                      |

For information on the variable (*Ch*), see Table 7-6, “Variable (Ch),” on page 209.

|          |                                                                                                                     |
|----------|---------------------------------------------------------------------------------------------------------------------|
| Examples | <pre>Dim ASpurious As Boolean SCPI.SENSE(1).SWEep.ASPurious = False ASpurious = SCPI.SENSE(1).SWEep.ASPurious</pre> |
|----------|---------------------------------------------------------------------------------------------------------------------|

|                |                                                 |
|----------------|-------------------------------------------------|
| Equivalent key | <b>[System] - Service Menu - Avoid Spurious</b> |
|----------------|-------------------------------------------------|

## SCPI.SENSE(*Ch*).SWEep.DELay

- Object type      Property
- Syntax            SCPI.SENSE(*Ch*).SWEep.DELay = *Value*  
*Value* = SCPI.SENSE(*Ch*).SWEep.DELay
- Description      Sets the sweep delay time of channels 1 to 16 (*Ch*).
- Variable

|              | <i>Value</i>                                                                                                                                                                                                 |
|--------------|--------------------------------------------------------------------------------------------------------------------------------------------------------------------------------------------------------------|
| Description  | Sweep delay time                                                                                                                                                                                             |
| Data type    | Double precision floating point type (Double)                                                                                                                                                                |
| Range        | 0 to 1                                                                                                                                                                                                       |
| Preset value | 0                                                                                                                                                                                                            |
| Unit         | s (second)                                                                                                                                                                                                   |
| Resolution   | 0.001                                                                                                                                                                                                        |
| Note         | If the specified variable is out of the allowable setup range, the minimum value (if the lower limit of the range is not reached) or the maximum value (if the upper limit of the range is exceeded) is set. |

For information on the variable (*Ch*), see Table 7-6, “Variable (Ch),” on page 209.

- Examples
- ```
Dim SweDel As Double
SCPI.SENSE(1).SWEep.DELay = 0.05
SweDel = SCPI.SENSE(1).SWEep.DELay
```

- Equivalent key **[Sweep Setup] - Sweep Delay**

SCPI.SENSE(*Ch*).SWEep.GENERation

Object type Property

Syntax SCPI.SENSE(*Ch*).SWEep.GENERation = *Param*
Param = SCPI.SENSE(*Ch*).SWEep.GENERation

Description Selects the sweep mode of channels 1 to 16 (*Ch*).

When the sweep type is the power sweep (POW specified with the SCPI.SENSE(*Ch*).SWEep.TYPE object), when the power calibration is on (ON specified with the SCPI.SOURCE(*Ch*).POWER.PORT(*Pt*).CORRection.STATe object), or the power slope value is other than 0 and the power slope function is on (ON specified with the SCPI.SOURCE(*Ch*).POWER.LEVel.SLOPe.STATe object), if you execute this object to try to set the sweep mode to the swept mode or the fast swept mode, an error occurs and the sweep mode is automatically set to the step mode or the fast step mode, respectively.

Variable

	<i>Param</i>
Description	Sweep mode
Data type	Character string type (String)
Range	Select from the following. <ul style="list-style-type: none"> •"STEPped" Sets the sweep mode to the stepped mode. •"ANALog" Sets the sweep mode to the swept mode. •"FSTepped" Sets the sweep mode to the fast stepped mode. •"FANalog" Sets the sweep mode to the fast swept mode.
Preset value	"STEPped"

For information on the variable (*Ch*), see Table 7-6, "Variable (*Ch*)," on page 209.

Examples

```
Dim SwptMode As String
SCPI.SENSE(1).SWEep.GENERation = "anal"
SwptMode = SCPI.SENSE(1).SWEep.GENERation
```

Related objects SCPI.SENSE(*Ch*).SWEep.TYPE on page 638
SCPI.SOURCE(*Ch*).POWER.PORT(*Pt*).CORRection.STATe on page 661
SCPI.SOURCE(*Ch*).POWER.LEVel.SLOPe.STATe on page 650

Equivalent key **[Sweep Setup] - Sweep Mode - Std Stepped|Std Swept|Fast Stepped|Fast Swept**

SCPI.SENSE(*Ch*).SWEep.POINTs

- Object type Property
- Syntax `SCPI.SENSE(Ch).SWEep.POINTs = Value`
Value = `SCPI.SENSE(Ch).SWEep.POINTs`
- Description Sets the number of measurement points of channels 1 to 16 (*Ch*).
- Variable

	<i>Value</i>
Description	Number of measurement points
Data type	Long integer type (Long)
Range	2 to 1601
Preset value	201
Note	If the specified variable is out of the allowable setup range, the minimum value (if the lower limit of the range is not reached) or the maximum value (if the upper limit of the range is exceeded) is set.

For information on the variable (*Ch*), see Table 7-6, “Variable (Ch),” on page 209.

- Examples `Dim Nop As Long`
`SCPI.SENSE(1).SWEep.POINTs = 801`
`Nop = SCPI.SENSE(1).SWEep.POINTs`
- Equivalent key **[Sweep Setup] - Points**

SCPI.SENSE(*Ch*).SWEep.TIME.AUTO

Object type	Property
Syntax	SCPI.SENSE(<i>Ch</i>).SWEep.TIME.AUTO = <i>Status</i> <i>Status</i> = SCPI.SENSE(<i>Ch</i>).SWEep.TIME.AUTO
Description	Sets whether to automatically set the sweep time of channels 1 to 16 (<i>Ch</i>).
Variable	

	<i>Status</i>
Description	ON/OFF of the auto setting of the sweep time
Data type	Boolean type (Boolean)
Range	Select from the following. <ul style="list-style-type: none"> •True or -1 Turns ON the auto setting. •False or 0 Turns OFF the auto setting.
Preset value	True or -1

For information on the variable (*Ch*), see Table 7-6, “Variable (Ch),” on page 209.

Examples

```
Dim SweAuto As Boolean
SCPI.SENSE(1).SWEep.TIME.AUTO = False
SweAuto = SCPI.SENSE(1).SWEep.TIME.AUTO
```

Related objects SCPI.SENSE(*Ch*).SWEep.TIME.DATA on page 637

Equivalent key **[Sweep Setup] - Sweep Time**

NOTE When performing the operation from the front panel, the auto setting of the sweep time is turned ON by setting the sweep time to 0 s.

SCPI.SENSE(*Ch*).SWEep.TIME.DATA

Object type	Property
Syntax	SCPI.SENSE(<i>Ch</i>).SWEep.TIME.DATA = <i>Value</i> <i>Value</i> = SCPI.SENSE(<i>Ch</i>).SWEep.TIME.DATA
Description	Sets the sweep time of channels 1 to 16 (<i>Ch</i>).

NOTE Before using this object to set the sweep time, turns OFF the auto setting of the sweep time (specify False with the SCPI.SENSE(*Ch*).SWEep.TIME.AUTO object).

Variable

	<i>Value</i>
Description	Sweep time
Data type	Double precision floating point type (Double)
Range	Varies depending on the measurement conditions
Preset value	Varies depending on the measurement conditions
Unit	s (second)
Note	If the specified variable is out of the allowable setup range, the minimum value (if the lower limit of the range is not reached) or the maximum value (if the upper limit of the range is exceeded) is set.

For information on the variable (*Ch*), see Table 7-6, “Variable (*Ch*),” on page 209.

Examples

```
Dim SweTime As Double
SCPI.SENSE(1).SWEep.TIME.AUTO = False
SCPI.SENSE(1).SWEep.TIME.DATA = 1.5
SweTime = SCPI.SENSE(1).SWEep.TIME.DATA
```

Related objects SCPI.SENSE(*Ch*).SWEep.TIME.AUTO on page 636

Equivalent key **[Sweep Setup] - Sweep Time**

SCPI.SENSE(*Ch*).SWEep.TYPE

Object type	Property
Syntax	SCPI.SENSE(<i>Ch</i>).SWEep.TYPE = <i>Param</i> <i>Param</i> = SCPI.SENSE(<i>Ch</i>).SWEep.TYPE
Description	Sets the sweep type of channels 1 to 16 (<i>Ch</i>).
Variable	

	<i>Param</i>
Description	Sweep type
Data type	Character string type (String)
Range	Select from the following. <ul style="list-style-type: none"> •"LINear" Sets the sweep type to the linear sweep. •"LOGarithmic" Sets the sweep type to the log sweep. *1 •"SEGment" Sets the sweep type to the segment sweep. •"POWer" Sets the sweep type to the power sweep.
Preset value	"LINear"

*1.If you execute this object to try to specify the log sweep when the frequency span condition necessary for the log sweep is not satisfied (the stop frequency is about 4 times or more the start frequency), an error occurs and the object is ignored.

For information on the variable (*Ch*), see Table 7-6, "Variable (Ch)," on page 209.

Examples

```
Dim SweType As String
SCPI.SENSE(1).SWEep.TYPE = "segm"
SweType = SCPI.SENSE(1).SWEep.TYPE
```

Equivalent key **[Sweep Setup] - Sweep Type - Lin Freq|Log Freq|Segment**

SCPI.SERVICE.CHANNEL.ACTIVE

Object type Property
 Syntax *Value* = SCPI.SERVICE.CHANNEL.ACTIVE
 Description Reads out the active channel number. (Read only)
 Variable

	<i>Value</i>
Description	Active channel number
Data type	Long integer type (Long)

Examples

```
Dim ActChan As Long
ActChan = SCPI.SERVICE.CHANNEL.ACTIVE
```

 Related objects SCPI.DISPLAY.WINDOW(Ch).ACTIVATE on page 395
 Equivalent key No equivalent key is available on the front panel.

SCPI.SERVICE.CHANNEL.COUNT

Object type Property
 Syntax *Value* = SCPI.SERVICE.CHANNEL.COUNT
 Description Reads out the upper limit of the number of channels of the E5070B/E5071B. (Read only)
 Variable

	<i>Value</i>
Description	Upper limit of the number of channels.
Data type	Long integer type (Long)

Examples

```
Dim MaxChan As Long
MaxChan = SCPI.SERVICE.CHANNEL.COUNT
```

 Equivalent key No equivalent key is available on the front panel.

SCPI.SERVICE.CHANNEL(*Ch*).TRACE.ACTIVE

Object type	Property
Syntax	<i>Value</i> = SCPI.SERVICE.CHANNEL(<i>Ch</i>).TRACE.ACTIVE
Description	Reads out the active trace number of channels 1 to 16 (<i>Ch</i>). (Read only)
Variable	

	<i>Value</i>
Description	Active trace number
Data type	Long integer type (Long)

Examples	<pre>Dim ActTrac As Long ActTrac = SCPI.SERVICE.CHANNEL(1).TRACE.ACTIVE</pre>
Related objects	SCPI.CALCULATE(Ch).PARAMETER(Tr).SELECT on page 259
Equivalent key	No equivalent key is available on the front panel.

SCPI.SERVICE.CHANNEL.TRACE.COUNT

Object type	Property
Syntax	<i>Value</i> = SCPI.SERVICE.CHANNEL.TRACE.COUNT
Description	Reads out the upper limit of the number of traces per channel. (Read only)
Variable	

	<i>Value</i>
Description	Upper limit of the number of traces.
Data type	Long integer type (Long)

Examples	<pre>Dim MaxTrac As Long MaxTrac = SCPI.SERVICE.CHANNEL.TRACE.COUNT</pre>
Equivalent key	No equivalent key is available on the front panel.

SCPI.SERVICE.PORT.COUNT

Object type Property
 Syntax *Value* = SCPI.SERVICE.PORT.COUNT
 Description Reads out the number of ports of the E5070B/E5071B. (Read only)
 Variable

	<i>Value</i>
Description	Number of ports
Data type	Long integer type (Long)

Examples

```
Dim MaxPort As Long
MaxPort = SCPI.SERVICE.PORT.COUNT
```

Equivalent key No equivalent key is available on the front panel.

SCPI.SERVICE.SREVISION

Object type Property
 Syntax *Value* = SCPI.SERVICE.SREVISION
 Description Reads out the system spec version of the E5070B/E5071B. (Read only)
 Variable

	<i>Value</i>
Description	1 means applying new system specifications. 0 means applying old system specifications.
Data type	Long integer type (Long)

Examples

```
Dim SystemRevision As Long
SystemRevision = SCPI.SERVICE.PORT.COUNT
```

Equivalent key No equivalent key is available on the front panel.

SCPI.SERVICE.SWEep.FREQuency.MAXimum

Object type Property

Syntax *Value* = SCPI.SERVICE.SWEep.FREQuency.MAXimum

Description Reads out the upper limit of the measurement frequency of the E5070B/E5071B. (Read only)

Variable

	<i>Value</i>
Description	Upper limit of the measurement frequency
Data type	Double precision floating point type (Double)

Examples

```
Dim MaxFreq As Double
MaxFreq = SCPI.SERVICE.SWEep.FREQuency.MAXimum
```

Equivalent key No equivalent key is available on the front panel.

SCPI.SERVICE.SWEep.FREQuency.MINimum

Object type Property

Syntax *Value* = SCPI.SERVICE.SWEep.FREQuency.MINimum

Description Reads out the lower limit of the measurement frequency of the E5070B/E5071B. (Read only)

Variable

	<i>Value</i>
Description	Lower limit of the measurement frequency
Data type	Double precision floating point type (Double)

Examples

```
Dim MinFreq As Double
MinFreq = SCPI.SERVICE.SWEep.FREQuency.MINimum
```

Equivalent key No equivalent key is available on the front panel.

SCPI.SERVICE.SWEep.POINTs

Object type	Property
Syntax	<i>Value</i> = SCPI.SERVICE.SWEep.POINTs
Description	Reads out the upper limit of the number of measurement points of the E5070B/E5071B. (Read only)

NOTE This command depends on the set of channel and trace.

Variable

	<i>Value</i>
Description	Upper limit of the number of measurement points
Data type	Long integer type (Long)

Examples

```
Dim MaxPoin As Long
MaxPoin = SCPI.SERVICE.SWEep.POINTs
```

Equivalent key No equivalent key is available on the front panel.

SCPI.SOURce(*Ch*).POWER.ATTenuation.DATA

Object type	Property
Syntax	SCPI.SOURce(<i>Ch</i>).POWER.ATTenuation.DATA = <i>Value</i> <i>Value</i> = SCPI.SOURce(<i>Ch</i>).POWER.ATTenuation.DATA
Description	Selects the attenuator used for channels 1 to 16 (<i>Ch</i>). The power ranges are determined depending on the attenuator to be used. When the Auto Power Range function is ON (Default settin is ON with firmware version 3.60 and later), this command is ignored and a proper attenuator and power range are selected automatically.

NOTE This object is available only when extended power range function (Option 214, 314, 414) is installed.

Variable

	<i>Value</i>																		
Description	<table> <thead> <tr> <th>Power ranges</th> <th>Setting</th> </tr> </thead> <tbody> <tr> <td>-20 to +10[dB]</td> <td>0</td> </tr> <tr> <td>-25 to +7 [dB]</td> <td>5</td> </tr> <tr> <td>-30 to +2 [dB]</td> <td>10</td> </tr> <tr> <td>-35 to -3 [dB]</td> <td>15</td> </tr> <tr> <td>-40 to -8 [dB]</td> <td>20</td> </tr> <tr> <td>-45 to -13[dB]</td> <td>25</td> </tr> <tr> <td>-50 to -18[dB]</td> <td>30</td> </tr> <tr> <td>-55 to -23[dB]</td> <td>35</td> </tr> </tbody> </table>	Power ranges	Setting	-20 to +10[dB]	0	-25 to +7 [dB]	5	-30 to +2 [dB]	10	-35 to -3 [dB]	15	-40 to -8 [dB]	20	-45 to -13[dB]	25	-50 to -18[dB]	30	-55 to -23[dB]	35
Power ranges	Setting																		
-20 to +10[dB]	0																		
-25 to +7 [dB]	5																		
-30 to +2 [dB]	10																		
-35 to -3 [dB]	15																		
-40 to -8 [dB]	20																		
-45 to -13[dB]	25																		
-50 to -18[dB]	30																		
-55 to -23[dB]	35																		
Data type	Long integer type (Long)																		
Range	0 to 35																		
Preset value	0																		
Unit	dB																		
Resolution	5																		
Note	If the specified variable is out of the allowable setup range, the minimum value (if the lower limit of the range is not reached) or the maximum value (if the upper limit of the range is exceeded) is set.																		

For information on the variable (*Ch*), see Table 7-6, “Variable (Ch),” on page 209.

Examples

```
Dim Att As Long
SCPI.SOURce(1).POWER.ATTenuation.DATA = 10
Att = SCPI.SOURce(1).POWER.ATTenuation.DATA
```

Related objects SCPI.SOURce(Ch).POWER.LEVel.IMMEDIATE. AMPLitude on page 648

SCPI.SOURce(Ch).POWer.CENTer

Object type	Property
Syntax	SCPI.SOURce(Ch).POWer.CENTer = <i>Value</i> <i>Value</i> = SCPI.SOURce(Ch).POWer.CENTer
Description	Sets the center value of the sweep range for the power sweep for channels 1 to 16 (<i>Ch</i>).
Variable	

	<i>Value</i>
Description	Center value
Data type	Double precision floating point type (Double)
Range	Varies depending on the power range.
Preset value	-7.5
Unit	dBm
Resolution	0.05 or 0.025
Note	If the specified variable is out of the allowable setup range, the minimum value (if the lower limit of the range is not reached) or the maximum value (if the upper limit of the range is exceeded) is set.

For information on the variable (*Ch*), refer to Table 7-6, “Variable (Ch),” on page 209.

Examples	<pre>Dim Pcntr As Double SCPI.SOURce(1).POWer.CENTer = 0 Pcntr = SCPI.SOURce(1).POWer.CENTer</pre>
Related objects	<p>SCPI.SENSE(Ch).SWEep.TYPE on page 638</p> <p>SCPI.SOURce(Ch).POWer.ATTenuation.DATA on page 644</p> <p>SCPI.SOURce(Ch).POWer.SPAN on page 664</p>
Equivalent key	[Center]

SCPI.SOURCE(*Ch*).POWER.LEVEL.IMMEDIATE.AMPLITUDE

Object type	Property
Syntax	SCPI.SOURCE(<i>Ch</i>).POWER.LEVEL.IMMEDIATE.AMPLITUDE = <i>Value</i> <i>Value</i> = SCPI.SOURCE(<i>Ch</i>).POWER.LEVEL.IMMEDIATE.AMPLITUDE
Description	Sets the power level of channels 1 to 16 (<i>Ch</i>).
Variable	

	<i>Value</i>
Description	Power level
Data type	Double precision floating point type (Double)
Range	Varies depending on the power range.
Preset value	0
Unit	dBm
Resolution	0.05
Note	If the specified variable is out of the allowable setup range, the minimum value (if the lower limit of the range is not reached) or the maximum value (if the upper limit of the range is exceeded) is set.

For information on the variable (*Ch*), see Table 7-6, “Variable (Ch),” on page 209.

Examples	<pre>Dim PowLev As Double SCPI.SOURCE(1).POWER.LEVEL.IMMEDIATE.AMPLITUDE = -10 PowLev = SCPI.SOURCE(1).POWER.LEVEL.IMMEDIATE.AMPLITUDE</pre>
Related objects	SCPI.SOURCE(<i>Ch</i>).POWER.ATTENUATION.DATA on page 644 SCPI.SOURCE(<i>Ch</i>).POWER.ATTENUATION.AUTO on page 645
Equivalent key	[Sweep Setup] - Power

SCPI.SOURce(Ch).POWer.LEVel.SLOPe.DATA

Object type	Property
Syntax	SCPI.SOURce(<i>Ch</i>).POWer.LEVel.SLOPe.DATA = <i>Value</i> <i>Value</i> = SCPI.SOURce(<i>Ch</i>).POWer.LEVel.SLOPe.DATA
Description	Sets the correction value of the power slope feature of channels 1 to 16 (<i>Ch</i>).
Variable	

	<i>Value</i>
Description	Correction value of the power slope feature
Data type	Double precision floating point type (Double)
Range	-2 to 2
Preset value	0
Unit	dB/GHz
Resolution	0.01
Note	If the specified variable is out of the allowable setup range, the minimum value (if the lower limit of the range is not reached) or the maximum value (if the upper limit of the range is exceeded) is set.

For information on the variable (*Ch*), refer to Table 7-6, “Variable (Ch),” on page 209.

Examples	Dim SlopLev As Double SCPI.SOURce(1).POWer.LEVel.SLOPe.DATA = 0.1 SlopLev = SCPI.SOURce(1).POWer.LEVel.SLOPe.DATA
Related objects	SCPI.SOURce(Ch).POWer.LEVel.SLOPe.STATe on page 650
Equivalent key	[Sweep Setup] - Power - Slop [xxx dB/GHz]

SCPI.SOURce(*Ch*).POWer.LEVel.SLOPe.STATe

Object type Property

Syntax SCPI.SOURce(*Ch*).POWer.LEVel.SLOPe.STATe = *Status*
Status = SCPI.SOURce(*Ch*).POWer.LEVel.SLOPe.STATe

Description Turns on/off the power slope feature for channels 1 to 16 (*Ch*). This function is a function to correct the attenuation of simple power level proportional to the frequency (attenuation due to cables and so on).

Variable

	<i>Status</i>
Description	On/off of the power slope feature
Data type	Boolean type (Boolean)
Range	Select from the following. <ul style="list-style-type: none"> •True or -1 Turns on the power slop feature. •False or 0 Turns off the power slop feature.
Preset value	False or 0

For information on the variable (*Ch*), refer to Table 7-6, “Variable (Ch),” on page 209.

Examples

```
Dim Slop As Boolean
SCPI.SOURce(1).POWer.LEVel.SLOPe.STATe = True
Slop = SCPI.SOURce(1).POWer.LEVel.SLOPe.STATe
```

Related objects SCPI.SOURce(Ch).POWer.LEVel.SLOPe.DATA on page 649
SCPI.SENSE(Ch).SWEep.GENERation on page 634

Equivalent key **[Sweep Setup] - Power - Slop [ON/OFF]**

SCPI.SOURce(*Ch*).POWer.PORT(*Pt*).CORRection. COLLeCt.ACQuire

Object type Property

Syntax SCPI.SOURce(*Ch*).POWer.PORT(*Pt*).CORRection.COLLeCt.ACQuire = *Param*

Description For ports 1 to 4 (*Pt*) of channels 1 to 16 (*Ch*), measure the power calibration data using the specified power sensor. When the measurement is complete successfully, the power level error correction is automatically turned on.

If the power meter is not connected correctly, an error occurs and the object is ignored. (No read)

Variable

	<i>Param</i>
Description	Selection of the power sensor
Data type	Character string type (String)
Range	Select from the following. <ul style="list-style-type: none"> •"ASENsor" Specifies power sensor A. •"BSENsor" Specifies power sensor B.

For information on the variable (*Ch*) and the variable (*Pt*), refer to Table 7-6, "Variable (Ch)," on page 209 and Table 7-9, "Variable (Pt)," on page 241, respectively.

Examples

```
Dim Dmy As Long
SCPI.SOURce(1).POWer.PORT(1).CORRection.COLLeCt.ACQuire = "asen"
Dmy = SCPI.IEEE4882.OPC
```

Related objects SCPI.IEEE4882.OPC on page 420

Equivalent key **[Cal] - Power Calibration - Take Cal Sweep**

SCPI.SOURCE.POWER.PORT.CORRECTION.COLLECT.ASENSOR.RCFactor

Object type	Property
Syntax	SCPI.SOURCE.POWER.PORT.CORRECTION.COLLECT.ASENSOR.RCFactor = <i>Value</i> <i>Value</i> = SCPI.SOURCE.POWER.PORT.CORRECTION.COLLECT.ASENSOR.RCFactor
Description	Sets the reference calibration coefficient (the calibration coefficient at 50 MHz) for power sensor A.

Variable

	<i>Value</i>
Description	Reference calibration coefficient
Data type	Double precision floating point type (Double)
Range	1 to 150
Preset value	100
Unit	% (percent)
Resolution	0.01
Note	If the specified variable is out of the allowable setup range, the minimum value (if the lower limit of the range is not reached) or the maximum value (if the upper limit of the range is exceeded) is set.

Examples	<pre>Dim CalRef As Double SCPI.SOURCE.POWER.PORT.CORRECTION.COLLECT.ASENSOR.RCFactor = 99.5 CalRef = SCPI.SOURCE.POWER.PORT.CORRECTION.COLLECT.ASENSOR.RCFactor</pre>
----------	---

Related objects	SCPI.SOURCE.POWER.PORT.CORRECTION.COLLECT.BSENSOR.RCFactor on page 654
-----------------	--

Equivalent key	[Cal] - Power Calibration - Sensor A Settings - Ref Cal Factor
----------------	---

SCPI.SOURce(Ch).POWer.PORT(Pt).CORRection. COLLEct.AVERAge.COUNT

Object type	Property
Syntax	SCPI.SOURce(Ch).POWer.PORT(Pt).CORRection.COLLEct.AVERAge.COUNT = <i>Value</i> <i>Value</i> = SCPI.SOURce(Ch).POWer.PORT(Pt).CORRection.COLLEct.AVERAge.COUNT
Description	For ports 1 to 4 (<i>Pt</i>) of channels 1 to 16 (<i>Ch</i>), sets the number of power calibration data measurements per measurement point (averaging factor).
Variable	

	<i>Value</i>
Description	Averaging factor
Data type	Long integer type (Long)
Range	1 to 100
Preset value	1
Note	If the specified variable is out of the allowable setup range, the minimum value (if the lower limit of the range is not reached) or the maximum value (if the upper limit of the range is exceeded) is set.

For information on the variable (*Ch*) and the variable (*Pt*), refer to Table 7-6, “Variable (Ch),” on page 209 and Table 7-9, “Variable (Pt),” on page 241, respectively.

Examples	Dim AvgCnt As Long SCPI.SOURce(1).POWer.PORT(1).CORRection.COLLEct.AVERAge.COUNT = 6 AvgCnt = SCPI.SOURce(1).POWer.PORT(1).CORRection.COLLEct.AVERAge.COUNT
Related objects	SCPI.SOURce(Ch).POWer.PORT(Pt).CORRection. COLLEct.ACQuire on page 651
Equivalent key	[Cal] - Power Calibration - Num of Readings

SCPI.SOURCE.POWER.PORT.CORRECTION.COLLECT.BSENSOR.RCFactor

Object type	Property
Syntax	SCPI.SOURCE.POWER.PORT.CORRECTION.COLLECT.BSENSOR.RCFactor = <i>Value</i> <i>Value</i> = SCPI.SOURCE.POWER.PORT.CORRECTION.COLLECT.BSENSOR.RCFactor
Description	Sets the reference calibration coefficient (the calibration coefficient at 50 MHz) for power sensor B.

Variable

	<i>Value</i>
Description	Reference calibration coefficient
Data type	Double precision floating point type (Double)
Range	1 to 150
Preset value	100
Unit	% (percent)
Resolution	0.01
Note	If the specified variable is out of the allowable setup range, the minimum value (if the lower limit of the range is not reached) or the maximum value (if the upper limit of the range is exceeded) is set.

Examples

```
Dim CalRef As Double
SCPI.SOURCE.POWER.PORT.CORRECTION.COLLECT.BSENSOR.RCFactor = 99
CalRef = SCPI.SOURCE.POWER.PORT.CORRECTION.COLLECT.BSENSOR.RCFactor
```

Related objects SCPI.SOURCE.POWER.PORT.CORRECTION.COLLECT.ASENSOR.RCFactor on page 652

Equivalent key **[Cal] - Power Calibration - Sensor B Settings - Ref Cal Factor**

SCPI.SOURce.POWer.PORT.CORRection.COLLect. NTOLerance

Object type	Property
Syntax	SCPI.SOURce.POWer.PORT.CORRection.COLLect.NTOLerance= <i>Value</i> <i>Value</i> = SCPI.SOURce.POWer.PORT.CORRection.COLLect.NTOLerance
Description	For ports 1 to 4 (<i>Pt</i>) of channels 1 to 16 (<i>Ch</i>), sets the tolerance of power calibration data for each measurement point.
Variable	

	<i>Value</i>
Description	Tolerance of power calibration
Data type	Double precision floating point type (Double)
Range	0 to 100
Preset value	5
Unit	dB
Resolution	0.001
Note	When the measurement result is beyond the tolerance, an error message appears and the power correction function does not turn on.

For information on the variable (*Ch*) and the variable (*Pt*), refer to Table 7-6, “Variable (Ch),” on page 209 and Table 7-9, “Variable (Pt),” on page 241, respectively.

Examples	Dim TorVal As Long SCPI.SOURce(1).POWer.PORT(1).CORRection.COLLect.NTOLerance = 10 TorVal = SCPI.SOURce(1).POWer.PORT(1).CORRection.COLLect.NTOLerance
Related objects	SCPI.SOURce(Ch).POWer.PORT(Pt).CORRection. COLLect.ACQuire on page 651
Equivalent key	[Cal] - Power Calibration - Tolerance

SCPI.SOURCE.POWER.PORT.CORRECTION.COLLECT.TABLE.ASENSOR.DATA

Object type	Property
Syntax	SCPI.SOURCE.POWER.PORT.CORRECTION.COLLECT.TABLE.ASENSOR.DATA = <i>Data</i> <i>Data</i> = SCPI.SOURCE.POWER.PORT.CORRECTION.COLLECT.TABLE.ASENSOR.DATA
Description	Sets the calibration coefficient table for power sensor A.
Variable	

	<i>Data</i>
Description	<p>Indicates the array data (for the calibration coefficient table) of 1 + Num (number of set data items)×2. Where n is an integer between 1 and Num.</p> <ul style="list-style-type: none"> • <i>Data</i>(0) The number of data items you want to set. Specify an integer between 0 to 100. When you set the number of data items to 0 (to clear the calibration coefficient table), you specify only <i>Data</i>(0) as the Data variable. • <i>Data</i>(n×2-1) The frequency of the n-th data item (1 kHz to 500 GHz). • <i>Data</i>(n×2) The calibration coefficient of the n-th data item (1% to 150%). <p>The index of the array starts from 0.</p>
Data type	Variant type (Variant)
Note	If the array data does not contain 1+Num (number of set data items)×2 when setting a calibration coefficient table, a runtime error occurs. For <i>Data</i> (n×2-1) and <i>Data</i> (n×2) in the array data, if the specified value is out of the allowable setup range, the minimum value (if the lower limit of the range is not reached) or the maximum value (if the upper limit of the range is exceeded) is set.

Examples

```
Dim CalFac As Variant
SCPI.SOURCE.POWER.PORT.CORRECTION.COLLECT.TABLE.ASENSOR.DATA = Array(2,1e7,99.8,
1e9,98.7)
CalFac = SCPI.SOURCE.POWER.PORT.CORRECTION.COLLECT.TABLE.ASENSOR.DATA
'''Clear Cal Factor Table
SCPI.SOURCE.POWER.PORT.CORRECTION.COLLECT.TABLE.ASENSOR.DATA = Array(0)
```

```
Dim CalFac(4) As Variant
Dim Ref As Variant
CalFac(0) = 2
CalFac(1) = 1e7
CalFac(2) = 99.8
CalFac(3) = 1e9
CalFac(4) = 98.7
SCPI.SOURCE.POWER.PORT.CORRECTION.COLLECT.TABLE.ASENSOR.DATA = CalFac
Ref = SCPI.SOURCE.POWER.PORT.CORRECTION.COLLECT.TABLE.ASENSOR.DATA
'''Clear Cal Factor Table
Dim CalFac(0) As Variant
CalFac(0) = 0
SCPI.SOURCE.POWER.PORT.CORRECTION.COLLECT.TABLE.ASENSOR.DATA = CalFac
```

Related objects	SCPI.SOURCE.POWER.PORT.CORRECTION.COLLECT.TABLE.BSENSOR.DATA on page 657
Equivalent key	[Cal] - Power Calibration - Sensor A Settings - Delete Add Clear Cal Factor Table

SCPI.SOURCE.POWER.PORT.CORRECTION.COLLECT.TABLE.BSENSOR.DATA

Object type Property

Syntax SCPI.SOURCE.POWER.PORT.CORRECTION.COLLECT.TABLE.BSENSOR.DATA = *Data*
Data = SCPI.SOURCE.POWER.PORT.CORRECTION.COLLECT.TABLE.BSENSOR.DATA

Description Sets the calibration coefficient table for power sensor B.

Variable

	<i>Data</i>
Description	<p>Indicates the array data (for the calibration coefficient table) of 1 + Num (number of set data items)×2. Where n is an integer between 1 and Num.</p> <ul style="list-style-type: none"> • <i>Data</i>(0) The number of data items you want to set. Specify an integer between 0 to 100. When you set the number of data items to 0 (to clear the calibration coefficient table), you specify only <i>Data</i>(0) as the Data variable. • <i>Data</i>(n×2-1) The frequency of the n-th data item (1 kHz to 500 GHz). • <i>Data</i>(n×2) The calibration coefficient of the n-th data item (1% to 150%). <p>The index of the array starts from 0.</p>
Data type	Variant type (Variant)
Note	If the array data does not contain 1+Num (number of set data items)×2 when setting a calibration coefficient table, a runtime error occurs. For <i>Data</i> (n×2-1) and <i>Data</i> (n×2) in the array data, if the specified value is out of the allowable setup range, the minimum value (if the lower limit of the range is not reached) or the maximum value (if the upper limit of the range is exceeded) is set.

Examples

```
Dim CalFac As Variant
SCPI.SOURCE.POWER.PORT.CORRECTION.COLLECT.TABLE.BSENSOR.DATA = Array(2,1e7,99.8,
1e9,98.7)
CalFac = SCPI.SOURCE.POWER.PORT.CORRECTION.COLLECT.TABLE.BSENSOR.DATA
'''Clear Cal Factor Table
SCPI.SOURCE.POWER.PORT.CORRECTION.COLLECT.TABLE.BSENSOR.DATA = Array(0)
```

```
Dim CalFac(4) As Variant
Dim Ref As Variant
CalFac(0) = 2
CalFac(1) = 1e7
CalFac(2) = 99.8
CalFac(3) = 1e9
CalFac(4) = 98.7
SCPI.SOURCE.POWER.PORT.CORRECTION.COLLECT.TABLE.BSENSOR.DATA = CalFac
Ref = SCPI.SOURCE.POWER.PORT.CORRECTION.COLLECT.TABLE.BSENSOR.DATA
'''Clear Cal Factor Table
Dim CalFac(0) As Variant
CalFac(0) = 0
SCPI.SOURCE.POWER.PORT.CORRECTION.COLLECT.TABLE.BSENSOR.DATA = CalFac
```

Related objects SCPI.SOURCE.POWER.PORT.CORRECTION.COLLECT.TABLE.ASENSOR.DATA on page 656

Equivalent key **[Cal] - Power Calibration - Sensor B Settings - Delete | Add | Clear Cal Factor Table**

**SCPI.SOURce(Ch).POWER.PORT(Pt).CORRection.
COLLect.TABLe.LOSS.DATA**

Object type	Property
Syntax	SCPI.SOURce(Ch).POWER.PORT(Pt).CORRection.COLLect.TABLe.LOSS.DATA = <i>Data</i> <i>Data</i> = SCPI.SOURce(Ch).POWER.PORT(Pt).CORRection.COLLect.TABLe.LOSS.DATA
Description	For ports 1 to 4 (<i>Pt</i>) of channels 1 to 16 (<i>Ch</i>), sets the loss compensation table.
Variable	

	<i>Data</i>
Description	Indicates the array data (for the loss compensation table) of 1 + Num (number of set data items)×2. Where n is an integer between 1 and Num. <ul style="list-style-type: none"> • <i>Data</i>(0) The number of data items you want to set. Specify an integer between 0 to 100. When you set the number of data items to 0 (to clear the loss compensation table), you specify only <i>Data</i>(0) as the <i>Data</i> variable. • <i>Data</i>(n×2-1) The frequency of the n-th data item (1 kHz to 500 GHz). • <i>Data</i>(n×2) The loss of the n-th data item (-100 dB to 100 dB). The index of the array starts from 0.
Data type	Variant type (Variant)
Note	If the array data does not contain 1+Num (number of set data items)×2 when setting a loss compensation table, a runtime error occurs. For <i>Data</i> (n×2-1) and <i>Data</i> (n×2) in the array data, if the specified value is out of the allowable setup range, the minimum value (if the lower limit of the range is not reached) or the maximum value (if the upper limit of the range is exceeded) is set.

For information on the variable (*Ch*) and the variable (*Pt*), refer to Table 7-6, “Variable (Ch),” on page 209 and Table 7-9, “Variable (Pt),” on page 241, respectively.

Examples

```
Dim Loss As Variant
SCPI.SOURce(1).POWER.PORT(1).CORRection.COLLect.TABLe.LOSS.DATA = Array(2,1e8,0.5,1e9,0.8)
Loss = SCPI.SOURce(1).POWER.PORT(1).CORRection.COLLect.TABLe.LOSS.DATA
'''Clear Loss Table
SCPI.SOURce(1).POWER.PORT(1).CORRection.COLLect.TABLe.LOSS.DATA = Array(0)
```

```
Dim Loss(4) As Variant
Dim Ref As Variant
Loss(0) = 2
Loss(1) = 1e8
Loss(2) = 0.5
Loss(3) = 1e9
Loss(4) = 0.8
SCPI.SOURce(1).POWER.PORT(1).CORRection.COLLect.TABLe.LOSS.DATA = Loss
Ref = SCPI.SOURce(1).POWER.PORT(1).CORRection.COLLect.TABLe.LOSS.DATA
'''Clear Loss Table
Dim Loss(0) As Variant
Loss(0) = 0
SCPI.SOURce(1).POWER.PORT(1).CORRection.COLLect.TABLe.LOSS.DATA = Loss
```

Related objects	SCPI.SOURce(Ch).POWER.PORT(Pt).CORRection. COLLect.TABLe.LOSS.STATe on page 659
Equivalent key	[Cal] - Power Calibration - Loss Compen - Delete Add Clear Loss Table

SCPI.SOURce(*Ch*).POWer.PORT(*Pt*).CORRection. COLLect.TABLe.LOSS.STATe

Object type Property

Syntax SCPI.SOURce(*Ch*).POWer.PORT(*Pt*).CORRection.COLLect.TABLe.LOSS.STATe = *Status*
Status = SCPI.SOURce(*Ch*).POWer.PORT(*Pt*).CORRection.COLLect.TABLe.LOSS.STATe

Description For ports 1 to 4 (*Pt*) of channels 1 to 16 (*Ch*), turns on/off the loss compensation.

Variable

	<i>Status</i>
Description	On/off of loss compensation
Data type	Boolean type (Boolean)
Range	Select from the following. <ul style="list-style-type: none"> • True or -1 Turns on the loss compensation. • False or 0 Turns off the loss compensation.
Preset value	False or 0

For information on the variable (*Ch*) and the variable (*Pt*), refer to Table 7-6, “Variable (Ch),” on page 209 and Table 7-9, “Variable (Pt),” on page 241, respectively.

Examples

```
Dim LComp As Boolean
SCPI.SOURce(1).POWer.PORT(1).CORRection.COLLect.TABLe.LOSS.STATe = True
LComp = SCPI.SOURce(1).POWer.PORT(1).CORRection.COLLect.TABLe.LOSS.STATe
```

Equivalent key **[Cal] - Power Calibration - Loss Comp - Compensation**

SCPI.SOURCE(Ch).POWER.PORT(Pt).CORRECTION.DATA

Object type	Property
Syntax	SCPI.SOURCE(Ch).POWER.PORT(Pt).CORRECTION.DATA = <i>Data</i> <i>Data</i> = SCPI.SOURCE(Ch).POWER.PORT(Pt).CORRECTION.DATA
Description	For ports 1 to 4 (<i>Pt</i>) of channels 1 to 16 (<i>Ch</i>), sets/reads out the power calibration data array.
Variable	

	<i>Data</i>
Description	Indicates the array data (power calibration data array) of NOP (number of points). Where <i>n</i> is an integer between 1 and NOP. <ul style="list-style-type: none"> • <i>Data(n-1)</i> Data at the <i>n</i>-th measurement point The index of the array starts from 0.
Data type	Variant type (Variant)
Note	If the array data does not contain NOP (number of measurement points) when setting a power calibration data array, a runtime error occurs.

For information on the variable (*Ch*) and the variable (*Pt*), refer to Table 7-6, “Variable (Ch),” on page 209 and Table 7-9, “Variable (Pt),” on page 241, respectively.

Examples	<pre>Dim FreqData As Variant SCPI.SENSE(1).SWEep.POINTs = 201 FreqData = SCPI.SENSE(1).FREQuency.DATA Dim CorData As Variant SCPI.SENSE(1).SWEep.POINTs = 201 CorData = SCPI.SOURCE(1).POWER.PORT(1).CORREction.DATA SCPI.SOURCE(1).POWER.PORT(2).CORREction.DATA = CorData</pre>
Related objects	<p>SCPI.SOURCE(Ch).POWER.PORT(Pt).CORREction.STATe on page 661</p> <p>SCPI.SENSE(Ch).SWEep.POINTs on page 635</p>
Equivalent key	No equivalent key is available on the front panel.

SCPI.SOURce(Ch).POWer.PORT(Pt).CORRection.STATe

Object type	Property
Syntax	SCPI.SOURce(<i>Ch</i>).POWer.PORT(<i>Pt</i>).CORRection.STATe = <i>Status</i> <i>Status</i> = SCPI.SOURce(<i>Ch</i>).POWer.PORT(<i>Pt</i>).CORRection.STATe
Description	For ports 1 to 4 (<i>Pt</i>) of channels 1 to 16 (<i>Ch</i>), turns on/off the power level error correction.
Variable	

	<i>Status</i>
Description	Turning on/off the power level error correction
Data type	Boolean type (Boolean)
Range	Select from the following. <ul style="list-style-type: none"> • True or -1 Turns on the power level error correction. • False or 0 Turns off the power level error correction.
Preset value	False or 0

For information on the variable (*Ch*) and the variable (*Pt*), refer to Table 7-6, “Variable (Ch),” on page 209 and Table 7-9, “Variable (Pt),” on page 241, respectively.

Examples	<pre>Dim PowCorr As Boolean SCPI.SOURce(1).POWer.PORT(1).CORRection.STATe = True PowCorr = SCPI.SOURce(1).POWer.PORT(1).CORRection.STATe</pre>
----------	--

Equivalent key	[Cal] - Power Calibration - Correction
----------------	---

SCPI.SOURCE(*Ch*).POWER.PORT.COUPLE

Object type Property

Syntax SCPI.SOURCE(*Ch*).POWER.PORT.COUPLE = *Status*
Status = SCPI.SOURCE(*Ch*).POWER.PORT.COUPLE

Description Sets whether to output the same power level for each port of channels 1 to 16 (*Ch*). When the power slope feature is on, the same power level is always outputted to all ports regardless of this setting because different power levels cannot be outputted for each port.

Variable

	<i>Status</i>
Description	Turning on/off the coupling between ports for the power level output
Data type	Boolean type (Boolean)
Range	Select from the following. <ul style="list-style-type: none"> • True or -1 Outputs the same power level to individual ports. • False or 0 Outputs different power levels to individual ports.
Preset value	True or -1

For information on the variable (*Ch*), refer to Table 7-6, “Variable (Ch),” on page 209.

Examples

```
Dim OutCpl As Boolean
SCPI.SOURCE(1).POWER.PORT.COUPLE = False
OutCpl = SCPI.SOURCE(1).POWER.PORT.COUPLE
```

Related objects SCPI.SOURCE(Ch).POWER.PORT(Pt).LEVEL.IMMEDIATE. AMPLITUDE on page 663

Equivalent key **[Sweep Setup] - Power - Port Couple**

SCPI.SOURce(Ch).POWer.PORT(Pt).LEVel.IMMEDIATE.AMPLitude

Object type Property

Syntax SCPI.SOURce(*Ch*).POWer.PORT(*Pt*).LEVel.IMMEDIATE.AMPLitude = *Value*
Value = SCPI.SOURce(*Ch*).POWer.PORT(*Pt*).LEVel.IMMEDIATE.AMPLitude

Description For ports 1 to 4 (*Pt*) of channels 1 to 16 (*Ch*), sets the power level.

Variable

	<i>Value</i>
Description	Power level at the specified port.
Data type	Double precision floating point type (Double)
Range	Varies depending on the power range.
Preset value	0
Unit	dBm
Resolution	0.05
Note	If the specified variable is out of the allowable setup range, the minimum value (if the lower limit of the range is not reached) or the maximum value (if the upper limit of the range is exceeded) is set.

For information on the variable (*Ch*) and the variable (*Pt*), refer to Table 7-6, “Variable (Ch),” on page 209 and Table 7-9, “Variable (Pt),” on page 241, respectively.

Examples

```
Dim PowLev As Double
SCPI.SOURce(1).POWer.PORT.COUPle = False
SCPI.SOURce(1).POWer.PORT(1).LEVel.IMMEDIATE.AMPLitude = -12.5
PowLev = SCPI.SOURce(1).POWer.PORT(1).LEVel.IMMEDIATE.AMPLitude
```

Related objects SCPI.SOURce(Ch).POWer.PORT.COUPle on page 662
SCPI.SOURce(Ch).POWer.ATTenuation.DATA on page 644

Equivalent key **[Sweep Setup] - Power - Port Power - Port 1 Power | Port 2 Power | Port 3 Power | Port 4 Power**

SCPI.SOURce(Ch).POWer.SPAN

Object type	Property
Syntax	SCPI.SOURce(Ch).POWer.SPAN = <i>Value</i> <i>Value</i> = SCPI.SOURce(Ch).POWer.SPAN
Description	Sets the span value of the sweep range for the power sweep for channels 1 to 16 (<i>Ch</i>).
Variable	

	<i>Value</i>
Description	Span value
Data type	Double precision floating point type (Double)
Range	Varies depending on the power range.
Preset value	15
Unit	dBm
Resolution	0.05
Note	If the specified variable is out of the allowable setup range, the minimum value (if the lower limit of the range is not reached) or the maximum value (if the upper limit of the range is exceeded) is set.

For information on the variable (*Ch*), refer to Table 7-6, “Variable (Ch),” on page 209.

Examples	<pre>Dim Pspan As Double SCPI.SOURce(1).POWer.SPAN = 10 Pspan = SCPI.SOURce(1).POWer.SPAN</pre>
Related objects	SCPI.SENSE(Ch).SWEep.TYPE on page 638 SCPI.SOURce(Ch).POWer.ATTenuation.DATA on page 644 SCPI.SOURce(Ch).POWer.CENTer on page 647
Equivalent key	[Span]

SCPI.SOURce(Ch).POWer.STARt

- Object type Property
- Syntax SCPI.SOURce(Ch).POWer.STARt = *Value*
Value = SCPI.SOURce(Ch).POWer.STARt
- Description Sets the start value of the sweep range for the power sweep for channels 1 to 16 (*Ch*).
- Variable

	<i>Value</i>
Description	Start value
Data type	Double precision floating point type (Double)
Range	Varies depending on the power range.
Preset value	-15
Unit	dBm
Resolution	0.05
Note	If the specified variable is out of the allowable setup range, the minimum value (if the lower limit of the range is not reached) or the maximum value (if the upper limit of the range is exceeded) is set.

For information on the variable (*Ch*), refer to Table 7-6, “Variable (Ch),” on page 209.

- Examples Dim Pstart As Double
SCPI.SOURce(1).POWer.STARt = -10
Pstart = SCPI.SOURce(1).POWer.STARt
- Related objects SCPI.SENSE(Ch).SWEep.TYPE on page 638
SCPI.SOURce(Ch).POWer.ATTenuation.DATA on page 644
SCPI.SOURce(Ch).POWer.STOP on page 666
- Equivalent key **[Start]**

SCPI.SOURce(*Ch*).POWer.STOP

Object type	Property
Syntax	SCPI.SOURce(<i>Ch</i>).POWer.STOP = <i>Value</i> <i>Value</i> = SCPI.SOURce(<i>Ch</i>).POWer.STOP
Description	Sets the stop value of the sweep range for the power sweep for channels 1 to 16 (<i>Ch</i>).
Variable	

	<i>Value</i>
Description	Stop value
Data type	Double precision floating point type (Double)
Range	Varies depending on the power range.
Preset value	0
Unit	dBm
Resolution	0.05
Note	If the specified variable is out of the allowable setup range, the minimum value (if the lower limit of the range is not reached) or the maximum value (if the upper limit of the range is exceeded) is set.

For information on the variable (*Ch*), refer to Table 7-6, “Variable (Ch),” on page 209.

Examples	<pre>Dim Pstop As Double SCPI.SOURce(1).POWer.STOP = 10 Pstop = SCPI.SOURce(1).POWer.STOP</pre>
Related objects	SCPI.SENSE(<i>Ch</i>).SWEep.TYPE on page 638 SCPI.SOURce(<i>Ch</i>).POWer.ATTenuation.DATA on page 644 SCPI.SOURce(<i>Ch</i>).POWer.STARt on page 665
Equivalent key	[Stop]

SCPI.STATus.OPERation.CONDITION

Object type Property
 Syntax *Value* = SCPI.STATus.OPERation.CONDITION
 Description Reads out the value of the Operation Status Condition Register. (Read only)

Variable

	<i>Value</i>
Description	Value of the Operation Status Condition Register
Data type	Long integer type (Long)

Examples

```
Dim Stat As Long
Stat = SCPI.STATus.OPERation.CONDITION
```

Related objects
 SCPI.STATus.OPERation.NTRansition on page 668
 SCPI.STATus.OPERation.PTRansition on page 669

Equivalent key No equivalent key is available on the front panel.

SCPI.STATus.OPERation.ENABLE

Object type Property
 Syntax SCPI.STATus.OPERation.ENABLE = *Value*
Value = SCPI.STATus.OPERation.ENABLE
 Description Sets the value of the Operation Status Enable Register.

Variable

	<i>Value</i>
Description	Value of the Operation Status Enable Register
Data type	Long integer type (Long)
Range	0 to 65535
Preset value	0
Note	The bit 0 to 3, bit 6 to13 and bit 15 can not be set to 1.

Examples

```
Dim Stat As Long
SCPI.STATus.OPERation.ENABLE = 16
Stat = SCPI.STATus.OPERation.ENABLE
```

Related objects SCPI.IEEE4882.SRE on page 422

Equivalent key No equivalent key is available on the front panel.

SCPI.STATUS.OPERation.EVENT

Object type Property

Syntax *Value* = SCPI.STATUS.OPERation.EVENT

Description Reads out the value of the Operation Status Event Register. (Read only)

Variable

	<i>Value</i>
Description	Value of the Operation Status Event Register
Data type	Long integer type (Long)

Examples

```
Dim Stat As Long
Stat = SCPI.STATUS.OPERation.EVENT
```

Related objects SCPI.IEEE4882.CLS on page 417
SCPI.STATUS.OPERation.NTRansition on page 668
SCPI.STATUS.OPERation.PTRansition on page 669

Equivalent key No equivalent key is available on the front panel.

SCPI.STATUS.OPERation.NTRansition

Object type Property

Syntax SCPI.STATUS.OPERation.NTRansition = *Value*
Value = SCPI.STATUS.OPERation.NTRansition

Description Sets the value of negative transition filter of the Operation Status Register.

Variable

	<i>Value</i>
Description	Value of the negative transition filter
Data type	Long integer type (Long)
Range	0 to 65535
Preset value	0
Note	The bit 0 to 3, bit 6 to13 and bit 15 can not be set to 1.

Examples

```
Dim Stat As Long
SCPI.STATUS.OPERation.NTRansition = 16
Stat = SCPI.STATUS.OPERation.NTRansition
```

Related objects SCPI.STATUS.OPERation.EVENT on page 668
SCPI.STATUS.OPERation.PTRansition on page 669

Equivalent key No equivalent key is available on the front panel.

SCPI.STATus.OPERation.PTRansition

Object type	Property
Syntax	SCPI.STATus.OPERation.PTRansition = <i>Value</i> <i>Value</i> = SCPI.STATus.OPERation.PTRansition
Description	Sets the value of positive transition filter of the Operation Status Register.
Variable	

	<i>Value</i>
Description	Value of the positive transition filter
Data type	Long integer type (Long)
Range	0 to 65535
Preset value	16432
Note	The bit 0 to 3, bit 6 to13 and bit 15 can not be set to 1.

Examples	Dim Stat As Long SCPI.STATus.OPERation.PTRansition = 0 Stat = SCPI.STATus.OPERation.PTRansition
Related objects	SCPI.STATus.OPERation.EVENT on page 668 SCPI.STATus.OPERation.NTRansition on page 668
Equivalent key	No equivalent key is available on the front panel.

SCPI.STATus.PRESet

Object type	Method
Syntax	SCPI.STATus.PRESet
Description	Initialize all registers. (No read)
Examples	SCPI.STATus.PRESet
Equivalent key	No equivalent key is available on the front panel.

SCPI.STATUS.QUESTIONABLE.BLIMIT.CHANNEL(*Ch*).CONDITION

Object type	Property
Syntax	<i>Value</i> = SCPI.STATUS.QUESTIONABLE.BLIMIT.CHANNEL(<i>Ch</i>).CONDITION
Description	Reads out the value of the Questionable Bandwidth Limit Channel Status Condition Register of channel 1 to channel 16. (Read only)
Variable	

	<i>Value</i>
Description	The value of the Questionable Bandwidth Limit Channel Status Condition Register
Data type	Long integer type (Long)

For information on the variable (*Ch*), see Table 7-6, “Variable (*Ch*),” on page 209.

Examples	<pre>Dim Stat As Long Stat = SCPI.STATUS.QUESTIONABLE.BLIMIT.CHANNEL(1).CONDITION</pre>
Related objects	<p>SCPI.STATUS.QUESTIONABLE.BLIMIT.CHANNEL(<i>Ch</i>).NTRANSITION on page 678</p> <p>SCPI.STATUS.QUESTIONABLE.BLIMIT.CHANNEL(<i>Ch</i>).PTRANSITION on page 679</p>
Equivalent key	No equivalent key is available on the front panel.

SCPI.STATus.QUEStionable.BLIMit.CHANnel(*Ch*).ECHannel.CONDITION

Object type	Property
Syntax	<i>Value</i> = SCPI.STATus.QUEStionable.BLIMit.CHANnel(<i>Ch</i>).ECHannel.CONDITION
Description	Reads out the value of the Questionable Bandwidth Limit Channel Extra Status Event Register of channel 1 to channel 16 . (Read only)
Variable	

	<i>Value</i>
Description	The value of the Questionable Bandwidth Limit Channel Extra Status Event Register
Data type	Long integer type (Long)

For information on the variable (*Ch*), see Table 7-6, “Variable (Ch),” on page 209.

Examples	<pre>Dim Stat As Long Stat = SCPI.STATus.QUEStionable.BLIMit.CHANnel(1).ECHannel.CONDITION</pre>
Related objects	<p>SCPI.STATus.QUEStionable.BLIMit.CHANnel(<i>Ch</i>).ECHannel.NTRansition on page 674</p> <p>SCPI.STATus.QUEStionable.BLIMit.CHANnel(<i>Ch</i>).ECHannel.PTRansition on page 675</p>
Equivalent key	No equivalent key is available on the front panel.

SCPI.STATus.QUEStionable.BLIMit.CHANnel(*Ch*).ECHannel.ENABLE

Object type	Property
Syntax	SCPI.STATus.QUEStionable.BLIMit.CHANnel(<i>Ch</i>).ECHannel.ENABLE = <i>Value</i> <i>Value</i> = SCPI.STATus.QUEStionable.BLIMit.CHANnel(<i>Ch</i>).ECHannel.ENABLE
Description	Sets the value of the Questionable Bandwidth Limit Channel Extra Status Enable Register of channel 1 to channel 16 .

Variable

	<i>Value</i>
Description	Value of the enable register
Data type	Long integer type (Long)
Range	0 to 65535
Preset value	Varies depending on the upper limit setting of the number of channels/traces.
Note	Bits 0 and 3 to 15 cannot be set to 1.

For information on the variable (*Ch*), see Table 7-6, “Variable (Ch),” on page 209.

Examples

```
Dim Stat As Long
SCPI.STATus.QUEStionable.BLIMit.CHANnel(1).ECHannel.ENABLE = 6
Stat = SCPI.STATus.QUEStionable.BLIMit.CHANnel(1).ECHannel.ENABLE
```

Related objects SCPI.STATus.QUEStionable.BLIMit.CHANnel(*Ch*).ENABLE on page 676

Equivalent key No equivalent key is available on the front panel.

SCPI.STATus.QUEStionable.BLIMit.CHANnel(Ch).ECHannel.EVENT

Object type	Property
Syntax	<i>Value</i> = SCPI.STATus.QUEStionable.BLIMit.CHANnel(<i>Ch</i>).ECHannel.EVENT
Description	Reads out the value of the Questionable Bandwidth Limit Channel Extra Status Event Register of channel 1 to channel 16 . (Read only)
Variable	

	<i>Value</i>
Description	the value of the Questionable Bandwidth Limit Channel Extra Status Event Register
Data type	Long integer type (Long)

For information on the variable (*Ch*), see Table 7-6, “Variable (Ch),” on page 209.

Examples	<pre>Dim Stat As Long Stat = SCPI.STATus.QUEStionable.BLIMit.CHANnel(1).ECHannel.EVENT</pre>
Related objects	SCPI.IEEE4882.CLS on page 417
Equivalent key	No equivalent key is available on the front panel.

SCPI.STATus.QUEStionable.BLIMit.CHANnel(*Ch*).ECHannel.NTRansition

Object type	Property
Syntax	SCPI.STATus.QUEStionable.BLIMit.CHANnel(<i>Ch</i>).ECHannel.NTRansition = <i>Value</i> <i>Value</i> = SCPI.STATus.QUEStionable.BLIMit.CHANnel(<i>Ch</i>).ECHannel.NTRansition
Description	Sets the value of the negative transition filter of the Questionable Bandwidth Limit Channel Extra Status Register of channel 1 to channel 16 .

Variable

	<i>Value</i>
Description	The value of the negative transition filter of the Questionable Bandwidth Limit Channel Extra Status Register
Data type	Long integer type (Long)
Range	0 to 65535
Preset value	0
Note	Bits 0 and 3 to 15 cannot be set to 1.

For information on the variable (*Ch*), see Table 7-6, “Variable (Ch),” on page 209.

Examples	<pre>Dim Stat As Long SCPI.STATus.QUEStionable.BLIMit.CHANnel(1).ECHannel.NTRansition = 6 Stat = SCPI.STATus.QUEStionable.BLIMit.CHANnel(1).ECHannel.NTRansition</pre>
Related objects	<p>SCPI.STATus.QUEStionable.BLIMit.CHANnel(<i>Ch</i>).ECHannel.EVENT on page 673</p> <p>SCPI.STATus.QUEStionable.BLIMit.CHANnel(<i>Ch</i>).ECHannel.PTRansition on page 675</p>
Equivalent key	No equivalent key is available on the front panel.

SCPI.STATus.QUEStionable.BLIMit.CHANnel(Ch).ECHannel.PTRansition

- Object type** Property
- Syntax** SCPI.STATus.QUEStionable.BLIMit.CHANnel(*Ch*).ECHannel.PTRansition = *Value*
Value = SCPI.STATus.QUEStionable.BLIMit.CHANnel(*Ch*).ECHannel.PTRansition
- Description** Sets the value of the positive transition filter of the Questionable Bandwidth Limit Channel Extra Status Register of channel 1 to channel 16 .
- Variable**

	<i>Value</i>
Description	The value of the positive transition filter of the Questionable Bandwidth Limit Channel Extra Status Register
Data type	Long integer type (Long)
Range	0 to 65535
Preset value	Varies depending on the upper limit setting of the number of channels/traces.
Note	Bits 0 and 3 to 15 cannot be set to 1.

For information on the variable (*Ch*), see Table 7-6, “Variable (Ch),” on page 209.

- Examples**
- ```
Dim Stat As Long
SCPI.STATus.QUEStionable.BLIMit.CHANnel(1).ECHannel.PTRansition = 6
Stat =
SCPI.STATus.QUEStionable.BLIMit.CHANnel(1).ECHannel.PTRansition
```
- Related objects** SCPI.STATus.QUEStionable.BLIMit.CHANnel(Ch).ECHannel.EVENT on page 673  
SCPI.STATus.QUEStionable.BLIMit.CHANnel(Ch).ECHannel.NTRansition on page 674
- Equivalent key** No equivalent key is available on the front panel.

**SCPI.STATus.QUEStionable.BLIMit.CHANnel(*Ch*).ENABLE**

|             |                                                                                                                                                          |
|-------------|----------------------------------------------------------------------------------------------------------------------------------------------------------|
| Object type | Property                                                                                                                                                 |
| Syntax      | SCPI.STATus.QUEStionable.BLIMit.CHANnel( <i>Ch</i> ).ENABLE = <i>Value</i><br><i>Value</i> = SCPI.STATus.QUEStionable.BLIMit.CHANnel( <i>Ch</i> ).ENABLE |
| Description | Sets the value of the Questionable Bandwidth Limit Channel Status Enable Register of channel 1 to channel 16 .                                           |
| Variable    |                                                                                                                                                          |

|              | <i>Value</i>                                                                  |
|--------------|-------------------------------------------------------------------------------|
| Description  | The value of the Questionable Bandwidth Limit Channel Status Enable Register  |
| Data type    | Long integer type (Long)                                                      |
| Range        | 0 to 65535                                                                    |
| Preset value | Varies depending on the upper limit setting of the number of channels/traces. |
| Note         | Bits 15 cannot be set to 1.                                                   |

For information on the variable (*Ch*), see Table 7-6, “Variable (Ch),” on page 209.

|                 |                                                                                                                                             |
|-----------------|---------------------------------------------------------------------------------------------------------------------------------------------|
| Examples        | <pre>Dim Stat As Long SCPI.STATus.QUEStionable.BLIMit.CHANnel(1).ENABLE = 16 Stat = SCPI.STATus.QUEStionable.BLIMit.CHANnel(1).ENABLE</pre> |
| Related objects | SCPI.STATus.QUEStionable.BLIMit.ENABLE on page 684                                                                                          |
| Equivalent key  | No equivalent key is available on the front panel.                                                                                          |



## SCPI.STATus.QUEStionable.BLIMit.CHANnel(Ch).EVENT

|             |                                                                                                                                |
|-------------|--------------------------------------------------------------------------------------------------------------------------------|
| Object type | Property                                                                                                                       |
| Syntax      | <i>Value</i> = SCPI.STATus.QUEStionable.BLIMit.CHANnel( <i>Ch</i> ).EVENT                                                      |
| Description | Reads out the value of the Questionable Bandwidth Limit Channel Status Event Register of channel 1 to channel 16 . (Read only) |

### Variable

|             | <i>Value</i>                                                                |
|-------------|-----------------------------------------------------------------------------|
| Description | The value of the Questionable Bandwidth Limit Channel Status Event Register |
| Data type   | Long integer type (Long)                                                    |

For information on the variable (*Ch*), see Table 7-6, “Variable (Ch),” on page 209.

**Examples**  

```
Dim Stat As Long
Stat = SCPI.STATus.QUEStionable.BLIMit.CHANnel(1).EVENT
```

**Related objects** SCPI.IEEE4882.CLS on page 417

**Equivalent key** No equivalent key is available on the front panel.

**SCPI.STATus.QUEStionable.BLIMit.CHANnel(*Ch*).NTRansition**

|             |                                                                                                                                                                    |
|-------------|--------------------------------------------------------------------------------------------------------------------------------------------------------------------|
| Object type | Property                                                                                                                                                           |
| Syntax      | SCPI.STATus.QUEStionable.BLIMit.CHANnel( <i>Ch</i> ).NTRansition = <i>Value</i><br><i>Value</i> = SCPI.STATus.QUEStionable.BLIMit.CHANnel( <i>Ch</i> ).NTRansition |
| Description | Sets the value of the negative transition filter of the Questionable Bandwidth Limit Channel Status Register of channel 1 to channel 16 .                          |
| Variable    |                                                                                                                                                                    |

|              | <i>Value</i>                                                                                            |
|--------------|---------------------------------------------------------------------------------------------------------|
| Description  | The value of the negative transition filter of the Questionable Bandwidth Limit Channel Status Register |
| Data type    | Long integer type (Long)                                                                                |
| Range        | 0 to 65535                                                                                              |
| Preset value | 0                                                                                                       |
| Note         | Bits 15 cannot be set to 1.                                                                             |

For information on the variable (*Ch*), see Table 7-6, “Variable (Ch),” on page 209.

|                 |                                                                                                                                                               |
|-----------------|---------------------------------------------------------------------------------------------------------------------------------------------------------------|
| Examples        | <pre>Dim Stat As Long SCPI.STATus.QUEStionable.BLIMit.CHANnel(1).NTRansition = 16 Stat = SCPI.STATus.QUEStionable.BLIMit.CHANnel(1).NTRansition</pre>         |
| Related objects | <p>SCPI.STATus.QUEStionable.BLIMit.CHANnel(<i>Ch</i>).EVENT on page 677</p> <p>SCPI.STATus.QUEStionable.BLIMit.CHANnel(<i>Ch</i>).PTRansition on page 679</p> |
| Equivalent key  | No equivalent key is available on the front panel.                                                                                                            |

## **SCPI.STATus.QUEStionable.BLIMit.CHANnel(*Ch*).PTRansition**

|             |                                                                                                                                                                    |
|-------------|--------------------------------------------------------------------------------------------------------------------------------------------------------------------|
| Object type | Property                                                                                                                                                           |
| Syntax      | SCPI.STATus.QUEStionable.BLIMit.CHANnel( <i>Ch</i> ).PTRansition = <i>Value</i><br><i>Value</i> = SCPI.STATus.QUEStionable.BLIMit.CHANnel( <i>Ch</i> ).PTRansition |
| Description | Sets the value of the positive transition filter of the Questionable Bandwidth Limit Channel Status Register of channel 1 to channel 16 .                          |
| Variable    |                                                                                                                                                                    |

|              | <i>Value</i>                                                                                            |
|--------------|---------------------------------------------------------------------------------------------------------|
| Description  | The value of the positive transition filter of the Questionable Bandwidth Limit Channel Status Register |
| Data type    | Long integer type (Long)                                                                                |
| Range        | 0 to 65535                                                                                              |
| Preset value | Varies depending on the upper limit setting of the number of channels/traces.                           |
| Note         | Bits 15 cannot be set to 1.                                                                             |

For information on the variable (*Ch*), see Table 7-6, “Variable (Ch),” on page 209.

|                 |                                                                                                                                                 |
|-----------------|-------------------------------------------------------------------------------------------------------------------------------------------------|
| Examples        | Dim Stat As Long<br>SCPI.STATus.QUEStionable.BLIMit.CHANnel(1).PTRansition = 0<br>Stat = SCPI.STATus.QUEStionable.BLIMit.CHANnel(1).PTRansition |
| Related objects | SCPI.STATus.QUEStionable.BLIMit.CHANnel(Ch).EVENT on page 677<br>SCPI.STATus.QUEStionable.BLIMit.CHANnel(Ch).NTRansition on page 678            |
| Equivalent key  | No equivalent key is available on the front panel.                                                                                              |

## **SCPI.STATus.QUEStionable.BLIMit.CONDiTion**

Object type      Property

Syntax            *Value* = SCPI.STATus.QUEStionable.BLIMit.CONDiTion

Description      Reads out the value of the Questionable Bandwidth Limit Status Condition Register. (Read only)

Variable

|             | <i>Value</i>                                                             |
|-------------|--------------------------------------------------------------------------|
| Description | The value of the Questionable Bandwidth Limit Status Condition Register. |
| Data type   | Long integer type (Long)                                                 |

Examples            `Dim Stat As Long`  
`Stat = SCPI.STATus.QUEStionable.BLIMit.CONDiTion`

Related objects    SCPI.STATus.QUEStionable.BLIMit.NTRansition on page 685  
SCPI.STATus.QUEStionable.BLIMit.PTRansition on page 686

Equivalent key     No equivalent key is available on the front panel.

## **SCPI.STATus.QUEStionable.BLIMit.ELIMit.CONDiTion**

Object type      Property

Syntax            *Value* = SCPI.STATus.QUEStionable.BLIMit.ELIMit.CONDiTion

Description      Reads out the value of the Questionable Bandwidth Limit Extra Status Condition Register. (Read only)

Variable

|             | <i>Value</i>                                                                   |
|-------------|--------------------------------------------------------------------------------|
| Description | The value of the Questionable Bandwidth Limit Extra Status Condition Register. |
| Data type   | Long integer type (Long)                                                       |

Examples            `Dim Stat As Long`  
`Stat = SCPI.STATus.QUEStionable.BLIMit.ELIMit.CONDiTion`

Related objects    SCPI.STATus.QUEStionable.BLIMit.ELIMit.NTRansition on page 682  
SCPI.STATus.QUEStionable.BLIMit.ELIMit.PTRansition on page 683

Equivalent key     No equivalent key is available on the front panel.

## SCPI.STATus.QUEStionable.BLIMit.ELIMit.ENABLE

**Object type** Property

**Syntax** SCPI.STATus.QUEStionable.BLIMit.ELIMit.ENABLE = *Value*  
*Value* = SCPI.STATus.QUEStionable.BLIMit.ELIMit.ENABLE

**Description** Sets the value of the Questionable Bandwidth Limit Extra Status Enable Register.

**Variable**

|              | <i>Value</i>                                                                  |
|--------------|-------------------------------------------------------------------------------|
| Description  | The value of the Questionable Bandwidth Limit Extra Status Enable Register.   |
| Data type    | Long integer type (Long)                                                      |
| Range        | 0 to 65535                                                                    |
| Preset value | Varies depending on the upper limit setting of the number of channels/traces. |
| Note         | Bits 0 and 3 to 15 cannot be set to 1.                                        |

**Examples**

```
Dim Stat As Long
SCPI.STATus.QUEStionable.BLIMit.ELIMit.ENABLE = 6
Stat = SCPI.STATus.QUEStionable.BLIMit.ELIMit.ENABLE
```

**Related objects** SCPI.STATus.QUEStionable.BLIMit.ENABLE on page 684

**Equivalent key** No equivalent key is available on the front panel.

## SCPI.STATus.QUEStionable.BLIMit.ELIMit.EVENT

**Object type** Property

**Syntax** *Value* = SCPI.STATus.QUEStionable.BLIMit.ELIMit.EVENT

**Description** Reads out the value of the Questionable Bandwidth Limit Extra Status Event Register. (Read only)

**Variable**

|             | <i>Value</i>                                                               |
|-------------|----------------------------------------------------------------------------|
| Description | The value of the Questionable Bandwidth Limit Extra Status Event Register. |
| Data type   | Long integer type (Long)                                                   |

**Examples**

```
Dim Stat As Long
Stat = SCPI.STATus.QUEStionable.BLIMit.ELIMit.EVENT
```

**Related objects** SCPI.IEEE4882.CLS on page 417

**Equivalent key** No equivalent key is available on the front panel.

**SCPI.STATUS.QUESTIONABLE.BLIMIT.ELIMIT.NTRANSITION**

|             |                                                                                                                                        |
|-------------|----------------------------------------------------------------------------------------------------------------------------------------|
| Object type | Property                                                                                                                               |
| Syntax      | SCPI.STATUS.QUESTIONABLE.BLIMIT.ELIMIT.NTRANSITION = <i>Value</i><br><i>Value</i> = SCPI.STATUS.QUESTIONABLE.BLIMIT.ELIMIT.NTRANSITION |
| Description | Sets the value of the negative transition filter of the Questionable Bandwidth Limit Extra Status Register.                            |

## Variable

|              | <i>Value</i>                                                                                           |
|--------------|--------------------------------------------------------------------------------------------------------|
| Description  | The value of the negative transition filter of the Questionable Bandwidth Limit Extra Status Register. |
| Data type    | Long integer type (Long)                                                                               |
| Range        | 0 to 65535                                                                                             |
| Preset value | 0                                                                                                      |
| Note         | Bits 0 and 3 to 15 cannot be set to 1.                                                                 |

|                 |                                                                                                                                              |
|-----------------|----------------------------------------------------------------------------------------------------------------------------------------------|
| Examples        | <pre>Dim Stat As Long SCPI.STATUS.QUESTIONABLE.BLIMIT.ELIMIT.NTRANSITION = 6 Stat = SCPI.STATUS.QUESTIONABLE.BLIMIT.ELIMIT.NTRANSITION</pre> |
| Related objects | <p>SCPI.STATUS.QUESTIONABLE.BLIMIT.ELIMIT.EVENT on page 681</p> <p>SCPI.STATUS.QUESTIONABLE.BLIMIT.ELIMIT.PTRANSITION on page 683</p>        |
| Equivalent key  | No equivalent key is available on the front panel.                                                                                           |

## SCPI.STATus.QUEStionable.BLIMit.ELIMit.PTRansition

**Object type** Property

**Syntax** SCPI.STATus.QUEStionable.BLIMit.ELIMit.PTRansition = *Value*  
*Value* = SCPI.STATus.QUEStionable.BLIMit.ELIMit.PTRansition

**Description** Sets the value of the positive transition filter of the Questionable Bandwidth Limit Extra Status Register.

**Variable**

|              | <i>Value</i>                                                                                           |
|--------------|--------------------------------------------------------------------------------------------------------|
| Description  | The value of the positive transition filter of the Questionable Bandwidth Limit Extra Status Register. |
| Data type    | Long integer type (Long)                                                                               |
| Range        | 0 to 65535                                                                                             |
| Preset value | Varies depending on the upper limit setting of the number of channels/traces.                          |
| Note         | Bits 0 and 3 to 15 cannot be set to 1.                                                                 |

**Examples**

```
Dim Stat As Long
SCPI.STATus.QUEStionable.BLIMit.ELIMit.PTRansition = 6
Stat = SCPI.STATus.QUEStionable.BLIMit.ELIMit.PTRansition
```

**Related objects** SCPI.STATus.QUEStionable.BLIMit.ELIMit.EVENT on page 681  
 SCPI.STATus.QUEStionable.BLIMit.ELIMit.NTRansition on page 682

**Equivalent key** No equivalent key is available on the front panel.

## **SCPI.STATUS.QUESTIONABLE.BLIMIT.ENABLE**

|             |                                                                                                                |
|-------------|----------------------------------------------------------------------------------------------------------------|
| Object type | Property                                                                                                       |
| Syntax      | SCPI.STATUS.QUESTIONABLE.BLIMIT.ENABLE = <i>Value</i><br><i>Value</i> = SCPI.STATUS.QUESTIONABLE.BLIMIT.ENABLE |
| Description | Sets the value of the Questionable Bandwidth Limit Status Enable Register.                                     |
| Variable    |                                                                                                                |

|              | <i>Value</i>                                                                  |
|--------------|-------------------------------------------------------------------------------|
| Description  | The value of the Questionable Bandwidth Limit Status Enable Register.         |
| Data type    | Long integer type (Long)                                                      |
| Range        | 0 to 65535                                                                    |
| Preset value | Varies depending on the upper limit setting of the number of channels/traces. |
| Note         | Bits 15 cannot be set to 1.                                                   |

|          |                                                                                                                       |
|----------|-----------------------------------------------------------------------------------------------------------------------|
| Examples | <pre>Dim Stat As Long SCPI.STATUS.QUESTIONABLE.BLIMIT.ENABLE = 16 Stat = SCPI.STATUS.QUESTIONABLE.BLIMIT.ENABLE</pre> |
|----------|-----------------------------------------------------------------------------------------------------------------------|

Related objects SCPI.STATUS.QUESTIONABLE.ENABLE on page 688

Equivalent key No equivalent key is available on the front panel.

## **SCPI.STATUS.QUESTIONABLE.BLIMIT.EVENT**

|             |                                                                                            |
|-------------|--------------------------------------------------------------------------------------------|
| Object type | Property                                                                                   |
| Syntax      | <i>Value</i> = SCPI.STATUS.QUESTIONABLE.BLIMIT.EVENT                                       |
| Description | Reads out the value of the Questionable Bandwidth Limit Status Event Register. (Read only) |
| Variable    |                                                                                            |

|             | <i>Value</i>                                                         |
|-------------|----------------------------------------------------------------------|
| Description | The value of the Questionable Bandwidth Limit Status Event Register. |
| Data type   | Long integer type (Long)                                             |

|          |                                                                          |
|----------|--------------------------------------------------------------------------|
| Examples | <pre>Dim Stat As Long Stat = SCPI.STATUS.QUESTIONABLE.BLIMIT.EVENT</pre> |
|----------|--------------------------------------------------------------------------|

Related objects SCPI.IEEE4882.CLS on page 417

Equivalent key No equivalent key is available on the front panel.



## SCPI.STATus.QUEStionable.BLIMit.NTRansition

|             |                                                                                                                          |
|-------------|--------------------------------------------------------------------------------------------------------------------------|
| Object type | Property                                                                                                                 |
| Syntax      | SCPI.STATus.QUEStionable.BLIMit.NTRansition = <i>Value</i><br><i>Value</i> = SCPI.STATus.QUEStionable.BLIMit.NTRansition |
| Description | Sets the value of the negative transition filter of the Questionable Bandwidth Limit Status Register.                    |
| Variable    |                                                                                                                          |

|              | <i>Value</i>                                                                                     |
|--------------|--------------------------------------------------------------------------------------------------|
| Description  | The value of the negative transition filter of the Questionable Bandwidth Limit Status Register. |
| Data type    | Long integer type (Long)                                                                         |
| Range        | 0 to 65535                                                                                       |
| Preset value | 0                                                                                                |
| Note         | Bits 0 and 3 to 15 cannot be set to 1.                                                           |

|                 |                                                                                                                                |
|-----------------|--------------------------------------------------------------------------------------------------------------------------------|
| Examples        | <pre>Dim Stat As Long SCPI.STATus.QUEStionable.BLIMit.NTRansition = 6 Stat = SCPI.STATus.QUEStionable.BLIMit.NTRansition</pre> |
| Related objects | SCPI.STATus.QUEStionable.BLIMit.EVENT on page 684<br>SCPI.STATus.QUEStionable.BLIMit.PTRansition on page 686                   |
| Equivalent key  | No equivalent key is available on the front panel.                                                                             |

## SCPI.STATUS.QUESTIONABLE.BLIMIT.PTRANSITION

Object type Property

Syntax SCPI.STATUS.QUESTIONABLE.BLIMIT.PTRANSITION = *Value*  
*Value* = SCPI.STATUS.QUESTIONABLE.BLIMIT.PTRANSITION

Description Sets the value of the positive transition filter of the Questionable Bandwidth Limit Status Register.

### Variable

|              | <i>Value</i>                                                                                     |
|--------------|--------------------------------------------------------------------------------------------------|
| Description  | The value of the positive transition filter of the Questionable Bandwidth Limit Status Register. |
| Data type    | Long integer type (Long)                                                                         |
| Range        | 0 to 65535                                                                                       |
| Preset value | Varies depending on the upper limit setting of the number of channels/traces.                    |
| Note         | Bits 15 cannot be set to 1.                                                                      |

Examples

```
Dim Stat As Long
SCPI.STATUS.QUESTIONABLE.BLIMIT.PTRANSITION = 6
Stat = SCPI.STATUS.QUESTIONABLE.BLIMIT.PTRANSITION
```

Related objects SCPI.STATUS.QUESTIONABLE.BLIMIT.EVENT on page 684  
SCPI.STATUS.QUESTIONABLE.BLIMIT.NTRANSITION on page 685

Equivalent key No equivalent key is available on the front panel.

## SCPI.STATus.QUEStionable.CONDiTion

- Object type Property
- Syntax *Value* = SCPI.STATus.QUEStionable.CONDiTion
- Description Reads out the value of the Questionable Status Condition Register. (Read only)

Variable

|             | <i>Value</i>                                        |
|-------------|-----------------------------------------------------|
| Description | Value of the Questionable Status Condition Register |
| Data type   | Long integer type (Long)                            |

- Examples  
`Dim Stat As Long`  
`Stat = SCPI.STATus.QUEStionable.CONDiTion`
- Related objects  
SCPI.STATus.QUEStionable.NTRansition on page 706  
SCPI.STATus.QUEStionable.PTRansition on page 707
- Equivalent key No equivalent key is available on the front panel.

## **SCPI.STATUS.QUESTIONABLE.ENABLE**

Object type      Property

Syntax            SCPI.STATUS.QUESTIONABLE.ENABLE = *Value*  
*Value* = SCPI.STATUS.QUESTIONABLE.ENABLE

Description      Sets the value of the Questionable Status Enable Register.

Variable

|              | <i>Value</i>                                         |
|--------------|------------------------------------------------------|
| Description  | Value of the Questionable Status Enable Register     |
| Data type    | Long integer type (Long)                             |
| Range        | 0 to 65535                                           |
| Preset value | 0                                                    |
| Note         | The bit 0 to 9 and bit 11 to 15 can not be set to 1. |

Examples            Dim Stat As Long  
                     SCPI.STATUS.QUESTIONABLE.ENABLE = 6  
                     Stat = SCPI.STATUS.QUESTIONABLE.ENABLE

Related objects    SCPI.IEEE4882.SRE on page 422

Equivalent key     No equivalent key is available on the front panel.

## SCPI.STATus.QUEStionable.EVENT

- Object type Property
- Syntax *Value* = SCPI.STATus.QUEStionable.EVENT
- Description Reads out the value of the Questionable Status Event Register. (Read only)
- Variable

|             | <i>Value</i>                                    |
|-------------|-------------------------------------------------|
| Description | Value of the Questionable Status Event Register |
| Data type   | Long integer type (Long)                        |

- Examples
- ```
Dim Stat As Long
Stat = SCPI.STATus.QUEStionable.EVENT
```

- Related objects
- SCPI.IEEE4882.CLS on page 417
 - SCPI.STATus.QUEStionable.NTRansition on page 706
 - SCPI.STATus.QUEStionable.PTRansition on page 707

- Equivalent key No equivalent key is available on the front panel.

SCPI.STATus.QUEStionable.LIMit.CHANnel(*Ch*). **CONDition**

- Object type Property
- Syntax *Value* = SCPI.STATus.QUEStionable.LIMit.CHANnel(*Ch*).CONDition
- Description Reads out the value of the Questionable Limit Channel Status Condition Register of channels 1 to 16 (*Ch*). (Read only)
- Variable

	<i>Value</i>
Description	Value of the Questionable Limit Channel Status Condition Register
Data type	Long integer type (Long)

For information on the variable (*Ch*), see Table 7-6, “Variable (*Ch*),” on page 209.

- Examples
- ```
Dim Stat As Long
Stat = SCPI.STATus.QUEStionable.LIMit.CHANnel(1).CONDition
```
- Related objects
- SCPI.STATus.QUEStionable.LIMit.CHANnel(*Ch*). NTRansition on page 697
  - SCPI.STATus.QUEStionable.LIMit.CHANnel(*Ch*). PTRansition on page 698
- Equivalent key No equivalent key is available on the front panel.

**SCPI.STATus.QUEStionable.LIMit.CHANnel(*Ch*).  
ECHannel.CONDition**

|             |                                                                                                                                      |
|-------------|--------------------------------------------------------------------------------------------------------------------------------------|
| Object type | Property                                                                                                                             |
| Syntax      | <i>Value</i> = SCPI.STATus.QUEStionable.LIMit.CHANnel( <i>Ch</i> ).CONDition                                                         |
| Description | Reads out the value of the Questionable Limit Channel Extra Status Condition Register of channels 1 to 16 ( <i>Ch</i> ). (Read only) |

## Variable

|             | <i>Value</i>                                                            |
|-------------|-------------------------------------------------------------------------|
| Description | Value of the Questionable Limit Channel Extra Status Condition Register |
| Data type   | Long integer type (Long)                                                |

For information on the variable (*Ch*), refer to Table 7-6, “Variable (*Ch*),” on page 209.

## Examples

```
Dim Stat As Long
Stat = SCPI.STATus.QUEStionable.LIMit.CHANnel(1).ECHannel.CONDition
```

## Related objects

SCPI.STATus.QUEStionable.LIMit.CHANnel(*Ch*). ECHannel.NTRansition on page 693

SCPI.STATus.QUEStionable.LIMit.CHANnel(*Ch*). ECHannel.PTRansition on page 694

## Equivalent key

No equivalent key is available on the front panel.

## **SCPI.STATus.QUEStionable.LIMit.CHANnel(Ch). ECHannel.ENABLE**

- Object type** Property
- Syntax** SCPI.STATus.QUEStionable.LIMit.CHANnel(Ch).ECHannel.ENABLE = *Value*  
*Value* = SCPI.STATus.QUEStionable.LIMit.CHANnel(Ch).ECHannel.ENABLE
- Description** Sets the value of the Questionable Limit Channel Extra Status Enable Register of channels 1 to 16 (*Ch*).
- Variable**

|              | <i>Value</i>                                                                  |
|--------------|-------------------------------------------------------------------------------|
| Description  | Value of the Questionable Limit Channel Extra Status Enable Register          |
| Data type    | Long integer type (Long)                                                      |
| Range        | 0 to 65535                                                                    |
| Preset value | Varies depending on the upper limit setting of the number of channels/traces. |
| Note         | Bits 0 and 3 to 15 cannot be set to 1.                                        |

For information on the variable (*Ch*), refer to Table 7-6, “Variable (Ch),” on page 209.

- Examples**
- ```
Dim Stat As Long
SCPI.STATus.QUEStionable.LIMit.CHANnel(1).ECHannel.ENABLE = 6
Stat = SCPI.STATus.QUEStionable.LIMit.CHANnel(1).ECHannel.ENABLE
```
- Related objects** SCPI.STATus.QUEStionable.LIMit.CHANnel(Ch).ENABLE on page 695
- Equivalent key** No equivalent key is available on the front panel.

**SCPI.STATus.QUEStionable.LIMit.CHANnel(*Ch*).
ECHannel.EVENT**

Object type	Property
Syntax	<i>Value</i> = SCPI.STATus.QUEStionable.LIMit.CHANnel(<i>Ch</i>).ECHannel.EVENT
Description	Reads out the value of the Questionable Limit Channel Extra Status Event Register of channels 1 to 16 (<i>Ch</i>). (Read only)

Variable

	<i>Value</i>
Description	Value of the Questionable Limit Channel Extra Status Event Register
Data type	Long integer type (Long)

For information on the variable (*Ch*), refer to Table 7-6, “Variable (*Ch*),” on page 209.

Examples

```
Dim Stat As Long
Stat = SCPI.STATus.QUEStionable.LIMit.CHANnel(1).ECHannel.EVENT
```

Related objects SCPI.IEEE4882.CLS on page 417

Equivalent key No equivalent key is available on the front panel.

SCPI.STATus.QUEStionable.LIMit.CHANnel(Ch). ECHannel.NTRansition

Object type Property

Syntax SCPI.STATus.QUEStionable.LIMit.CHANnel(Ch).ECHannel.NTRansition = *Value*
Value = SCPI.STATus.QUEStionable.LIMit.CHANnel(Ch).ECHannel.NTRansition

Description Sets the value of the negative transition filter of the Questionable Limit Channel Extra Status Register of channels 1 to 16 (*Ch*).

Variable

	<i>Value</i>
Description	Value of the negative transition filter
Data type	Long integer type (Long)
Range	0 to 65535
Preset value	0
Note	Bits 0 and 3 to 15 cannot be set to 1.

For information on the variable (*Ch*), refer to Table 7-6, “Variable (Ch),” on page 209.

Examples Dim Stat As Long
 SCPI.STATus.QUEStionable.LIMit.CHANnel(1).ECHannel.NTRansition = 6
 Stat = SCPI.STATus.QUEStionable.LIMit.CHANnel(1).ECHannel.NTRansition

Related objects SCPI.STATus.QUEStionable.LIMit.CHANnel(Ch). ECHannel.EVENT on page 692
 SCPI.STATus.QUEStionable.LIMit.CHANnel(Ch). ECHannel.PTRansition on page 694

Equivalent key No equivalent key is available on the front panel.

SCPI.STATus.QUEStionable.LIMit.CHANnel(Ch). ECHannel.PTRansition

Object type	Property
Syntax	SCPI.STATus.QUEStionable.LIMit.CHANnel(Ch).ECHannel.PTRansition = <i>Value</i> <i>Value</i> = SCPI.STATus.QUEStionable.LIMit.CHANnel(Ch).ECHannel.PTRansition
Description	Sets the value of the positive transition filter of the Questionable Limit Channel Extra Status Register of channels 1 to 16 (<i>Ch</i>).

Variable

	<i>Value</i>
Description	Value of the positive transition filter
Data type	Long integer type (Long)
Range	0 to 65535
Preset value	Varies depending on the upper limit setting of the number of channels/traces.
Note	Bits 0 and 3 to 15 cannot be set to 1.

For information on the variable (*Ch*), refer to Table 7-6, “Variable (Ch),” on page 209.

Examples	Dim Stat As Long SCPI.STATus.QUEStionable.LIMit.CHANnel(1).ECHannel.PTRansition = 6 Stat = SCPI.STATus.QUEStionable.LIMit.CHANnel(1).ECHannel.PTRansition
Related objects	SCPI.STATus.QUEStionable.LIMit.CHANnel(Ch). ECHannel.EVENT on page 692 SCPI.STATus.QUEStionable.LIMit.CHANnel(Ch). ECHannel.NTRansition on page 693
Equivalent key	No equivalent key is available on the front panel.

SCPI.STATus.QUEStionable.LIMit.CHANnel(*Ch*).ENABLE

Object type	Property
Syntax	SCPI.STATus.QUEStionable.LIMit.CHANnel(<i>Ch</i>).ENABLE = <i>Value</i> <i>Value</i> = SCPI.STATus.QUEStionable.LIMit.CHANnel(<i>Ch</i>).ENABLE
Description	Sets the value of the Questionable Limit Channel Status Enable Register of channels 1 to 16 (<i>Ch</i>).
Variable	

	<i>Value</i>
Description	Value of the Questionable Limit Channel Status Enable Register
Data type	Long integer type (Long)
Range	0 to 65535
Preset value	Varies depending on the upper limit setting for the channel/trace number.
Note	The bit 15 can not be set to 1.

For information on the variable (*Ch*), see Table 7-6, “Variable (Ch),” on page 209.

Examples	Dim Stat As Long SCPI.STATus.QUEStionable.LIMit.CHANnel(1).ENABLE = 16 Stat = SCPI.STATus.QUEStionable.LIMit.CHANnel(1).ENABLE
Related objects	SCPI.STATus.QUEStionable.LIMit.ENABLE on page 703
Equivalent key	No equivalent key is available on the front panel.

SCPI.STATus.QUEStionable.LIMit.CHANnel(*Ch*).EVENT

Object type	Property
Syntax	<i>Value</i> = SCPI.STATus.QUEStionable.LIMit.CHANnel(<i>Ch</i>).EVENT
Description	Reads out the value of the Questionable Limit Channel Status Event Register of channels 1 to 16 (<i>Ch</i>). (Read only)

Variable

	<i>Value</i>
Description	Value of the Questionable Limit Channel Status Event Register of the specified channel
Data type	Long integer type (Long)

For information on the variable (*Ch*), see Table 7-6, “Variable (Ch),” on page 209.

Examples

```
Dim Stat As Long
Stat = SCPI.STATus.QUEStionable.LIMit.CHANnel(1).EVENT
```

Related objects SCPI.IEEE4882.CLS on page 417

Equivalent key No equivalent key is available on the front panel.

SCPI.STATus.QUEStionable.LIMit.CHANnel(Ch). NTRansition

- Object type** Property
- Syntax** SCPI.STATus.QUEStionable.LIMit.CHANnel(Ch).NTRansition = *Value*
Value = SCPI.STATus.QUEStionable.LIMit.CHANnel(Ch).NTRansition
- Description** Sets the value of the negative transition filter of the Questionable Limit Channel Status Register of channels 1 to 16 (*Ch*).
- Variable**

	<i>Value</i>
Description	Value of the negative transition filter
Data type	Long integer type (Long)
Range	0 to 65535
Preset value	0
Note	The bit 15 can not be set to 1.

For information on the variable (*Ch*), see Table 7-6, “Variable (Ch),” on page 209.

- Examples**

```
Dim Stat As Long
SCPI.STATus.QUEStionable.LIMit.CHANnel(1).NTRansition = 16
Stat = SCPI.STATus.QUEStionable.LIMit.CHANnel(1).NTRansition
```
- Related objects** SCPI.STATus.QUEStionable.LIMit.CHANnel(Ch).EVENT on page 696
 SCPI.STATus.QUEStionable.LIMit.CHANnel(Ch). PTRansition on page 698
- Equivalent key** No equivalent key is available on the front panel.

SCPI.STATus.QUEStionable.LIMit.CHANnel(Ch). PTRansition

Object type	Property
Syntax	SCPI.STATus.QUEStionable.LIMit.CHANnel(Ch).PTRansition = <i>Value</i> <i>Value</i> = SCPI.STATus.QUEStionable.LIMit.CHANnel(Ch).PTRansition
Description	Sets the value of the positive transition filter of the Questionable Limit Channel Status Register of channels 1 to 16 (<i>Ch</i>).

Variable

	<i>Value</i>
Description	Value of the positive transition filter
Data type	Long integer type (Long)
Range	0 to 65535
Preset value	Varies depending on the upper limit setting for the channel/trace number.
Note	The bit 15 can not be set to 1.

For information on the variable (*Ch*), see Table 7-6, “Variable (Ch),” on page 209.

Examples	<pre>Dim Stat As Long SCPI.STATus.QUEStionable.LIMit.CHANnel(1).PTRansition = 0 Stat = SCPI.STATus.QUEStionable.LIMit.CHANnel(1).PTRansition</pre>
Related objects	<p>SCPI.STATus.QUEStionable.LIMit.CHANnel(Ch).EVENT on page 696</p> <p>SCPI.STATus.QUEStionable.LIMit.CHANnel(Ch). NTRansition on page 697</p>
Equivalent key	No equivalent key is available on the front panel.

SCPI.STATUS.QUESTIONABLE.LIMIT.CONDITION

- Object type Property
- Syntax *Value* = SCPI.STATUS.QUESTIONABLE.LIMIT.CONDITION
- Description Reads out the value of the Questionable Limit Status Condition Register. (Read only)
- Variable

	<i>Value</i>
Description	Value of the Questionable Limit Status Condition Register
Data type	Long integer type (Long)

- Examples

```
Dim Stat As Long
Stat = SCPI.STATUS.QUESTIONABLE.LIMIT.CONDITION
```
- Related objects
 SCPI.STATUS.QUESTIONABLE.LIMIT.NTRANSITION on page 704
 SCPI.STATUS.QUESTIONABLE.LIMIT.PTRANSITION on page 705
- Equivalent key No equivalent key is available on the front panel.

SCPI.STATUS.QUESTIONABLE.LIMIT.ELIMIT.CONDITION

- Object type Property
- Syntax *Value* = SCPI.STATUS.QUESTIONABLE.LIMIT.ELIMIT.CONDITION
- Description Reads out the value of the Questionable Limit Extra Status Condition Register. (Read only)
- Variable

	<i>Value</i>
Description	Value of the Questionable Limit Extra Status Condition Register
Data type	Long integer type (Long)

- Examples

```
Dim Stat As Long
Stat = SCPI.STATUS.QUESTIONABLE.LIMIT.ELIMIT.CONDITION
```
- Related objects
 SCPI.STATUS.QUESTIONABLE.LIMIT.ELIMIT.NTRANSITION on page 701
 SCPI.STATUS.QUESTIONABLE.LIMIT.ELIMIT.PTRANSITION on page 702
- Equivalent key No equivalent key is available on the front panel.

SCPI.STATus.QUEStionable.LIMit.ELIMit.ENABLE

Object type Property

Syntax `SCPI.STATus.QUEStionable.LIMit.ELIMit.ENABLE = Value`
Value = `SCPI.STATus.QUEStionable.LIMit.ELIMit.ENABLE`

Description Sets the value of the Questionable Limit Extra Status Enable Register.

Variable

	<i>Value</i>
Description	Value of the Questionable Limit Extra Status Enable Register
Data type	Long integer type (Long)
Range	0 to 65535
Preset value	Varies depending on the upper limit setting of the number of channels/traces.
Note	Bits 0 and 3 to 15 cannot be set to 1.

Examples

```
Dim Stat As Long
SCPI.STATus.QUEStionable.LIMit.ELIMit.ENABLE = 6
Stat = SCPI.STATus.QUEStionable.LIMit.ELIMit.ENABLE
```

Related objects `SCPI.STATus.QUEStionable.LIMit.ENABLE` on page 703

Equivalent key No equivalent key is available on the front panel.

SCPI.STATus.QUEStionable.LIMit.ELIMit.EVENT

Object type Property

Syntax *Value* = `SCPI.STATus.QUEStionable.LIMit.ELIMit.EVENT`

Description Reads out the value of the Questionable Limit Extra Status Event Register. (Read only)

Variable

	<i>Value</i>
Description	Value of the Questionable Limit Extra Status Event Register
Data type	Long integer type (Long)

Examples

```
Dim Stat As Long
Stat = SCPI.STATus.QUEStionable.LIMit.ELIMit.EVENT
```

Related objects `SCPI.IEEE4882.CLS` on page 417

Equivalent key No equivalent key is available on the front panel.

SCPI.STATus.QUEStionable.LIMit.ELIMit.NTRansition

Object type	Property
Syntax	SCPI.STATus.QUEStionable.LIMit.ELIMit.NTRansition = <i>Value</i> <i>Value</i> = SCPI.STATus.QUEStionable.LIMit.ELIMit.NTRansition
Description	Sets the value of the negative transition filter of the Questionable Limit Extra Status Register.

Variable

	<i>Value</i>
Description	Value of the negative transition filter
Data type	Long integer type (Long)
Range	0 to 65535
Preset value	0
Note	Bits 0 and 3 to 15 cannot be set to 1.

Examples	<pre>Dim Stat As Long SCPI.STATus.QUEStionable.LIMit.ELIMit.NTRansition = 6 Stat = SCPI.STATus.QUEStionable.LIMit.ELIMit.NTRansition</pre>
Related objects	<p>SCPI.STATus.QUEStionable.LIMit.ELIMit.EVENT on page 700</p> <p>SCPI.STATus.QUEStionable.LIMit.ELIMit.PTRansition on page 702</p>
Equivalent key	No equivalent key is available on the front panel.

SCPI.STATus.QUEStionable.LIMit.ELIMit.PTRansition

Object type	Property
Syntax	SCPI.STATus.QUEStionable.LIMit.ELIMit.PTRansition = <i>Value</i> <i>Value</i> = SCPI.STATus.QUEStionable.LIMit.ELIMit.PTRansition
Description	Sets the value of the positive transition filter of the Questionable Limit Extra Status Register.

Variable

	<i>Value</i>
Description	Value of the positive transition filter
Data type	Long integer type (Long)
Range	0 to 65535
Preset value	Varies depending on the upper limit setting of the number of channels/traces.
Note	Bits 0 and 3 to 15 cannot be set to 1.

Examples

```
Dim Stat As Long
SCPI.STATus.QUEStionable.LIMit.ELIMit.PTRansition = 6
Stat = SCPI.STATus.QUEStionable.LIMit.ELIMit.PTRansition
```

Related objects

SCPI.STATus.QUEStionable.LIMit.ELIMit.EVENT on page 700
SCPI.STATus.QUEStionable.LIMit.ELIMit.NTRansition on page 701

Equivalent key No equivalent key is available on the front panel.

SCPI.STATus.QUEStionable.LIMit.ENABLE

- Object type** Property
- Syntax** SCPI.STATus.QUEStionable.LIMit.ENABLE = *Value*
Value = SCPI.STATus.QUEStionable.LIMit.ENABLE
- Description** Sets the value of the Questionable Limit Status Enable Register.
- Variable**

	<i>Value</i>
Description	Value of the Questionable Limit Status Enable Register
Data type	Long integer type (Long)
Range	0 to 65535
Preset value	Varies depending on the upper limit setting for the channel/trace number.
Note	The bit 15 can not be set to 1.

- Examples**
- ```
Dim Stat As Long
SCPI.STATus.QUEStionable.LIMit.ENABLE = 16
Stat = SCPI.STATus.QUEStionable.LIMit.ENABLE
```

- Related objects** SCPI.STATus.QUEStionable.ENABLE on page 688
- Equivalent key** No equivalent key is available on the front panel.

## SCPI.STATus.QUEStionable.LIMit.EVENT

- Object type** Property
- Syntax** *Value* = SCPI.STATus.QUEStionable.LIMit.EVENT
- Description** Reads out the value of the Questionable Limit Status Event Register. (Read only)
- Variable**

|             | <i>Value</i>                                          |
|-------------|-------------------------------------------------------|
| Description | Value of the Questionable Limit Status Event Register |
| Data type   | Long integer type (Long)                              |

- Examples**
- ```
Dim Stat As Long
Stat = SCPI.STATus.QUEStionable.LIMit.EVENT
```
- Related objects** SCPI.IEEE4882.CLS on page 417
- Equivalent key** No equivalent key is available on the front panel.

SCPI.STATUS.QUESTIONABLE.LIMIT.NTRANSITION

Object type	Property
Syntax	SCPI.STATUS.QUESTIONABLE.LIMIT.NTRANSITION = <i>Value</i> <i>Value</i> = SCPI.STATUS.QUESTIONABLE.LIMIT.NTRANSITION
Description	Sets the value of negative transition filter of the Questionable Limit Status Register.
Variable	

	<i>Value</i>
Description	Value of the negative transition filter
Data type	Long integer type (Long)
Range	0 to 65535
Preset value	0
Note	The bit 15 can not be set to 1.

Examples	<pre>Dim Stat As Long SCPI.STATUS.QUESTIONABLE.LIMIT.NTRANSITION = 6 Stat = SCPI.STATUS.QUESTIONABLE.LIMIT.NTRANSITION</pre>
Related objects	SCPI.STATUS.QUESTIONABLE.LIMIT.EVENT on page 703 SCPI.STATUS.QUESTIONABLE.LIMIT.PTRANSITION on page 705
Equivalent key	No equivalent key is available on the front panel.

SCPI.STATus.QUEStionable.LIMit.PTRansition

- Object type Property
- Syntax SCPI.STATus.QUEStionable.LIMit.PTRansition = *Value*
Value = SCPI.STATus.QUEStionable.LIMit.PTRansition
- Description Sets the value of positive transition filter of the Questionable Limit Status Register.
- Variable

	<i>Value</i>
Description	Value of the positive transition filter
Data type	Long integer type (Long)
Range	0 to 65535
Preset value	Varies depending on the upper limit setting for the channel/trace number.
Note	The bit 15 can not be set to 1.

- Examples

```
Dim Stat As Long
SCPI.STATus.QUEStionable.LIMit.PTRansition = 6
Stat = SCPI.STATus.QUEStionable.LIMit.PTRansition
```
- Related objects
SCPI.STATus.QUEStionable.LIMit.EVENTt on page 703
SCPI.STATus.QUEStionable.LIMit.NTRansition on page 704
- Equivalent key
No equivalent key is available on the front panel.

SCPI.STATus.QUEStionable.NTRansition

Object type	Property
Syntax	SCPI.STATus.QUEStionable.NTRansition = <i>Value</i> <i>Value</i> = SCPI.STATus.QUEStionable.NTRansition
Description	Sets the value of negative transition filter of the Questionable Status Register.
Variable	

	<i>Value</i>
Description	Value of the negative transition filter
Data type	Long integer type (Long)
Range	0 to 65535
Preset value	0
Note	The bit 0 to 9 and bit 11 to 15 can not be set to 1.

Examples	<pre>Dim Stat As Long SCPI.STATus.QUEStionable.NTRansition = 6 Stat = SCPI.STATus.QUEStionable.NTRansition</pre>
Related objects	SCPI.STATus.QUEStionable.EVENT on page 689 SCPI.STATus.QUEStionable.PTRansition on page 707
Equivalent key	No equivalent key is available on the front panel.

SCPI.STATus.QUEStionable.PTRansition

Object type	Property
Syntax	SCPI.STATus.QUEStionable.PTRansition = <i>Value</i> <i>Value</i> = SCPI.STATus.QUEStionable.PTRansition
Description	Sets the value of positive transition filter of the Questionable Status Register.
Variable	

	<i>Value</i>
Description	Value of the positive transition filter
Data type	Long integer type (Long)
Range	0 to 65535
Preset value	1024
Note	The bit 0 to 9 and bit 11 to 15 can not be set to 1.

Examples	<pre>Dim Stat As Long SCPI.STATus.QUEStionable.PTRansition = 6 Stat = SCPI.STATus.QUEStionable.PTRansition</pre>
Related objects	SCPI.STATus.QUEStionable.EVENTt on page 689 SCPI.STATus.QUEStionable.NTRansition on page 706
Equivalent key	No equivalent key is available on the front panel.

SCPI.STATus.QUEStionable.RLIMit.CHANnel(*Ch*).CONDition

Object type	Property
Syntax	<i>Value</i> = SCPI.STATus.QUEStionable.RLIMit.CHANnel(<i>Ch</i>).CONDition
Description	Reads out the value of the Questionable Ripple Limit Channel Status Condition Register of channel 1 to channel 16 . (Read only)
Variable	

	<i>Value</i>
Description	The value of the Questionable Ripple Limit Channel Status Condition Register.
Data type	Long integer type (Long)

For information on the variable (*Ch*), see Table 7-6, “Variable (Ch),” on page 209.

Examples	<pre>Dim Stat As Long Stat = SCPI.STATus.QUEStionable.RLIMit.CHANnel(1).CONDition</pre>
Related objects	<p>SCPI.STATus.QUEStionable.RLIMit.CHANnel(<i>Ch</i>).NTRansition on page 716</p> <p>SCPI.STATus.QUEStionable.RLIMit.CHANnel(<i>Ch</i>).PTRansition on page 717</p>
Equivalent key	No equivalent key is available on the front panel.

SCPI.STATus.QUEStionable.RLIMit.CHANnel(*Ch*).ECHannel.CONDiTion

Object type	Property
Syntax	<i>Value</i> = SCPI.STATus.QUEStionable.RLIMit.CHANnel(<i>Ch</i>).ECHannel.CONDiTion
Description	Reads out the value of the Questionable Ripple Limit Channel Extra Status Condition Register of channel 1 to channel 16 . (Read only)
Variable	

	<i>Value</i>
Description	The value of the Questionable Ripple Limit Channel Extra Status Condition Register.
Data type	Long integer type (Long)

For information on the variable (*Ch*), see Table 7-6, “Variable (Ch),” on page 209.

Examples	<pre>Dim Stat As Long Stat = SCPI.STATus.QUEStionable.RLIMit.CHANnel(1).ECHannel.CONDiTion</pre>
Related objects	<p>SCPI.STATus.QUEStionable.RLIMit.CHANnel(Ch).ECHannel.NTRansition on page 712</p> <p>SCPI.STATus.QUEStionable.RLIMit.CHANnel(Ch).ECHannel.PTRansition on page 713</p>
Equivalent key	No equivalent key is available on the front panel.

SCPI.STATus.QUEStionable.RLIMit.CHANnel(*Ch*).ECHannel.ENABLE

Object type	Property
Syntax	SCPI.STATus.QUEStionable.RLIMit.CHANnel(<i>Ch</i>).ECHannel.ENABLE = <i>Value</i> <i>Value</i> = SCPI.STATus.QUEStionable.RLIMit.CHANnel(<i>Ch</i>).ECHannel.ENABLE
Description	Sets the value of the Questionable Ripple Limit Channel Extra Status Enable Register of channel 1 to channel 16 .

Variable

	<i>Value</i>
Description	The value of the Questionable Ripple Limit Channel Extra Status Enable Register.
Data type	Long integer type (Long)
Range	0 to 65535
Preset value	Varies depending on the upper limit setting of the number of channels/traces.
Note	Bits 0 and 3 to 15 cannot be set to 1.

For information on the variable (*Ch*), see Table 7-6, “Variable (Ch),” on page 209.

Examples

```
Dim Stat As Long
SCPI.STATus.QUEStionable.RLIMit.CHANnel(1).ECHannel.ENABLE = 6
Stat = SCPI.STATus.QUEStionable.RLIMit.CHANnel(1).ECHannel.ENABLE
```

Related objects SCPI.STATus.QUEStionable.RLIMit.CHANnel(*Ch*).ENABLE on page 714

Equivalent key No equivalent key is available on the front panel.

SCPI.STATus.QUEStionable.RLIMit.CHANnel(*Ch*).ECHannel.EVENT

- Object type** Property
- Syntax** *Value* = SCPI.STATus.QUEStionable.RLIMit.CHANnel(*Ch*).ECHannel.EVENT
- Description** Reads out the value of the Questionable Ripple Limit Channel Extra Status Event Register of channel 1 to channel 16 . (Read only)
- Variable**

	<i>Value</i>
Description	The value of the Questionable Ripple Limit Channel Extra Status Event Register.
Data type	Long integer type (Long)

For information on the variable (*Ch*), see Table 7-6, “Variable (Ch),” on page 209.

- Examples**
- ```
Dim Stat As Long
Stat = SCPI.STATus.QUEStionable.RLIMit.CHANnel(1).ECHannel.EVENT
```
- Related objects** SCPI.IEEE4882.CLS on page 417
- Equivalent key** No equivalent key is available on the front panel.

**SCPI.STATus.QUEStionable.RLIMit.CHANnel(*Ch*).ECHannel.NTRansition**

|             |                                                                                                                                                                                      |
|-------------|--------------------------------------------------------------------------------------------------------------------------------------------------------------------------------------|
| Object type | Property                                                                                                                                                                             |
| Syntax      | SCPI.STATus.QUEStionable.RLIMit.CHANnel( <i>Ch</i> ).ECHannel.NTRansition = <i>Value</i><br><i>Value</i> = SCPI.STATus.QUEStionable.RLIMit.CHANnel( <i>Ch</i> ).ECHannel.NTRansition |
| Description | Sets the value of the negative transition filter of the Questionable Ripple Limit Channel Extra Status Register of channel 1 to channel 16 .                                         |

## Variable

|              | <i>Value</i>                                                                                                |
|--------------|-------------------------------------------------------------------------------------------------------------|
| Description  | The value of the negative transition filter of the Questionable Ripple Limit Channel Extra Status Register. |
| Data type    | Long integer type (Long)                                                                                    |
| Range        | 0 to 65535                                                                                                  |
| Preset value | 0                                                                                                           |
| Note         | Bits 0 and 3 to 15 cannot be set to 1.                                                                      |

For information on the variable (*Ch*), see Table 7-6, “Variable (Ch),” on page 209.

|                 |                                                                                                                                                                                 |
|-----------------|---------------------------------------------------------------------------------------------------------------------------------------------------------------------------------|
| Examples        | <pre>Dim Stat As Long SCPI.STATus.QUEStionable.RLIMit.CHANnel(1).ECHannel.NTRansition = 6 Stat = SCPI.STATus.QUEStionable.RLIMit.CHANnel(1).ECHannel.NTRansition</pre>          |
| Related objects | <p>SCPI.STATus.QUEStionable.RLIMit.CHANnel(<i>Ch</i>).ECHannel.EVENT on page 711</p> <p>SCPI.STATus.QUEStionable.RLIMit.CHANnel(<i>Ch</i>).ECHannel.PTRansition on page 713</p> |
| Equivalent key  | No equivalent key is available on the front panel.                                                                                                                              |

## **SCPI.STATus.QUEStionable.RLIMit.CHANnel(*Ch*).ECHannel.PTRansition**

|             |                                                                                                                                                                                      |
|-------------|--------------------------------------------------------------------------------------------------------------------------------------------------------------------------------------|
| Object type | Property                                                                                                                                                                             |
| Syntax      | SCPI.STATus.QUEStionable.RLIMit.CHANnel( <i>Ch</i> ).ECHannel.PTRansition = <i>Value</i><br><i>Value</i> = SCPI.STATus.QUEStionable.RLIMit.CHANnel( <i>Ch</i> ).ECHannel.PTRansition |
| Description | Sets the value of the positive transition filter of the Questionable Ripple Limit Channel Extra Status Register of channel 1 to channel 16 .                                         |
| Variable    |                                                                                                                                                                                      |

|              | <i>Value</i>                                                                                                |
|--------------|-------------------------------------------------------------------------------------------------------------|
| Description  | The value of the positive transition filter of the Questionable Ripple Limit Channel Extra Status Register. |
| Data type    | Long integer type (Long)                                                                                    |
| Range        | 0 to 65535                                                                                                  |
| Preset value | Varies depending on the upper limit setting of the number of channels/traces.                               |
| Note         | Bits 0 and 3 to 15 cannot be set to 1.                                                                      |

For information on the variable (*Ch*), see Table 7-6, “Variable (Ch),” on page 209.

|                 |                                                                                                                                                                        |
|-----------------|------------------------------------------------------------------------------------------------------------------------------------------------------------------------|
| Examples        | <pre>Dim Stat As Long SCPI.STATus.QUEStionable.RLIMit.CHANnel(1).ECHannel.PTRansition = 6 Stat = SCPI.STATus.QUEStionable.RLIMit.CHANnel(1).ECHannel.PTRansition</pre> |
| Related objects | SCPI.STATus.QUEStionable.RLIMit.CHANnel(Ch).ECHannel.EVENT on page 711<br>SCPI.STATus.QUEStionable.RLIMit.CHANnel(Ch).ECHannel.NTRansition on page 712                 |
| Equivalent key  | No equivalent key is available on the front panel.                                                                                                                     |

**SCPI.STATus.QUEStionable.RLIMit.CHANnel(*Ch*).ENABLE**

Object type

Property

Syntax

SCPI.STATus.QUEStionable.RLIMit.CHANnel(*Ch*).ENABLE = *Value**Value* = SCPI.STATus.QUEStionable.RLIMit.CHANnel(*Ch*).ENABLE

Description

Sets the value of the Questionable Ripple Limit Channel Status Enable Register of channel 1 to channel 16.

Variable

|              | <i>Value</i>                                                                  |
|--------------|-------------------------------------------------------------------------------|
| Description  | The value of the Questionable Ripple Limit Channel Status Enable Register.    |
| Data type    | Long integer type (Long)                                                      |
| Range        | 0 to 65535                                                                    |
| Preset value | Varies depending on the upper limit setting of the number of channels/traces. |
| Note         | Bits cannot be set to 1.                                                      |

For information on the variable (*Ch*), see Table 7-6, “Variable (Ch),” on page 209.

Examples

```
Dim Stat As Long
SCPI.STATus.QUEStionable.RLIMit.CHANnel(1).ENABLE = 16
Stat = SCPI.STATus.QUEStionable.RLIMit.CHANnel(1).ENABLE
```

Related objects

SCPI.STATus.QUEStionable.RLIMit.ENABLE on page 722

Equivalent key

No equivalent key is available on the front panel.

## SCPI.STATus.QUEStionable.RLiMit.CHANnel(*Ch*).EVENT

- Object type** Property
- Syntax** *Value* = SCPI.STATus.QUEStionable.RLiMit.CHANnel(*Ch*).EVENT
- Description** Reads out the value of the Questionable Ripple Limit Channel Status Event Register of channel 1 to channel 16 . (Read only)

**Variable**

|             | <i>Value</i>                                                              |
|-------------|---------------------------------------------------------------------------|
| Description | The value of the Questionable Ripple Limit Channel Status Event Register. |
| Data type   | Long integer type (Long)                                                  |

For information on the variable (*Ch*), see Table 7-6, “Variable (Ch),” on page 209.

- Examples**  

```
Dim Stat As Long
Stat = SCPI.STATus.QUEStionable.RLiMit.CHANnel(1).EVENT
```
- Related objects** SCPI.IEEE4882.CLS on page 417
- Equivalent key** No equivalent key is available on the front panel.

**SCPI.STATus.QUEStionable.RLIMit.CHANnel(*Ch*).NTRan  
sition**

|             |                                                                                                                                                                    |
|-------------|--------------------------------------------------------------------------------------------------------------------------------------------------------------------|
| Object type | Property                                                                                                                                                           |
| Syntax      | SCPI.STATus.QUEStionable.RLIMit.CHANnel( <i>Ch</i> ).NTRansition = <i>Value</i><br><i>Value</i> = SCPI.STATus.QUEStionable.RLIMit.CHANnel( <i>Ch</i> ).NTRansition |
| Description | Sets the value of the negative transition filter of the Questionable Ripple Limit Channel Status Register of channel 1 to channel 16 .                             |

## Variable

|              | <i>Value</i>                                                                                          |
|--------------|-------------------------------------------------------------------------------------------------------|
| Description  | The value of the negative transition filter of the Questionable Ripple Limit Channel Status Register. |
| Data type    | Long integer type (Long)                                                                              |
| Range        | 0 to 65535                                                                                            |
| Preset value | 0                                                                                                     |
| Note         | Bits 15 cannot be set to 1.                                                                           |

For information on the variable (*Ch*), see Table 7-6, “Variable (Ch),” on page 209.

|                 |                                                                                                                                                        |
|-----------------|--------------------------------------------------------------------------------------------------------------------------------------------------------|
| Examples        | <pre>Dim Stat As Long SCPI.STATus.QUEStionable.RLIMit.CHANnel(1).NTRansition = 16 Stat = SCPI.STATus.QUEStionable.RLIMit.CHANnel(1).NTRansition</pre>  |
| Related objects | SCPI.STATus.QUEStionable.RLIMit.CHANnel( <i>Ch</i> ).EVENT on page 715<br>SCPI.STATus.QUEStionable.RLIMit.CHANnel( <i>Ch</i> ).PTRansition on page 717 |
| Equivalent key  | No equivalent key is available on the front panel.                                                                                                     |



## **SCPI.STATus.QUEStionable.RLIMit.CHANnel(Ch).PTRansition**

|             |                                                                                                                                                  |
|-------------|--------------------------------------------------------------------------------------------------------------------------------------------------|
| Object type | Property                                                                                                                                         |
| Syntax      | SCPI.STATus.QUEStionable.RLIMit.CHANnel(Ch).PTRansition = <i>Value</i><br><i>Value</i> = SCPI.STATus.QUEStionable.RLIMit.CHANnel(Ch).PTRansition |
| Description | Sets the value of the positive transition filter of the Questionable Ripple Limit Channel Status Register of channel 1 to channel 16 .           |
| Variable    |                                                                                                                                                  |

|              | <i>Value</i>                                                                                          |
|--------------|-------------------------------------------------------------------------------------------------------|
| Description  | The value of the positive transition filter of the Questionable Ripple Limit Channel Status Register. |
| Data type    | Long integer type (Long)                                                                              |
| Range        | 0 to 65535                                                                                            |
| Preset value | Varies depending on the upper limit setting of the number of channels/traces.                         |
| Note         | Bits 15 cannot be set to 1.                                                                           |

For information on the variable (*Ch*), see Table 7-6, “Variable (Ch),” on page 209.

|                 |                                                                                                                                                      |
|-----------------|------------------------------------------------------------------------------------------------------------------------------------------------------|
| Examples        | <pre>Dim Stat As Long SCPI.STATus.QUEStionable.RLIMit.CHANnel(1).PTRansition = 0 Stat = SCPI.STATus.QUEStionable.RLIMit.CHANnel(1).PTRansition</pre> |
| Related objects | SCPI.STATus.QUEStionable.RLIMit.CHANnel(Ch).EVENT on page 715<br>SCPI.STATus.QUEStionable.RLIMit.CHANnel(Ch).NTRansition on page 716                 |
| Equivalent key  | No equivalent key is available on the front panel.                                                                                                   |

## **SCPI.STATus.QUEStionable.RLIMit.CONDiTion**

|             |                                                                                             |
|-------------|---------------------------------------------------------------------------------------------|
| Object type | Property                                                                                    |
| Syntax      | <i>Value</i> = SCPI.STATus.QUEStionable.RLIMit.CONDiTion                                    |
| Description | Reads out the value of the Questionable Ripple Limit Status Condition Register. (Read only) |
| Variable    |                                                                                             |

|             | <i>Value</i>                                                          |
|-------------|-----------------------------------------------------------------------|
| Description | The value of the Questionable Ripple Limit Status Condition Register. |
| Data type   | Long integer type (Long)                                              |

|                 |                                                                                                                    |
|-----------------|--------------------------------------------------------------------------------------------------------------------|
| Examples        | <pre>Dim Stat As Long Stat = SCPI.STATus.QUEStionable.RLIMit.CONDiTion</pre>                                       |
| Related objects | SCPI.STATus.QUEStionable.RLIMit.NTRansition on page 723<br>SCPI.STATus.QUEStionable.RLIMit.PTRansition on page 724 |
| Equivalent key  | No equivalent key is available on the front panel.                                                                 |

## **SCPI.STATus.QUEStionable.RLIMit.ELIMit.CONDiTion**

|             |                                                                                                   |
|-------------|---------------------------------------------------------------------------------------------------|
| Object type | Property                                                                                          |
| Syntax      | <i>Value</i> = SCPI.STATus.QUEStionable.RLIMit.ELIMit.CONDiTion                                   |
| Description | Reads out the value of the Questionable Ripple Limit Extra Status Condition Register. (Read only) |
| Variable    |                                                                                                   |

|             | <i>Value</i>                                                                |
|-------------|-----------------------------------------------------------------------------|
| Description | The value of the Questionable Ripple Limit Extra Status Condition Register. |
| Data type   | Long integer type (Long)                                                    |

|                 |                                                                                                                                  |
|-----------------|----------------------------------------------------------------------------------------------------------------------------------|
| Examples        | <pre>Dim Stat As Long Stat = SCPI.STATus.QUEStionable.RLIMit.ELIMit.CONDiTion</pre>                                              |
| Related objects | SCPI.STATus.QUEStionable.RLIMit.ELIMit.NTRansition on page 720<br>SCPI.STATus.QUEStionable.RLIMit.ELIMit.PTRansition on page 721 |
| Equivalent key  | No equivalent key is available on the front panel.                                                                               |

## SCPI.STATus.QUEStionable.RLiMit.ELiMit.ENABLE

|             |                                                                                                                              |
|-------------|------------------------------------------------------------------------------------------------------------------------------|
| Object type | Property                                                                                                                     |
| Syntax      | SCPI.STATus.QUEStionable.RLiMit.ELiMit.ENABLE = <i>Value</i><br><i>Value</i> = SCPI.STATus.QUEStionable.RLiMit.ELiMit.ENABLE |
| Description | Sets the value of the Questionable Ripple Limit Extra Status Enable Register.                                                |
| Variable    |                                                                                                                              |

|              | <i>Value</i>                                                                  |
|--------------|-------------------------------------------------------------------------------|
| Description  | The value of the Questionable Ripple Limit Extra Status Enable Register.      |
| Data type    | Long integer type (Long)                                                      |
| Range        | 0 to 65535                                                                    |
| Preset value | Varies depending on the upper limit setting of the number of channels/traces. |
| Note         | Bits 0 and 3 to 15 cannot be set to 1.                                        |

|          |                                                                                                                               |
|----------|-------------------------------------------------------------------------------------------------------------------------------|
| Examples | Dim Stat As Long<br>SCPI.STATus.QUEStionable.RLiMit.ELiMit.ENABLE = 6<br>Stat = SCPI.STATus.QUEStionable.RLiMit.ELiMit.ENABLE |
|----------|-------------------------------------------------------------------------------------------------------------------------------|

Related objects SCPI.STATus.QUEStionable.RLiMit.ENABLE on page 722

Equivalent key No equivalent key is available on the front panel.

## SCPI.STATus.QUEStionable.RLiMit.ELiMit.EVENT

|             |                                                                                               |
|-------------|-----------------------------------------------------------------------------------------------|
| Object type | Property                                                                                      |
| Syntax      | <i>Value</i> = SCPI.STATus.QUEStionable.RLiMit.ELiMit.EVENT                                   |
| Description | Reads out the value of the Questionable Ripple Limit Extra Status Event Register. (Read only) |
| Variable    |                                                                                               |

|             | <i>Value</i>                                                            |
|-------------|-------------------------------------------------------------------------|
| Description | The value of the Questionable Ripple Limit Extra Status Event Register. |
| Data type   | Long integer type (Long)                                                |

|          |                                                                         |
|----------|-------------------------------------------------------------------------|
| Examples | Dim Stat As Long<br>Stat = SCPI.STATus.QUEStionable.RLiMit.ELiMit.EVENT |
|----------|-------------------------------------------------------------------------|

Related objects SCPI.IEEE4882.CLS on page 417

Equivalent key No equivalent key is available on the front panel.

**SCPI.STATUS.QUESTIONABLE.RLIMIT.ELIMIT.NTRANSITION**

|             |                                                                                                                                        |
|-------------|----------------------------------------------------------------------------------------------------------------------------------------|
| Object type | Property                                                                                                                               |
| Syntax      | SCPI.STATUS.QUESTIONABLE.RLIMIT.ELIMIT.NTRANSITION = <i>Value</i><br><i>Value</i> = SCPI.STATUS.QUESTIONABLE.RLIMIT.ELIMIT.NTRANSITION |
| Description | Sets the value of the negative transition filter of the Questionable Ripple Limit Extra Status Register.                               |

## Variable

|              | <i>Value</i>                                                                                        |
|--------------|-----------------------------------------------------------------------------------------------------|
| Description  | The value of the negative transition filter of the Questionable Ripple Limit Extra Status Register. |
| Data type    | Long integer type (Long)                                                                            |
| Range        | 0 to 65535                                                                                          |
| Preset value | 0                                                                                                   |
| Note         | Bits 0 and 3 to 15 cannot be set to 1.                                                              |

|                 |                                                                                                                                              |
|-----------------|----------------------------------------------------------------------------------------------------------------------------------------------|
| Examples        | <pre>Dim Stat As Long SCPI.STATUS.QUESTIONABLE.RLIMIT.ELIMIT.NTRANSITION = 6 Stat = SCPI.STATUS.QUESTIONABLE.RLIMIT.ELIMIT.NTRANSITION</pre> |
| Related objects | <p>SCPI.STATUS.QUESTIONABLE.RLIMIT.ELIMIT.EVENT on page 719</p> <p>SCPI.STATUS.QUESTIONABLE.RLIMIT.ELIMIT.PTRANSITION on page 721</p>        |
| Equivalent key  | No equivalent key is available on the front panel.                                                                                           |

## SCPI.STATus.QUEStionable.RLIMit.ELIMit.PTRansition

|             |                                                                                                                                        |
|-------------|----------------------------------------------------------------------------------------------------------------------------------------|
| Object type | Property                                                                                                                               |
| Syntax      | SCPI.STATus.QUEStionable.RLIMit.ELIMit.PTRansition = <i>Value</i><br><i>Value</i> = SCPI.STATus.QUEStionable.RLIMit.ELIMit.PTRansition |
| Description | Sets the value of the positive transition filter of the Questionable Ripple Limit Extra Status Register.                               |
| Variable    |                                                                                                                                        |

|              | <i>Value</i>                                                                                        |
|--------------|-----------------------------------------------------------------------------------------------------|
| Description  | The value of the positive transition filter of the Questionable Ripple Limit Extra Status Register. |
| Data type    | Long integer type (Long)                                                                            |
| Range        | 0 to 65535                                                                                          |
| Preset value | Varies depending on the upper limit setting of the number of channels/traces.                       |
| Note         | Bits 0 and 3 to 15 cannot be set to 1.                                                              |

|                 |                                                                                                                                         |
|-----------------|-----------------------------------------------------------------------------------------------------------------------------------------|
| Examples        | Dim Stat As Long<br>SCPI.STATus.QUEStionable.RLIMit.ELIMit.PTRansition = 6<br>Stat = SCPI.STATus.QUEStionable.RLIMit.ELIMit.PTRansition |
| Related objects | SCPI.STATus.QUEStionable.RLIMit.ELIMit.EVENT on page 719<br>SCPI.STATus.QUEStionable.RLIMit.ELIMit.NTRansition on page 720              |
| Equivalent key  | No equivalent key is available on the front panel.                                                                                      |

## **SCPI.STATus.QUEStionable.RLIMit.ENABLE**

|             |                                                                                                                |
|-------------|----------------------------------------------------------------------------------------------------------------|
| Object type | Property                                                                                                       |
| Syntax      | SCPI.STATus.QUEStionable.RLIMit.ENABLE = <i>Value</i><br><i>Value</i> = SCPI.STATus.QUEStionable.RLIMit.ENABLE |
| Description | Sets the value of the Questionable Ripple Limit Status Enable Register.                                        |
| Variable    |                                                                                                                |

|              | <i>Value</i>                                                                  |
|--------------|-------------------------------------------------------------------------------|
| Description  | The value of the Questionable Ripple Limit Status Enable Register.            |
| Data type    | Long integer type (Long)                                                      |
| Range        | 0 to 65535                                                                    |
| Preset value | Varies depending on the upper limit setting of the number of channels/traces. |
| Note         | Bits 15 cannot be set to 1.                                                   |

Examples

```
Dim Stat As Long
SCPI.STATus.QUEStionable.RLIMit.ENABLE = 16
Stat = SCPI.STATus.QUEStionable.RLIMit.ENABLE
```

Related objects SCPI.STATus.QUEStionable.ENABLE on page 688

Equivalent key No equivalent key is available on the front panel.

## **SCPI.STATus.QUEStionable.RLIMit.EVENT**

|             |                                                                                         |
|-------------|-----------------------------------------------------------------------------------------|
| Object type | Property                                                                                |
| Syntax      | <i>Value</i> = SCPI.STATus.QUEStionable.RLIMit.EVENT                                    |
| Description | Reads out the value of the Questionable Ripple Limit Status Event Register. (Read only) |
| Variable    |                                                                                         |

|             | <i>Value</i>                                                      |
|-------------|-------------------------------------------------------------------|
| Description | The value of the Questionable Ripple Limit Status Event Register. |
| Data type   | Long integer type (Long)                                          |

Examples

```
Dim Stat As Long
Stat = SCPI.STATus.QUEStionable.RLIMit.EVENT
```

Related objects SCPI.IEEE4882.CLS on page 417

Equivalent key No equivalent key is available on the front panel.

## SCPI.STATus.QUEStionable.RLIMit.NTRansition

|             |                                                                                                                          |
|-------------|--------------------------------------------------------------------------------------------------------------------------|
| Object type | Property                                                                                                                 |
| Syntax      | SCPI.STATus.QUEStionable.RLIMit.NTRansition = <i>Value</i><br><i>Value</i> = SCPI.STATus.QUEStionable.RLIMit.NTRansition |
| Description | Sets the value of the negative transition filter of the Questionable Ripple Limit Status Register.                       |
| Variable    |                                                                                                                          |

|              | <i>Value</i>                                                                                  |
|--------------|-----------------------------------------------------------------------------------------------|
| Description  | The value of the negative transition filter of the Questionable Ripple Limit Status Register. |
| Data type    | Long integer type (Long)                                                                      |
| Range        | 0 to 65535                                                                                    |
| Preset value | 0                                                                                             |
| Note         | Bits 15 cannot be set to 1.                                                                   |

|                 |                                                                                                                           |
|-----------------|---------------------------------------------------------------------------------------------------------------------------|
| Examples        | Dim Stat As Long<br>SCPI.STATus.QUEStionable.RLIMit.NTRansition = 6<br>Stat = SCPI.STATus.QUEStionable.RLIMit.NTRansition |
| Related objects | SCPI.STATus.QUEStionable.RLIMit.EVENT on page 722<br>SCPI.STATus.QUEStionable.RLIMit.PTRansition on page 724              |
| Equivalent key  | No equivalent key is available on the front panel.                                                                        |

## SCPI.STATus.QUEStionable.RLIMit.PTRansition

Object type Property

Syntax SCPI.STATus.QUEStionable.RLIMit.PTRansition = *Value*  
*Value* = SCPI.STATus.QUEStionable.RLIMit.PTRansition

Description Sets the value of the positive transition filter of the Questionable Ripple Limit Status Register.

### Variable

|              | <i>Value</i>                                                                                  |
|--------------|-----------------------------------------------------------------------------------------------|
| Description  | The value of the positive transition filter of the Questionable Ripple Limit Status Register. |
| Data type    | Long integer type (Long)                                                                      |
| Range        | 0 to 65535                                                                                    |
| Preset value | Varies depending on the upper limit setting of the number of channels/traces.                 |
| Note         | Bits 15 cannot be set to 1.                                                                   |

Examples

```
Dim Stat As Long
SCPI.STATus.QUEStionable.RLIMit.PTRansition = 6
Stat = SCPI.STATus.QUEStionable.RLIMit.PTRansition
```

Related objects

SCPI.STATus.QUEStionable.RLIMit.EVENT on page 722  
SCPI.STATus.QUEStionable.RLIMit.NTRansition on page 723

Equivalent key

No equivalent key is available on the front panel.



## SCPI.SYSTem.BACKlight

|             |                                                                                                                              |
|-------------|------------------------------------------------------------------------------------------------------------------------------|
| Object type | Property                                                                                                                     |
| Syntax      | SCPI.SYSTem.BACKlight = <i>Status</i><br><i>Status</i> = SCPI.SYSTem.BACKlight                                               |
| Description | Turns ON/OFF the backlight of the LCD display.<br>When the backlight is OFF, you cannot read the information on the display. |
| Variable    |                                                                                                                              |

|              | <i>Status</i>                                                                                                                                                                                                 |
|--------------|---------------------------------------------------------------------------------------------------------------------------------------------------------------------------------------------------------------|
| Description  | ON/OFF of the backlight                                                                                                                                                                                       |
| Data type    | Boolean type (Boolean)                                                                                                                                                                                        |
| Range        | Select from the following.<br><ul style="list-style-type: none"> <li>• True or -1                      Turns ON the backlight.</li> <li>• False or 0                      Turns OFF the backlight.</li> </ul> |
| Preset value | True or -1                                                                                                                                                                                                    |

**Examples**

```
Dim BckLght As Boolean
SCPI.SYSTem.BACKlight = False
BckLght = SCPI.SYSTem.BACKlight
```

Equivalent key      **[System] - Backlight**

**NOTE**                      To turn the backlight ON, press any key on the front panel.

## SCPI.SYSTem.BEEPer.COMPLete.IMMEdiate

|                 |                                                                                                   |
|-----------------|---------------------------------------------------------------------------------------------------|
| Object type     | Method                                                                                            |
| Syntax          | SCPI.SYSTem.BEEPer.COMPLete.IMMEdiate                                                             |
| Description     | Generates a beep for the notification of the completion of the operation. (No read)               |
| Examples        | <code>SCPI.SYSTem.BEEPer.COMPLete.IMMEdiate</code>                                                |
| Related objects | SCPI.SYSTem.BEEPer.COMPLete.STATe on page 726<br>SCPI.SYSTem.BEEPer.WARNing.IMMEdiate on page 727 |
| Equivalent key  | <b>[System] - Misc Setup - Beeper - Test Beep Complete</b>                                        |

## SCPI.SYSTem.BEEPer.COMPLete.STATe

|             |                                                                                                        |
|-------------|--------------------------------------------------------------------------------------------------------|
| Object type | Property                                                                                               |
| Syntax      | SCPI.SYSTem.BEEPer.COMPLete.STATe = <i>Status</i><br><i>Status</i> = SCPI.SYSTem.BEEPer.COMPLete.STATe |
| Description | Turns ON/OFF the beeper for the notification of the completion of the operation.                       |
| Variable    |                                                                                                        |

|              |                                                                                                                                                                                                                                                                                                                       |
|--------------|-----------------------------------------------------------------------------------------------------------------------------------------------------------------------------------------------------------------------------------------------------------------------------------------------------------------------|
|              | <i>Status</i>                                                                                                                                                                                                                                                                                                         |
| Description  | ON/OFF of the beeper for the notification of the completion of the operation                                                                                                                                                                                                                                          |
| Data type    | Boolean type (Boolean)                                                                                                                                                                                                                                                                                                |
| Range        | Select from the following.<br><ul style="list-style-type: none"> <li>•True or -1                      Turns ON the beeper for the notification of the completion of the operation.</li> <li>•False or 0                      Turns OFF the beeper for the notification of the completion of the operation.</li> </ul> |
| Preset value | True or -1                                                                                                                                                                                                                                                                                                            |

Examples

```
Dim BeepComp As Boolean
SCPI.SYSTem.BEEPer.COMPLete.STATe = False
BeepComp = SCPI.SYSTem.BEEPer.COMPLete.STATe
```

|                 |                                                                                                   |
|-----------------|---------------------------------------------------------------------------------------------------|
| Related objects | SCPI.SYSTem.BEEPer.COMPLete.IMMEdiate on page 726<br>SCPI.SYSTem.BEEPer.WARNing.STATe on page 727 |
| Equivalent key  | <b>[System] - Misc Setup - Beeper - Beep Complete</b>                                             |

## SCPI.SYSTem.BEEPer.WARning.IMMediate

|                 |                                                                                                   |
|-----------------|---------------------------------------------------------------------------------------------------|
| Object type     | Method                                                                                            |
| Syntax          | SCPI.SYSTem.BEEPer.WARning.IMMediate                                                              |
| Description     | Generates a beep for the notification of warning/limit test result. (No read)                     |
| Examples        | SCPI.SYSTem.BEEPer.WARning.IMMediate                                                              |
| Related objects | SCPI.SYSTem.BEEPer.WARning.STATe on page 727<br>SCPI.SYSTem.BEEPer.COMPLete.IMMediate on page 726 |
| Equivalent key  | <b>[System] - Misc Setup - Beeper - Test Beep Warning</b>                                         |

## SCPI.SYSTem.BEEPer.WARning.STATe

|             |                                                                                                      |
|-------------|------------------------------------------------------------------------------------------------------|
| Object type | Property                                                                                             |
| Syntax      | SCPI.SYSTem.BEEPer.WARning.STATe = <i>Status</i><br><i>Status</i> = SCPI.SYSTem.BEEPer.WARning.STATe |
| Description | Turns ON/OFF the beeper for the notification of warning/limit test result.                           |
| Variable    |                                                                                                      |

|              |                                                                                                                                                                                                                                                                                                             |
|--------------|-------------------------------------------------------------------------------------------------------------------------------------------------------------------------------------------------------------------------------------------------------------------------------------------------------------|
|              | <i>Status</i>                                                                                                                                                                                                                                                                                               |
| Description  | ON/OFF of the beeper for the notification of warning/limit test result                                                                                                                                                                                                                                      |
| Data type    | Boolean type (Boolean)                                                                                                                                                                                                                                                                                      |
| Range        | Select from the following.<br><ul style="list-style-type: none"> <li>• True or -1                      Turns ON the beeper for the notification of warning/limit test result.</li> <li>• False or 0                      Turns OFF the beeper for the notification of warning/limit test result.</li> </ul> |
| Preset value | True or -1                                                                                                                                                                                                                                                                                                  |

|                 |                                                                                                                    |
|-----------------|--------------------------------------------------------------------------------------------------------------------|
| Examples        | Dim BeepWarn As Boolean<br>SCPI.SYSTem.BEEPer.WARning.STATe = False<br>BeepWarn = SCPI.SYSTem.BEEPer.WARning.STATe |
| Related objects | SCPI.SYSTem.BEEPer.WARning.IMMediate on page 727<br>SCPI.SYSTem.BEEPer.COMPLete.STATe on page 726                  |
| Equivalent key  | <b>[System] - Misc Setup - Beeper - Beep Warning</b>                                                               |

## **SCPI.SYSem.COMMunicate.GPIB.PMETER.ADDress**

|             |                                                                                                                  |
|-------------|------------------------------------------------------------------------------------------------------------------|
| Object type | Property                                                                                                         |
| Syntax      | SCPI.SYSem.COMMunicate.GPIB.PMETER.ADDress = <i>Value</i><br><i>Value</i> = SCPI.COMMunicate.GPIB.PMETER.ADDress |
| Description | Sets/reads out the GPIB address of the power meter in use.                                                       |
| Variable    |                                                                                                                  |

|              | <i>Value</i>                                                                              |
|--------------|-------------------------------------------------------------------------------------------|
| Description  | GPIB address of the power meter                                                           |
| Data type    | Long integer type (Long)                                                                  |
| Range        | 0 to 30                                                                                   |
| Preset value | 13                                                                                        |
| Note         | If the specified parameter is out of the allowable setting range, a runtime error occurs. |

|          |                                                                                                                                 |
|----------|---------------------------------------------------------------------------------------------------------------------------------|
| Examples | <pre>Dim Paddr As Long SCPI.SYSem.COMMunicate.GPIB.PMETER.ADDress = 15 Paddr = SCPI.SYSem.COMMunicate.GPIB.PMETER.ADDress</pre> |
|----------|---------------------------------------------------------------------------------------------------------------------------------|

|                |                                                                 |
|----------------|-----------------------------------------------------------------|
| Equivalent key | <b>[System] - Misc Setup - GPIB Setup - Power Meter Address</b> |
|----------------|-----------------------------------------------------------------|

## SCPI.SYSem.COMMunicate.GPIB.SGENerator.ADDress

|                |                                                                                                                                |
|----------------|--------------------------------------------------------------------------------------------------------------------------------|
| Type of object | Property                                                                                                                       |
| Syntax         | SCPI.SYSem.COMMunicate.GPIB.SGENerator.ADDress = <i>Value</i><br><i>Value</i> = SCPI.SYSem.COMMunicate.GPIB.SGENerator.ADDress |
| Description    | Sets/reads out the GPIB address of the external signal source in use.                                                          |
| Variable       |                                                                                                                                |

|              | <i>Value</i>                                                                                  |
|--------------|-----------------------------------------------------------------------------------------------|
| Description  | The GPIB address of the external signal source                                                |
| Data type    | Long integer type (Long)                                                                      |
| Range        | 0 to 30                                                                                       |
| Preset value | 19                                                                                            |
| Note         | If the specified variable is out of the allowable setup range, an error occurs when executed. |

|                |                                                                                                                                           |
|----------------|-------------------------------------------------------------------------------------------------------------------------------------------|
| Example of use | <pre>Dim SGaddr As Long SCPI.SYSem.COMMunicate.GPIB.SGENerator.ADDress = 20 SGaddr = SCPI.SYSem.COMMunicate.GPIB.SGENerator.ADDress</pre> |
| Equivalent key | <b>[System] - Misc Setup - GPIB Setup - Signal Generator Address</b>                                                                      |

## SCPI.SYSTem.COMMunicate.GPIB.SGENerator.CCOMmand.FREQuency

|                |                                                                                                                                                                                                           |
|----------------|-----------------------------------------------------------------------------------------------------------------------------------------------------------------------------------------------------------|
| Type of object | Property                                                                                                                                                                                                  |
| Syntax         | SCPI.SYSTem.COMMunicate.GPIB.SGENerator.CCOMmand.FREQuency = <i>Param</i><br><i>Param</i> = SCPI.COMMunicate.GPIB.SGENerator.CCOMmand.FREQuency                                                           |
| Description    | Sets the output frequency setting command for the external signal source in use.<br><br>This command is available when the type of the external signal source is 1 (user-defined external signal source). |

### Variable

|              | <i>Value</i>                                                                                                                                                                                                                                                                                                                      |
|--------------|-----------------------------------------------------------------------------------------------------------------------------------------------------------------------------------------------------------------------------------------------------------------------------------------------------------------------------------|
| Description  | Frequency setting command for the user-defined external signal source                                                                                                                                                                                                                                                             |
| Data type    | Character string type (String)                                                                                                                                                                                                                                                                                                    |
| Range        | 254 characters or less                                                                                                                                                                                                                                                                                                            |
| Preset value | "FR %f% HZ"                                                                                                                                                                                                                                                                                                                       |
| Note         | If the specified variable is out of the allowable setup range, an error occurs when executed.<br><br>The output frequency in the command string is written as "%f%." The frequency of the external signal source, which changes for each measurement point, is set and the setting command is sent to the external signal source. |

|                 |                                                                                                                                                                                                                                                                                                                                                                |
|-----------------|----------------------------------------------------------------------------------------------------------------------------------------------------------------------------------------------------------------------------------------------------------------------------------------------------------------------------------------------------------------|
| Example of use  | <pre>Dim SGcomm As String SCPI.SYSTem.COMMunicate.GPIB.SGENerator.CCOMmand.FREQuency = "FREQ %f%HZ" SGcomm = SCPI.SYSTem.COMMunicate.GPIB.SGENerator.CCOMmand.FREQuency</pre>                                                                                                                                                                                  |
| Related objects | <p>SCPI.SYSTem.COMMunicate.GPIB.SGENerator.CCOMmand.POWER on page 731</p> <p>SCPI.SYSTem.COMMunicate.GPIB.SGENerator.CCOMmand.PRESet on page 732</p> <p>SCPI.SYSTem.COMMunicate.GPIB.SGENerator.CCOMmand.RFON on page 733</p> <p>SCPI.SYSTem.COMMunicate.GPIB.SGENerator.DWELL on page 734</p> <p>SCPI.SYSTem.COMMunicate.GPIB.SGENerator.TYPE on page 735</p> |
| Equivalent key  | <b>[System] - Misc Setup - GPIB Setup - Signal Generator Address - Custom Commands - Set Frequency</b>                                                                                                                                                                                                                                                         |

## **SCPI.SYSTem.COMMunicate.GPIB.SGENerator.CCOMmand.POWer**

**Type of object** Property

**Syntax** SCPI.SYSTem.COMMunicate.GPIB.SGENerator.CCOMmand.POWer = *Param*  
*Param* = SCPI.COMMunicate.GPIB.SGENerator.CCOMmand.POWer

**Description** Sets the output level setting command for the external signal source in use.  
 This command is available when the type of the external signal source is 1 (user-defined external signal source).

**Variable**

|              | <i>Value</i>                                                                                                                                                                                                                                                                                                                     |
|--------------|----------------------------------------------------------------------------------------------------------------------------------------------------------------------------------------------------------------------------------------------------------------------------------------------------------------------------------|
| Description  | Level setting command for the user-defined external signal source                                                                                                                                                                                                                                                                |
| Data type    | Character string type (String)                                                                                                                                                                                                                                                                                                   |
| Range        | 254 characters or less                                                                                                                                                                                                                                                                                                           |
| Preset value | "AP %p% DM"                                                                                                                                                                                                                                                                                                                      |
| Note         | If the specified variable is out of the allowable setup range, an error occurs when executed.<br><br>The output level in the command string is written as "%p%." The output level of the external signal source, which changes for each measurement point, is set and the setting command is sent to the external signal source. |

**Example of use**

```
Dim SGcomm As String
SCPI.SYSTem.COMMunicate.GPIB.SGENerator.CCOMmand.POWer = "AMPL
%p%DBM"
SGcomm = SCPI.SYSTem.COMMunicate.GPIB.SGENerator.CCOMmand.POWer
```

**Related objects**

SCPI.SYSTem.COMMunicate.GPIB.SGENerator.CCOMmand.FREQUency on page 730

SCPI.SYSTem.COMMunicate.GPIB.SGENerator.CCOMmand.PRESet on page 732

SCPI.SYSTem.COMMunicate.GPIB.SGENerator.CCOMmand.RFON on page 733

SCPI.SYSTem.COMMunicate.GPIB.SGENerator.DWELI on page 734

SCPI.SYSTem.COMMunicate.GPIB.SGENerator.TYPE on page 735

**Equivalent key** **[System] - Misc Setup - GPIB Setup - Signal Generator Address - Custom Commands - Set Power Level**

## SCPI.SYSTem.COMMunicate.GPIB.SGENerator.CCOMmand.PRESet

|                |                                                                                                                                                                                         |
|----------------|-----------------------------------------------------------------------------------------------------------------------------------------------------------------------------------------|
| Type of object | Property                                                                                                                                                                                |
| Syntax         | SCPI.SYSTem.COMMunicate.GPIB.SGENerator.CCOMmand.PRESet = <i>Param</i><br><i>Param</i> = SCPI.COMMunicate.GPIB.SGENerator.CCOMmand.POWER                                                |
| Description    | Sets the preset command for the external signal source in use.<br><br>This command is available when the type of the external signal source is 1 (user-defined external signal source). |

### Variable

|              | <i>Value</i>                                                                                  |
|--------------|-----------------------------------------------------------------------------------------------|
| Description  | Preset command for the user-defined external signal source                                    |
| Data type    | Character string type (String)                                                                |
| Range        | 254 characters or less                                                                        |
| Preset value | ""                                                                                            |
| Note         | If the specified variable is out of the allowable setup range, an error occurs when executed. |

|                 |                                                                                                                                                                                                                                                                                                                                                                   |
|-----------------|-------------------------------------------------------------------------------------------------------------------------------------------------------------------------------------------------------------------------------------------------------------------------------------------------------------------------------------------------------------------|
| Example of use  | <pre>Dim SGcomm As String SCPI.SYSTem.COMMunicate.GPIB.SGENerator.CCOMmand.PRESet = "*RST" SGcomm = SCPI.SYSTem.COMMunicate.GPIB.SGENerator.CCOMmand.PRESet</pre>                                                                                                                                                                                                 |
| Related objects | <p>SCPI.SYSTem.COMMunicate.GPIB.SGENerator.CCOMmand.FREQuency on page 730</p> <p>SCPI.SYSTem.COMMunicate.GPIB.SGENerator.CCOMmand.POWER on page 731</p> <p>SCPI.SYSTem.COMMunicate.GPIB.SGENerator.CCOMmand.RFON on page 733</p> <p>SCPI.SYSTem.COMMunicate.GPIB.SGENerator.DWELL on page 734</p> <p>SCPI.SYSTem.COMMunicate.GPIB.SGENerator.TYPE on page 735</p> |
| Equivalent key  | <b>[System] - Misc Setup - GPIB Setup - Signal Generator Address - Custom Commands - Preset</b>                                                                                                                                                                                                                                                                   |



## SCPI.SYSTem.COMMunicate.GPIB.SGENerator.CCOMmand.RFON

Type of object      Property

Syntax                SCPI.SYSTem.COMMunicate.GPIB.SGENerator.CCOMmand.RFON = *Param*  
*Param* = SCPI.COMMunicate.GPIB.SGENerator.CCOMmand.RFON

Description         Sets the command to turn on RF for the external signal source in use.

This command is available when the type of the external signal source is 1 (user-defined external signal source).

Variable

|              | <i>Value</i>                                                                                  |
|--------------|-----------------------------------------------------------------------------------------------|
| Description  | RF:on setting command for the user-defined external signal source                             |
| Data type    | Character string type (String)                                                                |
| Range        | 254 characters or less                                                                        |
| Preset value | "R3"                                                                                          |
| Note         | If the specified variable is out of the allowable setup range, an error occurs when executed. |

Example of use      Dim SGcomm As String  
SCPI.SYSTem.COMMunicate.GPIB.SGENerator.CCOMmand.RFON = "AMPL:STATE  
ON"  
SGcomm = SCPI.SYSTem.COMMunicate.GPIB.SGENerator.CCOMmand.RFON

Related objects     SCPI.SYSTem.COMMunicate.GPIB.SGENerator.CCOMmand.FREQUency on  
page 730  
SCPI.SYSTem.COMMunicate.GPIB.SGENerator.CCOMmand.POWER on page 731  
SCPI.SYSTem.COMMunicate.GPIB.SGENerator.CCOMmand.PRESet on page 732  
SCPI.SYSTem.COMMunicate.GPIB.SGENerator.DWELI on page 734  
SCPI.SYSTem.COMMunicate.GPIB.SGENerator.TYPE on page 735

Equivalent key      **[System] - Misc Setup - GPIB Setup - Signal Generator Address - Custom Commands  
- Turn RF Out On**

## SCPI.SYSTem.COMMunicate.GPIB.SGENerator.DWELl

|                |                                                                                                                       |
|----------------|-----------------------------------------------------------------------------------------------------------------------|
| Type of object | Property                                                                                                              |
| Syntax         | SCPI.SYSTem.COMMunicate.GPIB.SGENerator.DWELl = <i>Value</i><br><i>Value</i> = SCPI.COMMunicate.GPIB.SGENerator.DWELl |
| Description    | Sets a wait time after setting the frequency or output level for the external signal source in use.                   |
| Variable       |                                                                                                                       |

|              | <i>Value</i>                                                                                  |
|--------------|-----------------------------------------------------------------------------------------------|
| Description  | Wait time setting for the user-defined external signal source                                 |
| Data type    | Double precision floating point type (Double)                                                 |
| Range        | 0 to 1                                                                                        |
| Preset value | 0.1                                                                                           |
| Unit         | s (second)                                                                                    |
| Resolution   | 0.001                                                                                         |
| Note         | If the specified variable is out of the allowable setup range, an error occurs when executed. |

|                 |                                                                                                                                                                                                                                                                                                                                                                             |
|-----------------|-----------------------------------------------------------------------------------------------------------------------------------------------------------------------------------------------------------------------------------------------------------------------------------------------------------------------------------------------------------------------------|
| Example of use  | <pre>Dim SGdelay As Double SCPI.SYSTem.COMMunicate.GPIB.SGENerator.DWELl = 0.2 SGdelay = SCPI.SYSTem.COMMunicate.GPIB.SGENerator.DWELl</pre>                                                                                                                                                                                                                                |
| Related objects | <p>SCPI.SYSTem.COMMunicate.GPIB.SGENerator.CCOMmand.FREQuency on page 730</p> <p>SCPI.SYSTem.COMMunicate.GPIB.SGENerator.CCOMmand.POWER on page 731</p> <p>SCPI.SYSTem.COMMunicate.GPIB.SGENerator.CCOMmand.PRESet on page 732</p> <p>SCPI.SYSTem.COMMunicate.GPIB.SGENerator.CCOMmand.RFON on page 733</p> <p>SCPI.SYSTem.COMMunicate.GPIB.SGENerator.TYPE on page 735</p> |
| Equivalent key  | <b>[System] - Misc Setup - GPIB Setup - Signal Generator Address - Switching Time</b>                                                                                                                                                                                                                                                                                       |

## SCPI.SYSTem.COMMunicate.GPIB.SGENerator.TYPE

|                |                                                                                                                     |
|----------------|---------------------------------------------------------------------------------------------------------------------|
| Type of object | Property                                                                                                            |
| Syntax         | SCPI.SYSTem.COMMunicate.GPIB.SGENerator.TYPE = <i>Value</i><br><i>Value</i> = SCPI.COMMunicate.GPIB.SGENerator.TYPE |
| Description    | Sets the type of the external signal source in use.                                                                 |
| Variable       |                                                                                                                     |

|              | <i>Value</i>                                                                                                                               |
|--------------|--------------------------------------------------------------------------------------------------------------------------------------------|
| Description  | Type setting of the external signal source<br>1: User-defined<br>2: 8643A, 8644B, 8664A, 8665A/B<br>3: 8648A/B/C/D, ESG Series, PSG Series |
| Data type    | Long integer type (long)                                                                                                                   |
| Range        | 1 to 3                                                                                                                                     |
| Preset value | 3                                                                                                                                          |
| Note         | If the specified variable is out of the allowable setup range, an error occurs when executed.                                              |

Example of use  

```
Dim SGtype As long
SCPI.SYSTem.COMMunicate.GPIB.SGENerator.TYPE = 2
SGtype = SCPI.SYSTem.COMMunicate.GPIB.SGENerator.TYPE
```

Related objects  
 SCPI.SYSTem.COMMunicate.GPIB.SGENerator.CCOMmand.FREQuency on page 730  
 SCPI.SYSTem.COMMunicate.GPIB.SGENerator.CCOMmand.POWer on page 731  
 SCPI.SYSTem.COMMunicate.GPIB.SGENerator.CCOMmand.PRESet on page 732  
 SCPI.SYSTem.COMMunicate.GPIB.SGENerator.CCOMmand.RFON on page 733  
 SCPI.SYSTem.COMMunicate.GPIB.SGENerator.DWELI on page 734

Equivalent key  
**[System] - Misc Setup - GPIB Setup - Signal Generator Address - Custom Commands|8643A,8644B,8664A,8665A/B|8648A/B/C/D,ESG Series,PSG Series**

## SCPI.SYSem.CORRection.STATe

|             |                                                                                            |
|-------------|--------------------------------------------------------------------------------------------|
| Object type | Property                                                                                   |
| Syntax      | SCPI.SYSem.CORRection.STATe = <i>Status</i><br><i>Status</i> = SCPI.SYSem.CORRection.STATe |
| Description | Turns ON/OFF the system correction.                                                        |
| Variable    |                                                                                            |

|              |                                                                                                                                                                     |
|--------------|---------------------------------------------------------------------------------------------------------------------------------------------------------------------|
|              | <i>Status</i>                                                                                                                                                       |
| Description  | ON/OFF of the system correction                                                                                                                                     |
| Data type    | Boolean type (Boolean)                                                                                                                                              |
| Range        | Select from the following.<br>•True or -1                      Turns ON the system correction.<br>•False or 0                      Turns OFF the system correction. |
| Preset value | True or -1                                                                                                                                                          |

|          |                                                                                                           |
|----------|-----------------------------------------------------------------------------------------------------------|
| Examples | <pre>Dim SysCal As Boolean SCPI.SYSem.CORRection.STATe = False SysCal = SCPI.SYSem.CORRection.STATe</pre> |
|----------|-----------------------------------------------------------------------------------------------------------|

|                |                                                                 |
|----------------|-----------------------------------------------------------------|
| Equivalent key | <b>[System] - Misc Setup - Service Menu - System Correction</b> |
|----------------|-----------------------------------------------------------------|

## SCPI.SYSem.DATE

Object type      Property

Syntax            `SCPI.SYSem.DATE = Data`  
                      `Data = SCPI.SYSem.DATE`

Description      Sets the date of the clock built in the E5070B/E5071B.

Variable

|             | <i>Data</i>                                                                                                                                                                                                                                                                                                |
|-------------|------------------------------------------------------------------------------------------------------------------------------------------------------------------------------------------------------------------------------------------------------------------------------------------------------------|
| Description | Indicates 3-element array data (date of the built-in clock).<br><ul style="list-style-type: none"> <li>• <i>Data(0)</i>                Sets year.</li> <li>• <i>Data(1)</i>                Sets month.</li> <li>• <i>Data(2)</i>                Sets day.</li> </ul> The index of the array starts from 0. |
| Data type   | Variant type (Variant)                                                                                                                                                                                                                                                                                     |
| Range       | <ul style="list-style-type: none"> <li>• <i>Data(0)</i>                1980 to 2099</li> <li>• <i>Data(1)</i>                1 to 12</li> <li>• <i>Data(2)</i>                1 to 31</li> </ul>                                                                                                           |
| Resolution  | 1                                                                                                                                                                                                                                                                                                          |
| Note        | If the specified variable is out of the allowable setup range, the minimum value (if the lower limit of the range is not reached) or the maximum value (if the upper limit of the range is exceeded) is set.                                                                                               |

Examples

```
Dim Day As Variant
SCPI.SYSem.DATE = Array(2001,12,24)
Day = SCPI.SYSem.DATE
```

```
Dim Day(2) As Variant
Dim Ref As Variant
Day(0) = 2001
Day(1) = 12
Day(2) = 24
SCPI.SYSem.DATE = Day
Ref = SCPI.SYSem.DATE
```

Related objects    `SCPI.SYSem.TIME` on page 748  
                      `SCPI.DISPlay.CLOCK` on page 378

Equivalent key    **[System] - Misc Setup - Clock Setup - Set Date and Time**

## SCPI.SYSTem.ERROR

|             |                                                                                                                                                                                                                                                                                         |
|-------------|-----------------------------------------------------------------------------------------------------------------------------------------------------------------------------------------------------------------------------------------------------------------------------------------|
| Object type | Property                                                                                                                                                                                                                                                                                |
| Syntax      | <i>Err</i> = SCPI.SYSTem.ERROR                                                                                                                                                                                                                                                          |
| Description | Reads out the oldest error of the errors stored in the error queue of the E5070B/E5071B. The read-out error is deleted from the error queue. The size of the error queue is 100.<br><br>Executing the SCPI.IEEE4882.CLS object clears the errors stored in the error queue. (Read only) |

---

**NOTE** This object can not return an error that occurs by the manual operation or the SCPI command used in controlling the E5070B/E5071B from the external controller.

---

### Variable

|             | <i>Err</i>                                                                                                                                                                                                                                        |
|-------------|---------------------------------------------------------------------------------------------------------------------------------------------------------------------------------------------------------------------------------------------------|
| Description | Indicates 2-element array data (for error).<br><ul style="list-style-type: none"><li>• <i>Err(0)</i>                      Error number</li><li>• <i>Err(1)</i>                      Error message</li></ul> The index of the array starts from 0. |
| Data type   | Variant type (Variant)                                                                                                                                                                                                                            |
| Note        | If no error is stored in the error queue, 0 and "No error" are read out as the error number and the error message.                                                                                                                                |

**Examples**                      `Dim Err As Variant`  
                                  `Err = SCPI.SYSTem.ERROR`

**Related objects**            SCPI.IEEE4882.CLS on page 417

**Equivalent key**             No equivalent key is available on the front panel.

## SCPI.SYSTem.ISPC.PORT

**Object type** Property

**Syntax** SCPI.SYSTem.ISPCControl.PORT = *Value*  
*Status* = SCPI.SYSTem.ISPCControl.PORT

**Description** Specifies a test port to be selected for stimulus destination when the Initial Source Port Control feature is on.

**Variable**

|              | <i>Value</i>             |
|--------------|--------------------------|
| Description  | Selected Port            |
| Data type    | Long integer type (Long) |
| Range        | 1~4                      |
| Preset value | 1                        |

**Examples**

```
SCPI.INIT(ch).CONT = False
SCPI.SYST.ISPC.STAT = True
SCPI.SYST.ISPC.PORT = 1
```

**Related objects** SCPI.SYSTem.ISPC.STAT on page 740

**Equivalent key** **[System] - Service - Init Src Port [1|2|3|4]**

## SCPI.SYSTem.ISPC.STAT

|             |                                                                                                                                |
|-------------|--------------------------------------------------------------------------------------------------------------------------------|
| Object type | Property                                                                                                                       |
| Syntax      | SCPI.SYSTem.ISPCControl.STATe = <i>Status</i><br><i>Status</i> = SCPI.SYSTem.ISPCControl.STATe                                 |
| Description | Turns on/off the Initial Source Port Control feature (to switch the stimulus output in the trigger hold state to a test port). |
| Variable    |                                                                                                                                |

|              |                                                                                                                                      |
|--------------|--------------------------------------------------------------------------------------------------------------------------------------|
|              | <i>Status</i>                                                                                                                        |
| Description  | ON/OFF Initial Source Port Control feature                                                                                           |
| Data type    | Boolean type (Boolean)                                                                                                               |
| Range        | Select from the following.<br>•True or 1                   ON Control feature.<br>•False or 0                   OFF Control feature. |
| Preset value | True or 1                                                                                                                            |

Examples  
`SCPI.INIT(ch).CONT = False`  
`SCPI.SYST.ISPC.STAT = True`  
`SCPI.SYST.ISPC.PORT = 1`

Related objects    SCPI.SYSTem.ISPC.PORT on page 739

Equivalent key    **[System] - Service - Init Src Ctrl [ON]**



## SCPI.SYSTem.KLOCK.KBD

|             |                                                                                           |
|-------------|-------------------------------------------------------------------------------------------|
| Object type | Property                                                                                  |
| Syntax      | SCPI.SYSTem.KLOCK.KBD = <i>Status</i><br><i>Status</i> = SCPI.SYSTem.KLOCK.KBD            |
| Description | Sets whether to lock the operation of the front panel (key and rotary knob) and keyboard. |
| Variable    |                                                                                           |

|              |                                                                                                                                                                                              |
|--------------|----------------------------------------------------------------------------------------------------------------------------------------------------------------------------------------------|
|              | <i>Status</i>                                                                                                                                                                                |
| Description  | ON/OFF of lock                                                                                                                                                                               |
| Data type    | Boolean type (Boolean)                                                                                                                                                                       |
| Range        | Select from the following.<br><ul style="list-style-type: none"> <li>•True or -1                      Specifies lock.</li> <li>•False or 0                      Specifies unlock.</li> </ul> |
| Preset value | False or 0                                                                                                                                                                                   |

|                 |                                                                                         |
|-----------------|-----------------------------------------------------------------------------------------|
| Examples        | Dim FKLock As Boolean<br>SCPI.SYSTem.KLOCK.KBD = True<br>FKLock = SCPI.SYSTem.KLOCK.KBD |
| Related objects | SCPI.SYSTem.KLOCK.MOUSE on page 742                                                     |
| Equivalent key  | <b>[System] - Misc Setup - Front Panel &amp; Keyboard Lock</b>                          |

## SCPI.SYSTem.KLOCK.MOUSe

|             |                                                                                    |
|-------------|------------------------------------------------------------------------------------|
| Object type | Property                                                                           |
| Syntax      | SCPI.SYSTem.KLOCK.MOUSe = <i>Status</i><br><i>Status</i> = SCPI.SYSTem.KLOCK.MOUSe |
| Description | Sets whether to lock the operation of the mouse and touch screen.                  |
| Variable    |                                                                                    |

|              |                                                                                                                                                                                              |
|--------------|----------------------------------------------------------------------------------------------------------------------------------------------------------------------------------------------|
|              | <i>Status</i>                                                                                                                                                                                |
| Description  | ON/OFF of lock                                                                                                                                                                               |
| Data type    | Boolean type (Boolean)                                                                                                                                                                       |
| Range        | Select from the following.<br><ul style="list-style-type: none"> <li>•True or -1                      Specifies lock.</li> <li>•False or 0                      Specifies unlock.</li> </ul> |
| Preset value | False or 0                                                                                                                                                                                   |

|                 |                                                                                             |
|-----------------|---------------------------------------------------------------------------------------------|
| Examples        | Dim MTLock As Boolean<br>SCPI.SYSTem.KLOCK.MOUSe = True<br>MTLock = SCPI.SYSTem.KLOCK.MOUSe |
| Related objects | SCPI.SYSTem.KLOCK.KBD on page 741                                                           |
| Equivalent key  | <b>[System] - Key Lock - Mouse Lock</b>                                                     |

## SCPI.SYSTem.POFF

|                |                                        |
|----------------|----------------------------------------|
| Object type    | Method                                 |
| Syntax         | SCPI.SYSTem.POFF                       |
| Description    | Turns OFF the E5070B/E5071B. (No read) |
| Examples       | SCPI.SYSTem.POFF                       |
| Equivalent key | Standby switch                         |

## SCPI.SYSTem.PRESet

|                 |                                                                                                                                                                                                                                                                                                                                                                                                                         |
|-----------------|-------------------------------------------------------------------------------------------------------------------------------------------------------------------------------------------------------------------------------------------------------------------------------------------------------------------------------------------------------------------------------------------------------------------------|
| Object type     | Method                                                                                                                                                                                                                                                                                                                                                                                                                  |
| Syntax          | SCPI.SYSTem.PRESet                                                                                                                                                                                                                                                                                                                                                                                                      |
| Description     | <p>Presets the setting state of the E5070B/E5071B. There is the following difference from the setting state preset with the SCPI.IEEE4882.RST object. For details, see Appendix “List of Default Values” in the <i>E5070B/E5071B User’s Guide</i>. (No read)</p> <ul style="list-style-type: none"><li>• The continuous startup mode (see the SCPI.INITiate(Ch).CONTinuous object) of channel 1 is set to ON.</li></ul> |
| Examples        | SCPI.SYSTem.PRESet                                                                                                                                                                                                                                                                                                                                                                                                      |
| Related objects | SCPI.IEEE4882.RST on page 421                                                                                                                                                                                                                                                                                                                                                                                           |
| Equivalent key  | <b>[Preset] - OK</b>                                                                                                                                                                                                                                                                                                                                                                                                    |

## SCPI.SYSTem.SECurity.LEVel

Object type      Property

Syntax            SCPI.SYSTem.SECurity.LEVel = *Param*  
*Param* = SCPI.SYSTem.SECurity.LEVel

Description      Sets/Reads the security level.

Variable

|              |                                                                                                                                                                                                                                                                                                                                                         |
|--------------|---------------------------------------------------------------------------------------------------------------------------------------------------------------------------------------------------------------------------------------------------------------------------------------------------------------------------------------------------------|
|              | <b><i>Param</i></b>                                                                                                                                                                                                                                                                                                                                     |
| Description  | The security level.                                                                                                                                                                                                                                                                                                                                     |
| Data type    | Character string type (String)                                                                                                                                                                                                                                                                                                                          |
| Range        | Select from the following.<br><ul style="list-style-type: none"> <li>•"NON"                      Specifies OFF to the security level.</li> <li>•"LOW"                      Specifies LOW level to the security level.</li> <li>•"HIGH"                      Specifies HIGH level to the security level.</li> </ul>                                      |
| Preset value | "NON"                                                                                                                                                                                                                                                                                                                                                   |
| Note         | When the setting is LOW, it is able to change to NON or HIGH. But when this setting is HIGH, it is not able to change NON or LOW.<br>The setting can be turned NON by executing the preset or recalling when the setting of security level is HIGH.<br>Even if the setting is LOW and HIGH, the command that reads out the frequency is not influenced. |

Examples

```
Dim SecLev As String
SCPI.SYSTem.SECurity.LEVel = "LOW"
SecLev = SCPI.SYSTem.SECurity.LEVel
```

Equivalent key      **[System] - Service Menu - Security Level - None|Low|High**

## SCPI.SYSTem.SERvice

|             |                                                          |
|-------------|----------------------------------------------------------|
| Object type | Property                                                 |
| Syntax      | <i>Status</i> = SCPI.SYSTem.SERvice                      |
| Description | Reads out whether to be in the service mode. (Read only) |
| Variable    |                                                          |

|             |                                                                                                                                                                                                          |
|-------------|----------------------------------------------------------------------------------------------------------------------------------------------------------------------------------------------------------|
|             | <i>Status</i>                                                                                                                                                                                            |
| Description | Whether to be in the service mode                                                                                                                                                                        |
| Data type   | Boolean type (Boolean)                                                                                                                                                                                   |
| Range       | Select from the following.<br><ul style="list-style-type: none"> <li>•True or -1                      In the service mode.</li> <li>•False or 0                      Not in the service mode.</li> </ul> |

**Examples**

```
Dim SvMode As Boolean
SvMode = SCPI.SYSTem.SERvice
```

**Equivalent key**                      Displayed on the instrument status bar (at the bottom of the LCD display).

## SCPI.SYSTem.TEMPerature.HIGH

Object type      Property

Syntax            SCPI.SYSTem.TEMPerature.HIGH = *Status*  
*Status* = SCPI.SYSTem.TEMPerature.HIGH

Description      Turns ON/OFF the high temperature mode.

Variable

|              |                                                                                                                                                             |
|--------------|-------------------------------------------------------------------------------------------------------------------------------------------------------------|
|              | <i>Status</i>                                                                                                                                               |
| Description  | ON/OFF of the high temperature mode                                                                                                                         |
| Data type    | Boolean type (Boolean)                                                                                                                                      |
| Range        | Select from the following.<br>•True or -1              Turns ON the high temperature mode.<br>•False or 0              Turns OFF the high temperature mode. |
| Preset value | False or 0                                                                                                                                                  |

Examples            Dim TempMode As Boolean  
SCPI.SYSTem.TEMPerature.HIGH = True  
TempMode = SCPI.SYSTem.TEMPerature.HIGH

Equivalent key    **[System] - Service Menu - High Temperature**

## SCPI.SYSTem.TEMPerature.STATe

**Object type** Property

**Syntax** *Status* = SCPI.SYSTem.TEMPerature.STATe

**Description** Reads out whether the warm-up is enough to satisfy the specifications of the E5070B/E5071B. (Read only)

**Variable**

|             |                                                                                                                                                                                              |
|-------------|----------------------------------------------------------------------------------------------------------------------------------------------------------------------------------------------|
|             | <i>Status</i>                                                                                                                                                                                |
| Description | Whether the warm-up is enough or not.                                                                                                                                                        |
| Data type   | Boolean type (Boolean)                                                                                                                                                                       |
| Range       | Select from the following.<br><ul style="list-style-type: none"> <li>•True or -1                      Enough warm-up</li> <li>•False or 0                      Not enough warm-up</li> </ul> |

**Examples**

```
Dim WarmUp As Boolean
WarmUp = SCPI.SYSTem.TEMPerature.STATe
```

**Equivalent key** Displayed on the instrument status bar (at the bottom of the LCD display).

## SCPI.SYS<sup>TE</sup>M.TIME

|             |                                                                                            |
|-------------|--------------------------------------------------------------------------------------------|
| Object type | Property                                                                                   |
| Syntax      | SCPI.SYS <sup>TE</sup> M.TIME = <i>Data</i><br><i>Data</i> = SCPI.SYS <sup>TE</sup> M.TIME |
| Description | Sets the time of the clock built in the E5070B/E5071B.                                     |
| Variable    |                                                                                            |

|             | <i>Data</i>                                                                                                                                                                                                                                                                                                                                  |
|-------------|----------------------------------------------------------------------------------------------------------------------------------------------------------------------------------------------------------------------------------------------------------------------------------------------------------------------------------------------|
| Description | Indicates 3-element array data (time of the built-in clock). <ul style="list-style-type: none"> <li>• <i>Data</i>(0)                      Sets hour (24-hour basis)</li> <li>• <i>Data</i>(1)                      Sets minute.</li> <li>• <i>Data</i>(2)                      Sets second.</li> </ul> The index of the array starts from 0. |
| Data type   | Variant type (Variant)                                                                                                                                                                                                                                                                                                                       |
| Range       | <ul style="list-style-type: none"> <li>• <i>Data</i>(0)                      0 to 23</li> <li>• <i>Data</i>(1)                      0 to 59</li> <li>• <i>Data</i>(2)                      0 to 59</li> </ul>                                                                                                                                |
| Resolution  | 1                                                                                                                                                                                                                                                                                                                                            |
| Note        | If the specified variable is out of the allowable setup range, the minimum value (if the lower limit of the range is not reached) or the maximum value (if the upper limit of the range is exceeded) is set.                                                                                                                                 |

**Examples**

```
Dim Time As Variant
SCPI.SYSTEM.TIME = Array(21,30,0)
Time = SCPI.SYSTEM.TIME

Dim Time(2) As Variant
Dim Ref As Variant
Time(0) = 21
Time(1) = 30
Time(2) = 0
SCPI.SYSTEM.TIME = Time
Ref = SCPI.SYSTEM.TIME
```

**Related objects**      SCPI.SYS<sup>TE</sup>M.DATE on page 737  
SCPI.DISPLAY.CLOCK on page 378

**Equivalent key**      **[System] - Misc Setup - Clock Setup - Set Date and Time**



## SCPI.SYSTem.UPReset

|                 |                                                                                                                                                                                                                                                                                                                |
|-----------------|----------------------------------------------------------------------------------------------------------------------------------------------------------------------------------------------------------------------------------------------------------------------------------------------------------------|
| Object type     | Method                                                                                                                                                                                                                                                                                                         |
| Syntax          | SCPI.SYSTem.UPReset                                                                                                                                                                                                                                                                                            |
| Description     | <p>Performs presets with the user settings.</p> <p>The command is executed regardless of the operation mode in preset state. (No read)</p> <p>If you try to specify a file for a preset (D:\UserPreset.sta) that does not exist, a warning message is displayed and “SCPI.SYSTem.PRESet” will be executed.</p> |
| Examples        | <code>CPI.SYSTem.UPReset</code>                                                                                                                                                                                                                                                                                |
| Related objects | <p>SCPI.IEEE4882.RST on page 421</p> <p>SCPI.SYSTem.PRESet on page 743</p>                                                                                                                                                                                                                                     |
| Equivalent key  | <b>[Preset] - OK</b>                                                                                                                                                                                                                                                                                           |

## SCPI.TRIGger.SEQuence.AVERAge

Type of object      Property

Syntax                SCPI.TRIGger.SEQuence.AVERAge = *Status*  
*Status* = SCPI.TRIGger.SEQuence.AVERAge

Description         Turns on/off of the averaging trigger feature.  
The sweep averaging feature must be set to on when turning on the averaging trigger feature.

### Variable

|              | <i>Status</i>                                                                                                                                           |
|--------------|---------------------------------------------------------------------------------------------------------------------------------------------------------|
| Description  | On/off status of the averaging trigger                                                                                                                  |
| Data type    | Boolean type (Boolean)                                                                                                                                  |
| Range        | Select from the following.<br>•True or -1                Turns on the averaging trigger.<br>•False or 0                Turns off the averaging trigger. |
| Preset value | False or 0                                                                                                                                              |

Example of use      Dim Avetrig As Boolean  
SCPI.TRIGger.SEQuence.AVERAge = True  
Avetrig = TRIGger.SEQuence.AVERAge

Related objects     SCPI.SENSE(Ch).AVERAge.STATe on page 466

Equivalent key      **[Ave]** - Ave Trigger

## SCPI.TRIGger.SEQuence.EXTeRnal.DELay

Type of object Property

Syntax SCPI.TRIGger.SEQuence.EXTeRnal.DELay = *Value*  
*Value* = SCPI.TRIGger.SEQuence.EXTeRnal.DELay

Description When the trigger source is external, sets the time that it takes from receiving the trigger to starting measurement.

### Variable

|              | <i>Value</i>                                  |
|--------------|-----------------------------------------------|
| Description  | External trigger delay time                   |
| Data type    | Double precision floating point type (Double) |
| Range        | 0 to 1                                        |
| Preset value | 0                                             |
| Unit         | s (second)                                    |
| Resolution   | 10 μ                                          |

Example of use  

```
Dim ExtDel As Double
SCPI.TRIGger.SEQuence.EXTeRnal.DELay = 0.05
ExtDel = SCPI.TRIGger.SEQuence.EXTeRnal.DELay
```

Related objects  
 SCPI.TRIGger.SEQuence.EXTeRnal.LLATency.STATe on page 752  
 SCPI.TRIGger.SEQuence.POINt on page 754

Equivalent key **[Trigger] - Ext Trigger Delay**

## SCPI.TRIGger.SEQuence.EXTernal.LLATency.STATe

|                |                                                                                                                                                                                                                             |
|----------------|-----------------------------------------------------------------------------------------------------------------------------------------------------------------------------------------------------------------------------|
| Type of object | Property                                                                                                                                                                                                                    |
| Syntax         | SCPI.TRIGger.SEQuence.EXTernal.LLATency.STATe = <i>Status</i><br><i>Status</i> = SCPI.TRIGger.SEQuence.EXTernal.LLATency.STATe                                                                                              |
| Description    | Turns on/off the low-latency external trigger feature.<br><br>When turning on the low-latency external trigger feature, the point trigger feature must be set to on and the trigger source must be set to external trigger. |

---

**NOTE** When the point trigger feature is set to off, or when the trigger source is set to one other than the external trigger, the change is ignored.

---

### Variable

|              |                                                                                                                                                                                           |
|--------------|-------------------------------------------------------------------------------------------------------------------------------------------------------------------------------------------|
|              | <i>Status</i>                                                                                                                                                                             |
| Description  | On/off of the low-latency external trigger                                                                                                                                                |
| Data type    | Boolean type (Boolean)                                                                                                                                                                    |
| Range        | Select from the following.<br>•True or -1                      Turns on the low-latency external trigger.<br>•False or 0                      Turns off the low-latency external trigger. |
| Preset value | False or 0                                                                                                                                                                                |

Example of use  

```
Dim Llat As Boolean
SCPI.TRIGger.SEQuence.EXTernal.LLATency.STATe = True
Llat = SCPI.TRIGger.SEQuence.EXTernal.LLATency.STATe
```

Related objects  
SCPI.TRIGger.SEQuence.EXTernal.DELay on page 751  
SCPI.TRIGger.SEQuence.POINt on page 754  
SCPI.TRIGger.SEQuence.SOURce on page 757

Equivalent key  
**[Trigger] - Low Latency**

## SCPI.TRIGger.SEQuence.IMMediate

|                 |                                                                                                                                                                                                                                                                                                                                                                                                                                                                                                                                                                                                                                                                     |
|-----------------|---------------------------------------------------------------------------------------------------------------------------------------------------------------------------------------------------------------------------------------------------------------------------------------------------------------------------------------------------------------------------------------------------------------------------------------------------------------------------------------------------------------------------------------------------------------------------------------------------------------------------------------------------------------------|
| Object type     | Method                                                                                                                                                                                                                                                                                                                                                                                                                                                                                                                                                                                                                                                              |
| Syntax          | SCPI.TRIGger.SEQuence.IMMediate                                                                                                                                                                                                                                                                                                                                                                                                                                                                                                                                                                                                                                     |
| Description     | <p>Regardless of the setting of the trigger mode, generates a trigger immediately and executes a measurement.</p> <p>There is the following difference from the trigger with the SCPI.TRIGger.SEQuence.SINGle object.</p> <ul style="list-style-type: none"><li>• The execution of the object finishes at the time of a trigger.</li></ul> <p>If you execute this object when the trigger system is not in the trigger wait state (trigger event detection state), an error occurs when executed and the object is ignored.</p> <p>For details about the trigger system, see Section “Trigger System” in the <i>E5070B/E5071B Programmer’s Guide</i>. (No read)</p> |
| Examples        | <pre>SCPI.TRIGger.SEQuence.SOURce = "bus"<br/>SCPI.INITiate(1).CONTinuous = True<br/>SCPI.TRIGger.SEQuence.IMMediate</pre>                                                                                                                                                                                                                                                                                                                                                                                                                                                                                                                                          |
| Related objects | SCPI.TRIGger.SEQuence.IMMediate on page 753                                                                                                                                                                                                                                                                                                                                                                                                                                                                                                                                                                                                                         |
| Equivalent key  | No equivalent key is available on the front panel.                                                                                                                                                                                                                                                                                                                                                                                                                                                                                                                                                                                                                  |

## SCPI.TRIGger.SEQuence.POINt

|                |                                                                                            |
|----------------|--------------------------------------------------------------------------------------------|
| Type of object | Property                                                                                   |
| Syntax         | SCPI.TRIGger.SEQuence.POINt = <i>Status</i><br><i>Status</i> = SCPI.TRIGger.SEQuence.POINt |
| Description    | Turns on/off of the point trigger feature.                                                 |
| Variable       |                                                                                            |

|              |                                                                                                                                                                                               |
|--------------|-----------------------------------------------------------------------------------------------------------------------------------------------------------------------------------------------|
|              | <i>Status</i>                                                                                                                                                                                 |
| Description  | On/off of the point trigger                                                                                                                                                                   |
| Data type    | Boolean type (Boolean)                                                                                                                                                                        |
| Range        | Select from the following.<br>•True or -1                      Turns on the point trigger.<br>•False or 0                      Turns off the point trigger.                                   |
| Preset value | False or 0                                                                                                                                                                                    |
| Note         | When the point trigger feature is turned on, if the sweep mode is Swept, it changes to Stepped.<br>When the trigger source is set to the internal trigger (Internal), the setting is ignored. |

|                 |                                                                                                   |
|-----------------|---------------------------------------------------------------------------------------------------|
| Example of use  | <pre>Dim Ptrig As Boolean SCPI.TRIGger.SEQuence.POINt = True Ptrig = TRIGger.SEQuence.POINt</pre> |
| Related objects | SCPI.TRIGger.SEQuence.SOURce on page 757                                                          |
| Equivalent key  | <b>[Trigger] - Trigger Event</b>                                                                  |

## SCPI.TRIGger.SEQuence.SCOPE

Object type      Property

Syntax            `SCPI.TRIGger.SEQuence.SCOPE = Param`  
*Param* = SCPI.TRIGger.SEQuence.SCOPE

Description      Selects the channel to be triggered.

Variable

|              |                                                                                                                                                                                                    |
|--------------|----------------------------------------------------------------------------------------------------------------------------------------------------------------------------------------------------|
|              | <b><i>Param</i></b>                                                                                                                                                                                |
| Description  | Setting of the channel to be triggered                                                                                                                                                             |
| Data type    | Character string type (String)                                                                                                                                                                     |
| Range        | Select from the following.<br><ul style="list-style-type: none"> <li>•"ALL"                      Specifies all channels</li> <li>•"ACTive"                 Specifies the active channel</li> </ul> |
| Preset value | "ALL"                                                                                                                                                                                              |

Examples            `Dim TrigScop As String`  
`SCPI.TRIGger.SEQuence.SCOPE = "active"`  
`TrigSour = SCPI.TRIGger.SEQuence.SCOPE`

Equivalent key      **[Trigger] - Trigger Scope - All Channel|Active Channel**

## **SCPI.TRIGger.SEQuence.SINGle**

|                 |                                                                                                                                                                                                                                                                                                                                                                                                                                                                                                                                                                                                                                                                                                                                                                                                                              |
|-----------------|------------------------------------------------------------------------------------------------------------------------------------------------------------------------------------------------------------------------------------------------------------------------------------------------------------------------------------------------------------------------------------------------------------------------------------------------------------------------------------------------------------------------------------------------------------------------------------------------------------------------------------------------------------------------------------------------------------------------------------------------------------------------------------------------------------------------------|
| Object type     | Method                                                                                                                                                                                                                                                                                                                                                                                                                                                                                                                                                                                                                                                                                                                                                                                                                       |
| Syntax          | SCPI.TRIGger.SEQuence.SINGle                                                                                                                                                                                                                                                                                                                                                                                                                                                                                                                                                                                                                                                                                                                                                                                                 |
| Description     | <p>Regardless of the setting of the trigger mode, generates a trigger immediately and executes a measurement.</p> <p>There is the following difference from the trigger with the SCPI.TRIGger.SEQuence.IMMEDIATE object.</p> <ul style="list-style-type: none"><li>• The execution of the object finishes when the measurement (all of the sweep) initiated with this object is complete. In other words, you can wait for the end of the measurement using the SCPI.IEEE4882.OPC object.</li></ul> <p>If you execute this object when the trigger system is not in the trigger wait state (trigger event detection state), an error occurs when executed and the object is ignored.</p> <p>For details about the trigger system, see Section “Trigger System” in the <i>E5070B/E5071B Programmer’s Guide</i>. (No read)</p> |
| Examples        | <pre>Dim Dmy As Long SCPI.TRIGger.SEQuence.SOURce = "bus" SCPI.INITiate(1).CONTinuous = True SCPI.TRIGger.SEQuence.SINGle Dmy = SCPI.IEEE4882.OPC</pre>                                                                                                                                                                                                                                                                                                                                                                                                                                                                                                                                                                                                                                                                      |
| Related objects | <p>SCPI.TRIGger.SEQuence.IMMEDIATE on page 753</p> <p>SCPI.IEEE4882.OPC on page 420</p>                                                                                                                                                                                                                                                                                                                                                                                                                                                                                                                                                                                                                                                                                                                                      |
| Equivalent key  | No equivalent key is available on the front panel.                                                                                                                                                                                                                                                                                                                                                                                                                                                                                                                                                                                                                                                                                                                                                                           |



## SCPI.TRIGger.SEQuence.SOURce

- Object type** Property
- Syntax** SCPI.TRIGger.SEQuence.SOURce = *Param*  
*Param* = SCPI.TRIGger.SEQuence.SOURce
- Description** Selects the trigger source from the following 4 types.
- Internal trigger** Uses the internal trigger to generate continuous triggers automatically.
  - External trigger** Generates a trigger when the trigger signal is inputted externally via the Ext Trig connector or the handler interface.
  - Manual trigger** Generates a trigger when the key operation of **[Trigger] - Trigger** is executed from the front panel.
  - Bus trigger** Generates a trigger when the SCPI.IEEE4882.TRG object is executed.
- When you change the trigger source during sweep, the sweep is aborted.

**Variable**

|              | <i>Param</i>                                                                                                                                                                                                                                                 |
|--------------|--------------------------------------------------------------------------------------------------------------------------------------------------------------------------------------------------------------------------------------------------------------|
| Description  | Trigger source                                                                                                                                                                                                                                               |
| Data type    | Character string type (String)                                                                                                                                                                                                                               |
| Range        | Select from the following.<br><ul style="list-style-type: none"> <li>•"INternal" Specifies internal trigger.</li> <li>•"EXternal" Specifies external trigger.</li> <li>•"MANual" Specifies manual trigger.</li> <li>•"BUS" Specifies bus trigger.</li> </ul> |
| Preset value | "INternal"                                                                                                                                                                                                                                                   |

**Examples**

```
Dim TrigSour As String
SCPI.TRIGger.SEQuence.SOURce = "bus"
TrigSour = SCPI.TRIGger.SEQuence.SOURce
```

**Equivalent key** **[Trigger] - Trigger Source - Internal|External|Manual|Bus**

COM Object Reference  
**SCPI.TRIGger.SEQuence.SOURce**

---

**8****Waveform Analysis Library**

This chapter describes how to use the ripple analysis library and the procedures in the ripple analysis library.

## Ripple Analysis Library

By combining the COM objects provided for the E5070B/E5071B and the ripple analysis library, you can easily perform the ripple analysis of waveforms.

### Flow of Programming Using the Ripple Analysis Library

Below table shows the flow of program development using the ripple analysis library. First, set up the analysis range and peak definition to use the procedures for ripple analysis.

|                                                                           |
|---------------------------------------------------------------------------|
| <b>STEP 1. Condition setting before using the ripple analysis library</b> |
| <input type="checkbox"/> Specifying the analysis range                    |
| <input type="checkbox"/> Setting the peak definition                      |
| <b>STEP 2. Using the ripple analysis library</b>                          |

### Condition Setting Before Using the Ripple Analysis Library

Since the analysis conditions are not specified in the ripple analysis library, before using the procedure for ripple analysis, set up the analysis range and the peak definition using COM objects.

#### Specifying the Analysis Range

Use the following COM objects to specify the analysis range for ripple analysis. For more information on each object, see Chapter 7, “COM Object Reference.”

- SCPI.CALCulate(Ch).SELEcted.FUNcTION.DOMain.START on page 292
- SCPI.CALCulate(Ch).SELEcted.FUNcTION.DOMain.STOP on page 294
- SCPI.CALCulate(Ch).SELEcted.FUNcTION.DOMain.STATe on page 293
- SCPI.CALCulate(Ch).SELEcted.FUNcTION.DOMain.COUPle on page 291

#### Setting the Peak Definition

Use the following COM objects to set up the peak definition for ripple analysis. For more information on each object, see Chapter 7, “COM Object Reference.”

- SCPI.CALCulate(Ch).SELEcted.FUNcTION.PEXcursion on page 296
- SCPI.CALCulate(Ch).SELEcted.FUNcTION.PPOLarity on page 298

## List of the Ripple Analysis Library

Use the provided procedures for ripple analysis to analyze the ripple of waveforms and output the result. All procedures perform analysis only within the stimulus range for the specified channel.

For more information on the E5070B/E5071B ripple analysis library, refer to Procedure Reference on page 763.

| List of ripple analysis library                                                                                                                                                                                                                                                                                                                                                   |
|-----------------------------------------------------------------------------------------------------------------------------------------------------------------------------------------------------------------------------------------------------------------------------------------------------------------------------------------------------------------------------------|
| <ul style="list-style-type: none"> <li>Returns the maximum value of the difference between a positive peak and a negative peak.<br/>MaxPeakToPeak(Chan) on page 771</li> </ul>                                                                                                                                                                                                    |
| <ul style="list-style-type: none"> <li>Returns the maximum value of the difference between a positive peak and its right adjacent negative peak.<br/>MaxRightGap(Chan) on page 772</li> </ul>                                                                                                                                                                                     |
| <ul style="list-style-type: none"> <li>Returns the maximum value of the difference between a positive peak and its left adjacent negative peak.<br/>MaxLeftGap(Chan) on page 770</li> </ul>                                                                                                                                                                                       |
| <ul style="list-style-type: none"> <li>Returns the maximum value of the difference between a positive peak and its adjacent negative peak.<br/>MaxGap(Chan) on page 769</li> </ul>                                                                                                                                                                                                |
| <ul style="list-style-type: none"> <li>Returns the maximum value of the vertical distance between a line segment connecting 2 adjacent positive peaks and the negative peak between them.<br/>MaxEnvelopeGap(Chan) on page 768</li> </ul>                                                                                                                                         |
| <ul style="list-style-type: none"> <li>Returns the mean value of the differences between a negative peak and its right and left adjacent positive peaks.<br/>GapMean(Chan) on page 767</li> </ul>                                                                                                                                                                                 |
| <ul style="list-style-type: none"> <li>Returns the maximum value of the total of the differences between a negative peak and its right and left adjacent positive peaks.<br/>MaxRippleValue(Chan) on page 774</li> </ul>                                                                                                                                                          |
| <ul style="list-style-type: none"> <li>Returns the maximum value of the total of the differences between a negative peak and its right and left adjacent positive peaks and the stimulus value (<i>Stim</i>) of the valley of the ripple.<br/>MaxRipplePoint(Chan,Stim) on page 773</li> </ul>                                                                                    |
| <ul style="list-style-type: none"> <li>Returns the values (<i>LeftValue</i> and <i>RightValue</i>) and the stimulus values (<i>LeftStimulus</i> and <i>RightStimulus</i>) of the right and left negative peaks detected first below the specified value (<i>D</i>) relative to the maximum value.<br/>Pole(Chan,D,LeftStim,LeftValue,RightStim,RightValue) on page 775</li> </ul> |
| <ul style="list-style-type: none"> <li>Returns the difference between the positive peak detected first when searched from the left edge toward the right edge and its right adjacent negative peak.<br/>FirstRightGap(Chan) on page 765</li> </ul>                                                                                                                                |

| List of ripple analysis library                                                                                                                                                                                                                                             |
|-----------------------------------------------------------------------------------------------------------------------------------------------------------------------------------------------------------------------------------------------------------------------------|
| <ul style="list-style-type: none"><li>Returns the difference between the positive peak detected first when searched from the right edge toward the left edge and its left adjacent negative peak.<br/>FirstLeftGap(Chan) on page 763</li></ul>                              |
| <ul style="list-style-type: none"><li>Returns the difference of the stimulus value between the positive peak detected first when searched from the left edge toward the right edge and its right adjacent negative peak.<br/>FirstRightInterval(Chan) on page 766</li></ul> |
| <ul style="list-style-type: none"><li>Returns the difference of the stimulus value between the positive peak detected first when searched from the left edge toward the right edge and its left adjacent negative peak.<br/>FirstLeftInterval(Chan) on page 764</li></ul>   |

## Simple Use Example

Here is a simple sample program using the ripple analysis procedures.

```
Sub Sample()

Dim Val As Double (1)

SCPI.CALCulate(1).SElected.FUNction.PEXCursion = 1.5 (2)
SCPI.CALCulate(1).SElected.FUNction.PPOLarity = "BOTH" (2)
SCPI.CALCulate(1).SElected.FUNction.DOMain.START = 935E6 (3)
SCPI.CALCulate(1).SElected.FUNction.DOMain.STOP = 960E6 (3)
SCPI.CALCulate(1).SElected.FUNction.DOMain.STATE = True (3)
.
.
Val = MaxPeakToPeak(1) (4)

End Sub
```

Let us break down the code into a number of blocks and see what they do.

1. Defines a variable Val as Double.
2. Sets the lower limit of the peak excursion value and polarity for the peak search to 1.5 and both of positive peak and negative peak, respectively.
3. Sets the analysis range for channel 1 to 935 MHz to 960 MHz.
4. For channel 1, substitutes the return value from the MaxPeakToPeak function (procedure) in the ripple analysis library to the Val variable.

## Procedure Reference

This section describes the procedures in the ripple analysis library provided by the E5070B/E5071B in alphabetical order.

### FirstLeftGap(*Chan*)

**Syntax**

*Value* = FirstLeftGap(*Chan*)

**Description**

Returns the response difference between the positive peak detected first when searched from the right edge toward the left edge within the analysis range and its left adjacent negative peak.

**Figure 8-1**

**FirstLeftGap**

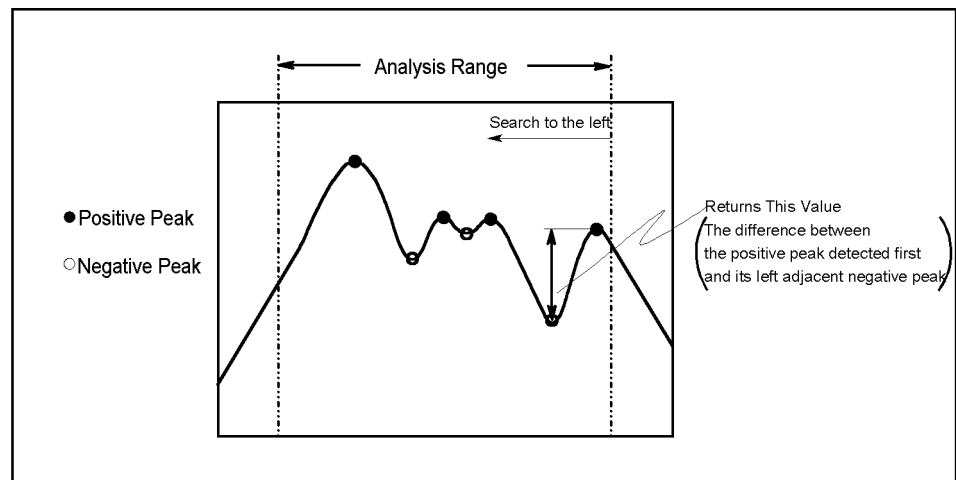

e5070ave031

**Variable**

|             |                                                                                               |
|-------------|-----------------------------------------------------------------------------------------------|
|             | <i>Chan</i>                                                                                   |
| Description | Specifies the channel number.                                                                 |
| Data type   | Integer type (Integer)                                                                        |
| Range       | 1 to 9                                                                                        |
| Note        | If the specified variable is out of the allowable setup range, an error occurs when executed. |

**Return value**

|             |                                                                                                                                                                                                |
|-------------|------------------------------------------------------------------------------------------------------------------------------------------------------------------------------------------------|
|             | <i>Value</i>                                                                                                                                                                                   |
| Description | Returns the response difference between the positive peak detected first when searched from the right edge toward the left edge within the analysis range and its left adjacent negative peak. |
| Data type   | Double precision floating point type (Double)                                                                                                                                                  |
| Note        | If no applicable point is detected, 0 is returned.                                                                                                                                             |

**Example of use**

```
Dim Value As Double

Value = FirstLeftGap(1)
MsgBox "First Left Gap =" & Value
```

### FirstLeftInterval(*Chan*)

**Syntax** *Value* = FirstLeftInterval(*Chan*)

**Description** Returns the stimulus difference between the positive peak detected first when searched from the right edge toward the left edge within the analysis range and its left adjacent negative peak.

Figure 8-2

#### FirstLeftInterval

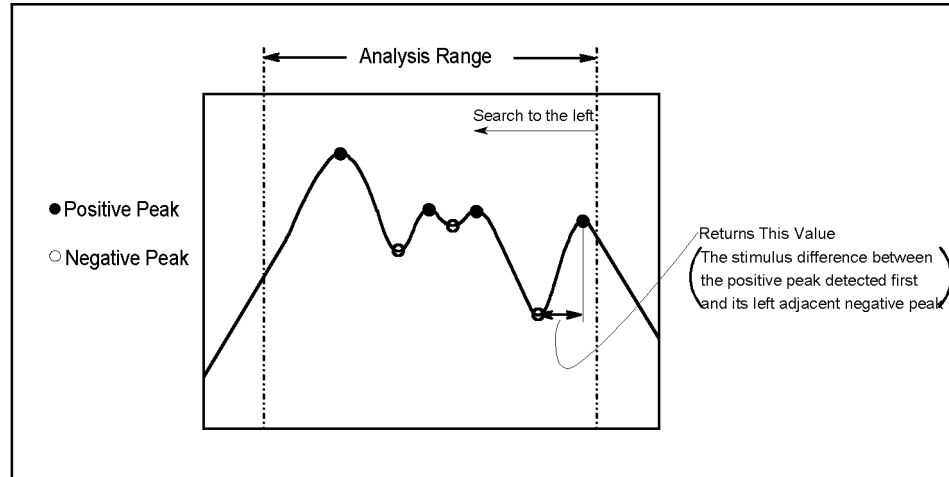

#### Variable

|             | <i>Chan</i>                                                                                   |
|-------------|-----------------------------------------------------------------------------------------------|
| Description | Specifies the channel number.                                                                 |
| Data type   | Integer type (Integer)                                                                        |
| Range       | 1 to 9                                                                                        |
| Note        | If the specified variable is out of the allowable setup range, an error occurs when executed. |

#### Return value

|             | <i>Value</i>                                                                                                                                                                                   |
|-------------|------------------------------------------------------------------------------------------------------------------------------------------------------------------------------------------------|
| Description | Returns the stimulus difference between the positive peak detected first when searched from the right edge toward the left edge within the analysis range and its left adjacent negative peak. |
| Data type   | Double precision floating point type (Double)                                                                                                                                                  |
| Note        | If no applicable point is detected, 0 is returned.                                                                                                                                             |

#### Example of use

```
Dim Value As Double
Value = FirstLeftInterval(1)
MsgBox "First Left Interval =" & Value
```



### FirstRightGap(*Chan*)

**Syntax** *Value* = FirstRightGap(*Chan*)

**Description** Returns the response difference between the positive peak detected first when searched from the left edge toward the right edge within the analysis range and its right adjacent negative peak.

**Figure 8-3** FirstRightGap

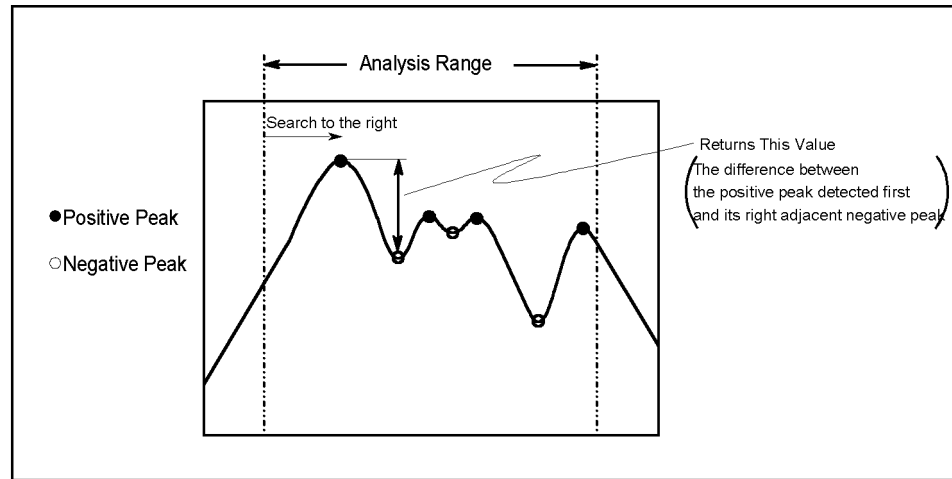

**Variable**

|             | <i>Chan</i>                                                                                   |
|-------------|-----------------------------------------------------------------------------------------------|
| Description | Specifies the channel number.                                                                 |
| Data type   | Integer type (Integer)                                                                        |
| Range       | 1 to 9                                                                                        |
| Note        | If the specified variable is out of the allowable setup range, an error occurs when executed. |

**Return value**

|             | <i>Value</i>                                                                                                                                                                                    |
|-------------|-------------------------------------------------------------------------------------------------------------------------------------------------------------------------------------------------|
| Description | Returns the response difference between the positive peak detected first when searched from the left edge toward the right edge within the analysis range and its right adjacent negative peak. |
| Data type   | Double precision floating point type (Double)                                                                                                                                                   |
| Note        | If no applicable point is detected, 0 is returned.                                                                                                                                              |

**Example of use**

```
Dim Value As Double
Value = FirstRightGap(1)
MsgBox "First Right Gap =" & Value
```

**FirstRightInterval(*Chan*)**

**Syntax**

*Value* = FirstRightInterval(*Chan*)

**Description**

Returns the stimulus difference between the positive peak detected first when searched from the left edge toward the right edge within the analysis range and its right adjacent negative peak.

**Figure 8-4**

**FirstRightInterval**

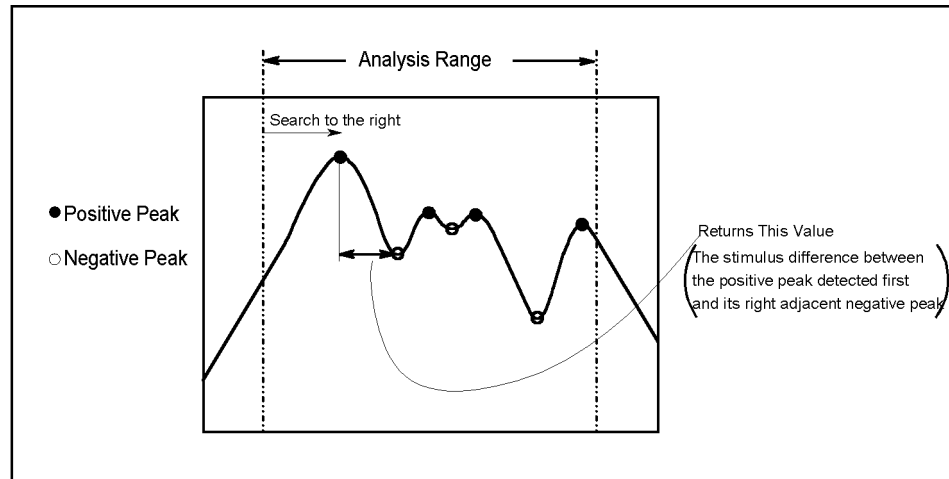

**Variable**

|             |                                                                                               |
|-------------|-----------------------------------------------------------------------------------------------|
|             | <i>Chan</i>                                                                                   |
| Description | Specifies the channel number.                                                                 |
| Data type   | Integer type (Integer)                                                                        |
| Range       | 1 to 9                                                                                        |
| Note        | If the specified variable is out of the allowable setup range, an error occurs when executed. |

**Return value**

|             |                                                                                                                                                                                                 |
|-------------|-------------------------------------------------------------------------------------------------------------------------------------------------------------------------------------------------|
|             | <i>Value</i>                                                                                                                                                                                    |
| Description | Returns the stimulus difference between the positive peak detected first when searched from the left edge toward the right edge within the analysis range and its right adjacent negative peak. |
| Data type   | Double precision floating point type (Double)                                                                                                                                                   |
| Note        | If no applicable point is detected, 0 is returned.                                                                                                                                              |

**Example of use**

```
Dim Value As Double
Value = FirstRightInterval(1)
MsgBox "First Right Interval =" & Value
```

## GapMean(*Chan*)

**Syntax** *Value* = GapMean(*Chan*)

**Description** Returns the mean value of the response differences between the negative peaks and its adjacent positive peaks within the analysis range.

**Figure 8-5**

**GapMean**

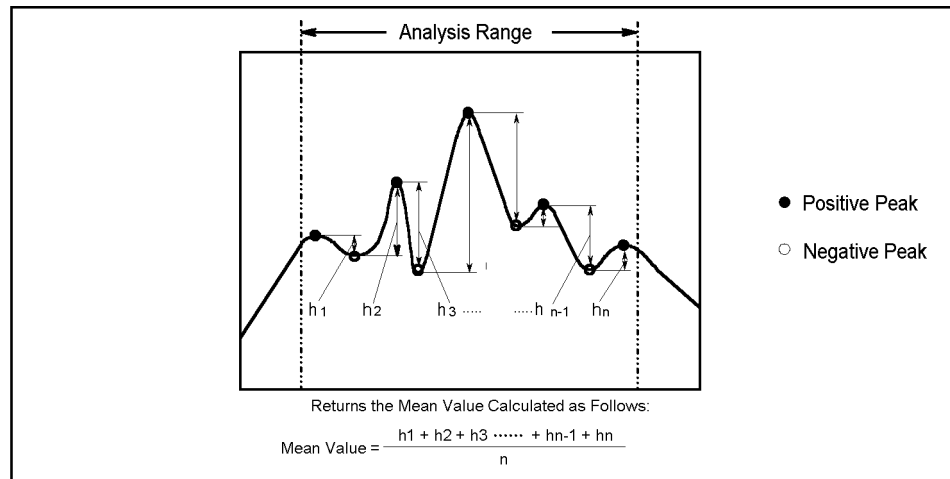

e5070ave027

### Variable

|             | <i>Chan</i>                                                                                   |
|-------------|-----------------------------------------------------------------------------------------------|
| Description | Specifies the channel number.                                                                 |
| Data type   | Integer type (Integer)                                                                        |
| Range       | 1 to 9                                                                                        |
| Note        | If the specified variable is out of the allowable setup range, an error occurs when executed. |

### Return value

|             | <i>Value</i>                                                                                                                  |
|-------------|-------------------------------------------------------------------------------------------------------------------------------|
| Description | Returns the mean value of the response differences between the negative peaks and its right and left adjacent positive peaks. |
| Data type   | Double precision floating point type (Double)                                                                                 |
| Note        | If no applicable point is detected, 0 is returned.                                                                            |

### Example of use

```
Dim Value As Double
Value = GapMean(1)
MsgBox "Gap Mean =" & Value
```

## MaxEnvelopeGap(*Chan*)

**Syntax** *Value* = MaxEnvelopeGap(*Chan*)

**Description** Returns the maximum value of the vertical distance between the line segments connecting 2 adjacent positive peaks and the negative peaks between them within the analysis range.

Figure 8-6

MaxEnvelopeGap

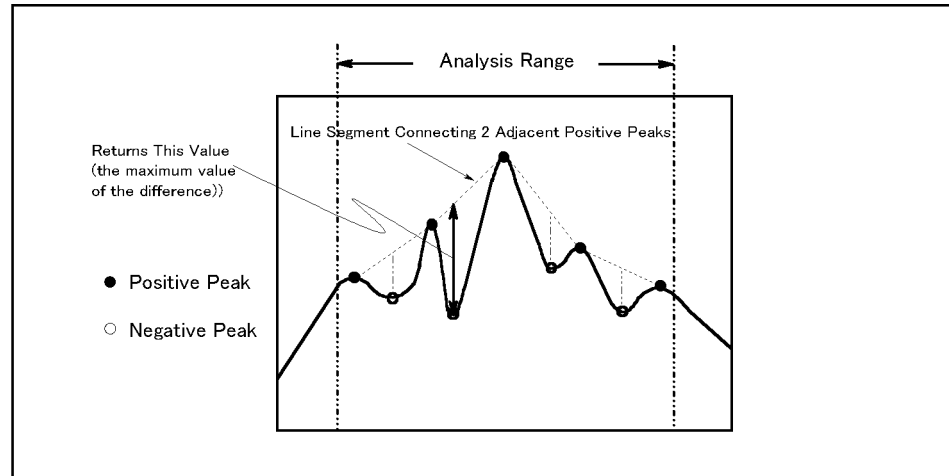

e5070ave026

### Variable

|             | <i>Chan</i>                                                                                   |
|-------------|-----------------------------------------------------------------------------------------------|
| Description | Specifies the channel number.                                                                 |
| Data type   | Integer type (Integer)                                                                        |
| Range       | 1 to 9                                                                                        |
| Note        | If the specified variable is out of the allowable setup range, an error occurs when executed. |

### Return value

|             | <i>Value</i>                                                                                                                                           |
|-------------|--------------------------------------------------------------------------------------------------------------------------------------------------------|
| Description | Returns the maximum value of the vertical distance between the line segments connecting 2 adjacent positive peaks and the negative peaks between them. |
| Data type   | Double precision floating point type (Double)                                                                                                          |
| Note        | If no applicable point is detected, 0 is returned.                                                                                                     |

### Example of use

```
Dim Value As Double
Value = MaxEnvelopeGap(1)
MsgBox "Max Envelope Gap =" & Value
```

## MaxGap(*Chan*)

**Syntax** *Value* = MaxGap(*Chan*)

**Description** Returns the maximum value of the response differences between the positive peaks and its adjacent negative peaks within the analysis range.

**Figure 8-7**

**MaxGap**

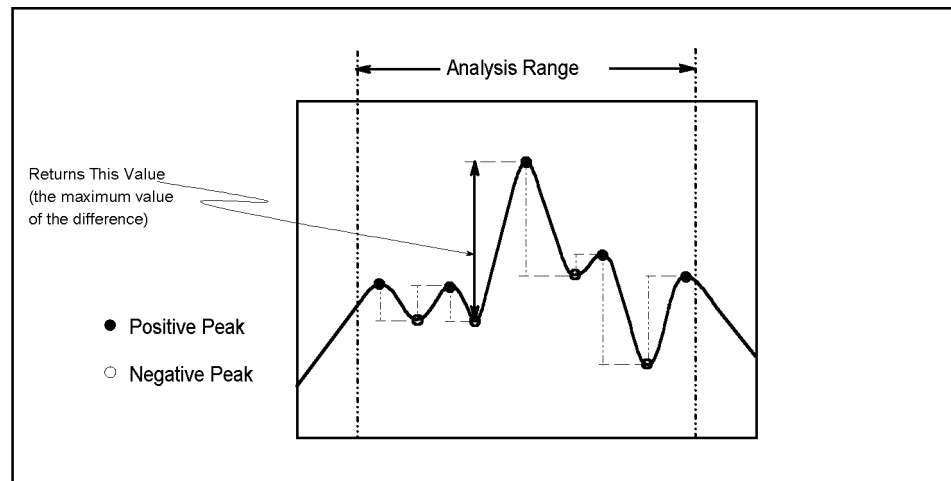

**Variable**

|             | <i>Chan</i>                                                                                   |
|-------------|-----------------------------------------------------------------------------------------------|
| Description | Specifies the channel number.                                                                 |
| Data type   | Integer type (Integer)                                                                        |
| Range       | 1 to 9                                                                                        |
| Note        | If the specified variable is out of the allowable setup range, an error occurs when executed. |

**Return value**

|             | <i>Value</i>                                                                                                      |
|-------------|-------------------------------------------------------------------------------------------------------------------|
| Description | Returns the maximum value of the response differences between the positive peaks and its adjacent negative peaks. |
| Data type   | Double precision floating point type (Double)                                                                     |
| Note        | If no applicable point is detected, 0 is returned.                                                                |

**Example of use**

```
Dim Value As Double
Value = MaxGap(1)
MsgBox "Max Gap =" & Value
```

**MaxLeftGap(*Chan*)**

**Syntax** *Value* = MaxLeftGap(*Chan*)

**Description** Returns the maximum value of the response differences between the positive peaks and its left adjacent negative peaks within the analysis range.

**Figure 8-8**

**MaxLeftGap**

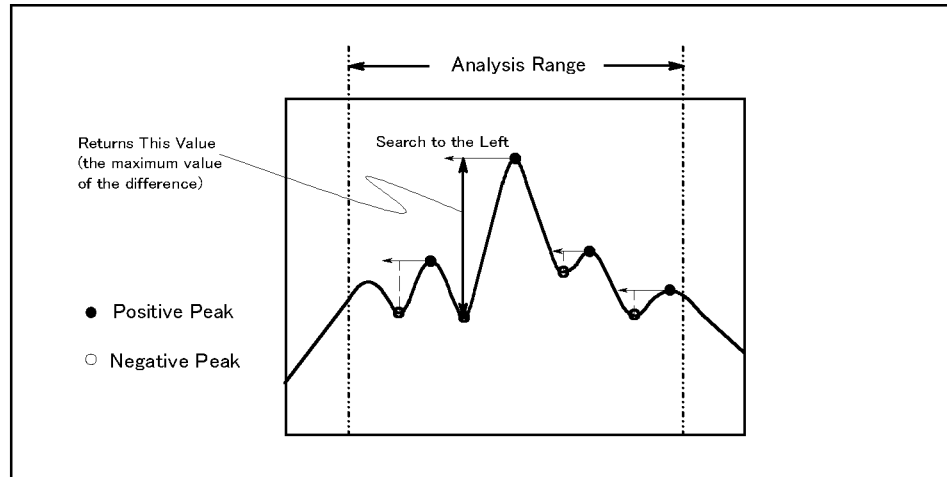

**Variable**

|             | <i>Chan</i>                                                                                   |
|-------------|-----------------------------------------------------------------------------------------------|
| Description | Specifies the channel number.                                                                 |
| Data type   | Integer type (Integer)                                                                        |
| Range       | 1 to 9                                                                                        |
| Note        | If the specified variable is out of the allowable setup range, an error occurs when executed. |

**Return value**

|             | <i>Value</i>                                                                                                           |
|-------------|------------------------------------------------------------------------------------------------------------------------|
| Description | Returns the maximum value of the response differences between the positive peaks and its left adjacent negative peaks. |
| Data type   | Double precision floating point type (Double)                                                                          |
| Note        | If no applicable point is detected, 0 is returned.                                                                     |

**Example of use**

```
Dim Value As Double
Value = MaxLeftGap(1)
MsgBox "Max Left Gap =" & Value
```

### MaxPeakToPeak(*Chan*)

**Syntax** *Value* = MaxPeakToPeak(*Chan*)

**Description** Returns the maximum value of the response differences between the positive peaks and the negative peaks within the analysis range.

**Figure 8-9**

#### MaxPeakToPeak

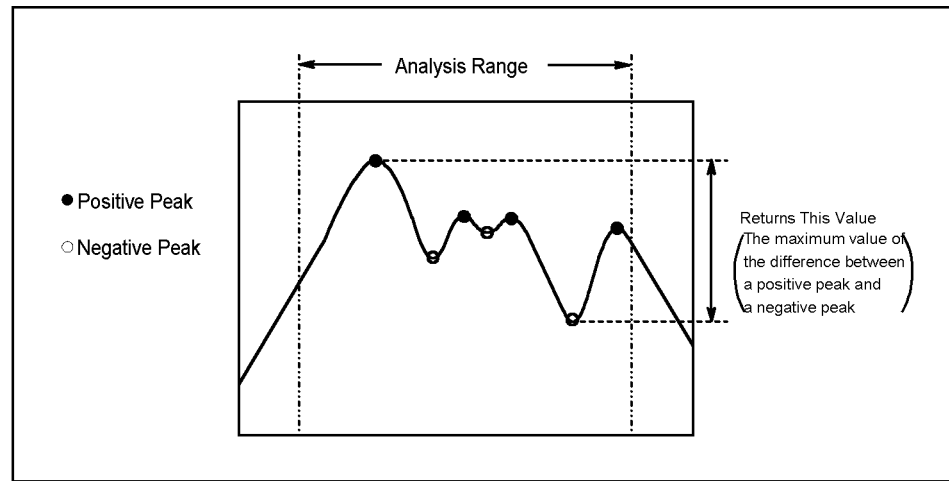

**Variable**

|             | <i>Chan</i>                                                                                   |
|-------------|-----------------------------------------------------------------------------------------------|
| Description | Specifies the channel number.                                                                 |
| Data type   | Integer type (Integer)                                                                        |
| Range       | 1 to 9                                                                                        |
| Note        | If the specified variable is out of the allowable setup range, an error occurs when executed. |

**Return value**

|             | <i>Value</i>                                                                                             |
|-------------|----------------------------------------------------------------------------------------------------------|
| Description | Returns the maximum value of the response differences between the positive peaks and the negative peaks. |
| Data type   | Double precision floating point type (Double)                                                            |
| Note        | If no applicable point is detected, 0 is returned.                                                       |

**Example of use**

```
Dim Value As Double

Value = MaxPeakToPeak(1)
MsgBox "Max Peak To Peak =" & Value
```

### MaxRightGap(*Chan*)

**Syntax** *Value* = MaxRightGap(*chan*)

**Description** Returns the maximum value of the response differences between the positive peaks and its right adjacent negative peaks within the analysis range.

Figure 8-10

MaxRightGap

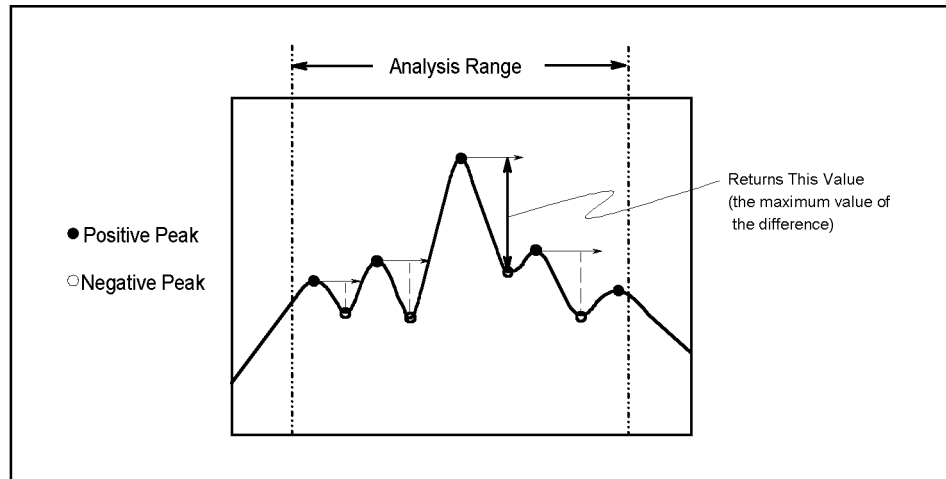

e5070ave023

**Variable**

|             |                                                                                               |
|-------------|-----------------------------------------------------------------------------------------------|
|             | <i>Chan</i>                                                                                   |
| Description | Specifies the channel number.                                                                 |
| Data type   | Integer type (Integer)                                                                        |
| Range       | 1 to 9                                                                                        |
| Note        | If the specified variable is out of the allowable setup range, an error occurs when executed. |

**Return value**

|             |                                                                                                                         |
|-------------|-------------------------------------------------------------------------------------------------------------------------|
|             | <i>Value</i>                                                                                                            |
| Description | Returns the maximum value of the response differences between the positive peaks and its right adjacent negative peaks. |
| Data type   | Double precision floating point type (Double)                                                                           |
| Note        | If no applicable point is detected, 0 is returned.                                                                      |

**Example of use**

```
Dim Value As Double
Value = MaxRightGap(1)
MsgBox "Max Right Gap =" & Value
```



### MaxRipplePoint(*Chan,Stim*)

**Syntax** *Value* = MaxRipplePoint(*Chan,Stim*)

**Description** Returns the maximum value of the sum of the response differences between the negative peaks and its adjacent positive peaks and the stimulus value of the applicable negative peaks within the analysis range.

**Figure 8-11** MaxRipplePoint

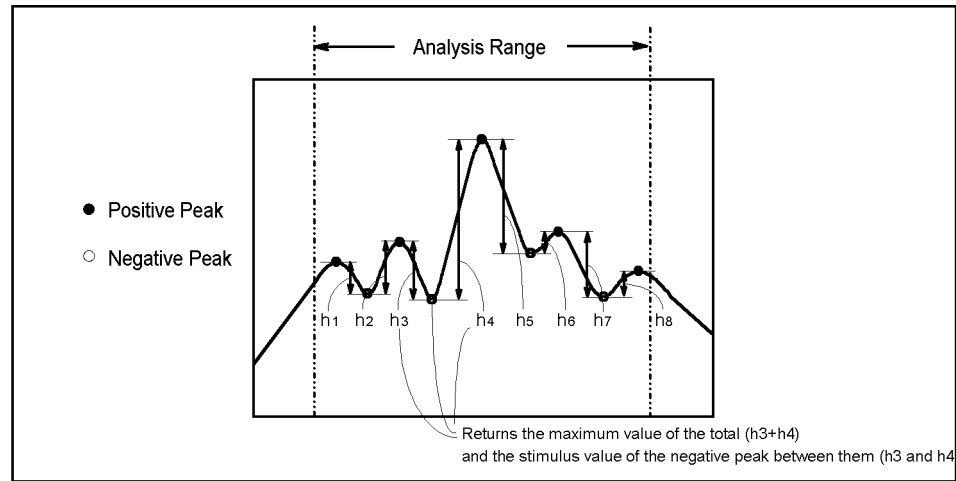

**Variable**

|             | <i>Chan</i>                                                                                   |
|-------------|-----------------------------------------------------------------------------------------------|
| Description | Specifies the channel number.                                                                 |
| Data type   | Integer type (Integer)                                                                        |
| Range       | 1 to 9                                                                                        |
| Note        | If the specified variable is out of the allowable setup range, an error occurs when executed. |

**Return value**

|             | <i>Value</i>                                                                                                                 |
|-------------|------------------------------------------------------------------------------------------------------------------------------|
| Description | Returns the maximum value of the sum of the response differences between the negative peaks and its adjacent positive peaks. |
| Data type   | Double precision floating point type (Double)                                                                                |
| Note        | If no applicable point is detected, 0 is returned.                                                                           |

|             | <i>Stim</i>                                                                                                                                                        |
|-------------|--------------------------------------------------------------------------------------------------------------------------------------------------------------------|
| Description | Returns the stimulus value of the negative peak at which the sum of the response differences between the negative peak and its adjacent positive peaks is maximum. |
| Data type   | Double precision floating point type (Double)                                                                                                                      |
| Note        | If no applicable point is detected, 0 is returned.                                                                                                                 |

**Example of use**

```
Dim Value As Double
Dim Stim As Double

Value = MaxRipplePoint(1, Stim)
MsgBox "Max Ripple Value =" & Value & " , Stimulus =" & Stim
```

### MaxRippleValue(*Chan*)

**Syntax** `Value = MaxRippleValue(Chan)`

**Description** Returns the maximum value of the sum of the response differences between the negative peaks and its adjacent positive peaks within the analysis range.

Figure 8-12 MaxRippleValue

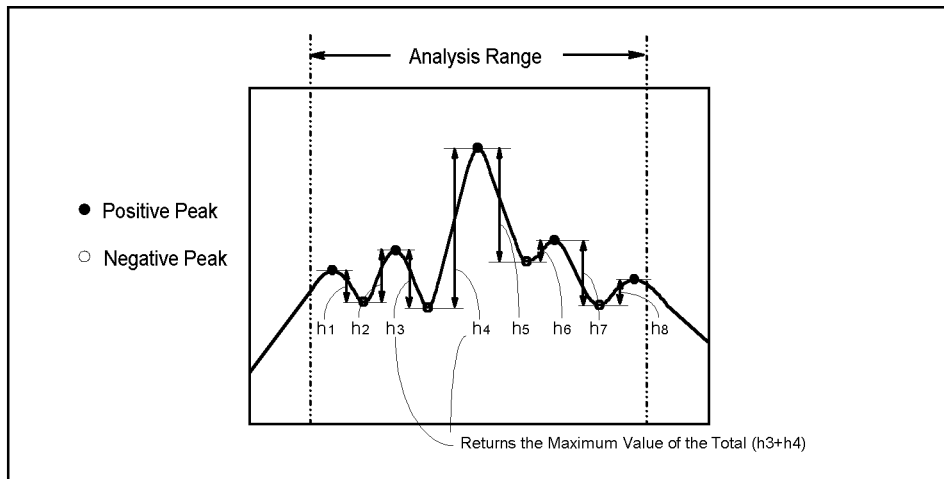

e5070ave029

**Variable**

|             |                                                                                               |
|-------------|-----------------------------------------------------------------------------------------------|
|             | <i>Chan</i>                                                                                   |
| Description | Specifies the channel number.                                                                 |
| Data type   | Integer type (Integer)                                                                        |
| Range       | 1 to 9                                                                                        |
| Note        | If the specified variable is out of the allowable setup range, an error occurs when executed. |

**Return value**

|             |                                                                                                                              |
|-------------|------------------------------------------------------------------------------------------------------------------------------|
|             | <i>Value</i>                                                                                                                 |
| Description | Returns the maximum value of the sum of the response differences between the negative peaks and its adjacent positive peaks. |
| Data type   | Double precision floating point type (Double)                                                                                |
| Note        | If no applicable point is detected, 0 is returned.                                                                           |

**Example of use**

```
Dim Value As Double
Value = MaxRippleValue(1)
MsgBox "Max Ripple Value =" & Value
```

**Pole(*Chan,D,LeftStim,LeftValue,RightStim,RightValue*)**

**Syntax**

Call Pole(*Chan,D,LeftStim,LeftValue,RightStim,RightValue*)

**Description**

For the negative peaks below the specified value (*D*) relative to the maximum value of the positive peaks within the analysis range, returns the response value (*LeftValue*) and stimulus value (*LeftStimulus*) of the negative peak first detected when searched to the left from the maximum value of the positive peaks, and the response value (*RightValue*) and stimulus value (*RightStimulus*) of the negative peak first detected when searched to the right from the maximum value of the positive peaks.

**Figure 8-13**

**Pole**

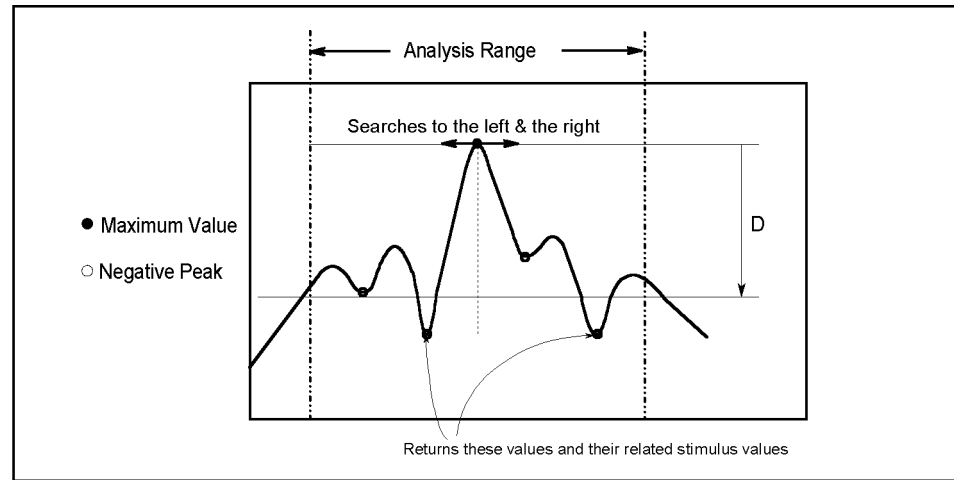

e5070ave030

**Variable**

|             |                                                                                               |
|-------------|-----------------------------------------------------------------------------------------------|
|             | <i>Chan</i>                                                                                   |
| Description | Specifies the channel number.                                                                 |
| Data type   | Integer type (Integer)                                                                        |
| Range       | 1 to 9                                                                                        |
| Note        | If the specified variable is out of the allowable setup range, an error occurs when executed. |

|             |                                                  |
|-------------|--------------------------------------------------|
|             | <i>D</i>                                         |
| Description | Specifies the difference from the maximum value. |
| Data type   | Double precision floating point type (Double)    |

**Return value  
 (arguments)**

|             | <i>LeftStim</i>                                                                                                          |
|-------------|--------------------------------------------------------------------------------------------------------------------------|
| Description | Returns the stimulus value of the negative peak first detected to the left from the maximum value of the positive peaks. |
| Data type   | Double precision floating point type (Double)                                                                            |
| Note        | If no applicable point is detected, 0 is returned.                                                                       |

|             | <i>LeftValue</i>                                                                                                         |
|-------------|--------------------------------------------------------------------------------------------------------------------------|
| Description | Returns the response value of the negative peak first detected to the left from the maximum value of the positive peaks. |
| Data type   | Double precision floating point type (Double)                                                                            |
| Note        | If no applicable point is detected, 0 is returned.                                                                       |

|             | <i>RightStim</i>                                                                                                          |
|-------------|---------------------------------------------------------------------------------------------------------------------------|
| Description | Returns the stimulus value of the negative peak first detected to the right from the maximum value of the positive peaks. |
| Data type   | Double precision floating point type (Double)                                                                             |
| Note        | If no applicable point is detected, 0 is returned.                                                                        |

|             | <i>RightValue</i>                                                                                                         |
|-------------|---------------------------------------------------------------------------------------------------------------------------|
| Description | Returns the response value of the negative peak first detected to the right from the maximum value of the positive peaks. |
| Data type   | Double precision floating point type (Double)                                                                             |
| Note        | If no applicable point is detected, 0 is returned.                                                                        |

**Example of use**

```
Dim LeftStim As Double
Dim LeftValue As Double
Dim RightStim As Double
Dim RightValue As Double

Call Pole(1, 1, LeftStim, LeftValue, RightStim, RightValue)

MsgBox "Left Pole =" & LeftStim & ":" & LeftValue
MsgBox "Right Pole =" & RightStim & ":" & RightValue
```

---

---

# 9

## Complex Operation Library

This chapter describes the complex operation library.

## Complex operation library

By using the complex operation library, you can perform operations of complex numbers.

### Data of the complex type

In the complex operation library, you can use the complex type (Complex) as a data type. Data of the complex type consists of a real part (.real) and an imaginary part (.imag) as shown in the following example.

```
Dim Num as Complex
Num.real=1.0
Num.imag=2.0
```

### List of procedures

The following table lists the procedures included in the complex operation library.

| Procedure name                 | Function                                                                             |
|--------------------------------|--------------------------------------------------------------------------------------|
| ComplexSet(x,y) on page 782    | Sets a complex number.<br>(Specify a real part and an imaginary part.)               |
| ComplexPolar(x,y) on page 782  | Sets a complex number.<br>(Specify an absolute value and a phase angle.)             |
| ComplexSetArray(x) on page 783 | Converts a variant type or double floating point type array to a complex type array. |
| ComplexAdd(x,y) on page 779    | Returns the result of the addition.                                                  |
| ComplexSub(x,y) on page 784    | Returns the result of the subtraction.                                               |
| ComplexMul(x,y) on page 781    | Returns the result of the multiplication.                                            |
| ComplexDiv(x,y) on page 780    | Returns the result of the division.                                                  |
| ComplexAbs(x) on page 779      | Returns the absolute value.                                                          |
| ComplexArg(x) on page 779      | Returns the phase angle.                                                             |
| ComplexNorm(x) on page 782     | Returns the square of the absolute value.                                            |
| ComplexConj(x) on page 780     | Returns the conjugate complex number.                                                |
| ComplexCos(x) on page 780      | Returns the cosine.                                                                  |
| ComplexCosh(x) on page 780     | Returns the hyperbolic cosine.                                                       |
| ComplexSin(x) on page 783      | Returns the sine.                                                                    |
| ComplexSinh(x) on page 783     | Returns the hyperbolic sine.                                                         |
| ComplexExp(x) on page 781      | Returns $e^x$ .                                                                      |
| ComplexLog(x) on page 781      | Returns the natural logarithm.                                                       |
| ComplexLog10(x) on page 781    | Returns the common logarithm.                                                        |
| ComplexSqrt(x) on page 784     | Returns the square root.                                                             |

## Procedure Reference

This section describes the procedures in the complex operation library in alphabetical order.

### ComplexAbs(x)

|                       |                                                                                                |
|-----------------------|------------------------------------------------------------------------------------------------|
| <b>Syntax</b>         | <i>Result</i> = ComplexAbs(x)                                                                  |
| <b>Description</b>    | Returns the absolute value of a complex number <i>x</i> .                                      |
| <b>Data type</b>      | <i>x</i> Complex type (Complex)<br><i>Result</i> Double precision floating point type (Double) |
| <b>Example of use</b> | Dim a As Complex, b As Double<br>a = ComplexSet(1.5, 2.0)<br>b = ComplexAbs(a)                 |

### ComplexAdd(x,y)

|                       |                                                                                                                              |
|-----------------------|------------------------------------------------------------------------------------------------------------------------------|
| <b>Syntax</b>         | <i>Result</i> = ComplexAdd(x,y)                                                                                              |
| <b>Description</b>    | Returns the result (x+y) of the addition of a complex number <i>x</i> and another <i>y</i> .                                 |
| <b>Data type</b>      | <i>x</i> Complex type (Complex)<br><i>y</i> Complex type (Complex)<br><i>Result</i> Complex type (Complex)                   |
| <b>Example of use</b> | Dim a As Complex, b As Complex, c As Complex<br>a = ComplexSet(1.5, 2.0)<br>b = ComplexSet(0.5, 3.5)<br>c = ComplexAdd(a, b) |

### ComplexArg(x)

|                       |                                                                                                                                                                           |
|-----------------------|---------------------------------------------------------------------------------------------------------------------------------------------------------------------------|
| <b>Syntax</b>         | <i>Result</i> = ComplexArg(x)                                                                                                                                             |
| <b>Description</b>    | Returns the phase angle (radian) of a complex number <i>x</i> .                                                                                                           |
| <b>Data type</b>      | <i>x</i> Complex type (Complex)<br><i>Result</i> Double precision floating point type (Double)                                                                            |
| <b>Example of use</b> | Dim a As Complex, b As Double, c As Double, pi As Double<br>a = ComplexSet(1.5, 2.0)<br>b = ComplexArg(a)<br>pi = 3.14159265<br>c = b * 180 / pi       ` radian -> degree |

## ComplexConj(x)

|                       |                                                                                       |                        |
|-----------------------|---------------------------------------------------------------------------------------|------------------------|
| <b>Syntax</b>         | <i>Result</i> = ComplexConj( <i>x</i> )                                               |                        |
| <b>Description</b>    | Returns the conjugate complex number of a complex number <i>x</i> .                   |                        |
| <b>Data type</b>      | <i>x</i>                                                                              | Complex type (Complex) |
|                       | <i>Result</i>                                                                         | Complex type (Complex) |
| <b>Example of use</b> | <pre>Dim a As Complex, b As Complex a = ComplexSet(1.5, 2.0) b = ComplexConj(a)</pre> |                        |

## ComplexCos(x)

|                       |                                                                                      |                        |
|-----------------------|--------------------------------------------------------------------------------------|------------------------|
| <b>Syntax</b>         | <i>Result</i> = ComplexCos( <i>x</i> )                                               |                        |
| <b>Description</b>    | Returns the cosine (cos( <i>x</i> )) of a complex number <i>x</i> .                  |                        |
| <b>Data type</b>      | <i>x</i>                                                                             | Complex type (Complex) |
|                       | <i>Result</i>                                                                        | Complex type (Complex) |
| <b>Example of use</b> | <pre>Dim a As Complex, b As Complex a = ComplexSet(1.5, 2.0) b = ComplexCos(a)</pre> |                        |

## ComplexCosh(x)

|                       |                                                                                       |                        |
|-----------------------|---------------------------------------------------------------------------------------|------------------------|
| <b>Syntax</b>         | <i>Result</i> = ComplexCosh( <i>x</i> )                                               |                        |
| <b>Description</b>    | Returns the hyperbolic cosine (cosh( <i>x</i> )) of a complex number <i>x</i> .       |                        |
| <b>Data type</b>      | <i>x</i>                                                                              | Complex type (Complex) |
|                       | <i>Result</i>                                                                         | Complex type (Complex) |
| <b>Example of use</b> | <pre>Dim a As Complex, b As Complex a = ComplexSet(1.5, 2.0) b = ComplexCosh(a)</pre> |                        |

## ComplexDiv(x,y)

|                       |                                                                                                                                |                        |
|-----------------------|--------------------------------------------------------------------------------------------------------------------------------|------------------------|
| <b>Syntax</b>         | <i>Result</i> = ComplexDiv( <i>x</i> , <i>y</i> )                                                                              |                        |
| <b>Description</b>    | Returns the result ( <i>x</i> / <i>y</i> ) of the division of a complex number <i>x</i> and another <i>y</i> .                 |                        |
| <b>Data type</b>      | <i>x</i>                                                                                                                       | Complex type (Complex) |
|                       | <i>y</i>                                                                                                                       | Complex type (Complex) |
|                       | <i>Result</i>                                                                                                                  | Complex type (Complex) |
| <b>Example of use</b> | <pre>Dim a As Complex, b As Complex, c As Complex a = ComplexSet(1.5, 2.0) b = ComplexSet(0.5, 3.5) c = ComplexDiv(a, b)</pre> |                        |



## ComplexExp(x)

|                       |                                                                                      |                        |
|-----------------------|--------------------------------------------------------------------------------------|------------------------|
| <b>Syntax</b>         | <i>Result</i> = ComplexExp(x)                                                        |                        |
| <b>Description</b>    | Returns $e^x$ .                                                                      |                        |
| <b>Data type</b>      | <i>x</i>                                                                             | Complex type (Complex) |
|                       | <i>Result</i>                                                                        | Complex type (Complex) |
| <b>Example of use</b> | <pre>Dim a As Complex, b As Complex a = ComplexSet(1.5, 2.0) b = ComplexExp(a)</pre> |                        |

## ComplexLog(x)

|                       |                                                                                      |                        |
|-----------------------|--------------------------------------------------------------------------------------|------------------------|
| <b>Syntax</b>         | <i>Result</i> = ComplexLog(x)                                                        |                        |
| <b>Description</b>    | Returns the natural logarithm ( $\log(x)$ ) of a complex number $x$ .                |                        |
| <b>Data type</b>      | <i>x</i>                                                                             | Complex type (Complex) |
|                       | <i>Result</i>                                                                        | Complex type (Complex) |
| <b>Example of use</b> | <pre>Dim a As Complex, b As Complex a = ComplexSet(1.5, 2.0) b = ComplexLog(a)</pre> |                        |

## ComplexLog10(x)

|                       |                                                                                        |                        |
|-----------------------|----------------------------------------------------------------------------------------|------------------------|
| <b>Syntax</b>         | <i>Result</i> = ComplexLog(x)                                                          |                        |
| <b>Description</b>    | Returns the common logarithm ( $\log_{10}(x)$ ) of a complex number $x$ .              |                        |
| <b>Data type</b>      | <i>x</i>                                                                               | Complex type (Complex) |
|                       | <i>Result</i>                                                                          | Complex type (Complex) |
| <b>Example of use</b> | <pre>Dim a As Complex, b As Complex a = ComplexSet(1.5, 2.0) b = ComplexLog10(a)</pre> |                        |

## ComplexMul(x,y)

|                       |                                                                                                                                |                        |
|-----------------------|--------------------------------------------------------------------------------------------------------------------------------|------------------------|
| <b>Syntax</b>         | <i>Result</i> = ComplexMul(x,y)                                                                                                |                        |
| <b>Description</b>    | Returns the result ( $x \times y$ ) of the multiplication of a complex number $x$ and another $y$ .                            |                        |
| <b>Data type</b>      | <i>x</i>                                                                                                                       | Complex type (Complex) |
|                       | <i>y</i>                                                                                                                       | Complex type (Complex) |
|                       | <i>Result</i>                                                                                                                  | Complex type (Complex) |
| <b>Example of use</b> | <pre>Dim a As Complex, b As Complex, c As Complex a = ComplexSet(1.5, 2.0) b = ComplexSet(0.5, 3.5) c = ComplexMul(a, b)</pre> |                        |

## ComplexNorm(x)

|                       |                                                                                      |                                               |
|-----------------------|--------------------------------------------------------------------------------------|-----------------------------------------------|
| <b>Syntax</b>         | $Result = \text{ComplexNorm}(x)$                                                     |                                               |
| <b>Description</b>    | Returns the square of the absolute value of a complex number $x$ .                   |                                               |
| <b>Data type</b>      | $x$                                                                                  | Complex type (Complex)                        |
|                       | <i>Result</i>                                                                        | Double precision floating point type (Double) |
| <b>Example of use</b> | <pre>Dim a As Complex, b As Double a = ComplexSet(1.5, 2.0) b = ComplexNorm(a)</pre> |                                               |

## ComplexPolar(x,y)

|                       |                                                                                                                                            |                                               |
|-----------------------|--------------------------------------------------------------------------------------------------------------------------------------------|-----------------------------------------------|
| <b>Syntax</b>         | $z = \text{ComplexPolar}(x,y)$                                                                                                             |                                               |
| <b>Description</b>    | Sets a complex number to a complex type variable $z$ . Specify a complex number with an absolute value $x$ and a phase angle $y$ (radian). |                                               |
| <b>Data type</b>      | $x$                                                                                                                                        | Double precision floating point type (Double) |
|                       | $y$                                                                                                                                        | Double precision floating point type (Double) |
|                       | $z$                                                                                                                                        | Complex type (Complex)                        |
| <b>Example of use</b> | <pre>Dim a As Complex, pi As Double pi = 3.14159265 a = ComplexPolar(2.5, 60 * pi / 180)</pre>                                             |                                               |

## ComplexSet(x,y)

|                       |                                                                                                                                                                                            |                                               |
|-----------------------|--------------------------------------------------------------------------------------------------------------------------------------------------------------------------------------------|-----------------------------------------------|
| <b>Syntax</b>         | $z = \text{ComplexSet}(x,y)$                                                                                                                                                               |                                               |
| <b>Description</b>    | Sets a complex number to a complex type variable $z$ . Specify a complex number with a real part $x$ and an imaginary part $y$ . (Sets $x$ and $y$ to $z.real$ and $z.imag$ respectively.) |                                               |
| <b>Data type</b>      | $x$                                                                                                                                                                                        | Double precision floating point type (Double) |
|                       | $y$                                                                                                                                                                                        | Double precision floating point type (Double) |
|                       | $z$                                                                                                                                                                                        | Complex type (Complex)                        |
| <b>Example of use</b> | <pre>Dim a as Complex a = ComplexSet(1.5, 2.0)</pre>                                                                                                                                       |                                               |

## ComplexSetArray(x)

|                       |                                                                                                                                                                                                                            |     |                                                                                     |     |                              |
|-----------------------|----------------------------------------------------------------------------------------------------------------------------------------------------------------------------------------------------------------------------|-----|-------------------------------------------------------------------------------------|-----|------------------------------|
| <b>Syntax</b>         | $y = \text{ComplexSetArray}(x)$                                                                                                                                                                                            |     |                                                                                     |     |                              |
| <b>Description</b>    | Converts a variant type or double floating point type array $x$ that contains complex numbers using 2 elements to store each complex number in the order of the real part and imaginary part to a complex type array $y$ . |     |                                                                                     |     |                              |
| <b>Data type</b>      | <table> <tr> <td><math>x</math></td> <td>Variant type (Variant) array or Double precision floating point type (Double) array</td> </tr> <tr> <td><math>y</math></td> <td>Complex type (Complex) array</td> </tr> </table>  | $x$ | Variant type (Variant) array or Double precision floating point type (Double) array | $y$ | Complex type (Complex) array |
| $x$                   | Variant type (Variant) array or Double precision floating point type (Double) array                                                                                                                                        |     |                                                                                     |     |                              |
| $y$                   | Complex type (Complex) array                                                                                                                                                                                               |     |                                                                                     |     |                              |
| <b>Example of use</b> | <pre>Dim a as Variant, b as Complex a = SCPI.CALCulate(1).SElected.DATA.SDATA b = ComplexSetArray(a)</pre>                                                                                                                 |     |                                                                                     |     |                              |

## ComplexSin(x)

|                       |                                                                                                                                                       |     |                        |               |                        |
|-----------------------|-------------------------------------------------------------------------------------------------------------------------------------------------------|-----|------------------------|---------------|------------------------|
| <b>Syntax</b>         | $Result = \text{ComplexSin}(x)$                                                                                                                       |     |                        |               |                        |
| <b>Description</b>    | Returns the sine ( $\sin(x)$ ) of a complex number $x$ .                                                                                              |     |                        |               |                        |
| <b>Data type</b>      | <table> <tr> <td><math>x</math></td> <td>Complex type (Complex)</td> </tr> <tr> <td><i>Result</i></td> <td>Complex type (Complex)</td> </tr> </table> | $x$ | Complex type (Complex) | <i>Result</i> | Complex type (Complex) |
| $x$                   | Complex type (Complex)                                                                                                                                |     |                        |               |                        |
| <i>Result</i>         | Complex type (Complex)                                                                                                                                |     |                        |               |                        |
| <b>Example of use</b> | <pre>Dim a As Complex, b As Complex a = ComplexSet(1.5, 2.0) b = ComplexSin(a)</pre>                                                                  |     |                        |               |                        |

## ComplexSinh(x)

|                       |                                                                                                                                                       |     |                        |               |                        |
|-----------------------|-------------------------------------------------------------------------------------------------------------------------------------------------------|-----|------------------------|---------------|------------------------|
| <b>Syntax</b>         | $Result = \text{ComplexSinh}(x)$                                                                                                                      |     |                        |               |                        |
| <b>Description</b>    | Returns the hyperbolic sine ( $\sinh(x)$ ) of a complex number $x$ .                                                                                  |     |                        |               |                        |
| <b>Data type</b>      | <table> <tr> <td><math>x</math></td> <td>Complex type (Complex)</td> </tr> <tr> <td><i>Result</i></td> <td>Complex type (Complex)</td> </tr> </table> | $x$ | Complex type (Complex) | <i>Result</i> | Complex type (Complex) |
| $x$                   | Complex type (Complex)                                                                                                                                |     |                        |               |                        |
| <i>Result</i>         | Complex type (Complex)                                                                                                                                |     |                        |               |                        |
| <b>Example of use</b> | <pre>Dim a As Complex, b As Complex a = ComplexSet(1.5, 2.0) b = ComplexSinh(a)</pre>                                                                 |     |                        |               |                        |

## ComplexSqrt(x)

|                       |                                                                                       |                        |
|-----------------------|---------------------------------------------------------------------------------------|------------------------|
| <b>Syntax</b>         | <i>Result</i> = ComplexSqrt( <i>x</i> )                                               |                        |
| <b>Description</b>    | Returns the square root ( $\sqrt{x}$ ) of a complex number <i>x</i> .                 |                        |
| <b>Data type</b>      | <i>x</i>                                                                              | Complex type (Complex) |
|                       | <i>Result</i>                                                                         | Complex type (Complex) |
| <b>Example of use</b> | <pre>Dim a As Complex, b As Complex a = ComplexSet(1.5, 2.0) b = ComplexSqrt(a)</pre> |                        |

## ComplexSub(x,y)

|                       |                                                                                                                                |                        |
|-----------------------|--------------------------------------------------------------------------------------------------------------------------------|------------------------|
| <b>Syntax</b>         | <i>Result</i> = ComplexSub( <i>x</i> , <i>y</i> )                                                                              |                        |
| <b>Description</b>    | Returns the result ( $x - y$ ) of the subtraction of a complex number <i>x</i> and another <i>y</i> .                          |                        |
| <b>Data type</b>      | <i>x</i>                                                                                                                       | Complex type (Complex) |
|                       | <i>y</i>                                                                                                                       | Complex type (Complex) |
|                       | <i>Result</i>                                                                                                                  | Complex type (Complex) |
| <b>Example of use</b> | <pre>Dim a As Complex, b As Complex, c As Complex a = ComplexSet(1.5, 2.0) b = ComplexSet(0.5, 3.5) c = ComplexSub(a, b)</pre> |                        |

## Sample Program

```

:
:

Dim Dmy As Long
Dim s21_raw As Variant
Dim s31_raw As Variant
Dim s21_Comp As Complex
Dim s31_Comp As Complex
Dim trAce_ratio_comp As Complex
Dim trAce_ratio(401) As Double

SCPI.DISPlay.Split = "D1"
SCPI.DISPlay.WINDow(1).Split = "D12_34"
SCPI.CALCulate(1).PARAmeter.Count = 2
SCPI.CALCulate(1).PARAmeter(1).DEFine = "s21"
SCPI.CALCulate(1).PARAmeter(2).DEFine = "s31"
SCPI.SENSE(1).SWEp.POINTs = 201

:
:
:

SCPI.TRIGger.SEQuence.Source = "bus"
SCPI.TRIGger.SEQuence.SINGLE
Dmy = SCPI.IEEE4882.OPC

''' Get corrected data array
SCPI.CALCulate(1).PARAmeter(1).SElect
s21_raw = SCPI.CALCulate(1).SElected.DATA.SDATA
SCPI.CALCulate(1).PARAmeter(2).SElect
s31_raw = SCPI.CALCulate(1).SElected.DATA.SDATA

For i = 0 To 200

 ''' Copy corrected data array to the complex data array
 ''' to take advantage of complex operation library
 s21_Comp = ComplexSet(s21_raw(2 * i), s21_raw(2 * i + 1))
 s31_Comp = ComplexSet(s31_raw(2 * i), s31_raw(2 * i + 1))

 ''' Calculate the ratio of S31 and S21
 ''' S31/S21
 trAce_ratio_comp = ComplexDiv(s31_Comp, s21_Comp)

 trAce_ratio(2 * i) = trAce_ratio_comp.real
 trAce_ratio(2 * i + 1) = trAce_ratio_comp.imag

Next i

SCPI.CALCulate(1).PARAmeter.Count = 4

''' Write "S31/S21" data to corrected data array for the trace 3 (LogMag)
SCPI.CALCulate(1).PARAmeter(3).SElect
SCPI.CALCulate(1).SElected.Format = "MLOG"
SCPI.CALCulate(1).SElected.DATA.SDATA = trAce_ratio

''' Write "S31/S21" data to corrected data array for the trace 4 (Phase)
SCPI.CALCulate(1).PARAmeter(4).SElect
SCPI.CALCulate(1).SElected.Format = "PHASe"
SCPI.CALCulate(1).SElected.DATA.SDATA = trAce_ratio

:
:

```



---

## **A** **Manual Changes**

This appendix contains the information required to adapt this manual to versions or configurations of the E5070B/E5071B manufactured earlier than the current printing date of this manual.

---

## Manual Changes

To adapt this manual to your E5070B/E5071B, refer to Table A-1 and Table A-2.

**Table A-1** Manual Changes by Serial Number

| Serial Prefix or Number | Make Manual Changes |
|-------------------------|---------------------|
| MY423                   | Change 6            |

**Table A-2** Manual Changes by Firmware Version

| Version | Make Manual Changes |
|---------|---------------------|
| A.03.0x | Change 1            |
| A.03.53 | Change 2            |
| A.03.54 | Change 3            |
| A.03.62 | Change 4            |
| A.04.00 | Change 5            |
| A.05.00 | Change 7            |
| A.06.00 | Change 8            |
| A.06.50 | Change 9            |
| A.08.01 | Change 10           |

The ten-character serial number is stamped on the serial number plate (Figure A-1) on the rear panel.

**Figure A-1** Example of Serial Number Plate

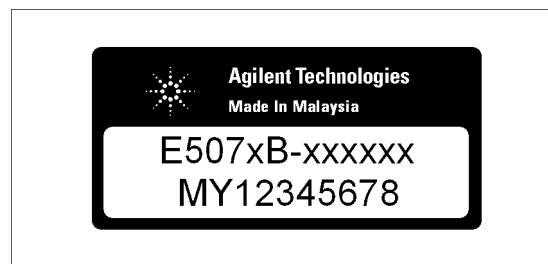

e5070bu7013



## Change 10

The firmware revision A.08.01 and below does not support the following COM objects. Please delete their descriptions in this manual.

- SCPI.CALCulate(Ch).SElected.MARKer(Mk).NOTCh. DATA on page 331
- SCPI.CALCulate(Ch).SElected.MARKer.NOTCh.STATE on page 332
- SCPI.CALCulate(Ch).SElected.MARKer(Mk).NOTCh. THReshold on page 333

The firmware revision A.08.01 or lower does not support the following functions. Please delete the descriptions about these functions from this manual.

- Notch search function

## Change 9

The firmware revision A.06.50 and below does not support the following COM objects. Please delete their descriptions in this manual.

- SCPI.CALCulate(Ch).SElected.EQUation.STATE on page 279
- SCPI.CALCulate(Ch).SElected.EQUation.TEXT on page 280
- SCPI.CALCulate(Ch).SElected.EQUation.VALid on page 281
- SCPI.PROGram.VARiable.ARRay(Vnum).DATA on page 459
- SCPI.PROGram.VARiable.ARRay(Vnum).SIZE on page 461
- SCPI.PROGram.VARiable.DOUBLE(Vnum).DATA on page 462
- SCPI.PROGram.VARiable.LONG(Vnum).DATA on page 463
- SCPI.PROGram.VARiable.STRING(Vnum).DATA on page 464
- SCPI.SENSE(Ch).CORREction.COLLECT.ADAPter(Pt).LENGth on page 488
- SCPI.SENSE(Ch).CORREction.COLLECT.ECAL.UTHRu.STATE on page 533
- SCPI.SENSE(Ch).CORREction.COLLECT.METHod.ADAPter.REMOval on page 534
- SCPI.SERVice.SWEp.FREQUency.MAXimum on page 642
- SCPI.SERVice.SWEp.FREQUency.MINimum on page 642
- SCPI.SERVice.SWEp.POINts on page 643
- SCPI.TRIGger.SEQUence.SCOPE on page 755

The following COM objects include parameters, which cannot be chosen with the firmware revision A.06.50 and below.

- SCPI.SENSE(Ch).CORREction.COLLECT.CKIT.STAN(Std).TYPE on page 517

The firmware revision A.06.50 or lower does not support the following functions. Please delete the descriptions about these functions from this manual.

- Equation editor function
- User definition variable function
- Function to trigger only the active channel

## Manual Changes

### Manual Changes

- Change of the dialog box for checking the product information
- Calibration kits, 85038A/F/M, have been added
- Available power meters, N1911A/N1912A, have been added.
- Function to remove/insert adapter characteristics.
- Unknown Thru Calibration function

### Change 8

The firmware revision A.06.00 and below does not support the following COM objects. Please delete their descriptions in this manual.

- SCPI.MMEMory.STORe.SNP.DATA on page 450
- SCPI.MMEMory.STORe.SNP.FORMat on page 451
- SCPI.MMEMory.STORe.SNP.TYPE.S1P on page 452
- SCPI.MMEMory.STORe.SNP.TYPE.S2P on page 453
- SCPI.MMEMory.STORe.SNP.TYPE.S3P on page 454
- SCPI.MMEMory.STORe.SNP.TYPE.S4P on page 455
- SCPI.SENSE(Ch).CORRection.COLLEct.PARTIal.SAVE on page 545
- SCPI.SENSE(Ch).CORRection.TRIGGer.FREE.STATE on page 584
- SCPI.SOURce.POWer.PORT.CORRection.COLLEct. NTOLerance on page 655
- SCPI.TRIGGer.SEQUence.AVERAge on page 750
- SCPI.TRIGGer.SEQUence.EXTErnal.DELay on page 751
- SCPI.TRIGGer.SEQUence.EXTErnal.LLATency.STATE on page 752

The firmware revision A.06.00 or lower does not support the following functions. Please delete the descriptions about these functions from this manual.

- Low latency external trigger function
- Averaging trigger function
- Function of tolerance setting at power calibration
- Function of trigger source setting at calibration
- Function of data saving in touchstone format by using front panel
- Function of simplified full 3/4 port calibration by using front panel
- Simplified 3/4 port TRL calibration function
- Partial overwrite function

### Change 7

The firmware revision A.05.00 and below does not support the following COM objects. Please delete their descriptions in this manual.

- SCPI.CALCulate(Ch).FSIMulator.BALun.CZConversion.BPORT(Bpt).IMAGinary on page 209

- SCPI.CALCulate(Ch).FSIMulator.BALun.CZConversion. BPORT(Bpt).REAL on page 211
- SCPI.CALCulate(Ch).FSIMulator.BALun.DZConversion. BPORT(Bpt).IMAGinary on page 222
- SCPI.CALCulate(Ch).FSIMulator.BALun.DZConversion. BPORT(Bpt).REAL on page 223
- SCPI.CALCulate(Ch).FSIMulator.SENDEd.ZCONversion. PORT(Pt).IMAGinary on page 252
- SCPI.CALCulate(Ch).FSIMulator.SENDEd.ZCONversion. PORT(Pt).REAL on page 253
- SCPI.CALCulate(Ch).SELEcted.CORRection.EDElay. MEdium on page 271
- SCPI.CALCulate(Ch).SELEcted.CORRection.EDElay. WGCutoff on page 273
- SCPI.DISPlay.WINDow(Ch).ANNotation.MARKer.ALIGN. STATe on page 396
- SCPI.DISPlay.WINDow(Ch).ANNotation.MARKer.SINGLE. STATe on page 397
- SCPI.DISPlay.WINDow(Ch).TRACe(Tr).ANNotation.MARKer.POSition.X on page 403
- SCPI.DISPlay.WINDow(Ch).TRACe(Tr).ANNotation.MARKer.POSition.Y on page 404
- SCPI.MMEMory.LOAD.CKIT(Ckit) on page 432
- SCPI.MMEMory.STORe.CKIT(Ckit) on page 442
- SCPI.SENSE(Ch).CORRection.COLLEct.ACQUIRE.SUBCLass on page 483
- SCPI.SENSE(Ch).CORRection.COLLEct.ACQUIRE.TRLLine on page 485
- SCPI.SENSE(Ch).CORRection.COLLEct.ACQUIRE. TRLReflect on page 486
- SCPI.SENSE(Ch).CORRection.COLLEct.ACQUIRE.TRLThru on page 487
- SCPI.SENSE(Ch).CORRection.COLLEct.CKIT.ORDER. SELEct on page 493
- SCPI.SENSE(Ch).CORRection.COLLEct.CKIT.ORDER. TRLLine(Cpt\_m,Cpt\_n) on page 497
- SCPI.SENSE(Ch).CORRection.COLLEct.CKIT.ORDER. TRLReflect on page 498
- SCPI.SENSE(Ch).CORRection.COLLEct.CKIT.ORDER. TRLThru(Cpt\_m,Cpt\_n) on page 499
- SCPI.SENSE(Ch).CORRection.COLLEct.CKIT.STAN(Std). CHARacter on page 507
- SCPI.SENSE(Ch).CORRection.COLLEct.CKIT.STAN(Std) .FMAXimum on page 509
- SCPI.SENSE(Ch).CORRection.COLLEct.CKIT.STAN(Std) .FMINimum on page 510
- SCPI.SENSE(Ch).CORRection.COLLEct.CKIT.TRLOption. IMPedance on page 519
- SCPI.SENSE(Ch).CORRection.COLLEct.CKIT.TRLOption. RPLane on page 520
- SCPI.SENSE(Ch).CORRection.COLLEct.ECAL.ORIentation .STATe on

## Manual Changes

### Manual Changes

page 525

- SCPI.SENSE(Ch).CORRection.COLLEct.ECAL.PATH(Cpt) on page 526
- SCPI.SENSE(Ch).CORRection.COLLEct.METHod.TRL2 on page 541
- SCPI.SENSE(Ch).CORRection.COLLEct.METHod.TRL3 on page 542
- SCPI.SENSE(Ch).CORRection.COLLEct.METHod.TRL4 on page 543
- SCPI.SENSE(Ch).CORRection.EXTension.AUTO.CONFig on page 548
- SCPI.SENSE(Ch).CORRection.EXTension.AUTO.DCOFFset on page 549
- SCPI.SENSE(Ch).CORRection.EXTension.AUTO.LOSS on page 550
- SCPI.SENSE(Ch).CORRection.EXTension.AUTO.MEASure on page 551
- SCPI.SENSE(Ch).CORRection.EXTension.AUTO.PORT(Pt) on page 552
- SCPI.SENSE(Ch).CORRection.EXTension.AUTO.RESet on page 553
- SCPI.SENSE(Ch).CORRection.EXTension.AUTO.STARt on page 554
- SCPI.SENSE(Ch).CORRection.EXTension.AUTO.STOP on page 555
- SCPI.SENSE(Ch).CORRection.EXTension.PORT(Pt). FREQUency(Fq) on page 556
- SCPI.SENSE(Ch).CORRection.EXTension.PORT(Pt). INCLude(II).STATe on page 558
- SCPI.SENSE(Ch).CORRection.EXTension.PORT(Pt).LDC on page 560
- SCPI.SENSE(Ch).CORRection.EXTension.PORT(Pt) .LOSS(Loss) on page 561
- SCPI.SENSE(Ch).CORRection.EXTension.PORT(Pt).TIME on page 563
- SCPI.SENSE.MULTiplexer.CATalog on page 594
- SCPI.SENSE.MULTiplexer(Id).INCount on page 597
- SCPI.SENSE.MULTiplexer(Id).NAME on page 598
- SCPI.SENSE(Ch).MULTiplexer(Id).PORT(Pt).CATalog on page 600
- SCPI.SENSE(Ch).MULTiplexer(Id).PORT(Pt).SELEct on page 601
- SCPI.SYSTem.UPReset on page 749

The following COM objects include parameters, which cannot be chosen with the firmware revision A.05.00 and below.

- SCPI.DISPlay.SPLit on page 391
- SCPI.DISPlay.WINDow(Ch).SPLit on page 400
- SCPI.SENSE(Ch).CORRection.COLLEct.CKIT.ORDER. LOAD(Cpt) on page 490
- SCPI.SENSE(Ch).CORRection.COLLEct.CKIT.ORDER. OPEN(Cpt) on page 492
- SCPI.SENSE(Ch).CORRection.COLLEct.CKIT.ORDER. SELEct on page 493
- SCPI.SENSE(Ch).CORRection.COLLEct.CKIT.ORDER. SHORt(Cpt) on page 494
- SCPI.SENSE(Ch).CORRection.COLLEct.CKIT.ORDER. THRU(Cpt\_m,Cpt\_n) on page 495
- SCPI.SENSE(Ch).CORRection.COLLEct.METHod.TYPE on page 544

- SCPI.SENSE(Ch).MULTIplexer(Id).COUNT on page 595

The firmware revision A.05.00 or below does not support the following functions. Please delete the descriptions about these functions in this manual.

- User preset function
- Function to display the marker value for non-active traces.
- Function to the display position where the marker value are displayed.
- Function to align the marker value.
- User recovery function \*1
- TRL calibration by softkeys
- Function to set the Waveguide for the media type.
- Loss correction.
- Auto port extension and auto loss value calculation.
- Function to turn off the auto-detect function of the Ecal module (Manual setting is available).
- Conversion function of differential/common port reference impedance of the fixture simulator in complex format.
- Function to have the E5091A-016 multiport test set correspond to this instrument.
- Function to select the 85052C for the calibration kit.
- Function to specify up to eight calibration standards for each calibration class.
- Reading/Writing of the calibration standard files.
- Function to set the measurement point to a maximum of 20001. \*2

## Change 6

The serial prefix MY423 or below dose not support the USB(USBTMC) interface port. Please delete the discription in this manual.

## Change 5

The firmware revision A.04.00 and below does not support the following COM objects. Please delete their descriptions in this manual.

- SCPI.CALCulate(Ch).SELected.BLIMit.STATe on page 268
- SCPI.CALCulate(Ch).SELected.BLIMit.DB on page 261
- SCPI.CALCulate(Ch).SELected.BLIMit.DISPlay.MARKer on page 262
- SCPI.CALCulate(Ch).SELected.BLIMit.DISPlay.VALue on page 263
- SCPI.CALCulate(Ch).SELected.BLIMit.FAIL on page 264
- SCPI.CALCulate(Ch).SELected.BLIMit.MAXimum on page 265

\*1. This function is available when the volume label on the C-drive is CP600 or higher.

\*2. This function is available when the channel/trace is set to Ch 1 / Tr 4 20001 Points.

Manual Changes  
Manual Changes

- SCPI.CALCulate(Ch).SELEcted.BLIMit.MINimum on page 266
- SCPI.CALCulate(Ch).SELEcted.BLIMit.REPort.DATA on page 267
- SCPI.CALCulate(Ch).SELEcted.LIMit.REPort.ALL on page 309
- SCPI.CALCulate(Ch).SELEcted.LIMit.OFFSet.AMPLitude on page 306
- SCPI.CALCulate(Ch).SELEcted.LIMit.OFFSet.MARKer on page 307
- SCPI.CALCulate(Ch).SELEcted.LIMit.OFFSet.STIMulus on page 308
- SCPI.CALCulate(Ch).SELEcted.RLIMit.STATe on page 352
- SCPI.CALCulate(Ch).SELEcted.RLIMit.DATA on page 345
- SCPI.CALCulate(Ch).SELEcted.RLIMit.DISPlay.SELEct on page 348
- SCPI.CALCulate(Ch).SELEcted.RLIMit.DISPlay.VALue on page 349
- SCPI.CALCulate(Ch).SELEcted.RLIMit.DISPlay.LINE on page 347
- SCPI.CALCulate(Ch).SELEcted.RLIMit.FAIL on page 350
- SCPI.CALCulate(Ch).SELEcted.RLIMit.REPort.DATA on page 351
- SCPI.MMEMory.LOAD.RLIMit on page 435
- SCPI.MMEMory.STORe.RLIMit on page 447
- SCPI.SENSE(Ch).CORRection.COEFFicient.DATA on page 470
- SCPI.SENSE(Ch).CORRection.COEFFicient.METHod.ERESponse on page 472
- SCPI.SENSE(Ch).CORRection.COEFFicient.METHod.RESPonse.OPEN on page 473
- SCPI.SENSE(Ch).CORRection.COEFFicient.METHod.RESPonse.SHORt on page 473
- SCPI.SENSE(Ch).CORRection.COEFFicient.METHod.SOLT1 on page 475
- SCPI.SENSE(Ch).CORRection.COEFFicient.METHod.SOLT2 on page 476
- SCPI.SENSE(Ch).CORRection.COEFFicient.METHod.SOLT3 on page 477
- SCPI.SENSE(Ch).CORRection.COEFFicient.METHod.SOLT4 on page 478
- SCPI.SENSE(Ch).CORRection.COEFFicient.METHod.RESPonse.THRU on page 474
- SCPI.SENSE(Ch).CORRection.COEFFicient.SAVE on page 479
- SCPI.SENSE(Ch).CORRection.COLLEct.ECAL.ERESponse on page 523
- SCPI.SENSE(Ch).CORRection.COLLEct.METHod.ERESponse on page 535
- SCPI.STATus.QUEStionable.BLIMit.EVENT on page 684
- SCPI.STATus.QUEStionable.BLIMit.CHANnel(Ch).EVENT on page 677
- SCPI.STATus.QUEStionable.BLIMit.CHANnel(Ch).CONDition on page 670
- SCPI.STATus.QUEStionable.BLIMit.CHANnel(Ch).ECHannel.EVENT on page 673
- SCPI.STATus.QUEStionable.BLIMit.CHANnel(Ch).ECHannel.CONDition on page 671

- SCPI.STATus.QUEStionable.BLIMit.CHANnel(Ch).ECHannel.ENABLE on page 672
- SCPI.STATus.QUEStionable.BLIMit.CHANnel(Ch).ECHannel.NTRansition on page 674
- SCPI.STATus.QUEStionable.BLIMit.CHANnel(Ch).ECHannel.PTRansition on page 675
- SCPI.STATus.QUEStionable.BLIMit.CHANnel(Ch).ENABLE on page 676
- SCPI.STATus.QUEStionable.BLIMit.CHANnel(Ch).NTRansition on page 678
- SCPI.STATus.QUEStionable.BLIMit.CHANnel(Ch).PTRansition on page 679
- SCPI.STATus.QUEStionable.BLIMit.CONDition on page 680
- SCPI.STATus.QUEStionable.BLIMit.ELIMit.EVENT on page 681
- SCPI.STATus.QUEStionable.BLIMit.ELIMit.CONDition on page 680
- SCPI.STATus.QUEStionable.BLIMit.ELIMit.ENABLE on page 681
- SCPI.STATus.QUEStionable.BLIMit.ELIMit.NTRansition on page 682
- SCPI.STATus.QUEStionable.BLIMit.ELIMit.PTRansition on page 683
- SCPI.STATus.QUEStionable.BLIMit.ENABLE on page 684
- SCPI.STATus.QUEStionable.BLIMit.NTRansition on page 685
- SCPI.STATus.QUEStionable.BLIMit.PTRansition on page 686
- SCPI.STATus.QUEStionable.RLIMit.EVENT on page 722
- SCPI.STATus.QUEStionable.RLIMit.CHANnel(Ch).EVENT on page 715
- SCPI.STATus.QUEStionable.RLIMit.CHANnel(Ch).CONDition on page 708
- SCPI.STATus.QUEStionable.RLIMit.CHANnel(Ch).ECHannel.EVENT on page 711
- SCPI.STATus.QUEStionable.RLIMit.CHANnel(Ch).ECHannel.CONDition on page 709
- SCPI.STATus.QUEStionable.RLIMit.CHANnel(Ch).ECHannel.ENABLE on page 710
- SCPI.STATus.QUEStionable.RLIMit.CHANnel(Ch).ECHannel.NTRansition on page 712
- SCPI.STATus.QUEStionable.RLIMit.CHANnel(Ch).ECHannel.PTRansition on page 713
- SCPI.STATus.QUEStionable.RLIMit.CHANnel(Ch).ENABLE on page 714
- SCPI.STATus.QUEStionable.RLIMit.CHANnel(Ch).NTRansition on page 716
- SCPI.STATus.QUEStionable.RLIMit.CHANnel(Ch).PTRansition on page 717
- SCPI.STATus.QUEStionable.RLIMit.CONDition on page 718
- SCPI.STATus.QUEStionable.RLIMit.ELIMit.CONDition on page 718
- SCPI.STATus.QUEStionable.RLIMit.ELIMit.ENABLE on page 719
- SCPI.STATus.QUEStionable.RLIMit.ELIMit.NTRansition on page 720

## Manual Changes

### Manual Changes

- SCPI.STATus.QUEStionable.RLIMit.ELIMit.PTRansition on page 721
- SCPI.STATus.QUEStionable.RLIMit.ENABLE on page 722
- SCPI.STATus.QUEStionable.RLIMit.NTRansition on page 723
- SCPI.STATus.QUEStionable.RLIMit.PTRansition on page 724
- SCPI.SYSTem.SECurity.LEVel on page 744

The following COM objects include parameters, which cannot be chosen with the firmware revision A.04.00 and below.

- SCPI.DISPlay.TABLe.TYPE on page 394
- SCPI.SENSE(Ch).CORRection.COLLEct.METHod.TYPE on page 544
- SCPI.SENSE(Ch).CORRection.TYPE(Tr) on page 585

The firmware revision A.04.00 and below does not support the following functions. Please delete the descriptions about these functions in this manual.

- Offset limit line function
- Ripple test function
- Bandwidth test function
- Enhanced response calibration
- Frequency information appearing as asterisks
- Disable USB mass storage devices

### Change 4

The firmware revision A.03.62 and below does not support the following COM objects. Please delete their descriptions in this manual.

- SCPI.CALCulate(Ch).PARAmeter(Tr).SPORt on page 260
- SCPI.CALCulate(Ch).SELEcted.MIXer.XAXis on page 341
- SCPI.CALCulate(Ch).SELEcted.OFFset.XAXis on page 344
- SCPI.SENSE(Ch).CORRection.CLEAr on page 469
- SCPI.SENSE(Ch).CORRection.COLLEct.CLEAr on page 521
- SCPI.SENSE(Ch).CORRection.OFFSet.CLEAr on page 566
- SCPI.SENSE(Ch).CORRection.OFFSet.COLLEct.ACQuire.LOAD on page 567
- SCPI.SENSE(Ch).CORRection.OFFSet.COLLEct.ACQuire.OPEN on page 568
- SCPI.SENSE(Ch).CORRection.OFFSet.COLLEct.ACQuire.PMETer on page 569
- SCPI.SENSE(Ch).CORRection.OFFSet.COLLEct.ACQuire.SHORt on page 571
- SCPI.SENSE(Ch).CORRection.OFFSet.COLLEct.ACQuire.THRU on page 572
- SCPI.SENSE(Ch).CORRection.OFFSet.COLLEct.CLEAr on page 573
- SCPI.SENSE(Ch).CORRection.OFFSet.COLLEct.ECAL.SMIX2 on page 574
- SCPI.SENSE(Ch).CORRection.OFFSet.COLLEct.ECAL.SOLT1 on page 575



- SCPI.SENSE(Ch).CORREction.OFFSet.COLLEct.METHod.SMIX2 on page 576
- SCPI.SENSE(Ch).CORREction.OFFSet.COLLEct.METHod.SOLT1 on page 577
- SCPI.SENSE(Ch).CORREction.OFFSet.COLLEct.SAVE on page 578
- SCPI.SENSE(Ch).CORREction.RECeiver(Pt).COLLEct.ACQuire on page 580
- SCPI.SENSE(Ch).CORREction.RECeiver(Pt).STATe on page 581
- SCPI.SENSE(Ch).OFFSet.ASPurious on page 609
- SCPI.SENSE(Ch).OFFSet.LOCal.CONTRol.STATe on page 610
- SCPI.SENSE(Ch).OFFSet.LOCal.FREQuency.DATA on page 611
- SCPI.SENSE(Ch).OFFSet.LOCal.FREQuency.DIVisor on page 612
- SCPI.SENSE(Ch).OFFSet.LOCal.FREQuency.MULTIplier on page 613
- SCPI.SENSE(Ch).OFFSet.LOCal.FREQuency.OFFSet on page 614
- SCPI.SENSE(Ch).OFFSet.LOCal.FREQuency.STARt on page 615
- SCPI.SENSE(Ch).OFFSet.LOCal.FREQuency.STOP on page 616
- SCPI.SENSE(Ch).OFFSet.LOCal.POWER.LEVel.IMMEDIATE.AMPLitude on page 617
- SCPI.SENSE(Ch).OFFSet.LOCal.POWER.LEVel.SLOPe.DATA on page 618
- SCPI.SENSE(Ch).OFFSet.LOCal.POWER.LEVel.SLOPe.STATe on page 619
- SCPI.SENSE(Ch).OFFSet.LOCal.STATe on page 620
- SCPI.SENSE(Ch).OFFSet.PORT(Pt).FREQuency.DATA on page 621
- SCPI.SENSE(Ch).OFFSet.PORT(Pt).FREQuency.DIVisor on page 622
- SCPI.SENSE(Ch).OFFSet.PORT(Pt).FREQuency.MULTIplier on page 623
- SCPI.SENSE(Ch).OFFSet.PORT(Pt).FREQuency.OFFSet on page 624
- SCPI.SENSE(Ch).OFFSet.PORT(Pt).FREQuency.STARt on page 625
- SCPI.SENSE(Ch).OFFSet.PORT(Pt).FREQuency.STOP on page 626
- SCPI.SENSE(Ch).OFFSet.STATe on page 627
- SCPI.SYSTEM.COMMunicate.GPIB.SGENerator.ADDRess on page 729
- SCPI.SYSTEM.COMMunicate.GPIB.SGENerator.CCOMmand.FREQuency on page 730
- SCPI.SYSTEM.COMMunicate.GPIB.SGENerator.CCOMmand.POWER on page 731
- SCPI.SYSTEM.COMMunicate.GPIB.SGENerator.CCOMmand.PRESet on page 732
- SCPI.SYSTEM.COMMunicate.GPIB.SGENerator.CCOMmand.RFON on page 733
- SCPI.SYSTEM.COMMunicate.GPIB.SGENerator.DWELL on page 734
- SCPI.SYSTEM.COMMunicate.GPIB.SGENerator.TYPE on page 735
- SCPI.TRIGger.SEQuence.POINt on page 754

## Manual Changes

### Manual Changes

The following COM objects include parameters, which cannot be chosen with the firmware revision A.03.62 and below.

- SCPI.CALCulate(Ch).FSIMulator.BALun.PARAmeter(Tr). SSBalanced.DEFIne on page 228
- SCPI.CALCulate(Ch).PARAmeter(Tr).DEFIne on page 258
- SCPI.CALCulate(Ch).SELEcted.CONVersion.FUNcTION on page 269
- SCPI.SENSE(Ch).CORRection.TYPE(Tr) on page 585

The firmware revision A.03.62 and below does not support the following functions. Please delete the descriptions about these functions in this manual.

- Scalar-mixer calibration
- Vector-mixer calibration
- Absolute measurement function and receiver calibration
- Frequency offset function (including the avoid spurious function)
- External signal generator control function
- Point trigger function
- Z/Y Transmission-Shunt conversion
- Imbalance 3 and 4 parameters for SE-SE-Bal measurement (Fixture simulator)
- Assignable x-axis such as RF+LO, RF-LO, and LO-RF frequencies for each active trace
- Conjugation for converting vector mixer measurement parameters
- 7 mm calibration kits such as 85031B and 85050C/D
- Calibration data and calibration coefficient clear functions

### Change 3

The firmware revision A.03.54 and below does not support the following COM objects. Please delete their descriptions in this manual.

- SCPI.SERVice.SREVision on page 641
- SCPI.SOURce(Ch).POWER.ATTenuation.AUTO on page 645

The firmware revision A.03.54 and below does not support the following functions. Please delete the descriptions about these functions in this manual

- Auto Power Range set function

### Change 2

The firmware revision A.03.53 and below does not support the following COM objects. Please delete their descriptions in this manual.

- SCPI.SYSTem.ISPC.PORT on page 739
- SCPI.SYSTem.ISPC.STAT on page 740

The firmware revision A.03.53 and below does not support the following functions. Please

delete the descriptions about these functions in this manual

- ❑ Initial Source Port Control function

## Change 1

The firmware revision A.03.0x does not support the following COM objects. Please delete their descriptions in this manual.

- SCPI.CALCulate(Ch).FSIMulator.EMBed.NETWork(Nwk). FILEname on page 234
- SCPI.CALCulate(Ch).FSIMulator.EMBed.NETWork(Nwk). TYPE on page 235
- SCPI.CALCulate(Ch).FSIMulator.EMBed.STATE on page 236
- SCPI.CALCulate(Ch).FSIMulator.EMBed.TOPology.A. PORTs on page 237
- SCPI.CALCulate(Ch).FSIMulator.EMBed.TOPology.B. PORTs on page 238
- SCPI.CALCulate(Ch).FSIMulator.EMBed.TOPology.C. PORTs on page 239
- SCPI.CALCulate(Ch).FSIMulator.EMBed.TYPE on page 240
- SCPI.SENSE(Ch).CORRection.COLLEct.ECAL.CCHeck. ACQuire on page 522
- SCPI.SENSE(Ch).CORRection.COLLEct.ECAL.UCHar on page 532
- SCPI.SENSE(Ch).CORRection.COLLEct.SIMPLified.SAVE on page 547

The firmware revision A.03.0x does not support the following functions. Please delete the descriptions about these functions in this manual

- ❑ Loading and executing program in batch process

Manual Changes  
**Manual Changes**

**A**

- analysis
  - ripple analysis library, 760
- Application objects, 136
- array data
  - storing array data, 75
- Array function, 44
- automatic Loading
  - Loading a project at power-on, 50

**B**

- break point, 59

**C**

- Calib\_Solt
  - procedure for full n-port calibration, 98
- calibration
  - Calib\_Solt procedure, 98
- class module, 37
  - inserting class module, 40
- Clear
  - Error queue, 417
  - Status register, 417
- Clear Echo button, 63
- Close Editor button, 36
- code window, 42
- coding
  - auto-complete function, 45
  - coding a VBA program, 42
- COM OBJECT
  - NAME, 199
  - OnPress Event, 204
  - Parse, 200
  - Prompt, 201
  - SCPI.ABORT, 208
  - SCPI.CALCulate(Ch).FSIMulator.BALun.CZConversion.BPORT(Bpt).IMAGinary, 209
  - SCPI.CALCulate(Ch).FSIMulator.BALun.CZConversion.BPORT(Bpt).REAL, 211
  - SCPI.CALCulate(Ch).FSIMulator.BALun.CZConversion.BPORT(Bpt).Z0.R, 212
  - SCPI.CALCulate(Ch).FSIMulator.BALun.CZConversion.STATE, 213
  - SCPI.CALCulate(Ch).FSIMulator.BALun.DEVice, 214
  - SCPI.CALCulate(Ch).FSIMulator.BALun.DMCircuit.BPORT(Bpt).PARAMeters.C, 215
  - SCPI.CALCulate(Ch).FSIMulator.BALun.DMCircuit.BPORT(Bpt).PARAMeters.G, 216
  - SCPI.CALCulate(Ch).FSIMulator.BALun.DMCircuit.BPORT(Bpt).PARAMeters.L, 217
  - SCPI.CALCulate(Ch).FSIMulator.BALun.DMCircuit.BPORT(Bpt).PARAMeters.R, 218
  - SCPI.CALCulate(Ch).FSIMulator.BALun.DMCircuit.BPORT(Bpt).TYPE, 219
  - SCPI.CALCulate(Ch).FSIMulator.BALun.DMCircuit.BPORT(Bpt).USER.FILEName, 220
  - SCPI.CALCulate(Ch).FSIMulator.BALun.DMCircuit.STATE, 221
  - SCPI.CALCulate(Ch).FSIMulator.BALun.DZConversion.BPORT(Bpt).IMAGinary, 222
  - SCPI.CALCulate(Ch).FSIMulator.BALun.DZConversion.BPORT(Bpt).REAL, 223
  - SCPI.CALCulate(Ch).FSIMulator.BALun.DZConversion.BPORT(Bpt).Z0.R, 224
  - SCPI.CALCulate(Ch).FSIMulator.BALun.DZConversion.STATE, 225
  - SCPI.CALCulate(Ch).FSIMulator.BALun.PARAmeter(Tr).BBALanced.DEFINE, 226
  - SCPI.CALCulate(Ch).FSIMulator.BALun.PARAmeter(Tr).SBALanced.DEFINE, 227
  - SCPI.CALCulate(Ch).FSIMulator.BALun.PARAmeter(Tr).SSBalanced.DEFINE, 228
  - SCPI.CALCulate(Ch).FSIMulator.BALun.STATE, 229
  - SCPI.CALCulate(Ch).FSIMulator.BALun.TOPology.BBALanced.PPORS, 230
  - SCPI.CALCulate(Ch).FSIMulator.BALun.TOPology.PROPerty.STATE, 231
  - SCPI.CALCulate(Ch).FSIMulator.BALun.TOPology.SBALanced.PPORS, 232
  - SCPI.CALCulate(Ch).FSIMulator.BALun.TOPology.SSBalanced.PPORS, 233
  - SCPI.CALCulate(Ch).FSIMulator.EMBed.NETWork(Nwk).FILENAME, 234
  - SCPI.CALCulate(Ch).FSIMulator.EMBed.NETWork(Nwk).TYPE, 235
  - SCPI.CALCulate(Ch).FSIMulator.EMBed.STATE, 236
  - SCPI.CALCulate(Ch).FSIMulator.EMBed.TOPology.APORTS, 237
  - SCPI.CALCulate(Ch).FSIMulator.EMBed.TOPology.BPORTS, 238
  - SCPI.CALCulate(Ch).FSIMulator.EMBed.TOPology.CPORTS, 239
  - SCPI.CALCulate(Ch).FSIMulator.EMBed.TYPE, 240
  - SCPI.CALCulate(Ch).FSIMulator.SENDEd.DEEMbed.PORT(Prt).TYPE, 241
  - SCPI.CALCulate(Ch).FSIMulator.SENDEd.DEEMbed.PORT(Pt).USER.FILEName, 243
  - SCPI.CALCulate(Ch).FSIMulator.SENDEd.DEEMbed.STATE, 244
  - SCPI.CALCulate(Ch).FSIMulator.SENDEd.PMCircuit.PORT(Pt).PARAMeters.C, 245
  - SCPI.CALCulate(Ch).FSIMulator.SENDEd.PMCircuit.PORT(Pt).PARAMeters.L, 247
  - SCPI.CALCulate(Ch).FSIMulator.SENDEd.PMCircuit.PORT(Pt).PARAMeters.R, 248
  - SCPI.CALCulate(Ch).FSIMulator.SENDEd.PMCircuit.PORT(Pt).TYPE, 249
  - SCPI.CALCulate(Ch).FSIMulator.SENDEd.PMCircuit.PORT(Pt).USER.FILEName, 250
  - SCPI.CALCulate(Ch).FSIMulator.SENDEd.PMCircuit.STATE, 251
  - SCPI.CALCulate(Ch).FSIMulator.SENDEd.ZCONversion.PORT(Pt).IMAGinary, 252

- 
- SCPI.CALCulate(Ch).FSIMulator.SENDEd.ZCONversion.PORT(Pt).REAL, 253
  - SCPI.CALCulate(Ch).FSIMulator.SENDEd.ZCONversion.PORT(Pt).Z0.R, 254
  - SCPI.CALCulate(Ch).FSIMulator.SENDEd.ZCONversion.STATe, 255
  - SCPI.CALCulate(Ch).FSIMulator.STATe, 256
  - SCPI.CALCulate(Ch).PARAmeter(Tr).COUNt, 257
  - SCPI.CALCulate(Ch).PARAmeter(Tr).DEFine, 258
  - SCPI.CALCulate(Ch).PARAmeter(Tr).SElect, 259
  - SCPI.CALCulate(Ch).PARAmeter(Tr).SPORt, 260
  - SCPI.CALCulate(Ch).SElected.BLIMit.DB, 261
  - SCPI.CALCulate(Ch).SElected.BLIMit.DISPlay.MARKeR, 262
  - SCPI.CALCulate(Ch).SElected.BLIMit.DISPlay.VALue, 263
  - SCPI.CALCulate(Ch).SElected.BLIMit.FAIL, 264
  - SCPI.CALCulate(Ch).SElected.BLIMit.MAXimum, 265
  - SCPI.CALCulate(Ch).SElected.BLIMit.MINimum, 266
  - SCPI.CALCulate(Ch).SElected.BLIMit.REPORt.DATA, 267
  - SCPI.CALCulate(Ch).SElected.BLIMit.STATe, 268
  - SCPI.CALCulate(Ch).SElected.CONVersion.FUNcTION, 269
  - SCPI.CALCulate(Ch).SElected.CONVersion.STATe, 270
  - SCPI.CALCulate(Ch).SElected.CORRection.EDELAy.MEDIum, 271
  - SCPI.CALCulate(Ch).SElected.CORRection.EDELAy.TIME, 272
  - SCPI.CALCulate(Ch).SElected.CORRection.EDELAy.WGCutoff, 273
  - SCPI.CALCulate(Ch).SElected.CORRection.OFFSet.PHASE, 274
  - SCPI.CALCulate(Ch).SElected.DATA.FDATA, 275
  - SCPI.CALCulate(Ch).SElected.DATA.FMEMory, 276
  - SCPI.CALCulate(Ch).SElected.DATA.SDATA, 277
  - SCPI.CALCulate(Ch).SElected.DATA.SMEMory, 278
  - SCPI.CALCulate(Ch).SElected.EQUation.STATe, 279
  - SCPI.CALCulate(Ch).SElected.EQUation.TEXT, 280
  - SCPI.CALCulate(Ch).SElected.EQUation.VALid, 281
  - SCPI.CALCulate(Ch).SElected.FILTer.GATE.TIME.CENTer, 282
  - SCPI.CALCulate(Ch).SElected.FILTer.GATE.TIME.SHAPe, 283
  - SCPI.CALCulate(Ch).SElected.FILTer.GATE.TIME.SPAN, 284
  - SCPI.CALCulate(Ch).SElected.FILTer.GATE.TIME.STARt, 285
  - SCPI.CALCulate(Ch).SElected.FILTer.GATE.TIME.STATe, 286
  - SCPI.CALCulate(Ch).SElected.FILTer.GATE.TIME.STOP, 287
  - SCPI.CALCulate(Ch).SElected.FILTer.GATE.TIME.TYPE, 288
  - SCPI.CALCulate(Ch).SElected.FORMat, 289
  - SCPI.CALCulate(Ch).SElected.FUNcTION.DATA, 290
  - SCPI.CALCulate(Ch).SElected.FUNcTION.DOMain.COUPLE, 291
  - SCPI.CALCulate(Ch).SElected.FUNcTION.DOMain.STARt, 292
  - SCPI.CALCulate(Ch).SElected.FUNcTION.DOMain.STATe, 293
  - SCPI.CALCulate(Ch).SElected.FUNcTION.DOMain.STOP, 294
  - SCPI.CALCulate(Ch).SElected.FUNcTION.EXECute, 295
  - SCPI.CALCulate(Ch).SElected.FUNcTION.PEXCURsion, 296
  - SCPI.CALCulate(Ch).SElected.FUNcTION.POINts, 297
  - SCPI.CALCulate(Ch).SElected.FUNcTION.PPOLARity, 298
  - SCPI.CALCulate(Ch).SElected.FUNcTION.TARGET, 299
  - SCPI.CALCulate(Ch).SElected.FUNcTION.TTRANsition, 300
  - SCPI.CALCulate(Ch).SElected.FUNcTION.TYPE, 301
  - SCPI.CALCulate(Ch).SElected.LIMit.DATA, 302
  - SCPI.CALCulate(Ch).SElected.LIMit.DISPlay.STATe, 304
  - SCPI.CALCulate(Ch).SElected.LIMit.FAIL, 305
  - SCPI.CALCulate(Ch).SElected.LIMit.OFFSet.AMPLitude, 306
  - SCPI.CALCulate(Ch).SElected.LIMit.OFFSet.MARKeR, 307
  - SCPI.CALCulate(Ch).SElected.LIMit.OFFSet.STIMulus, 308
  - SCPI.CALCulate(Ch).SElected.LIMit.REPORt.ALL, 309
  - SCPI.CALCulate(Ch).SElected.LIMit.REPORt.DATA, 310
  - SCPI.CALCulate(Ch).SElected.LIMit.REPORt.POINts, 311
  - SCPI.CALCulate(Ch).SElected.LIMit.STATe, 312
  - SCPI.CALCulate(Ch).SElected.MARKeR(Mk).ACTivate, 313
  - SCPI.CALCulate(Ch).SElected.MARKeR(Mk).BWIDTH.ATA, 314
  - SCPI.CALCulate(Ch).SElected.MARKeR(Mk).BWIDTH.STATe, 315
  - SCPI.CALCulate(Ch).SElected.MARKeR(Mk).BWIDTH.THReshhold, 316
  - SCPI.CALCulate(Ch).SElected.MARKeR(Mk).COUPLE, 317
  - SCPI.CALCulate(Ch).SElected.MARKeR(Mk).DISCrete, 318
  - SCPI.CALCulate(Ch).SElected.MARKeR(Mk).FUNcTION.DOMain.COUPLE, 319
  - SCPI.CALCulate(Ch).SElected.MARKeR(Mk).FUNcTION.DOMain.STARt, 320
  - SCPI.CALCulate(Ch).SElected.MARKeR(Mk).FUNcTION.DOMain.STATe, 321
  - SCPI.CALCulate(Ch).SElected.MARKeR(Mk).FUNcTION.DOMain.STOP, 322
  - SCPI.CALCulate(Ch).SElected.MARKeR(Mk).FUNcTION.EXECute, 323
  - SCPI.CALCulate(Ch).SElected.MARKeR(Mk).FUNcTION.PPOLARity, 325

- SCPI.CALCulate(Ch).SElected.MARKer(Mk).FUNctIon.  
TARGet, 326
- SCPI.CALCulate(Ch).SElected.MARKer(Mk).FUNctIon.  
TRACking, 327
- SCPI.CALCulate(Ch).SElected.MARKer(Mk).FUNctIon.  
TTRansiTion, 328
- SCPI.CALCulate(Ch).SElected.MARKer(Mk).FUNctIon.  
TYPE, 329
- SCPI.CALCulate(Ch).SElected.MARKer(Mk).NOTCh.D  
ATA, 331
- SCPI.CALCulate(Ch).SElected.MARKer(Mk).NOTCh.T  
HReshhold, 333
- SCPI.CALCulate(Ch).SElected.MARKer(Mk).REFerence  
.STATe, 334
- SCPI.CALCulate(Ch).SElected.MARKer(Mk).SET, 335
- SCPI.CALCulate(Ch).SElected.MARKer(Mk).STATe,  
336
- SCPI.CALCulate(Ch).SElected.MARKer(Mk).X, 337
- SCPI.CALCulate(Ch).SElected.MARKer(Mk).Y, 338
- SCPI.CALCulate(Ch).SElected.MARKer.NOTCCà.STA  
Te, 332
- SCPI.CALCulate(Ch).SElected.MATH.FUNctIon, 339
- SCPI.CALCulate(Ch).SElected.MATH.MEMorize, 340
- SCPI.CALCulate(Ch).SElected.MIXer.XAXis, 341
- SCPI.CALCulate(Ch).SElected.MSTatistics.DATa, 342
- SCPI.CALCulate(Ch).SElected.MSTatistics.STATe, 343
- SCPI.CALCulate(Ch).SElected.OFFset.XAXis, 344
- SCPI.CALCulate(Ch).SElected.RLIMit.DATa, 345
- SCPI.CALCulate(Ch).SElected.RLIMit.DISPlay.LINE,  
347
- SCPI.CALCulate(Ch).SElected.RLIMit.DISPlay.SELect,  
348
- SCPI.CALCulate(Ch).SElected.RLIMit.DISPlay.VAlue,  
349
- SCPI.CALCulate(Ch).SElected.RLIMit.FAIL, 350
- SCPI.CALCulate(Ch).SElected.RLIMit.REPort.DATa,  
351
- SCPI.CALCulate(Ch).SElected.RLIMit.STATe, 352
- SCPI.CALCulate(Ch).SElected.SMOothing.APERture,  
353
- SCPI.CALCulate(Ch).SElected.SMOothing.STATe, 354
- SCPI.CALCulate(Ch).SElected.TRANSform.TIME.CEN  
Ter, 355
- SCPI.CALCulate(Ch).SElected.TRANSform.TIME.IMPul  
se.WIDTh, 356
- SCPI.CALCulate(Ch).SElected.TRANSform.TIME.KBES  
sel, 357
- SCPI.CALCulate(Ch).SElected.TRANSform.TIME.LPFR  
equency, 358
- SCPI.CALCulate(Ch).SElected.TRANSform.TIME.SPAN  
, 359
- SCPI.CALCulate(Ch).SElected.TRANSform.TIME.STAR  
t, 360
- SCPI.CALCulate(Ch).SElected.TRANSform.TIME.STAT  
e, 361
- SCPI.CALCulate(Ch).SElected.TRANSform.TIME.STEP  
.RTIME, 362
- SCPI.CALCulate(Ch).SElected.TRANSform.TIME.STIM  
ulus, 363
- SCPI.CALCulate(Ch).SElected.TRANSform.TIME.STOP  
, 364
- SCPI.CALCulate(Ch).SElected.TRANSform.TIME.TYPE  
, 365
- SCPI.CALCulate(Cn).FSIMulator.SENDeD.PMCircuit.PO  
RT(Pt).PARAmeters.G, 246
- SCPI.CALCulate(Cn).SElected.MARKer(Mk).FUNctIon.  
PEXCursion, 324
- SCPI.CONTRol.HANDler.A.DATa, 366
- SCPI.CONTRol.HANDler.B.DATa, 367
- SCPI.CONTRol.HANDler.C.DATa, 368
- SCPI.CONTRol.HANDler.C.MODE, 369
- SCPI.CONTRol.HANDler.D.DATa, 370
- SCPI.CONTRol.HANDler.D.MODE, 371
- SCPI.CONTRol.HANDler.E.DATa, 372
- SCPI.CONTRol.HANDler.EXTension.INDeX.STATe, 373
- SCPI.CONTRol.HANDler.EXTension.RTRigger.STATe,  
374
- SCPI.CONTRol.HANDler.F.DATa, 375
- SCPI.CONTRol.HANDler.OUTPUT(Num).DATa, 376
- SCPI.DISPlay.ANNotation.FREQuency.STATe, 377
- SCPI.DISPlay.CCLear, 377
- SCPI.DISPlay.CLOCK, 378
- SCPI.DISPlay.COLOr(Dnum).BACK, 379
- SCPI.DISPlay.COLOr(Dnum).GRATicule(Gnum), 380
- SCPI.DISPlay.COLOr(Dnum).LIMit(Lnum), 381
- SCPI.DISPlay.COLOr(Dnum).RESet, 382
- SCPI.DISPlay.COLOr(Dnum).TRACe(Tr).DATa, 383
- SCPI.DISPlay.COLOr(Dnum).TRACe(Tr).MEMory, 384
- SCPI.DISPlay.ECHO.CLEar, 385
- SCPI.DISPlay.ECHO.DATa, 385
- SCPI.DISPlay.ENABLE, 386
- SCPI.DISPlay.FSIGN, 387
- SCPI.DISPlay.IMAGe, 388
- SCPI.DISPlay.MAXimize, 389
- SCPI.DISPlay.SKEY.STATe, 390
- SCPI.DISPlay.SPLit, 391
- SCPI.DISPlay.TABLE.STATe, 393
- SCPI.DISPlay.TABLE.TYPE, 394
- SCPI.DISPlay.UPDate.IMMEDIATE, 395
- SCPI.DISPlay.WINDow(Ch).ACTivate, 395
- SCPI.DISPlay.WINDow(Ch).ANNotation.MARKer.ALIG  
n. STATe, 396
- SCPI.DISPlay.WINDow(Ch).ANNotation.MARKer.SING  
le.STATe, 397
- SCPI.DISPlay.WINDow(Ch).LABel, 398
- SCPI.DISPlay.WINDow(Ch).MAXimize, 399
- SCPI.DISPlay.WINDow(Ch).SPLit, 400
- SCPI.DISPlay.WINDow(Ch).TITLe.DATa, 401
- SCPI.DISPlay.WINDow(Ch).TITLe.STATe, 402
- SCPI.DISPlay.WINDow(Ch).TRACe(Tr).ANNotation.M  
ARKer.POSition.X, 403
- SCPI.DISPlay.WINDow(Ch).TRACe(Tr).ANNotation.M  
ARKer.POSition.Y, 404

- 
- SCPI.DISPlay.WINdow(Ch).TRACe(Tr).MEMory.STATe, 405
  - SCPI.DISPlay.WINdow(Ch).TRACe(Tr).STATe, 406
  - SCPI.DISPlay.WINdow(Ch).TRACe(Tr).Y.SCALe.AUT O, 406
  - SCPI.DISPlay.WINdow(Ch).TRACe(Tr).Y.SCALe.PDIV ision, 407
  - SCPI.DISPlay.WINdow(Ch).TRACe(Tr).Y.SCALe.RLE Vel, 408
  - SCPI.DISPlay.WINdow(Ch).TRACe(Tr).Y.SCALe.RPOS ition, 409
  - SCPI.DISPlay.WINdow(Ch).X.SPACing, 410
  - SCPI.DISPlay.WINdow(Ch).Y.SCALe.DIVisions, 411
  - SCPI.FORMat.BORDER, 412
  - SCPI.FORMat.DATA, 413
  - SCPI.HCOPy.ABORt, 415
  - SCPI.HCOPy.IMAGe, 415
  - SCPI.HCOPy.IMMediate, 416
  - SCPI.IEEE4882.CLS, 417
  - SCPI.IEEE4882.ESE, 418
  - SCPI.IEEE4882.ESR, 419
  - SCPI.IEEE4882.IDN, 419
  - SCPI.IEEE4882.OPC, 420
  - SCPI.IEEE4882.OPT, 421
  - SCPI.IEEE4882.RST, 421
  - SCPI.IEEE4882.SRE, 422
  - SCPI.IEEE4882.STB, 423
  - SCPI.IEEE4882.TRG, 423
  - SCPI.IEEE4882.WAI, 423
  - SCPI.INITiate(Ch).CONTinuous, 424
  - SCPI.INITiate(Ch).IMMediate, 425
  - SCPI.MMEMory.CATalog(Dir), 426
  - SCPI.MMEMory.COPY, 427
  - SCPI.MMEMory.DELete, 428
  - SCPI.MMEMory.LOAD.ASCFactor, 429
  - SCPI.MMEMory.LOAD.BSCFactor, 430
  - SCPI.MMEMory.LOAD.CHANnel.STATe, 431
  - SCPI.MMEMory.LOAD.CKIT(Ckit), 432
  - SCPI.MMEMory.LOAD.LIMit, 433
  - SCPI.MMEMory.LOAD.PLOSs(Pt), 434
  - SCPI.MMEMory.LOAD.RLIMit, 435
  - SCPI.MMEMory.LOAD.SEGMent, 436
  - SCPI.MMEMory.LOAD.STATe, 437
  - SCPI.MMEMory.MDIRectory, 438
  - SCPI.MMEMory.STORe.ASCFactor, 439
  - SCPI.MMEMory.STORe.BSCFactor, 440
  - SCPI.MMEMory.STORe.CHANnel.CLEAr, 441
  - SCPI.MMEMory.STORe.CHANnel.STATe, 441
  - SCPI.MMEMory.STORe.CKIT(Ckit), 442
  - SCPI.MMEMory.STORe.FDATa, 443
  - SCPI.MMEMory.STORe.IMAGe, 444
  - SCPI.MMEMory.STORe.LIMit, 445
  - SCPI.MMEMory.STORe.PLOSs(Pt), 446
  - SCPI.MMEMory.STORe.RLIMit, 447
  - SCPI.MMEMory.STORe.SALL, 448
  - SCPI.MMEMory.STORe.SEGMent, 449
  - SCPI.MMEMory.STORe.SNP.DATA, 450
  - SCPI.MMEMory.STORe.SNP.FORMat, 451
  - SCPI.MMEMory.STORe.SNP.TYPE.S1P, 452
  - SCPI.MMEMory.STORe.SNP.TYPE.S2P, 453
  - SCPI.MMEMory.STORe.SNP.TYPE.S3P, 454
  - SCPI.MMEMory.STORe.SNP.TYPE.S4P, 455
  - SCPI.MMEMory.STORe.STATe, 456
  - SCPI.MMEMory.STORe.STYPE, 457
  - SCPI.OUTPUT.STATe, 458
  - SCPI.PROGram.VARiable.ARRay(Vnum)DATA, 459
  - SCPI.PROGram.VARiable.ARRay(Vnum)SIZE, 461
  - SCPI.PROGram.VARiable.DOUBLE(Vnum)DATA, 462
  - SCPI.PROGram.VARiable.LONG(Vnum)DATA, 463
  - SCPI.PROGram.VARiable.STRING(Vnum)DATA, 464
  - SCPI.SENS(Ch).CORRection.COEFFicient.DATA, 470
  - SCPI.SENS(Ch).CORRection.COEFFicient.METHod.ERE Sponse, 472
  - SCPI.SENSE(Ch).AVERAge.CLEAr, 465
  - SCPI.SENSE(Ch).AVERAge.COUNT, 465
  - SCPI.SENSE(Ch).AVERAge.STATe, 466
  - SCPI.SENSE(Ch).BANDwidth.RESolution, 467
  - SCPI.SENSE(Ch).BWIDth.RESolution, 468
  - SCPI.SENSE(Ch).CORRection.COLLECT.METHod.ERESpo nse, 535
  - SCPI.SENSE(Ch).CORRection.CLEAr, 469
  - SCPI.SENSE(Ch).CORRection.COEFFicient.METHod.RE Sponse.OPEN, 473
  - SCPI.SENSE(Ch).CORRection.COEFFicient.METHod.RE Sponse.SHORT, 473
  - SCPI.SENSE(Ch).CORRection.COEFFicient.METHod.RE Sponse.THRU, 474
  - SCPI.SENSE(Ch).CORRection.COEFFicient.METHod.SL OT2, 476
  - SCPI.SENSE(Ch).CORRection.COEFFicient.METHod.SL OT3, 477
  - SCPI.SENSE(Ch).CORRection.COEFFicient.METHod.SL OT4, 478
  - SCPI.SENSE(Ch).CORRection.COEFFicient.METHod.SO LT1, 475
  - SCPI.SENSE(Ch).CORRection.COEFFicient.SAVE, 479
  - SCPI.SENSE(Ch).CORRection.COLLECT.ACQUIRE.ISOLat ion, 480
  - SCPI.SENSE(Ch).CORRection.COLLECT.ACQUIRE.LOAD, 481
  - SCPI.SENSE(Ch).CORRection.COLLECT.ACQUIRE.OPEN, 482
  - SCPI.SENSE(Ch).CORRection.COLLECT.ACQUIRE.SHORT , 482
  - SCPI.SENSE(Ch).CORRection.COLLECT.ACQUIRE.SUBCl ass, 483
  - SCPI.SENSE(Ch).CORRection.COLLECT.ACQUIRE.THRU, 484
  - SCPI.SENSE(Ch).CORRection.COLLECT.ACQUIRE.TRLLine, 485
  - SCPI.SENSE(Ch).CORRection.COLLECT.ACQUIRE.TRLRe flect, 486
  - SCPI.SENSE(Ch).CORRection.COLLECT.ACQUIRE.TRLTh ru, 487



- SCPI.SENSE(Ch).CORRection.COLLECT.ADAPter(Pt).LENGth, 488
- SCPI.SENSE(Ch).CORRection.COLLECT.CKIT.LABel, 489
- SCPI.SENSE(Ch).CORRection.COLLECT.CKIT.ORDER.LOAD(Cpt), 490
- SCPI.SENSE(Ch).CORRection.COLLECT.CKIT.ORDER.OPEN(Cpt), 492
- SCPI.SENSE(Ch).CORRection.COLLECT.CKIT.ORDER.SELect, 493
- SCPI.SENSE(Ch).CORRection.COLLECT.CKIT.ORDER.SHORT(Cpt), 494
- SCPI.SENSE(Ch).CORRection.COLLECT.CKIT.ORDER.THRU(Cpt\_m,Cpt\_n), 495
- SCPI.SENSE(Ch).CORRection.COLLECT.CKIT.ORDER.TRLLine(Cpt\_m,Cpt\_n), 497
- SCPI.SENSE(Ch).CORRection.COLLECT.CKIT.ORDER.TRLReflect, 498
- SCPI.SENSE(Ch).CORRection.COLLECT.CKIT.ORDER.TRLThru(Cpt\_m,Cpt\_n), 499
- SCPI.SENSE(Ch).CORRection.COLLECT.CKIT.RESet, 500
- SCPI.SENSE(Ch).CORRection.COLLECT.CKIT.SELect, 500
- SCPI.SENSE(Ch).CORRection.COLLECT.CKIT.STAN(Std).ARBitrary, 502
- SCPI.SENSE(Ch).CORRection.COLLECT.CKIT.STAN(Std).C0, 503
- SCPI.SENSE(Ch).CORRection.COLLECT.CKIT.STAN(Std).C1, 504
- SCPI.SENSE(Ch).CORRection.COLLECT.CKIT.STAN(Std).C2, 505
- SCPI.SENSE(Ch).CORRection.COLLECT.CKIT.STAN(Std).C3, 506
- SCPI.SENSE(Ch).CORRection.COLLECT.CKIT.STAN(Std).CHARacter, 507
- SCPI.SENSE(Ch).CORRection.COLLECT.CKIT.STAN(Std).DELay, 508
- SCPI.SENSE(Ch).CORRection.COLLECT.CKIT.STAN(Std).FMAX, 509
- SCPI.SENSE(Ch).CORRection.COLLECT.CKIT.STAN(Std).FMIN, 510
- SCPI.SENSE(Ch).CORRection.COLLECT.CKIT.STAN(Std).L0, 511
- SCPI.SENSE(Ch).CORRection.COLLECT.CKIT.STAN(Std).L1, 512
- SCPI.SENSE(Ch).CORRection.COLLECT.CKIT.STAN(Std).L2, 513
- SCPI.SENSE(Ch).CORRection.COLLECT.CKIT.STAN(Std).L3, 514
- SCPI.SENSE(Ch).CORRection.COLLECT.CKIT.STAN(Std).LABel, 515
- SCPI.SENSE(Ch).CORRection.COLLECT.CKIT.STAN(Std).LOSS, 516
- SCPI.SENSE(Ch).CORRection.COLLECT.CKIT.STAN(Std).TYPE, 517
- SCPI.SENSE(Ch).CORRection.COLLECT.CKIT.STAN(Std).Z0, 518
- SCPI.SENSE(Ch).CORRection.COLLECT.CKIT.TRLOptio.n.IMPedance, 519
- SCPI.SENSE(Ch).CORRection.COLLECT.CKIT.TRLOptio.n.RPLane, 520
- SCPI.SENSE(Ch).CORRection.COLLECT.CLEAR, 521
- SCPI.SENSE(Ch).CORRection.COLLECT.ECAL.CCHECK.ACQUIRE, 522
- SCPI.SENSE(Ch).CORRection.COLLECT.ECAL.ERESponse, 523
- SCPI.SENSE(Ch).CORRection.COLLECT.ECAL.ISOLatio.n.STATE, 524
- SCPI.SENSE(Ch).CORRection.COLLECT.ECAL.ORIentati.on.STATE, 525
- SCPI.SENSE(Ch).CORRection.COLLECT.ECAL.PATH(Cp.t), 526
- SCPI.SENSE(Ch).CORRection.COLLECT.ECAL.SOLT1, 527
- SCPI.SENSE(Ch).CORRection.COLLECT.ECAL.SOLT2, 528
- SCPI.SENSE(Ch).CORRection.COLLECT.ECAL.SOLT3, 529
- SCPI.SENSE(Ch).CORRection.COLLECT.ECAL.SOLT4, 530
- SCPI.SENSE(Ch).CORRection.COLLECT.ECAL.THRU, 531
- SCPI.SENSE(Ch).CORRection.COLLECT.ECAL.UCHAR, 532
- SCPI.SENSE(Ch).CORRection.COLLECT.ECAL.UTHRU.STATE, 533
- SCPI.SENSE(Ch).CORRection.COLLECT.METHOD.ADAPter.REMOval, 534
- SCPI.SENSE(Ch).CORRection.COLLECT.METHOD.RESPo.nse.OPEN, 536
- SCPI.SENSE(Ch).CORRection.COLLECT.METHOD.RESPo.nse.SHORT, 536
- SCPI.SENSE(Ch).CORRection.COLLECT.METHOD.RESPo.nse.THRU, 537
- SCPI.SENSE(Ch).CORRection.COLLECT.METHOD.SOLT1, 537
- SCPI.SENSE(Ch).CORRection.COLLECT.METHOD.SOLT2, 538
- SCPI.SENSE(Ch).CORRection.COLLECT.METHOD.SOLT3, 539
- SCPI.SENSE(Ch).CORRection.COLLECT.METHOD.SOLT4, 540
- SCPI.SENSE(Ch).CORRection.COLLECT.METHOD.TRL2, 541
- SCPI.SENSE(Ch).CORRection.COLLECT.METHOD.TRL3, 542
- SCPI.SENSE(Ch).CORRection.COLLECT.METHOD.TRL4, 543
- SCPI.SENSE(Ch).CORRection.COLLECT.METHOD.TYPE, 544
- SCPI.SENSE(Ch).CORRection.COLLECT.PARTIAL.SAVE, 545

- 
- SCPI.SENSE(Ch).CORRection.COLLECT.SAVE, 546
  - SCPI.SENSE(Ch).CORRection.COLLECT.SIMPLIFIED.SAVE, 547
  - SCPI.SENSE(Ch).CORRection.EXTension.AUTO.CONFIG, 548
  - SCPI.SENSE(Ch).CORRection.EXTension.AUTO.DCOFFset, 549
  - SCPI.SENSE(Ch).CORRection.EXTension.AUTO.LOSS, 550
  - SCPI.SENSE(Ch).CORRection.EXTension.AUTO.MEASURE, 551
  - SCPI.SENSE(Ch).CORRection.EXTension.AUTO.PORT(Pt), 552
  - SCPI.SENSE(Ch).CORRection.EXTension.AUTO.RESet, 553
  - SCPI.SENSE(Ch).CORRection.EXTension.AUTO.STARt, 554
  - SCPI.SENSE(Ch).CORRection.EXTension.AUTO.STOP, 555
  - SCPI.SENSE(Ch).CORRection.EXTension.PORT(Pt).FREQUENCY(Fq), 556
  - SCPI.SENSE(Ch).CORRection.EXTension.PORT(Pt).INCLUDE(IL).STATE, 558
  - SCPI.SENSE(Ch).CORRection.EXTension.PORT(Pt).LDC, 560
  - SCPI.SENSE(Ch).CORRection.EXTension.PORT(Pt).LOSS(Loss), 561
  - SCPI.SENSE(Ch).CORRection.EXTension.PORT(Pt).TIME, 563
  - SCPI.SENSE(Ch).CORRection.EXTension.STATE, 564
  - SCPI.SENSE(Ch).CORRection.IMPedance.INPUT.MAGNITUDE, 565
  - SCPI.SENSE(Ch).CORRection.OFFSet.CLEAR, 566
  - SCPI.SENSE(Ch).CORRection.OFFSet.COLLECT.ACQUIRE.LOAD, 567
  - SCPI.SENSE(Ch).CORRection.OFFSet.COLLECT.ACQUIRE.OPEN, 568
  - SCPI.SENSE(Ch).CORRection.OFFSet.COLLECT.ACQUIRE.PMETER, 569
  - SCPI.SENSE(Ch).CORRection.OFFSet.COLLECT.ACQUIRE.SHORT, 571
  - SCPI.SENSE(Ch).CORRection.OFFSet.COLLECT.ACQUIRE.THROUGH, 572
  - SCPI.SENSE(Ch).CORRection.OFFSet.COLLECT.CLEAR, 573
  - SCPI.SENSE(Ch).CORRection.OFFSet.COLLECT.ECAL.SMIX2, 574
  - SCPI.SENSE(Ch).CORRection.OFFSet.COLLECT.ECAL.SOLT1, 575
  - SCPI.SENSE(Ch).CORRection.OFFSet.COLLECT.METHOD.SMIX2, 576
  - SCPI.SENSE(Ch).CORRection.OFFSet.COLLECT.METHOD.SOLT1, 577
  - SCPI.SENSE(Ch).CORRection.OFFSet.COLLECT.SAVE, 578
  - SCPI.SENSE(Ch).CORRection.PROPERTY, 579
  - SCPI.SENSE(Ch).CORRection.RECEIVER(Pt).COLLECT.ACQUIRE, 580
  - SCPI.SENSE(Ch).CORRection.RECEIVER(Pt).STATE, 581
  - SCPI.SENSE(Ch).CORRection.RVELOCITY.COAX, 582
  - SCPI.SENSE(Ch).CORRection.STATE, 583
  - SCPI.SENSE(Ch).CORRection.TRIGGER.FREE.STATE, 584
  - SCPI.SENSE(Ch).CORRection.TYPE, 585
  - SCPI.SENSE(Ch).FREQUENCY.CENTER, 587
  - SCPI.SENSE(Ch).FREQUENCY.CW, 588
  - SCPI.SENSE(Ch).FREQUENCY.DATA, 589
  - SCPI.SENSE(Ch).FREQUENCY.FIXED, 590
  - SCPI.SENSE(Ch).FREQUENCY.SPAN, 591
  - SCPI.SENSE(Ch).FREQUENCY.START, 592
  - SCPI.SENSE(Ch).FREQUENCY.STOP, 593, 594
  - SCPI.SENSE(Ch).MULTIPLEXER(Id).OUTPUT.DATA, 599
  - SCPI.SENSE(Ch).MULTIPLEXER(Id).PORT(Pt).CATALOG, 600
  - SCPI.SENSE(Ch).MULTIPLEXER(Id).PORT(Pt).SELECT, 601
  - SCPI.SENSE(Ch).MULTIPLEXER(Id).STATE, 603
  - SCPI.SENSE(Ch).MULTIPLEXER(Id).TSET9.OUTPUT.DATA, 604
  - SCPI.SENSE(Ch).MULTIPLEXER(Id).TSET9.PORT1, 605
  - SCPI.SENSE(Ch).MULTIPLEXER(Id).TSET9.PORT2, 606
  - SCPI.SENSE(Ch).MULTIPLEXER(Id).TSET9.PORT3, 607
  - SCPI.SENSE(Ch).MULTIPLEXER(Id).TSET9.PORT4, 608
  - SCPI.SENSE(Ch).OFFSet.ASPURIOUS, 609
  - SCPI.SENSE(Ch).OFFSet.LOCAL.CONTROL.STATE, 610
  - SCPI.SENSE(Ch).OFFSet.LOCAL.FREQUENCY.DATA, 611
  - SCPI.SENSE(Ch).OFFSet.LOCAL.FREQUENCY.DIVISOR, 612
  - SCPI.SENSE(Ch).OFFSet.LOCAL.FREQUENCY.MULTIPLIER, 613
  - SCPI.SENSE(Ch).OFFSet.LOCAL.FREQUENCY.OFFSet, 614
  - SCPI.SENSE(Ch).OFFSet.LOCAL.FREQUENCY.START, 615
  - SCPI.SENSE(Ch).OFFSet.LOCAL.FREQUENCY.STOP, 616
  - SCPI.SENSE(Ch).OFFSet.LOCAL.POWER.LEVEL.IMMEDIATE.AMPLITUDE, 617
  - SCPI.SENSE(Ch).OFFSet.LOCAL.POWER.LEVEL.SLOPE.DATA, 618
  - SCPI.SENSE(Ch).OFFSet.LOCAL.POWER.LEVEL.SLOPE.STATE, 619
  - SCPI.SENSE(Ch).OFFSet.LOCAL.STATE, 620
  - SCPI.SENSE(Ch).OFFSet.PORT(Pt).FREQUENCY.DATA, 621
  - SCPI.SENSE(Ch).OFFSet.PORT(Pt).FREQUENCY.DIVISOR, 622
  - SCPI.SENSE(Ch).OFFSet.PORT(Pt).FREQUENCY.MULTIPLIER, 623
  - SCPI.SENSE(Ch).OFFSet.PORT(Pt).FREQUENCY.OFFSet, 624
  - SCPI.SENSE(Ch).OFFSet.PORT(Pt).FREQUENCY.START, 625
  - SCPI.SENSE(Ch).OFFSet.PORT(Pt).FREQUENCY.STOP, 626

- SCPI.SENSE(Ch).OFFSet.STATe, 627  
 SCPI.SENSE(Ch).ROSCillator.SOURce, 628  
 SCPI.SENSE(Ch).SEGMENT.DATA, 629  
 SCPI.SENSE(Ch).SEGMENT.SWEep.POINts, 631  
 SCPI.SENSE(Ch).SEGMENT.SWEep.TIME.DATA, 631  
 SCPI.SENSE(Ch).SWEep.ASPurious, 632  
 SCPI.SENSE(Ch).SWEep.DELay, 633  
 SCPI.SENSE(Ch).SWEep.GENERation, 634  
 SCPI.SENSE(Ch).SWEep.POINts, 635  
 SCPI.SENSE(Ch).SWEep.TIME.AUTO, 636  
 SCPI.SENSE(Ch).SWEep.TIME.DATA, 637  
 SCPI.SENSE(Ch).SWEep.TYPE, 638  
 SCPI.SENSE.MULTIplexer(Id).DISPlay.STATe, 596  
 SCPI.SENSE.MULTIplexer(Id).INCount, 597  
 SCPI.SENSE.MULTIplexer(Id).NAME, 598  
 SCPI.SENSE.MULTIplexer(Id).TSET9.OUTPut.DATA, 595  
 SCPI.SERVICE.CHANnel(Ch).TRACe.ACTive, 640  
 SCPI.SERVICE.CHANnel.ACTive, 639  
 SCPI.SERVICE.CHANnel.COUNT, 639  
 SCPI.SERVICE.CHANnel.TRACe.COUNT, 640  
 SCPI.SERVICE.PORT.COUNT, 641  
 SCPI.SERVICE.SREVision, 641  
 SCPI.SERVICE.SWEep.FREQuency.MAXimum, 642  
 SCPI.SERVICE.SWEep.FREQuency.MINimum, 642  
 SCPI.SERVICE.SWEep.POINts, 643  
 SCPI.SOURCE(Ch).POWER.ATTenuation.AUTO, 645  
 SCPI.SOURCE(Ch).POWER.ATTenuation.DATA, 644  
 SCPI.SOURCE(Ch).POWER.CENTer, 647  
 SCPI.SOURCE(Ch).POWER.LEVel.IMMEDIATE.AMPLitude, 648  
 SCPI.SOURCE(Ch).POWER.LEVel.SLOPe.DATA, 649  
 SCPI.SOURCE(Ch).POWER.LEVel.SLOPe.STATe, 650  
 SCPI.SOURCE(Ch).POWER.PORT(Pt).CORRection.COLLECT.ACQUIRE, 651  
 SCPI.SOURCE(Ch).POWER.PORT(Pt).CORRection.COLLECT.AVERAGE.COUNT, 653  
 SCPI.SOURCE(Ch).POWER.PORT(Pt).CORRection.COLLECT.TABLE.LOSS.DATA, 658  
 SCPI.SOURCE(Ch).POWER.PORT(Pt).CORRection.COLLECT.TABLE.LOSS.STATe, 659  
 SCPI.SOURCE(Ch).POWER.PORT(Pt).CORRection.DATA, 660  
 SCPI.SOURCE(Ch).POWER.PORT(Pt).CORRection.STATe, 661  
 SCPI.SOURCE(Ch).POWER.PORT(Pt).LEVel.IMMEDIATE.AMPLitude, 663  
 SCPI.SOURCE(Ch).POWER.PORT.COUPLE, 662  
 SCPI.SOURCE(Ch).POWER.SPAN, 664  
 SCPI.SOURCE(Ch).POWER.START, 665  
 SCPI.SOURCE(Ch).POWER.STOP, 666  
 SCPI.SOURCE.POWER.PORT.CORRection.COLLECT.ASENSor.RCFactor, 652  
 SCPI.SOURCE.POWER.PORT.CORRection.COLLECT.BESENSor.RCFactor, 654  
 SCPI.SOURCE.POWER.PORT.CORRection.COLLECT.NTOlerance, 655  
 SCPI.SOURCE.POWER.PORT.CORRection.COLLECT.TABLE.ASENSor.DATA, 656  
 SCPI.SOURCE.POWER.PORT.CORRection.COLLECT.TABLE.BESENSor.DATA, 657  
 SCPI.STATUS.OPERation.CONDITION, 667  
 SCPI.STATUS.OPERation.ENABLE, 667  
 SCPI.STATUS.OPERation.EVENT, 668  
 SCPI.STATUS.OPERation.NTRANSITION, 668  
 SCPI.STATUS.OPERation.PTRANSITION, 669  
 SCPI.STATUS.PRESet, 669  
 SCPI.STATUS.QUESTIONable.BLIMIT.CHANnel(Ch).CONDITION, 670  
 SCPI.STATUS.QUESTIONable.BLIMIT.CHANnel(Ch).ECHANnel.CONDITION, 671  
 SCPI.STATUS.QUESTIONable.BLIMIT.CHANnel(Ch).ECHANnel.ENABLE, 672  
 SCPI.STATUS.QUESTIONable.BLIMIT.CHANnel(Ch).ECHANnel.EVENT, 673  
 SCPI.STATUS.QUESTIONable.BLIMIT.CHANnel(Ch).ECHANnel.NTRANSITION, 674  
 SCPI.STATUS.QUESTIONable.BLIMIT.CHANnel(Ch).ECHANnel.PTRANSITION, 675  
 SCPI.STATUS.QUESTIONable.BLIMIT.CHANnel(Ch).ENABLE, 676  
 SCPI.STATUS.QUESTIONable.BLIMIT.CHANnel(Ch).EVENT, 677  
 SCPI.STATUS.QUESTIONable.BLIMIT.CHANnel(Ch).NTRANSITION, 678  
 SCPI.STATUS.QUESTIONable.BLIMIT.CHANnel(Ch).PTRANSITION, 679  
 SCPI.STATUS.QUESTIONable.BLIMIT.CONDITION, 680  
 SCPI.STATUS.QUESTIONable.BLIMIT.ELIMIT.CONDITION, 680  
 SCPI.STATUS.QUESTIONable.BLIMIT.ELIMIT.ENABLE, 681  
 SCPI.STATUS.QUESTIONable.BLIMIT.ELIMIT.EVENT, 681  
 SCPI.STATUS.QUESTIONable.BLIMIT.ELIMIT.NTRANSITION, 682  
 SCPI.STATUS.QUESTIONable.BLIMIT.ELIMIT.PTRANSITION, 683  
 SCPI.STATUS.QUESTIONable.BLIMIT.ENABLE, 684  
 SCPI.STATUS.QUESTIONable.BLIMIT.EVENT, 684  
 SCPI.STATUS.QUESTIONable.BLIMIT.NTRANSITION, 685  
 SCPI.STATUS.QUESTIONable.BLIMIT.PTRANSITION, 686  
 SCPI.STATUS.QUESTIONable.CONDITION, 687  
 SCPI.STATUS.QUESTIONable.ENABLE, 688  
 SCPI.STATUS.QUESTIONable.EVENT, 689  
 SCPI.STATUS.QUESTIONable.LIMIT.CHANnel(Ch).CONDITION, 689  
 SCPI.STATUS.QUESTIONable.LIMIT.CHANnel(Ch).ECHANnel.CONDITION, 690  
 SCPI.STATUS.QUESTIONable.LIMIT.CHANnel(Ch).ECHANnel.ENABLE, 691  
 SCPI.STATUS.QUESTIONable.LIMIT.CHANnel(Ch).ECHANnel.EVENT, 692  
 SCPI.STATUS.QUESTIONable.LIMIT.CHANnel(Ch).ECHANnel.NTRANSITION, 693

- SCPI.STATus.QUEStionable.LIMit.CHANnel(Ch).ECHannel.PTRansition, 694
- SCPI.STATus.QUEStionable.LIMit.CHANnel(Ch).ENABle, 695
- SCPI.STATus.QUEStionable.LIMit.CHANnel(Ch).EVENT, 696
- SCPI.STATus.QUEStionable.LIMit.CHANnel(Ch).NTRansition, 697
- SCPI.STATus.QUEStionable.LIMit.CHANnel(Ch).PTRAnsitioN, 698
- SCPI.STATus.QUEStionable.LIMit.CONDiTion, 699
- SCPI.STATus.QUEStionable.LIMit.ELIMit.CONDiTion, 699
- SCPI.STATus.QUEStionable.LIMit.ELIMit.ENABLE, 700
- SCPI.STATus.QUEStionable.LIMit.ELIMit.EVENTt, 700
- SCPI.STATus.QUEStionable.LIMit.ELIMit.NTRansition, 701
- SCPI.STATus.QUEStionable.LIMit.ELIMit.PTRansition, 702
- SCPI.STATus.QUEStionable.LIMit.ENABLE, 703
- SCPI.STATus.QUEStionable.LIMit.EVENTt, 703
- SCPI.STATus.QUEStionable.LIMit.NTRansition, 704
- SCPI.STATus.QUEStionable.LIMit.PTRansition, 705
- SCPI.STATus.QUEStionable.NTRansition, 706
- SCPI.STATus.QUEStionable.PTRansition, 707
- SCPI.STATus.QUEStionable.RLIMit.CHANnel(Ch).CONDiTion, 708
- SCPI.STATus.QUEStionable.RLIMit.CHANnel(Ch).ECHannel.CONDiTion, 709
- SCPI.STATus.QUEStionable.RLIMit.CHANnel(Ch).ECHannel.ENABLE, 710
- SCPI.STATus.QUEStionable.RLIMit.CHANnel(Ch).ECHannel.EVENTt, 711
- SCPI.STATus.QUEStionable.RLIMit.CHANnel(Ch).ECHannel.NTRansition, 712
- SCPI.STATus.QUEStionable.RLIMit.CHANnel(Ch).ECHannel.PTRansition, 713
- SCPI.STATus.QUEStionable.RLIMit.CHANnel(Ch).ENABle, 714
- SCPI.STATus.QUEStionable.RLIMit.CHANnel(Ch).EVENTt, 715
- SCPI.STATus.QUEStionable.RLIMit.CHANnel(Ch).NTRansition, 716
- SCPI.STATus.QUEStionable.RLIMit.CHANnel(Ch).PTRansition, 717
- SCPI.STATus.QUEStionable.RLIMit.CONDiTion, 718
- SCPI.STATus.QUEStionable.RLIMit.ELIMit.ENABLE, 719
- SCPI.STATus.QUEStionable.RLIMit.ELIMit.EVENTt, 719
- SCPI.STATus.QUEStionable.RLIMit.ELIMit.NTRansition, 720
- SCPI.STATus.QUEStionable.RLIMit.ELIMit.PTRansition, 721
- SCPI.STATus.QUEStionable.RLIMit.ENABLE, 722
- SCPI.STATus.QUEStionable.RLIMit.EVENTt, 722
- SCPI.STATus.QUEStionable.RLIMit.NTRansition, 723
- SCPI.STATus.QUEStionable.RLIMit.PTRansition, 724
- SCPI.SYSTem.BACKlight, 725
- SCPI.SYSTem.BEEPer.COMPLete.IMMEDIATE, 726
- SCPI.SYSTem.BEEPer.COMPLete.STATe, 726
- SCPI.SYSTem.BEEPer.WARNing.IMMEDIATE, 727
- SCPI.SYSTem.BEEPer.WARNing.STATe, 727
- SCPI.SYSTem.COMMunicate.GPIB.PMETer.ADDRess, 728
- SCPI.SYSTem.COMMunicate.GPIB.SGENerator.ADDRess, 729
- SCPI.SYSTem.COMMunicate.GPIB.SGENerator.CCOMmand.FREQuency, 730
- SCPI.SYSTem.COMMunicate.GPIB.SGENerator.CCOMmand.POWER, 731
- SCPI.SYSTem.COMMunicate.GPIB.SGENerator.CCOMmand.PRESet, 732
- SCPI.SYSTem.COMMunicate.GPIB.SGENerator.CCOMmand.RFON, 733
- SCPI.SYSTem.COMMunicate.GPIB.SGENerator.DWELL, 734
- SCPI.SYSTem.COMMunicate.GPIB.SGENerator.TYPE, 735
- SCPI.SYSTem.CORRection.STATe, 736
- SCPI.SYSTem.DATE, 737
- SCPI.SYSTem.ERRor, 738
- SCPI.SYSTem.ISPControl.PORT, 739
- SCPI.SYSTem.ISPControl.STATe, 740
- SCPI.SYSTem.KLOCK.KBD, 741
- SCPI.SYSTem.KLOCK.MOUSE, 742
- SCPI.SYSTem.POFF, 742
- SCPI.SYSTem.PRESet, 743
- SCPI.SYSTem.SECurity.LEVel, 744
- SCPI.SYSTem.SERVice, 745
- SCPI.SYSTem.TEMPerature.HIGH, 746
- SCPI.SYSTem.TEMPerature.STATe, 747
- SCPI.SYSTem.TIME, 748
- SCPI.SYSTem.UPReset, 749
- SCPI.TRIGger.SEQuence.AVERAge, 750
- SCPI.TRIGger.SEQuence.EXTernal.DELay, 751
- SCPI.TRIGger.SEQuence.EXTernal.LLATency.STATe, 752
- SCPI.TRIGger.SEQuence.IMMEDIATE, 753
- SCPI.TRIGger.SEQuence.POINt, 754
- SCPI.TRIGger.SEQuence.SCOPE, 755
- SCPI.TRIGger.SEQuence.SINGLE, 756
- SCPI.TRIGger.SEQuence.SOURCE, 757
- UserMenu.Item(Key\_id).Caption, 202
- UserMenu.Item(Key\_id).Enabled, 203
- UserMenu.PRESet, 204
- UserMenu.Press(Key\_id), 205
- UserMenu.Show, 205
- UserMenu\_OnPress(ByVal Key\_id As Long), 204
- VBAVersion, 206
- WaitOnSRQ, 207
- COM object
  - about COM object, 31
  - accessing a list of COM objects, 66
  - auto-complete function, 45

- 
- control methods of the E5070B/E5071B, 31
  - conversion rules from SCPI commands, 137
  - ECHO, 198
  - list by front panel key, 160
  - list by function, 138
  - looking up COM objects, 24
  - major control difference between COM object and SCPI command, 32
  - object model, 136
  - object tree, 178
  - overview of E5070B/E5071B COM object, 31
  - COM object reference
    - notational rules, 196
  - Complex operation library, 778
    - ComplexAbs(x), 779
    - ComplexAdd(x,y), 779
    - ComplexArg(x), 779
    - ComplexConj(x), 780
    - ComplexCos(x), 780
    - ComplexCosh(x), 780
    - ComplexDiv(x,y), 780
    - ComplexExp(x), 781
    - ComplexLog(x), 781
    - ComplexLog10(x), 781
    - ComplexMul(x,y), 781
    - ComplexNorm(x), 782
    - ComplexPolar(x,y), 782
    - ComplexSet(x,y), 782
    - ComplexSetArray(x), 783
    - ComplexSin(x), 783
    - ComplexSinh(x), 783
    - ComplexSqrt(x), 784
    - ComplexSub(x,y), 784
  - Complex type, 778
    - ComplexAbs(x), 779
    - ComplexAdd(x,y), 779
    - ComplexArg(x), 779
    - ComplexConj(x), 780
    - ComplexCos(x), 780
    - ComplexCosh(x), 780
    - ComplexDiv(x,y), 780
    - ComplexExp(x), 781
    - ComplexLog(x), 781
    - ComplexLog10(x), 781
    - ComplexMul(x,y), 781
    - ComplexNorm(x), 782
    - ComplexPolar(x,y), 782
    - ComplexSet(x,y), 782
    - ComplexSetArray(x), 783
    - ComplexSin(x), 783
    - ComplexSinh(x), 783
    - ComplexSqrt(x), 784
    - ComplexSub(x,y), 784
  - control methods, 30
  - control system
    - control system based on the macro function, 29
  - controlling E5070B/E5071B
    - control methods of the E5070B/E5071B, 31
    - controlling peripherals
      - control methods, 30
      - implementing a control system, 29
      - overview, 88
- D**
- data
    - reading/writing measurement data, 75
  - data hint, 60
  - DC bias
    - application program for DC power supply, 90
  - debugging, 57
  - description
    - COM Object reference, 196
  - display
    - Display\_Update procedure, 110
    - echo Window, 63
    - initial screen of Visual Basic Editor, 34
    - switching from Visual Basic Editor to E5070B/E5071B measurement screen, 36
  - Display\_Update
    - procedure for displaying analysis results, 110
- E**
- echo window, 63
  - Echo Window button, 63
  - End statement
    - stopping a VBA program, 56
  - equivalent key
    - equivalent key to COM object, 197
  - error handling routine
    - On Error GoTo sentence, 98
  - errors
    - run-time errors, 57
    - syntax errors, 57
  - event
    - COM objects, 31
    - executing a procedure with assigned softkey, 80
  - examples
    - COM object reference, 197
  - Executing Power Calibration, 126
  - export
    - saving a module, 47
  - external instruments
    - controlling external instruments from E5070B/E5071B, 87
- F**
- F/W version, 419
  - FEM, 118
  - Firmware version, 419
  - FirstLeftGap(Chan), 763
  - FirstLeftInterval(Chan), 764
  - FirstLRightInterval(Chan), 766
  - FirstRightGap(Chan), 765
  - For•••Next statement, 44
-

front panel key  
equivalent key to COM object, 197

## G

GapMean(Chan), 767

## H

help  
using VBA online help, 64  
history  
manual printing, 2

## I

I/O library  
controlling peripherals from E5070B/E5071B, 87  
immediate window, 60  
import  
loading a module, 50  
index  
storing array data, 75  
Initialization  
Error queue, 417  
Status register, 417  
Installation and Quick Start Guide, 4

## L

library references  
automatic library references, 67  
limit test setting  
Setup\_Limitline procedure, 109  
Load & Run, 54  
Load Project button, 49  
loading  
loading a module, 50  
loading a project, 49  
loading a project at power-on, 50  
local window  
debug toolbar, 58

## M

macro  
introduction of the macro function, 28  
Macro Break key, 55  
macro function  
control system based on the macro function, 29  
Macro Run key, 54  
Macros dialog box, 53  
manual changes, 787  
manual printing history, 2  
MaxEnvelopeGap(Chan), 768  
MaxGap(Chan), 769  
MaxLeftGap(Chan), 770  
MaxPeakToPeak(Chan), 771  
MaxRightGap(Chan), 772  
MaxRipplePoint(Chan,Stim), 773

MaxRippleValue(Chan), 774  
measurement  
detecting the end of measurement, 70  
program for measuring a band-pass filter, 96  
program for measuring a duplexer, 104  
program for measuring FEM, 118  
measurement conditions  
Setup\_Parameter, 108  
Measurement using E5091A, 118  
menu bar, 34  
method  
COM objects, 31  
modules  
class module, 37  
deleting modules, 41  
loading a module, 50  
saving a module, 47  
standard module, 37  
user form, 37

## O

object box, 42  
object browser, 66  
object model, 136  
option ID, 421

## P

peripherals  
controlling peripherals from E5070B/E5071B, 87  
Pole(Chan,D,LeftStim,LeftValue,RightStim,RightValue),  
775  
Power Calibration, 126  
Preset User Menu button, 81  
procedure box, 42  
Product information, 419  
Programmer's Guide, 4  
programming  
auto-complete function, 45  
coding a VBA program, 42  
project, 37  
loading a project, 49  
saving a project file, 46  
project explorer, 35  
property  
COM objects, 31  
monitoring property values, 60  
property window, 35

## Q

quick watch, 62

## R

reading  
reading/writing measurement data, 75  
reference  
automatic library references, 67

- 
- related objects
    - COM object reference, 197
  - Reset
    - Error queue, 417
    - Instrument setting, 421
    - Status register, 417
  - Ripple
    - Ripple Analysis Library, 760
  - ripple
    - reading out a bandpass ripple value, 108
  - ripple Analysis
    - setting the peak definition, 760
  - ripple analysis
    - FirstLeftGap(Chan), 763
    - FirstLeftInterval(Chan), 764
    - FirstRightInterval(Chan), 766
    - FirstRightGap(Chan), 765
    - flow of programming, 760
    - GapMean(Chan), 767
    - MaxEnvelopeGap(Chan), 768
    - MaxGap(Chan), 769
    - MaxLeftGap(Chan), 770
    - MaxPeakToPeak(Chan), 771
    - MaxRightGap(Chan), 772
    - MaxRipplePoint(Chan,Stim), 773
    - MaxRippleValue(Chan), 774
    - Pole(Chan,D,LeftStim,LeftValue,RightStim,RightValue), 775
    - simple use example, 762
    - specifying analysis range, 760
  - running
    - running a VBA program, 52
  - S**
  - sample program
    - apl\_bsc.vba, 96
    - apl\_fem.vba, 118
    - apl\_sys.vba, 104
    - ctrl\_ext.vba, 93
    - how to load, 24, 25
    - map\_drive.vba, 132
    - meas\_sing.vba, 73
    - meas\_srq.vba, 70
    - meas\_user.vba, 82
    - pow\_cal.vba, 126
    - read\_write.vba, 76
    - visa32.bas, 88
    - vpptype.bas, 88
  - sample program disk
    - notice, 3
  - Save Project button, 47
  - saving
    - saving a module, 47
    - saving a project file, 46
  - SCPI, 421
  - SCPI command
    - major control difference between COM object and SCPI command, 32
  - SCPI objects, 137
  - segment sweep setting
    - Setup\_Segment procedure, 108
  - Select Macro button, 54
  - Serial number plate, 788
  - Service Request Enable Register
    - Setting, 422
  - Setup\_Limitline
    - procedure for limit test setting, 109
  - Setup\_Parameter
    - procedure for setting measurement conditions, 108
  - Setup\_Register
    - procedure for setting status register, 109
  - Setup\_Segment
    - procedure for segment sweep setting, 108
  - softkey
    - executing a procedure with assigned softkey, 80
    - executing a VBA program in the VBA folder, 54
  - SRQ
    - suspending program until detection, 70
  - Standard Event Status Register
    - Reading out, 419
    - Setting valid registers, 418
  - standard module, 37
    - inserting standard module, 40
  - Status Byte Register
    - Reading out, 423
  - status register
    - detecting the end of measurement, 70
  - status register setting
    - Setup\_Register procedure, 109
  - step-in
    - debug toolbar, 58
  - step-out
    - debug toolbar, 58
  - step-over
    - debug toolbar, 58
  - Stop button, 55
  - syntax
    - COM object reference, 196
  - T**
  - toolbar, 34
    - debug toolbar, 58
  - trigger, 423
  - triggering
    - detecting the end of measurement, 70
  - type of object
    - COM object reference, 196
  - U**
  - user form, 37
    - inserting UserForm, 38
  - User Menu button, 81
  - user menu function, 80
-

User Variable, 85  
User's Guide, 4  
UserMenu\_OnPress Procedure, 80

## V

variable  
    COM object reference, 197  
    monitoring variables, 60  
Variant type  
    storing array data, 75  
VBA  
    introduction of the macro function, 28  
VBA Editor button, 34  
VBA programmer's  
    contents of this manual, 22  
    how to use this manual, 24  
VBA Programmer's Guide, 4  
vbreadme.txt  
    CD-ROM, 89  
viClose function  
    VISA, 92  
viOpen function  
    VISA, 90  
viOpenDefaultRM function  
    VISA, 90  
VISA  
    control flow with VISA, 89  
    importing definition files, 88  
    notes on using VISA library with VB, 89  
    online help of VISA library, 89  
    program to read out the product information on peripherals,  
        93  
    programming using VISA, 89  
visa.hlp  
    CD-ROM, 89  
Visual Basic Editor  
    closing Visual Basic Editor, 36  
    displaying Visual Basic Editor, 34  
    initial screen, 34  
viVPrintf function  
    VISA, 91  
viVScanf function  
    VISA, 92

## W

wait, 423  
WaitOnSRQ, 70  
watch window, 61  
writing  
    reading/writing measurement data, 75



# REGIONAL SALES AND SUPPORT OFFICES

*For more information about Agilent Technologies test and measurement products, applications, services, and for a current sales office listing, visit our web site: <http://www.agilent.com/find/tmdir>. You can also contact one of the following centers and ask for a test and measurement sales representative. 21/01/2004*

## **United States:**

Test and Measurement Call Center  
(tel) 1 800 452-4844  
(fax) 1 888 900-8921

## **Australia/New Zealand:**

(tel) (61 3) 9210-5555 (Australia)  
(fax) (61 3) 9210-5899  
(tel) (64 4) 939-0636 (New Zealand)  
(fax) (64 4) 972-5364

## **Canada:**

Test and Measurement Call Center  
(tel) 1 877 894-4414  
(fax) 1 888 900-8921

## **Asia Pacific:**

(tel) (65) 6375-8100  
(fax) (65) 6836-0252  
Email: [tm\\_asia@agilent.com](mailto:tm_asia@agilent.com)

## **China:**

(tel) 800 810-0189  
(fax) 800 820-2816

## **Europe:**

(tel) (31 20) 547-2323  
(fax) (31 20) 547-2390

## **Japan:**

Call Center  
(tel) 0120 421-345  
(tel) (81) 426 56-7832  
(fax) (81) 426 56-7840

## **Korea:**

(tel) (82 2) 2004-5004  
(fax) (82 2) 2004-5115

## **Latin America:**

(tel) (305) 269-7500  
(fax) (305) 269-7599

## **Taiwan:**

(tel) 0800 047 866  
(fax) 0800 286 331