

Keysight X-Series Signal Analyzer

This help file provides documentation for the following X-Series Analyzers:

PXA Signal Analyzer N9030A
MXA Signal Analyzer N9020A
EXA Signal Analyzer N9010A
CXA Signal Analyzer N9000A

Notice: This document contains references to Agilent. Please note that Agilent's Test and Measurement business has become Keysight Technologies. For more information, go to www.keysight.com.

Multi-Standard
Radio (MSR) Mode
User's &
Programmer's
Reference

Notices

Copyright Notice

© Keysight Technologies 2011–2015

No part of this manual may be reproduced in any form or by any means (including electronic storage and retrieval or translation into a foreign language) without prior agreement and written consent from Keysight Technologies, Inc. as governed by United States and international copyright laws.

Manual Part Number

N9083-90001

Edition

Edition: 1, June 2015

Supersedes: August 2014

Published by:

Keysight Technologies, Inc.
1400 Fountaingrove Parkway
Santa Rosa, CA 95403

Technology Licenses

The hardware and/or software described in this document are furnished under a license and may be used or copied only in accordance with the terms of such license.

U.S. Government Rights

The Software is “commercial computer software,” as defined by Federal Acquisition Regulation (“FAR”) 2.101. Pursuant to FAR 12.212 and 27.405-3 and Department of Defense FAR Supplement (“DFARS”) 227.7202, the US government acquires commercial computer software under the same terms by which the software is customarily provided to the public. Accordingly, Keysight provides the Software to US government customers under its standard commercial license, which is embodied in its End User License Agreement (EULA), a copy of which can be found at

<http://www.keysight.com/find/sweula>

The license set forth in the EULA represents the exclusive authority by which the US government may use, modify, distribute, or disclose the Software. The EULA and the license set forth therein, does not require or permit, among other things, that Keysight: (1) Furnish technical information related to commercial computer software or commercial computer software documentation that is not customarily provided to the public; or (2) Relinquish to, or otherwise provide, the government rights in excess of these rights customarily provided to the public to use, modify, reproduce, release, perform, display, or disclose commercial computer software or commercial computer software documentation. No additional government requirements beyond those set forth in the EULA shall apply, except to the extent that those terms, rights, or licenses are explicitly required from all providers of commercial computer software pursuant to the FAR and the DFARS and are set forth specifically in writing elsewhere in the EULA. Keysight shall be under no obligation to update, revise or otherwise modify the Software. With respect to any technical data as defined by FAR 2.101, pursuant to FAR 12.211 and 27.404.2 and DFARS 227.7102, the US government acquires no greater than Limited Rights as defined in FAR 27.401 or DFAR 227.7103-5 (c), as applicable in any technical data.

Warranty

THE MATERIAL CONTAINED IN THIS DOCUMENT IS PROVIDED “AS IS,” AND IS SUBJECT TO BEING CHANGED, WITHOUT NOTICE, IN FUTURE EDITIONS. FURTHER, TO THE MAXIMUM EXTENT PERMITTED BY APPLICABLE LAW, KEYSIGHT DISCLAIMS ALL WARRANTIES, EITHER EXPRESS OR IMPLIED, WITH REGARD TO THIS MANUAL AND ANY INFORMATION CONTAINED HEREIN, INCLUDING BUT NOT LIMITED TO THE IMPLIED WARRANTIES OF MERCHANTABILITY AND FITNESS FOR A PARTICULAR PURPOSE. KEYSIGHT SHALL NOT BE LIABLE FOR ERRORS OR FOR INCIDENTAL OR CONSEQUENTIAL DAMAGES IN CONNECTION WITH THE FURNISHING, USE, OR PERFORMANCE OF THIS DOCUMENT OR OF ANY INFORMATION CONTAINED HEREIN. SHOULD KEYSIGHT AND THE USER HAVE A SEPARATE WRITTEN AGREEMENT WITH WARRANTY TERMS COVERING THE MATERIAL IN THIS DOCUMENT THAT CONFLICT WITH THESE TERMS, THE WARRANTY TERMS IN THE SEPARATE AGREEMENT SHALL CONTROL.

Safety Information

CAUTION

A CAUTION notice denotes a hazard. It calls attention to an operating procedure, practice, or the like that, if not correctly performed or adhered to, could result in damage to the product or loss of important data. Do not proceed beyond a CAUTION notice until the indicated conditions are fully understood and met.

WARNING

A WARNING notice denotes a hazard. It calls attention to an operating procedure, practice, or the like that, if not correctly performed or adhered to, could result in personal injury or death. Do not proceed beyond a WARNING notice until the indicated conditions are fully understood and met.

Table of Contents

Multi-Standard Radio (MSR) Mode User's & Programmer's Reference	i
Table of Contents	iii
1 About the Analyzer	75
Installing Application Software	76
Viewing a License Key	76
Obtaining and Installing a License Key	76
Updating Measurement Application Software	76
X-Series Options and Accessories	78
Front-Panel Features	79
Display Annotations	80
Rear-Panel Features	81
Window Control Keys	82
Multi-Window	82
Zoom	82
Next Window	83
Full Screen	84
Display Enable (Remote Command Only)	84
Mouse and Keyboard Control	86
Right-Click	86
PC Keyboard	88
Instrument Security & Memory Volatility	91
2 About the MSR Measurement Application	93
What Does the MSR Application Do?	94
3 Programming the Analyzer	97
What Programming Information is Available?	98
List of SCPI Commands	99
STATus Subsystem	137
Detailed Description	139
What Are Status Registers	140
What Are Status Register SCPI Commands	140
How to Use the Status Registers	141
Using a Status Register	142
Using the Service Request (SRQ) Method	144
Generating a Service Request	144
Status Register System	145
The Status Byte Register	145
Standard Event Status Register	147
Operation and Questionable Status Registers	149
Operation Status Register	149
Questionable Status Register	149
STATus Subsystem Command Descriptions	150
Operation Register	150

Operation Condition Query	150
Operation Enable	151
Operation Event Query	151
Operation Negative Transition	151
Operation Positive Transition	152
Preset the Status Byte	152
Questionable Register	153
Questionable Condition	153
Questionable Enable	153
Questionable Event Query	154
Questionable Negative Transition	154
Questionable Positive Transition	154
Questionable Calibration Register	155
Questionable Calibration Condition	155
Questionable Calibration Enable	155
Questionable Calibration Event Query	156
Questionable Calibration Negative Transition	156
Questionable Calibration Positive Transition	157
Questionable Calibration Skipped Register	157
Questionable Calibration Skipped Condition	157
Questionable Calibration Skipped Enable	158
Questionable Calibration Skipped Event Query	158
Questionable Calibration Skipped Negative Transition	159
Questionable Calibration Skipped Positive Transition	159
Questionable Calibration Extended Failure Register	159
Questionable Calibration Extended Failure Condition	160
Questionable Calibration Extended Failure Enable	160
Questionable Calibration Extended Failure Event Query	160
Questionable Calibration Extended Failure Negative Transition	161
Questionable Calibration Extended Failure Positive Transition	161
Questionable Calibration Extended Needed Register	162
Questionable Calibration Extended Needed Condition	162
Questionable Calibration Extended Needed Enable	162
Questionable Calibration Extended Needed Event Query	163
Questionable Calibration Extended Needed Negative Transition	163
Questionable Calibration Extended Needed Positive Transition	164
Questionable Frequency Register	164
Questionable Frequency Condition	164
Questionable Frequency Enable	165
Questionable Frequency Event Query	165
Questionable Frequency Negative Transition	165
Questionable Frequency Positive Transition	166
Questionable Integrity Register	166
Questionable Integrity Condition	166
Questionable Integrity Enable	167
Questionable Integrity Event Query	167

Questionable Integrity Negative Transition	168
Questionable Integrity Positive Transition	168
Questionable Integrity Signal Register	169
Questionable Integrity Signal Condition	169
Questionable Integrity Signal Enable	169
Questionable Integrity Signal Event Query	170
Questionable Integrity Signal Negative Transition	170
Questionable Integrity Signal Positive Transition	170
Questionable Integrity Uncalibrated Register	171
Questionable Integrity Uncalibrated Condition	171
Questionable Integrity Uncalibrated Enable	171
Questionable Integrity Uncalibrated Event Query	172
Questionable Integrity Uncalibrated Negative Transition	172
Questionable Integrity Uncalibrated Positive Transition	173
Questionable Power Register	173
Questionable Power Condition	173
Questionable Power Enable	174
Questionable Power Event Query	174
Questionable Power Negative Transition	175
Questionable Power Positive Transition	175
Questionable Temperature Register	175
Questionable Temperature Condition	176
Questionable Temperature Enable	176
Questionable Temperature Event Query	176
Questionable Temperature Negative Transition	177
Questionable Temperature Positive Transition	177
IEEE 488.2 Common Commands	179
All	179
Clear Status	181
Standard Event Status Enable	182
Standard Event Status Register Query	182
Identification Query	183
Operation Complete	183
Query Instrument Options	184
Recall Instrument State	185
*RST (Remote Command Only)	185
Save Instrument State	186
Service Request Enable	186
Status Byte Query	186
Trigger	187
Self Test Query	187
Wait-to-Continue	187
4 Input/Output Functions	189
Input/Output	190
Input/Output variables - Preset behavior	191

RF Input	192
Input Z Correction	192
RF Coupling	193
External Mixer	194
More Information	195
Ext Mix Setup	198
Mixer Presets	203
Mixer Bias	209
Mixer Path	209
Mixer Path	210
Cable IF Loss	211
I/Q	212
Baseband I/Q (Option BBA)	212
Baseband I/Q Remote Language Compatibility	214
I/Q Path	215
I+jQ	216
I Only	216
Q Only	216
I Setup	217
I Differential Input	217
I Input Z	218
I Skew	218
I Probe	219
Combined Differential/Input Z (Remote Command Only)	221
Q Setup	222
Q Same as I	222
Q Differential Input	222
Q Input Z	223
Q Skew	224
Q Probe	224
Reference Z	226
I/Q Cable Calibrate...	227
I/Q Probe Setup	228
Attenuation	228
Offset	229
Coupling	230
Calibrate	231
Clear Calibration	231
RF Calibrator	232
50 MHz	232
4.8 GHz	233
Off	233
External Gain	233
Ext Preamp	234
More Information	235
MS	235

BTS	236
I Ext Gain	237
Q Ext Gain	238
Filter Type	238
Restore Input/Output Defaults	239
Freq Ref In	240
Sense	241
Internal	242
External	242
Pulse	242
More Information	243
Ext Ref Freq	243
External Reference Lock BW	244
External Ref Coupling	245
Output Config	246
Trig Out	247
Polarity	247
Off	248
Sweeping (HSWP)	248
Measuring	248
Main Trigger	248
Gate Trigger	249
Gate	249
Source Point Trigger	249
Odd/Even Trace Point	250
Analog Out	250
More Information	250
Auto	251
Off	251
Screen Video	251
Log Video (RF Envelope, Ref=Mixer Level)	252
Linear Video (RF Envelope, Ref=Ref Level)	253
Demod Audio	254
Digital Bus	254
Bus Out On/Off	255
I/Q Cal Out	255
1 kHz Square Wave	256
250 kHz Square Wave	256
Off	256
Aux IF Out	256
Off	257
Second IF	257
Arbitrary IF	258
Fast Log Video	258
I/Q Guided Calibration	259
I/Q Isolation Calibration	259

Next	259
Exit	259
I/Q Isolation Calibration Time (Remote Command Only)	260
I/Q Cable Calibrate...	260
I Port	261
I-bar Port	262
Q Port	263
Q-bar Port	264
I/Q Cable Calibration Time (Remote Command Only)	265
I/Q Probe Calibration	265
I Port	266
I-bar Port	267
Q Port	268
Q-bar Port	269
Show Adapter Screen	270
I/Q Probe Calibration Time (Remote Command Only)	271
Exit Confirmation	271
LISN Control	271
V-network (Remote Command Only)	271
Phase (Remote Command Only)	272
150 kHz Highpass (Remote Command Only)	272
Protective Earth (Remote Command Only)	272
5 Mode Functions	275
Mode	276
More Information	277
Spectrum Analyzer	278
CMMB	278
DVB-T/H with T2	279
EMI Receiver	279
IQ Analyzer (Basic)	279
W-CDMA with HSPA+	280
GSM/EDGE/EDGE Evo	280
802.16 OFDMA (WiMAX/WiBro)	280
Vector Signal Analyzer (VXA)	281
Phase Noise	281
Noise Figure	282
Analog Demod	282
Bluetooth	282
TD-SCDMA with HSPA/8PSK	282
cdma2000	283
1xEV-DO	283
LTE-Advanced FDD	283
LTE-Advanced TDD	284
MSR	284
WLAN	285

SCPI Language Compatibility	285
iDEN/WiDEN/MOTOTalk	285
ISDB-T	286
Digital Cable TV	286
Remote Language Compatibility	286
89601 VSA	287
DTMB (CTTB)	287
Application Mode Number Selection (Remote Command Only)	288
Application Mode Catalog Query (Remote Command Only)	289
Application Identification (Remote Commands Only)	290
Current Application Model	290
Current Application Revision	290
Current Application Options	291
Application Identification Catalog (Remote Commands Only)	291
Application Catalog Number of Entries	291
Application Catalog Model Numbers	292
Application Catalog Revision	292
Application Catalog Options	292
Detailed List of Modes	293
1xEV-DO	293
802.16 OFDMA (WiMAX/WiBro)	293
802.16 OFDM (Fixed WiMAX)	293
89601 VSA	294
Analog Demod	295
Bluetooth	295
cdma2000	295
CMMB	295
Combined WLAN	296
Combined Fixed WiMAX	296
Digital Cable TV	296
DTMB (CTTB)	297
DVB-T/H with T2	297
EMI Receiver	297
GSM/EDGE/EDGE Evo	298
iDEN/WiDEN/MOTOTalk	298
IQ Analyzer (Basic)	298
ISDB-T	299
LTE	299
LTE TDD	299
LTE-Advanced FDD	299
LTE-Advanced TDD	300
MSR	300
Noise Figure	301
Phase Noise	301
Real Time Spectrum Analyzer	301
Remote Language Compatibility	302

SCPI Language Compatibility	302
Spectrum Analyzer	302
TD-SCDMA with HSPA/8PSK	303
Vector Signal Analyzer (VXA)	303
W-CDMA with HSPA+	304
WLAN	304
Global Settings	304
Global Center Freq	304
Restore Defaults	305
Mode Setup	306
Radio	306
Band	306
Operating Band	306
OB Start Freq	308
OB Stop Freq	309
Band Category	310
Assumed Adj Channels	310
Intermod	311
Interference Pwr Present	311
Freq Offset from Edge	311
Span	312
Offset Side	312
Non-Contiguous Interference Region	312
Format	313
LTE FDD	314
Select LTE FDD Parameter Set	314
Parameter Set Name	315
Format Parameter List	315
Bandwidth	319
W-CDMA	319
Select W-CDMA Parameter Set	320
Parameter Set Name	320
Format Parameter List	320
GSM/EDGE	325
Select GSM/EDGE Parameter Set	325
Parameter Set Name	326
Format Parameter List	326
cdma2000	330
Select cdma2000 Parameter Set	330
Parameter Set Name	330
Format Parameter List	331
1xEV-DO	335
Select 1xEV-DO Parameter Set	335
Parameter Set Name	336
Format Parameter List	336
LTE TDD	344

Select LTE TDD Parameter Set	344
Parameter Set Name	344
Format Parameter List	344
Bandwidth	349
TD-SCDMA	349
Select TD-SCDMA Parameter Set	350
Parameter Set Name	350
Format Parameter List	350
Noise Reduction	356
Noise Floor Extension	357
More Information	358
Restore Mode Defaults	359
Preset Type (Remote Command Only)	359
6 System Functions	361
File	362
File Explorer	362
Page Setup	363
Print	364
Restore Down	364
Minimize	364
Exit	365
Print	365
Maximize/Restore Down	365
Maximize	365
Restore Down	366
Print	367
System	368
Show	368
Errors	368
Previous Page	369
Next Page	370
History	370
Verbose SCPI On/Off	370
Refresh	371
Clear Error Queue	371
Status	371
Input Overload Enable (Remote Command Only)	371
Power Up (Remote Command Only)	372
System	372
Show System contents (Remote Command Only)	373
Computer System description (Remote Command Only)	373
Hardware	374
LXI	375
System Remote Commands (Remote Commands Only)	375
System Powerdown (Remote Command Only)	375

System Log Off (Remote Command Only)	375
List installed Options (Remote Command Only)	376
Lock the Front-panel keys (Remote Command Only)	376
List SCPI Commands (Remote Command Only)	377
SCPI Version Query (Remote Command Only)	377
Date (Remote Command Only)	377
Time (Remote Command Only)	377
Power On	378
Mode and Input/Output Defaults	378
User Preset	379
Last State	379
Power On Application	380
Configure Applications	380
Preloading Applications	381
Access to Configure Applications utility	381
Virtual memory usage	381
Select All	382
Deselect All	382
Move Up	382
Move Down	383
Select/Deselect	383
Save Changes and Exit	383
Exit Without Saving	384
Restore Power On Defaults	384
Configure Applications - Instrument boot-up	384
Configure Applications - Windows desktop	384
Configure Applications - Remote Commands	385
Configuration list (Remote Command Only)	385
Configuration Memory Available (Remote Command Only)	385
Configuration Memory Total (Remote Command Only)	386
Configuration Memory Used (Remote Command Only)	386
Configuration Application Memory (Remote Command Only)	386
Alignments	386
Auto Align	387
Normal	387
Partial	388
Off	389
All but RF	389
Alert	390
Execute Expired Alignments (Remote Command Only)	393
Align Now	393
All	393
All but RF	395
RF	397
External Mixer	398
Show Alignment Statistics	399

Restore Align Defaults	404
Backup or Restore Align Data...	405
Alignment Data Wizard	406
Perform Backup (Remote Command Only)	411
Perform Restore (Remote Command Only)	412
Advanced	412
Characterize Preselector	412
Characterize Reference Clock	414
Characterize Noise Floor	417
TDS Alignment	419
Timebase DAC	419
Calibrated	420
User	420
I/O Config	421
GPIB	421
GPIB Address	421
GPIB Controller	422
SCPI LAN	423
SCPI Telnet	423
SCPI Socket	423
SICL Server	424
HiSLIP Server	425
SCPI Socket Control Port (Remote Command Only)	425
Reset Web Password	426
LXI	426
LAN Reset	426
Device Identification (Remote Command Only)	427
System IDN Response	427
Factory	427
User	428
Query USB Connection (Remote Command Only)	428
USB Connection Status (Remote Command Only)	429
USB Packet Count (Remote Command Only)	429
Restore Defaults	430
Restore Input/Output Defaults	430
Restore Power On Defaults	431
Restore Align Defaults	431
Restore Misc Defaults	432
Restore Mode Defaults (All Modes)	433
All	434
Control Panel...	434
Licensing...	435
Security	437
USB	438
Read-Write	438
Read only	438

Diagnostics	439
Show Hardware Statistics	439
SCPI for Show Hardware Statistics (Remote Commands Only)	440
Advanced	441
Internet Explorer...	442
7 Trigger Functions	443
Trigger	444
Trigger Source Presets	445
RF Trigger Source	448
I/Q Trigger Source	449
More Information	450
Free Run	451
Video (IF Envelope)	452
Trigger Level	452
Trig Slope	453
Trig Delay	454
Line	455
Trig Slope	456
Trig Delay	456
External 1	457
Trigger Level	457
Trig Slope	458
Trig Delay	459
Zero Span Delay Comp On/Off	459
External 2	460
Trigger Level	460
Trig Slope	461
Trig Delay	461
Zero Span Delay Comp On/Off	462
RF Burst	463
Absolute Trigger Level	463
Relative Trigger Level	464
Trigger Slope	465
Trig Delay	466
Periodic Timer (Frame Trigger)	467
Period	468
Offset	469
Reset Offset Display	470
Sync Source	470
Off	471
External 1	471
External 2	472
RF Burst	474
Trig Delay	476
Auto/Holdoff	477

Auto Trig	477
Trig Holdoff	478
Holdoff Type	478
8 Channel Power Measurement	481
AMPTD Y Scale	490
Ref Value	490
Attenuation	490
Dual Attenuator Configurations:	491
Single Attenuator Configuration:	492
(Mech) Atten	492
Attenuator Configurations and Auto/Man	494
Enable Elec Atten	494
More Information	495
Mechanical Attenuator Transition Rules	495
When the Electronic Attenuation is enabled from a disabled state:	495
Examples in the dual attenuator configuration:	495
When the Electronic Attenuation is disabled from an enabled state:	496
Using the Electronic Attenuator: Pros and Cons	496
Elec Atten	496
Adjust Atten for Min Clip	497
Pre-Adjust for Min Clip	497
Off	498
Elec Atten Only	498
Mech + Elec Atten	499
(Mech) Atten Step	499
Adjust Atten (Remote Command only)	500
Scale/Div	500
Presel Center	501
Proper Preselector Operation	501
Preselector Adjust	502
μ W Path Control	503
Standard Path	504
Low Noise Path Enable	504
More Information	505
μ W Preselector Bypass	506
Internal Preamp	507
Off	509
Low Band	509
Full Range	509
Ref Position	509
Auto Scaling	510
Auto Couple	511
More Information	511
Auto/Man Active Function keys	511
Auto/Man 1-of-N keys	511

BW	513
Res BW	513
Video BW	514
Filter Type	516
Cont (Continuous Measurement/Sweep)	517
File	519
FREQ Channel	520
Carrier Ref Freq	520
Carrier Setup	520
Carriers	521
Configure Carriers	521
Select Carrier	521
Measure Carrier	522
Carrier Offset	522
Radio Format	522
Carrier Allocation	525
Non-Contiguous	525
Carrier Conf Presets	527
MSR Test Config	528
MSR Non-Contig Test Config	532
Single RAT Config	535
Max BS RF Bandwidth	539
Channel Spacing Delta	539
Apply to Meas Offset/Limits	542
RF Bandwidth (Remote Command Only)	542
RF Bandwidth Center (Remote Command Only)	543
Sub-block Center (Remote Command Only)	543
Sub-block Bandwidth (Remote Command Only)	543
Sub-block Gap (Remote Command Only)	544
Input/Output	545
Marker	546
Select Marker	546
Marker Type	546
Properties	547
Select Marker	547
Relative To	547
All Markers Off	548
Marker X Axis Value (Remote Command Only)	548
Marker X Axis Position (Remote Command Only)	548
Marker Y Axis Value (Remote Command only)	549
Backward Compatibility SCPI Commands	549
Marker Function	551
Marker To	552
Meas	553
Remote Measurement Functions	553
Measurement Group of Commands	554

Current Measurement Query (Remote Command Only)	556
Limit Test Current Results (Remote Command Only)	556
Data Query (Remote Command Only)	556
Calculate/Compress Trace Data Query (Remote Command Only)	557
Calculate Peaks of Trace Data (Remote Command Only)	562
Hardware-Accelerated Fast Power Measurement (Remote Command Only)	563
Reset Fast Power Measurement (Remote Command Only)	563
Define Fast Power Measurement (Remote Command Only)	564
Define Fast Power Measurement Query (Remote Command Only)	573
Configure Fast Power Measurement (Remote Command Only)	574
Initiate Fast Power Measurement (Remote Command Only)	575
Fetch Fast Power Measurement (Remote Command Only)	575
Execute Fast Power Measurement (Remote Command Only)	575
Binary Read Fast Power Measurement (Remote Command Only)	576
Diagnostic Binary Read Fast Power Measurement (Remote Command Only)	576
Format Data: Numeric Data (Remote Command Only)	577
Format Data: Byte Order (Remote Command Only)	578
Meas Setup	579
Avg/Hold Num	579
Avg Mode	580
Carrier Results (Only for MSR and LTE-Advanced FDD/TDD)	581
PhNoise Opt	581
PhNoise Opt Auto	581
PhNoise Opt State	582
IF Gain	583
IF Gain Auto	583
IF Gain State	583
PSD Unit	584
Meas Preset	584
Mode	586
Mode Preset	587
How-To Preset	588
Preset Type (Remote Command Only)	589
Mode Setup	590
Peak Search	591
Print	592
Quick Save	593
Recall	595
State	595
More Information	596
From File...	597
Edit Register Names	598
Register 1 thru Register 16	599
Register 1 thru Register 16	599
Data (Import)	600
Parameter Set	601

Masks	604
Open...	605
Restart	606
More Information	606
Save	608
State	608
To File . . .	609
Edit Register Names	611
More Information	611
Register 1 thru Register 16	612
Register 1 thru Register 16	612
Mass Storage Catalog (Remote Command Only)	613
Mass Storage Change Directory (Remote Command Only)	613
Mass Storage Copy (Remote Command Only)	614
Mass Storage Device Copy (Remote Command Only)	614
Mass Storage Delete (Remote Command Only)	614
Mass Storage Data (Remote Command Only)	615
Mass Storage Make Directory (Remote Command Only)	615
Mass Storage Move (Remote Command Only)	615
Mass Storage Remove Directory (Remote Command Only)	616
Mass Storage Determine Removable Media (Remote Command Only)	616
Mass Storage Determine Removable Media Label (Remote Command Only)	616
Mass Storage Determine Removable Media Write-protect status (Remote Command Only)	617
Mass Storage Determine Removable Media size (Remote Command Only)	617
Trace (+State)	617
From Trace	619
From File...	619
Register 1 thru Register 16	621
Data (Export)	622
Parameter Set	622
Measurement Results	623
Save As . . .	626
Screen Image	627
Themes	628
3D Color	628
3D Monochrome	628
Flat Color	629
Flat Monochrome	629
Save As...	629
Single (Single Measurement/Sweep)	630
More Information	630
Source	631
Span X Scale	632
Sweep/Control	633
Sweep Time	633

Sweep Setup	634
Auto Sweep Time Rules	634
Pause	635
Gate	635
Gate On/Off	635
Gate View On/Off	636
Gate View Setup	639
Gate View Sweep Time	640
Gate View Start Time	640
Gate Delay	641
Gate Length	641
Gate Source	642
Line	643
External 1	643
External 2	645
RF Burst	648
Periodic Timer (Frame Trigger)	651
Control Edge/Level	662
Gate Holdoff	663
Gate Delay Compensation	664
More Information	665
Min Fast Position Query (Remote Command Only)	666
Gate Preset (Remote Command Only)	666
Gate Level (Remote Command Only)	666
Gate Polarity (Remote Command Only)	667
Points	667
System	669
Trace/Detector	670
Trace Type	670
Detector	670
Auto	671
Detector Selection	671
Trigger	673
Free Run	673
Video	673
Trigger Level	673
Trig Slope	673
Trig Delay	673
Line	673
Trig Slope	673
Trig Delay	673
External 1	673
Trigger Level	673
Trig Slope	673
Trig Delay	673
Zero Span Delay Comp	673

External 2	674
Trigger Level	674
Trig Slope	674
Trig Delay	674
Zero Span Delay Comp	674
RF Burst	674
Absolute Trigger	674
Relative Trigger	674
Trig Slope	674
Trig Delay	674
Periodic Timer	674
Period	674
Offset	674
Reset Offset Display	674
Sync Source	675
Off	675
External 1	675
External 2	675
RF Burst	675
Trig Delay	675
Auto/Holdoff	675
Auto Trig	675
Trig Holdoff	675
Holdoff Type	676
User Preset	677
User Preset	677
User Preset All Modes	678
Save User Preset	679
View/Display	680
View selection by name (MSR and LTE-Advanced FDD/TDD only)	682
Selects the results view. The following SCPI command allows you to select the desired measurement view by enumeration.	682
Selects the results view. The following SCPI command allows you to select the desired measurement view by enumeration.	683
View selection by name (DTMB (CTTB), DVB-T/H only)	683
View selection by name (ISDB-T, CMMB only)	684
Display	684
Annotation	684
Meas Bar On/Off	685
Screen	686
Active Function Values On/Off	686
Title	687
Change Title	687
Clear Title	688
Graticule	689
System Display Settings	689

Annotation Local Settings	689
Themes	690
Backlight	691
Backlight Intensity	692
Power Results (Only for MSR and LTE-Advanced FDD/TDD)	692
Traces Window	693
Results Window for MSR	693
Carrier Info (Only for MSR and LTE-Advanced FDD/TDD)	694
Traces Window	695
Results Window	695
Carrier Freq (Only for MSR and LTE-Advanced FDD/TDD)	696
Bar Graph	696
9 Occupied Bandwidth Measurement	697
AMPTD Y Scale (Amplitude/Y Scale)	701
Ref Value	701
Attenuation	701
Dual Attenuator Configurations:	702
Single Attenuator Configuration:	703
(Mech) Atten	703
Attenuator Configurations and Auto/Man	705
Enable Elec Atten	705
More Information	706
Mechanical Attenuator Transition Rules	706
When the Electronic Attenuation is enabled from a disabled state:	706
Examples in the dual attenuator configuration:	706
When the Electronic Attenuation is disabled from an enabled state:	707
Using the Electronic Attenuator: Pros and Cons	707
Elec Atten	707
Adjust Atten for Min Clip	708
Pre-Adjust for Min Clip	708
Off	709
Elec Atten Only	709
Mech + Elec Atten	710
(Mech) Atten Step	710
Adjust Atten (Remote Command only)	711
Scale/Div	711
Presel Center	712
Proper Preselector Operation	712
Preselector Adjust	713
μ W Path Control	714
Standard Path	715
Low Noise Path Enable	715
More Information	716
μ W Preselector Bypass	717
Internal Preamp	718

Off	720
Low Band	720
Full Range	720
Ref Position	720
Auto Scaling	721
Auto Couple	722
More Information	722
Auto/Man Active Function keys	722
Auto/Man 1-of-N keys	722
BW	724
Res BW	724
Video BW	725
Filter Type	726
Cont (Continuous Measurement/Sweep)	728
File	730
FREQ Channel	731
Carrier Ref Freq	731
Carrier Setup	731
Carriers	732
Configure Carriers	732
Select Carrier	732
Measure Carrier	733
Carrier Offset	733
Radio Format	733
Carrier Allocation	736
Non-Contiguous	736
Carrier Conf Presets	738
MSR Test Config	739
MSR Non-Contig Test Config	743
Single RAT Config	746
Max BS RF Bandwidth	750
Channel Spacing Delta	750
Apply to Meas Offset/Limits	753
RF Bandwidth (Remote Command Only)	753
RF Bandwidth Center (Remote Command Only)	754
Sub-block Center (Remote Command Only)	754
Sub-block Bandwidth (Remote Command Only)	754
Sub-block Gap (Remote Command Only)	755
Input/Output	756
Marker	757
Select Marker	757
Select Marker	757
Marker Type	757
Properties	758
Select Marker	758
Select Marker	758

Relative To	758
All Markers Off	759
Marker X Axis Value (Remote Command Only)	759
Marker X Axis Position (Remote Command Only)	760
Marker Y Axis Value (Remote Command Only)	760
Backward Compatibility SCPI Commands	761
Marker Function	762
Marker To	763
Meas	764
Remote Measurement Functions	764
Measurement Group of Commands	765
Current Measurement Query (Remote Command Only)	767
Limit Test Current Results (Remote Command Only)	767
Data Query (Remote Command Only)	767
Calculate/Compress Trace Data Query (Remote Command Only)	768
Calculate Peaks of Trace Data (Remote Command Only)	773
Hardware-Accelerated Fast Power Measurement (Remote Command Only)	774
Reset Fast Power Measurement (Remote Command Only)	774
Define Fast Power Measurement (Remote Command Only)	775
Define Fast Power Measurement Query (Remote Command Only)	784
Configure Fast Power Measurement (Remote Command Only)	785
Initiate Fast Power Measurement (Remote Command Only)	786
Fetch Fast Power Measurement (Remote Command Only)	786
Execute Fast Power Measurement (Remote Command Only)	786
Binary Read Fast Power Measurement (Remote Command Only)	787
Diagnostic Binary Read Fast Power Measurement (Remote Command Only)	787
Format Data: Numeric Data (Remote Command Only)	788
Format Data: Byte Order (Remote Command Only)	789
Meas Setup	790
Avg/Hold Num	790
Avg Mode	791
Occ BW % Pwr	791
x dB	792
IF Gain	793
IF Gain Auto	793
IF Gain State	793
Limit (for MSR and LTE-Advanced FDD/TDD mode)	794
Limit Test	794
Bandwidth for MSR	795
Meas Preset	795
Max Hold (Remote Command Only)	795
Mode	797
Mode Preset	798
How-To Preset	799
Mode Setup	801
Peak Search	802

Table of Contents

Print	803
Quick Save	804
Recall	806
State	806
More Information	807
From File...	808
Edit Register Names	809
Register 1 thru Register 16	810
Register 1 thru Register 16	810
Data (Import)	811
Parameter Set	812
Masks	815
Open...	816
Restart	817
More Information	817
Save	819
State	819
To File . . .	820
Edit Register Names	822
More Information	822
Register 1 thru Register 16	823
Register 1 thru Register 16	823
Mass Storage Catalog (Remote Command Only)	824
Mass Storage Change Directory (Remote Command Only)	824
Mass Storage Copy (Remote Command Only)	825
Mass Storage Device Copy (Remote Command Only)	825
Mass Storage Delete (Remote Command Only)	825
Mass Storage Data (Remote Command Only)	826
Mass Storage Make Directory (Remote Command Only)	826
Mass Storage Move (Remote Command Only)	826
Mass Storage Remove Directory (Remote Command Only)	827
Mass Storage Determine Removable Media (Remote Command Only)	827
Mass Storage Determine Removable Media Label (Remote Command Only)	827
Mass Storage Determine Removable Media Write-protect status (Remote Command Only)	828
Mass Storage Determine Removable Media size (Remote Command Only)	828
Trace (+State)	828
From Trace	830
From File...	830
Register 1 thru Register 16	832
Data (Export)	833
Parameter Set	833
Measurement Results	834
Meas Results File Definition	835
Meas Results File Example	836
Save As . . .	837

Screen Image	838
Themes	839
3D Color	839
3D Monochrome	839
Flat Color	840
Flat Monochrome	840
Save As...	840
Mass Storage Catalog (Remote Command Only)	841
Mass Storage Change Directory (Remote Command Only)	841
Mass Storage Copy (Remote Command Only)	841
Mass Storage Device Copy (Remote Command Only)	842
Mass Storage Data (Remote Command Only)	842
Mass Storage Delete (Remote Command Only)	842
Mass Storage Make Directory (Remote Command Only)	843
Mass Storage Move (Remote Command Only)	843
Mass Storage Remove Directory (Remote Command Only)	843
Single (Single Measurement/Sweep)	844
More Information	844
Source	845
Span X Scale	846
Span	846
Last Span	847
Sweep/Control	848
Sweep Time	848
Sweep Setup	849
Auto Sweep Time Rules	849
Pause	850
Gate	850
Gate On/Off	850
Gate View On/Off	851
Gate View Setup	854
Gate View Sweep Time	855
Gate View Start Time	855
Gate Delay	856
Gate Length	856
Gate Source	857
Line	858
External 1	858
External 2	860
RF Burst	863
Periodic Timer (Frame Trigger)	866
Control Edge/Level	877
Gate Holdoff	878
Gate Delay Compensation	879
More Information	880
Min Fast Position Query (Remote Command Only)	881

Table of Contents

Gate Preset (Remote Command Only)	881
Gate Level (Remote Command Only)	881
Gate Polarity (Remote Command Only)	882
Points	882
System	884
Trace/Detector	885
Trace Type	885
Detector	885
Auto	886
Detector Selection	886
Trigger	888
Free Run	888
Video	888
Trigger Level	888
Trig Slope	888
Trig Delay	888
Line	888
Trig Slope	888
Trig Delay	888
External 1	888
Trigger Level	888
Trig Slope	888
Trig Delay	888
Zero Span Delay Comp	888
External 2	889
Trigger Level	889
Trig Slope	889
Trig Delay	889
Zero Span Delay Comp	889
RF Burst	889
Absolute Trigger	889
Relative Trigger	889
Trig Slope	889
Trig Delay	889
Periodic Timer	889
Period	889
Offset	889
Reset Offset Display	889
Sync Source	890
Off	890
External 1	890
External 2	890
RF Burst	890
Trig Delay	890
Auto/Holdoff	890
Auto Trig	890

Trig Holdoff	890
Holdoff Type	891
User Preset	892
User Preset	892
User Preset All Modes	893
Save User Preset	894
Display	895
Display	895
Annotation	895
Meas Bar On/Off	896
Screen	897
Active Function Values On/Off	897
Title	898
Change Title	898
Clear Title	899
Graticule	900
System Display Settings	900
Annotation Local Settings	900
Themes	901
Backlight	902
Backlight Intensity	903
View Selection	903
View Selection by Name	903
View Selection by Number	904
OBW Results	904
OBW Boundaries	905
Spectrum View	905
View Selection	909
View Selection by Name	910
View Selection by Number	910
OBW Results	911
OBW Boundaries	911
Spectrum View	911
Boundary Frequency	915
x dB BW Boundaries	916
10 ACP Measurement	917
AMPTD Y Scale	929
Ref Value	929
Attenuation	929
Dual Attenuator Configurations:	930
Single Attenuator Configuration:	931
(Mech) Atten	931
Attenuator Configurations and Auto/Man	933
Enable Elec Atten	933
More Information	934

Mechanical Attenuator Transition Rules	934
When the Electronic Attenuation is enabled from a disabled state:	934
Examples in the dual attenuator configuration:	934
When the Electronic Attenuation is disabled from an enabled state:	935
Using the Electronic Attenuator: Pros and Cons	935
Elec Atten	935
Adjust Atten for Min Clip	936
Pre-Adjust for Min Clip	936
Off	937
Elec Atten Only	937
Mech + Elec Atten	938
(Mech) Atten Step	938
Adjust Atten (Remote Command only)	939
Scale/Div	939
Presel Center	940
Proper Preselector Operation	940
Preselector Adjust	941
μ W Path Control	942
Standard Path	943
Low Noise Path Enable	943
More Information	944
μ W Preselector Bypass	945
Internal Preamp	946
Off	948
Low Band	948
Full Range	948
Ref Position	948
Auto Scaling	949
Auto Couple	950
More Information	950
Auto/Man Active Function keys	950
Auto/Man 1-of-N keys	950
BW	952
Res BW	952
Video BW	953
RBW Control	955
Filter Type	955
Filter BW	956
Cont (Continuous Measurement/Sweep)	957
File	959
FREQ Channel	960
Carrier Ref Freq	960
Carrier Setup	960
Carriers	961
Configure Carriers	961
Select Carrier	961

Measure Carrier	962
Carrier Offset	962
Radio Format	962
Carrier Allocation	965
Non-Contiguous	965
Carrier Conf Presets	967
MSR Test Config	968
MSR Non-Contig Test Config	972
Single RAT Config	975
Max BS RF Bandwidth	979
Channel Spacing Delta	979
Apply to Meas Offset/Limits	982
RF Bandwidth (Remote Command Only)	982
RF Bandwidth Center (Remote Command Only)	983
Sub-block Center (Remote Command Only)	983
Sub-block Bandwidth (Remote Command Only)	983
Sub-block Gap (Remote Command Only)	984
Input/Output	985
Marker	986
Select Marker	986
Marker Type	986
Properties	987
Select Marker	987
Relative To	987
Marker Trace	988
Couple Markers	989
Marker All Off	989
Marker X Axis Value (Remote Command only)	989
Marker X Axis Position (Remote Command only)	990
Marker Y Axis Value (Remote Command only)	991
Backward Compatibility Remote Commands	991
Marker Function	992
Marker To	993
Meas	994
Remote Measurement Functions	994
Measurement Group of Commands	995
Current Measurement Query (Remote Command Only)	997
Limit Test Current Results (Remote Command Only)	997
Data Query (Remote Command Only)	997
Calculate/Compress Trace Data Query (Remote Command Only)	998
Calculate Peaks of Trace Data (Remote Command Only)	1003
Hardware-Accelerated Fast Power Measurement (Remote Command Only)	1004
Reset Fast Power Measurement (Remote Command Only)	1004
Define Fast Power Measurement (Remote Command Only)	1005
Define Fast Power Measurement Query (Remote Command Only)	1014
Configure Fast Power Measurement (Remote Command Only)	1015

Initiate Fast Power Measurement (Remote Command Only)	1016
Fetch Fast Power Measurement (Remote Command Only)	1016
Execute Fast Power Measurement (Remote Command Only)	1016
Binary Read Fast Power Measurement (Remote Command Only)	1017
Diagnostic Binary Read Fast Power Measurement (Remote Command Only)	1017
Format Data: Numeric Data (Remote Command Only)	1018
Format Data: Byte Order (Remote Command Only)	1019
Meas Setup	1020
Average/Hold Number	1020
Avg Mode	1021
Power Ref (MSR Only)	1021
Carrier Index	1022
Manual	1023
Total Power	1023
PSD	1024
Offset/Limits	1025
Select Offset	1025
Offset Freq	1026
Integ BW	1027
Offset BW	1029
Res BW	1029
Video BW	1030
RBW Control	1032
Limits	1033
Select Offset	1034
Abs Limit	1034
Rel Lim (Car)	1035
Rel Limit (PSD)	1038
Fail Mask	1039
Offset Side	1040
Method for Offset	1041
Method for Offset	1042
Offset Frequency Define	1044
Inner Offset/Limits	1045
Select Inner Offset	1045
Offset Freq	1045
Integ BW	1046
Offset BW	1047
Res BW	1047
Video BW	1048
RBW Control	1049
Limits	1050
Select Inner Offset	1050
Abs Limit	1051
Rel Limit (Car)	1051
Rel Limit (PSD)	1052

Fail Mask	1053
Offset Side	1054
Method for Offset	1055
Filter Alpha for Offset	1055
Power Ref Type	1056
Offset Frequency Define for Inner Offset (MSR and LTE-Advanced FDD/TDD only)	1057
Carrier Result	1057
Meas Method	1058
Meas Type	1060
PSD Ref	1060
Limit Test	1061
Noise Correction	1062
Apply Carrier Config to Offset/Limits (Only for MSR)	1062
PhNoise Opt	1063
PhNoise Opt Auto	1063
PhNoise Opt State	1063
Meas Preset	1064
Offset RRC Weighting (Backward Compatibility SCPI)	1065
Offset Filter Alpha (Backward Compatibility SCPI)	1066
Method for Carrier (Backward Compatibility SCPI)	1066
Mode	1068
Mode Preset	1069
How-To Preset	1070
Preset Type (Remote Command Only)	1071
Mode Setup	1072
Peak Search	1073
Next Peak	1073
Next Pk Right	1073
Next Pk Left	1073
Marker Delta	1074
Pk-Pk Search	1074
Min Search	1074
Print	1076
Quick Save	1077
Recall	1079
State	1079
More Information	1080
From File...	1081
Edit Register Names	1082
Register 1 thru Register 16	1083
Register 1 thru Register 16	1083
Data (Import)	1084
Parameter Set	1085
Masks	1088
Open...	1089

Table of Contents

Restart	1090
More Information	1090
Save	1092
State	1092
To File . . .	1093
Edit Register Names	1095
More Information	1095
Register 1 thru Register 16	1096
Register 1 thru Register 16	1096
Mass Storage Catalog (Remote Command Only)	1097
Mass Storage Change Directory (Remote Command Only)	1097
Mass Storage Copy (Remote Command Only)	1098
Mass Storage Device Copy (Remote Command Only)	1098
Mass Storage Delete (Remote Command Only)	1098
Mass Storage Data (Remote Command Only)	1099
Mass Storage Make Directory (Remote Command Only)	1099
Mass Storage Move (Remote Command Only)	1099
Mass Storage Remove Directory (Remote Command Only)	1100
Mass Storage Determine Removable Media (Remote Command Only)	1100
Mass Storage Determine Removable Media Label (Remote Command Only)	1100
Mass Storage Determine Removable Media Write-protect status (Remote Command Only)	1101
Mass Storage Determine Removable Media size (Remote Command Only)	1101
Trace (+State)	1101
From Trace	1103
From File...	1103
Register 1 thru Register 16	1105
Data (Export)	1106
Parameter Set	1106
Measurement Results	1107
Save As . . .	1115
Screen Image	1116
Themes	1117
3D Color	1117
3D Monochrome	1118
Flat Color	1118
Flat Monochrome	1118
Save As...	1118
Single (Single Measurement/Sweep)	1120
More Information	1120
Source	1121
SPAN X Scale	1122
Span	1122
Last Span	1123
Sweep/Control	1124
Sweep TimeSweep Time	1124

Sweep Setup	1125
Auto Sweep Time Rules	1126
Pause	1126
Gate	1126
Gate On/Off	1127
Gate View On/Off	1128
Gate View Setup	1131
Gate View Sweep Time	1131
Gate View Start Time	1132
Gate Delay	1132
Gate Length	1133
Gate Source	1133
Line	1134
External 1	1135
External 2	1137
RF Burst	1139
Periodic Timer (Frame Trigger)	1142
Control Edge/Level	1153
Gate Holdoff	1154
Gate Delay Compensation	1155
More Information	1156
Min Fast Position Query (Remote Command Only)	1157
Gate Preset (Remote Command Only)	1157
Gate Level (Remote Command Only)	1158
Gate Polarity (Remote Command Only)	1158
Points	1158
System	1160
Trace/Detector	1161
Select Trace (Front-panel Only)	1161
Trace Type	1161
View/Blank	1162
Detector	1163
Auto	1164
Detector Selection	1164
Trigger	1166
Free Run	1166
Video	1166
Trigger Level	1166
Trig Slope	1166
Trig Delay	1166
Line	1166
Trig Slope	1166
Trig Delay	1166
External 1	1166
Trigger Level	1166
Trig Slope	1166

Trig Delay	1166
Zero Span Delay Comp	1166
External 2	1167
Trigger Level	1167
Trig Slope	1167
Trig Delay	1167
Zero Span Delay Comp	1167
RF Burst	1167
Absolute Trigger	1167
Relative Trigger	1167
Trig Slope	1167
Trig Delay	1167
Periodic Timer	1167
Period	1167
Offset	1167
Reset Offset Display	1167
Sync Source	1168
Off	1168
External 1	1168
External 2	1168
RF Burst	1168
Trig Delay	1168
Auto/Holdoff	1168
Auto Trig	1168
Trig Holdoff	1168
Holdoff Type	1169
User Preset	1170
User Preset	1170
User Preset All Modes	1171
Save User Preset	1172
View/Display	1173
Spectrum Window	1175
Results Window	1175
Display	1178
Annotation	1178
Meas Bar On/Off	1179
Screen	1180
Active Function Values On/Off	1180
Title	1181
Change Title	1181
Clear Title	1182
Graticule	1183
System Display Settings	1183
Annotation Local Settings	1183
Themes	1184
Backlight	1185

Backlight Intensity	1186
Power Results (MSR and LTE-Advanced FDD/TDD Only)	1186
Power Result Type (MSR and LTE-Advanced FDD/TDD Only)	1187
Carrier Info (MSR and LTE-Advanced FDD/TDD Only)	1187
Carrier Freq (MSR and LTE-Advanced FDD/TDD Only)	1189
Bar Graph	1189
11 Spectrum Emission Mask Measurement	1191
AMPTD Y Scale	1213
Ref Value	1213
Attenuation	1213
Dual Attenuator Configurations:	1214
Single Attenuator Configuration:	1215
(Mech) Atten	1215
Attenuator Configurations and Auto/Man	1217
Enable Elec Atten	1217
More Information	1218
Mechanical Attenuator Transition Rules	1218
When the Electronic Attenuation is enabled from a disabled state:	1218
Examples in the dual attenuator configuration:	1218
When the Electronic Attenuation is disabled from an enabled state:	1219
Using the Electronic Attenuator: Pros and Cons	1219
Elec Atten	1219
Adjust Atten for Min Clip	1220
Pre-Adjust for Min Clip	1220
Off	1221
Elec Atten Only	1221
Mech + Elec Atten	1222
(Mech) Atten Step	1222
Adjust Atten (Remote Command only)	1223
Scale/Div	1223
Presel Center	1224
Proper Preselector Operation	1224
Preselector Adjust	1225
μ W Path Control	1226
Standard Path	1227
Low Noise Path Enable	1227
More Information	1228
μ W Preselector Bypass	1229
Internal Preamp	1230
Off	1232
Low Band	1232
Full Range	1232
Ref Position	1232
Auto Scaling	1233
Auto Couple	1235

More Information	1235
Auto/Man Active Function keys	1235
Auto/Man 1-of-N keys	1235
BW	1237
Filter Type	1237
Cont (Continuous Measurement/Sweep)	1238
File	1240
FREQ Channel	1241
Carrier Ref Freq	1241
Carrier Setup	1241
Carriers	1242
Configure Carriers	1242
Select Carrier	1242
Measure Carrier	1243
Carrier Offset	1243
Radio Format	1243
Carrier Allocation	1246
Non-Contiguous	1246
Carrier Conf Presets	1248
MSR Test Config	1249
MSR Non-Contig Test Config	1253
Single RAT Config	1256
Max BS RF Bandwidth	1260
Channel Spacing Delta	1260
Apply to Meas Offset/Limits	1263
RF Bandwidth (Remote Command Only)	1263
RF Bandwidth Center (Remote Command Only)	1264
Sub-block Center (Remote Command Only)	1264
Sub-block Bandwidth (Remote Command Only)	1264
Sub-block Gap (Remote Command Only)	1265
Input/Output	1266
Marker	1267
Select Marker	1267
Marker Type	1267
Couple Markers	1268
All Markers Off	1268
Marker X Axis Value (Remote Command Only)	1268
Marker X Axis Position (Remote Command Only)	1269
Marker Y Axis Value (Remote Command Only)	1270
Marker Function	1271
Marker To	1272
Meas	1273
Remote Measurement Functions	1273
Measurement Group of Commands	1274
Current Measurement Query (Remote Command Only)	1276
Limit Test Current Results (Remote Command Only)	1276

Data Query (Remote Command Only)	1276
Calculate/Compress Trace Data Query (Remote Command Only)	1277
Calculate Peaks of Trace Data (Remote Command Only)	1282
Hardware-Accelerated Fast Power Measurement (Remote Command Only)	1283
Reset Fast Power Measurement (Remote Command Only)	1283
Define Fast Power Measurement (Remote Command Only)	1284
Define Fast Power Measurement Query (Remote Command Only)	1293
Configure Fast Power Measurement (Remote Command Only)	1294
Initiate Fast Power Measurement (Remote Command Only)	1295
Fetch Fast Power Measurement (Remote Command Only)	1295
Execute Fast Power Measurement (Remote Command Only)	1295
Binary Read Fast Power Measurement (Remote Command Only)	1296
Diagnostic Binary Read Fast Power Measurement (Remote Command Only)	1296
Format Data: Numeric Data (Remote Command Only)	1297
Format Data: Byte Order (Remote Command Only)	1298
Meas Setup	1299
Avg/Hold Num	1299
Meas Type	1299
Ref Channel	1300
Sweep Time	1300
Sweep Type	1301
Auto	1302
Swept	1303
FFT	1303
Power Ref (Only for MSR and LTE-Advanced FDD/TDD)	1303
Carrier Index (Only for MSR and LTE-Advanced FDD/TDD)	1305
Manual (Only for MSR and LTE-Advanced FDD/TDD)	1305
Res BW	1306
Video BW	1307
VBW/RBW	1309
Offset/Limits	1310
Select Offset	1310
Start Freq	1310
Stop Freq	1313
Sweep Time	1316
Sweep Type	1317
Auto	1318
Swept	1318
FFT	1319
Offset Side	1319
Res BW	1320
Meas BW	1323
Video BW	1324
VBW/RBW	1325
Limits	1326
Select Offset	1326

Abs Start	1327
Abs Stop	1329
Rel Start	1332
Rel Stop	1334
Fail Mask	1337
Offset Freq Define (Only for MSR and LTE-Advanced FDD/TDD)	1339
Inner Offset/Limits (Only for MSR and LTE-Advanced FDD/TDD)	1342
Select Offset	1343
Start Freq	1343
Stop Freq	1344
Sweep Time	1345
Sweep Type	1345
Auto	1346
Swept	1347
FFT	1347
Offset Side	1347
Res BW	1349
Meas BW	1350
Video BW	1351
VBW/RBW	1351
Limits	1352
Select Offset	1352
Abs Start	1353
Abs Stop	1354
Rel Start	1355
Rel Stop	1355
Fail Mask	1356
Offset Freq Define	1357
Cumulate Mask	1360
Cumulate Mask Stop Frequency	1360
Non-Contiguous Meas Region	1361
Method	1361
Filter Alpha	1362
Apply Carrier Config to Offset/Limits (Only for MSR) [XA11]	1363
Meas Preset	1363
Mode	1364
Mode Preset	1365
How-To Preset	1366
Preset Type (Remote Command Only)	1367
Mode Setup	1368
Peak Search	1369
Print	1370
Quick Save	1371
Recall	1373
State	1373
More Information	1374

From File...	1375
Edit Register Names	1376
Register 1 thru Register 16	1377
Register 1 thru Register 16	1377
Data (Import)	1378
Parameter Set	1379
Masks	1382
Open...	1383
Restart	1384
More Information	1384
Save	1386
State	1386
To File . . .	1387
Edit Register Names	1389
More Information	1389
Register 1 thru Register 16	1390
Register 1 thru Register 16	1390
Mass Storage Catalog (Remote Command Only)	1391
Mass Storage Change Directory (Remote Command Only)	1391
Mass Storage Copy (Remote Command Only)	1392
Mass Storage Device Copy (Remote Command Only)	1392
Mass Storage Delete (Remote Command Only)	1392
Mass Storage Data (Remote Command Only)	1393
Mass Storage Make Directory (Remote Command Only)	1393
Mass Storage Move (Remote Command Only)	1393
Mass Storage Remove Directory (Remote Command Only)	1394
Mass Storage Determine Removable Media (Remote Command Only)	1394
Mass Storage Determine Removable Media Label (Remote Command Only)	1394
Mass Storage Determine Removable Media Write-protect status (Remote Command Only)	1395
Mass Storage Determine Removable Media size (Remote Command Only)	1395
Trace (+State)	1395
From Trace	1397
From File...	1397
Register 1 thru Register 16	1399
Data (Export)	1400
Parameter Set	1400
Measurement Results	1401
Meas Results File Contents	1402
Save As . . .	1411
Screen Image	1412
Themes	1413
3D Color	1413
3D Monochrome	1413
Flat Color	1414
Flat Monochrome	1414

Table of Contents

Save As...	1414
Single (Single Measurement/Sweep)	1415
More Information	1415
Source	1416
Span X Scale	1417
Ref Value	1417
Scale/Div	1417
Ref Position	1418
Auto Scaling	1418
Sweep/Control	1420
Pause	1420
Gate	1420
Gate On/Off	1420
Gate View On/Off	1421
Gate View Setup	1424
Gate View Sweep Time	1425
Gate View Start Time	1425
Gate Delay	1426
Gate Length	1426
Gate Source	1427
Line	1428
External 1	1428
External 2	1430
RF Burst	1433
Periodic Timer (Frame Trigger)	1436
Control Edge/Level	1447
Gate Holdoff	1448
Gate Delay Compensation	1449
More Information	1450
Min Fast Position Query (Remote Command Only)	1451
Gate Preset (Remote Command Only)	1451
Gate Level (Remote Command Only)	1451
Gate Polarity (Remote Command Only)	1452
System	1453
Trace/Detector	1454
Trace Type	1454
Chan Detector	1454
Chan Detector Auto	1455
Chan Detector Selection	1455
Offset Detector	1456
Offset Detector Auto	1456
Offset Detector Selection	1457
Trigger	1458
Free Run	1458
Video	1458
Trigger Level	1458

Trig Slope	1458
Trig Delay	1458
Line	1458
Trig Slope	1458
Trig Delay	1458
External 1	1458
Trigger Level	1458
Trig Slope	1458
Trig Delay	1458
Zero Span Delay Comp	1458
External 2	1459
Trigger Level	1459
Trig Slope	1459
Trig Delay	1459
Zero Span Delay Comp	1459
RF Burst	1459
Absolute Trigger	1459
Relative Trigger	1459
Trig Slope	1459
Trig Delay	1459
Periodic Timer	1459
Period	1459
Offset	1459
Reset Offset Display	1459
Sync Source	1460
Off	1460
External 1	1460
External 2	1460
RF Burst	1460
Trig Delay	1460
Auto/Holdoff	1460
Auto Trig	1460
Trig Holdoff	1460
Holdoff Type	1461
User Preset	1462
User Preset	1462
User Preset All Modes	1463
Save User Preset	1464
View/Display	1465
View Selection by Name (Remote Command Only)	1465
Views Selection by Number (Remote Command only)	1465
Display	1466
Annotation	1467
Meas Bar On/Off	1468
Screen	1468
Active Function Values On/Off	1468

Title	1469
Change Title	1469
Clear Title	1470
Graticule	1471
System Display Settings	1471
Annotation Local Settings	1471
Themes	1472
Backlight	1473
Backlight Intensity	1474
Abs Pwr Freq	1474
Abs Peak Pwr & Freq (Total Pwr Ref)	1474
Trace Window	1476
Results Window	1476
Abs Peak Pwr & Freq (PSD Ref)	1476
Trace Window	1478
Results Window	1478
Abs Peak Pwr & Freq (Spectrum Pk Ref)	1478
Trace Window	1480
Results Window	1480
Rel Pwr Freq	1480
Rel Peak Pwr & Freq (Total Pwr Ref)	1480
Trace Window	1481
Results Window	1481
Rel Peak Pwr & Freq (PSD Ref)	1482
Trace Window	1482
Results Window	1483
Rel Peak Pwr & Freq (Spectrum Pk Ref)	1483
Trace Window	1484
Results Window	1484
Integrated Power	1485
Integrated Power (Total Pwr Ref)	1485
Trace Window	1487
Results Window	1487
Integrated Power (PSD Ref)	1488
Trace Window	1489
Results Window	1489
Integrated Power (Spectrum Pk Ref)	1490
Trace Window	1491
Results Window	1491
Carrier Info (MSR and LTE-Advanced FDD/TDD Only)	1492
Carrier Freq (MSR and LTE-Advanced FDD/TDD Only)	1494
Limit Lines	1494
12 Spurious Emissions Measurement	1495
AMPTD Y Scale	1498
Ref Value	1498

Attenuation	1498
Dual Attenuator Configurations:	1499
Single Attenuator Configuration:	1500
(Mech) Atten	1500
Attenuator Configurations and Auto/Man	1502
Enable Elec Atten	1502
More Information	1503
Mechanical Attenuator Transition Rules	1503
When the Electronic Attenuation is enabled from a disabled state:	1503
Examples in the dual attenuator configuration:	1503
When the Electronic Attenuation is disabled from an enabled state:	1504
Using the Electronic Attenuator: Pros and Cons	1504
Elec Atten	1504
Adjust Atten for Min Clip	1505
Pre-Adjust for Min Clip	1505
Off	1506
Elec Atten Only	1506
Mech + Elec Atten	1507
(Mech) Atten Step	1507
Adjust Atten (Remote Command only)	1508
Scale/Div	1508
Presel Center	1509
Proper Preselector Operation	1510
Preselector Adjust	1510
μ W Path Control	1511
Standard Path	1512
Low Noise Path Enable	1513
More Information	1513
μ W Preselector Bypass	1515
Internal Preamp	1516
Off	1517
Low Band	1517
Full Range	1517
Auto Scaling	1518
Auto Couple	1519
More Information	1519
Auto/Man Active Function keys	1519
Auto/Man 1-of-N keys	1519
BW	1521
Cont (Continuous Measurement/Sweep)	1522
File	1524
FREQ Channel	1525
Carrier Ref Freq	1525
Carrier Setup	1525
Carriers	1526
Configure Carriers	1526

Select Carrier	1526
Measure Carrier	1527
Carrier Offset	1527
Radio Format	1527
Carrier Allocation	1530
Non-Contiguous	1530
Carrier Conf Presets	1532
MSR Test Config	1533
MSR Non-Contig Test Config	1537
Single RAT Config	1540
Max BS RF Bandwidth	1544
Channel Spacing Delta	1544
Apply to Meas Offset/Limits	1547
RF Bandwidth (Remote Command Only)	1547
RF Bandwidth Center (Remote Command Only)	1548
Sub-block Center (Remote Command Only)	1548
Sub-block Bandwidth (Remote Command Only)	1548
Sub-block Gap (Remote Command Only)	1549
Input/Output	1550
Marker	1551
Select Marker	1551
Marker Type	1551
Properties	1552
Select Marker	1552
Relative To	1552
Couple Markers	1553
All Markers Off	1553
Marker X Axis Value (Remote Command only)	1554
Marker X Axis Position (Remote Command only)	1554
Marker Y Axis Value (Remote Command only)	1555
Marker Function	1556
Marker To	1557
Meas	1558
Remote Measurement Functions	1558
Measurement Group of Commands	1559
Current Measurement Query (Remote Command Only)	1561
Limit Test Current Results (Remote Command Only)	1561
Data Query (Remote Command Only)	1561
Calculate/Compress Trace Data Query (Remote Command Only)	1562
Calculate Peaks of Trace Data (Remote Command Only)	1567
Hardware-Accelerated Fast Power Measurement (Remote Command Only)	1568
Reset Fast Power Measurement (Remote Command Only)	1568
Define Fast Power Measurement (Remote Command Only)	1569
Define Fast Power Measurement Query (Remote Command Only)	1578
Configure Fast Power Measurement (Remote Command Only)	1579
Initiate Fast Power Measurement (Remote Command Only)	1580

Fetch Fast Power Measurement (Remote Command Only)	1580
Execute Fast Power Measurement (Remote Command Only)	1580
Binary Read Fast Power Measurement (Remote Command Only)	1581
Diagnostic Binary Read Fast Power Measurement (Remote Command Only)	1581
Format Data: Numeric Data (Remote Command Only)	1582
Format Data: Byte Order (Remote Command Only)	1583
Meas Setup	1584
Avg/Hold Num	1584
Avg Mode	1584
Range Table	1585
Range	1585
Frequency Range (Only for MSR and LTE-Advanced FDD/TDD)	1587
Frequency Type (Only for MSR)	1587
Abs Start Freq (Only for MSR and LTE-Advanced FDD/TDD)	1588
Abs Stop Freq(Only for MSR and LTE-Advanced FDD/TDD)	1589
Offset Start Freq (Only for MSR)	1590
Offset Stop Freq(Only for MSR)	1590
Offset Side (Only for MSR)	1591
Res BW	1592
Video BW	1593
Filter Type	1594
Abs Start Limit	1595
Abs Stop Limit	1596
Peak Excursion	1598
Pk Threshold	1599
Attenuation	1599
Detector 1	1600
Detector 2	1601
Sweep Time	1602
Points	1603
IF Gain	1604
IF Gain Auto	1604
IF Gain State	1605
Meas Type	1606
Spur	1607
Spurious Report Mode	1607
Apply Carrier Config to Range Table (Only for MSR and LTE-Advanced FDD/TDD)	1608
Meas Preset	1608
Fast Spurious Meas (Remote Command only)	1608
Mode	1610
Mode Preset	1611
How-To Preset	1612
Preset Type (Remote Command Only)	1613
Mode Setup	1614
Peak Search	1615
Next Peak	1615

Table of Contents

Next Pk Right	1615
Next Pk Left	1616
Marker Delta	1616
Pk-Pk Search	1616
Min Search	1616
Print	1618
Quick Save	1619
Recall	1621
State	1621
More Information	1622
From File...	1623
Edit Register Names	1624
Register 1 thru Register 16	1625
Register 1 thru Register 16	1625
Data (Import)	1626
Parameter Set	1627
Masks	1630
Open...	1631
Restart	1632
More Information	1632
Save	1634
State	1634
To File . . .	1635
Edit Register Names	1637
More Information	1637
Register 1 thru Register 16	1638
Register 1 thru Register 16	1638
Mass Storage Catalog (Remote Command Only)	1639
Mass Storage Change Directory (Remote Command Only)	1639
Mass Storage Copy (Remote Command Only)	1640
Mass Storage Device Copy (Remote Command Only)	1640
Mass Storage Delete (Remote Command Only)	1640
Mass Storage Data (Remote Command Only)	1641
Mass Storage Make Directory (Remote Command Only)	1641
Mass Storage Move (Remote Command Only)	1641
Mass Storage Remove Directory (Remote Command Only)	1642
Mass Storage Determine Removable Media (Remote Command Only)	1642
Mass Storage Determine Removable Media Label (Remote Command Only)	1642
Mass Storage Determine Removable Media Write-protect status (Remote Command Only)	1643
Mass Storage Determine Removable Media size (Remote Command Only)	1643
Trace (+State)	1643
From Trace	1645
From File...	1645
Register 1 thru Register 16	1647
Data (Export)	1648

Parameter Set	1648
Measurement Results	1649
Meas Results File Definition	1650
Meas Results File Example	1652
Save As . . .	1655
Screen Image	1656
Themes	1657
3D Color	1657
3D Monochrome	1657
Flat Color	1658
Flat Monochrome	1658
Save As...	1658
Single (Single Measurement/Sweep)	1659
More Information	1659
Source	1660
Span X Scale	1661
Sweep/Control	1662
Sweep Setup	1662
Auto Sweep Time Rules	1662
Sweep Type	1663
Pause	1663
Gate	1663
Gate On/Off	1664
Gate View On/Off	1665
Gate View Setup	1668
Gate View Sweep Time	1668
Gate View Start Time	1669
Gate Delay	1669
Gate Length	1670
Gate Source	1670
Line	1671
External 1	1672
External 2	1674
RF Burst	1676
Periodic Timer (Frame Trigger)	1679
Control Edge/Level	1690
Gate Holdoff	1691
Gate Delay Compensation	1692
More Information	1693
Min Fast Position Query (Remote Command Only)	1694
Gate Preset (Remote Command Only)	1694
Gate Level (Remote Command Only)	1695
Gate Polarity (Remote Command Only)	1695
Gate	1695
System	1697
Trace/Detector	1698

Table of Contents

Trigger	1699
Free Run	1699
Video	1699
Trigger Level	1699
Trig Slope	1699
Trig Delay	1699
Line	1699
Trig Slope	1699
Trig Delay	1699
External 1	1699
Trigger Level	1699
Trig Slope	1699
Trig Delay	1699
Zero Span Delay Comp	1699
External 2	1700
Trigger Level	1700
Trig Slope	1700
Trig Delay	1700
Zero Span Delay Comp	1700
RF Burst	1700
Absolute Trigger	1700
Relative Trigger	1700
Trig Slope	1700
Trig Delay	1700
Periodic Timer	1700
Period	1700
Offset	1700
Reset Offset Display	1700
Sync Source	1701
Off	1701
External 1	1701
External 2	1701
RF Burst	1701
Trig Delay	1701
Auto/Holdoff	1701
Auto Trig	1701
Trig Holdoff	1701
Holdoff Type	1702
User Preset	1703
User Preset	1703
User Preset All Modes	1704
Save User Preset	1705
View/Display	1706
Display	1706
Annotation	1706
Meas Bar On/Off	1707

Screen	1708
Active Function Values On/Off	1708
Title	1709
Change Title	1709
Clear Title	1710
Graticule	1711
System Display Settings	1711
Annotation Local Settings	1711
Themes	1712
Backlight	1713
Backlight Intensity	1714
View Selection	1714
Graph + Metrics	1715
Range Table	1716
All Ranges	1718
Range Table Selection (SCPI only command)	1719
13 Conformance EVM	1721
AMPTD (Amplitude) Y Scale	1740
Attenuation	1740
Dual Attenuator Configurations:	1740
Single Attenuator Configuration:	1741
(Mech) Atten	1742
Attenuator Configurations and Auto/Man	1743
Enable Elec Atten	1743
More Information	1744
Mechanical Attenuator Transition Rules	1744
When the Electronic Attenuation is enabled from a disabled state:	1745
Examples in the dual attenuator configuration:	1745
When the Electronic Attenuation is disabled from an enabled state:	1745
Using the Electronic Attenuator: Pros and Cons	1745
Elec Atten	1746
Adjust Atten for Min Clip	1746
Pre-Adjust for Min Clip	1747
Off	1748
Elec Atten Only	1748
Mech + Elec Atten	1748
(Mech) Atten Step	1748
Adjust Atten (Remote Command only)	1749
Presel Center	1749
Proper Preselector Operation	1750
Preselector Adjust	1751
μ W Path Control	1752
Standard Path	1753
Low Noise Path Enable	1753
More Information	1754

Table of Contents

μW Preselector Bypass	1755
Internal Preamp	1756
Off	1758
Low Band	1758
Full Range	1758
Attenuation	1758
Auto Couple	1759
More Information	1759
Auto/Man Active Function keys	1759
Auto/Man 1-of-N keys	1759
BW	1761
Cont (Continuous Measurement/Sweep)	1762
File	1764
FREQ Channel	1765
Carrier Ref Freq	1765
Carrier Setup	1765
Carriers	1766
Configure Carriers	1766
Select Carrier	1766
Measure Carrier	1767
Carrier Offset	1767
Radio Format	1767
Carrier Allocation	1770
Non-Contiguous	1770
Carrier Conf Presets	1772
MSR Test Config	1773
MSR Non-Contig Test Config	1777
Single RAT Config	1780
Max BS RF Bandwidth	1784
Channel Spacing Delta	1784
Apply to Meas Offset/Limits	1787
RF Bandwidth (Remote Command Only)	1787
RF Bandwidth Center (Remote Command Only)	1788
Sub-block Center (Remote Command Only)	1788
Sub-block Bandwidth (Remote Command Only)	1788
Sub-block Gap (Remote Command Only)	1789
Input/Output	1790
Marker	1791
Marker > (Marker To)	1792
Marker Fctn (Function)	1793
Meas	1794
Remote Measurement Functions	1794
Measurement Group of Commands	1795
Current Measurement Query (Remote Command Only)	1797
Limit Test Current Results (Remote Command Only)	1797
Data Query (Remote Command Only)	1797

Calculate/Compress Trace Data Query (Remote Command Only)	1798
Calculate Peaks of Trace Data (Remote Command Only)	1803
Hardware-Accelerated Fast Power Measurement (Remote Command Only)	1804
Reset Fast Power Measurement (Remote Command Only)	1804
Define Fast Power Measurement (Remote Command Only)	1805
Define Fast Power Measurement Query (Remote Command Only)	1814
Configure Fast Power Measurement (Remote Command Only)	1815
Initiate Fast Power Measurement (Remote Command Only)	1816
Fetch Fast Power Measurement (Remote Command Only)	1816
Execute Fast Power Measurement (Remote Command Only)	1816
Binary Read Fast Power Measurement (Remote Command Only)	1817
Diagnostic Binary Read Fast Power Measurement (Remote Command Only)	1817
Format Data: Numeric Data (Remote Command Only)	1818
Format Data: Byte Order (Remote Command Only)	1819
Meas (Measure) Setup	1820
Meas (Measure) Setup	1820
LTE FDD Average/Hold Number	1820
Meas (Measure) Setup	1821
W-CDMA Average/Hold Number	1821
Meas (Measure) Setup	1822
GSM/EDGE Average/Hold Number	1822
Meas (Measure) Setup	1823
cdma2000 Average/Hold Number	1823
Meas (Measure) Setup	1823
1xEV-DO Average/Hold Number	1824
Meas (Measure) Setup	1824
LTE TDD Average/Hold Number	1825
Meas (Measure) Setup	1825
TD-SCDMA Average/Hold Number	1825
Spectrum	1826
Meas Preset	1826
LTE FDD Downlink Result Output Selection (SCPI only)	1827
LTE FDD Downlink Set All Results (SCPI Only)	1828
LTE FDD Uplink Set All Results (SCPI Only)	1829
W-CDMA Result Output Selection for BTS (SCPI only)	1829
GSM/EDGE Result Output Selection (SCPI only)	1830
cdma2000 Result Output Selection (SCPI only)	1831
1xEV-DO Result Output Selection for BTS (SCPI only)	1832
LTE TDD Downlink Result Output Selection (SCPI only)	1834
TD-SCDMA Result Output Selection (SCPI only)	1836
Mode	1838
Mode Preset	1839
How-To Preset	1840
Mode Setup	1842
Peak Search	1843
Print	1844

Table of Contents

Quick Save	1845
Recall	1847
State	1847
More Information	1848
From File...	1849
Edit Register Names	1850
Register 1 thru Register 16	1851
Register 1 thru Register 16	1851
Data (Import)	1852
Parameter Set	1853
Masks	1856
Open...	1857
Restart	1858
More Information	1858
Save	1860
State	1860
To File . . .	1861
Edit Register Names	1863
More Information	1863
Register 1 thru Register 16	1864
Register 1 thru Register 16	1864
Mass Storage Catalog (Remote Command Only)	1865
Mass Storage Change Directory (Remote Command Only)	1865
Mass Storage Copy (Remote Command Only)	1866
Mass Storage Device Copy (Remote Command Only)	1866
Mass Storage Delete (Remote Command Only)	1866
Mass Storage Data (Remote Command Only)	1867
Mass Storage Make Directory (Remote Command Only)	1867
Mass Storage Move (Remote Command Only)	1867
Mass Storage Remove Directory (Remote Command Only)	1868
Mass Storage Determine Removable Media (Remote Command Only)	1868
Mass Storage Determine Removable Media Label (Remote Command Only)	1868
Mass Storage Determine Removable Media Write-protect status (Remote Command Only)	1869
Mass Storage Determine Removable Media size (Remote Command Only)	1869
Trace (+State)	1869
From Trace	1871
From File...	1871
Register 1 thru Register 16	1873
Data (Export)	1874
Parameter Set	1874
Meas Results	1875
Save As . . .	1875
Screen Image	1876
Themes	1877
3D Color	1878

3D Monochrome	1878
Flat Color	1878
Flat Monochrome	1879
Save As...	1879
Single (Single Measurement/Sweep)	1880
More Information	1880
Source	1881
SPAN X Scale	1882
Sweep/Control	1883
System	1884
Trace/Detector	1885
Trigger	1886
Free Run	1886
Video	1886
Trigger Level	1886
Trig Slope	1886
Trig Delay	1886
Line	1886
Trig Slope	1886
Trig Delay	1886
External 1	1886
Trigger Level	1886
Trig Slope	1886
Trig Delay	1886
Zero Span Delay Comp	1886
External 2	1887
Trigger Level	1887
Trig Slope	1887
Trig Delay	1887
Zero Span Delay Comp	1887
RF Burst	1887
Absolute Trigger	1887
Relative Trigger	1887
Trig Slope	1887
Trig Delay	1887
Periodic Timer	1887
Period	1887
Offset	1887
Offset Adjust (Remote Command Only)	1887
Reset Offset Display	1888
Sync Source	1888
Off	1888
External 1	1888
External 2	1888
RF Burst	1888
Trig Delay	1888

Auto/Holdoff	1888
Auto Trig	1888
Trig Holdoff	1889
Holdoff Type	1889
User Preset	1890
User Preset	1890
User Preset All Modes	1891
Save User Preset	1892
View/Display	1893
Display	1893
Annotation	1893
Meas Bar On/Off	1894
Screen	1895
Active Function Values On/Off	1895
Title	1896
Change Title	1896
Clear Title	1897
Graticule	1898
System Display Settings	1898
Annotation Local Settings	1898
Themes	1899
Backlight	1900
Backlight Intensity	1901
Result Metrics Carrier Index	1901
14 Power Stat CCDF Measurement	1903
AMPTD Y Scale	1908
Attenuation	1908
Dual Attenuator Configurations:	1908
Single Attenuator Configuration:	1909
(Mech) Atten	1910
Attenuator Configurations and Auto/Man	1911
Enable Elec Atten	1911
More Information	1912
Mechanical Attenuator Transition Rules	1912
When the Electronic Attenuation is enabled from a disabled state:	1913
Examples in the dual attenuator configuration:	1913
When the Electronic Attenuation is disabled from an enabled state:	1913
Using the Electronic Attenuator: Pros and Cons	1913
Elec Atten	1914
Adjust Atten for Min Clip	1914
Pre-Adjust for Min Clip	1915
Off	1916
Elec Atten Only	1916
Mech + Elec Atten	1916
(Mech) Atten Step	1916

Adjust Atten (Remote Command only)	1917
Presel Center	1917
Proper Preselector Operation	1918
Preselector Adjust	1919
μ W Path Control	1920
Standard Path	1921
Low Noise Path Enable	1921
More Information	1922
μ W Preselector Bypass	1923
Internal Preamp	1924
Off	1926
Low Band	1926
Full Range	1926
Range	1926
Range Auto/Man	1927
I Range	1928
1 V Peak	1929
0.5 V Peak	1929
0.25 V Peak	1929
0.125 V Peak	1930
Q Range Value	1930
Q Same as I	1931
1 V Peak	1931
0.5 V Peak	1932
0.25 V Peak	1932
0.125 V Peak	1932
I/Q Gain Ranges	1932
1 V Peak	1932
0.5 V Peak	1932
0.25 V Peak	1933
0.125 V Peak	1933
Presel Center	1933
Presel Adjust	1933
Y Axis Unit	1933
Reference Level Offset	1934
μ W Path Control	1934
Auto Couple	1935
More Information	1935
Auto/Man Active Function keys	1935
Auto/Man 1-of-N keys	1935
BW	1937
Info BW	1937
Cont (Continuous Measurement/Sweep)	1939
File	1941
FREQ Channel	1942
Center Freq	1942

Center Freq Offset	1943
Carrier Ref Freq	1943
Carrier Setup	1944
Carriers	1944
Configure Carriers	1944
Select Carrier	1944
Measure Carrier	1945
Carrier Offset	1945
Radio Format	1946
Carrier Allocation	1948
Non-Contiguous	1949
Carrier Conf Presets	1950
MSR Test Config	1951
MSR Non-Contig Test Config	1956
Single RAT Config	1958
Max BS RF Bandwidth	1962
Channel Spacing Delta	1962
Apply to Meas Offset/Limits	1965
RF Bandwidth (Remote Command Only)	1965
RF Bandwidth Center (Remote Command Only)	1966
Sub-block Center (Remote Command Only)	1966
Sub-block Bandwidth (Remote Command Only)	1966
Sub-block Gap (Remote Command Only)	1967
Input/Output	1968
Marker	1969
Select Marker	1969
Marker Type	1969
Properties	1970
Select Marker	1970
Relative To	1970
Marker Trace	1971
Couple Markers	1971
All Markers Off	1971
Marker X Axis Value (Remote Command Only)	1972
Marker Y Axis Value (Remote Command Only)	1972
Marker Function	1974
Marker To	1975
Meas	1976
Remote Measurement Functions	1976
Measurement Group of Commands	1977
Current Measurement Query (Remote Command Only)	1979
Limit Test Current Results (Remote Command Only)	1979
Data Query (Remote Command Only)	1979
Calculate/Compress Trace Data Query (Remote Command Only)	1980
Calculate Peaks of Trace Data (Remote Command Only)	1985
Hardware-Accelerated Fast Power Measurement (Remote Command Only)	1986

Reset Fast Power Measurement (Remote Command Only)	1986
Define Fast Power Measurement (Remote Command Only)	1987
Define Fast Power Measurement Query (Remote Command Only)	1996
Configure Fast Power Measurement (Remote Command Only)	1997
Initiate Fast Power Measurement (Remote Command Only)	1998
Fetch Fast Power Measurement (Remote Command Only)	1998
Execute Fast Power Measurement (Remote Command Only)	1998
Binary Read Fast Power Measurement (Remote Command Only)	1999
Diagnostic Binary Read Fast Power Measurement (Remote Command Only)	1999
Format Data: Numeric Data (Remote Command Only)	2000
Format Data: Byte Order (Remote Command Only)	2001
Meas Setup	2002
Counts	2002
Meas Cycles	2002
Meas Interval (Not 1xEVDO)	2003
IF Gain	2004
IF Gain Auto	2004
IF Gain State	2005
Meas Preset	2005
Mode	2007
Mode Preset	2008
How-To Preset	2009
Preset Type (Remote Command Only)	2010
Mode Setup	2011
Peak Search	2012
Print	2013
Quick Save	2014
Recall	2016
State	2016
More Information	2017
From File...	2018
Edit Register Names	2019
Register 1 thru Register 16	2020
Register 1 thru Register 16	2020
Data (Import)	2021
Parameter Set	2022
Masks	2025
Open...	2026
Restart	2027
More Information	2027
Save	2029
State	2029
To File . . .	2030
Edit Register Names	2032
More Information	2032
Register 1 thru Register 16	2033

Register 1 thru Register 16	2033
Mass Storage Catalog (Remote Command Only)	2034
Mass Storage Change Directory (Remote Command Only)	2034
Mass Storage Copy (Remote Command Only)	2035
Mass Storage Device Copy (Remote Command Only)	2035
Mass Storage Delete (Remote Command Only)	2035
Mass Storage Data (Remote Command Only)	2036
Mass Storage Make Directory (Remote Command Only)	2036
Mass Storage Move (Remote Command Only)	2036
Mass Storage Remove Directory (Remote Command Only)	2037
Mass Storage Determine Removable Media (Remote Command Only)	2037
Mass Storage Determine Removable Media Label (Remote Command Only)	2037
Mass Storage Determine Removable Media Write-protect status (Remote Command Only)	2038
Mass Storage Determine Removable Media size (Remote Command Only)	2038
Trace (+State)	2038
From Trace	2040
From File...	2040
Register 1 thru Register 16	2042
Data (Export)	2043
Parameter Set	2043
Measurement Results	2044
Meas Results File Definition	2045
Meas Results File Example	2046
Save As . . .	2048
Screen Image	2049
Themes	2050
3D Color	2050
3D Monochrome	2050
Flat Color	2051
Flat Monochrome	2051
Save As...	2051
Single (Single Measurement/Sweep)	2052
More Information	2052
Source	2053
Span X Scale	2054
Scale/Div	2054
Sweep/Control	2055
Pause/Resume	2055
System	2056
Trace/Detector	2057
Store Ref Trace	2057
Ref Trace	2057
Gaussian Line	2058
Trigger	2059
Free Run	2059

Video	2059
Trigger Level	2059
Trig Slope	2059
Trig Delay	2059
Line	2059
Trig Slope	2059
Trig Delay	2059
External 1	2059
Trigger Level	2059
Trig Slope	2059
Trig Delay	2059
Zero Span Delay Comp	2059
External 2	2060
Trigger Level	2060
Trig Slope	2060
Trig Delay	2060
Zero Span Delay Comp	2060
RF Burst	2060
Absolute Trigger	2060
Relative Trigger	2060
Trig Slope	2060
Trig Delay	2060
Periodic Timer	2060
Period	2060
Offset	2060
Offset Adjust (Remote Command Only)	2060
Reset Offset Display	2061
Sync Source	2061
Off	2061
External 1	2061
External 2	2061
RF Burst	2061
Trig Delay	2061
Auto/Holdoff	2061
Auto Trig	2061
Trig Holdoff	2062
Holdoff Type	2062
Baseband I/Q	2062
I/Q Mag	2062
Trigger Level	2062
Trig Slope	2062
Trig Delay	2062
I	2062
Trigger Level	2062
Trig Slope	2062
Trig Delay	2062

Q	2062
Trigger Level	2062
Trig Slope	2062
Trig Delay	2062
Input I	2063
Trigger Level	2063
Trig Slope	2063
Trig Delay	2063
Input Q	2063
Trigger Level	2063
Trig Slope	2063
Trig Delay	2063
Aux Channel Center Freq	2063
Trigger Level	2063
Trig Slope	2063
Trig Delay	2063
Trigger Center Freq	2063
Trigger BW	2063
User Preset	2064
User Preset	2064
User Preset All Modes	2065
Save User Preset	2066
View/Display	2067
Metrics window	2069
Graph window	2070
Wave window (TD-SCDMA and LTE TDD only)	2070
Display	2071
Annotation	2071
Meas Bar On/Off	2072
Screen	2073
Active Function Values On/Off	2073
Title	2074
Change Title	2074
Clear Title	2075
Graticule	2076
System Display Settings	2076
Annotation Local Settings	2076
Themes	2077
Backlight	2078
Backlight Intensity	2079
15 Monitor Spectrum Measurement	2081
AMPTD Y Scale	2084
Ref Value	2084
Attenuation	2084
Dual Attenuator Configurations:	2085

Single Attenuator Configuration:	2085
(Mech) Atten	2086
Attenuator Configurations and Auto/Man	2087
Enable Elec Atten	2088
More Information	2089
Mechanical Attenuator Transition Rules	2089
When the Electronic Attenuation is enabled from a disabled state:	2089
Examples in the dual attenuator configuration:	2089
When the Electronic Attenuation is disabled from an enabled state:	2089
Using the Electronic Attenuator: Pros and Cons	2090
Elec Atten	2090
Adjust Atten for Min Clip	2091
Pre-Adjust for Min Clip	2091
Off	2092
Elec Atten Only	2092
Mech + Elec Atten	2093
(Mech) Atten Step	2093
Adjust Atten (Remote Command only)	2093
Scale/Div	2094
Presel Center	2094
Proper Preselector Operation	2095
Preselector Adjust	2096
μ W Path Control	2097
Standard Path	2098
Low Noise Path Enable	2098
More Information	2099
μ W Preselector Bypass	2100
Internal Preamp	2101
Off	2102
Low Band	2103
Full Range	2103
Ref Position	2103
Auto Scaling	2104
Auto Couple	2105
More Information	2105
Auto/Man Active Function keys	2105
Auto/Man 1-of-N keys	2105
BW	2107
Res BW	2107
Video BW	2108
VBW:3dB RBW	2110
Span:3dB RBW	2110
Cont (Continuous Measurement/Sweep)	2112
File	2114
FREQ Channel	2115
Center Freq	2115

Center Freq Offset	2116
Carrier Ref Freq	2116
Carrier Setup	2117
Carriers	2117
Configure Carriers	2117
Select Carrier	2117
Measure Carrier	2118
Carrier Offset	2118
Radio Format	2119
Carrier Allocation	2121
Non-Contiguous	2122
Carrier Conf Presets	2123
MSR Test Config	2124
MSR Non-Contig Test Config	2129
Single RAT Config	2131
Max BS RF Bandwidth	2135
Channel Spacing Delta	2135
Apply to Meas Offset/Limits	2138
RF Bandwidth (Remote Command Only)	2138
RF Bandwidth Center (Remote Command Only)	2139
Sub-block Center (Remote Command Only)	2139
Sub-block Bandwidth (Remote Command Only)	2139
Sub-block Gap (Remote Command Only)	2140
Input/Output	2141
Marker	2142
Select Marker	2142
Marker Type	2142
Properties	2143
Select Marker	2143
Relative To	2143
Marker Trace	2143
Couple Markers	2144
All Markers Off	2144
Marker X Axis Value (Remote Command only)	2145
Marker X Axis Position (Remote Command only)	2145
Marker Y Axis Value (Remote Command only)	2146
Marker Function	2147
Select Marker	2147
Marker Function Type	2147
Band Adjust	2147
Band/Interval Span for Frequency Domain	2148
Band/Interval Left for Frequency Domain	2148
Band/Interval Right for Frequency Domain	2149
Marker To	2150
Meas	2151
Remote Measurement Functions	2151

Measurement Group of Commands	2152
Current Measurement Query (Remote Command Only)	2154
Limit Test Current Results (Remote Command Only)	2154
Data Query (Remote Command Only)	2154
Calculate/Compress Trace Data Query (Remote Command Only)	2155
Calculate Peaks of Trace Data (Remote Command Only)	2160
Hardware-Accelerated Fast Power Measurement (Remote Command Only)	2161
Reset Fast Power Measurement (Remote Command Only)	2161
Define Fast Power Measurement (Remote Command Only)	2162
Define Fast Power Measurement Query (Remote Command Only)	2171
Configure Fast Power Measurement (Remote Command Only)	2172
Initiate Fast Power Measurement (Remote Command Only)	2173
Fetch Fast Power Measurement (Remote Command Only)	2173
Execute Fast Power Measurement (Remote Command Only)	2173
Binary Read Fast Power Measurement (Remote Command Only)	2174
Diagnostic Binary Read Fast Power Measurement (Remote Command Only)	2174
Format Data: Numeric Data (Remote Command Only)	2175
Format Data: Byte Order (Remote Command Only)	2176
Meas Setup	2177
Avg/Hold Num	2177
Avg Mode	2177
Meas Preset	2178
Mode	2179
Mode Preset	2180
How-To Preset	2181
Preset Type (Remote Command Only)	2182
Mode Setup	2183
Peak Search	2184
Print	2185
Quick Save	2186
Recall	2188
State	2188
More Information	2189
From File...	2190
Edit Register Names	2191
Register 1 thru Register 16	2192
Register 1 thru Register 16	2192
Data (Import)	2193
Parameter Set	2194
Masks	2197
Open...	2198
Restart	2199
More Information	2199
Save	2201
State	2201
To File . . .	2202

Edit Register Names	2204
More Information	2204
Register 1 thru Register 16	2205
Register 1 thru Register 16	2205
Mass Storage Catalog (Remote Command Only)	2206
Mass Storage Change Directory (Remote Command Only)	2206
Mass Storage Copy (Remote Command Only)	2207
Mass Storage Device Copy (Remote Command Only)	2207
Mass Storage Delete (Remote Command Only)	2207
Mass Storage Data (Remote Command Only)	2208
Mass Storage Make Directory (Remote Command Only)	2208
Mass Storage Move (Remote Command Only)	2208
Mass Storage Remove Directory (Remote Command Only)	2209
Mass Storage Determine Removable Media (Remote Command Only)	2209
Mass Storage Determine Removable Media Label (Remote Command Only)	2209
Mass Storage Determine Removable Media Write-protect status (Remote Command Only)	2210
Mass Storage Determine Removable Media size (Remote Command Only)	2210
Trace (+State)	2210
From Trace	2212
From File...	2212
Register 1 thru Register 16	2214
Data (Export)	2215
Parameter Set	2215
Meas Results	2216
Save As . . .	2216
Screen Image	2217
Themes	2218
3D Color	2219
3D Monochrome	2219
Flat Color	2219
Flat Monochrome	2220
Save As...	2220
Single (Single Measurement/Sweep)	2221
More Information	2221
Source	2222
Span X Scale	2223
Span	2223
IDEN Mode Span Preset for Monitor Spectrum	2224
Full Span	2224
Last Span	2224
Adjust Span to Carrier Config (MSR and LTE-Advanced FDD/TDD mode only)	2225
Sweep/Control	2226
Sweep Time	2226
Pause	2226
Gate	2227

Gate On/Off	2227
Gate View On/Off	2228
Gate View Setup	2231
Gate View Sweep Time	2232
Gate View Start Time	2232
Gate Delay	2233
Gate Length	2233
Gate Source	2234
Line	2235
External 1	2235
External 2	2237
RF Burst	2240
Periodic Timer (Frame Trigger)	2243
Control Edge/Level	2254
Gate Holdoff	2255
Gate Delay Compensation	2256
More Information	2257
Min Fast Position Query (Remote Command Only)	2258
Gate Preset (Remote Command Only)	2258
Gate Level (Remote Command Only)	2258
Gate Polarity (Remote Command Only)	2259
Points	2259
System	2261
Trace/Detector	2262
Select Trace	2262
Trace Type	2262
Update	2263
Display	2263
Detector	2264
Auto	2265
Clear Trace	2265
Clear All Traces	2265
Trigger	2267
Free Run	2267
Video	2267
Trigger Level	2267
Trig Slope	2267
Trig Delay	2267
Line	2267
Trig Slope	2267
Trig Delay	2267
External 1	2267
Trigger Level	2267
Trig Slope	2267
Trig Delay	2267
Zero Span Delay Comp	2267

External 2	2268
Trigger Level	2268
Trig Slope	2268
Trig Delay	2268
Zero Span Delay Comp	2268
RF Burst	2268
Absolute Trigger	2268
Relative Trigger	2268
Trig Slope	2268
Trig Delay	2268
Periodic Timer	2268
Period	2268
Offset	2268
Reset Offset Display	2268
Sync Source	2269
Off	2269
External 1	2269
External 2	2269
RF Burst	2269
Trig Delay	2269
Auto/Holdoff	2269
Auto Trig	2269
Trig Holdoff	2269
Holdoff Type	2270
User Preset	2271
User Preset	2271
User Preset All Modes	2272
Save User Preset	2273
View/Display	2274
View for all modes except MSR, 1xEV-DO, LTE-Advanced FDD/TDD	2274
1xEV-DO Mode View	2275
MSR and LTE-Advanced FDD/TDD Mode Views	2275
View Selection by Name (MSR and LTE-Advanced FDD/TDD mode only)	2276
View Selection by Number (MSR and LTE-Advanced FDD/TDD mode only)	2276
Display	2276
Annotation	2277
Meas Bar On/Off	2278
Screen	2279
Active Function Values On/Off	2279
Title	2280
Change Title	2280
Clear Title	2281
Graticule	2282
System Display Settings	2282
Annotation Local Settings	2282
Themes	2283

Backlight	2284
Backlight Intensity	2285
Result Trace (MSR and LTE-Advanced FDD/TDD mode only)	2285
Carrier Info (MSR and LTE-Advanced FDD/TDD mode only)	2286
Carrier Freq (MSR and LTE-Advanced FDD/TDD mode only)	2287
Carrier Attribute (MSR and LTE-Advanced FDD/TDD mode only)	2288
Sub-block Attribute (Only for MSR and LTE-Advanced FDD/TDD)	2288
16 Waveform Measurement	2291
AMPTD Y Scale	2295
Ref Value (RF Envelope View)	2295
Attenuation	2295
Dual Attenuator Configurations:	2296
Single Attenuator Configuration:	2297
(Mech) Atten	2297
Attenuator Configurations and Auto/Man	2299
Enable Elec Atten	2299
More Information	2300
Mechanical Attenuator Transition Rules	2300
When the Electronic Attenuation is enabled from a disabled state:	2300
Examples in the dual attenuator configuration:	2300
When the Electronic Attenuation is disabled from an enabled state:	2301
Using the Electronic Attenuator: Pros and Cons	2301
Elec Atten	2301
Adjust Atten for Min Clip	2302
Pre-Adjust for Min Clip	2302
Off	2303
Elec Atten Only	2303
Mech + Elec Atten	2304
(Mech) Atten Step	2304
Adjust Atten (Remote Command only)	2305
Scale/Div (RF Envelope View)	2305
Presel Center	2306
Proper Preselector Operation	2306
Preselector Adjust	2307
μ W Path Control	2308
Standard Path	2309
Low Noise Path Enable	2309
More Information	2310
μ W Preselector Bypass	2311
Internal Preamp	2312
Off	2314
Low Band	2314
Full Range	2314
Ref Position (RF Envelope View)	2314
Auto Scaling	2315

Range	2316
Range Auto/Man	2316
I Range	2317
1 V Peak	2318
0.5 V Peak	2318
0.25 V Peak	2319
0.125 V Peak	2319
Q Range Value	2319
Q Same as I	2320
1 V Peak	2320
0.5 V Peak	2321
0.25 V Peak	2321
0.125 V Peak	2321
I/Q Gain Ranges	2321
1 V Peak	2321
0.5 V Peak	2322
0.25 V Peak	2322
0.125 V Peak	2322
Ref Value	2322
Ref Value (RF Envelope View)	2322
Ref Value (I/Q Waveform View)	2323
Scale/Div	2324
Scale/Div (RF Envelope View)	2324
Scale/Div (I/Q Waveform View)	2324
Ref Position	2325
Ref Position (RF Envelope View)	2325
Ref Position (I/Q Waveform View)	2326
Auto Couple	2327
More Information	2327
Auto/Man Active Function keys	2327
Auto/Man 1-of-N keys	2327
BW	2329
Digital IF BW	2329
Filter Type	2330
Filter BW	2331
Filter Alpha	2332
Filter Type Bwcc	2332
Gaussian	2333
Gaussian filters	2333
Flattop	2337
Flattop Filters	2338
Channel Filter Bandwidth Bwcc (Remote Command Only)	2339
Cont (Continuous Measurement/Sweep)	2340
File	2342
FREQ Channel	2343
Center Freq	2343

Center Freq Offset	2344
Carrier Ref Freq	2344
Carrier Setup	2345
Carriers	2345
Configure Carriers	2345
Select Carrier	2345
Measure Carrier	2346
Carrier Offset	2346
Radio Format	2347
Carrier Allocation	2349
Non-Contiguous	2350
Carrier Conf Presets	2351
MSR Test Config	2352
MSR Non-Contig Test Config	2357
Single RAT Config	2359
Max BS RF Bandwidth	2363
Channel Spacing Delta	2363
Apply to Meas Offset/Limits	2366
RF Bandwidth (Remote Command Only)	2366
RF Bandwidth Center (Remote Command Only)	2367
Sub-block Center (Remote Command Only)	2367
Sub-block Bandwidth (Remote Command Only)	2367
Sub-block Gap (Remote Command Only)	2368
Input/Output	2369
Marker	2370
Select Marker	2370
Marker Type	2370
Properties	2371
Select Marker	2371
Relative To	2371
Marker Trace	2372
Couple Markers	2372
All Markers Off	2373
Marker X Axis Value (Remote Command Only)	2373
Marker X Axis Position (Remote Command Only)	2374
Marker Y Axis Value (Remote Command Only)	2374
Backward Compatibility SCPI Commands	2375
Marker ->	2376
Marker Function	2377
Select Marker	2377
Marker Function Type	2377
Band Adjust	2378
Band/Interval Span for Time Domain	2378
Band/Interval Left for Time Domain	2378
Band/Interval Right for Time Domain	2379
Meas	2381

Remote Measurement Functions	2381
Measurement Group of Commands	2382
Current Measurement Query (Remote Command Only)	2384
Limit Test Current Results (Remote Command Only)	2384
Data Query (Remote Command Only)	2384
Calculate/Compress Trace Data Query (Remote Command Only)	2385
Calculate Peaks of Trace Data (Remote Command Only)	2390
Hardware-Accelerated Fast Power Measurement (Remote Command Only)	2391
Reset Fast Power Measurement (Remote Command Only)	2391
Define Fast Power Measurement (Remote Command Only)	2392
Define Fast Power Measurement Query (Remote Command Only)	2401
Configure Fast Power Measurement (Remote Command Only)	2402
Initiate Fast Power Measurement (Remote Command Only)	2403
Fetch Fast Power Measurement (Remote Command Only)	2403
Execute Fast Power Measurement (Remote Command Only)	2403
Binary Read Fast Power Measurement (Remote Command Only)	2404
Diagnostic Binary Read Fast Power Measurement (Remote Command Only)	2404
Format Data: Numeric Data (Remote Command Only)	2405
Format Data: Byte Order (Remote Command Only)	2406
Meas Setup	2407
Average/Hold Num	2407
Avg Mode	2407
Avg Type	2408
Avg Type Auto	2409
Time Avg Num	2409
Meas Time	2410
Sample Rate	2410
PhNoise Opt	2411
Auto	2412
Best Close-in P Noise	2412
Best Wide-offset P Noise	2413
Fast Tuning	2413
Advanced	2414
ADC Dither	2414
ADC Dither Auto	2414
ADC Dither	2414
IF Gain	2415
IF Gain Auto	2416
IF Gain State	2416
IF Gain Offset	2417
Meas Preset	2418
HW Averaging	2418
Time Avg Num	2419
Sample Period (Aperture) Setting (Remote Command Only)	2419
Mode	2420
Mode Preset	2421

How-To Preset	2422
Preset Type (Remote Command Only)	2423
Mode Setup	2424
Peak Search	2425
Next Peak	2425
Min Search	2425
Print	2427
Quick Save	2428
Recall	2430
State	2430
More Information	2431
From File...	2432
Edit Register Names	2433
Register 1 thru Register 16	2434
Register 1 thru Register 16	2434
Data (Import)	2435
Parameter Set	2436
Masks	2439
Open...	2440
Restart	2441
More Information	2441
Save	2443
State	2443
To File . . .	2444
Edit Register Names	2446
More Information	2446
Register 1 thru Register 16	2447
Register 1 thru Register 16	2447
Mass Storage Catalog (Remote Command Only)	2448
Mass Storage Change Directory (Remote Command Only)	2448
Mass Storage Copy (Remote Command Only)	2449
Mass Storage Device Copy (Remote Command Only)	2449
Mass Storage Delete (Remote Command Only)	2449
Mass Storage Data (Remote Command Only)	2450
Mass Storage Make Directory (Remote Command Only)	2450
Mass Storage Move (Remote Command Only)	2450
Mass Storage Remove Directory (Remote Command Only)	2451
Mass Storage Determine Removable Media (Remote Command Only)	2451
Mass Storage Determine Removable Media Label (Remote Command Only)	2451
Mass Storage Determine Removable Media Write-protect status (Remote Command Only)	2452
Mass Storage Determine Removable Media size (Remote Command Only)	2452
Trace (+State)	2452
From Trace	2454
From File...	2454
Register 1 thru Register 16	2456

Table of Contents

Data (Export)	2457
Parameter Set	2457
Meas Results	2458
Save As . . .	2458
Screen Image	2459
Themes	2460
3D Color	2461
3D Monochrome	2461
Flat Color	2461
Flat Monochrome	2462
Save As...	2462
Single (Single Measurement/Sweep)	2463
More Information	2463
Source	2464
Span X Scale	2465
Ref Value	2465
Scale/Div	2465
Ref Position	2466
Auto Scaling	2466
Sweep/Control	2468
Pause/Resume	2468
Abort (Remote Command Only)	2468
System	2470
Trace/Detector	2471
Trigger	2472
Free Run	2472
Video	2472
Trigger Level	2472
Trig Slope	2472
Trig Delay	2472
Line	2472
Trig Slope	2472
Trig Delay	2472
External 1	2472
Trigger Level	2472
Trig Slope	2472
Trig Delay	2472
Zero Span Delay Comp	2472
External 2	2473
Trigger Level	2473
Trig Slope	2473
Trig Delay	2473
Zero Span Delay Comp	2473
RF Burst	2473
Absolute Trigger	2473
Relative Trigger	2473

Trig Slope	2473
Trig Delay	2473
Periodic Timer	2473
Period	2473
Offset	2473
Offset Adjust (Remote Command Only)	2473
Reset Offset Display	2474
Sync Source	2474
Off	2474
External 1	2474
External 2	2474
RF Burst	2474
Trig Delay	2474
Auto/Holdoff	2474
Auto Trig	2474
Trig Holdoff	2475
Holdoff Type	2475
Baseband I/Q	2475
I/Q Mag	2475
Trigger Level	2475
Trig Slope	2475
Trig Delay	2475
I	2475
Trigger Level	2475
Trig Slope	2475
Trig Delay	2475
Q	2475
Trigger Level	2475
Trig Slope	2475
Trig Delay	2475
Input I	2476
Trigger Level	2476
Trig Slope	2476
Trig Delay	2476
Input Q	2476
Trigger Level	2476
Trig Slope	2476
Trig Delay	2476
Aux Channel Center Freq	2476
Trigger Level	2476
Trig Slope	2476
Trig Delay	2476
Trigger Center Freq	2476
Trigger BW	2476
User Preset	2477
User Preset	2477

Table of Contents

User Preset All Modes	2478
Save User Preset	2479
View/Display	2480
View Selection by name (Remote Command Only)	2480
View Selection by number (Remote Command Only)	2480
Display	2481
Annotation	2481
Meas Bar On/Off	2482
Screen	2483
Active Function Values On/Off	2483
Title	2484
Change Title	2484
Clear Title	2485
Graticule	2486
System Display Settings	2486
Annotation Local Settings	2486
Themes	2487
Backlight	2488
Backlight Intensity	2489
RF Envelope	2489
I/Q Waveform	2490

1 About the Analyzer

The X-Series signal analyzer measures and monitors complex RF and microwave signals. Analog baseband analysis is available on MXA. The analyzer integrates traditional spectrum measurements with advanced vector signal analysis to optimize speed, accuracy, and dynamic range. The analyzer has Windows 7[®] built in as an operating system, which expands its usability.

With a broad set of applications and demodulation capabilities, an intuitive user interface, outstanding connectivity and powerful one-button measurements, the analyzer is ideal for both R&D and manufacturing engineers working on cellular, emerging wireless communications, general purpose, aerospace and defense applications.

Installing Application Software

If you want to install a measurement application after your initial hardware purchase, you need only to license it. All of the available applications are loaded in your instrument at the time of purchase.

Thus, when you purchase a new application, you will receive an entitlement certificate that you can use to obtain a license key for that application. To activate the new measurement application, enter the license key that you obtain into the instrument.

For the latest information on Keysight Spectrum/Signal Analyzer measurement applications and upgrade kits, visit the following internet URL.

www.keysight.com/find/sa_upgrades

Viewing a License Key

Measurement applications that you purchased with your instrument have been installed and activated at the factory before shipment. The instrument requires a unique License Key for every measurement application purchased. The license key is a hexadecimal string that is specific to your measurement application, instrument model number and serial number. It enables you to install, or reactivate, that particular application.

Press **System, Show, System** to display the measurement applications that are currently licensed in your analyzer.

Go to the following location to view the license keys for the installed measurement applications:

```
C:\Program Files\Agilent\Licensing
```

You may want to keep a copy of your license key in a secure location. To do this, you can print out a copy of the display showing the license numbers. If you should lose your license key, call your nearest Keysight Technologies service or sales office for assistance.

Obtaining and Installing a License Key

If you purchase an additional application that requires installation, you will receive an "Entitlement Certificate", which may be redeemed for a license key for one instrument. To obtain your license key, follow the instructions that accompany the certificate.

Installing a license key for the selected application can be done automatically using a USB memory device. To do this, you copy the license file to the USB memory device, at the root level. Follow the instructions that come with your software installation kit.

Installing a license key can also be done manually using the built-in license management application, which may be found via the instrument front panel keys at **System, Licensing. . .**, or on-disk at:

```
C:\Program Files\Agilent\Licensing
```

You can also use these procedures to reinstall a license key that has been accidentally deleted, or lost due to a memory failure.

Updating Measurement Application Software

All the software applications were loaded at the time of original instrument manufacture. It is a good idea to regularly update your software with the latest available version. This helps to ensure that you receive

any improvements and expanded functionality.

Because the software was loaded at the initial purchase, further additional measurement applications may now be available. If the application you are interested in licensing is not available, you will need to do a software update. (To display a list of installed applications, press **System, Show, System.**)

Check the appropriate page of the Keysight web site for the latest available software versions, according to the name of your instrument, as follows:

www.keysight.com/find/pxa_software

www.keysight.com/find/mxa_software

www.keysight.com/find/exa_software

www.keysight.com/find/cxa_software

www.keysight.com/find/mxe_software

You can load the updated software package into the instrument from a USB drive, or directly from the internet. An automatic loading program is included with the files.

X-Series Options and Accessories

You can view an online list of available Options and Accessories for your instrument as follows:

1. Browse to one of the following URLs, according to the product name of your instrument:

www.keysight.com/find/cxa

www.keysight.com/find/exa

www.keysight.com/find/mxa

www.keysight.com/find/pxa

www.keysight.com/find/mxe

2. The home page for your instrument appears (in some cases, you may see an initial splash screen containing a button named View the Webpage, which you should click to display the home page).
3. Locate the Options tab, as highlighted in the example below, which shows the home page for the MXA.

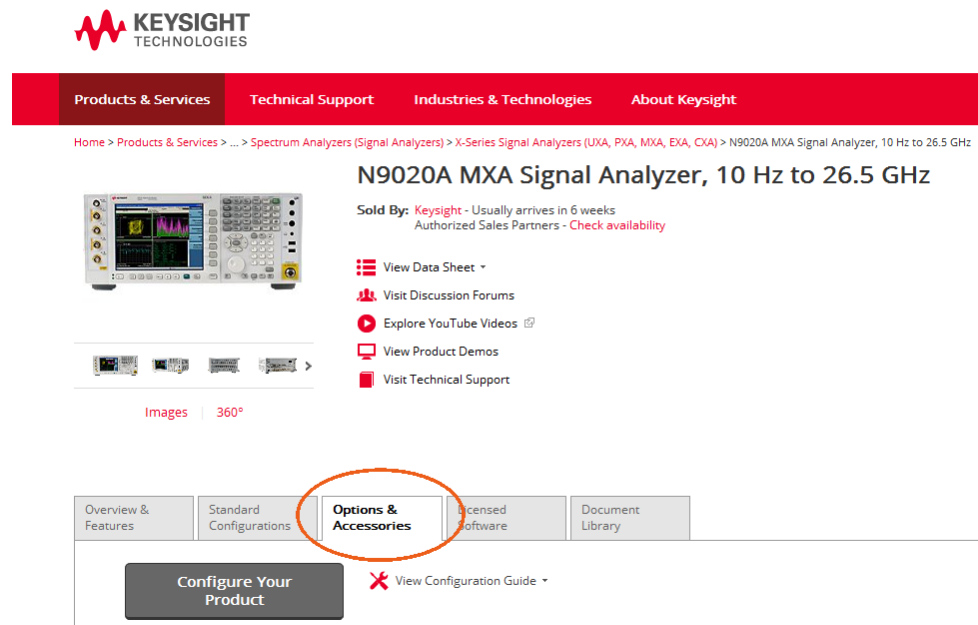

4. Click the Options tab, to display a list of available options and accessories for your instrument.

Front-Panel Features

The instrument's Front-panel features are fully detailed in the section "Front-Panel Features" (under the chapter "Front and Rear Panel Features") of the document:

[Getting Started Guide](#)

If you are viewing this information as a Help file in the instrument, then you can click on the link above to open the PDF document.

Display Annotations

Display Annotations are fully detailed under the chapter "Front and Rear Panel Features" of the document:

[Getting Started Guide](#)

If you are viewing this information as a Help file in the instrument, then you can click on the link above to open the PDF document.

Rear-Panel Features

The instrument's Rear-panel features are fully detailed in the section "Rear-Panel Features" (under the chapter "Front and Rear Panel Features") of the document:

[Getting Started Guide](#)

If you are viewing this information as a Help file in the instrument, then you can click on the link above to open the PDF document.

Window Control Keys

The instrument provides three front-panel keys for controlling windows. They are Multi Window, Zoom, and Next Window. These are all “immediate action” keys.

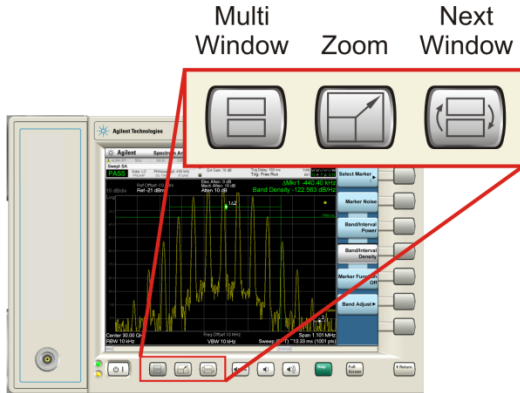

Multi-Window



The **Multi Window** front-panel key will toggle you back and forth between the Normal View and the last Multi Window View (Zone Span, Trace Zoom or Spectrogram) that you were in, when using the Swept SA measurement of the Spectrum Analyzer Mode. It remembers which View you were in through a Preset. This “previous view” is set to Zone Span on a Restore Mode Defaults.

Key Path	Front-panel key
Initial S/W Revision	Prior to A.02.00

Zoom

Zoom is a toggle function. Pressing this key once increases the size of the selected window. Pressing the key again returns the window to the original size.

When Zoom is on for a window, that window will get the entire primary display area. The zoomed window, since it is the selected window, is outlined in green.

Zoom is local to each Measurement. Each Measurement remembers its Zoom state. The Zoom state of each Measurement is part of the Mode’s state.

NOTE

Data acquisition and processing for the other windows continues while a window is zoomed, as does all SCPI communication with the other windows.

Remote Command	:DISPlay:WINDow:FORMat:ZOOM
Remote Command	:DISPlay:WINDow:FORMat:TILE

Example	:DISP:WIND:FORM:ZOOM sets zoomed :DISP:WIND:FORM:TILE sets un-zoomed
Preset	TILE
Initial S/W Revision	Prior to A.02.00

Next Window

Selects the next window of the current view. When the Next Window key is pressed, the next window in the order of precedence becomes selected. If the selected window was zoomed, the next window will also be zoomed.

The window numbers are as follows. Note that these numbers also determine the order of precedence (that is, Next Window goes from 1 to 2, then 2 to 3, etc.):

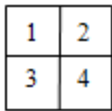

Four window display

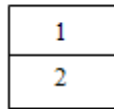

Two window display

RTSA measurements:

Only two windows are available in the Spectrogram view under the Spectrum measurement and up to three windows are available in the Power vs. Time measurement, depending on the view set up.

Remote Command	:DISPlay:WINDow[:SElect] <number> :DISPlay:WINDow[:SElect]?
Example	:DISP:WIND 1
Preset	1
Min	1
Max	If <number> is greater than the number of windows, limit to <number of windows>
Initial S/W Revision	Prior to A.02.00

One and only one window is always selected. The selected window has the focus; this means that all window-specific key presses apply only to that window. You can tell which window is selected by the thick green border around it. If a window is not selected, its boundary is gray.

If a window in a multi-window display is zoomed it is still outlined in green. If there is only one window, the green outline is not used. This allows the user to distinguish between a zoomed window and a display with only one window.

The selected window is local to each Measurement. Each Measurement remembers which window is selected. The selected window for each Measurement is remembered in Mode state.

NOTE

When this key is pressed in Help Mode, it toggles focus between the table of contents window and the topic pane window.

Full Screen

When **Full Screen** is pressed the measurement window expands horizontally over the entire instrument display. The screen graticule area expands to fill the available display area.

It turns off the display of the softkey labels, however the menus and active functions still work. (Though it would obviously be very hard to navigate without the key labels displayed.) Pressing **Full Screen** again while Full Screen is in effect cancels Full Screen.

Note that the banner and status lines are unaffected. You can get even more screen area for your data display by turning off the Meas Bar (in the Display menu) which also turns off the settings panel.

Full Screen is a Meas Global function. Therefore it is cancelled by the **Preset** key.

Key Path	Display
Remote Command	:DISPlay:FSCReen[:STATe] OFF ON 0 1 :DISPlay:FSCReen[:STATe]?
Preset	Unaffected by Preset but set to Off by Restore Misc Defaults or shutdown and restart
State Saved	Not saved in instrument state.
Backwards Compatibility SCPI	:DISPlay:MENU[:STATe] OFF ON 0 1 This emulates ESA full screen functionality, which is the same as the FSCReen command in PSA except that the sense of on/off is reversed (that is, OFF means the menus are OFF, so Fullscreen is ON) and the default is ON (meaning Fullscreen is OFF).
Backwards Compatibility Notes	In ESA/PSA, Full Screen was turned on with a softkey, so pressing any other key turned Full Screen off. In the X-Series, because a hardkey is provided to turn this function on and off, pressing any other key no longer turns off Full Screen
Initial S/W Revision	Prior to A.02.00

Display Enable (Remote Command Only)

Turns the display on/off, including the display drive circuitry. The backlight stays lit so you can tell that the instrument is on. The display enable setting is mode global. The reasons for turning the display off are three:

- To increase speed as much as possible by freeing the instrument from having to update the display
- To reduce emissions from the display, drive circuitry
- For security purposes

If you have turned off the display:

- and you are in local operation, the display can be turned back on by pressing any key or by sending the SYSTem:DEFAults MISC command or the DISPlay:ENABle ON (neither *RST nor SYSTem:PRESet enable the display.)

- and you are in remote operation, the display can be turned back on by pressing the **Local** or **Esc** keys or by sending the SYSTem:DEFaults MISC command or the DISPlay:ENABle ON (neither *RST nor SYSTem:PRESet enable the display.)

and you are using either the SYSTem:KLOCK command or GPIB local lockout, then no front-panel key press will turn the display back on. You must turn it back on remotely.

Remote Command	:DISPlay:ENABle OFF ON 0 1 :DISPlay:ENABle?
Example	DISP:ENAB OFF
Couplings	DISP:ENAB OFF turns Backlight OFF and DISP:ENAB ON turns Backlight ON. However, settings of Backlight do not change the state of DISP:ENAB
Preset	On Set by SYST:DEF MISC, but Not affected by *RST or SYSTem:PRESet.
State Saved	Not saved in instrument state.
Backwards Compatibility Notes	SYST:PRES no longer turns on DISPlay:ENABle as it did in legacy analyzers
Initial S/W Revision	Prior to A.02.00

Mouse and Keyboard Control

If you do not have access to the instrument front-panel, there are several ways that a mouse and PC Keyboard can give you access to functions normally accessed using the front-panel keys.

Right-Click

If you plug in a mouse and right-click on the analyzer screen, a menu will appear as below:

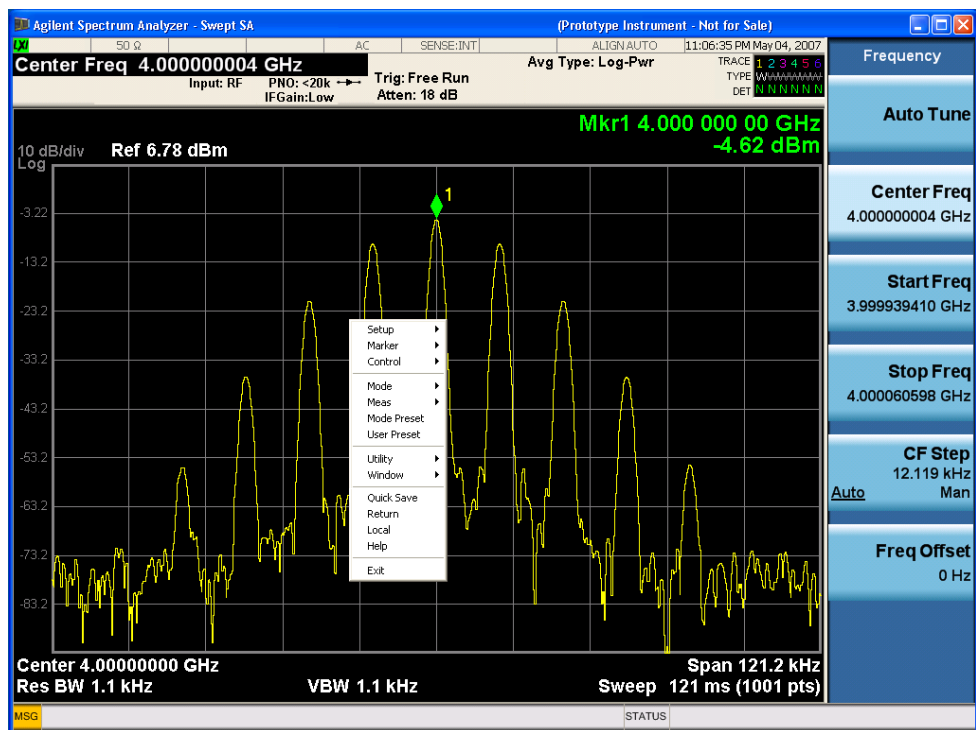

Placing the mouse on one of the rows marked with a right arrow symbol will cause that row to expand, as for example below where the mouse is hovered over the “Utility” row:

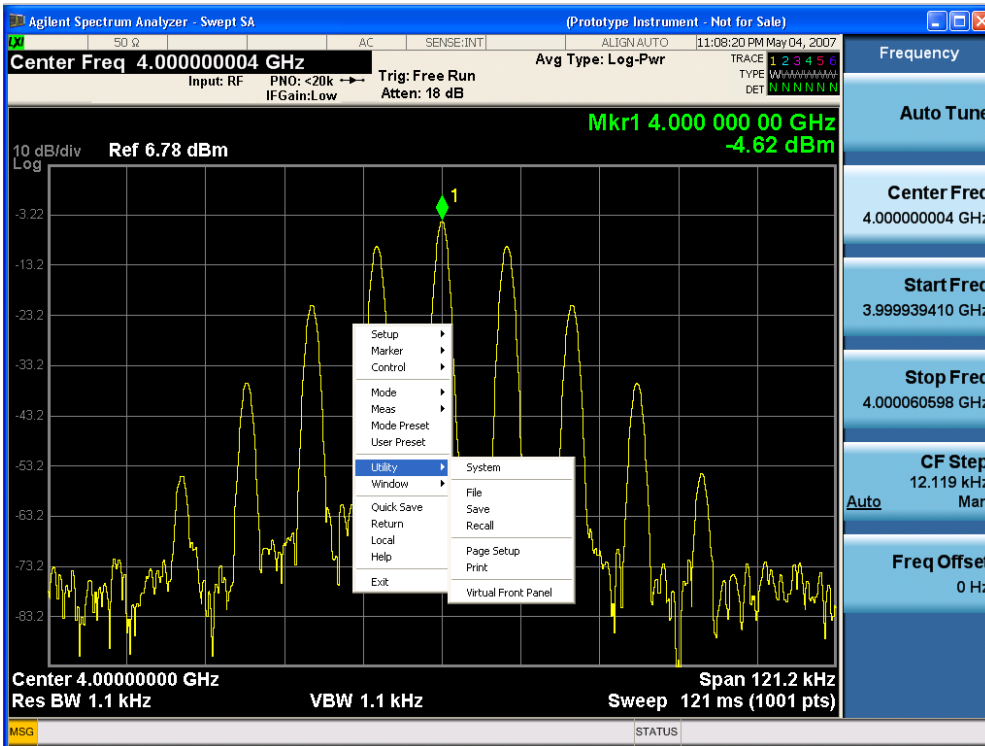

This method can be used to access any of the front-panel keys by using a mouse; as for example if you are accessing the instrument through Remote Desktop.

The array of keys thus available is shown below:

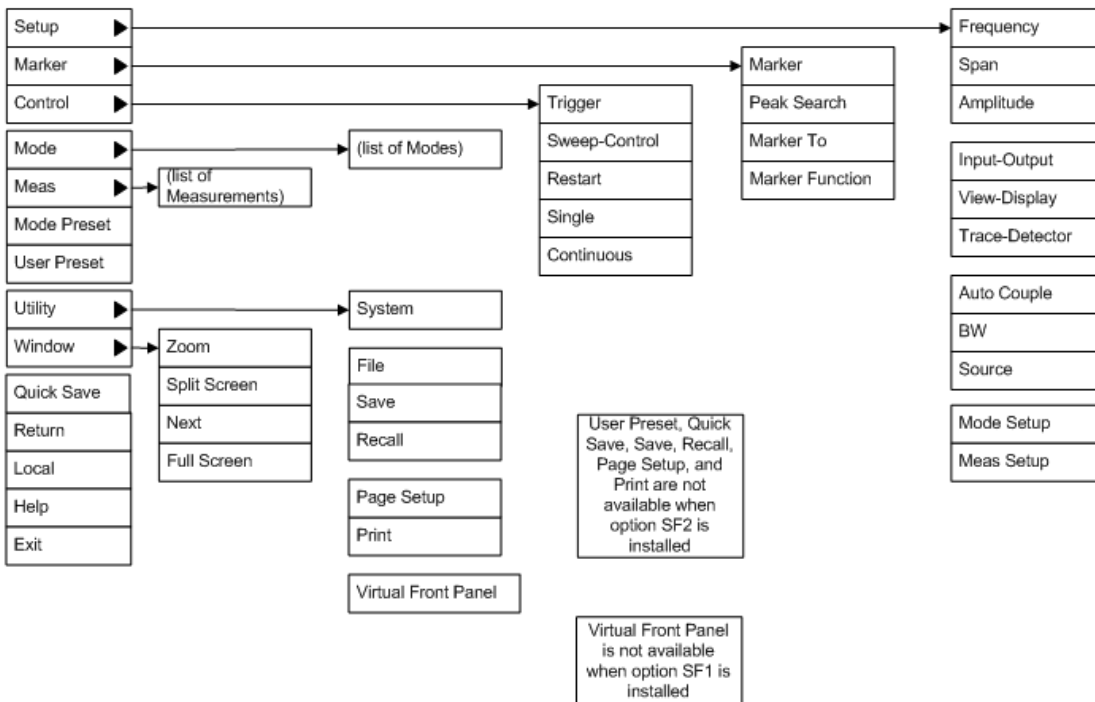

PC Keyboard

If you have a PC keyboard plugged in (or via Remote Desktop), certain key codes on the PC keyboard map to front-panel keys on the GPSA front panel. These key codes are shown below:

Front-panel key	Key code
Frequency	CTRL+SHIFT+F
Span	CTRL+SHIFT+S
Amplitude	CTRL+SHIFT+A
Input/Output	CTRL+SHIFT+O
View/Display	CTRL+SHIFT+V
Trace/Detector	CTRL+ALT+T
Auto Couple	CTRL+SHIFT+C
Bandwidth	CTRL+ALT+B
Source	CTRL+ALT-U
Marker	CTRL+ALT+K
Peak Search	CTRL+ALT+P
Marker To	CTRL+ALT+N
Marker Function	CTRL+ALT+F
System	CTRL+SHIFT+Y
Quick Save	CTRL+Q
Save	CTRL+S
Recall	CTRL+R
Mode Preset	CTRL+M
User Preset	CTRL+U
Print	CTRL+P
File	CTRL+SHIFT+L
Mode	CTRL+SHIFT+M
Measure	CTRL+ALT+M
Mode Setup	CTRL+SHIFT+E
Meas Setup	CTRL+ALT+E
Trigger	CTRL+SHIFT+T
Sweep/Control	CTRL+SHIFT+W
Restart	CTRL+ALT+R
Single	CTRL+ALT+S
Cont	CTRL+ALT+C
Zoom	CTRL+SHIFT+Z
Next Window	CTRL+SHIFT+N
Split Screen	CTRL+L

Front-panel key	Key code
Full Screen	CTRL+SHIFT+B
Return	CTRL+SHIFT+R
Mute	Mute
Inc Audio	Volume Up
Dec Audio	Volume Down
Help	F1
Control	CTRL
Alt	ALT
Enter	Return
Cancel	Esc
Del	Delete
Backspace	Backspace
Select	Space
Up Arrow	Up
Down Arrow	Down
Left Arrow	Left
Right Arrow	Right
Menu key 1	CTRL+SHIFT+F1
Menu key 2	CTRL+SHIFT+F2
Menu key 3	CTRL+SHIFT+F3
Menu key 4	CTRL+SHIFT+F4
Menu key 5	CTRL+SHIFT+F5
Menu key 6	CTRL+SHIFT+F6
Menu key 7	CTRL+SHIFT+F7
Backspace	BACKSPACE
Enter	ENTER
Tab	Tab
1	1
2	2
3	3
4	4
5	5
6	6
7	7
8	8
9	9
0	0

1 About the Analyzer
 Mouse and Keyboard Control

This is a pictorial view of the table:

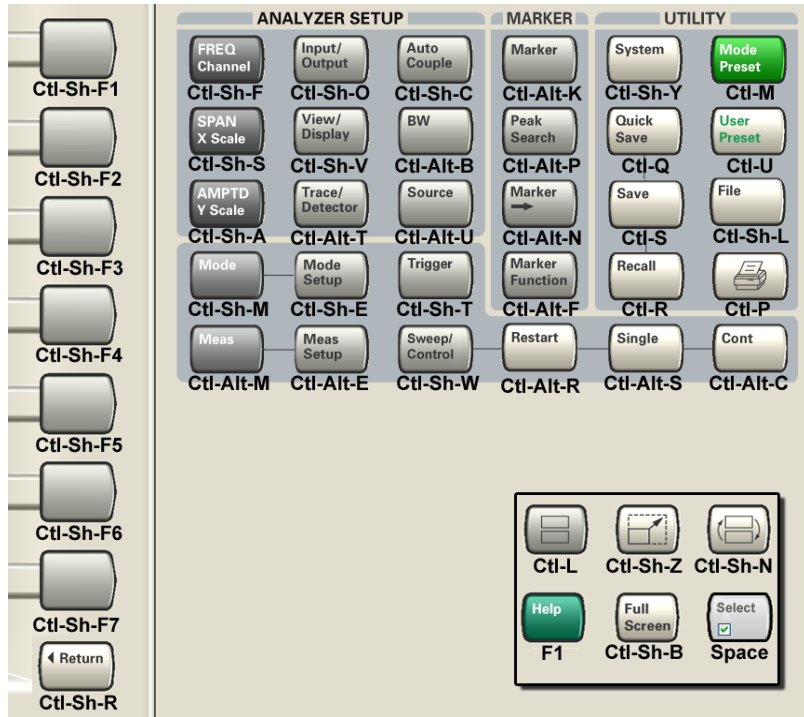

Instrument Security & Memory Volatility

If you are using the instrument in a secure environment, you may need details of how to clear or sanitize its memory, in compliance with published security standards of the United States Department of Defense, or other similar authorities.

For X-Series instruments, this information is contained in the document "Security Features and Document of Volatility". This document is not included in the Documentation DVD, or the instrument's on-disk library, but it may be downloaded from Keysight's web site.

To obtain a copy of the document, click on or browse to the following URL:

www.keysight.com/find/security

To locate and download the document, select Model Number "N9020A", then click "Submit". Then, follow the on-screen instructions to download the file.

2 About the MSR Measurement Application

This chapter provides overall information on MSR communications systems, and describes MSR measurements made by the analyzer.

What Does the MSR Application Do?

This analyzer can be used for testing a MSR downlink signal in base station continuous spectrum operation or non-contiguous operation complying with the standards listed below. Because they are continually changed, each release will support the most recent version of these standards:

- 3GPP TS 37.141 V10.6.0 (2012-03) E-UTRA, UTRA and GSM/EDGE; Multi-Standard Radio (MSR) Base Station (BS) conformance testing (Release 10)
- 3GPP TS 37.104 V9.4.0 (2010-12) E-UTRA, UTRA and GSM/EDGE; Multi-Standard Radio (MSR) Base Station (BS) transmission and reception (Release 9)

The instrument automatically makes these measurements using the measurement methods and limits defined in the documents. The detailed results displayed by the measurements enable you to analyze MSR signals performance. You may alter the measurement parameters for specific analysis.

This analyzer makes the following measurements providing power measurements and modulation analysis for the MSR signals, currently only BTS is supported for Radio Device in MSR mode, so all the measurements are based on MSR downlink signals:

- Channel Power
- Occupied BW
- Adjacent Channel Power (ACP)
- Spectrum Emission Mask
- Spurious Emissions
- MSR Conformance EVM
- Power Stat CCDF
- Monitor Spectrum
- IQ Waveform (Time Domain)

The following description are the guidelines for this applicaiton.

- E-UTRA and UTRA FDD are names of radio formats defined and used in the 3GPP documents. In this application, LTE and W-CDMA are used instead of E-UTRA and UTRA.
- The Multi-Standard Radio mode needs a license N9083A-1FP on the X-Series instrument. Except this license, it requires licenses of the other modes to enable Radio Formats.

Radio Format	Required Options
GSM/EDGE	N/W9071A-2FP GSM/EDGE Measurement Application N/W9071A-3FP EDGE Evolution Measurement Application

Radio Format	Required Options
W-CDMA	N/W9073A-1FP W-CDMA Measurement Application N/W9073A-2FP HSDPA/HSUPA Measurement Application N/W9073A-3FP HSPA+ Measurement Application
LTE FDD	N/W9080A-1FP (Windows XP) or N/W9080B-1FP (Windows 7) LTE FDD Measurement Application
LTE TDD	N/W9082A-1FP (Windows XP) or N/W9082B-1FP (Windows 7) LTE TDD Measurement Application
cdma2000	N/W9072A-2FP cdma2000 Measurement Application
1xEV-DO	N/W9076A-1FP CDMA 1xEVDO Measurement Application
TD-SCDMA	N/W9079A-1FP TD-SCDMA Measurement Application

- If you need to make valid measurements on Multi-Standard Radio signal bandwidths greater than 10MHz, WB (25MHz or wider) option needs to be installed in PXA/MXA/EXA/CXA.

2 About the MSR Measurement Application

What Does the MSR Application Do?

3 Programming the Analyzer

This section provides introductory information about the programming documentation included with your product.

- ["What Programming Information is Available?" on page 98](#)
- ["STATus Subsystem " on page 137](#)
- ["IEEE 488.2 Common Commands" on page 179](#)

What Programming Information is Available?

The X-Series Documentation can be accessed through the Additional Documentation page in the instrument Help system and is included on the Documentation DVD shipped with the instrument. It can also be found online at: http://www.keysight.com/find/mxa_manuals.

The following resources are available to help you create programs for automating your X-Series measurements:

Resource	Description
X-Series Programmer's Guide	Provides general SCPI programming information on the following topics: <ul style="list-style-type: none">• Programming the X-Series Applications• Programming fundamentals• Programming examples Note that SCPI command descriptions for measurement applications are not in this book, but are in the User's and Programmer's Reference.
User's and Programmer's Reference manuals	Describes all front-panel keys and softkeys, including SCPI commands for a measurement application. Note that: <ul style="list-style-type: none">• Each measurement application has its own User's and Programmer's Reference.• The content in this manual is duplicated in the instrument's Help (the Help that you see for a key is identical to what you see in this manual).
Embedded Help in your instrument	Describes all front-panel keys and softkeys, including SCPI commands, for a measurement application. Note that the content that you see in Help when you press a key is identical to what you see in the User's and Programmer's Reference.
X-Series Getting Started Guide	Provides valuable sections related to programming including: <ul style="list-style-type: none">• Licensing New Measurement Application Software - After Initial Purchase• Configuring instrument LAN Hostname, IP Address, and Gateway Address• Using the controller to connect to the instrument remotely• Using the Embedded Web Server Telnet connection to communicate SCPI This printed document is shipped with the instrument.
Keysight Application Notes	Printable PDF versions of pertinent application notes.
Keysight VISA User's Guide	Describes the Keysight Virtual Instrument Software Architecture (VISA) library and shows how to use it to develop I/O applications and instrument drivers on Windows PCs.

List of SCPI Commands

```

*CAL?
*CLS
*ESE <integer>
*ESE?
*ESR?
*IDN?
*OPC
*OPC?
*OPT?
*RCL <register#>
*RST
*SAV <register#>
*SRE <integer>
*SRE?
*STB?
*TRG
*TST?
*WAI
ABORT
ACP:OFFS:INN:TYPE ETOC
ACP:OFFS:INN:TYPE?
CALCulate:ACPower:LIMit:STATe OFF | ON | 0 | 1
CALCulate:ACPower:LIMit:STATe?
CALCulate:ACPower:MARKer:AOff
CALCulate:ACPower:MARKer:COUple[:STATe] ON | OFF | 1 | 0
CALCulate:ACPower:MARKer:COUple[:STATe]?
CALCulate:ACPower:MARKer[1]|2|...|12:FUNCTion:RESult?
CALCulate:ACPower:MARKer[1]|2|...|12:MAXimum
CALCulate:ACPower:MARKer[1]|2|...|12:MAXimum:LEFT
CALCulate:ACPower:MARKer[1]|2|...|12:MAXimum:NEXT
CALCulate:ACPower:MARKer[1]|2|...|12:MAXimum:RIGHT
CALCulate:ACPower:MARKer[1]|2|...|12:MINimum
CALCulate:ACPower:MARKer[1]|2|...|12:MODE POSition | DELTA | OFF
CALCulate:ACPower:MARKer[1]|2|...|12:MODE?
CALCulate:ACPower:MARKer[1]|2|...|12:PTPeak
CALCulate:ACPower:MARKer[1]|2|...|12:REFerence <integer>
CALCulate:ACPower:MARKer[1]|2|...|12:REFerence?
CALCulate:ACPower:MARKer[1]|2|...|12:STATe OFF | ON | 0 | 1
CALCulate:ACPower:MARKer[1]|2|...|12:STATe?
CALCulate:ACPower:MARKer[1]|2|...|12:TRACe 1 | 2 | 3
CALCulate:ACPower:MARKer[1]|2|...|12:TRACe?
CALCulate:ACPower:MARKer[1]|2|...|12:X <freq>
CALCulate:ACPower:MARKer[1]|2|...|12:X?
CALCulate:ACPower:MARKer[1]|2|...|12:X:POSition <real>
CALCulate:ACPower:MARKer[1]|2|...|12:X:POSition?
CALCulate:ACPower:MARKer[1]|2|...|12:Y?
CALCulate:ACPower:OFFSet[:OUTer]:LIST:LIMit:NEGative[:UPPer]:DATA <real>,
...
CALCulate:ACPower:OFFSet[:OUTer]:LIST:LIMit:NEGative[:UPPer]:DATA?

```

```
CALCulate:ACPower:OFFSet[:OUTer]:LIST:LIMit:POSitive[:UPPer]:DATA <real>,
...
CALCulate:ACPower:OFFSet[:OUTer]:LIST:LIMit:POSitive[:UPPer]:DATA?
CALCulate:CEVM:WCDMa:FERRor? <integer>
CALCulate:CEVM:WCDMa:RMSevm? <integer>
CALCulate:CHPower:MARKer:AOff
CALCulate:CHPower:MARKer[1]|2|...|12:MAXimum
CALCulate:CHPower:MARKer[1]|2|...|12:MODE POSition | DELTA | OFF
CALCulate:CHPower:MARKer[1]|2|...|12:MODE?
CALCulate:CHPower:MARKer[1]|2|...|12:REFerence <integer>
CALCulate:CHPower:MARKer[1]|2|...|12:REFerence?
CALCulate:CHPower:MARKer[1]|2|...|12:STATE OFF | ON | 0 | 1
CALCulate:CHPower:MARKer[1]|2|...|12:STATE?
CALCulate:CHPower:MARKer[1]|2|...|12:X <real>
CALCulate:CHPower:MARKer[1]|2|...|12:X?
CALCulate:CHPower:MARKer[1]|2|...|12:X:POSition <real>
CALCulate:CHPower:MARKer[1]|2|...|12:X:POSition?
CALCulate:CHPower:MARKer[1]|2|...|12:Y?
CALCulate:CLIMits:FAIL?
CALCulate:DATA<n>:COMPRESS? BLOCK | CFIT | MAXimum | MINimum | MEAN |
DMEan | RMS | RMSCubed | SAMple | SDEviation | PPHase[, <soffset>[,
<length>[, <roffset>[, <rlimit>]]]]
CALCulate:DATA[n]?
CALCulate:DATA[1]|2|...|6:PEAKs? <threshold>, <excursion>[, AMPLitude |
FREQuency | TIME[, ALL | GTDLine | LTDLine]]
CALCulate:DATA[1]|2|...|6:PEAKs? <threshold>, <excursion>[, AMPLitude |
FREQuency | TIME]
CALCulate:FPOWER:POWER[1,2,...,999]?
CALCulate:FPOWER:POWER[1,2,...,999]:CONFigure
CALCulate:FPOWER:POWER[1,2,...,999]:DEFine "configurationstring"
CALCulate:FPOWER:POWER[1,2,...,999]:DEFine?
CALCulate:FPOWER:POWER[1,2,...,999]:FETCh?
CALCulate:FPOWER:POWER[1,2,...,999]:INITiate
CALCulate:FPOWER:POWER[1,2,...,999]:READ2?
CALCulate:FPOWER:POWER[1,2,...,999]:READ?
CALCulate:FPOWER:POWER[1,2,...,999]:READ1?
CALCulate:FPOWER:POWER[1,2,...,999]:RESet
CALCulate:MCPower:OFFSet:LIST:LIMit:NEGative[:UPPer]:DATA (PSAPowerSuite)
CALCulate:MCPower:OFFSet:LIST:LIMit:POSitive[:UPPer]:DATA (PSAPowerSuite)
CALCulate:MONitor:MARKer:AOff
CALCulate:MONitor:MARKer:COUPle[:STATe] ON | OFF | 1 | 0
CALCulate:MONitor:MARKer:COUPle[:STATe]?
CALCulate:MONitor:MARKer[1]|2|...|12:FUNCTion NOISe | BPOWER | BDENsity |
OFF
CALCulate:MONitor:MARKer[1]|2|...|12:FUNCTion?
CALCulate:MONitor:MARKer[1]|2|...|12:FUNCTion:BAND:LEFT <freq>
CALCulate:MONitor:MARKer[1]|2|...|12:FUNCTion:BAND:LEFT?
CALCulate:MONitor:MARKer[1]|2|...|12:FUNCTion:BAND:RIGHT <freq>
CALCulate:MONitor:MARKer[1]|2|...|12:FUNCTion:BAND:RIGHT?
CALCulate:MONitor:MARKer[1]|2|...|12:FUNCTion:BAND:SPAN <freq>
CALCulate:MONitor:MARKer[1]|2|...|12:FUNCTion:BAND:SPAN?
CALCulate:MONitor:MARKer[1]|2|...|12:FUNCTion:RESult?
```



```

CALCulate:MONitor:MARKer[1]|2|...|12:MAXimum
CALCulate:MONitor:MARKer[1]|2|...|12:MODE POSITION | DELTa | OFF
CALCulate:MONitor:MARKer[1]|2|...|12:MODE?
CALCulate:MONitor:MARKer[1]|2|...|12:REFeRence <integer>
CALCulate:MONitor:MARKer[1]|2|...|12:REFeRence?
CALCulate:MONitor:MARKer[1]|2|...|12:TRACe <integer>
CALCulate:MONitor:MARKer[1]|2|...|12:TRACe?
CALCulate:MONitor:MARKer[1]|2|...|12:X <freq>
CALCulate:MONitor:MARKer[1]|2|...|12:X?
CALCulate:MONitor:MARKer[1]|2|...|12:X:POSition <real>
CALCulate:MONitor:MARKer[1]|2|...|12:X:POSition?
CALCulate:MONitor:MARKer[1]|2|...|12:Y?
CALCulate:OBWidth:LIMit:FBLimit <freq>
CALCulate:OBWidth:LIMit:FBLimit?
CALCulate:OBWidth:LIMit[:TEST] ON | OFF | 1 | 0
CALCulate:OBWidth:LIMit[:TEST]?
CALCulate:OBWidth:MARKer:AOFF
CALCulate:OBWidth:MARKer[1]|2|...|12:MAXimum
CALCulate:OBWidth:MARKer[1]|2|...|12:MODE POSITION | DELTa | OFF
CALCulate:OBWidth:MARKer[1]|2|...|12:MODE?
CALCulate:OBWidth:MARKer[1]|2|...|12:REFeRence <integer>
CALCulate:OBWidth:MARKer[1]|2|...|12:REFeRence?
CALCulate:OBWidth:MARKer[1]|2|...|12:STATE OFF | ON | 0 | 1
CALCulate:OBWidth:MARKer[1]|2|...|12:STATE?
CALCulate:OBWidth:MARKer[1]|2|...|12:X <freq>
CALCulate:OBWidth:MARKer[1]|2|...|12:X?
CALCulate:OBWidth:MARKer[1]|2|...|12:X:POSition <real>
CALCulate:OBWidth:MARKer[1]|2|...|12:X:POSition?
CALCulate:OBWidth:MARKer[1]|2|...|12:Y?
CALCulate:PStatistic:MARKer:AOFF
CALCulate:PStatistic:MARKer[1]|2|...|12:FUNCTion:RESult?
CALCulate:PStatistic:MARKer[1]|2|...|12:MODE POSITION | DELTa | OFF
CALCulate:PStatistic:MARKer[1]|2|...|12:MODE?
CALCulate:PStatistic:MARKer[1]|2|...|12:REFeRence <integer>
CALCulate:PStatistic:MARKer[1]|2|...|12:REFeRence?
CALCulate:PStatistic:MARKer[1]|2|...|12:TRACe MEASured | GAUSSian |
REFeRence
CALCulate:PStatistic:MARKer[1]|2|...|12:TRACe?
CALCulate:PStatistic:MARKer[1]|2|...|12:X <rel_ampl>
CALCulate:PStatistic:MARKer[1]|2|...|12:X?
CALCulate:PStatistic:MARKer[1]|2|...|12:Y?
CALCulate:PStatistic:STORE:REFeRence
CALCulate:SEMask:LLINE:STATE ON | OFF | 1 | 0
CALCulate:SEMask:LLINE:STATE?
CALCulate:SEMask:MARKer:AOFF
CALCulate:SEMask:MARKer:COUPle[:STATE] ON | OFF | 1 | 0
CALCulate:SEMask:MARKer:COUPle[:STATE]?
CALCulate:SEMask:MARKer[1]|2|...|12:FUNCTion:RESult?
CALCulate:SEMask:MARKer[1]|2|...|12:MODE POSITION | OFF
CALCulate:SEMask:MARKer[1]|2|...|12:MODE?
CALCulate:SEMask:MARKer[1]|2|...|12:X <freq>
CALCulate:SEMask:MARKer[1]|2|...|12:X?
CALCulate:SEMask:MARKer[1]|2|...|12:X:POSition <real>

```

3 Programming the Analyzer

List of SCPI Commands

```
CALCulate:SEMask:MARKer[1]|2|...|12:X:POSition?
CALCulate:SEMask:MARKer[1]|2|...|12:Y?
CALCulate:SPURious:MARKer:AOFF
CALCulate:SPURious:MARKer:COUple[:STATe] ON | OFF | 1 | 0
CALCulate:SPURious:MARKer:COUple[:STATe]?
CALCulate:SPURious:MARKer[1]|2|...|12:MAXimum
CALCulate:SPURious:MARKer[1]|2|...|12:MAXimum:LEFT
CALCulate:SPURious:MARKer[1]|2|...|12:MAXimum:NEXT
CALCulate:SPURious:MARKer[1]|2|...|12:MAXimum:RIGHT
CALCulate:SPURious:MARKer[1]|2|...|12:MINimum
CALCulate:SPURious:MARKer[1]|2|...|12:MODE POSition | DELTa | OFF
CALCulate:SPURious:MARKer[1]|2|...|12:MODE?
CALCulate:SPURious:MARKer[1]|2|...|12:PTPeak
CALCulate:SPURious:MARKer[1]|2|...|12:REFerence <integer>
CALCulate:SPURious:MARKer[1]|2|...|12:REFerence?
CALCulate:SPURious:MARKer[1]|2|...|12:X <freq>
CALCulate:SPURious:MARKer[1]|2|...|12:X?
CALCulate:SPURious:MARKer[1]|2|...|12:X:POSition <integer>
CALCulate:SPURious:MARKer[1]|2|...|12:X:POSition?
CALCulate:SPURious:MARKer[1]|2|...|12:Y?
CALCulate:SPURious[:RANGe][:LIST]:LIMit:ABSolute[:UPPer]:DATA[:START]
<ampl>, ...
CALCulate:SPURious[:RANGe][:LIST]:LIMit:ABSolute[:UPPer]:DATA[:START]?
CALCulate:SPURious[:RANGe][:LIST]:LIMit:ABSolute[:UPPer]:DATA:STOP <ampl>,
...
CALCulate:SPURious[:RANGe][:LIST]:LIMit:ABSolute[:UPPer]:DATA:STOP?
CALCulate:SPURious[:RANGe][:LIST]:LIMit:ABSolute[:UPPer]:DATA:STOP:AUTO
OFF|ON|0|1, ...
CALCulate:SPURious[:RANGe][:LIST]:LIMit:ABSolute[:UPPer]:DATA:STOP:AUTO?
CALCulate:WAVEform:MARKer:AOFF
CALCulate:WAVEform:MARKer:COUple[:STATe] ON | OFF | 1 | 0
CALCulate:WAVEform:MARKer:COUple[:STATe]?
CALCulate:WAVEform:MARKer[1]|2|...|12:FUNCTion BPOWER | BDENSity | OFF
CALCulate:WAVEform:MARKer[1]|2|...|12:FUNCTion?
CALCulate:WAVEform:MARKer[1]|2|...|12:FUNCTion:BAND:LEFT <time>
CALCulate:WAVEform:MARKer[1]|2|...|12:FUNCTion:BAND:LEFT?
CALCulate:WAVEform:MARKer[1]|2|...|12:FUNCTion:BAND:RIGHT <time>
CALCulate:WAVEform:MARKer[1]|2|...|12:FUNCTion:BAND:RIGHT?
CALCulate:WAVEform:MARKer[1]|2|...|12:FUNCTion:BAND:SPAN <time>
CALCulate:WAVEform:MARKer[1]|2|...|12:FUNCTion:BAND:SPAN?
CALCulate:WAVEform:MARKer[1]|2|...|12:FUNCTion:RESUlt?
CALCulate:WAVEform:MARKer[1]|2|...|12:MAXimum
CALCulate:WAVEform:MARKer[1]|2|...|12:MAXimum:NEXT
CALCulate:WAVEform:MARKer[1]|2|...|12:MINimum
CALCulate:WAVEform:MARKer[1]|2|...|12:MODE POSition | DELTa | OFF
CALCulate:WAVEform:MARKer[1]|2|...|12:MODE?
CALCulate:WAVEform:MARKer[1]|2|...|12:REFerence <integer>
CALCulate:WAVEform:MARKer[1]|2|...|12:REFerence?
CALCulate:WAVEform:MARKer[1]|2|...|12:STATE OFF | ON | 0 | 1
CALCulate:WAVEform:MARKer[1]|2|...|12:STATE?
CALCulate:WAVEform:MARKer[1]|2|...|12:TRACe RFENvelope | I | Q | IQ
CALCulate:WAVEform:MARKer[1]|2|...|12:TRACe?
```

```

CALCulate:WAVEform:MARKer[1]|2|...|12:X <time>
CALCulate:WAVEform:MARKer[1]|2|...|12:X?
CALCulate:WAVEform:MARKer[1]|2|...|12:X:POSition <real>
CALCulate:WAVEform:MARKer[1]|2|...|12:X:POSition?
CALCulate:WAVEform:MARKer[1]|2|...|4:X:SPAN
CALCulate:WAVEform:MARKer[1]|2|...|12:Y?
CALibration[:ALL]
CALibration[:ALL]?
CALibration[:ALL]:NPENDING
CALibration:AUTO ALERT
CALibration:AUTO ON | PARTIAL | OFF
CALibration:AUTO?
CALibration:AUTO:ALERT TEMPERATURE | DAY | WEEK | NONE
CALibration:AUTO:ALERT?
CALibration:AUTO:MODE ALL | NRF
CALibration:AUTO:MODE?
CALibration:AUTO:TIME:OFF?
CALibration:DATA:BACKup <filename>
CALibration:DATA:DEFault
CALibration:DATA:REStore <filename>
CALibration:EMIXer
CALibration:EMIXer?
CALibration:EXPIred?
CALibration:FREQuency:REFerence:COARse
CALibration:FREQuency:REFerence:COARse <integer>
CALibration:FREQuency:REFerence:COARse?
CALibration:FREQuency:REFerence:FINE <integer>
CALibration:FREQuency:REFerence:FINE?
CALibration:FREQuency:REFerence:MODE CALibrated | USER
CALibration:FREQuency:REFerence:MODE?
CALibration:IQ:FLATness:I
CALibration:IQ:FLATness:IBAR
CALibration:IQ:FLATness:I|IBAR|Q|QBAR:TIME?
CALibration:IQ:FLATness:Q
CALibration:IQ:FLATness:QBAR
CALibration:IQ:ISOLation
CALibration:IQ:ISOLation:TIME?
CALibration:IQ:PROBE:I
CALibration:IQ:PROBE:IBar
CALibration:IQ:PROBE:I|IBAR|Q|QBAR:TIME?
CALibration:IQ:PROBE:I|Q:CLEar
CALibration:IQ:PROBE:Q
CALibration:IQ:PROBE:QBar
CALibration:NFLoor
CALibration:NFLoor?
CALibration:NRF
CALibration:NRF?
CALibration:NRF:NPENDING
CALibration:REFerence:CLOCK?
CALibration:REFerence:CLOCK:END?
CALibration:REFerence:CLOCK:INITialize?
CALibration:RF
CALibration:RF?

```

3 Programming the Analyzer

List of SCPI Commands

```
CALibration:RF:NPENding
CALibration:RFPSelector:SCHeduler:TIME:NEXT?
CALibration:SOURce:STATe OFF | ON | 0 | 1
CALibration:SOURce:STATe?
CALibration:TDS
CALibration:TEMPerature:CURRent?
CALibration:TEMPerature:LALL?
CALibration:TEMPerature:LPReselector?
CALibration:TEMPerature:LRF?
CALibration:TEMPerature:NFLoor?
CALibration:TEMPerature:RFPSelector:LCONducted?
CALibration:TEMPerature:RFPSelector:LRADiated?
CALibration:TIME:ELAPsed:NFLoor?
CALibration:TIME:LALL?
CALibration:TIME:LPReselector?
CALibration:TIME:LRF?
CALibration:TIME:NFLoor?
CALibration:TIME:REFerence:CLOCK?
CALibration:TIME:RFPSelector:LCONducted?
CALibration:TIME:RFPSelector:LRADiated?
CALibration:YTF
CALibration:YTF?
CALibration:YTF:NPENding
CONF FSC
CONFigure?
CONFigure:ACP
CONFigure:ACP:NDEFault
CONFigure:ACPower
CONFigure:CEVM
CONFigure:CEVM:NDEFault
CONFigure:CHPower
CONFigure:CHPower
CONFigure:CHPower:NDEFault
CONFigure:MONitor
CONFigure:MONitor
CONFigure:MONitor:NDEFault
CONFigure:OBWidth
CONFigure:OBWidth
CONFigure:OBWidth:NDEFault
CONFigure:PStatistic
CONFigure:PStatistic
CONFigure:PStatistic:NDEFault
CONFigure:SEMask
CONFigure:SEMask
CONFigure:SEMask:NDEFault
CONFigure:SPURious
CONFigure:SPURious
CONFigure:SPURious:NDEFault
CONFigure:WAVEform
CONFigure:WAVEform
CONFigure:WAVEform:NDEFault
COUple ALL | NONE
DISPlay:<measurement>:ANNotation:TITLe:DATA <string>
```

```

DISPlay:<measurement>:ANNOtation:TITLe:DATA?
DISPlay:ACPower:VIEW:NSElect <integer>
DISPlay:ACPower:VIEW:NSElect?
DISPlay:ACPower:VIEW:RTYPE OUTER | OINNER
DISPlay:ACPower:VIEW:RTYPE
DISPlay:ACPower:VIEW[:SElect] PRESult | CINformation
DISPlay:ACPower:VIEW[:SElect]?
DISPlay:ACPower:VIEW[1]:WINDow[1]:BGRaph OFF | ON | 0 | 1
DISPlay:ACPower:VIEW[1]:WINDow[1]:BGRaph?
DISPlay:ACPower:VIEW:WINDow:CINformation:FREQuency OFFSet | ABSolute
DISPlay:ACPower:VIEW:WINDow:CINformation:FREQuency?
DISPlay:ACPower:VIEW[1]:WINDow[1]:TRACe:Y[:SCALe]:COUPlE 0 | 1 | OFF | ON
DISPlay:ACPower:VIEW[1]:WINDow[1]:TRACe:Y[:SCALe]:COUPlE?
DISPlay:ACPower:VIEW[1]:WINDow[1]:TRACe:Y[:SCALe]:PDIVision <rel_ampl>
DISPlay:ACPower:VIEW[1]:WINDow[1]:TRACe:Y[:SCALe]:PDIVision?
DISPlay:ACPower:VIEW[1]:WINDow[1]:TRACe:Y[:SCALe]:RLEVEl <real>
DISPlay:ACPower:VIEW[1]:WINDow[1]:TRACe:Y[:SCALe]:RLEVEl?
DISPlay:ACPower:VIEW[1]:WINDow[1]:TRACe:Y[:SCALe]:RPOStion TOP | CENTER |
BOTTom
DISPlay:ACPower:VIEW[1]:WINDow[1]:TRACe:Y[:SCALe]:RPOStion?
DISPlay:ACTivefunc[:STATe] ON | OFF | 1 | 0
DISPlay:ACTivefunc[:STATe]?
DISPlay:ANNOtation:MBAR[:STATe] OFF | ON | 0 | 1
DISPlay:ANNOtation:MBAR[:STATe]?
DISPlay:ANNOtation:SCREen[:STATe] OFF | ON | 0 | 1
DISPlay:ANNOtation:SCREen[:STATe]?
DISPlay:BACKlight ON | OFF
DISPlay:BACKlight?
DISPlay:BACKlight:INTensity <integer>
DISPlay:BACKlight:INTensity?
DISPlay:CEVM:VIEW:RMCindex <integer>
DISPlay:CEVM:VIEW:RMCindex?
DISPlay:CHPower:VIEW:NSElect <integer>
DISPlay:CHPower:VIEW:NSElect?
DISPlay:CHPower:VIEW[:SElect] RFSpectrum | SHOULder
DISPlay:CHPower:VIEW[:SElect] RFSpectrum | SHOULder | MASK
DISPlay:CHPower:VIEW[:SElect] PRESult | CINformation
DISPlay:CHPower:VIEW[:SElect]?
DISPlay:CHPower:VIEW[:SElect]?
DISPlay:CHPower:VIEW[:SElect]?
DISPlay:CHPower:VIEW[1]:WINDow[1]:BGRaph ON | OFF | 1 | 0
DISPlay:CHPower:VIEW[1]:WINDow[1]:BGRaph?
DISPlay:CHPower:VIEW:WINDow:CINformation:FREQuency OFFSet | ABSolute
DISPlay:CHPower:VIEW:WINDow:CINformation:FREQuency?
DISPlay:CHPower:VIEW[1]:WINDow[1]:TRACe:Y[:SCALe]:COUPlE 0 | 1 | OFF | ON
DISPlay:CHPower:VIEW[1]:WINDow[1]:TRACe:Y[:SCALe]:COUPlE?
DISPlay:CHPower:VIEW[1]:WINDow[1]:TRACe:Y[:SCALe]:PDIVision <rel_ampl>
DISPlay:CHPower:VIEW[1]:WINDow[1]:TRACe:Y[:SCALe]:PDIVision?
DISPlay:CHPower:VIEW[1]:WINDow[1]:TRACe:Y[:SCALe]:RLEVEl <real>
DISPlay:CHPower:VIEW[1]:WINDow[1]:TRACe:Y[:SCALe]:RLEVEl?
DISPlay:CHPower:VIEW[1]:WINDow[1]:TRACe:Y[:SCALe]:RPOStion TOP | CENTER |
BOTTom
DISPlay:CHPower:VIEW[1]:WINDow[1]:TRACe:Y[:SCALe]:RPOStion?

```

3 Programming the Analyzer

List of SCPI Commands

```
DISPlay:ENABle OFF | ON | 0 | 1
DISPlay:ENABle?
DISPlay:FSCREEN[:STATE] OFF | ON | 0 | 1
DISPlay:FSCREEN[:STATE]?
DISPlay:MENU[:STATE] OFF | ON | 0 | 1
DISPlay:MONitor:VIEW:NSElect <integer>
DISPlay:MONitor:VIEW:NSElect?
DISPlay:MONitor:VIEW[:SElect] RTRace | CINformation
DISPlay:MONitor:VIEW[:SElect]?
DISPlay:MONitor:VIEW:WINDow:CATtribute OFF | ON | 0 | 1
DISPlay:MONitor:VIEW:WINDow:CATtribute?
DISPlay:MONitor:VIEW:WINDow:CINformation:FREQuency OFFSet | ABSolute
DISPlay:MONitor:VIEW:WINDow:CINformation:FREQuency?
DISPlay:MONitor:VIEW:WINDow:SATtribute[:STATE] OFF | ON | 0 | 1
DISPlay:MONitor:VIEW:WINDow:SATtribute[:STATE]?
DISPlay:MONitor:VIEW:WINDow:TRACe[1]|2|3:CLEar
DISPlay:MONitor:VIEW:WINDow:TRACe:CLEar:ALL
DISPlay:MONitor:VIEW:WINDow:TRACe[1]|2|3:TYPE
DISPlay:MONitor:VIEW[1]:WINDow[1]:TRACe:Y[:SCALE]:COUPle 0 | 1 | OFF | ON
DISPlay:MONitor:VIEW[1]:WINDow[1]:TRACe:Y[:SCALE]:COUPle?
DISPlay:MONitor:VIEW[1]:WINDow[1]:TRACe:Y[:SCALE]:PDIVision <rel_ampl>
DISPlay:MONitor:VIEW[1]:WINDow[1]:TRACe:Y[:SCALE]:PDIVision?
DISPlay:MONitor:VIEW[1]:WINDow[1]:TRACe:Y[:SCALE]:RLEVel <real>
DISPlay:MONitor:VIEW[1]:WINDow[1]:TRACe:Y[:SCALE]:RLEVel?
DISPlay:MONitor:VIEW[1]:WINDow[1]:TRACe:Y[:SCALE]:RPOSITION TOP | CENTER |
BOTTom
DISPlay:MONitor:VIEW[1]:WINDow[1]:TRACe:Y[:SCALE]:RPOSITION?
DISPlay:OBwidth:VIEW:NSElect <integer>
DISPlay:OBwidth:VIEW:NSElect?
DISPlay:OBwidth:VIEW[:SElect] OBWResults | BOUNDaries
DISPlay:OBwidth:VIEW[:SElect]?
DISPlay:OBwidth:VIEW2:WINDow2:BOUNDaries:FREQuency OFFSet | ABSolute
DISPlay:OBwidth:VIEW2:WINDow2:BOUNDaries:FREQuency?
DISPlay:OBwidth:VIEW[1]:WINDow[1]:TRACe:Y[:SCALE]:COUPle 0 | 1 | OFF | ON
DISPlay:OBwidth:VIEW[1]:WINDow[1]:TRACe:Y[:SCALE]:COUPle?
DISPlay:OBwidth:VIEW[1]:WINDow[1]:TRACe:Y[:SCALE]:PDIVision <rel_ampl>
DISPlay:OBwidth:VIEW[1]:WINDow[1]:TRACe:Y[:SCALE]:PDIVision?
DISPlay:OBwidth:VIEW[1]:WINDow[1]:TRACe:Y[:SCALE]:RLEVel <real>
DISPlay:OBwidth:VIEW[1]:WINDow[1]:TRACe:Y[:SCALE]:RLEVel?
DISPlay:OBwidth:VIEW[1]:WINDow[1]:TRACe:Y[:SCALE]:RPOSITION TOP | CENTER |
BOTTom
DISPlay:OBwidth:VIEW[1]:WINDow[1]:TRACe:Y[:SCALE]:RPOSITION?
DISPlay:OBwidth:VIEW:WINDow[1]:XDB 0 | 1 | OFF | ON
DISPlay:OBwidth:VIEW:WINDow[1]:XDB?
DISPlay:PStatistic:GAUSSian[:STATE] OFF | ON | 0 | 1
DISPlay:PStatistic:GAUSSian[:STATE]?
DISPlay:PStatistic:RTRace[:STATE] OFF | ON | 0 | 1
DISPlay:PStatistic:RTRace[:STATE]?
DISPlay:PStatistic:VIEW[1]:WINDow2:TRACe:X[:SCALE]:PDIVision <rel_ampl>
DISPlay:PStatistic:VIEW[1]:WINDow2:TRACe:X[:SCALE]:PDIVision?
DISPlay:PStatistic:XScale
DISPlay:SEMask:VIEW:NSElect <integer>
DISPlay:SEMask:VIEW:NSElect?
```

```

DISPlay:SEMask:VIEW[:SElect] APFReq | RPFReq | IPOWer | CINformation
DISPlay:SEMask:VIEW[:SElect]?
DISPlay:SEMask:VIEW[1]:WINDow[1]:CINformation:FREQuency OFFSet | ABSolute
DISPlay:SEMask:VIEW[1]:WINDow[1]:CINformation:FREQuency?
DISPlay:SEMask:VIEW[1]:WINDow[1]:TRACe:X[:SCALe]:COUple 0 | 1 | OFF | ON
DISPlay:SEMask:VIEW[1]:WINDow[1]:TRACe:X[:SCALe]:COUple?
DISPlay:SEMask:VIEW[1]:WINDow[1]:TRACe:X[:SCALe]:PDIVision ?
DISPlay:SEMask:VIEW[1]:WINDow[1]:TRACe:X[:SCALe]:PDIVision <freq>
DISPlay:SEMask:VIEW[1]:WINDow[1]:TRACe:X[:SCALe]:RLEVel <freq>
DISPlay:SEMask:VIEW[1]:WINDow[1]:TRACe:X[:SCALe]:RLEVel?
DISPlay:SEMask:VIEW[1]:WINDow[1]:TRACe:X[:SCALe]:RPOStion LEFT | CENTer |
RIGHT
DISPlay:SEMask:VIEW[1]:WINDow[1]:TRACe:X[:SCALe]:RPOStion?
DISPlay:SEMask:VIEW[1]:WINDow[1]:TRACe:Y[:SCALe]:COUple 0 | 1 | ON | OFF
DISPlay:SEMask:VIEW[1]:WINDow[1]:TRACe:Y[:SCALe]:COUple?
DISPlay:SEMask:VIEW[1]:WINDow[1]:TRACe:Y[:SCALe]:PDIVision <rel_ampl>
DISPlay:SEMask:VIEW[1]:WINDow[1]:TRACe:Y[:SCALe]:PDIVision?
DISPlay:SEMask:VIEW[1]:WINDow[1]:TRACe:Y[:SCALe]:RLEVel <real>
DISPlay:SEMask:VIEW[1]:WINDow[1]:TRACe:Y[:SCALe]:RLEVel?
DISPlay:SEMask:VIEW[1]:WINDow[1]:TRACe:Y[:SCALe]:RPOStion TOP | CENTer |
BOTTOm
DISPlay:SEMask:VIEW[1]:WINDow[1]:TRACe:Y[:SCALe]:RPOStion?
DISPlay:SPURious:VIEW:RANGe[:SElect] <integer>
DISPlay:SPURious:VIEW:RANGe[:SElect]?
DISPlay:SPURious:VIEW:RANGe:TABLE <integer>
DISPlay:SPURious:VIEW:RANGe:TABLE?
DISPlay:SPURious:VIEW[:SElect] RESult | RANGe | ALL
DISPlay:SPURious:VIEW[:SElect]?
DISPlay:SPURious:VIEW[1]:WINDow[1]:TRACe:Y[:SCALe]:COUple 0 | 1 | OFF | ON
DISPlay:SPURious:VIEW[1]:WINDow[1]:TRACe:Y[:SCALe]:COUple?
DISPlay:SPURious:VIEW[1]:WINDow[1]:TRACe:Y[:SCALe]:PDIVision <rel_ampl>
DISPlay:SPURious:VIEW[1]:WINDow[1]:TRACe:Y[:SCALe]:PDIVision?
DISPlay:SPURious:VIEW[1]:WINDow[1]:TRACe:Y[:SCALe]:RLEVel <real>
DISPlay:SPURious:VIEW[1]:WINDow[1]:TRACe:Y[:SCALe]:RLEVel?
DISPlay:WAVEform:VIEW:NSElect <integer>
DISPlay:WAVEform:VIEW:NSElect?
DISPlay:WAVEform:VIEW[:SElect] RFENvelope | IQ
DISPlay:WAVEform:VIEW[:SElect]?
DISPlay:WAVEform:VIEW[1]|2:WINDow[1]:TRACe:X[:SCALe]:COUple 0 | 1 | OFF |
ON
DISPlay:WAVEform:VIEW[1]|2:WINDow[1]:TRACe:X[:SCALe]:COUple?
DISPlay:WAVEform:VIEW[1]|2:WINDow[1]:TRACe:X[:SCALe]:PDIVision <time>
DISPlay:WAVEform:VIEW[1]|2:WINDow[1]:TRACe:X[:SCALe]:PDIVision?
DISPlay:WAVEform:VIEW[1]|2:WINDow[1]:TRACe:X[:SCALe]:RLEVel <time>
DISPlay:WAVEform:VIEW[1]|2:WINDow[1]:TRACe:X[:SCALe]:RLEVel?
DISPlay:WAVEform:VIEW[1]|2:WINDow[1]:TRACe:X[:SCALe]:RPOStion LEFT |
CENTer | RIGHT
DISPlay:WAVEform:VIEW[1]|2:WINDow[1]:TRACe:X[:SCALe]:RPOStion?
DISPlay:WAVEform:VIEW[1]|2:WINDow[1]:TRACe:Y[:SCALe]:COUple 0 | 1 | OFF |
ON
DISPlay:WAVEform:VIEW[1]|2:WINDow[1]:TRACe:Y[:SCALe]:COUple?
DISPlay:WAVEform:VIEW2:WINDow[1]:TRACe:Y[:SCALe]:PDIVision <voltage>

```

3 Programming the Analyzer

List of SCPI Commands

```
DISPlay:WAVEform:VIEW[1]:WINDow[1]:TRACe:Y[:SCALe]:PDIvIson <rel_amp1>
DISPlay:WAVEform:VIEW2:WINDow[1]:TRACe:Y[:SCALe]:PDIvIson?
DISPlay:WAVEform:VIEW[1]:WINDow[1]:TRACe:Y[:SCALe]:PDIvIson?
DISPlay:WAVEform:VIEW[1]:WINDow[1]:TRACe:Y[:SCALe]:RLEVel <amp1>
DISPlay:WAVEform:VIEW2:WINDow[1]:TRACe:Y[:SCALe]:RLEVel <voltage>
DISPlay:WAVEform:VIEW[1]:WINDow[1]:TRACe:Y[:SCALe]:RLEVel?
DISPlay:WAVEform:VIEW2:WINDow[1]:TRACe:Y[:SCALe]:RLEVel?
DISPlay:WAVEform:VIEW2:WINDow[1]:TRACe:Y[:SCALe]:RPOStIton TOP | CENTER |
BOTTom
DISPlay:WAVEform:VIEW[1]:WINDow[1]:TRACe:Y[:SCALe]:RPOStIton TOP | CENTER
| BOTTom
DISPlay:WAVEform:VIEW2:WINDow[1]:TRACe:Y[:SCALe]:RPOStIton?
DISPlay:WAVEform:VIEW[1]:WINDow[1]:TRACe:Y[:SCALe]:RPOStIton?
DISPlay:WINDow[1]:ANNOtation[:ALL] OFF | ON | 0 | 1
DISPlay:WINDow[1]:ANNOtation[:ALL]?
DISPlay:WINDow:FORMat:TILE
DISPlay:WINDow:FORMat:ZOOM
DISPlay:WINDow[:SElect] <number>
DISPlay:WINDow[:SElect]?
DISPlay:WINDow[1]:TRACe:GRATICule:GRID[:STATE] OFF | ON | 0 | 1
DISPlay:WINDow[1]:TRACe:GRATICule:GRID[:STATE]?
FETCh:ACP[n]?
FETCh:CEVM[n]?
FETCh:CHPower:CHPower?
FETCh:CHPower:DENSity?
FETCh:CHPower[n]?
FETCh:MONitor[n]?
FETCh:OBWidth:FERRor?
FETCh:OBWidth[n]?
FETCh:OBWidth:OBWidth?
FETCh:OBWidth:XDB?
FETCh:PStAtIstIc[n]?
FETCh:SEMAsk[n]?
FETCh:SPURious[n]?
FETCh:WAVEform[n]?
FORMat:BORDER NORMAL | SWAPPed
FORMat:BORDER?
FORMat[:TRACe][:DATA] ASCIi | INTeger, 32 | REAL, 32 | REAL, 64
FORMat[:TRACe][:DATA]?
GLOBal:DEFault
GLOBal:FREQuency:CENTER[:STATE] 1 | 0 | ON | OFF
GLOBal:FREQuency:CENTER[:STATE]?
HCOpy:ABORT
HCOpy[:IMMedIate]
INITiate:ACP
INITiate:CEVM
INITiate:CHPower
INITiate:CONTInuous OFF | ON | 0 | 1
INITiate:CONTInuous?
INITiate[:IMMedIate]
INITiate:MONitor
INITiate:OBWidth
INITiate:PAUSE
```



```

INITiate:PStAtistic
INITiate:REStArt
INITiate:RESume
INITiate:SEMask
INITiate:SPURious
INITiate:WAVEform
INPut:COUPling AC | DC
INPut:COUPling?
INPut:COUPling:I|Q DC | LFR1 | LFR2
INPut:COUPling:I|Q?
INPut:IMPedance:IQ U50 | B50 | U1M | B1M
INPut:IMPedance:IQ?
INPut:IMPedance:REFErence <integer>
INPut:IMPedance:REFErence?
INPut[1]:IQ:BALEnced[:STATE] OFF | ON | 0 | 1
INPut[1]:IQ:BALEnced[:STATE]?
INPut:IQ[:I]:DIFFerential OFF | ON | 0 | 1
INPut:IQ[:I]:DIFFerential?
INPut[1]:IQ[:I]:IMPedance LOW | HIGH
INPut[1]:IQ[:I]:IMPedance?
INPut:IQ:MIRROred OFF | ON | 0 | 1
INPut:IQ:MIRROred?
INPut:IQ:Q:DIFFerential OFF | ON | 0 | 1
INPut:IQ:Q:DIFFerential?
INPut[1]:IQ:Q:IMPedance LOW | HIGH
INPut[1]:IQ:Q:IMPedance?
INPut[1]:IQ:TYPE IQ | I | Q
INPut[1]:IQ:TYPE?
INPut[1]|2:LISN:FILTER:HPAS[:STATE] ON | OFF
INPut[1]|2:LISN:FILTER:HPAS[:STATE]?
INPut[1]|2:LISN:PEARth GROunded | FLOating
INPut[1]|2:LISN:PEARth?
INPut[1]|2:LISN:PHASe L1 | L2 | L3 | N
INPut[1]|2:LISN:PHASe?
INPut[1]|2:LISN[:TYPE] FOURphase | ESH2Z5 | ENV216 | OFF
INPut[1]|2:LISN[:TYPE]?
INPut:MIxer EXTErnal | INTernal
INPut:MIxer?
INPut:OFFSet:I|Q <voltage>
INPut:OFFSet:I|Q?
INST:NSEL 105
INST:NSEL 102
INSTrument:CATalog?
INSTrument:COUPlE:DEFault
INSTrument:COUPlE:FREQuency:CENTer ALL | NONE
INSTrument:COUPlE:FREQuency:CENTer?
INSTrument:DEFault
INSTrument:NSElect <integer>
INSTrument:NSElect?
INSTrument[:SElect] SANalyzer
INSTrument[:SElect] SA | RTSA | SEQAN | EMI | BASIC | WCDMA | EDGE GSM |
WIMAX OFDMA | VSA | PNOISE | NFIGure | ADEMOD | BTooth | TDSCDMA | CDMA2K |
CDMA1XEV | LTE | LTETDD | LTEAFDD | LTEATDD | MSR | DVB | DTMB | DCTV |

```

3 Programming the Analyzer

List of SCPI Commands

```
ISDBT | CMMB | WLAN | CWLAN | CWIMAXOFDM | WIMAXFIXED | IDEN | RLC |
SCPILC | VSA89601
INSTrument[:SElect] RECeiver
INSTrument[:SElect] GSM
INSTrument[:SElect] 'SA' | 'PNOISE' | 'EDGE' | 'GSM' | 'BASIC'
INSTrument[:SElect]?
INST:SEL SCPILC
INST:SEL LTE
INST:SEL LTETDD
INST:SEL EMI
LXI:IDENTify[:STATE] OFF | ON | 0 | 1
LXI:IDENTify[:STATE]?
MEASure:ACP[n]?
MEASure:CEVM[n]?
MEASure:CHPower:CHPower?
MEASure:CHPower:DENSity?
MEASure:CHPower[n]?
MEASure:MONitor[n]?
MEASure:OBWidth:FERRor?
MEASure:OBWidth[n]?
MEASure:OBWidth:OBWidth?
MEASure:OBWidth:XDB?
MEASure:PStatistic[n]?
MEASure:SEMask[n]?
MEASure:SPURious[n]?
MEASure:WAVEform[n]?
MMEMory:CATalog? [<directory_name>]
MMEMory:CDIRectory [<directory_name>]
MMEMory:CDIRectory?
MMEMory:COPY <string>, <string>[, <string>, <string>]
MMEMory:COPY:DEVIce <source_string>, <dest_string>
MMEMory:DATA <file_name>, <data>
MMEMory:DATA? <file_name>
MMEMory:DELeTe <file_name>[, <directory_name>]
MMEMory:LOAD:MASK <string>
MMEMory:LOAD:PSET LTEFdd1 | LTEFdd2 | LTEFdd3 | WCDMa1 | WCDMa2 | WCDMa3 |
GSM1 | GSM2 | GSM3 | CDMA1 | CDMA2 | CDMA3 | EVDO1 | EVDO2 | EVDO3 |
LTETdd1 | LTETdd2 | LTETdd3 | TDSCdma1 | TDSCdma2 | TDSCdma3, <string>
MMEMory:LOAD:STATe 1, <filename>
MMEMory:LOAD:STATe <filename>
MMEMory:MDIRectory <directory_name>
MMEMory:MOVE <string>, <string>[, <string>, <string>]
MMEMory:RDIRectory <directory_name>
MMEMory:REGister:STATe:LAbel <regnumber>, "label"
MMEMory:REGister:STATe:LAbel? <regnumber>
MMEMory:RMEDIA:LAbel <partition>, <string>
MMEMory:RMEDIA:LAbel? <partition>
MMEMory:RMEDIA:LIST?
MMEMory:RMEDIA:SIZE? <partition>
MMEMory:RMEDIA:WPRotect? <partition>
```

```

MMEMory:STORe:PSET LTEFdd1 | LTEFdd2 | LTEFdd3 | WCDMa1 | WCDMa2 | WCDMa3
| GSM1 | GSM2 | GSM3 | CDMA1 | CDMA2 | CDMA3 | EVDO1 | EVDO2 | EVDO3 |
LTETdd1 | LTETdd2 | LTETdd3 | TDSCdma1 | TDSCdma2 | TDSCdma3, <string>
MMEMory:STORe:RESults <string>
MMEMory:STORe:RESults <string>
MMEMory:STORe:RESults <string>
MMEMory:STORe:RESults <string>
MMEMory:STORe:RESults <string>
MMEMory:STORe:RESults <string>
MMEMory:STORe:SCReen <filename>
MMEMory:STORe:SCReen:THEME TDColor | TDMonochrome | FCOLor | FMONochrome
MMEMory:STORe:SCReen:THEME?
MMEMory:STORe:STATe 1, <filename>
MMEMory:STORe:STATe <filename>
MMEMory:STORe:TRACe TRACE1 | TRACE2 | TRACE3 | TRACE4 | TRACE5 | TRACE6 |
ALL, <filename>
MMEMory:STORe:TRACe:REGister TRACE1 | TRACE2 | TRACE3 | TRACE4 | TRACE5 |
TRACE6 | ALL, <integer>
OUTPut:ANALog OFF | SVIDeo | LOGVideo | LINVideo | DAUDio
OUTPut:ANALog?
OUTPut:ANALog:AUTO OFF | ON | 0 | 1
OUTPut:ANALog:AUTO?
OUTPut:AUX SIF | AIF | LOGVideo | OFF
OUTPut:AUX?
OUTPut:AUX:AIF <value>
OUTPut:AUX:AIF?
OUTPut:AUX:IO <Value>
OUTPut:AUX:IO?
OUTPut:DBUS[1][:STATe] ON | OFF | 1 | 0
OUTPut:DBUS[1][:STATe]?
OUTPut:IQ:OUTPut IQ1 | IQ250 | OFF
OUTPut:IQ:OUTPut?
OUTPut:UPOrt <Value>
READ:ACP[n]?
READ:CEVM[n]?
READ:CHPower:CHPower?
READ:CHPower:DENSity
READ:CHPower[n]?
READ:MONitor[n]?
READ:OBWidth:FERRor?
READ:OBWidth[n]?
READ:OBWidth:OBWidth?
READ:OBWidth:XDB?
READ:PStatistic[n]?
READ:SEMask[n]?
READ:SPURious[n]?
READ:WAVEform[n]?
[:SENSe]:<measurement>:TRIGger:SOURce
[:SENSe]:<measurement>:TRIGger:SOURce IF
[:SENSe]:ACPoweR:AVERAge:COUNT <integer>
[:SENSe]:ACPoweR:AVERAge:COUNT?
[:SENSe]:ACPoweR:AVERAge[:STATe] OFF | ON | 0 | 1

```

3 Programming the Analyzer

List of SCPI Commands

```
[ :SENSe]:ACPower:AVERAge[:STATe]?
[ :SENSe]:ACPower:AVERAge:TCONtrol EXPonential | REPeat
[ :SENSe]:ACPower:AVERAge:TCONtrol?
[ :SENSe]:ACPower:BANDwidth[:RESolution] <freq>
[ :SENSe]:ACPower:BANDwidth[:RESolution]?
[ :SENSe]:ACPower:BANDwidth[:RESolution]:AUTO ON | OFF | 1 | 0
[ :SENSe]:ACPower:BANDwidth[:RESolution]:AUTO?
[ :SENSe]:ACPower:BANDwidth:SHAPE GAUSSian | FLATtop
[ :SENSe]:ACPower:BANDwidth:SHAPE?
[ :SENSe]:ACPower:BANDwidth:TYPE DB3 | DB6
[ :SENSe]:ACPower:BANDwidth:TYPE?
[ :SENSe]:ACPower:BANDwidth:VIDeo <freq>
[ :SENSe]:ACPower:BANDwidth:VIDeo?
[ :SENSe]:ACPower:BANDwidth:VIDeo:AUTO OFF | ON | 0 | 1
[ :SENSe]:ACPower:BANDwidth:VIDeo:AUTO?
[ :SENSe]:ACPower:BWIDth[:RESolution]
[ :SENSe]:ACPower:BWIDth:SHAPE
[ :SENSe]:ACPower:BWIDth:TYPE
[ :SENSe]:ACPower:BWIDth:VIDeo
[ :SENSe]:ACPower:CARRier[1]|2:AUTO[:STATe] OFF | ON | 0 | 1
[ :SENSe]:ACPower:CARRier[1]|2:AUTO[:STATe]?
[ :SENSe]:ACPower:CARRier[1]|2:CPSD <real>
[ :SENSe]:ACPower:CARRier[1]|2:CPSD?
[ :SENSe]:ACPower:CARRier:INDex <integer>
[ :SENSe]:ACPower:CARRier:INDex?
[ :SENSe]:ACPower:CARRier[1]|2:LIST:METhod IBW | RRC, ...
[ :SENSe]:ACPower:CARRier[1]|2:LIST:METhod?
[ :SENSe]:ACPower:CARRier[1]|2[:POWER] <real>
[ :SENSe]:ACPower:CARRier[1]|2[:POWER]?
[ :SENSe]:ACPower:CARRier:PREFerence:TYPE LRCarriers | MPCarrier | CINDex |
MANual | MPCSubblock | TMCarriers
[ :SENSe]:ACPower:CARRier:PREFerence:TYPE?
[ :SENSe]:ACPower:CORREction:NOISE[:AUTO] OFF | ON | 0 | 1
[ :SENSe]:ACPower:CORREction:NOISE[:AUTO]?
[ :SENSe]:ACPower:DETEctor:AUTO ON | OFF | 1 | 0
[ :SENSe]:ACPower:DETEctor:AUTO?
[ :SENSe]:ACPower:DETEctor[:FUNction] AVERAge | NEGative | NORMAL |
POSitive | SAMple
[ :SENSe]:ACPower:DETEctor[:FUNction]?
[ :SENSe]:ACPower:FILTEr[:RRC]:ALPHa <real>
[ :SENSe]:ACPower:FILTEr[:RRC]:ALPHa?
[ :SENSe]:ACPower:FILTEr[:RRC][:STATe] OFF | ON | 0 | 1
[ :SENSe]:ACPower:FILTEr[:RRC][:STATe]?
[ :SENSe]:ACPower:FREQUency:SPAN <freq>
[ :SENSe]:ACPower:FREQUency:SPAN?
[ :SENSe]:ACPower:FREQUency:SPAN:PREVIOUS
[ :SENSe]:ACPower:FREQUency:SYNThesis:AUTO[:STATe] OFF | ON | 0 | 1
[ :SENSe]:ACPower:FREQUency:SYNThesis:AUTO[:STATe]?
[ :SENSe]:ACPower:FREQUency:SYNThesis[:STATe] 1 | 2 | 3
[ :SENSe]:ACPower:FREQUency:SYNThesis[:STATe]?
[ :SENSe]:ACPower:LIMit[:STATe]
[ :SENSe]:ACPower:MCONdition:IMMEDIATE
[ :SENSe]:ACPower:METhod IBW | IBWRange | FAST | RBW | FPOWER
```

```

[:SENSe]:ACPower:MEtHod?
[:SENSe]:ACPower:OFFSet[1]|2:INNeR:LIST:ABSolute <real>, ...
[:SENSe]:ACPower:OFFSet[1]|2:INNeR:LIST:ABSolute?
[:SENSe]:ACPower:OFFSet[1]|2:INNeR:LIST:BA NDwidth[:INtegration] <freq>,
...
[:SENSe]:ACPower:OFFSet[1]|2:INNeR:LIST:BA NDwidth[:INtegration]?
[:SENSe]:ACPower:OFFSet[1]|2:INNeR:LIST:BA NDwidth:RESolution <freq>, ...
[:SENSe]:ACPower:OFFSet[1]|2:INNeR:LIST:BA NDwidth:RESolution?
[:SENSe]:ACPower:OFFSet[1]|2:INNeR:LIST:BA NDwidth:RESolution:AUTO
ON|OFF|1|0, ...
[:SENSe]:ACPower:OFFSet[1]|2:INNeR:LIST:BA NDwidth:RESolution:AUTO?
[:SENSe]:ACPower:OFFSet[1]|2:INNeR:LIST:BA NDwidth:SHAPE GAUSSian|FLATtop,
...
[:SENSe]:ACPower:OFFSet[1]|2:INNeR:LIST:BA NDwidth:SHAPE?
[:SENSe]:ACPower:OFFSet[1]|2:INNeR:LIST:BA NDwidth:TYPE DB3|DB6, ...
[:SENSe]:ACPower:OFFSet[1]|2:INNeR:LIST:BA NDwidth:TYPE?
[:SENSe]:ACPower:OFFSet[1]|2:INNeR:LIST:BA NDwidth:VIDeo <freq>, ...
[:SENSe]:ACPower:OFFSet[1]|2:INNeR:LIST:BA NDwidth:VIDeo?
[:SENSe]:ACPower:OFFSet[1]|2:INNeR:LIST:BA NDwidth:VIDeo:AUTO OFF|ON|0|1,
...
[:SENSe]:ACPower:OFFSet[1]|2:INNeR:LIST:BA NDwidth:VIDeo:AUTO?
[:SENSe]:ACPower:OFFSet[1]|2:INNeR:LIST:FILTer:ALPHA <real>, ...
[:SENSe]:ACPower:OFFSet[1]|2:INNeR:LIST:FILTer:ALPHA?
[:SENSe]:ACPower:OFFSet[1]|2:INNeR:LIST:FILTer[:RRC][:STATe] ON|OFF|1|0,
...
[:SENSe]:ACPower:OFFSet[1]|2:INNeR:LIST:FILTer[:RRC][:STATe]?
[:SENSe]:ACPower:OFFSet[1]|2:INNeR:LIST[:FREQuency] <freq>, ...
[:SENSe]:ACPower:OFFSet[1]|2:INNeR:LIST[:FREQuency]?
[:SENSe]:ACPower:OFFSet[1]|2:INNeR:LIST:PREFeRence CUMulative|NORMAl, ...
[:SENSe]:ACPower:OFFSet[1]|2:INNeR:LIST:PREFeRence?
[:SENSe]:ACPower:OFFSet[1]|2:INNeR:LIST:PREFeRence:AUTO OFF|ON|0|1, ...
[:SENSe]:ACPower:OFFSet[1]|2:INNeR:LIST:PREFeRence:AUTO?
[:SENSe]:ACPower:OFFSet[1]|2:INNeR:LIST:RCARrier <real>, ...
[:SENSe]:ACPower:OFFSet[1]|2:INNeR:LIST:RCARrier?
[:SENSe]:ACPower:OFFSet[1]|2:INNeR:LIST:RPSDensity <rel_ampl>, ...
[:SENSe]:ACPower:OFFSet[1]|2:INNeR:LIST:RPSDensity?
[:SENSe]:ACPower:OFFSet[1]|2:INNeR:LIST:SIDE NEGative|BOTH|POSitive, ...
[:SENSe]:ACPower:OFFSet[1]|2:INNeR:LIST:SIDE?
[:SENSe]:ACPower:OFFSet[1]|2:INNeR:LIST:STATe OFF|ON|0|1, ...
[:SENSe]:ACPower:OFFSet[1]|2:INNeR:LIST:STATe?
[:SENSe]:ACPower:OFFSet[1]|2:INNeR:LIST:TEST ABSolute|AND|OR|RELative, ...
[:SENSe]:ACPower:OFFSet[1]|2:INNeR:LIST:TEST?
[:SENSe]:ACPower:OFFSet[1]|2:LIST:BWIDth[:INtegration]
[:SENSe]:ACPower:OFFSet[1]|2:LIST:BWIDth:RESolution
[:SENSe]:ACPower:OFFSet[1]|2:LIST:BWIDth:SHAPE
[:SENSe]:ACPower:OFFSet[1]|2:LIST:BWIDth:TYPE
[:SENSe]:ACPower:OFFSet[1]|2:LIST:BWIDth:VIDeo
[:SENSe]:ACPower:OFFSet[1]|2[:OUTer]:LIST:ABSolute <real>, ...
[:SENSe]:ACPower:OFFSet[1]|2[:OUTer]:LIST:ABSolute?
[:SENSe]:ACPower:OFFSet[1]|2[:OUTer]:LIST:BA NDwidth[:INtegration] <freq>,
...
[:SENSe]:ACPower:OFFSet[1]|2[:OUTer]:LIST:BA NDwidth[:INtegration]?

```

3 Programming the Analyzer

List of SCPI Commands

```

[:SENSe]:ACPower:OFFSet[1]|2[:OUTer]:LIST:BANDwidth:RESolution <freq>, ...
[:SENSe]:ACPower:OFFSet[1]|2[:OUTer]:LIST:BANDwidth:RESolution?
[:SENSe]:ACPower:OFFSet[1]|2[:OUTer]:LIST:BANDwidth:RESolution:AUTO
ON|OFF|1|0, ...
[:SENSe]:ACPower:OFFSet[1]|2[:OUTer]:LIST:BANDwidth:RESolution:AUTO?
[:SENSe]:ACPower:OFFSet[1]|2[:OUTer]:LIST:BANDwidth:SHAPE
GAUSSian|FLATtop, ...
[:SENSe]:ACPower:OFFSet[1]|2[:OUTer]:LIST:BANDwidth:SHAPE?
[:SENSe]:ACPower:OFFSet[1]|2[:OUTer]:LIST:BANDwidth:TYPE DB3|DB6, ...
[:SENSe]:ACPower:OFFSet[1]|2[:OUTer]:LIST:BANDwidth:TYPE?
[:SENSe]:ACPower:OFFSet[1]|2[:OUTer]:LIST:BANDwidth:VIDeo <freq>, ...
[:SENSe]:ACPower:OFFSet[1]|2[:OUTer]:LIST:BANDwidth:VIDeo?
[:SENSe]:ACPower:OFFSet[1]|2[:OUTer]:LIST:BANDwidth:VIDeo:AUTO OFF|ON|0|1,
...
[:SENSe]:ACPower:OFFSet[1]|2[:OUTer]:LIST:BANDwidth:VIDeo:AUTO?
[:SENSe]:ACPower:OFFSet[1]|2[:OUTer]:LIST:FILTer:ALPHa <real>, ...
[:SENSe]:ACPower:OFFSet[1]|2[:OUTer]:LIST:FILTer:ALPHa?
[:SENSe]:ACPower:OFFSet[1]|2[:OUTer]:LIST:FILTer[:RRC][:STATE] ON|OFF|1|0,
...
[:SENSe]:ACPower:OFFSet[1]|2[:OUTer]:LIST:FILTer[:RRC][:STATE]?
[:SENSe]:ACPower:OFFSet[1]|2[:OUTer]:LIST[:FREQuency] <freq>, ...
[:SENSe]:ACPower:OFFSet[1]|2[:OUTer]:LIST[:FREQuency]?
[:SENSe]:ACPower:OFFSet[1]|2[:OUTer]:LIST:RCARrier <real>, ...
[:SENSe]:ACPower:OFFSet[1]|2[:OUTer]:LIST:RCARrier?
[:SENSe]:ACPower:OFFSet[1]|2[:OUTer]:LIST:RPSDensity <rel_ampl>, ...
[:SENSe]:ACPower:OFFSet[1]|2[:OUTer]:LIST:RPSDensity?
[:SENSe]:ACPower:OFFSet[1]|2[:OUTer]:LIST:SIDE NEGative|BOTH|POSitive, ...
[:SENSe]:ACPower:OFFSet[1]|2[:OUTer]:LIST:SIDE?
[:SENSe]:ACPower:OFFSet[1]|2[:OUTer]:LIST:STATE OFF|ON|0|1, ...
[:SENSe]:ACPower:OFFSet[1]|2[:OUTer]:LIST:STATE?
[:SENSe]:ACPower:OFFSet[1]|2[:OUTer]:LIST:TEST ABSolute|AND|OR|RELative,
...
[:SENSe]:ACPower:OFFSet[1]|2[:OUTer]:LIST:TEST?
[:SENSe]:ACPower:OFFSet[1]|2[:OUTer]:TYPE CTOCenter | CTOEdge | ETOCenter
| ETOEdge
[:SENSe]:ACPower:OFFSet[1]|2[:OUTer]:TYPE?
[:SENSe]:ACPower:SWEep:POINTs <integer>
[:SENSe]:ACPower:SWEep:POINTs?
[:SENSe]:ACPower:SWEep:TIME <time>
[:SENSe]:ACPower:SWEep:TIME?
[:SENSe]:ACPower:SWEep:TIME:AUTO OFF | ON | 0 | 1
[:SENSe]:ACPower:SWEep:TIME:AUTO?
[:SENSe]:ACPower:SWEep:TIME:AUTO:RULEs NORMAl | ACCuracy
[:SENSe]:ACPower:SWEep:TIME:AUTO:RULEs?
[:SENSe]:ACPower:TYPE TPreF | PSDFeF
[:SENSe]:ACPower:TYPE?
[:SENSe]:ACPR:AVERage:COUNT
[:SENSe]:ACPR:AVERage:TCONtrol
[:SENSe]:ACPR:FILTer[:RRC]:ALPHa
[:SENSe]:ACPR:FILTer[:RRC][:STATE]
[:SENSe]:ACPR:OFFSet[1]|2:LIST:ABSolute (PSAW-CDMA, PSACdma2000)
[:SENSe]:ACPR:OFFSet[1]|2:LIST:BANDwidth

```

```

[:SENSE]:ACPR:OFFSet[1]|2:LIST:BWIDth
[:SENSE]:ACPR:SWEep:DETEctor[:FUNction]
[:SENSE]:ACPR:SWEep:TYPE
[:SENSE]:ACPR:TRIGger:SOURce
[:SENSE]:ACP:SWEep:BANDwidth|BWIDth[:RESolution] (PSAW-CDMA, PSAcma2000)
[:SENSE]:CARRier<n>:FORMat NONE | LTEFdd1 | LTEFdd2 | LTEFdd3 | WCDMa1 |
WCDMa2 | WCDMa3 | GSM1 | GSM2 | GSM3 | CDMA1 | CDMA2 | CDMA3 | EVDO1 |
EVDO2 | EVDO3 | LTETdd1 | LTETdd2 | LTETdd3 | TDSCdma1 | TDSCdma2 |
TDSCdma3
[:SENSE]:CARRier<n>:FORMat ?
[:SENSE]:CARRier<n>:FREQuency:OFFSet <freq>
[:SENSE]:CARRier<n>:FREQuency:OFFSet?
[:SENSE]:CARRier<n>[:STATE] OFF | ON | 0 | 1
[:SENSE]:CARRier<n>[:STATE]?
[:SENSE]:CARRier:CONFIg?
[:SENSE]:CARRier:CONFIg:ALLocation CONTiguous | NCONTiguous
[:SENSE]:CARRier:CONFIg:ALLocation?
[:SENSE]:CARRier:CONFIg:ALLocation:NCONTiguous:ABPoint <integer>
[:SENSE]:CARRier:CONFIg:ALLocation:NCONTiguous:ABPoint?
[:SENSE]:CARRier:CONFIg:CDMA:CMAX <integer>
[:SENSE]:CARRier:CONFIg:CDMA:CMAX?
[:SENSE]:CARRier:CONFIg:CDMA:SPACing:DELTA <freq>
[:SENSE]:CARRier:CONFIg:CDMA:SPACing:DELTA?
[:SENSE]:CARRier:CONFIg:EVDO:CMAX <integer>
[:SENSE]:CARRier:CONFIg:EVDO:CMAX?
[:SENSE]:CARRier:CONFIg:EVDO:SPACing:DELTA <freq>
[:SENSE]:CARRier:CONFIg:EVDO:SPACing:DELTA?
[:SENSE]:CARRier:CONFIg:GSM:CMAX <integer>
[:SENSE]:CARRier:CONFIg:GSM:CMAX?
[:SENSE]:CARRier:CONFIg:GSM:SPACing:DELTA <freq>
[:SENSE]:CARRier:CONFIg:GSM:SPACing:DELTA?
[:SENSE]:CARRier:CONFIg:LTEFdd:BANDwidth B1M4 | B3M | B5M | B10M | B15M |
B20M
[:SENSE]:CARRier:CONFIg:LTEFdd:BANDwidth?
[:SENSE]:CARRier:CONFIg:LTEFdd:BANDwidth:NARRowest B1M4 | B3M | B5M | B10M
| B15M | B20M
[:SENSE]:CARRier:CONFIg:LTEFdd:BANDwidth:NARRowest?
[:SENSE]:CARRier:CONFIg:LTEFdd:CMAX <integer>
[:SENSE]:CARRier:CONFIg:LTEFdd:CMAX?
[:SENSE]:CARRier:CONFIg:LTEFdd:LOCation UPPer | LOWer
[:SENSE]:CARRier:CONFIg:LTEFdd:LOCation?
[:SENSE]:CARRier:CONFIg:LTEFdd:SPACing:DELTA <freq>
[:SENSE]:CARRier:CONFIg:LTEFdd:SPACing:DELTA?
[:SENSE]:CARRier:CONFIg:NTC4:COUNT <integer>
[:SENSE]:CARRier:CONFIg:NTC4:COUNT?
[:SENSE]:CARRier:CONFIg:RFBWidth <freq>
[:SENSE]:CARRier:CONFIg:RFBWidth?
[:SENSE]:CARRier:CONFIg:WCDMa:CMAX <integer>
[:SENSE]:CARRier:CONFIg:WCDMa:CMAX?
[:SENSE]:CARRier:CONFIg:WCDMa:SPACing:DELTA <freq>
[:SENSE]:CARRier:CONFIg:WCDMa:SPACing:DELTA?
[:SENSE]:CARRier:COUNT <integer>

```

```

[:SENSe]:CARRier:COUNT?
[:SENSe]:CARRier:REFeRence <freq>
[:SENSe]:CARRier:REFeRence?
[:SENSe]:CARRier:RFBWidth?
[:SENSe]:CARRier:RFBWidth:CENTer?
[:SENSe]:CARRier:SBLock[1]|2:BWIDth?
[:SENSe]:CARRier:SBLock[1]|2:CENTer?
[:SENSe]:CARRier:SBLock:GAP?
[:SENSe]:CEVM:CDMA:AVERAge:COUNT <integer>
[:SENSe]:CEVM:CDMA:AVERAge:COUNT?
[:SENSe]:CEVM:CDMA:AVERAge[:STATe] OFF | ON | 0 | 1
[:SENSe]:CEVM:CDMA:AVERAge[:STATe]?
[:SENSe]:CEVM:CDMA:RESult ON | OFF | 0 | 1, ...
[:SENSe]:CEVM:CDMA:RESult?
[:SENSe]:CEVM:EVDO:AVERAge:COUNT <integer>
[:SENSe]:CEVM:EVDO:AVERAge:COUNT?
[:SENSe]:CEVM:EVDO:AVERAge[:STATe] OFF | ON | 0 | 1
[:SENSe]:CEVM:EVDO:AVERAge[:STATe]?
[:SENSe]:CEVM:EVDO[:BTS]:RESult ON | OFF | 0 | 1, ...
[:SENSe]:CEVM:EVDO[:BTS]:RESult?
[:SENSe]:CEVM:GSM:AVERAge:COUNT <integer>
[:SENSe]:CEVM:GSM:AVERAge:COUNT?
[:SENSe]:CEVM:GSM:AVERAge[:STATe] OFF | ON | 0 | 1
[:SENSe]:CEVM:GSM:AVERAge[:STATe]?
[:SENSe]:CEVM:GSM:RESult ON | OFF | 0 | 1, ...
[:SENSe]:CEVM:GSM:RESult?
[:SENSe]:CEVM:LTEFdd:AVERAge:COUNT <integer>
[:SENSe]:CEVM:LTEFdd:AVERAge:COUNT?
[:SENSe]:CEVM:LTEFdd:AVERAge[:STATe] OFF | ON | 0 | 1
[:SENSe]:CEVM:LTEFdd:AVERAge[:STATe]?
[:SENSe]:CEVM:LTEFdd[:DLINK]:RESult ON | OFF | 0 | 1, ...
[:SENSe]:CEVM:LTEFdd[:DLINK]:RESult?
[:SENSe]:CEVM:LTEFdd[:DLINK]:RESult:ALL ON | OFF | 0 | 1
[:SENSe]:CEVM:LTEFdd:ULINK:RESult:ALL ON | OFF | 0 | 1
[:SENSe]:CEVM:LTETdd:AVERAge:COUNT <integer>
[:SENSe]:CEVM:LTETdd:AVERAge:COUNT?
[:SENSe]:CEVM:LTETdd:AVERAge[:STATe] OFF | ON | 0 | 1
[:SENSe]:CEVM:LTETdd:AVERAge[:STATe]?
[:SENSe]:CEVM:LTETdd[:DLINK]:RESult ON | OFF | 0 | 1, ...
[:SENSe]:CEVM:LTETdd[:DLINK]:RESult?
[:SENSe]:CEVM:SPECTrum NORMAl | INVert
[:SENSe]:CEVM:SPECTrum?
[:SENSe]:CEVM:TDSCdma:AVERAge:COUNT <integer>
[:SENSe]:CEVM:TDSCdma:AVERAge:COUNT?
[:SENSe]:CEVM:TDSCdma:AVERAge[:STATe] OFF | ON | 0 | 1
[:SENSe]:CEVM:TDSCdma:AVERAge[:STATe]?
[:SENSe]:CEVM:TDSCdma:RESult ON | OFF | 0 | 1, ...
[:SENSe]:CEVM:TDSCdma:RESult?
[:SENSe]:CEVM:WCDMa:AVERAge:COUNT <integer>
[:SENSe]:CEVM:WCDMa:AVERAge:COUNT?
[:SENSe]:CEVM:WCDMa:AVERAge[:STATe] OFF | ON | 0 | 1
[:SENSe]:CEVM:WCDMa:AVERAge[:STATe]?
[:SENSe]:CEVM:WCDMa:RESult[:BTS] ON | OFF | 0 | 1, ...

```



```

[:SENSE]:CEVM:WCDMA:RESult[:BTS]?
[:SENSE]:CHPower:AVERAge:COUNT <integer>
[:SENSE]:CHPower:AVERAge:COUNT?
[:SENSE]:CHPower:AVERAge[:STATE] ON | OFF | 1 | 0
[:SENSE]:CHPower:AVERAge[:STATE]?
[:SENSE]:CHPower:AVERAge:TCONtrol EXPOntial | REPeat
[:SENSE]:CHPower:AVERAge:TCONtrol?
[:SENSE]:CHPower:BANDwidth[:RESolution] <bandwidth>
[:SENSE]:CHPower:BANDwidth[:RESolution]?
[:SENSE]:CHPower:BANDwidth[:RESolution]:AUTO ON | OFF | 1 | 0
[:SENSE]:CHPower:BANDwidth[:RESolution]:AUTO?
[:SENSE]:CHPower:BANDwidth:SHAPE GAUSSian | FLATtop
[:SENSE]:CHPower:BANDwidth:SHAPE?
[:SENSE]:CHPower:BANDwidth:VIDeo <bandwidth>
[:SENSE]:CHPower:BANDwidth:VIDeo?
[:SENSE]:CHPower:BANDwidth:VIDeo:AUTO ON | OFF | 1 | 0
[:SENSE]:CHPower:BANDwidth:VIDeo:AUTO?
[:SENSE]:CHPower:BWIDth[:RESolution]
[:SENSE]:CHPower:BWIDth:SHAPE
[:SENSE]:CHPower:DETEctor:AUTO ON | OFF | 1 | 0
[:SENSE]:CHPower:DETEctor:AUTO?
[:SENSE]:CHPower:DETEctor[:FUNction] NORMal | AVERAge | POSitive | SAMple
| NEGative
[:SENSE]:CHPower:DETEctor[:FUNction]?
[:SENSE]:CHPower:FREQuency:SYNThesis:AUTO[:STATE] OFF | ON | 0 | 1
[:SENSE]:CHPower:FREQuency:SYNThesis:AUTO[:STATE]?
[:SENSE]:CHPower:FREQuency:SYNThesis[:STATE] 1 | 2 | 3
[:SENSE]:CHPower:FREQuency:SYNThesis[:STATE]?
[:SENSE]:CHPower:IF:GAIN:AUTO[:STATE] ON | OFF | 1 | 0
[:SENSE]:CHPower:IF:GAIN:AUTO[:STATE]?
[:SENSE]:CHPower:IF:GAIN[:STATE] ON | OFF | 1 | 0
[:SENSE]:CHPower:IF:GAIN[:STATE]?
[:SENSE]:CHPower:SWEep:POINts <integer>
[:SENSE]:CHPower:SWEep:POINts?
[:SENSE]:CHPower:SWEep:TIME <time>
[:SENSE]:CHPower:SWEep:TIME?
[:SENSE]:CHPower:SWEep:TIME:AUTO OFF | ON | 0 | 1
[:SENSE]:CHPower:SWEep:TIME:AUTO?
[:SENSE]:CHPower:SWEep:TIME:AUTO:RULEs NORMal | ACCuracy
[:SENSE]:CHPower:SWEep:TIME:AUTO:RULEs?
[:SENSE]:CORREction:BTS[:RF]:GAIN <rel_ampl>
[:SENSE]:CORREction:BTS[:RF]:GAIN?
[:SENSE]:CORREction:BTS[:RF]:LOSS <rel_ampl>
[:SENSE]:CORREction:BTS[:RF]:LOSS?
[:SENSE]:CORREction:IMPedance[:INPut][:MAGNitude] 50 | 75
[:SENSE]:CORREction:IMPedance[:INPut][:MAGNitude]?
[:SENSE]:CORREction:IQ:I:GAIN <rel_ampl>
[:SENSE]:CORREction:IQ:I:GAIN?
[:SENSE]:CORREction:IQ:I|Q:ATTenuation <rel_ampl>
[:SENSE]:CORREction:IQ:I|Q:ATTenuation?
[:SENSE]:CORREction:IQ:I|Q:ATTenuation:RATio <real>
[:SENSE]:CORREction:IQ:I|Q:ATTenuation:RATio?
[:SENSE]:CORREction:IQ[:I]:SKEW <seconds>

```

3 Programming the Analyzer

List of SCPI Commands

```
[ :SENSe]:CORRection:IQ[:I]:SKEW?
[ :SENSe]:CORRection:IQ:Q:GAIN <rel_ampl>
[ :SENSe]:CORRection:IQ:Q:GAIN?
[ :SENSe]:CORRection:IQ:Q:SKEW <seconds>
[ :SENSe]:CORRection:IQ:Q:SKEW?
[ :SENSe]:CORRection:MS[:RF]:GAIN <rel_ampl>
[ :SENSe]:CORRection:MS[:RF]:GAIN?
[ :SENSe]:CORRection:MS[:RF]:LOSS <rel_ampl>
[ :SENSe]:CORRection:MS[:RF]:LOSS?
[ :SENSe]:CORRection:NOISe:FLOOr ON | OFF | 1 | 0
[ :SENSe]:CORRection:NOISe:FLOOr?
[ :SENSe]:CORRection:OFFSet[:MAGNitude]
[ :SENSe]:CORRection:SA[:RF]:GAIN <rel_ampl>
[ :SENSe]:CORRection:SA[:RF]:GAIN?
[ :SENSe]:EBWidth:AVERAge:COUNT
[ :SENSe]:EBWidth:FREQuency:SPAN
[ :SENSe]:EBWidth:MAXHold
[ :SENSe]:EBWidth:XDB
[ :SENSe]:FEED AREFERENCE
[ :SENSe]:FEED RF | AIQ | EMIXer
[ :SENSe]:FEED IQ | IONLy | QONLy
[ :SENSe]:FEED?
[ :SENSe]:FEED?
[ :SENSe]:FEED:AREFERENCE REF50 | REF4800 | OFF
[ :SENSe]:FEED:AREFERENCE?
[ :SENSe]:FEED:IQ:TYPE IQ | IONLy | QONLy
[ :SENSe]:FEED:IQ:TYPE?
[ :SENSe]:FREQuency:CENTer <freq>
[ :SENSe]:FREQuency:CENTer?
[ :SENSe]:FREQuency:CENTer:AUTO ON | OFF | 1 | 0
[ :SENSe]:FREQuency:CENTer:AUTO?
[ :SENSe]:FREQuency:CENTer:OFFSet <freq>
[ :SENSe]:FREQuency:CENTer:OFFSet?
[ :SENSe]:MCONdition:IMMediate
[ :SENSe]:MCPower:AVERAge:COUNT (PSAPowerSuite, PSAW-CDMA, PSAcdma2000)
[ :SENSe]:MCPower:CARRier[1]|2[:POWER]
[ :SENSe]:MCPower:FILTer[:RRC]:ALPHA
[ :SENSe]:MCPower:FILTer[:RRC][:STATE]
[ :SENSe]:MCPower:LIMit[:STATE]
[ :SENSe]:MCPower:METHod (PSAPowerSuite)
[ :SENSe]:MCPower:OFFSet[1]|2:LIST:ABSolute (PSAW-CDMA)
[ :SENSe]:MCPower:OFFSet[1]|2:LIST:BANDwidth[:INTEgration] (PSAPowerSuite)
[ :SENSe]:MCPower:OFFSet[1]|2:LIST:BWIDth[:INTEgration] (PSAPowerSuite)
[ :SENSe]:MCPower:OFFSet[1]|2:LIST[:FREQuency] (PSAPowerSuite)
[ :SENSe]:MCPower:OFFSet[1]|2:LIST:RCARRier (PSAWCDMA)
[ :SENSe]:MCPower:OFFSet[1]|2:LIST:TEST
[ :SENSe]:MIXer:BAND A | Q | U | V | W | NA | ND | NE | NF | NG | NJ | NK |
NQ | NU | NV | NW | NY | NEXT | DD | DF | DG | DJ | DK | DQ | DV | DW | DY
| DEXT | MA | ME | MU | MCOAX | USB
[ :SENSe]:MIXer:BAND?
[ :SENSe]:MIXer:BIAS <real>
[ :SENSe]:MIXer:BIAS?
[ :SENSe]:MIXer:BIAS:STATE OFF | ON | 0 | 1
```

```

[:SENSe]:MIXer:BIAS:StATE?
[:SENSe]:MIXer:CIFLoss <rel_ampl>
[:SENSe]:MIXer:CIFLoss?
[:SENSe]:MIXer:MPATH NORMAl | DUAL | AUX
[:SENSe]:MIXer:MPATH?
[:SENSe]:MIXer:UIFFfreq <real>
[:SENSe]:MIXer:UIFFreq?
[:SENSe]:MONitor:AVERAge:COUNT <integer>
[:SENSe]:MONitor:AVERAge:COUNT?
[:SENSe]:MONitor:AVERAge[:StATE] OFF | ON | 0 | 1
[:SENSe]:MONitor:AVERAge[:StATE]?
[:SENSe]:MONitor:AVERAge:TCONtrol EXPonential | REPeat
[:SENSe]:MONitor:AVERAge:TCONtrol?
[:SENSe]:MONitor:BANDwidth[:RESolution] <freq>
[:SENSe]:MONitor:BANDwidth[:RESolution]?
[:SENSe]:MONitor:BANDwidth[:RESolution]:AUTO OFF | ON | 0 | 1
[:SENSe]:MONitor:BANDwidth[:RESolution]:AUTO?
[:SENSe]:MONitor:BANDwidth:VIDeo <bandwidth>
[:SENSe]:MONitor:BANDwidth:VIDeo?
[:SENSe]:MONitor:BANDwidth:VIDeo:AUTO ON | OFF | 1 | 0
[:SENSe]:MONitor:BANDwidth:VIDeo:AUTO?
[:SENSe]:MONitor:BANDwidth:VIDeo:RATio <real>
[:SENSe]:MONitor:BANDwidth:VIDeo:RATio?
[:SENSe]:MONitor:BANDwidth:VIDeo:RATio:AUTO OFF | ON | 0 | 1
[:SENSe]:MONitor:BANDwidth:VIDeo:RATio:AUTO?
[:SENSe]:MONitor:BWIDth[:RESolution]
[:SENSe]:MONitor:BWIDth:VIDeo
[:SENSe]:MONitor:BWIDth:VIDeo:RATio
[:SENSe]:MONitor:DETEctor:AUTO ON | OFF | 1 | 0
[:SENSe]:MONitor:DETEctor:AUTO?
[:SENSe]:MONitor:DETEctor[:FUNction]
[:SENSe]:MONitor:DETEctor:TRACe AVERAge | NEGative | NORMAl | POSitive |
SAMPLE
[:SENSe]:MONitor:DETEctor:TRACe?
[:SENSe]:MONitor:FREQuency:SPAN <freq>
[:SENSe]:MONitor:FREQuency:SPAN?
[:SENSe]:MONitor:FREQuency:SPAN:ADJust
[:SENSe]:MONitor:FREQuency:SPAN:BANDwidth[:RESolution]:RATio <integer>
[:SENSe]:MONitor:FREQuency:SPAN:BANDwidth[:RESolution]:RATio?
[:SENSe]:MONitor:FREQuency:SPAN:BANDwidth[:RESolution]:RATio:AUTO OFF | ON
| 0 | 1
[:SENSe]:MONitor:FREQuency:SPAN:BANDwidth[:RESolution]:RATio:AUTO?
[:SENSe]:MONitor:FREQuency:SPAN:BWIDth[:RESolution]:RATio
[:SENSe]:MONitor:FREQuency:SPAN:FULL
[:SENSe]:MONitor:FREQuency:SPAN:PREVious
[:SENSe]:MONitor:SWEep:POINts <integer>
[:SENSe]:MONitor:SWEep:POINts?
[:SENSe]:MONitor:SWEep:TIME <time>
[:SENSe]:MONitor:SWEep:TIME?
[:SENSe]:MONitor:SWEep:TIME:AUTO OFF | ON | 0 | 1
[:SENSe]:MONitor:SWEep:TIME:AUTO?
[:SENSe]:OBWidth:AVERAge:COUNT <integer>
[:SENSe]:OBWidth:AVERAge:COUNT?

```

3 Programming the Analyzer

List of SCPI Commands

```
[ :SENSe]:OBWidth:AVERAge[:STATe] ON | OFF | 1 | 0
[ :SENSe]:OBWidth:AVERAge[:STATe]?
[ :SENSe]:OBWidth:AVERAge:TCONtrol EXPONential | REPeat
[ :SENSe]:OBWidth:AVERAge:TCONtrol?
[ :SENSe]:OBWidth:BANDwidth[:RESolution] <bandwidth>
[ :SENSe]:OBWidth:BANDwidth[:RESolution]?
[ :SENSe]:OBWidth:BANDwidth[:RESolution]:AUTO ON | OFF | 1 | 0
[ :SENSe]:OBWidth:BANDwidth[:RESolution]:AUTO?
[ :SENSe]:OBWidth:BANDwidth:SHAPE GAUSSian | FLATtop
[ :SENSe]:OBWidth:BANDwidth:SHAPE?
[ :SENSe]:OBWidth:BANDwidth:VIDeo <bandwidth>
[ :SENSe]:OBWidth:BANDwidth:VIDeo?
[ :SENSe]:OBWidth:BANDwidth:VIDeo:AUTO ON | OFF | 1 | 0
[ :SENSe]:OBWidth:BANDwidth:VIDeo:AUTO?
[ :SENSe]:OBWidth:BWIDth[:RESolution]
[ :SENSe]:OBWidth:BWIDth:SHAPE
[ :SENSe]:OBWidth:BWIDth:VIDeo
[ :SENSe]:OBWidth:DETEctor:AUTO ON | OFF | 1 | 0
[ :SENSe]:OBWidth:DETEctor:AUTO?
[ :SENSe]:OBWidth:DETEctor[:FUNction] NORMAl | AVERAge | POSitive | SAMPlE
| NEGative
[ :SENSe]:OBWidth:DETEctor[:FUNction]?
[ :SENSe]:OBWidth:FREQUency:SPAN <freq>
[ :SENSe]:OBWidth:FREQUency:SPAN?
[ :SENSe]:OBWidth:FREQUency:SPAN:AUTO ON | OFF | 0 | 1
[ :SENSe]:OBWidth:FREQUency:SPAN:AUTO?
[ :SENSe]:OBWidth:FREQUency:SPAN:PREVious
[ :SENSe]:OBWidth:IF:GAIN:AUTO[:STATe] ON | OFF | 1 | 0
[ :SENSe]:OBWidth:IF:GAIN:AUTO[:STATe]?
[ :SENSe]:OBWidth:IF:GAIN[:STATe] ON | OFF | 1 | 0
[ :SENSe]:OBWidth:IF:GAIN[:STATe]?
[ :SENSe]:OBWidth:MAXHold ON | OFF | 1 | 0
[ :SENSe]:OBWidth:MAXHold?
[ :SENSe]:OBWidth:PERCent <real>
[ :SENSe]:OBWidth:PERCent?
[ :SENSe]:OBWidth:SWEep:POINts <integer>
[ :SENSe]:OBWidth:SWEep:POINts?
[ :SENSe]:OBWidth:SWEep:TIME <time>
[ :SENSe]:OBWidth:SWEep:TIME?
[ :SENSe]:OBWidth:SWEep:TIME:AUTO OFF | ON | 0 | 1
[ :SENSe]:OBWidth:SWEep:TIME:AUTO?
[ :SENSe]:OBWidth:SWEep:TIME:AUTO:RULEs NORMAl | ACCuracy
[ :SENSe]:OBWidth:SWEep:TIME:AUTO:RULEs?
[ :SENSe]:OBWidth:XDB <rel_ampl>
[ :SENSe]:OBWidth:XDB?
[ :SENSe]:POWER:IQ[:I]:RANGE[:UPPer] <ampl>
[ :SENSe]:POWER:IQ[:I]:RANGE[:UPPer]?
[ :SENSe]:POWER:IQ:Q:RANGE[:UPPer] <ampl>
[ :SENSe]:POWER:IQ:Q:RANGE[:UPPer]?
[ :SENSe]:POWER:IQ:RANGE:AUTO OFF | ON | 0 | 1
[ :SENSe]:POWER:IQ:RANGE:AUTO?
[ :SENSe]:POWER[:RF]:ATTenuation <rel_ampl>
[ :SENSe]:POWER[:RF]:ATTenuation?
```

```

[:SENSE]:POWER[:RF]:ATTenuation:AUTO OFF | ON | 0 | 1
[:SENSE]:POWER[:RF]:ATTenuation:AUTO?
[:SENSE]:POWER[:RF]:ATTenuation:STEP[:INCRement] 10 dB | 2 dB
[:SENSE]:POWER[:RF]:ATTenuation:STEP[:INCRement]?
[:SENSE]:POWER[:RF]:EATTenuation <rel_ampl>
[:SENSE]:POWER[:RF]:EATTenuation?
[:SENSE]:POWER[:RF]:EATTenuation:STATE OFF | ON | 0 | 1
[:SENSE]:POWER[:RF]:EATTenuation:STATE?
[:SENSE]:POWER[:RF]:GAIN:BAND LOW | FULL
[:SENSE]:POWER[:RF]:GAIN:BAND?
[:SENSE]:POWER[:RF]:GAIN[:STATE] OFF | ON | 0 | 1
[:SENSE]:POWER[:RF]:GAIN[:STATE]?
[:SENSE]:POWER[:RF]:MMW:PADJust
[:SENSE]:POWER[:RF]:MW:PADJust
[:SENSE]:POWER[:RF]:MW:PATH STD | LNPath | MPBypass | FULL
[:SENSE]:POWER[:RF]:MW:PATH?
[:SENSE]:POWER[:RF]:MW:PRESelector[:STATE] ON | OFF | 0 | 1
[:SENSE]:POWER[:RF]:MW:PRESelector[:STATE]?
[:SENSE]:POWER[:RF]:PADJust <freq>
[:SENSE]:POWER[:RF]:PADJust?
[:SENSE]:POWER[:RF]:PADJust:PRESelector MWAVe | MMWave | EXTERNAL
[:SENSE]:POWER[:RF]:PADJust:PRESelector?
[:SENSE]:POWER[:RF]:PCENTER
[:SENSE]:POWER[:RF]:RANGE:AUTO ON | OFF | 1 | 0
[:SENSE]:POWER[:RF]:RANGE:AUTO?
[:SENSE]:POWER[:RF]:RANGE:OPTimize IMMEDIATE
[:SENSE]:POWER[:RF]:RANGE:OPTimize:ATTenuation OFF | ELECTRICAL | COMBINED
[:SENSE]:POWER[:RF]:RANGE:OPTimize:ATTenuation?
[:SENSE]:POWER[:RF]:RANGE:OPTimize:TYPE EONLY | COMBINED
[:SENSE]:POWER[:RF]:RANGE:OPTimize:TYPE?
[:SENSE]:PSTATistic:BANDwidth <freq>
[:SENSE]:PSTATistic:BANDwidth?
[:SENSE]:PSTATistic:BWIDth
[:SENSE]:PSTATistic:COUNTs <integer>
[:SENSE]:PSTATistic:COUNTs?
[:SENSE]:PSTATistic:GAUSSian[:STATE]
[:SENSE]:PSTATistic:IF:GAIN:AUTO[:STATE] ON | OFF | 1 | 0
[:SENSE]:PSTATistic:IF:GAIN:AUTO[:STATE]?
[:SENSE]:PSTATistic:IF:GAIN[:STATE] ON | OFF | 1 | 0
[:SENSE]:PSTATistic:IF:GAIN[:STATE]?
[:SENSE]:PSTATistic:RTRace[:STATE]
[:SENSE]:PSTATistic:SRTRace
[:SENSE]:PSTATistic:SWEep:CYCLes <integer>
[:SENSE]:PSTATistic:SWEep:CYCLes?
[:SENSE]:PSTATistic:SWEep:TIME <time>
[:SENSE]:PSTATistic:SWEep:TIME?
[:SENSE]:RADio:ACHannel[:TYPE] LTE | WCDMA
[:SENSE]:RADio:ACHannel[:TYPE]?
[:SENSE]:RADio:BAND:CATegory <integer>
[:SENSE]:RADio:BAND:CATegory?
[:SENSE]:RADio:BAND:CATegory:AUTO ON | OFF | 0 | 1
[:SENSE]:RADio:BAND:CATegory:AUTO?

```

3 Programming the Analyzer

List of SCPI Commands

```
[ :SENSe]:RADIo:BAND[:SElect] NONE | BAND1 | BAND2 | BAND3 | BAND4 | BAND5
| BAND6 | BAND7 | BAND8 | BAND9 | BAND10 | BAND11 | BAND12 | BAND13 |
BAND14 | BAND17 | BAND18 | BAND19 | BAND20 | BAND21 | BAND22 | BAND23 |
BAND24 | BAND25
[:SENSe]:RADIo:BAND[:SElect]?
[:SENSe]:RADIo:BAND:START <freq>
[:SENSe]:RADIo:BAND:START?
[:SENSe]:RADIo:BAND:START:AUTO ON | OFF | 0 | 1
[:SENSe]:RADIo:BAND:START:AUTO?
[:SENSe]:RADIo:BAND:STOP <freq>
[:SENSe]:RADIo:BAND:STOP?
[:SENSe]:RADIo:BAND:STOP:AUTO ON | OFF | 0 | 1
[:SENSe]:RADIo:BAND:STOP:AUTO?
[:SENSe]:RADIo:FORMat:CDMA{1:3}:FREQuency:SYNTHeSis:STATe 1 | 2 | 3
[:SENSe]:RADIo:FORMat:CDMA{1:3}:FREQuency:SYNTHeSis:STATe?
[:SENSe]:RADIo:FORMat:CDMA[1]|2|3:ACPoweR:CARRier[1]
|2:BANDwidth:INTeGratIOn <freq>
[:SENSe]:RADIo:FORMat:CDMA[1]|2|3:ACPoweR:CARRier[1]
|2:BANDwidth:INTeGratIOn?
[:SENSe]:RADIo:FORMat:CDMA[1]|2|3:CHPower:BANDwidth:INTeGratIOn <freq>
[:SENSe]:RADIo:FORMat:CDMA[1]|2|3:CHPower:BANDwidth:INTeGratIOn?
[:SENSe]:RADIo:FORMat:CDMA[1]|2|3:PSET:NAME <string>
[:SENSe]:RADIo:FORMat:CDMA[1]|2|3:PSET:NAME?
[:SENSe]:RADIo:FORMat:CDMA[1]|2|3:SEMAsk:BANDwidth[1]|2:INTeGratIOn <freq>
[:SENSe]:RADIo:FORMat:CDMA[1]|2|3:SEMAsk:BANDwidth[1]|2:INTeGratIOn?
[:SENSe]:RADIo:FORMat:EVDO{1:3}:FREQuency:SYNTHeSis:STATe 1 | 2 | 3
[:SENSe]:RADIo:FORMat:EVDO{1:3}:FREQuency:SYNTHeSis:STATe?
[:SENSe]:RADIo:FORMat:EVDO[1]|2|3:ACPoweR:CARRier[1]
|2:BANDwidth:INTeGratIOn <freq>
[:SENSe]:RADIo:FORMat:EVDO[1]|2|3:ACPoweR:CARRier[1]
|2:BANDwidth:INTeGratIOn?
[:SENSe]:RADIo:FORMat:EVDO[1]|2|3:CHPower:BANDwidth:INTeGratIOn <freq>
[:SENSe]:RADIo:FORMat:EVDO[1]|2|3:CHPower:BANDwidth:INTeGratIOn?
[:SENSe]:RADIo:FORMat:EVDO[1]|2|3:PSET:NAME <string>
[:SENSe]:RADIo:FORMat:EVDO[1]|2|3:PSET:NAME?
[:SENSe]:RADIo:FORMat:EVDO[1]|2|3:SEMAsk:BANDwidth[1]|2:INTeGratIOn <freq>
[:SENSe]:RADIo:FORMat:EVDO[1]|2|3:SEMAsk:BANDwidth[1]|2:INTeGratIOn?
[:SENSe]:RADIo:FORMat:GSM[1]|2|3:PSET:NAME <string>
[:SENSe]:RADIo:FORMat:GSM[1]|2|3:PSET:NAME?
[:SENSe]:RADIo:FORMat:LTEFdd[1]|2|3:ACPoweR:CARRier[1]
|2:BANDwidth:INTeGratIOn <freq>
[:SENSe]:RADIo:FORMat:LTEFdd[1]|2|3:ACPoweR:CARRier[1]
|2:BANDwidth:INTeGratIOn?
[:SENSe]:RADIo:FORMat:LTEFdd[1]|2|3:BANDwidth B1M4 | B3M | B5M | B10M |
B15M | B20M
[:SENSe]:RADIo:FORMat:LTEFdd[1]|2|3:BANDwidth?
[:SENSe]:RADIo:FORMat:LTEFdd[1]|2|3:CHPower:BANDwidth:INTeGratIOn <freq>
[:SENSe]:RADIo:FORMat:LTEFdd[1]|2|3:CHPower:BANDwidth:INTeGratIOn?
[:SENSe]:RADIo:FORMat:LTEFdd[1]|2|3:PSET:NAME <string>
[:SENSe]:RADIo:FORMat:LTEFdd[1]|2|3:PSET:NAME?
[:SENSe]:RADIo:FORMat:LTEFdd[1]|2|3:SEMAsk:BANDwidth[1]|2:INTeGratIOn
<freq>
```

```

[:SENSE]:RADIO:FORMAt:LTEFdd[1]|2|3:SEMAsk:BANDwidth[1]|2:INTEgration?
[:SENSE]:RADIO:FORMAt:LTETdd[1]|2|3:ACPower:CARRier[1]
|2:BANDwidth:INTEgration <freq>
[:SENSE]:RADIO:FORMAt:LTETdd[1]|2|3:ACPower:CARRier[1]
|2:BANDwidth:INTEgration?
[:SENSE]:RADIO:FORMAt:LTETdd[1]|2|3:CHPower:BANDwidth:INTEgration <freq>
[:SENSE]:RADIO:FORMAt:LTETdd[1]|2|3:CHPower:BANDwidth:INTEgration?
[:SENSE]:RADIO:FORMAt:LTETdd[1]|2|3:PSET:NAME <string>
[:SENSE]:RADIO:FORMAt:LTETdd[1]|2|3:PSET:NAME?
[:SENSE]:RADIO:FORMAt:LTETdd[1]|2|3:RADIO:STANdard:DGPU CONF0 | CONF1 |
CONF2 | CONF3 | CONF4 | CONF5 | CONF6 | CONF7 | CONF8
[:SENSE]:RADIO:FORMAt:LTETdd[1]|2|3:RADIO:STANdard:DGPU?
[:SENSE]:RADIO:FORMAt:LTETdd[1]|2|3:RADIO:STANdard:ULDL CONF0 | CONF1 |
CONF2 | CONF3 | CONF4 | CONF5 | CONF6
[:SENSE]:RADIO:FORMAt:LTETdd[1]|2|3:RADIO:STANdard:ULDL?
[:SENSE]:RADIO:FORMAt:LTETdd[1]|2|3:SEMAsk:BANDwidth[1]|2:INTEgration
<freq>
[:SENSE]:RADIO:FORMAt:LTETdd[1]|2|3:SEMAsk:BANDwidth[1]|2:INTEgration?
[:SENSE]:RADIO:FORMAt:TDSCdma[1]|2|3:ACPower:CARRier[1]
|2:BANDwidth:INTEgration <freq>
[:SENSE]:RADIO:FORMAt:TDSCdma[1]|2|3:ACPower:CARRier[1]
|2:BANDwidth:INTEgration?
[:SENSE]:RADIO:FORMAt:TDSCdma[1]|2|3:CHPower:BANDwidth:INTEgration <freq>
[:SENSE]:RADIO:FORMAt:TDSCdma[1]|2|3:CHPower:BANDwidth:INTEgration?
[:SENSE]:RADIO:FORMAt:TDSCdma[1]|2|3:FREQuency:SYNThesis:STATe 1 | 2 | 3
[:SENSE]:RADIO:FORMAt:TDSCdma[1]|2|3:FREQuency:SYNThesis:STATe?
[:SENSE]:RADIO:FORMAt:TDSCdma[1]|2|3:PSET:NAME <string>
[:SENSE]:RADIO:FORMAt:TDSCdma[1]|2|3:PSET:NAME?
[:SENSE]:RADIO:FORMAt:TDSCdma[1]|2|3:SEMAsk:BANDwidth[1]|2:INTEgration
<freq>
[:SENSE]:RADIO:FORMAt:TDSCdma[1]|2|3:SEMAsk:BANDwidth[1]|2:INTEgration?
[:SENSE]:RADIO:FORMAt:WCDMa{1:3}:FREQuency:SYNThesis:STATe 1 | 2 | 3
[:SENSE]:RADIO:FORMAt:WCDMa{1:3}:FREQuency:SYNThesis:STATe?
[:SENSE]:RADIO:FORMAt:WCDMa[1]|2|3:ACPower:CARRier[1]
|2:BANDwidth:INTEgration <freq>
[:SENSE]:RADIO:FORMAt:WCDMa[1]|2|3:ACPower:CARRier[1]
|2:BANDwidth:INTEgration?
[:SENSE]:RADIO:FORMAt:WCDMa[1]|2|3:CHPower:BANDwidth:INTEgration <freq>
[:SENSE]:RADIO:FORMAt:WCDMa[1]|2|3:CHPower:BANDwidth:INTEgration?
[:SENSE]:RADIO:FORMAt:WCDMa[1]|2|3:PSET:NAME <string>
[:SENSE]:RADIO:FORMAt:WCDMa[1]|2|3:PSET:NAME?
[:SENSE]:RADIO:FORMAt:WCDMa[1]|2|3:SEMAsk:BANDwidth[1]|2:INTEgration
<freq>
[:SENSE]:RADIO:FORMAt:WCDMa[1]|2|3:SEMAsk:BANDwidth[1]|2:INTEgration?
[:SENSE]:RADIO:IMODulation:INTErference:FREQuency:OFFSet <freq>
[:SENSE]:RADIO:IMODulation:INTErference:FREQuency:OFFSet?
[:SENSE]:RADIO:IMODulation:INTErference:REGIon INNER | OUTER
[:SENSE]:RADIO:IMODulation:INTErference:REGIon?
[:SENSE]:RADIO:IMODulation:INTErference:SIDE NEGAtive | POSitive
[:SENSE]:RADIO:IMODulation:INTErference:SIDE?
[:SENSE]:RADIO:IMODulation:INTErference:SPAN <freq>
[:SENSE]:RADIO:IMODulation:INTErference:SPAN?

```

3 Programming the Analyzer
List of SCPI Commands

```

[:SENSe]:RADio:IMODulation:INTerference[:STATE] OFF | ON | 0 | 1
[:SENSe]:RADio:IMODulation:INTerference[:STATE]?
[:SENSe]:ROSCillator:BANDwidth WIDE | NARRow
[:SENSe]:ROSCillator:BANDwidth?
[:SENSe]:ROSCillator:COUPling NORMAl | NACQuisition
[:SENSe]:ROSCillator:COUPling?
[:SENSe]:ROSCillator:EXTErnal:FREQuency <freq>
[:SENSe]:ROSCillator:EXTErnal:FREQuency?
[:SENSe]:ROSCillator:SOURce INTernal | EXTErnal
[:SENSe]:ROSCillator:SOURce?
[:SENSe]:ROSCillator:SOURce:TYPE INTernal | EXTErnal | SENSE | PULSe
[:SENSe]:ROSCillator:SOURce:TYPE?
[:SENSe]:SEMAsk:AVERage:COUNt <integer>
[:SENSe]:SEMAsk:AVERage:COUNt?
[:SENSe]:SEMAsk:AVERage[:STATE] ON | OFF | 1 | 0
[:SENSe]:SEMAsk:AVERage[:STATE]?
[:SENSe]:SEMAsk:BANDwidth[1]|2[:RESolution] <bandwidth>
[:SENSe]:SEMAsk:BANDwidth[1]|2[:RESolution]?
[:SENSe]:SEMAsk:BANDwidth[1]|2[:RESolution]:AUTO OFF | ON | 1 | 0
[:SENSe]:SEMAsk:BANDwidth[1]|2[:RESolution]:AUTO?
[:SENSe]:SEMAsk:BANDwidth:SHAPE ASENse | GAUSSian | FLATtop
[:SENSe]:SEMAsk:BANDwidth:SHAPE?
[:SENSe]:SEMAsk:BANDwidth[1]|2:VIDeo <bandwidth>
[:SENSe]:SEMAsk:BANDwidth[1]|2:VIDeo?
[:SENSe]:SEMAsk:BANDwidth[1]|2:VIDeo:AUTO OFF | ON | 1 | 0
[:SENSe]:SEMAsk:BANDwidth[1]|2:VIDeo:AUTO?
[:SENSe]:SEMAsk:BANDwidth[1]|2:VIDeo:RATio <real>
[:SENSe]:SEMAsk:BANDwidth[1]|2:VIDeo:RATio
[:SENSe]:SEMAsk:BANDwidth[1]|2:VIDeo:RATio:AUTO OFF | ON | 1 | 0
[:SENSe]:SEMAsk:BANDwidth[1]|2:VIDeo:RATio:AUTO?
[:SENSe]:SEMAsk:BWIDth[1]|2[:RESolution]
[:SENSe]:SEMAsk:BWIDth[1]|2:VIDeo
[:SENSe]:SEMAsk:BWIDth[1]|2:VIDeo:RATio
[:SENSe]:SEMAsk:CARRier:INDex <integer>
[:SENSe]:SEMAsk:CARRier:INDex?
[:SENSe]:SEMAsk:CARRier:PREFErence:TYPE LRCarriers | MPCCarrier | CINDEX |
MANual | MPCSubblock | RFBandwidth
[:SENSe]:SEMAsk:CARRier:PREFErence:TYPE?
[:SENSe]:SEMAsk:DETEctor:CARRier:AUTO ON | OFF | 1 | 0
[:SENSe]:SEMAsk:DETEctor:CARRier:AUTO?
[:SENSe]:SEMAsk:DETEctor:CARRier[:FUNction] AVERage | NEGative | NORMAl |
POSitive | SAMPlE
[:SENSe]:SEMAsk:DETEctor:CARRier[:FUNction]?
[:SENSe]:SEMAsk:DETEctor:OFFSet:AUTO ON | OFF | 1 | 0
[:SENSe]:SEMAsk:DETEctor:OFFSet:AUTO?
[:SENSe]:SEMAsk:DETEctor:OFFSet[:FUNction] AVERage | NEGative | NORMAl |
POSitive | SAMPlE
[:SENSe]:SEMAsk:DETEctor:OFFSet[:FUNction]?
[:SENSe]:SEMAsk:FILTer[:RRC]:ALPHa <real>
[:SENSe]:SEMAsk:FILTer[:RRC]:ALPHa?
[:SENSe]:SEMAsk:FILTer[:RRC][:STATE] OFF | ON | 0 | 1
[:SENSe]:SEMAsk:FILTer[:RRC][:STATE]?

```



```

[:SENSE]:SEMAsk:MCONdition:IMMediate
[:SENSE]:SEMAsk:NCONtiguous:REGion INNER | OUTER
[:SENSE]:SEMAsk:NCONtiguous:REGion?
[:SENSE]:SEMAsk:OFFSet[1]|2:INNER:CMASk:FREQuency:STOP <freq>
[:SENSE]:SEMAsk:OFFSet[1]|2:INNER:CMASk:FREQuency:STOP?
[:SENSE]:SEMAsk:OFFSet[1]|2:INNER:CMASk[:STATe] ON | OFF | 0 | 1
[:SENSE]:SEMAsk:OFFSet[1]|2:INNER:CMASk[:STATe]?
[:SENSE]:SEMAsk:OFFSet[1]|2:INNER:LIST:BANDwidth:IMULti <integer>, ...
[:SENSE]:SEMAsk:OFFSet[1]|2:INNER:LIST:BANDwidth:IMULti?
[:SENSE]:SEMAsk:OFFSet[1]|2:INNER:LIST:BANDwidth[:RESolution] <bandwidth>,
...
[:SENSE]:SEMAsk:OFFSet[1]|2:INNER:LIST:BANDwidth[:RESolution]?
[:SENSE]:SEMAsk:OFFSet[1]|2:INNER:LIST:BANDwidth[:RESolution]:AUTO OFF |
ON | 1 | 0, ...
[:SENSE]:SEMAsk:OFFSet[1]|2:INNER:LIST:BANDwidth[:RESolution]:AUTO?
[:SENSE]:SEMAsk:OFFSet[1]|2:INNER:LIST:BANDwidth:VIDeo <freq>, ...
[:SENSE]:SEMAsk:OFFSet[1]|2:INNER:LIST:BANDwidth:VIDeo?
[:SENSE]:SEMAsk:OFFSet[1]|2:INNER:LIST:BANDwidth:VIDeo:AUTO OFF | ON | 0 |
1, ...
[:SENSE]:SEMAsk:OFFSet[1]|2:INNER:LIST:BANDwidth:VIDeo:AUTO?
[:SENSE]:SEMAsk:OFFSet[1]|2:INNER:LIST:BANDwidth:VIDeo:RATio <real>, ...
[:SENSE]:SEMAsk:OFFSet[1]|2:INNER:LIST:BANDwidth:VIDeo:RATio?
[:SENSE]:SEMAsk:OFFSet[1]|2:INNER:LIST:BANDwidth:VIDeo:RATio:AUTO OFF | ON
| 0 | 1, ...
[:SENSE]:SEMAsk:OFFSet[1]|2:INNER:LIST:BANDwidth:VIDeo:RATio:AUTO?
[:SENSE]:SEMAsk:OFFSet[1]|2:INNER:LIST:FREQuency:START <freq>, ...
[:SENSE]:SEMAsk:OFFSet[1]|2:INNER:LIST:FREQuency:START?
[:SENSE]:SEMAsk:OFFSet[1]|2:INNER:LIST:FREQuency:STOP <freq>, ...
[:SENSE]:SEMAsk:OFFSet[1]|2:INNER:LIST:FREQuency:STOP?
[:SENSE]:SEMAsk:OFFSet[1]|2:INNER:LIST:SIDE BOTH | NEGative | POSitive,
...
[:SENSE]:SEMAsk:OFFSet[1]|2:INNER:LIST:SIDE?
[:SENSE]:SEMAsk:OFFSet[1]|2:INNER:LIST:START:ABSolute <real>, ...
[:SENSE]:SEMAsk:OFFSet[1]|2:INNER:LIST:START:ABSolute?
[:SENSE]:SEMAsk:OFFSet[1]|2:INNER:LIST:START:RCARrier <rel_ampl>, ...
[:SENSE]:SEMAsk:OFFSet[1]|2:INNER:LIST:START:RCARrier?
[:SENSE]:SEMAsk:OFFSet[1]|2:INNER:LIST:STATe ON | OFF | 1 | 0, ...
[:SENSE]:SEMAsk:OFFSet[1]|2:INNER:LIST:STATe?
[:SENSE]:SEMAsk:OFFSet[1]|2:INNER:LIST:STOP:ABSolute <real>, ...
[:SENSE]:SEMAsk:OFFSet[1]|2:INNER:LIST:STOP:ABSolute?
[:SENSE]:SEMAsk:OFFSet[1]|2:INNER:LIST:STOP:ABSolute:COUPLE ON | OFF | 1 |
0, ...
[:SENSE]:SEMAsk:OFFSet[1]|2:INNER:LIST:STOP:ABSolute:COUPLE?
[:SENSE]:SEMAsk:OFFSet[1]|2:INNER:LIST:STOP:RCARrier <rel_ampl>, ...
[:SENSE]:SEMAsk:OFFSet[1]|2:INNER:LIST:STOP:RCARrier?
[:SENSE]:SEMAsk:OFFSet[1]|2:INNER:LIST:STOP:RCARrier:COUPLE ON | OFF | 1 |
0, ...
[:SENSE]:SEMAsk:OFFSet[1]|2:INNER:LIST:STOP:RCARrier:COUPLE?
[:SENSE]:SEMAsk:OFFSet[1]|2:INNER:LIST:SWEep:TIME <time>, ...
[:SENSE]:SEMAsk:OFFSet[1]|2:INNER:LIST:SWEep:TIME?
[:SENSE]:SEMAsk:OFFSet[1]|2:INNER:LIST:SWEep:TIME:AUTO ON | OFF | 1 | 0,
...

```

3 Programming the Analyzer
List of SCPI Commands

```

[:SENSe]:SEMask:OFFSet[1]|2:INNeR:LIST:SWEep:TIME:AUTO?
[:SENSe]:SEMask:OFFSet[1]|2:INNeR:LIST:TEST ABSolute | AND | OR |
RELative, ...
[:SENSe]:SEMask:OFFSet[1]|2:INNeR:LIST:TEST?
[:SENSe]:SEMask:OFFSet[1]|2:INNeR:TYPE CTOC | CTOE | ETOC | ETOE | STOC |
STOE
[:SENSe]:SEMask:OFFSet[1]|2:INNeR:TYPE?
[:SENSe]:SEMask:OFFSet[1]|2:LIST:BWIDth:IMULti
[:SENSe]:SEMask:OFFSet[1]|2:LIST:BWIDth[:RESolution]
[:SENSe]:SEMask:OFFSet[1]|2:LIST:BWIDth:VIDeo
[:SENSe]:SEMask:OFFSet[1]|2:LIST:SWEep[:TIME]
[:SENSe]:SEMask:OFFSet[1]|2[:OUTer]:LIST:BANdwidth:IMULti <integer>, ...
[:SENSe]:SEMask:OFFSet[1]|2[:OUTer]:LIST:BANdwidth:IMULti?
[:SENSe]:SEMask:OFFSet[1]|2[:OUTer]:LIST:BANdwidth[:RESolution]
<bandwidth>, ...
[:SENSe]:SEMask:OFFSet[1]|2[:OUTer]:LIST:BANdwidth[:RESolution]?
[:SENSe]:SEMask:OFFSet[1]|2[:OUTer]:LIST:BANdwidth[:RESolution]:AUTO OFF |
ON | 1 | 0, ...
[:SENSe]:SEMask:OFFSet[1]|2[:OUTer]:LIST:BANdwidth[:RESolution]:AUTO?
[:SENSe]:SEMask:OFFSet[1]|2[:OUTer]:LIST:BANdwidth:VIDeo <freq>, ...
[:SENSe]:SEMask:OFFSet[1]|2[:OUTer]:LIST:BANdwidth:VIDeo?
[:SENSe]:SEMask:OFFSet[1]|2[:OUTer]:LIST:BANdwidth:VIDeo:AUTO OFF | ON | 0
| 1, ...
[:SENSe]:SEMask:OFFSet[1]|2[:OUTer]:LIST:BANdwidth:VIDeo:AUTO?
[:SENSe]:SEMask:OFFSet[1]|2[:OUTer]:LIST:BANdwidth:VIDeo:RATio <real>, ...
[:SENSe]:SEMask:OFFSet[1]|2[:OUTer]:LIST:BANdwidth:VIDeo:RATio?
[:SENSe]:SEMask:OFFSet[1]|2[:OUTer]:LIST:BANdwidth:VIDeo:RATio:AUTO OFF |
ON | 0 | 1, ...
[:SENSe]:SEMask:OFFSet[1]|2[:OUTer]:LIST:BANdwidth:VIDeo:RATio:AUTO?
[:SENSe]:SEMask:OFFSet[1]|2[:OUTer]:LIST:FREQuency:START <freq>, ...
[:SENSe]:SEMask:OFFSet[1]|2[:OUTer]:LIST:FREQuency:START?
[:SENSe]:SEMask:OFFSet[1]|2[:OUTer]:LIST:FREQuency:STOP <freq>, ...
[:SENSe]:SEMask:OFFSet[1]|2[:OUTer]:LIST:FREQuency:STOP?
[:SENSe]:SEMask:OFFSet[1]|2[:OUTer]:LIST:SIDE BOTH | NEGative | POSitive,
...
[:SENSe]:SEMask:OFFSet[1]|2[:OUTer]:LIST:SIDE?
[:SENSe]:SEMask:OFFSet[1]|2[:OUTer]:LIST:START:ABSolute <real>, ...
[:SENSe]:SEMask:OFFSet[1]|2[:OUTer]:LIST:START:ABSolute?
[:SENSe]:SEMask:OFFSet[1]|2[:OUTer]:LIST:START:RCARrier <rel_ampl>, ...
[:SENSe]:SEMask:OFFSet[1]|2[:OUTer]:LIST:START:RCARrier?
[:SENSe]:SEMask:OFFSet[1]|2[:OUTer]:LIST:STATe ON | OFF | 1 | 0, ...
[:SENSe]:SEMask:OFFSet[1]|2[:OUTer]:LIST:STATe?
[:SENSe]:SEMask:OFFSet[1]|2[:OUTer]:LIST:STOP:ABSolute <real>, ...
[:SENSe]:SEMask:OFFSet[1]|2[:OUTer]:LIST:STOP:ABSolute?
[:SENSe]:SEMask:OFFSet[1]|2[:OUTer]:LIST:STOP:ABSolute:COUple ON | OFF | 1
| 0, ...
[:SENSe]:SEMask:OFFSet[1]|2[:OUTer]:LIST:STOP:ABSolute:COUple?
[:SENSe]:SEMask:OFFSet[1]|2[:OUTer]:LIST:STOP:RCARrier <rel_ampl>, ...
[:SENSe]:SEMask:OFFSet[1]|2[:OUTer]:LIST:STOP:RCARrier?
[:SENSe]:SEMask:OFFSet[1]|2[:OUTer]:LIST:STOP:RCARrier:COUple ON | OFF | 1
| 0, ...
[:SENSe]:SEMask:OFFSet[1]|2[:OUTer]:LIST:STOP:RCARrier:COUple?

```

```

[:SENSE]:SEMask:OFFSet[1]|2[:OUTER]:LIST:SWEep:TIME <time>, ...
[:SENSE]:SEMask:OFFSet[1]|2[:OUTER]:LIST:SWEep:TIME?
[:SENSE]:SEMask:OFFSet[1]|2[:OUTER]:LIST:SWEep:TIME:AUTO ON | OFF | 1 | 0,
...
[:SENSE]:SEMask:OFFSet[1]|2[:OUTER]:LIST:SWEep:TIME:AUTO?
[:SENSE]:SEMask:OFFSet[1]|2[:OUTER]:LIST:TEST ABSolute | AND | OR |
RELative, ...
[:SENSE]:SEMask:OFFSet[1]|2[:OUTER]:LIST:TEST?
[:SENSE]:SEMask:OFFSet[1]|2[:OUTER]:TYPE CTOC | CTOE | ETOC | ETOE | RTOC
| RTOE
[:SENSE]:SEMask:OFFSet[1]|2[:OUTER]:TYPE?
[:SENSE]:SEMask:OFFSet[1]|2:TYPE CTOCenter | CTOEdge | ETOCenter | ETOEdge
[:SENSE]:SEMask:SWEep[1]|2:TIME <time>
[:SENSE]:SEMask:SWEep[1]|2:TIME?
[:SENSE]:SEMask:SWEep[1]|2:TIME:AUTO OFF | 0 | ON | 1
[:SENSE]:SEMask:SWEep[1]|2:TIME:AUTO?
[:SENSE]:SEMask:TYPE PSDRef | TPreF | SPRef
[:SENSE]:SEMask:TYPE?
[:SENSE]:SPECtrum:Bandwidth|BWIDth:IF:SHAPE
[:SENSE]:SPECtrum:Bandwidth:PFFT:TYPE
[:SENSE]:SPECtrum:BWIDth:PFFT:TYPE
[:SENSE]:SPECtrum:DIF:FILTer:TYPE
[:SENSE]:SPECtrum:DIF:FILTer:TYPE?
[:SENSE]:SPECtrum:WBIF:FILTer[:TYPE]
[:SENSE]:SPECtrum:WBIF:FILTer[:TYPE]?
[:SENSE]:SPURious:AVERage:COUNT <integer>
[:SENSE]:SPURious:AVERage:COUNT?
[:SENSE]:SPURious:AVERage[:STATE] ON | OFF | 1 | 0
[:SENSE]:SPURious:AVERage[:STATE]?
[:SENSE]:SPURious:AVERage:TCONtrol EXPonential | REPeat
[:SENSE]:SPURious:AVERage:TCONtrol?
[:SENSE]:SPURious:FSMeas ON | OFF | 1 | 0
[:SENSE]:SPURious:FSMeas?
[:SENSE]:SPURious:IF:GAIN:AUTO[:STATE] OFF|ON|0|1, ...
[:SENSE]:SPURious:IF:GAIN:AUTO[:STATE]?
[:SENSE]:SPURious:IF:GAIN[:STATE] OFF|ON|0|1, ...
[:SENSE]:SPURious:IF:GAIN[:STATE]?
[:SENSE]:SPURious:MCONdition:IMMediate
[:SENSE]:SPURious:POWer[:RF]:RANGE:AUTO
[:SENSE]:SPURious[:RANGE]:ALL:SWEep:TYPE:AUTO OFF | ON | 0 | 1
[:SENSE]:SPURious[:RANGE]:ALL:SWEep:TYPE:AUTO?
[:SENSE]:SPURious[:RANGE][:LIST]:ATTenuation <rel_ampl>, ...
[:SENSE]:SPURious[:RANGE][:LIST]:ATTenuation?
[:SENSE]:SPURious[:RANGE][:LIST]:ATTenuation:AUTO OFF|ON|0|1, ...
[:SENSE]:SPURious[:RANGE][:LIST]:ATTenuation:AUTO?
[:SENSE]:SPURious[:RANGE][:LIST]:BANDwidth[:RESolution] <freq>, ...
[:SENSE]:SPURious[:RANGE][:LIST]:BANDwidth[:RESolution]?
[:SENSE]:SPURious[:RANGE][:LIST]:BANDwidth[:RESolution]:AUTO OFF|ON|0|1,
...
[:SENSE]:SPURious[:RANGE][:LIST]:BANDwidth[:RESolution]:AUTO?
[:SENSE]:SPURious[:RANGE][:LIST]:BANDwidth:SHAPE GAUSSian|FLATtop, ...
[:SENSE]:SPURious[:RANGE][:LIST]:BANDwidth:SHAPE?

```

3 Programming the Analyzer

List of SCPI Commands

```
[ :SENSe]:SPURious[:RANGe][:LIST]:BANDwidth:VIDeo <freq>, ...
[:SENSe]:SPURious[:RANGe][:LIST]:BANDwidth:VIDeo?
[:SENSe]:SPURious[:RANGe][:LIST]:BANDwidth:VIDeo:AUTO OFF|ON|0|1, ...
[:SENSe]:SPURious[:RANGe][:LIST]:BANDwidth:VIDeo:AUTO?
[:SENSe]:SPURious[:RANGe][:LIST]:BWIDth[:RESolution]
[:SENSe]:SPURious[:RANGe][:LIST]:BWIDth:SHAPE
[:SENSe]:SPURious[:RANGe][:LIST]:BWIDth:VIDeo
[:SENSe]:SPURious[:RANGe][:LIST]:DETEctor2[:FUNCTion]
OFF|AVERAge|NEGAtive|NORMAl|POSitive|SAMPle|RMS, ...
[:SENSe]:SPURious[:RANGe][:LIST]:DETEctor[1][:FUNCTion]
AVERAge|NEGAtive|NORMAl|POSitive|SAMPle|RMS, ...
[:SENSe]:SPURious[:RANGe][:LIST]:DETEctor2[:FUNCTion]?
[:SENSe]:SPURious[:RANGe][:LIST]:DETEctor[1][:FUNCTion]?
[:SENSe]:SPURious[:RANGe][:LIST]:FREQUency:START <freq>, ...
[:SENSe]:SPURious[:RANGe][:LIST]:FREQUency:START?
[:SENSe]:SPURious[:RANGe][:LIST]:FREQUency:STOP <freq>, ...
[:SENSe]:SPURious[:RANGe][:LIST]:FREQUency:STOP?
[:SENSe]:SPURious[:RANGe][:LIST]:FREQUency:TYPE ABSolute|OFFSet, ...
[:SENSe]:SPURious[:RANGe][:LIST]:FREQUency:TYPE?
[:SENSe]:SPURious[:RANGe][:LIST]:OFFSet:FREQUency:START <freq>, ...
[:SENSe]:SPURious[:RANGe][:LIST]:OFFSet:FREQUency:START?
[:SENSe]:SPURious[:RANGe][:LIST]:OFFSet:FREQUency:STOP <freq>, ...
[:SENSe]:SPURious[:RANGe][:LIST]:OFFSet:FREQUency:STOP?
[:SENSe]:SPURious[:RANGe][:LIST]:OFFSet:SIDE NEGAtive|POSitive, ...
[:SENSe]:SPURious[:RANGe][:LIST]:OFFSet:SIDE?
[:SENSe]:SPURious[:RANGe][:LIST]:PEAK:EXCURsion <rel_ampl>, ...
[:SENSe]:SPURious[:RANGe][:LIST]:PEAK:EXCURsion?
[:SENSe]:SPURious[:RANGe][:LIST]:PEAK:THREshold <real>, ...
[:SENSe]:SPURious[:RANGe][:LIST]:PEAK:THREshold?
[:SENSe]:SPURious[:RANGe][:LIST]:STATE ON|OFF|1|0, ...
[:SENSe]:SPURious[:RANGe][:LIST]:STATE?
[:SENSe]:SPURious[:RANGe][:LIST]:SWEep:POINTs <integer>
[:SENSe]:SPURious[:RANGe][:LIST]:SWEep:POINTs?
[:SENSe]:SPURious[:RANGe][:LIST]:SWEep:POINTs:AUTO OFF|ON|0|1, ...
[:SENSe]:SPURious[:RANGe][:LIST]:SWEep:POINTs:AUTO?
[:SENSe]:SPURious[:RANGe][:LIST]:SWEep:TIME <time>, ...
[:SENSe]:SPURious[:RANGe][:LIST]:SWEep:TIME?
[:SENSe]:SPURious[:RANGe][:LIST]:SWEep:TIME:AUTO OFF|ON|0|1, ...
[:SENSe]:SPURious[:RANGe][:LIST]:SWEep:TIME:AUTO?
[:SENSe]:SPURious:REPT:MODE ALL | LIMTest | MMARgin
[:SENSe]:SPURious:REPT:MODE?
[:SENSe]:SPURious:SPUR <integer>
[:SENSe]:SPURious:SPUR?
[:SENSe]:SPURious:SWEep:TIME:AUTO:RULEs NORMAl | ACCuracy
[:SENSe]:SPURious:SWEep:TIME:AUTO:RULEs?
[:SENSe]:SPURious:TYPE EXAMine | FULL
[:SENSe]:SPURious:TYPE?
[:SENSe]:SWEep:EGATE:CONTRol EDGE | LEVEl
[:SENSe]:SWEep:EGATE:CONTRol?
[:SENSe]:SWEep:EGATE:DELay <time>
[:SENSe]:SWEep:EGATE:DELay?
[:SENSe]:SWEep:EGATE:DELay:COMPensation:TYPE OFF | SETTled | GDELay
[:SENSe]:SWEep:EGATE:DELay:COMPensation:TYPE?
```

```

[:SENSe]:SWEep:EGATE:EXTErnal[1]|2:LEVel <voltage>
[:SENSe]:SWEep:EGATE:EXTErnal[1]|2:LEVel?
[:SENSe]:SWEep:EGATE:HOLDOff <time>
[:SENSe]:SWEep:EGATE:HOLDOff?
[:SENSe]:SWEep:EGATE:HOLDOff:AUTO OFF | ON | 0 | 1
[:SENSe]:SWEep:EGATE:HOLDOff:AUTO?
[:SENSe]:SWEep:EGATE:LENGth <time>
[:SENSe]:SWEep:EGATE:LENGth?
[:SENSe]:SWEep:EGATE:MINFast?
[:SENSe]:SWEep:EGATE:POLarity NEGative | POSitive
[:SENSe]:SWEep:EGATE:POLarity?
[:SENSe]:SWEep:EGATE:SOURce EXTErnal1 | EXTErnal2 | LINE | FRAME | RFBurst
[:SENSe]:SWEep:EGATE:SOURce?
[:SENSe]:SWEep:EGATE[:STATE] OFF | ON | 0 | 1
[:SENSe]:SWEep:EGATE[:STATE]?
[:SENSe]:SWEep:EGATE:TIME <time>
[:SENSe]:SWEep:EGATE:TIME?
[:SENSe]:SWEep:EGATE:VIEW ON | OFF | 1 | 0
[:SENSe]:SWEep:EGATE:VIEW?
[:SENSe]:SWEep:EGATE:VIEW:STARt <time>
[:SENSe]:SWEep:EGATE:VIEW:STARt?
[:SENSe]:SWEep:TIME:GATE:LEVel HIGH | LOW
[:SENSe]:SWEep:TIME:GATE:LEVel?
[:SENSe]:SWEep:TYPE FFT | SWEep
[:SENSe]:SWEep:TYPE AUTO
[:SENSe]:SWEep:TYPE SWP
[:SENSe]:SWEep:TYPE?
[:SENSe]:SWEep:TYPE:AUTO OFF | ON | 0 | 1
[:SENSe]:SWEep:TYPE:AUTO?
[:SENSe]:VOLTage:IQ[:I]:RANGE[:UPPer] <voltage>
[:SENSe]:VOLTage:IQ[:I]:RANGE[:UPPer]?
[:SENSe]:VOLTage:IQ:Q:RANGE[:UPPer] <voltage>
[:SENSe]:VOLTage:IQ:Q:RANGE[:UPPer]?
[:SENSe]:VOLTage:IQ:RANGE:AUTO OFF | ON | 0 | 1
[:SENSe]:VOLTage:IQ:RANGE:AUTO?
[:SENSe]:VOLTage|POWER:IQ:MIRROred OFF | ON | 0 | 1
[:SENSe]:VOLTage|POWER:IQ:MIRROred?
[:SENSe]:WAVEform:ADC:DITHer:AUTO[:STATE] OFF | ON | 0 | 1
[:SENSe]:WAVEform:ADC:DITHer:AUTO[:STATE]?
[:SENSe]:WAVEform:ADC:DITHer[:STATE] OFF | ON | 0 | 1
[:SENSe]:WAVEform:ADC:DITHer[:STATE]?
[:SENSe]:WAVEform:APERture?
[:SENSe]:WAVEform:AVERage:COUNT <integer>
[:SENSe]:WAVEform:AVERage:COUNT?
[:SENSe]:WAVEform:AVERage[:STATE] OFF | ON | 0 | 1
[:SENSe]:WAVEform:AVERage[:STATE]?
[:SENSe]:WAVEform:AVERage:TACount <integer>
[:SENSe]:WAVEform:AVERage:TACount?
[:SENSe]:WAVEform:AVERage:TACount:AUTO OFF | ON | 0 | 1
[:SENSe]:WAVEform:AVERage:TACount:AUTO?
[:SENSe]:WAVEform:AVERage:TCONtrol EXPonential | REPEAT
[:SENSe]:WAVEform:AVERage:TCONtrol?
[:SENSe]:WAVEform:AVERage:TYPE LOG | MAXimum | MINimum | RMS | SCALar

```

3 Programming the Analyzer

List of SCPI Commands

```
[ :SENSe]:WAVeform:AVERAge:TYPE?
[ :SENSe]:WAVeform:AVERAge:TYPE:AUTO[:STATE] ON | OFF | 1 | 0
[ :SENSe]:WAVeform:AVERAge:TYPE:AUTO[:STATE]?
[ :SENSe]:WAVeform:BANDwidth|BWIDth[:RESolution]:TYPE
[ :SENSe]:WAVeform:BANDwidth[:RESolution]
[ :SENSe]:WAVeform:BANDwidth:SHAPE
[ :SENSe]:WAVeform:BWIDth[:RESolution]
[ :SENSe]:WAVeform:BWIDth:SHAPE
[ :SENSe]:WAVeform:DIF:BANDwidth <freq>
[ :SENSe]:WAVeform:DIF:BANDwidth?
[ :SENSe]:WAVeform:DIF:FILTer:ALPHa <real>
[ :SENSe]:WAVeform:DIF:FILTer:ALPHa?
[ :SENSe]:WAVeform:DIF:FILTer:BANDwidth <freq>
[ :SENSe]:WAVeform:DIF:FILTer:BANDwidth?
[ :SENSe]:WAVeform:DIF:FILTer:BANDwidth:AUTO ON | OFF | 1 | 0
[ :SENSe]:WAVeform:DIF:FILTer:BANDwidth:AUTO?
[ :SENSe]:WAVeform:DIF:FILTer:TYPE GAUSSian | FLATtop
[ :SENSe]:WAVeform:DIF:FILTer:TYPE GAUSSian | FLATtop | SNYquist |
RSNYquist | RCOSine | RRCosine
[ :SENSe]:WAVeform:DIF:FILTer:TYPE?
[ :SENSe]:WAVeform:DIF:FILTer:TYPE?
[ :SENSe]:WAVeform:FREQuency:SYNThesis:AUTO[:STATE] OFF | ON | 0 | 1
[ :SENSe]:WAVeform:FREQuency:SYNThesis:AUTO[:STATE]?
[ :SENSe]:WAVeform:FREQuency:SYNThesis[:STATE] 1 | 2 | 3
[ :SENSe]:WAVeform:FREQuency:SYNThesis[:STATE]?
[ :SENSe]:WAVeform:IF:GAIN:AUTO[:STATE] ON | OFF | 1 | 0
[ :SENSe]:WAVeform:IF:GAIN:AUTO[:STATE]?
[ :SENSe]:WAVeform:IF:GAIN:OFFSet <rel_ampl>
[ :SENSe]:WAVeform:IF:GAIN:OFFSet?
[ :SENSe]:WAVeform:IF:GAIN[:STATE] AUTOrange | LOW | HIGH
[ :SENSe]:WAVeform:IF:GAIN[:STATE]?
[ :SENSe]:WAVeform:PDITHer
[ :SENSe]:WAVeform:SRATe <freq>
[ :SENSe]:WAVeform:SRATe?
[ :SENSe]:WAVeform:SWEep:TIME <time>
[ :SENSe]:WAVeform:SWEep:TIME?
[ :SENSe]:WAVeform:WBIF:ADC:DITHer
[ :SENSe]:WAVeform:WBIF:FILTer:ALPHa
[ :SENSe]:WAVeform:WBIF:FILTer:BANDwidth <real>
[ :SENSe]:WAVeform:WBIF:FILTer:BANDwidth?
[ :SENSe]:WAVeform:WBIF:FILTer[:TYPE] GAUSSian | NONE | NYquist | RNYquist
| RCOSine | RRCosine
[ :SENSe]:WAVeform:WBIF:FILTer[:TYPE]?
STATus:OPERation:CONDition?
STATus:OPERation:ENABle <integer>
STATus:OPERation:ENABle?
STATus:OPERation[:EVENT]?
STATus:OPERation:NTRansition <integer>
STATus:OPERation:NTRansition?
STATus:OPERation:PTRansition <integer>
STATus:OPERation:PTRansition?
STATus:PRESet
STATus:QUESTionable:CALibration:CONDition?
```

```

STATUS:QUESTionable:CALibration:ENABLE <integer>
STATUS:QUESTionable:CALibration:ENABLE?
STATUS:QUESTionable:CALibration[:EVENT]?
STATUS:QUESTionable:CALibration:EXTended:FAILure:CONDition?
STATUS:QUESTionable:CALibration:EXTended:FAILure:ENABLE <integer>
STATUS:QUESTionable:CALibration:EXTended:FAILure:ENABLE?
STATUS:QUESTionable:CALibration:EXTended:FAILure[:EVENT]?
STATUS:QUESTionable:CALibration:EXTended:FAILure:NTRansition <integer>
STATUS:QUESTionable:CALibration:EXTended:FAILure:NTRansition?
STATUS:QUESTionable:CALibration:EXTended:FAILure:PTRansition <integer>
STATUS:QUESTionable:CALibration:EXTended:FAILure:PTRansition?
STATUS:QUESTionable:CALibration:EXTended:NEEDED:CONDition?
STATUS:QUESTionable:CALibration:EXTended:NEEDED:ENABLE <integer>
STATUS:QUESTionable:CALibration:EXTended:NEEDED:ENABLE?
STATUS:QUESTionable:CALibration:EXTended:NEEDED[:EVENT]?
STATUS:QUESTionable:CALibration:EXTended:NEEDED:NTRansition <integer>
STATUS:QUESTionable:CALibration:EXTended:NEEDED:NTRansition?
STATUS:QUESTionable:CALibration:EXTended:NEEDED:PTRansition <integer>
STATUS:QUESTionable:CALibration:EXTended:NEEDED:PTRansition?
STATUS:QUESTionable:CALibration:NTRansition <integer>
STATUS:QUESTionable:CALibration:NTRansition?
STATUS:QUESTionable:CALibration:PTRansition <integer>
STATUS:QUESTionable:CALibration:PTRansition?
STATUS:QUESTionable:CALibration:SKIPPed:CONDition?
STATUS:QUESTionable:CALibration:SKIPPed:ENABLE <integer>
STATUS:QUESTionable:CALibration:SKIPPed:ENABLE?
STATUS:QUESTionable:CALibration:SKIPPed[:EVENT]?
STATUS:QUESTionable:CALibration:SKIPPed:NTRansition <integer>
STATUS:QUESTionable:CALibration:SKIPPed:NTRansition?
STATUS:QUESTionable:CALibration:SKIPPed:PTRansition <integer>
STATUS:QUESTionable:CALibration:SKIPPed:PTRansition?
STATUS:QUESTionable:CONDition?
STATUS:QUESTionable:ENABLE <integer>
STATUS:QUESTionable:ENABLE?
STATUS:QUESTionable[:EVENT]?
STATUS:QUESTionable:FREQuency:CONDition?
STATUS:QUESTionable:FREQuency:ENABLE <integer>
STATUS:QUESTionable:FREQuency:ENABLE?
STATUS:QUESTionable:FREQuency[:EVENT]?
STATUS:QUESTionable:FREQuency:NTRansition <integer>
STATUS:QUESTionable:FREQuency:NTRansition?
STATUS:QUESTionable:FREQuency:PTRansition <integer>
STATUS:QUESTionable:FREQuency:PTRansition?
STATUS:QUESTionable:INTEgrity:CONDition?
STATUS:QUESTionable:INTEgrity:ENABLE <integer>
STATUS:QUESTionable:INTEgrity:ENABLE?
STATUS:QUESTionable:INTEgrity[:EVENT]?
STATUS:QUESTionable:INTEgrity:NTRansition <integer>
STATUS:QUESTionable:INTEgrity:NTRansition?
STATUS:QUESTionable:INTEgrity:PTRansition <integer>
STATUS:QUESTionable:INTEgrity:PTRansition?
STATUS:QUESTionable:INTEgrity:SIGNal:CONDition?
STATUS:QUESTionable:INTEgrity:SIGNal:ENABLE <integer>

```

```
STATUS:QUESTIONABLE:INTEGRITY:SIGNAl:ENABle?
STATUS:QUESTIONABLE:INTEGRITY:SIGNAl[:EVENT]?
STATUS:QUESTIONABLE:INTEGRITY:SIGNAl:NTRANSITION <integer>
STATUS:QUESTIONABLE:INTEGRITY:SIGNAl:NTRANSITION?
STATUS:QUESTIONABLE:INTEGRITY:SIGNAl:PTRANSITION <integer>
STATUS:QUESTIONABLE:INTEGRITY:SIGNAl:PTRANSITION?
STATUS:QUESTIONABLE:INTEGRITY:UNCalibrated:CONDition?
STATUS:QUESTIONABLE:INTEGRITY:UNCalibrated:ENABle
STATUS:QUESTIONABLE:INTEGRITY:UNCalibrated:ENABle?
STATUS:QUESTIONABLE:INTEGRITY:UNCalibrated[:EVENT]?
STATUS:QUESTIONABLE:INTEGRITY:UNCalibrated:NTRANSITION <integer>
STATUS:QUESTIONABLE:INTEGRITY:UNCalibrated:NTRANSITION?
STATUS:QUESTIONABLE:INTEGRITY:UNCalibrated:PTRANSITION <integer>
STATUS:QUESTIONABLE:INTEGRITY:UNCalibrated:PTRANSITION?
STATUS:QUESTIONABLE:NTRANSITION <integer>
STATUS:QUESTIONABLE:NTRANSITION?
STATUS:QUESTIONABLE:POWER:CONDition?
STATUS:QUESTIONABLE:POWER:ENABle <integer>
STATUS:QUESTIONABLE:POWER:ENABle?
STATUS:QUESTIONABLE:POWER[:EVENT]?
STATUS:QUESTIONABLE:POWER:NTRANSITION <integer>
STATUS:QUESTIONABLE:POWER:NTRANSITION?
STATUS:QUESTIONABLE:POWER:PTRANSITION <integer>
STATUS:QUESTIONABLE:POWER:PTRANSITION?
STATUS:QUESTIONABLE:PTRANSITION <integer>
STATUS:QUESTIONABLE:PTRANSITION?
STATUS:QUESTIONABLE:TEMPerature:CONDition?
STATUS:QUESTIONABLE:TEMPerature:ENABle <integer>
STATUS:QUESTIONABLE:TEMPerature:ENABle?
STATUS:QUESTIONABLE:TEMPerature[:EVENT]?
STATUS:QUESTIONABLE:TEMPerature:NTRANSITION <integer>
STATUS:QUESTIONABLE:TEMPerature:NTRANSITION?
STATUS:QUESTIONABLE:TEMPerature:PTRANSITION <integer>
STATUS:QUESTIONABLE:TEMPerature:PTRANSITION?
SYSTEM:APPLication:CATalog[:NAME]?
SYSTEM:APPLication:CATalog[:NAME]:COUNT?
SYSTEM:APPLication:CATalog:OPTion? <model>
SYSTEM:APPLication:CATalog:REVision? <model>
SYSTEM:APPLication[:CURRENT][:NAME]?
SYSTEM:APPLication[:CURRENT]:OPTion?
SYSTEM:APPLication[:CURRENT]:REVision?
SYSTEM:COMMunicate:GPIB[1][:SELF]:ADDRes <integer>
SYSTEM:COMMunicate:GPIB[1][:SELF]:ADDRes?
SYSTEM:COMMunicate:GPIB[1][:SELF]:CONTroller[:ENABle] ON | OFF | 0 | 1
SYSTEM:COMMunicate:GPIB[1][:SELF]:CONTroller[:ENABle]?
SYSTEM:COMMunicate:LAN:SCPI:HISLip:ENABle OFF | ON | 0 | 1
SYSTEM:COMMunicate:LAN:SCPI:HISLip:ENABle?
SYSTEM:COMMunicate:LAN:SCPI:SICL:ENABle OFF | ON | 0 | 1
SYSTEM:COMMunicate:LAN:SCPI:SICL:ENABle?
SYSTEM:COMMunicate:LAN:SCPI:SOCKet:CONTrol?
SYSTEM:COMMunicate:LAN:SCPI:SOCKet:ENABle OFF | ON | 0 | 1
SYSTEM:COMMunicate:LAN:SCPI:SOCKet:ENABle?
SYSTEM:COMMunicate:LAN:SCPI:TELNet:ENABle OFF | ON | 0 | 1
```



```

SYSTEM:COMMunicate:LAN:SCPI:TELNet:ENABle?
SYSTEM:COMMunicate:USB:CONNECTION?
SYSTEM:COMMunicate:USB:PACKets?
SYSTEM:COMMunicate:USB:STATUS?
SYSTEM:CONFigure[:SYSTEM]?
SYSTEM:CSYSTEM?
SYSTEM:DATE "<year>, <month>, <day>"
SYSTEM:DATE?
SYSTEM:DEFault [ALL] | ALIGn | INPut | MISC | MODes | PON
SYSTEM:ERRor[:NEXT]?
SYSTEM:ERRor:OVERload[:STATE] 0 | 1 | OFF | ON
SYSTEM:ERRor:PUP?
SYSTEM:ERRor:VERBose OFF | ON | 0 | 1
SYSTEM:ERRor:VERBose?
SYSTEM:HELP:HEADers?
SYSTEM:HID?
SYSTEM:IDN <string>
SYSTEM:IDN?
SYSTEM:KLOCK OFF | ON | 0 | 1
SYSTEM:KLOCK?
SYSTEM:LKEY <"OptionInfo">, <"LicenseInfo">
SYSTEM:LKEY? <"OptionInfo">
SYSTEM:LKEY:DELeTe <"OptionInfo">, <"LicenseInfo">
SYSTEM:LKEY:LIST?
SYSTEM:LOFF
SYSTEM:MRELay:COUNT?
SYSTEM:OPTions?
SYSTEM:PDOWN [NORMal | FORCe]
SYSTEM:PON:APPLication:LLIST <stringofINSTRument:SElectnames>
SYSTEM:PON:APPLication:LLIST?
SYSTEM:PON:APPLication:VMEMory[:AVAILable]?
SYSTEM:PON:APPLication:VMEMory:TOTAL?
SYSTEM:PON:APPLication:VMEMory:USED?
SYSTEM:PON:APPLication:VMEMory:USED:NAME? <INSTRument:SElectname>
SYSTEM:PON:ETIME?
SYSTEM:PON:MODE SA | BASIC | ADEMOD | NFIGURE | PNOISE | CDMA2K | TDSCDMA
| VSA | VSA89601 | WCDMA | WIMAXOFDMA
SYSTEM:PON:MODE?
SYSTEM:PON:TIME?
SYSTEM:PON:TYPE PRESet
SYSTEM:PON:TYPE MODE | USER | LAST
SYSTEM:PON:TYPE?
SYSTEM:PRESet
SYSTEM:PRESet:TYPE FACTory | MODE | USER
SYSTEM:PRESet:TYPE?
SYSTEM:PRESet:USER
SYSTEM:PRESet:USER:ALL
SYSTEM:PRESet:USER:SAVE
SYSTEM:PRINT:THEME TDColor | TDMonochrome | FCOLOR | FMONochrome
SYSTEM:PRINT:THEME?
SYSTEM:PUP:PROcEss
SYSTEM:SECurity:USB:WPROtect[:ENABle] ON | OFF | 0 | 1
SYSTEM:SECurity:USB:WPROtect[:ENABle]?

```

3 Programming the Analyzer

List of SCPI Commands

```
SYSTem:SHOW OFF | ERRor | SYSTem | HARDWare | LXI | HWStatistics |  
ALIGNment | SOFTWare | CAPplication  
SYSTem:SHOW?  
SYSTem:TEMPerature:HEXTreme?  
SYSTem:TEMPerature:LEXTreme?  
SYSTem:TIME "<hour>, <minute>, <second>"  
SYSTem:TIME?  
SYSTem:VERSion?  
TRACe[1]|2|3:ACPowEr:DISPlay[:STATe] ON | OFF | 0 | 1  
TRACe[1]|2|3:ACPowEr:DISPlay[:STATe]?  
TRACe[1]|2|3:ACPowEr:TYPE WRITe | AVERAge | MAXHold | MINHold  
TRACe[1]|2|3:ACPowEr:TYPE?  
TRACe[1]|2|3:ACPowEr:UPDate[:STATe] ON | OFF | 0 | 1  
TRACe[1]|2|3:ACPowEr:UPDate[:STATe]?  
TRACe:CHPower:TYPE WRITe | AVERAge | MAXHold | MINHold  
TRACe:CHPower:TYPE?  
TRACe:MONitor:CLear [TRACE1] | TRACE2 | TRACE3  
TRACe:MONitor:CLear:ALL  
TRACe[1]|2|3:MONitor:DISPlay[:STATe] ON | OFF | 0 | 1  
TRACe[1]|2|3:MONitor:DISPlay[:STATe]?  
TRACe[1]|2|3:MONitor:TYPE WRITe | AVERAge | MAXHold | MINHold  
TRACe[1]|2|3:MONitor:TYPE?  
TRACe[1]|2|3:MONitor:UPDate[:STATe] ON | OFF | 0 | 1  
TRACe[1]|2|3:MONitor:UPDate[:STATe]?  
TRACe:OBWidth:TYPE WRITe | AVERAge | MAXHold | MINHold  
TRACe:OBWidth:TYPE?  
TRACe:SEMAsk:TYPE WRITe | AVERAge | MAXHold | MINHold  
TRACe:SEMAsk:TYPE?  
TRIGger:<measurement>[:SEQuence]:IQ:SOURce EXTernal1 | EXTernal2 |  
IMMEdiate | IQMag | IDEMod | QDEMod | IINPut | QINPut | AIQMag  
TRIGger:<measurement>[:SEQuence]:IQ:SOURce?  
TRIGger:<measurement>[:SEQuence]:RF:SOURce EXTernal1 | EXTernal2 |  
IMMEdiate | LINE | FRAME | RFBurst | VIdEo | IF | ALARm | LAN | TV  
TRIGger:<measurement>[:SEQuence]:RF:SOURce?  
TRIGger:<measurement>[:SEQuence]:SOURce EXTernal1 | EXTernal2 | IMMEdiate  
| LINE | FRAME | RFBurst | VIdEo | IF | ALARm | LAN | IQMag | IDEMod |  
QDEMod | IINPut | QINPut | AIQMag | TV  
TRIGger:<measurement>[:SEQuence]:SOURce?  
TRIGger[:SEQuence]:ATRigger <time>  
TRIGger[:SEQuence]:ATRigger?  
TRIGger[:SEQuence]:ATRigger:STATe OFF | ON | 0 | 1  
TRIGger[:SEQuence]:ATRigger:STATe?  
TRIGger[:SEQuence]:DELay <time>  
TRIGger[:SEQuence]:DELay?  
TRIGger[:SEQuence]:DELay:STATe OFF | ON | 0 | 1  
TRIGger[:SEQuence]:DELay:STATe?  
TRIGger[:SEQuence]:EXTernal2:DELay <time>  
TRIGger[:SEQuence]:EXTernal:DELay  
TRIGger[:SEQuence]:EXTernal1:DELay <time>  
TRIGger[:SEQuence]:EXTernal2:DELay?  
TRIGger[:SEQuence]:EXTernal1:DELay?  
TRIGger[:SEQuence]:EXTernal1:DELay:COMPensation OFF | ON | 0 | 1
```

```

TRIGger[:SEQuence]:EXTErnal2:DElay:COMPensation OFF | ON | 0 | 1
TRIGger[:SEQuence]:EXTErnal2:DElay:COMPensation?
TRIGger[:SEQuence]:EXTErnal1:DElay:COMPensation?
TRIGger[:SEQuence]:EXTErnal2:DElay:STATE OFF | ON | 0 | 1
TRIGger[:SEQuence]:EXTErnal1:DElay:STATE OFF | ON | 0 | 1
TRIGger[:SEQuence]:EXTErnal2:DElay:STATE?
TRIGger[:SEQuence]:EXTErnal1:DElay:STATE?
TRIGger[:SEQuence]:EXTErnal1:LEVel <level>
TRIGger[:SEQuence]:EXTErnal2:LEVel
TRIGger[:SEQuence]:EXTErnal:LEVel
TRIGger[:SEQuence]:EXTErnal2:LEVel?
TRIGger[:SEQuence]:EXTErnal1:LEVel?
TRIGger[:SEQuence]:EXTErnal1:SLOPe POSitive | NEGative
TRIGger[:SEQuence]:EXTErnal2:SLOPe POSitive | NEGative
TRIGger[:SEQuence]:EXTErnal:SLOPe
TRIGger[:SEQuence]:EXTErnal2:SLOPe?
TRIGger[:SEQuence]:EXTErnal1:SLOPe?
TRIGger[:SEQuence]:FRAME:ADJust <time>
TRIGger[:SEQuence]:FRAME:DElay <time>
TRIGger[:SEQuence]:FRAME:DElay?
TRIGger[:SEQuence]:FRAME:DElay:STATE OFF | ON | 0 | 1
TRIGger[:SEQuence]:FRAME:DElay:STATE?
TRIGger[:SEQuence]:FRAME:EXTErnal2:LEVel
TRIGger[:SEQuence]:FRAME:EXTErnal1:LEVel
TRIGger[:SEQuence]:FRAME:EXTErnal2:SLOPe
TRIGger[:SEQuence]:FRAME:EXTErnal1:SLOPe
TRIGger[:SEQuence]:FRAME:OFFSet <time>
TRIGger[:SEQuence]:FRAME:OFFSet?
TRIGger[:SEQuence]:FRAME:OFFSet:DISPlay:RESet
TRIGger[:SEQuence]:FRAME:PERiod <time>
TRIGger[:SEQuence]:FRAME:PERiod?
TRIGger[:SEQuence]:FRAME:RFBurst:LEVel:ABSolute
TRIGger[:SEQuence]:FRAME:RFBurst:SLOPe
TRIGger[:SEQuence]:FRAME:SYNC EXTErnal
TRIGger[:SEQuence]:FRAME:SYNC EXTErnal1 | EXTErnal2 | RFBurst | OFF
TRIGger[:SEQuence]:FRAME:SYNC?
TRIGger[:SEQuence]:FRAME:SYNC:HOLDoff <time>
TRIGger[:SEQuence]:FRAME:SYNC:HOLDoff?
TRIGger[:SEQuence]:FRAME:SYNC:HOLDoff:STATE OFF | ON | 0 | 1
TRIGger[:SEQuence]:FRAME:SYNC:HOLDoff:STATE?
TRIGger[:SEQuence]:HOLDoff <time>
TRIGger[:SEQuence]:HOLDoff?
TRIGger[:SEQuence]:HOLDoff:STATE OFF | ON | 0 | 1
TRIGger[:SEQuence]:HOLDoff:STATE?
TRIGger[:SEQuence]:HOLDoff:TYPE NORMAl | ABOVe | BELow
TRIGger[:SEQuence]:HOLDoff:TYPE?
TRIGger[:SEQuence]:IF:LEVel
TRIGger[:SEQuence]:IF:LEVel?
TRIGger[:SEQuence]:IF:SLOPe NEGative | POSitive
TRIGger[:SEQuence]:IF:SLOPe?
TRIGger[:SEQuence]:LINE:DElay <time>
TRIGger[:SEQuence]:LINE:DElay?
TRIGger[:SEQuence]:LINE:DElay:STATE OFF | ON | 0 | 1

```

3 Programming the Analyzer

List of SCPI Commands

```
TRIGger[:SEquence]:LINE:DElay:STATe?
TRIGger[:SEquence]:LINE:SLOPe POSitive | NEGative
TRIGger[:SEquence]:LINE:SLOPe?
TRIGger[:SEquence]:OFFSet <time>
TRIGger[:SEquence]:OFFSet?
TRIGger[:SEquence]:OFFSet:STATe OFF | ON | 0 | 1
TRIGger[:SEquence]:OFFSet:STATe?
TRIGger[:SEquence]:RFBurst:DElay <time>
TRIGger[:SEquence]:RFBurst:DElay?
TRIGger[:SEquence]:RFBurst:DElay:STATe OFF | ON | 0 | 1
TRIGger[:SEquence]:RFBurst:DElay:STATe?
TRIGger[:SEquence]:RFBurst:LEVel
TRIGger[:SEquence]:RFBurst:LEVel:ABSolute <ampl>
TRIGger[:SEquence]:RFBurst:LEVel:ABSolute?
TRIGger[:SEquence]:RFBurst:LEVel:RELative <rel_ampl>
TRIGger[:SEquence]:RFBurst:LEVel:RELative?
TRIGger[:SEquence]:RFBurst:LEVel:TYPE ABSolute | RELative
TRIGger[:SEquence]:RFBurst:LEVel:TYPE?
TRIGger[:SEquence]:RFBurst:SLOPe POSitive | NEGative
TRIGger[:SEquence]:RFBurst:SLOPe?
TRIGger[:SEquence]:SLOPe POSitive | NEGative
TRIGger[:SEquence]:SLOPe?
TRIGger[:SEquence]:SOURCe EXTernal
TRIGger[:SEquence]:VIDeo:DElay <time>
TRIGger[:SEquence]:VIDeo:DElay?
TRIGger[:SEquence]:VIDeo:DElay:STATe OFF | ON | 0 | 1
TRIGger[:SEquence]:VIDeo:DElay:STATe?
TRIGger[:SEquence]:VIDeo:LEVel <ampl>
TRIGger[:SEquence]:VIDeo:LEVel?
TRIGger[:SEquence]:VIDeo:SLOPe POSitive | NEGative
TRIGger[:SEquence]:VIDeo:SLOPe?
TRIGger|TRIGger1|TRIGger2[:SEquence]:OUTPut HSWP | MEASuring | MAIN | GATE
| GTRigger | OEven | SPOint | SSweep | SSETtled | S1Marker | S2Marker |
S3Marker | S4Marker | OFF
TRIGger|TRIGger1|TRIGger2[:SEquence]:OUTPut?
TRIGger|TRIGger1|TRIGger2[:SEquence]:OUTPut:POLarity POSitive | NEGative
TRIGger|TRIGger1|TRIGger2[:SEquence]:OUTPut:POLarity?
UNIT:ACPower:POWER:PSD DBMHZ | DBMMHZ
UNIT:ACPower:POWER:PSD?
UNIT:CHPower:POWER:PSD DBMHZ | DBMMHZ
UNIT:CHPower:POWER:PSD?
```

STATus Subsystem

The following diagram provides a graphical overview of the entire X-Series Status Register System.

For readability, the diagram is split into two sections:

- ["X-Series Status Register System \(1\) " on page 138](#)
- ["X-Series Status Register System \(2\) " on page 139](#)

X-Series Status Register System (1)

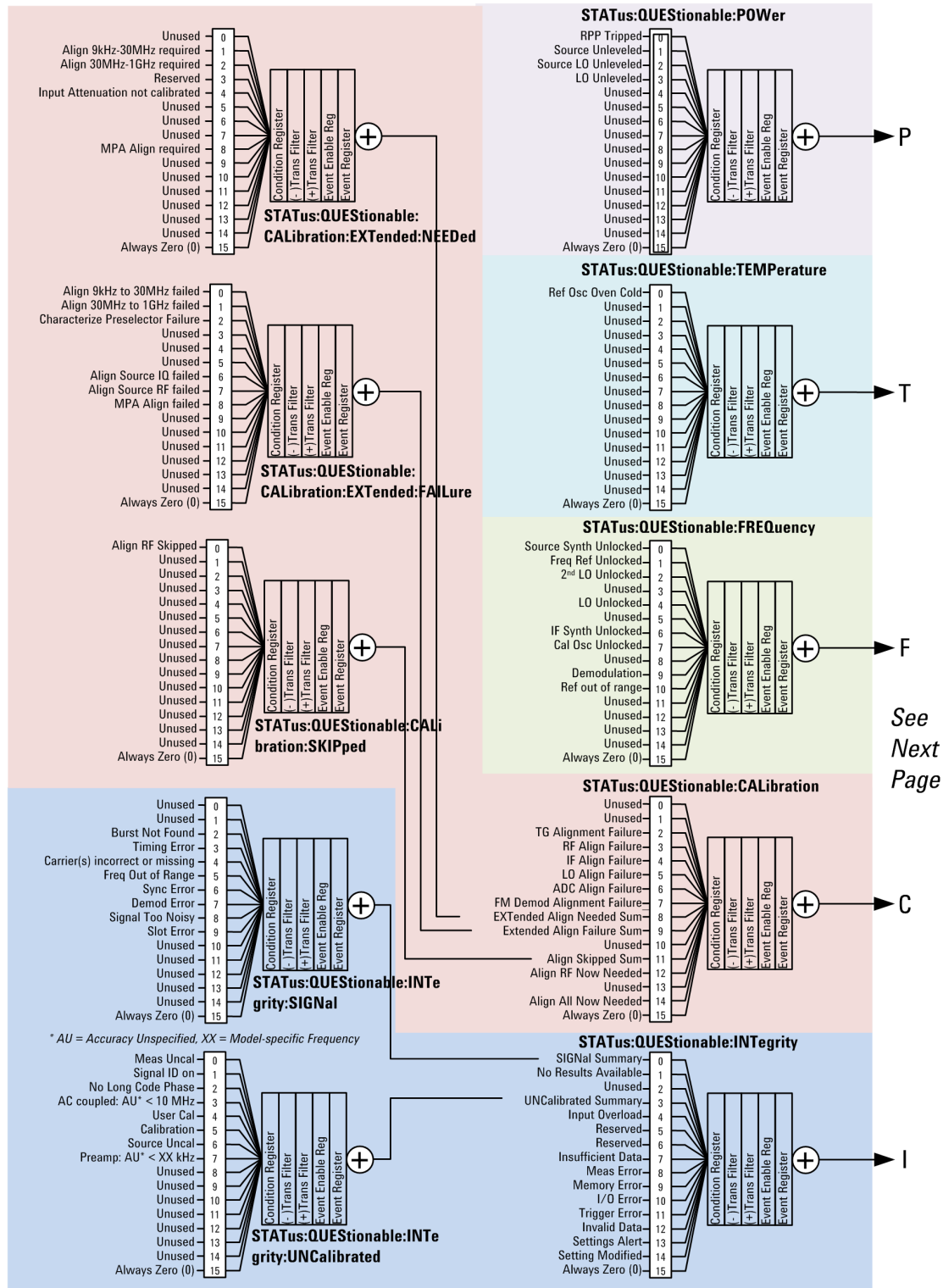

X-Series Status Register System (2)

See
 Previous
 Page

P
 T
 F
 C
 I

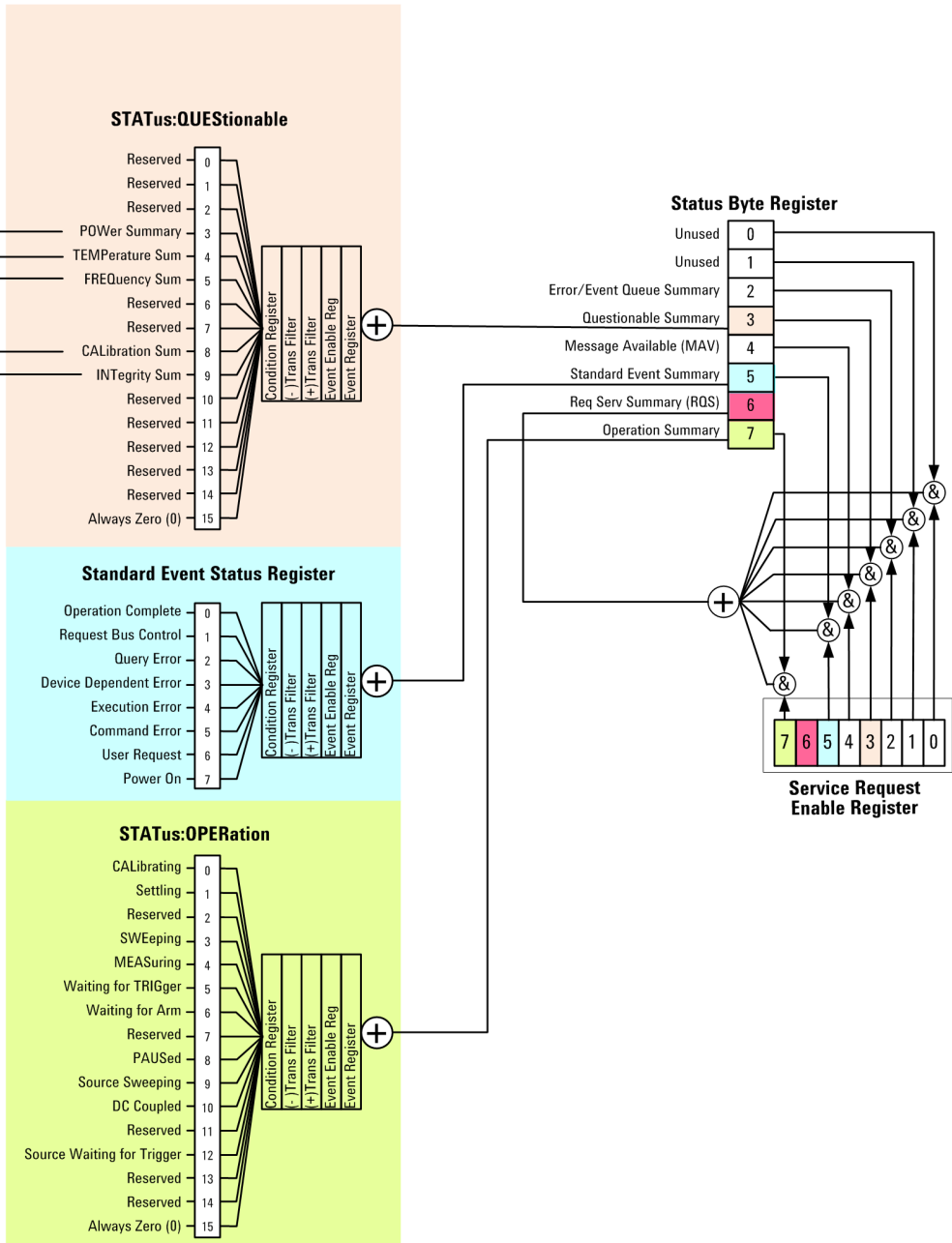

Detailed Description

The STATus subsystem remote commands set and query the status hardware registers. This system of registers monitors various events and conditions in the instrument. Software written to control the instrument may need to monitor some of these events and conditions.

NOTE

All status register commands are sequential. Most commands can be started immediately and will overlap with any existing commands that are already running. This is not true of status commands. All the commands in the spectrum analyzer are assumed to be overlapped unless a command description specifically says that it is sequential.

What Are Status Registers

The status system contains multiple registers that are arranged in a hierarchical order. The lower-level status registers propagate their data to the higher-level registers in the data structures by means of summary bits. The status byte register is at the top of the hierarchy and contains general status information for the instrument's events and conditions. All other individual registers are used to determine the specific events or conditions. For a diagram of the registers and their interconnections, see above.

The operation and questionable status registers are sets of registers that monitor the overall instrument condition. They are accessed with the STATus:OPERation and STATus:QUEStionable commands in the STATus command subsystem. Each register set is made up of five registers:

- Condition Register – Reports the real-time state of the signals monitored by this register set. There is no latching or buffering for a condition register.
- Positive Transition Register – This filter register controls which signals will set a bit in the event register when the signal makes a low to high transition (when the condition bit changes from 0 to 1).
- Negative Transition Register – This filter register controls which signals will set a bit in the event register when the signal makes a high to low transition (when the condition bit changes from 1 to 0).
- Event Register – Latches any signal state changes, in the way specified by the filter registers. Bits in the event register are never cleared by signal state changes. Event registers are cleared when read. They are also cleared by *CLS and by presetting the instrument.
- Event Enable Register – Controls which of the bits, being set in the event register, will be summarized as a single output for the register set. Summary bits are then used by the next higher register.

The STATus:QUEStionable registers report abnormal operating conditions. The status register hierarchy is:

1. The summary outputs from the six STATus:QUEStionable:<keyword> detail registers are inputs to the STATus:QUEStionable register.
2. The summary output from the STATus:QUEStionable register is an input to the Status Byte Register. See the overall system in Figure at the beginning of this section.

The STATus:OPERation register set has no summarized inputs. The inputs to the STATus:OPERation:CONDition register indicate the real time state of the instrument. The STATus:OPERation:EVENT register summary output is an input to the Status Byte Register.

What Are Status Register SCPI Commands

Most monitoring of the instrument conditions is done at the highest level using the IEEE common commands indicated below. Complete command descriptions are available in the IEEE commands section at the beginning of the language reference. Individual status registers can be set and queried using the commands in the STATus subsystem of the language reference.

- *CLS (clear status) clears the status byte by emptying the error queue and clearing all the event registers.
- *ESE, *ESE? (event status enable) sets and queries the bits in the enable register part of the standard event status register.
- *ESR? (event status register) queries and clears the event register part of the standard event status register.
- *OPC, *OPC? (operation complete) sets the standard event status register to monitor the completion of all commands. The query stops any new commands from being processed until the current processing is complete, then returns a '1'.
- *PSC, *PSC? (power-on state clear) sets the power-on state so that it clears the service request enable register and the event status enable register at power on.
- *SRE, *SRE? (service request enable) sets and queries the value of the service request enable register.
- *STB? (status byte) queries the value of the status byte register without erasing its contents.

How to Use the Status Registers

A program often needs to be able to detect and manage error conditions or changes in instrument status. There are two methods you can use to programmatically access the information in status registers:

- The polling method
- The service request (SRQ) method

In the polling method, the instrument has a passive role. It only tells the controller that conditions have changed when the controller asks the right question. In the SRQ method, the instrument takes a more active role. It tells the controller when there has been a condition change without the controller asking. Either method allows you to monitor one or more conditions.

The polling method works well if you do not need to know about changes the moment they occur. The SRQ method should be used if you must know immediately when a condition changes. To detect a change using the polling method, the program must repeatedly read the registers.

Use the SRQ method when:

- you need time-critical notification of changes
- you are monitoring more than one device which supports SRQs
- you need to have the controller do something else while waiting
- you can't afford the performance penalty inherent to polling

Use polling when:

- your programming language/development environment does not support SRQ interrupts
- you want to write a simple, single-purpose program and don't want the added complexity of setting up an SRQ handler

- To monitor a condition:
 - a. Determine which register contains the bit that reports the condition.
 - b. Send the unique SCPI query that reads that register.
 - c. Examine the bit to see if the condition has changed.

You can monitor conditions in different ways.

- Check the current instrument hardware and firmware status.

Do this by querying the condition registers which continuously monitor status. These registers represent the current state of the instrument. Bits in a condition register are updated in real time. When the condition monitored by a particular bit becomes true, the bit is set to 1. When the condition becomes false, the bit is reset to 0.

- Monitor a particular condition (bit).

You can enable a particular bit(s), using the event enable register. The instrument will then monitor that particular condition(s). If the bit becomes true (0 to 1 transition) in the event register, it will stay set until the event register is cleared. Querying the event register allows you to detect that this condition occurred even if the condition no longer exists. The event register can only be cleared by querying it or sending the *CLS command.

- Monitor a particular type of change in a condition (bit).
 - The transition registers are preset to register if the condition goes from 0 to 1 (false to true, or a positive transition).
 - This can be changed so the selected condition is detected if the bit goes from 1 to 0 (true to false, or a negative transition).
 - It can also be set for both types of transitions occurring.
 - Or it can be set for neither transition. If both transition registers are set to 0 for a particular bit position, that bit will not be set in the event register for either type of change.

Using a Status Register

Each bit in a register is represented by a numerical value based on its location. See figure below. This number is sent with the command to enable a particular bit. If you want to enable more than one bit, you would send the sum of all the bits that you want to monitor.

Figure: Status Register Bit Values

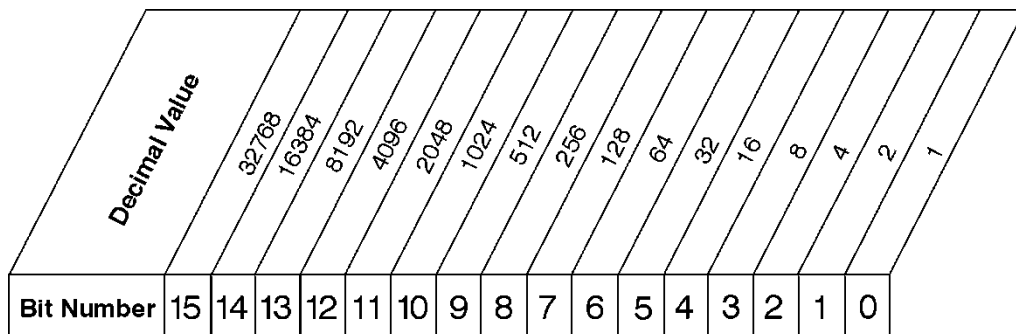

STATus:OPERation:ENABle < num >
 STATus:OPERation:ENABle?

Standard Operation Event Enable Register

ck730a

Bit 15 is not used to report status.

Example 1:

1. To enable bit 0 and bit 6 of standard event status register, you would send the command *ESE 65 because $1 + 64 = 65$.
2. The results of a query are evaluated in a similar way. If the *STB? command returns a decimal value of 140, ($140 = 128 + 8 + 4$) then bit 7 is true, bit 3 is true and bit 2 is true.

Example 2:

1. Suppose you want to know if an Auto-trigger Timeout occurs, but you only cared about that specific condition. So you would want to know what was happening with bit 10 in the Status Questionable Integrity register, and not about any other bits.
2. It's usually a good idea to start by clearing all the status registers with *CLS.
3. Sending the STAT:QUES:INT:ENAB 1024 command lets you monitor only bit 10 events, instead of the default monitoring all the bits in the register. The register default is for positive transition events (0 to 1 transition). That is, when an auto-trigger timeout occurs. If instead, you wanted to know when the Auto-trigger timeout condition is cleared, then you would set the STAT:QUES:INT:PTR 0 and the STAT:QUES:INT:NTR 32767.
4. So now the only output from the Status Questionable Integrity register will come from a bit 10 positive transition. That output goes to the Integrity Sum bit 9 of the Status Questionable register.
5. You can do a similar thing with this register to only look at bit 9 using, STAT:QUES:ENAB 512.
6. The Status Questionable register output goes to the "Status Questionable Summary" bit 3 of the Status Byte Register. The output from this register can be enabled using the *SRE 8 command.
7. Finally, you would use the serial polling functionality available for the particular bus/software that you are using to monitor the Status Byte Register. (You could also use *STB? to poll the Status Byte Register.)

Using the Service Request (SRQ) Method

Your language, bus, and programming environment must be able to support SRQ interrupts. (For example, BASIC used with VXI-11.3 (GPIB over LAN). When you monitor a condition with the SRQ method, you must:

1. Determine which bit monitors the condition.
2. Determine how that bit reports to the request service (RQS) bit of the status byte.
3. Send SCPI commands to enable the bit that monitors the condition and to enable the summary bits that report the condition to the RQS bit.
4. Enable the controller to respond to service requests.

When the condition changes, the instrument sets its RQS bit. The controller is informed of the change as soon as it occurs. As a result, the time the controller would otherwise have used to monitor the condition can be used to perform other tasks. Your program determines how the controller responds to the SRQ.

Generating a Service Request

To use the SRQ method, you must understand how service requests are generated. Bit 6 of the status byte register is the request service (RQS) bit. The *SRE command is used to configure the RQS bit to report changes in instrument status. When such a change occurs, the RQS bit is set. It is cleared when the status byte register is queried using *SRE? (with a serial poll.) It can be queried without erasing the contents with *STB?.

When a register set causes a summary bit in the status byte to change from 0 to 1, the instrument can initiate the service request (SRQ) process. However, the process is only initiated if both of the following conditions are true:

- The corresponding bit of the service request enable register is also set to 1.
- The instrument does not have a service request pending. (A service request is considered to be pending between the time the instrument's SRQ process is initiated and the time the controller reads the status byte register.)

The SRQ process sets the SRQ true. It also sets the status byte's request service (RQS) bit to 1. Both actions are necessary to inform the controller that the instrument requires service. Setting the SRQ line only informs the controller that some device on the bus requires service. Setting the RQS bit allows the controller to determine which instrument requires service.

If your program enables the controller to detect and respond to service requests, it should instruct the controller to perform a serial poll when the SRQ is set true. Each device on the bus returns the contents of its status byte register in response to this poll. The device whose RQS bit is set to 1 is the device that requested service.

When you read the instrument's status byte register with a serial poll, the RQS bit is reset to 0. Other bits in the register are not affected.

If the status register is configured to SRQ on end-of-measurement and the measurement is in continuous mode, then restarting a measurement (INIT command) can cause the measuring bit to pulse low. This causes an SRQ when you have not actually reached the "end-of-measurement" condition. To avoid this:

1. Set INITiate:CONTinuous off.
2. Set/enable the status registers.

3. Restart the measurement (send INIT).

Status Register System

The hardware status registers are combined to form the instrument status system. Specific status bits are assigned to monitor various aspects of the instrument operation and status. See the diagram of the status system above for information about the bit assignments and status register interconnections.

The Status Byte Register

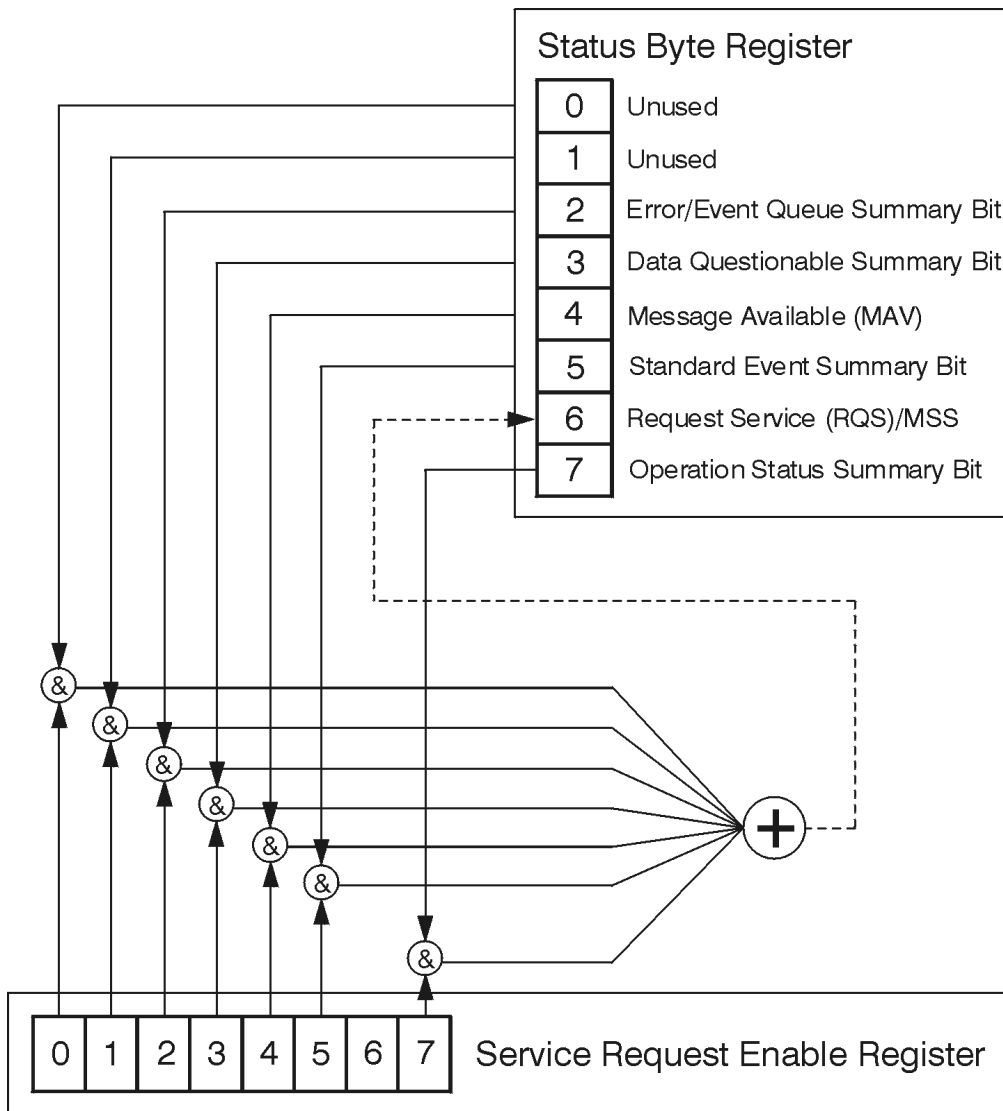

ck776a

The RQS bit is read and reset by a serial poll. The same bit position (MSS) is read, non-destructively by the *STB? command. If you serial poll bit 6 it is read as RQS, but if you send *STB it reads bit 6 as MSS. For more information refer to IEEE 488.2 standards, section 11.

	Description	Standard Operation Status Summary Bit	Request Service (RQS) Summary Bit	Standard Event Status Summary Bit	Message Available (MAV)	Data Questionable Status Summary Bit	Error/Event Queue Summary Bit	Unused	Unused
Bit Number	7	6	5	4	3	2	1	0	0

*STB?

Status Byte Register

ck725a

Bit	Description
0, 1	These bits are always set to 0.
2	A 1 in this bit position indicates that the SCPI error queue is not empty which means that it contains at least one error message.
3	A 1 in this bit position indicates that the data questionable summary bit has been set. The data questionable event register can then be read to determine the specific condition that caused this bit to be set.
4	A 1 in this bit position indicates that the instrument has data ready in the output queue. There are no lower status groups that provide input to this bit.
5	A 1 in this bit position indicates that the standard event summary bit has been set. The standard event status register can then be read to determine the specific event that caused this bit to be set.
6	A 1 in this bit position indicates that the instrument has at least one reason to report a status change. This bit is also called the master summary status bit (MSS).
7	A 1 in this bit position indicates that the standard operation summary bit has been set. The standard operation event register can then be read to determine the specific condition that caused this bit to be set.

To query the status byte register, send the command *STB?. The response will be the decimal sum of the bits which are set to 1. For example, if bit number 7 and bit number 3 are set to 1, the decimal sum of the 2 bits is 128 plus 8. So the decimal value 136 is returned. The *STB command does not clear the status register.

In addition to the status byte register, the status byte group also contains the service request enable register. This register lets you choose which bits in the status byte register will trigger a service request.

Send the *SRE <integer> command where <integer> is the sum of the decimal values of the bits you want to enable plus the decimal value of bit 6. For example, assume that you want to enable bit 7 so that whenever the standard operation status register summary bit is set to 1 it will trigger a service request. Send the command *SRE 192 (because 192 = 128 + 64). You must always add 64 (the numeric value of RQS

bit 6) to your numeric sum when you enable any bits for a service request. The command *SRE? returns the decimal value of the sum of the bits previously enabled with the *SRE <integer> command.

The service request enable register presets to zeros (0).

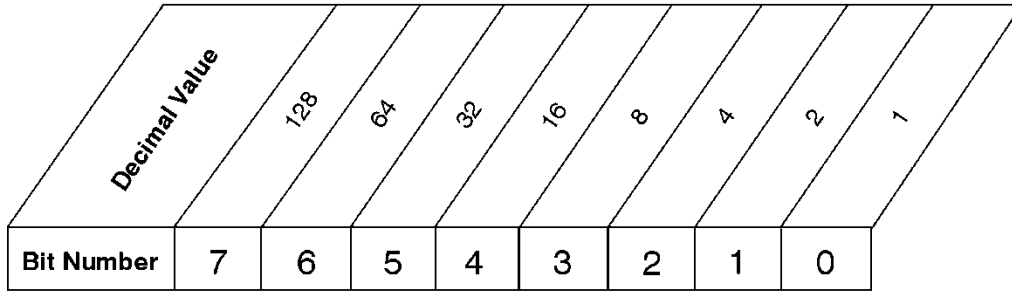

*SRE <num>
 *SRE?

Service Request Enable Register

ck726a

Standard Event Status Register

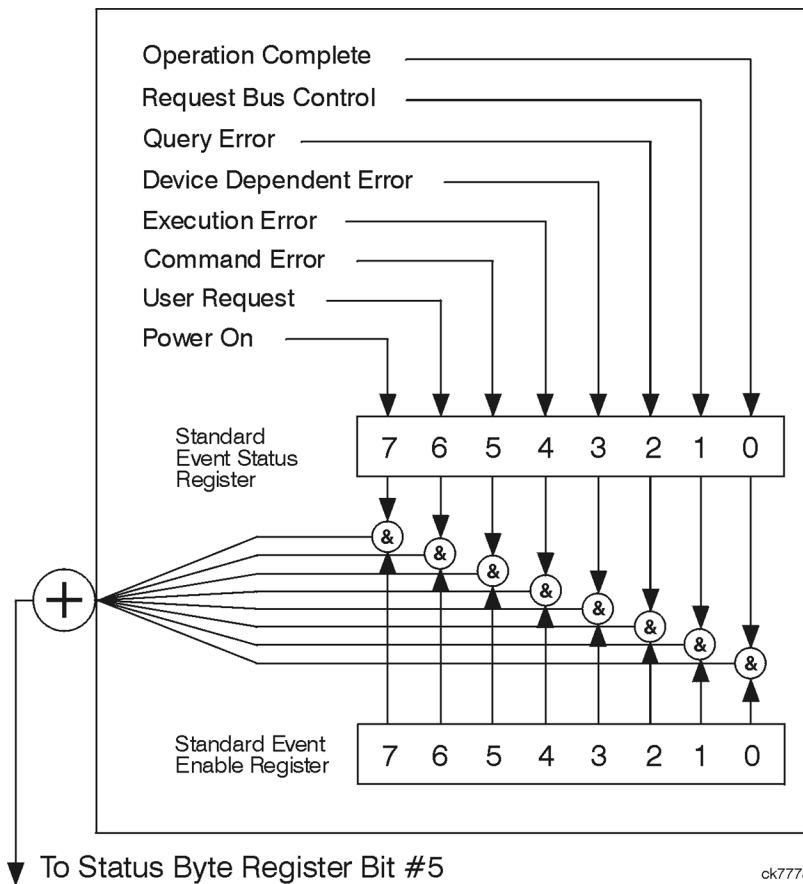

The standard event status register contains the following bits:

Bit Number	7	6	5	4	3	2	1	0	

*ESR?

Standard Event Status Register

ck727a

Bit	Description
0	A 1 in this bit position indicates that all pending operations were completed following execution of the *OPC command.
1	This bit is for GPIB handshaking to request control. Currently it is set to 0 because there are no implementations where the spectrum analyzer controls another instrument.
2	A 1 in this bit position indicates that a query error has occurred. Query errors have SCPI error numbers from -499 to -400.
3	A 1 in this bit position indicates that a device dependent error has occurred. Device dependent errors have SCPI error numbers from -399 to -300 and 1 to 32767.
4	A 1 in this bit position indicates that an execution error has occurred. Execution errors have SCPI error numbers from -299 to -200.
5	A 1 in this bit position indicates that a command error has occurred. Command errors have SCPI error numbers from -199 to -100.
6	A 1 in this bit position indicates that the LOCAL key has been pressed. This is true even if the instrument is in local lockout mode.
7	A 1 in this bit position indicates that the instrument has been turned off and then on.

The standard event status register is used to determine the specific event that set bit 5 in the status byte register. To query the standard event status register, send the command *ESR?. The response will be the decimal sum of the bits which are enabled (set to 1). For example, if bit number 7 and bit number 3 are enabled, the decimal sum of the 2 bits is 128 plus 8. So the decimal value 136 is returned.

In addition to the standard event status register, the standard event status group also contains a standard event status enable register. This register lets you choose which bits in the standard event status register will set the summary bit (bit 5 of the status byte register) to 1. Send the *ESE <integer> command where <integer> is the sum of the decimal values of the bits you want to enable. For example, to enable bit 7 and bit 6 so that whenever either of those bits is set to 1, the standard event status summary bit of the status

byte register will be set to 1, send the command *ESE 192 (128 + 64). The command *ESE? returns the decimal value of the sum of the bits previously enabled with the *ESE <integer> command.

The standard event status enable register presets to zeros (0).

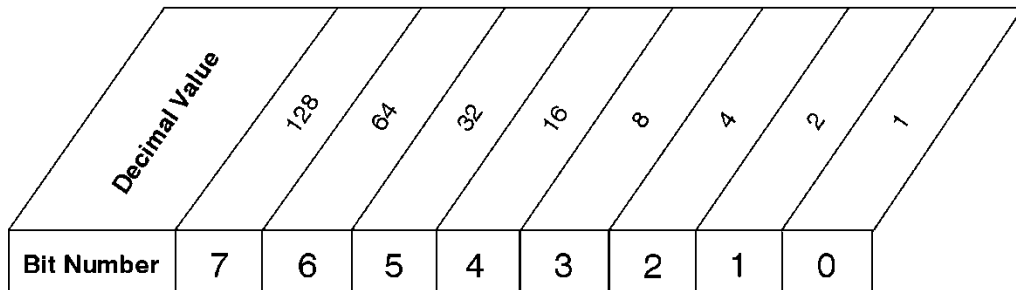

*ESE <num>
 *ESE?

Standard Event Status Enable Register

ck728a

Operation and Questionable Status Registers

The operation and questionable status registers are registers that monitor the overall instrument condition. They are accessed with the STATUS:OPERation and STATUS:QUESTionable commands in the STATUS command subsystem. See the figure at the beginning of this chapter.

Operation Status Register

The operation status register monitors the current instrument measurement state. It checks to see if the instrument is calibrating, sweeping, or waiting for a trigger. For more information see the *OPC? command located in the IEEE Common Commands section.

Bit	Condition	Operation
0	Calibrating	The instrument is busy executing its Align Now process
3	Sweeping	The instrument is busy taking a sweep.
4	Measuring	The instrument is busy making a measurement. Measurements often require multiple sweeps. They are initiated by keys under the MEASURE key or with the MEASure group of commands. The bit is valid for most X-Series Modes.
5	Waiting for trigger	The instrument is waiting for the trigger conditions to be met, then it will trigger a sweep or measurement.

Questionable Status Register

The questionable status register monitors the instrument's condition to see if anything questionable has happened to it. It is looking for anything that might cause an error or a bad measurement like a hardware problem, an out of calibration situation, or a unusual signal. All the bits are summary bits from lower-level event registers.

Bit	Condition	Operation
-----	-----------	-----------

3	Power summary	The instrument hardware has detected a power unlevelled condition.
4	Temperature summary	The instrument is still warming up.
5	Frequency summary	The instrument hardware has detected an unlocked condition or a problem with the external frequency reference.
8	Calibration summary	The instrument has detected a hardware problem while doing the automatic internal alignment process.
9	Integrity summary	The instrument has detected a questionable measurement condition such as: bad timing, bad signal/data, timeout problem, signal overload, or "meas uncal".

STATus Subsystem Command Descriptions

The STATus subsystem controls the SCPI-defined instrument status reporting structures. Each status register has a set of five commands used for querying or masking that particular register.

Numeric values for bit patterns can be entered using decimal or hexadecimal representations. (i.e. 0 to 32767 is equivalent to #H0 to #H7FFF. It is also equal to all ones, 11111111111111) See the SCPI Basics information about using bit patterns for variable parameters.

Operation Register

"Operation Condition Query" on page 150

"Operation Enable" on page 151

"Operation Event Query" on page 151

"Operation Negative Transition" on page 151

"Operation Positive Transition" on page 152

Operation Condition Query

This query returns the decimal value of the sum of the bits in the Status Operation Condition register.

NOTE The data in this register is continuously updated and reflects the current conditions.

Mode	All
Remote Command	:STATus:OPERation:CONDition?
Example	STAT:OPER:COND?
Preset	0
Status Bits/OPC dependencies	Sequential command
Initial S/W Revision	Prior to A.02.00

Operation Enable

This command determines which bits in the Operation Event register, will set the Operation Status Summary bit (bit 7) in the Status Byte Register. The variable <integer> is the sum of the decimal values of the bits you want to enable.

NOTE The preset condition is to have all bits in this enable register set to 0. To have any Operation Events reported to the Status Byte Register, one or more bits need to be set to 1.

Mode	All
Remote Command	:STATus:OPERation:ENABle <integer> :STATus:OPERation:ENABle?
Example	STAT:OPER:ENAB 1 Sets the register so that Align Now operation will be reported to the Status Byte Register.
Preset	0
Min	0
Max	32767
Status Bits/OPC dependencies	Sequential command
Initial S/W Revision	Prior to A.02.00

Operation Event Query

This query returns the decimal value of the sum of the bits in the Operation Event register.

NOTE The register requires that the associated PTR or NTR filters be set before a condition register bit can set a bit in the event register. The data in this register is latched until it is queried. Once queried, the register is cleared.

Mode	All
Remote Command	:STATus:OPERation[:EVENT]?
Example	STAT:OPER?
Preset	0
Status Bits/OPC dependencies	Sequential command
Initial S/W Revision	Prior to A.02.00

Operation Negative Transition

This command determines which bits in the Operation Condition register will set the corresponding bit in the Operation Event register when the condition register bit has a negative transition (1 to 0). The variable <integer> is the sum of the decimal values of the bits that you want to enable.

Mode	All
Remote Command	:STATus:OPERation:NTRansition <integer> :STATus:OPERation:NTRansition?
Example	STAT:OPER:NTR 1 Align Now operation complete will be reported to the Status Byte Register.
Preset	0
Min	0
Max	32767
Status Bits/OPC dependencies	Sequential command
Initial S/W Revision	Prior to A.02.00

Operation Positive Transition

This command determines which bits in the Operation Condition register will set the corresponding bit in the Operation Event register when the condition register bit has a positive transition (0 to 1). The variable <integer> is the sum of the decimal values of the bits that you want to enable.

Mode	All
Remote Command	:STATus:OPERation:PTRansition <integer> :STATus:OPERation:PTRansition?
Example	STAT:OPER:PTR 1 Align Now operation beginning will be reported to the Status Byte Register.
Preset	32767
Min	0
Max	32767
Status Bits/OPC dependencies	Sequential command
Initial S/W Revision	Prior to A.02.00

Preset the Status Byte

Sets bits in most of the enable and transition registers to their default state. It presets all the Transition Filters, Enable Registers, and the Error/Event Queue Enable. It has no effect on Event Registers, Error/Event QUEUE, IEEE 488.2 ESE, and SRE Registers as described in IEEE Standard 488.2–1992, IEEE Standard Codes, Formats, Protocols, and Common Commands for Use with ANSI/IEEE Std 488.1–1987. New York, NY, 1992.

Remote Command	:STATus:PRESet
Example	STAT:PRES
Initial S/W Revision	Prior to A.02.00

Questionable Register

"Questionable Condition " on page 153

"Questionable Enable " on page 153

"Questionable Event Query " on page 154

"Questionable Negative Transition " on page 154

"Questionable Positive Transition" on page 154

Questionable Condition

This query returns the decimal value of the sum of the bits in the Questionable Condition register.

NOTE The data in this register is continuously updated and reflects the current conditions.

Mode	All
Remote Command	:STATus:QUESTionable:CONDition?
Example	STAT:QUES:COND?
Preset	0
Status Bits/OPC dependencies	Sequential command
Initial S/W Revision	Prior to A.02.00

Questionable Enable

This command determines which bits in the Questionable Event register will set the Questionable Status Summary bit (bit3) in the Status Byte Register. The variable <integer> is the sum of the decimal values of the bits you want to enable.

NOTE The preset condition is all bits in this enable register set to 0. To have any Questionable Events reported to the Status Byte Register, one or more bits need to be set to 1. The Status Byte Event Register should be queried after each measurement to check the Questionable Status Summary (bit 3). If it is equal to 1, a condition during the test may have made the test results invalid. If it is equal to 0, this indicates that no hardware problem or measurement problem was detected by the analyzer.

Mode	All
Remote Command	:STATus:QUESTionable:ENABle <integer> :STATus:QUESTionable:ENABle?
Example	STAT:OPER:PTR 1 Align Now operation beginning will be reported to the Status Byte Register.
Preset	0
Min	0
Max	32767
Status Bits/OPC dependencies	Sequential command
Initial S/W Revision	Prior to A.02.00

Questionable Event Query

This query returns the decimal value of the sum of the bits in the Questionable Event register.

NOTE

The register requires that the associated PTR or NTR filters be set before a condition register bit can set a bit in the event register. The data in this register is latched until it is queried. Once queried, the register is cleared.

Mode	All
Remote Command	:STATus:QUEStionable[:EVENT]?
Example	STAT:QUES?
Preset	0
Status Bits/OPC dependencies	Sequential command
Initial S/W Revision	Prior to A.02.00

Questionable Negative Transition

This command determines which bits in the Questionable Condition register will set the corresponding bit in the Questionable Event register when the condition register bit has a negative transition (1 to 0). The variable <integer> is the sum of the decimal values of the bits that you want to enable.

Mode	All
Remote Command	:STATus:QUEStionable:NTRansition <integer> :STATus:QUEStionable:NTRansition?
Example	STAT:QUES:NTR 16 Temperature summary 'questionable cleared' will be reported to the Status Byte Register.
Preset	0
Min	0
Max	32767
Status Bits/OPC dependencies	Sequential command
Initial S/W Revision	Prior to A.02.00

Questionable Positive Transition

This command determines which bits in the Questionable Condition register will set the corresponding bit in the Questionable Event register when the condition register bit has a positive transition (0 to 1). The variable <integer> is the sum of the decimal values of the bits that you want to enable.

Mode	All
Remote Command	:STATus:QUEStionable:PTRansition <integer>

	:STATus:QUEStionable:PTRansition?
Example	STAT:QUES:PTR 16 Temperature summary 'questionable asserted' will be reported to the Status Byte Register.
Preset	32767
Min	0
Max	32767
Status Bits/OPC dependencies	Sequential command
Initial S/W Revision	Prior to A.02.00

Questionable Calibration Register

"Questionable Calibration Condition " on page 155

"Questionable Calibration Enable " on page 155

"Questionable Calibration Event Query " on page 156

"Questionable Calibration Negative Transition " on page 156

"Questionable Calibration Positive Transition " on page 157

Questionable Calibration Condition

This query returns the decimal value of the sum of the bits in the Questionable Calibration Condition register.

NOTE The data in this register is continuously updated and reflects the current conditions.

Mode	All
Remote Command	:STATus:QUEStionable:CALibration:CONDition?
Example	STAT:QUES:CAL:COND?
Preset	0
Status Bits/OPC dependencies	Sequential command
Initial S/W Revision	Prior to A.02.00

Questionable Calibration Enable

This command determines which bits in the Questionable Calibration Condition Register will set bits in the Questionable Calibration Event register, which also sets the Calibration Summary bit (bit 8) in the Questionable Register. The variable <integer> is the sum of the decimal values of the bits you want to enable.

Mode	All
Remote Command	:STATus:QUESTionable:CALibration:ENABLE <integer> :STATus:QUESTionable:CALibration:ENABLE?
Example	STAT:QUES:CAL:ENAB 16384 Can be used to query if an alignment is needed, if you have turned off the automatic alignment process.
Min	0
Max	32767
Status Bits/OPC dependencies	Sequential command
Initial S/W Revision	Prior to A.02.00

Questionable Calibration Event Query

This query returns the decimal value of the sum of the bits in the Questionable Calibration Event register.

NOTE

The register requires that the associated PTR or NTR filters be set before a condition register bit can set a bit in the event register. The data in this register is latched until it is queried. Once queried, the register is cleared.

Mode	All
Remote Command	:STATus:QUESTionable:CALibration[:EVENT]?
Example	STAT:QUES:CAL?
Preset	0
Status Bits/OPC dependencies	Sequential command
Initial S/W Revision	Prior to A.02.00

Questionable Calibration Negative Transition

This command determines which bits in the Questionable Calibration Condition register will set the corresponding bit in the Questionable Calibration Event register when the condition register bit has a negative transition (1 to 0). The variable <integer> is the sum of the decimal values of the bits that you want to enable.

Mode	All
Remote Command	:STATus:QUESTionable:CALibration:NTRansition <integer> :STATus:QUESTionable:CALibration:NTRansition?
Example	STAT:QUES:CAL:NTR 16384 Alignment is not required.
Preset	0
Min	0

Max	32767
Status Bits/OPC dependencies	Sequential command
Initial S/W Revision	Prior to A.02.00

Questionable Calibration Positive Transition

This command determines which bits in the Questionable Calibration Condition register will set the corresponding bit in the Questionable Calibration Event register when the condition register bit has a positive transition (0 to 1). The variable <integer> is the sum of the decimal values of the bits that you want to enable.

Mode	All
Remote Command	:STATus:QUESTionable:CALibration:PTRansition <integer> :STATus:QUESTionable:CALibration:PTRansition?
Example	STAT:QUES:CAL:PTR 16384 Alignment is required.
Preset	32767
Min	0
Max	32767
Status Bits/OPC dependencies	Sequential command
Initial S/W Revision	Prior to A.02.00

Questionable Calibration Skipped Register

"Questionable Calibration Skipped Condition " on page 157

"Questionable Calibration Skipped Enable " on page 158

"Questionable Calibration Skipped Event Query " on page 158

"Questionable Calibration Skipped Negative Transition " on page 159

"Questionable Calibration Skipped Positive Transition " on page 159

Questionable Calibration Skipped Condition

This query returns the decimal value of the sum of the bits in the Questionable Calibration Skipped Condition register.

NOTE The data in this register is continuously updated and reflects the current conditions.

Mode	All
Remote Command	:STATus:QUESTionable:CALibration:SKIPped:CONDition?

Example	STAT:QUES:CAL:SKIP:COND?
Preset	0
Status Bits/OPC dependencies	Sequential command
Initial S/W Revision	Prior to A.02.00

Questionable Calibration Skipped Enable

This command determines which bits in the Questionable Calibration Skipped Condition Register will set bits in the Questionable Calibration Skipped Event register, which also sets bit 11 of the Questionable Calibration Register. The variable <integer> is the sum of the decimal values of the bits you want to enable.

Mode	All
Remote Command	:STATus:QUESTionable:CALibration:SKIpped:ENABle <integer> :STATus:QUESTionable:CALibration:SKIpped:ENABle?
Example	STAT:QUES:CAL:SKIP:ENAB 1 Can be used to query if an EMI alignment skipped condition is detected
Preset	32767
Min	0
Max	32767
Status Bits/OPC dependencies	Sequential command
Initial S/W Revision	Prior to A.02.00

Questionable Calibration Skipped Event Query

This query returns the decimal value of the sum of the bits in the Questionable Calibration Event register.

NOTE The register requires that the associated PTR or NTR filters be set before a condition register bit can set a bit in the event register. The data in this register is latched until it is queried. Once queried, the register is cleared.

Mode	All
Remote Command	:STATus:QUESTionable:CALibration:SKIpped[:EVENT]?
Example	STAT:QUES:CAL:SKIP?
Preset	0
Status Bits/OPC dependencies	Sequential command
Initial S/W Revision	Prior to A.02.00

Questionable Calibration Skipped Negative Transition

This command determines which bits in the Questionable Calibration Skipped Condition register will set the corresponding bit in the Questionable Calibration Skipped Event register when the condition register bit has a negative transition (1 to 0). The variable <integer> is the sum of the decimal values of the bits that you want to enable.

Mode	All
Remote Command	:STATus:QUESTionable:CALibration:SKIPped:NTRansition <integer> :STATus:QUESTionable:CALibration:SKIPped:NTRansition?
Example	STAT:QUES:CAL:SKIP:NTR 1 Align RF skipped is not required.
Preset	0
Min	0
Max	32767
Status Bits/OPC dependencies	Sequential command
Initial S/W Revision	Prior to A.02.00

Questionable Calibration Skipped Positive Transition

This command determines which bits in the Questionable Calibration Skipped Condition register will set the corresponding bit in the Questionable Calibration Skipped Event register when the condition register bit has a positive transition (0 to 1). The variable <integer> is the sum of the decimal values of the bits that you want to enable.

Mode	All
Remote Command	:STATus:QUESTionable:CALibration:SKIPped:PTRansition <integer> :STATus:QUESTionable:CALibration:SKIPped:PTRansition?
Example	STAT:QUES:CAL:SKIP:PTR 1 Align RF skipped is required.
Preset	32767
Min	0
Max	32767
Status Bits/OPC dependencies	Sequential command
Initial S/W Revision	Prior to A.02.00

Questionable Calibration Extended Failure Register

["Questionable Calibration Extended Failure Condition " on page 160](#)

["Questionable Calibration Extended Failure Enable " on page 160](#)

["Questionable Calibration Extended Failure Event Query " on page 160](#)

["Questionable Calibration Extended Failure Negative Transition " on page 161](#)

"Questionable Calibration Extended Failure Positive Transition " on page 161

Questionable Calibration Extended Failure Condition

This query returns the decimal value of the sum of the bits in the Questionable Calibration Extended Failure Condition register.

NOTE	The data in this register is continuously updated and reflects the current conditions.
Mode	All
Remote Command	:STATus:QUEStionable:CALibration:EXTended:FAILure:CONDition?
Example	STAT:QUES:CAL:EXT:FAIL:COND?
Preset	0
Status Bits/OPC dependencies	Sequential command
Initial S/W Revision	Prior to A.02.00

Questionable Calibration Extended Failure Enable

This command determines which bits in the Questionable Calibration Extended Failure Condition Register will set bits in the Questionable Calibration Extended Failure Event register, which also sets bit 9 of the Questionable Calibration Register. The variable <integer> is the sum of the decimal values of the bits you want to enable.

Mode	All
Remote Command	:STATus:QUEStionable:CALibration:EXTended:FAILure:ENABle <integer> :STATus:QUEStionable:CALibration:EXTended:FAILure:ENABle?
Example	STAT:QUES:CAL:EXT:FAIL:ENAB 1 Can be used to query if an EMI conducted alignment is needed.
Preset	32767
Min	0
Max	32767
Status Bits/OPC dependencies	Sequential command
Initial S/W Revision	Prior to A.02.00

Questionable Calibration Extended Failure Event Query

This query returns the decimal value of the sum of the bits in the Questionable Calibration Extended Failure Event register.

NOTE	The register requires that the associated PTR or NTR filters be set before a condition register bit can set a bit in the event register. The data in this register is latched until it is queried. Once queried, the register is cleared.
-------------	---

Mode	All
Remote Command	:STATus:QUESTionable:CALibration:EXTended:FAILure[:EVENT]?
Example	STAT:QUES:CAL:EXT:FAIL?
Preset	0
Status Bits/OPC dependencies	Sequential command
Initial S/W Revision	Prior to A.02.00

Questionable Calibration Extended Failure Negative Transition

This command determines which bits in the Questionable Calibration Extended Failure Condition register will set the corresponding bit in the Questionable Calibration Extended Failure Event register when the condition register bit has a negative transition (1 to 0). The variable <integer> is the sum of the decimal values of the bits that you want to enable.

Mode	All
Remote Command	:STATus:QUESTionable:CALibration:EXTended:FAILure:NTRansition <integer> :STATus:QUESTionable:CALibration:EXTended:FAILure:NTRansition?
Example	STAT:QUES:CAL:EXT:FAIL:NTR 1 EMI conducted align failure is not required.
Preset	0
Min	0
Max	32767
Status Bits/OPC dependencies	Sequential command
Initial S/W Revision	Prior to A.02.00

Questionable Calibration Extended Failure Positive Transition

This command determines which bits in the Questionable Calibration Extended Failure Condition register will set the corresponding bit in the Questionable Calibration Extended Failure Event register when the condition register bit has a positive transition (0 to 1). The variable <integer> is the sum of the decimal values of the bits that you want to enable.

Mode	All
Remote Command	:STATus:QUESTionable:CALibration:EXTended:FAILure:PTRansition <integer> :STATus:QUESTionable:CALibration:EXTended:FAILure:PTRansition?
Example	STAT:QUES:CAL:EXT:FAIL:PTR 1 EMI conducted align failure is required.
Preset	32767
Min	0
Max	32767

Status Bits/OPC dependencies	Sequential command
Initial S/W Revision	Prior to A.02.00

Questionable Calibration Extended Needed Register

"Questionable Calibration Extended Needed Condition " on page 162

"Questionable Calibration Extended Needed Enable " on page 162

"Questionable Calibration Extended Needed Event Query " on page 163

"Questionable Calibration Extended Needed Negative Transition " on page 163

"Questionable Calibration Extended Needed Positive Transition " on page 164

Questionable Calibration Extended Needed Condition

This query returns the decimal value of the sum of the bits in the Questionable Calibration Extended Needed Condition register.

NOTE

The data in this register is continuously updated and reflects the current conditions.

Mode	All
Remote Command	:STATus:QUESTionable:CALibration:EXTended:NEEDED:CONDition?
Example	STAT:QUES:CAL:EXT:NEED:COND?
Preset	0
Status Bits/OPC dependencies	Sequential command
Initial S/W Revision	Prior to A.02.00

Questionable Calibration Extended Needed Enable

This command determines which bits in the Questionable Calibration Extended Needed Condition Register will set bits in the Questionable Calibration Extended Needed Event register, which also sets bit 14 of the Questionable Calibration Register. The variable <integer> is the sum of the decimal values of the bits you want to enable.

Mode	All
Remote Command	:STATus:QUESTionable:CALibration:EXTended:NEEDED:ENABle <integer> :STATus:QUESTionable:CALibration:EXTended:NEEDED:ENABle?
Example	STAT:QUES:CAL:EXT:NEED:ENAB 2 Can be used to query if an EMI conducted alignment is needed.
Preset	32767
Min	0

Max	32767
Status Bits/OPC dependencies	Sequential command
Initial S/W Revision	Prior to A.02.00

Questionable Calibration Extended Needed Event Query

This query returns the decimal value of the sum of the bits in the Questionable Calibration Extended Needed Event register.

NOTE The register requires that the associated PTR or NTR filters be set before a condition register bit can set a bit in the event register. The data in this register is latched until it is queried. Once queried, the register is cleared.

Mode	All
Remote Command	:STATus:QUESTionable:CALibration:EXTended:NEEDED[:EVENT]?
Example	STAT:QUES:CAL:EXT:NEED?
Preset	0
Status Bits/OPC dependencies	Sequential command
Initial S/W Revision	Prior to A.02.00

Questionable Calibration Extended Needed Negative Transition

This command determines which bits in the Questionable Calibration Extended Needed Condition register will set the corresponding bit in the Questionable Calibration Extended Needed Event register when the condition register bit has a negative transition (1 to 0). The variable <integer> is the sum of the decimal values of the bits that you want to enable.

Mode	All
Remote Command	:STATus:QUESTionable:CALibration:EXTended:NEEDED:NTRansition <integer> :STATus:QUESTionable:CALibration:EXTended:NEEDED:NTRansition?
Example	STAT:QUES:CAL:EXT:NEED:NTR 2 Align EMI conducted is not required.
Preset	0
Min	0
Max	32767
Status Bits/OPC dependencies	Sequential command
Initial S/W Revision	Prior to A.02.00

Questionable Calibration Extended Needed Positive Transition

This command determines which bits in the Questionable Calibration Extended Needed Condition register will set the corresponding bit in the Questionable Calibration Extended Needed Event register when the condition register bit has a positive transition (0 to 1). The variable <integer> is the sum of the decimal values of the bits that you want to enable.

Mode	All
Remote Command	:STATus:QUESTionable:CALibration:EXTended:NEEDed:PTRansition <integer> :STATus:QUESTionable:CALibration:EXTended:NEEDed:PTRansition?
Example	STAT:QUES:CAL:EXT:NEED:PTR 2 Align EMI conducted is required.
Preset	32767
Min	0
Max	32767
Status Bits/OPC dependencies	Sequential command
Initial S/W Revision	Prior to A.02.00

Questionable Frequency Register

"Questionable Frequency Condition " on page 164

"Questionable Frequency Enable " on page 165

"Questionable Frequency Event Query " on page 165

"Questionable Frequency Negative Transition " on page 165

"Questionable Frequency Positive Transition " on page 166

Questionable Frequency Condition

This query returns the decimal value of the sum of the bits in the Questionable Frequency Condition register.

NOTE

The data in this register is continuously updated and reflects the current conditions.

Mode	All
Remote Command	:STATus:QUESTionable:FREQuency:CONDition?
Example	STAT:QUES:FREQ:COND?
Preset	0
Status Bits/OPC dependencies	Sequential command
Initial S/W Revision	Prior to A.02.00

Questionable Frequency Enable

This command determines which bits in the Questionable Frequency Condition Register will set bits in the Questionable Frequency Event register, which also sets the Frequency Summary bit (bit 5) in the Questionable Register. The variable <integer> is the sum of the decimal values of the bits you want to enable.

Mode	All
Remote Command	:STATus:QUESTionable:FREQuency:ENABle <integer> :STATus:QUESTionable:FREQuency:ENABle?
Example	STAT:QUES:FREQ:ENAB 2 Frequency Reference Unlocked will be reported to the Frequency Summary of the Status Questionable register.
Preset	32767
Min	0
Max	32767
Status Bits/OPC dependencies	Sequential command
Initial S/W Revision	Prior to A.02.00

Questionable Frequency Event Query

This query returns the decimal value of the sum of the bits in the Questionable Frequency Event register.

NOTE

The register requires that the associated PTR or NTR filters be set before a condition register bit can set a bit in the event register. The data in this register is latched until it is queried. Once queried, the register is cleared.

Mode	All
Remote Command	:STATus:QUESTionable:FREQuency[:EVENT]?
Example	STAT:QUES:FREQ?
Preset	0
Status Bits/OPC dependencies	Sequential command
Initial S/W Revision	Prior to A.02.00

Questionable Frequency Negative Transition

This command determines which bits in the Questionable Frequency Condition register will set the corresponding bit in the Questionable Frequency Event register when the condition register bit has a negative transition (1 to 0). The variable <integer> is the sum of the decimal values of the bits that you want to enable.

Mode	All
------	-----

Remote Command	:STATus:QUESTionable:FREQuency:NTRansition <integer> :STATus:QUESTionable:FREQuency:NTRansition?
Example	STAT:QUES:FREQ:NTR 2 Frequency Reference 'regained lock' will be reported to the Frequency Summary of the Status Questionable register.
Preset	0
Min	0
Max	32767
Status Bits/OPC dependencies	Sequential command
Initial S/W Revision	Prior to A.02.00

Questionable Frequency Positive Transition

This command determines which bits in the Questionable Frequency Condition register will set the corresponding bit in the Questionable Frequency Event register when the condition register bit has a positive transition (0 to 1). The variable <integer> is the sum of the decimal values of the bits that you want to enable.

Mode	All
Remote Command	:STATus:QUESTionable:FREQuency:PTRansition <integer> :STATus:QUESTionable:FREQuency:PTRansition?
Example	STAT:QUES:FREQ:PTR 2 Frequency Reference 'became unlocked' will be reported to the Frequency Summary of the Status Questionable register.
Preset	32767
Min	0
Max	32767
Status Bits/OPC dependencies	Sequential command
Initial S/W Revision	Prior to A.02.00

Questionable Integrity Register

["Questionable Integrity Condition " on page 166](#)

["Questionable Integrity Enable " on page 167](#)

["Questionable Integrity Event Query " on page 167](#)

["Questionable Integrity Negative Transition " on page 168](#)

["Questionable Integrity Positive Transition " on page 168](#)

Questionable Integrity Condition

This query returns the decimal value of the sum of the bits in the Questionable Integrity Condition register.

NOTE

The data in this register is continuously updated and reflects the current conditions.

Mode	All
Remote Command	:STATus:QUESTionable:INTEgrity:CONDition?
Example	STAT:QUES:INT:COND?
Preset	0
Status Bits/OPC dependencies	Sequential command
Initial S/W Revision	Prior to A.02.00

Questionable Integrity Enable

This command determines which bits in the Questionable Integrity Condition Register will set bits in the Questionable Integrity Event register, which also sets the Integrity Summary bit (bit 9) in the Questionable Register. The variable <integer> is the sum of the decimal values of the bits you want to enable.

Mode	All
Remote Command	:STATus:QUESTionable:INTEgrity:ENABle <integer> :STATus:QUESTionable:INTEgrity:ENABle?
Example	STAT:QUES:INT:ENAB 8 Measurement Uncalibrated Summary will be reported to the Integrity Summary of the Status Questionable register.
Preset	32767
Min	0
Max	32767
Status Bits/OPC dependencies	Sequential command
Initial S/W Revision	Prior to A.02.00

Questionable Integrity Event Query

This query returns the decimal value of the sum of the bits in the Questionable Integrity Event register.

NOTE

The register requires that the associated PTR or NTR filters be set before a condition register bit can set a bit in the event register. The data in this register is latched until it is queried. Once queried, the register is cleared.

Mode	All
Remote Command	:STATus:QUESTionable:INTEgrity[:EVENT]?
Example	STAT:QUES:INT?
Preset	0
Status Bits/OPC dependencies	Sequential command

Initial S/W Revision	Prior to A.02.00
----------------------	------------------

Questionable Integrity Negative Transition

This command determines which bits in the Questionable Integrity Condition register will set the corresponding bit in the Questionable Integrity Event register when the condition register bit has a negative transition (1 to 0)

The variable <integer> is the sum of the decimal values of the bits that you want to enable.

Mode	All
Remote Command	:STATus:QUEStionable:INTEgrity:NTRansition <integer> :STATus:QUEStionable:INTEgrity:NTRansition?
Example	STAT:QUES:INT:NTR 8 Measurement 'regained calibration' Summary will be reported to the Integrity Summary of the Status Questionable register.
Preset	0
Min	0
Max	32767
Status Bits/OPC dependencies	Sequential command
Initial S/W Revision	Prior to A.02.00

Questionable Integrity Positive Transition

This command determines which bits in the Questionable Integrity Condition register will set the corresponding bit in the Questionable Integrity Event register when the condition register bit has a positive transition (0 to 1). The variable <integer> is the sum of the decimal values of the bits that you want to enable.

Mode	All
Remote Command	:STATus:QUEStionable:INTEgrity:PTRansition <integer> :STATus:QUEStionable:INTEgrity:PTRansition?
Example	STAT:QUES:INT:PTR 8 Measurement 'became uncalibrated' Summary will be reported to the Integrity Summary of the Status Questionable register.
Preset	32767
Min	0
Max	32767
Status Bits/OPC dependencies	Sequential command
Initial S/W Revision	Prior to A.02.00

Questionable Integrity Signal Register

"Questionable Integrity Signal Condition" on page 169

"Questionable Integrity Signal Enable" on page 169

"Questionable Integrity Signal Event Query" on page 170

"Questionable Integrity Signal Negative Transition" on page 170

"Questionable Integrity Signal Positive Transition" on page 170

Questionable Integrity Signal Condition

This query returns the decimal value of the sum of the bits in the Questionable Integrity Signal Condition register.

NOTE

The data in this register is continuously updated and reflects the current conditions.

Mode	All
Remote Command	:STATus:QUEStionable:INTEgrity:SIGNal:CONDition?
Example	STAT:QUES:INT:SIGN:COND?
Preset	0
Status Bits/OPC dependencies	Sequential command
Initial S/W Revision	Prior to A.02.00

Questionable Integrity Signal Enable

This command determines which bits in the Questionable Integrity Signal Condition Register will set bits in the Questionable Integrity Signal Event register, which also sets the Integrity Summary bit (bit 9) in the Questionable Register. The variable <integer> is the sum of the decimal values of the bits you want to enable.

Mode	All
Remote Command	:STATus:QUEStionable:INTEgrity:SIGNal:ENABle <integer> :STATus:QUEStionable:INTEgrity:SIGNal:ENABle?
Example	STAT:QUES:INT:SIGN:ENAB 4 Burst Not Found will be reported to the Integrity Summary of the Status Questionable register.
Preset	32767
Min	0
Max	32767
Status Bits/OPC dependencies	Sequential command
Initial S/W Revision	Prior to A.02.00

Questionable Integrity Signal Event Query

This query returns the decimal value of the sum of the bits in the Questionable Integrity Signal Event register.

NOTE

The register requires that the associated PTR or NTR filters be set before a condition register bit can set a bit in the event register. The data in this register is latched until it is queried. Once queried, the register is cleared.

Mode	All
Remote Command	:STATus:QUEStionable:INTEgrity:SIGNal[:EVENT]?
Example	STAT:QUES:INT:SIGN?
Preset	0
Status Bits/OPC dependencies	Sequential command
Initial S/W Revision	Prior to A.02.00

Questionable Integrity Signal Negative Transition

This command determines which bits in the Questionable Integrity Signal Condition register will set the corresponding bit in the Questionable Integrity Signal Event register when the condition register bit has a negative transition (1 to 0). The variable <integer> is the sum of the decimal values of the bits that you want to enable.

Mode	All
Remote Command	:STATus:QUEStionable:INTEgrity:SIGNal:NTRansition <integer> :STATus:QUEStionable:INTEgrity:SIGNal:NTRansition?
Example	STAT:QUES:INT:SIGN:NTR 4 Burst found will be reported to the Integrity Summary of the Status Questionable register.
Preset	0
Min	0
Max	32767
Status Bits/OPC dependencies	Sequential command
Initial S/W Revision	Prior to A.02.00

Questionable Integrity Signal Positive Transition

This command determines which bits in the Questionable Integrity Signal Condition register will set the corresponding bit in the Questionable Integrity Signal Event register when the condition register bit has a positive transition (0 to 1). The variable <integer> is the sum of the decimal values of the bits that you want to enable.

Mode	All
Remote Command	:STATus:QUEStionable:INTEgrity:SIGNal:PTRansition <integer> :STATus:QUEStionable:INTEgrity:SIGNal:PTRansition?
Example	STAT:QUES:INT:SIGN:PTR 4 Burst not found will be reported to the Integrity Summary of the Status Questionable register.
Preset	32767
Min	0
Max	32767
Status Bits/OPC dependencies	Sequential command
Initial S/W Revision	Prior to A.02.00

Questionable Integrity Uncalibrated Register

"Questionable Integrity Uncalibrated Condition " on page 171

"Questionable Integrity Uncalibrated Enable " on page 171

"Questionable Integrity Uncalibrated Event Query " on page 172

"Questionable Integrity Uncalibrated Negative Transition " on page 172

"Questionable Integrity Uncalibrated Positive Transition " on page 173

Questionable Integrity Uncalibrated Condition

This query returns the decimal value of the sum of the bits in the Questionable Integrity Uncalibrated Condition register.

NOTE

The data in this register is continuously updated and reflects the current conditions.

Mode	All
Remote Command	:STATus:QUEStionable:INTEgrity:UNCalibrated:CONDition?
Example	STAT:QUES:INT:UNC:COND?
Preset	0
Status Bits/OPC dependencies	Sequential command
Initial S/W Revision	Prior to A.02.00

Questionable Integrity Uncalibrated Enable

This command determines which bits in the Questionable Integrity Uncalibrated Condition Register will set bits in the Questionable Integrity Uncalibrated Event register, which also sets the Data Uncalibrated Summary bit (bit 3) in the Questionable Integrity Register. The variable <integer> is the sum of the decimal values of the bits you want to enable.

Mode	All
Remote Command	:STATus:QUESTionable:INTegrity:UNCalibrated:ENABle :STATus:QUESTionable:INTegrity:UNCalibrated:ENABle?
Example	STAT:QUES:INT:UNC:ENAB 1 Oversweep (Meas Uncal) will be reported to the Integrity Summary of the Status Questionable register.
Preset	32767
Min	0
Max	32767
Status Bits/OPC dependencies	Sequential command
Initial S/W Revision	Prior to A.02.00

Questionable Integrity Uncalibrated Event Query

This query returns the decimal value of the sum of the bits in the Questionable Integrity Uncalibrated Event register.

NOTE

The register requires that the associated PTR or NTR filters be set before a condition register bit can set a bit in the event register. The data in this register is latched until it is queried. Once queried, the register is cleared.

Mode	All
Remote Command	:STATus:QUESTionable:INTegrity:UNCalibrated[:EVENT]?
Example	STAT:QUES:INT:UNC?
Preset	0
Status Bits/OPC dependencies	Sequential command
Initial S/W Revision	Prior to A.02.00

Questionable Integrity Uncalibrated Negative Transition

This command determines which bits in the Questionable Integrity Uncalibrated Condition register will set the corresponding bit in the Questionable Integrity Uncalibrated Event register when the condition register bit has a negative transition (1 to 0). The variable <integer> is the sum of the decimal values of the bits that you want to enable.

Mode	All
Remote Command	:STATus:QUESTionable:INTegrity:UNCalibrated:NTRansition <integer> :STATus:QUESTionable:INTegrity:UNCalibrated:NTRansition?
Example	STAT:QUES:INT:UNC:NTR 1 Oversweep cleared will be reported to the Integrity Summary of the Status Questionable register.

Preset	0
Min	0
Max	32767
Status Bits/OPC dependencies	Sequential command
Initial S/W Revision	Prior to A.02.00

Questionable Integrity Uncalibrated Positive Transition

This command determines which bits in the Questionable Integrity Uncalibrated Condition register will set the corresponding bit in the Questionable Integrity Uncalibrated Event register when the condition register bit has a positive transition (0 to 1). The variable <integer> is the sum of the decimal values of the bits that you want to enable.

Mode	All
Remote Command	:STATus:QUEStionable:INTEgrity:UNCalibrated:PTRansition <integer> :STATus:QUEStionable:INTEgrity:UNCalibrated:PTRansition?
Example	STAT:QUES:INT:UNC:PTR 1 Oversweep (Meas Uncal) occurred will be reported to the Integrity Summary of the Status Questionable register.
Preset	32767
Min	0
Max	32767
Status Bits/OPC dependencies	Sequential command
Initial S/W Revision	Prior to A.02.00

Questionable Power Register

["Questionable Power Condition " on page 173](#)

["Questionable Power Enable " on page 174](#)

["Questionable Power Event Query " on page 174](#)

["Questionable Power Negative Transition " on page 175](#)

["Questionable Power Positive Transition " on page 175](#)

Questionable Power Condition

This query returns the decimal value of the sum of the bits in the Questionable Power Condition register.

NOTE The data in this register is continuously updated and reflects the current conditions.

Mode	All
Remote Command	:STATus:QUESTionable:POWer:CONDition?
Example	STAT:QUES:POW:COND?
Preset	0
Status Bits/OPC dependencies	Sequential command
Initial S/W Revision	Prior to A.02.00

Questionable Power Enable

This command determines which bits in the Questionable Power Condition Register will set bits in the Questionable Power Event register, which also sets the Power Summary bit (bit 3) in the Questionable Register. The variable <integer> is the sum of the decimal values of the bits you want to enable.

Mode	All
Remote Command	:STATus:QUESTionable:POWer:ENABle <integer> :STATus:QUESTionable:POWer:ENABle?
Example	STAT:QUES:POW:ENAB 32 50 MHz Input Pwr too High for Cal will be reported to the Power Summary of the Status Questionable register.
Preset	32767
Min	0
Max	32767
Status Bits/OPC dependencies	Sequential command
Initial S/W Revision	Prior to A.02.00

Questionable Power Event Query

This query returns the decimal value of the sum of the bits in the Questionable Power Event register.

NOTE

The register requires that the associated PTR or NTR filters be set before a condition register bit can set a bit in the event register. The data in this register is latched until it is queried. Once queried, the register is cleared.

Mode	All
Remote Command	:STATus:QUESTionable:POWer[:EVENT]?
Example	STAT:QUES:POW?
Preset	0
Status Bits/OPC dependencies	Sequential command
Initial S/W Revision	Prior to A.02.00

Questionable Power Negative Transition

This command determines which bits in the Questionable Power Condition register will set the corresponding bit in the Questionable Power Event register when the condition register bit has a negative transition (1 to 0). The variable <integer> is the sum of the decimal values of the bits that you want to enable.

Mode	All
Remote Command	:STATus:QUEStionable:POWer:NTRansition <integer> :STATus:QUEStionable:POWer:NTRansition?
Example	STAT:QUES:POW:NTR 32 50 MHz Input Power became OK for Cal will be reported to the Power Summary of the Status Questionable register.
Preset	0
Min	0
Max	32767
Status Bits/OPC dependencies	Sequential command
Initial S/W Revision	Prior to A.02.00

Questionable Power Positive Transition

This command determines which bits in the Questionable Power Condition register will set the corresponding bit in the Questionable Power Event register when the condition register bit has a positive transition (0 to 1). The variable <integer> is the sum of the decimal values of the bits that you want to enable.

Mode	All
Remote Command	:STATus:QUEStionable:POWer:PTRansition <integer> :STATus:QUEStionable:POWer:PTRansition?>
Example	STAT:QUES:POW:PTR 32 50 MHz Input Power became too high for Cal will be reported to the Power Summary of the Status Questionable register.
Preset	32767
Min	0
Max	32767
Status Bits/OPC dependencies	Sequential command
Initial S/W Revision	Prior to A.02.00

Questionable Temperature Register

"Questionable Temperature Condition" on page 176

"Questionable Temperature Enable" on page 176

"Questionable Temperature Event Query" on page 176

"Questionable Temperature Negative Transition" on page 177

"Questionable Temperature Positive Transition" on page 177

Questionable Temperature Condition

This query returns the decimal value of the sum of the bits in the Questionable Temperature Condition register.

NOTE The data in this register is continuously updated and reflects the current conditions.

Mode	All
Remote Command	:STATus:QUESTionable:TEMPerature:CONDition?
Example	STAT:QUES:TEMP:COND?
Preset	0
Status Bits/OPC dependencies	Sequential command
Initial S/W Revision	Prior to A.02.00

Questionable Temperature Enable

This command determines which bits in the Questionable Temperature Condition Register will set bits in the Questionable Temperature Event register, which also sets the Temperature Summary bit (bit 4) in the Questionable Register. The variable <integer> is the sum of the decimal values of the bits you want to enable.

Mode	All
Remote Command	:STATus:QUESTionable:TEMPerature:ENABle <integer> :STATus:QUESTionable:TEMPerature:ENABle?
Example	STAT:QUES:TEMP:ENAB 1 Reference Oscillator Oven Cold will be reported to the Temperature Summary of the Status Questionable register.
Preset	32767
Min	0
Max	32767
Status Bits/OPC dependencies	Sequential command
Initial S/W Revision	Prior to A.02.00

Questionable Temperature Event Query

This query returns the decimal value of the sum of the bits in the Questionable Temperature Event register.

NOTE

The register requires that the associated PTR or NTR filters be set before a condition register bit can set a bit in the event register. The data in this register is latched until it is queried. Once queried, the register is cleared

Mode	All
Remote Command	:STATus:QUEStionable:TEMPerature[:EVENT]?
Example	STAT:QUES:TEMP?
Preset	0
Status Bits/OPC dependencies	Sequential command
Initial S/W Revision	Prior to A.02.00

Questionable Temperature Negative Transition

This command determines which bits in the Questionable Temperature Condition register will set the corresponding bit in the Questionable Temperature Event register when the condition register bit has a negative transition (1 to 0). The variable <integer> is the sum of the decimal values of the bits that you want to enable.

Mode	All
Remote Command	:STATus:QUEStionable:TEMPerature:NTRansition <integer> :STATus:QUEStionable:TEMPerature:NTRansition?
Example	STAT:QUES:TEMP:NTR 1 Reference Oscillator Oven not cold will be reported to the Temperature Summary of the Status Questionable register.
Preset	0
Min	0
Max	32767
Status Bits/OPC dependencies	Sequential command
Initial S/W Revision	Prior to A.02.00

Questionable Temperature Positive Transition

This command determines which bits in the Questionable Temperature Condition register will set the corresponding bit in the Questionable Temperature Event register when the condition register bit has a positive transition (0 to 1). The variable <integer> is the sum of the decimal values of the bits that you want to enable.

Mode	All
Remote Command	:STATus:QUEStionable:TEMPerature:PTRansition <integer> :STATus:QUEStionable:TEMPerature:PTRansition?
Example	STAT:QUES:TEMP:PTR 1 Reference Oscillator Oven became cold will be reported to the

	Temperature Summary of the Status Questionable register.
Preset	32767
Min	0
Max	32767
Status Bits/OPC dependencies	Sequential command
Initial S/W Revision	Prior to A.02.00

IEEE 488.2 Common Commands

The instrument supports the following subset of IEEE 488.2 Common Commands, as defined in Chapter 10 of [IEEE Standard 488.2–1992](#). As indicated in the detailed descriptions, some of these commands correspond directly to instrument front-panel key functionality, while others are available only as remote commands.

Command	Description
*CAL?	Align Now "All " on page 393
*CLS	"Clear Status " on page 181
*ESE	"Standard Event Status Enable " on page 182
*ESE?	
*ESR?	"Standard Event Status Register Query " on page 182
*IDN?	"Identification Query " on page 183
*OPC	"Operation Complete " on page 183
*OPC?	
*OPT?	"Query Instrument Options " on page 184
*RCL	"Recall Instrument State " on page 185
*RST	"*RST (Remote Command Only)" on page 185
*SAV	"Save Instrument State " on page 186
*SRE	"Service Request Enable " on page 186
*SRE?	
*STB?	"Status Byte Query " on page 186
*TRG	"Trigger " on page 187
*TST?	"Self Test Query " on page 187
*WAI	"Wait-to-Continue " on page 187

All

(In MXE the key label is "**All (plus RF Presel 20 Hz – 3.6 GHz)**") Immediately executes an alignment of all subsystems. In MXE, the Align Now All is followed by additionally aligning the RF Preselector section, so in MXE, the key label contains the parenthetical note "(plus RF Presel 20 Hz – 3.6 GHz)". The instrument stops any measurement currently underway, performs the alignment, then restarts the measurement from the beginning (similar to pressing the **Restart** key).

If an interfering user signal is present at the RF Input, the alignment is performed on all subsystems except the RF. After completion, the Error Condition message "Align skipped: 50 MHz interference" or "Align skipped: 4.8 GHz interference" is generated. In addition the Error Condition message "Align Now, RF required" is generated, and bits 11 and 12 are set in the Status Questionable Calibration register.

The query form of the remote commands (:CALibration[:ALL]? or *CAL?) invokes the alignment of all subsystems and returns a success or failure value. An interfering user signal is not grounds for failure; if the

alignment was able to succeed on all portions but unable to align the RF because of an interfering signal, the resultant will be the success value.

Successful completion of **Align Now, All** will clear the “Align Now, All required” Error Condition, and clear bit 14 in the Status Questionable Calibration register. It will also begin the elapsed time counter for Last Align Now, All Time, and capture the Last Align Now, All Temperature.

In the MXE, successful completion will also clear the “Align 20 Hz to 30 MHz required” Error Condition, the “Align 30 MHz to 3.6 GHz required” Error Condition, and the “Align 20 Hz to 3.6 GHz required” Error Condition, and clear bits 1 and bit 2 and clear the bit 1 in the Status Questionable Calibration Extended Needed register.

If the Align RF subsystem succeeded in aligning (no interfering signal present), the elapsed time counter begins for Last Align Now, RF Time, and the temperature is captured for the Last Align Now, RF Temperature. In addition the Error Conditions “Align skipped: 50 MHz interference” and “Align skipped: 4.8 GHz interference” are cleared, the Error Condition “Align Now, RF required” is cleared, and bits 11 and 12 are cleared in the Status Questionable Calibration register

Align Now, All can be interrupted by pressing the Cancel (ESC) front-panel key or remotely with Device Clear followed by the :ABORt SCPI command. When this occurs the Error Condition message “Align Now, All required” is generated, and bit 14 is set in the Status Questionable Condition register. This is because new alignment data may be employed for an individual subsystem, but not a cohesive set of data for all subsystems.

In many cases, you might find it more convenient to change alignments to Normal, instead of executing Align Now, All. When the Auto Align process transitions to Normal, the analyzer will immediately start to update only the alignments that have expired, thus efficiently restoring the alignment process.

Key Path	System, Alignments, Align Now
Mode	All
Remote Command	:CALibration[:ALL] :CALibration[:ALL]?
Example	:CAL
Notes	:CALibration[:ALL]? returns 0 if successful :CALibration[:ALL]? returns 1 if failed :CALibration[:ALL]? is the same as *CAL? While Align Now, All is performing the alignment, bit 0 in the Status Operation register is set. Completion, or termination, will clear bit 0 in the Status Operation register. This command is sequential; it must complete before further SCPI commands are processed. Interrupting the alignment from remote is accomplished by invoking Device Clear followed by the :ABORt command. Successful completion will clear bit 14 in the Status Questionable Calibration register. An interfering user signal is not grounds for failure of Align Now, All. However, bits 11 and 12 are set in the Status Questionable Calibration register to indicate Align Now, RF is required. An interfering user supplied signal will result in the instrument requiring an Align Now, RF with the interfering signal removed.
Couplings	Initializes the time for the Last Align Now, All Time. Records the temperature for the Last Align Now, All Temperature.

	If Align RF component succeeded, initializes the time for the Last Align Now, RF Time. If Align RF component succeeded, records the temperature for the Last Align Now, RF Temperature.
Status Bits/OPC dependencies	Bits 11, 12, or 14 may be set in the Status Questionable Calibration register.
Initial S/W Revision	Prior to A.02.00

Mode	All
Remote Command	*CAL?
Example	*CAL?
Notes	*CAL? returns 0 if successful *CAL? returns 1 if failed :CALibration[:ALL]? is the same as *CAL? See additional remarks described with :CALibration[:ALL]? Everything about :CALibration[:ALL]? is synonymous with *CAL? including all conditions, status register bits, and couplings
Initial S/W Revision	Prior to A.02.00

Mode	All
Remote Command	:CALibration[:ALL]:NPENDING
Example	CAL:NPEN
Notes	:CALibration[:ALL]:NPENDING is the same as :CALibration[:ALL] including all conditions, status register bits, except this scpi command does not BLOCK the scpi session, so the user should use status register bits to query if the calibration is successfully completed or not. Typical usage is: 1) :CALibration:ALL:NPENDING (Start a calibration) 2) :STATus:OPERation:CONDition? (Check if the calibration is completed or not, If bit 0 is set, then the system is doing calibration, the user should repeat this scpi query until the bit is cleared) 3):STATus:QUEStionable:CALibration:CONDition? (Check if there are any errors/failures in previous calibration procedure
Initial S/W Revision	X.14.20

Clear Status

Clears the status byte register. It does this by emptying the error queue and clearing all bits in all of the event registers. The status byte register summarizes the states of the other registers. It is also responsible for generating service requests.

Key Path	No equivalent key. Related key System, Show Errors, Clear Error Queue
----------	--

Remote Command	*CLS
Example	*CLS Clears the error queue and the Status Byte Register.
Notes	For related commands, see the SYSTem:ERRor[:NEXT]? command. See also the STATus:PRESet command and all commands in the STATus subsystem.
Status Bits/OPC dependencies	Resets all bits in all event registers to 0, which resets all the status byte register bits to 0 also.
Backwards Compatibility Notes	In general the status bits used in the X-Series status system will be backwards compatible with ESA and PSA. However, note that all conditions will generate events that go into the event log, and some will also generate status bits.
Initial S/W Revision	Prior to A.02.00

Standard Event Status Enable

Selects the desired bits from the standard event status enable register. This register monitors I/O errors and synchronization conditions such as operation complete, request control, query error, device dependent error, status execution error, command error, and power on. The selected bits are OR'd to become a summary bit (bit 5) in the byte register which can be queried.

The query returns the state of the standard event status enable register.

Key Path	No equivalent key. Related key System, Show Errors, Clear Error Queue
Remote Command	*ESE <integer> *ESE?
Example	*ESE 36 Enables the Standard Event Status Register to monitor query and command errors (bits 2 and 5). *ESE? Returns a 36 indicating that the query and command status bits are enabled.
Notes	For related commands, see the STATus subsystem and SYSTem:ERRor[:NEXT]? commands.
Preset	255
State Saved	Not saved in state.
Min	0
Max	255
Status Bits/OPC dependencies	Event Enable Register of the Standard Event Status Register.
Initial S/W Revision	Prior to A.02.00

Standard Event Status Register Query

Queries and clears the standard event status event register. (This is a destructive read.) The value returned is a hexadecimal number that reflects the current state (0/1) of all the bits in the register.

Remote Command	*ESR?
-----------------------	-------

Example	*ESR? Returns a 1 if there is either a query or command error, otherwise it returns a zero.
Notes	For related commands, see the <code>STATUS</code> subsystem commands.
Preset	0
Min	0
Max	255
Status Bits/OPC dependencies	Standard Event Status Register (bits 0 - 7).
Initial S/W Revision	Prior to A.02.00

Identification Query

Returns a string of instrument identification information. The string will contain the model number, serial number, and firmware revision.

The response is organized into four fields separated by commas. The field definitions are as follows:

- Manufacturer
- Model
- Serial number
- Firmware version

Key Path	No equivalent key. See related key System, Show System.
Remote Command	*IDN?
Example	*IDN? Returns instrument identification information, such as: Agilent Technologies, N9020A, US01020004, A.01.02 Keysight Technologies, N9020A, US01020004, A.01.02
Initial S/W Revision	Prior to A.02.00
Modified at S/W Revision	x.14.50

Operation Complete

The *OPC command sets bit 0 in the standard event status register (SER) to “1” when pending operations have finished, that is when all overlapped commands are complete. It does not hold off subsequent operations. You can determine when the overlapped commands have completed either by polling the OPC bit in SER, or by setting up the status system such that a service request (SRQ) is asserted when the OPC bit is set.

The *OPC? query returns a “1” after all the current overlapped commands are complete. So it holds off subsequent commands until the “1” is returned, then the program continues. This query can be used to synchronize events of other instruments on the external bus.

Remote Command	*OPC *OPC?
Example	INIT:CONT 0 Selects single sweeping. INIT:IMM Initiates a sweep. *OPC? Holds off any further commands until the sweep is complete.
Status Bits/OPC dependencies	Not global to all remote ports or front panel. *OPC only considers operation that was initiated on the same port as the *OPC command was issued from. *OPC is an overlapped command, but *OPC? is sequential.
Backwards Compatibility Notes	<ol style="list-style-type: none"> 1. The ESA/PSA/VSA products do not meet all the requirements for the *OPC command specified by IEEE 488.2. This is corrected for X-Series. This will sometimes cause behavior that is not backward compatible, but it will work as customers expect. 2. Commands such as, *OPC/*OPC?/*WAI/*RST used to be global. They considered front panel operation in conjunction with the GPIB functionality. Now they are evaluated on a per channel basis. That is, the various rear panel remote ports and the front panel i/o are all considered separately. Only the functionality initiated on the port where the *OPC was sent, is considered for its operation. 3. *OPC used to hold off until the operation bits were cleared. Now it holds off until all overlapping commands are completed. Also, earlier instruments did not wait for completion of all processes, only the ones identified here (in the STATus:OPERation register): Calibrating: monitored by PSA, ESA, VSA (E4406A) Sweeping: monitored by PSA, ESA, VSA (E4406A) Waiting for Trigger: monitored by PSA, ESA, VSA (E4406A) Measuring: monitored by PSA and ESA (but not in all Modes). Paused: monitored by VSA (E4406A). Printing: monitored by VSA (E4406A). Mass memory busy: monitored by VSA (E4406A).
Initial S/W Revision	Prior to A.02.00

Query Instrument Options

Returns a string of all the installed instrument options. It is a comma separated list with quotes, such as: "503,P03,PFR".

To be IEEE compliant, this command should return an arbitrary ascii variable that would not begin and end with quotes. But the quotes are needed to be backward compatible with previous SA products and software. So, the actual implementation will use arbitrary ascii. But quotes will be sent as the first and last ascii characters that are sent with the comma-separated option list.

Remote Command	*OPT?
Initial S/W Revision	Prior to A.02.00

Recall Instrument State

This command recalls the instrument state from the specified instrument memory register.

- If the state being loaded has a newer firmware revision than the revision of the instrument, no state is recalled and an error is reported
- If the state being loaded has an equal firmware revision than the revision of the instrument, the state will be loaded.
- If the state being loaded has an older firmware revision than the revision of the instrument, the instrument will only load the parts of the state that apply to the older revision.

Remote Command	*RCL <register #>
Example	*RCL 7 Recalls the instrument state that is currently stored in register 7.
Notes	Registers 0 through 6 are accessible from the front panel in menu keys for Recall Registers.
Min	0
Max	127
Status Bits/OPC dependencies	The command is sequential.
Initial S/W Revision	Prior to A.02.00

*RST (Remote Command Only)

*RST is equivalent to :SYST:PRESet:INIT:CONT OFF, which is a Mode Preset in the Single measurement state. This remote command is preferred over Mode Preset remote command - :SYST:PRESet, as optimal remote programming occurs with the instrument in the single measurement state.

Remote Command	*RST
Example	*RST
Notes	Sequential Clears all pending OPC bits and the Status Byte is set to 0.
Couplings	A *RST will cause the currently running measurement to be aborted and cause the default measurement to be active. *RST gets the mode to a consistent state with all of the default couplings set.
Backwards Compatibility Notes	In legacy analyzers *RST did not set the analyzer to Single, but in the X-Series it does, for compliance with the IEEE 488.2 specification. In the X-Series, *RST does not do a *CLS (clear the status bits and the error queue). In legacy analyzers, *RST used to do the equivalent of SYSTem:PRESet, *CLS and INITiate:CONTinuous OFF. But to be 488.2 compliant, *RST in the X-Series does not do a *CLS.
Initial S/W Revision	Prior to A.02.00

Save Instrument State

This command saves the current instrument state and mode to the specified instrument memory register.

Remote Command	*SAV <register #>
Example	*SAV 9 Saves the instrument state in register 9.
Notes	Registers 0 through 6 are accessible from the front panel in menu keys for Save Registers.
Min	0
Max	127
Status Bits/OPC dependencies	The command is sequential.
Initial S/W Revision	Prior to A.02.00

Service Request Enable

This command enables the desired bits of the service request enable register.

The query returns the value of the register, indicating which bits are currently enabled.

Remote Command	*SRE <integer> *SRE?
Example	*SRE 22 Enables bits 1, 2, and 4 in the service request enable register.
Notes	For related commands, see the STATus subsystem and SYSTem:ERRor[:NEXT]? commands.
Preset	0
Min	0
Max	255
Status Bits/OPC dependencies	Service Request Enable Register (all bits, 0 - 7).
Initial S/W Revision	Prior to A.02.00

Status Byte Query

Returns the value of the status byte register without erasing its contents.

Remote Command	*STB?
Example	*STB? Returns a decimal value for the bits in the status byte register. For example, if a 16 is returned, it indicates that bit 5 is set and one of the conditions monitored in the standard event status register is set.
Notes	See related command *CLS.
Status Bits/OPC dependencies	Status Byte Register (all bits, 0 - 7).
Initial S/W Revision	Prior to A.02.00

Trigger

This command triggers the instrument. Use the :TRIGger[:SEQuence]:SOURce command to select the trigger source.

Key Path	No equivalent key. See related keys Single and Restart.
Remote Command	*TRG
Example	*TRG Triggers the instrument to take a sweep or start a measurement, depending on the current instrument settings.
Notes	See related command :INITiate:IMMediate.
Initial S/W Revision	Prior to A.02.00

Self Test Query

This query performs the internal self-test routines and returns a number indicating the success of the testing. A zero is returned if the test is successful, 1 if it fails.

Remote Command	*TST?
Example	*TST? Runs the self-test routines and returns 0=passed, 1=some part failed.
Initial S/W Revision	Prior to A.02.00

Wait-to-Continue

This command causes the instrument to wait until all overlapped commands are completed before executing any additional commands. There is no query form for the command.

Remote Command	*WAI
Example	INIT:CONT OFF; INIT;*WAI Sets the instrument to single sweep. Starts a sweep and waits for its completion.
Status Bits/OPC dependencies	Not global to all remote ports or front panel. *OPC only considers operation that was initiated on the same port as the *OPC command was issued from.
Initial S/W Revision	Prior to A.02.00

4 Input/Output Functions

Input/Output

The Input/Output features are common across multiple Modes and Measurements. These common features are described in this section. See the Measurement description for information on features that are unique.

The Input/Output key accesses the keys that control the Input/Output parameters of the instrument. In general, these are functions associated with external connections to the analyzer, either to the inputs or the outputs. Since these connections tend to be fairly stable within a given setup, in general, the input/output settings do not change when you Preset the analyzer.

Other functions related to the input/output connections, but which tend to change on a measurement by measurement basis, can be found under the **Trigger** and **AMPTDY Scale** keys. In addition, some of the digital I/O bus configurations can be found under the **System** key.

NOTE

The functions in the Input/Output menu are "global" (common) to all Modes (applications). But individual Input/Output functions only appear in a Mode if they apply to that Mode. Functions that apply to a Mode but not to all measurements in the Mode may be grayed-out in some measurements.

["Input/Output variables - Preset behavior" on page 191](#)

The Input Port selection is the first menu under the **Input/Output** key:

Key Path	Front-panel key
Remote Command	[:SENSe] :FEED RF AIQ EMIXer [:SENSe] :FEED?
Example	:FEED RF :FEED?
Couplings	The [:SENSe]:FEED RF command turns the calibrator OFF
Preset	This setting is unaffected by a Preset or power cycle. It survives a Mode Preset and mode changes. It is set to RF on a "Restore Input/Output Defaults" or "Restore System Defaults->All"
State Saved	Saved in instrument state
Backwards Compatibility SCPI	[:SENSe] :FEED AREference In the PSA the calibrator was one of the inputs and selected using the AREF parameter to the same :FEED command that switched the inputs. In the X-Series it is controlled in a separate menu and overrides the input selection. For code compatibility the [:SENSe]:FEED AREference command is provided, and is aliased to [SENSe]:FEED:AREF REF50, which causes the input to be switched to the 50 MHz calibrator. The [:SENSe]:FEED RF command switches the input back to the RF port and turns the calibrator OFF, thus providing full compatibility with the PSA calibrator function. Note that after sending this, the query [:SENSe]:FEED? will NOT return "AREF" but instead the currently selected input.
Backwards Compatibility SCPI	[:SENSe] :FEED IQ IONLy QONLy [:SENSe] :FEED? The parameters IQ IONLy QONLy are supported for backwards compatibility with the E44406A. [:SENSe]:FEED IQ aliases to [:SENSe]:FEED: IQ:TYPE IQ [:SENSe]:FEED IONLy aliases to [:SENSe]:FEED:IQ:TYPE IONLy

	<p>[;SENSe]:FEED QONLy aliases to [;SENSe]:FEED:IQ:TYPE QONLy</p> <p>The query [;SENSe]:FEED? will always returns AIQ whatever the type of legacy parameters IQ IONLy QONLy has been used.</p>
Backwards Compatibility Notes	<p>Most of the settings in the X-Series Input/Output system, including External Gain, Amplitude Corrections settings and data, etc., are shared by all modes and are not changed by a mode switch. Furthermore, most variables in the Input/Output system key are not affected by Mode Preset. Both of these behaviors represent a departure from legacy behavior.</p> <p>In the X-Series. Input/Output settings are reset by using the "Restore Input/Output Defaults" function. They can also be reset to their default values through the System->Restore System Defaults-> In/Out Config key or through the System ->Restore System Defaults -> All key (and corresponding SCPI).</p> <p>While this matches most use cases better, it does create some code compatibility issues. For example, Amplitude Corrections are no longer turned off by a Mode Preset, but instead by using the "Restore Input/Output Defaults" key/SCPI.</p> <p>Although Input/Output settings are not part of each Mode's State, they are saved in the Save State files, so that all of the instrument settings can be recalled with Recall State, as in legacy instruments.</p>
Initial S/W Revision	Prior to A.02.00
Remote Command	<p>:INPut:MIXer EXTernal INTernal</p> <p>:INPut:MIXer?</p>
Example	<p>INP:MIX INT</p> <p>INP:MIX?</p>
Notes	<p>In legacy analyzers you choose between the Internal mixer or an External Mixer. In the X-Series, the External Mixer is one of the choices for the Input and is selected using the FEED command (:SENSe:FEED EXTMIxer).</p> <p>For compatibility, the INPut:MIXer EXTernal INTernal legacy command is mapped as follows:</p> <ol style="list-style-type: none"> 1. When INPut:MIXer EXTernal is received, SENSe:FEED EMIXer is executed. 2. When INPut:MIXer INTernal is received, SENSe:FEED RF is executed. 3. When INPut:MIXer? is received, the response will be INT if any input other than the external mixer is selected and EXT if the external mixer is selected
Preset	INT
Backwards Compatibility Notes	<p>PSA supports the following SCPI Command :</p> <p>:INPut:MIXer:TYPE PRESelected UNPReselect</p> <p>:INPut:MIXer:TYPE?</p> <p>PXA does not support the :INPut:MIXer:TYPE command.</p>
Initial S/W Revision	A.08.01

Input/Output variables - Preset behavior

Virtually all the input/output settings are NOT a part of mode preset. They can be set to their default value

by one of the three ways:

- by using the Restore Input/Output Defaults key on the first page of the input/output menu,
- by using the System->Restore System Defaults->Input/Output Settings or,
- by using the System -> Restore System Defaults->All. Also, they survive a Preset and a Power cycle.

A very few of the Input/Output settings do respond to a Mode Preset; for example, if the Calibrator is on it turns off on a Preset, and if DC coupling is in effect it switches to AC on a Preset. These exceptions are made in the interest of reliability and usability, which overrides the need for absolute consistency. Exceptions are noted in the SCPI table for the excepted functions.

RF Input

Selects the front-panel RF input port to be the analyzer signal input. If RF is already selected, pressing this key accesses the RF input setup functions.

Key Path	Input/Output
Example	[:SENSe]:FEED RF
Couplings	The act of connecting the U7227A USB Preamplifier to one of the analyzer's USB ports will cause the Input to automatically switch to the RF Input. If the RF Calibrator is on, it is turned off. Subsequently disconnecting the USB Preamp from USB does not change the Input selection nor restore the previous selection.
Readback	The RF input port, RF coupling, and current input impedance settings appear on this key as: "XX, YY, ZZ" where XX is RF, RF2, RFIO1, RFIO2, depending on what input is selected (only appears on analyzers with multiple RF inputs) YY is AC or DC ZZ is 50Ω or 75Ω
Initial S/W Revision	Prior to A.02.00
Modified at S/W Revision	A.14.00

Input Z Correction

Sets the input impedance for unit conversions. This affects the results when the y-axis unit is voltage or current units (dBmV, dBμV, dBμA, V, A), but not when it is power units (dBm, W). The impedance you select is for computational purposes only, since the actual impedance is set by internal hardware to 50 ohms. Setting the computational input impedance to 75 ohms is useful when using a 75 ohm to 50 ohm adapter to measure a 75 ohm device on an analyzer with a 50 ohm input impedance.

There are a variety ways to make 50 to 75 ohm transitions, such as impedance transformers or minimum loss pads. The choice of the solution that is best for your measurement situation requires balancing the amount of loss that you can tolerate with the amount of measurement frequency range that you need. If you are using one of these pads/adaptors with the **Input Z Corr** function, you might also want to use the **Ext Gain** key. This function is used to set a correction value to compensate for the gain (loss) through your pad. This correction factor is applied to the displayed measurement values.

Key Path	Input/Output, RF Input
Remote Command	[:SENSe] :CORRection:IMPedance [:INPut] [:MAGNitude] 50 75 [:SENSe] :CORRection:IMPedance [:INPut] [:MAGNitude] ?
Example	CORR:IMP 75 sets the input impedance correction to 75 ohms. CORR:IMP?
Couplings	In the N9000A option C75, when RF Input 2 is selected, the Input Z Correction will automatically change to 75 ohms. You may then change it to whatever is desired. When the main RF Input is selected, the Input Z Correction will automatically change to 50 ohms. You may then change it to whatever is desired.
Preset	This is unaffected by a Preset but is set to 50 ohms on a "Restore Input/Output Defaults" or "Restore System Defaults->All" Some instruments/options may have 75 ohms available.
State Saved	Saved in instrument state
Readback	50 Ω or 75 Ω . Current setting reads back to the RF key.
Initial S/W Revision	Prior to A.02.00

RF Coupling

Specifies alternating current (AC) or direct current (DC) coupling at the analyzer RF input port. Selecting AC coupling switches in a blocking capacitor that blocks any DC voltage present at the analyzer input. This decreases the input frequency range of the analyzer, but prevents damage to the input circuitry of the analyzer if there is a DC voltage present at the RF input.

In AC coupling mode, you can view signals below the corner frequency of the DC block, but below a certain frequency the amplitude accuracy is not specified. The frequency below which specifications do not apply is:

X-Series Model	Lowest Freq for meeting specs when AC coupled	Lowest Freq for meeting specs when DC coupled
N9000A-503/507	100 kHz	n/a
N9000A-C75 Input 2	1 MHz	n/a
N9000A-513/526	10 MHz	9 kHz
N9010A	10 MHz	9 kHz
N9020A	10 MHz	20 Hz
N9030A	10 MHz	3 Hz

Some amplitude specifications apply only when coupling is set to DC. Refer to the appropriate amplitude specifications and characteristics for your analyzer.

When operating in DC coupled mode, ensure protection of the analyzer input circuitry by limiting the DC part of the input level to within 200 mV of 0 Vdc. In AC or DC coupling, limit the input RF power to +30 dBm (1 Watt).

Key Path	Input/Output, RF Input
Remote Command	:INPut:COUPling AC DC :INPut:COUPling?
Example	INP:COUP DC
Dependencies	This key does not appear in models that are always AC coupled. When the SCPI command to set DC coupling is sent to these models, it results in the error "Illegal parameter value; This model is always AC coupled" In these models, the SCPI query INP:COUP? always returns AC. This key does not appear in models that are always DC coupled. When the SCPI command to set AC coupling is sent to these models, it results in the error "Illegal parameter value; This instrument is always DC coupled" In these models, the SCPI query INP:COUP? always returns DC.
Preset	AC on models that support AC coupling On models that are always DC coupled, such as millimeter wave models (frequency ranges 30 GHz and above), the preset is DC.
State Saved	Saved in instrument state.
Initial S/W Revision	Prior to A.02.00
Modified at S/W Revision	A.03.00

External Mixer

This key allows you to choose an External Mixer through which to apply signal input to the analyzer. When chosen, the LO/IF port becomes the input to the analyzer.

External Mixing requires option EXM. The External Mixer key will not appear unless option EXM is installed. The presence of the LO/IF connector alone does not indicate that you have Option EXM licensed. To verify that option EXM is installed, press **System, Show, System**.

When External Mixer is selected, the **Center Freq** key controls the setting of the Center Freq in external mixing, which is separate from the settings of Center Freq for the RF Input or BBIQ. Each input retains its unique settings for Center Freq. A unique SCPI command is provided solely for the external mixing Center Freq (see the **Center Freq** key description), which only affects the External Mixer CF, although sending the generic Center Freq command while External Mixer is selected also controls the External Mixer CF.

See "[More Information](#)" on page 195

Key Path	Input/Output
Example	:FEED EMIX
Notes	Not all measurements support the use of the External Mixer input. When External Mixer is selected in a measurement that does not support it, the "No result; Meas invalid with Ext Mixing" error condition occurs.
Dependencies	Unless option EXM is present, the External Mixer key is blanked, and all SCPI commands associated with menus accessed by this key return an error

	Manual FFT mode is available with external mixing, but not with Signal ID.
Preset	All settings under this key are returned to their default state when Restore Input/Output Defaults is pressed.
State Saved	All settings under this key, and all Frequency settings, are remembered when you go out of External Mixer, so that when External Mixer is chosen again, all the external mixer functions will retain their previous settings, with the exception of Signal ID which is set to OFF (Signal ID is also set to Off unless External Mixer is the selected Input).
Readback Text	The readback text on this key shows the currently selected mixer, in square brackets.
Backwards Compatibility Notes	Unlike PSA, all external mixer settings including Center Frequency are retained when you go in and out of External Mixing. Also, Preset does not take you out of External Mixing (Restore Input/Output Defaults does).
Initial S/W Revision	A.08.01

More Information

X-series analyzers have a combined LO Out/IF In connection, whereas earlier analyzers used separate ports for the LO Out and the IF in. Internal diplexers in the analyzer and the mixer simplify the connection for the user – only a single SMA cable is required.

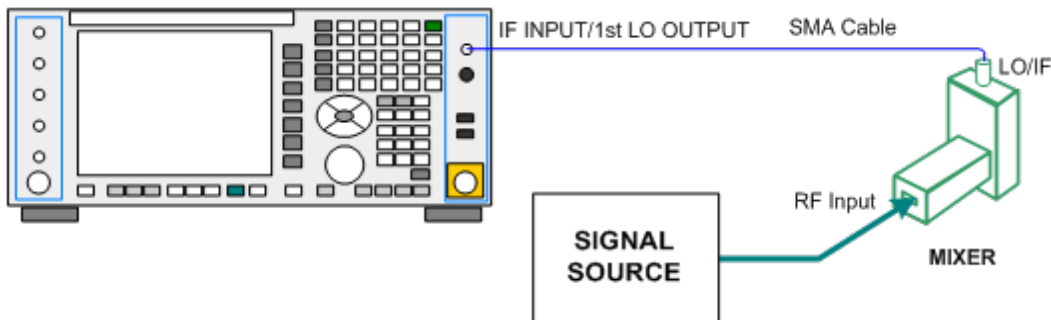

Legacy Keysight and some third party mixers have separate LO In and IF out connections. This requires you to use an external diplexer to connect these mixers. A diplexer can easily be purchased for this purpose (for example, Diplexer Model # DPL.26 or # DPL.313B from OML Inc., Morgan Hill CA)

The connection diagram for such a legacy mixer is:

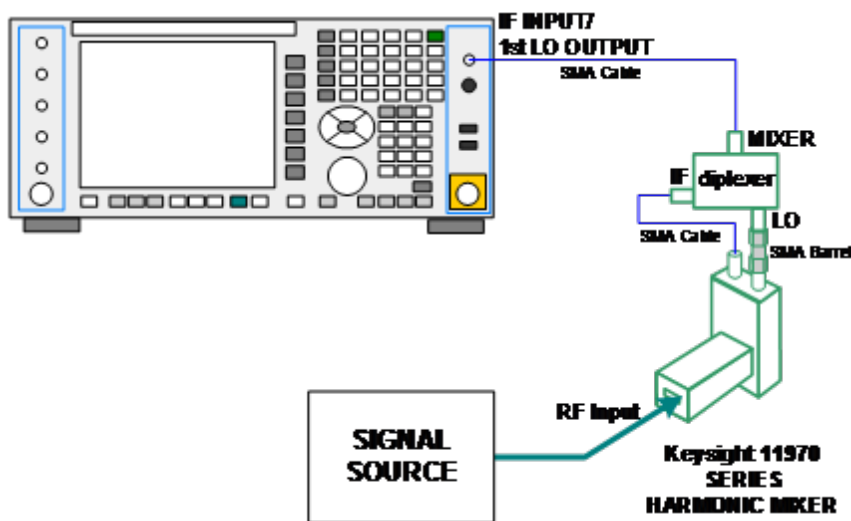

In addition, External Mixing in the X-Series supports the new Keysight M1970 series of Harmonic Mixers, which provide a USB connection for download of calibration data and additional control.

The connection diagram for one of the Keysight USB mixers is:

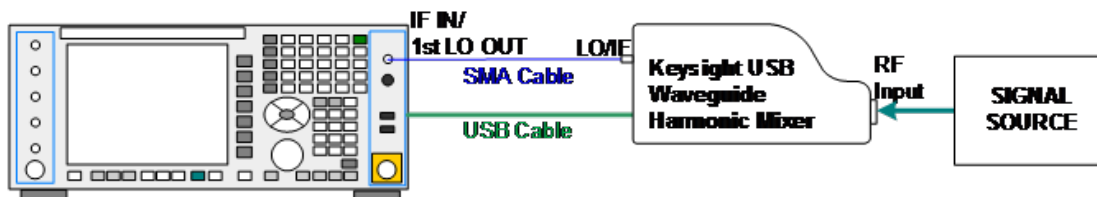

Also available in the M1970 series is the M1971E E-Band Waveguide Harmonic Mixer, which provides additional inputs and outputs for special functionality as described below. This mixer has multiple signal paths which allows it to function in three different states:

- Normal, in which it functions as a classic external mixer with a single conversion:

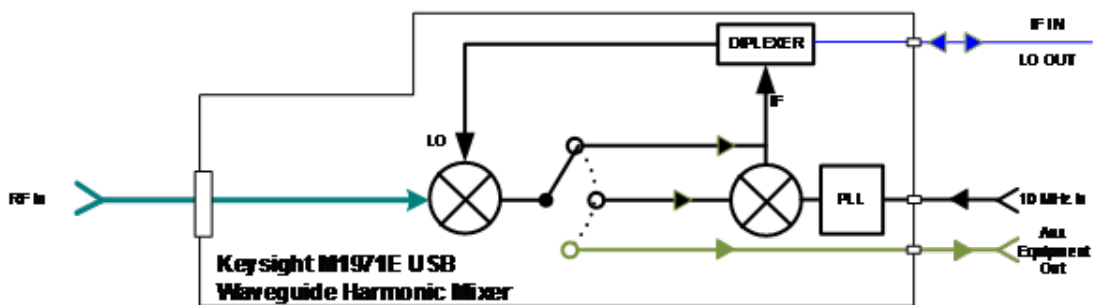

- Dual Conversion, which gives you a wider image-free range. In Dual Conversion, the first conversion is to a higher IF frequency and you provide a 10 MHz signal to which an internal PLL is locked, to effect a second downconversion:

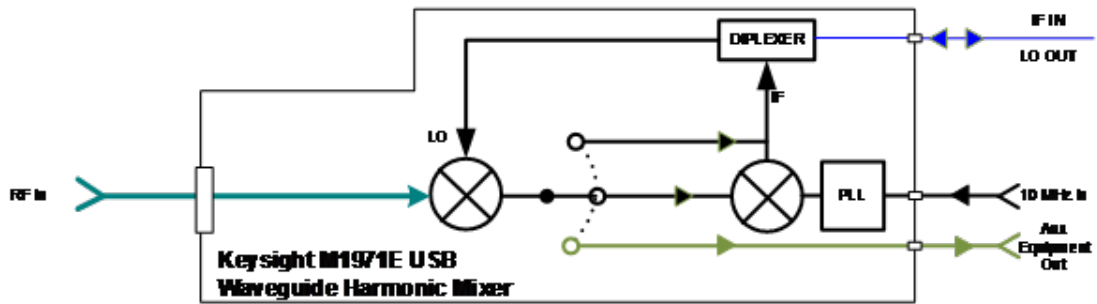

- Aux Equipment, wherein the first mixer output drives an output connector on the mixer and the analyzer is out of the circuit:

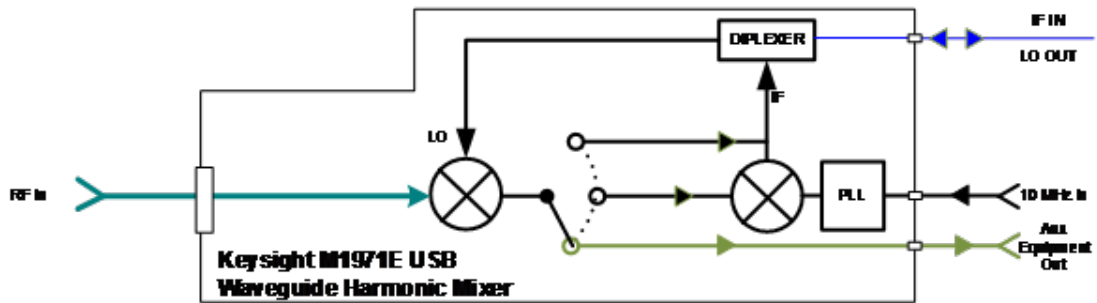

External Mixing is only supported in certain Modes and Measurements in the X-Series, as shown in the table below:

Mode	Measurements	Sig ID (Image Suppress only)	
Spectrum Analyzer	Swept SA	Y*	
	TOI	Y	
	Harmonics	N	
	Spurious Emissions	Y	
	Channel Power	Y	
	Occupied BW	Y	
	ACP	Y	
	Spectrum Emissions Mask	Y	
	CCDF	N	
	Burst Power	N	
	List Sweep	N	
	Phase Noise	Monitor Spectrum	Y
		Log Plot	Y
Spot Frequency		N	
Waveform		N	
I/Q Analyzer	Complex Spectrum	N	

	Waveform	N
Vector Signal Analyzer	Vector Analysis	N
	Analog Demod	N
	Digital Demod	N

* the Swept SA measurement also supports Image Shift

Ext Mix Setup

This menu lets you select the mixer type, and lets you configure your mixer (if necessary). While in this menu, and any of its submenus, the External Mixer Setup screen appears, showing you the current settings for the selected mixer. These settings may be dependent on which IF path is currently in use, whether a + or – harmonic is currently selected, etc.

To apply any amplitude correction factors needed to correct mixer flatness, you enter values into one of the Correction tables (under Input/Output, Corrections). The correction conversion loss values can be extracted from data supplied with the mixer or from manual measurements you make to determine the conversion loss. Note that the correction applied by the Correction tables is global to the analyzer; therefore you should make sure to turn off the External Mixer corrections when you are not using the External Mixer input.

NOTE

The Keysight USB Mixers automatically give their flatness data to the analyzer, and the correction is applied internally. No correction needs to be entered by the user, and the correction does not appear in the user-accessible Corrections tables. The user is free to enter additional corrections into the Correction tables under Input/Output, Corrections.

Key Path	Input/Output, External Mixer
State Saved	All settings in the Mixer Setup are part of the Input/Output system, and hence are saved whenever State is saved.
Readback Text	The readback line on this key shows the currently selected mixer, in square brackets.
Initial S/W Revision	A.08.01
Modified at S/W Revision	A.08.50

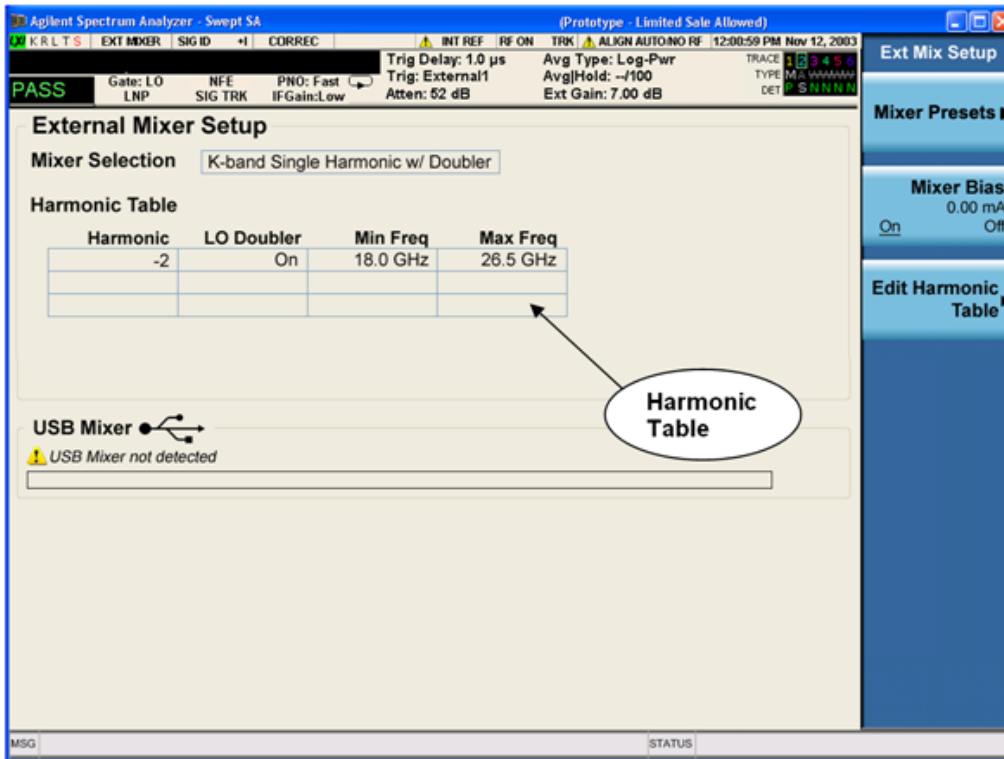

The External Mixer Setup screen looks like this

The current Mixer selection (the current or most recently connected USB Mixer, or the most recent Mixer Preset, or “Custom” if the user has modified the setup) reads out at the top of this screen.

The Harmonic Table currently being used reads out below the Mixer Selection. It shows each range being used for the current mixer. Note that a band may be made up of up to 3 ranges. Each range represents a choice of mixer harmonic and doubler state. When you select a Mixer Preset, it sets the analyzer Start and Stop frequency to the values shown in the Harmonic Table; Start Freq is set to the Min Freq for the bottom range, and Stop Freq is set to the Max Freq for the top range. In many cases you can exceed these nominal values; the absolute maximum and minimum frequency for each preset are shown in the tables that accompany the key descriptions for the Mixer Presets.

NOTE

If the current measurement has a limited Span available to it, and cannot achieve the Span shown in the table (Span=Stop Freq – Start Freq), the analyzer uses the maximum Span the measurement allows, and sets the Center Freq to the midpoint of the Start and Stop Freq values in the Harmonic Table.

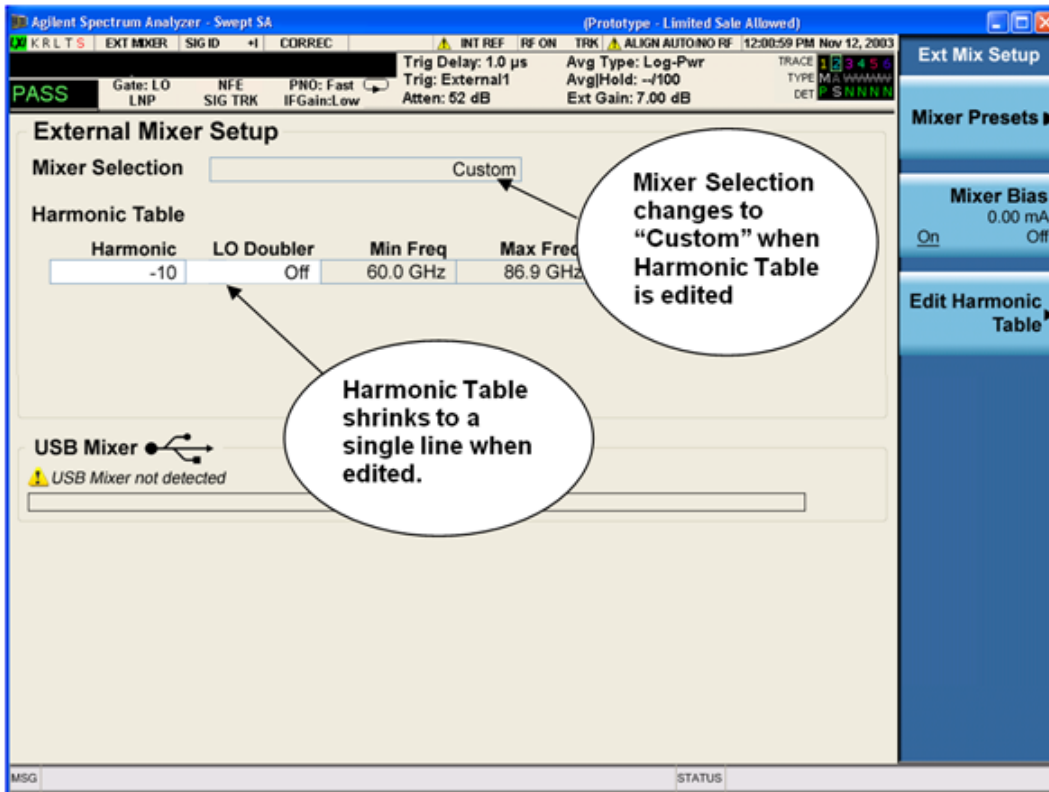

You may customize the Harmonic Table, but when you do this the analyzer goes into “single harmonic” mode. You may enter the harmonic number and whether to use the doubler or not, but now range switching is not supported, so you can only have one harmonic.

When you edit the Harmonic Table, the Mixer Selection changes to “Custom.” To change it back you must go back into the Mixer Presets menu and select a Preset.

When you edit the Harmonic Table, the nominal Min Freq and Max Freq that are available will usually be different than the Preset you were using; and the absolute frequency limits will change as well. This may result in a change to your Start and/or Stop Freq, if the current values fall outside the new range, requiring you to retune your Center Freq to get your signal back in the center.

The analyzer supports the Keysight M1970 Series Harmonic Mixers with USB connection. While in External Mixing, if one of these mixers is plugged in to a USB port, it is automatically detected and displayed in the “USB Mixer” area of the setup screen, including its model number and serial number.

The analyzer assumes that if you plug a mixer into the USB, that is the mixer you want to use. Therefore:

1. If a USB mixer is connected to the USB port, the Mixer Presets menu is grayed out, as none of the presets make sense with a USB Mixer connected. Note that once the analyzer has acquired the USB Mixer, the mixer selection will remain if it is subsequently unplugged from the USB, allowing you to plug it back in with no change to your settings. However, once you unplug it, the Mixer Presets key will stop being grayed out, allowing you to preset to a different mixer.
2. When **Restore Input/Output Defaults** is performed, if an Keysight USB Mixer is plugged into the analyzer’s USB port, the Mixer Selection remains unchanged.

- When recalling an instrument state, if a Keysight USB Mixer is plugged into the analyzer's USB port, and the Mixer Selection in the recalled state is for a USB Mixer that does not match the mixer currently plugged in, you will have to unplug your mixer and then plug it back in to get the analyzer to recognize your mixer.

As long as the selection in Ext Mixer Setup shows one of the USB mixers, both the **Mixer Bias** and **Edit Harmonic Table** keys will be greyed out.

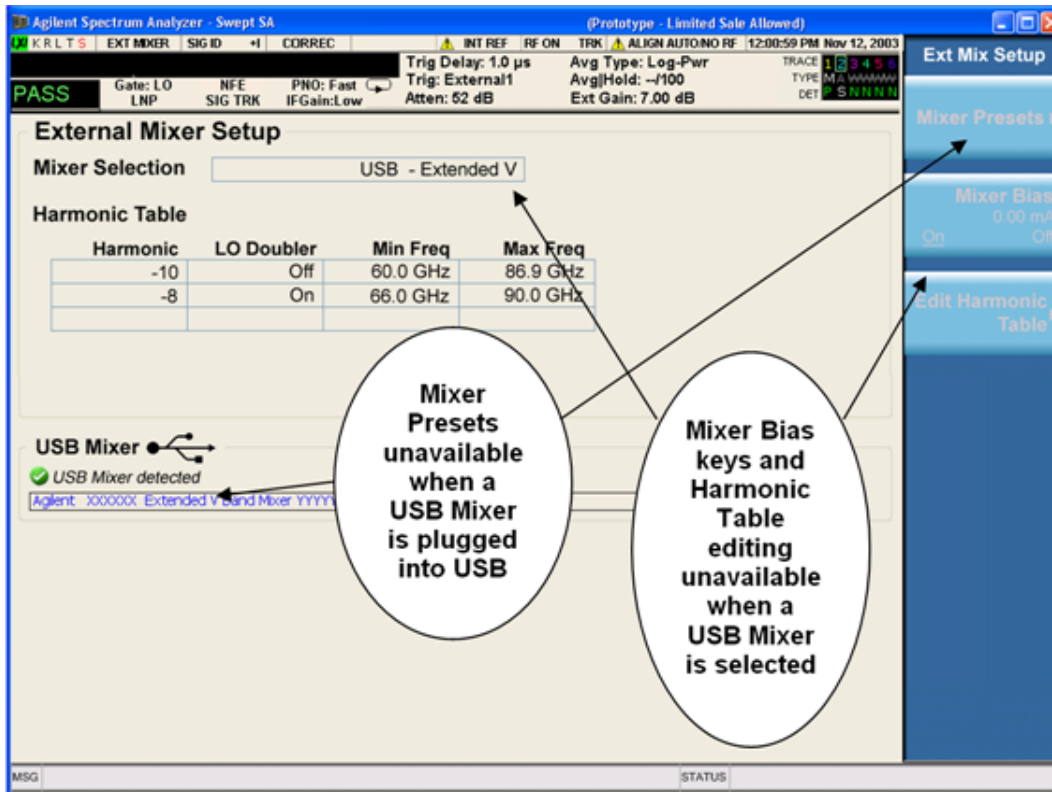

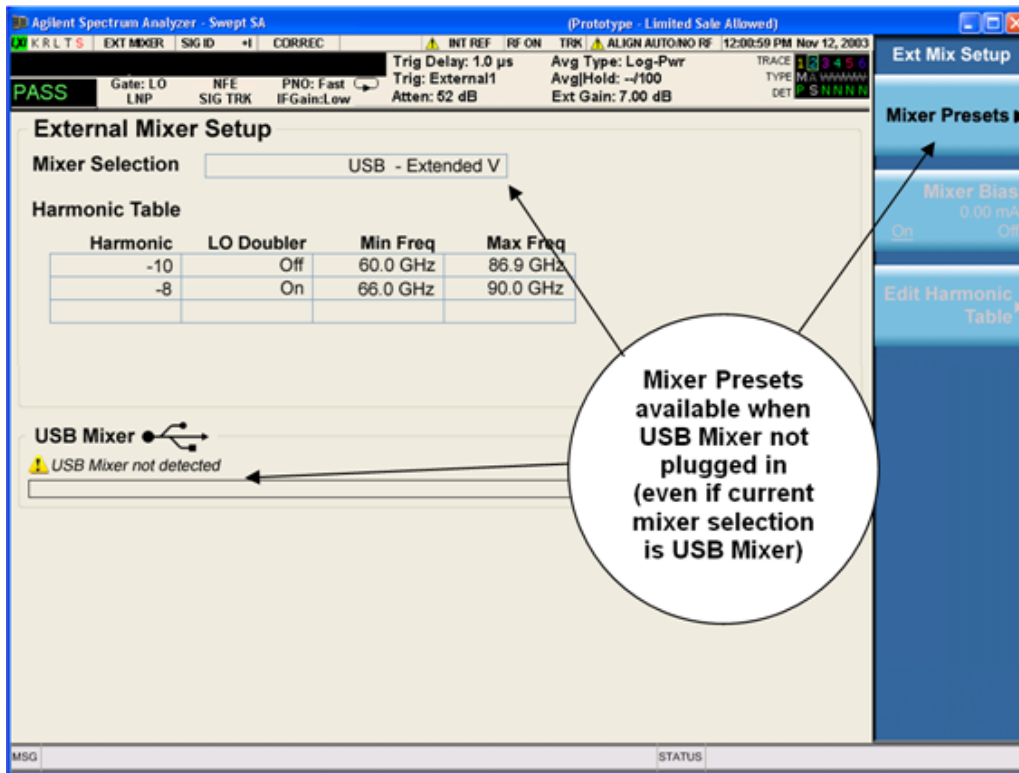

Only one USB Mixer is supported at a time. To switch to a different USB Mixer, disconnect the one that is no longer being used prior to connecting a new one.

The Mixer Selection displayed and softkey readback for the Keysight M1970 series mixers is:

Mixer Model	Mixer Selection display on Setup Screen	Readback on softkeys
Keysight M1970E: Option 001: 60 to 90 GHz Waveguide Harmonic Mixer	USB - M1970E E-Band	USB Mixer E-Band
Keysight M1971E: Option 001: 60 to 90 GHz Waveguide Harmonic Mixer	USB - M1971E-001 E-Band	USB Mixer E-Band
Keysight M1971E: Option 003: 55 to 90 GHz Waveguide Harmonic Mixer	USB - M1971E-003 Extended E-Band	USB Mixer Extended E
Keysight M1970V Option 001: 50 to 75 GHz Waveguide Harmonic Mixer	USB - M1970V-001 V-Band	USB Mixer V-Band
Keysight M1970V Option 002: 50 to 80 GHz Waveguide Harmonic Mixer	USB - M1970V-002 Extended V-Band	USB Mixer Extended V
Keysight M1970W Option 001: 75 to 110 GHz Waveguide Harmonic Mixer	USB - M1970W-001 W-Band	USB Mixer W-Band

The Keysight USB mixer essentially acts as a “remote front end” and is fully calibrated over the specified frequency range, without requiring any user interaction. This is particularly useful at high mm-wave frequencies, where cable loss is typically quite large, and it is desirable to bring the front end right up to the device under test, rather than bringing the mm-wave signal to the analyzer using a lossy and uncalibrated cable or waveguide connection.

Connecting the mixer to the USB port on the analyzer switches you to External Mixing, aborts the current measurement, and initiates an alignment of the mixer. A popup message, “USB Mixer connected” appears on the display. When a USB mixer and the LO/IF cable are connected the alignment is performed. When the alignment begins, an “Aligning” popup replaces the previous message on the display. When the alignment completes, the current measurement restarts.

Mixer Presets

This menu lets you preset the mixer setup for the particular type of mixer that you are using.

These presets are divided into four groups:

- one for Keysight legacy mixers,
- three for general purpose mixers:
 - o presets that use a single harmonic and no doubling
 - o presets that use a single harmonic but double the LO
 - o presets that use multiple harmonics

Note that the IF/LO port provides a 3.8–14 GHz LO in two bands: 3.8–8.7 (LO fundamental), and 8.6–14 GHz (doubled LO).

In most cases, once you have executed the preset, you will not need to adjust any further settings.

Key Path	Input/Output, External Mixer, Ext Mix Setup
Remote Command	[:SENSe]:MIXer:BAND A Q U V W NA ND NE NF NG NJ NK NQ NU NV NW NY NEXT DD DF DG DJ DK DQ DV DW DY DEXT MA ME MU MCOAX USB [:SENSe]:MIXer:BAND?
Example	:MIX:BAND A :MIX:BAND?
Notes	A Q U V W select Keysight 11970 mixer presets NA ND NE NF NG NJ NK NQ NU NV NW NY NEXT select single harmonic, non-doubled LO presets DD DF DG DJ DK DQ DV DW DY DEXT select single harmonic, doubled LO presets MA ME MU MCOAX select multiple harmonic presets All of these presets are detailed in their respective key descriptions The query form of this command returns the most recent preset, UNLESS the harmonic table has been edited after the preset was executed. If the harmonic table has been edited it returns CUSTOM The command USB will refresh the USB mixer connection and automatically detect the mixer band. The query form of this command returns the following if an Keysight USB Mixer is plugged into the analyzer’s USB port: USBE Keysight E-Band USB Mixer

	<p>USBV Keysight V-Band USB Mixer</p> <p>USBVEXT Keysight Extended V-Band USB Mixer</p> <p>USBWKeysight W-Band USB Mixer</p> <p>Note that the parameters CUSTOM, USBV, USBVEXT, and USBW are query responses only, and cannot be sent TO the analyzer.</p> <p>The following cross-reference matches the mixer band designators used by Keysight to the EIA waveguide designations:</p> <p>EIAKeysightFreq Range</p> <p>WR-28 A26.5 – 40 GHz</p> <p>WR-22 Q33 – 50 GHz</p> <p>WR-19 U40 – 60 GHz</p> <p>WR-15 V50 – 75 GHz</p> <p>WR-12 E60 – 90 GHz</p> <p>WR-10 W75 – 110 GHz</p> <p>WR-8 F90 – 140 GHz</p> <p>WR-6 D110 – 170 GHz</p> <p>WR-5 G140 – 220 GHz</p> <p>WR-3 J220 – 325 GHz</p>
Preset	<p>When Restore Input/Output Defaults is performed, an “A” mixer preset is also issued (11970A band), unless an Keysight USB Mixer is plugged into the analyzer’s USB port, in which case the Mixer Selection remains unchanged.</p> <p>When using Keysight USB Mixers, if a Restore All Defaults (SCPI command SYSTem:DEFault) has been perform, either remove and reinsert the USB cable or press the Refresh USB Mixer Connection softkey.</p>
Backwards Compatibility Notes	<p>The [:SENSE]:MIXer:BAND command was used in PSA and ESA to select the mixer band. In the X-Series, only the legacy parameters A, Q, U, V, and W are honored, and they preset the analyzer to match the corresponding Keysight 11970 legacy mixer. Parameters D, E, F, G ,J , K, Y, which were accepted in ESA and PSA, return an error if sent. If you are using a mixer in one of these bands, you should study the tables of presets and choose the appropriate preset to match your application. Also the USER parameter is no longer accepted, as the control model for mixer customization is very different in the X-Series.</p>
Initial S/W Revision	A.08.01
Modified at S/W Revision	A.14.00

Keysight 11970

This menu allows you to preset for one of the models in the Keysight 11970 series.

Because the X-Series has an LO range of 3.8 – 14 GHz, and older analyzers had an LO range of 3.0 – 6.8 GHz, the harmonic numbers used in the X-Series may differ from those used on older analyzers for the same mixers. Additionally, some of the 11970 mixers cannot be operated over their full range with the X-Series without switching harmonics. Consequently, you will find that some of the bands (A-Band, for example) are broken into two ranges for use with the X-Series.

See ["More Information" on page 206](#)

Key Path	Input/Output, External Mixer, Ext Mix Setup, Mixer Presets
Example	MIX:BAND A
Initial S/W Revision	A.08.01

More Information

Below are the 11970A presets. The 11970U and the 11970W use a single harmonic. The other three switch harmonics mid-band. Both harmonic ranges are shown in the table. None of these mixers use LO doubling.

The 11970 K-band mixer and the 11974 preselected mixer series are not supported.

Preset	Readout in setup screen	Readback on softkeys	Range	Harm #	RF start	RF stop	RF center
A-band	Keysight 11970A	Keysight 11970A	1	-6	26.5	30.45	28.475
			2	-8	30.35	40	35.175
Q-band	Keysight 11970Q	Keysight 11970Q	1	-8	33	40.8	36.9
			2	-10	39.8	50	44.9
U-band	Keysight 11970U	Keysight 11970U	..	-10	40	60	50
V-band	Keysight 11970V	Keysight 11970V	1	-12	50	66	58
			2	-14	53	75	64
W-band	Keysight 11970W	Keysight 11970W	..	-18	75	110	92.5

Single Harmonic

These presets choose a setup that uses a single harmonic and no doubling for the LO.

Key Path	Input/Output, External Mixer, Ext Mix Setup, Mixer Presets
Example	MIX:BAND NA
Initial S/W Revision	A.08.01

These are the presets for single harmonic operation with no doubler:

Mixer	Readout in setup screen	Readback on softkeys	Harm #	RF start	RF stop	RF center
K-band	K-band Single Harmonic, no doubler	Sngl harm LOx1 K-band	-4	18	26.5	22.25
A-band	A-band Single Harmonic, no doubler	Sngl harm LOx1 A-band	-6	26.5	40	33.25
D-band	D-band Single Harmonic, no doubler	Sngl harm LOx1 D-band	-20	110	170	140
E-band	E-band Single Harmonic, no doubler	Sngl harm LOx1 E-band	-12	60	90	75
F-band	F-band Single	Sngl harm LOx1	-18	90	140	115

Mixer	Readout in setup screen	Readback on softkeys	Harm #	RF start	RF stop	RF center
	Harmonic, no doubler	F-band				
Q-band	Q-band Single Harmonic, no doubler	Sngl harm LOx1 Q-band	-6	33	50	41.5
U-band	U-band Single Harmonic, no doubler	Sngl harm LOx1 U-band	-8	40	60	50
V-band	V-band Single Harmonic, no doubler	Sngl harm LOx1 V-band	-10	50	75	62.5
W-band	W-band Single Harmonic, no doubler	Sngl harm LOx1 W-band	-14	75	110	92.5
G-band	G-band Single Harmonic, no doubler	Sngl harm LOx1 G-band	-26	140	220	180
Y-band	Y-band Single Harmonic, no doubler	Sngl harm LOx1 Y-band	-30	170	260	215
J-band	J-band Single Harmonic, no doubler	Sngl harm LOx1 J-band	-38	220	325	272.5
Extended	Extended Single Harmonic, no doubler	Sngl harm LOx1 Extended	-40	155	345	250

Single Harmonic w/doubler

These presets choose a setup that uses a single harmonic and doubling for the LO.

Key Path	Input/Output, External Mixer, Ext Mix Setup, Mixer Presets
Example	MIX:BAND DW
Initial S/W Revision	A.08.01

These are the presets for single harmonic operation with LO doubling:

Mixer	Readout in setup screen	Readback on softkeys	Harm #	RF start	RF stop	RF center
D-band	D-band Single Harmonic w/doubler	Sngl harm LOx2 K-band	-14	110	170	140
F-band	F-band Single Harmonic w/doubler	Sngl harm LOx2 A-band	-10	90	140	115
G-band	G-band Single Harmonic w/doubler	Sngl harm LOx2 A-band	-16	140	220	180
J-band	J-band Single	Sngl harm LOx2	-24	220	325	272.5

Mixer	Readout in setup screen	Readback on softkeys	Harm #	RF start	RF stop	RF center
	Harmonic w/doubler	A-band				
K-band	K-band Single Harmonic w/doubler	Sngl harm LOx2 A-band	-2	18	26.5	22.25
Q-band	Q-band Single Harmonic w/doubler	Sngl harm LOx2 A-band	-4	33	50	41.5
V-band	V-band Single Harmonic w/doubler	Sngl harm LOx2 A-band	-6	50	75	62.5
W-band	W-band Single Harmonic w/doubler	Sngl harm LOx2 A-band	-8	75	110	92.5
Y-band	Y-band Single Harmonic w/doubler	Sngl harm LOx2 A-band	-20	170	260	215
Extended	Extended Single Harmonic w/doubler	Sngl harm LOx2 A-band	-28	245	390	317.5

Multiple Harmonics

These presets choose a setup that uses multiple harmonics and may or may not use doubling for the LO.

Key Path	Input/Output, External Mixer, Ext Mix Setup, Mixer Presets
Example	MIX:BAND MA
Initial S/W Revision	A.08.01

These are the presets for multiple harmonic operation:

Mixer	Readout in setup screen	Readback on softkeys	Range	Harm #	Dblr?	RF start	RF stop	RF Center
A-band	A-band Multiple Harmonic	Multi harm A-band	1	-4	N	26.5	34.1	30.3
			2	-4	Y	33.1	40	36.55
E-band	E-band Multiple Harmonic	Multi harm E-band	1	-6	Y	60	83	71.5
			2	-8	Y	65	90	77.5
U-band	U-band Multiple Harmonic	Multi harm U-band	1	-6	N	40	51.5	45.75
			2	-6	Y	49.5	60	54.75
Coaxial	Coaxial Multiple Harmonic	Multi harm Coaxial	1	-4	N	26.5	34	30.25
			2	-4	Y	32.5	55	43.75
			3	-6	Y	50	70	60

Mixer Bias

Adjusts an internal bias source for use with external mixers. The bias signal is present on the center conductor of the IF input connector on the front panel. The shunt current range is from –10 mA to 10 mA and it can be set whether Mixer Bias state is On or Off, but it will only be applied if it is On.

The bias remains as set if the user switches to another input (e.g., the RF Input).

Key Path	Input/Output, External Mixer, Ext Mix Setup
Remote Command	[:SENSe]:MIXer:BIAS <real> [:SENSe]:MIXer:BIAS? [:SENSe]:MIXer:BIAS:STATe OFF ON 0 1 [:SENSe]:MIXer:BIAS:STATe?
Example	:MIX:BIAS 0 :MIX:BIAS? MIX:BIAS:STAT 0 MIX:BIAS:STAT?
Preset	This is unaffected by Preset but is set to OFF and 0 on a "Restore Input/Output Defaults"
State Saved	Saved in instrument state
Min	-10 mA
Max	10 mA
Initial S/W Revision	A.08.01

Mixer Path

This parameter determines which path you wish to use when using the M1971E USB E-Band mixer:

- Normal, in which it functions as a classic external mixer with a single conversion
- Dual Conversion, in which the first conversion is to a higher IF frequency (nominally 1.5 GHz) and you provide a 10 MHz signal to which an internal PLL is locked, to effect a second downconversion. The higher IF frequency used in Dual Conversion increases the image frequency offset, giving you a wider image-free conversion range. This reduces aliasing effects and improves the image suppress functionality for wideband signals.
- Aux Equipment, wherein the first mixer output drives an output connector on the mixer and the analyzer is out of the circuit. When you connect an M1971E Mixer to USB, the instrument will pull the IF and RF flatness data from the USB mixer and write this data to a user-accessible file in .csv format for your use when Aux Equipment is selected.

Key Path	Input/Output, Input, Ext Mix Setup, Mixer Path
Remote Command	[:SENSe]:MIXer:MPATH NORMAL DUAL AUX [:SENSe]:MIXer:MPATH?
Example	:MIX:MPATH NORM
Dependencies	This control only appears when an M1971E USB Mixer is connected to the USB port of the

	<p>instrument</p> <p>When Aux Equipment is the selection, Sig Id is turned off to avoid shifting the LO. It is not turned back on when a different path is selected.</p> <p>When Aux Equipment is the selection, there is no valid result, so the analyzer displays a “No Result; Meas invalid with Aux Equip” error condition message. This is error 135.</p> <p>When Dual Conversion is selected, if no signal is sensed at the 10 MHz input port, an error condition will be generated, “Ref missing or out of range;M1971E” (error 521). This also lights the Error LED on the mixer itself.</p>
Couplings	When the Aux Equipment path is chosen, the analyzer switches to Zero Span.
Preset	NORMal
State Saved	Saved in instrument state
Initial S/W Revision	A.16.00

Mixer Path

This parameter determines which path you wish to use when using the M1971E USB E-Band mixer:

- Normal, in which it functions as a classic external mixer with a single conversion
- Dual Conversion, in which the first conversion is to a higher IF frequency (nominally 1.5 GHz) and you provide a 10 MHz signal to which an internal PLL is locked, to effect a second downconversion. The higher IF frequency used in Dual Conversion increases the image frequency offset, giving you a wider image-free conversion range. This reduces aliasing effects and improves the image suppress functionality for wideband signals.
- Aux Equipment, wherein the first mixer output drives an output connector on the mixer and the analyzer is out of the circuit. When you connect an M1971E Mixer to USB, the instrument will pull the IF and RF flatness data from the USB mixer and write this data to a user-accessible file in .csv format for your use when Aux Equipment is selected.

Key Path	Input/Output, Input, Ext Mix Setup, Mixer Path
Remote Command	[:SENSe] :MIXer :MPATH NORMal DUAL AUX [:SENSe] :MIXer :MPATH?
Example	:MIX:MPAT NORM
Dependencies	<p>This control only appears when an M1971E USB Mixer is connected to the USB port of the instrument</p> <p>When Aux Equipment is the selection, Sig Id is turned off to avoid shifting the LO. It is not turned back on when a different path is selected.</p> <p>When Aux Equipment is the selection, there is no valid result, so the analyzer displays a “No Result; Meas invalid with Aux Equip” error condition message. This is error 135.</p> <p>When Dual Conversion is selected, if no signal is sensed at the 10 MHz input port, an error condition will be generated, “Ref missing or out of range;M1971E” (error 521). This also lights the Error LED on the mixer itself.</p>
Couplings	When the Aux Equipment path is chosen, the analyzer switches to Zero Span.

Preset	NORMal
State Saved	Saved in instrument state
Initial S/W Revision	A.16.00

User IF Freq

Specifies the user's desired IF frequency when using the Aux Equipment path. This setting will determine the LO frequency the instrument will drive into the mixer to correspond to the center frequency specified by the user.

Key Path	Input/Output, External Mixer, Ext Mix Setup
Remote Command	[:SENSe] :MIXer :UIFFfreq <real> [:SENSe] :MIXer :UIFFfreq?
Example	:MIX:UIFF 300 MHz
Dependencies	Only appears if an M1971E mixer is connected to USB and the Mixer Path is Aux Equipment
Preset	1.2 GHz
State Saved	Saved in Input/Output state
Min	-4 GHz
Max	4 GHz
Initial S/W Revision	A.16.00

Cable IF Loss

The loss at the IF in the IF/LO cable can be compensated for with this function, by entering the loss in dB for your cable.

The cable loss will depend on the IF frequency. The IF frequency varies depending on which IF path your measurement is using. For best accuracy, characterize your cable's loss for the IF frequency or frequencies you will be using.

IF Frequencies:

10 MHz path: 322.5 MHz

25 MHz path: 322.5 MHz

40 MHz path: 250 MHz

140 MHz path: 300 MHz

Key Path	Input/Output, External Mixer
Key Path	Input/Output, External Mixer, Calibrate Mixer
Remote Command	[:SENSe] :MIXer :CIFLoss <rel_ampl> [:SENSe] :MIXer :CIFLoss?

Example	:MIX:CIFL 0.23 DB :MIX:CIFL?
Preset	0.26 dB
State Saved	Saved in instrument state
Min	-100
Max	100
Initial S/W Revision	A.08.01

I/Q

This feature is not available unless the ["Baseband I/Q \(Option BBA\)" on page 212](#) is installed.

Selects the front-panel I/Q input ports to be the analyzer signal input. If I/Q is already selected, pressing this key accesses the I/Q setup menu.

Key Path	Input/Output
Mode	BASIC, CDMA2K, EDGE GSM, TDSCDMA, VSA89601, WIMAX OFDMA, LTE, LTE TDD, LTE FDD, LTE ATDD, DCTV, DTMB (CTTB), DVB-T/H with T2, CMMB, ISDBT, WCDMA, VXA, CDMA1XEV, WLAN
Example	FEED AIQ
Notes	Not all measurements support the use of the I/Q signal input. When I/Q is selected in a measurement that does not support it, the "No Result; Meas invalid with I/Q inputs" error condition message appears. This is error 135
Initial S/W Revision	Prior to A.02.00

Baseband I/Q (Option BBA)

The Baseband I/Q functionality is a hardware option. It is option BBA. If the option is not installed, none of the I/Q functionality is enabled.

The Baseband I/Q has four input ports and one output port. The input ports are I, I-bar, Q, and Q-bar. The I and I-bar together compose the I channel and the Q and Q-bar together compose the Q channel. Each channel has two modes of operation, Single-Ended (also called "unbalanced") and Differential Input (also called "balanced"). When in Single-Ended operation, only the main port (I or Q) is used and the complementary port (I-bar or Q-bar) is ignored. When in Differential Input mode, both main and complementary ports are used.

The input settings (range, attenuation, skew, impedance, external gain) apply to the channels, not the individual ports.

The system supports a variety of 1 M Ω input passive probes as well as the Keysight 113x Series active differential probes using the Infinimax probe interface.

The Keysight 113x Series active probes can be used for both single ended and differential measurements. In either case a single connection is made for each channel (on either the I or Q input). The input is

automatically configured to 50 Ω single ended and the probe power is supplied through the Infinimax interface. The probe can be configured for a variety of input coupling and low frequency rejection modes. In addition, a wide range of offset voltages and probe attenuation accessories are supported at the probe interface. The active probe has the advantage that it does not significantly load the circuit under test, even with unity gain probing.

With passive 1 M Ω probes, the probe will introduce a capacitive load on the circuit, unless higher attenuation is used at the probe interface. Higher attenuation reduces the signal level and degrades the signal-to-noise-ratio of the measurement. Passive probes are available with a variety of attenuation values for a moderate cost. Most Keysight passive probes can be automatically identified by the system, setting the input impedance setting required as well as the nominal attenuation. For single ended measurements a single probe is used for each channel. Other passive probes can be used, with the attenuation and impedance settings configured manually.

For full differential measurements, the system supports probes on each of the four inputs. The attenuation of the probes should be the same for good common mode rejection and channel match.

Both active and passive probes in single ended and differential configurations can be calibrated. This calibration uses the Cal Out BNC connection and a probe connection accessory. The calibration achieves excellent absolute gain flatness in a probed measurement. It matches both the gain and frequency response of the I and Q channels as well as any delay skew, resulting in high accuracy in derived measurements such as Error Vector Magnitude (EVM).

When a probe is connected a status message will be displayed. The message will indicate if calibration data is available or not. Calibration data is saved for each type of probe (including "none") for each port and will be reapplied whenever that type of probe is re-connected to the same port. For probes with EEPROM identification, the calibration data will be stored based on the unique probe identifier and will reapply data for that particular probe if it is available. The data will not follow a probe from one port to another. For probes without EEPROM identification, the instrument cannot distinguish between different probes of the same type and it will use the data from the last calibration for that probe type on that port.

When in differential mode, both the main and complementary probes are expected to be of the same type.

In some situations, the I and Q channels should be configured identically. In other situations it is convenient to control them independently. Some menus have a "Q Same as I" setting that will cause the Q channel configuration to mirror the I channel configuration, avoiding the overhead of double data entry when the channels should be the same.

The output port is for calibrating the I/Q input ports, although it can also be manually controlled.

There are two types of calibrations available: cable calibration and probe calibration. The cable calibration will guide the user through connecting each input port in turn. All ports must be calibrated together. The probe calibration is done for a specific channel (I or Q). If in Single-Ended mode, only the main port is calibrated. When in Differential Input mode, the user is guided through calibrating both main and complementary ports.

The front panel I/Q port LEDs indicate the current state of that port. On (green) indicates it is active, and off (dark) indicates it is not in use. For example, the Cal Out port LED is on if and only if there is signal coming out of that port.

The input is a context and some parameters have separate values for each context. The SCPI for these parameters has an optional "[:RF|IQ]" node. If the specific context is omitted, the command acts on the current input context's value. Here are the parameters that are input context sensitive:

- Center Frequency
- Trigger Source

It is important to distinguish between the I and Q input ports and the displayed I and Q data values. The I and Q input ports feed into a digital receiver that does digital tuning and filtering. The I and Q data seen by the user (either on the display or through SCPI) corresponds to the real ("I") and the imaginary ("Q") output from the digital receiver. When the input path is I+jQ or I Only and the center frequency is 0 Hz the I input ends up in as the real output from the receiver and appears as "I" data. Likewise, when the input path is I+jQ and the center frequency is 0 Hz, the Q input ends up as the imaginary output from the receiver and appears as "Q" data. However, when the input path is Q Only, the Q input is sent to the receiver as Q+j0, so the receiver output has the Q input coming out on the real output, and so in Q Only, the signal from the Q input port appears as the "I" data. Another situation where the I and Q data do not necessarily correspond directly to the I and Q inputs is when the center frequency is non-zero. The digital processing involved in the tuning is a complex operation. This will result in I Only data appearing as both "I" and "Q" data, the same as that signal would appear if seen through the RF input port.

Baseband I/Q Remote Language Compatibility

For the Keysight E4406A VSA Series Transmitter Tester, Option B7C provided baseband I/Q inputs. Code compatibility has been provided to allow many of the commands for option B7C to function properly with the X-Series. The X-Series has hardware differences and additional capabilities (e.g., E4406A does not have independent settings of I & Q nor does it provide for probe calibrations) which make 100% compatibility impossible.

1. The following commands are supported:

:CALibration:IQ:FLATness

:INPut:IMPedance:IQ U50|B50|U1M|B1M

:INPut:IMPedance:REFerence <integer>

2. The [:SENSe]:FEED RF|IQ|IONLY|QONLY|AREFERENCE|IFALIGN command supports all parameters except IFALIGN. The FEED? query will return only RF|AIQ|AREF.

3. The following commands are not supported:

:CALibration:GIQ

:CALibration:IQ:CMR

:INPut:IQ:ALIGN OFF|ON|0|1

The Rohde & Schwarz FSQ-B71 also provides baseband I/Q inputs. A certain amount of code compatibility is provided in the X-Series, however hardware differences make this a somewhat limited set.

Supported:

The "<1|2>" is supported as "[1]".

INPut<1|2>:IQ:BALanced[:STATe] ON | OFF

INPut<1|2>:IQ:TYPE I | Q | IQ

INPut<1|2>:IQ:IMPedance LOW | HIGH

Not Supported:

INPut<1|2>:SElect AIQ | RF

TRACe<1|2>:IQ:DATA:FORMat COMPatible | IQBLock | IQPair>

TRACe<1|2>:IQ:DATA:MEMory? <offset samples>,<# of samples>

TRACe<1|2>:IQ:DATA?

TRACe<1|2>:IQ:SET <filter type>,<rbw>,<sample rate>,<trigger source>,<trigger slope>,<pretrigger samples>,<# of samples>

TRACe<1|2>:IQ:SRATe 10.0kHz to 81.6MHz

TRACe<1|2>:IQ[:STATe] ON|OFF

The Rohde & Schwarz FMU has the following SCPI, which is not supported (these commands start/abort the probe calibration procedure, which is manually interactive from the front panel):

CALibration:ABORt

CALibration:PROBe[:START]

I/Q Path

Selects which I/Q input channels are active. The LED next to each I/Q input port will be on when that port is active.

The analysis bandwidth for each channel is the same as that of the instrument. For example, the base N9020A has a bandwidth of 10 MHz. With I/Q input the I and Q channels would each have an analysis bandwidth of 10 MHz, giving 20 MHz of bandwidth when the I/Q Path is I+jQ. With option B25, the available bandwidth becomes 25 MHz, giving 25 MHz each to I and Q and 50 MHz to I+jQ.

I/Q voltage to power conversion processing is dependent on the I/Q Path selected.

- With I+jQ input we know that the input signal may not be symmetrical about 0 Hz, because it has a complex component. Therefore, above 0 Hz only the positive frequency information is displayed, and below 0 Hz only the negative frequency information is displayed.
- With all other Input Path selections, the input signal has no complex component and therefore is always symmetrical about 0 Hz. In this case, by convention, the power conversion shows the combined voltage for both the positive and negative frequencies. The information displayed below 0 Hz is the mirror of the information displayed above 0 Hz. This results in a power reading 6.02 dB higher (for both) than would be seen with only the positive frequency voltage. Note also that, in this case the real signal may have complex modulation embedded in it, but that must be recovered by further signal processing.

Key Path	Input/Output, I/Q
Remote Command	[:SENSe] :FEED:IQ:TYPE IQ IONLy QONLy [:SENSe] :FEED:IQ:TYPE?
Example	Set the input to be both the I and Q channels, combined as I + j * Q. FEED:IQ:TYPE IQ
Preset	IQ
State Saved	Yes This is unaffected by a Preset but is set to the default value on a "Restore Input/Output Defaults" or

	"Restore System Defaults->All"
Range	I+jQ I Only Q Only
Readback Text	I+jQ I Only Q Only
Initial S/W Revision	Prior to A.02.00

Remote Command	:INPut [1] :IQ:TYPE IQ I Q :INPut [1] :IQ:TYPE?
Notes	For R&S FSQ-B71 compatibility
Preset	IQ
Initial S/W Revision	Prior to A.02.00

I+jQ

Sets the signal input to be both the I and Q channels. The I and Q channel data will be combined as $I + j * Q$.

Key Path	Input/Output, I/Q, I/Q Path
Example	Set the input to be both the I and Q channels, combined as $I + j * Q$. FEED:IQ:TYPE IQ
Initial S/W Revision	Prior to A.02.00

I Only

Sets the signal input to be only the I channel. The Q channel will be ignored. The data collected is still complex. When the center frequency is 0 the imaginary part will always be zero, but for any other center frequency both the real and imaginary parts will be significant.

Key Path	Input/Output, I/Q, I/Q Path
Example	Set the input to be only the I channel. FEED:IQ:TYPE IONL
Initial S/W Revision	Prior to A.02.00

Q Only

Sets the signal input to be only the Q channel. The I channel will be ignored. The Q channel will be sent to the digital receiver block as $Q+j0$. The receiver's output is still complex. When the center frequency is 0 the imaginary part will always be zero, but for any other center frequency both the real and imaginary parts will be significant. Note that since the receiver's real output is displayed as the "I" data, when the center frequency is 0, the Q Only input appears as the "I" data.

Key Path	Input/Output, I/Q, I/Q Path
Example	Set the input to be only the Q channel. FEED:IQ:TYPE QONL
Initial S/W Revision	Prior to A.02.00

I Setup

Access the channel setup parameters for the I channel.

Key Path	Input/Output, I/Q
Initial S/W Revision	Prior to A.02.00

I Differential Input

Selects differential input on or off for the I channel. For differential input (also called balanced input), the analyzer uses both main and complementary ports. When differential input is off (also called single-ended or unbalanced input), the analyzer uses only the main port.

Key Path	Input/Output, I/Q, I Setup
Remote Command	:INPut:IQ[:I]:DIFFerential OFF ON 0 1 :INPut:IQ[:I]:DIFFerential?
Example	Put the I channel in Differential Input mode INP:IQ:DIFF ON
Notes	When I Differential Input = On, the analyzer will check for attenuation mismatches between the I and I-bar ports. If the difference in attenuation values exceeds 0.5 dB a Settings Alert error condition, error 159 will be set. When I Differential Input = On, and IQ Path is I+jQ, the Q Differential input must also be On. Similarly, when I Differential Input = Off, and IQ Path is I+jQ, the Q Differential input must also be Off. If the states of the two inputs do not match, an error condition message is generated, 159;Settings Alert;I/Q mismatch:Differential.
Couplings	Some active probes include built-in differential capability. When one of these probes is sensed, this key is disabled. Since the differential capability is handled in the probe, the Analyzer will use only the main port and the key will show that the Analyzer's Differential Input mode is Off (indicating that the complementary port is not in use). When Q Same as I is On, the value set for I will also be copied to Q.
Preset	Off
State Saved	Yes This is unaffected by a Preset but is set to the default value on a "Restore Input/Output Defaults" or "Restore System Defaults->All"
Range	Off On
Initial S/W Revision	Prior to A.02.00

Remote Command	:INPut [1] :IQ:BAALanced [:STATe] OFF ON 0 1 :INPut [1] :IQ:BAALanced [:STATe] ?
Notes	For R&S FSQ-B71 compatibility, with no independent settings for the I and Q channels. Therefore, it is tied only to the I channel and does not provide an equivalent for the Q channel. For proper operation of the backwards compatibility command Q Same as I should be set to On.
Preset	OFF
Initial S/W Revision	Prior to A.02.00

I Input Z

Selects the input impedance for the I channel. The impedance applies to both the I and I-bar ports.

The input impedance controls the hardware signal path impedance match. It is not used for converting voltage to power. The voltage to power conversion always uses the Reference Z parameter. The Reference Z parameter applies to both I and Q channels.

Key Path	Input/Output, I/Q, I Setup
Remote Command	:INPut [1] :IQ[:I] :IMPedance LOW HIGH :INPut [1] :IQ[:I] :IMPedance?
Example	Set the I channel input impedance to 1 MΩ INP:IQ:IMP HIGH
Notes	LOW = 50 Ω, HIGH = 1 MΩ When IQ Path is I+jQ, the I Input Z setting must be the same as the Q Input Z setting. If the settings of the two inputs do not match, an error condition message is generated, 159;Settings Alert;I/Q mismatch:Input Z.
Couplings	Input impedance is a built-in characteristic of a probe. Therefore, whenever a probe is sensed, this key is disabled and the value is set to match the probe. When no probe is sensed on Q and Q Same as I is On, the value set for I will also be copied to Q.
Preset	LOW
State Saved	Yes This is unaffected by a Preset but is set to the default value on a "Restore Input/Output Defaults" or "Restore System Defaults->All"
Range	50 Ω 1 MΩ
Initial S/W Revision	Prior to A.02.00

I Skew

Sets the skew factor for the I channel. The skew will shift the channel's data in time. Use this to compensate for differences in the electrical lengths of the input paths due to cabling.

Key Path	Input/Output, I/Q, I Setup
Remote Command	[:SENSe]:CORRection:IQ[:I]:SKEW <seconds>

	<code>[:SENSe] :CORRection:IQ[:I]:SKEW?</code>
Example	Delay the data for the I channel by 10 ns. <code>CORR:IQ:SKEW 10 ns</code>
Preset	0
State Saved	Yes This is unaffected by Preset but is set to the default value on a "Restore Input/Output Defaults" or "Restore System Defaults->All"
Range	0 s to 100 ns
Min	0 s
Max	+100 ns
Initial S/W Revision	Prior to A.02.00

I Probe

Access the probe setup parameters for the I channel. See ["I/Q Probe Setup" on page 228](#).

Key Path	Input/Output, I/Q, I Setup
State Saved	No
Readback Text	[<I port probe id>] This is reporting the type of probe sensed on the I port. There is no parameter for overriding what is sensed.
Initial S/W Revision	Prior to A.02.00

Attenuation

The attenuation is part of the calibration data stored with the probe type and is initially the value that was returned by the last calibration. You can modify this value and any changes will be stored with the calibration data and will survive power cycles and presets. When a probe calibration is performed the attenuation value will be overwritten by the calibration.

Key Path	Input/Output, I/Q, I Setup Q Setup, I Probe Q Probe
Remote Command	<code>[:SENSe] :CORRection:IQ:I Q:ATTenuation:RATio <real></code> <code>[:SENSe] :CORRection:IQ:I Q:ATTenuation:RATio?</code>
Example	Set the attenuation for the current I probe to 100.00:1. <code>CORR:IQ:I:ATT:RAT 100</code>
Notes	Each probe type has its own attenuation setting. As probes are changed the attenuation value will reflect the new probe's setting. Changing the attenuation affects only the current probe type's setting and leaves all others unchanged. When the IQ Path is I+jQ, the Q probe attenuation setting must match the I Probe attenuation setting within 1 dB. If this is not the case, an error condition message is generated, 159;Settings Alert;I/Q mismatch:Attenuation.

Preset	Each probe type has its own default. The default for the "Unknown" probe type is 1:1.
State Saved	Saved with probe calibration data. It survives a power cycle and is not affected by a Preset or Restore.
Range	0.001 to 10000
Min	0.001
Max	10000
Initial S/W Revision	Prior to A.02.00

This is an alternate form of the SCPI that allows input as a power instead of a ratio.

Remote Command	<code>[[:SENSe]:CORRection:IQ:I Q:ATTenuation <rel_ampl></code> <code>[[:SENSe]:CORRection:IQ:I Q:ATTenuation?</code>
Example	Set the attenuation for the current I probe type to 100.00:1. CORR:IQ:I:ATT 20 dB
Range	-60 dB to +80 dB
Min	-60 dB
Max	+80 dB
Initial S/W Revision	Prior to A.02.00

Calibrate

Invokes the guided probe calibration. The guided probe calibration is context sensitive and depends on the channel (I or Q) and the Differential Input state. The calibration is only performed on the selected channel. When Differential Input is on, both the probe attached to the main port and the probe attached to the complementary port are calibrated. When Differential Input is off, only the probe attached to the main port is calibrated. See "[I/Q Guided Calibration](#)" on page 259.

Key Path	Input/Output, I/Q, I Setup Q Setup, I Probe Q Probe, Coupling
Readback Text	The last calibration date, or if no calibration exists, "(empty)". Last: <cal date> <cal time> Example: Last: 8/22/2007 1:02:49 PM
Initial S/W Revision	Prior to A.02.00

Clear Calibration

Clears the calibration data for the current port and probe. It does not clear the data for other probe types or other ports. If the sensed probe has EEPROM identification, only the data for that specific probe is

cleared. After this command has completed, the probe calibration state will be the same as if no probe calibration had ever been performed for the specified channel and probe. The probe attenuation will be the default value for that probe type and the Cable Calibration frequency response corrections will be used. This command is dependent on the Differential Input state. When Differential Input is on, both the data for the probe attached to the main port and the data for the probe attached to the complementary port are cleared. When Differential Input is off, only data for the probe attached to the main port is cleared.

Key Path	Input/Output, I/Q, I Setup Q Setup, I Probe Q Probe
Remote Command	:CALibration:IQ:PROBe:I Q:CLEAr
Example	Clear the calibration data for the I channel and the current probe (with EEPROM identification) or probe type (without EEPROM identification). :CAL:IQ:PROBe:I:CLE
Initial S/W Revision	Prior to A.02.00

Combined Differential/Input Z (Remote Command Only)

This is Remote Command only (no front panel) and is for backwards compatibility only. It combines the Differential Input and Input Z selections into a single SCPI command.

Remote Command	:INPut:IMPedance:IQ U50 B50 U1M B1M :INPut:IMPedance:IQ?
Example	:INPut:IMPedance:IQ U50 This is equivalent to the following two SCPI commands: :INP:IQ:DIFF OFF :INP:IQ:IMP 50
Notes	Provided for E4406A code compatibility. The enum values translate as follows: U50: Differential Input = Off, Input Z = 50Ω B50: Differential Input = On, Input Z = 50Ω U1M: Differential Input = Off, Input Z = 1 MΩ B1M: Differential Input = On, Input Z = 1 MΩ This command is for backwards compatibility. It combines the Input Z (50Ω or 1 MΩ) parameter with the Differential Input (Off = "Unbalanced", On = "Balanced") parameter into a single enumeration. This backwards compatibility SCPI command was for an instrument without independent settings for the I and Q channels. Therefore, it is tied only to the I channel and does not provide an equivalent for the Q channel. For proper operation of the backwards compatibility command Q Same as I should be set to On. Also, note the subtle difference between this SCPI command and the backwards compatibility command for Input Z. The Input Z SCPI has "IQ" before "IMP" while this command has that order reversed.
Couplings	This command does not have an independent parameter, but instead is tied to the Differential Input and Input Z parameters. The coupling for those parameters apply to this command too.

Preset	U50
Initial S/W Revision	Prior to A.02.00

Q Setup

Access the channel setup parameters for the Q channel.

Key Path	Input/Output, I/Q
Readback Text	When Q Same as I is On the readback is "Q Same as I".
Initial S/W Revision	Prior to A.02.00

Q Same as I

Many, but not all, usages require the I and Q channels have an identical setup. To simplify channel setup, the Q Same as I will cause the Q channel parameters to be mirrored from the I channel. That way you only need to set up one channel (the I channel). The I channel values are copied to the Q channel, so at the time Q Same as I is turned off the I and Q channel setups will be identical. This does not apply to Probe settings or to parameters that are determined by the probe.

Key Path	Input/Output, I/Q, Q Setup
Remote Command	:INPut:IQ:MIRRored OFF ON 0 1 :INPut:IQ:MIRRored?
Example	Turn off the mirroring of parameters from I to Q. INP:IQ:MIRR OFF
Couplings	Only displayed for the Q channel. When Yes, the I channel values for some parameters are mirrored (copied) to the Q channel. However, when a parameter is determined by the type of probe and a probe is sensed, the probe setting is always used and the I channel setting is ignored. The following parameters are mirrored: Differential Input (when not determined by probe) Input Z (when not determined by probe)
Preset	This is unaffected by a Preset but is set to the default value (Q Same as I set to "On") on a "Restore Input/Output Defaults" or "Restore System Defaults->All"
State Saved	Saved in instrument state
Range	On Off
Readback Text	"Q Same as I" when On, otherwise none.
Initial S/W Revision	Prior to A.02.00

Q Differential Input

Selects differential input on or off for the Q channel. For differential input (also called balanced input), the analyzer uses both the Q and Q-bar ports. When differential input is off (also called single-ended or

unbalanced input), the analyzer uses only the Q port.

Key Path	Input/Output, I/Q, Q Setup
Remote Command	:INPut:IQ:Q:DIFFerential OFF ON 0 1 :INPut:IQ:Q:DIFFerential?
Example	Put the Q channel in Differential Input mode INP:IQ:Q:DIFF ON
Notes	When Differential Input = On, the analyzer will check for attenuation mismatches between the Q and Q-bar ports. If the difference in attenuation values exceeds 0.5 dB a Settings Alert error condition, error 159 will be set. When Q Differential Input = On, and IQ Path is I+jQ, the I Differential input must also be On. Similarly, when Q Differential Input = Off, and IQ Path is I+jQ, the I Differential input must also be Off. If the states of the two inputs do not match, an error condition message is generated, 159;Settings Alert;I/Q mismatch:Differential.
Couplings	Some active probes include built-in differential capability. When one of these probes is sensed, this key is disabled. Since the differential capability is handled in the probe, the Analyzer will use only the main port and the key will show that the Analyzer's Differential Input mode is Off (indicating that the complementary port not in use). When a differential probe is not sensed and Q Same as I is On, the value set for I will be copied to Q. This key is disabled when Q Same as I is On.
Preset	Off
State Saved	Yes This is unaffected by a Preset but is set to the default value on a "Restore Input/Output Defaults" or "Restore System Defaults->All"
Range	Off On
Initial S/W Revision	Prior to A.02.00

Q Input Z

Selects the input impedance for the Q channel. The impedance applies to both the Q and Q-bar ports.

The input impedance controls the hardware signal path impedance match. It is not used for converting voltage to power. The voltage to power conversion always uses the Reference Z parameter. The Reference Z parameter applies to both I and Q channels.

Key Path	Input/Output, I/Q, Q Setup
Remote Command	:INPut [1] :IQ:Q:IMPedance LOW HIGH :INPut [1] :IQ:Q:IMPedance?
Example	Set the Q channel input impedance to 1 M Ω INP:IQ:Q:IMP HIGH
Notes	LOW = 50 Ω , HIGH = 1 M Ω When IQ Path is I+jQ, the I Input Z setting must be the same as the Q Input Z setting. If the settings of the two inputs do not match, an error condition message is generated, 159;Settings Alert;I/Q mismatch:Input Z.

Couplings	Input impedance is a built-in characteristic of a probe. Therefore, whenever a probe is sensed, this key is disabled and the value is set to match the probe. When no probe is sensed and Q Same as I is On, the value set for I will also be copied to Q. This key is disabled when Q Same as I is On.
Preset	LOW
State Saved	Yes This is unaffected by Preset but is set to the default value on a "Restore Input/Output Defaults" or "Restore System Defaults->All"
Range	50 Ω 1 M Ω
Initial S/W Revision	Prior to A.02.00

Q Skew

Sets the skew factor for the Q channel. The skew will shift the channel's data in time. Use this to compensate for differences in the electrical lengths of the input paths due to cabling and probes.

Key Path	Input/Output, I/Q, Q Setup
Remote Command	<code>[:SENSe]:CORRection:IQ:Q:SKEW <seconds></code> <code>[:SENSe]:CORRection:IQ:Q:SKEW?</code>
Example	Delay the data for the Q channel by 10 ns. <code>CORR:IQ:Q:SKEW 10 ns</code>
Preset	0
State Saved	Yes This is unaffected by a Preset but is set to the default value on a "Restore Input/Output Defaults" or "Restore System Defaults->All"
Range	0 s to 100 ns
Min	0 s
Max	+100 ns
Initial S/W Revision	Prior to A.02.00

Q Probe

Accesses the probe setup parameters for the Q channel. See "[I/Q Probe Setup](#)" on page 228.

Key Path	Input/Output, I/Q, Q Setup
State Saved	No
Readback Text	<code>[<Q port probe id>]</code> This is reporting the type of probe sensed on the Q port. There is no parameter for overriding what is sensed.
Initial S/W Revision	Prior to A.02.00

Attenuation

The attenuation is part of the calibration data stored with the probe type and is initially the value that was returned by the last calibration. You can modify this value and any changes will be stored with the calibration data and will survive power cycles and presets. When a probe calibration is performed the attenuation value will be overwritten by the calibration.

Key Path	Input/Output, I/Q, I Setup Q Setup, I Probe Q Probe
Remote Command	<code>[:SENSe] :CORRection:IQ:I Q:ATTenuation:RATio <real></code> <code>[:SENSe] :CORRection:IQ:I Q:ATTenuation:RATio?</code>
Example	Set the attenuation for the current I probe to 100.00:1. CORR:IQ:I:ATT:RAT 100
Notes	Each probe type has its own attenuation setting. As probes are changed the attenuation value will reflect the new probe's setting. Changing the attenuation affects only the current probe type's setting and leaves all others unchanged. When the IQ Path is I+jQ, the Q probe attenuation setting must match the I Probe attenuation setting within 1 dB. If this is not the case, an error condition message is generated, 159;Settings Alert;I/Q mismatch:Attenuation.
Preset	Each probe type has its own default. The default for the "Unknown" probe type is 1:1.
State Saved	Saved with probe calibration data. It survives a power cycle and is not affected by a Preset or Restore.
Range	0.001 to 10000
Min	0.001
Max	10000
Initial S/W Revision	Prior to A.02.00

This is an alternate form of the SCPI that allows input as a power instead of a ratio.

Remote Command	<code>[:SENSe] :CORRection:IQ:I Q:ATTenuation <rel_ampl></code> <code>[:SENSe] :CORRection:IQ:I Q:ATTenuation?</code>
Example	Set the attenuation for the current I probe type to 100.00:1. CORR:IQ:I:ATT 20 dB
Range	-60 dB to +80 dB
Min	-60 dB
Max	+80 dB
Initial S/W Revision	Prior to A.02.00

Calibrate

Invokes the guided probe calibration. The guided probe calibration is context sensitive and depends on the channel (I or Q) and the Differential Input state. The calibration is only performed on the selected channel. When Differential Input is on, both the probe attached to the main port and the probe attached to the

complementary port are calibrated. When Differential Input is off, only the probe attached to the main port is calibrated. See "[I/Q Guided Calibration](#)" on page 259.

Key Path	Input/Output, I/Q, I Setup Q Setup, I Probe Q Probe, Coupling
Readback Text	The last calibration date, or if no calibration exists, "(empty)". Last: <cal date> <cal time> Example: Last: 8/22/2007 1:02:49 PM
Initial S/W Revision	Prior to A.02.00

Clear Calibration

Clears the calibration data for the current port and probe. It does not clear the data for other probe types or other ports. If the sensed probe has EEPROM identification, only the data for that specific probe is cleared. After this command has completed, the probe calibration state will be the same as if no probe calibration had ever been performed for the specified channel and probe. The probe attenuation will be the default value for that probe type and the Cable Calibration frequency response corrections will be used. This command is dependent on the Differential Input state. When Differential Input is on, both the data for the probe attached to the main port and the data for the probe attached to the complementary port are cleared. When Differential Input is off, only data for the probe attached to the main port is cleared.

Key Path	Input/Output, I/Q, I Setup Q Setup, I Probe Q Probe
Remote Command	:CALibration:IQ:PROBe:I Q:CLEar
Example	Clear the calibration data for the I channel and the current probe (with EEPROM identification) or probe type (without EEPROM identification). :CAL:IQ:PROBe:I:CLE
Initial S/W Revision	Prior to A.02.00

Reference Z

Sets the value of the impedance to be used in converting voltage to power for the I and Q channels. This does not change the hardware's path impedance (see "[I Input Z](#)" on page 218).

Key Path	Input/Output, I/Q
Remote Command	:INPut:IMPedance:REFerence <integer> :INPut:IMPedance:REFerence?
Example	Set the I/Q reference impedance to 50 Ω INP:IMP:REF 50
Preset	50 Ω
State Saved	Yes

	This is unaffected by a Preset but is set to the default value on a "Restore Input/Output Defaults" or "Restore System Defaults->All"
Range	1 Ω to 1 M Ω
Min	1 Ω
Max	1 M Ω
Initial S/W Revision	Prior to A.02.00

I/Q Cable Calibrate...

The I/Q cable calibration creates correction data for each of the front panel I/Q ports. This calibration data is used whenever no probe specific calibration data is available. It is important that all ports are calibrated using the same short BNC cable so that the data is comparable from port to port.

The guided calibration (front panel only) will show connection diagrams and guide you through the isolation calibration and calibrating each port. The calibration data for each port is stored separately, so as soon as a port is calibrated that data is saved and will be used. If you press "Exit" to exit the calibration process, the data for the ports already completed will still be used. It is recommended that a calibration be completed once started, or if exited, that it be properly done before the next use of the I/Q ports. The "Next" button will perform the calibration for the current port and then proceed to the next step in the calibration procedure. The "Back" button will return to the prior port in the procedure. Both keys and dialog buttons are supplied for ease of use. The dialog buttons are for mouse use and the softkeys for front panel use.

The calibration can also be done via SCPI, but no connection diagrams will be shown. You will have to make the correct connections before issuing each port calibration command. Again, it is recommended that all ports be calibrated at the same time.

The instrument state remains as it was prior to entering the calibration procedure except while a port is actually being calibrated. Once a port is calibrated it returns to the prior state. A port calibration is in process only from the time the "Next" button is pressed until the next screen is shown. For SCPI, this corresponds to the time from issuing the CAL:IQ:FLAT:I|B|Q|QB command until the operation is complete.

For example, if the prior instrument state is Cal Out = Off, Input = I+jQ, and Differential = Off, then up until the time the "Next" button is pressed the I Input and Q Input LEDs are on and the Cal Out, I-bar Input and Q-bar Input LEDs are off. Once the "Next" button is pressed for the I port calibration, only the Cal Out and I Input LEDs will be on and the others will be off. When the screen progresses to the next step ("Next" button again enabled), the prior state is restored and only the I Input and Q Input LEDs are on (Cal Out is off again).

The last calibration date and time for each port will be displayed. Any calibrations that are more than a day older than the most recent calibration will be displayed with the color amber.

Key Path	Input/Output, I/Q
Initial S/W Revision	Prior to A.02.00

I/Q Probe Setup

The set of I/Q probe setup parameters will change based on the type of probe that is sensed. All probe types have the Attenuation parameter, and all probe types can be calibrated. The remaining parameters are only available for some probe types and will not be shown when not available. The probe type is determined by and reported for only for the I and Q ports, never the I-bar or Q-bar ports. The menu title will be "<ch>: <probe id>", where "<ch>" is either "I" or "Q" and "<probe id>" is the type of probe. For example, for the I Probe setup with an Keysight 1130A probe connected to the I port, the title will be "I: 1130A".

Probe calibration data is stored for each probe type for each channel. When no probe is sensed, the probe type "Unknown" is used, and this is also treated like a probe type with its own calibration data. When a probe is changed, the calibration data for that probe type for that port is restored. An advisory message will be displayed showing the new probe type and the calibration status. The calibration data is stored permanently (survives a power cycle) and is not affected by a Preset or any of the Restore commands. When the probe has EEPROM identification (most newer Keysight probes have this), the calibration data is stored by probe serial number and port, so if you have two probes of the same type, the correct calibration data will be used for each. For probes that do not have EEPROM identification, the calibration data is stored by probe type and port and the instrument cannot distinguish between different probes of the same type. In all cases (with or without EEPROM identification), the calibration data is port specific, so it will not follow a specific probe from port to port if the probe is moved.

The "Unknown" probe type is used whenever no probe is sensed. When no calibration data exists for "Unknown" the latest cable calibration data is used (see "[I/Q Guided Calibration](#)" on page 259).

Attenuation

The attenuation is part of the calibration data stored with the probe type and is initially the value that was returned by the last calibration. You can modify this value and any changes will be stored with the calibration data and will survive power cycles and presets. When a probe calibration is performed the attenuation value will be overwritten by the calibration.

Key Path	Input/Output, I/Q, I Setup Q Setup, I Probe Q Probe
Remote Command	[:SENSe] :CORRection:IQ:I Q:ATTenuation:RATio <real> [:SENSe] :CORRection:IQ:I Q:ATTenuation:RATio?
Example	Set the attenuation for the current I probe to 100.00:1. CORR:IQ:I:ATT:RAT 100
Notes	Each probe type has its own attenuation setting. As probes are changed the attenuation value will reflect the new probe's setting. Changing the attenuation affects only the current probe type's setting and leaves all others unchanged. When the IQ Path is I+jQ, the Q probe attenuation setting must match the I Probe attenuation setting within 1 dB. If this is not the case, an error condition message is generated, 159;Settings Alert;I/Q mismatch:Attenuation.
Preset	Each probe type has its own default. The default for the "Unknown" probe type is 1:1.
State Saved	Saved with probe calibration data. It survives a power cycle and is not affected by a Preset or Restore.
Range	0.001 to 10000
Min	0.001

Max	10000
Initial S/W Revision	Prior to A.02.00

This is an alternate form of the SCPI that allows input as a power instead of a ratio.

Remote Command	<code>[:SENSe]:CORRection:IQ:I Q:ATTenuation <rel_amp1></code> <code>[:SENSe]:CORRection:IQ:I Q:ATTenuation?</code>
Example	Set the attenuation for the current I probe type to 100.00:1. <code>CORR:IQ:I:ATT 20 dB</code>
Range	-60 dB to +80 dB
Min	-60 dB
Max	+80 dB
Initial S/W Revision	Prior to A.02.00

Offset

Some active probes have DC offset capability. When one of these probes is connected this control will be visible. The signal is adjusted for the DC offset before entering the analyzer's port. This allows for removal of a DC offset before reaching the analyzer's input port voltage limits. For example, a signal that varies 1 V peak-to-peak with a DC offset equal to the analyzer's max input voltage would exceed the input limits of the analyzer for half its cycle. Removing the DC offset allows the analyzer to correctly process the entire signal.

Key Path	Input/Output, I/Q, I Setup Q Setup, I Probe Q Probe
Remote Command	<code>:INPut:OFFSet:I Q <voltage></code> <code>:INPut:OFFSet:I Q?</code>
Example	Remove a DC offset of -0.5 V from the I channel input. <code>INP:OFFS:I -0.5</code>
Notes	Only some probe types support Offset. For those that do, each probe type has its own Offset setting. As probes are changed the Offset value will reflect the new probe's setting. Changing the Offset affects only the current probe type's setting and leaves all others unchanged.
Preset	0 V
State Saved	Saved with probe calibration data. It survives power cycle and is not affected by Preset or Restore.
Range	-18 V to +18 V
Min	-18 V
Max	+18 V
Initial S/W Revision	Prior to A.02.00

Coupling

Some probe types allow coupling to reject low frequencies. This will filter out the DC component of a signal that is composed of a DC bias plus some AC signal. This control is visible only for probe types that have this capability.

Key Path	Input/Output, I/Q, I Setup Q Setup, I Probe Q Probe
Remote Command	:INPut:COUPling:I Q DC LFR1 LFR2 :INPut:COUPling:I Q?
Example	Set the probe to low frequency rejection below 1.7 Hz. INP:COUP:I LFR1
Notes	Only some probe types support Coupling. For those that do, each probe type has its own Coupling setting. As probes are changed the Coupling value will reflect the new probe's setting. Changing the Coupling affects only the current probe type's setting and leaves all others unchanged.
Preset	DC
State Saved	Saved with probe calibration data. It survives a power cycle and is not affected by a Preset or Restore.
Range	DC AC 1.7 Hz LFR1 AC 0.14 Hz LFR2
Readback Text	DC LFR1 LFR2
Initial S/W Revision	Prior to A.02.00

DC

Turns off low frequency rejection, allowing signals down to DC.

Key Path	Input/Output, I/Q, I Setup Q Setup, I Probe Q Probe, Coupling
Example	Turn off low frequency rejection on the I channel INP:COUP:I DC
Initial S/W Revision	Prior to A.02.00

LFR1

Turns on low frequency rejection, rejecting signal component lower than 1.7 Hz.

Key Path	Input/Output, I/Q, I Setup Q Setup, I Probe Q Probe, Coupling
Example	Turn on low frequency rejection on the I channel for frequencies lower than 1.7 Hz INP:COUP:I LFR1
Initial S/W Revision	Prior to A.02.00

LFR2

Turns on low frequency rejection, rejecting signal component lower than 0.14 Hz.

Key Path	Input/Output, I/Q, I Setup Q Setup, I Probe Q Probe, Coupling
Example	Turn on low frequency rejection on the I channel for frequencies lower than 0.14 Hz INP:COUP:I LFR2
Initial S/W Revision	Prior to A.02.00

Calibrate

Invokes the guided probe calibration. The guided probe calibration is context sensitive and depends on the channel (I or Q) and the Differential Input state. The calibration is only performed on the selected channel. When Differential Input is on, both the probe attached to the main port and the probe attached to the complementary port are calibrated. When Differential Input is off, only the probe attached to the main port is calibrated. See "[I/Q Guided Calibration](#)" on page 259.

Key Path	Input/Output, I/Q, I Setup Q Setup, I Probe Q Probe, Coupling
Readback Text	The last calibration date, or if no calibration exists, "(empty)". Last: <cal date> <cal time> Example: Last: 8/22/2007 1:02:49 PM
Initial S/W Revision	Prior to A.02.00

Clear Calibration

Clears the calibration data for the current port and probe. It does not clear the data for other probe types or other ports. If the sensed probe has EEPROM identification, only the data for that specific probe is cleared. After this command has completed, the probe calibration state will be the same as if no probe calibration had ever been performed for the specified channel and probe. The probe attenuation will be the default value for that probe type and the Cable Calibration frequency response corrections will be used. This command is dependent on the Differential Input state. When Differential Input is on, both the data for the probe attached to the main port and the data for the probe attached to the complementary port are cleared. When Differential Input is off, only data for the probe attached to the main port is cleared.

Key Path	Input/Output, I/Q, I Setup Q Setup, I Probe Q Probe
Remote Command	:CALibration:IQ:PROBe:I Q:CLEAr
Example	Clear the calibration data for the I channel and the current probe (with EEPROM identification) or probe type (without EEPROM identification). :CAL:IQ:PROBe:I:CLE
Initial S/W Revision	Prior to A.02.00

RF Calibrator

Lets you choose a calibrator signal to look at or turns the calibrator "off".

Key Path	Input/Output
Remote Command	<code>[:SENSe] :FEED:AREFERENCE REF50 REF4800 OFF</code> <code>[:SENSe] :FEED:AREFERENCE?</code>
Example	FEED:AREF REF50 selects the 50 MHz amplitude reference as the signal input. FEED:AREF REF4800 selects the 4.8 GHz amplitude reference as the signal input FEED:AREF OFF turns the calibrator "off" (switches back to the selected input – RF or I/Q)
Dependencies	Selecting an input (RF or I/Q) turns the Calibrator OFF. This is true whether the input is selected by the keys or with the [:SENSe]:FEED command. The 4.8 GHz internal reference is only available in some models and frequency range options. If the 4.8 GHz reference is not present, the 4.8 GHz softkey will be blanked, and if the REF4800 parameter is sent, the analyzer will generate an error.
Couplings	When one of the calibrator signals is selected, the analyzer routes that signal (an internal amplitude reference) to the analyzer, and changes the main input selection to RF so the calibrator signal can be seen. When you turn the calibrator off it does not switch back to the previously selected input.
Preset	OFF
State Saved	Saved in instrument state
Readback	Off, 50 MHz, 4.8 GHz
Initial S/W Revision	Prior to A.02.00

Remote Command	<code>:CALibration:SOURce:STATe OFF ON 0 1</code> <code>:CALibration:SOURce:STATe?</code>
Notes	For ESA backwards compatibility. In the ESA the calibrator was a separate output which you connected to the input and switched on with this command. In the X-Series, the ON parameter is aliased to the [:SENSe]:FEED:AREF REF50 command and the OFF parameter is aliased to [:SENSe]:FEED:AREF OFF. When CALibration:SOURce:STATe? is received, 1 will be returned if any of the references is selected and 0 if the Calibrator is "Off"
Preset	OFF
Initial S/W Revision	Prior to A.02.00

50 MHz

Selects the 50 MHz internal reference as the input signal.

Key Path	Input/Output, RF Calibrator
----------	-----------------------------

Example	:FEED:AREF REF50
Readback	50 MHz
Initial S/W Revision	Prior to A.02.00

4.8 GHz

Selects the 4.8 GHz internal reference as the input signal.

Key Path	Input/Output, RF Calibrator
Example	:FEED:AREF REF4800
Dependencies	The 4.8 GHz internal reference is only available in some models and frequency range options. If the 4.8 GHz reference is not present, the 4.8 GHz softkey will be blanked, and if the REF4800 parameter is sent, the analyzer will generate an error.
Readback	4.8 GHz
Initial S/W Revision	Prior to A.02.00
Modified at S/W Revision	A.03.00

Off

Switches the input back to the selected input (RF or I/Q)

Key Path	Input/Output, RF Calibrator
Example	:FEED:AREF OFF
Readback	Off
Initial S/W Revision	Prior to A.02.00

External Gain

Compensates for gain or loss in the measurement system outside the spectrum analyzer. The External Gain is subtracted from the amplitude readout (or the loss is added to the amplitude readout). So, the displayed signal level represents the signal level at the output of the device-under-test, which can be the input of an external device that provides gain or loss.

Entering an External Gain value does not affect the Reference Level, therefore the trace position on screen changes, as do all of the values represented by the trace data. Thus, the values of exported trace data, queried trace data, marker amplitudes, trace data used in calculations such as N dB points, trace math, peak threshold, etc., are all affected by External Gain. Changing the External Gain, even on a trace that is not updating, will immediately change all of the above, without new data needing to be taken.

NOTE

Changing the External Gain causes the analyzer to immediately stop the current sweep and prepare to begin a new sweep. The data will not change until the trace data updates because the offset is applied to the data as it is taken. If a trace is exported with a nonzero External Gain, the exported data will contain the trace data with the offset applied.

In the Spectrum Analyzer mode, a Preamp is the common external device providing gain or loss. In a measurement application mode like GSM or W-CDMA, the gain or loss could be from a BTS (Base Transceiver Station) or an MS (Mobile Station). So in the Spectrum Analyzer mode MS and BTS would be grayed out and the only choice would be Ext Preamp. Similarly in some of the digital communications applications, Ext Preamp will be grayed out and you would have a choice of MS or BTS.

Key Path	Input/Output
Couplings	The Ext Preamp, MS, and BS keys may be grayed out depending on which measurement is currently selected. If any of the grayed out keys are pressed, or the equivalent SCPI command is sent, an advisory message is generated.
Readback	1-of-N selection [variable]
Initial S/W Revision	Prior to A.02.00

Ext Preamp

This function is similar to the reference level offset function. Both affect the displayed signal level. Ref Lvl Offset is a mathematical offset only, no analyzer configuration is affected. Ext Preamp gain is used when determining the auto-coupled value of the Attenuator. The External Gain value and the Maximum Mixer Level settings are both part of the automatic setting equation for the RF attenuation setting. (10 dB of Attenuation is added for every 10 dB of External Gain.)

Note that the Ref Lvl Offset and Maximum Mixer Level are described in the Amplitude section. They are reset by the instrument Preset. The External Preamp Gain is reset by the "Restore Input/Output Defaults" or "Restore System Defaults->All functions. . The External Gain is subtracted from the amplitude readout so that the displayed signal level represents the signal level at the output of the device-under-test, which is the input of the external device that is providing gain or loss.

["More Information" on page 235](#)

Key Path	Input/Output, External Gain
Remote Command	<code>[:SENSe] :CORRection:SA[:RF]:GAIN <rel_ampl></code> <code>[:SENSe] :CORRection:SA[:RF]:GAIN?</code>
Example	CORR:SA:GAIN 10 sets the Ext Gain value to 10 dB CORR:SA:GAIN -10 sets the Ext Gain value to -10 dB (that is, an attenuation of 10 dB)
Notes	Does not auto return.
Dependencies	The reference level limits are determined in part by the External Gain/Atten, Max Mixer Level, and RF Atten. This key is grayed out in Modes that do not support External Gain
Preset	This is unaffected by Preset but is set to 0 dB on a "Restore Input/Output Defaults" or "Restore System Defaults->All"

State Saved	Saved in instrument state
Min	-120 dB
Max	120 dB
Readback	Preamp Gain, <Ext Gain value> dB
Backwards Compatibility SCPI	[:SENSe] :CORRection:OFFSet [:MAGNitude] The legacy "Ext Preamp Gain" key is now called "Ext Gain" and the sub-menu has choices of Ext Preamp MS BTS for backwards compatibility.
Initial S/W Revision	Prior to A.02.00
Modified at S/W Revision	A.14.00

More Information

The U7227A USB Preamplifier is an accessory for the X-Series Signal Analyzer that provides gain externally, and whose gain settings are automatically loaded into the analyzer over USB whenever it is connected to one of the analyzer's USB ports.

While the USB Preamplifier is plugged into one of the analyzer's USB ports, the analyzer will consider it to be in the signal path of the RF Input and will apply the calibration data from the USB Preamp to measurements taken at the RF Input (on 2 input boxes, it will be considered to be in the signal path of RF Input 1; it is not supported for RF Input 2).

The USB Preamplifier contains its own cal data. This includes a noise trace suitable for use with NFE, for those models which support NFE. The act of connecting the Preamp to USB will cause the cal data to be downloaded from the preamp. When this happens an informational message is provided saying "Cal data loaded from USB Preamp". The analyzer will then automatically apply the calibration factors loaded from the Preamp in any measurement that supports the USB Preamp.

The External Preamp Gain setting may still be used, even though it is not required for the USB Preamp (since the USB Preamp supplies its own gain data to the analyzer which is applied automatically). Connecting the USB Preamp does not change the External Preamp Gain setting, however unless you have another gain or attenuation element in the signal path, the appropriate setting for External Preamp Gain is 0 dB.

Overload detection and reporting will apply when the USB preamplifier is connected to USB. The USB Preamplifier has its own overload detector which reports overloads to the instrument over USB. This generates an error condition, "Input Overload;USB Preamp."

If, while the USB Preamp is connected to USB, a measurement is selected that does not support the USB preamplifier, the "No result; Meas invalid with Preamp" error condition is generated.

MS

Sets an external gain/attenuation value for MS (Mobile Station) tests.

Key Path	Input/Output, External Gain
Remote Command	[:SENSe] :CORRection:MS [:RF] :GAIN <rel_amp1> [:SENSe] :CORRection:MS [:RF] :GAIN?

Example	CORR:MS:GAIN 10 sets the Ext Gain value to 10 dB CORR:MS:GAIN -10 sets the Ext Gain value to -10 dB (that is, a loss of 10 dB.)
Notes	Does not auto return.
Dependencies	The reference level limits are determined in part by the External Gain, Max Mixer Level, RF Atten This key is grayed out in modes that do not support MS.
Preset	This is unaffected by a Preset but is set to 0 dB on a "Restore Input/Output Defaults" or "Restore System Defaults->All"
State Saved	Saved in instrument state.
Min	-100 dB
Max	100 dB
Readback	MS, <Ext Gain value> dB
Initial S/W Revision	Prior to A.02.00

Remote Command	<code>[:SENSe] :CORRection:MS[:RF]:LOSS <rel_ampl></code> <code>[:SENSe] :CORRection:MS[:RF]:LOSS?</code>
Example	CORR:MS:LOSS 10 sets the Ext Gain value to -10 dB, and subsequently querying :LOSS will give 10 dB CORR:MS:LOSS -10 sets the Ext Gain value to 10 dB, and subsequently querying :LOSS will give -10 dB
Notes	A positive value of <rel_ampl> in the above command means a loss and a negative value indicates a gain. Anytime :LOSS is set it sets :GAIN to the negative value of the parameter sent. Anytime :LOSS is queried it gives the negative of :GAIN
Preset	This is unaffected by a Preset but is set to 0 dB on a "Restore Input/Output Defaults" or "Restore System Defaults->All"
Min	100 dB
Max	-100 dB
Initial S/W Revision	Prior to A.02.00

BTS

Sets an external attenuation value for BTS (Base Transceiver Station) tests.

Key Path	Input/Output, External Gain
Remote Command	<code>[:SENSe] :CORRection:BTS[:RF]:GAIN <rel_ampl></code> <code>[:SENSe] :CORRection:BTS[:RF]:GAIN?</code>
Example	CORR:BTS:GAIN 10 sets the Ext Gain value to 10 dB CORR:BTS:GAIN -10 sets the Ext Gain value to -10 dB (that is, a loss of 10 dB.)

Notes	Does not auto return.
Dependencies	The reference level limits are determined in part by the External Gain, Max Mixer Level, RF Atten This key is grayed out in modes that do not support BTS.
Preset	This is unaffected by a Preset but is set to 0 dB on a "Restore Input/Output Defaults" or "Restore System Defaults->All"
State Saved	Saved in instrument state.
Min	-100 dB
Max	100 dB
Readback	BTS, <Ext Gain value> dB
Initial S/W Revision	Prior to A.02.00

Remote Command	<code>[:SENSe] :CORRection:BTS[:RF]:LOSS <rel_ampl></code> <code>[:SENSe] :CORRection:BTS[:RF]:LOSS?</code>
Example	<code>CORR:BTS:LOSS 10</code> sets the Ext Gain value to -10 dB, and subsequently querying <code>:LOSS</code> will give 10 dB <code>CORR:BTS:LOSS -10</code> sets the Ext Gain value to 10 dB, and subsequently querying <code>:LOSS</code> will give -10 dB
Notes	A positive value of <rel_ampl> in the above command means a loss and a negative value indicates a gain. Anytime <code>:LOSS</code> is set it sets <code>:GAIN</code> to the negative value of the parameter sent. Anytime <code>:LOSS</code> is queried it gives the negative of <code>:GAIN</code>
Preset	This is unaffected by a Preset but is set to 0 dB on a "Restore Input/Output Defaults" or "Restore System Defaults->All"
Min	100 dB
Max	-100 dB
Initial S/W Revision	Prior to A.02.00

I Ext Gain

This function affects the I channel input. However, when Q Gain in I+jQ is set to Same as I Gain, this value is applied to both I and Q channel inputs.

Key Path	Input/Output, External Gain
Remote Command	<code>[:SENSe] :CORRection:IQ:I:GAIN <rel_ampl></code> <code>[:SENSe] :CORRection:IQ:I:GAIN?</code>
Example	Set the I Ext Gain to 10 dB <code>CORR:IQ:I:GAIN 10</code> Set the I Ext Gain to -10 dB (that is, a loss of 10 dB.)

	CORR:IQ:I:GAIN -10
Dependencies	Not available unless option BBA is installed
Preset	0 dB This is unaffected by a Preset but is set to 0 dB on a "Restore Input/Output Defaults" or "Restore System Defaults->All"
State Saved	Saved in instrument state.
Min	-100 dB
Max	100 dB
Readback Text	I Gain, <I Ext Gain> dB
Initial S/W Revision	Prior to A.02.00

Q Ext Gain

This function affects the Q channel input.

Key Path	Input/Output, External Gain
Remote Command	<code>[:SENSe]:CORRection:IQ:Q:GAIN <rel_ampl></code> <code>[:SENSe]:CORRection:IQ:Q:GAIN?</code>
Example	Set the Q Ext Gain to 10 dB <code>CORR:IQ:Q:GAIN 10</code> Set the Q Ext Gain to -10 dB (that is, a loss of 10 dB.) <code>CORR:IQ:Q:GAIN -10</code>
Dependencies	Not available unless option BBA is installed.
Preset	0 dB This is unaffected by a Preset but is set to 0 dB on a "Restore Input/Output Defaults" or "Restore System Defaults->All"
State Saved	Saved in instrument state
Min	-100 dB
Max	100 dB
Readback Text	Q Gain, <I Ext Gain> dB
Initial S/W Revision	Prior to A.02.00

Filter Type

This parameter allows you to select the type of IF filter (post ADC, digital filter) that is used. This is an advanced control that normally does not need to be changed.

Key Path	Meas Setup, Advanced
Mode	BASIC
Remote Command	[:SENSe] :SPEctrum:DIF:FILTer:TYPE GAUSSian FLATtop SNYQuist RSNYquist RCOSine RRCosine [:SENSe] :SPEctrum:DIF:FILTer:TYPE?
Example	SPEC:DIF:FILT:TYPE GAUS SPEC:DIF:FILT:TYPE?
Dependencies	Gaussian and Flattop are available in all DIF configurations. For the other filter types, the filters are only available when Option DP2, B40, or wider IF Bandwidth option is installed.
Preset	FLAT
State Saved	Saved in instrument state.
Range	Gaussian Flattop When Option DP2, B40, or wider IF Bandwidth option is installed, the range is as follows. Gaussian Flattop Short Nyquist Root Short Nyquist Raised Cosine Root RaisedCosine
Backwards Compatibility SCPI	[:SENSe] :SPEctrum:BANDwidth:PFFT:TYPE [:SENSe] :SPEctrum:BWIDth:PFFT:TYPE [:SENSe] :SPEctrum:BANDwidth BWIDth:IF:SHAPE
Initial S/W Revision	Prior to A.02.00
Modified at S/W Revision	A.13.00

Remote Command	[:SENSe] :SPEctrum:WBIF:FILTer [:TYPE] GAUSSian NONE NYQuist RNYQuist RCOSine RRCosine [:SENSe] :SPEctrum:WBIF:FILTer [:TYPE] ?
-----------------------	--

Restore Input/Output Defaults

This selection causes the group of settings and data associated with the **Input/Output** key to be a reset to their default values. In addition, when a Source is installed, licensed and selected, Restore Input/Output defaults will initiate a Source Preset.

This level of Restore System Defaults does not affect any other system settings or mode settings and does not cause a mode switch. All the features described in this section are reset using this key, including Input Corrections and Data (described in the Corrections section).

Key Path	Input/Output
Example	:SYST:DEF INP presets all the Input/Output variables to their factory default values.
Notes	Refer to the Utility Functions for information about Restore System Defaults and the complete description of the :SYSTem:DEFAult INPut: command.
Initial S/W Revision	Prior to A.02.00

Freq Ref In

Specifies the frequency reference as being the internal reference at the rear panel input labeled EXT REF IN, a 1 pulse per second signal at the EXT REF IN input,, external reference or sensing the presence of a signal at the EXT REF IN input.

When the frequency reference is set to internal, the internal 10 MHz reference is used even if an external reference is connected.

When the frequency reference is set to external, the instrument will use the external reference. However, if there is no external signal present, or it is not within the proper amplitude range, a condition error message is generated. When the external signal becomes valid, the error is cleared.

When the frequency reference is set to Pulse, the instrument expects a 1 pulse per second signal at the EXT REF IN input. The instrument uses this signal to adjust the frequency of the internal reference.

If Sense is selected, the instrument checks whether a signal is present at the external reference connector. If it senses a signal within 5 ppm of the External Ref Freq (as set on the **External Ref Freq** softkey), it will automatically switch to the external reference. If it senses a 1 pulse per second signal, it enters Pulse mode, wherein the signal is used to adjust the internal reference. When no signal is present, it automatically switches to the internal reference. No message is generated as the reference switches between pulse, external and internal. The monitoring of the external reference occurs approximately on 1 millisecond intervals, and never occurs in the middle of a measurement acquisition, only at the end of the measurement (end of the request).

If for any reason the instrument's frequency reference is not able to obtain lock, Status bit 1 in the Questionable Frequency register will be true and a condition error message is generated. When lock is regained, Status bit 1 in the Questionable Frequency register will be cleared and the condition error will be cleared.

If an external frequency reference is being used, you must enter the frequency of the external reference if it is not exactly 10 MHz. The External Ref Freq key is provided for this purpose.

Key Path	Input/Output
Remote Command	<code>[[:SENSe]:ROSCillator:SOURce:TYPE INTernal EXTernal SENSE PULSE</code> <code>[[:SENSe]:ROSCillator:SOURce:TYPE?</code>
Dependencies	The PULSE parameter, and support of the 1 pps signal at the EXT REF IN input, are not available in firmware prior to A.13.00. They are also not available in some model numbers. If not available, the Pulse key will be blank, and sending the PULSE parameter via SCPI will generate an error:
Preset	This is unaffected by a Preset but is set to SENSE on a "Restore Input/Output Defaults" or "Restore System Defaults->All".
State Saved	Saved in instrument state.
Status Bits/OPC dependencies	STATus:QUESTIONable:FREQUENCY bit 1 set if unlocked.
Backwards Compatibility Notes	Freq Ref In was not saved in state in the legacy instruments. It is a part of state in the X-Series.
Initial S/W Revision	Prior to A.02.00
Modified at S/W Revision	A.14.00

Remote Command	<code>[:SENSe] :ROSCillator:SOURce?</code>
Notes	<p>The query <code>[SENSe]:ROSCillator:SOURce?</code> returns the current switch setting. This means:</p> <ol style="list-style-type: none"> 1. If it was set to <code>SENSe</code> but there is no external reference nor 1 pps signal so the instrument is actually using the internal reference, then this query returns <code>INTernal</code> and not <code>SENSe</code>. 2. If it was set to <code>SENSe</code> and there is an external reference present, the query returns <code>EXTernal</code> and not <code>SENSe</code>. 3. If it was set to <code>SENSe</code> and there is a 1 pps signal present, the query returns <code>PULSe</code> and not <code>SENSe</code>. 4. If it was set to <code>EXTernal</code>, then the query returns "EXTernal" 5. If it was set to <code>INTernal</code>, then the query returns "INTernal". 6. If it was set to <code>PULSe</code>, then the query returns "PULSe"
Preset	<code>SENSe</code>
Backwards Compatibility Notes	<p>The query <code>[SENSe]:ROSCillator:SOURce?</code> was a query-only command in ESA which always returned whichever reference the instrument was using. The instrument automatically switched to the ext ref if it was present.</p> <p>In PSA (which had no sensing) the command <code>[SENSe]:ROSCillator:SOURce</code> set the reference (INT or EXT), so again its query returned the actual routing.</p> <p>Thus the query form of this command is 100% backwards compatible with both instruments.</p>
Initial S/W Revision	Prior to A.02.00

Remote Command	<code>[:SENSe] :ROSCillator:SOURce INTernal EXTernal</code>
Notes	For PSA compatibility the command form is provided and is directly mapped to <code>[SENSe]:ROSCillator:SOURce:TYPE</code>
Initial S/W Revision	Prior to A.02.00

Sense

If Sense is selected, the instrument checks whether a signal is present at the external reference connector. If it senses a signal within 5 ppm of the External Ref Freq (as set on the **External Ref Freq** softkey), it will use this signal as an External Reference. If it senses a 1 pulse per second signal, it will use this signal to adjust the internal reference by adjusting the User setting of the Timebase DAC. When no signal is present, it automatically switches to the internal reference.

Key Path	Input/Output, Freq Ref In
Example	<code>:ROSC:SOUR:TYPE SENS</code>
Couplings	If set to <code>SENSe</code> and the analyzer senses a 1 pulse per second signal, it sets the System, Alignments, Timebase DAC setting to "User". This setting survives Preset and Power Cycle but is set to "Calibrated" on a System, Restore Defaults, Align or a System, Restore Defaults, All

Readback	Sense
Initial S/W Revision	Prior to A.02.00
Modified at S/W Revision	A.14.00

Internal

The internal reference is used. A 1 pps signal at the EXT REF IN port, or a signal there between 1 and 50 MHz, will cause a warning triangle to appear in the settings panel next to the word “INTERNAL”, but will otherwise be ignored.

Key Path	Input/Output, Freq Ref In
Example	:ROSC:SOUR:TYPE INT
Readback	Internal
Initial S/W Revision	Prior to A.02.00
Modified at S/W Revision	A.14.00

External

The external reference is used.

Key Path	Input/Output, Freq Ref In
Example	:ROSC:SOUR:TYPE EXT
Readback	External
Initial S/W Revision	Prior to A.02.00

Pulse

The internal reference continues to be the frequency reference for the instrument in that it determines the reference contribution to the phase noise, but its average frequency is adjusted to follow the 1 pps signal at the EXT REF IN input. Therefore, the analyzer frequency accuracy will be dominated by the aging rate of the 1 pps signal instead of the aging rate of the internal reference, except during the time it takes to lock to a new 1 pps signal, approximately 10 minutes.

See "[More Information](#)" on page 243

Key Path	Input/Output, Freq Ref In
Example	:ROSC:SOUR:TYPE PULS
Couplings	Sets the System, Alignments, Timebase DAC setting to “User”. This setting survives Preset and Power Cycle but it set to “Calibrated” on a System, Restore Defaults, Align or a System, Restore Defaults, All

Readback	Pulse
Initial S/W Revision	A.14.00

More Information

When a 1 pps signal is present at the EXT REF IN input, and either **Pulse** or **Sense** is selected, the internal reference frequency is affected by this signal; in effect, it “learns” a new accuracy setting. This setting can be seen by going to the **System, Alignments, Timebase Dac** menu, and looking at the **User** key in that menu. You will note that User has become automatically selected, and that the value shown on the **User** key is the updated value of the timebase DAC as “learned” from the 1 pps signal. Note that this replaces any value the user might have previously set on this key.

Once the setting is learned the user may remove the 1 pps signal; the User setting for the Timebase DAC is retained until you manually select “Calibrated” or execute a System, Restore Defaults, Align or a System, Restore Defaults, All. If you want to make the User setting permanent there is information in the Service Guide that tells you how to change the Calibrated setting of the Timebase DAC.

Note also that if the 1 pps signal is removed when Sense is selected, the analyzer will simply switch to the normal state of the Internal reference and display SENSE:INT in the Settings Panel. However, if the 1 pps signal is removed when Pulse is selected, the analyzer will generate an error

The J7203A Atomic Frequency Reference is an accessory for the X-Series Signal Analyzer that provides a highly accurate 1 pps timebase to use in conjunction with the Pulse setting. With the J7203A, the 1 pps signal is guaranteed to meet the input requirements of the EXT REF IN port, and the improved accuracy of the analyzer’s internal frequency reference is specified. This is the only 1 pps signal that is guaranteed to function properly with the X-Series.

Ext Ref Freq

This key tells the analyzer the frequency of the external reference. When the external reference is in use (either because the reference has been switched to External or because the Reference has been switched to Sense and there is a valid external reference present) this information is used by the analyzer to determine the internal settings needed to lock to that particular external reference signal.

For the instrument to stay locked, the value entered must be within 5 ppm of the actual external reference frequency. So it is important to get it close, or you risk an unlock condition.

Note that this value only affects the instrument’s ability to lock. It does not affect any calculations or measurement results. See “Freq Offset” in the Frequency section for information on how to offset frequency values.

Key Path	Input/Output, Freq Ref In
Remote Command	<code>[:SENSe] :ROSCillator:EXTernal:FREQuency <freq></code> <code>[:SENSe] :ROSCillator:EXTernal:FREQuency?</code>
Example	ROSC:EXT:FREQ 20 MHz sets the external reference frequency to 20 MHz, but does not select the external reference. ROSC:SOUR:TYPE EXT selects the external reference.
Dependencies	Still available with Internal or Pulse selected, to allow setup for when External is in use. However, the

	setting has no effect if the Internal Reference is in use (Freq Ref In set to Internal, Pulse, or SENSE:INT or SENSE:PULSE).
Preset	This is unaffected by a Preset but is set to 10 MHz on a "Restore Input/Output Defaults" or "Restore System Defaults->All"
Min	CXA: 10 MHz EXA: 10 MHz MXA: 1 MHz PXA: 1 MHz
Max	CXA: 10 MHz EXA: 10 MHz EXA with option R13: 20 MHz MXA: 50 MHz PXA: 50 MHz
Default Unit	Hz
Initial S/W Revision	Prior to A.02.00
Modified at S/W Revision	A.14.00

External Reference Lock BW

This control lets you adjust the External Reference phase lock bandwidth. This control is available in some models of the X-Series.

The PXA variable reference loop bandwidth allows an external reference to be used and have the analyzer close-in phase noise improved to match that of the reference. This could result in an improvement of tens of decibels. The choice of "Wide" or "Narrow" affects the phase noise at low offset frequencies, especially 4 to 400 Hz offset. When using an external reference with superior phase noise, we recommend setting the external reference phase-locked-loop bandwidth to wide (60 Hz), to take advantage of that superior performance. When using an external reference with inferior phase noise performance, we recommend setting that bandwidth to narrow (15 Hz). In these relationships, inferior and superior phase noise are with respect to -134 dBc/Hz at 30 Hz offset from a 10 MHz reference. Because most reference sources have phase noise behavior that falls off at a rate of 30 dB/decade, this is usually equivalent to -120 dBc/Hz at 10 Hz offset.

Key Path	Input/Output, Freq Ref In
Scope	Mode Global
Remote Command	[[:SENSE]:ROSCillator:BANDwidth WIDE NARROW [:SENSE]:ROSCillator:BANDwidth?
Example	ROSC:BAND WIDE

Dependencies	Still available with Internal or Pulse selected, to allow setup for when External is in use. However, the setting has no effect if the Internal Reference is in use (Freq Ref In set to Internal, Pulse, or SENSE:INT or SENSE:PULSE). This key only appears in analyzers equipped with the required hardware.
Preset	This is unaffected by a Preset but is set to Narrow on a "Restore Input/Output Defaults" or "Restore System Defaults -> All"
State Saved	Saved in Input/Output state.
Initial S/W Revision	A.04.00
Modified at S/W Revision	A.14.00

External Ref Coupling

Only appears with option ERC installed and licensed.

This function lets you couple the sweep system of the analyzer to the state of the External Reference. If **Normal** is selected, data acquisition proceeds regardless of the state of the External Reference. When you select **Ext Ref Out Of Range Stops Acquisition**, the data acquisition (sweep or measurement) stops when either the "521, External ref out of range" or the "503, Frequency Reference unlocked" error message is asserted. Note that this will only take place if the **Freq Ref In** selection is **External**.

With the acquisition stopped, the data display will stop updating (even if this occurs in the middle of a sweep or measurement) and no data will be returned to a READ? or MEASure? query; that is, these queries will not complete because the analyzer will not respond to them. Furthermore, no response will be generated to a *WAI? or *OPC? query.

Proper SCPI sequences are shown below, which will always fail to return if the acquisition stops during the requested sweep or measurement. Note that, for predictable operation of this function, it is best to operate the analyzer in single measurement mode (INIT:CONT OFF), because if operating in continuous mode, the analyzer may respond to the above queries even after the acquisition stops, with data left over from the previous acquisition.

```
:INIT:CONT OFF
:INIT:IMM;*OPC?
--
:INIT:CONT OFF
:INIT:IMM;*WAI?
--
:INIT:CONT OFF
:READ?
--
:INIT:CONT OFF
```

:MEASure?

When the acquisition ceases, in addition to the error condition(s) described above, a popup error message will be generated informing you that the acquisition has ceased due to an invalid external reference. This message will stay on the screen while the acquisition is suspended.

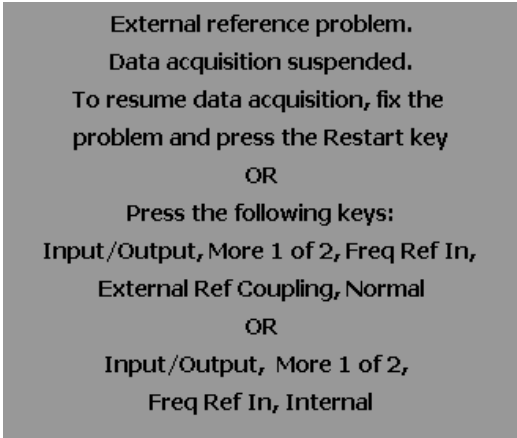

If you press the Restart key this message will be taken off the screen and a new acquisition will be attempted. If the External Reference problem persists the message will re-appear. You can also remove the message by changing back to the **Normal** setting of Sweep/Ext Ref Coupling, or by pressing **Freq Ref In, Internal**, or **Freq Ref In, Sense**, or **Restore Input/Output Defaults**.

The setting of External Ref Coupling is persistent across power-cycling and is not reset with a Preset. It is reset to the default state (Normal) when **Restore Input/Output Defaults** is invoked, which will also restart normal data acquisition.

The detection of invalid external reference is under interrupt processing. If the external reference becomes invalid then returns to valid in too short a time, no error condition will be detected or reported and therefore the acquisition will not be stopped.

Key Path	Input/Output, Freq Ref In
Mode	All
Remote Command	[:SENSe] :ROSCillator :COUPling NORMal NACquisition [:SENSe] :ROSCillator :COUPling ?
Preset	This setting is persistent: it survives power-cycling or a Preset and is reset with Restore Input/Output defaults.
State Saved	Not saved in instrument state
Readback	Normal Stop Acq
Initial S/W Revision	A.02.00

Output Config

Accesses keys that configure various output settings, like the frequency reference output, trigger output and analog output.

Key Path	Input/Output
Backwards Compatibility Notes	In ESA there was not a user interface to enable the Video Output (Analog Output), Trigger Output, or Gate Output. In the X-Series each of these physical connectors requires configuration, thus the user interface has been added for X-Series, along with the potential for an output you think is always on to be switched off.
Initial S/W Revision	Prior to A.02.00

Trig Out

Select the type of output signal that will be output from the Trig 1 Out, or Trig 2 Out connectors.

Key Path	Input/Output, Output Config
Remote Command	:TRIGger TRIGger1 TRIGger2[:SEquence]:OUTPut HSWP MEASuring MAIN GATE GTRigger OEVEN SPOint SSWeep SSEtled S1Marker S2Marker S3Marker S4Marker OFF :TRIGger TRIGger1 TRIGger2[:SEquence]:OUTPut?
Example	TRIG:OUTP HSWP TRIG2:OUTP GATE
Dependencies	The second Trigger output (Trig 2 Out) does not appear in all models; in models that do not support it, the Trig 2 Out key is blanked, and sending the SCPI command for this output generates an error, "Hardware missing; Not available for this model number" In models that do not support the Trigger 2 output, this error is returned if trying to set Trig 2 Out and a query of Trig 2 Out returns OFF.
Preset	Trigger 1: Sweeping (HSWP) Trigger 2: Gate This is unaffected by a Preset but is preset to the above values on a "Restore Input/Output Defaults" or "Restore System Defaults->All"
State Saved	Saved in instrument state
Initial S/W Revision	Prior to A.02.00

Polarity

Sets the output to the Trig 1 Out, or Trig 2 Out, connector to trigger on either the positive or negative polarity.

Key Path	Input/Output, Output Config, Trig 1/2 Output
Remote Command	:TRIGger TRIGger1 TRIGger2[:SEquence]:OUTPut:POLarity POSitive NEGative :TRIGger TRIGger1 TRIGger2[:SEquence]:OUTPut:POLarity?
Example	TRIG1:OUTP:POL POS
Preset	This is unaffected by a Preset but is set to POSitive on a "Restore Input/Output Defaults" or "Restore System Defaults->All"

State Saved	Saved in instrument state
Initial S/W Revision	Prior to A.02.00

Off

Selects no signal to be output to the Trig 1 Out, or Trig 2 Out, connector.

Key Path	Input/Output, Output Config, Trig 1/2 Output
Example	TRIG1:OUTP OFF
Readback	Off
Initial S/W Revision	Prior to A.02.00

Sweeping (HSWP)

Selects the Sweeping Trigger signal to be output to the Trig 1 Out, or Trig 2 Out, connector when a measurement is made. This signal has historically been known as "HSWP" (High = Sweeping), and is 5 V TTL level with 50 ohm output impedance.

Key Path	Input/Output, Output Config, Trig 1/2 Output
Example	TRIG1:OUTP HSWP
Readback	Sweeping
Initial S/W Revision	Prior to A.02.00

Measuring

Selects the Measuring trigger signal to be output to the Trig 1 Out, or Trig 2 Out, connector. This signal is true while the Measuring status bit is true.

Key Path	Input/Output, Output Config, Trig 1/2 Output
Example	TRIG1:OUTP MEAS
Readback	Measuring
Initial S/W Revision	Prior to A.02.00

Main Trigger

Selects the current instrument trigger signal to be output to the Trig 1 Out, or Trig 2 Out, connector.

Key Path	Input/Output, Output Config, Trig 1/2 Output
----------	---

Example	TRIG1:OUTP MAIN
Readback	Main Trigger
Initial S/W Revision	Prior to A.02.00

Gate Trigger

Selects the gate trigger signal to be output to the Trig 1 Out, or Trig 2 Out, connector. This is the source of the gate timing, not the actual gate signal.

Key Path	Input/Output, Output Config, Trig 1/2 Output
Example	TRIG1:OUTP GTR
Readback	Gate Trigger
Initial S/W Revision	Prior to A.02.00

Gate

Selects the gate signal to be output to the Trig 1 Out, or Trig 2 Out, connector. The gate signal has been delayed and its length determined by delay and length settings. When the polarity is positive, a high on the Trig 1 Out, or Trig 2 Out, represents the time the gate is configured to pass the signal.

Key Path	Input/Output, Output Config, Trig 1/2 Output
Example	TRIG1:OUTP GATE
Readback	Gate
Initial S/W Revision	Prior to A.02.00

Source Point Trigger

Selects the gate signal to be output to the Trig 1 Out, or Trig 2 Out, connector for use as the Point Trigger when operating an external source in Tracking mode. When Ext Trigger 1 is selected as the Point Trigger under Source, the Source Point Trigger under Trig1 Out automatically gets selected. Similarly, when Ext Trigger 2 is selected as the Point Trigger under Source, the Source Point Trigger key under Trig 2 Out automatically gets selected

Key Path	Input/Output, Output Config, Trig 1/2 Output
Example	TRIG1:OUTP SPO
Readback	Source Point
Initial S/W Revision	Prior to A.02.00

Odd/Even Trace Point

Selects either the odd or even trace points as the signal to be output to the Trig 1 Out, or Trig 2 Out, connector when performing swept spectrum analysis. When the polarity is positive, this output goes high during the time the analyzer is sweeping past the first point (Point 0) and every other following trace point. The opposite is true if the polarity is negative.

Key Path	Input/Output, Output Config, Trig 1/2 Output
Example	TRIG1:OUTP OEV
Readback	Odd/Even
Initial S/W Revision	Prior to A.02.00

Analog Out

This menu lets you control which signal is fed to the “Analog Out” connector on the analyzer rear panel.

See ["More Information" on page 250](#)

Key Path	Input/Output, Output Config
Remote Command	:OUTPut:ANALog OFF SVIDeo LOGVideo LINVideo DAUDio :OUTPut:ANALog?
Example	OUTP:ANAL SVIDeo ! causes the analog output type to be Screen Video
Preset	This is unaffected by Preset but is set to DAUDio on a "Restore Input/Output Defaults" or "Restore System Defaults->All
Preset	OFF
State Saved	Saved in Input/Output State
Readback line	1-of-N selection [variable]
Backwards Compatibility Notes	Prior to A.04.00, OFF was the default functionality except when in the Analog Demod application or with Tune and Listen, in which case it was DAUDio, and there was no selection menu. So for backwards compatibility with earlier X-Series firmware versions, Auto (:OUTP:ANAL:AUTO ON) will duplicate the prior behavior. The DNWB and SANalyzer parameters, which were legal in PSA but perform no function in the X-Series, are accepted without error.
Initial S/W Revision	A.04.00

More Information

The table below gives the range for each output.

Analog Out	Nominal Range exc. (10% overrange)	Scale Factor	Notes
Off	0 V		

Analog Out	Nominal Range exc. (10% overrange)	Scale Factor	Notes
Screen Video	0 – 1 V open circuit	10%/division	8566 compatible
Log Video	0 – 1 V terminated	1/(192.66 dB/V)	dB referenced to mixer level, 1V out for –10 dBm at the mixer.
Linear Video	0 – 1 V terminated	100%/V	Linear referenced to Ref Level, 1 V out for RF envelope at the Ref Level.
Demod Audio	(varies with analyzer setting)		

Auto

Selects the Auto state for the Analog Output menu. In this state, the Analog Output will automatically be set to the most sensible setting for the current mode or measurement.

If you make a selection manually from the Analog Out menu, this selection will remain in force until you change it (or re-select Auto), even if you go to a mode or measurement for which the selected output does not apply.

Key Path	Input/Output, Output Config, Analog Out
Remote Command	OUTPut:ANALog:AUTO OFF ON 0 1 OUTPut:ANALog:AUTO?
Example	OUTP:ANAL:AUTO ON
Preset	ON
State Saved	Saved in Input/Output State
Initial S/W Revision	A.04.00

Off

Turns off the analog output.

Key Path	Input/Output, Output Config, Analog Out
Example	OUTP:ANAL OFF ! causes the analog output to be off
Readback Text	Off
Initial S/W Revision	A.04.00

Screen Video

Selects the analog output to be the screen video signal. In this mode, the pre-detector data is output to the Analog Out connector. The output looks very much like the trace displayed on the analyzer's screen,

and depends on the Log/Lin display Scale, Reference Level, and dB per division, but is not influenced by the selected detector or any digital flatness corrections or trace post-processing (like Trace Averaging).

Note that this mode is similar to the Analog Output of the HP 8566 family and the Video Out (opt 124) capability of the Keysight PSA analyzer (E444x), although there are differences in the behavior.

Key Path	Input/Output, Output Config, Analog Out
Example	OUTP:ANAL SVID
Dependencies	<p>Because the Screen Video output uses one of the two IF processing channels, only one detector is available while Screen Video is selected. All active traces will change to use the same detector as the selected trace when Screen Video is activated.</p> <p>Screen Video output is not available while any EMI Detector is selected (Quasi Peak, RMS Average or EMI Average), because these detectors use both IF processing channels. Consequently, if the user chooses an EMI Detector, there will be no Screen Video output.</p> <p>The output holds at its last value during an alignment and during a marker count. After a sweep:</p> <ul style="list-style-type: none"> • If a new sweep is to follow (as in Continuous sweep mode), the output holds at its last value during the retrace before the next sweep starts. If the analyzer is in zero-span, there is no retrace, as the analyzer remains tuned to the Center Frequency and does not sweep. Therefore, in zero-span, the output simply remains live between display updates. • If no new sweep is to follow (as in Single sweep mode), the output remains live, and continues to show the pre-detector data <p>This function depends on optional capability; the key will be blanked and the command will generate an "Option not available" error unless you have Option YAV or YAS licensed in your instrument.</p>
Couplings	Screen Video output changes while in FFT Sweeps, so for measurements that use exclusively FFT Sweeps, or if the user manually chooses FFT Sweeps, the Screen Video output will look different than it does in swept mode.
Readback Text	Screen Video
Backwards Compatibility Notes	See " Backwards Compatibility: " on page 252, below.
Initial S/W Revision	A.04.00

Backwards Compatibility:

The Screen Video function is intended to be very similar to the 8566 Video Output and the PSA Option 124. However, unlike the PSA, it is not always on; it must be switched on by the Screen Video key. Also, unlike the PSA, there are certain dependencies (detailed above) – for example, the Quasi Peak Detector is unavailable when Screen Video is on.

Furthermore, the PSA Option 124 hardware was unipolar and its large range was padded to be exactly right for use as a Screen Video output. In the X-Series, the hardware is bipolar and has a wider range to accommodate the other output choices. Therefore, the outputs won't match up exactly and users may have to modify their setup when applying the X-Series in a PSA application.

Log Video (RF Envelope, Ref=Mixer Level)

Selects the analog output to be the log of the video signal. In this mode, the pre-detector data is output to the Analog Out connector with a Log scaling. The output is referenced to the current level at the mixer, does not depend on display settings like Reference Level or dB per division, and it is not influenced by the

selected detector or any digital flatness corrections or trace post-processing (like Trace Averaging), but does change with input attenuation.

The output is designed so that full scale (1 V) corresponds to -10 dBm at the mixer. The full range (0–1 V) covers 192.66 dB ; thus, 0 V corresponds to -202.66 dBm at the mixer.

Key Path	Input/Output, Output Config, Analog Out
Example	OUTP:ANAL LOGV
Dependencies	<p>Because the Log Video output uses one of the two IF processing channels, only one detector is available while Screen Video is selected. All active traces will change to use the same detector as the selected trace when Log Video is activated.</p> <p>Log Video output is not available while any EMI Detector is selected (Quasi Peak, RMS Average or EMI Average), because these detectors use both IF processing channels. Consequently, if the user chooses an EMI Detector, there will be no Log Video output.</p> <p>The output holds at its last value during an alignment, during a marker count, and during retrace (after a sweep and before the next sweep starts).</p> <p>This function depends on optional capability. The key will be blanked and the command will generate an “Option not available” error unless you have Option YAV licensed in your instrument.</p>
Couplings	Log Video output changes while in FFT Sweeps, so for measurements that use exclusively FFT Sweeps, or if the user manually chooses FFT Sweeps, the Log Video output will look different than it does in swept mode.
Readback Text	Log Video
Initial S/W Revision	A.04.00

Linear Video (RF Envelope, Ref=Ref Level)

Selects the analog output to be the envelope signal on a linear (voltage) scale. In this mode, the pre-detector data is output to the Analog Out connector with a Linear scaling. The output is based on the current Reference Level, and is not influenced by the selected detector or any digital flatness corrections or trace post-processing (like Trace Averaging).

The scaling is set so that 1 V output occurs with an instantaneous video level equal to the reference level, and 0 V occurs at the bottom of the graticule. This scaling gives you the ability to control the gain without having another setup control for the key. But it requires you to control the look of the display (the reference level) in order to control the analog output.

This mode is ideal for looking at Amplitude Modulated signals, as the linear envelope effectively demodulates the signal.

Key Path	Input/Output, Output Config, Analog Out
Example	OUTP:ANAL LINV
Dependencies	<p>Because the Linear Video output uses one of the two IF processing channels, only one detector is available while Linear Video is selected. All active traces will change to use the same detector as the selected trace when Log Video is activated.</p> <p>Linear Video output is not available while any EMI Detector is selected (Quasi Peak, RMS Average or EMI Average), because these detectors use both IF processing channels. Consequently, if the user chooses an EMI Detector, there will be no Linear Video output.</p>

	The output holds at its last value during an alignment and during a marker count and during retrace (after a sweep and before the next sweep starts). This function depends on optional capability; the key will be blanked and the command will generate an “Option not available” error unless you have Option YAV licensed in your instrument.
Couplings	Linear Video output changes while in FFT Sweeps, so for measurements that use exclusively FFT Sweeps, or if the user manually chooses FFT Sweeps, the Linear Video output will look different than it does in swept mode.
Readback Text	Linear Video
Initial S/W Revision	A.04.00

Demod Audio

Selects the analog output to be the demodulation of the video signal.

When Demod Audio is selected, the demodulated audio signal appears at this output whenever the Analog Demod application is demodulating a signal or when **Analog Demod Tune and Listen** is operating in the Swept SA measurement.

When Analog Out is in the Auto state, this output is auto-selected when in the Analog Demod mode or when **Analog Demod Tune and Listen** is operating in the Swept SA measurement.

If any other Analog Output is manually selected when in the Analog Demod mode or when **Analog Demod Tune and Listen** is operating in the Swept SA measurement, a condition warning message appears.

Key Path	Input/Output, Output Config, Analog Out
Example	OUTP:ANAL DAUD
Dependencies	This key only appears if the Analog Demod application (N9063A), the N6141A or W6141A application, or Option EMC is installed and licensed, otherwise the key will be blanked and the command will generate an “Option not available” error. The output holds at its last value during an alignment and during a marker count. It is not held between sweeps, in order for Tune and Listen to work properly. When Demod Audio is the selected Analog Output: <ul style="list-style-type: none"> • all active traces are forced to use the same detector. • CISPR detectors (QPD, EMI Avg, RMS Avg) are unavailable
Readback Text	Demod Audio
Initial S/W Revision	Prior to A.02.00 (this was the default functionality, and there was no selection)
Modified at S/W Revision	A.04.00

Digital Bus

This menu allows you to configure the LVDS connector located on the rear panel of the instrument. It is a unidirectional link of real time data at a 90 MSa/s rate. The ADC is sampling a 22.5 MHz IF.

The data that appears on this port is raw, uncorrected ADC samples, unless you have option RTL. With option RTL, you get fully corrected I/Q data.

This connector will only be active when the Narrowband IF Path is currently in use.

Key Path	Input/Output, Output Config
Initial S/W Revision	A.04.00

Bus Out On/Off

When Bus Out is on, all acquisitions are streamed to the output port including acquisitions for internal purposes such as Alignment. The internal processing and routing of acquisitions continues as usual and is unaffected by the state of Bus Out.

When Bus Out is off, no signal appears on the LVDS port.

Key Path	Input/Output, Output Config, Digital Bus
Scope	Mode Global
Remote Command	:OUTPut:DBUS[1][:STATE] ON OFF 1 0 :OUTPut:DBUS[1][:STATE]?
Example	OUTP:DBUS ON
Preset	This is unaffected by a Preset but is set to Off on a "Restore Input/Output Defaults" or "Restore System Defaults -> All"
State Saved	Saved in Input/Output State
Initial S/W Revision	Prior to A.02.00
Modified at S/W Revision	A.04.00

I/Q Cal Out

The Baseband I/Q "Cal Out" port can be turned on with either a 1 kHz or a 250 kHz square wave. This can be turned on independent of the input selection. A Preset will reset this to Off.

Key Path	Input/Output, Output Config
Remote Command	:OUTPut:IQ:OUTPut IQ1 IQ250 OFF :OUTPut:IQ:OUTPut?
Example	OUTP:IQ:OUTP IQ1
Couplings	An I/Q Cable Calibration or an I/Q Probe Calibration will change the state of the Cal Out port as needed by the calibration routine. When the calibration is finished the I/Q Cal Out is restored to the pre-calibration state.
Preset	Off
State Saved	Saved in instrument state
Range	1 kHz Square Wave 250 kHz Square Wave Off
Readback Text	1 kHz 250 kHz Off
Initial S/W Revision	Prior to A.02.00

1 kHz Square Wave

Turns on the 1 kHz square wave signal at the Cal Out port. This choice is only available with option BBA.

Key Path	Input/Output, Output Config, I/Q Cal Out
Readback	I/Q 1kHz
Initial S/W Revision	Prior to A.02.00

250 kHz Square Wave

Turns on the 250 kHz square wave signal at the Cal Out port. This choice is only available with option BBA.

Key Path	Input/Output, Output Config, I/Q Cal Out
Readback	I/Q 250kHz
Initial S/W Revision	Prior to A.02.00

Off

Turns off the signal at the Cal Out port. This choice is only available with option BBA.

Key Path	Input/Output, Output Config, I/Q Cal Out
Readback	Off
Initial S/W Revision	Prior to A.02.00

Aux IF Out

This menu controls the signals that appear on the SMA output on the rear panel labeled “AUX IF OUT

The Aux IF Out functionality is only valid for RF and External Mixer inputs. When using the External Mixing path, the Aux IF Out levels (for all three Options CR3, CRP, and ALV) will be uncalibrated because the factory default Aux IF level was set to accommodate the expected IF levels for the RF path.

Key Path	Input/Output, Output Config
Remote Command	:OUTPut:AUX SIF AIF LOGVideo OFF :OUTPut:AUX?
Dependencies	The softkey does not appear in models that do not support the Aux IF Out.
Preset	This is unaffected by a Preset but is set to OFF on a "Restore Input/Output Defaults" or "Restore System Defaults->All"
State Saved	Saved in Input/Output state
Readback line	1-of-N selection [variable]
Backwards Compatibility Notes	In the PSA, the IF output has functionality equivalent to the "Second IF" function in the X-Series' Aux IF Out menu. In the X-Series, it is necessary to switch the Aux IF Out to “Second IF” to get this

functionality, whereas in PSA it is always on, since there are no other choices. Hence a command to switch this function to “Second IF” will have to be added by customers migrating from PSA who use the IF Output in PSA.

Initial S/W Revision	A.04.00
----------------------	---------

Off

In this mode nothing comes out of the “AUX IF OUT” connector on the rear panel. The connector appears as an open-circuit (that is, it is not terminated in any way).

Key Path	Input/Output, Output Config, Aux IF Out
----------	--

Example	OUTP:AUX OFF causes the aux output type to be off
----------------	--

Readback Text	Off
---------------	-----

Initial S/W Revision	A.04.00
----------------------	---------

Second IF

In this mode the 2nd IF output is routed to the rear panel connector. The annotation on the key shows the current 2nd IF frequency in use in the analyzer.

The frequency of the 2nd IF depends on the current IF signal path as shown in the table below:

IF Path Selected	Frequency of “Second IF” Output
10 MHz	322.5 MHz
25 MHz	322.5 MHz
40 MHz	250 MHz
140 MHz	300 MHz

The signal quality, such as signal to noise ratio and phase noise, are excellent in this mode.

Key Path	Input/Output, Output Config, Aux IF Out
----------	--

Example	OUTP:AUX SIF causes the aux output type to be Second IF
----------------	--

Dependencies	Does not appear unless Option CR3 is installed.
--------------	---

Readback Text	Second IF
---------------	-----------

Initial S/W Revision	A.04.00
----------------------	---------

Arbitrary IF

In this mode the 2nd IF output is mixed with a local oscillator and mixer to produce an arbitrary IF output between 10 MHz and 75 MHz with 500 kHz resolution. The phase noise in this mode will not be as good as in Second IF mode.

The IF output frequency is adjustable, through an active function which appears on the Arbitrary IF selection key, from 10 MHz to 75 MHz with 500 kHz resolution.

The bandwidth of this IF output varies with band and center frequency, but is about 40 MHz at the -3 dB width. When the output is centered at lower frequencies in its range, signal frequencies at the bottom of the bandwidth will “fold”. For example, with a 40 MHz bandwidth (20 MHz half-bandwidth), and a 15 MHz IF center, a signal -20 MHz relative to the spectrum analyzer center frequency will have a relative response of about -3 dB with a frequency 20 MHz below the 15 MHz IF center. This -5 MHz frequency will fold to become a +5 MHz signal at the IF output. Therefore, lower IF output frequencies are only useful with known band-limited signals.

Key Path	Input/Output, Output Config, Aux IF Out
Example	OUTP:AUX AIF causes the aux output type to be the Arbitrary IF
Dependencies	Does not appear unless Option CRP is installed.
Readback Text	Arbitrary IF
Initial S/W Revision	A.04.00

Key Path	Input/Output, Output Config, Aux IF Out
Scope	Mode Global
Remote Command	:OUTPut:AUX:AIF <value> :OUTPut:AUX:AIF?
Example	:OUTP:AUX:AIF 50 MHZ
Preset	This is unaffected by a Preset but is set to 70 MHz on a "Restore Input/Output Defaults" or "Restore System Defaults->All"
State Saved	Saved in Input/Output State
Min	10 MHz
Max	75 MHz
Default Unit	Hz
Initial S/W Revision	A.04.00

Fast Log Video

In this mode the 2nd IF output is passed through a log amp and the log envelope of the IF signal is sent to the rear panel. The open circuit output level varies by about 25 mV per dB, with a top-of-screen signal producing about 1.6 Volts. The output impedance is nominally 50 ohms.

This mode is intended to meet the same needs as Option E4440A-H7L Fast Rise Time Video Output on the Keysight E4440A PSA Series, allowing you to characterize pulses with fast rise times using standard measurement suites on modern digital scopes.

Key Path	Input/Output, Output Config, Aux IF Out
Example	OUTP:AUX LOGVideo causes the aux output type to be Fast Log Video
Dependencies	Does not appear unless Option ALV is installed. The output is off during an alignment but not during a marker count, and is not blanked during retrace (after a sweep and before the next sweep starts).
Readback Text	Fast Log Video
Initial S/W Revision	A.04.00

I/Q Guided Calibration

Calibrating the Baseband I/Q ports requires several steps and manual connections. The Guided Calibration will interactively step you through the required steps, displaying diagrams to help with the connections. The steps will vary depending on the setup.

In the Guided Calibration windows, the date and time of the last calibration are displayed. If any of the items listed are displayed in yellow, this indicates that the calibration for that item is inconsistent with the latest calibration, and you should complete the entire calibration process before you exit the calibration.

I/Q Isolation Calibration

The I/Q Isolation Calibration must be run before calibrating any port with either the I/Q Cable Calibration or I/Q Probe Calibration. This calibration is performed with nothing connected to any of the front panel I/Q ports. This is the first step in both the I/Q Cable Calibration and the I/Q Probe Calibration.

Next

Perform the I/Q Isolation calibration.

Key Path	Input/Output, I/Q, I/Q Cable Calibration
Remote Command	:CALibration:IQ:ISOLation
Example	CAL:IQ:ISOL
Notes	All front panel I/Q ports must not be connected to anything.
Notes	All cables and probes should be disconnected from the I/Q ports before issuing the SCPI command.
State Saved	No.
Initial S/W Revision	Prior to A.02.00

Exit

Exits the calibration procedure. All ports calibrated before pressing Exit will use the newly acquired calibration data.

Key Path	Input/Output, I/Q, I/Q Cable Calibration
Notes	Using the Exit button will not restore the calibration data to the state prior to entering the guided calibration. Once a port is calibrated the data is stored immediately and the only way to change it is to redo the calibration step. When the calibration may be left in an inconsistent state, a confirmation dialog will be displayed (see "Exit Confirmation" on page 271).
Initial S/W Revision	Prior to A.02.00

I/Q Isolation Calibration Time (Remote Command Only)

Returns the last date and time that the I/Q Isolation Calibration was performed. This is a remote query command only.

Remote Command	:CALibration:IQ:ISOLation:TIME?
Example	:CAL:IQ:ISOL:TIME?
Notes	This returns 6 integer values: year, month, day, hour, minute, second. When no calibration has been performed, all values will be 0.
Initial S/W Revision	A.02.00

I/Q Cable Calibrate...

The I/Q cable calibration creates correction data for each of the front panel I/Q ports. This calibration data is used whenever no probe specific calibration data is available. It is important that all ports are calibrated using the same short BNC cable so that the data is comparable from port to port.

The guided calibration (front panel only) will show connection diagrams and guide you through the isolation calibration and calibrating each port. The calibration data for each port is stored separately, so as soon as a port is calibrated that data is saved and will be used. If you press "Exit" to exit the calibration process, the data for the ports already completed will still be used. It is recommended that a calibration be completed once started, or if exited, that it be properly done before the next use of the I/Q ports. The "Next" button will perform the calibration for the current port and then proceed to the next step in the calibration procedure. The "Back" button will return to the prior port in the procedure. Both keys and dialog buttons are supplied for ease of use. The dialog buttons are for mouse use and the softkeys for front panel use.

The calibration can also be done via SCPI, but no connection diagrams will be shown. You will have to make the correct connections before issuing each port calibration command. Again, it is recommended that all ports be calibrated at the same time.

The instrument state remains as it was prior to entering the calibration procedure except while a port is actually being calibrated. Once a port is calibrated it returns to the prior state. A port calibration is in process only from the time the "Next" button is pressed until the next screen is shown. For SCPI, this corresponds to the time from issuing the CAL:IQ:FLAT:|I|B|Q|QB command until the operation is complete.

For example, if the prior instrument state is Cal Out = Off, Input = I+jQ, and Differential = Off, then up until the time the "Next" button is pressed the I Input and Q Input LEDs are on and the Cal Out, I-bar Input and Q-bar Input LEDs are off. Once the "Next" button is pressed for the I port calibration, only the Cal Out and I

Input LEDs will be on and the others will be off. When the screen progresses to the next step ("Next" button again enabled), the prior state is restored and only the I Input and Q Input LEDs are on (Cal Out is off again).

The last calibration date and time for each port will be displayed. Any calibrations that are more than a day older than the most recent calibration will be displayed with the color amber.

Key Path	Input/Output, I/Q
Initial S/W Revision	Prior to A.02.00

I Port

The I port calibration is performed with the front panel's I port connected via a short BNC cable to the Cal Out port. The guided calibration will show a diagram of the required connections.

Back

Return to the prior step in the calibration procedure.

Key Path	Input/Output, I/Q, Q Setup, Q Probe, Calibrate
Initial S/W Revision	Prior to A.02.00

Next

Perform the I port calibration.

Key Path	Input/Output, I/Q, I/Q Cable Calibrate...
Remote Command	:CALibration:IQ:FLATness:I
Example	CAL:IQ:FLAT:I
Notes	The recommended procedure is to use the same BNC cable to calibrate all I/Q ports. All I/Q ports should be calibrated sequentially during the procedure. The calibration data is saved as soon as the port is calibrated and will survive power cycles. It is not reset by any preset or restore data commands.
Notes	The I port must be connected to the Cal Out port before issuing the SCPI command.
State Saved	No.
Initial S/W Revision	Prior to A.02.00

Exit

Exit the calibration procedure. All ports calibrated before pressing Exit will use the newly acquired calibration data.

Key Path	Input/Output, I/Q, I/Q Cable Calibrate...
Notes	Using the Exit button will not restore the calibration data to the state prior to entering the guided calibration. Once a port is calibrated the data is stored immediately and the only way to change it is

to redo the calibration step.

When the calibration may be left in an inconsistent state, a confirmation dialog will be displayed (see "Exit Confirmation" on page 271).

Initial S/W Revision	Prior to A.02.00
----------------------	------------------

I-bar Port

The I-bar port calibration is performed with the front panel's I-bar port connected via a short BNC cable to the Cal Out port. The guided calibration will show a diagram of the required connections.

Back

Return to the prior step in the calibration procedure.

Key Path	Input/Output, I/Q, I/Q Cable Calibration
Notes	Using the Back button will not restore the calibration data to a prior state. Once a port is calibrated the data is stored immediately and the only way to change it is to redo the calibration step. The Back button allows the user to go back to a prior step to redo that calibration step.
Initial S/W Revision	Prior to A.02.00

Next

Perform the I-bar port calibration.

Key Path	Input/Output, I/Q, I/Q Cable Calibrate...
Remote Command	:CALibration:IQ:FLATness:IBAR
Example	CAL:IQ:FLAT:IBAR
Notes	The recommended procedure is to use the same BNC cable to calibrate all I/Q ports. All I/Q ports should be calibrated sequentially during the procedure. The calibration data is saved as soon as the port is calibrated and will survive power cycles. It is not reset by any preset or restore data commands.
Notes	The I-bar port must be connected to the Cal Out port before issuing the SCPI command.
State Saved	No
Initial S/W Revision	Prior to A.02.00

Exit

Exit the calibration procedure. All ports calibrated before pressing Exit will use the newly acquired calibration data.

Key Path	Input/Output, I/Q, I/Q Cable Calibrate...
Notes	Using the Exit button will not restore the calibration data to the state prior to entering the guided calibration. Once a port is calibrated the data is stored immediately and the only way to change it is

to redo the calibration step.

When the calibration may be left in an inconsistent state, a confirmation dialog will be displayed (see ["Exit Confirmation" on page 271](#)).

Initial S/W Revision	Prior to A.02.00
----------------------	------------------

Q Port

The Q port calibration is performed with the front panel's Q port connected via a short BNC cable to the Cal Out port. The guided calibration will show a diagram of the required connections.

Back

Return to the prior step in the calibration procedure.

Key Path	Input/Output, I/Q, I/Q Cable Calibrate...
Notes	Using the Back button will not restore the calibration data to a prior state. Once a port is calibrated the data is stored immediately and the only way to change it is to redo the calibration step. The Back button allows the user to go back to a prior step to redo that calibration step.
Initial S/W Revision	Prior to A.02.00

Next

Perform the Q port calibration.

Key Path	Input/Output, I/Q, I/Q Cable Calibrate...
Remote Command	<code>:CALibration:IQ:FLATness:Q</code>
Example	CAL:IQ:FLAT:Q
Notes	The recommended procedure is to use the same BNC cable to calibrate all I/Q ports. All I/Q ports should be calibrated sequentially during the procedure. The calibration data is saved as soon as the port is calibrated and will survive power cycles. It is not reset by any preset or restore data commands.
Notes	The Q port must be connected to the Cal Out port before issuing the SCPI command.
State Saved	No
Initial S/W Revision	Prior to A.02.00

Exit

Exit the calibration procedure. All ports calibrated before pressing Exit will use the newly acquired calibration data.

Key Path	Input/Output, I/Q, I/Q Cable Calibrate...
Notes	Using the Exit button will not restore the calibration data to the state prior to entering the guided calibration. Once a port is calibrated the data is stored immediately and the only way to change it is

to redo the calibration step.
When the calibration may be left in an inconsistent state, a confirmation dialog will be displayed (see "Exit Confirmation" on page 271).

Initial S/W Revision	Prior to A.02.00
----------------------	------------------

Q-bar Port

The Q-bar port calibration is performed with the front panel's Q-bar port connected via a short BNC cable to the Cal Out port. The guided calibration will show a diagram of the required connections.

Back

Return to the prior step in the calibration procedure.

Key Path	Input/Output, I/Q, I/Q Cable Calibrate...
Notes	Using the Back button will not restore the calibration data to a prior state. Once a port is calibrated the data is stored immediately and the only way to change it is to redo the calibration step. The Back button allows the user to go back to a prior step to redo that calibration step.
Initial S/W Revision	Prior to A.02.00

Next

Perform the Q-bar port calibration.

Key Path	Input/Output, I/Q, I/Q Cable Calibrate...
Remote Command	:CALibration:IQ:FLATness:QBAR
Example	CAL:IQ:FLAT:QBAR
Notes	The recommended procedure is to use the same BNC cable to calibrate all I/Q ports. All I/Q ports should be calibrated sequentially during the procedure. The calibration data is saved as soon as the port is calibrated and will survive power cycles. It is not reset by any preset or restore data commands.
Notes	The Q-bar port must be connected to the Cal Out port before issuing the SCPI command.
State Saved	No
Initial S/W Revision	Prior to A.02.00

Exit

Exit the calibration procedure. All ports calibrated before pressing Exit will use the newly acquired calibration data.

Key Path	Input/Output, I/Q, I/Q Cable Calibrate...
Notes	Using the Exit button will not restore the calibration data to the state prior to entering the guided calibration. Once a port is calibrated the data is stored immediately and the only way to change it is

to redo the calibration step.

When the calibration may be left in an inconsistent state, a confirmation dialog will be displayed (see **"Exit Confirmation" on page 271**).

Initial S/W Revision Prior to A.02.00

I/Q Cable Calibration Time (Remote Command Only)

Returns the last date and time that the I/Q Cable Calibration was performed for a specific port. This is a remote query command only.

Remote Command :CALibration:IQ:FLATness:I|IBAR|Q|QBAR:TIME?

Example :CAL:IQ:FLAT:I:TIME?

Notes This returns 6 integer values: year, month, day, hour, minute, second. When no calibration has been performed, all values will be 0.

Initial S/W Revision A.02.00

I/Q Probe Calibration

The I/Q probe calibration creates correction data for one of the front panel I/Q channels. When the probe has EEPROM identification, the data is unique to that specific probe. When the probe does not have EEPROM identification, the data will be used for all probes of the same type. The data is also unique to the channel, so calibration data for the I channel will not be used for the Q channel and vice versa.

The guided calibration (front panel only) will show connection diagrams and guide the user through the I/Q Isolation Calibration and through calibrating each port. The calibration data for each port is stored separately, so as soon as a port is calibrated that data is saved and will be used. If a user presses "Exit" to exit the calibration process, the data for the port already completed will still be used. It is recommended that a calibration be completed once started, or if exited, that it be properly done before the next use of the probe. The "Next" button will perform the calibration for the current port and then proceed to the next step in the calibration procedure. The "Back" button will return to the prior port in the procedure. Both softkeys and dialog buttons are supplied for ease of use. The dialog buttons are for mouse use and the softkeys for front panel use.

The calibration can also be done via SCPI, but no connection diagrams will be shown. The user will have to make the correct connections before issuing each port calibration command. Again, it is recommended that all ports be calibrated at the same time.

For Active probes or when Differential is Off, only the main port is calibrated, otherwise both the main and complementary ports are calibrated.

The instrument state remains as it was prior to entering the calibration procedure except while a port is actually being calibrated. Once a port is calibrated it returns to the prior state. A port calibration is in process only from the time the "Next" button is pressed until the next screen is shown. For SCPI, this corresponds to the time from issuing the CAL:IQ:PROB:I|I|B|Q|QB command until the operation is complete.

For example, if the prior instrument state is Cal Out = Off, Input = I+jQ, and Differential = Off, then up until the time the "Next" button is pressed the I Input and Q Input LEDs are on and the Cal Out, I-bar Input and

Q-bar Input LEDs are off. Once the "Next" button is pressed for the I port calibration, only the Cal Out and I Input LEDs will be on and the others will be off. When the screen progresses to the next step ("Next" button again enabled), the prior state is restored and only the I Input and Q Input LEDs are on (Cal Out is off again).

The last calibration date and time for each relevant port will be displayed. For passive probes with Differential On, any calibration that is more than a day older than the most recent calibration will be displayed with the color amber.

I Port

The I port calibration is performed with the probe body attached to the front panel's I port and the probe tip connected via an adapter to the Cal Out port. The guided calibration will show a diagram of the required connections.

Show Adapter

Show a connection diagram and instructions for the probe and adapter. See ["Show Adapter Screen" on page 270](#).

Key Path	Input/Output, I/Q, I Setup, I Probe, Calibrate
Notes	Either a passive or an active probe adapter diagram will be shown, depending on the type of probe attached.
Initial S/W Revision	Prior to A.02.00

Back

Return to the prior step in the calibration procedure.

Key Path	Input/Output, I/Q, Q Setup, Q Probe, Calibrate
Initial S/W Revision	Prior to A.02.00

Next

Perform the I port calibration.

Key Path	Input/Output, I/Q, I Setup, I Probe, Calibrate
Remote Command	<code>:CALibration:IQ:PROBe:I</code>
Example	<code>CAL:IQ:PROB:I</code>
Notes	The I port must be connected to the Cal Out port before issuing the SCPI command. The calibration data is saved as soon as the port is calibrated and will survive power cycles. It is not reset by any preset or restore data commands.
State Saved	No
Initial S/W Revision	Prior to A.02.00

Exit

Exit the calibration procedure. All ports calibrated before pressing Exit will use the newly acquired calibration data.

Key Path	Input/Output, I/Q, I Setup, I Probe, Calibrate
Notes	Using the Exit button will not restore the calibration data to the state prior to entering the guided calibration. Once a port is calibrated the data is stored immediately and the only way to change it is to redo the calibration step. When the calibration may be left in an inconsistent state, a confirmation dialog will be displayed (see "Exit Confirmation" on page 271).
Initial S/W Revision	Prior to A.02.00

I-bar Port

The I-bar port calibration is performed with the probe body attached to the front panel's I-bar port and the probe tip connected via an adapter to the Cal Out port. The I-bar probe calibration is only available for passive probes with Differential On. The guided calibration will show a diagram of the required connections.

Show Adapter

Show a connection diagram and instructions for the probe and adapter. See ["Show Adapter Screen" on page 270](#).

Key Path	Input/Output, I/Q, I Setup, I Probe, Calibrate
Notes	Either a passive or an active probe adapter diagram will be shown, depending on the type of probe attached.
Initial S/W Revision	Prior to A.02.00

Back

Return to the prior step in the calibration procedure.

Key Path	Input/Output, I/Q, I Setup, I Probe, Calibrate
Notes	Using the Back button will not restore the calibration data to a prior state. Once a port is calibrated the data is stored immediately and the only way to change it is to redo the calibration step. The Back button allows the user to go back to a prior step to redo that calibration step.
Initial S/W Revision	Prior to A.02.00

Next

Perform the I-bar port calibration.

Key Path	Input/Output, I/Q, I Setup, I Probe, Calibrate
----------	---

Remote Command	:CALibration:IQ:PROBe:IBar
Example	CAL:IQ:PROB:IB
Notes	The I-bar port must be connected to the Cal Out port before issuing the SCPI command. The calibration data is saved as soon as the port is calibrated and will survive power cycles. It is not reset by any preset or restore data commands.
State Saved	No
Initial S/W Revision	Prior to A.02.00

Exit

Exit the calibration procedure. All ports calibrated before pressing Exit will use the newly acquired calibration data.

Key Path	Input/Output, I/Q, I Setup, I Probe, Calibrate
Notes	Using the Exit button will not restore the calibration data to the state prior to entering the guided calibration. Once a port is calibrated the data is stored immediately and the only way to change it is to redo the calibration step. When the calibration may be left in an inconsistent state, a confirmation dialog will be displayed (see "Exit Confirmation" on page 271).
Initial S/W Revision	Prior to A.02.00

Q Port

The Q port calibration is performed with the probe body attached to the front panel's Q port and the probe tip connected via an adapter to the Cal Out port. The guided calibration will show a diagram of the required connections.

Show Adapter

Show a connection diagram and instructions for the probe and adapter. See ["Show Adapter Screen" on page 270](#).

Key Path	Input/Output, I/Q, Q Setup, Q Probe, Calibrate
Notes	Either a passive or an active probe adapter diagram will be shown, depending on the type of probe attached.
Initial S/W Revision	Prior to A.02.00

Back

Return to the prior step in the calibration procedure.

Key Path	Input/Output, I/Q, Q Setup, Q Probe, Calibrate
Initial S/W Revision	Prior to A.02.00

Next

Perform the Q port calibration.

Key Path	Input/Output, I/Q, Q Setup, Q Probe, Calibrate
Remote Command	:CALibration:IQ:PROBe:Q
Example	CAL:IQ:PROB:Q
Notes	The Q port must be connected to the Cal Out port before issuing the SCPI command. The calibration data is saved as soon as the port is calibrated and will survive power cycles. It is not reset by any preset or restore data commands.
State Saved	No
Initial S/W Revision	Prior to A.02.00

Exit

Exit the calibration procedure. All ports calibrated before pressing Exit will use the newly acquired calibration data.

Key Path	Input/Output, I/Q, Q Setup, Q Probe, Calibrate
Notes	Using the Exit button will not restore the calibration data to the state prior to entering the guided calibration. Once a port is calibrated the data is stored immediately and the only way to change it is to redo the calibration step. When the calibration may be left in an inconsistent state, a confirmation dialog will be displayed (see "Exit Confirmation" on page 271).
Initial S/W Revision	Prior to A.02.00

Q-bar Port

The Q-bar port calibration is performed with the probe body attached to the front panel's Q-bar port and the probe tip connected via an adapter to the Cal Out port. The Q-bar probe calibration is only available for passive probes with Differential On. The guided calibration will show a diagram of the required connections.

Show Adapter

Show a connection diagram and instructions for the probe and adapter. See ["Show Adapter Screen" on page 270](#).

Key Path	Input/Output, I/Q, Q Setup, Q Probe, Calibrate
Notes	Either a passive or an active probe adapter diagram will be shown, depending on the type of probe attached.
Initial S/W Revision	Prior to A.02.00

Back

Return to the prior step in the calibration procedure.

Key Path	Input/Output, I/Q, Q Setup, Q Probe, Calibrate
Notes	Using the Back button will not restore the calibration data to a prior state. Once a port is calibrated the data is stored immediately and the only way to change it is to redo the calibration step. The Back button allows the user to go back to a prior step to redo that calibration step.
Initial S/W Revision	Prior to A.02.00

Next

Perform the Q-bar port calibration.

Key Path	Input/Output, I/Q, Q Setup, Q Probe, Calibrate
Remote Command	<code>:CALibration:IQ:PROBE:QBar</code>
Example	<code>CAL:IQ:PROB:QB</code>
Notes	The Q-bar port must be connected to the Cal Out port before issuing the SCPI command. The calibration data is saved as soon as the port is calibrated and will survive power cycles. It is not reset by any preset or restore data commands.
State Saved	No
Initial S/W Revision	Prior to A.02.00

Exit

Exit the calibration procedure. All ports calibrated before pressing Exit will use the newly acquired calibration data.

Key Path	Input/Output, I/Q, Q Setup, Q Probe, Calibrate
Notes	Using the Exit button will not restore the calibration data to the state prior to entering the guided calibration. Once a port is calibrated the data is stored immediately and the only way to change it is to redo the calibration step. When the calibration may be left in an inconsistent state, a confirmation dialog will be displayed (see "Exit Confirmation" on page 271).
Initial S/W Revision	Prior to A.02.00

Show Adapter Screen

When one of the Probe Calibration Show Adapter buttons is pressed, a diagram of the probe with its adapter will be shown. Depending on the type of probe attached, either the Passive Probe Adapter or the Active Probe Adapter diagram will be shown.

I/Q Probe Calibration Time (Remote Command Only)

Return the last date and time that the I/Q Probe Calibration was performed for a specific port. This is a remote query command only.

Remote Command	:CALibration:IQ:PROBe:I IBAR Q QBAR:TIME?
Example	:CAL:IQ:PROB:I:TIME?
Notes	This returns 6 integer values: year, month, day, hour, minute, second. When no calibration has been performed, all values will be 0. The value is specific to both the port and probe, so the value will change as probes are connected or disconnected.
Initial S/W Revision	A.02.00

Exit Confirmation

When Exit is pressed during one of the calibration routines, the calibration may be in an inconsistent state with some of the ports having newly measured calibration data and others with old data. If this is the case, a dialog box will appear to confirm that the user really wants to exit. A "Yes" answer will exit the calibration procedure, leaving potentially inconsistent calibration data in place. A "No" answer will return to the calibration procedure.

LISN Control

Enables you to access LISN related functions. LISN control is only available with option LSN indicating that the LISN IO board is installed. This is a remote query command only.

V-network (Remote Command Only)

Enables you to select the V-network that is controlled via the AUX IO port.

Remote Command	INPut [1] 2:LISN[:TYPE] FOURphase ESH2Z5 ENV216 OFF INPut [1] 2:LISN[:TYPE] ?
Example	:INP:LISN FOUR
Notes	FOURPhase and ESH2-Z5 R&S ESH2-Z5 (four phases and protective earth are controllable) ENV216 R&S ENV216 (two phases and highpass are controllable) OFF Remote control deactivated This query will return :- FOUR when ESH2-Z5 is selected.
Preset	Set to off on a "Restore Input/Output Defaults"
State Saved	Saved in instrument state
Initial S/W Revision	A.14.50

Phase (Remote Command Only)

This command enables you to select the phase of the V-network that is used, which is controlled via the AUX IO port. The permissible selection depends on the selected V-network.

Remote Command	INPut [1] 2:LISN:PHASe L1 L2 L3 N INPut [1] 2:LISN:PHASe?
Example	:INP:LISN:PHAS L1
Couplings	L2, L3 keys are grayed out when ENV216 is selected. If the grayed out key is pressed, an advisory message is generated. If the equivalent SCPI command is sent, this same message is generated as part of a “-224, Illegal parameter value; must apply ESH2Z5 to make this phase available” warning.
Preset	Set to N on a "Restore Input/Output Defaults"
State Saved	Saved in instrument state
Range	Phase N Phase L1 Phase L2 Phase L3 Only one phase can be selected.
Initial S/W Revision	A.14.50

150 kHz Highpass (Remote Command Only)

Controls highpass setting on the V-network.

Remote Command	INPut [1] 2:LISN:FILTer:HPAS[:STATe] ON OFF INPut [1] 2:LISN:FILTer:HPAS[:STATe]?
Example	:INP:LISN:FILT:HPAS ON
Dependencies	Only available for ENV216 V-network . This key is grayed out when a V-network that is not ENV216 is selected. If the grayed out key is pressed, an advisory message is generated. If the equivalent SCPI command is sent, this same message is generated as part of a “-221, Settings conflicts; LISN function not available” warning.
Preset	Set to off on a "Restore Input/Output Defaults"
State Saved	Saved in instrument state
Range	ON OFF
Initial S/W Revision	A.14.50

Protective Earth (Remote Command Only)

Enables you to set the Protective Earth setting that is controlled via the AUX IO port.

Remote Command	INPut [1] 2:LISN:PEARth GROunded FLOating INPut [1] 2:LISN:PEARth?
Example	:INP:LISN:PEAR GRO
Dependencies	Only available for ESH2Z5. This key is grayed out when a v-network other than ESH2Z5 is selected. If the grayed out key is pressed, an advisory message is generated. If the equivalent SCPI command is

	sent, this same message is generated as part of a “-221, Settings conflict; LISN function not available” warning.
Preset	Set to GRO on a "Restore Input/Output Defaults"
State Saved	Saved in instrument state
Range	GRO FLO
Initial S/W Revision	A.14.50

5 Mode Functions

Mode

The Mode key allows you to select the available measurement applications or “Modes”. Modes are a collection of measurement capabilities packaged together to provide an instrument personality that is specific to your measurement needs. Each application software product is ordered separately by Model Number and must be licensed to be available. Once an instrument mode is selected, only the commands that are valid for that mode can be executed.

NOTE

Key operation can be different between modes. The information displayed in Help is about the current mode.

To access Help for a different Mode you must first exit Help (by pressing the Cancel (Esc) key). Then select the desired mode and re-access Help.

For more information on Modes, preloading Modes, and memory requirements for Modes, see ["More Information" on page 277](#)

Key Path	Front-panel key
Remote Command	:INSTrument[:SElect] SA RTSA SEQAN EMI BASIC WCDMA EDGE GSM WIMAXOFDMA VSA PNOISE NFIGure ADEMOD BTooth TDSCDMA CDMA2K CDMA1XEV LTE LTETDD LTEAFDD LTEATDD MSR DVB DTMB DCTV ISDBT CMMB WLAN CWLAN CWIMAXOFDM WIMAXFIXED IDEN RLC SCPILC VSA89601 :INSTrument[:SElect]?
Example	:INST SA
Notes	The available parameters are dependent upon installed and licensed applications resident in the instrument. Parameters given here are an example, specific parameters are in the individual Application. A list of the valid mode choices is returned with the INST:CAT? Query.
Preset	This is unaffected by a Preset but is set on a “Restore System Defaults->All” to: For N9038A: EMI For all other models: SA
State Saved	Saved in instrument state
Backwards Compatibility SCPI	:INSTrument[:SElect] GSM provided for backwards compatibility. Mapped to EDGE GSM.
Backwards Compatibility SCPI	:INSTrument[:SElect] SANalyzer provided for ESU compatibility. When this command is received, the analyzer aliases it to the following: INST:SEL SCPILC This results in the analyzer being placed in SCPI Language Compatibility Mode, in order to emulate the ESU Spectrum Analyzer Mode.
Backwards	:INSTrument[:SElect] RECEiver

Compatibility SCPI	provided for ESU compatibility. When this command is received, the analyzer aliases it to the following: :INST:SEL EMI :CONF FSC This results in the analyzer being placed in the EMI Receiver Mode, running the Frequency Scan measurement, in order to emulate the ESU Receiver Mode.
Initial S/W Revision	Prior to A.02.00
Modified at S/W Revision	A.13.00

Example	:INST 'SA'
Notes	The query is not a quoted string. It is an enumeration as indicated in the Instrument Select table above. The command must be sequential: i.e. continued parsing of commands cannot proceed until the instrument select is complete and the resultant SCPI trees are available.
Backwards Compatibility SCPI	:INSTrument[:SElect] 'SA' 'PNOISE' 'EDGE' 'GSM' 'BASIC'
Initial S/W Revision	Prior to A.02.00

More Information

The Mode name appears on the banner after the word “Keysight” followed by the Measurement Title. For example, for the Spectrum Analyzer mode with the Swept SA measurement running:



It is possible to specify the order in which the Modes appear in the Mode menu, using the Configure Applications utility (**System, Power On, Configure Applications**). It is also possible, using the same utility, to specify a subset of the available applications to load into memory at startup time, which can significantly decrease the startup time of the analyzer. During runtime, if an application that is not loaded into memory is selected (by either pressing that applications Mode key or sending that applications :INST:SEL command over SCPI), there will be a pause while the Application is loaded. During this pause a message box that says “Loading application, please wait...” is displayed.

Each application (Mode) that runs in the X-Series signal analyzers consumes virtual memory. The various applications consume varying amounts of virtual memory, and as more applications run, the memory consumption increases. Once an application is run, some of its memory remains allocated even when it is not running, and is not released until the analyzer program (xSA.exe) is shut down.

Keysight characterizes each Mode and assigns a memory usage quantity based on a conservative estimate. There is a limited amount of virtual memory available to applications (note that this is virtual memory and is independent of how much physical RAM is in the instrument). The instrument keeps track of how much memory is being used by all loaded applications – which includes those that preloaded at startup, and all of those that have been run since startup.

When you request a Mode that is not currently loaded, the instrument looks up the memory estimate for that Mode, and adds it to the residual total for all currently loaded Modes. If there is not enough virtual memory to load the Mode, a dialog box and menu will appear that gives you four options:

1. Close and restart the analyzer program without changing your configured preloads. This may free up enough memory to load the requested Mode, depending on your configured preloads
2. Clear out all preloads and close and restart the analyzer program with only the requested application preloaded, and with that application running. This choice is guaranteed to allow you to run the requested application; but you will lose your previously configured preloads. In addition, there may be little or no room for other applications, depending on the size of the requested application.
3. Bring up the Configure Applications utility in order to reconfigure the preloaded apps to make room for the applications you want to run (this will then require restarting the analyzer program with your new configuration). This is the recommended choice because it gives you full flexibility to select exactly what you want.
4. Exit the dialog box without doing anything, which means you will be unable to load the application you requested.

In each case except 4, this will cause the analyzer software to close, and you will lose all unsaved traces and results.

If you attempt to load a mode via SCPI that will exceed memory capacity, the Mode does not load and an error message is returned:

```
-225, "Out of memory;Insufficient resources to load Mode (mode name) "
```

where "mode name" is the SCPI parameter for the Mode in question, for example, SA for Spectrum Analyzer Mode.

Spectrum Analyzer

Selects the Spectrum Analyzer mode for general purpose measurements. There are several measurements available in this mode. General spectrum analysis measurements, in swept and zero span, can be done using the first key in the Meas menu, labeled Swept SA. Other measurements in the Meas Menu are designed to perform specialized measurement tasks, including power and demod measurements.

If you are using the Help feature, this mode must be currently active to access its detailed information. If it is not active, exit the Help feature (Esc key), select the mode, and re-access Help.

Key Path	Mode
Example	INST:SEL SA INST:NSEL 1
Initial S/W Revision	Prior to A.02.00

CMMB

Selects the CMMB mode for measurements of digital video signals using this format. There are several power and demod measurements available in this mode.

If you are using the Help feature, this mode must be currently active to access its detailed information. If it is not active, exit the Help feature (Esc key), select the mode, and re-access Help.

Key Path	Mode
Example	INST:SEL CMMB INST:NSEL 240
Initial S/W Revision	A.03.00

DVB-T/H with T2

Selects the DVB-T/H mode for measurements of digital video signals using this format. There are several power and demod measurements available in this mode.

If you are using the Help feature, this mode must be currently active to access its detailed information. If it is not active, exit the Help feature (Esc key), select the mode, and re-access Help.

Key Path	Mode
Example	INST:SEL DVB INST:NSEL 235
Initial S/W Revision	A.02.00
Modified at S/W Revision	A.07.00

EMI Receiver

The EMI Receiver Mode makes EMC measurements. Several measurements are provided to aid the user in characterizing EMC performance of their systems, including looking at signals with CISPR-16 compliant detectors, performing scans for interfering signals, and determining and charting interfering signals over time.

If you are using the Help feature, this mode must be currently active to access its detailed information. If it is not active, exit the Help feature (Esc key), select the mode, and re-access Help.

Key Path	Mode
Example	INST:SEL EMI INST:NSEL 141
Initial S/W Revision	A.07.01

IQ Analyzer (Basic)

The IQ Analyzer Mode makes general purpose frequency domain and time domain measurements. These measurements often use alternate hardware signal paths when compared with a similar measurement in the Signal Analysis Mode using the Swept SA measurement. These frequency domain and time domain measurements can be used to output I/Q data results when measuring complex modulated digital signals.

If you are using the Help feature, this mode must be currently active to access its detailed information. If it is not active, exit the Help feature (Esc key), select the mode, and re-access Help.

Key Path	Mode
Example	INST:SEL BASIC INST:NSEL 8
Initial S/W Revision	Prior to A.02.00

W-CDMA with HSPA+

Selects the W-CDMA with HSPA+ mode for general purpose measurements of signals following this standard. There are several measurements available in this mode.

If you are using the Help feature, this mode must be currently active to access its detailed information. If it is not active, exit the Help feature (Esc key), select the mode, and re-access Help.

Key Path	Mode
Example	INST:SEL WCDMA INST:NSEL 9
Initial S/W Revision	Prior to A.02.00

GSM/EDGE/EDGE Evo

Selects the GSM with EDGE mode for general purpose measurements of signals following this standard. There are several measurements available in this mode.

If you are using the Help feature, this mode must be currently active to access its detailed information. If it is not active, exit the Help feature (Esc key), select the mode, and re-access Help.

Key Path	Mode
Example	INST:SEL EDGE GSM INST:NSEL 13
Initial S/W Revision	Prior to A.02.00
Modified at S/W Revision	A.02.00

802.16 OFDMA (WiMAX/WiBro)

Selects the OFDMA mode for general purpose measurements of WiMAX signals. There are several measurements available in this mode.

If you are using the Help feature, this mode must be currently active to access its detailed information. If it is not active, exit the Help feature (Esc key), select the mode, and re-access Help.

Key Path	Mode
Example	INST:SEL WIMAXOFDMA INST:NSEL 75
Initial S/W Revision	Prior to A.02.00

Vector Signal Analyzer (VXA)

The N9064A (formerly 89601X) VXA Vector signal and WLAN modulation analysis application provides solutions for basic vector signal analysis, analog demodulation, and digital demodulation. The digital demodulation portion of N9064A allows you to perform measurements on standard-based formats such as cellular, wireless networking and digital video as well as general purpose flexible modulation analysis for wide range of digital formats, FSK to 1024QAM, with easy-to-use measurements and display tools such as constellation and eye diagram, EVM traces and up to four simultaneous displays. Analog baseband analysis is available using the MXA and PXA with option BBA. Option 3FP WLAN has been discontinued.

N9064A honors existing 89601X licenses with all features and functionalities found on X-Series software versions prior to A.06.00. Specifically:

N9064A-1 is equivalent to 89601X-205

N9064A-2 is equivalent to 89601X-AYA

If you are using the Help feature, this mode must be currently active to access its detailed information. If it is not active, exit the Help feature (Esc key), select the mode, and re-access Help.

Key Path	Mode
Example	INST:SEL VSA INST:NSEL 100
Initial S/W Revision	Prior to A.02.00

Phase Noise

The Phase Noise mode provides pre-configured measurements for making general purpose measurements of device phase noise.

If you are using the Help feature, this mode must be currently active to access its detailed information. If it is not active, exit the Help feature (Esc key), select the mode, and re-access Help.

Key Path	Mode
Example	INST:SEL PNOISE or INST:NSEL 14
Initial S/W Revision	Prior to A.02.00

Noise Figure

The Noise Figure mode provides pre-configured measurements for making general purpose measurements of device noise figure.

If you are using the Help feature, this mode must be currently active to access its detailed information. If it is not active, exit the Help feature (Esc key), select the mode, and re-access Help.

Key Path	Mode
Example	INST:SEL NFIGURE INST:NSEL 219
Initial S/W Revision	Prior to A.02.00

Analog Demod

Selects the Analog Demod mode for making measurements of AM, FM and phase modulated signals.

If you are using the Help feature, this mode must be currently active to access its detailed information. If it is not active, exit the Help feature (Esc key), select the mode, and re-access Help.

Key Path	Mode
Example	INST:SEL ADEMOM INST:NSEL 234
Initial S/W Revision	Prior to A.02.00

Bluetooth

Selects the Bluetooth mode for Bluetooth specific measurements. There are several measurements available in this mode.

If you are using the Help feature, this mode must be currently active to access its detailed information. If it is not active, exit the Help feature (Esc key), select the mode, and re-access Help.

Key Path	Mode
Example	INST:SEL BT INST:NSEL 228
Initial S/W Revision	A.06.01

TD-SCDMA with HSPA/8PSK

Selects the TD-SCDMA mode for general purpose measurements of signals following this standard. There are several measurements available in this mode.

If you are using the Help feature, this mode must be currently active to access its detailed information. If it is not active, exit the Help feature (Esc key), select the mode, and re-access Help.

Key Path	Mode
Example	INST:SEL TDSCDMA INST:NSEL 211
Initial S/W Revision	Prior to A.02.00

cdma2000

Selects the cdma2000 mode for general purpose measurements of signals following this standard. There are several measurements available in this mode.

If you are using the Help feature, this mode must be currently active to access its detailed information. If it is not active, exit the Help feature (Esc key), select the mode, and re-access Help.

Key Path	Mode
Example	INST:SEL CDMA2K INST:NSEL 10
Initial S/W Revision	Prior to A.02.00

1xEV-DO

Selects the 1xEV-DO mode for general purpose measurements of signals following this standard. There are several measurements available in this mode.

If you are using the Help feature, this mode must be currently active to access its detailed information. If it is not active, exit the Help feature (Esc key), select the mode, and re-access Help.

Key Path	Mode
Example	INST:SEL CDMA1XEV INST:NSEL 15
Initial S/W Revision	Prior to A.02.00

LTE-Advanced FDD

As LTE-Advanced FDD and LTE modes are converged into one single application, the single softkey under Mode menu is designed to select the covered mode. The display mode of the LTE and LTE-Advanced FDD are distinguished by the licenses.

If you are using the Help feature, this mode must be currently active to access its detailed information. If it is not active, exit the Help feature (Esc key), select the mode, and re-access Help.

Key Path	Mode
Example	INST:SEL LTEAFDD

	INST:NSEL 107
Notes	When the N9080A/80B-1FP exists, the display mode name is LTE. When the N9080A/80B-1FP and N9080B-2FP all exist, the display mode name is LTE FDD & LTE-A FDD.
Backwards Compatibility SCPI	INST:SEL LTE INST:NSEL 102
Initial S/W Revision	A.14.00
Modified at S/W Revision	A.14.50

LTE-Advanced TDD

As LTE-Advanced TDD and LTE TDD modes are converged into one single application, the single softkey under Mode menu is designed to select the covered mode. The display mode of the LTE TDD and LTE-Advanced TDD are distinguished by the licenses.

If you are using the Help feature, this mode must be currently active to access its detailed information. If it is not active, exit the Help feature (Esc key), select the mode, and re-access Help.

Key Path	Mode
Example	INST:SEL LTEATDD INST:NSEL 108
Notes	When the N9082A/82B-1FP exists, the display mode name is LTE TDD. When the N9082A/82B-1FP and N9082B-2FP all exist, the display mode name is LTE TDD & LTE-A TDD.
Backwards Compatibility SCPI	INST:SEL LTETDD INST:NSEL 105
Initial S/W Revision	A.14.00
Modified at S/W Revision	A.14.50

MSR

Selects the MSR mode. The MSR mode makes several measurements for Cellular Communication devices that can be configured with multiple radio formats simultaneously following the 3GPP standard of Multi-Standard Radio, including GSM/EDGE, WCDMA/HSPA+ and LTE.

If you are using the Help feature, this mode must be currently active to access its detailed information. If it is not active, exit the Help feature (Esc key), select the mode, and re-access Help.

Key Path	Mode
Example	INST:SEL MSR INST:NSEL 106
Initial S/W Revision	A.09.491

WLAN

Selects the WLAN mode for general purpose measurements of signals following this standard. There are several measurements available in this mode.

If you are using the Help feature, this mode must be currently active to access its detailed information. If it is not active, exit the Help feature (Esc key), select the mode, and re-access Help.

Key Path	Mode
Example	INST:SEL WLAN INST:NSEL 217
Initial S/W Revision	A.09.491

SCPI Language Compatibility

The SCPI Language Compatibility mode provides remote language compatibility for SCPI-based instruments, such as the Rohde and Schwartz FSP and related series of spectrum analyzers.

NOTE After changing into or out of this mode, allow a 1 second delay before sending any subsequent commands.

If you are using the Help feature, this mode must be currently active to access its detailed information. If it is not active, exit the Help feature (Esc key), select the mode, and re-access Help.

Key Path	Mode
Example	INST:SEL SCPILC Or INST:NSEL 270
Initial S/W Revision	A.06.00

iDEN/WiDEN/MOTOTalk

Selects the iDEN/WiDEN/MOTOTalk mode for general purpose measurements of iDEN and iDEN-related signals. There are several measurements available in this mode.

If you are using the Help feature, this mode must be currently active to access its detailed information. If it is not active, exit the Help feature (Esc key), select the mode, and re-access Help.

Key Path	Mode
Example	INST:SEL IDEN INST:NSEL 103
Initial S/W Revision	A.02.00

ISDB-T

Selects the ISDB-T mode for measurements of digital video signals using this format. There are several power and demod measurements available in this mode.

If you are using the Help feature, this mode must be currently active to access its detailed information. If it is not active, exit the Help feature (Esc key), select the mode, and re-access Help.

Key Path	Mode
Example	INST:SEL ISDBT INST:NSEL 239
Initial S/W Revision	A.03.00

Digital Cable TV

Selects the Digital Cable TV mode for measurements of digital cable television systems. There are several power and demod measurements available in this mode.

If you are using the Help feature, this mode must be currently active to access its detailed information. If it is not active, exit the Help feature (Esc key), select the mode, and re-access Help.

Key Path	Mode
Example	INST:SEL DCTV INST:NSEL 238
Initial S/W Revision	A.07.00

Remote Language Compatibility

The Remote Language Compatibility (RLC) mode provides remote command backwards compatibility for the 8560 series of spectrum analyzers, known as legacy spectrum analyzers.

NOTE After changing into or out of this mode, allow a 1 second delay before sending any subsequent commands.

If you are using the Help feature, this mode must be currently active to access its detailed information. If it is not active, exit the Help feature (Esc key), select the mode, and re-access Help.

Key Path	Mode
Example	INST:SEL RLC Or INST:NSEL 266
Initial S/W Revision	Prior to A.02.00

89601 VSA

Selecting the 89601 VSA mode will start the 89600 VSA software. The 89600 VSA software is powerful, PC-based software, offering the industry's most sophisticated general purpose and standards specific signal evaluation and troubleshooting tools for R&D engineers. Even for proprietary and non-standard signals in SATCOM or MILCOM applications, you can make signal quality measurements with customized IQ constellation. Reach deeper into signals, gather more data on signal problems, and gain greater insight.

- Over 35 general-purpose analog and digital demodulators ranging from 2FSK to 4096QAM
- Flexible and custom IQ and OFDM signal analysis for single carrier
- Standards specific modulation analysis including:
 - Cellular: GSM/EDGE, cdma2000, W-CDMA, TD-SCDMA, LTE(FDD/TDD),
 - LTE-Advanced and more
 - Wireless networking: 802.11a/b/g, 802.11n, 802.ac, 802.16 WiMAX (fixed/mobile), WiSUN (MR-FSK PHY)
 - RFID
 - Digital satellite video and other satellite signals, radar, LMDS
 - Up to 400K bin FFT, for the highest resolution spectrum analysis
 - A full suite of time domain analysis tools, including signal capture and playback, time gating, and CCDF measurements
 - 20 simultaneous trace displays and the industry's most complete set of marker functions
 - Easy-to-use Microsoft Windows graphical user interface

For more information see the Keysight 89600 Series VSA web site at www.keysight.com/find/89600vsa

To learn more about how to use the 89600 VSA running in the X-Series, after the 89600 VSA software is running, open the 89600 VSA Help and open the "About Keysight X-Series Signal Analyzer with 89600 VSA Software" help topic.

Key Path	Mode
Example	INST:SEL VSA89601 INST:NSEL 101
Initial S/W Revision	Prior to A.02.00

DTMB (CTTB)

Selects the DTMB (CTTB) mode for measurements of digital video signals using this format. There are several power and demod measurements available in this mode.

If you are using the Help feature, this mode must be currently active to access its detailed information. If it is not active, exit the Help feature (Esc key), select the mode, and re-access Help.

Key Path	Mode
Example	INST:SEL DTMB INST:NSEL 236
Initial S/W Revision	A.02.00

Application Mode Number Selection (Remote Command Only)

Select the measurement mode by its mode number. The actual available choices depend upon which applications are installed in your instrument. The modes appear in this table in the same order they appear in the Mode menu (if the order is not changed by the Configure Applications utility found in the **System, Power On** menu). See "[Detailed List of Modes](#)" on page 293 for Mode details.

The Mode Number is the parameter for use with the :INSTrument:NSElect command. The Mode Parameter is the parameter for use with the :INSTrument[:SElect] command.

Mode	Mode Number	Mode Parameter
Spectrum Analyzer	1	SA
Real Time Spectrum Analyzer	107	RTSA
Sequence Analyzer	400	SEQAN
EMI Receiver	141	EMI
I/Q Analyzer (Basic)	8	BASIC
WCDMA with HSPA+	9	WCDMA
GSM/EDGE/EDGE Evo	13	EDGE GSM
802.16 OFDMA (WiMAX/WiBro)	75	WIMAX OFDMA
Vector Signal Analyzer (VXA)	100	VSA
Phase Noise	14	PNOISE
Noise Figure	219	NFIGure
Analog Demod	234	ADEMOD
Bluetooth	228	BTtooth
TD-SCDMA with HSPA/8PSK	211	TDSCDMA
cdma2000	10	CDMA2K
1xEV-DO	15	CDMA1XEV
LTE	102	LTE
LTE TDD	105	LTETDD
LTE-Advanced FDD	107	LTEAFDD
LTE-Advanced TDD	108	LTEATDD
MSR	106	MSR
DVB-T/H with T2	235	DVB

Mode	Mode Number	Mode Parameter
DTMB (CTTB)	236	DTMB
Digital Cable TV	238	DCTV
ISDB-T	239	ISDBT
CMMB	240	CMMB
WLAN	217	WLAN
Combined WLAN	19	CWLAN
Combined Fixed WiMAX	81	CWIMAXOFDM
802.16 OFDM (Fixed WiMAX)	104	WIMAXFIXED
iDEN/WiDEN/MotoTalk	103	IDEN
Remote Language Compatibility	266	RLC
SCPI Language Compatibility	270	SCPILC
89601 VSA	101	VSA89601

Remote Command	:INSTRument:NSElect <integer> :INSTRument:NSElect?
Example	:INST:NSEL 1
Notes	SA mode is 1 The command must be sequential: i.e. continued parsing of commands cannot proceed until the instrument select is complete and the resultant SCPI trees are available.
Preset	Not affected by Preset. Set to default mode (1 for SA mode) following Restore System Defaults.
State Saved	Saved in instrument state
Initial S/W Revision	Prior to A.02.00

Application Mode Catalog Query (Remote Command Only)

Returns a string containing a comma separated list of names of all the installed and licensed measurement modes (applications). These names can only be used with the :INSTRument[:SElect] command.

Remote Command	:INSTRument:CATalog?
Example	:INST:CAT?
Notes	Query returns a quoted string of the installed and licensed modes separated with a comma. Example: "SA,PNOISE,WCDMA"
Backwards	VSA (E4406A) :INSTRument:CATalog? returned a list of installed INSTRument:SELECT items as a comma separated

Compatibility Notes	<p>list of string values: "BASIC", "GSM", "EDGE GSM", "CDMA", "NADC", "PDC", "WCDMA", "CDMA2K", "CDMA1XEV", "IDEN", "WIDEN", "WLAN", "SERVICE"</p> <p>X-Series uses the ESA/PSA compatible query of a string contain comma separated values: "SA,PNOISE,NFIGURE,BASIC,CDMA,CDMA2K,WCDMA,CDMA1XEV,EDGE GSM,GSM,NADC,PDC,TDSCDMA,DMODULATION,WLAN"</p>
Initial S/W Revision	Prior to A.02.00

Application Identification (Remote Commands Only)

Each entry in the Mode Menu will have a Model Number and associated information: Version, and Options. This information is displayed in the Show System screen. The corresponding SCPI remote commands are defined here.

"Current Application Model " on page 290

"Current Application Revision" on page 290

"Current Application Options" on page 291

Current Application Model

Returns a string that is the Model Number of the currently selected application (mode).

Remote Command	:SYSTem:APPLication[:CURRent]:NAME?
Example	:SYST:APPL?
Notes	<p>Query returns a quoted string that is the Model Number of the currently selected application (Mode). Example: "N9060A" String length is 6 characters.</p>
Preset	Not affected by Preset
State Saved	Not saved in state, the value will be the selected application when a Save is done.
Initial S/W Revision	Prior to A.02.00

Current Application Revision

Returns a string that is the Revision of the currently selected application (mode).

Remote Command	:SYSTem:APPLication[:CURRent]:REVIion?
Example	:SYST:APPL:REV?
Notes	<p>Query returns a quoted string that is the Revision of the currently selected application (Mode). Example: "1.0.0.0"</p>

String length is a maximum of 23 characters. (each numeral can be an integer + 3 decimal points)

Preset	Not affected by a Preset
State Saved	Not saved in state, the value will be the selected application when a Save is done.
Initial S/W Revision	Prior to A.02.00

Current Application Options

Returns a string that is the Options list of the currently selected application (Mode).

Remote Command	:SYSTem:APPLication[:CURRent]:OPTion?
Example	:SYST:APPL:OPT?
Notes	Query returns a quoted string that is the Option list of the currently selected application (Mode). The format is the name as the *OPT? or SYSTem:OPTion command: a comma separated list of option identifiers. Example: "1FP,2FP" String length is a maximum of 255 characters.
Preset	Not affected by a Preset
State Saved	Not saved in state per se, the value will be the selected application when a Save is invoked.
Initial S/W Revision	Prior to A.02.00

Application Identification Catalog (Remote Commands Only)

A catalog of the installed and licensed applications (Modes) can be queried for their identification.

["Application Catalog Number of Entries" on page 291](#)

["Application Catalog Model Numbers" on page 292](#)

["Application Catalog Revision" on page 292](#)

["Application Catalog Options" on page 292](#)

Application Catalog Number of Entries

Returns the number of installed and licensed applications (Modes).

Remote Command	:SYSTem:APPLication:CATalog[:NAME]:COUNt?
Example	:SYST:APPL:CAT:COUN?
Preset	Not affected by Preset
State Saved	Not saved in instrument state.
Initial S/W Revision	Prior to A.02.00

Application Catalog Model Numbers

Returns a list of Model Numbers for the installed and licensed applications (Modes).

Remote Command	:SYSTem:APPLication:CATalog[:NAME]?
Example	:SYST:APPL:CAT?
Notes	Returned value is a quoted string of a comma separated list of Model Numbers. Example, if SAMS and Phase Noise are installed and licensed: "N9060A,N9068A" String length is COUNT * 7 - 1. (7 = Model Number length + 1 for comma. -1 = no comma for the 1st entry.)
Preset	Not affected by a Preset
State Saved	Not saved in instrument state.
Initial S/W Revision	Prior to A.02.00

Application Catalog Revision

Returns the Revision of the provided Model Number.

Remote Command	:SYSTem:APPLication:CATalog:REVision? <model>
Example	:SYST:APPL:CAT:REV? 'N9060A'
Notes	Returned value is a quoted string of revision for the provided Model Number. The revision will be a null-string ("") if the provided Model Number is not installed and licensed. Example, if SAMS is installed and licensed: "1.0.0.0"
Preset	Not affected by a Preset.
State Saved	Not saved in instrument state.
Initial S/W Revision	Prior to A.02.00

Application Catalog Options

Returns a list of Options for the provided Model Number

Remote Command	:SYSTem:APPLication:CATalog:OPTion? <model>
Example	:SYST:APPL:CAT:OPT? 'N9060A'
Notes	Returned value is a quoted string of a comma separated list of Options, in the same format as *OPT? or :SYSTem:OPTion?. If the provided Model Number is not installed and licensed a null-string ("") will be returned. Example, if SAMS is installed and licensed: "2FP" String length is a maximum of 255 characters.
Preset	Not affected by a Preset

State Saved	Not saved in instrument state.
Initial S/W Revision	Prior to A.02.00

Detailed List of Modes

This section contains an alphabetical list of Modes available in the X-Series, along with a brief description of each Mode.

Note that with the exception of the 89601 VSA, only licensed applications appear in the Mode menu. The 89601 will always appear, because it's licensing is handled differently.

1xEV-DO

Selects the 1xEV-DO mode for general purpose measurements of signals following this standard. There are several measurements available in this mode.

If you are using the Help feature, this mode must be currently active to access its detailed information. If it is not active, exit the Help feature (Esc key), select the mode, and re-access Help.

Key Path	Mode
Example	INST:SEL CDMA1XEV INST:NSEL 15
Initial S/W Revision	Prior to A.02.00

802.16 OFDMA (WiMAX/WiBro)

Selects the OFDMA mode for general purpose measurements of WiMAX signals. There are several measurements available in this mode.

If you are using the Help feature, this mode must be currently active to access its detailed information. If it is not active, exit the Help feature (Esc key), select the mode, and re-access Help.

Key Path	Mode
Example	INST:SEL WIMAXOFDMA INST:NSEL 75
Initial S/W Revision	Prior to A.02.00

802.16 OFDM (Fixed WiMAX)

Selects the 802.16 OFDM (Fixed WiMAX) mode. This mode allows modulation quality measurements of signals that comply with IEEE 802.16a-2003 and IEEE 802.16-2004 standards, with flexibility to measure nonstandard OFDM formats. Along with the typical digital demodulation measurement results, several additional 802.16 OFDM unique trace data formats and numeric error data results provide enhanced data analysis.

If you are using the Help feature, this mode must be currently active to access its detailed information. If it is not active, exit the Help feature (Esc key), select the mode, and re-access Help.

Key Path	Mode
Example	INST:SEL WIMAXFIXED INST:NSEL 104
Initial S/W Revision	A.02.00

89601 VSA

Selecting the 89601 VSA mode will start the 89600 VSA software. The 89600 VSA software is powerful, PC-based software, offering the industry's most sophisticated general purpose and standards specific signal evaluation and troubleshooting tools for R&D engineers. Even for proprietary and non-standard signals in SATCOM or MILCOM applications, you can make signal quality measurements with customized IQ constellation. Reach deeper into signals, gather more data on signal problems, and gain greater insight.

- Over 35 general-purpose analog and digital demodulators ranging from 2FSK to 4096QAM
- Flexible and custom IQ and OFDM signal analysis for single carrier
- Standards specific modulation analysis including:
 - Cellular: GSM/EDGE, cdma2000, W-CDMA, TD-SCDMA, LTE(FDD/TDD),
 - LTE-Advanced and more
 - Wireless networking: 802.11a/b/g, 802.11n, 802.ac, 802.16 WiMAX (fixed/mobile), WiSUN (MR-FSK PHY)
 - RFID
 - Digital satellite video and other satellite signals, radar, LMDS
 - Up to 400K bin FFT, for the highest resolution spectrum analysis
 - A full suite of time domain analysis tools, including signal capture and playback, time gating, and CCDF measurements
 - 20 simultaneous trace displays and the industry's most complete set of marker functions
 - Easy-to-use Microsoft Windows graphical user interface

For more information see the Keysight 89600 Series VSA web site at www.keysight.com/find/89600vsa

To learn more about how to use the 89600 VSA running in the X-Series, after the 89600 VSA software is running, open the 89600 VSA Help and open the "About Keysight X-Series Signal Analyzer with 89600 VSA Software" help topic.

Key Path	Mode
Example	INST:SEL VSA89601 INST:NSEL 101
Initial S/W Revision	Prior to A.02.00

Analog Demod

Selects the Analog Demod mode for making measurements of AM, FM and phase modulated signals.

If you are using the Help feature, this mode must be currently active to access its detailed information. If it is not active, exit the Help feature (Esc key), select the mode, and re-access Help.

Key Path	Mode
Example	INST:SEL ADEM0D INST:NSEL 234
Initial S/W Revision	Prior to A.02.00

Bluetooth

Selects the Bluetooth mode for Bluetooth specific measurements. There are several measurements available in this mode.

If you are using the Help feature, this mode must be currently active to access its detailed information. If it is not active, exit the Help feature (Esc key), select the mode, and re-access Help.

Key Path	Mode
Example	INST:SEL BT INST:NSEL 228
Initial S/W Revision	A.06.01

cdma2000

Selects the cdma2000 mode for general purpose measurements of signals following this standard. There are several measurements available in this mode.

If you are using the Help feature, this mode must be currently active to access its detailed information. If it is not active, exit the Help feature (Esc key), select the mode, and re-access Help.

Key Path	Mode
Example	INST:SEL CDMA2K INST:NSEL 10
Initial S/W Revision	Prior to A.02.00

CMMB

Selects the CMMB mode for measurements of digital video signals using this format. There are several power and demod measurements available in this mode.

If you are using the Help feature, this mode must be currently active to access its detailed information. If it is not active, exit the Help feature (Esc key), select the mode, and re-access Help.

Key Path	Mode
Example	INST:SEL CMMB INST:NSEL 240
Initial S/W Revision	A.03.00

Combined WLAN

Selects the CWLAN mode for general purpose measurements of signals following this standard. There are several measurements available in this mode.

If you are using the Help feature, this mode must be currently active to access its detailed information. If it is not active, exit the Help feature (Esc key), select the mode, and re-access Help.

Key Path	Mode
Example	INST:SEL CWLAN INST:NSEL 19
Initial S/W Revision	A.02.00

Combined Fixed WiMAX

Selects the Combined Fixed WiMAX mode for general purpose measurements of signals following this standard. There are several measurements available in this mode.

If you are using the Help feature, this mode must be currently active to access its detailed information. If it is not active, exit the Help feature (Esc key), select the mode, and re-access Help.

Key Path	Mode
Example	INST:SEL CWIMAXOFDM INST:NSEL 81
Initial S/W Revision	A.02.00

Digital Cable TV

Selects the Digital Cable TV mode for measurements of digital cable television systems. There are several power and demod measurements available in this mode.

If you are using the Help feature, this mode must be currently active to access its detailed information. If it is not active, exit the Help feature (Esc key), select the mode, and re-access Help.

Key Path	Mode
Example	INST:SEL DCTV

	INST:NSEL 238
Initial S/W Revision	A.07.00

DTMB (CTTB)

Selects the DTMB (CTTB) mode for measurements of digital video signals using this format. There are several power and demod measurements available in this mode.

If you are using the Help feature, this mode must be currently active to access its detailed information. If it is not active, exit the Help feature (Esc key), select the mode, and re-access Help.

Key Path	Mode
Example	INST:SEL DTMB INST:NSEL 236
Initial S/W Revision	A.02.00

DVB-T/H with T2

Selects the DVB-T/H mode for measurements of digital video signals using this format. There are several power and demod measurements available in this mode.

If you are using the Help feature, this mode must be currently active to access its detailed information. If it is not active, exit the Help feature (Esc key), select the mode, and re-access Help.

Key Path	Mode
Example	INST:SEL DVB INST:NSEL 235
Initial S/W Revision	A.02.00
Modified at S/W Revision	A.07.00

EMI Receiver

The EMI Receiver Mode makes EMC measurements. Several measurements are provided to aid the user in characterizing EMC performance of their systems, including looking at signals with CISPR-16 compliant detectors, performing scans for interfering signals, and determining and charting interfering signals over time.

If you are using the Help feature, this mode must be currently active to access its detailed information. If it is not active, exit the Help feature (Esc key), select the mode, and re-access Help.

Key Path	Mode
Example	INST:SEL EMI INST:NSEL 141
Initial S/W Revision	A.07.01

GSM/EDGE/EDGE Evo

Selects the GSM with EDGE mode for general purpose measurements of signals following this standard. There are several measurements available in this mode.

If you are using the Help feature, this mode must be currently active to access its detailed information. If it is not active, exit the Help feature (Esc key), select the mode, and re-access Help.

Key Path	Mode
Example	INST:SEL EDGEGSM INST:NSEL 13
Initial S/W Revision	Prior to A.02.00
Modified at S/W Revision	A.02.00

iDEN/WiDEN/MOTOTalk

Selects the iDEN/WiDEN/MOTOTalk mode for general purpose measurements of iDEN and iDEN-related signals. There are several measurements available in this mode.

If you are using the Help feature, this mode must be currently active to access its detailed information. If it is not active, exit the Help feature (Esc key), select the mode, and re-access Help.

Key Path	Mode
Example	INST:SEL IDEN INST:NSEL 103
Initial S/W Revision	A.02.00

IQ Analyzer (Basic)

The IQ Analyzer Mode makes general purpose frequency domain and time domain measurements. These measurements often use alternate hardware signal paths when compared with a similar measurement in the Signal Analysis Mode using the Swept SA measurement. These frequency domain and time domain measurements can be used to output I/Q data results when measuring complex modulated digital signals.

If you are using the Help feature, this mode must be currently active to access its detailed information. If it is not active, exit the Help feature (Esc key), select the mode, and re-access Help.

Key Path	Mode
Example	INST:SEL BASIC INST:NSEL 8
Initial S/W Revision	Prior to A.02.00

ISDB-T

Selects the ISDB-T mode for measurements of digital video signals using this format. There are several power and demod measurements available in this mode.

If you are using the Help feature, this mode must be currently active to access its detailed information. If it is not active, exit the Help feature (Esc key), select the mode, and re-access Help.

Key Path	Mode
Example	INST:SEL ISDBT INST:NSEL 239
Initial S/W Revision	A.03.00

LTE

Selects the LTE mode for general purpose measurements of signals following the LTE FDD standard. There are several measurements available in this mode.

If you are using the Help feature, this mode must be currently active to access its detailed information. If it is not active, exit the Help feature (Esc key), select the mode, and re-access Help.

Key Path	Mode
Example	INST:SEL LTE INST:NSEL 102
Initial S/W Revision	Prior to A.02.00

LTE TDD

Selects the LTE TDD mode for general purpose measurements of signals following the LTE TDD standard. There are several measurements available in this mode.

If you are using the Help feature, this mode must be currently active to access its detailed information. If it is not active, exit the Help feature (Esc key), select the mode, and re-access Help.

Key Path	Mode
Example	INST:SEL LTETDD INST:NSEL 105
Initial S/W Revision	A.03.00

LTE-Advanced FDD

As LTE-Advanced FDD and LTE modes are converged into one single application, the single softkey under Mode menu is designed to select the covered mode. The display mode of the LTE and LTE-Advanced FDD are distinguished by the licenses.

If you are using the Help feature, this mode must be currently active to access its detailed information. If it is not active, exit the Help feature (Esc key), select the mode, and re-access Help.

Key Path	Mode
Example	INST:SEL LTEAFDD INST:NSEL 107
Notes	When the N9080A/80B-1FP exists, the display mode name is LTE. When the N9080A/80B-1FP and N9080B-2FP all exist, the display mode name is LTE FDD & LTE-A FDD.
Backwards Compatibility SCPI	INST:SEL LTE INST:NSEL 102
Initial S/W Revision	A.14.00
Modified at S/W Revision	A.14.50

LTE-Advanced TDD

As LTE-Advanced TDD and LTE TDD modes are converged into one single application, the single softkey under Mode menu is designed to select the covered mode. The display mode of the LTE TDD and LTE-Advanced TDD are distinguished by the licenses.

If you are using the Help feature, this mode must be currently active to access its detailed information. If it is not active, exit the Help feature (Esc key), select the mode, and re-access Help.

Key Path	Mode
Example	INST:SEL LTEATDD INST:NSEL 108
Notes	When the N9082A/82B-1FP exists, the display mode name is LTE TDD. When the N9082A/82B-1FP and N9082B-2FP all exist, the display mode name is LTE TDD & LTE-A TDD.
Backwards Compatibility SCPI	INST:SEL LTETDD INST:NSEL 105
Initial S/W Revision	A.14.00
Modified at S/W Revision	A.14.50

MSR

Selects the MSR mode. The MSR mode makes several measurements for Cellular Communication devices that can be configured with multiple radio formats simultaneously following the 3GPP standard of Multi-Standard Radio, including GSM/EDGE, WCDMA/HSPA+ and LTE.

If you are using the Help feature, this mode must be currently active to access its detailed information. If it is not active, exit the Help feature (Esc key), select the mode, and re-access Help.

Key Path	Mode
----------	------

Example	INST:SEL MSR INST:NSEL 106
Initial S/W Revision	A.09.491

Noise Figure

The Noise Figure mode provides pre-configured measurements for making general purpose measurements of device noise figure.

If you are using the Help feature, this mode must be currently active to access its detailed information. If it is not active, exit the Help feature (Esc key), select the mode, and re-access Help.

Key Path	Mode
Example	INST:SEL NFIGURE INST:NSEL 219
Initial S/W Revision	Prior to A.02.00

Phase Noise

The Phase Noise mode provides pre-configured measurements for making general purpose measurements of device phase noise.

If you are using the Help feature, this mode must be currently active to access its detailed information. If it is not active, exit the Help feature (Esc key), select the mode, and re-access Help.

Key Path	Mode
Example	INST:SEL PNOISE or INST:NSEL 14
Initial S/W Revision	Prior to A.02.00

Real Time Spectrum Analyzer

The Real Time Spectrum Analyzer (RTSA) mode provides real-time signal analysis, very high probability-of-intercept for intermittent signals with appropriate triggers.

If you are using the Help feature, this mode must be currently active to access its detailed information. If it is not active, exit the Help feature (Esc key), select the mode, and re-access Help.

Key Path	Mode
Example	INST:SEL RTSA or INST:NSEL 107

Initial S/W Revision	A.13.00
----------------------	---------

Remote Language Compatibility

The Remote Language Compatibility (RLC) mode provides remote command backwards compatibility for the 8560 series of spectrum analyzers, known as legacy spectrum analyzers.

NOTE After changing into or out of this mode, allow a 1 second delay before sending any subsequent commands.

If you are using the Help feature, this mode must be currently active to access its detailed information. If it is not active, exit the Help feature (Esc key), select the mode, and re-access Help.

Key Path	Mode
Example	INST:SEL RLC Or INST:NSEL 266
Initial S/W Revision	Prior to A.02.00

SCPI Language Compatibility

The SCPI Language Compatibility mode provides remote language compatibility for SCPI-based instruments, such as the Rohde and Schwartz FSP and related series of spectrum analyzers.

NOTE After changing into or out of this mode, allow a 1 second delay before sending any subsequent commands.

If you are using the Help feature, this mode must be currently active to access its detailed information. If it is not active, exit the Help feature (Esc key), select the mode, and re-access Help.

Key Path	Mode
Example	INST:SEL SCPI LC Or INST:NSEL 270
Initial S/W Revision	A.06.00

Spectrum Analyzer

Selects the Spectrum Analyzer mode for general purpose measurements. There are several measurements available in this mode. General spectrum analysis measurements, in swept and zero span, can be done using the first key in the Meas menu, labeled Swept SA. Other measurements in the Meas Menu are designed to perform specialized measurement tasks, including power and demod measurements.

If you are using the Help feature, this mode must be currently active to access its detailed information. If it is not active, exit the Help feature (Esc key), select the mode, and re-access Help.

Key Path	Mode
Example	INST:SEL SA INST:NSEL 1
Initial S/W Revision	Prior to A.02.00

TD-SCDMA with HSPA/8PSK

Selects the TD-SCDMA mode for general purpose measurements of signals following this standard. There are several measurements available in this mode.

If you are using the Help feature, this mode must be currently active to access its detailed information. If it is not active, exit the Help feature (Esc key), select the mode, and re-access Help.

Key Path	Mode
Example	INST:SEL TDSCDMA INST:NSEL 211
Initial S/W Revision	Prior to A.02.00

Vector Signal Analyzer (VXA)

The N9064A (formerly 89601X) VXA Vector signal and WLAN modulation analysis application provides solutions for basic vector signal analysis, analog demodulation, and digital demodulation. The digital demodulation portion of N9064A allows you to perform measurements on standard-based formats such as cellular, wireless networking and digital video as well as general purpose flexible modulation analysis for wide range of digital formats, FSK to 1024QAM, with easy-to-use measurements and display tools such as constellation and eye diagram, EVM traces and up to four simultaneous displays. Analog baseband analysis is available using the MXA and PXA with option BBA. Option 3FP WLAN has been discontinued.

N9064A honors existing 89601X licenses with all features and functionalities found on X-Series software versions prior to A.06.00. Specifically:

N9064A-1 is equivalent to 89601X-205

N9064A-2 is equivalent to 89601X-AYA

If you are using the Help feature, this mode must be currently active to access its detailed information. If it is not active, exit the Help feature (Esc key), select the mode, and re-access Help.

Key Path	Mode
Example	INST:SEL VSA INST:NSEL 100
Initial S/W Revision	Prior to A.02.00

W-CDMA with HSPA+

Selects the W-CDMA with HSPA+ mode for general purpose measurements of signals following this standard. There are several measurements available in this mode.

If you are using the Help feature, this mode must be currently active to access its detailed information. If it is not active, exit the Help feature (Esc key), select the mode, and re-access Help.

Key Path	Mode
Example	INST:SEL WCDMA INST:NSEL 9
Initial S/W Revision	Prior to A.02.00

WLAN

Selects the WLAN mode for general purpose measurements of signals following this standard. There are several measurements available in this mode.

If you are using the Help feature, this mode must be currently active to access its detailed information. If it is not active, exit the Help feature (Esc key), select the mode, and re-access Help.

Key Path	Mode
Example	INST:SEL WLAN INST:NSEL 217
Initial S/W Revision	A.09.491

Global Settings

Opens a menu that allows you to switch certain Meas Global parameters to a Mode Global state. These switches apply to all Modes that support global settings. No matter what Mode you are in when you set the “Global Center Frequency” switch to on, it applies to all Modes that support Global Settings.

Key Path	Mode Setup
Initial S/W Revision	Prior to A.02.00

Global Center Freq

The software maintains a Mode Global value called “Global Center Freq”.

When the **Global Center Freq** key is switched to **On** in any mode, the current mode’s center frequency is copied into the Global Center Frequency, and from then on all modes that support global settings use the Global Center Frequency. So you can switch between any of these modes and the Center Freq will remain unchanged.

Adjusting the Center Freq of any mode which supports Global Settings, while **Global Center Freq** is **On**, will modify the Global Center Frequency.

When **Global Center Freq** is turned **Off**, the Center Freq of the current mode is unchanged, but now the Center Freq of each mode is once again independent.

When **Mode Preset** is pressed while **Global Center Freq** is **On**, the Global Center Freq is preset to the preset Center Freq of the current mode.

This function is reset to Off when the Restore Defaults key is pressed in the Global Settings menu, or when **System, Restore Defaults, All Modes** is pressed.

Key Path	Mode Setup, Global Settings
Scope	Mode Global
Remote Command	:INSTrument:COUPle:FREQuency:CENTer ALL NONE :INSTrument:COUPle:FREQuency:CENTer?
Example	INST:COUP:FREQ:CENT ALL INST:COUP:FREQ:CENT?
Preset	Set to Off on Global Settings, Restore Defaults and System, Restore Defaults, All Modes
Range	On Off
Initial S/W Revision	Prior to A.02.00

Remote Command	:GLOBal:FREQuency:CENTer[:STATe] 1 0 ON OFF :GLOBal:FREQuency:CENTer[:STATe]?
Preset	Off
Initial S/W Revision	Prior to A.02.00

Restore Defaults

This key resets all of the functions in the Global Settings menu to Off. This also occurs when **System, Restore Defaults, All Modes** is pressed.

Key Path	Mode Setup, Global Settings
Remote Command	:INSTrument:COUPle:DEFault
Example	INST:COUP:DEF
Backwards Compatibility SCPI	:GLOBal:DEFault
Initial S/W Revision	Prior to A.02.00

Mode Setup

Accesses a menu that enables you to select mode parameters. These settings are in effect for all measurements in the current mode.

Key Path	Front Panel
Initial S/W Revision	A.10.00

Radio

Accesses the Radio menu.

Key Path	Mode Setup
Initial S/W Revision	A.10.00

Band

Accesses the Band menu.

Key Path	Mode Setup, Radio
Initial S/W Revision	A.10.00

Operating Band

Sets operating band of the DUT using the MSR band numbers defined in the 3GPP standard. Operating band affects the frequency ranges and limits of Spectrum Emission Mask and Spurious Emission. Operating bands are defined in 3GPP documents such as TS 37.141.

- None – No operating band is specified. Operating band range is not taken into account in the measurements.
- Others – Corresponding operating band is selected. The measurement frequency range and limits are determined by the operating parameters.

OB Start Freq, OB Stop Freq and Band Category are set as defined in the table below when they are in Auto mode.

MSR and E-UTRA Band number	UTRA Band number	GSM/EDGE Band designation	Downlink (DL) BS transmit UE receive			Band category
1	I	-	2110 MHz	-	2170 MHz	1
2	II	PCS 1900	1930 MHz	-	1990 MHz	2

3	III	DCS 1800	1805 MHz	-	1880 MHz	2
4	IV	-	2110 MHz	-	2155 MHz	1
5	V	GSM 850	869 MHz	-	894 MHz	2
6 (1)	VI	-	875 MHz	-	885 MHz	1 (1)
7	VII	-	2620 MHz	-	2690 MHz	1
8	VIII	E-GSM	925 MHz	-	960 MHz	2
9	IX	-	1844.9 MHz	-	1879.9 MHz	1
10	X	-	2110 MHz	-	2170 MHz	1
11	XI	-	1475.9 MHz	-	1495.9 MHz	1
12	XII	-	729 MHz	-	746 MHz	1
13	XIII	-	746 MHz	-	756 MHz	1
14	XIV	-	758 MHz	-	768 MHz	1
15	XV	-	Reserved			
16	XVI	-	Reserved			
17	-	-	734 MHz	-	746 MHz	1 (2)
18	-	-	860 MHz	-	875 MHz	1 (2)
19	XIX	-	875 MHz	-	890 MHz	1
20	XX	-	791 MHz	-	821 MHz	1
21	XXI	-	1495.9 MHz	-	1510.9 MHz	1
22	XXII	-	3510 MHz	-	3590 MHz	1
23	-	-	2180 MHz	-	2200 MHz	1 (2)
24	-	-	1525 MHz	-	1559 MHz	1 (2)

25	XXV	-	1930 MHz	-	1995 MHz	1
NOTE 1:The band is for UTRA only.						
NOTE 2:The band is for E-UTRA only.						

Key Path	Mode Setup, Radio, Band
Remote Command	[[:SENSE]:RADio:BAND[:SElect] NONE BAND1 BAND2 BAND3 BAND4 BAND5 BAND6 BAND7 BAND8 BAND9 BAND10 BAND11 BAND12 BAND13 BAND14 BAND17 BAND18 BAND19 BAND20 BAND21 BAND22 BAND23 BAND24 BAND25 [:SENSE]:RADio:BAND[:SElect]?
Example	RAD:BAND BAND1 RAD:BAND?
State Saved	Saved in instrument state
Range	None Band 1(2110-2170MHz) Band 2(1930-1990MHz) Band 3(1805-1880MHz) Band 4(2110-2155MHz) Band 5(869-894MHz) Band 6(875-885MHz) Band 7(2620-2690MHz) Band 8(925-960MHz) Band 9(1844.9-1879.9MHz) Band 10(2110-2170MHz) Band 11(1475.9-1495.9MHz) Band 12(728-746MHz) Band 13(746-756MHz) Band 14(758-768MHz) Band 17(734-746MHz) Band 18(860-875MHz) Band 19(875-890MHz) Band 20(791-821MHz) Band 21(1495.9-1510.9MHz) Band 22(3510 - 3590 MHz) Band 23(2180 - 2200MHz) Band 24(1525 - 1559MHz) Band 25(1930 - 1995MHz)
Initial S/W Revision	A.10.00
Modified at S/W Revision	A.11.00

OB Start Freq

Sets operating band start frequency. It is automatically set depending on Operating Band selection as described in the table in "[Operating Band](#)" on page 306 when in auto mode. Operating band start frequency determines limit evaluation range of Spurious Emissions and Spectrum Emission Mask.

Measurement frequency range of Spurious Emissions and Spectrum Emission Mask

In Spurious Emissions frequency between Operating Band Start Freq – 10 MHz and Operating Band Stop Freq + 10 MHz are not measured for limit test.

In Spectrum Emission Mask, frequency below Operating Band Start Freq – 10 MHz and frequency above Operating Band Stop Freq + 10 MHz are not measured for limit test.

Key Path	Mode Setup, Radio, Band
Remote Command	[:SENSe]:RADio:BAND:StARt <freq> [:SENSe]:RADio:BAND:StARt? [:SENSe]:RADio:BAND:StARt:AUTO ON OFF 0 1 [:SENSe]:RADio:BAND:StARt:AUTO?
Example	RAD:BAND:STAR 2110MHz RAD:BAND:STAR? RAD:BAND:STAR:AUTO ON RAD:BAND:STAR?
Couplings	This value is always less than or equal to OB Stop Freq.
Preset	Automatically calculated ON
State Saved	Saved in instrument state
Min	10 MHz
Max	Instrument Max Freq – 10 MHz
Initial S/W Revision	A.10.00

OB Stop Freq

Sets operating band stop frequency. It is automatically set depending on Operating Band selection as described in the table in "[Operating Band](#)" on page 306 when in auto mode. Operating band start frequency determines limit evaluation range of Spurious Emissions and Spectrum Emission Mask. See "Measurement frequency range of Spurious Emissions and Spectrum Emission Mask" section in Operating Band Start Freq for more information.

Key Path	Mode Setup, Radio, Band
Remote Command	[:SENSe]:RADio:BAND:StOP <freq> [:SENSe]:RADio:BAND:StOP? [:SENSe]:RADio:BAND:StOP:AUTO ON OFF 0 1 [:SENSe]:RADio:BAND:StOP:AUTO?
Example	RAD:BAND:STOP 2170MHz RAD:BAND:STOP? RAD:BAND:STOP:AUTO ON RAD:BAND:STOP:AUTO?
Couplings	This value is always greater than or equal to OB Start Freq.
Preset	Automatically calculated ON
State Saved	Saved in instrument state
Min	10 MHz

Max	Instrument Max Freq – 10 MHz
Initial S/W Revision	A.10.00

Band Category

Sets band category. It is automatically set depending on Operating Band selection as described in the table in "[Operating Band](#)" on page 306 when in auto mode. Operating band start frequency determines limit evaluation range of Spurious Emissions and Spectrum Emission Mask. See "Measurement frequency range of Spurious Emissions and Spectrum Emission Mask" section in Operating Band Start Freq for more information.

Key Path	Mode Setup, Radio, Band
Remote Command	[:SENSe] :RADio :BAND :CATegory <integer> [:SENSe] :RADio :BAND :CATegory? [:SENSe] :RADio :BAND :CATegory :AUTO ON OFF 0 1 [:SENSe] :RADio :BAND :CATegory :AUTO ?
Example	RAD :BAND :CAT 1 RAD :BAND :CAT ? RAD :BAND :CAT :AUTO ON RAD :BAND :CAT :AUTO ?
Preset	Automatically calculated ON
State Saved	Saved in instrument state
Min	1
Max	2
Initial S/W Revision	A.10.00

Assumed Adj Channels

Sets assumed adjacent channel referred to preset offsets and limits of ACP. The offset/limit preset runs only when the carrier config preset is initiated by changing one of the parameters under Carrier Conf Presets menu.

Key Path	Mode Setup, Radio
Remote Command	[:SENSe] :RADio :ACHannel [:TYPE] LTE WCDMA [:SENSe] :RADio :ACHannel [:TYPE] ?
Example	RAD :ACH LTE RAD :ACH ?
Preset	LTE
State Saved	Saved in instrument state

Range	LTE W-CDMA
Readback	LTE W-CDMA
Initial S/W Revision	A.10.00

Intermod

The menu for parameters for intermodulation interference signal is displayed when this key is pressed.

Key Path	Mode Setup, Radio
Initial S/W Revision	A.10.00

Interference Pwr Present

Sets whether interference signal for the intermodulation tests exists or not. If exists, limits are not evaluated over the interference signal frequency range specified by the span and the center frequency parameters in Adjacent Channel, Spectrum Emission Mask and Spurious Emissions.

Key Path	Mode Setup, Radio, Intermod
Remote Command	[:SENSe] :RADio:IMODulation:INTerference[:STATe] OFF ON 0 1 [:SENSe] :RADio:IMODulation:INTerference[:STATe] ?
Example	RAD:IMOD:INT 1 RAD:IMOD:INT?
Preset	OFF
State Saved	Saved in instrument state
Range	Yes No
Initial S/W Revision	A.10.00

Freq Offset from Edge

Sets the center frequency of the interference signal for intermodulation tests. The frequency is set as offset frequency from the BS RF bandwidth edge. Interference Offset Side determines on which side of the BS RF bandwidth the interference signal exists.

Key Path	Mode Setup, Radio, Intermod
Remote Command	[:SENSe] :RADio:IMODulation:INTerference:FREQuency:OFFSet <freq> [:SENSe] :RADio:IMODulation:INTerference:FREQuency:OFFSet ?
Example	RAD:IMOD:INT:FREQ:OFFS 5MHz RAD:IMOD:INT:FREQ:OFFS?
Preset	5MHz

State Saved	Saved in instrument state
Min	0 Hz
Max	20.0 MHz
Initial S/W Revision	A.10.00

Span

Sets the span of the interference signal for intermodulation tests.

Key Path	Mode Setup, Radio, Intermod
Remote Command	[:SENSe] :RADio:IMODulation:INTerference:SPAN <freq> [:SENSe] :RADio:IMODulation:INTerference:SPAN?
Example	RAD:IMOD:INT:SPAN 5MHz RAD:IMOD:INT:SPAN?
Preset	5MHz
State Saved	Saved in instrument state
Min	200 kHz
Max	20.0 MHz
Initial S/W Revision	A.10.00

Offset Side

Sets which side of the BS RF bandwidth the interference signal exists on.

Key Path	Mode Setup, Radio, Intermod
Remote Command	[:SENSe] :RADio:IMODulation:INTerference:SIDE NEGative POSitive [:SENSe] :RADio:IMODulation:INTerference:SIDE?
Example	RAD:IMOD:INT:SIDE POS RAD:IMOD:INT:SIDE?
Preset	POSitive
State Saved	Saved in instrument state
Initial S/W Revision	A.10.00

Non-Contiguous Interference Region

Sets the region the interfering signal exists at in the Non-Contiguous mode

Inner – The interfering signal exists at the inner region. This setting is only effective when Carrier Alloc is Non-Contiguous. When in Contiguous, the interference region is always outside regardless of the selection of this parameter.

Outer – The interfering signal exists at either of the outer regions.

Key Path	Mode Setup, Radio, Intermod
Remote Command	[:SENSE] :RADio:IMODulation:INTerference:REGion INNER OUTer [:SENSe] :RADio:IMODulation:INTerference:REGion?
Example	RAD:IMOD:INT:REG OUT RAD:IMOD:INT:REG?
Preset	OUTer
State Saved	Saved in instrument state
Initial S/W Revision	A.13.00

Format

All parameters for each radio format can be modified in Format Parameter List in Mode Setup individually. There are three Format Parameter Lists for each radio format. You can assign one Format Parameter List to each carrier.

Basically, parameters are based on the measurement in each application as follows:

Original Application / Measurement	Measurement SCPI node of Original Measurement
GSM/EDGE / EDGE EVM	EEVM
W-CDMA / Mod Accuracy	RHO
LTE FDD / Conformance EVM	CEVM
cdma2000 / Mod Accuracy	RHO
1xEV-DO / Mod Accuracy	RHO
TD-SCDMA / Mod Accuracy	EVM
LTE TDD / Conformance EVM	CEVM

However, some parameters are from the original application's mode parameters and some are newly added.

If you have a set of SCPI lists to set up the original measurement, you can easily convert it for the MSR's CEVM by simply replacing the measurement node name with "RADio:FORMat:<Radio Format node>" as follows:

Radio Format	SCPI node in Original Measurement	Radio Format node
GSM/EDGE	:EEVM	:RADio:FORMat:GSM{List Index}
W-CDMA	:RHO	:RADio:FORMat:WCDMa{List Index}
LTE FDD	:CEVM	:RADio:FORMat::LTFdd{List Index}
cdma2000	:RHO	:RADio:FORMat:CDMA{List Index}
1xEV-DO	:RHO	:RADio:FORMat:EVDO{List index}
TD-SCDMA	:EVM	:RADio:FORMat:TDSCdma{List Index}

LTE TDD	:CEVM	:RADio:FORMat:LTETdd{List Index}
---------	-------	----------------------------------

For example,

GSM/EDGE mode – Frequency Error Tolerance Range in the EDGE EVM measurement

[[:SENSe]:EEVM:FERRor:TRANge

➔[:SENSe]:RADio:FORMat:GSM1:FERRor:TRANge (convert node)

LTE mode – Detection in the Conformance EVM measurement

[[:SENSe]:CEVM:PROFile:AUTO:DETECT

➔[:SENSe]:RADio:FORMat:LTEFdd3:PROFile:AUTO:DETECT (convert node)

For parameters from the original application's mode, you need to convert or insert the SCPI node individually. For example,

GSM/EDGE mode – Mod Scheme in the GSM/EDGE mode

[[:SENSe]:SYNC:NORMal:MODulation

➔[:SENSe]:RADio:FORMat:GSM1:SYNC:NORMal:MODulation (insert node)

LTE mode – Spectrum in the LTE mode

:SPECTrum

➔[:SENSe]:RADio:FORMat:LTEFdd3:SPECTrum (insert node)

Key Path	Mode Setup
Initial S/W Revision	A.10.00
Modified at S/W Revision	A.11.00

LTE FDD

Accesses the LTE FDD menu for LTE FDD Parameter Set. This key is available only when Option N/W9080A-1FP is installed.

Key Path	Mode Setup, Format
Initial S/W Revision	A.10.00

Select LTE FDD Parameter Set

Selects LTE FDD parameter set and shows its parameters on menu.

Key Path	Mode Setup, Format, LTE FDD
----------	-----------------------------

State Saved	Saved in instrument state
Initial S/W Revision	A.10.00

Parameter Set Name

Sets the name of the selected LTE FDD parameter set.

Key Path	Mode Setup, Format, LTE FDD
Remote Command	<code>[[:SENSe]:RADio:FORMat:LTEFdd[1] 2 3:PSET:NAME <string></code> <code>[[:SENSe]:RADio:FORMat:LTEFdd[1] 2 3:PSET:NAME?</code>
Example	<code>RAD:FORM:LTEF2:PSET:NAME "Parameter Set 2"</code> <code>RAD:FORM:LTEF2:PSET:NAME?</code>
Preset	"LTE FDD 1" "LTE FDD 2" "LTE FDD 3"
State Saved	Saved in instrument state
Initial S/W Revision	A.10.00

Format Parameter List

Since most parameters are the same as those used in the original measurement, the SCPI commands in the original measurement can be used to set up the LTE FDD parameter sets by converting the measurement node.

The following SCPI commands in the LTE FDD Conformance EVM measurement are converted for the MSR's CEVM as follows:

SCPI Command in LTE FDD CEVM	SCPI Command in MSR CEVM
<code>[[:SENSe]:CEVM:AVERage:COUNT</code>	<code>[[:SENSe]:CEVM:LTEFdd:AVERage:COUNT</code>
<code>[[:SENSe]:CEVM:AVERage[:STATe]</code>	<code>[[:SENSe]:CEVM:LTEFdd:AVERage[:STATe]</code>

These commands are not in the Format Parameter List. See ["LTE FDD Average/Hold Number" on page 1820](#) for details.

The preset of the following command differs between the LTE FDD CEVM and MSR CEVM.

SCPI Command in LTE FDD CEVM	SCPI Command in MSR CEVM	Preset in MSR CEVM
<code>[[:SENSe]:CEVM:MCFilter:STATe</code>	<code>[[:SENSe]:RADio:FORMat:LTEFdd{1:3}:MCFilter:STATe</code>	1

The following SCPI commands in the LTE FDD Conformance EVM measurement are not available in the MSR.

SCPI Command not available in MSR CEVM
--

:DISPlay:CEVM:VIEW1 VIEW[:SElect]
[[:SENSe]:CEVM:AVERage:NUMber
[[:SENSe]:CEVM:AVERage:TCONtrol
[[:SENSe]:CEVM:BERate:FILE:FORMat
[[:SENSe]:CEVM:BERate:FILE:NAME
[[:SENSe]:CEVM:BERate:FILE:PATH
[[:SENSe]:CEVM:BERate:FILE:Q:NAME
[[:SENSe]:CEVM:BERate:FILE:SEPArated
[[:SENSe]:CEVM:BERate:OSRatio
[[:SENSe]:CEVM:DLINK:DECode:DFINclude
[[:SENSe]:CEVM:DLINK:DECode:RNTI:MAXimum:RA
[[:SENSe]:CEVM:DLINK:DECode:RNTI:MAXimum:TPC
[[:SENSe]:CEVM:DLINK:DECode:RNTI:MINimum:RA
[[:SENSe]:CEVM:DLINK:DECode:RNTI:MINimum:TPC
[[:SENSe]:CEVM:DLINK:RESult
[[:SENSe]:CEVM:EVM:COPY[:IMMediate]/nquery/
[[:SENSe]:CEVM:METHod
[[:SENSe]:CEVM:ULINK:BERate:DECoder:CONFigure
[[:SENSe]:CEVM:ULINK:BERate:DECoder:ITERation
[[:SENSe]:CEVM:ULINK:BERate:DECoder[:STATe]
[[:SENSe]:CEVM:ULINK:BERate:PRBS:SYNC:AUTO
[[:SENSe]:CEVM:ULINK:BERate:PRBS:SYNC:INITial
[[:SENSe]:CEVM:ULINK:BERate:PRBS[:TYPE]
[[:SENSe]:CEVM:ULINK:BERate:RESult
[[:SENSe]:CEVM:ULINK:BERate:RESync:LENGth
[[:SENSe]:CEVM:ULINK:BERate:RESync:MODE
[[:SENSe]:CEVM:ULINK:BERate[:STATe]
[[:SENSe]:CEVM:ULINK:BERate:SYNC:AUTO
[[:SENSe]:CEVM:ULINK:BERate:SYNC:FOFFset
[[:SENSe]:CEVM:ULINK:BERate:SYNC:LOCation
[[:SENSe]:CEVM:ULINK:DECode:PUSCh
[[:SENSe]:CEVM:ULINK:RESult

See also the following sections.

["ACP Measurement Noise Bandwidth" on page 317](#)

["SEM Integ BW" on page 317](#)

"CHP Integ BW" on page 318

Key Path	Mode Setup, Format, LTE FDD
Initial S/W Revision	A.10.00
Modified at S/W Revision	A.13.00

ACP Measurement Noise Bandwidth

Specifies the Measurement Noise Bandwidth used to calculate the power in the carriers in the ACP measurement.

Key Path	Mode Setup, Format, LTE FDD, Format Parameter List												
Mode	MSR												
Remote Command	[:SENSE]:RADio:FORMat:LTEFdd[1] 2 3:ACPower:CARRier[1] 2:BANDwidth:INTEgration <freq> [:SENSE]:RADio:FORMat:LTEFdd[1] 2 3:ACPower:CARRier[1] 2:BANDwidth:INTEgration?												
Example	RAD:FORM:LTEF:ACP:CARR:BAND:INT 20MHz RAD:FORM:LTEF:ACP:CARR:BAND:INT?												
Notes	You must be in the MSR mode. Use :INSTRument:SELEct to set the mode.												
Couplings	When Demod Bandwidth of the parameter set is changed, the value of this parameter also changes as shown in the following table. Note that you cannot set the value exceeding the corresponding Demod Bandwidth.												
	<table border="1"> <tr> <td>1.4 MHz (B1M4)</td> <td>1.095 MHz</td> </tr> <tr> <td>3 MHz (B3M)</td> <td>2.715 MHz</td> </tr> <tr> <td>5 MHz (B5M)</td> <td>4.515 MHz</td> </tr> <tr> <td>10 MHz (B10M)</td> <td>9.015 MHz</td> </tr> <tr> <td>15 MHz (B15M)</td> <td>13.515 MHz</td> </tr> <tr> <td>20 MHz (B20M)</td> <td>18.015 MHz</td> </tr> </table>	1.4 MHz (B1M4)	1.095 MHz	3 MHz (B3M)	2.715 MHz	5 MHz (B5M)	4.515 MHz	10 MHz (B10M)	9.015 MHz	15 MHz (B15M)	13.515 MHz	20 MHz (B20M)	18.015 MHz
1.4 MHz (B1M4)	1.095 MHz												
3 MHz (B3M)	2.715 MHz												
5 MHz (B5M)	4.515 MHz												
10 MHz (B10M)	9.015 MHz												
15 MHz (B15M)	13.515 MHz												
20 MHz (B20M)	18.015 MHz												
Preset	4.515 MHz 4.5 MHz												
State Saved	Saved in instrument state.												
Min	100 kHz												
Max	20 MHz												
Initial S/W Revision	A.13.00												

SEM Integ BW

Specifies the integration bandwidth used to calculate the power in carriers in the SEM measurement.

Key Path	Mode Setup, Format, LTE FDD, Format Parameter List												
Mode	MSR												
Remote Command	[:SENSE] :RADio:FORMat:LTEFdd [1] 2 3 :SEMAsk:BANDwidth [1] 2 :INTEgration <freq> [:SENSE] :RADio:FORMat:LTEFdd [1] 2 3 :SEMAsk:BANDwidth [1] 2 :INTEgration?												
Example	RAD:FORM:LTEF:SEM:BAND:INT 20MHz RAD:FORM:LTEF:SEM:BAND:INT?												
Notes	You must be in the MSR mode to use this command. Use :INSTRument:SElect to set the mode.												
Couplings	When Demod Bandwidth of the parameter set is changed, the value of this parameter also changes as shown in the following table. Note that you cannot set the value exceeding the corresponding Demod Bandwidth.												
	<table border="1"> <tr> <td>1.4 MHz (B1M4)</td> <td>1.095 MHz</td> </tr> <tr> <td>3 MHz (B3M)</td> <td>2.715 MHz</td> </tr> <tr> <td>5 MHz (B5M)</td> <td>4.515 MHz</td> </tr> <tr> <td>10 MHz (B10M)</td> <td>9.015 MHz</td> </tr> <tr> <td>15 MHz (B15M)</td> <td>13.515 MHz</td> </tr> <tr> <td>20 MHz (B20M)</td> <td>18.015 MHz</td> </tr> </table>	1.4 MHz (B1M4)	1.095 MHz	3 MHz (B3M)	2.715 MHz	5 MHz (B5M)	4.515 MHz	10 MHz (B10M)	9.015 MHz	15 MHz (B15M)	13.515 MHz	20 MHz (B20M)	18.015 MHz
1.4 MHz (B1M4)	1.095 MHz												
3 MHz (B3M)	2.715 MHz												
5 MHz (B5M)	4.515 MHz												
10 MHz (B10M)	9.015 MHz												
15 MHz (B15M)	13.515 MHz												
20 MHz (B20M)	18.015 MHz												
Preset	4.515 MHz 4.5 MHz												
State Saved	Saved in instrument state.												
Min	100 kHz												
Max	20 MHz												
Initial S/W Revision	A.13.00												

CHP Integ BW

Specifies the range of integration used in calculating the power in the carriers in the CHP measurement.

Key Path	Mode Setup, Format, LTE FDD, Format Parameter List
Mode	MSR
Remote Command	[:SENSE] :RADio:FORMat:LTEFdd [1] 2 3 :CHPower:BANDwidth:INTEgration <freq> [:SENSE] :RADio:FORMat:LTEFdd [1] 2 3 :CHPower:BANDwidth:INTEgration?
Example	RAD:FORM:LTEF:CHP:BAND:INT 20MHz RAD:FORM:LTEF:CHP:BAND:INT?
Notes	You must be in the MSR mode to use this command. Use :INSTRument:SElect to set the mode.
Couplings	When Demod Bandwidth of the parameter set is changed, the value of this parameter also changes as shown in the following table. Note that you cannot set the value exceeding the corresponding Demod Bandwidth.

1.4 MHz (B1M4)	1.4 MHz
3 MHz (B3M)	3 MHz
5 MHz (B5M)	5 MHz
10 MHz (B10M)	10 MHz
15 MHz (B15M)	15 MHz
20 MHz (B20M)	20 MHz

Preset	5 MHz
State Saved	Saved in instrument state.
Min	100 kHz
Max	20 MHz
Initial S/W Revision	A.13.00

Bandwidth

Sets bandwidth of the selected LTE FDD parameter set.

Key Path	Mode Setup, Format, LTE FDD
Remote Command	[:SENSe] :RADio:FORMat:LTEFdd[1] 2 3 :BANDwidth B1M4 B3M B5M B10M B15M B20M [:SENSe] :RADio:FORMat:LTEFdd[1] 2 3 :BANDwidth?
Example	RAD:FORM:LTEF2:BAND B10M RAD:FORM:LTEF2:BAND?
Preset	B5M
State Saved	Saved in instrument state
Range	1.4MHz(6RB) 3MHz(15RB) 5MHz(25RB) 10MHz(50RB) 15MHz(75RB) 20MHz(100RB)
Readback	The currently selected Bandwidth
Initial S/W Revision	A.10.00

W-CDMA

Accesses the W-CDMA menu for W-CDMA Parameter Set. This key is available only when Option N/W9073A-1FP is installed.

Key Path	Mode Setup, Format
Initial S/W Revision	A.10.00

Select W-CDMA Parameter Set

Selects W-CDMA parameter set and shows its parameters on menu.

Key Path	Mode Setup, Format, W-CDMA
State Saved	Saved in instrument state
Initial S/W Revision	A.10.00

Parameter Set Name

Sets the name of the selected W-CDMA parameter set.

Key Path	Mode Setup, Format, W-CDMA
Remote Command	[:SENSe] :RADio:FORMat:WCDMa [1] 2 3 :PSET:NAME <string> [:SENSe] :RADio:FORMat:WCDMa [1] 2 3 :PSET:NAME?
Example	RAD:FORM:WCDM2:PSET:NAME "Parameter Set 2" RAD:FORM:WCDM2:PSET:NAME?
Preset	"W-CDMA 1" "W-CDMA 2" "W-CDMA 3"
State Saved	Saved in instrument state
Initial S/W Revision	A.10.00

Format Parameter List

Since most parameters are the same as those used in the original measurement, the SCPI commands in the original measurement can be used to set up the W-CDMA parameter sets by converting the measurement node.

The following SCPI commands in the W-CDMA application are converted for the MSR's CEVM as follows:

Parameter Name	SCPI Command in W-CDMA mode	SCPI Command in W-CDMA Format Parameter List
HSPA Enable	[:SENSe] :RADio:CONFigure:EHSPa [:STATe]	[:SENSe] :RADio:FORMat:WCDMa {1 :3 } :CONFigure:EHSPa [:STATe]
HSPA+ Enable	[:SENSe] :RADio:CONFigure:HSDPa [:STATe]	[:SENSe] :RADio:FORMat:WCDMa {1 :3 } :CONFigure:HSDPa [:STATe]

The following SCPI commands in the W-CDMA Mod Accuracy measurement are converted for the MSR's CEVM as follows:

SCPI Command in Mod Accuracy	SCPI Command in MSR CEVM
[:SENSe] :RHO:AVERage:COUNt	[:SENSe] :CEVM:WCDMa:AVERage:COUNt
[:SENSe] :RHO:AVERage[:STATe]	[:SENSe] :CEVM:WCDMa:AVERage[:STATe]
[:SENSe] :RHO:SPECTrum	[:SENSe] :CEVM:SPECTrum

These commands are not in the Format Parameter List. See "[W-CDMA Average/Hold Number](#)" on page 1821 and "[Spectrum](#)" on page 1826 for details.

The following SCPI commands in the W-CDMA Mod Accuracy measurement are not available in the MSR.

```

SCPI Command not available in MSR CEVM
:CALCulate:RHO:LIMit:CDERror
:CALCulate:RHO:LIMit:CPICH[:BTS]
:CALCulate:RHO:LIMit:CPICH[:BTS]:POWer
:CALCulate:RHO:LIMit:FERRor
:CALCulate:RHO:LIMit:PEAK
:CALCulate:RHO:LIMit:RHO
:CALCulate:RHO:LIMit:RMS
:CALCulate:RHO:MARKer{1:12}:AOFF/nquery/
:CALCulate:RHO:MARKer{1:12}:CHIP
:CALCulate:RHO:MARKer{1:12}:COUPle[:STATe]
:CALCulate:RHO:MARKer{1:12}:CPEak[:STATe]
:CALCulate:RHO:MARKer{1:12}:FUNction:RESult?/qonly/
:CALCulate:RHO:MARKer{1:12}:MAXimum/nquery/
:CALCulate:RHO:MARKer{1:12}:MAXimum:HIGHer/nquery/
:CALCulate:RHO:MARKer{1:12}:MAXimum:LEFT/nquery/
:CALCulate:RHO:MARKer{1:12}:MAXimum:LOWer/nquery/
:CALCulate:RHO:MARKer{1:12}:MAXimum:NEXT/nquery/
:CALCulate:RHO:MARKer{1:12}:MAXimum:RIGHT/nquery/
:CALCulate:RHO:MARKer{1:12}:MINimum/nquery/
:CALCulate:RHO:MARKer{1:12}:MODE
:CALCulate:RHO:MARKer{1:12}:PTPeak/nquery/
:CALCulate:RHO:MARKer{1:12}:REFerence
:CALCulate:RHO:MARKer{1:12}:STATe
:CALCulate:RHO:MARKer{1:12}:TRACe
:CALCulate:RHO:MARKer{1:12}:X
:CALCulate:RHO:MARKer{1:12}:X:POStion
:CALCulate:RHO:MARKer{1:12}:Y?/qonly/
:DISPlay:RHO:CDOMain:SPAN:STARt
:DISPlay:RHO:CDOMain:SPAN:STOP
:DISPlay:RHO:VIEW1|VIEW:NSElect
:DISPlay:RHO:VIEW1|VIEW[:SElect]
:DISPlay:RHO:VIEW1|VIEW:WINDow:TEXT:TFUNit
:DISPlay:RHO:VIEW1|VIEW:WINDow2:TRACe:COFFset

```

:DISPlay:RHO:VIEW1 VIEW:WINDow2:TRACe:FVECTor[:STATe]
:DISPlay:RHO:VIEW1 VIEW:WINDow2:TRACe:IQCHips
:DISPlay:RHO:VIEW1 VIEW:WINDow2:TRACe:POLar
:DISPlay:RHO:VIEW1 VIEW:WINDow2:TRACe:ROTQpi[:STATe]
:DISPlay:RHO:VIEW2:WINDow1 WINDow:TRACe:X[:SCALe]:COUPle
:DISPlay:RHO:VIEW2:WINDow1 WINDow:TRACe:X[:SCALe]:PDIVision
:DISPlay:RHO:VIEW2:WINDow1 WINDow:TRACe:X[:SCALe]:RLEVel
:DISPlay:RHO:VIEW2:WINDow1 WINDow:TRACe:X[:SCALe]:RPOStion
:DISPlay:RHO:VIEW2:WINDow1 WINDow:TRACe:Y[:SCALe]:COUPle
:DISPlay:RHO:VIEW2:WINDow1 WINDow:TRACe:Y[:SCALe]:PDIVision
:DISPlay:RHO:VIEW2:WINDow1 WINDow:TRACe:Y[:SCALe]:RLEVel
:DISPlay:RHO:VIEW2:WINDow1 WINDow:TRACe:Y[:SCALe]:RPOStion
:DISPlay:RHO:VIEW2:WINDow2:TRACe:X[:SCALe]:COUPle
:DISPlay:RHO:VIEW2:WINDow2:TRACe:X[:SCALe]:PDIVision
:DISPlay:RHO:VIEW2:WINDow2:TRACe:X[:SCALe]:RLEVel
:DISPlay:RHO:VIEW2:WINDow2:TRACe:X[:SCALe]:RPOStion
:DISPlay:RHO:VIEW2:WINDow2:TRACe:Y[:SCALe]:COUPle
:DISPlay:RHO:VIEW2:WINDow2:TRACe:Y[:SCALe]:PDIVision
:DISPlay:RHO:VIEW2:WINDow2:TRACe:Y[:SCALe]:RLEVel
:DISPlay:RHO:VIEW2:WINDow2:TRACe:Y[:SCALe]:RPOStion
:DISPlay:RHO:VIEW2:WINDow3:TRACe:X[:SCALe]:COUPle
:DISPlay:RHO:VIEW2:WINDow3:TRACe:X[:SCALe]:PDIVision
:DISPlay:RHO:VIEW2:WINDow3:TRACe:X[:SCALe]:RLEVel
:DISPlay:RHO:VIEW2:WINDow3:TRACe:X[:SCALe]:RPOStion
:DISPlay:RHO:VIEW2:WINDow3:TRACe:Y[:SCALe]:COUPle
:DISPlay:RHO:VIEW2:WINDow3:TRACe:Y[:SCALe]:PDIVision
:DISPlay:RHO:VIEW2:WINDow3:TRACe:Y[:SCALe]:RLEVel
:DISPlay:RHO:VIEW2:WINDow3:TRACe:Y[:SCALe]:RPOStion
:DISPlay:RHO:VIEW3:WINDow:TRACe:Y[:SCALe]:PDIVision
:DISPlay:RHO:VIEW3:WINDow:TRACe:Y[:SCALe]:RLEVel
:DISPlay:RHO:VIEW6:WINDow:TRACe:Y[:SCALe]:COUPle
:DISPlay:RHO:VIEW6:WINDow:TRACe:Y[:SCALe]:PDIVision
:DISPlay:RHO:VIEW6:WINDow:TRACe:Y[:SCALe]:RLEVel
:DISPlay:RHO:VIEW6:WINDow:TRACe:Y[:SCALe]:RPOStion
:DISPlay:RHO:VIEW6:WINDow2:TRACe:Y[:SCALe]:COUPle
:DISPlay:RHO:VIEW6:WINDow2:TRACe:Y[:SCALe]:PDIVision
:DISPlay:RHO:VIEW6:WINDow2:TRACe:Y[:SCALe]:RLEVel

:DISPlay:RHO:VIEW6:WINDow2:TRACe:Y[:SCALe]:RPOSition
:DISPlay:RHO:VIEW6:WINDow3:TRACe:Y[:SCALe]:COUPlE
:DISPlay:RHO:VIEW6:WINDow3:TRACe:Y[:SCALe]:PDIVision
:DISPlay:RHO:VIEW6:WINDow3:TRACe:Y[:SCALe]:RLEVel
:DISPlay:RHO:VIEW6:WINDow3:TRACe:Y[:SCALe]:RPOSition
[:SENSe]:RHO:AVERAge:TCONtrol
[:SENSe]:RHO:AVERAge:TYPE
[:SENSe]:RHO:CBUFFer:OFFSet
[:SENSe]:RHO:SBOundary:LIST[:BTS]:APPend
[:SENSe]:RHO:SBOundary:LIST[:BTS]:INIT
[:SENSe]:RHO:SBOundary:LIST[:BTS]:PRESet
[:SENSe]:RHO:SBOundary:LIST[:BTS]:REPLace
[:SENSe]:RHO:SBOundary:LIST:MS:APPend
[:SENSe]:RHO:SBOundary:LIST:MS:INIT
[:SENSe]:RHO:SBOundary:LIST:MS:REPLace

See also the following sections.

["ACP Measurement Noise Bandwidth" on page 323](#)

["SEM Integ BW " on page 324](#)

["CHP Integ BW" on page 324](#)

["Phase Noise Optimization " on page 325](#)

Key Path	Mode Setup, Format, WCDMA
Initial S/W Revision	A.10.00
Modified at S/W Revision	A.13.00

ACP Measurement Noise Bandwidth

Specifies the Measurement Noise Bandwidth used to calculate the power in the carriers in the ACP measurement.

Key Path	Mode Setup, Format, W-CDMA, Format Parameter List
Mode	MSR
Remote Command	[:SENSe]:RADio:FORMat:WCDMa[1] 2 3:ACPowEr:CARRier[1] 2:BANDwidth:INTegration <freq> [:SENSe]:RADio:FORMat:WCDMa[1] 2 3:ACPowEr:CARRier[1] 2:BANDwidth:INTegration?
Example	RAD:FORM:WCDM:ACP:CARR:BAND:INT 5MHz

	RAD:FORM:WCDM:ACP:CARR:BAND:INT?
Notes	You must be in the MSR mode. Use :INSTrument:SElect to set the mode.
Preset	3.84 MHz
State Saved	Saved in instrument state.
Min	100 kHz
Max	5 MHz
Initial S/W Revision	A.13.00

SEM Integ BW

Specifies the integration bandwidth used to calculate the power in carriers in the SEM measurement.

Key Path	Mode Setup, Format, W-CDMA, Format Parameter List
Mode	MSR
Remote Command	[:SENSe] :RADio:FORMat:WCDMa [1] 2 3:SEMAsk:BANDwidth [1] 2:INTEgration <freq> [:SENSe] :RADio:FORMat:WCDMa [1] 2 3:SEMAsk:BANDwidth [1] 2:INTEgration?
Example	RAD:FORM:WCDM:SEM:BAND:INT 5MHz RAD:FORM:WCDM:SEM:BAND:INT?
Notes	You must be in the MSR mode to use this command. Use :INSTrument:SElect to set the mode.
Preset	3.84 MHz
State Saved	Saved in instrument state.
Min	100 kHz
Max	5 MHz
Initial S/W Revision	A.13.00

CHP Integ BW

Specifies the range of integration used in calculating the power in the carriers in the CHP measurement.

Key Path	Mode Setup, Format, W-CDMA, Format Parameter List
Mode	MSR
Remote Command	[:SENSe] :RADio:FORMat:WCDMa [1] 2 3:CHPower:BANDwidth:INTEgration <freq> [:SENSe] :RADio:FORMat:WCDMa [1] 2 3:CHPower:BANDwidth:INTEgration?
Example	RAD:FORM:WCDM:CHP:BAND:INT 5MHz RAD:FORM:WCDM:CHP:BAND:INT?
Notes	You must be in the MSR mode to use this command. Use :INSTrument:SElect to set the mode.
Preset	5 MHz
State Saved	Saved in instrument state.

Min	100 kHz
Max	5 MHz
Initial S/W Revision	A.13.00

Phase Noise Optimization

The Phase Noise Optimization setting affects the phase noise distribution on the analyzer's LO.

Key Path	Mode Setup, Format, Format Parameter List
Mode	MSR
Remote Command	[:SENSe]:RADio:FORMat:WCDMa{1:3}:FREQuency:SYNThesis:STATe 1 2 3 [:SENSe]:RADio:FORMat:WCDMa{1:3}:FREQuency:SYNThesis:STATe?
Example	RAD:FORM:WCDM1:FREQ:SYNT:STAT 1 RAD:FORM:WCDM1:FREQ:SYNT:STAT?
Notes	Parameter key: 1 - Best Close-in 2 - Best Wide-offset 3 - Fast Tuning
Preset	Models with option EP2: 3 Other: 1
State Saved	Saved in instrument state.
Initial S/W Revision	A.13.00

GSM/EDGE

Accesses the GSM/EDGE menu for GSM/EDGE Parameter Set. This key is available only when Option N/W9071A-2FP is installed.

Key Path	Mode Setup, Format
Initial S/W Revision	A.10.00

Select GSM/EDGE Parameter Set

Selects GSM/EDGE parameter set and shows its parameters on menu.

Key Path	Mode Setup, Format, GSM/EDGE
State Saved	Saved in instrument state
Initial S/W Revision	A.10.00

Parameter Set Name

Sets the name of the selected GSM/EDGE parameter set.

Key Path	Mode Setup, Format, GSM/EDGE
Remote Command	<code>[[:SENSE]:RADIO:FORMat:GSM[1] 2 3:PSET:NAME <string></code> <code>[[:SENSE]:RADIO:FORMat:GSM[1] 2 3:PSET:NAME?</code>
Example	<code>RAD:FORM:GSM2:PSET:NAME "Parameter Set 2"</code> <code>RAD:FORM:GSM2:PSET:NAME?</code>
Preset	"GSM/EDGE 1" "GSM/EDGE 2" "GSM/EDGE 3"
State Saved	Saved in instrument state
Initial S/W Revision	A.10.00

Format Parameter List

Since most parameters are the same as those used in the original measurement, the SCPI commands in the original measurement can be used to set up the GSM/EDGE parameter sets by converting the measurement node.

The following SCPI commands in the GSM/EDGE application are converted for the MSR's CEVM as follows:

Parameter Name	SCPI Command in GSM/EDGE mode	SCPI Command in GSM/EDGE Format Parameter List
Burst Type	<code>[[:SENSE]:CHANnel:BURSt</code>	<code>[[:SENSE]:RADIO:FORMat:GSM{1:3}:CHANnel:BURSt</code>
Time Slot	<code>[[:SENSE]:CHANnel:SLOT</code>	<code>[[:SENSE]:RADIO:FORMat:GSM{1:3}:CHANnel:SLOT</code>
Time Slot State	<code>[[:SENSE]:CHANnel:SLOT:AUTO</code>	<code>[[:SENSE]:RADIO:FORMat:GSM{1:3}:CHANnel:SLOT:AUTO</code>
TSC	<code>[[:SENSE]:CHANnel:TSCode</code>	<code>[[:SENSE]:RADIO:FORMat:GSM{1:3}:CHANnel:TSCode</code>
TSC Auto Detection	<code>[[:SENSE]:CHANnel:TSCode:AUTO</code>	<code>[[:SENSE]:RADIO:FORMat:GSM{1:3}:CHANnel:TSCode:AUTO</code>
Carrier Bandpass Filter	<code>[[:SENSE]:RADIO:CARRier:NUMBer</code>	<code>[[:SENSE]:RADIO:FORMat:GSM{1:3}:RADIO:CARRier:NUMBer</code>
Carrier	<code>[[:SENSE]:RADIO:CARRier[:TYPE]</code>	<code>[[:SENSE]:RADIO:FORMat:GSM{1:3}:RADIO:CARRier[:TYPE]</code> Note that the preset of this command is MULTI, while that of the original SCPI command is SING.
HSR Pulse Shape Filter	<code>[[:SENSE]:RADIO:PSHape</code>	<code>[[:SENSE]:RADIO:FORMat:GSM{1:3}:RADIO:PSHape</code>
RF Sync Delay	<code>[[:SENSE]:SYNC:BURSt:RFAMplitude:DELay</code>	<code>[[:SENSE]:RADIO:FORMat:GSM{1:3}:SYNC:BURSt:RFAMplitude:DELay</code>
Burst Search	<code>[[:SENSE]:SYNC:BURSt:STHReshold</code>	<code>[[:SENSE]:RADIO:FORMat:GSM{1:3}:SYNC:BURSt:STHReshold</code>

Threshold		
Manual Method	[:SENSe]:SYNC:CONFigure:MEtHod	[:SENSe]:RADio:FORMat:GSM {1:3}:SYNC:CONFigure:MEtHod
Mod Scheme HSR	[:SENSe]:SYNC:HSRate:MODulation	[:SENSe]:RADio:FORMat:GSM {1:3}:SYNC:HSRate:MODulation
Mod Scheme HSR Auto	[:SENSe]:SYNC:HSRate:MODulation:AUTO	[:SENSe]:RADio:FORMat:GSM {1:3}:SYNC:HSRate:MODulation:AUTO
Mod Scheme	[:SENSe]:SYNC:NORMal:MODulation	[:SENSe]:RADio:FORMat:GSM {1:3}:SYNC:NORMal:MODulation
AQPSK SCPIr	[:SENSe]:SYNC:NORMal:MODulation:AQPSk:ALPHa:SCPIr	[:SENSe]:RADio:FORMat:GSM {1:3}:SYNC:NORMal:MODulation:AQPSk:ALPHa:SCPIr
Mod Scheme Auto	[:SENSe]:SYNC:NORMal:MODulation:AUTO	[:SENSe]:RADio:FORMat:GSM {1:3}:SYNC:NORMal:MODulation:AUTO
AQPSK AutoDet	[:SENSe]:SYNC:NORMal:MODulation:AUTO:AQPSk	[:SENSe]:RADio:FORMat:GSM {1:3}:SYNC:NORMal:MODulation:AUTO:AQPSk

The following SCPI commands in the GSM/EDGE EDGE EVM measurement are converted for the MSR's CEVM as follows:

SCPI Command in EDGE EVM	SCPI Command in MSR CEVM
[:SENSe]:EEVM:AVERage:COUnT	[:SENSe]:CEVM:GSM:AVERage:COUnT
[:SENSe]:EEVM:AVERage[:STATe]	[:SENSe]:CEVM:GSM:AVERage[:STATe]

These commands are not in the Format Parameter List. See "[GSM/EDGE Average/Hold Number](#)" on page 1822 for details.

The following SCPI commands in the GSM/EDGE EDGE EVM measurement are not available in MSR CEVM.

SCPI Command not available in MSR CEVM
:CALCulate:EEVM:LIMit:BTS:EXTReme:EVMP95
:CALCulate:EEVM:LIMit:BTS:EXTReme:FERRor
:CALCulate:EEVM:LIMit:BTS:EXTReme:IQOOffset
:CALCulate:EEVM:LIMit:BTS:EXTReme:PEVM
:CALCulate:EEVM:LIMit:BTS:EXTReme:PPERror
:CALCulate:EEVM:LIMit:BTS:EXTReme:REVM
:CALCulate:EEVM:LIMit:BTS:EXTReme:REVM:HSRate
:CALCulate:EEVM:LIMit:BTS:EXTReme:REVM:NSRate

:CALCulate:EEVM:LIMit:BTS:EXTReme:RPERror

:CALCulate:EEVM:LIMit:BTS:NORMal:EVMP95

:CALCulate:EEVM:LIMit:BTS:NORMal:FERRor

:CALCulate:EEVM:LIMit:BTS:NORMal:IQOOffset

:CALCulate:EEVM:LIMit:BTS:NORMal:PEVM

:CALCulate:EEVM:LIMit:BTS:NORMal:PPERror

:CALCulate:EEVM:LIMit:BTS:NORMal:REVM

:CALCulate:EEVM:LIMit:BTS:NORMal:REVM:HSRate

:CALCulate:EEVM:LIMit:BTS:NORMal:REVM:NSRate

:CALCulate:EEVM:LIMit:BTS:NORMal:RPERror

:CALCulate:EEVM:LIMit:MBTS:EXTReme:FERRor

:CALCulate:EEVM:LIMit:MBTS:NORMal:FERRor

:CALCulate:EEVM:LIMit:MS:EXTReme:EVMP95

:CALCulate:EEVM:LIMit:MS:EXTReme:FERRor

:CALCulate:EEVM:LIMit:MS:EXTReme:IQOOffset

:CALCulate:EEVM:LIMit:MS:EXTReme:PEVM

:CALCulate:EEVM:LIMit:MS:EXTReme:PPERror

:CALCulate:EEVM:LIMit:MS:EXTReme:REVM

:CALCulate:EEVM:LIMit:MS:EXTReme:REVM:HSRate

:CALCulate:EEVM:LIMit:MS:EXTReme:REVM:NSRate

:CALCulate:EEVM:LIMit:MS:EXTReme:RPERror

:CALCulate:EEVM:LIMit:MS:NORMal:EVMP95

:CALCulate:EEVM:LIMit:MS:NORMal:FERRor

:CALCulate:EEVM:LIMit:MS:NORMal:IQOOffset

:CALCulate:EEVM:LIMit:MS:NORMal:PEVM

:CALCulate:EEVM:LIMit:MS:NORMal:PPERror

:CALCulate:EEVM:LIMit:MS:NORMal:REVM

:CALCulate:EEVM:LIMit:MS:NORMal:REVM:HSRate

:CALCulate:EEVM:LIMit:MS:NORMal:REVM:NSRate

:CALCulate:EEVM:LIMit:MS:NORMal:RPERror

:CALCulate:EEVM:LIMit:PBTS:EXTReme:FERRor

:CALCulate:EEVM:LIMit:PBTS:NORMal:FERRor

:CALCulate:EEVM:LIMit:TEST[:STATe]

:CALCulate:EEVM:LIMit:TYPE

:CALCulate:EEVM:MARKer{1:12}:AOFF/nquery/

:CALCulate:EEVM:MARKer{1:12}:COUPl[:STATe]

:CALCulate:EEVM:MARKer{1:12}:FUNctio:RESult?/qonly/

:CALCulate:EEVM:MARKer{1:12}:MAXimum/nquery/
:CALCulate:EEVM:MARKer{1:12}:MINimum/nquery/
:CALCulate:EEVM:MARKer{1:12}:MODE
:CALCulate:EEVM:MARKer{1:12}:REFerence
:CALCulate:EEVM:MARKer{1:12}:STATe
:CALCulate:EEVM:MARKer{1:12}:TRACe
:CALCulate:EEVM:MARKer{1:12}:X
:CALCulate:EEVM:MARKer{1:12}:X:POSition
:CALCulate:EEVM:MARKer{1:12}:Y?/qonly/
:DISPlay:EEVM:SDERotation[:STATe]
:DISPlay:EEVM:SDOTs[:STATe]
[:SENSe]:EEVM:SDOTs[:STATe] (BWCC)
:DISPlay:EEVM:TEXT:TFUNit
:DISPlay:EEVM:VIEW1|VIEW:NSElect
:DISPlay:EEVM:VIEW1|VIEW[:SElect]
:DISPlay:EEVM:VIEW1|VIEW:WINDow2:TRACe:POLar
:DISPlay:EEVM:VIEW2:WINDow:TRACe:MAXHold[:STATe]
:DISPlay:EEVM:VIEW2:WINDow:TRACe:MINHold[:STATe]
:DISPlay:EEVM:VIEW2:WINDow:TRACe:X[:SCALe]:COUPle
:DISPlay:EEVM:VIEW2:WINDow:TRACe:X[:SCALe]:PDIVision
:DISPlay:EEVM:VIEW2:WINDow:TRACe:X[:SCALe]:RLEVel
:DISPlay:EEVM:VIEW2:WINDow:TRACe:X[:SCALe]:RPOSition
:DISPlay:EEVM:VIEW2:WINDow:TRACe:Y[:SCALe]:COUPle
:DISPlay:EEVM:VIEW2:WINDow:TRACe:Y[:SCALe]:PDIVision
:DISPlay:EEVM:VIEW2:WINDow:TRACe:Y[:SCALe]:RLEVel
:DISPlay:EEVM:VIEW2:WINDow:TRACe:Y[:SCALe]:RPOSition
:DISPlay:EEVM:VIEW2:WINDow2:TRACe:X[:SCALe]:COUPle
:DISPlay:EEVM:VIEW2:WINDow2:TRACe:X[:SCALe]:PDIVision
:DISPlay:EEVM:VIEW2:WINDow2:TRACe:X[:SCALe]:RLEVel
:DISPlay:EEVM:VIEW2:WINDow2:TRACe:X[:SCALe]:RPOSition
:DISPlay:EEVM:VIEW2:WINDow2:TRACe:Y[:SCALe]:COUPle
:DISPlay:EEVM:VIEW2:WINDow2:TRACe:Y[:SCALe]:PDIVision
:DISPlay:EEVM:VIEW2:WINDow2:TRACe:Y[:SCALe]:RLEVel
:DISPlay:EEVM:VIEW2:WINDow2:TRACe:Y[:SCALe]:RPOSition
:DISPlay:EEVM:VIEW2:WINDow3:TRACe:X[:SCALe]:COUPle
:DISPlay:EEVM:VIEW2:WINDow3:TRACe:X[:SCALe]:PDIVision
:DISPlay:EEVM:VIEW2:WINDow3:TRACe:X[:SCALe]:RLEVel

:DISPlay:EEVM:VIEW2:WINDow3:TRACe:X[:SCALe]:RPOSition
:DISPlay:EEVM:VIEW2:WINDow3:TRACe:Y[:SCALe]:COUPlE
:DISPlay:EEVM:VIEW2:WINDow3:TRACe:Y[:SCALe]:PDIVision
:DISPlay:EEVM:VIEW2:WINDow3:TRACe:Y[:SCALe]:RLEVel
:DISPlay:EEVM:VIEW2:WINDow3:TRACe:Y[:SCALe]:RPOSition
[:SENSe]:EEVM:AVERAge:TCONtrol
[:SENSe]:EEVM:AVERAge:TYPE

See also the following sections.

[ACP Measurement Noise Bandwidth](#)

[SEM Integ BW](#)

[CHP Integ BW](#)

[Phase Noise Optimization](#)

Key Path	Mode Setup, Format, GSM/EDGE
Initial S/W Revision	A.10.00
Modified at S/W Revision	A.13.00

cdma2000

Accesses the cdma2000 menu for cdma2000 Parameter Set. This key is available only when Option N/W9072A-2FP is installed.

Key Path	Mode Setup, Format
Initial S/W Revision	A.12.00

Select cdma2000 Parameter Set

Selects cdma2000 parameter set and shows its parameters on menu.

Key Path	Mode Setup, Format, cdma2000
State Saved	Saved in instrument state
Initial S/W Revision	A.12.00

Parameter Set Name

Sets the name of the selected cdma2000 parameter set.

Key Path	Mode Setup, Format, cdma2000
Remote Command	[[:SENSE]:RADIO:FORMAT:CDMA[1] 2 3:PSET:NAME <string> [:SENSE]:RADIO:FORMAT:CDMA[1] 2 3:PSET:NAME?
Example	RAD:FORM:CDMA2:PSET:NAME "Parameter Set 2" RAD:FORM:CDMA2:PSET:NAME?
Preset	"cdma2000 1" "cdma2000 2" "cdma2000 3"
State Saved	Saved in instrument state
Initial S/W Revision	A.12.00

Format Parameter List

Since most parameters are the same as those used in the original measurement, the SCPI commands in the original measurement can be used to set up the cdma2000 parameter sets by converting the measurement node.

The following SCPI commands in the cdma2000 Mod Accuracy measurement are converted for the MSR's CEVM as follows:

SCPI Command in Mod Accuracy	SCPI Command in MSR CEVM
[[:SENSE]:RHO:AVERAge:COUNT	[[:SENSE]:CEVM:CDMA:AVERAge:COUNT
[[:SENSE]:RHO:AVERAge[:STATe]	[[:SENSE]:CEVM:CDMA:AVERAge[:STATe]
[[:SENSE]:RHO:SPECTrum	[[:SENSE]:CEVM:SPECTrum

These commands above are not in the Format Parameter List. See "[cdma2000 Average/Hold Number](#)" on [page 1823](#) and "[Spectrum](#)" on [page 1826](#) for details.

The following SCPI commands in the cdma2000 Mod Accuracy measurement are not available in the MSR.

SCPI Command not available in MSR CEVM
:CALCulate:RHO:DTXBurst
:CALCulate:RHO:LIMit:CDERror
:CALCulate:RHO:LIMit:PEAK
:CALCulate:RHO:LIMit:PHASe
:CALCulate:RHO:LIMit:RHO
:CALCulate:RHO:LIMit:RMS
:CALCulate:RHO:LIMit:TIMing
:CALCulate:RHO:MARKer{1:12}:AOFF/nquery/
:CALCulate:RHO:MARKer{1:12}:CHIP
:CALCulate:RHO:MARKer{1:12}:COUPlE[:STATe]
:CALCulate:RHO:MARKer{1:12}:CPEak[:STATe]

:CALCulate:RHO:MARKer{1:12}:FUNction:RESult?/qonly/
:CALCulate:RHO:MARKer{1:12}:MAXimum/nquery/
:CALCulate:RHO:MARKer{1:12}:MAXimum:HIGHer/nquery/
:CALCulate:RHO:MARKer{1:12}:MAXimum:LEFT/nquery/
:CALCulate:RHO:MARKer{1:12}:MAXimum:LOWer/nquery/
:CALCulate:RHO:MARKer{1:12}:MAXimum:NEXT/nquery/
:CALCulate:RHO:MARKer{1:12}:MAXimum:RIGHt/nquery/
:CALCulate:RHO:MARKer{1:12}:MINimum/nquery/
:CALCulate:RHO:MARKer{1:12}:MODE
:CALCulate:RHO:MARKer{1:12}:PTPeak/nquery/
:CALCulate:RHO:MARKer{1:12}:REFerence
:CALCulate:RHO:MARKer{1:12}:STATe
:CALCulate:RHO:MARKer{1:12}:TRACe
:CALCulate:RHO:MARKer{1:12}:X
:CALCulate:RHO:MARKer{1:12}:X:POSition
:CALCulate:RHO:MARKer{1:12}:Y?/qonly/
:DISPlay:RHO:ANNotation:TITLe:DATA
:DISPlay:RHO:VIEW1 VIEW:NSElect
:DISPlay:RHO:VIEW1 VIEW[:SElect]
:DISPlay:RHO:VIEW1 VIEW:WINDow:TEXT:TFUNit
:DISPlay:RHO:VIEW1 VIEW:WINDow:TRACe:COFFset
:DISPlay:RHO:VIEW1 VIEW:WINDow:TRACe:FVEctor[:STATe]
:DISPlay:RHO:VIEW1 VIEW:WINDow:TRACe:IQCHips
:DISPlay:RHO:VIEW1 VIEW:WINDow:TRACe:POLar
:DISPlay:RHO:VIEW1 VIEW:WINDow:TRACe:ROTQpi[:STATe]
:DISPlay:RHO:VIEW2:WINDow1 WINDow:TRACe:X[:SCALe]:COUPle
:DISPlay:RHO:VIEW2:WINDow1 WINDow:TRACe:X[:SCALe]:PDIVision
:DISPlay:RHO:VIEW2:WINDow1 WINDow:TRACe:X[:SCALe]:RLEVel
:DISPlay:RHO:VIEW2:WINDow1 WINDow:TRACe:X[:SCALe]:RPOSition
:DISPlay:RHO:VIEW2:WINDow1 WINDow:TRACe:Y[:SCALe]:COUPle
:DISPlay:RHO:VIEW2:WINDow1 WINDow:TRACe:Y[:SCALe]:PDIVision
:DISPlay:RHO:VIEW2:WINDow1 WINDow:TRACe:Y[:SCALe]:RLEVel
:DISPlay:RHO:VIEW2:WINDow1 WINDow:TRACe:Y[:SCALe]:RPOSition
:DISPlay:RHO:VIEW2:WINDow2:TRACe:X[:SCALe]:COUPle
:DISPlay:RHO:VIEW2:WINDow2:TRACe:X[:SCALe]:PDIVision
:DISPlay:RHO:VIEW2:WINDow2:TRACe:X[:SCALe]:RLEVel
:DISPlay:RHO:VIEW2:WINDow2:TRACe:X[:SCALe]:RPOSition

:DISPlay:RHO:VIEW2:WINDow2:TRACe:Y[:SCALe]:COUPle
:DISPlay:RHO:VIEW2:WINDow2:TRACe:Y[:SCALe]:PDIVision
:DISPlay:RHO:VIEW2:WINDow2:TRACe:Y[:SCALe]:RLEVel
:DISPlay:RHO:VIEW2:WINDow2:TRACe:Y[:SCALe]:RPOStion
:DISPlay:RHO:VIEW2:WINDow3:TRACe:X[:SCALe]:COUPle
:DISPlay:RHO:VIEW2:WINDow3:TRACe:X[:SCALe]:PDIVision
:DISPlay:RHO:VIEW2:WINDow3:TRACe:X[:SCALe]:RLEVel
:DISPlay:RHO:VIEW2:WINDow3:TRACe:X[:SCALe]:RPOStion
:DISPlay:RHO:VIEW2:WINDow3:TRACe:Y[:SCALe]:COUPle
:DISPlay:RHO:VIEW2:WINDow3:TRACe:Y[:SCALe]:PDIVision
:DISPlay:RHO:VIEW2:WINDow3:TRACe:Y[:SCALe]:RLEVel
:DISPlay:RHO:VIEW2:WINDow3:TRACe:Y[:SCALe]:RPOStion
[:SENSe]:RHO:AVERAge:TCONtrol
[:SENSe]:RHO:AVERAge:TYPE
[:SENSe]:RHO:TRIGGer:SOURce

See also the following sections.

["ACP Measurement Noise Bandwidth" on page 333](#)

["SEM Integ BW" on page 334](#)

["CHP Integ BW" on page 334](#)

["Phase Noise Optimization" on page 335](#)

Key Path	Mode Setup, Format, cdma2000
Initial S/W Revision	A.12.00
Modified at S/W Revision	A.13.00

ACP Measurement Noise Bandwidth

Specifies the Measurement Noise Bandwidth used to calculate the power in the carriers in the ACP measurement.

Key Path	Mode Setup, Format, cdma2000, Format Parameter List
Mode	MSR
Remote Command	[:SENSe]:RADio:FORMat:CDMA[1] 2 3:ACPowEr:CARRier[1] 2:BANDwidth:INTEgration <freq> [:SENSe]:RADio:FORMat:CDMA[1] 2 3:ACPowEr:CARRier[1] 2:BANDwidth:INTEgration?
Example	RAD:FORM:CDMA:ACP:CARR:BAND:INT 1.25MHz

	RAD:FORM:CDMA:ACP:CARR:BAND:INT?
Notes	You must be in the MSR mode. Use :INSTrument:SElect to set the mode.
Preset	1.23 MHz
State Saved	Saved in instrument state.
Min	100 kHz
Max	1.25 MHz
Initial S/W Revision	A.13.00

SEM Integ BW

Specifies the integration bandwidth used to calculate the power in carriers in the SEM measurement.

Key Path	Mode Setup, Format, cdma2000, Format Parameter List
Mode	MSR
Remote Command	[:SENSe] :RADio:FORMat:CDMA [1] 2 3 :SEMAsk:BA NDwidth [1] 2 :INTEgration <freq> [:SENSe] :RADio:FORMat:CDMA [1] 2 3 :SEMAsk:BA NDwidth [1] 2 :INTEgration?
Example	RAD:FORM:CDMA:SEM:BA ND:INT 1.25MHz RAD:FORM:CDMA:SEM:BA ND:INT?
Notes	You must be in the MSR mode to use this command. Use :INSTrument:SElect to set the mode.
Preset	1.23 MHz
State Saved	Saved in instrument state.
Min	100 kHz
Max	1.25 MHz
Initial S/W Revision	A.13.00

CHP Integ BW

Specifies the range of integration used in calculating the power in the carriers in the CHP measurement.

Key Path	Mode Setup, Format, cdma2000, Format Parameter List
Mode	MSR
Remote Command	[:SENSe] :RADio:FORMat:CDMA [1] 2 3 :CHPowe r:BA NDwidth:INTEgration <freq> [:SENSe] :RADio:FORMat:CDMA [1] 2 3 :CHPowe r:BA NDwidth:INTEgration?
Example	RAD:FORM:CDMA:CHP:BA ND:INT 1.25MHz RAD:FORM:CDMA:CHP:BA ND:INT?
Notes	You must be in the MSR mode to use this command. Use :INSTrument:SElect to set the mode.
Preset	1.23 MHz
State Saved	Saved in instrument state.

Min	100 kHz
Max	1.25 MHz
Initial S/W Revision	A.13.00

Phase Noise Optimization

The Phase Noise Optimization setting affects the phase noise distribution on the analyzer's LO.

Key Path	Mode Setup, Format, Format Parameter List
Mode	MSR
Remote Command	<code>[:SENSe] :RADio :FORMat :CDMA { 1 : 3 } :FREQUency :SYNTHeSis :STATe 1 2 3</code> <code>[:SENSe] :RADio :FORMat :CDMA { 1 : 3 } :FREQUency :SYNTHeSis :STATe ?</code>
Example	RAD:FORM:CDMA1:FREQ:SYNT:STAT 1 RAD:FORM:CDMA1:FREQ:SYNT:STAT?
Notes	Parameter key: 1 - Best Close-in 2 - Best Wide-offset 3 - Fast Tuning
Preset	Models with option EP2: 3 Other: 1
State Saved	Saved in instrument state.
Initial S/W Revision	A.13.00

1xEV-DO

Accesses the 1xEV-DO menu for 1xEV-DO Parameter Set. This key is available only when Option N/W9076A-1FP is installed.

Key Path	Mode Setup, Format
Initial S/W Revision	A.12.00

Select 1xEV-DO Parameter Set

Selects 1xEV-DO parameter set and shows its parameters on menu.

Key Path	Mode Setup, Format, 1xEV-DO
State Saved	Saved in instrument state
Initial S/W Revision	A.12.00

Parameter Set Name

Sets the name of the selected 1xEV-DO parameter set.

Key Path	Mode Setup, Format, 1xEV-DO
Remote Command	<code>[[:SENSE]:RADIO:FORMAt:EVDO[1] 2 3:PSET:NAME <string></code> <code>[[:SENSE]:RADIO:FORMAt:EVDO[1] 2 3:PSET:NAME?</code>
Example	<code>RAD:FORM:EVDO:PSET:NAME "Parameter Set 2"</code> <code>RAD:FORM:EVDO:PSET:NAME?</code>
Preset	"1xEV-DO 1" "1xEV-DO 2" "1xEV-DO 3"
State Saved	Saved in instrument state
Initial S/W Revision	A.12.00

Format Parameter List

Since most parameters are the same as those used in the original measurement, the SCPI commands in the original measurement can be used to set up the 1xEV-DO parameter sets by converting the measurement node.

The following SCPI commands in the 1xEV-DO application are converted for the MSR's CEVM as follows:

Parameter Name	SCPI Command in 1xEV-DO mode	SCPI Command in 1xEV-DO Format Parameter List
Physical Layer Subtype	<code>[[:SENSE]:RADIO:PLSubtype</code>	<code>[[:SENSE]:RADIO:FORMAt:EVDO{1:3}:PLSubtype</code>

The following SCPI commands in the 1xEV-DO Mod Accuracy measurement are converted for the MSR's CEVM as follows:

SCPI Command in Mod Accuracy	SCPI Command in MSR CEVM
<code>[[:SENSE]:RHO[:BTS]:AVERAge:COUNT</code> <code>[[:SENSE]:RHO:MS:AVERAge:COUNT</code>	<code>[[:SENSE]:CEVM:EVDO:AVERAge:COUNT</code>
<code>[[:SENSE]:RHO[:BTS]:AVERAge[:STATe]</code> <code>[[:SENSE]:RHO:MS:AVERAge[:STATe]</code>	<code>[[:SENSE]:CEVM:EVDO:AVERAge[:STATe]</code>
<code>[[:SENSE]:RHO[:BTS]:SPECTrum</code> <code>[[:SENSE]:RHO:MS:SPECTrum</code>	<code>[[:SENSE]:CEVM:SPECTrum</code>

These commands are not in the Format Parameter List. See ["1xEV-DO Average/Hold Number" on page 1824](#) and ["Spectrum" on page 1826](#) for details.

The following SCPI commands in the 1xEV-DO Mod Accuracy measurement are not available in the MSR.

SCPI Command not available in MSR CEVM
<code>:CALCulate:RHO[:BTS]:LIMit:DATA[:ACTive]:LOWer</code>

:CALCulate:RHO[:BTS]:LIMit:DATA[:ACTive][:UPPer]
:CALCulate:RHO[:BTS]:LIMit:FREQuency
:CALCulate:RHO[:BTS]:LIMit:MAC:INACTive[:UPPer]
:CALCulate:RHO[:BTS]:LIMit:PEAK
:CALCulate:RHO[:BTS]:LIMit:PHASe
:CALCulate:RHO[:BTS]:LIMit:POFFset
:CALCulate:RHO[:BTS]:LIMit:PRESet
:CALCulate:RHO[:BTS]:LIMit:RHO:ALL
:CALCulate:RHO[:BTS]:LIMit:RHO:DATA
:CALCulate:RHO[:BTS]:LIMit:RHO:MAC
:CALCulate:RHO[:BTS]:LIMit:RHO:PILot
:CALCulate:RHO[:BTS]:LIMit:RHO:PREamble
:CALCulate:RHO[:BTS]:LIMit:RMS
:CALCulate:RHO[:BTS]:LIMit:TIMing
:CALCulate:RHO[:BTS]:MARKer{1:12}:AOFF/nquery/
:CALCulate:RHO[:BTS]:MARKer{1:12}:CHIP
:CALCulate:RHO[:BTS]:MARKer{1:12}:COUPle[:STATe]
:CALCulate:RHO[:BTS]:MARKer{1:12}:MAXimum/nquery/
:CALCulate:RHO[:BTS]:MARKer{1:12}:MAXimum:LEFT/nquery/
:CALCulate:RHO[:BTS]:MARKer{1:12}:MAXimum:NEXT/nquery/
:CALCulate:RHO[:BTS]:MARKer{1:12}:MAXimum:RIGHT/nquery/
:CALCulate:RHO[:BTS]:MARKer{1:12}:MINimum/nquery/
:CALCulate:RHO[:BTS]:MARKer{1:12}:MODE
:CALCulate:RHO[:BTS]:MARKer{1:12}:PTPeak/nquery/
:CALCulate:RHO[:BTS]:MARKer{1:12}:REFerence
:CALCulate:RHO[:BTS]:MARKer{1:12}:STATe
:CALCulate:RHO[:BTS]:MARKer{1:12}:TRACe
:CALCulate:RHO[:BTS]:MARKer{1:12}:X
:CALCulate:RHO[:BTS]:MARKer{1:12}:X:POSition
:CALCulate:RHO[:BTS]:MARKer{1:12}:Y?/qonly/
:CALCulate:RHO[:BTS]:WCODe:ORDer
:CALCulate:RHO[:BTS]:IQ:COMBined[:STATe]
:DISPlay:RHO[:BTS]:ANNotation:TITLe:DATA
:DISPlay:RHO[:BTS]:CDEScramble[:STATe]
:DISPlay:RHO[:BTS]:CHANnel:TYPE
:DISPlay:RHO[:BTS]:FVECTor[:STATe]
:DISPlay:RHO[:BTS]:INTerpolate

:DISPlay:RHO[:BTS]:IQCHips
:DISPlay:RHO[:BTS]:IQPType
:DISPlay:RHO[:BTS]:OFFSet
:DISPlay:RHO[:BTS]:ROTQpi[:STATe]
:DISPlay:RHO[:BTS]:VIEW:NSElect
:DISPlay:RHO[:BTS]:VIEW[:SElect]
:DISPlay:RHO[:BTS]:VIEW5:WINDow1 WINDow:TRACe:X[:SCALe]:COUPlE
:DISPlay:RHO[:BTS]:VIEW5:WINDow1 WINDow:TRACe:X[:SCALe]:PDIVision
:DISPlay:RHO[:BTS]:VIEW5:WINDow1 WINDow:TRACe:X[:SCALe]:RLEVel
:DISPlay:RHO[:BTS]:VIEW5:WINDow1 WINDow:TRACe:X[:SCALe]:RPOSition
:DISPlay:RHO[:BTS]:VIEW5:WINDow1 WINDow:TRACe:Y[:SCALe]:COUPlE
:DISPlay:RHO[:BTS]:VIEW5:WINDow1 WINDow:TRACe:Y[:SCALe]:PDIVision
:DISPlay:RHO[:BTS]:VIEW5:WINDow1 WINDow:TRACe:Y[:SCALe]:RLEVel
:DISPlay:RHO[:BTS]:VIEW5:WINDow1 WINDow:TRACe:Y[:SCALe]:RPOSition
:DISPlay:RHO[:BTS]:VIEW5:WINDow2:TRACe:X[:SCALe]:COUPlE
:DISPlay:RHO[:BTS]:VIEW5:WINDow2:TRACe:X[:SCALe]:PDIVision
:DISPlay:RHO[:BTS]:VIEW5:WINDow2:TRACe:X[:SCALe]:RLEVel
:DISPlay:RHO[:BTS]:VIEW5:WINDow2:TRACe:X[:SCALe]:RPOSition
:DISPlay:RHO[:BTS]:VIEW5:WINDow2:TRACe:Y[:SCALe]:COUPlE
:DISPlay:RHO[:BTS]:VIEW5:WINDow2:TRACe:Y[:SCALe]:PDIVision
:DISPlay:RHO[:BTS]:VIEW5:WINDow2:TRACe:Y[:SCALe]:RLEVel
:DISPlay:RHO[:BTS]:VIEW5:WINDow2:TRACe:Y[:SCALe]:RPOSition
:DISPlay:RHO[:BTS]:VIEW5:WINDow3:TRACe:X[:SCALe]:COUPlE
:DISPlay:RHO[:BTS]:VIEW5:WINDow3:TRACe:X[:SCALe]:PDIVision
:DISPlay:RHO[:BTS]:VIEW5:WINDow3:TRACe:X[:SCALe]:RLEVel
:DISPlay:RHO[:BTS]:VIEW5:WINDow3:TRACe:X[:SCALe]:RPOSition
:DISPlay:RHO[:BTS]:VIEW5:WINDow3:TRACe:Y[:SCALe]:COUPlE
:DISPlay:RHO[:BTS]:VIEW5:WINDow3:TRACe:Y[:SCALe]:PDIVision
:DISPlay:RHO[:BTS]:VIEW5:WINDow3:TRACe:Y[:SCALe]:RLEVel
:DISPlay:RHO[:BTS]:VIEW5:WINDow3:TRACe:Y[:SCALe]:RPOSition
:DISPlay:RHO[:BTS]:VIEW6:WINDow1 WINDow:TRACe:X[:SCALe]:COUPlE
:DISPlay:RHO[:BTS]:VIEW6:WINDow1 WINDow:TRACe:X[:SCALe]:PDIVision
:DISPlay:RHO[:BTS]:VIEW6:WINDow1 WINDow:TRACe:X[:SCALe]:RLEVel
:DISPlay:RHO[:BTS]:VIEW6:WINDow1 WINDow:TRACe:X[:SCALe]:RPOSition
:DISPlay:RHO[:BTS]:VIEW6:WINDow1 WINDow:TRACe:Y[:SCALe]:COUPlE
:DISPlay:RHO[:BTS]:VIEW6:WINDow1 WINDow:TRACe:Y[:SCALe]:PDIVision
:DISPlay:RHO[:BTS]:VIEW6:WINDow1 WINDow:TRACe:Y[:SCALe]:RLEVel

:DISPlay:RHO[:BTS]:VIEW6:WINDow1 WINDow:TRACe:Y[:SCALe]:RPOSition
:DISPlay:RHO[:BTS]:VIEW6:WINDow2:TRACe:X[:SCALe]:COUPlE
:DISPlay:RHO[:BTS]:VIEW6:WINDow2:TRACe:X[:SCALe]:PDIVision
:DISPlay:RHO[:BTS]:VIEW6:WINDow2:TRACe:X[:SCALe]:RLEVel
:DISPlay:RHO[:BTS]:VIEW6:WINDow2:TRACe:X[:SCALe]:RPOSition
:DISPlay:RHO[:BTS]:VIEW6:WINDow2:TRACe:Y[:SCALe]:COUPlE
:DISPlay:RHO[:BTS]:VIEW6:WINDow2:TRACe:Y[:SCALe]:PDIVision
:DISPlay:RHO[:BTS]:VIEW6:WINDow2:TRACe:Y[:SCALe]:RLEVel
:DISPlay:RHO[:BTS]:VIEW6:WINDow2:TRACe:Y[:SCALe]:RPOSition
:DISPlay:RHO[:BTS]:VIEW7:WINDow1 WINDow:TRACe:X[:SCALe]:PDIVision
:DISPlay:RHO[:BTS]:VIEW7:WINDow1 WINDow:TRACe:X[:SCALe]:RLEVel
:DISPlay:RHO[:BTS]:VIEW7:WINDow1 WINDow:TRACe:X[:SCALe]:RPOSition
:DISPlay:RHO[:BTS]:VIEW7:WINDow1 WINDow:TRACe:Y[:SCALe]:COUPlE
:DISPlay:RHO[:BTS]:VIEW7:WINDow1 WINDow:TRACe:Y[:SCALe]:PDIVision
:DISPlay:RHO[:BTS]:VIEW7:WINDow1 WINDow:TRACe:Y[:SCALe]:RLEVel
[:SENSe]:RHO[:BTS]:AVERAge:TCONtrol
[:SENSe]:RHO[:BTS]:TRIGger:SOURce
[:SENSe]:RHO:SWEEp:POINts
:CALCulate:RHO:MS:IQ:COMBined[:STATe]
:CALCulate:RHO:MS:LIMit:ACDPower[:SUB0]
:CALCulate:RHO:MS:LIMit:ACDPower:SUB2
:CALCulate:RHO:MS:LIMit:ACK:GAIN[:SUB0]
:CALCulate:RHO:MS:LIMit:ACK:GAIN:SUB2
:CALCulate:RHO:MS:LIMit:AUXPilot:GAIN:SUB2
:CALCulate:RHO:MS:LIMit:CDErRor[:SUB0]
:CALCulate:RHO:MS:LIMit:CDErRor:SUB2
:CALCulate:RHO:MS:LIMit:DATA:GAIN[:SUB0]
:CALCulate:RHO:MS:LIMit:DRC:GAIN[:SUB0]
:CALCulate:RHO:MS:LIMit:DRC:GAIN:SUB2
:CALCulate:RHO:MS:LIMit:DSC:GAIN:SUB2
:CALCulate:RHO:MS:LIMit:FERRor[:SUB0]
:CALCulate:RHO:MS:LIMit:FERRor:SUB2
:CALCulate:RHO:MS:LIMit:ICDPower[:SUB0]
:CALCulate:RHO:MS:LIMit:ICDPower:SUB2
:CALCulate:RHO:MS:LIMit:PEAK[:SUB0]
:CALCulate:RHO:MS:LIMit:PEAK:SUB2
:CALCulate:RHO:MS:LIMit:POFFset[:SUB0]

:CALCulate:RHO:MS:LIMit:POFFset:SUB2
:CALCulate:RHO:MS:LIMit:RHO[:SUB0]
:CALCulate:RHO:MS:LIMit:RHO:SUB2
:CALCulate:RHO:MS:LIMit:RMS[:SUB0]
:CALCulate:RHO:MS:LIMit:RMS:SUB2
:CALCulate:RHO:MS:LIMit:RRI:GAIN:SUB2
:CALCulate:RHO:MS:LIMit:RRI[:SUB0]
:CALCulate:RHO:MS:LIMit:T2P:TOTal:GAIN:SUB2
:CALCulate:RHO:MS:MARKer{1:12}:AOFF
:CALCulate:RHO:MS:MARKer{1:12}:CHIP
:CALCulate:RHO:MS:MARKer{1:12}:COUPle[:STATe]
:CALCulate:RHO:MS:MARKer{1:12}:MAXimum
:CALCulate:RHO:MS:MARKer{1:12}:MAXimum:LEFT
:CALCulate:RHO:MS:MARKer{1:12}:MAXimum:NEXT
:CALCulate:RHO:MS:MARKer{1:12}:MAXimum:RIGHT
:CALCulate:RHO:MS:MARKer{1:12}:MINimum
:CALCulate:RHO:MS:MARKer{1:12}:MODE
:CALCulate:RHO:MS:MARKer{1:12}:PTPeak
:CALCulate:RHO:MS:MARKer{1:12}:REFerence
:CALCulate:RHO:MS:MARKer{1:12}:STATe
:CALCulate:RHO:MS:MARKer{1:12}:TRACe
:CALCulate:RHO:MS:MARKer{1:12}:X
:CALCulate:RHO:MS:MARKer{1:12}:X:POSition
:CALCulate:RHO:MS:MARKer{1:12}:Y?/qonly/
:CALCulate:RHO:MS:WCODe:ORDer
:DISPlay:RHO:MS:ANNotation:TITLe:DATA
:DISPlay:RHO:MS:FVECTor[:STATe]
:DISPlay:RHO:MS:INTerpolate
:DISPlay:RHO:MS:IQCHeads
:DISPlay:RHO:MS:IQPType
:DISPlay:RHO:MS:MARKer:CONSolidated
:DISPlay:RHO:MS:OFFSet
:DISPlay:RHO:MS:PointPerChip
:DISPlay:RHO:MS:ROTQpi[:STATe]
:DISPlay:RHO:MS:VIEW1 VIEW:NSElect
:DISPlay:RHO:MS:VIEW1 VIEW[:SElect]
:DISPlay:RHO:MS:VIEW3:WINDow1 WINDow:TRACe:X[:SCALe]:COUPle

:DISPlay:RHO:MS:VIEW3:WINDow1 WINDow:TRACe:X[:SCALe]:PDIVision
:DISPlay:RHO:MS:VIEW3:WINDow1 WINDow:TRACe:X[:SCALe]:RLEVel
:DISPlay:RHO:MS:VIEW3:WINDow1 WINDow:TRACe:X[:SCALe]:RPOSition
:DISPlay:RHO:MS:VIEW3:WINDow1 WINDow:TRACe:Y[:SCALe]:COUPlE
:DISPlay:RHO:MS:VIEW3:WINDow1 WINDow:TRACe:Y[:SCALe]:PDIVision
:DISPlay:RHO:MS:VIEW3:WINDow1 WINDow:TRACe:Y[:SCALe]:RLEVel
:DISPlay:RHO:MS:VIEW3:WINDow1 WINDow:TRACe:Y[:SCALe]:RPOSition
:DISPlay:RHO:MS:VIEW3:WINDow2:TRACe:X[:SCALe]:COUPlE
:DISPlay:RHO:MS:VIEW3:WINDow2:TRACe:X[:SCALe]:PDIVision
:DISPlay:RHO:MS:VIEW3:WINDow2:TRACe:X[:SCALe]:RLEVel
:DISPlay:RHO:MS:VIEW3:WINDow2:TRACe:X[:SCALe]:RPOSition
:DISPlay:RHO:MS:VIEW3:WINDow2:TRACe:Y[:SCALe]:COUPlE
:DISPlay:RHO:MS:VIEW3:WINDow2:TRACe:Y[:SCALe]:PDIVision
:DISPlay:RHO:MS:VIEW3:WINDow2:TRACe:Y[:SCALe]:RLEVel
:DISPlay:RHO:MS:VIEW3:WINDow2:TRACe:Y[:SCALe]:RPOSition
:DISPlay:RHO:MS:VIEW3:WINDow3:TRACe:X[:SCALe]:COUPlE
:DISPlay:RHO:MS:VIEW3:WINDow3:TRACe:X[:SCALe]:PDIVision
:DISPlay:RHO:MS:VIEW3:WINDow3:TRACe:X[:SCALe]:RLEVel
:DISPlay:RHO:MS:VIEW3:WINDow3:TRACe:X[:SCALe]:RPOSition
:DISPlay:RHO:MS:VIEW3:WINDow3:TRACe:Y[:SCALe]:COUPlE
:DISPlay:RHO:MS:VIEW3:WINDow3:TRACe:Y[:SCALe]:PDIVision
:DISPlay:RHO:MS:VIEW3:WINDow3:TRACe:Y[:SCALe]:RLEVel
:DISPlay:RHO:MS:VIEW3:WINDow3:TRACe:Y[:SCALe]:RPOSition
:DISPlay:RHO:MS:VIEW4:WINDow1 WINDow:TRACe:X[:SCALe]:PDIVision
:DISPlay:RHO:MS:VIEW4:WINDow1 WINDow:TRACe:X[:SCALe]:RLEVel
:DISPlay:RHO:MS:VIEW4:WINDow1 WINDow:TRACe:X[:SCALe]:RPOSition
:DISPlay:RHO:MS:VIEW4:WINDow1 WINDow:TRACe:Y[:SCALe]:COUPlE
:DISPlay:RHO:MS:VIEW4:WINDow1 WINDow:TRACe:Y[:SCALe]:PDIVision
:DISPlay:RHO:MS:VIEW4:WINDow1 WINDow:TRACe:Y[:SCALe]:RLEVel
[;SENSe]:RHO:MS:AVERAge:TCONtrol
[;SENSe]:RHO:MS:TRIGger:SOURce

See also the following sections.

["ACP Measurement Noise Bandwidth" on page 342](#)

["SEM Integ BW" on page 342](#)

["CHP Integ BW" on page 343](#)

"Phase Noise Optimization" on page 343

Key Path	Mode Setup, Format, 1xEV-DO
Initial S/W Revision	A.10.00
Modified at S/W Revision	A.12.00, A.13.00

ACP Measurement Noise Bandwidth

Specifies the Measurement Noise Bandwidth used to calculate the power in the carriers in the ACP measurement.

Key Path	Mode Setup, Format, 1xEV-DO, Format Parameter List
Mode	MSR
Remote Command	<code>[:SENSE] :RADio:FORMat:EVDO [1] 2 3 :ACPowEr:CARRier [1] 2 :BANDwidth:INTegration <freq></code> <code>[:SENSE] :RADio:FORMat:EVDO [1] 2 3 :ACPowEr:CARRier [1] 2 :BANDwidth:INTegration?</code>
Example	<code>RAD:FORM:EVDO:ACP:CARR:BAND:INT 1.25MHz</code> <code>RAD:FORM:EVDO:ACP:CARR:BAND:INT?</code>
Notes	You must be in the MSR mode. Use <code>:INSTrument:SElect</code> to set the mode.
Preset	1.23 MHz
State Saved	Saved in instrument state.
Min	100 kHz
Max	1.25 MHz
Initial S/W Revision	A.13.00

SEM Integ BW

Specifies the integration bandwidth used to calculate the power in carriers in the SEM measurement.

Key Path	Mode Setup, Format, 1xEV-DO, Format Parameter List
Mode	MSR
Remote Command	<code>[:SENSE] :RADio:FORMat:EVDO [1] 2 3 :SEMAsk:BANDwidth [1] 2 :INTegration <freq></code> <code>[:SENSE] :RADio:FORMat:EVDO [1] 2 3 :SEMAsk:BANDwidth [1] 2 :INTegration?</code>
Example	<code>RAD:FORM:EVDO:SEM:BAND:INT 1.25MHz</code> <code>RAD:FORM:EVDO:SEM:BAND:INT?</code>
Notes	You must be in the MSR mode to use this command. Use <code>:INSTrument:SElect</code> to set the mode.
Preset	1.23 MHz
State Saved	Saved in instrument state.
Min	100 kHz

Max	1.25 MHz
Initial S/W Revision	A.13.00

CHP Integ BW

Specifies the range of integration used in calculating the power in the carriers in the CHP measurement.

Key Path	Mode Setup, Format, 1xEV-DO, Format Parameter List
Mode	MSR
Remote Command	<code>[:SENSe] :RADio:FORMat:EVDO [1] 2 3 :CHPower:Bandwidth:INTEgration <freq></code> <code>[:SENSe] :RADio:FORMat:EVDO [1] 2 3 :CHPower:Bandwidth:INTEgration?</code>
Example	<code>RAD:FORM:EVDO:CHP:BAND:INT 1.25MHz</code> <code>RAD:FORM:EVDO:CHP:BAND:INT?</code>
Notes	You must be in the MSR mode to use this command. Use :INSTRument:SElect to set the mode.
Preset	1.23 MHz
State Saved	Saved in instrument state.
Min	100 kHz
Max	1.25 MHz
Initial S/W Revision	A.13.00

Phase Noise Optimization

The Phase Noise Optimization setting affects the phase noise distribution on the analyzer's LO.

Key Path	Mode Setup, Format, Format Parameter List
Mode	MSR
Remote Command	<code>[:SENSe] :RADio:FORMat:EVDO {1:3} :FREQuency:SYNTHeSis:STATe 1 2 3</code> <code>[:SENSe] :RADio:FORMat:EVDO {1:3} :FREQuency:SYNTHeSis:STATe?</code>
Example	<code>RAD:FORM:EVDO1:FREQ:SYNT:STAT 1</code> <code>RAD:FORM:EVDO1:FREQ:SYNT:STAT?</code>
Notes	Parameter key: 1 - Best Close-in 2 - Best Wide-offset 3 - Fast Tuning
Preset	Models with option EP2: 3 Other: 1
State Saved	Saved in instrument state.
Initial S/W Revision	A.13.00

LTE TDD

Accesses the LTE TDD menu for LTE TDD Parameter Set. This key is available only when Option N/W9082A-1FP is installed.

Key Path	Mode Setup, Format
Initial S/W Revision	A.16.00

Select LTE TDD Parameter Set

Selects LTE TDD parameter set and shows its parameters on menu.

Key Path	Mode Setup, Format, LTE TDD
State Saved	Saved in instrument state
Initial S/W Revision	A.16.00

Parameter Set Name

Sets the name of the selected LTE TDD parameter set.

Key Path	Mode Setup, Format, LTE TDD
Remote Command	<code>[[:SENSe]:RADio:FORMat:LTETdd[1] 2 3:PSET:NAME <string></code> <code>[[:SENSe]:RADio:FORMat:LTETdd[1] 2 3:PSET:NAME?</code>
Example	<code>RAD:FORM:LTET2:PSET:NAME "Parameter Set 2"</code> <code>RAD:FORM:LTET2:PSET:NAME?</code>
Preset	"LTE TDD 1" "LTE TDD 2" "LTE TDD 3"
State Saved	Saved in instrument state
Initial S/W Revision	A.16.00

Format Parameter List

Since most parameters are the same as those used in the original measurement, the SCPI commands in the original measurement can be used to set up the LTE TDD parameter sets by converting the measurement node.

The following SCPI commands in the LTE TDD Conformance EVM measurement are converted for the MSR's CEVM as follows:

SCPI Command in LTE TDD CEVM	SCPI Command in MSR CEVM
<code>[[:SENSe]:CEVM:AVERage:COUNT</code>	<code>[[:SENSe]:CEVM:LTETdd:AVERage:COUNT</code>
<code>[[:SENSe]:CEVM:AVERage[:STATE]</code>	<code>[[:SENSe]:CEVM:LTETdd:AVERage[:STATE]</code>

These commands are not in the Format Parameter List. See "[LTE TDD Average/Hold Number](#)" on page 1825 and "[Spectrum](#)" on page 1826 for details.

The preset of the following command differs between the LTE TDD CEVM and MSR CEVM.

SCPI Command in LTE TDD CEVM	SCPI Command in MSR CEVM	Preset in MSR CEVM
[SENSE]:CEVM:MCFilter:STATe	[SENSE]:RADio:FORMat:LTETdd{1:3}:MCFilter:STATe	1

The following SCPI commands in the LTE TDD Conformance EVM measurement are not available in the MSR

SCPI Command not available in MSR CEVM
:DISPlay:CEVM:VIEW1 VIEW[:SElect]
[SENSE]:CEVM:AVERAge:NUMber
[SENSE]:CEVM:AVERAge:TCONtrol
[SENSE]:CEVM:DLINK:DECode:DFINclude
[SENSE]:CEVM:DLINK:DECode:RNTI:MAXimum:RA
[SENSE]:CEVM:DLINK:DECode:RNTI:MAXimum:TPC
[SENSE]:CEVM:DLINK:DECode:RNTI:MINimum:RA
[SENSE]:CEVM:DLINK:DECode:RNTI:MINimum:TPC
[SENSE]:CEVM:DLINK:RESult
[SENSE]:CEVM:EVM:COPI[:IMMediate]/nquery/
[SENSE]:CEVM:METhod
[SENSE]:CEVM:ULINK:DECode:PUSCh
[SENSE]:CEVM:ULINK:RESult

See also the following sections.

Section "[ACP Measurement Noise Bandwidth](#)" on page 346

Section "[SEM Integ BW](#)" on page 346

Section "[CHP Integ BW](#)" on page 347

Section "[UL/DL Config](#)" on page 348

Section "[Dw/GP/Up Len](#)" on page 348

Key Path	Mode Setup, Format, LTE TDD
Initial S/W Revision	A.16.00

ACP Measurement Noise Bandwidth

Specifies the Measurement Noise Bandwidth used to calculate the power in the carriers in the ACP measurement.

Key Path	Mode Setup, Format, LTE TDD, Format Parameter List												
Mode	MSR												
Remote Command	[:SENSe] :RADio:FORMat:LTETdd[1] 2 3 :ACPowEr:CARRier[1] 2 :BANDwidth:INTEgration <freq> [:SENSe] :RADio:FORMat:LTETdd[1] 2 3 :ACPowEr:CARRier[1] 2 :BANDwidth:INTEgration?												
Example	RAD:FORM:LTET:ACP:CARR:BAND:INT 20MHz RAD:FORM:LTET:ACP:CARR:BAND:INT?												
Notes	You must be in the MSR mode. Use :INSTrument:SELEct to set the mode.												
Couplings	When Demod Bandwidth of the parameter set is changed, the value of this parameter also changes as shown in the following table. Note that you cannot set the value exceeding the corresponding Demod Bandwidth.												
	<table border="1"> <tr> <td>1.4 MHz (B1M4)</td> <td>1.095 MHz</td> </tr> <tr> <td>3 MHz (B3M)</td> <td>2.715 MHz</td> </tr> <tr> <td>5 MHz (B5M)</td> <td>4.515 MHz</td> </tr> <tr> <td>10 MHz (B10M)</td> <td>9.015 MHz</td> </tr> <tr> <td>15 MHz (B15M)</td> <td>13.515 MHz</td> </tr> <tr> <td>20 MHz (B20M)</td> <td>18.015 MHz</td> </tr> </table>	1.4 MHz (B1M4)	1.095 MHz	3 MHz (B3M)	2.715 MHz	5 MHz (B5M)	4.515 MHz	10 MHz (B10M)	9.015 MHz	15 MHz (B15M)	13.515 MHz	20 MHz (B20M)	18.015 MHz
1.4 MHz (B1M4)	1.095 MHz												
3 MHz (B3M)	2.715 MHz												
5 MHz (B5M)	4.515 MHz												
10 MHz (B10M)	9.015 MHz												
15 MHz (B15M)	13.515 MHz												
20 MHz (B20M)	18.015 MHz												
Preset	4.515 MHz 4.5 MHz												
State Saved	Saved in instrument state.												
Min	100 kHz												
Max	20 MHz												
Initial S/W Revision	A.16.00												

SEM Integ BW

Specifies the integration bandwidth used to calculate the power in carriers in the SEM measurement.

Key Path	Mode Setup, Format, LTE TDD, Format Parameter List
Mode	MSR
Remote Command	[:SENSe] :RADio:FORMat:LTETdd[1] 2 3 :SEMAsk:BANDwidth[1] 2 :INTEgration <freq> [:SENSe] :RADio:FORMat:LTETdd[1] 2 3 :SEMAsk:BANDwidth[1] 2 :INTEgration?
Example	RAD:FORM:LTET:SEM:BAND:INT 20MHz RAD:FORM:LTET:SEM:BAND:INT?

Notes	You must be in the MSR mode to use this command. Use :INSTRument:SElect to set the mode.												
Couplings	When Demod Bandwidth of the parameter set is changed, the value of this parameter also changes as shown in the following table. Note that you cannot set the value exceeding the corresponding Demod Bandwidth.												
	<table border="1"> <tr> <td>1.4 MHz (B1M4)</td> <td>1.095 MHz</td> </tr> <tr> <td>3 MHz (B3M)</td> <td>2.715 MHz</td> </tr> <tr> <td>5 MHz (B5M)</td> <td>4.515 MHz</td> </tr> <tr> <td>10 MHz (B10M)</td> <td>9.015 MHz</td> </tr> <tr> <td>15 MHz (B15M)</td> <td>13.515 MHz</td> </tr> <tr> <td>20 MHz (B20M)</td> <td>18.015 MHz</td> </tr> </table>	1.4 MHz (B1M4)	1.095 MHz	3 MHz (B3M)	2.715 MHz	5 MHz (B5M)	4.515 MHz	10 MHz (B10M)	9.015 MHz	15 MHz (B15M)	13.515 MHz	20 MHz (B20M)	18.015 MHz
1.4 MHz (B1M4)	1.095 MHz												
3 MHz (B3M)	2.715 MHz												
5 MHz (B5M)	4.515 MHz												
10 MHz (B10M)	9.015 MHz												
15 MHz (B15M)	13.515 MHz												
20 MHz (B20M)	18.015 MHz												
Preset	4.515 MHz 4.5 MHz												
State Saved	Saved in instrument state.												
Min	100 kHz												
Max	20 MHz												
Initial S/W Revision	A.16.00												

CHP Integ BW

Specifies the range of integration used in calculating the power in the carriers in the CHP measurement.

Key Path	Mode Setup, Format, LTE TDD, Format Parameter List												
Mode	MSR												
Remote Command	[:SENSe]:RADio:FORMat:LTETdd[1] 2 3:CHPower:BANDwidth:INTEgration <freq> [:SENSe]:RADio:FORMat:LTETdd[1] 2 3:CHPower:BANDwidth:INTEgration?												
Example	RAD:FORM:LTET:CHP:BAND:INT 20MHz RAD:FORM:LTET:CHP:BAND:INT?												
Notes	You must be in the MSR mode to use this command. Use :INSTRument:SElect to set the mode.												
Couplings	When Demod Bandwidth of the parameter set is changed, the value of this parameter also changes as shown in the following table. Note that you cannot set the value exceeding the corresponding Demod Bandwidth.												
	<table border="1"> <tr> <td>1.4 MHz (B1M4)</td> <td>1.4 MHz</td> </tr> <tr> <td>3 MHz (B3M)</td> <td>3 MHz</td> </tr> <tr> <td>5 MHz (B5M)</td> <td>5 MHz</td> </tr> <tr> <td>10 MHz (B10M)</td> <td>10 MHz</td> </tr> <tr> <td>15 MHz (B15M)</td> <td>15 MHz</td> </tr> <tr> <td>20 MHz (B20M)</td> <td>20 MHz</td> </tr> </table>	1.4 MHz (B1M4)	1.4 MHz	3 MHz (B3M)	3 MHz	5 MHz (B5M)	5 MHz	10 MHz (B10M)	10 MHz	15 MHz (B15M)	15 MHz	20 MHz (B20M)	20 MHz
1.4 MHz (B1M4)	1.4 MHz												
3 MHz (B3M)	3 MHz												
5 MHz (B5M)	5 MHz												
10 MHz (B10M)	10 MHz												
15 MHz (B15M)	15 MHz												
20 MHz (B20M)	20 MHz												

Preset	5 MHz
State Saved	Saved in instrument state.
Min	100 kHz
Max	20 MHz
Initial S/W Revision	A.16.00

UL/DL Config

This key allows you to set the Uplink and Downlink allocation configuration of the signal being measured. The choice of link direction will determine which slot in the frame is used for uplink transmission, and which slot for downlink transmission.

Key Path	Mode Setup, Format, LTE TDD, Format Parameter List
Mode	MSR
Remote Command	<code>[:SENSe]:RADio:FORMat:LTETdd[1] 2 3:RADio:STANdard:ULDL CONF0 CONF1 CONF2 CONF3 CONF4 CONF5 CONF6</code> <code>[:SENSe]:RADio:FORMat:LTETdd[1] 2 3:RADio:STANdard:ULDL?</code>
Example	<code>RAD:FORM:LTET1:RAD:STAN:ULDL CONF0</code>
Notes	CONF0: Configuration 0 (DSUUUDSUUU) CONF1: Configuration 1 (DSUUDDSUUD) CONF2: Configuration 2 (DSUDDDSUDD) CONF3: Configuration 3 (DSUUUDDDDDD) CONF4: Configuration 4 (DSUUDDDDDD) CONF5: Configuration 5 (DSUDDDDDDDD) CONF6: Configuration 6 (DSUUUDSUUD)
Preset	CONF0
State Saved	Saved in instrument state.
Range	Configuration 0 Configuration 1 Configuration 2 Configuration 3 Configuration 4 Configuration 5 Configuration 6
Initial S/W Revision	A.16.00

Dw/GP/Up Len

This key allows you to set the DwPTS/GP/UpPTS length configuration of the signal being measured. The choice of link direction will determine the length of DwPTS, GP and UpPTS in the Special Subframe.

Key Path	Mode Setup, Format, LTE TDD, Format Parameter List
Mode	MSR
Remote Command	<code>[:SENSe]:RADio:FORMat:LTETdd[1] 2 3:RADio:STANdard:DGPU CONF0 CONF1 CONF2 CONF3 CONF4 CONF5 CONF6 CONF7 CONF8</code>

	<code>[:SENSE] :RADio:FORMat:LTETdd[1] 2 3 :RADio:STANdard:DGPU?</code>
Example	<code>RAD:FORM:LTET2:RAD:STAN:DGPU CONF0</code>
Notes	CONF0: Configuration 0 CONF1: Configuration 1 CONF2: Configuration 2 CONF3: Configuration 3 CONF4: Configuration 4 CONF5: Configuration 5 CONF6: Configuration 6 CONF7: Configuration 7 CONF8: Configuration 8
Preset	CONF0
State Saved	Saved in instrument state.
Range	Configuration 0 Configuration 1 Configuration 2 Configuration 3 Configuration 4 Configuration 5 Configuration 6 Configuration 7 Configuration 8
Initial S/W Revision	A.16.00

Bandwidth

Sets bandwidth of the selected LTE FDD parameter set.

Key Path	Mode Setup, Format, LTE FDD
Remote Command	<code>[:SENSE] :RADio:FORMat:LTEFdd[1] 2 3 :BANDwidth B1M4 B3M B5M B10M B15M B20M</code> <code>[:SENSE] :RADio:FORMat:LTEFdd[1] 2 3 :BANDwidth?</code>
Example	<code>RAD:FORM:LTEF2:BAND B10M</code> <code>RAD:FORM:LTEF2:BAND?</code>
Preset	B5M
State Saved	Saved in instrument state
Range	1.4MHz(6RB) 3MHz(15RB) 5MHz(25RB) 10MHz(50RB) 15MHz(75RB) 20MHz(100RB)
Readback	The currently selected Bandwidth
Initial S/W Revision	A.10.00

TD-SCDMA

Accesses the TD-SCDMA menu for TD-SCDMA Parameter Set. This key is available only when Option N/W9079A-1FP is installed.

Key Path	Mode Setup, Format
Initial S/W Revision	A.16.00

Select TD-SCDMA Parameter Set

Selects TD-SCDMA parameter set and shows its parameters on menu.

Key Path	Mode Setup, Format, TD-SCDMA
State Saved	Saved in instrument state
Initial S/W Revision	A.16.00

Parameter Set Name

Sets the name of the selected TD-SCDMA parameter set.

Key Path	Mode Setup, Format, TD-SCDMA
Remote Command	<code>[[:SENSE]:RADIO:FORMAt:TDSCdma[1] 2 3:PSET:NAME <string></code> <code>[[:SENSE]:RADIO:FORMAt:TDSCdma[1] 2 3:PSET:NAME?</code>
Example	<code>RAD:FORM:TDSC2:PSET:NAME "Parameter Set 2"</code> <code>RAD:FORM:TDSC2:PSET:NAME?</code>
Preset	"TD-SCDMA 1" "TD-SCDMA 2" "TD-SCDMA 3"
State Saved	Saved in instrument state
Initial S/W Revision	A.16.00

Format Parameter List

Since most parameters are the same as those used in the original measurement, the SCPI commands in the original measurement can be used to set up the TD-SCDMA parameter sets by converting the measurement node.

The following SCPI command in the TD-SCDMA application is converted for this measurement as follows:

Parameter Name	SCPI Command in TD-SCDMA mode	SCPI Command in TD-SCDMA Format Parameter List
HSPA/8PSK Enable	<code>[[:SENSE]:RADIO:CONFIgure:HSDPa[:STATe]</code>	<code>[[:SENSE]:RADIO:FORMAt:TDSCdma{1:3}:CONFIgure:HSDPa[:STATe]</code>
Filter Alpha	<code>[[:SENSE]:TDEMod:ALPHa</code>	<code>[[:SENSE]:RADIO:FORMAt:TDSCdma{1:3}:TDEMod:ALPHa</code>
Select Code Channel	<code>[[:SENSE]:TDEMod:CDCHannel</code>	<code>[[:SENSE]:RADIO:FORMAt:TDSCdma{1:3}:TDEMod:CDCHannel</code>
Code Channel Status	<code>[[:SENSE]:TDEMod:CDCHannel:ACTIve</code>	<code>[[:SENSE]:RADIO:FORMAt:TDSCdma{1:3}:TDEMod:CDCHannel:ACTIve</code>
Code Channel Detection	<code>[[:SENSE]:TDEMod:CDCHannel:DETEction</code>	<code>[[:SENSE]:RADIO:FORMAt:TDSCdma{1:3}:TDEMod:CDCHannel:DETEction</code>
Code Channel	<code>[[:SENSE]:TDEMod:CDCHannel:DETEction:AUTO</code>	<code>[[:SENSE]:RADIO:FORMAt:TDSCdma</code>

Detection		{1:3}:TDEMod:CDCHannel:DETection:AUTO
Select All Code Channels	[.SENSe]:TDEMod:CDCHannel:SALL	[.SENSe]:RADio:FORMat:TDSCdma {1:3}:TDEMod:CDCHannel:SALL
Select All Code Channels	[.SENSe]:TDEMod:CDCHannel:SElect	[.SENSe]:RADio:FORMat:TDSCdma {1:3}:TDEMod:CDCHannel:SElect
EVM Result IQ Offset	[.SENSe]:TDEMod:EVMResult:IQOffset	[.SENSe]:RADio:FORMat:TDSCdma {1:3}:TDEMod:EVMResult:IQOffset
Multi-Carrier Demod	[.SENSe]:TDEMod:MCARrier	[.SENSe]:RADio:FORMat:TDSCdma {1:3}:TDEMod:MCARrier
Modulation Format	[.SENSe]:TDEMod:MODFormat	[.SENSe]:RADio:FORMat:TDSCdma {1:3}:TDEMod:MODFormat
Mod Scheme	[.SENSe]:TDEMod:MODScheme:AUTO	[.SENSe]:RADio:FORMat:TDSCdma {1:3}:TDEMod:MODScheme:AUTO
Midamble Shift	[.SENSe]:TDEMod:MSHift	[.SENSe]:RADio:FORMat:TDSCdma {1:3}:TDEMod:MSHift
Max User for TS0	[.SENSe]:TDEMod:MXUSer:TS0	[.SENSe]:RADio:FORMat:TDSCdma {1:3}:TDEMod:MXUSer:TS0
Max User for TS1	[.SENSe]:TDEMod:MXUSer:TS1 TS	[.SENSe]:RADio:FORMat:TDSCdma {1:3}:TDEMod:MXUSer:TS1 TS
Max User for TS2	[.SENSe]:TDEMod:MXUSer:TS2	[.SENSe]:RADio:FORMat:TDSCdma {1:3}:TDEMod:MXUSer:TS2
Max User for TS3	[.SENSe]:TDEMod:MXUSer:TS3	[.SENSe]:RADio:FORMat:TDSCdma {1:3}:TDEMod:MXUSer:TS3
Max User for TS4	[.SENSe]:TDEMod:MXUSer:TS4	[.SENSe]:RADio:FORMat:TDSCdma {1:3}:TDEMod:MXUSer:TS4
Max User for TS5	[.SENSe]:TDEMod:MXUSer:TS5	[.SENSe]:RADio:FORMat:TDSCdma {1:3}:TDEMod:MXUSer:TS5
Max User for TS6	[.SENSe]:TDEMod:MXUSer:TS6	[.SENSe]:RADio:FORMat:TDSCdma {1:3}:TDEMod:MXUSer:TS6
Normalize	[.SENSe]:TDEMod:NORMalize	[.SENSe]:RADio:FORMat:TDSCdma {1:3}:TDEMod:NORMalize
Phase Shift	[.SENSe]:TDEMod:PHASe:SHIFt	[.SENSe]:RADio:FORMat:TDSCdma {1:3}:TDEMod:PHASe:SHIFt
Phase Shift Detection	[.SENSe]:TDEMod:PHASe:SHIFt:DETection:AUTO	[.SENSe]:RADio:FORMat:TDSCdma {1:3}:TDEMod:PHASe:SHIFt:DETection:AUTO
Select Code Length	[.SENSe]:TDEMod:SCLength	[.SENSe]:RADio:FORMat:TDSCdma {1:3}:TDEMod:SCLength
Scramble Code	[.SENSe]:TDEMod:SCODE	[.SENSe]:RADio:FORMat:TDSCdma {1:3}:TDEMod:SCODE
Slot Frequency Reference	[.SENSe]:TDEMod:SREFerence	[.SENSe]:RADio:FORMat:TDSCdma {1:3}:TDEMod:SREFerence
Sync Type	[.SENSe]:TDEMod:SYNC	[.SENSe]:RADio:FORMat:TDSCdma {1:3}:TDEMod:SYNC

Active Channel Threshold	[[:SENSe]:TDEMod:THReshold:CHANnel	[[:SENSe]:RADio:FORMat:TDSCdma {1:3}:TDEMod:THReshold:CHANnel
Active Channel Threshold State	[[:SENSe]:TDEMod:THReshold:CHANnel:AUTO	[[:SENSe]:RADio:FORMat:TDSCdma {1:3}:TDEMod:THReshold:CHANnel:AUTO
Active Slot Threshold	[[:SENSe]:TDEMod:THReshold:SLOT	[[:SENSe]:RADio:FORMat:TDSCdma {1:3}:TDEMod:THReshold:SLOT
Timing Reference	[[:SENSe]:TDEMod:TREference	[[:SENSe]:RADio:FORMat:TDSCdma {1:3}:TDEMod:TREference
Switching Point	[[:SENSe]:TDEMod:ULSPoint	[[:SENSe]:RADio:FORMat:TDSCdma {1:3}:TDEMod:ULSPoint
Uplink Pilot	[[:SENSe]:TDEMod:UPTS	[[:SENSe]:RADio:FORMat:TDSCdma {1:3}:TDEMod:UPTS

The following SCPI commands in the TD-SCDMA Mod Accuracy measurement are converted for the MSR's CEVM as follows:

SCPI Command in Mod Accuracy	SCPI Command in MSR CEVM
[[:SENSe]:EVM:AVERage:COUNT	[[:SENSe]:CEVM:TDSCdma:AVERage:COUNT
[[:SENSe]:EVM:AVERage[:STATe]	[[:SENSe]:CEVM:TDSCdma:AVERage[:STATe]

These commands are not in the Format Parameter List. See ["TD-SCDMA Average/Hold Number" on page 1825](#) and ["Spectrum" on page 1826](#) for details.

The following SCPI commands in the TD-SCDMA Mod Accuracy measurement are not available in the MSR.

:CALCulate:EVM:LIMit{1:2}:FERRor
:CALCulate:EVM:LIMit{1:2}:PCDE
:CALCulate:EVM:LIMit{1:2}:PEAK
:CALCulate:EVM:LIMit{1:2}:RHO
:CALCulate:EVM:LIMit{1:2}:RMS
:CALCulate:EVM:MARKer{1:12}:AOFF/nquery/
:CALCulate:EVM:MARKer{1:12}:CHIP
:CALCulate:EVM:MARKer{1:12}:COUPlE[:STATe]
:CALCulate:EVM:MARKer{1:12}:CPEak[:STATe]
:CALCulate:EVM:MARKer{1:12}:FUNction:RESult?/qonly/
:CALCulate:EVM:MARKer{1:12}:MAXimum/nquery/
:CALCulate:EVM:MARKer{1:12}:MAXimum:HIGHer/nquery/
:CALCulate:EVM:MARKer{1:12}:MAXimum:LEFT/nquery/
:CALCulate:EVM:MARKer{1:12}:MAXimum:LOWer/nquery/

:CALCulate:EVM:MARKer{1:12}:MAXimum:NEXT/nquery/
:CALCulate:EVM:MARKer{1:12}:MAXimum:RIGHT/nquery/
:CALCulate:EVM:MARKer{1:12}:MINimum/nquery/
:CALCulate:EVM:MARKer{1:12}:MODE
:CALCulate:EVM:MARKer{1:12}:PTPeak/nquery/
:CALCulate:EVM:MARKer{1:12}:REFerence
:CALCulate:EVM:MARKer{1:12}:STATe
:CALCulate:EVM:MARKer{1:12}:TRACe
:CALCulate:EVM:MARKer{1:12}:X
:CALCulate:EVM:MARKer{1:12}:X:POSition
:CALCulate:EVM:MARKer{1:12}:Y?/qonly/
:DISPlay:EVM:ANNotation:TITLe:DATA
:DISPlay:EVM:FVECTor[:STATe]
:DISPlay:EVM:INTerpolate[:STATe]
:DISPlay:EVM:IQPoints
:DISPlay:EVM:IQPoints:OFFSet
:DISPlay:EVM:IQPType
:DISPlay:EVM:ROTation[:STATe]
:DISPlay:EVM:VIEW1 VIEW:NSElect
:DISPlay:EVM:VIEW1 VIEW[:SElect]
:DISPlay:EVM:VIEW2:WINDow1 WINDow:TRACe:X[:SCALe]:COUPle
:DISPlay:EVM:VIEW2:WINDow1 WINDow:TRACe:X[:SCALe]:PDIVision
:DISPlay:EVM:VIEW2:WINDow1 WINDow:TRACe:X[:SCALe]:RLEVel
:DISPlay:EVM:VIEW2:WINDow1 WINDow:TRACe:X[:SCALe]:RPOSition
:DISPlay:EVM:VIEW2:WINDow1 WINDow:TRACe:Y[:SCALe]:COUPle
:DISPlay:EVM:VIEW2:WINDow1 WINDow:TRACe:Y[:SCALe]:PDIVision
:DISPlay:EVM:VIEW2:WINDow1 WINDow:TRACe:Y[:SCALe]:RLEVel
:DISPlay:EVM:VIEW2:WINDow1 WINDow:TRACe:Y[:SCALe]:RPOSition
:DISPlay:EVM:VIEW2:WINDow2:TRACe:X[:SCALe]:COUPle
:DISPlay:EVM:VIEW2:WINDow2:TRACe:X[:SCALe]:PDIVision
:DISPlay:EVM:VIEW2:WINDow2:TRACe:X[:SCALe]:RLEVel
:DISPlay:EVM:VIEW2:WINDow2:TRACe:X[:SCALe]:RPOSition
:DISPlay:EVM:VIEW2:WINDow2:TRACe:Y[:SCALe]:COUPle
:DISPlay:EVM:VIEW2:WINDow2:TRACe:Y[:SCALe]:PDIVision
:DISPlay:EVM:VIEW2:WINDow2:TRACe:Y[:SCALe]:RLEVel
:DISPlay:EVM:VIEW2:WINDow2:TRACe:Y[:SCALe]:RPOSition
:DISPlay:EVM:VIEW2:WINDow3:TRACe:X[:SCALe]:COUPle

:DISPlay:EVM:VIEW2:WINDow3:TRACe:X[:SCALe]:PDIVision
:DISPlay:EVM:VIEW2:WINDow3:TRACe:X[:SCALe]:RLEVel
:DISPlay:EVM:VIEW2:WINDow3:TRACe:X[:SCALe]:RPOStion
:DISPlay:EVM:VIEW2:WINDow3:TRACe:Y[:SCALe]:COUPle
:DISPlay:EVM:VIEW2:WINDow3:TRACe:Y[:SCALe]:PDIVision
:DISPlay:EVM:VIEW2:WINDow3:TRACe:Y[:SCALe]:RLEVel
:DISPlay:EVM:VIEW2:WINDow3:TRACe:Y[:SCALe]:RPOStion
:DISPlay:EVM:VIEW3:WINDow1 WINDow:TRACe:X[:SCALe]:COUPle
:DISPlay:EVM:VIEW3:WINDow1 WINDow:TRACe:X[:SCALe]:PDIVision
:DISPlay:EVM:VIEW3:WINDow1 WINDow:TRACe:X[:SCALe]:RLEVel
:DISPlay:EVM:VIEW3:WINDow1 WINDow:TRACe:X[:SCALe]:RPOStion
:DISPlay:EVM:VIEW3:WINDow1 WINDow:TRACe:Y[:SCALe]:COUPle
:DISPlay:EVM:VIEW3:WINDow1 WINDow:TRACe:Y[:SCALe]:PDIVision
:DISPlay:EVM:VIEW3:WINDow1 WINDow:TRACe:Y[:SCALe]:RLEVel
:DISPlay:EVM:VIEW3:WINDow1 WINDow:TRACe:Y[:SCALe]:RPOStion
:DISPlay:EVM:VIEW4:WINDow1 WINDow:TRACe:X[:SCALe]:COUPle
:DISPlay:EVM:VIEW4:WINDow1 WINDow:TRACe:X[:SCALe]:PDIVision
:DISPlay:EVM:VIEW4:WINDow1 WINDow:TRACe:X[:SCALe]:RLEVel
:DISPlay:EVM:VIEW4:WINDow1 WINDow:TRACe:X[:SCALe]:RPOStion
:DISPlay:EVM:VIEW4:WINDow1 WINDow:TRACe:Y[:SCALe]:COUPle
:DISPlay:EVM:VIEW4:WINDow1 WINDow:TRACe:Y[:SCALe]:PDIVision
:DISPlay:EVM:VIEW4:WINDow1 WINDow:TRACe:Y[:SCALe]:RLEVel
:DISPlay:EVM:VIEW4:WINDow1 WINDow:TRACe:Y[:SCALe]:RPOStion
[.SENSe]:EVM:AVERAge:TCONtrol

See also the following sections.

Section ["ACP Measurement Noise Bandwidth" on page 355](#)

Section ["SEM Integ BW" on page 355](#)

Section ["CHP Integ BW" on page 355](#)

Section ["Phase Noise Optimization" on page 356](#)

Key Path	Mode Setup, Format, TD-SCDMA
Initial S/W Revision	A.16.00

ACP Measurement Noise Bandwidth

Specifies the Measurement Noise Bandwidth used to calculate the power in the carriers in the ACP measurement.

Key Path	Mode Setup, Format, TD-SCDMA, Format Parameter List
Mode	MSR
Remote Command	<code>[:SENSE]:RADio:FORMat:TDSCdma[1] 2 3:ACPowEr:CARRier[1] 2:BANDwidth:INTEgration <freq></code> <code>[:SENSe]:RADio:FORMat:TDSCdma[1] 2 3:ACPowEr:CARRier[1] 2:BANDwidth:INTEgration?</code>
Example	<code>RAD:FORM:TDSC:ACP:CARR:BAND:INT 5MHz</code> <code>RAD:FORM:TDSC:ACP:CARR:BAND:INT?</code>
Notes	You must be in the MSR mode. Use <code>:INSTrument:SElect</code> to set the mode.
Preset	1.28 MHz
State Saved	Saved in instrument state.
Min	100 kHz
Max	5 MHz
Initial S/W Revision	A.16.00

SEM Integ BW

Specifies the integration bandwidth used to calculate the power in carriers in the SEM measurement.

Key Path	Mode Setup, Format, TD-SCDMA, Format Parameter List
Mode	MSR
Remote Command	<code>[:SENSE]:RADio:FORMat:TDSCdma[1] 2 3:SEMAsk:BANDwidth[1] 2:INTEgration <freq></code> <code>[:SENSe]:RADio:FORMat:TDSCdma[1] 2 3:SEMAsk:BANDwidth[1] 2:INTEgration?</code>
Example	<code>RAD:FORM:TDSC:SEM:BAND:INT 5MHz</code> <code>RAD:FORM:TDSC:SEM:BAND:INT?</code>
Notes	You must be in the MSR mode to use this command. Use <code>:INSTrument:SElect</code> to set the mode.
Preset	1.28 MHz
State Saved	Saved in instrument state.
Min	100 kHz
Max	5 MHz
Initial S/W Revision	A.16.00

CHP Integ BW

Specifies the range of integration used in calculating the power in the carriers in the CHP measurement.

Key Path	Mode Setup, Format, TD-SCDMA, Format Parameter List
Mode	MSR
Remote Command	[:SENSe] :RADio :FORMat :TDSCdma [1] 2 3 :CHPower :BANDwidth :INTEgration <freq> [:SENSe] :RADio :FORMat :TDSCdma [1] 2 3 :CHPower :BANDwidth :INTEgration?
Example	RAD:FORM:TDSC:CHP:BAND:INT 5MHz RAD:FORM:TDSC:CHP:BAND:INT?
Notes	You must be in the MSR mode to use this command. Use :INSTrument:SElect to set the mode.
Preset	1.6 MHz
State Saved	Saved in instrument state.
Min	100 kHz
Max	5 MHz
Initial S/W Revision	A.16.00

Phase Noise Optimization

The Phase Noise Optimization setting affects the phase noise distribution on the analyzer's LO.

Key Path	Mode Setup, Format, Format Parameter List
Mode	MSR
Remote Command	[:SENSe] :RADio :FORMat :TDSCdma [1] 2 3 :FREQuency :SYNTHeSis :STATe 1 2 3 [:SENSe] :RADio :FORMat :TDSCdma [1] 2 3 :FREQuency :SYNTHeSis :STATe?
Example	RAD:FORM:TDSC1:FREQ:SYNT:STAT 1 RAD:FORM:TDSC1:FREQ:SYNT:STAT?
Notes	Parameter key: 1 - Best Close-in 2 - Best Wide-offset 3 - Fast Tuning
Preset	Models with option EP2: 3 Other: 1
State Saved	Saved in instrument state.
Initial S/W Revision	A.16.00

Noise Reduction

Noise Reduction accesses a menu for configuring the noise compensation of the instrument. This menu only appears in models that support Noise Reduction.

Key Path	Mode Setup
Initial S/W Revision	A.04.00

Noise Floor Extension

Turns on the **Noise Floor Extension** function. When this function is On, the expected noise power of the analyzer (derived from a factory calibration) is subtracted from the trace data. This will usually reduce the apparent noise level by about 10 dB in low band, and 8 dB in high band (>~3.6 GHz).

Noise Floor Extension works with any RBW, VBW, detector, any setting of Average Type, any amount of trace averaging, and any signal type. It is ineffective when the trace is not smoothed (smoothing processes include narrow VBWs, trace averaging, and long sweep times with the detector set to Average or Peak). It works best with extreme amounts of smoothing, and with the average detector, with the Average Type set to Power.

NOTE

Noise Floor Extensions has no effect unless the RF Input is selected, therefore it does nothing when External Mixing is selected.

In those cases where the cancellation is ineffective, it nonetheless has no undesirable side-effects. There is no significant speed impact to having **Noise Floor Extension** on.

The best accuracy is achieved when substantial smoothing occurs in each point before trace averaging. Thus, when using the average detector, results are better with long sweep times and fewer trace averages. When using the sample detector, the VBW filter should be set narrow with less trace averaging, instead of a wide VBW filter with more trace averaging.

See "[More Information](#)" on page 358

Key Path	Mode Setup, Noise Reduction
Scope	Meas Global
Remote Command	[:SENSe]:CORRection:NOISe:FLOOr ON OFF 1 0 [:SENSe]:CORRection:NOISe:FLOOr?
Example	CORR:NOIS:FLO ON
Dependencies	This key only appears in instruments with the NFE or NF2 license installed. In all others, the key does not appear, however the SCPI command will be accepted without error (but will have no effect).
Couplings	When NFE is enabled in any mode manually, a prompt will be displayed reminding you to perform the Characterize Noise Floor operation if it is needed. If NFE is enabled through SCPI and a Characterize Noise Floor operation is needed, an error will be entered in the system error queue.
Preset	Unaffected by Mode Preset. Turned off by Restore Mode Defaults.
State Saved	No
Initial S/W Revision	A.04.00

More Information

The analyzer is characterized in the factory (or during a field calibration) with a model of the noise, referred to the input mixer, versus frequency in each band and path combination. Bands are 0 (low band) and 1 through 4 (high band) in a 26.5 GHz instrument, for example. Paths include normal paths, preamp paths, the electronic attenuator, etc.

In most band/path combinations, the noise can be well characterized based on just two parameters and the analyzer frequency response before compensation for frequency-dependent losses.

After the noise density at the input mixer is estimated, the effects of the input attenuator, RBW, detector, etc. are computed to get the estimated input-port-referred noise level.

In the simplest case, the measured power (signal plus analyzer noise) in each display point (bucket) is compensated by subtracting the estimated noise power, leaving just the signal power. This is the operation when the detector is Average and the Average Type is set to Power.

In other cases, operation is often not quite as good but still highly effective. With peak detection, the noise floor is estimated based on the RBW and the duration of the bucket using the same equations used in the noise marker function. The voltage of the noise is subtracted from the voltage of the observed signal-plus-noise measurement to compute the estimated signal voltage. The peak detector is one example of processing that varies with detector to give good estimates of the signal level without the analyzer noise.

For best operation, the average detector and the power scale are recommended, as already stated. Peak detection for pulsed-RF can still give excellent effectiveness. FFT analysis does not work well, and does not do NFE well, with pulsed-RF signals, so this combination is not recommended. Negative peak detection is not very useful, either. Sample detection works well, but is never better than the average detector because it doesn't smooth as well. The Normal detector is a combination of peak and negative peak behaviors, and works about as well as these.

For best operation, extreme smoothing is desirable, as already stated. Using narrow VBWs works well, but using very long bucket durations and the average detector works best. Reducing the number of trace points will make the buckets longer.

For best operation, the power scale (Average Type = Power) is optimum. When making CW measurements in the presence of noise without NFE, averaging on the decibel scale has the advantage of reducing the effect of noise. When using NFE, the NFE does an even better job than using the log scale ever could. Using NFE with the log scale is not synergistic, though; NFE with the power scale works a little better than NFE with log averaging type.

The results from NFE with internal preamp can often be lower than the theoretical noise in a signal source at room temperature, a noise density of -174 dBm/Hz. This is expected and useful behavior, because NFE is designed to report the amount of input signal that is in excess of the thermal noise, not the amount that includes the thermal noise. This can be a useful behavior because thermal noise often interferes with what you want to measure, instead of being part of what you want to measure. Note that NFE is not adequately accurate to always be able to read below kTB.

On instruments with the NF2 license installed, the calibrated Noise Floor used by Noise Floor Extensions should be refreshed periodically. Keysight recommends that the **Characterize Noise Floor** operation be performed after the first 500 hours of operation, and once every calendar year. The key to perform this is located in the **System, Alignments, Advanced** menu. If you have not done this yourself at the recommended interval, then when you turn on Noise Floor Extensions, the analyzer will prompt you to do so with a dialog that says:

“This action will take several minutes to perform. Please disconnect all cables from the RF input and press Enter to proceed. Press ESC to cancel, or Postpone to postpone for a week.”

If you Cancel, you will be prompted again the next time you turn NFE on. If you postpone, you will be prompted again after a week passes and you then turn NFE on.

Restore Mode Defaults

Resets the state for the currently active mode by resetting the mode persistent settings to their factory default values, clearing mode data and by performing a Mode Preset. This function will never cause a mode switch. This function performs a full preset for the currently active mode; whereas, Mode Preset performs a partial preset. Restore Mode Defaults does not affect any system settings. System settings are reset by the Restore System Defaults function. This function does reset mode data; as well as settings.

Key Path	Mode Setup
Remote Command	:INSTrument:DEFault
Example	:INST:DEF
Notes	Clears all pending OPC bits. The Status Byte is set to 0. A message comes up saying: “If you are sure, press key again”.
Couplings	A Restore Mode Defaults will cause the currently running measurement to be aborted and causes the default measurement to be active. It gets the mode to a consistent state with all of the default couplings set.
Initial S/W Revision	Prior to A.02.00

Preset Type (Remote Command Only)

As stated in the Backward Compatibility section, to be compatible with ESA/PSA the PRESet:TYPE command will be implemented as a no-op.

Mode	All
Remote Command	:SYSTem:PRESet:TYPE FACTory MODE USER :SYSTem:PRESet:TYPE?
Example	:SYST:PRES:TYPE FACT
Notes	This command is supported for backward compatibility only. It is a no-op which does not change the behavior of any preset operation.
Preset	This is unaffected by Preset but is set to Mode on a “Restore System Defaults->All”
State Saved	No
Initial S/W Revision	Prior to A.02.00

6 System Functions

File

Opens a menu that enables you to access various standard and custom Windows functions. Press any other front-panel key to exit

Key Path	Front-panel key
Initial S/W Revision	Prior to A.02.00

File Explorer

Opens the standard Windows File Explorer. The File Explorer opens in the My Documents directory for the current user.

The File Explorer is a separate Windows application, so to return to the analyzer once you are in the File Explorer, you may either:

Exit the File Explorer by clicking on the red X in the upper right corner, with a mouse

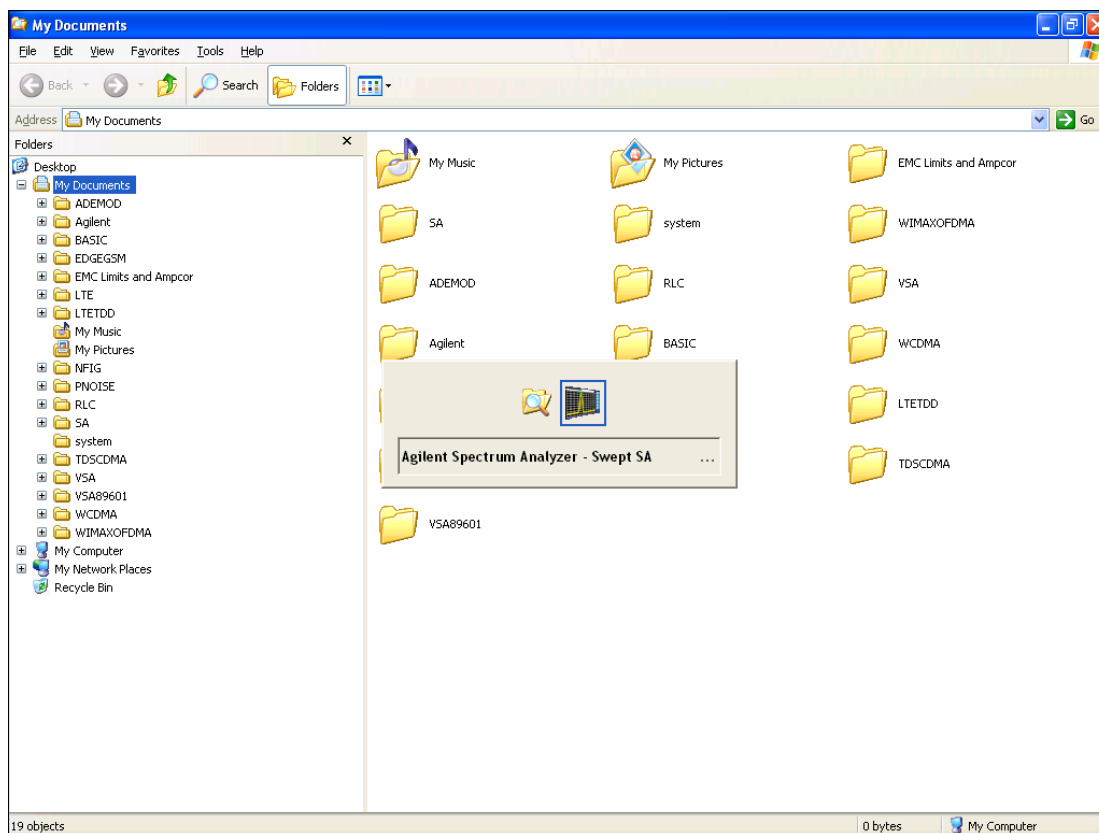

Or use Alt-Tab: press and hold the Alt key and press and release the Tab key until the Analyzer logo is showing in the window in the center of the screen, as shown above, then release the Alt key.

The ability to access File Explorer is not available if Option SF1 is installed.

Key Path	File
Initial S/W Revision	Prior to A.02.00

Page Setup

The Page Setup key brings up a Windows Page Setup dialog that allows you to control aspects of the pages sent to the printer when the PRINT hardkey is pressed.

Key Path	File
Initial S/W Revision	Prior to A.02.00

Paper size, the printer paper source, the page orientation and the margins are all settable. Just like any standard Windows dialog, you may navigate the dialog using the front-panel keys, or a mouse. There are no SCPI commands for controlling these parameters.

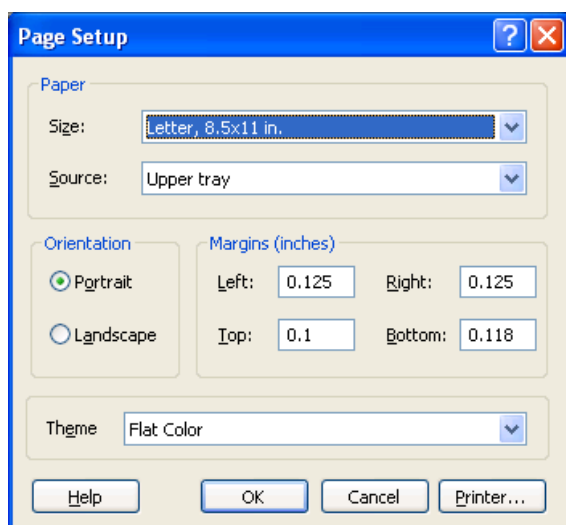

Also contained in this dialog is a drop-down control that lets you select the Theme to use when printing. For more on Themes, see information under View/Display, Display, System Display Settings, Theme. The Theme control has a corresponding SCPI command.

Parameter Name	Print Themes
Parameter Type	Enum
Mode	All
Remote Command	:SYSTem:PRINt:THEME TDCoLor TDMonochrome FCOLor FMONochrome :SYSTem:PRINt:THEME?
Example	:SYST:PRIN:THEM FCOL
Setup	:SYSTem:DEFault MISC
Preset	FCOL; not part of Preset, but is reset by Restore Misc Defaults or Restore System Defaults All and

	survives subsequent running of the modes.
State Saved	No
Initial S/W Revision	Prior to A.02.00

Print

This front-panel key is equivalent to performing a File, Print, OK. It immediately performs the currently configured Print to the Default printer.

The :HCOPY command is equivalent to pressing the PRINT key. The HCOpy:ABORt command can be used to abort a print which is already in progress. Sending HCOpy:ABORt will cause the analyzer to stop sending data to the printer, although the printer may continue or even complete the print, depending on how much data was sent to the printer before the user sent the ABORt command.

Key Path	Front-panel key
Remote Command	:HCOPY[:IMMediate]
Initial S/W Revision	Prior to A.02.00

Key Path	SCPI command only
Remote Command	:HCOPY:ABORt
Initial S/W Revision	Prior to A.02.00

Restore Down

This key allows you to Restore Down the Instrument Application and reverses the action taken by Maximize. This key is only visible when the application has been maximized, and after the Restore Down action has been completed this key is replaced by the Maximize key.

Key Path	File
Mode	All
Notes	No equivalent remote command for this key.
State Saved	No
Initial S/W Revision	A.05.01

Minimize

The Minimize key causes the analyzer display to disappear down into the task bar, allowing you to see the Windows Desktop. You can use Alt-Tab (press and hold the Alt  key and press and release the Tab key) to restore the analyzer display.

Key Path	File
Mode	All
Notes	No equivalent remote command for this key.
State Saved	No
Initial S/W Revision	A.05.01

Exit

This key, when pressed, will exit the Instrument Application. A dialog box is used to confirm that you intended to exit the application:

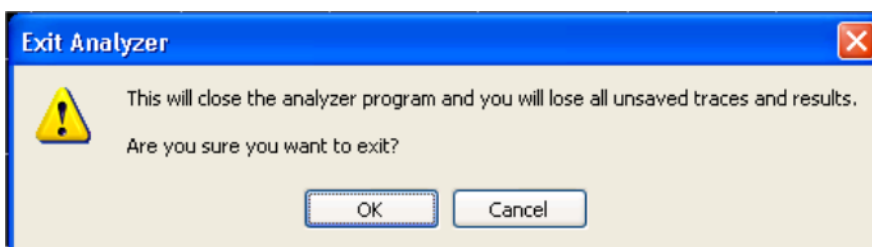

Key Path	File
Mode	All
Notes	The Instrument Application will close. No further SCPI commands can be sent. Use with caution!
Initial S/W Revision	Prior to A.02.00

Print

The Print key opens a Print dialog for configured printing (for example, to the printer of your choice). Refer to your Microsoft Windows Operating System manual for more information.

Maximize/Restore Down

These keys allow the Instrument Application to be maximized and then restored to its prior state. Only one of the two keys is visible at a time. When not already maximized the Maximize Application key is visible, and when maximized, the Restore Down Application key is visible and replaces the Maximize Application key.

Maximize

This key allows you to Maximize the Instrument Application, which causes the analyzer display to fill the screen. Once the application is maximized, this key is replaced by the Restore Down key.

Key Path	File
Mode	All

Notes	No equivalent remote command for this key.
State Saved	No
Initial S/W Revision	A.05.01

Restore Down

This key allows you to Restore Down the Instrument Application and reverses the action taken by Maximize. This key is only visible when the application has been maximized, and after the Restore Down action has been completed this key is replaced by the Maximize key.

Key Path	File
Mode	All
Notes	No equivalent remote command for this key.
State Saved	No
Initial S/W Revision	A.05.01

Print

This front-panel key is equivalent to performing a File, Print, OK. It immediately performs the currently configured Print to the Default printer.

The :HCOPY command is equivalent to pressing the PRINT key. The HCOPY:ABORT command can be used to abort a print which is already in progress. Sending HCOPY:ABORT will cause the analyzer to stop sending data to the printer, although the printer may continue or even complete the print, depending on how much data was sent to the printer before the user sent the ABORT command.

Key Path	Front-panel key
Remote Command	:HCOPY[:IMMEDIATE]
Initial S/W Revision	Prior to A.02.00

Key Path	SCPI command only
Remote Command	:HCOPY:ABORT
Initial S/W Revision	Prior to A.02.00

System

Opens a menu of keys that access various configuration menus and dialogs.

Key Path	Front-panel key
Notes	No remote command for this key specifically.
Initial S/W Revision	Prior to A.02.00

Show

Accesses a menu of choices that enable you to select the information window you want to view.

Key Path	System
Mode	All
Remote Command	:SYSTem:SHOW OFF ERRor SYSTem HARDware LXI HWStatistics ALIGNment SOFTware CAPplication :SYSTem:SHOW?
Example	:SYST:SHOW SYST
Notes	This command displays (or exits) the various System information screens.
Preset	OFF
State Saved	No
Range	OFF ERRor SYSTem HARDware LXI HWStatistics ALIGNment SOFTware CAPplication
Initial S/W Revision	Prior to A.02.00

Errors

There are two modes for the Errors selection, History and Status.

The list of errors displayed in the Errors screen does not automatically refresh. You must press the Refresh key or leave the screen and return to it to refresh it.

History brings up a screen displaying the event log in chronological order, with the newest event at the top. The history queue can hold up to 100 messages (if a message has a repeat count greater than 1 it only counts once against this number of 100). Note that this count bears no relation to the size of the SCPI queue. If the queue extends onto a second page, a scroll bar appears to allow scrolling with a mouse. Time is displayed to the second.

Status brings up a screen summarizing the status conditions currently in effect. Note that the time is displayed to the second.

The fields on the Errors display are:

Type (unlabeled) - Displays the icon identifying the event or condition as an error or warning.

ID - Displays the error number.

Message - Displays the message text.

Repeat (RPT) - This field shows the number of consecutive instances of the event, uninterrupted by other events. If an event occurs 5 times with no other intervening event, the value of repeat will be 5.

If the value of Repeat is 1 the field does not display. If the value of Repeat is >1, the time and date shown are those of the most recent occurrence. If the value of repeat reaches 999,999 it stops there.

Time - Shows the most recent time (including the date) at which the event occurred.

Key Path	System, Show
Mode	All
Remote Command	:SYSTem:ERRor[:NEXT]?
Example	:SYST:ERR?
Notes	The return string has the format: “<Error Number>,<Error>” Where <Error Number> and <Error> are those shown on the Show Errors screen
Backwards Compatibility Notes	In some legacy analyzers, the Repeat field shows the number of times the message has repeated since the last time the error queue was cleared. In the X-Series, the Repeat field shows the number of times the error has repeated since the last intervening error. So the count may very well be different than in the past even for identical signal conditions Unlike previous analyzers, in the X-Series all errors are reported through the Message or Status lines and are logged to the event queue. They never appear as text in the graticule area (as they sometimes do in previous analyzers) and they are never displayed in the settings panel at the top of the screen (as they sometimes do, by changing color, in previous analyzers). As a consequence of the above, the user can only see one status condition (the most recently generated) without looking at the queue. In the past, at least in the Spectrum Analyzer, multiple status conditions might display on the right side of the graticule. In general, there is no backwards compatibility specified or guaranteed between the error numbers in the X-Series and those of earlier products. Error, event, and status processing code in customers' software will probably need to be rewritten to work with X-Series. In the legacy analyzers, some conditions report as errors and others simply turn on status bits. Conditions that report as errors often report over and over as long as the condition exists. In the X-series, all conditions report as start and stop events. Consequently, software that repeatedly queries for a condition error until it stops reporting will have to be rewritten for the X-series.
Initial S/W Revision	Prior to A.02.00

Previous Page

See ["Next Page" on page 370.](#)

Key Path	System, Show, Errors
Initial S/W Revision	Prior to A.02.00

Next Page

Next Page and Previous Page menu keys move you between pages of the log, if it fills more than one page. These keys are grayed out in some cases:

- If on the last page of the log, the Next Page key is grayed-out
- If on the first page of the log, the Previous Page key is grayed-out.
- If there is only one page, both keys are grayed out.

Key Path	System, Show, Errors
Initial S/W Revision	Prior to A.02.00

History

The History and Status keys select the Errors view. The Status key has a second line that shows a number in [square brackets]. This is the number of currently open status items.

Key Path	System, Show, Errors
Initial S/W Revision	Prior to A.02.00

Verbose SCPI On/Off

When you turn Verbose SCPI on, additional information is returned when you send the :SYSTem:ERRor? query. The additional information consists of the characters that stimulated the error. This can aid you in debugging your test programs by indicating where in the parsing of a SCPI command the instrument encountered an invalid command or query.

Specifically, with Verbose SCPI on, the SYSTem:ERRor? query is expanded to show the SCPI data received, with the indicator <Err> at the point in the stream that the error occurred.

Verbose SCPI has no effect on the Show Errors screen or front panel Message Line; it only changes the response to the :SYST:ERR? query.

See the example below, where the invalid command "SENS:BOGUS" is sent:

Normal response to :SYST:ERR (using the Telnet window):

```
SCPI> SENS:BOGUS
```

```
SCPI> SYST:ERR?
```

```
-113,"Undefined header"
```

Now after turning on Verbose SCPI:

```
SCPI> SYST:BOGUS
```

```
SCPI> SYST:ERR?
```

```
-113,"Undefined header;SYST:BOGUS<Err>"
```

Key Path	System, Show, Errors
Mode	All
Remote Command	:SYSTem:ERRor:VERBose OFF ON 0 1 :SYSTem:ERRor:VERBose?
Example	:SYST:ERR:VERB ON
Preset	This is unaffected by Preset but is set to OFF on a "Restore System Defaults->Misc"
State Saved	No
Range	On Off
Initial S/W Revision	Prior to A.02.00

Refresh

When pressed, refreshes the Show Errors display.

Key Path	System, Show, Errors
Initial S/W Revision	Prior to A.02.00

Clear Error Queue

This clears all errors in all error queues.

Note the following:

- Clear Error Queue does not affect the current status conditions.
- Mode Preset does not clear the error queue.
- Restore System Defaults will clear all error queues.
- *CLS only clears the queue if it is sent remotely and *RST does not affect any error queue.
- Switching modes does not affect any error queues.

Key Path	System, Show, Errors
Initial S/W Revision	Prior to A.02.00

Status

See "[History](#)" on page 370.

Input Overload Enable (Remote Command Only)

Input Overload errors are reported using the Input Overload status bit (bit 12 in the Measurement Integrity status register). Input Overloads (for example, ADC Overload errors) can come and go with great frequency, generating many error events (for example, for signals just on the verge of overload), and so are

not put into the SCPI error queue by default. Normally the status bit is the only way for detecting these errors remotely.

It is possible to enable Input Overload reporting to the SCPI queue, by issuing the :SYSTem:ERRor:OVERload ON command. To return to the default state, issue the :SYSTem:ERRor:OVERload OFF command. In either case, Input Overloads always set the status bit.

NOTE

For versions of firmware before A.10.01, the Input Overload was only a Warning and so was never available in the SCPI queue, although it did set the status bit. For A.10.01 and later, the Input Overload is an error and can be enabled to the SCPI queue using this command.

Key Path	SCPI only
Remote Command	:SYSTem:ERRor:OVERload[:STATe] 0 1 OFF ON
Example	:SYST:ERR:OVER 1 Enable overload errors
Preset	Set to OFF by Restore Misc Defaults (no Overload errors go to SCPI)
State Saved	Saved in instrument state.
Initial S/W Revision	A.10.01

Power Up (Remote Command Only)

This serves to show the errors encountered during the application boot-up, such as: mismatch FW-FPGA, missing Calibration data, missing hardware and construction errors.

Remote Command	:SYSTem:ERRor:PUP?
Notes	<p>If no error occurs, the return value will be: "No Power Up Errors." Return Value: <list of error strings>. <List of error strings> is an <IEEE488 Block> format. Return Value Example: "Power up errors, see details in Windows Event Log" "Unmatched FPGA Version(s), See details in Windows Event Log"</p>
Initial S/W Revision	E.14.30

System

The System screen is formatted into three groupings: product descriptive information, options tied to the hardware, and software products:

<Product Name> <Product Description>		
Product Number: N9020A		
Serial Number: US46220924		
Firmware Revision: A.01.01		
Computer Name: <hostname>		
Host ID: N9020A,US44220924		
N9020A-503	Frequency Range to 3.6 GHz	
N9020A-PFR	Precison Frequency Reference	
N9020A-P03	Preamp 3.6 GHz	
N9060A-2FP	Spectrum Analysis Measurement Suite	1.0.0.0
N9073A-1FP	WCDMA	1.0.0.0
N9073A-2FP	WCDMA with HSDPA	1.0.0.0

The Previous Page is grayed-out if the first page of information is presently displayed. The Next Page menu key is grayed-out if the last page is information is presently displayed.

Key Path	System, Show
Mode	All
Example	SYST:SHOW SYST
Backwards Compatibility Notes	The hardware statistics that are displayed in the PSA Show System screen have been moved to a dedicated Show Hardware Statistics screen in the Service Menu.
Initial S/W Revision	Prior to A.02.00

Show System contents (Remote Command Only)

A remote command is available to obtain the contents of the Show System screen (the entire contents, not just the currently displayed page).

Remote Command	:SYSTem:CONFigure[:SYSTem]?
Example	:SYST:CONF?
Notes	The output is an IEEE Block format of the Show System contents. Each line is separated with a new-line character.
Initial S/W Revision	Prior to A.02.00

Computer System description (Remote Command Only)

A remote command is available to obtain the Computer System description. The Computer System is the operating system and patch level as reported by operating system.

LXI

This key shows you the product number, serial number, firmware revision, computer name, IP address, Host ID, LXI Class, LXI Version, MAC Address, and the Auto-MDIX Capability.

Key Path	System, Show
Initial S/W Revision	Prior to A.02.00

System Remote Commands (Remote Commands Only)

The commands in this section have no front-panel key equivalent.

"System Powerdown (Remote Command Only)" on page 375

"System Log Off (Remote Command Only)" on page 375

"List installed Options (Remote Command Only)" on page 376

"Lock the Front-panel keys (Remote Command Only)" on page 376

"List SCPI Commands (Remote Command Only)" on page 377

"SCPI Version Query (Remote Command Only)" on page 377

"Date (Remote Command Only)" on page 377

"Time (Remote Command Only)" on page 377

Initial S/W Revision	Prior to A.02.00
----------------------	------------------

System Powerdown (Remote Command Only)

Remote Command	SYSTem: PDOWn [NORMal FORCe]
Notes	Shuts down the instrument in the normal way (NORMal) or forced way (FORCe). In case there is another application with modified data pending for saving, the application prompt the user. The system waits until the user responds in the normal mode. It will go off after 20 seconds of wait in the force mode and all data will be lost.

System Log Off (Remote Command Only)

This SCPI command provides a means to terminate all open Windows applications and log off the current user. This is equivalent to performing the Windows command "shutdown -l -f -t0".

Remote Command	SYSTem: LOFF
Example	SYST:LOFF

Notes	Initiates an immediate log off of the current user. This exits the instrument application, thus any unsaved measurement result will be lost. You cannot use *WAI or *OPC? to synchronize operation. In addition to the instrument application, all other Windows programs will be terminated without the opportunity to save any work in progress. The instrument will require human interaction to perform a Log In to regain instrument operation.
Initial S/W Revision	A.14.50

List installed Options (Remote Command Only)

Lists the installed options that pertain to the instrument (signal analyzer). .

Mode	All
Remote Command	:SYSTem:OPTions?
Example	:SYST:OPT?
Notes	The return string is a comma separated list of the installed options. For example: "503,P03,PFR" :SYSTem:OPTions? and *OPT? are the same.
State Saved	No
Initial S/W Revision	Prior to A.02.00

Lock the Front-panel keys (Remote Command Only)

Disables the instrument keyboard to prevent local input when the instrument is controlled remotely. Annunciation showing a "K" for 'Klock" (keyboard lock) alerts the local user that the keyboard is locked. Klock is similar to the GPIB Local Lockout function; namely that no front-panel keys are active with the exception of the Power Standby key. (The instrument is allowed to be turned-off if Klock is ON.) The Klock command is used in remote control situations where Local Lockout cannot be used.

Although primary intent of Klock is to lock-out the front panel, it will lock-out externally connected keyboards through USB. Klock has no effect on externally connected pointing devices (mice).

The front panel 'Local' key (Cancel/Esc) has no effect if Klock is ON.

Mode	All
Remote Command	:SYSTem:KLOCK OFF ON 0 1 :SYSTem:KLOCK?
Example	:SYST:KLOC ON
Notes	Keyboard lock remains in effect until turned-off or the instrument is power-cycled
Preset	Initialized to OFF at startup, unaffected by Preset
State Saved	No
Initial S/W Revision	Prior to A.02.00

List SCPI Commands (Remote Command Only)

Outputs a list of the valid SCPI commands for the currently selected Mode.

Remote Command	:SYSTem:HELP:HEADers?
Example	:SYST:HELP:HEAD?
Notes	The output is an IEEE Block format with each command separated with the New-Line character (hex 0x0A)
Initial S/W Revision	Prior to A.02.00

SCPI Version Query (Remote Command Only)

Returns the SCPI version number with which the instrument complies. The SCPI industry standard changes regularly. This command indicates the version used when the instrument SCPI commands were defined.

Remote Command	:SYSTem:VERSion?
Example	:SYST:VERS?
Initial S/W Revision	Prior to A.02.00

Date (Remote Command Only)

The recommended access to the Date, Time, and Time zone of the instrument is through the Windows native control (Control Panel or accessing the Task Bar). You may also access this information remotely, as shown in this command and Time (below).

Sets or queries the date in the instrument.

Mode	All
Remote Command	:SYSTem:DATE "<year>,<month>,<day>" :SYSTem:DATE?
Example	:SYST:DATE "2006,05,26"
Notes	<year> is the four digit representation of year. (for example, 2006) <month> is the two digit representation of year. (for example. 01 to 12) <day> is the two digit representation of day. (for example, 01 to 28, 29, 30, or 31) depending on the month and year Unless the current account has Power User or Administrator privileges, an error will be generated by this command and no action will be taken.
Initial S/W Revision	Prior to A.02.00

Time (Remote Command Only)

Sets or queries the time in the instrument.

Mode	All
Remote Command	:SYSTem:TIME "<hour>,<minute>,<second>" :SYSTem:TIME?
Example	:SYST:TIME "13,05,26"
Notes	<hour> is the two digit representation of the hour in 24 hour format <minute> is the two digit representation of minute <second> is the two digit representation of second Unless the current account has Power User or Administrator privileges, an error will be generated by this command and no action will be taken.
Initial S/W Revision	Prior to A.02.00

Power On

Enables you to select how the instrument should power on. The options are: Mode and Input/Output Defaults, User Preset and Last State.

Key Path	System
Mode	All
Remote Command	:SYSTem:PON:TYPE MODE USER LAST :SYSTem:PON:TYPE?
Example	:SYST:PON:TYPE MODE
Preset	This is unaffected by a Preset but is set to Mode on a "Restore System Defaults->All"
State Saved	No
Backwards Compatibility SCPI	:SYSTem:PON:TYPE PRESet the "PRESet" parameter is supported for backward compatibility only and behaves the same as MODE.
Backwards Compatibility Notes	The Preset Type key in legacy analyzers has been removed, and the Power On toggle key has been replaced by this 1-of-N key in the System menu.
Initial S/W Revision	Prior to A.02.00

Mode and Input/Output Defaults

When the analyzer is powered on in Mode and Input/Output Defaults, it performs a Restore Mode Defaults to all modes in the instrument and also performs a Restore Input/Output Defaults.

Persistent parameters (such as Amplitude Correction tables or Limit tables) are not affected at power on, even though they are normally cleared by Restore Input/Output Defaults and/or Restore Mode Defaults.

Key Path	System, Power On
Mode	All

Example	SYST:PON:TYPE MODE
Readback Text	Defaults
Initial S/W Revision	Prior to A.02.00

User Preset

Sets **Power On** to **User Preset**. When the analyzer is powered on in User Preset, it will User Preset each mode and switch to the power-on mode. Power On User Preset will not affect any settings beyond what a normal User Preset affects.

NOTE An instrument could never power up for the first time in User Preset.

Key Path	System, Power On
Mode	All
Example	SYST:PON:TYPE USER
Readback Text	User Preset
Backwards Compatibility Notes	Power On User Preset will cause the instrument to power up in the power-on mode, not the last mode the instrument was in prior to shut down. Also, Power On User Preset will User Preset all modes. This does not exactly match legacy behavior.
Initial S/W Revision	Prior to A.02.00

Last State

Sets **Power On** to **Last**. When the analyzer is powered on, it will put all modes in the last state they were in prior to when the analyzer was put into Power Standby and it will wake up in the mode it was last in prior to powering off the instrument. The saving of the active mode prior to shutdown happens behind the scenes when a controlled shutdown is requested by using the front panel power **Standby** key or by using the remote command `SYSTem:PDOWn`. The non-active modes are saved as they are deactivated and recalled by Power On Last State.

NOTE An instrument can never power up for the first time in Last.

If line power to the analyzer is interrupted, for example by pulling the line cord plug or by switching off power to a test rack, Power On Last State may not work properly. For proper operation, Power On Last State depends on you shutting down the instrument using the Standby key or the `SYSTem:PDOWn` SCPI command. This will ensure the last state of each mode is saved and can be recalled during a power up.

Key Path	System, Power On
Mode	All
Example	SYST:PON:TYPE LAST
Notes	Power on Last State only works if you have done a controlled shutdown prior to powering on in Last. If a controlled shutdown is not done when in Power On Last State, the instrument will power up in the last active mode, but it may not power up in the active mode's last state. If an invalid mode state

	is detected, a Mode Preset will occur. To control the shutdown under remote control use the :SYSTem:PDOWn command.
Readback Text	Last State
Backwards Compatibility Notes	It is no longer possible to power-up the analyzer in the last mode the analyzer was running with that mode in the preset state. (ESA/PSA SYST:PRESET:TYPE MODE with SYST:PON:PRESET) You can power-on the analyzer in the last mode the instrument was running in its last state (SYST:PON:TYPE LAST), or you can specify the mode to power-up in its preset state (SYST:PON:MODE <mode>).
Initial S/W Revision	Prior to A.02.00

Power On Application

Accesses a menu that lists the available Modes and lets you select which Mode is to be the power-on application.

This application is used for Power On Type “Mode and Input/Output Defaults” and Restore System Defaults All.

Key Path	System, Power On
Mode	All
Remote Command	:SYSTem:PON:MODE SA BASIC ADEMOM NFIGURE PNOISE CDMA2K TDSCDMA VSA VSA89601 WCDMA WIMAXOFDMA :SYSTem:PON:MODE?
Example	SYST:PON:MODE SA
Notes	The list of possible modes (and remote parameters) to choose from is dependent on which modes are installed in the instrument.
Preset	This is unaffected by a Preset but is set on a “Restore System Defaults->All” to: For N9038A: EMI For all other models: SA
State Saved	No
Initial S/W Revision	Prior to A.02.00

Configure Applications

The Configure Applications utility can be used to:

- select applications for preload
- determine how many applications can fit in memory at one time
- specify the order of the Modes in the Mode menu.

This utility consists of a window with instructions, a set of “Select Application” checkboxes, a “fuel bar” style memory gauge, and keys that help you set up your configuration.

For more information, see the following topics:

["Preloading Applications" on page 381](#)

["Access to Configure Applications utility" on page 381](#)

["Virtual memory usage" on page 381](#)

Key Path	System, Power On
Example	:SYST:SHOW CAPP Displays the Config Applications screen
Initial S/W Revision	A.02.00

Preloading Applications

During runtime, if a Mode that is not preloaded is selected using the Mode menu or sending SCPI commands, there will be a pause while the Application is loaded. During this pause a message that says “Loading application, please wait ...” is displayed. Once loaded, the application stays loaded, so the next time you select it during a session, there is no delay.

Preloading enables you to “preload” at startup, to eliminate the runtime delay. Preloading an application will cause it to be loaded into the analyzer’s memory when the analyzer program starts up. If you do this, the delay will increase the time it takes to start up the analyzer program, but this may be preferable to having to wait the first time you select an application. Note that, once an application is loaded into memory, it cannot be unloaded without exiting and restarting the analyzer program.

Note that there are more applications available for the X-Series than can fit into Windows Virtual Memory. By allowing you to choose which licensed applications to load at startup, the Configure Applications utility allows you to make optimal use of your memory.

Access to Configure Applications utility

A version of the utility runs the first time you power up the analyzer after purchasing it from Keysight. The utility automatically configures preloads so that as many licensed applications as possible are preloaded while keeping the total estimated virtual memory usage below the limit. This auto-configuration only takes place at the very first run, and after analyzer software upgrades.

You may, at any time, manually call up the Configure Applications utility by pressing System, Power On, Configure Applications, to find a configuration that works best for you, and then restart the analyzer program.

The utility may also be called if, during operation of the analyzer, you attempt to load more applications than can fit in memory at once.

Virtual memory usage

There are more applications available for the X-Series than can fit into memory at any one time, so the Configure Applications utility includes a memory tracker that serves two purposes:

1. It will not let you preload more applications than will fit into memory at once.

2. You can determine how many of your favorite applications can reside in memory at one time.

The utility provides a graphical representation of the amount of memory (note that the memory in question here is Virtual memory and is a limitation imposed by the operating system, not by the amount of physical memory you have in your analyzer). You select applications to preload by checking the boxes on the left. Checked applications preload at startup. The colored fuel bar indicates the total memory required when all the checked applications are loaded (either preloaded or selected during runtime).

Here is what the fuel bar colors mean:

RED: the applications you have selected cannot all fit into the analyzer's memory. You must deselect applications until the fuel bar turns yellow.

YELLOW: the applications you have selected can all fit into the analyzer's memory, but there is less than 10% of the memory left, probably not enough to load any other applications, either via preload or by selecting a Mode while the analyzer is running..

GREEN: The indicator is green when <90% of the memory limit is consumed. This means the applications you have selected can all fit into the analyzer's memory with room to spare. You will likely be able to load one or more other applications without running out of memory.

Select All

Marks all applications in the selection list. This allows you to enable all applications licensed on the instrument for pre-loading, or is a convenience for selecting all applications in one operation and then letting you deselect individual applications.

Key Path	System, Power On, Configure Applications
Initial S/W Revision	A.02.00

Deselect All

Clears the marks from all applications in the selection list, except the Power On application. The Power On application cannot be eliminated from the pre-load list.

Key Path	System, Power On, Configure Applications
Initial S/W Revision	A.02.00

Move Up

The application list is the order that applications appear in the Mode Menu. This key enables you to shift the selected application up in the list, thus moving the selected application earlier in the Mode Menu.

Key Path	System, Power On, Configure Applications
Initial S/W Revision	A.02.00

Move Down

The application list is the order that applications appear in the Mode Menu. This key enables you to shift the selected application down in the list, thus moving the selected application later in the Mode Menu.

Key Path	System, Power On, Configure Applications
Initial S/W Revision	A.02.00

Select/Deselect

Toggles the currently highlighted application in the list.

Key Path	System, Power On, Configure Applications
Initial S/W Revision	A.02.00

Save Changes and Exit

Applies the configuration of the applications list. The marked applications will be pre-loaded in memory the next time the instrument application is started, and the order of the applications in the list will be the order of the applications in the Mode Menu.

After saving your changes, the analyzer asks you if you would like it to restart so that your changes can take effect (see dialog box, below). If you choose not to restart, the changes will not take effect until the next time you shut down and restart the analyzer.

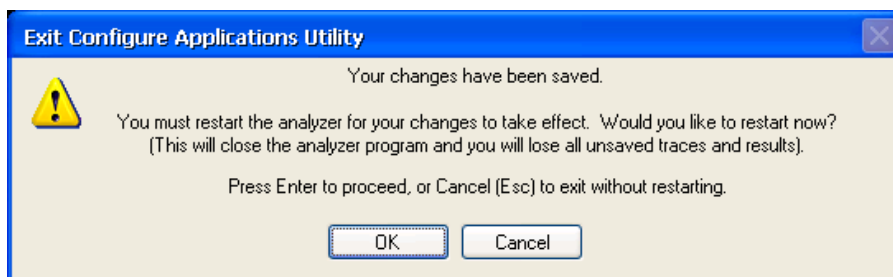

Key Path	System, Power On, Configure Applications
Remote Command	:SYSTem:PUP:PROcEss
Example	:SYST:PUP:PROC This is the SCPI command for restarting the analyzer. You must Wait after this command for the instrument application to restart
Notes	The softkey will be grayed-out when the virtual memory of the selected applications exceeds 100% of the limit.
Notes	You cannot use *WAI or *OPC? to synchronize operation after a restart. This command stops and restarts the instrument application, thus the SCPI operation is terminated and restarted. A remote program must use fixed wait time to resume sending commands to the instrument. The wait time will be dependent upon which applications are pre-loaded.
Initial S/W Revision	A.02.00
Modified at S/W Revision	A.04.00

Exit Without Saving

Pressing this key will exit the Configure Applications utility without saving your changes.

Key Path	System, Power On, Configure Applications
Initial S/W Revision	A.02.00
Modified at S/W Revision	A.04.00

Restore Power On Defaults

This selection causes the Power On Type and Power On Application settings to be a reset to their default values. This level of Restore System Defaults does not affect any other system settings, mode settings and does not cause a mode switch. The Power On key, under the Restore System Defaults menu, causes the same action.

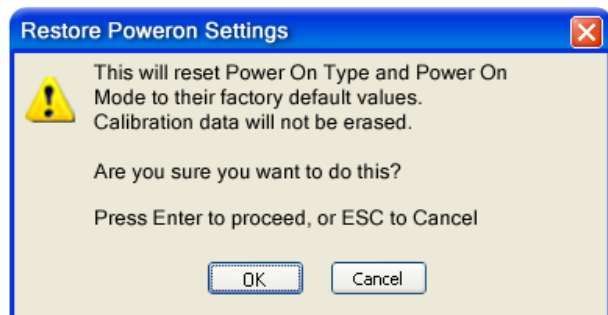

If you press any key other than OK or Enter, it is construed as a Cancel, because the only path that will actually cause the reset to be executed is through OK or Enter.

Key Path	System, Power On
Example	:SYST:DEF PON
Initial S/W Revision	Prior to A.02.00

Configure Applications - Instrument boot-up

At start-up of the analyzer programa dialog box similar to the one under the **System, Power On, Configure Applications** key will be displayed allowing you to choose which licensed applications are to be loaded. This dialog will only be displayed if the memory required to pre-load all of the licensed applications exceeds the Virtual Memory available.

Configure Applications - Windows desktop

The Configure Applications Utility may be run from the Windows Desktop. The utility is launched by double-clicking the

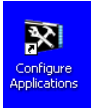

icon on the desktop, which brings-up a dialog box similar to the one under the **System, Power On, Configure Applications** key, allowing you to choose which licensed applications are to be loaded when the analyzer program starts up. This dialog box has mouse buttons on it that do the job the softkeys normally do in the **System, Power On, Configure Applications** menu.

Configure Applications - Remote Commands

The following topics provide details on using remote commands to configure the list of applications you want to load into the instrument memory or query the Virtual Memory utilization for your applications.

- "Configuration list (Remote Command Only)" on page 385
- "Configuration Memory Available (Remote Command Only)" on page 385
- "Configuration Memory Total (Remote Command Only)" on page 386
- "Configuration Memory Used (Remote Command Only)" on page 386
- "Configuration Application Memory (Remote Command Only)" on page 386

Configuration list (Remote Command Only)

This remote command is used to set or query the list of applications to be loaded in-memory.

Remote Command	:SYSTem:PON:APPLication:LLISt <string of INSTRument:SElect names> :SYSTem:PON:APPLication:LLISt?
Example	:SYST:PON:APPL:LLIS "SA,BASIC,WCDMA"
Notes	<string of INSTRument:SElect names> are from the enums of the :INSTRument:SElect command. The order of the <INSTRument:SElect names> is the order that the applications are loaded into memory, and the order that they appear in the Mode Menu. Error message -225 "Out of Memory" is reported when more applications are listed than can reside in Virtual Memory. When this occurs, the existing applications load list is unchanged.
Preset	Not affected by Preset
State Saved	Not saved in instrument state
Initial S/W Revision	A.02.00

Configuration Memory Available (Remote Command Only)

This remote command is used to query the amount of Virtual Memory remaining.

Remote Command	:SYSTem:PON:APPLication:VMEMory[:AVAILable]?
Example	:SYST:PON:APPL:VMEM?
Preset	Not affected by Preset
Initial S/W Revision	A.02.00

Configuration Memory Total (Remote Command Only)

This remote command is used to query the limit of Virtual Memory allowed for applications.

Remote Command	:SYSTem:PON:APPLication:VMEMory:TOTal?
Example	:SYST:PON:APPL:VMEM:TOT?
Preset	Not affected by Preset
Initial S/W Revision	A.02.00

Configuration Memory Used (Remote Command Only)

This remote command is a query of the amount of Virtual Memory used by all measurement applications.

Remote Command	:SYSTem:PON:APPLication:VMEMory:USED?
Example	:SYST:PON:APPL:VMEM:USED?
Preset	Not affected by Preset
Initial S/W Revision	A.02.00

Configuration Application Memory (Remote Command Only)

This remote command is used to query the amount of Virtual Memory a particular application consumes.

Remote Command	:SYSTem:PON:APPLication:VMEMory:USED:NAME? <INSTrument:SElect name>
Example	:SYST:PON:APPL:VMEM:USED:NAME? CDMA2K
Notes	<INSTrument:SElect name> is from the enums of the :INSTrument:SElect command Value returned will be 0 (zero) if the name provided is invalid.
Preset	Not affected by Preset
Initial S/W Revision	Prior to A.02.00

Alignments

The Alignments Menu controls and displays the automatic alignment of the instrument, and provides the ability to restore the default alignment values.

The current setting of the alignment system is displayed in the system Settings Panel along the top of the display, including a warning icon for conditions that may cause specifications to be impacted.



Key Path	System
Initial S/W Revision	Prior to A.02.00

Auto Align

Configures the method for which the automatic background alignment is run.

Automatic background alignments are run periodically between measurement acquisitions. The instrument's software determines when alignments are to be performed to maintain warranted operation. The recommended setting for Auto Align is Normal.

An Auto Align execution cannot be aborted with the Cancel (ESC) key. To interrupt an Auto Align execution, select **Auto Align Off**.

Key Path	System, Alignments
Mode	All
Remote Command	:CALibration:AUTO ON PARTial OFF :CALibration:AUTO?
Example	:CAL:AUTO ON
Notes	While Auto Align is executing, bit 0 of Status Operation register is set.
Couplings	Auto Align is set to Off if Restore Align Data is invoked.
Preset	This is unaffected by Preset but is set to ON upon a "Restore System Defaults->Align".
State Saved	No
Status Bits/OPC dependencies	When Auto Align is executing, bit 0 in the Status Operational register is set.
Backwards Compatibility SCPI	:CALibration:AUTO ALERt Parameter ALERt is for backward compatibility only and is mapped to PARTial
Backwards Compatibility Notes	<ol style="list-style-type: none"> 1. ESA SCPI for Auto Align is :CALibration:AUTO <Boolean>. The command for X-Series is an enumeration. Thus the parameters of "0" and "1" are not possible in X-Series. 2. Similarly, the ESA SCPI for :CALibration:AUTO? returned the Boolean value 1 or 0, in X-Series it is an Enumeration (string). Thus, queries by customer applications into numeric variables will result in an error 3. In PSA Auto Align OFF was not completely off, it is equivalent to PARTial in X-Series. In X-Series, OFF will be fully OFF. This means users of PSA SCPI who choose OFF may see degraded performance and should migrate their software to use PARTial.
Initial S/W Revision	Prior to A.02.00

Normal

Auto Align, Normal turns on the automatic alignment of all measurement systems. The Auto Align, Normal selection maintains the instrument in warranted operation across varying temperature and over time.

If the condition "Align Now, All required" is set, transition to Auto Align, Normal will perform the required alignments and clear the "Align Now, All required" condition and then continue with further alignments as required to maintain the instrument adequately aligned for warranted operation.

When **Auto Align, Normal** is selected the Auto Align Off time is set to zero.

When **Auto Align, Normal** is selected the Settings Panel indicates ALIGN AUTO.

Key Path	System, Alignments, Auto Align
Mode	All
Example	:CAL:AUTO ON
Notes	Alignment processing as a result of the transition to Normal will be executed sequentially. Thus, *OPC? or *WAI following CAL:AUTO ON will return when the alignment processing is complete. The presence of an external signal may interfere with the RF portion of the alignment. If so, the Error Condition message “Align skipped: 50 MHz interference” or “Align skipped: 4.8 GHz interference” is reported, and bit 11 is set in the Status Questionable Calibration register. After the interfering signal is removed, subsequent alignment of the RF will clear the condition, and clear bit 11 in the Status Questionable Calibration register.
Readback Text	Normal
Status Bits/OPC dependencies	An interfering user signal may prevent automatic alignment of the RF subsystem. If this occurs, the Error Condition message “Align skipped: 50 MHz interference” or “Align skipped: 4.8 GHz interference” is reported, the Status Questionable Calibration bit 11 is set, and the alignment proceeds. When a subsequent alignment of the RF subsystem succeeds, either by the next cycle of automatic alignment or from an Align Now, RF, the Error Condition and Status Questionable Calibration bit 11 are cleared.
Initial S/W Revision	Prior to A.02.00

Partial

Auto Align, Partial disables the full automatic alignment and the maintenance of warranted operation for the benefit of improved measurement throughput. Accuracy is retained for the Resolution Bandwidth filters and the IF Passband, which is critical to FFT accuracy, demodulation, and many measurement applications. With Auto Align set to Partial, you are now responsible for maintaining warranted operation by updating the alignments when they expire. The Auto Align, Alert mechanism will notify you when alignments have expired. One solution to expired alignments is to perform the Align All, Now operation. Another is to return the Auto Align selection to Normal.

Auto Align, Partial is recommended for measurements where the throughput is so important that a few percent of improvement is more valued than an increase in the accuracy errors of a few tenths of a decibel. One good application of Auto Align, Partial would be an automated environment where the alignments can be called during overhead time when the device-under-test is exchanged.

When **Auto Align, Partial** is selected the elapsed time counter begins for Auto Align Off time.

When **Auto Align, Partial** is selected the Settings Panel indicates ALIGN PARTIAL with a warning icon. The warning icon is to inform the operator that they are responsible for maintaining the warranted operation of the instrument

Key Path	System, Alignments, Auto Align
Mode	All
Example	:CAL:AUTO PART
Notes	Auto Align Partial begins the elapsed time counter for Auto Align Off time.
Readback Text	Partial
Initial S/W Revision	Prior to A.02.00

Off

Auto Align, Off disables automatic alignment and the maintenance of warranted operation, for the benefit of maximum measurement throughput. With Auto Align set to Off, you are now responsible for maintaining warranted operation by updating the alignments when they expire. The Auto Align, Alert mechanism will notify you when alignments have expired. One solution to expired alignments is to perform the Align All, Now operation. Another is to return the Auto Align selection to Normal.

The Auto Align, Off setting is rarely the best choice, because Partial gives almost the same improvement in throughput while maintaining the warranted performance for a much longer time. The choice is intended for unusual circumstances such as the measurement of radar pulses where you might like the revisit time to be as consistent as possible.

When **Auto Align, Off** is selected the Auto Align Off time is initialized and the elapsed time counter begins.

When **Auto Align, Off** is selected the Settings Panel indicates ALIGN OFF with a warning icon. The warning icon is to inform the operator that they are responsible for maintaining the warranted operation of the instrument:

Key Path	System, Alignments, Auto Align
Mode	All
Example	:CAL:AUTO OFF
Notes	Auto Align Off begins the elapsed time counter for Auto Align Off time.
Couplings	Auto Align is set to Off if Restore Align Data is invoked.
Readback Text	Off
Initial S/W Revision	Prior to A.02.00

All but RF

Auto Align, All but RF, configures automatic alignment to include or exclude the RF subsystem. (Eliminating the automatic alignment of the RF subsystem prevents the input impedance from changing. The normal input impedance of 50 ohms can change to an open circuit when alignments are being used. Some devices under test do not behave acceptably under such circumstances, for example by showing instability.) When Auto Align, All but RF ON is selected, the operator is responsible for performing an Align Now, RF when RF-related alignments expire. The Auto Align, Alert mechanism will notify the operator to perform an Align Now, All when the combination of time and temperature variation is exceeded.

When Auto Align, All but RF ON is selected the Settings Panel indicates ALIGN AUTO/NO RF with a warning icon (warning icon is intended to inform the operator they are responsible for the maintaining the RF alignment of the instrument):

Key Path	System, Alignments, Auto Align
Mode	All
Remote Command	:CALibration:AUTO:MODE ALL NRF :CALibration:AUTO:MODE?

Example	:CAL:AUTO:MODE NRF
Preset	This is unaffected by Preset but is set to ALL on a “Restore System Defaults->Align”.
State Saved	No
Readback Text	RF or NRF
Initial S/W Revision	Prior to A.02.00

Alert

The instrument will signal an Alert when conditions exist such that you will need to perform a full alignment (for example, Align Now, All). The Alert can be configured in one of four settings; Time & Temperature, 24 hours, 7 days, or None. A confirmation is required when a selection other than Time & Temperature is chosen. This prevents accidental deactivation of alerts.

With Auto Align set to Normal, the configuration of Alert is not relevant because the instrument’s software maintains the instrument in warranted operation.

Key Path	System, Alignments, Auto Align
Mode	All
Remote Command	:CALibration:AUTO:ALERT TTEMperature DAY WEEK NONE :CALibration:AUTO:ALERT?
Example	:CAL:AUTO:ALER TTEM
Notes	The alert that alignment is needed is the setting of bit 14 in the Status Questionable Calibration register.
Preset	This is unaffected by Preset but is set to TTEMperature on a “Restore System Defaults->Align”.
State Saved	No
Status Bits/OPC dependencies	The alert is the Error Condition message “Align Now, All required” and bit 14 is set in the Status Questionable Calibration register.
Initial S/W Revision	Prior to A.02.00

Time & Temperature

With Auto Align Alert set to Time & Temperature the instrument will signal an alert when alignments expire due to the combination of the passage of time and changes in temperature. The alert is the Error Condition message “Align Now, All required”. If this choice for Alert is selected, the absence of an alert means that the analyzer alignment is sufficiently up-to-date to maintain warranted accuracy.

Key Path	System, Alignments, Auto Align, Alert
Mode	All
Example	:CAL:AUTO:ALER TTEM
Readback Text	Time & Temp
Status Bits/OPC	Bit 14 is set in the Status Questionable Calibration register.

dependencies

Initial S/W Revision Prior to A.02.00

24 hours

With Auto Align Alert set to 24 Hours the instrument will signal an alert after a time span of 24 hours since the last successful full alignment (for example, Align Now, All or completion of a full Auto Align). You may choose this selection in an environment where the temperature is stable on a daily basis at a small risk of accuracy errors in excess of the warranted specifications. The alert is the Error Condition message “Align Now, All required”.

For front-panel operation, confirmation is required to transition into this setting of Alert. The confirmation dialog is:

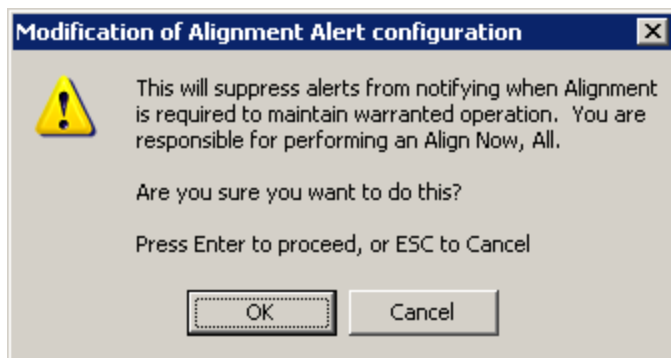

No confirmation is required when Alert is configured through a remote command.

Key Path	System, Alignments, Auto Align, Alert
Mode	All
Example	:CAL:AUTO:ALER DAY
Readback Text	24 hours
Status Bits/OPC dependencies	Bit 14 is set in the Status Questionable Calibration register.
Initial S/W Revision	Prior to A.02.00

7 days

With Auto Align Alert is set to 7 days the instrument will signal an alert after a time span of 168 hours since the last successful full alignment (for example, Align Now, All or completion of a full Auto Align). You may choose this selection in an environment where the temperature is stable on a weekly basis, at a modest risk of accuracy degradations in excess of warranted performance. The alert is the Error Condition message “Align Now, All required”.

For front panel operation, confirmation is required for the customer to transition into this setting of Alert. The confirmation dialog is:

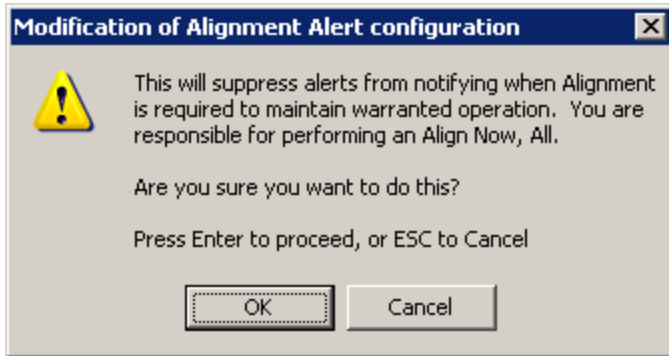

No confirmation is required when Alert is configured through a remote command.

Key Path	System, Alignments, Auto Align, Alert
Mode	All
Example	:CAL:AUTO:ALER WEEK
Readback Text	7 days
Status Bits/OPC dependencies	Bit 14 is set in the Status Questionable Calibration register.
Initial S/W Revision	Prior to A.02.00

None

With Auto Align Alert set to None the instrument will not signal an alert. This is provided for rare occasions where you are making a long measurement which cannot tolerate Auto Align interruptions, and must have the ability to capture a screen image at the end of the measurement without an alert posted to the display. Keysight does not recommend using this selection in any other circumstances, because of the risk of accuracy performance drifting well beyond expected levels without the operator being informed.

For front panel operation, confirmation is required to transition into this setting of Alert. The confirmation dialog is:

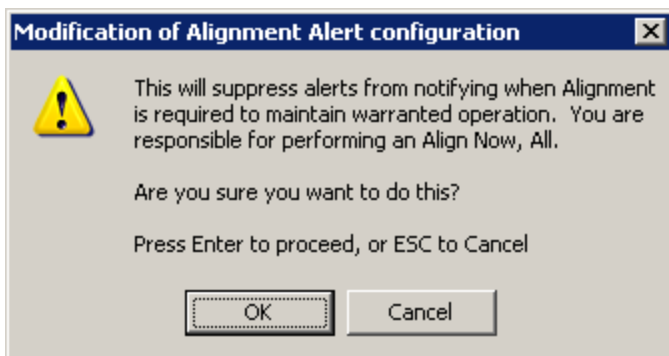

No confirmation is required when Alert is configured through a remote command.

Key Path	System, Alignments, Auto Align, Alert
Mode	All
Example	:CAL:AUTO:ALER NONE
Initial S/W Revision	Prior to A.02.00

Execute Expired Alignments (Remote Command Only)

Alignments can be expired in the situation where Auto Align is in the state of Partial or Off. This feature runs the alignments that have expired. This is different than performing an Align All, Now operation. Align All, Now performs an alignment of all subsystems regardless of whether they are needed or not, with Execute Expired Alignments, only the individual subsystems that have become due are aligned.

Mode	All
Remote Command	:CALibration:EXPired?
Example	:CAL:EXP?
Notes	:CALibration:EXPired? returns 0 if successful :CALibration:EXPired? returns 1 if failed
Initial S/W Revision	Prior to A.02.00

Align Now

Accesses alignment processes that are immediate action operations. They perform complete operations and run until they are complete.

Key Path	System, Alignments
Initial S/W Revision	Prior to A.02.00

All

(In MXE the key label is “**All (plus RF Presel 20 Hz – 3.6 GHz)**”)Immediately executes an alignment of all subsystems. In MXE, the Align Now All is followed by additionally aligning the RF Preselector section, so in MXE, the key label contains the parenthetical note “(plus RF Presel 20 Hz – 3.6 GHz)”. The instrument stops any measurement currently underway, performs the alignment, then restarts the measurement from the beginning (similar to pressing the **Restart** key).

If an interfering user signal is present at the RF Input, the alignment is performed on all subsystems except the RF. After completion, the Error Condition message “Align skipped: 50 MHz interference” or “Align skipped: 4.8 GHz interference” is generated. In addition the Error Condition message “Align Now, RF required” is generated, and bits 11 and 12 are set in the Status Questionable Calibration register.

The query form of the remote commands (:CALibration[:ALL]? or *CAL?) invokes the alignment of all subsystems and returns a success or failure value. An interfering user signal is not grounds for failure; if the

alignment was able to succeed on all portions but unable to align the RF because of an interfering signal, the resultant will be the success value.

Successful completion of **Align Now, All** will clear the “Align Now, All required” Error Condition, and clear bit 14 in the Status Questionable Calibration register. It will also begin the elapsed time counter for Last Align Now, All Time, and capture the Last Align Now, All Temperature.

In the MXE, successful completion will also clear the “Align 20 Hz to 30 MHz required” Error Condition, the “Align 30 MHz to 3.6 GHz required” Error Condition, and the “Align 20 Hz to 3.6 GHz required” Error Condition, and clear bits 1 and bit 2 and clear the bit 1 in the Status Questionable Calibration Extended Needed register.

If the Align RF subsystem succeeded in aligning (no interfering signal present), the elapsed time counter begins for Last Align Now, RF Time, and the temperature is captured for the Last Align Now, RF Temperature. In addition the Error Conditions “Align skipped: 50 MHz interference” and “Align skipped: 4.8 GHz interference” are cleared, the Error Condition “Align Now, RF required” is cleared, and bits 11 and 12 are cleared in the Status Questionable Calibration register

Align Now, All can be interrupted by pressing the Cancel (ESC) front-panel key or remotely with Device Clear followed by the :ABORt SCPI command. When this occurs the Error Condition message “Align Now, All required” is generated, and bit 14 is set in the Status Questionable Condition register. This is because new alignment data may be employed for an individual subsystem, but not a cohesive set of data for all subsystems.

In many cases, you might find it more convenient to change alignments to Normal, instead of executing Align Now, All. When the Auto Align process transitions to Normal, the analyzer will immediately start to update only the alignments that have expired, thus efficiently restoring the alignment process.

Key Path	System, Alignments, Align Now
Mode	All
Remote Command	:CALibration[:ALL] :CALibration[:ALL]?
Example	:CAL
Notes	:CALibration[:ALL]? returns 0 if successful :CALibration[:ALL]? returns 1 if failed :CALibration[:ALL]? is the same as *CAL? While Align Now, All is performing the alignment, bit 0 in the Status Operation register is set. Completion, or termination, will clear bit 0 in the Status Operation register. This command is sequential; it must complete before further SCPI commands are processed. Interrupting the alignment from remote is accomplished by invoking Device Clear followed by the :ABORt command. Successful completion will clear bit 14 in the Status Questionable Calibration register. An interfering user signal is not grounds for failure of Align Now, All. However, bits 11 and 12 are set in the Status Questionable Calibration register to indicate Align Now, RF is required. An interfering user supplied signal will result in the instrument requiring an Align Now, RF with the interfering signal removed.
Couplings	Initializes the time for the Last Align Now, All Time. Records the temperature for the Last Align Now, All Temperature.

	If Align RF component succeeded, initializes the time for the Last Align Now, RF Time. If Align RF component succeeded, records the temperature for the Last Align Now, RF Temperature.
Status Bits/OPC dependencies	Bits 11, 12, or 14 may be set in the Status Questionable Calibration register.
Initial S/W Revision	Prior to A.02.00

Mode	All
Remote Command	*CAL?
Example	*CAL?
Notes	*CAL? returns 0 if successful *CAL? returns 1 if failed :CALibration[:ALL]? is the same as *CAL? See additional remarks described with :CALibration[:ALL]? Everything about :CALibration[:ALL]? is synonymous with *CAL? including all conditions, status register bits, and couplings
Initial S/W Revision	Prior to A.02.00

Mode	All
Remote Command	:CALibration[:ALL]:NPENDING
Example	CAL:NPEN
Notes	:CALibration[:ALL]:NPENDING is the same as :CALibration[:ALL] including all conditions, status register bits, except this scpi command does not BLOCK the scpi session, so the user should use status register bits to query if the calibration is successfully completed or not. Typical usage is: 1) :CALibration:ALL:NPENDING (Start a calibration) 2) :STATus:OPERation:CONDition? (Check if the calibration is completed or not, If bit 0 is set, then the system is doing calibration, the user should repeat this scpi query until the bit is cleared) 3):STATus:QUEStionable:CALibration:CONDition? (Check if there are any errors/failures in previous calibration procedure
Initial S/W Revision	X.14.20

All but RF

(In MXE the key label is “All but RF (not including RF Presel)”)

Immediately executes an alignment of all subsystems except the RF subsystem . The instrument will stop any measurement currently underway, perform the alignment, and then restart the measurement from the beginning (similar to pressing the Restart key). This can be used to align portions of the instrument that are not impacted by an interfering user input signal.

This operation might be chosen instead of **All** if you do not want the device under test to experience a large change in input impedance, such as a temporary open circuit at the analyzer input.

The query form of the remote commands (:CALibration:NRF?) will invoke the alignment and return a success or failure value.

Successful completion of Align Now, All but RF will clear the “Align Now, All required” Error Condition, and clear bit 14 in the Status Questionable Calibration register. If “Align Now, All required” was in effect prior to executing the All but RF, the Error Condition message “Align Now, RF required” is generated and bit 12 in the Status Questionable Calibration register is set. It will also begin the elapsed time counter for Last Align Now, All Time, and capture the Last Align Now, All Temperature.

Align Now, All but RF can be interrupted by pressing the Cancel (ESC) front-panel key or remotely with Device Clear followed by the :ABORt SCPI command. When this occurs the Error Condition message “Align Now, All required” is generated, and bit 14 is set in the Status Questionable Condition register. This is because new alignment data may be used for an individual subsystem, but not a full new set of data for all subsystems.

In models with the RF Preselector, such as the N9038A, the “All but RF” alignment will execute an alignment of all subsystems except the RF subsystem of the Spectrum Analyzer, as well as the system gain of the RF Preselector.

Key Path	System, Alignments, Align Now
Mode	All
Remote Command	:CALibration:NRF :CALibration:NRF?
Example	:CAL:NRF
Notes	:CALibration:NRF? returns 0 if successful :CALibration:NRF? returns 1 if failed While Align Now, All but RF is performing the alignment, bit 0 in the Status Operation register is set. Completion, or termination, will clear bit 0 in the Status Operation register. This command is sequential; it must complete before further SCPI commands are processed. Interrupting the alignment from remote is accomplished by invoking Device Clear followed by the :ABORt command. Successful completion will clear bit 14 in the Status Questionable Calibration register and set bit 12 if invoked with “Align Now, All required”.
Couplings	Initializes the time for the Last Align Now, All Time. Records the temperature for the Last Align Now, All Temperature.
Status Bits/OPC dependencies	Bits 12 or 14 may be set in the Status Questionable Calibration register.
Initial S/W Revision	Prior to A.02.00

Mode	All
Remote Command	:CALibration:NRF:NPending
Example	CAL:NRF:NPEN

Notes	<p>:CALibration:NRF:NPENding is the same as :CALibration:NRF including all conditions, status register bits, except that this scpi command does not BLOCK the scpi session, so the user should use status register bits to query if the calibration is successfully completed or not.</p> <p>Typical usage is:</p> <p>1):CALibration:NRF:NPENding (start theAll but RF calibration)</p> <p>2):STATus:OPERation:CONDition? (If bit 0 is set, then the system is doing calibration, the user should do re-query until this bit is cleared)</p> <p>3):STATus:QUEStionable:CALibration:CONDition? (to check if there are any errors/failures in previous calibration procedure)</p>
Initial S/W Revision	X.14.20

RF

(In MXE the key label is “**RF Only**”)

Immediately executes an alignment of the RF subsystem . The instrument stops any measurement currently underway, performs the alignment, then restarts the measurement from the beginning (similar to pressing the **Restart** key).

This operation might be desirable if the alignments had been set to not include RF alignments, or if previous RF alignments could not complete because of interference which has since been removed.

If an interfering user signal is present at the RF Input, the alignment will terminate and generate the Error Condition message “Align skipped: 50 MHz interference” or “Align skipped: 4.8 GHz interference”, and Error Condition “Align Now, RF required”. In addition, bits 11 and 12 will be set in the Status Questionable Calibration register.

The query form of the remote commands (:CALibration:RF?) will invoke the alignment of the RF subsystem and return a success or failure value. An interfering user signal is grounds for failure.

Successful completion of Align Now, RF will begin the elapsed time counter for Last Align Now, RF Time, and capture the Last Align Now, RF Temperature.

Align Now, RF can be interrupted by pressing the Cancel (ESC) front-panel key or remotely with Device Clear followed by the :ABORt SCPI command. When this occurs, the Error Condition message “Align Now, RF required” is generated, and bit 12 is set in the Status Questionable Condition register. None of the new alignment data is used.

In models with the RF Preselector, such as the N9038A, the RF alignment will execute an alignment of the RF subsystem of the Spectrum Analyzer, as well as the RF subsystem on RF Preselector path.

Key Path	System, Alignments, Align Now
Mode	All
Remote Command	:CALibration:RF :CALibration:RF?
Example	:CAL:RF

Notes	<p>:CALibration:RF? returns 0 if successful</p> <p>:CALibration:RF? returns 1 if failed (including interfering user signal)</p> <p>While Align Now, RF is performing the alignment, bit 0 in the Status Operation register is set. Completion, or termination, will clear bit 0 in the Status Operation register.</p> <p>This command is sequential; it must complete before further SCPI commands are processed. Interrupting the alignment from remote is accomplished by invoking Device Clear followed by the :ABORt command.</p> <p>Successful completion clears the Error Conditions “Align skipped: 50 MHz interference” and “Align skipped: 4800 MHz interference” and the Error Conditions “Align RF failed” and “Align Now, RF required”, and clears bits 3, 11, and 12 in the Status Questionable Calibration register.</p> <p>A failure encountered during alignment will generate the Error Condition message “Align RF failed” and set bit 3 in the Status Questionable Calibration register.</p> <p>An interfering user signal will result in bits 11 and 12 to be set in the Status Questionable Calibration register to indicate Align Now, RF is required.</p> <p>An interfering user supplied signal will result in the instrument requiring an Align Now, RF with the interfering signal removed.</p>
Couplings	<p>Initializes the time for the Last Align Now, RF Time.</p> <p>Records the temperature for the Last Align Now, RF Temperature.</p>
Status Bits/OPC dependencies	Bits 11, 12, or 14 may be set in the Status Questionable Calibration register.
Initial S/W Revision	Prior to A.02.00

Mode	All
Remote Command	:CALibration:RF:NPENding
Example	CAL:RF:NPEN
Notes	<p>:CALibration:RF:NPENding is the same as :CALibration:RF including all conditions, status register bits, except that this scpi command does not BLOCK the scpi session, so the user should use status register bits to query if the calibration is successfully completed or not.</p> <p>Typical usage is:</p> <ol style="list-style-type: none"> 1):CALibration:RF:NPENding (Start a RF calibration) 2):STATus:OPERation:CONDition? (If bit 0 is set, then the system is doing calibration, the user should do re-query until this bit is cleared) 3):STATus:QUEStionable:CALibration:CONDition? (to check if there are any errors/failures in previous calibration procedure)
Initial S/W Revision	X.14.20

External Mixer

Immediately executes an alignment of the External Mixer that is plugged into the USB port. The instrument stops any measurement currently underway, performs the alignment, then restarts the measurement from

the beginning (similar to pressing the Restart key). As this alignment calibrates the LO power to the mixer, this is considered an LO alignment; and failure is classified as an LO alignment failure.

The query form of the remote commands (:CALibration:EMIXer?) will invoke the alignment of the External Mixer and return a success or failure value.

Key Path	System, Alignments, Align Now
Mode	All
Remote Command	:CALibration:EMIXer :CALibration:EMIXer?
Example	:CAL:EMIX
Notes	:CAL:EMIX? returns 0 if successful :CAL:EMIX? returns 1 if failed While Align Now, Ext Mix is performing the alignment, bit 0 in the Status Operation register is set. Completion, or termination, will clear bit 0 in the Status Operation register. This command is sequential; it must complete before further SCPI commands are processed. Interrupting the alignment from remote is accomplished by invoking Device Clear followed by the :ABORt command. A failure encountered during alignment will generate the Error Condition message “Align LO failed” and set bit 5 in the Status Questionable Calibration register. Successful completion will clear the “Align LO failed” message and bit 5 in the Status Questionable Calibration register.
Dependencies	This key does not appear unless option EXM is present and is grayed-out unless a USB mixer is plugged in to the USB.
Status Bits/OPC dependencies	Bit3 may be set in the Status Questionable Calibration Extended Failure register.
Initial S/W Revision	A.08.00

Show Alignment Statistics

Shows alignment information you can use to ensure that the instrument is operating in a specific manner. The Show Alignment Statistics screen is where you can view time and temperature information.

Values which are displayed are only updated when the Show Alignment Statistics screen is invoked, they are not updated while the Show Alignment Statistics screen is being displayed. The remote commands that access this information obtain current values.

An example of the Show Alignment Statistics screen would be similar to:

6 System Functions
System

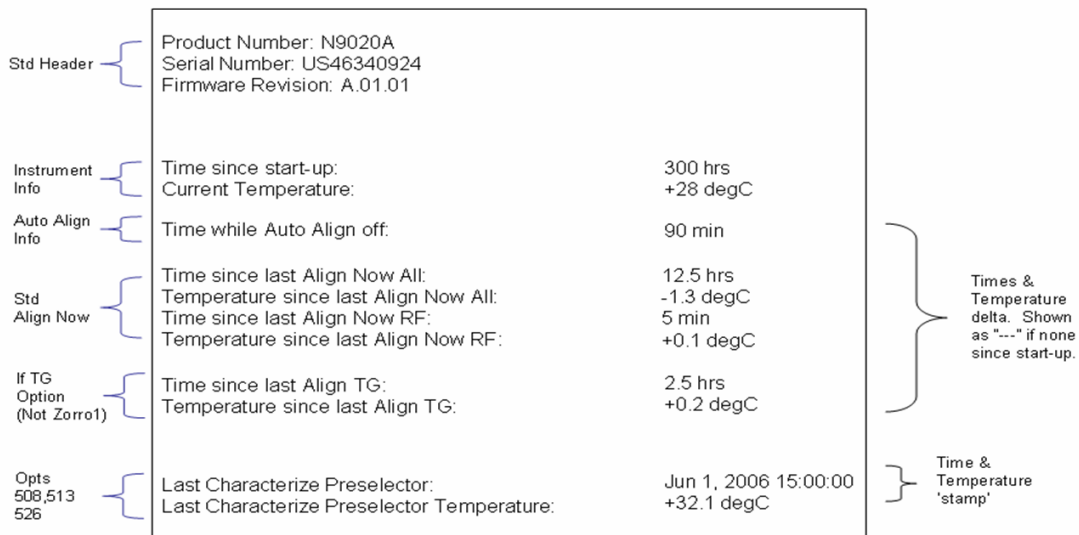

A successful Align Now, RF will set the Last Align RF temperature to the current temperature, and reset the Last Align RF time. A successful Align Now, All or Align Now, All but RF will set the Last Align Now All temperature to the current temperature, and reset the Last Align Now All time. A successful Align Now, All will also reset the Last Align RF items if the RF portion of the Align Now succeeded.

Key Path	System, Alignments
Mode	All
Notes	The values displayed on the screen are only updated upon entry to the screen and not updated while the screen is being displayed.
Initial S/W Revision	Prior to A.02.00

Key Path	Visual annotation in the Show Alignment Statistics screen
Mode	All
Remote Command	:SYSTem:PON:TIME?
Example	:SYST:PON:TIME?
Notes	Value is the time since the most recent start-up in seconds.
State Saved	No
Initial S/W Revision	Prior to A.02.00

Key Path	Visual annotation in the Show Alignment Statistics screen
Mode	All
Remote Command	:CALibration:TEMPerature:CURRent?
Example	:CAL:TEMP:CURR?

Notes	Value is in degrees Centigrade. Value is invalid if using default alignment data (Align Now, All required)
State Saved	No
Initial S/W Revision	Prior to A.02.00

Key Path	Visual annotation in the Show Alignment Statistics screen
Mode	All
Remote Command	:CALibration:TIME:LALL?
Example	:CAL:TIME:LALL?
Notes	Value is the elapsed time, in seconds, since the last successful Align Now, All or Align Now, All but RF was executed.
State Saved	No
Initial S/W Revision	Prior to A.02.00

Key Path	Visual annotation in the Show Alignment Statistics screen
Mode	All
Remote Command	:CALibration:TEMPerature:LALL?
Example	:CAL:TEMP:LALL?
Notes	Value is in degrees Centigrade at which the last successful Align Now, All or Align Now, All but RF was executed.
State Saved	No
Initial S/W Revision	Prior to A.02.00

Key Path	Visual annotation in the Show Alignment Statistics screen
Mode	All
Remote Command	:CALibration:TIME:LRF?
Example	:CAL:TIME:LRF?
Notes	Value is the elapsed time, in seconds, since the last successful Align Now, RF was executed, either individually or as a component of Align Now, All.
State Saved	No
Initial S/W Revision	Prior to A.02.00

Key Path	Visual annotation in the Show Alignment Statistics screen
Mode	All

Remote Command	:CALibration:TEMPerature:LRF?
Example	:CAL:TEMP:LRF?
Notes	Value is in degrees Centigrade at which the last successful Align Now, RF was executed, either individually or as a component of Align Now, All.
State Saved	No
Initial S/W Revision	Prior to A.02.00

Key Path	Visual annotation in the Show Alignment Statistics screen
Mode	All
Remote Command	:CALibration:TIME:LPreselector?
Example	:CAL:TIME:LPR?
Notes	Value is the date and time the last successful Characterize Preselector was executed. The date is separated from the time by a space character. Returns "" if no Characterize Preselector has ever been performed on the instrument.
Dependencies	In models that do not include preselectors, this command is not enabled and any attempt to set or query will yield an error.
State Saved	No
Initial S/W Revision	Prior to A.02.00

Key Path	Visual annotation in the Show Alignment Statistics screen
Mode	All
Remote Command	:CALibration:TEMPerature:LPreselector?
Example	:CAL:TEMP:LPR?
Notes	Value is in degrees Centigrade at which the last successful Characterize Preselector was executed.
Dependencies	In models that do not include preselectors, this command is not enabled and any attempt to set or query will yield an error.
State Saved	No
Initial S/W Revision	Prior to A.02.00

Key Path	Visual annotation in the Show Alignment Statistics screen
Mode	All
Remote Command	:CALibration:AUTO:TIME:OFF?
Example	:CAL:AUTO:TIME:OFF?
Notes	Value is the elapsed time, in seconds, since Auto Align has been set to Off or Off with Alert. The value is 0 if Auto Align is ALL or NORF.

State Saved	No
Initial S/W Revision	Prior to A.02.00

Key Path	Visual annotation in the Show Alignment Statistics screen
Mode	All
Remote Command	:CALibration:TIME:RFPSector:LCONducted?
Example	:CAL:TIME:RFPS:LCON?
Notes	Values are the date and time the last successful Align Now, 20 Hz – 30 MHz was executed. The date is separated from the time by a semi-colon character.
State Saved	No

Key Path	Visual annotation in the Show Alignment Statistics screen
Mode	All
Remote Command	:CALibration:TEMPerature:RFPSector:LCONducted?
Example	:CAL:TEMP:RFPS:LCON?
Notes	Value is in degrees Centigrade at which the last successful Align Now, 20 Hz – 30 MHz was executed.
State Saved	No

Key Path	Visual annotation in the Show Alignment Statistics screen
Mode	All
Remote Command	:CALibration:TIME:RFPSector:LRADiated?
Example	:CAL:TIME:RFPS:LRAD?
Notes	Value is the date and time the last successful Align Now, 30 MHz – 3.6 GHz was executed. The date is separated from the time by a semi-colon character.
State Saved	No

Key Path	Visual annotation in the Show Alignment Statistics screen
Mode	All
Remote Command	:CALibration:TEMPerature:RFPSector:LRADiated?
Example	:CAL:TEMP:RFPS:LRAD?
Notes	Value is in degrees Centigrade at which the last successful Align Now, 30 MHz – 3.6 GHz was executed.
State Saved	No

Key Path	Visual annotation in the Show Alignment Statistics screen
Mode	All
Remote Command	:CALibration:RFPSelector:SCHeuler:TIME:NEXT? This query returns data using the following format "YYYY/MM/DD; HH:MM:SS"
Example	:CAL:RFPS:SCH:TIME:NEXT?
Notes	The next run time will be updated based on the start date/time and recurrence set by the users. "date" is representation of the date the task will run in the form of "YYYY/MM/DD" where: <ul style="list-style-type: none"> -YYYY is the four digit representation of year. (for example, 2009) -MM is the two digit representation of month. (for example, 01 to 12) -DD is the two digit representation of the day. (for example, 01 to 28, 29, 30 or 31 depending on the month and year) "Time" is a representation of the time of day the task will run in the form of "HH:MM:SS" where: <ul style="list-style-type: none"> -HH is the two digit representation of the hour in 24 hour format -MM is the two digit representation of minute -SS is the two digit representation of seconds For model N9038A only.
State Saved	No

Restore Align Defaults

Initializes the alignment user interface settings, not alignment data, to the factory default values. Align Now, All must be executed if the value of the Timebase DAC results in a change.

For front panel operation, you are prompted to confirm action before setting the alignment parameters to factory defaults:

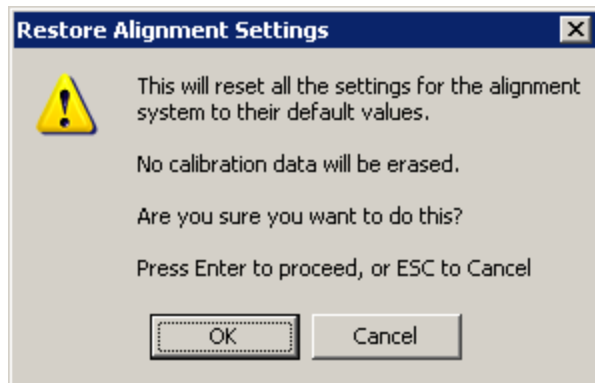

The parameters affected are:

Parameter	Setting
Timebase DAC	Calibrated
Timebase DAC setting	Calibrated value

Auto Align State	Normal (if the instrument is not operating with default alignment data, Off otherwise)
Auto Align All but RF	Off
Auto Align Alert	Time & Temperature

Key Path	System, Alignments
Mode	All
Example	:SYST:DEF ALIG
Notes	Alignment processing that results as the transition to Auto Alignment Normal will be executed sequentially; thus *OPC? or *WAI will wait until the alignment processing is complete.
Initial S/W Revision	Prior to A.02.00

Backup or Restore Align Data...

Opens the utility for backing-up or restoring the alignment data.

Alignment data for the instrument resides on the hard drive in a database. Keysight uses high quality hard drives; however it is highly recommended the alignment data be backed-up to storage outside of the instrument. Additionally, for customers who use multiple CPU Assemblies or multiple disk drives, the alignment that pertains to the instrument must be transferred to the resident hard drive after a CPU or hard drive is replaced. This utility facilitates backing-up and restoring the alignment data.

NOTE

This utility allows the operator to navigate to any location of the Windows file system. It is intended that the operator use a USB memory device or Mapped Network Drive to back up the alignment data to storage outside of the instrument.

The PC6 and PC7 CPUs contain a removable SD memory card. With one of these CPU's installed the Backup and Restore Alignment Data wizard will default to the SD card as the backup location. At (every) power-on, the software will check to determine if the calibration data on the SD memory card (the backup) is newer than the data in use on the SSD. In such situations, before the application is loaded the operator will be given the opportunity to restore the data from the backup. If the operator responds "Yes", the Backup and Restore Alignment Data wizard will be invoked to perform the restore.

Key Path	System, Alignments
Initial S/W Revision	A.02.00

Key Path	System, Alignments
Mode	All
Remote Command	:CALibration:DATA:DEFault
Example	:CAL:DATA:DEF
Couplings	Sets Auto Align to Off. Sets bit 14 in the Status Questionable Calibration register. The Error Condition

message "Align Now, All required" is generated.

Initial S/W Revision Prior to A.02.00

Alignment Data Wizard

The Backup or Restore Alignment Data wizard guides you through the operation of backing-up or restoring the alignment data.

The following dialogue boxes operates without a mouse or external keyboard when you use the default file names.

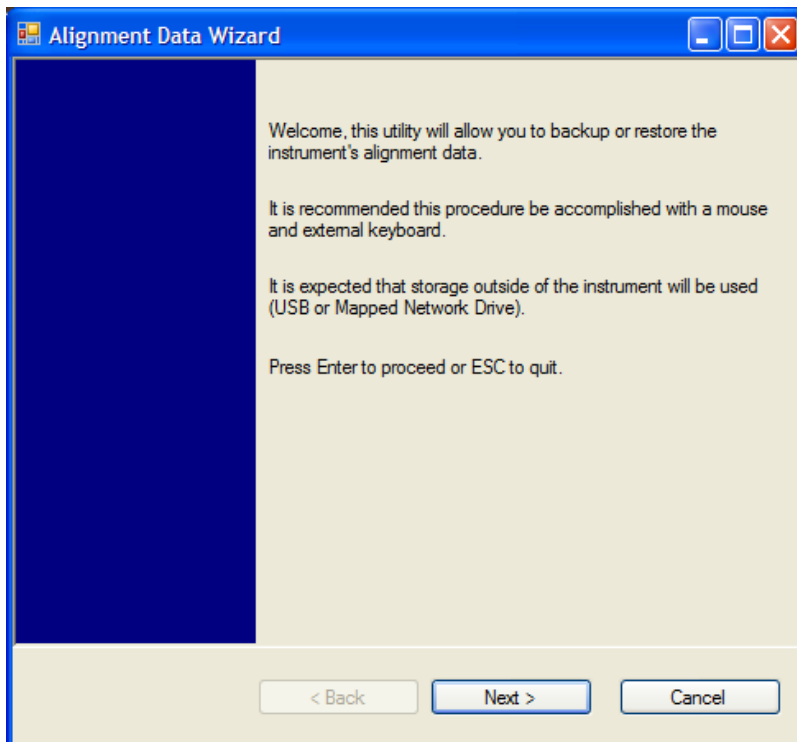

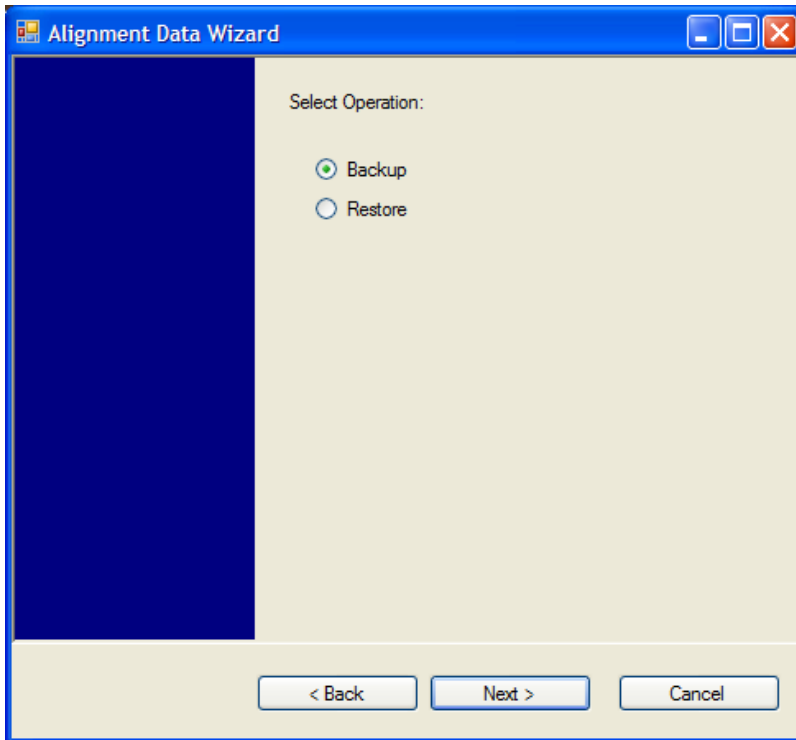

The backup screen indicates the approximate amount of space required to contain the backup file.

The default file name will be AlignDataBackup_<model number>_<serial number>_<date in YYYYMMDDHHMMSS>.bak.

The default backup location will be first drive identified as an external drive (USB or LAN) if such is available; if not, the internal D: partition will be selected.

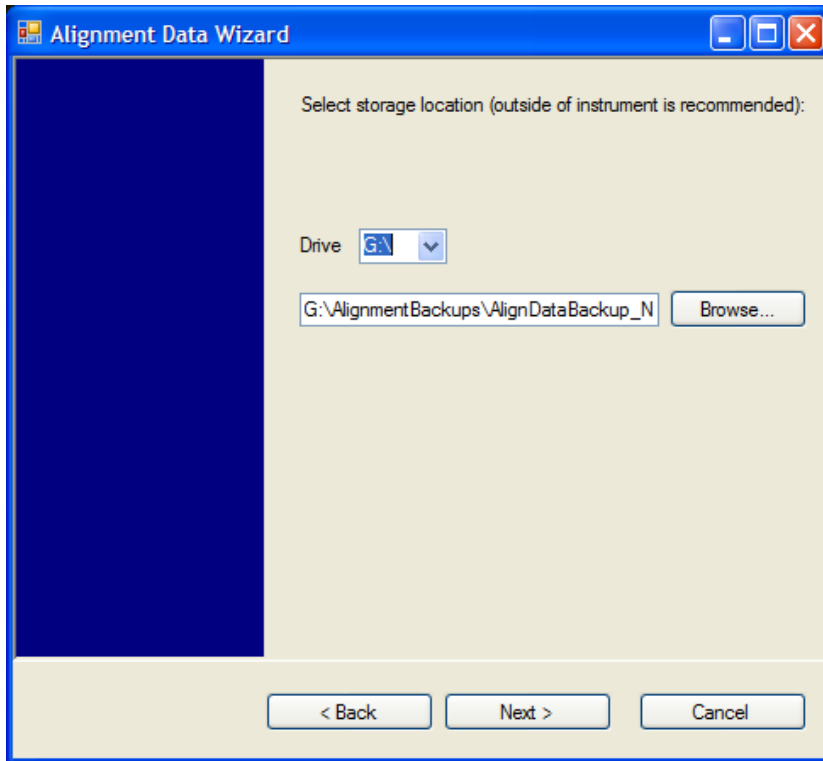

Changing the drive letter will also modify the path displayed in the box below. When this step is first loaded, the drive drop-down menu is populated with connected drives, which provide the user with write access. If there are many unreachable network drives connected to the instrument, this step can take a few seconds. If a USB drive is present, it will be selected by default. The path defaults to the AlignmentBackups folder, and a filename is automatically created in the form of AlignDataBackup_<model>_<serial number>_<date><time>. When the "Next >" button is pressed, you will be prompted to create a new folder if the chosen path does not yet exist.

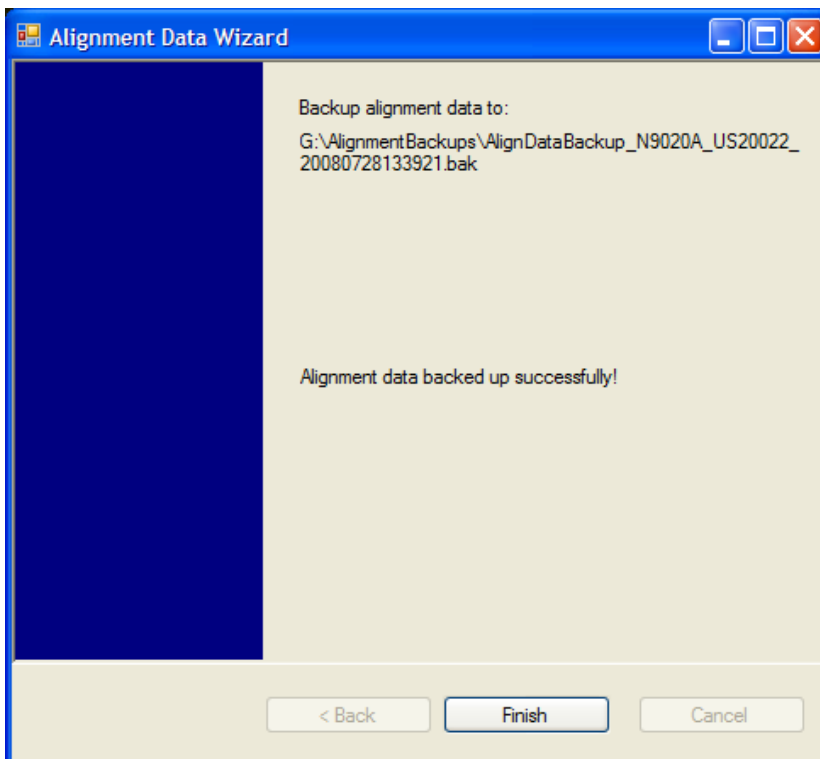
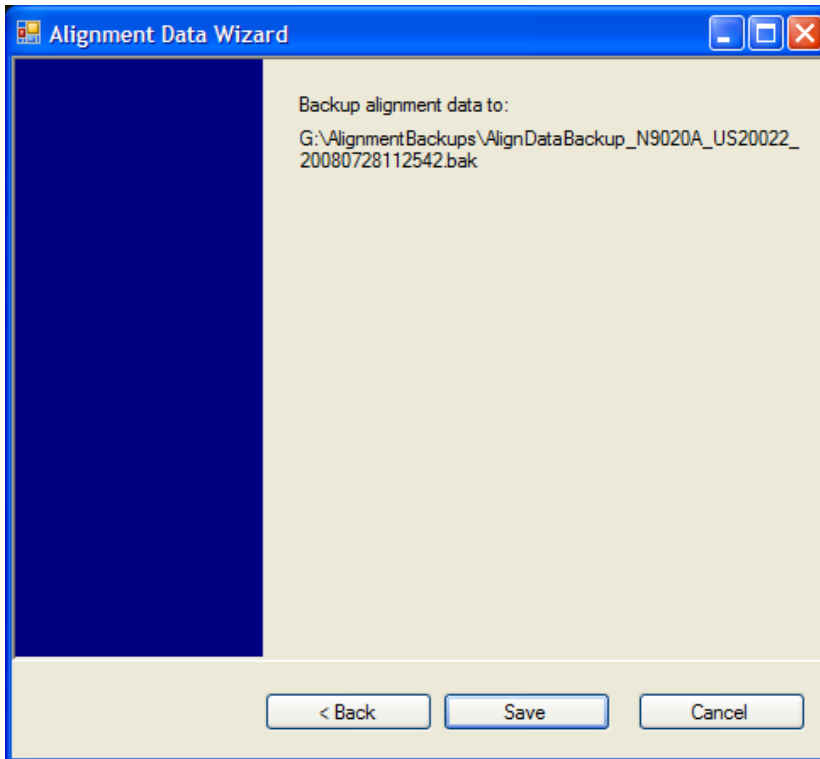

The restore operation checks the validity of the restore file using the database's built-in file validation. If the restore file is corrupt, the existing alignment data will remain in use.

If the serial number information in the backup file being restored is different from that of the instrument, the following message appears (the serial number shown are examples):

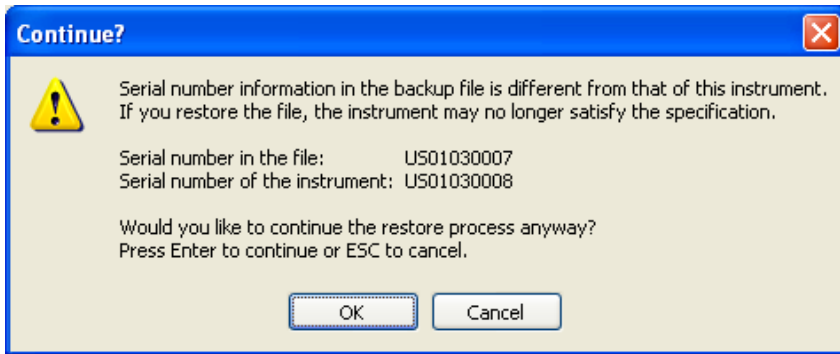

The default restore location will be first drive identified as an external drive (USB or LAN) if such is available; if not, the internal D: partition will be selected. The default restore file will be the most recent file that matches the default backup file name format: AlignDataBackup_<model number>_<serial number>_<date>.bak

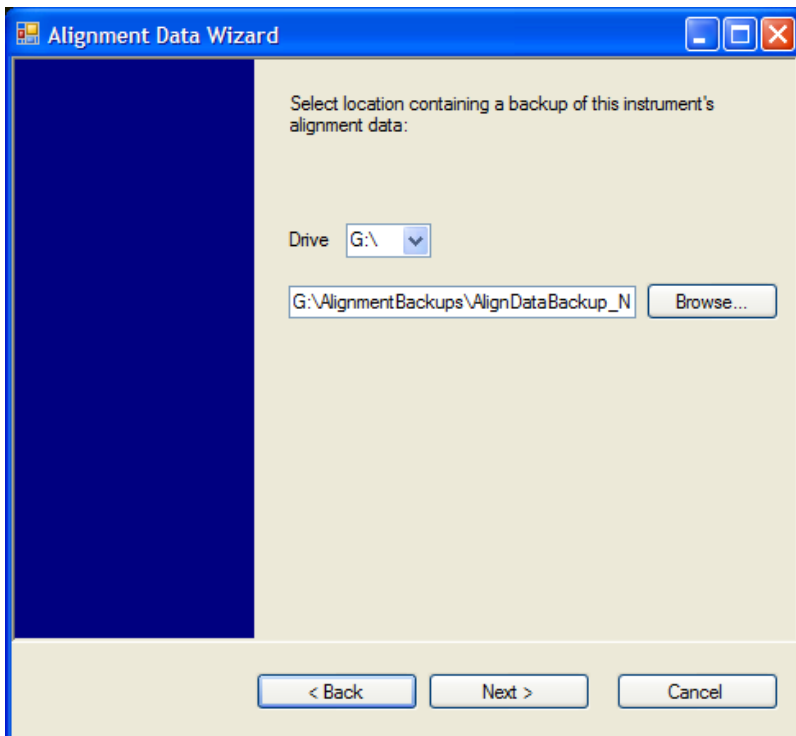

Changing the drive letter also modifies the path displayed in the box below. When this step is first loaded, the drive drop-down menu is populated with connected drives, which provide you with read access. The path defaults to the AlignBackups folder. The most recent *.bak file in the folder will also be selected by default.

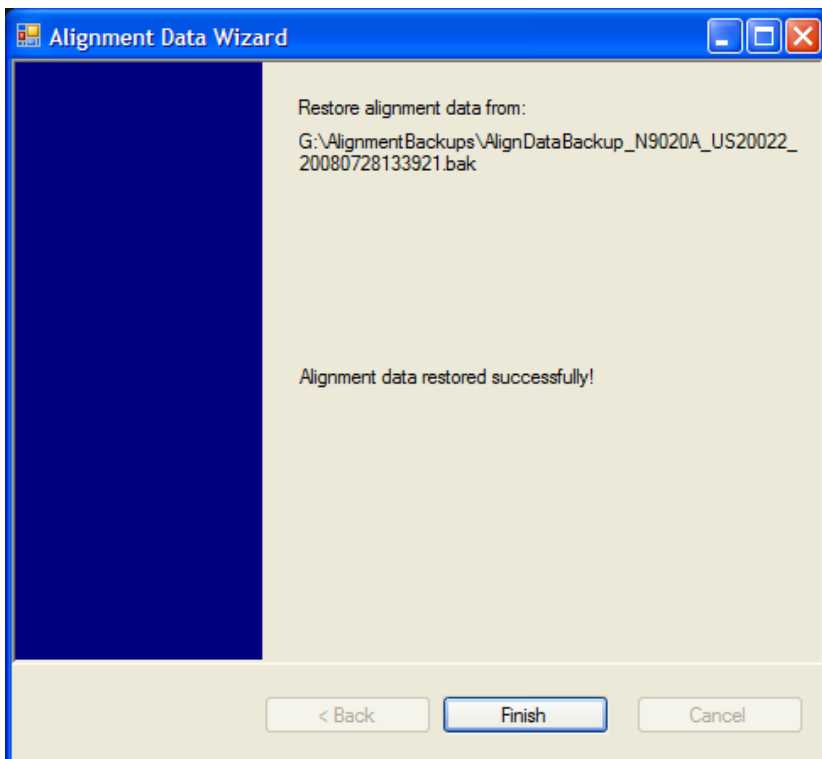
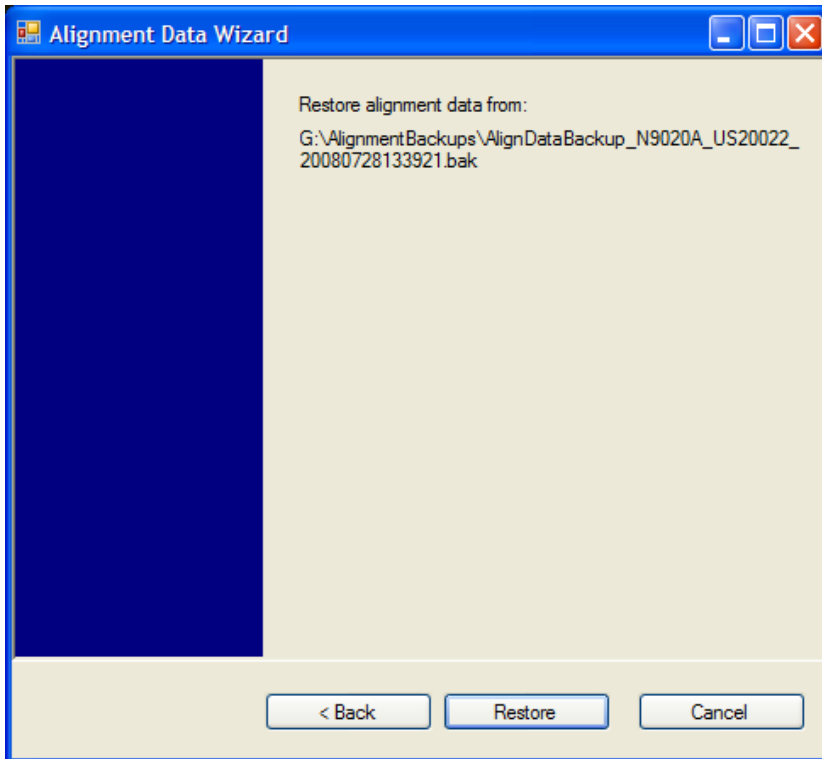

Perform Backup (Remote Command Only)

Invokes an alignment data backup operation to the provided Folder.

NOTE

It is recommended that the Folder provided is outside of the instrument (USB or Mapped Network Drive).

Remote Command	:CALibration:DATA:BACKup <filename>
Example	:CAL:DATA:BACK "F:\AlignDataBackup_N9020A_US00000001_2008140100.bak"
Initial S/W Revision	A.02.00

Perform Restore (Remote Command Only)

Invokes an alignment data restore operation from the provided filename.

Remote Command	:CALibration:DATA:RESTore <filename>
Example	:CAL:DATA:REST "F:\ AlignDataBackup_N9020A_US00000001_2008140100.bak "
Initial S/W Revision	A.02.00

Advanced

Accesses alignment processes that are immediate action operations that perform operations that run until complete. Advanced alignments are performed on an irregular basis, or require additional operator interaction

Key Path	System, Alignments
Initial S/W Revision	Prior to A.02.00

Characterize Preselector

The Preselector tuning curve drifts over temperature and time. Recognize that the Amplitude, Presel Center function adjusts the preselector for accurate amplitude measurements at an individual frequency. Characterize Preselector improves the amplitude accuracy by ensuring the Preselector is approximately centered at all frequencies without the use of the Amplitude, Presel Center function. Characterize Preselector can be useful in situations where absolute amplitude accuracy is not of utmost importance, and the throughput savings or convenience of not performing a Presel Center is desired. Presel Center is required prior to any measurement for best (and warranted) amplitude accuracy.

Keysight recommends that the Characterize Preselector operation be performed yearly as part of any calibration, but performing this operation every three months can be worthwhile.

Characterize Preselector immediately executes a characterization of the Preselector, which is a YIG-tuned filter (YTF). The instrument stops any measurement currently underway, performs the characterization, then restarts the measurement from the beginning (similar to pressing the Restart key).

The query form of the remote commands (:CALibration:YTF?) will invoke the alignment of the YTF subsystem and return a success or failure value.

A failure encountered during alignment will generate the Error Condition message “Characterize Preselector failure” and set bit 3 in the STATus:QUESTionable:CALibration:EXTended:FAILure status register. Successful completion of Characterize Preselector will clear this Condition. It will also begin the

elapsed time counter for Last Characterize Preselector Time, and capture the Last Characterize Preselector Temperature.

The last Characterize Preselector Time and Temperature survives across the power cycle as this operation is performed infrequently.

NOTE

The Characterize Preselector function can be interrupted by pressing the Cancel (ESC) front-panel key or remotely with Device Clear followed by the :ABORt SCPI command. None of the new characterization data is then used. However, since the old characterization data is purged at the beginning of the characterization, you now have an uncharacterized preselector. You should re-execute this function and allow it to finish before making any further preselected measurements.

Key Path	System, Alignments, Advanced
Mode	All
Remote Command	:CALibration:YTF :CALibration:YTF?
Example	:CAL:YTF
Notes	:CALibration:YTF? returns 0 if successful :CALibration:YTF? returns 1 if failed (including interfering user signal) While Advanced, Characterize Preselector is performing the alignment, bit 0 in the Status Operation register is set. Completion, or termination, will clear bit 0 in the Status Operation register. This command is sequential; it must complete before further SCPI commands are processed. Interrupting the alignment from remote is accomplished by invoking Device Clear followed by the :ABORt command. Successful completion will clear bit 9 in the Status Questionable Calibration register. A failure encountered during alignment will generate the Error Condition message “Characterize Preselector failed” and set bit 9 in the Status Questionable Calibration register. For Options that support frequencies > 3.6 GHz only.
Dependencies	This key does not appear in models that do not contain preselectors. In these models the SCPI command is accepted without error but no action is taken.
Couplings	Initializes the time for the Last Characterize Preselector Time. Records the temperature for the Last Characterize Preselector Temperature.
Initial S/W Revision	Prior to A.02.00

Mode	All
Remote Command	:CALibration:YTF:NPENding
Example	CAL:YTF:NPEN
Notes	:CALibration:YTF:NPENding is the same as :CALibration:YTF including all conditions, status register bits, except that this scpi command does not BLOCK the scpi session, so the user should use status register bits to query if the calibration is successfully completed or not. Typical usage is: 1) :CALibration:YTF:NPENding (Start a YTF calibration)

	2) :STATus:OPERation:CONDition? (Check if the calibration is completed or not, If bit 0 is set, then the system is doing calibration, the user should repeat this scpi query until the bit is cleared)
	3):STATus:QUESTionable:CALibration:EXTended:FAILure:CONDition? (Check if bit 2 is set or not. If this bit is set, that means there are some errors in previous internal source calibration)
Initial S/W Revision	X.14.20

Characterize Reference Clock

Characterizing the reference clock is calibrating the Reference Input Phase with the External Reference Output. This feature is only available when either option DP2 or B40 is present. It requires connecting the 10 MHz OUT to the EXT REF IN port with a BNC cable before running the characterization.

See ["Front panel guided calibration sequence" on page 415](#)

Key Path	System, Alignments, Advanced
Mode	All
Remote Command	:CALibration:REFerence:CLOCK?
Example	:CAL:REF:CLOC:INIT? //connect cable :CAL:REF:CLOC? //disconnect cable :CAL:REF:CLOC:END?
Notes	:CALibration:REFerence:CLOCK? returns 0 if successful :CALibration:REFerence:CLOCK? returns 1 if failed
Dependencies	Option DP2 or B40
Couplings	Initializes the time for the Last Characterize Reference Clock Time. Records the temperature for the Last Characterize Reference Clock Temperature. Expected to be run after :CAL:REF:CLOC:INIT, and before :CAL:REF:CLOC:END.
Initial S/W Revision	A.13.00

Parameter Name	Characterize Reference Clock Initialization
Mode	All
Remote Command	:CALibration:REFerence:CLOCK:INITialize?
Example	:CAL:REF:CLOC:INIT?
Notes	:CALibration:REFerence:CLOCK:INIT? returns 0 if successful :CALibration:REFerence:CLOCK:INIT? returns 1 if failed
Dependencies	Option DP2 or B40
Couplings	Expected to be run before sending the :CAL:REF:CLOC? command. This will stop the current measurement when it has completed (does not abort the current data acquisition), and it will prepare the instrument for the expected cabling.

Force Restart	Yes
Initial S/W Revision	A.12.00

Parameter Name	Characterize Reference Clock End
Mode	All
Remote Command	:CALibration:REFeRence:CLOCk:END?
Example	:CAL:REF:CLOC:END?
Notes	:CALibration:REFeRence:CLOCk:END? returns 0 if successful :CALibration:REFeRence:CLOCk:END? returns 1 if failed
Dependencies	Option DP2 or B40
Couplings	Expected to be run after sending the :CAL:REF:CLOC? command, and after removing the cable used in that Characterize Reference Clock step. This will resume any queued measurements, and it concludes the reference clock characterization.
Force Restart	Yes
Initial S/W Revision	A.12.00

Parameter Name	Last Characterize Reference Clock
Key Path	Visual annotation in the Show Alignment Statistics screen
Parameter Type	String
Mode	All
Remote Command	:CALibration:TIME:REFeRence:CLOCk?
Example	:CAL:TIME:REFeRence:CLOCk?
Notes	Value is the date and time the last successful Characterize Reference Clock was executed. The date is separated from the time by a space character. Returns "" if Characterize Reference Clock has never been performed on the instrument.
Dependencies	Option DP2 or B40
State Saved	No
Initial S/W Revision	A.12.00

Front panel guided calibration sequence

When selecting "Characterize Reference Clock" through the front panel, the following form will be shown.

Step 1 of the guided calibration sequence:

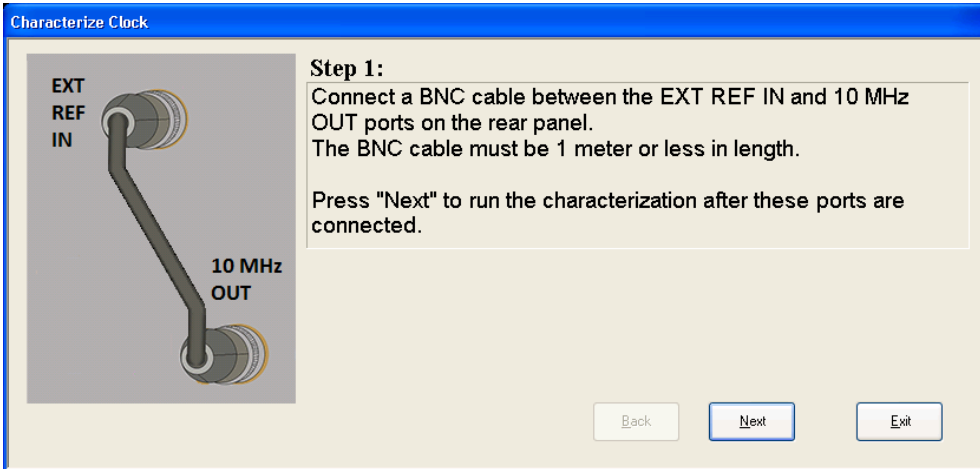

Step 2 of the guided calibration sequence:

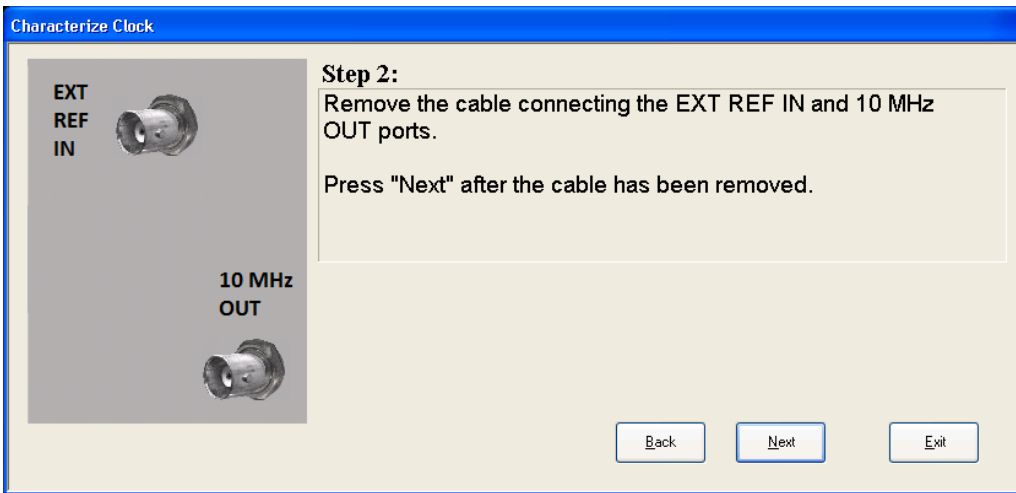

Step 3 of the guided calibration sequence:

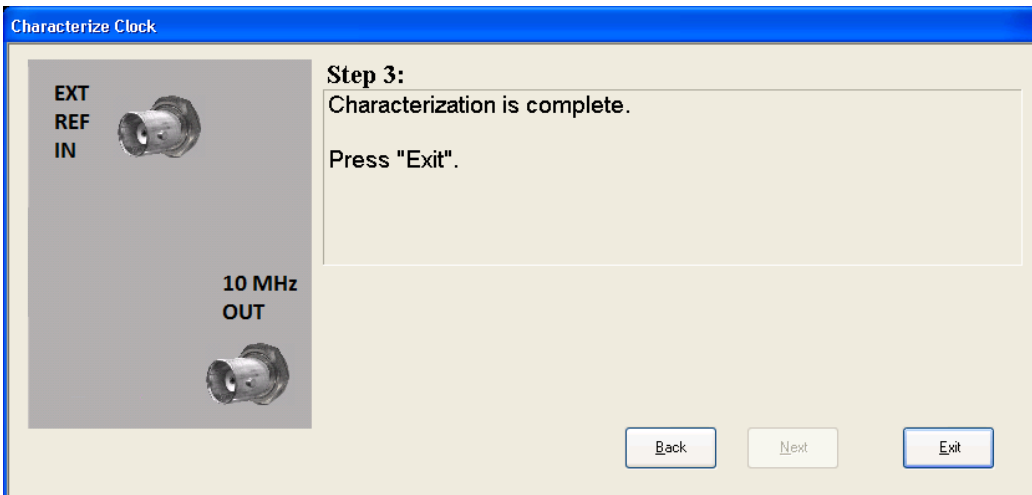

Characterize Noise Floor

On instruments with the NF2 license installed, the calibrated Noise Floor used by Noise Floor Extensions should be refreshed periodically. To do this, press the **Characterize Noise Floor** key. When you press this key, the instrument stops any measurement currently underway, and a dialog appears with an OK and Cancel button which says:

“This action will take several minutes to perform. Please disconnect all cables from the RF input and press Enter to proceed. Press ESC to cancel.”

When you press Enter or OK, the characterization proceeds. After the characterization, the analyzer restarts the measurement from the beginning (similar to pressing the Restart key). The characterization takes many minutes to run.

The noise floor model used by NFE includes an estimation of the temperature behavior of the noise floor, but this is only an estimation. The noise floor changes little with the age of the components. However, even small changes in the estimated level of the noise floor can make large changes in the effective noise floor, because the effective noise floor is the error in the estimation of the noise floor. Keysight recommends that the Characterize Noise Floor operation be performed when the analyzer is operating at an ambient temperature that is significantly different than the ambient temperature at which this alignment was last run. In addition, Keysight recommends that the Characterize Noise Floor operation be performed after the first 500 hours of operation, and once every calendar year.

The noise floor model from the last operation of Characterize Noise Floor survives across the power cycle.

NOTE

The Characterize Noise Floor function can be interrupted by pressing the Cancel (ESC) front-panel key or remotely with Device Clear followed by the :ABORt SCPI command. None of the new characterization data is then used. However, since the old characterization data is purged at the beginning of the characterization, you now have an uncharacterized noise floor. You should re-execute this function and allow it to finish before making any further measurements with NFE. Until you do, the analyzer will display a “Characterize Noise Floor required” message and set bit 12 in the Status Questionable Calibration register (STATus:QUEStionable:CALibration:EXTended:NEEDED).

Key Path	System, Alignments, Advanced
Mode	All
Remote Command	:CALibration:NFLoor :CALibration:NFLoor?
Example	:CAL:NFL
Notes	:CALibration:NFLoor? returns 0 if successful :CALibration:NFLoor? returns 1 if failed (including interfering user signal) While Characterize Noise Floor is performing the alignment, bit ? in the Status Operation register is set. Completion, or termination, will clear bit ? in the Status Operation register. This command is sequential; it must complete before further SCPI commands are processed. Interrupting the alignment from remote is accomplished by invoking Device Clear followed by the :ABORt command. A failure encountered during characterization will generate the Error Condition message “Characterize Noise Floor failed” message and set bit ? in the Status Questionable Calibration register. Successful completion will clear bit ? in the Status Questionable Calibration register.
Dependencies	This key does not appear in models that do not contain NFE. In these models the SCPI command is

	accepted without error but no action is taken.
Couplings	Successful completion of Characterize Noise Floor will begin the elapsed time counter or the Last Characterize Noise Floor Time.
Initial S/W Revision	A.14.00

Key Path	Visual annotation in the Show Alignment Statistics screen
Mode	All
Remote Command	:CALibration:TIME:NFLoor?
Example	:CAL:TIME:NFL?
Notes	Value is the date and time the last successful Characterize Noise Floor was executed. The date is separated from the time by a space character. Returns "" if no Characterize Noise Floor has ever been performed on the instrument.
Dependencies	In models that do not include NFE, this command is not enabled and any attempt to set or query will yield an error.
State Saved	No
Initial S/W Revision	A.14.00

Key Path	Visual annotation in the Show Alignment Statistics screen
Mode	All
Remote Command	:CALibration:TEMPerature:NFLoor?
Example	:CAL:TEMP:NFL?
Notes	Value is the temperature of the last successful Characterize Noise Floor was executed. Returns "" if no Characterize Noise Floor has ever been performed on the instrument.
Dependencies	In models that do not include NFE, this command is not enabled and any attempt to set or query will yield an error.
State Saved	No
Initial S/W Revision	A.14.00

Key Path	Visual annotation in the Show Alignment Statistics screen
Mode	All
Remote Command	:CALibration:TIME:ELAPsed:NFLoor?
Example	:CAL:TIME:ELAP:NFL?
Notes	Value is the elapsed time the instrument was powered-on since the last successful Characterize Noise Floor was executed. Returns "" if no Characterize Noise Floor has ever been performed on the instrument.
Dependencies	In models that do not include NFE, this command is not enabled and any attempt to set or query will yield an error.

State Saved	No
Initial S/W Revision	A.14.00

TDS Alignment

This function only appears in the MXE and this TDS alignment includes AlignNowAll and RFPreset alignment. Immediately executes an alignment of the TDS subsystem. The instrument will stop any measurement currently underway, perform the alignment, and then restart the measurement from the beginning (similar to pressing the Restart key).

Align TDS can be interrupted by pressing the Cancel (ESC) front-panel key or from remote with Device Clear followed by the :ABORT SCPI command. When this occurs, no new TDS alignment data will be employed.

Key Path	System, Alignments, Advanced
Mode	All
Remote Command	:CALibration:TDS
Example	:CAL:TDS
Notes	See SCPI for Align Piece
Initial S/W Revision	A.13.0

Timebase DAC

Allows control of the internal 10 MHz reference oscillator timebase. This may be used to adjust for minor frequency alignment between the signal and the internal frequency reference. This adjustment has no effect if the instrument is operating with an External Frequency Reference.

If the value of the Timebase DAC changes (by switching to Calibrated from User with User set to a different value, or in User with a new value entered) an alignment may be necessary. The alignment system will take appropriate action; which will either invoke an alignment or cause an Alert.

Key Path	System, Alignments
Mode	All
Remote Command	:CALibration:FREquency:REFerence:MODE CALibrated USER :CALibration:FREquency:REFerence:MODE?
Example	:CAL:FREQ:REF:MODE CAL
Notes	If the value of the timebase is changed the alignment system automatically performs an alignment or alerts that an alignment is due. If the value of the timebase is changed the alignment system automatically performs an alignment or alerts that an alignment is due.
Preset	This is unaffected by Preset but is set to CALibrated on a "Restore System Defaults->Align".

State Saved	No
Initial S/W Revision	Prior to A.02.00

Calibrated

Sets the Timebase DAC to the value established during factory or field calibration. The value displayed on the menu key is the calibrated value.

Key Path	System, Alignments, Timebase DAC
Mode	All
Example	:CAL:FREQ:REF:MODE CAL
Readback Text	[xxx] < where xxx is the calibrated value
Initial S/W Revision	Prior to A.02.00

User

Allows setting the Timebase DAC to a value other than the value established during the factory or field calibration. The value displayed on the menu key is the calibrated value.

Key Path	System, Alignments, Timebase DAC
Mode	All
Example	:CAL:FREQ:REF:MODE USER
Readback Text	xxx < where xxx is the Timebase DAC setting
Initial S/W Revision	Prior to A.02.00

Key Path	System, Alignments, Timebase DAC
Mode	All
Remote Command	:CALibration:FREQuency:REFerence:FINE <integer> :CALibration:FREQuency:REFerence:FINE?
Example	:CAL:FREQ:REF:FINE 8191
Notes	If the value of the timebase is changed the alignment system automatically performs an alignment or alerts that an alignment is due.
Couplings	Setting :CAL:FREQ:REF:FINE sets :CAL:FREQ:REF:MODE USER
Preset	This is unaffected by Preset but is set to the factory setting on a "Restore System Defaults->Align".
State Saved	No
Min	0
Max	16383
Backwards	:CALibration:FREQuency:REFerence:COARse

Compatibility SCPI	ESA hardware contained two DAC controls for the Timebase. In X-Series the command :CALibration:FREQuency:REFerence:FINE is the method for adjusting the timebase. The :COARse command is provided as an alias to :FINE.
Initial S/W Revision	Prior to A.02.00
Remote Command	:CALibration:FREQuency:REFerence:COARse <integer> :CALibration:FREQuency:REFerence:COARse?
Example	:CAL:FREQ:REF:COAR 8191
Notes	This is an alias for CAL:FREQ:REF:FINE any change to COARse is reflected in FINE and vice-versa. See CAL:FREQ:REF:FINE for description of functionality.
Couplings	Setting :CAL:FREQ:REF:COAR sets :CAL:FREQ:REF:MODE USER
Initial S/W Revision	Prior to A.02.00

I/O Config

Activates a menu for identifying and changing the I/O configuration for remote control.

Key Path	System
Initial S/W Revision	Prior to A.02.00

GPIB

Activates a menu for configuring the GPIB I/O port.

Key Path	System, I/O Config
Initial S/W Revision	A.02.00

GPIB Address

Select the GPIB remote address.

Key Path	System, I/O Config, GPIB
Mode	All
Remote Command	:SYSTem:COMMunicate:GPIB[1][:SELF]:ADDRess <integer> :SYSTem:COMMunicate:GPIB[1][:SELF]:ADDRess?
Example	:SYST:COMM:GPIB:ADDR 17
Notes	Changing the Address on the GPIB port requires all further communication to use the new address.
Preset	This is unaffected by Preset but is set to 18 on a "Restore System Defaults->Misc"

State Saved	No
Range	0 to 30
Min	0
Max	30
Initial S/W Revision	Prior to A.02.00

GPIB Controller

Sets the GPIB port into controller or device mode. In the normal state, GPIB controller is disabled, which allows the analyzer to be controlled by a remote computer. When GPIB Controller is enabled, the instrument can run software applications that use the instrument's computer as a GPIB controller; controlling devices connected to the instrument's GPIB port.

NOTE

When GPIB Controller is enabled, the analyzer application itself cannot be controlled over GPIB. In this case it can easily be controlled via LAN or USB. The GPIB port cannot be a controller and device at the same time. Only one controller can be active on the GPIB bus at any given time. If the analyzer is the controller, an external PC cannot be a controller.

To control the instrument from the software that is performing GPIB controller operation, you can use an internal TCP/IP connection to the analyzer application. Use the address TCPIP0:localhost:inst0:INSTR to send SCPI commands to the analyzer application.

Key Path	System, I/O Config, GPIB
Mode	All
Scope	Mode Global
Remote Command	:SYSTem:COMMunicate:GPIB[1][:SELF]:CONTroller[:ENABle] ON OFF 0 1 :SYSTem:COMMunicate:GPIB[1][:SELF]:CONTroller[:ENABle]?
Example	:SYST:COMM:GPIB:CONT ON Will set GPIB port to Controller
Notes	When the instrument becomes the Controller bit 0 in the Standard Event Status Register is set (and when the instrument relinquishes Controller capability bit 0 is cleared in the Standard Event Status Register).
Preset	This is unaffected by Preset but is set to OFF on a "Restore System Defaults->Misc"
State Saved	No
Range	Disabled Enabled
Initial S/W Revision	A.02.00

Disabled

Disables the GPIB Controller capability, this is the default (or normal) setting.

Key Path	System, I/O Config, GPIB, GPIB Controller
----------	--

Example	:SYST:COMM:GPIB:CONT OFF	Will set GPIB port to Device
Initial S/W Revision	A.02.00	

Enabled

Enables the GPIB Controller capability.

Key Path	System, I/O Config, GPIB, GPIB Controller	
Example	:SYST:COMM:GPIB:CONT ON	Will set GPIB port to Controller
Initial S/W Revision	A.02.00	

SCPI LAN

Activates a menu for identifying and changing the SCPI over a LAN configuration. There are a number of different ways to send SCPI remote commands to the instrument over LAN. It can be a problem to have multiple users simultaneously accessing the instrument over the LAN. These keys limit that somewhat by disabling the telnet, socket, and/or SICL capability.

Key Path	System, I/O Config
Initial S/W Revision	Prior to A.02.00

SCPI Telnet

Turns the SCPI LAN telnet capability On or Off allowing you to limit SCPI access over LAN through telnet.

Key Path	System, I/O Config, SCPI LAN
Mode	All
Remote Command	:SYSTem:COMMunicate:LAN:SCPI:TELNet:ENABle OFF ON 0 1 :SYSTem:COMMunicate:LAN:SCPI:TELNet:ENABle?
Example	:SYST:COMM:LAN:SCPI:TELN:ENAB OFF
Preset	This is unaffected by Preset but is set to ON with a "Restore System Defaults->Misc"
State Saved	No
Range	On Off
Initial S/W Revision	Prior to A.02.00

SCPI Socket

Turns the capability of establishing Socket LAN sessions On or Off. This allows you to limit SCPI access over LAN through socket sessions.

Key Path	System, I/O Config, SCPI LAN
Mode	All
Remote Command	:SYSTem:COMMunicate:LAN:SCPI:SOCKet:ENABle OFF ON 0 1 :SYSTem:COMMunicate:LAN:SCPI:SOCKet:ENABle?
Example	:SYST:COMM:LAN:SCPI:SOCK:ENAB OFF
Preset	This is unaffected by a Preset but is set to ON with a “Restore System Defaults->Misc”
State Saved	No
Range	On Off
Initial S/W Revision	Prior to A.02.00

SICL Server

Turns the SICL server capability On or Off, enabling you to limit SCPI access over LAN through the SICL server. (SICL IEEE 488.2 protocol.)

Parameter	Description	Setting
Maximum Connections	The maximum number of connections that can be accessed simultaneously	5
Instrument Name	The name (same as the remote SICL address) of your analyzer	inst0
Instrument Logical Unit	The unique integer assigned to your analyzer when using SICL LAN	8
Emulated GPIB Name	The name (same as the remote SICL address) of the device used when communicating with your analyzer	gpib7
Emulated GPIB Logical Unit	The unique integer assigned to your device when it is being controlled using SICL LAN	8
Emulated GPIB Address	The emulated GPIB address assigned to your transmitter tester when it is a SICL server (the same as your GPIB address)	18

Key Path	System, I/O Config, SCPI LAN
Mode	All
Remote Command	:SYSTem:COMMunicate:LAN:SCPI:SICL:ENABle OFF ON 0 1 :SYSTem:COMMunicate:LAN:SCPI:SICL:ENABle?
Example	:SYST:COMM:LAN:SCPI:SICL:ENAB OFF
Preset	This is unaffected by Preset, but is set to ON with a “Restore System Defaults->Misc”
State Saved	No
Range	On Off
Initial S/W Revision	Prior to A.02.00

HiSLIP Server

Turns the HiSLIP server capability On or Off, enabling you to limit SCPI access over LAN through the HiSLIP server.

HiSLIP stands for High Speed LAN Instrument Protocol and is part of the IVI-6.1 specification.

Here is an example of a VISA connection string used to connect to the HiSLIP Server on an X-Series Spectrum Analyzer:

```
TCPIP0::a-n9030a-93016::hislip0::INSTR
```

In the example above, hislip0 is the HiSLIP device name that VISA users must include in their HiSLIP VISA Address strings. Your HiSLIP device name may be different depending on your VISA settings.

Key Path	System, I/O Config, SCPI LAN
Mode	All
Remote Command	:SYSTem:COMMunicate:LAN:SCPI:HISLip:ENABle OFF ON 0 1 :SYSTem:COMMunicate:LAN:SCPI:HISLip:ENABle?
Example	:SYST:COMM:LAN:SCPI:HISL:ENAB OFF
Preset	This is unaffected by Preset, but is set to ON with a "Restore System Defaults-> Misc"
State Saved	No
Range	On Off
Initial S/W Revision	A.11.00

SCPI Socket Control Port (Remote Command Only)

Returns the TCP/IP port number of the control socket associated with the SCPI socket session. This query enables you to obtain the unique port number to open when a device clear is to be sent to the instrument. Every time a connection is made to the SCPI socket, the instrument creates a peer control socket. The port number for this socket is random. The user must use this command to obtain the port number of the control socket. To force a device clear on this socket, open the port and send the string "DCL" to the instrument.

If this SCPI command is sent to a non SCPI Socket interface, then 0 is returned.

Mode	All
Remote Command	:SYSTem:COMMunicate:LAN:SCPI:SOCKet:CONTrol?
Example	:SYST:COMM:LAN:SCPI:SOCK:CONT?
Preset	This is unaffected by Preset or "Restore System Defaults-> Misc".
State Saved	No
Range	0 to 65534
Min	0
Max	65534
Initial S/W Revision	Prior to A.02.00

Reset Web Password

The embedded web server contains certain capabilities which are password protected; modifying the LAN configuration of the instrument, and access to web pages that can change the settings of the instrument. The default password for software versions less than A.14.49 is 'agilent' (without the quotes), for software versions greater than A.14.50 the password is 'measure4u' (without the quotes). The control provided here is the means to set the web password as the user desires, or to reset the password to the factory default.

Selecting Reset web password brings up a control for resetting the password as the user desires, or to the factory default. An external keyboard is required to change the password from the factory default. The control is:

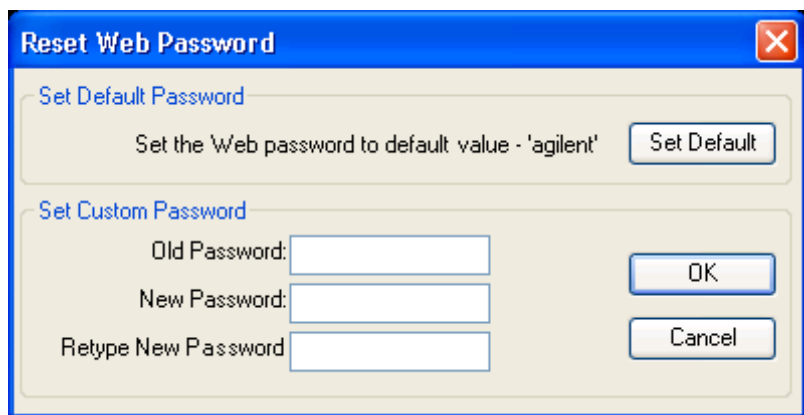

If this control is entered without an external keyboard or mouse connected, you can cancel the control by pressing the Cancel (ESC) front-panel key.

Key Path	System, I/O Config
Mode	All
Initial S/W Revision	Prior to A.02.00

LXI

Opens a menu that allows you to access the various LXI configuration properties.

Key Path	System, I/O Config
Initial S/W Revision	Prior to A.02.00

LAN Reset

Resets the LAN connection.

Key Path	System, I/O Config, LXI
Initial S/W Revision	Prior to A.02.00

Device Identification (Remote Command Only)

Enabling the LXI device identification will place the LXI Status Indicator to the 'Identify' state. Disabling the LXI device identification will place the LXI Status Indicator to the 'No Fault' state. The LXI Status indicator is in the upper left region of the instrument's graphical user interface ()

Mode	All
Remote Command	:LXI:IDENtify[:STATe] OFF ON 0 1 :LXI:IDENtify[:STATe]?
Example	:LXI:IDEN ON
Preset	Not part of Preset, but reset to OFF on Restore System Defaults All
State Saved	No
Range	On Off
Initial S/W Revision	A.12.50

System IDN Response

This key allows you to specify a response to the *IDN? query, or to return the analyzer to the Factory response if you have changed it.

To choose the factory-set response, press the **Factory** key.

To specify your own response, press the **User** key, and enter your desired response.

If your test software is expecting the response to indicate Agilent Technologies as the Manufacturer, you can conveniently configure the response by pressing the Agilent key.

Key Path	System, I/O Config
Mode	All
Remote Command	
Notes	<ul style="list-style-type: none"> • This affects the response given in all Modes of the Analyzer, unless the current Mode has also specified a custom response, in which case the current Mode's custom IDN response takes precedence over the System's, but only while that Mode is the current Mode.. • It survives shutdown and restart of the software and therefore survives a power cycle
Preset	This is unaffected by Preset but is set to Factory on a "Restore System Defaults->Misc"
State Saved	No
Initial S/W Revision	A.06.00
Modified at S/W Revision	x.14.50

Factory

This key selects the factory setting, for example:

"Agilent Technologies,N9020A,MY00012345,A.05.01"

where the fields are manufacturer, model number, serial number, firmware revision.

Key Path	System, I/O Config, IDN Response
Example	:SYST:IDN:CONF FACT
Initial S/W Revision	A.06.0

User

This key allows you to specify your own response to the *IDN? query. You may enter your desired response with the Alpha Editor or a plugin PC keyboard.

When you press this key, the active function becomes the current User string with the cursor at the end. This makes it easy to edit the existing string.

If you enter a null string (for example, by clearing the User String while editing and then pressing **Done**) the analyzer automatically reverts to the Factory setting.

Key Path	System, I/O Config, IDN Response
Example	:SYST:IDN:CONF USER
Initial S/W Revision	A.06.00

SYSTem:IDN Response setting (Remote command)

This SCPI command is used to set or clear the User SYSTem:IDN response.

Remote Command	:SYSTem:IDN <string> :SYSTem:IDN?
Notes	<ul style="list-style-type: none"> • The format of the <string> must be four fields each separated by a comma, example: :SYST:IDN "XYZ Corp,Model 12,012345,A.01.01" • The four fields are <manufacturer>, <model number>, <serial number>, <firmware revision>. Thus, the text within a field cannot contain a comma. • This affects the response given in all Modes of the Analyzer, unless the current Mode has also specified a custom response, in which case the current Mode's custom IDN response takes precedence over the System's, but only while that Mode is the current Mode.. • It survives shutdown and restart of the software and therefore survives a power cycle • Null string as parameter restores the Factory setting, example: :SYST:IDN ""
Preset	This is unaffected by Preset but is set to the original factory setting on a "Restore System Defaults->Misc"
Initial S/W Revision	A.06.00

Query USB Connection (Remote Command Only)

Enables you to determine the speed of the USB connection.

Mode	All
Remote Command	:SYSTem:COMMunicate:USB:CONNectioN?
Example	:SYST:COMM:USB:CONN?
Notes	NONE – Indicates no USB connection has been made. LSPeed – Indicates a USB low speed connection (1.5 Mbps). This is reserved for future use, the T+M488 protocol is not supported on low speed connections. HSPeed – Indicates that a USB high speed connection (480 Mbps) has been negotiated. FSPeed – Indicates that a USB full speed connection (12 Mbps) has been negotiated.
State Saved	No
Range	NONE LSPeed HSPeed FSPeed
Initial S/W Revision	Prior to A.02.00

USB Connection Status (Remote Command Only)

Enables you to determine the current status of the USB connection.

Mode	All
Remote Command	:SYSTem:COMMunicate:USB:STATus?
Example	:SYST:COMM:USB:STAT?
Notes	SUSPended – Indicates that the USB bus is currently in its suspended state. The bus is in the suspended state when: <ul style="list-style-type: none"> • The bus is not connected to any controller • The controller is currently powered off • The controller has explicitly placed the USB device into the suspended state. When in the suspended state, no USB activity, including start of frame packets are received. ACTive – Indicates that the USB device is in the active state. When the device is in the active state, it is receiving periodic start of frames but it isn't necessarily receiving or transmitting data.
State Saved	No
Range	SUSPended ACTive
Initial S/W Revision	Prior to A.02.00

USB Packet Count (Remote Command Only)

Enables you to determine the number of packets received and transmitted on the USB bus.

Mode	All
Remote Command	:SYSTem:COMMunicate:USB:PACKets?
Example	:SYST:COMM:USB:PACK?

Notes	Two integers are returned. The first is the number of packets received since application invocation, the second is the number of packets transmitted since application invocation. If no packets have been received or transmitted the response is 0,0. The packet count is initialized to 0,0 when the instrument application is started.
State Saved	No
Initial S/W Revision	Prior to A.02.00

Restore Defaults

Provides incremental initialization of the system setting groups along with supporting a comprehensive reset of the entire instrument back to a factory default state. The menu selections are the groups of system settings and when one is selected, that particular group of system settings is reset back to their default values.

Key Path	System
Mode	All
Remote Command	:SYSTem:DEFault [ALL] ALIGn INPut MISC MODes PON
Example	SYST:DEF
State Saved	No
Initial S/W Revision	Prior to A.02.00

Restore Input/Output Defaults

Causes the group of settings and data associated with Input/Output front-panel key to be a reset to their default values. This level of Restore System Defaults does not affect any other system settings, mode settings and does not cause a mode switch. .

Confirmation is required to restore the Input/Output setting. The confirmation dialog is:

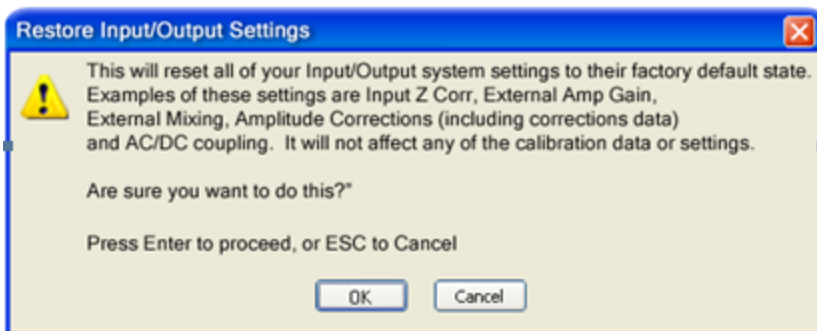

Key Path	System, Restore System Defaults
Example	:SYST:DEF INP
Initial S/W Revision	Prior to A.02.00

Restore Power On Defaults

This selection causes the Power On settings to be a reset to their default value. This level of Restore System Defaults does not affect any other system settings, mode settings and does not cause a mode switch. The Power On settings and their default values are Power On Type reset to Mode and Input/Output Defaults and Power On Application reset to whatever the factory set as its default value.

Confirmation is required to restore the factory default values. The confirmation dialog is:

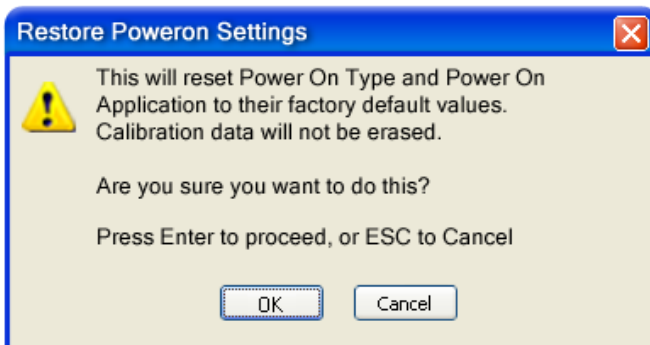

Key Path	System, Restore System Defaults
Example	:SYST:DEF PON
Initial S/W Revision	Prior to A.02.00

Restore Align Defaults

This selection causes the Alignment system settings to be a reset to their default values. This does not affect any Alignment data stored in the system. This level of Restore System Defaults does not affect any other system settings, mode settings and does not cause a mode switch.

After performing this function, it may impact the auto-alignment time of the instrument until a new alignment baseline has been established.

Confirmation is required to restore the factory default values. The confirmation dialog is:

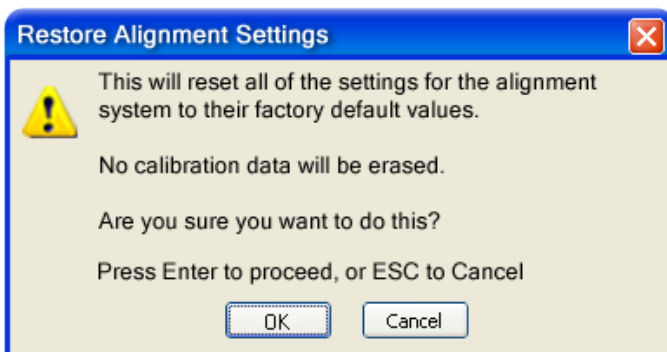

Key Path	System, Restore System Defaults
Example	:SYST:DEF ALIG
Initial S/W Revision	Prior to A.02.00

Restore Misc Defaults

This selection causes miscellaneous system settings to be reset to their default values. With this reset, you lose the GPIB address and it is reset to 18, so this should be used with caution. This level of Restore System Defaults does not affect any other system settings, mode settings and does not cause a mode switch. This miscellaneous group contains the rest of the settings that have not been part of the other Restore System Defaults groups. The following table is a complete list of settings associated with this group:

Miscellaneous Setting	Default Value
Verbose SCPI	Off
The SYST:PRES:TYPE	MODE
Auto File Name Number	000
Save Type	State
State Save To	Register 1
Screen Save To	SCREEN000.png
DISP:ENABLE	ON
Full Screen	Off
SCPI Telnet	ON
SCPI Socket	ON
SICL Server	ON
Softkey Language	English
System Annotation	ON
Display Theme	TDColor
System IDN Response	Factory result of *IDN?
System IDN Response selection	Factory
Display Intensity	100
Display Backlight	ON
GPIB Address	18

Confirmation is required to restore the factory default values. The confirmation dialog is:

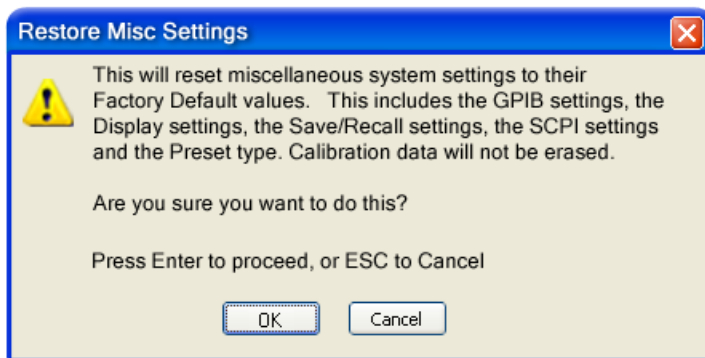

Key Path	System, Restore System Defaults
Example	:SYST:DEF MISC
Initial S/W Revision	Prior to A.02.00
Modified at S/W Revision	x.14.50

Restore Mode Defaults (All Modes)

This selection resets all of the modes in the instrument back to their default state just as a Restore Mode Defaults does and it switches the instrument to the power-on mode and causes the default measurement for the power-on mode to be active. This level of Restore System Defaults does not affect any system settings, but it does affect the state of all modes and does cause a mode switch unless the instrument was already in the power-on mode.

Confirmation is required to restore the factory default values. The confirmation dialog is:

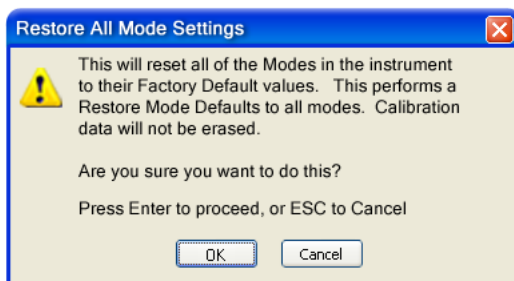

Key Path	System, Restore System Defaults
Example	:SYST:DEF MOD
Couplings	An All Mode will cause the currently running measurement to be aborted, mode switch to the power-on mode and activate the default measurement for the power-on mode.. It gets the mode to a consistent state with all of the default couplings set.
Initial S/W Revision	Prior to A.02.00

All

This performs a comprehensive reset of ALL analyzer settings to their factory default values. It resets all of the system setting groups, causes a Restore Mode Defaults for all modes in the instrument, and switches back to the power-on mode. It does not affect the User Preset file or any user saved files.

Confirmation is required to restore the factory default values. The confirmation dialog is:

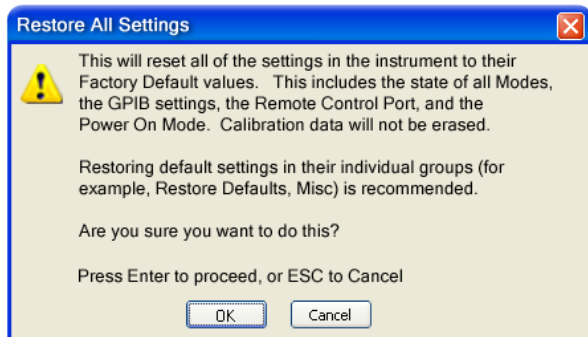

NOTE

If you are using an Keysight USB External Mixer, then you will need to perform a Refresh USB Mixer Connection after Restoring All Defaults.

Key Path	System, Restore System Defaults
Example	:SYST:DEF ALL
Notes	If using Keysight USB External Mixer, perform a Refresh USB Mixer Connection (SCPI command :MIX:BAND USB) following a Restore All Defaults.
Couplings	An All will cause the currently running measurement to be aborted and get all modes to a consistent state, so it is unnecessary to couple any settings.
Initial S/W Revision	Prior to A.02.00
Modified at S/W Revision	A.14.00

Control Panel...

Opens the Windows Control Panel. The Control Panel is used to configure certain elements of Windows that are not configured through the hardkey/softkey System menus.

NOTE

This feature is not available if option SF1 is installed.

The Control Panel is a separate Windows application, so to return to the analyzer once you are in the Control Panel, you may either:

Exit the Control Panel by clicking on the red X in the upper right hand corner, with a mouse

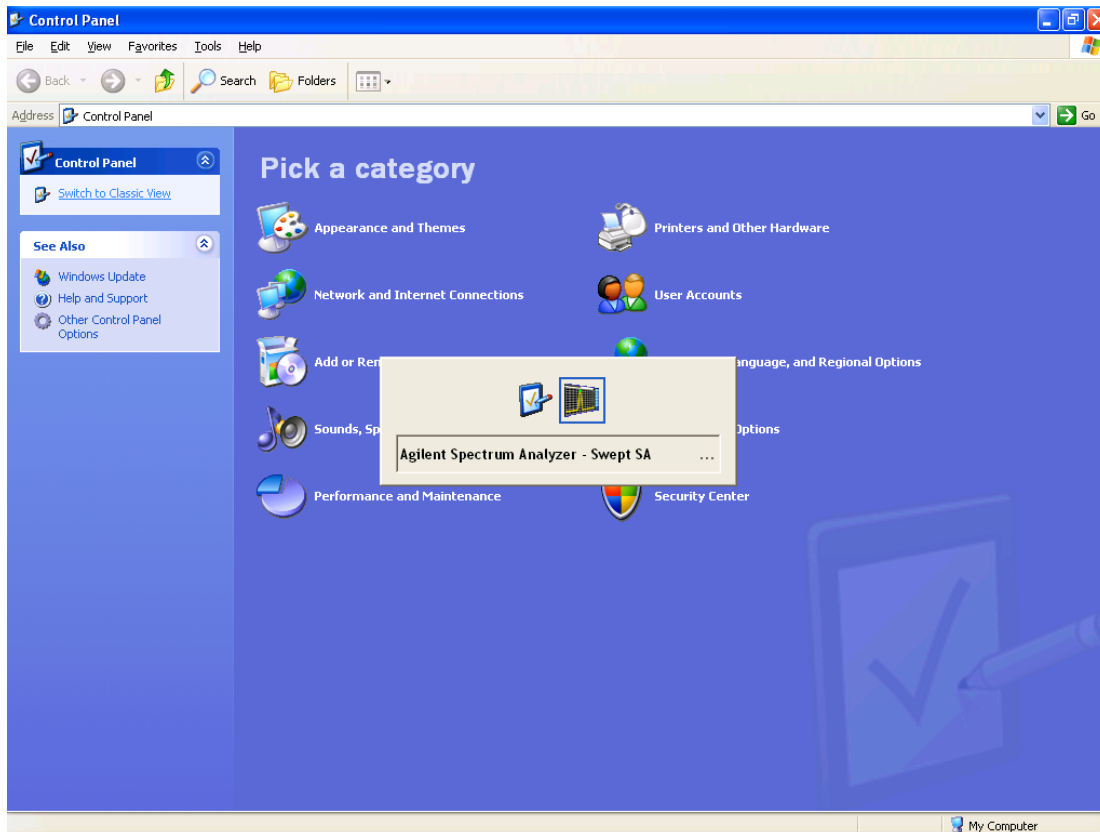

Or use Alt-Tab: press and hold the Alt  key and press and release the Tab key until the Analyzer logo is showing in the window in the center of the screen, as above, then release the Alt key.

Key Path	System
Notes	No remote command for this key.
Initial S/W Revision	Prior to A.02.00

Licensing...

Opens the license explorer.

NOTE This feature is not available if option SF1 is installed.

For Help on this key, select Help in the menu bar at the top of the license explorer window.

Key Path	System
Notes	No equivalent remote command for this key.
Backwards Compatibility Notes	In ESA the SCPI command for displaying the Show Licenses screen is: :SYSTem:CONFIgure:LKEY:STATe OFF ON 0 1:SYSTem:CONFIgure:LKEY:STATe? There are no equivalent SCPI commands in the X-Series for displaying the License Explorer.

Initial S/W Revision Prior to A.02.00

Remote Command :SYSTem:LKEY <"OptionInfo">, <"LicenseInfo">

Example SYST:LKEY "N9073A-1FP",
"027253AD27F83CDA5673A9BA5F427FDA5E4F25AEB1017638211AC9F60D9C639FE539735909C551DE0A91"

Notes The <"OptionInfo"> contains the feature and the version. You must specify the feature but can omit the version. If you omit the version, the system regards it as the latest one, since the system knows which version is supported for each feature.

The <"LicenseInfo"> contains the signature, the expiration date, and serial number for transport if transportable. You must specify the signature, but you can omit the other information. If you omit the expiration date, the system regards it as permanent. If you omit the serial number, the system regards it as non-transportable. As a result, this supports reverse compatibility.

Initial S/W Revision Prior to A.02.00

Remote Command :SYSTem:LKEY:DELeTe <"OptionInfo">,<"LicenseInfo">

Example SYST:LKEY:DEL 'N9073A-1FP',
"027253AD27F83CDA5673A9BA5F427FDA5E4F25AEB1017638211AC9F60D9C639FE539735909C551DE0A91"

Notes The <"OptionInfo"> contains the feature and the version. You must specify the feature but can omit the version. If you omit the version, the system regards it as the latest one, if more than one version is installed.

The <"LicenseInfo"> contains the signature, the expiration date, and whether or not be transportable. You must specify the signature, but you can omit the other information. If you omit the expiration date, the system regards it as permanent. If you omit the transportability, the system regards it as non-transportable. As a result, this supports reverse compatibility.

Initial S/W Revision Prior to A.02.00

Remote Command :SYSTem:LKEY:LIST?

Notes

Return Value:
An <arbitrary block data> of all the installed instrument licenses.
The format of each license is as follows.
<Feature>,<Version>,<Signature>,<Expiration Date>,<Serial Number for Transport>
Return Value Example:

```
#3136
N9073A-1FP,1.000,B043920A51CA
N9060A-2FP,1.000,4D1D1164BE64
N9020A-508,1.000,389BC042F920
N9073A-1F1,1.000,5D71E9BA814C,13-aug-2005
<arbitrary block data> is:
#NMMM<data>
Where:
N is the number of digits that describes the number of MMM characters. For example if the data was
55 bytes, N would be 2.
MMM would be the ASCII representation of the number of bytes. In the previous example, N would be
55.
<data> ASCII contents of the data
```

Initial S/W Revision Prior to A.02.00

Remote Command :SYSTem:LKEY? <"OptionInfo">

Example SYST:LKEY? "N9073A-1FP"

Notes The <"OptionInfo"> contains the feature and the version. You must specify the feature but can omit the version. If you omit the version, the system regards it as the latest one.

Return Value:

<"LicenseInfo"> if the license is valid, null otherwise.

<"LicenseInfo"> contains the signature, the expiration date, and serial number if transportable.

Return Value Example:

"B043920A51CA"

Initial S/W Revision Prior to A.02.00

Remote Command :SYSTem:HID?

Notes Return value is the host ID as a string

Initial S/W Revision Prior to A.02.00

Security

Accesses capabilities for operating the instrument in a security controlled environment.

Key Path **System**

Initial S/W Revision A.04.00

USB

The Windows operating system can be configured to disable write access to the USB ports for users who are in a secure environment where transferring data from the instrument is prohibited. This user interface is a convenient way for the customer to disable write access to USB.

Key Path	System, Security
Mode	All
Scope	Mode Global
Remote Command	:SYSTem:SECurity:USB:WPRotect[:ENABLE] ON OFF 0 1 :SYSTem:SECurity:USB:WPRotect[:ENABLE]?
Example	:SYST:SEC:USB:WPR ON Will set USB ports to Read-only
Notes	When the USB ports are in Read-only mode then no data can be stored to USB, including the internal USB memory used for a back-up location for the calibration data.
Dependencies	This key is grayed-out unless the current user has administrator privileges.
Preset	This is unaffected by Preset or any Restore System Defaults. An Agilent Recovery will set the USB to write protect OFF
State Saved	No
Range	Read-Write Read only
Initial S/W Revision	A.04.00

Read-Write

Selection for allowing full read-write access to the USB ports.

Key Path	System, Security, USB
Example	:SYST:SEC:USB:WPR OFF Will set USB ports to Read-Write
Initial S/W Revision	A.04.00

Read only

Selection for disabling write access to the USB ports.

Key Path	System, Security, USB
Example	:SYST:SEC:USB:WPR ON Will set USB ports to Read only
Initial S/W Revision	A.04.00

Diagnostics

The Diagnostics key in the System menu gives you access to basic diagnostic capabilities of the instrument.

Show Hardware Statistics

Provides a display of various hardware statistics. The statistics include the following:

- Mechanical relay cycles
- High and Low temperature extremes
- Elapsed time that the instrument has been powered-on (odometer)

The display should appear listing the statistics, product number, serial number, and firmware revision.

Hardware Statistical Information	
Agilent MXA Signal Analyzer	
Product Number: N9020A	
Serial Number: US00061145	
Instrument S/W Revision: A.12.00	
Revision Date: 7/11/2012 12:11:10 PM	
Component Name	Value
MechAtten #1 Count Total	457304
Calibrator Switch Cycles	105953
AC/DC Switch Cycles	114240
2 dB #1 Mechanical Atten Cycles	112655
2 dB #2 Mechanical Atten Cycles	124456
MechAtten #2 Count Total	472265
6 dB Mechanical Atten Cycles	115302
10 dB Mechanical Atten Cycles	93602
20 dB Mechanical Atten Cycles	144781
30 dB Mechanical Atten Cycles	118580
Low Noise Path Switch	45668
Preselector Bypass Cycles	31133
High temperature operating extreme	45.75
Low temperature operating extreme	-23.9375
Elapsed Time (On-Time)(hours)	134164

In some CXA models this field is called "Fixed Aten"

Some CXA models omit these fields

Only shown if LNP installed

Only shown if MPB installed

The CXA models in which the AC/DC Switch field is called Fixed Aten and that omit the mechanical attenuation fields are the N9000A–503/507 models.

Modular HWs only have time and temperature information in Show Hardware Statistics.

The data will be updated only when the Show Hardware Statistics menu key is pressed, it will not be updated while the screen is displayed.

The tabular data should be directly printable.

Key Path	System, Diagnostics
Mode	All
Notes	The values displayed on the screen are only updated upon entry to the screen and not updated while the screen is being displayed.
Initial S/W Revision	Prior to A.02.00

SCPI for Show Hardware Statistics (Remote Commands Only)

Each of the hardware statistic items can be queried via SCPI.

- "Query the Mechanical Relay Cycle Count" on page 440
- "Query the Operating Temperature Extremes" on page 440
- "Query the Elapsed Time since 1st power on" on page 441

Query the Mechanical Relay Cycle Count

Return the count of mechanical relay cycles.

For N9038A model, there are additional 2 Mechanical Relays which are <N9038A Input2>, <N9038A Bypass>.

Remote Command	:SYSTem:MRELay:COUNT?
Example	:SYST:MREL:COUN?
Notes	<p>Query Only</p> <p>The return value is a comma separated list of the individual counts for each mechanical relay.</p> <p>The position of the relays in the list is:</p> <p>"<Cal Signal>,<AC/DC>,<2dB #1 Atten>,<2dB #2 Atten>,<6dB Atten>,<10dB Atten>,<20dB Atten>,<30dB Atten>,<Fixed Atten>,<Low Noise Path Switch>,<Presel Bypass>,<N9038A Input2>,<N9038A Bypass>"</p> <p>Items in the list not pertaining to your particular hardware configuration will return as -999 for those items.</p>
Initial S/W Revision	Prior to A.02.00
Modified at S/W Revision	A.08.00

Query the Operating Temperature Extremes

Returns the low operating temperature extreme value. The value survives a power-cycle and is the temperature extreme encountered since the value was reset by the factory or service center.

Mode	All
Remote Command	:SYSTem:TEMPerature:LEXTreme?
Example	:SYST:TEMP:LEXT?
Notes	Value is in degrees Celsius at which the lowest operating temperature has been recorded since 1st

	power-up.
State Saved	No
Initial S/W Revision	Prior to A.02.00
<hr/>	
Mode	All
Remote Command	:SYSTem:TEMPerature:HEXTreme?
Example	:SYST:TEMP:HEXT?
Notes	Value is in degrees Celsius at which the highest operating temperature has been recorded since 1st power-up.
State Saved	No
Initial S/W Revision	Prior to A.02.00

Query the Elapsed Time since 1st power on

Returns the elapsed on-time in minutes since 1st power-on.

Remote Command	:SYSTem:PON:ETIMe?
Example	:SYST:PON:ETIM?
Notes	Query Only
Initial S/W Revision	Prior to A.02.00

Advanced

Accesses advanced diagnostic capabilities performed in the factory or under instructions from repair procedures. This menu key is only visible when the logged-in user is "saservice".

NOTE This feature is not available if option SF1 is installed.

The first access to the Advanced Diagnostic Menu after invoking the instrument application will require an authentication, which is to enter the Service Code. Subsequent accesses to the Advanced Diagnostic Menu are unimpeded. The Authentication dialog looks like:

“OK” is the default key thus the Enter key is used to complete the entry. If invalid Service Code is entered authentication is not granted and you are provided the following dialog:



Key Path	System, Diagnostics
Notes	Password is required to access this menu.
Initial S/W Revision	Prior to A.02.00

	Keysight Converged	PSA
IP Address	SYSTem:COMMunicate:LAN:ADDRess <string> SYSTem:COMMunicate:LAN:ADDRess?	:SYSTem:COMMunicate:LAN[;SELF]:IP <string> :SYSTem:COMMunicate:LAN[;SELF]:IP?
Gateway	SYSTem:COMMunicate:LAN:DGATeway <string> SYSTem:COMMunicate:LAN:DGATeway?	:SYSTem:COMMunicate:LAN[;SELF]:GATEway <string> :SYSTem:COMMunicate:LAN[;SELF]:GATEway?
Subnet Mask	SYSTem:COMMunicate:LAN:SMASK <string> SYSTem:COMMunicate:LAN:SMASK?	:SYSTem:COMMunicate:LAN[;SELF]:SUBNetmask <string> :SYSTem:COMMunicate:LAN[;SELF]:SUBNetmask?

Internet Explorer...

This key launches Microsoft Internet Explorer. A mouse and external keyboard are highly desired for using Internet Explorer. When Internet Explorer is running, close Internet Explorer to return focus to the Instrument Application (or use Alt-Tab).

NOTE This feature is not available if option SF1 is installed.

Key Path	System
Mode	All
Notes	No equivalent remote command for this key.
Initial S/W Revision	A.05.01

7 Trigger Functions

Trigger

Accesses a menu of keys to control the selection of the trigger source and the setup of each of the trigger sources. The analyzer is designed to allow triggering from a number of different sources, for example, Free Run, Video, External, RF Burst, and so forth.

The TRIG:SOURCe command (below) will specify the trigger source for the currently selected input (RF or I/Q). If you change inputs, the new input remembers the trigger source it was last programmed to for the current measurement, and uses that trigger source. You can directly set the trigger source for each input using the TRIGger:RF:SOURce and TRIGger:IQ:SOURce commands (later in this section). When in External Mixing, the analyzer uses the RF trigger source.

Note the inclusion of the <measurement> parameter in the command below. Because each measurement remembers its own Trigger Source, the command must be qualified with the measurement name. Note that for the Swept SA measurement this is not the case; for backwards compatibility, no <measurement> parameter is used when setting the Trigger Source for the Swept SA measurement.

See ["Trigger Source Presets" on page 445](#)

See ["RF Trigger Source" on page 448](#)

See ["I/Q Trigger Source" on page 449](#)

See ["More Information" on page 450](#)

Key Path	Front-panel key
Remote Command	<pre>:TRIGger:<measurement>[:SEquence]:SOURce EXTernal1 EXTernal2 IMMediate LINE FRAMe RFBurst VIDeo IF ALARm LAN IQMag IDEMod QDEMod IINPut QINPut AIQMag TV :TRIGger:<measurement>[:SEquence]:SOURce?</pre> <p>where <measurement> is the measurement for which you wish to set the Source (blank for the Swept SA measurement)</p>
Example	<pre>TRIG:ACP:SOUR EXT1</pre> <p>Selects the external 1 trigger input for the ACP measurement and the selected input</p> <pre>TRIG:SOUR VID</pre> <p>Selects video triggering for the Swept SA (SANalyzer) measurement in the Spectrum Analyzer mode. For SAN, do not use the <measurement> keyword. Only send this form in the Spectrum Analyzer mode or you will get an Undefined Header error</p>
Notes	<p>Not all measurements have all the trigger sources available to them. Check the trigger source documentation for your specific measurement to see what sources are available.</p> <p>Not all trigger sources are available for each input. See the "RF Trigger Source" on page 448 and "I/Q Trigger Source" on page 449 commands for detailed information on which trigger sources are available for each input.</p> <p>Other trigger-related commands are found in the INITiate and ABORt SCPI command subsystems.</p> <p>*OPC should be used after requesting data. This will hold off any subsequent changes to the selected trigger source, until after the sweep is completed and the data is returned.</p> <p>Available ranges and presets can vary from mode to mode.</p>
Dependencies	<p>In some models, there is no second External input. In these models, the External 2 key is blanked and</p>

	the EXternal2 parameter will generate a "Hardware missing; Not available for this model number" message.
Preset	See table below
Status Bits/OPC dependencies	The Status Operation Register bit 5 "Waiting for Trigger" is set at the same time as the Sweeping or Measuring bit is set. It is cleared when the trigger actually occurs (that is, after the trigger event occurs and all the applicable trigger criteria have been met). A corresponding pop-up message ("Waiting for trigger") is generated if no trigger signal appears after approximately 2 sec. This message goes away when a trigger signal appears.
Backwards Compatibility SCPI	:TRIGger[:SEquence]:SOURCe EXTernal For backward compatibility, the parameter EXTernal is mapped to EXTernal1
Backwards Compatibility SCPI	[:SENSe]:<measurement>:TRIGger:SOURce This backwards compatibility alias command is provided for ESA/PSA compatibility This backwards compatibility command does not apply to the Swept SA measurement, for that just use :TRIGger:SOURCe This backwards compatibility command does not apply to the monitor spectrum, log plot and spot frequency measurements
Backwards Compatibility SCPI	[:SENSe]:<measurement>:TRIGger:SOURce IF In earlier instruments, the parameter IF was used by apps for the video trigger, so using the IF parameter selects VIDeo triggering. Sending IF in the command causes VID to be returned to a query.
Backwards Compatibility SCPI	[:SENSe]:ACPr:TRIGger:SOURce This backwards Compatibility SCPI command is provided to support the same functionality as [:SENSe]:ACPr:TRIGger:SOURce (PSA W-CDMA, PSA cdma2000 and PSA 1xEVDO) due to the fact that the ACPr node conflicts with the ACPower node.
Initial S/W Revision	Prior to A.02.00
Modified at S/W Revision	A.03.00

Trigger Source Presets

Here are the Trigger Source Presets for the various measurements:

Meas	Mode	Preset for RF	Preset for IQ	Notes
Swept SA	SA	IMM	IQ not supported	
CHP	SA, WCDMA, C2K, WIMAX OFDMA, 1xEVDO, DVB-T/H, DTMB, LTE, LTETDD, CMMB, ISDB-T, Digital Cable TV, MSR	IMM	IQ not supported	
OBW	SA, WCDMA, C2K, WIMAX OFDMA,	1xEVDO: EXT1 others: IMM	IQ not supported	For 1xEVDO mode, the trigger source is coupled with the gate state, as well as the gate

	TD-SCDMA, 1xEVDO, LTE, LTETDD, CMMB, ISDB-T, MSR			source. When the trigger source changes to RFBurst, External1 or External2, the gate state is set to on, and the gate source is set identically with the trigger source. When the trigger source changes to IMMEDIATE, VIDEO, LINE, FRAME or IF, the gate state is set to off.
CCDF	SA, WCDMA, C2K, WIMAX OFDMA, TD-SCDMA, 1xEV-DO, DVB-T/H, DTMB, LTE, LTETDD, CMMB, ISDB-T, Digital Cable TV, MSR	WIMAX OFDMA: RFBurst LTETDD: BTS: External 1 MS: Periodic Timer TD-SCDMA and 1xEV-DO: BTS: External 1 MS: RFBurst SA, WCDMA, C2K, LTE, CMMB, ISDB-T, DVB-T/H, DTMB, Digital Cable TV, MSR: IMMEDIATE	TD-SCDMA and 1xEV-DO: BTS: External 1 MS: IQMag LTETDD: BTS: External 1 MS: Periodic Timer Others: IMM	For TD-SCDMA: Trigger source is coupled with radio device. When radio device changes to BTS, trigger source will be changed to EXTERNAL1. When radio device changes to MS, trigger source will be set as RFBurst for RF or IQ Mag for BBIQ. When TriggerSource is RFBurst or IQ Mag, Measure Interval is grayed out.
ACP	SA, WCDMA, C2K, WIMAX OFDMA, TD-SCDMA, 1xEVDO, DVB-T/H, DTMB, LTE, LTETDD, CMMB, ISDB-T, Digital Cable TV, MSR	IMM	IQ not supported	
Tx Power	SA, GSM, TD-SCDMA	SA, GSM: RFBurst TD-SCDMA: EXTERNAL	IMM	TD-SCDMA doesn't support the Line and Periodic Timer parameters. When the mode is TD-SCDMA, if the Radio Device is switched to BTS, the value will be changed to External 1 and if the Radio device is switched to MS, the value will be changed to RFBurst
SPUR	SA, WCDMA, C2K, WIMAX OFDMA, TD-SCDMA, 1xEV-DO, DVB-T/H, LTE, LTETDD, MSR	IMM	IQ not supported	
SEM	SA, WCDMA, C2K, WIMAX OFDMA, TD-SCDMA, 1xEVDO, DVB-	1xEVDO(BTS): EXTERNAL1 All others: IMMEDIATE	IQ not supported	

	T/H, DTMB, LTE, LTETDD, CMMB, ISDB-T, Digital Cable TV, MSR			
CDP	WCDMA	IMM	IMM	
RHO	WCDMA	IMM	IMM	
PCON	WCDMA	IMM	IMM	
QPSK	WCDMA, C2K, 1xEVDO	All except CDMA1xEVDO: IMMediate CDMA1xEVDO: EXT1	IMM	
MON	All except SA and BASIC	IMM	IQ not supported	
WAV		LTETDD: BTS: External 1 MS: Periodic Timer GSM/EDGE: RFBurst All others: IMMediate	LTETDD: BTS: External 1 MS: Periodic Timer GSM/EDGE: IQMag All others: IMMMediate	
PVT	WIMAXOFDMA	RFB	IMM	
EVM	WIMAXOFDMA, DVB-T/H, DTMB, LTE, LTETDD, CMMB, ISDB-T, Digital Cable TV	All but CMMB: IMM CMMB: Periodic Timer	All but CMMB: IMM CMMB: External 1	LTE, LTETDD supports Free Run, Video and External 1 only.
SPEC	BASIC	IMM	IMM	
LOG Plot	PN	IMM	IQ not supported	
Spot Freq	PN	IMM	IQ not supported	
GMSK PVT	EDGE/GSM	RFB	IMM	
GMSK PFER	EDGE/GSM	RFB	IQMag	
GMSK ORFS	EDGE/GSM	RF Burst	IQ not supported	
EDGE PVT	EDGE/GSM	RFB	IMM	

EDGE EVM	EDGE/GSM	RFB	IQMag
EDGE ORFS	EDGE/GSM	Periodic Timer	IQ not supported
Combined WCDMA	WCDMA	IMM	IQ not supported
Combined GSM	EDGE/GSM	RFB	IQ not supported
List Power Step	WCDMA, EDGE/GSM	IMM	IQ not supported
Transmit On/Off Power	LTETDD	LTETDD: BTS: External 1 MS: Periodic Timer	LTETDD: BTS: External 1 MS: Periodic Timer
Transmit Analysis	BLUETOOTH	RFB	IQ not supported
Adjacent Channel Power	BLUETOOTH	IMM	IQ not supported
LE In-band Emissions	BLUETOOTH	IMM	IQ not supported
EDR In-band Spurious Emissions	BLUETOOTH	Periodic Timer	IQ not supported
Conformance EVM	LTE, LTETDD, MSR	IMM	IMM

RF Trigger Source

The **RF Trigger Source** command selects the trigger to be used for the specified measurement when RF is the selected input. The RF trigger source can be queried and changed even while another input is selected, but it is inactive until RF becomes the selected input.

Note the inclusion of the <measurement> parameter in the command below. Because each measurement remembers its own Trigger Source, the command must be qualified with the measurement name. Note that for the Swept SA measurement this is not the case; for backwards compatibility, no <measurement> parameter is used when setting the Trigger Source for the Swept SA measurement.

Remote Command	<code>:TRIGger:<measurement>[:SEquence]:RF:SOURce EXTernal1 EXTernal2 IMMEDIATE LINE FRAME RFBurst VIDEO IF ALARm LAN TV</code> <code>:TRIGger:<measurement>[:SEquence]:RF:SOURce?</code>
-----------------------	--

Example	<code>TRIG:ACP:RF:SOUR EXT1</code> Selects the external 1 trigger input for the ACP measurement and the RF input
----------------	---

	<p>TRIG:RF:SOUR VID</p> <p>Selects video triggering for the SANalyzer measurement and the RF input. For SAN, do not use the <measurement> keyword.</p>
Notes	<p>Not all measurements have all the trigger sources available to them. Check the trigger source documentation for your specific measurement to see what sources are available.</p> <p>Not all trigger sources are available for each input. For the RF Trigger Source, the following trigger sources are available:</p> <ul style="list-style-type: none"> –IMMediate - free run triggering –VIDeo - triggers on the video signal level –LINE - triggers on the power line signal –EXTernal1 (or EXTernal) - triggers on an externally connected trigger source marked “Trigger 1 In” on the rear panel –EXTernal2 - triggers on an externally connected trigger source marked “Trigger 2 In” on the front panel. In some models, there is no second External input. In these models, the External 2 key is blanked and the EXTernal2 parameter will generate a “Hardware missing; Not available for this model number” message –RFBurst - triggers on the bursted frame –FRAMe - triggers on the periodic timer –IF (video) - same as video, for backwards compatibility only <p>*OPC should be used after requesting data. This will hold off any subsequent changes to the selected trigger source, until after the sweep is completed and the data is returned.</p> <p>Available ranges, and presets can vary from mode to mode.</p>
Status Bits/OPC dependencies	<p>The Status Operation Register bit 5 "Waiting for Trigger" is set at the same time as the Sweeping or Measuring bit is set. It is cleared when the trigger actually occurs (that is, after the trigger event occurs and all the applicable trigger criteria have been met). A corresponding pop-up message ("Waiting for trigger") is generated if no trigger signal appears after approximately 2 sec. This message goes away when a trigger signal appears.</p>
Initial S/W Revision	Prior to A.02.00

I/Q Trigger Source

This command selects the trigger to be used for the specified measurement when I/Q (which requires option BBA) is the selected input. The I/Q trigger source can be queried and changed even while another input is selected, but it is inactive until I/Q becomes the selected input.

Remote Command	<pre>:TRIGger:<measurement>[:SEquence]:IQ:SOURce EXTernal1 EXTernal2 IMMediate IQMag IDEMod QDEMod IINPut QINPut AIQMag :TRIGger:<measurement>[:SEquence]:IQ:SOURce?</pre>
Example	<p>TRIG:WAVeform:SOUR IQM</p> <p>Selects I/Q magnitude triggering for the IQ Waveform measurement and the I/Q input</p>
Notes	<p>Not all measurements have all the trigger sources available to them. Check the trigger source documentation for your specific measurement to see what sources are available.</p> <p>Not all trigger sources are available for each input. For the I/Q Trigger Source, the following trigger sources are available:</p>

	<ul style="list-style-type: none"> –IMMediate - free run triggering –EXternal1 (or EXternal) - triggers on an externally connected trigger source on the rear panel –EXternal2 - triggers on an externally connected trigger source on the front panel –IQMag - triggers on the magnitude of the I/Q signal –IDEMod - triggers on the I/Q signal's demodulated I voltage –QDEMod - triggers on the I/Q signal's demodulated Q voltage –IINPut - triggers on the I channel's ADC voltage –QINPut - triggers on the Q channel's ADC voltage –AIQMag - triggers on the magnitude of the auxiliary receiver channel I/Q signal <p>*OPC should be used after requesting data. This will hold off any subsequent changes to the selected trigger source, until after the sweep is completed and the data is returned.</p> <p>Available ranges, and from mode to mode presets can vary</p>
Status Bits/OPC dependencies	The Status Operation Register bit 5 "Waiting for Trigger" is set at the same time as the Sweeping or Measuring bit is set. It is cleared when the trigger actually occurs (that is, after the trigger event occurs and all the applicable trigger criteria have been met). A corresponding pop-up message ("Waiting for trigger") is generated if no trigger signal appears after approximately 2 sec. This message goes away when a trigger signal appears.
Initial S/W Revision	Prior to A.02.00

More Information

The trigger menus let you select the trigger source and trigger settings for a sweep or measurement. In triggered operation (basically, any trigger source other than Free Run), the analyzer will begin a sweep or measurement only with the selected trigger conditions are met, generally when your trigger source signal meets the specified trigger level and polarity requirements. (In FFT measurements, the trigger controls when the data acquisition begins for FFT conversion.)

For each of the trigger sources, you may define a set of operational parameters or settings which will be applied when that source is selected as the current trigger source. Examples of these settings are Trigger Level, Trigger Delay, and Trigger Slope. You may apply different settings for each source; so, for example, you could have a Trigger Level of 1v for External 1 trigger and –10 dBm for Video trigger.

Once you have established the settings for a given trigger source, they generally will remain unchanged for that trigger source as you go from measurement to measurement within a Mode (although the settings do change as you go from Mode to Mode). Furthermore, the trigger settings within a Mode are the same for the **Trigger** menu, the **Gate Source** menu, and the **Sync Source** menu that is part of the **Periodic Timer Trigger Setup** menu. That is, if **Ext1** trigger level is set to 1v in the **Trigger** menu, it will appear as 1v in both the **Gate Source** and the **Sync Source** menus. For these reasons the trigger settings commands are not qualified with the measurement name, the way the trigger source commands are.

The settings setup menu can be accessed by pressing the key for the current trigger source a second time. For example, one press of Video selects the Video trigger as the source. The Video key becomes highlighted and the hollow arrow on the key turns black. Now a second press of the key takes you into the Video Trigger Setup menu.

Trigger Setup Parameters:

The following examples show trigger setup parameters using an external trigger source.

Example 1 illustrates the trigger conditions with negative slope and no trigger occurs during trigger Holdoff time.

Example 2 illustrates the trigger conditions with positive slope, trigger delay, and auto trigger time.

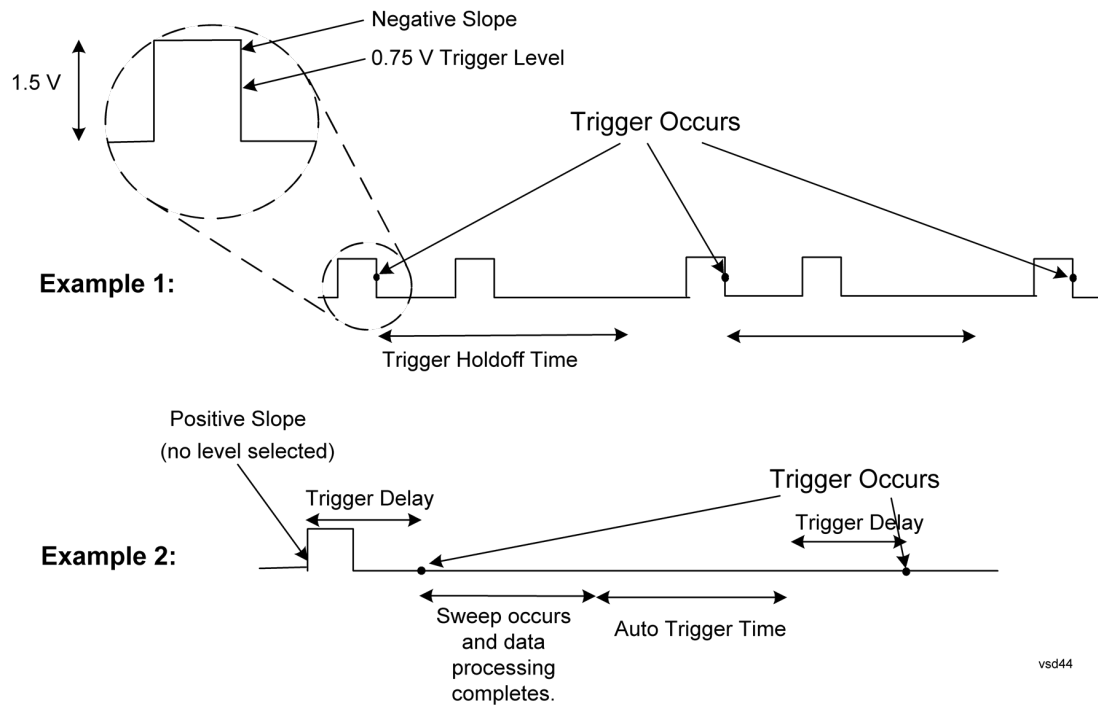

Free Run

Pressing this key, when it is not selected, selects free-run triggering. Free run triggering occurs immediately after the sweep/measurement is initiated.

Key Path	Trigger
Example	TRIG:SOUR IMM Swept SA measurement TRIG:<meas>:SOUR IMM Measurements other than Swept SA
State Saved	Saved in instrument state
Status Bits/OPC dependencies	The Status Operation Register bit 5 "Waiting for Trigger" is set at the same time as the Sweeping or Measuring bit is set. It is cleared when the trigger actually occurs (that is, after the trigger event occurs and all the applicable trigger criteria have been met). A corresponding pop-up message ("Waiting for trigger") is generated if no trigger signal appears after approximately 2 sec. This message goes away when a trigger signal appears.
Initial S/W Revision	Prior to A.02.00

Video (IF Envelope)

Pressing this key, when it is not selected, selects the video signal as the trigger. The Video trigger condition is met when the video signal (the filtered and detected version of the input signal, including both RBW and VBW filtering) crosses the video trigger level.

NOTE When the detector selected for all active traces is the average detector, the video signal for triggering does not include any VBW filtering.

The video trigger level is shown as a labeled line on the display. The line is displayed as long as video is the selected trigger source.

Pressing this key, when it is already selected, accesses the video trigger setup functions.

Key Path	Trigger
Example	TRIG:SOUR VID Swept SA measurement TRIG:<meas>:SOUR VID Measurements other than Swept SA
Notes	Log Plot and Spot Frequency measurements do not support Video Trigger
Dependencies	Video trigger is allowed in average detector mode.
State Saved	Saved in instrument state
Status Bits/OPC dependencies	The Status Operation Register bit 5 "Waiting for Trigger" is set at the same time as the Sweeping or Measuring bit is set. It is cleared when the trigger actually occurs (that is, after the trigger event occurs and all the applicable trigger criteria have been met). A corresponding pop-up message ("Waiting for trigger") is generated if no trigger signal appears after approximately 2 sec. This message goes away when a trigger signal appears.
Backwards Compatibility Notes	In the past, the Average detector was not available when Video triggering was on, and consequently, functions that set the detector to average (such as Marker Noise or Band/Intvl Power) were not available when the video trigger was on. Similarly, Video triggering was not available when the detector was Average. In the X-Series, these restrictions are removed.
Initial S/W Revision	Prior to A.02.00

Trigger Level

Sets a level for the video signal trigger. When the video signal crosses this level, with the chosen slope, the trigger occurs. This level is displayed with a horizontal line only if **Video** is the selected trigger source.

Key Path	Trigger, Video
Remote Command	:TRIGger[:SEquence]:VIDeo:LEVel <ampl> :TRIGger[:SEquence]:VIDeo:LEVel?
Example	TRIG:VID:LEV -40 dBm
Notes	When sweep type = FFT, the video trigger uses the amplitude envelope in a bandwidth wider than the FFT width as a trigger source. This might often be useful, but does not have the same relationship between the displayed trace and the trigger level as in swept triggering. Amplitude Corrections are not taken into account by the Video Trig Level. For example, if you have

given yourself effective gain with an amplitude correction factor, the Video Trigger will not fire until you have dropped the trigger line that far below the displayed signal level, rather than simply dropping it down to the displayed signal level.

Note that other corrections, specifically External Gain and Ref Level Offset, modify the actual trace data as it is taken and therefore ARE taken into account by Trig Level.

Couplings	This same level is used for the Video trigger source in the Trigger menu and for the Video selection in the Gate Source menu.
Preset	Set the Video Trigger Level -25 dBm on Preset. When the Video Trigger Level becomes the active function, if the value is off screen, set it to either the top or bottom of screen, depending on which direction off screen it was.
State Saved	Saved in instrument state
Min	-170 dBm
Max	+30 dBm
Default Unit	Depends on the current selected Y axis unit
Backwards Compatibility SCPI	:TRIGger[:SEquence]:IF:LEVel :TRIGger[:SEquence]:IF:LEVel?
Backwards Compatibility Notes	This alias is provided for backward compatibility with VSA/PSA comms apps.
Initial S/W Revision	Prior to A.02.00

Trig Slope

Controls the trigger polarity. It is set positive to trigger on a rising edge and negative to trigger on a falling edge.

Key Path	Trigger, Video
Remote Command	:TRIGger[:SEquence]:VIDeo:SLOPe POSitive NEGative :TRIGger[:SEquence]:VIDeo:SLOPe?
Example	TRIG:VID:SLOP NEG
Preset	POSitive
State Saved	Saved in instrument state
Backwards Compatibility SCPI	:TRIGger[:SEquence]:IF:SLOPe NEGative POSitive :TRIGger[:SEquence]:IF:SLOPe? For backward compatibility with VSA/PSA comms apps
Backwards Compatibility Notes	The legacy :TRIGger[:SEquence]:SLOPe command affects the slopes for the VID, LINE, EXT1, EXT2, and RFB triggers.
Initial S/W Revision	Prior to A.02.00

Remote Command	:TRIGger[:SEquence]:SLOPe POSitive NEGative :TRIGger[:SEquence]:SLOPe?
Example	TRIG:SLOP NEG
Preset	POSitive
State Saved	Saved in instrument state
Backwards Compatibility Notes	In ESA/PSA, the Trigger Slope was global to all triggers. In the X-Series, the slope can be set individually for each Trigger Source. For backward compatibility, the global SLOPe command updates all instances of trigger slope (VID, LINE, EXT1, EXT2, TV, RFB). The query returns the trigger slope setting of the currently selected trigger source.
Initial S/W Revision	Prior to A.02.00

Trig Delay

Controls a time delay during that the analyzer will wait to begin a sweep after meeting the trigger criteria. You can use negative delay to pre-trigger the instrument in the time domain or FFT, but not in swept spans.

Key Path	Trigger, Video
Remote Command	:TRIGger[:SEquence]:VIDeo:DELaY <time> :TRIGger[:SEquence]:VIDeo:DELaY? :TRIGger[:SEquence]:VIDeo:DELaY:STATe OFF ON 0 1 :TRIGger[:SEquence]:VIDeo:DELaY:STATe?
Example	TRIG:VID:DEL:STAT ON TRIG:VID:DEL 100 ms
Notes	Video trigger delay may be set to negative values, in time domain, FFT and even swept. It makes intuitive sense in time domain and works well in FFT mode where the bandwidth of the filter before the video trigger is about 1.25 span. In swept spans, negative settings of Trig Delay are treated as a zero setting within the internal hardware and the advisory message "Neg. Trig Delay unavailable in Swept Mode, zero delay used." is generated when such a delay is set.
Preset	Off, 1 us
State Saved	Saved in instrument state
Min	-150 ms
Max	+500 ms
Default Unit	s
Backwards Compatibility Notes	! For backward compatibility with VSA/PSA comms apps :TRIGger[:SEquence]:IF:DELaY :TRIGger[:SEquence]:DELaY The legacy :TRIGger[:SEquence]:DELaY command affects the delay for the VID, LINE, EXT1, EXT2, and RFB triggers.
Initial S/W Revision	Prior to A.02.00

Remote Command	:TRIGger[:SEquence]:DELay <time> :TRIGger[:SEquence]:DELay? :TRIGger[:SEquence]:DELay:STATE OFF ON 0 1 :TRIGger[:SEquence]:DELay:STATE?
Example	TRIG:DEL 1 ms
Preset	1 us
State Saved	Saved in instrument state
Backwards Compatibility Notes	In ESA/PSA, the Trigger Delay was global to all triggers. In the X-Series, the delay can be set individually for each Trigger Source. For backward compatibility, the global DELay command updates all instances of trigger slope (VID, LINE, EXT1, EXT2) except TV and RFBurst. The query returns the trigger delay setting of the currently selected trigger source.
Initial S/W Revision	Prior to A.02.00

Remote Command	:TRIGger[:SEquence]:OFFSet <time> :TRIGger[:SEquence]:OFFSet? :TRIGger[:SEquence]:OFFSet:STATE OFF ON 0 1 :TRIGger[:SEquence]:OFFSet:STATE?
Example	TRIG:OFFS ON TRIG:OFFS -100 ms
Notes	These are ESA commands for trigger offset that allowed you to use a positive or negative delay when in zero span and in a Res BW \geq 1 kHz. For ESA compatibility, X-series analyzers keep track of this offset and adds it to the Trigger Delay for VIDEo, LINE, EXTernal1 or EXTernal2 whenever the value is sent to the hardware, if in Zero Span and RBW \geq 1 kHz.
Preset	Off, 0 s
State Saved	Saved in instrument state
Min	-11 s
Max	+11 s
Initial S/W Revision	Prior to A.02.00

Line

Pressing this key, when it is not selected, selects the line signal as the trigger. A new sweep/measurement will start synchronized with the next cycle of the line voltage. Pressing this key, when it is already selected, access the line trigger setup menu.

Key Path	Trigger
Example	TRIG:SOUR LINE Swept SA measurement TRIG:<meas>:SOUR LINE Measurements other than Swept SA
Dependencies	Line trigger is not available when operating from a "dc power source", for example, when the

	instrument is powered from batteries.
State Saved	Saved in instrument state
Status Bits/OPC dependencies	The Status Operation Register bit 5 "Waiting for Trigger" is set at the same time as the Sweeping or Measuring bit is set. It is cleared when the trigger actually occurs (that is, after the trigger event occurs and all the applicable trigger criteria have been met). A corresponding pop-up message ("Waiting for trigger") is generated if no trigger signal appears after approximately 2 sec. This message goes away when a trigger signal appears.
Initial S/W Revision	Prior to A.02.00

Trig Slope

Controls the trigger polarity. It is set positive to trigger on a rising edge and negative to trigger on a falling edge.

Key Path	Trigger, Line
Remote Command	:TRIGger[:SEquence]:LINE:SLOPe POSitive NEGative :TRIGger[:SEquence]:LINE:SLOPe?
Example	TRIG:LINE:SLOP NEG
Preset	POSitive
State Saved	Saved in instrument state
Backwards Compatibility Notes	The legacy :TRIGger[:SEquence]:SLOPe command affects the slopes for the VID, LINE, EXT1, EXT2, and RFB triggers.
Initial S/W Revision	Prior to A.02.00

Trig Delay

Controls a time delay during which the analyzer will wait to begin a sweep after meeting the trigger criteria. You can use negative delay to pre-trigger the instrument in time domain or FFT, but not in swept spans.

Key Path	Trigger, Line
Remote Command	:TRIGger[:SEquence]:LINE:DELAy <time> :TRIGger[:SEquence]:LINE:DELAy? :TRIGger[:SEquence]:LINE:DELAy:STATe OFF ON 0 1 :TRIGger[:SEquence]:LINE:DELAy:STATe?
Example	TRIG:LINE:DEL:STAT ON TRIG:LINE:DEL 100 ms
Notes	Video trigger delay may be set to negative values, in time domain, FFT and even swept. It makes intuitive sense in time domain and works well in FFT mode where the bandwidth of the filter before the video trigger is about 1.25 span. In swept spans, negative settings of Trig Delay are treated as a

	zero setting within the internal hardware and the advisory message "Neg. Trig Delay unavailable in Swept Mode, zero delay used." is generated when such a delay is set.
Preset	Off, 1.000 us
State Saved	Saved in instrument state
Min	-150 ms
Max	500 ms
Default Unit	S
Backwards Compatibility Notes	The legacy :TRIGger[:SEQuence]:DELay command affects the delay for the VID, LINE, EXT1, EXT2, and RFB triggers. The legacy :TRIGger[:SEQuence]:OFFSet command is supported for the VIDeo, LINE, EXT1, and EXT2 triggers.
Initial S/W Revision	Prior to A.02.00

External 1

Pressing this key, when it is not selected, selects an external input signal as the trigger. A new sweep/measurement will start when the external trigger condition is met using the external 1 input connector on the rear panel.

Pressing this key, when it is already selected, accesses the external 1 trigger setup menu.

Key Path	Trigger
Example	TRIG:SOUR EXT1 Swept SA measurement TRIG:<meas>:SOUR EXT1 Measurements other than Swept SA
Dependencies	Grayed out if in use by Point Trigger in the Source Setup menu. Forced to Free Run if already selected and Point Trigger is set to External 1.
State Saved	Saved in instrument state
Status Bits/OPC dependencies	The Status Operation Register bit 5 "Waiting for Trigger" is set at the same time as the Sweeping or Measuring bit is set. It is cleared when the trigger actually occurs (that is, after the trigger event occurs and all the applicable trigger criteria have been met). A corresponding pop-up message ("Waiting for trigger") is generated if no trigger signal appears after approximately 2 sec. This message goes away when a trigger signal appears.
Initial S/W Revision	Prior to A.02.00

Trigger Level

Sets the value where the external 1 trigger input will trigger a new sweep/measurement.

Key Path	Trigger, External 1
Remote Command	:TRIGger[:SEQuence]:EXTernal1:LEVel <level>

	:TRIGger[:SEquence]:EXTernal1:LEVel?
Example	TRIG:EXT1:LEV 0.4 V
Couplings	This same level is used for the Ext1 trigger source in the Trigger menu, for the Ext1 selection in the Periodic Timer sync source (in the Trigger menu and in the Gate Source menu), and also for the Ext1 selection in the Gate Source menu.
Preset	1.2 V
State Saved	Saved in instrument state
Min	-5 V
Max	5 V
Default Unit	V
Backwards Compatibility SCPI	:TRIGger[:SEquence]:EXTernal:LEVel
Backwards Compatibility SCPI	For backward compatibility, the parameter EXTernal is mapped to EXTernal1
Backwards Compatibility SCPI	:TRIGger[:SEquence]:FRAMe:EXTernal1:LEVel
Initial S/W Revision	Prior to A.02.00

Trig Slope

Controls the trigger polarity. It is set positive to trigger on a rising edge and negative to trigger on a falling edge.

Key Path	Trigger, External 1
Remote Command	:TRIGger[:SEquence]:EXTernal1:SLOPe POSitive NEGative :TRIGger[:SEquence]:EXTernal1:SLOPe?
Example	TRIG:EXT1:SLOP NEG
Couplings	This same slope is used in the Ext1 selection for the trigger source in the Trigger menu and for the period timer sync source (in the Trigger menu and in the Gate Source menu).
Preset	POSitive
State Saved	Saved in instrument state
Backwards Compatibility SCPI	:TRIGger[:SEquence]:EXTernal:SLOPe
Backwards Compatibility SCPI	For backward compatibility, the parameter EXTernal is mapped to EXTernal1
Backwards Compatibility SCPI	:TRIGger[:SEquence]:FRAMe:EXTernal1:SLOPe
Backwards Compatibility Notes	The legacy :TRIGger[:SEquence]:SLOPe command affects the slopes for the VID, LINE, EXT1, EXT2, and RFB triggers.
Initial S/W Revision	Prior to A.02.00

Trig Delay

Controls a time delay during which the analyzer will wait to begin a sweep after meeting the trigger criteria. You can use negative delay to pre-trigger the instrument in time domain or FFT, but not in swept spans.

Key Path	Trigger, External 1
Remote Command	:TRIGger[:SEquence]:EXTernal1:DElay <time> :TRIGger[:SEquence]:EXTernal1:DElay? :TRIGger[:SEquence]:EXTernal1:DElay:STATe OFF ON 0 1 :TRIGger[:SEquence]:EXTernal1:DElay:STATe?
Example	TRIG:EXT1:DEL:STAT ON TRIG:EXT1:DEL 100 ms
Notes	Video trigger delay may be set to negative values, in time domain, FFT and even swept. It makes intuitive sense in time domain and works well in FFT mode where the bandwidth of the filter before the video trigger is about 1.25 span. In swept spans, negative settings of Trig Delay are treated as a zero setting within the internal hardware and the advisory message "Neg. Trig Delay unavailable in Swept Mode, zero delay used." is generated when such a delay is set.
Preset	Off, 1.000 us
State Saved	Saved in instrument state
Min	-150 ms
Max	+500 ms
Default Unit	s
Backwards Compatibility SCPI	:TRIGger[:SEquence]:EXTernal:DElay For backward compatibility, the parameter EXTernal is mapped to EXTernal1
Backwards Compatibility Notes	The legacy :TRIGger[:SEquence]:DElay command affects the delay for the VID, LINE, EXT1, EXT2, and RFB triggers. The legacy :TRIGger[:SEquence]:OFFSet command is supported for the VIDeO, LINE, EXT1, and EXT2 triggers.
Initial S/W Revision	Prior to A.02.00

Zero Span Delay Comp On/Off

In zero span, there is a natural delay in the signal path, which comes from the RBW filter. This is usually desirable, as it allows you to trigger on events and also see those events, because the signal is delayed from the trigger event. However, in some cases it is desirable to eliminate this delay, so that trigger events line up exactly with the zero time point in zero span. You can use the **Zero Span Delay Comp On/Off** feature to enable or disable zero span delay compensation.

Key Path	Trigger, External 1
Remote Command	:TRIGger[:SEquence]:EXTernal1:DElay:COMPensation OFF ON 0 1 :TRIGger[:SEquence]:EXTernal1:DElay:COMPensation?
Example	TRIG:EXT1:DEL:COMP ON

Dependencies	No effect except in zero-span, but not locked out in nonzero spans. Blanked in modes that do not support zero-span measurements. If the SCPI command is sent when the key is blanked, an error is returned: -221, "Settings conflict; Feature not supported for this measurement" In analyzers shipping N9060A, this feature requires N9060A-7FP.
Preset	OFF
State Saved	Saved in instrument state
Initial S/W Revision	A.11.00

External 2

Pressing this key, when it is not selected, selects an external input signal as the trigger. A new sweep/measurement will start when the external trigger condition is met using the external 2 input connector. The external trigger 2 input connector is on the rear panel.

Pressing this key, when it is already selected, accesses the external 2 trigger setup menu.

Key Path	Trigger
Example	TRIG:SOUR EXT2 Swept SA measurement TRIG:<meas>:SOUR EXT2 Measurements other than Swept SA
Dependencies	In some models, there is no second External input. In these models, the External 2 key is blanked and the EXTernal2 parameter will generate a "Hardware missing; Not available for this model number" message. Grayed out if in use by Point Trigger in the Source Setup menu. Forced to Free Run if already selected and Point Trigger is set to External 2.
State Saved	Saved in instrument state
Status Bits/OPC dependencies	The Status Operation Register bit 5 "Waiting for Trigger" is set at the same time as the Sweeping or Measuring bit is set. It is cleared when the trigger actually occurs (that is, after the trigger event occurs and all the applicable trigger criteria have been met). A corresponding pop-up message ("Waiting for trigger") is generated if no trigger signal appears after approximately 2 sec. This message goes away when a trigger signal appears.
Initial S/W Revision	Prior to A.02.00
Modified at S/W Revision	A.03.00

Trigger Level

Sets the value where the external 2 trigger input will trigger a new sweep/measurement.

Key Path	Trigger, External 2
Remote Command	:TRIGger[:SEquence]:EXTernal2:LEVel :TRIGger[:SEquence]:EXTernal2:LEVel?

Example	TRIG:EXT2:LEV 1.1 V
Couplings	This same level is used for the Ext2 trigger source in the Trigger menu, for the Ext2 selection in the Periodic Timer sync source (in the Trigger menu and in the Gate Source menu), and also for the Ext2 selection in the Gate Source menu.
Preset	1.2 V
State Saved	Saved in instrument state
Min	-5 V
Max	5 V
Default Unit	V
Backwards Compatibility SCPI	:TRIGger[:SEquence]:FRAMe:EXTeRnAl2:LEVeL
Initial S/W Revision	Prior to A.02.00

Trig Slope

Controls the trigger polarity. It is set positive to trigger on a rising edge and negative to trigger on a falling edge.

Key Path	Trigger, External 2
Remote Command	:TRIGger[:SEquence]:EXTeRnAl2:SLOPe POSitive NEGative :TRIGger[:SEquence]:EXTeRnAl2:SLOPe?
Example	TRIG:EXT2:SLOP NEG
Couplings	This same slope is used in the Ext2 selection for the trigger source in the Trigger menu and for the period timer sync source (in the Trigger menu and in the Gate Source menu).
Preset	POSitive
State Saved	Saved in instrument state
Backwards Compatibility SCPI	:TRIGger[:SEquence]:FRAMe:EXTeRnAl2:SLOPe
Backwards Compatibility Notes	The legacy :TRIGger[:SEquence]:SLOPe command affects the slopes for the VID, LINE, EXT1, EXT2, and RFB triggers.
Initial S/W Revision	Prior to A.02.00

Trig Delay

Controls a time delay during which the analyzer will wait to begin a sweep after meeting the trigger criteria. You can use negative delay to pre-trigger the instrument in time domain or FFT, but not in swept spans.

Key Path	Trigger, External 2
Remote Command	:TRIGger[:SEquence]:EXTeRnAl2:DELAy <time>

	:TRIGger[:SEquence]:EXternal2:DElay?
	:TRIGger[:SEquence]:EXternal2:DElay:STATe OFF ON 0 1
	:TRIGger[:SEquence]:EXternal2:DElay:STATe?
Example	TRIG:EXT2:DEL:STAT ON TRIG:EXT2:DEL 100 ms
Notes	Video trigger delay may be set to negative values, in time domain, FFT and even swept. It makes intuitive sense in time domain and works well in FFT mode where the bandwidth of the filter before the video trigger is about 1.25 span. In swept spans, negative settings of Trig Delay are treated as a zero setting within the internal hardware and the advisory message "Neg. Trig Delay unavailable in Swept Mode, zero delay used." is generated when such a delay is set.
Preset	Off, 1.000 us
State Saved	Saved in instrument state
Min	-150 ms
Max	500 ms
Default Unit	s
Backwards Compatibility Notes	The legacy :TRIGger[:SEquence]:DElay command affects the delay for the VID, LINE, EXT1, EXT2, and RFB triggers. The legacy :TRIGger[:SEquence]:OFFSet command is supported for the VIDEO, LINE, EXT1, and EXT2 triggers.
Initial S/W Revision	Prior to A.02.00

Zero Span Delay Comp On/Off

In zero span, there is a natural delay in the signal path, which comes from the RBW filter. This is usually desirable, as it allows you to trigger on events and also see those events, because the signal is delayed from the trigger event. However, in some cases it is desirable to eliminate this delay, so that trigger events line up exactly with the zero time point in zero span. You can use the **Zero Span Delay Comp On/Off** feature to enable or disable zero span delay compensation.

Key Path	Trigger, External 2
Remote Command	:TRIGger[:SEquence]:EXternal2:DElay:COMPensation OFF ON 0 1 :TRIGger[:SEquence]:EXternal2:DElay:COMPensation?
Example	TRIG:EXT2:DEL:COMP ON
Dependencies	No effect except in zero-span, but not locked out in nonzero spans. Blanked in modes that do not support zero-span measurements. If the SCPI command is sent when the key is blanked, an error is returned: -221, "Settings conflict; Feature not supported for this measurement" In analyzers shipping N9060A, this feature requires N9060A-7FP.
Preset	OFF
State Saved	Saved in instrument state
Initial S/W Revision	A.11.00

RF Burst

Pressing this key, when it is not selected, selects the RF Burst as the trigger. A new sweep/measurement will start when an RF burst envelope signal is identified from the signal at the RF Input connector. Pressing this key, when it is already selected, accesses the RF Burst trigger setup menu.

In some models, a variety of burst trigger circuitry is available, resulting in various available burst trigger bandwidths. The analyzer automatically chooses the appropriate trigger path based on the hardware configuration and other settings of the analyzer.

Key Path	Trigger
Example	TRIG:SOUR RFB Swept SA measurement TRIG:<meas>:SOUR RFB Measurements other than Swept SA
State Saved	Saved in instrument state
Status Bits/OPC dependencies	The Status Operation Register bit 5 "Waiting for Trigger" is set at the same time as the Sweeping or Measuring bit is set. It is cleared when the trigger actually occurs (that is, after the trigger event occurs and all the applicable trigger criteria have been met). A corresponding pop-up message ("Waiting for trigger") is generated if no trigger signal appears after approximately 2 sec. This message goes away when a trigger signal appears.
Backwards Compatibility Notes	The legacy command: :TRIGger[:SEquence]:RFBurst:FSElectivity[:STATe] OFF ON 0 1 is not supported in the X-Series, as the hardware to do Frequency Selective burst triggers does not exist in X-Series.
Initial S/W Revision	Prior to A.02.00
Modified at S/W Revision	A.04.00

Absolute Trigger Level

Sets the absolute trigger level for the RF burst envelope.

When using the External Mixing path, the Absolute Trigger Level is uncalibrated because the factory default was set to accommodate the expected IF levels for the RF path.

Key Path	Trigger, RF Burst
Scope	Meas Global
Remote Command	:TRIGger[:SEquence]:RFBurst:LEVel:ABSolute <ampl> :TRIGger[:SEquence]:RFBurst:LEVel:ABSolute?
Example	TRIG:RFB:LEV:ABS 10 dBm sets the trigger level of the RF burst envelope signal to the absolute level of 10 dBm
Notes	Sending this command does not switch the setting from relative to absolute; to switch it you need to send the :TRIGger[:SEquence]:RFBurst:LEVel:TYPE command, below. Amplitude Corrections are not taken into account by the Absolute Trigger Level. For example, if you

	<p>have given yourself effective gain with an amplitude correction factor, the Absolute Trigger will not fire until you have set the trigger level that far below the displayed signal level, rather than simply to the displayed signal level. This is only true for Amplitude Corrections, not External Gain or Ref Level Offset functions.</p> <p>If mode is Bluetooth, the default value is -50 dBm.</p>
Couplings	This same level is used for the RF Burst trigger source in the Trigger menu, for the RF Burst selection in the Periodic Timer sync source (in the Trigger menu and in the Gate Source menu), and also for the RF Burst selection in the Gate Source menu
Preset	-20 dBm
State Saved	Saved in instrument state
Min	-200 dBm
Max	100 dBm
Default Unit	depends on the current selected Y-Axis unit
Backwards Compatibility SCPI	:TRIGger[:SEquence]:FRAMe:RFBurst:LEVel:ABSolute
Initial S/W Revision	Prior to A.02.00
Modified at S/W Revision	A.04.00

Key Path	Trigger, RF Burst
Remote Command	:TRIGger[:SEquence]:RFBurst:LEVel:TYPE ABSolute RELative :TRIGger[:SEquence]:RFBurst:LEVel:TYPE?
Example	TRIG:RFB:LEV:TYPE REL sets the trigger level type of the RF burst trigger to Relative.
Preset	ABSolute
State Saved	Saved in instrument state
Initial S/W Revision	Prior to A.02.00
Modified at S/W Revision	A.04.00

Relative Trigger Level

Sets the relative trigger level for the RF burst envelope.

In some models, the relative burst trigger function is implemented in hardware. In other models, without the advanced triggering hardware required, the relative burst trigger function is implemented in software in some measurements, and is unavailable in other measurements.

When implemented in software, the relative RF Burst trigger function is implemented as follows:

1. The measurement starts with the absolute RF Burst trigger setting. If it cannot get a trigger with that level, auto trigger fires and the acquisition starts anyway. After the acquisition, the measurement searches for the peak in the acquired waveform and saves it.

2. Now, in the next cycle of the measurement, the measurement determines a new absolute RF Burst level based on the peak value from the first measurement and the Relative RF Burst Trigger Level (always 0 or negative dB) set by the user. The following formula is used:
 3. absolute RF Burst level = peak level of the previous acquisition + relative RF Burst level
 4. If the new absolute RF Burst level differs from the previous by more than 0.5 dB, the new level is sent to the hardware; otherwise it is not updated (to avoid slowing down the acquisition)
- Steps 2 and 3 repeat for subsequent measurements.

Key Path	Trigger, RF Burst
Scope	Meas Global
Remote Command	:TRIGger[:SEquence]:RFBurst:LEVel:RELative <rel_ampl> :TRIGger[:SEquence]:RFBurst:LEVel:RELative?
Example	TRIG:RFB:LEV:REL -10 dB sets the trigger level of the RF burst envelope signal to the relative level of -10 dB
Notes	Sending this command does not switch the setting from absolute to relative; to switch it you need to send the :TRIGger[:SEquence]:RFBurst:LEVel:TYPE command, above. The relative trigger level is not available in some measurements. In those measurements the RELative parameter, and the :TRIGger[:SEquence]:RFBurst:LEVel:TYPE command (above), will generate an error if sent.
Dependencies	This key is grayed out and Absolute Trigger Level selected if the required hardware is not present in your analyzer and the current measurement does not support Relative triggering.
Preset	-6 dB GSM: -25 dB
State Saved	Saved in instrument state
Min	-45 dB
Max	0 dB
Default Unit	dB or dBc
Backwards Compatibility SCPI	:TRIGger[:SEquence]:RFBurst:LEVel This legacy command is aliased to :TRIGger[:SEquence]:RFBurst:LEVel:RELative because the PSA had ONLY relative burst triggering
Initial S/W Revision	Prior to A.02.00
Modified at S/W Revision	A.04.00

Trigger Slope

It is set positive to trigger on a rising edge and negative to trigger on a falling edge.

Key Path	Trigger, RF Burst
Remote Command	:TRIGger[:SEquence]:RFBurst:SLOPe POSitive NEGative :TRIGger[:SEquence]:RFBurst:SLOPe?

Example	TRIG:RFB:SLOP NEG
Couplings	This same slope is used in the RF Burst selection for the trigger source in the Trigger menu and for the period timer sync source (in the Trigger menu and in the Gate Source menu).
Preset	POSitive
State Saved	Saved in instrument state
Backwards Compatibility SCPI	:TRIGger[:SEQuence]:FRAMe:RFBurst:SLOPe
Backwards Compatibility Notes	The legacy :TRIGger[:SEQuence]:SLOPe command affects the slopes for the VID, LINE, EXT1, EXT2, and RFB triggers.
Initial S/W Revision	Prior to A.02.00

Trig Delay

Controls a time delay during which the analyzer will wait to begin a sweep after meeting the trigger criteria. You can use negative delay to pre-trigger the instrument in time domain or FFT, but not in swept spans.

Key Path	Trigger, RF Burst
Remote Command	:TRIGger[:SEQuence]:RFBurst:DELAy <time> :TRIGger[:SEQuence]:RFBurst:DELAy? :TRIGger[:SEQuence]:RFBurst:DELAy:STATe OFF ON 0 1 :TRIGger[:SEQuence]:RFBurst:DELAy:STATe?
Example	TRIG:RFB:DEL:STAT ON TRIG:RFB:DEL 100 ms
Notes	Video trigger delay may be set to negative values, in time domain, FFT and even swept. It makes intuitive sense in time domain and works well in FFT mode where the bandwidth of the filter before the video trigger is about 1.25 span. In swept spans, negative settings of Trig Delay are treated as a zero setting within the internal hardware and the advisory message "Neg. Trig Delay unavailable in Swept Mode, zero delay used." is generated when such a delay is set.
Preset	Off, 1.000 us
State Saved	Saved in instrument state
Min	-150 ms
Max	500 ms
Default Unit	s
Backwards Compatibility Notes	The legacy :TRIGger[:SEQuence]:DELAy command affects the delay for the VID, LINE, EXT1, EXT2, and RFB triggers.
Initial S/W Revision	Prior to A.02.00

Periodic Timer (Frame Trigger)

Pressing this key, when it is not selected, selects the internal periodic timer signal as the trigger. Triggering occurrences are set by the **Period** parameter, which is modified by the **Sync Source** and **Offset**. Pressing this key, when it is already selected, accesses the periodic timer trigger setup functions.

If you do not have a sync source selected (it is Off), then the internal timer will not be synchronized with any external timing events.

Key Path	Trigger
Example	TRIG:SOUR FRAM Swept SA measurement TRIG:<meas>:SOUR FRAM Measurements other than Swept SA
State Saved	Saved in instrument state
Readback	[Sync: <value of Sync Source>], for example, [Sync: External 1]
Status Bits/OPC dependencies	The Status Operation Register bit 5 "Waiting for Trigger" is set at the same time as the Sweeping or Measuring bit is set. It is cleared when the trigger actually occurs (that is, after the trigger event occurs and all the applicable trigger criteria have been met). A corresponding pop-up message ("Waiting for trigger") is generated if no trigger signal appears after approximately 2 sec. This message goes away when a trigger signal appears.
Initial S/W Revision	Prior to A.02.00

Periodic Timer Triggering:

This feature selects the internal periodic timer signal as the trigger. Trigger occurrences are set by the **Periodic Timer** parameter, which is modified by the **Sync Source** and **Offset**.

The figure below shows the action of the periodic timer trigger. Before reviewing the figure, we'll explain some uses for the periodic trigger.

A common application is measuring periodic burst RF signals for which a trigger signal is not easily available. For example, we might be measuring a TDMA radio which bursts every 20 ms. Let's assume that the 20 ms period is very consistent. Let's also assume that we do not have an external trigger source available that is synchronized with the period, and that the signal-to-noise ratio of the signal is not high enough to provide a clean RF burst trigger at all of the analysis frequencies. For example, we might want to measure spurious transmissions at an offset from the carrier that is larger than the bandwidth of the RF burst trigger. In this application, we can set the Periodic Timer to a 20.00 ms period and adjust the offset from that timer to position our trigger just where we want it. If we find that the 20.00 ms is not exactly right, we can adjust the period slightly to minimize the drift between the period timer and the signal to be measured.

A second way to use this feature would be to use **Sync Source** temporarily, instead of **Offset**. In this case, we might tune to the signal in a narrow span and use the RF Burst trigger to synchronize the periodic timer. Then we would turn the sync source off so that it would not miss-trigger. Miss-triggering can occur when we are tuned so far away from the RF burst trigger that it is no longer reliable.

A third example would be to synchronize to a signal that has a reference time element of much longer period than the period of interest. In some CDMA applications, it is useful to look at signals with a short periodicity, by synchronizing that periodicity to the "even-second clock" edge that happens every two

seconds. Thus, we could connect the even-second clock trigger to Ext1 and use then Ext1 as the sync source for the periodic timer.

The figure below illustrates this third example. The top trace represents the even-second clock. It causes the periodic timer to synchronize with the leading edge shown. The analyzer trigger occurs at a time delayed by the accumulated offset from the period trigger event. The periodic timer continues to run, and triggers continue to occur, with a periodicity determined by the analyzer time base. The timer output (labeled "late event") will drift away from its ideal time due to imperfect matching between the time base of the signal being measured and the time base of the analyzer, and also because of imperfect setting of the period parameter. But the synchronization is restored on the next even-second clock event. ("Accumulated offset" is described in the in the **Offset** function section.)

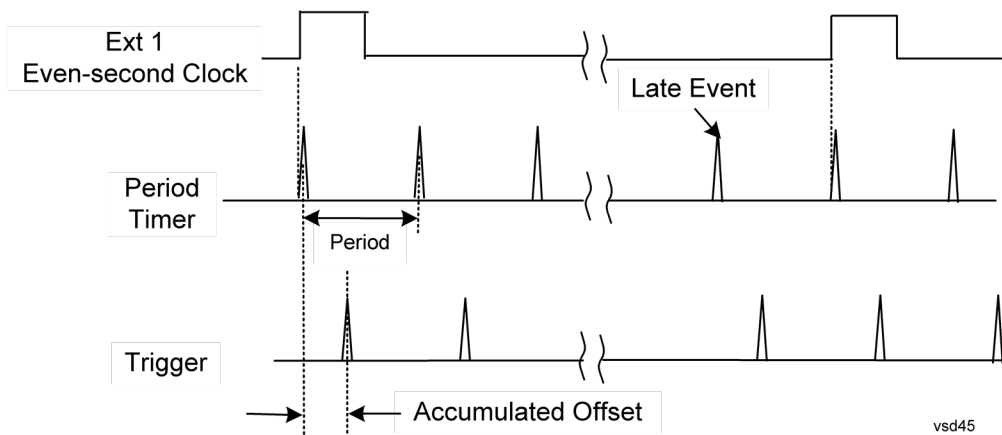

Period

Sets the period of the internal periodic timer clock. For digital communications signals, this is usually set to the frame period of your current input signal. In the case that sync source is not set to OFF, and the external sync source rate is changed for some reason, the periodic timer is synchronized at the every external synchronization pulse by resetting the internal state of the timer circuit.

Key Path	Trigger, Periodic Timer
Remote Command	:TRIGger[:SEquence]:FRAMe:PERiod <time> :TRIGger[:SEquence]:FRAMe:PERiod?
Example	TRIG:FRAM:PER 100 ms
Dependencies	The invalid data indicator turns on when the period is changed, until the next sweep/measurement completes.
Couplings	The same period is used in the Gate Source selection of the period timer.
Preset	20 ms GSM: 4.615383
State Saved	Saved in instrument state
Min	100.000 ns
Max	559.0000 ms
Default Unit	S
Initial S/W Revision	Prior to A.02.00

Offset

Adjusts the accumulated offset between the periodic timer events and the trigger event. Adjusting the accumulated offset is different than setting an offset, and requires explanation.

The periodic timer is usually not synchronized with any external events, so the timing of its output events has no absolute meaning. Since the timing relative to external events (RF signals) is important, you need to be able to adjust (offset) it. However, you have no direct way to see when the periodic timer events occur. All that you can see is the trigger timing. When you want to adjust the trigger timing, you will be changing the internal offset between the periodic timer events and the trigger event. Because the absolute value of that internal offset is unknown, we will just call that the accumulated offset. Whenever the Offset parameter is changed, you are changing that accumulated offset. You can reset the displayed offset using Reset Offset Display. Changing the display does not change the value of the accumulated offset, and you can still make additional changes to accumulated offset.

To avoid ambiguity, we define that an increase in the "offset" parameter, either from the knob or the SCPI adjust command, serves to delay the timing of the trigger event.

Key Path	Trigger, Periodic Timer
Remote Command	:TRIGger[:SEquence]:FRAMe:OFFSet <time> :TRIGger[:SEquence]:FRAMe:OFFSet?
Example	TRIG:FRAM:OFFS 1.2 ms
Notes	<p>The front panel interface (for example, the knob), and this command, adjust the accumulated offset, which is shown on the active function display. However, the actual amount sent to the hardware each time the offset is updated is the delta value, that is, the current accumulated offset value minus the previous accumulated offset value. Note that the accumulated offset value is essentially arbitrary; it represents the accumulated offset from the last time the offset was zeroed (with the Reset Offset Display key).</p> <p>Note that this command does not change the period of the trigger waveform. Note also that Offset is used only when the sync source is set to OFF, otherwise delay is used, see section "Trig Delay" on page 476.</p> <p>An increase in the "offset" parameter, either from the knob or the SCPI adjust command, serves to delay the timing of the trigger event.</p>
Notes	<p>When the SCPI command is sent the value shown on the key (and the Active Function, if this happens to be the active function) is updated with the new value. However, the actual amount sent to the hardware is the delta value, that is, the current accumulated offset value minus the previous accumulated offset value.</p> <p>The SCPI query simply returns the value currently showing on the key.</p>
Dependencies	The invalid data indicator turns on when the offset is changed, until the next sweep/measurement completes.
Couplings	The same offset is used in the Gate Source selection of the period timer.
Preset	0 s
State Saved	Saved in instrument state
Min	-10.000 s
Max	10.000 s

Default Unit	S
Initial S/W Revision	Prior to A.02.00

Reset Offset Display

Resets the value of the periodic trigger offset display setting to 0.0 seconds. The current displayed trigger location may include an offset value defined with the **Offset** key. Pressing this key redefines the currently displayed trigger location as the new trigger point that is 0.0 s offset. The **Offset** key can then be used to add offset relative to this new timing.

Key Path	Trigger, Periodic Timer
Remote Command	:TRIGger[:SEquence]:FRAMe:OFFSet:DISPlay:RESet
Example	TRIG:FRAM:OFFS:DISP:RES
Initial S/W Revision	Prior to A.02.00

Sync Source

Selects a signal source for you to synchronize your periodic timer trigger to, otherwise you are triggering at some arbitrary location in the frame. Synchronization reduces the precision requirements on the setting of the period.

For convenience you may adjust the level and slope of the selected sync source in a conditional branch setup menu accessed from the Sync Source menu. Note that these settings match those in the **Trigger** and **Gate Source** menus; that is, each trigger source has only one value of level and slope, regardless of which menu it is accessed from.

Key Path	Trigger, Periodic Timer
Remote Command	:TRIGger[:SEquence]:FRAMe:SYNC EXTernal1 EXTernal2 RFBurst OFF :TRIGger[:SEquence]:FRAMe:SYNC?
Example	TRIG:FRAM:SYNC EXT2
Dependencies	In some models, there is no second External input. In these models, the External 2 key is blanked and the EXTernal2 parameter will generate a "Hardware missing; Not available for this model number" message.
Preset	Off GSM/EDGE, MSR,LTE,LTETDD: RFBurst
State Saved	Saved in instrument state
Readback	The current setting is read back to this key and it is also Readback to the previous Periodic Timer trigger key.
Backwards Compatibility SCPI	:TRIGger[:SEquence]:FRAMe:SYNC EXTernal For backward compatibility, the parameter EXTernal is mapped to EXTernal1
Initial S/W Revision	Prior to A.02.00

 Modified at S/W Revision A.03.00, A.14.00

Off

Turns off the sync source for your periodic trigger. With the sync source off, the timing will drift unless the signal source frequency is locked to the analyzer frequency reference.

Key Path	Trigger, Periodic Timer, Sync Source
Example	TRIG:FRAM:SYNC OFF
Readback	Off
Initial S/W Revision	Prior to A.02.00

External 1

Pressing this key, when it is not selected, selects an external input signal as the trigger. A new sweep/measurement will start when the external trigger condition is met using the external 1 input connector on the rear panel.

Pressing this key, when it is already selected, accesses the external 1 trigger setup menu.

Key Path	Trigger
Example	TRIG:SOUR EXT1 Swept SA measurement TRIG:<meas>:SOUR EXT1 Measurements other than Swept SA
Dependencies	Grayed out if in use by Point Trigger in the Source Setup menu. Forced to Free Run if already selected and Point Trigger is set to External 1.
State Saved	Saved in instrument state
Status Bits/OPC dependencies	The Status Operation Register bit 5 "Waiting for Trigger" is set at the same time as the Sweeping or Measuring bit is set. It is cleared when the trigger actually occurs (that is, after the trigger event occurs and all the applicable trigger criteria have been met). A corresponding pop-up message ("Waiting for trigger") is generated if no trigger signal appears after approximately 2 sec. This message goes away when a trigger signal appears.
Initial S/W Revision	Prior to A.02.00

Trigger Level

Sets the value where the external 1 trigger input will trigger a new sweep/measurement.

Key Path	Trigger, External 1
Remote Command	:TRIGger[:SEquence]:EXTernal1:LEVel <level> :TRIGger[:SEquence]:EXTernal1:LEVel?

Example	TRIG:EXT1:LEV 0.4 V
Couplings	This same level is used for the Ext1 trigger source in the Trigger menu, for the Ext1 selection in the Periodic Timer sync source (in the Trigger menu and in the Gate Source menu), and also for the Ext1 selection in the Gate Source menu.
Preset	1.2 V
State Saved	Saved in instrument state
Min	-5 V
Max	5 V
Default Unit	V
Backwards Compatibility SCPI	:TRIGger[:SEquence]:EXTernal:LEVel
Backwards Compatibility SCPI	For backward compatibility, the parameter EXTernal is mapped to EXTernal1
Backwards Compatibility SCPI	:TRIGger[:SEquence]:FRAMe:EXTernal1:LEVel
Initial S/W Revision	Prior to A.02.00

Trig Slope

Controls the trigger polarity. It is set positive to trigger on a rising edge and negative to trigger on a falling edge.

Key Path	Trigger, External 1
Remote Command	:TRIGger[:SEquence]:EXTernal1:SLOPe POSitive NEGative :TRIGger[:SEquence]:EXTernal1:SLOPe?
Example	TRIG:EXT1:SLOP NEG
Couplings	This same slope is used in the Ext1 selection for the trigger source in the Trigger menu and for the period timer sync source (in the Trigger menu and in the Gate Source menu).
Preset	POSitive
State Saved	Saved in instrument state
Backwards Compatibility SCPI	:TRIGger[:SEquence]:EXTernal:SLOPe
Backwards Compatibility SCPI	For backward compatibility, the parameter EXTernal is mapped to EXTernal1
Backwards Compatibility SCPI	:TRIGger[:SEquence]:FRAMe:EXTernal1:SLOPe
Backwards Compatibility Notes	The legacy :TRIGger[:SEquence]:SLOPe command affects the slopes for the VID, LINE, EXT1, EXT2, and RFB triggers.
Initial S/W Revision	Prior to A.02.00

External 2

Pressing this key, when it is not selected, selects an external input signal as the trigger. A new sweep/measurement will start when the external trigger condition is met using the external 2 input

connector. The external trigger 2 input connector is on the rear panel.

Pressing this key, when it is already selected, accesses the external 2 trigger setup menu.

Key Path	Trigger
Example	TRIG:SOUR EXT2 Swept SA measurement TRIG:<meas>:SOUR EXT2 Measurements other than Swept SA
Dependencies	In some models, there is no second External input. In these models, the External 2 key is blanked and the EXTernal2 parameter will generate a "Hardware missing; Not available for this model number" message. Grayed out if in use by Point Trigger in the Source Setup menu. Forced to Free Run if already selected and Point Trigger is set to External 2.
State Saved	Saved in instrument state
Status Bits/OPC dependencies	The Status Operation Register bit 5 "Waiting for Trigger" is set at the same time as the Sweeping or Measuring bit is set. It is cleared when the trigger actually occurs (that is, after the trigger event occurs and all the applicable trigger criteria have been met). A corresponding pop-up message ("Waiting for trigger") is generated if no trigger signal appears after approximately 2 sec. This message goes away when a trigger signal appears.
Initial S/W Revision	Prior to A.02.00
Modified at S/W Revision	A.03.00

Trigger Level

Sets the value where the external 2 trigger input will trigger a new sweep/measurement.

Key Path	Trigger, External 2
Remote Command	:TRIGger[:SEQuence]:EXTernal2:LEVel :TRIGger[:SEQuence]:EXTernal2:LEVel?
Example	TRIG:EXT2:LEV 1.1 V
Couplings	This same level is used for the Ext2 trigger source in the Trigger menu, for the Ext2 selection in the Periodic Timer sync source (in the Trigger menu and in the Gate Source menu), and also for the Ext2 selection in the Gate Source menu.
Preset	1.2 V
State Saved	Saved in instrument state
Min	-5 V
Max	5 V
Default Unit	V
Backwards Compatibility SCPI	:TRIGger[:SEQuence]:FRAMe:EXTernal2:LEVel
Initial S/W Revision	Prior to A.02.00

Trig Slope

Controls the trigger polarity. It is set positive to trigger on a rising edge and negative to trigger on a falling edge.

Key Path	Trigger, External 2
Remote Command	:TRIGger[:SEquence]:EXTernal2:SLOPe POSitive NEGative :TRIGger[:SEquence]:EXTernal2:SLOPe?
Example	TRIG:EXT2:SLOP NEG
Couplings	This same slope is used in the Ext2 selection for the trigger source in the Trigger menu and for the period timer sync source (in the Trigger menu and in the Gate Source menu).
Preset	POSitive
State Saved	Saved in instrument state
Backwards Compatibility SCPI	:TRIGger[:SEquence]:FRAMe:EXTernal2:SLOPe
Backwards Compatibility Notes	The legacy :TRIGger[:SEquence]:SLOPe command affects the slopes for the VID, LINE, EXT1, EXT2, and RFB triggers.
Initial S/W Revision	Prior to A.02.00

RF Burst

Pressing this key, when it is not selected, selects the RF Burst as the trigger. A new sweep/measurement will start when an RF burst envelope signal is identified from the signal at the RF Input connector. Pressing this key, when it is already selected, accesses the RF Burst trigger setup menu.

In some models, a variety of burst trigger circuitry is available, resulting in various available burst trigger bandwidths. The analyzer automatically chooses the appropriate trigger path based on the hardware configuration and other settings of the analyzer.

Key Path	Trigger
Example	TRIG:SOUR RFB Swept SA measurement TRIG:< meas>:SOUR RFB Measurements other than Swept SA
State Saved	Saved in instrument state
Status Bits/OPC dependencies	The Status Operation Register bit 5 "Waiting for Trigger" is set at the same time as the Sweeping or Measuring bit is set. It is cleared when the trigger actually occurs (that is, after the trigger event occurs and all the applicable trigger criteria have been met). A corresponding pop-up message ("Waiting for trigger") is generated if no trigger signal appears after approximately 2 sec. This message goes away when a trigger signal appears.
Backwards Compatibility Notes	The legacy command: :TRIGger[:SEquence]:RFBurst:FSElectivity[:STATe] OFF ON 0 1 is not supported in the X-Series, as the hardware to do Frequency Selective burst triggers does not exist in X-Series.
Initial S/W Revision	Prior to A.02.00
Modified at S/W Revision	A.04.00

Absolute Trigger Level

Sets the absolute trigger level for the RF burst envelope.

When using the External Mixing path, the Absolute Trigger Level is uncalibrated because the factory default was set to accommodate the expected IF levels for the RF path.

Key Path	Trigger, RF Burst
Scope	Meas Global
Remote Command	:TRIGger[:SEquence]:RFBurst:LEVel:ABSolute <ampl> :TRIGger[:SEquence]:RFBurst:LEVel:ABSolute?
Example	TRIG:RFB:LEV:ABS 10 dBm sets the trigger level of the RF burst envelope signal to the absolute level of 10 dBm
Notes	Sending this command does not switch the setting from relative to absolute; to switch it you need to send the :TRIGger[:SEquence]:RFBurst:LEVel:TYPE command, below. Amplitude Corrections are not taken into account by the Absolute Trigger Level. For example, if you have given yourself effective gain with an amplitude correction factor, the Absolute Trigger will not fire until you have set the trigger level that far below the displayed signal level, rather than simply to the displayed signal level. This is only true for Amplitude Corrections, not External Gain or Ref Level Offset functions. If mode is Bluetooth, the default value is -50 dBm.
Couplings	This same level is used for the RF Burst trigger source in the Trigger menu, for the RF Burst selection in the Periodic Timer sync source (in the Trigger menu and in the Gate Source menu), and also for the RF Burst selection in the Gate Source menu
Preset	-20 dBm
State Saved	Saved in instrument state
Min	-200 dBm
Max	100 dBm
Default Unit	depends on the current selected Y-Axis unit
Backwards Compatibility SCPI	:TRIGger[:SEquence]:FRAME:RFBurst:LEVel:ABSolute
Initial S/W Revision	Prior to A.02.00
Modified at S/W Revision	A.04.00

Key Path	Trigger, RF Burst
Remote Command	:TRIGger[:SEquence]:RFBurst:LEVel:TYPE ABSolute RELative :TRIGger[:SEquence]:RFBurst:LEVel:TYPE?
Example	TRIG:RFB:LEV:TYPE REL sets the trigger level type of the RF burst trigger to Relative.
Preset	ABSolute

State Saved	Saved in instrument state
Initial S/W Revision	Prior to A.02.00
Modified at S/W Revision	A.04.00

Trigger Slope

It is set positive to trigger on a rising edge and negative to trigger on a falling edge.

Key Path	Trigger, RF Burst
Remote Command	:TRIGger[:SEquence]:RFBurst:SLOPe POSitive NEGative :TRIGger[:SEquence]:RFBurst:SLOPe?
Example	TRIG:RFB:SLOP NEG
Couplings	This same slope is used in the RF Burst selection for the trigger source in the Trigger menu and for the period timer sync source (in the Trigger menu and in the Gate Source menu).
Preset	POSitive
State Saved	Saved in instrument state
Backwards Compatibility SCPI	:TRIGger[:SEquence]:FRAME:RFBurst:SLOPe
Backwards Compatibility Notes	The legacy :TRIGger[:SEquence]:SLOPe command affects the slopes for the VID, LINE, EXT1, EXT2, and RFB triggers.
Initial S/W Revision	Prior to A.02.00

Trig Delay

This setting delays the measurement timing relative to the Periodic Timer.

Key Path	Trigger, Periodic Timer
Remote Command	:TRIGger[:SEquence]:FRAME:DELAy <time> :TRIGger[:SEquence]:FRAME:DELAy? :TRIGger[:SEquence]:FRAME:DELAy:STATE OFF ON 0 1 :TRIGger[:SEquence]:FRAME:DELAy:STATE?
Notes	Note that delay is used when the sync source is not set to OFF. If the sync source is set to OFF, offset is used.
Preset	Off, 1.000 us
State Saved	Saved in instrument state
Min	-150 ms
Max	+500 ms
Default Unit	s
Initial S/W Revision	Prior to A.02.00

Auto/Holdoff

Opens up a menu that lets you adjust Auto Trigger and Trigger Holdoff parameters

Key Path	Trigger
Readback line	Displays a summary of the Auto Trig and Holdoff settings, in square brackets First line: Auto Off or Auto On Second Line: "Hld" followed by: <ul style="list-style-type: none"> • If Holdoff is Off, readback Off • If Holdoff On and Type = Normal, readback value • If Holdoff On and Type = Above, readback value followed by AL • If Holdoff On and Type = Below, readback value followed by BL • If Holdoff Type selection is not supported by the current measurement, Holdoff Type is always Normal
Initial S/W Revision	A.02.00

Auto Trig

Sets the time that the analyzer will wait for the trigger conditions to be met. If they are not met after that much time, then the analyzer is triggered anyway.

Key Path	Trigger, Auto/Holdoff
Remote Command	:TRIGger[:SEQuence]:ATRigger <time> :TRIGger[:SEQuence]:ATRigger? :TRIGger[:SEQuence]:ATRigger:STATe OFF ON 0 1 :TRIGger[:SEQuence]:ATRigger:STATe?
Example	TRIG:ATR:STAT ON TRIG:ATR 100 ms
Notes	The "time that the analyzer will wait" starts when the analyzer is ready for a trigger, which may be hundreds of ms after the data acquisition for a sweep is done. The "time" ends when the trigger condition is satisfied, not when the delay ends.
Preset	Off, 100 ms
State Saved	Saved in instrument state
Min	1 ms
Max	100 s
Default Unit	s
Initial S/W Revision	Prior to A.02.00

Trig Holdoff

Sets the holdoff time between triggers. When the trigger condition is satisfied, the trigger occurs, the delay begins, and the holdoff time begins. New trigger conditions will be ignored until the holdoff time expires. For a free-running trigger, the holdoff value is the minimum time between triggers.

Key Path	Trigger, Auto/Holdoff
Remote Command	:TRIGger[:SEquence]:HOLDoff <time> :TRIGger[:SEquence]:HOLDoff? :TRIGger[:SEquence]:HOLDoff:STATe OFF ON 0 1 :TRIGger[:SEquence]:HOLDoff:STATe?
Example	TRIG:HOLD:STAT ON TRIG:HOLD 100 ms
Dependencies	Unavailable if the selected Input is BBIQ. If this is the case, the key is grayed out if it is pressed the informational message "Feature not supported for this Input" is displayed. If the SCPI command is sent, the error "Settings conflict; Feature not supported for this Input" is generated.
Preset	Off, 100 ms
State Saved	Saved in instrument state
Min	0 s
Max	0.5 s
Default Unit	s
Initial S/W Revision	Prior to A.02.00

Holdoff Type

Lets you set the Trigger Holdoff Type.

NOTE Holdoff Type is not supported by all measurements. If the current measurement does not support it, this key will be blank and the Holdoff Type will be Normal. If the Holdoff Type SCPI is sent while in such a measurement, the SCPI will be accepted and the setting remembered, but it will have no effect until a measurement is in force that supports Holdoff Type.

Trigger Holdoff Type functionality:

- NORMAl
- This is the "oscilloscope" type of trigger holdoff, and is the setting when the Holdoff Type key does not appear. In this type of holdoff, no new trigger will be accepted until the holdoff interval has expired after the previous trigger.
- ABOVE
- If the trigger slope is positive, a trigger event is generated only if the signal characteristic of interest crosses the trigger threshold (with positive slope) and then remains above the threshold for at least the holdoff time. For negative slope, the trigger event is generated if the signal characteristic crosses the

threshold (with negative slope) after having been above the threshold for at least the holdoff time. In either case, the trigger event is associated with the time the level was crossed.

- BELow
- If the trigger slope is positive, a trigger event is generated only if the signal characteristic of interest crosses the trigger threshold (with positive slope) after having been below the threshold for at least the holdoff time. For negative slope, the trigger event is generated if the signal characteristic crosses the threshold (with negative slope) and then remains below the threshold for at least the holdoff time. In either case, the trigger event is associated with the time the level was crossed.

Key Path	Trigger, Auto/Holdoff
Remote Command	:TRIGger[:SEquence]:HOLDoff:TYPE NORMal ABOVe BELow :TRIGger[:SEquence]:HOLDoff:TYPE?
Example	TRIG:HOLD:TYPE NORM
Preset	All modes but GSM/EDGE: Normal GSM/EDGE: Below
State Saved	Saved in instrument state
Initial S/W Revision	A.02.00

8 Channel Power Measurement

The Channel Power measurement is used to find the total power present in a specified bandwidth. The power spectral density (the power in the signal normalized to 1 Hz) is also reported (In WLAN mode or WLAN radio standard in SA mode, the peak power spectral density for 1 MHz is reported). For measurement results and views, see ["View/Display" on page 680](#).

This topic contains the following sections:

["Measurement Commands for Channel Power" on page 482](#)

["Remote CommandResults for Channel Power Measurement" on page 483](#)

Measurement Commands for Channel Power

These commands are used to measure the total rms power in a specified integration bandwidth.

Use `:INSTrument:SElect` to set the mode.

```
:CONFigure:CHPower
:CONFigure:CHPower:NDEFault
:INITiate:CHPower
:FETCh:CHPower[n]?
:MEASure:CHPower[n]?
:READ:CHPower[n]?
:FETCh:CHPower:CHPower?
:MEASure:CHPower:CHPower?
:READ:CHPower:CHPower?
:FETCh:CHPower:DENSity?
:MEASure:CHPower:DENSity?
:READ:CHPower:DENSity
```

For more measurement related commands, see the SENSE subsystem, and the section "[Remote Measurement Functions](#)" on page 2381.

Remote Command Results for Channel Power Measurement

For DVB-T/H and DTMB (CTTB) mode, see ["DVB-T/H and DTMB \(CTTB\) Mode Remote Command Results" on page 484](#).

For ISDB-T and CMMB mode, see ["ISDB-T and CMMB mode Remote Command Results" on page 486](#).

For MSR, see ["Remote Command Results for WLAN Channel Power Measurement" on page 489](#)

For LTE-Advanced FDD/TDD, see ["LTE-Advanced FDD/TDD Mode Remote Command Results " on page 488](#)

For WLAN, see ["MSR Mode Remote Command Results" on page 487](#)

Command	Return Value
FETCh:CHPower[n]?	Refer to the table below.
MEASure:CHPower[n]?	
READ:CHPower[n]?	
FETCh:CHPower:CHPower?	Returns the Channel Power (dBm) (BW compatibility functionality)
MEASure:CHPower:CHPower?	
READ:CHPower:CHPower?	
FETCh:CHPower:DENSity?	Returns the Power Spectral Density (dBm/Hz) (BW compatibility functionality)
MEASure:CHPower:DENSity?	
READ:CHPower:DENSity?	

n	Results Returned
n=1 (or not specified)	Returns scalar results: <ol style="list-style-type: none"> Channel Power is a floating point number representing the total channel power in the specified integration bandwidth. PSD (Power Spectral Density) is the power in the specified unit bandwidth. The unit bandwidth is selected by the PSD Unit parameter in either dBm/Hz or dBm/MHz.
2	Returns floating point numbers that are the captured trace data of the power (in dBm/resolution BW) of the signal. The frequency span of the captured trace data is specified by the Span key.

DVB-T/H and DTMB (CTTB) Mode Remote Command Results

The following commands are available only for DVB-T/H and DTMB (CTTB) mode.

Condition	n	Results Returned
	n=1 (or not specified)	Returns scalar results: 1. Channel Power is a floating point number representing the total channel power in the specified integration bandwidth. 2. PSD (Power Spectral Density) is the power in the specified unit bandwidth. The unit bandwidth is selected by the PSD Unit parameter in either dBm/Hz or dBm/MHz.
	2	Returns floating point numbers that are the captured trace data of the power (in dBm/resolution BW) of the signal. The frequency span of the captured trace data is specified by the Span key.
Mode = DVB-T/H or Mode = DTMB (CTTB)	3	Returns 7 comma-separated scalar results, in the following order. 1. The shoulder attenuation result (dB) 2. Lower shoulder attenuation result (dB) 3. Upper shoulder attenuation result (dB) 4. Lower Offset - MAX shoulder point power (dBm) 5. Lower Offset - MAX shoulder point frequency (MHz) 6. Upper Offset - MAX shoulder point power (dBm) 7. Upper Offset - MAX shoulder point frequency (MHz) If the results are not available, -999.0 is returned. For example, if current view is RF spectrum or spectrum mask, -999.0 is returned.
Mode = DVB-T/H or Mode = DTMB (CTTB)	4	Returns floating point numbers that are the captured trace data of the power (in dBm/resolution BW) of the signal in the left graph of the shoulder attenuation view. If the results are not available, -999.0 is returned. For example, if current view is RF spectrum or spectrum mask, -999.0 is returned.
Mode = DVB-T/H or Mode = DTMB (CTTB)	5	Returns floating point numbers that are the captured trace data of the power (in dBm/resolution BW) of the signal in the right graph of the shoulder attenuation view. If the results are not available, -999.0 is returned. For example, if current view is RF spectrum or spectrum mask, -999.0 is returned.
Mode = DVB-T/H or Mode = DTMB (CTTB)	6	Returns floating point numbers that are the captured trace data of the power (in dBm/resolution BW) of the mask in the spectrum mask view. If the results are not available, -999.0 is returned. For example, if current view is RF spectrum or shoulder attenuation, -999.0 is returned.
Mode = DVB-T/H or Mode = DTMB (CTTB)	7	Returns the failed point information in the following order: 1. the 1st failed point frequency (MHz) 2. the 1st failed point absolute power (dBm) 3. the 1st failed point relative power (dB) 4. the 2nd failed point frequency (MHz) 5. the 2nd failed point absolute power (dBm)

6. the 2nd failed point relative power (dB)

...

$3*N-2$. the ($3*N-2$)th failed point frequency (MHz)

$3*N-1$. the ($3*N-1$)th failed point absolute power (dBm)

$3*N$. the ($3*N$)th failed point relative power (dB)

If the number of failed points is less than 20, it will show all of them (frequency, power and relative power), $N < 20$;

If the number of failed points is great than 20, the first ten failed points and the last ten failed points will be show, $N=20$.

If the results are not available, -999.0 is returned.

For example, if current view is RF spectrum or shoulder attenuation, -999.0 is returned.

ISDB-T and CMMB mode Remote Command Results

The following commands are available only for ISDB-T and CMMB mode.

Condition	n	Results Returned
	n=1 (or not specified)	Returns scalar results: 1. Channel Power is a floating point number representing the total channel power in the specified integration bandwidth. 2. PSD (Power Spectral Density) is the power in the specified unit bandwidth. The unit bandwidth is selected by the PSD Unit parameter in either dBm/Hz or dBm/MHz.
	2	Returns floating point numbers that are the captured trace data of the power (in dBm/resolution BW) of the signal. The frequency span of the captured trace data is specified by the Span key.
Mode = ISDB-T or Mode = CMMB	3	Returns 7 comma-separated scalar results, in the following order. 1. The shoulder attenuation result (dB) 2. Lower shoulder attenuation result (dB) 3. Upper shoulder attenuation result (dB) 4. Lower Offset - MAX shoulder point power (dBm) 5. Lower Offset - MAX shoulder point frequency (MHz) 6. Upper Offset - MAX shoulder point power (dBm) 7. Upper Offset - MAX shoulder point frequency (MHz) If the results are not available, -999.0 is returned. For example, if current view is RF spectrum or spectrum mask, -999.0 is returned.
Mode = ISDB-T or Mode = CMMB	4	Returns floating point numbers that are the captured trace data of the power (in dBm/resolution BW) of the signal in the left window of the shoulder attenuation view. If the results are not available, -999.0 is returned. For example, if current view is RF spectrum or spectrum mask, -999.0 is returned.
Mode = ISDB-T or Mode = CMMB	5	Returns floating point numbers that are the captured trace data of the power (in dBm/resolution BW) of the signal in the right window of the shoulder attenuation view. If the results are not available, -999.0 is returned. For example, if current view is RF spectrum or spectrum mask, -999.0 is returned.

MSR Mode Remote Command Results

The following commands are available only for MSR mode.

Condition	n	Results Returned
	n=1 (or not specified)	Returns scalar results: 1. Channel Power is a floating point number representing the total channel power in the specified integration bandwidth. 2. PSD (Power Spectral Density) is the power in the specified unit bandwidth. The unit bandwidth is selected by the PSD Unit parameter in either dBm/Hz or dBm/MHz.
	2	Returns floating point numbers that are the captured trace data of the power (in dBm/resolution BW) of the signal. The frequency span of the captured trace data is specified by the Span key.
Mode = MSR	3	Returns [Carriers] comma-separated scalar results, in the following order. 1. Total Power of Carrier 1 (dBm) 2. Total Power of Carrier 2 (dBm) ... [Carriers]. Total Power of Carrier [Carriers] (dBm) If the result is not available, NaN (9.91E+37) is returned. Number of returned values might be changed in future releases.
Mode = MSR	4	Returns comma-separated scalar results, in the following order. 1. Total Power of LTE FDD carriers (dBm) 2. Total Power of W-CDMA carriers (dBm) 3. Total Power of GSM/EDGE carriers (dBm) 4. Total Power of cdma2000 carriers (dBm) 5. Total Power of 1xEV-DO carriers (dBm) ... The number of results is incremented by one when a new format is supported. If the result is not available, NaN (9.91E+37) is returned. Number of returned values will be changed in future releases if the number of supported radio format is increased.

LTE-Advanced FDD/TDD Mode Remote Command Results

The following commands are available only for LTE-Advanced FDD/TDD mode.

Condition	n	Results Returned
	n=1 (or not specified)	Returns scalar results: 1. Channel Power is a floating point number representing the total channel power in the specified integration bandwidth. 2. PSD (Power Spectral Density) is the power in the specified unit bandwidth. The unit bandwidth is selected by the PSD Unit parameter in either dBm/Hz or dBm/MHz.
	2	Returns floating point numbers that are the captured trace data of the power (in dBm/resolution BW) of the signal. The frequency span of the captured trace data is specified by the Span key.
Mode = LTEATDD/ LTEAFDD	3	Returns comma-separated scalar results, in the following order. 1. Total Power of Component Carrier 0 (dBm) 2. Total Power of Component Carrier 1 (dBm) 3. Total Power of Component Carrier 2 (dBm) 4. Total Power of Component Carrier 3 (dBm) 5. Total Power of Component Carrier 4 (dBm) If the result is not available, NaN (9.91E+37) is returned.
Mode = LTEATDD/ LTEAFDD	4	Returns comma-separated scalar results, in the following order. The unit bandwidth is selected by the PSD Unit parameter in either dBm/Hz or dBm/MHz. 1. Total Power Spectral Density of Component Carrier 0 (PSD Unit) 2. Total Power Spectral Density of Component Carrier 1 (PSD Unit) 3. Total Power Spectral Density of Component Carrier 2 (PSD Unit) 4. Total Power Spectral Density of Component Carrier 3 (PSD Unit) 5. Total Power Spectral Density of Component Carrier 4 (PSD Unit) If the result is not available, NaN (9.91E+37) is returned.

Remote Command Results for WLAN Channel Power Measurement

n	Results Returned
n=1 (or not specified)	<p>Returns scalar results:</p> <p>When the radio standard is NOT WLAN 802.11ac 80 + 80 MHz:</p> <ol style="list-style-type: none"> 1. Channel Power is a floating point number representing the total channel power in the specified integration bandwidth. 2. PSD (Power Spectral Density) is the power in the specified unit bandwidth. The unit bandwidth is selected by the PSD Unit parameter in either dBm/Hz or dBm/MHz. <p>When the radio standard is WLAN 802.11ac 80 + 80 MHz:</p> <ol style="list-style-type: none"> 1. Channel Power of the carrier of which the center frequency is indicated by Freq Segment 1 is a floating point number representing the total channel power of the first segment in the specified integration bandwidth. 2. PSD (Power Spectral Density) of the carrier of which the center frequency is indicated by Freq Segment 1 is the power in the specified unit bandwidth of the first segment. The unit bandwidth is selected by the PSD Unit parameter in either dBm/Hz or dBm/MHz. 3. Channel Power of the carrier of which the center frequency is indicated by Freq Segment 2 is a floating point number representing the total channel power of the second segment in the specified integration bandwidth. 4. PSD (Power Spectral Density) of the carrier of which the center frequency is indicated by Freq Segment 2 is the power in the specified unit bandwidth of the second segment. The unit bandwidth is selected by the PSD Unit parameter in either dBm/Hz or dBm/MHz.
2	Returns floating point numbers that are the captured trace data of the power (in dBm/resolution BW) of the signal. The frequency span of the captured trace data is specified by the Span key.

Key Path	Meas
Mode	SA, WCDMA, C2K, WIMAX OFDMA, 1xEVDO, DVB-T/H, DTMB (CTTB), ISDB-T, CMMB, LTE, LTETDD, Digital Cable TV, WLAN, MSR, LTEAFDD, LTEATDD
Initial S/W Revision	Prior to A.02.00
Modified at S/W Revision	A.03.00

AMPTD Y Scale

Accesses a menu of functions that enable you to set the vertical scale parameters. The parameter values are measurement independent, except all Attenuation values and the Internal Preamp selection, which are the same across all measurements.

Key Path	Front-panel key
Initial S/W Revision	Prior to A.02.00

Ref Value

Sets the value for the absolute power reference. However, since the Auto Scaling is defaulted to On, this value is automatically determined by the measurement result. When you set a value manually, Auto Scaling automatically changes to Off.

Key Path	AMPTD Y Scale
Mode	SA, WCDMA, C2K, WIMAX OFDMA, 1xEVDO, DVB-T/H, DTMB (CTTB), ISDB-T, CMMB, LTE, LTETDD, Digital Cable TV, WLAN, MSR, LTEAFDD, LTEATDD
Remote Command	:DISPlay:CHPower:VIEW[1]:WINDow[1]:TRACe:Y[:SCALe]:RLEVel <real> :DISPlay:CHPower:VIEW[1]:WINDow[1]:TRACe:Y[:SCALe]:RLEVel?
Example	DISP:CHP:VIEW:WIND:TRAC:Y:RLEV 10 dBm DISP:CHP:VIEW:WIND:TRAC:Y:RLEV?
Notes	You must be in the Spectrum Analysis mode, W-CDMA mode, cdma2000 mode, DVB-T/H mode, DTMB (CTTB) mode, ISDB-T mode, CMMB mode, Digital Cable TV mode, LTD mode, LTE TDD mode, WLAN mode, 1xEVDO mode, MSR, LTE-Advanced FDD/TDD mode or WIMAX OFDMA mode to use this command. Use :INSTrument:SElect to set the mode.
Couplings	When the Auto Scaling is On, this value is automatically determined by the measurement result. When you set a value manually, Auto Scaling automatically changes to Off.
Preset	10.00 dBm
State Saved	Saved in instrument state.
Min	-250.00 dBm
Max	250.00 dBm
Initial S/W Revision	Prior to A.02.00
Modified at S/W Revision	A.02.00, A.03.00

Attenuation

This menu controls the attenuator functions and interactions between the attenuation system components.

There are two attenuator configurations in the X-Series. One is a dual attenuator configuration consisting of a mechanical attenuator and an optional electronic attenuator. The other configuration uses a single

attenuator with combined mechanical and electronic sections that controls all the attenuation functions. Different models in the X-Series come with different configurations.

See ["Dual Attenuator Configurations:" on page 491](#)

See ["Single Attenuator Configuration:" on page 492](#)

Most Attenuation settings are the same for all measurements – they do not change as you change measurements. Settings like these are called “Meas Global” and are unaffected by Meas Preset.

Key Path	AMPTD Y Scale
Scope	Meas Global
Dependencies	In measurements that support the I/Q inputs, this key is unavailable when I/Q is the selected input, and is replaced by the Range key in that case.
Readback Line	Contains a summary in [] brackets of the current total attenuation. See the descriptions of the , " (Mech) Atten " on page 2297, and " Enable Elec Atten " on page 2299 keys for more detail on the contributors to the total attenuation. Note that when "Pre-Adjust for Min Clip" is on, this value can change at the start of every measurement.
Initial S/W Revision	Prior to A.02.00
Modified at S/W Revision	A.03.00

Dual Attenuator Configurations:

Configuration 1: Mechanical attenuator + optional electronic attenuator

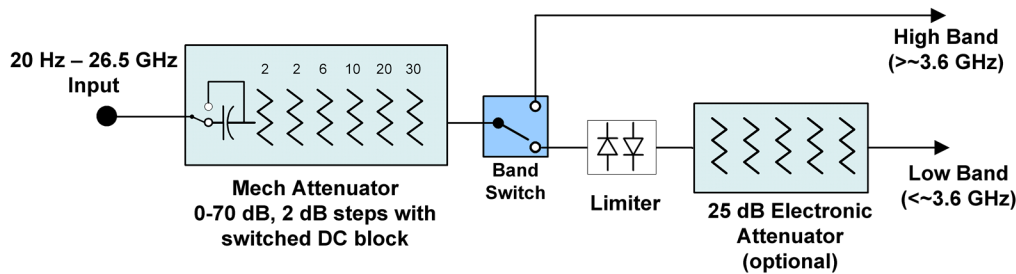

Configuration 2: Mechanical attenuator, no optional electronic attenuator

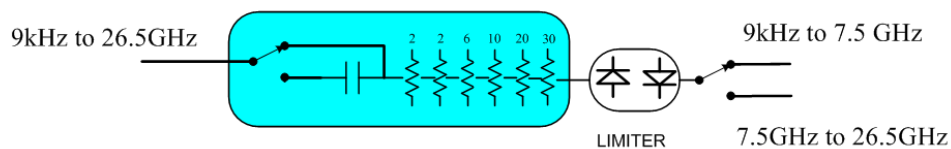

(note that Configuration 2 is not strictly speaking a dual-section attenuator, since there is no electronic section available. However, it behaves exactly like Configuration 1 without the Electronic Attenuator option EA3, therefore for the sake of this document it is grouped into the “Dual Attenuator” configuration)

Single Attenuator Configuration:

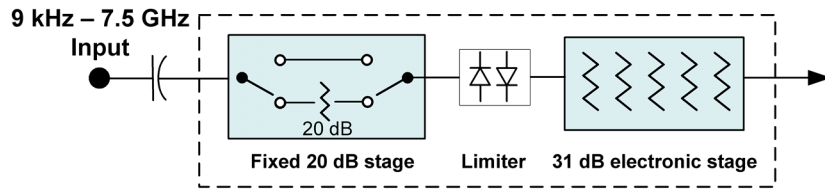

You can tell which attenuator configuration you have by pressing the Attenuation key, which (in most Modes) opens the Attenuation menu. If the first key in the Attenuation menu says **Mech Atten** you have the dual attenuator configuration. If the first key says **Atten** you have the single attenuator configuration.

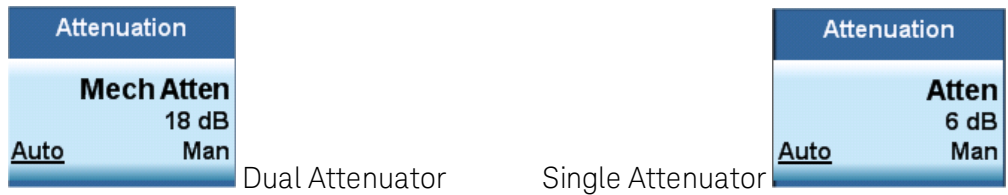

In the single attenuator configuration, you control the attenuation with a single control, as the fixed stage has only two states. In the dual attenuator configuration, both stages have significant range so you are given separate control of the mechanical and electronic attenuator stages.

When you have the dual attenuator configuration, you may still have only a single attenuator, because unless option EA3 (the Electronic Attenuator option) is available, and you purchase it, you will have only the mechanical attenuator.

(Mech) Atten

This key is labeled **Mech Atten** in dual attenuator models and **Atten** in single attenuator models. In the dual attenuator configuration, this key only affects the mechanical attenuator.

This key lets you modify the attenuation applied to the RF input signal path. This value is normally auto coupled to the Ref Level, the Internal Preamp Gain, any External Gain that is entered, and the Max Mixer Level, as described in the table below.

See "[Attenuator Configurations and Auto/Man](#)" on page 494

Key Path	AMPTD Y Scale, Attenuation
Remote Command	<pre>[:SENSe] : POWer [:RF] : ATTenuation <rel_ampl> [:SENSe] : POWer [:RF] : ATTenuation? [:SENSe] : POWer [:RF] : ATTenuation : AUTO OFF ON 0 1 [:SENSe] : POWer [:RF] : ATTenuation : AUTO?</pre>
Example	<p>POW:ATT 20</p> <p>Dual attenuator configuration: sets the mechanical attenuator to 20 dB</p> <p>Single attenuator mode: sets the main attenuation to 20 dB (see below for definition of “main” attenuation).</p> <p>If the attenuator was in Auto, it sets it to Manual.</p>
Dependencies	Some measurements do not support the Auto setting of (Mech) Atten . In these measurements, the

Auto/Man selection is not available, and the Auto/Man line on the key disappears.

In dual attenuator configurations, when the electronic attenuator is enabled, the mechanical attenuator has no auto setting and the Auto/Man line on the key disappears. The state of Auto/Man is remembered and restored when the electronic attenuator is once again disabled. This is described in more detail in the ["Enable Elec Atten" on page 2299](#) key description.

See ["Attenuator Configurations and Auto/Man" on page 494](#) for more information on the Auto/Man functionality of Attenuation.

Couplings

When **(Mech) Atten** is in Auto, it uses the following algorithm to determine a value:

If the USB Preamp is connected to USB, use 0 dB.

Otherwise, $Atten = ReferenceLevel + PreAmpGain + ExternalGain - RefLevelOffset - MaxMixerLevel + IF\ Gain$.

Limit this value to be between 6 dB and the Max value. No value below 6 dB can ever be chosen by Auto.

The resulting value is rounded up to the largest value possible given the attenuation step setting. That is, 50.01 dB would change to 60 dB (for a 10 dB attenuation step).

The "IF Gain" term in the equation above is either 0 dB or +10 dB, depending on the settings of FFT IF Gain, Swept IF Gain, max Ref Level and the Auto/Man setting of Mech Atten.

In External Mixing and BBIQ, where the Attenuator is not in the signal path, the Attenuator setting changes as described above when **(Mech) Atten** is in Auto, but no changes are made to the actual attenuator hardware setting until the input is changed back to the RF Input.

Preset The preset for Mech Attenuation is "Auto."
 The Auto value of attenuation is:
 CXA, EXA, MXA and PXA: 10 dB

State Saved Saved in instrument state

Min 0 dB

The attenuation set by this key cannot be decreased below 6 dB with the knob or step keys. To get to a value below 6 dB it has to be directly entered from the keypad or via SCPI. This protects from adjusting the attenuation to a dangerously small value which can put the instrument at risk of damage to input circuitry. However, if the current mechanical attenuation is below 6 dB it can be increased with the knob and step keys, but not decreased.

Max CXA N9000A-503/507: 50 dB
 CXA N9000A-513/526: 70dB
 EXA: 60 dB
 MXA and PXA: 70 dB

In the single attenuator configuration, the total of ATT and EATT cannot exceed 50 dB, so if the EATT is set to 24 dB first, the main attenuation cannot be greater than 26 dB and will be reduced accordingly; if the main attenuator is set to 40 dB first, EATT cannot be greater than 10 dB.

Initial S/W Revision Prior to A.02.00

Modified at S/W Revision A.03.00

Attenuator Configurations and Auto/Man

As described in the Attenuation key description, there are two distinct attenuator configurations available in the X-Series, the single attenuator and dual attenuator configurations. In dual attenuator configurations, we have the mechanical attenuation and the electronic attenuation, and the current total attenuation is the sum of the electronic + mechanical attenuation. In single attenuator configurations, we refer to the attenuation set using the **(Mech) Atten** key (or POW:ATT SCPI) as the “main” attenuation; and the attenuation that is set by the SCPI command POW:EATT as the “soft” attenuation (the POW:EATT command is honored even in the single attenuator configuration, for compatibility purposes). Then the current total attenuation is the sum of the main + soft attenuation. See the **Elec Atten** key description for more on “soft” attenuation.

In the dual attenuator configuration, when the electronic attenuator is enabled, there is no Auto/Man functionality for the mechanical attenuator, and the third line of the key label (the Auto/Man line) disappears:

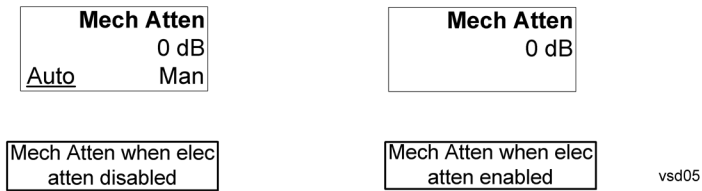

Enable Elec Atten

Enables the Electronic Attenuator.

The electronic attenuator offers finer steps than the mechanical attenuator, has no acoustical noise, is faster, and is less subject to wear. These advantages primarily aid in remote operation and are negligible for front panel use. See ["Using the Electronic Attenuator: Pros and Cons" on page 496](#) for a detailed discussion of the pros and cons of using the electronic attenuator.

For the single attenuator configuration, for SCPI backwards compatibility, the “soft” attenuation feature replaces the dual attenuator configuration’s electronic attenuator. All the same couplings and limitations apply. See ["Attenuator Configurations and Auto/Man" on page 2299](#)

See ["More Information" on page 495](#)

Key Path	AMPTD Y Scale, Attenuation
Remote Command	[:SENSE] :POWer [:RF] :EATTenuation:STATe OFF ON 0 1 [:SENSE] :POWer [:RF] :EATTenuation:STATe?
Example	POW:EATT:STAT ON
Dependencies	This key only appears in Dual Attenuator models with an Electronic Attenuator installed. It does not appear in models with the Single Attenuator configuration, as in the single attenuator configuration there is no “electronic attenuator” there is only a single integrated attenuator (which has both a mechanical and electronic stage). However, in the single attenuator configuration, EATT SCPI commands are accepted for compatibility with other X-series instruments and set a “soft” attenuation as described in "Attenuator Configurations and Auto/Man" on page 2299 . The electronic attenuator (and the “soft” attenuation function provided in single attenuator configurations) is unavailable above 3.6 GHz. Therefore, if the Stop Frequency of the analyzer is > 3.6 GHz then the Enable Elec Atten key will be OFF and grayed out.

If the Internal Preamp is on, meaning it is set to Low Band or Full, the electronic attenuator (and the “soft” attenuation function provided in single attenuator configurations) is unavailable. In this case the **Enable Elec Atten** key will be OFF and grayed out.

If either of the above is true, if the SCPI command is sent, an error indicating that the electronic attenuator is unavailable will be sent.

If the electronic/soft Attenuator is enabled, then the Stop Freq of the analyzer is limited to 3.6 GHz and the Internal Preamp is unavailable.

The SCPI-only “soft” electronic attenuation for the single-attenuator configuration is not available in all measurements; in particular, it is not available in the Swept SA measurement.

Couplings	Enabling and disabling the Electronic Attenuator affects the setting of the Mechanical Attenuator (in dual attenuator configurations). This is described in more detail below this table.
Preset	OFF for Swept SA measurement; ON for all other measurements that support the electronic attenuator
State Saved	Saved in instrument state
Initial S/W Revision	Prior to A.02.00
Modified at S/W Revision	A.03.00

More Information

Mechanical Attenuator Transition Rules

When the Electronic Attenuator is enabled, the Mechanical Attenuator transitions to a state that has no Auto function. Below are the rules for transitioning the Mechanical Attenuator. NOTE that the information below ONLY applies to the dual attenuator configurations, and ONLY when the Electronic Attenuator is installed:

When the Electronic Attenuation is enabled from a disabled state:

- The Mechanical Attenuator is initialized to 10 dB (this is its optimal performance setting). You can then set it as desired with SCPI, numeric keypad, step keys, or knob, and it behaves as it normally would in manual mode
- The Auto/Man state of (Mech) Atten is saved
- The Auto/Man line on the (Mech) Atten key disappears and the auto rules are disabled
- The Electronic Attenuator is set to 10 dB less than the previous value of the Mechanical Attenuator, within the limitation that it must stay within the range of 0 to 24 dB of attenuation.

Examples in the dual attenuator configuration:

- Mech Atten at 20 dB. Elec Atten enabled, Mech Atten set to 10 dB, and Elec Atten set to 10 dB. New total attenuation equals the value before Elec Atten enabled.
- Mech Atten at 0 dB. Elec Atten enabled, Mech Atten set to 10 dB, and Elec Atten set to 0 dB. New total attenuation does not equal the value before Elec Atten enabled.
- Mech Atten at 40 dB. Elec Atten enabled, Mech Atten set to 10 dB, and Elec Atten set to 24 dB. New total attenuation does not equal the value before Elec Atten enabled.

When the Electronic Attenuation is disabled from an enabled state:

- The Elec Atten key is grayed out
- The Auto/Man state of (Mech) Atten is restored
- If now in Auto, (Mech) Atten recouples
- If now in Man, (Mech) Atten is set to the value of total attenuation that existed before the Elec Atten was disabled. The resulting value is rounded up to the smallest value possible given the (Mech) Atten Step setting - (That is, 57 dB changes to 58 dB when (Mech) Atten Step is 2 dB.)

Using the Electronic Attenuator: Pros and Cons

The electronic attenuator offers finer steps than the mechanical attenuator, has no acoustical noise, is faster, and is less subject to wear.

The “finer steps” advantage of the electronic attenuator is beneficial in optimizing the alignment of the analyzer dynamic range to the signal power in the front panel as well as remote use. Thus, you can achieve improved relative signal measurement accuracy. Compared to a mechanical attenuator with 2 dB steps, the 1 dB resolution of the electronic attenuator only gives better resolution when the odd-decibel steps are used. Those odd-decibel steps are less accurately calibrated than the even-decibel steps, so one tradeoff for this superior relative accuracy is reduced absolute amplitude accuracy.

Another disadvantage of the electronic attenuator is that the spectrum analyzer loses its “Auto” setting, making operation less convenient.

Also, the relationship between the dynamic range specifications (TOI, SHI, compression and noise) and instrument performance are less well-known with the electrical attenuator. With the mechanical attenuator, TOI, SHI and compression threshold levels increase dB-for-dB with increasing attenuation, and the noise floor does as well. With the electronic attenuator, there is an excess attenuation of about 1 to 3 dB between 0 and 3.6 GHz, making the effective TOI, SHI, and so forth, less well known. Excess attenuation is the actual attenuation relative to stated attenuation. Excess attenuation is accounted for in the analyzer calibration

Elec Atten

Controls the Electronic Attenuator in dual attenuator configurations. This key does not appear in single attenuator configurations, as the control of both the mechanical and electronic stages of the single attenuator is integrated into the single **Atten** key.

Key Path	AMPTD Y Scale, Attenuation
Remote Command	<code>[:SENSe] :POWer [:RF] :EATTenuation <rel_ampl></code> <code>[:SENSe] :POWer [:RF] :EATTenuation?</code>
Notes	Electronic Attenuation's specification is defined only when Mechanical Attenuation is 6 dB.
Dependencies	This key only appears in Dual Attenuator models with an Electronic Attenuator installed. It does not appear in models with the Single Attenuator configuration, as in the single attenuator configuration there is no “electronic attenuator” there is only a single integrated attenuator (which has both a mechanical and electronic stage). However, in the single attenuator configuration, EATT SCPI commands are accepted for compatibility with other X-series instruments and set a “soft” attenuation as described in "Attenuator Configurations and Auto/Man" on page 2299 . The “soft” attenuation is treated as an addition to the “main” attenuation value set by the Atten softkey or the

	POW:ATT SCPI command and affects the total attenuation displayed on the Attenuation key and the Meas Bar. When Enable Elec Atten is off or grayed out, the Elec Atten key is grayed out.
Preset	0 dB
State Saved	Saved in instrument state
Min	0 dB
Max	Dual attenuator configuration: 24 dB Single attenuator configuration: the total of ATT and EATT cannot exceed 50 dB, so if the EATT is set to 24 dB first, the main attenuation cannot be greater than 26 dB and will be reduced accordingly; if the main attenuator is set to 40 dB first, EATT cannot be greater than 10 dB
Initial S/W Revision	Prior to A.02.00
Modified at S/W Revision	A.03.00

Adjust Atten for Min Clip

Sets the combination of mechanical and electronic attenuation and gain based on the current measured signal level so that clipping will be at a minimum.

This is an "immediate action" function, that is, it executes once, when the key is pressed.

This key is grayed out in measurements that do not support this functionality. The spectrum analyzer measurement, Swept SA, does not support this functionality.

Key Path	AMPTD Y Scale, Attenuation
Remote Command	<code>[:SENSe] :POWer [:RF] :RANGe:OPTimize IMMEDIATE</code>
Initial S/W Revision	Prior to A.02.00
Modified at S/W Revision	A.03.00

Pre-Adjust for Min Clip

If this function is on, it does the adjustment described under "[Adjust Atten for Min Clip](#)" on page 2302 each time a measurement restarts. Therefore, in Continuous measurement mode, it only executes before the first measurement.

In dual attenuator models, you can set **Elec+Mech Atten**, in which case both attenuators participate in the autoranging, or **Elec Atten Only**, in which case the mechanical attenuator does not participate in the autoranging. This latter case results in less wear on the mechanical attenuator and is usually faster.

This key is grayed out in measurements that do not support this functionality. The spectrum analyzer measurement, Swept SA, does not support this functionality.

Key Path	AMPTD Y Scale, Attenuation
Remote Command	<code>[:SENSe] :POWer [:RF] :RANGe:OPTimize:ATTenuation OFF ELECTRICAL COMBINED</code>

	<code>[:SENSe] :POWer [:RF] :RANGe:OPTimize:ATTenuation?</code>
Notes	The SCPI parameter ELECtrical sets this function to On in single attenuator models. The SCPI parameter COMBined is mapped to ELECtrical in single attenuator models; if you send COMBined, it sets the function to On and returns ELEC to a query.
Dependencies	This key only appears in Dual Attenuator models with an Electronic Attenuator installed. In instruments with Dual Attenuator model, when Enable Elec Atten is off or grayed out, the Pre-Adjust for Min Clip key is grayed out.
Preset	OFF for Swept SA measurement; ON for all other measurements that support Pre-Adjust for Min Clip
State Saved	Saved in instrument state
Range	Dual attenuator models: Off Elec Atten Only Mech + Elec Atten Single attenuator models: Off On
Initial S/W Revision	Prior to A.02.00
Modified at S/W Revision	A.03.00

Remote Command	<code>[:SENSe] :POWer [:RF] :RANGe:AUTO ON OFF 1 0</code> <code>[:SENSe] :POWer [:RF] :RANGe:AUTO?</code>
Notes	ON aliases to "Elec Atten Only" (:POW:RANG:OPT:ATT ELEC) OFF aliases to "Off" (:POW:RANG:OPT:ATT OFF) The query :POW:RANG:AUTO? returns true if :POW:RANG:OPT:ATT is not "Off"
Initial S/W Revision	Prior to A.02.00

Off

Turns **Pre-Adjust for Min Clip** off. This is the default setting.

This key is grayed out in measurements that do not support this functionality. The spectrum analyzer measurement, Swept SA, does not support this functionality.

Key Path	AMPTD Y Scale, Attenuation, Pre-Adjust for Min Clip
Example	:POW:RANGe:OPT:ATT OFF
Initial S/W Revision	Prior to A.02.00

Elec Atten Only

Selects only the electric attenuator to participate in auto ranging. This offers less wear on the mechanical attenuator and is usually faster.

This key is grayed out in measurements that do not support this functionality. The spectrum analyzer measurement, Swept SA, does not support this functionality.

Key Path	AMPTD Y Scale, Attenuation, Pre-Adjust for Min Clip
Example	:POW:RANGe:OPT:ATT ELEC
Initial S/W Revision	Prior to A.02.00

Mech + Elec Atten

In dual attenuator models, this selects both attenuators participate in the autoranging.

This key is grayed out in measurements that do not support this functionality. The spectrum analyzer measurement, Swept SA, does not support this functionality.

Key Path	AMPTD Y Scale, Attenuation, Pre-Adjust for Min Clip
Example	:POW:RANGe:OPT:ATT COMB
Initial S/W Revision	Prior to A.02.00

(Mech) Atten Step

This controls the step size used when making adjustments to the input attenuation.

This key is labeled **Mech Atten Step** in dual attenuator models and **Atten Step** in single attenuator models. In the dual attenuator configuration, this key only affects the step size of the mechanical attenuator.

Key Path	AMPTD Y Scale, Attenuation
Remote Command	[[:SENSe]:POWer[:RF]:ATTenuation:STEP[:INCRement] 10 dB 2 dB [:SENSe]:POWer[:RF]:ATTenuation:STEP[:INCRement]?
Example	POW:ATT:STEP 2
Notes	Note this feature works like a 1-N choice from the front panel, but it takes a specific value (in dB) when used remotely. The only valid values are 2 and 10.
Dependencies	Blanked in CXA and EXA if option FSA (2 dB steps) is not present. If blanked, attempts to set it via SCPI will yield an error.
Couplings	When the attenuation step size changes, the current mechanical attenuation value is adjusted (if necessary) to be quantized to the new step size. That is, if step is set to 10 dB, mech atten is increased if necessary so it is a multiple of 10 dB
Preset	PXA and MXA: 2 dB EXA and CXA: 10 dB (2 dB with option FSA)
State Saved	Saved in instrument state
Initial S/W Revision	Prior to A.02.00
Modified at S/W Revision	A.03.00

Adjust Atten (Remote Command only)

Allows you to select;

-Electric attenuator only

-Combination of Electric attenuator and Mechanical attenuator

when the SCPI command [:SENSe]:POWer[:RF]:RANGe:OPTimize IMMEDIATE is executed.

Remote Command	<code>[:SENSe]:POWer[:RF]:RANGe:OPTimize:TYPE EONLy COMBined</code> <code>[:SENSe]:POWer[:RF]:RANGe:OPTimize:TYPE?</code>
Example	<code>POW:RANG:OPT:TYPE EONL</code> <code>POW:RANG:OPT:TYPE?</code>
Preset	COMBined
State Saved	Saved in instrument state
Initial S/W Revision	A.16.00

Scale/Div

Sets the units per division of the vertical scale in the logarithmic display. However, since the Auto Scaling is defaulted to On, this value is automatically determined by the measurement result. When you set a value manually, Auto Scaling automatically changes to Off.

Key Path	AMPTD Y Scale
Mode	SA, WCDMA, C2K, WIMAX OFDMA, 1xEVDO, DVB-T/H, DTMB (CTTB), ISDB-T, CMMB, LTE, LTETDD, Digital Cable TV, WLAN, MSR, LTEAFDD, LTEATDD
Remote Command	<code>:DISPlay:CHPower:VIEW[1]:WINDow[1]:TRACe:Y[:SCALe]:PDIVision <rel_ampl></code> <code>:DISPlay:CHPower:VIEW[1]:WINDow[1]:TRACe:Y[:SCALe]:PDIVision?</code>
Example	<code>DISP:CHP:VIEW:WIND:TRAC:Y:PDIV 2</code> <code>DISP:CHP:VIEW:WIND:TRAC:Y:PDIV?</code>
Notes	You must be in the Spectrum Analysis mode, W-CDMA mode, cdma2000 mode, DVB-T/H mode, DTMB (CTTB) mode, ISDB-T mode, CMMB mode, Digital Cable TV mode, LTE mode, LTE TDD mode, WLAN mode, 1xEVDO mode, MSR, LTE-Advanced FDD/TDD mode or WIMAX OFDMA mode to use this command. Use :INSTrument:SElect to set the mode.
Couplings	When the Auto Scaling is On, this value is automatically determined by the measurement result. When you set a value manually, Auto Scaling automatically changes to Off.
Preset	10.00 dB
State Saved	Saved in instrument state.
Min	0.10 dB
Max	20.00 dB
Initial S/W Revision	Prior to A.02.00
Modified at S/W Revision	A.02.00, A.03.00

Presel Center

When this key is pressed, the centering of the preselector filter is adjusted to optimize the amplitude accuracy at the frequency of the selected marker. If the selected marker is not on when Presel Center is pressed, the analyzer will turn on the selected marker, perform a peak search, and then perform centering on the marker's center frequency. If the selected marker is already on and between the start and stop frequencies of the analyzer, the analyzer performs the preselector calibration on that marker's frequency. If the selected marker is already on, but outside the frequency range between Start Freq and Stop Freq, the analyzer will first perform a peak search, and then perform centering on the marker's center frequency.

The value displayed on the **Presel Adjust** key will change to reflect the new preselector tuning (see **Presel Adjust**).

A number of considerations should be observed to ensure proper operation. See "[Proper Preselector Operation](#)" on page 501.

Key Path	AMPTD Y Scale
Remote Command	[:SENSe] :POWer [:RF] :PCENter
Example	POW:PCEN
Notes	Note that the rules outlined above under the key description apply for the remote command as well as the key. The result of the command is dependent on marker position, and so forth. Any message shown by the key press is also shown in response to the remote command.
Dependencies	<ul style="list-style-type: none"> • Grayed out if the microwave preselector is off.) • If the selected marker's frequency is below Band 1, advisory message 0.5001 is generated and no action is taken. • Grayed out if entirely in Band 0. • Blank in models that do not include a preselector, such as option 503. If the SCPI is sent in these instruments, it is accepted without error, and the query always returns 0. • Grayed out in the Spectrogram View.
Couplings	The active marker position determines where the centering will be attempted. If the analyzer is in a measurement such as averaging when centering is initiated, the act of centering the preselector will restart averaging but the first average trace will not be taken until the centering is completed.
Status Bits/OPC dependencies	When centering the preselector, *OPC will not return true until the process is complete and a subsequent measurement has completed, nor will results be returned to a READ or MEASure command. The Measuring bit should remain set while this command is operating and should not go false until the subsequent sweep/measurement has completed.
Initial S/W Revision	Prior to A.02.00
Modified at S/W Revision	A.03.00

Proper Preselector Operation

A number of considerations should be observed to ensure proper operation:

1. If the selected marker is off, the analyzer will turn on a marker, perform a peak search, and adjust the preselector using the selected marker's frequency. It uses the "highest peak" peak search method unqualified by threshold or excursion, so that there is no chance of a 'no peak found' error. It continues with that peak, even if it is the peak of just noise. Therefore, for this operation to work properly, there should be a signal on screen in a preselected range for the peak search to find.
2. If the selected marker is already on, the analyzer will attempt the centering at that marker's frequency. There is no preselector for signals below about 3.6 GHz, therefore if the marker is on a signal below 3.6 GHz, no centering will be attempted and an advisory message generated
3. In some models, the preselector can be bypassed. If it is bypassed, no centering will be attempted in that range and a message will be generated.

Preselector Adjust

Allows you to manually adjust the preselector filter frequency to optimize its response to the signal of interest. This function is only available when **"Presel Center"** on page 2306 is available.

For general purpose signal analysis, using Presel Center is recommended. Centering the filter minimizes the impact of long-term preselector drift. Presel Adjust can be used instead to manually optimize the preselector. One application of manual optimization would be to peak the preselector response, which both optimizes the signal-to-noise ratio and minimizes amplitude variations due to small (short-term) preselector drifting.

Key Path	AMPTD Y Scale
Scope	Meas Global
Remote Command	[:SENSe] :POWeR [:RF] :PADJust <freq> [:SENSe] :POWeR [:RF] :PADJust?
Example	POW:PADJ 100KHz POW:PADJ?
Notes	The value on the key reads out to 0.1 MHz resolution.
Dependencies	<ul style="list-style-type: none"> • Grayed out if microwave preselector is off.) • Grayed out if entirely in Band 0. • Blank in models that do not include a preselector, such as option 503. If the SCPI is sent in these instruments, it is accepted without error, and the query always returns 0. • Grayed out in the Spectrogram View.
Preset	0 MHz
State Saved	The Presel Adjust value set by Presel Center , or by manually adjusting Presel Adjust , is not saved in instrument state, and does not survive a Preset or power cycle.
Min	-500 MHz
Max	500 MHz
Default Unit	Hz
Backwards Compatibility SCPI	[:SENSe] :POWeR [:RF] :MW :PADJust [:SENSe] :POWeR [:RF] :MMW :PADJust

	PSA had multiple preselectors, but the X-Series has only one. These commands simply alias to [:SENSe]:POWer[:RF]:PADJust
Initial S/W Revision	Prior to A.02.00
Modified at S/W Revision	A.03.00

Remote Command	[:SENSe]:POWer[:RF]:PADJust:PRESelector MWAVE MMWave EXternal [:SENSe]:POWer[:RF]:PADJust:PRESelector?
Notes	PSA had multiple preselectors, and you could select which preselector to adjust. Since the X-Series has only one mm/uW preselector, the preselector selection softkey is no longer available. However, to provide backward compatibility, we accept the legacy remote commands. The command form has no effect, the query always returns MWAVE
Initial S/W Revision	Prior to A.02.00

μW Path Control

The **μW Path Control** functions include the **μW Preselector Bypass** (Option MPB) and **Low Noise Path** (Option LNP) controls in the High Band path circuits.

When the μW Preselector is bypassed, the user has better flatness, but will be subject to spurs from out of band interfering signals. When the Low Noise Path is enabled, the analyzer automatically switches around certain circuitry in the high frequency bands which can contribute to noise, when it is appropriate based on other analyzer settings.

For most applications, the preset state is Standard Path, which gives the best remote-control throughput, minimizes acoustic noise from switching and minimizes the risk of wear out in the hardware switches. For applications that utilize the wideband IF paths, the preset state is the μW Preselector Bypass path, if option MPB is present. This is because, when using a wideband IF such as the 140 MHz IF, the μW Preselector's bandwidth can be narrower than the available IF bandwidth, causing degraded amplitude flatness and phase linearity, so it is desirable to bypass the preselector in the default case.

Users may choose Low Noise Path Enable. It gives a lower noise floor, especially in the 21–26.5 GHz region, though without improving many measures of dynamic range, and without giving the best possible noise floor. The preamp, if purchased and used, gives better noise floor than does the Low Noise Path, however its compression threshold and third-order intercept are much poorer than that of the non-preamp Low Noise Path. There are some applications, typically for signals around –30 dBm, for which the third-order dynamic range of the standard path is good enough, but the noise floor is not low enough even with 0 dB input attenuation. When the third-order dynamic range of the preamp path is too little and the noise floor of the standard path is too high, the Low Noise Path can provide the best dynamic range.

Key Path	AMPTD Y Scale
Mode	SA, BASIC, PNOISE, VSA , LTE, LTETDD
Scope	Meas Global
Remote Command	[:SENSe]:POWer[:RF]:MW:PATH STD LNPath MPBypass FULL

	[:SENSe] :POWer [:RF] :MW :PATH?
Example	:POW:MW:PATH LNP Enables the Low Noise path
Notes	<p>If a Presel Center is performed, the analyzer will momentarily switch to the Standard Path, regardless of the setting of μW Path Control</p> <p>The DC Block will always be switched in when the low noise path is switched in, to protect succeeding circuitry from DC. Note that this does not mean “when the low noise path is enabled” but when, based on the Low Noise Path rules, the path is actually switched in. This can happen when the selection is Low Noise Path Enable . In the case where the DC Block is switched in the analyzer is now AC coupled. However, if the user has selected DC coupling, the UI will still behave as though it were DC coupled, including all annunciation, warnings, status bits, and responses to SCPI queries. This is because, based on other settings, the analyzer could switch out the low noise path at any time and hence go back to being DC coupled.</p> <p>Alignment switching ignores the settings in this menu, and restores them when finished.</p>
Dependencies	Unavailable in BBIQ and External Mixing
Preset	<p>All modes other than IQ Analyzer mode and VXA: STD</p> <p>IQ Analyzer, VXA and WLAN mode:</p> <p>MPB option present and licensed: MPB</p> <p>MPB option not present and licensed: STD</p>
State Saved	Save in instrument state
Readback	Value selected in the submenu
Initial S/W Revision	A.04.00
Modified at S/W Revision	A.10.00

Standard Path

This path gives the best remote-control throughput, minimizes acoustic noise from switching and minimizes the risk of wear in the hardware switches, particularly in remote test scenarios where both low band and high band setups will follow in rapid succession.

In this path, the bypass of the low band/high band switch and microwave preamp is never activated, which can cause some noise degradation but preserves the life of the bypass switch.

Key Path	AMPTD Y Scale, μW Path Control
Example	:POW:MW:PATH STD
Readback Text	Standard Path
Initial S/W Revision	A.04.00

Low Noise Path Enable

You may choose Low Noise Path Enable, which gives a lower noise floor under some circumstances, particularly when operating in the 21–26.5 GHz region. With the Low Noise Path enabled, the low band/high band switch and microwave preamp are bypassed whenever all of the following are true:

- The analyzer is not in the Low Band, meaning:
- the start frequency is above 3.5 GHz and
- the stop frequency is above 3.6 GHz.
- the internal preamp is not installed or (if installed) is set to **Off** or **Low Band**

Note that this means that, when any part of a sweep is done in Low Band, the Low Noise Path is not used, whether or not the **Low Noise Path Enable** is selected in the user interface. Also, if the preamp is turned on, the Low Noise Path is not used, whether or not the **Low Noise Path Enable** is selected in the user interface. The only time the Low Noise Path is used is when **Low Noise Path Enable** is selected, the sweep is completely in High Band (> 3.6 GHz) and no preamp is in use.

See "[More Information](#)" on page 505

Key Path	AMPTD Y Scale, μW Path Control
Measurement	Swept SA
Example	:POW:MW:PATH LNP
Notes	<p>For measurements that use IQ acquisition, the low noise path is used when the Center Frequency is in High Band (> 3.6 GHz) and no preamp is in use.</p> <p>In other words, the rules above are modified to use only the center frequency to qualify which path to switch in.</p> <p>This is not the case for FFT's in the Swept SA measurement; they use the same rules as swept measurements.</p>
Dependencies	<p>Key is blanked if current mode does not support it.</p> <p>Key is grayed out if mode supports it but current measurement does not support it.</p> <p>Unless Option LNP is present and licensed, key is blank and if SCPI command sent, error -241, "Hardware missing; Option not installed" is generated.</p>
Readback Text	Low Noise Path Enable
Initial S/W Revision	A.04.00

More Information

The user should understand that the Low Noise Path, while giving improved DANL, has the disadvantage of decreased TOI performance and decreased gain compression performance relative to the standard path.

The user should also understand that the bypass switch is a mechanical switch and has finite life, so if the **Low Noise Path** is enabled, it is possible to cause frequent cycling of this switch by frequently changing analyzer settings such that the above conditions hold true only some of the time. A user making tests of this nature should consider opting for the **Standard Path**, which will never throw the bypass switch, at the expense of some degraded noise performance.

The low noise path is useful for situations where the signal level is so low that the analyzer performance is dominated by noise even with 0 dB attenuation, but still high enough that the preamp option would have excessive third-order intermodulation or compression. The preamp, if purchased and used, gives better noise floor than does the "Low Noise Path." However, its compression threshold and third-order intercept are much poorer than that of the non-preamp path. There are some applications, typically for signals around -30 dBm, for which the third-order dynamic range of the standard path is good enough, but the

noise floor is not low enough even with 0 dB input attenuation. When the third-order dynamic range of the preamp path is too little and the noise floor of the standard path is too high, the Low Noise Path can provide the best dynamic range

The graph below illustrates the concept. It shows, in red, the performance of an analyzer at different attenuation settings, both with the preamp on and off, in a measurement that is affected by both analyzer noise and analyzer TOI. The green shows the best available dynamic range, offset by 0.5 dB for clarity. The blue shows how the best available dynamic range improves for moderate signal levels with the low noise path switched in. In this illustration, the preamp improves the noise floor by 15 dB while degrading the third-order intercept by 30 dB, and the low noise path reduces loss by 8 dB. The attenuator step size is 2 dB.

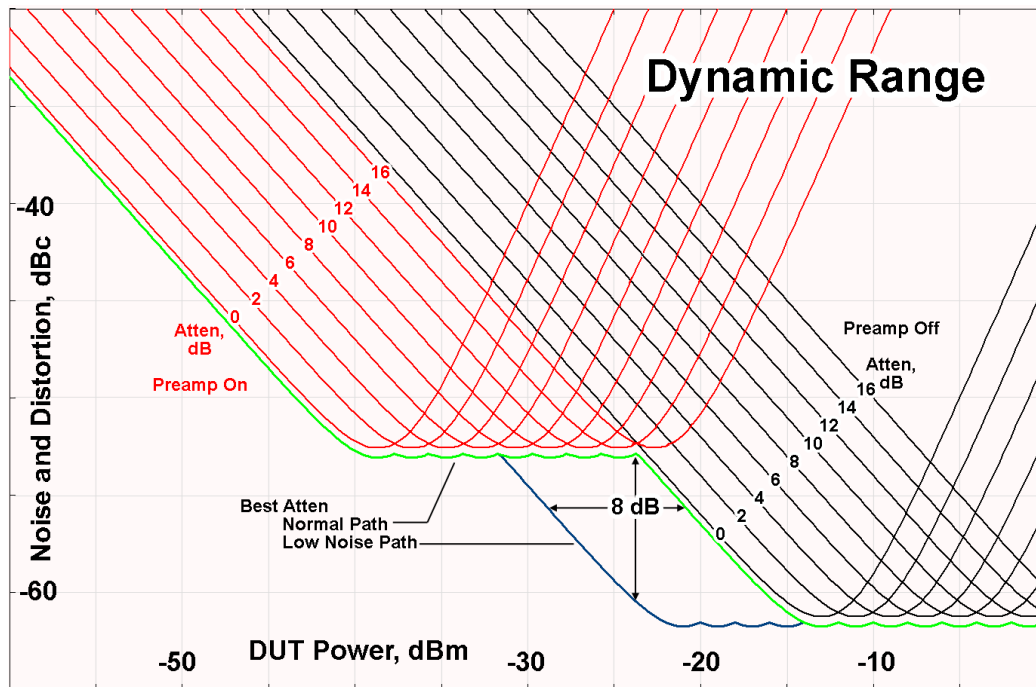

There are other times where selecting the low noise path improves performance, too. Compression-limited measurements such as finding the nulls in a pulsed-RF spectrum can profit from the low noise path in a way similar to the TOI-limited measurement illustrated. Accuracy can be improved when the low noise path allows the optimum attenuation to increase from a small amount like 0, 2 or 4 dB to a larger amount, giving better return loss at the analyzer input. Harmonic measurements, such as second and third harmonic levels, are much improved using the low noise path because of the superiority of that path for harmonic (though not intermodulation) distortion performance.

μW Preselector Bypass

This key toggles the preselector bypass switch for band 1 and higher. When the microwave preselector is on, the signal path is preselected. When the microwave preselector is off, the signal path is not preselected. The preselected path is the normal path for the analyzer.

The preselector is a tunable bandpass filter which prevents signals away from the frequency of interest from combining in the mixer to generate in-band spurious signals (images). The consequences of using a preselector filter are its limited bandwidth, the amplitude and phase ripple in its passband, and any amplitude and phase instability due to center frequency drift.

Option MPB or pre-selector bypass provides an unpreselected input mixer path for certain X-Series signal analyzers with frequency ranges above 3.6 GHz. This signal path allows a wider bandwidth and less amplitude variability, which is an advantage when doing modulation analysis and broadband signal analysis. The disadvantage is that, without the preselector, image signals will be displayed. Another disadvantage of bypassing the preselector is increased LO emission levels at the front panel input port.

Image responses are separated from the real signal by twice the 1st IF. For IF Paths of 10 MHz and 25 MHz, the 1st IF is 322.5 MHz, so the image response and the real signal will be separated by 645 MHz. The 1st IF will be different for other IF Path settings. When viewing a real signal and its corresponding image response in internal mixing, the image response will be to the left of the real signal.

Also, the image response and the real signal typically have the same amplitude and exhibit the same shape factor.

However, if Option FS1, Fast Sweep Capability, is enabled, the image response in the Swept SA measurement will appear lower in amplitude and have a much wider shape factor compared to the real signal.

Key Path	AMPTD Y Scale, μW Path Control
Example	:POW:MW:PATH MPB
Dependencies	Key is blanked if current mode does not support it. Key is grayed out if mode supports it but current measurement does not support it. Key is blank unless Option MPB is present and licensed. If SCPI command sent when MPB not present, error -241, "Hardware missing; Option not installed" is generated.
Readback Text	μ W Preselector Bypass
Initial S/W Revision	A.04.00

Remote Command	[:SENSe] :POWer [:RF] :MW:PRESelector [:STATe] ON OFF 0 1 [:SENSe] :POWer [:RF] :MW:PRESelector [:STATe] ?
Example	:POW:MW:PRES OFF Bypasses the microwave preselector
Notes	The ON parameter sets the STD path (:POW:MW:PATH STD) The OFF parameter sets path MPB (:POW:MW:PATH MPB)
Preset	ON

Internal Preamp

Accesses a menu of keys that control the internal preamps. Turning on the preamp gives a better noise figure, but a poorer TOI to noise floor dynamic range. You can optimize this setting for your particular measurement.

The instrument takes the preamp gain into account as it sweeps. If you sweep outside of the range of the preamp the instrument will also account for that. The displayed result will always reflect the correct gain.

For some measurements, when the preamp is on and any part of the displayed frequency range is below the lowest frequency for which the preamp has specifications, a warning condition message appears in the status line. For example, for a preamp with a 9 kHz lowest specified frequency: "Preamp: Accy unspec'd below 9 kHz".

Key Path	AMPTD Y Scale
Scope	Meas Global
Remote Command	[:SENSe] :POWer [:RF] :GAIN [:STATe] OFF ON 0 1 [:SENSe] :POWer [:RF] :GAIN [:STATe] ?
Dependencies	Preamp is not available on all hardware platforms. If the preamp is not present or is unlicensed, the key is not shown. The preamp is not available when the electronic/soft attenuator is enabled.
Couplings	The act of connecting the U7227A USB Preamplifier to one of the analyzer's USB ports will cause the Internal Preamp to be switched on. When this happens an informational message will be generated: "Internal Preamp turned on for optimal operation with USB Preamp." Note that if the Internal Preamp was already on, there will be no change to the setting, but if it was Off it will be switched On, to Full Range. Note that this same action occurs when the SA mode is selected while the USB Preamp is connected to one of the analyzer's USB ports, if it is the first time that the SA mode has run since powerup, or if the last time the SA mode was running the USB Preamp was NOT connected. Subsequently disconnecting the USB Preamp from USB does not change the Internal Preamp setting nor restore the previous setting.
Preset	OFF
State Saved	Saved in instrument state
Initial S/W Revision	Prior to A.02.00
Modified at S/W Revision	A.14.00

Key Path	AMPTD Y Scale, Internal Preamp
Scope	Meas Global
Remote Command	[:SENSe] :POWer [:RF] :GAIN :BAND LOW FULL [:SENSe] :POWer [:RF] :GAIN :BAND ?
Dependencies	Preamp is not available on all hardware platforms. If the preamp is not present or is unlicensed, the key is not shown. If a POW:GAIN:BAND FULL command is sent when a low band preamp is available, the preamp band parameter is to LOW instead of FULL, and an "Option not installed" message is generated.
Preset	LOW
State Saved	Saved in instrument state
Initial S/W Revision	Prior to A.02.00

Off

Turns the internal preamp off

Key Path	AMPTD Y Scale, Internal Preamp
Example	:POW:GAIN OFF
Readback	Off
Initial S/W Revision	Prior to A.02.00

Low Band

Sets the internal preamp to use only the low band.

The frequency range of the installed (optional) low-band preamp is displayed in square brackets on the **Low Band** key label.

Key Path	AMPTD Y Scale, Internal Preamp
Example	:POW:GAIN ON :POW:GAIN:BAND LOW
Readback	Low Band
Initial S/W Revision	Prior to A.02.00

Full Range

Sets the internal preamp to use its full range. The low band (0–3.6 GHz or 0–3GHz, depending on the model) is supplied by the low band preamp and the frequencies above low band are supplied by the high band preamp.

The frequency range of the installed (optional) preamp is displayed in square brackets on the **Full Range** key label. If the high band option is not installed the Full Range key does not appear.

Key Path	AMPTD Y Scale, Internal Preamp
Example	:POW:GAIN ON :POW:GAIN:BAND FULL
Readback	Full Range
Initial S/W Revision	Prior to A.02.00

Ref Position

Positions the reference level at the top, center, or bottom of the Y Scale display. Changing the reference position does not change the reference level value.

Key Path	AMPTD Y Scale
Mode	SA, WCDMA, C2K, WIMAX OFDMA, 1xEVDO, DVB-T/H, DTMB (CTTB), ISDB-T, CMMB, LTE, LTETDD, Digital Cable TV, WLAN, MSR, LTEAFDD, LTEATDD
Remote Command	:DISPlay:CHPower:VIEW[1]:WINDow[1]:TRACe:Y[:SCALe]:RPOSition TOP CENTER BOTTom :DISPlay:CHPower:VIEW[1]:WINDow[1]:TRACe:Y[:SCALe]:RPOSition?
Example	DISP:CHP:VIEW:WIND:TRAC:Y:RPOS CENT DISP:CHP:VIEW:WIND:TRAC:Y:RPOS?
Notes	You must be in the Spectrum Analysis mode, W-CDMA mode, cdma2000 mode, DVB-T/H mode, DTMB (CTTB) mode, ISDB-T mode, CMMB mode, Digital Cable TV mode, LTE mode, LTE TDD mode, WLAN mode, 1xEVDO mode, MSR, LTE-Advanced FDD/TDD mode or WIMAX OFDMA mode to use this command. Use :INSTrument:SELect to set the mode.
Preset	TOP
State Saved	Saved in instrument state.
Range	Top Ctr Bot
Initial S/W Revision	Prior to A.02.00
Modified at S/W Revision	A.02.00, A.03.00

Auto Scaling

Toggles the Auto Scaling function between On and Off.

Key Path	AMPTD Y Scale
Mode	SA, WCDMA, C2K, WIMAX OFDMA, 1xEVDO, DVB-T/H, DTMB (CTTB), ISDB-T, CMMB, LTE, LTETDD, Digital Cable TV, WLAN, MSR, LTEAFDD, LTEATDD
Remote Command	:DISPlay:CHPower:VIEW[1]:WINDow[1]:TRACe:Y[:SCALe]:COUPle 0 1 OFF ON :DISPlay:CHPower:VIEW[1]:WINDow[1]:TRACe:Y[:SCALe]:COUPle?
Example	DISP:CHP:VIEW:WIND:TRAC:Y:COUP OFF DISP:CHP:VIEW:WIND:TRAC:Y:COUP?
Couplings	When Auto Scaling is On, and the Restart front-panel key is pressed, this function automatically sets the scale per division to 10 dB and determines the reference values based on the measurement results. When you set a value to either Scale/Div or Ref Value manually, Auto Scaling automatically changes to Off.
Preset	1
State Saved	Saved in instrument state.
Range	On Off
Initial S/W Revision	Prior to A.02.00
Modified at S/W Revision	A.02.00, A.03.00

Auto Couple

The Auto Couple feature provides a quick and convenient way to automatically couple multiple instrument settings. This helps ensure accurate measurements and optimum dynamic range. When the Auto Couple feature is activated, either from the front panel or remotely, all parameters of the current measurement that have an Auto/Manual mode are set to Auto mode and all measurement settings dependent on (or coupled to) the Auto/Man parameters are automatically adjusted for optimal performance.

However, the Auto Couple key actions are confined to the current measurement only. It does not affect other measurements in the mode, and it does not affect markers, marker functions, or trace or display attributes.

See "[More Information](#)" on page 511

Key Path	Front-panel key
Remote Command	:COUPle ALL NONE
Example	:COUP ALL
Notes	:COUPle ALL puts all Auto/Man parameters in Auto mode (equivalent to pressing the Auto Couple key). :COUPLE NONE puts all Auto/Man parameters in manual mode. It decouples all the coupled instrument parameters and is not recommended for making measurements.
Initial S/W Revision	Prior to A.02.00

More Information

There are two types of functions that have Auto/Manual modes.

Auto/Man Active Function keys

An Auto/Man toggle key controls the binary state associated with an instrument parameter by toggling between **Auto** (where the parameter is automatically coupled to the other parameters it is dependent upon) and **Man** (where the parameter is controlled independent of the other parameters), as well as making the parameter the active function. The current mode is indicated on the softkey with either **Auto** or **Man** underlined as illustrated below.

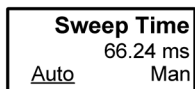

vsd07

Auto/Man 1-of-N keys

An Auto/Man 1-of-N key allows you to manually pick from a list of parameter values, or place the function in Auto, in which case the value is automatically selected (and indicated) as shown below. If in Auto, Auto is underlined on the calling key. If in manual operation, manual is indicated on the calling key. But the calling key does not actually toggle the function, it simply opens the menu.

8 Channel Power Measurement
Auto Couple

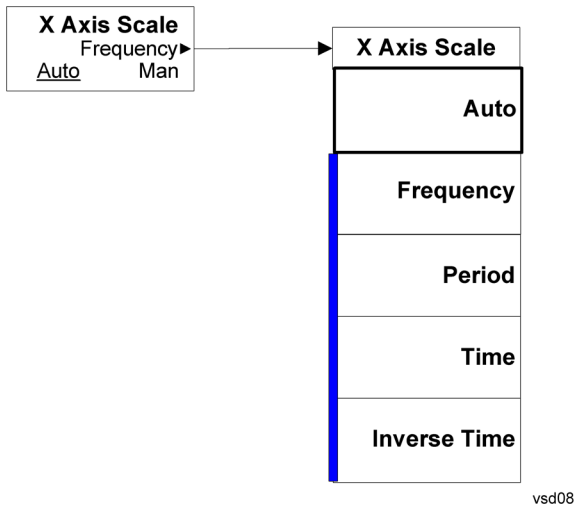

BW

Accesses a menu of functions that enable you to specify and control the video and resolution bandwidths. You can also select the type of filter for the measurement and set the filter bandwidth.

Key Path	Front-panel key
Initial S/W Revision	Prior to A.02.00

Res BW

Sets the value of the resolution bandwidth (RBW). If an unavailable bandwidth is entered with the numeric keypad, the closest available bandwidth is selected.

LTE-Advanced FDD/TDD Auto RBW:

Bandwidth	RBW (KHz)
1.4MHz	20
3MHz	43
5MHz	68
10MHz	150
15MHz	220
20MHz	270

the resolution bandwidth is predefined based on the corresponding bandwidth of the single LTE carrier, which is listed above. When ResBW mode is Auto, the narrowest RBW over the active carriers is selected for Multi-carriers.

Key Path	BW
Mode	SA, WCDMA, C2K, WIMAX OFDMA, 1xEVDO, DVB-T/H, DTMB (CTTB), ISDB-T, CMMB, LTE, LTE-TDD, Digital Cable TV, WLAN, MSR, LTEAFDD, LTEATDD
Remote Command	[:SENSe]:CHPower:BANDwidth[:RESolution] <bandwidth> [:SENSe]:CHPower:BANDwidth[:RESolution]? [:SENSe]:CHPower:BANDwidth[:RESolution]:AUTO ON OFF 1 0 [:SENSe]:CHPower:BANDwidth[:RESolution]:AUTO?
Example	CHP:BAND 5 MHz CHP:BAND? CHP:BAND:AUTO ON CHP:BAND:AUTO?
Notes	You must be in the Spectrum Analysis mode, W-CDMA mode, cdma2000 mode, DVB-T/H mode, DTMB (CTTB) mode, ISDB-T mode, CMMB mode, Digital Cable TV mode, LTE mode, LTE TDD mode, WLAN mode, 1xEVDO mode, MSR, LTE-Advanced FDD/TDD mode or WIMAX OFDMA mode to use this command. Use :INSTRument:SElect to set the mode.

Couplings	<p>Sweep time is coupled to the RBW. As the RBW changes, the sweep time (if set to Auto) is changed to maintain amplitude calibration.</p> <p>Video bandwidth (VBW) is coupled to the RBW. As the resolution bandwidth changes, the video bandwidth (if set to Auto) changes to maintain the ratio of VBW/RBW (10:1).</p> <p>When the Res BW is set to Auto, the resolution bandwidth is auto-coupled to the span. The ratio of Span/RBW is approximately 106:1 when auto coupled. When Res BW is set to Man, and the bandwidths are entered manually, these bandwidths are used regardless of other analyzer settings.</p>
Preset	<p>SA: Auto</p> <p>WCDMA: 240 kHz</p> <p>C2K: 24 kHz</p> <p>WIMAX OFDMA: 100kHz</p> <p>1xEVDO: 30kHz</p> <p>DVB-T/H: 3.9kHz</p> <p>DTMB (CTTB): 3.9kHz</p> <p>ISDB-T: 30kHz</p> <p>CMMB: 3.9kHz</p> <p>LTE: Auto</p> <p>LTETDD: Auto</p> <p>Digital Cable TV: 3.9kHz</p> <p>WLAN: 100 kHz</p> <p>MSR: 100kHz</p> <p>LTEAFDD/LTEATDD: Auto</p> <p>WCDMA, C2K, 1xEVDO, WIMAX OFDMA, DVB-T/H, DTMB (CTTB), ISDB-T, CMMB, Digital Cable TV, WLAN, MSR: OFF</p> <p>SA, LTE, LTETDD, LTEAFDD, LTEATDD: ON</p>
State Saved	Saved in instrument state.
Min	1 Hz
Max	8 MHz
Backwards Compatibility SCPI	<code>[:SENSe] :CHPower:BWIDth [:RESolution]</code>
Initial S/W Revision	Prior to A.02.00
Modified at S/W Revision	A.02.00, A.03.00

Video BW

Changes the analyzer post-detection filter (VBW).

Key Path	BW
Mode	SA, WCDMA, C2K, WIMAX OFDMA, 1xEVDO, DVB-T/H, DTMB (CTTB), ISDB-T, CMMB, LTE, LTETDD, Digital Cable TV, WLAN, MSR, LTEAFDD, LTEATDD
Remote Command	<code>[:SENSe] :CHPower:BANDwidth:VIDeo <bandwidth></code>

	[:SENSe]:CHPower:BANDwidth:VIDeo?
	[:SENSe]:CHPower:BANDwidth:VIDeo:AUTO ON OFF 1 0
	[:SENSe]:CHPower:BANDwidth:VIDeo:AUTO?
Example	CHP:BAND:VID 2.4 MHz CHP:BAND:VID? CHP:BAND:VID:AUTO OFF CHP:BAND:VID:AUTO?
Notes	You must be in the Spectrum Analysis mode, W-CDMA mode, cdma2000 mode, DVB-T/H mode, DTMB (CTTB) mode, ISDB-T mode, CMMB mode, Digital Cable TV mode, LTE mode, LTE TDD mode, WLAN mode, 1xEVDO mode, MSR,LTE-Advanced FDD/TDD mode or WIMAX OFDMA mode to use this command. Use :INSTrument:SElect to set the mode.
Dependencies	See Couplings
Couplings	<p>Video bandwidth (VBW) is coupled to the RBW. As the resolution bandwidth changes, the video bandwidth (if set to Auto) changes to maintain the ratio set by VBW/RBW.</p> <p>Sweep Time is coupled to the Video Bandwidth (VBW). As the VBW is changed, the sweep time (when set to Auto) is changed to maintain amplitude calibration. This occurs because of common hardware between the two circuits, even though the Video BW filter is not actually “in-circuit” when the detector is set to Average. Because the purpose of the average detector and the VBW filter are the same, either can be used to reduce the variance of the result.</p> <p>Although the VBW filter is not “in-circuit” when using the average detector, the Video BW key can have an effect on (Auto) sweep time, and is not disabled. In this case, reducing the VBW setting increases the sweep time, which increases the averaging time, producing a lower-variance trace.</p> <p>When using the average detector with either Sweep Time set to Man, or in zero span, the VBW setting has no effect and is disabled (grayed out).</p> <p>When the video bandwidth is AUTO coupled, the video bandwidth value is set to: Resolution Bandwidth * Video Bandwidth to Resolution Bandwidth Ratio</p>
Preset	SA: Auto WCDMA: 2.4MHz C2K: 240 kHz WIMAX OFDMA: Auto 1xEVDO: 300 kHz DVB-T/H: 39kHz DTMB (CTTB): 39kHz ISDB-T: 300kHz CMMB: 39kHz LTE, MSR: Auto LTETDD: Auto LTEAFDD,LTEATDD:Auto Digital Cable TV: 39kHz WLAN: Auto ON

State Saved	Saved in instrument state.
Min	1 Hz
Max	50 MHz
Initial S/W Revision	Prior to A.02.00
Modified at S/W Revision	A.02.00, A.03.00

Filter Type

Selects the type of bandwidth filter that is used. The choices are Gaussian or Flat top.

Key Path	BW
Mode	SA, WCDMA, C2K, WIMAX OFDMA, 1xEVDO, DVB-T/H, DTMB (CTTB), ISDB-T, CMMB, LTE, LTE-TDD, Digital Cable TV, WLAN, MSR, LTEAFDD, LTEATDD
Remote Command	[:SENSe] :CHPower :BANDwidth :SHAPE GAUSSian FLATtop [:SENSe] :CHPower :BANDwidth :SHAPE?
Example	CHP:BAND:SHAP GAUS CHP:BAND:SHAP?
Preset	GAUSSian
State Saved	Saved in instrument state.
Range	Gaussian Flattop
Backwards Compatibility SCPI	[:SENSe] :CHPower :BWIDth :SHAPE
Initial S/W Revision	Prior to A.02.00
Modified at S/W Revision	A.02.00, A.03.00

Cont (Continuous Measurement/Sweep)

Sets the analyzer for Continuous measurement operation. The single/continuous state is Meas Global so the setting will affect all measurements. If you are Paused, pressing **Cont** does a Resume.

Key Path	Front-panel key
Remote Command	:INITiate:CONTinuous OFF ON 0 1 :INITiate:CONTinuous?
Example	:INIT:CONT 0 puts analyzer in Single measurement operation. :INIT:CONT 1 puts analyzer in Continuous measurement operation
Preset	ON (Note that SYST:PRESet sets INIT:CONT to ON but *RST sets INIT:CONT to OFF)
State Saved	Saved in instrument state
Backwards Compatibility Notes	For Spectrum Analysis mode in ESA and PSA, there is no Cont hardkey, instead there is a Sweep Single/Cont key. In these analyzers, switching the Sweep Single/Cont key from Single to Cont restarts averages (displayed average count reset to 1), but does not restart Max Hold and Min Hold . The X-Series has Single and Cont keys in place of the SweepSingleCont key. In the X-Series, if in single measurement, the Cont key (and INIT:CONT ON) switches to continuous measurement, but never restarts a measurement and never resets a sweep.
Initial S/W Revision	Prior to A.02.00

In Swept SA Measurement (Spectrum Analysis Mode):

The analyzer takes repetitive sweeps, averages, measurements, etc., when in Continuous mode. When the average count reaches the Average/Hold Number the count stops incrementing, but the analyzer keeps sweeping. See the Trace/Detector section for the averaging formula used both before and after the Average/Hold Number is reached. The trigger condition must be met prior to each sweep. The type of trace processing for multiple sweeps, is set under the Trace/Detector key, with choices of **Trace Average**, **Max Hold**, or **Min Hold**.

In Other Measurements/Modes:

With **Avg/Hold Num** (in the **Meas Setup** menu) set to **Off** or set to **On** with a value of 1, a sweep is taken after the trigger condition is met; and the analyzer continues to take new sweeps after the current sweep has completed and the trigger condition is again met. However, with **Avg/Hold Num** set to On with a value >1, multiple sweeps (data acquisitions) are taken for the measurement. The trigger condition must be met prior to each sweep. The sweep is not stopped when the average count k equals the number N set for Avg/Hold Num is reached, but the number k stops incrementing. A measurement average usually applies to all traces, marker results, and numeric results. But sometimes it only applies to the numeric results.

If the analyzer is in Single measurement, pressing the **Cont** key does not change k and does not cause the sweep to be reset; the only action is to put the analyzer into Continuous measurement operation.

If it is already in continuous sweep:

the INIT:CONT 1 command has no effect

8 Channel Power Measurement
Cont (Continuous Measurement/Sweep)

the INIT:CONT 0 command will place the analyzer in Single Sweep but will have no effect on the current sequence until $k = N$, at which point the current sequence will stop and the instrument will go to the idle state.

File

See "File" on page 362

FREQ Channel

Accesses a menu of keys that allow you to control the Frequency and Channel parameters of the instrument.

Some features in the Frequency menu are the same for all measurements - they do not change as you change measurements. Settings like these are called "Meas Global" and are unaffected by Meas Preset. For example, the Center Freq setting is the same for all measurements - it does not change as you change measurements.

Key Path	Front Panel
Mode	MSR
Initial S/W Revision	A.10.00

Carrier Ref Freq

Sets carrier reference frequency. The center frequencies of carriers are defined as offset frequency from this value. This reference frequency is also the reference of carrier configuration preset.

Key Path	FREQ Channel
Mode	MSR
Measurement	all
Remote Command	<code>[:SENSe] :CARRier:REFerence <freq></code> <code>[:SENSe] :CARRier:REFerence?</code>
Example	CARR:REF 2GHz CARR:REF?
Preset	1GHz
State Saved	Saved in instrument state
Min	Depends on instrument minimum center frequency. Same as Center Freq
Max	Depends on instrument maximum center frequency. Same as Center Freq
Initial S/W Revision	A.10.00

Carrier Setup

Accesses the Carrier Setup menu.

Key Path	FREQ Channel
Initial S/W Revision	A.10.00

Carriers

Specifies how many carriers are used in MSR measurements. Base station RF bandwidth is determined from the carrier 1 to the carrier specified by this value whatever carriers' Present Pwr states are. Select Carrier can be select up to this value.

Key Path	FREQ Channel, Carrier Setup
Measurement	All
Remote Command	<code>[:SENSe] :CARRier:COUNT <integer></code> <code>[:SENSe] :CARRier:COUNT?</code>
Example	CARR:COUN 10 CARR:COUN?
Preset	1
State Saved	Saved in instrument state.
Min	1
Max	100
Initial S/W Revision	A.10.00

Configure Carriers

Accesses a menu of commonly used carrier configuration parameters.

Key Path	FREQ Channel, Carrier Setup
Initial S/W Revision	A.10.00

Select Carrier

Selects which carrier's configuration menu is displayed.

This key is also connected to the carrier info tables of some measurements. When the value is changed in a measurement which has carrier table view, the highlight in the table moves to Select Carrier. The highlight of the table and Select Carrier are not coupled.

Key Path	FREQ Channel, Carrier Setup, Configure Carriers
Preset	1
State Saved	No
Min	1
Max	Value of Carriers
Initial S/W Revision	A.10.00

Measure Carrier

Sets whether to measure this carrier or not.

Key Path	FREQ Channel, Carrier Setup, Configure Carriers
Remote Command	<code>[:SENSe] :CARRier<n> [:STATe] OFF ON 0 1</code> <code>[:SENSe] :CARRier<n> [:STATe] ?</code>
Example	CARR10 1 CARR10?
Notes	The command is used with a sub-op code <n> (default=1) to specify the carrier for configuration. The range of the sub-op code is determined by the number of carriers.
Preset	ON
State Saved	Saved in instrument state
Range	On Off
Initial S/W Revision	A.10.00

Carrier Offset

Sets the carrier center frequency as offset from Carrier Ref Frequency.

Key Path	FREQ Channel, Carrier Setup, Configure Carriers
Remote Command	<code>[:SENSe] :CARRier<n> :FREQuency:OFFSet <freq></code> <code>[:SENSe] :CARRier<n> :FREQuency:OFFSet ?</code>
Example	CARR10:FREQ:OFFS 10MHz CARR10:FREQ:OFFS?
Notes	The command is used with a sub-op code <n> (default=1) to specify the carrier for configuration. The range of the sub-op code is determined by the number of carriers.
Preset	0Hz
State Saved	Saved in instrument state
Min	-1GHz
Max	1GHz
Initial S/W Revision	A.10.00

Radio Format

Selects a format parameter set to set the radio format of the selected carrier.

NONE – No format is specified. Channel spacing, measurement BW and FOffset,RAT are values of defaults of LTE FDD 5MHz.

LTE FDD Parameter Set 1 – Selects LTE FDD parameter set 1. LTE FDD (E-UTRA FDD) is the radio format of the carrier.

LTE FDD Parameter Set 2 – Selects LTE FDD parameter set 2. LTE FDD (E-UTRA FDD) is the radio format of the carrier.

LTE FDD Parameter Set 3 – Selects LTE FDD parameter set 3. LTE FDD (E-UTRA FDD) is the radio format of the carrier.

W-CDMA Parameter Set 1 – Selects W-CDMA parameter set 1. W-CDMA (UTRA FDD) is the radio format of the carrier.

W-CDMA Parameter Set 2 – Selects W-CDMA parameter set 2. W-CDMA (UTRA FDD) is the radio format of the carrier.

W-CDMA Parameter Set 3 – Selects W-CDMA parameter set 3. W-CDMA (UTRA FDD) is the radio format of the carrier.

GSM/EDGE Parameter Set 1 – Selects GSM/EDGE parameter set 1. GSM/EDGE is the radio format of the carrier.

GSM/EDGE Parameter Set 2 – Selects GSM/EDGE parameter set 2. GSM/EDGE is the radio format of the carrier.

GSM/EDGE Parameter Set 3 – Selects GSM/EDGE parameter set 3. GSM/EDGE is the radio format of the carrier.

cdma2000 Parameter Set 1 – Selects cdma2000 parameter set 1. cdma2000 is the radio format of the carrier.

cdma2000 Parameter Set 2 – Selects cdma2000 parameter set 2. cdma2000 is the radio format of the carrier.

cdma2000 Parameter Set 3 – Selects cdma2000 parameter set 3. cdma2000 is the radio format of the carrier.

1xEV-DO Parameter Set 1 – Selects 1xEV-DO parameter set 1. 1xEV-DO is the radio format of the carrier.

1xEV-DO Parameter Set 2 – Selects 1xEV-DO parameter set 2. 1xEV-DO is the radio format of the carrier.

1xEV-DO Parameter Set 3 – Selects 1xEV-DO parameter set 3. 1xEV-DO is the radio format of the carrier.

LTE TDD Parameter Set 1 – Selects LTE TDD parameter set 1. LTE TDD (E-UTRA TDD) is the radio format of the carrier.

LTE TDD Parameter Set 2 – Selects LTE TDD parameter set 2. LTE TDD (E-UTRA TDD) is the radio format of the carrier.

LTE TDD Parameter Set 3 – Selects LTE TDD parameter set 3. LTE TDD (E-UTRA TDD) is the radio format of the carrier.

TD-SCDMA Parameter Set 1 – Selects TD-SCDMA parameter set 1. TD-SCDMA (UTRA-TDD LCR) is the radio format of the carrier.

TD-SCDMA Parameter Set 2 – Selects TD-SCDMA parameter set 2. TD-SCDMA (UTRA-TDD LCR) is the radio format of the carrier.

TD-SCDMA Parameter Set 3 – Selects TD-SCDMA parameter set 3. TD-SCDMA (UTRA-TDD LCR) is the radio format of the carrier.

Key Path	FREQ Channel, Carrier Setup, Configure Carriers
Remote Command	[:SENSe]:CARRier<n>:FORMat NONE LTEFdd1 LTEFdd2 LTEFdd3 WCDma1 WCDma2 WCDma3 GSM1 GSM2 GSM3 CDMA1 CDMA2 CDMA3 EVDO1 EVDO2 EVDO3 LTEFdd1 LTEFdd2 LTEFdd3 TDSCdma1 TDSCdma2 TDSCdma3 [:SENSe]:CARRier<n>:FORMat ?
Example	CARR10:FORM LTEF1 CARR10:FORM?
Notes	The command is used with a sub-op code <n> (default=1) to specify the carrier for configuration. The range of the sub-op code is determined by the number of carriers.
Dependencies	The following licenses are required for each key to be displayed. Without the licenses, corresponding enum values cannot be set even via the SCPI command. <ul style="list-style-type: none"> • LTE FDD - N9080A-1FP or W9080A-1FP • W-CDMA - N9073A-1FP or W9073A-1FP • GSM/EDGE - N9071A-2FP or W9071A-2FP • cdma2000 - N9072A-2FP or W9072A-2FP • 1xEV-DO - N9076A-1FP or W9076A-1FP • LTE TDD - N9082A-1FP or W9082A-1FP • TD-SCDMA - N9079A-1FP or W9079A-1FP
State Saved	Saved in instrument state
Range	None LTE FDD [Parameter Set 1] Parameter Set 1 ("LTE FDD 1") Parameter Set 2 ("LTE FDD 2") Parameter Set 3 ("LTE FDD 3") W-CDMA [Parameter Set 1] Parameter Set 1 ("W-CDMA 1") Parameter Set 2 ("W-CDMA 2") Parameter Set 3 ("W-CDMA 3") GSM/EDGE [Parameter Set 1] Parameter Set 1 ("GSM/EDGE 1") Parameter Set 2 ("GSM/EDGE 2") Parameter Set 3 ("GSM/EDGE 3") cdma2000 [Parameter Set 1] Parameter Set 1 ("cdma2000 1") Parameter Set 2 ("cdma2000 2") Parameter Set 3 ("cdma2000 3") 1xEV-DO [Parameter Set 1] Parameter Set 1 ("1xEV-DO 1") Parameter Set 2 ("1xEV-DO 2") Parameter Set 3 ("1xEV-DO 3")

	LTE TDD [Parameter Set 1] Parameter Set 1 ("LTE TDD 1") Parameter Set 2 ("LTE TDD 2") Parameter Set 3 ("LTE TDD 3") TD-SCDMA [Parameter Set 1] Parameter Set 1 ("TD-SCDMA 1") Parameter Set 2 ("TD-SCDMA 2") Parameter Set 3 ("TD-SCDMA 3")
Readback	The readback line on this key shows the currently selected Radio Format in square brackets.
Initial S/W Revision	A.10.00
Modified at S/W Revision	A.12.00, A.16.00

Carrier Allocation

Specifies the carrier frequency allocation. There are two types of allocation, contiguous and non-contiguous. Non-Contiguous frequency allocation is defined as an allocation where two sub-blocks are separated with a sub-block gap.

Contiguous – All the carriers belong to one block and no sub-block gap exists.

Non-Contiguous – Carriers are separated into two sub-blocks. Allocation Break Pt Carrier determines how sub-blocks are configured.

Key Path	FREQ Channel, Carrier Setup
Scope	Meas Global
Remote Command	[:SENSe]:CARRier:CONFig:ALLocation CONTiguous NCONtiguous [:SENSe]:CARRier:CONFig:ALLocation?
Example	CARR:CONF:ALL CONT CARR:CONF:ALL?
Preset	CONTiguous
State Saved	Saved in instrument state.
Range	Contiguous Non-Contiguous
Initial S/W Revision	A.13.00

Non-Contiguous

Opens a menu that enables you to set a non-contiguous parameter.

Key Path	FREQ Channel, Carrier Setup, Carrier Allocation
Initial S/W Revision	A.13.00

Allocation Break Pt Carrier

Specifies an allocation break point in non-contiguous carrier allocation. First sub-block starts from the lowest frequency carrier and stops at the allocation break point carrier. Next sub-block starts from the next upper frequency carrier and ends at the highest frequency carrier.

Two examples are shown below. In these examples carrier indices are not in the order of carrier frequency. In the first example, Allocation Break Pt Carrier is 2. It means that sub-block 1 ends at carrier 2 and sub-block 2 starts at carrier 5. Sub-block gap is located between carrier 2 and 5. In the second example, Allocation Break Pt Carrier is 3 and the sub-block gap comes between carrier 3 and 2.

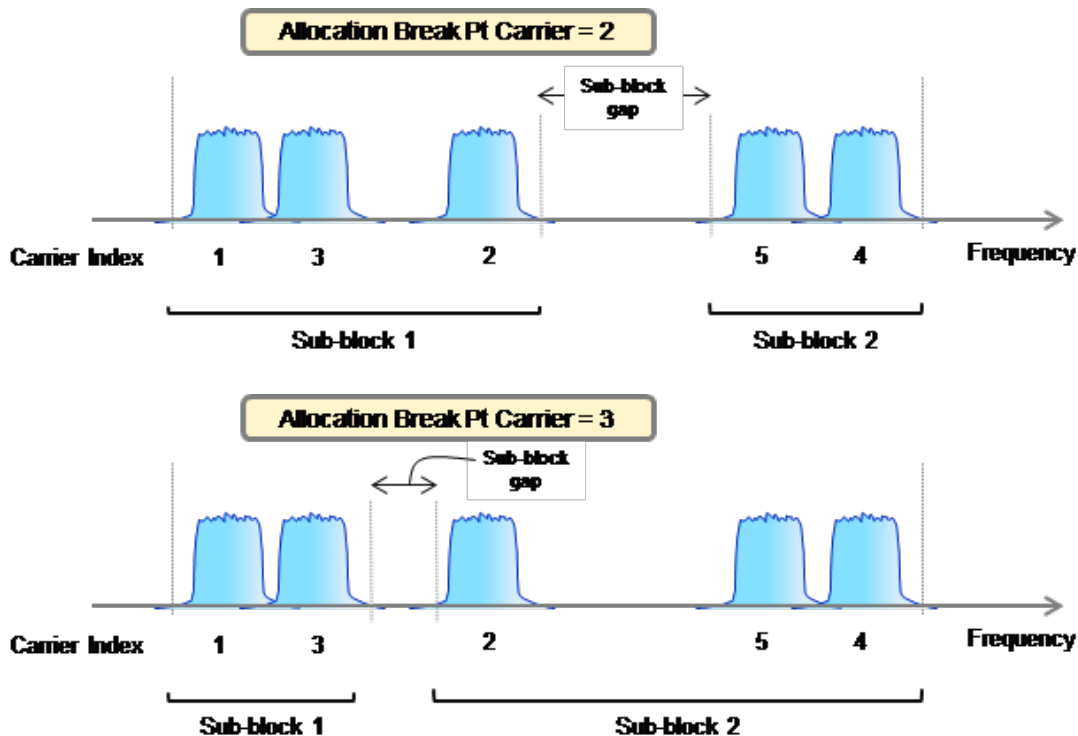

Key Path	FREQ Channel, Carrier Setup, Carrier Allocation, Non-Contiguous
Scope	Meas Global
Remote Command	[[:SENSE]:CARRIER:CONFIG:ALLOCATION:NCONTIGUOUS:ABPOINT <integer> [:SENSE]:CARRIER:CONFIG:ALLOCATION:NCONTIGUOUS:ABPOINT?
Example	CARR:CONF:ALL:NCON:ABP 5 CARR:CONF:ALL:NCON:ABP?
Dependencies	The maximum value depends on the number of carriers.
Couplings	This value can change when you decrease the number of carriers.
Preset	1
State Saved	Saved in instrument state.
Min	1
Max	99
Initial S/W Revision	A.13.00

Carrier Conf Presets

Pressing this key pops up Conf Presets. Each parameter under this menu initiate carrier configuration preset when its value is changed.

Appropriate licenses are required to select carrier config enum. Required licenses are shown here. Note that N/W means N or W license, i.e. N/W9073A-1FP means either N9073A-1FP or W9073A-1FP is required.

TC1a (FDD): N/W9073A-1FP (W-CDMA)

TC2 (FDD): N/W9080A-1FP (LTE FDD)

TC3a (FDD): N/W9073A-1FP (W-CDMA) and N9080A-1FP (LTE FDD)

TC4a (FDD): N/W9071A-2FP (GSM/EDGE) and N/W9073A-1FP (W-CDMA)

TC4b (FDD): N/W9071A-2FP (GSM/EDGE) and N9080A-1FP (LTE FDD)

TC4c (FDD): N/W9071A-2FP (GSM/EDGE), N/W9073A-1FP (W-CDMA) and N9080A-1FP (LTE FDD)

TC4d (FDD): N/W9071A-2FP (GSM/EDGE) and N/W9073A-1FP (W-CDMA)

TC4e (FDD): N/W9071A-2FP (GSM/EDGE) and N9080A-1FP (LTE FDD)

TC4a (FDD) Two Carriers: N/W9071A-2FP (GSM/EDGE) and N/W9073A-1FP (W-CDMA)

TC4b (FDD) Two Carriers: N/W9071A-2FP (GSM/EDGE) and N9080A-1FP (LTE FDD)

TC4c (FDD) Two Carriers: N/W9071A-2FP (GSM/EDGE), N/W9073A-1FP (W-CDMA) and N9080A-1FP (LTE FDD)

NTC1a (FDD): N/W9073A-1FP (W-CDMA)

NTC2 (FDD): N/W9080A-1FP (LTE FDD)

NTC3a (FDD): N/W9073A-1FP (W-CDMA) and N9080A-1FP (LTE FDD)

NTC4a (FDD): N/W9071A-2FP (GSM/EDGE) and N/W9073A-1FP (W-CDMA)

NTC4b (FDD): N/W9071A-2FP (GSM/EDGE) and N9080A-1FP (LTE FDD)

NTC4c (FDD): N/W9071A-2FP (GSM/EDGE), N/W9073A-1FP (W-CDMA) and N9080A-1FP (LTE FDD)

LTE FDD: N/W9080A-1FP (LTE FDD)

W-CDMA: N/W9073A-1FP (W-CDMA)

GSM/EDGE: N/W9071A-2FP (GSM/EDGE)

cdma2000: N/W9072A-2FP (cdma2000)

1xEV-DO: N/W9076A-1FP (1xEV-DO)

Enum keys don't appear on the menu if required licenses are not installed.

Key Path	FREQ Channel, Carrier Setup
----------	-----------------------------

Remote Command	<code>[:SENSe] :CARRier:CONFig?</code>
Example	CARR:CONF TC1AFDD CARR:CONF?
Notes	The softkey for NONE is not available.
State Saved	Saved in instrument state
Initial S/W Revision	A.10.00
Modified at S/W Revision	A.12.00, A.13.00

MSR Test Config

Accesses the menu to select MSR Test Configurations.

Key Path	FREQ Channel, Carrier Setup
Initial S/W Revision	A.10.00

Carrier Conf Presets

Pressing this key pops up Conf Presets. Each parameter under this menu initiate carrier configuration preset when its value is changed.

Appropriate licenses are required to select carrier config enum. Required licenses are shown here. Note that N/W means N or W license, i.e. N/W9073A-1FP means either N9073A-1FP or W9073A-1FP is required.

TC1a (FDD): N/W9073A-1FP (W-CDMA)

TC2 (FDD): N/W9080A-1FP (LTE FDD)

TC3a (FDD): N/W9073A-1FP (W-CDMA) and N9080A-1FP (LTE FDD)

TC4a (FDD): N/W9071A-2FP (GSM/EDGE) and N/W9073A-1FP (W-CDMA)

TC4b (FDD): N/W9071A-2FP (GSM/EDGE) and N9080A-1FP (LTE FDD)

TC4c (FDD): N/W9071A-2FP (GSM/EDGE), N/W9073A-1FP (W-CDMA) and N9080A-1FP (LTE FDD)

TC4d (FDD): N/W9071A-2FP (GSM/EDGE) and N/W9073A-1FP (W-CDMA)

TC4e (FDD): N/W9071A-2FP (GSM/EDGE) and N9080A-1FP (LTE FDD)

TC4a (FDD) Two Carriers: N/W9071A-2FP (GSM/EDGE) and N/W9073A-1FP (W-CDMA)

TC4b (FDD) Two Carriers: N/W9071A-2FP (GSM/EDGE) and N9080A-1FP (LTE FDD)

TC4c (FDD) Two Carriers: N/W9071A-2FP (GSM/EDGE), N/W9073A-1FP (W-CDMA) and N9080A-1FP (LTE FDD)

NTC1a (FDD): N/W9073A-1FP (W-CDMA)

NTC2 (FDD): N/W9080A-1FP (LTE FDD)

NTC3a (FDD): N/W9073A-1FP (W-CDMA) and N9080A-1FP (LTE FDD)

NTC4a (FDD): N/W9071A-2FP (GSM/EDGE) and N/W9073A-1FP (W-CDMA)

NTC4b (FDD): N/W9071A-2FP (GSM/EDGE) and N9080A-1FP (LTE FDD)

NTC4c (FDD): N/W9071A-2FP (GSM/EDGE), N/W9073A-1FP (W-CDMA) and N9080A-1FP (LTE FDD)

LTE FDD: N/W9080A-1FP (LTE FDD)

W-CDMA: N/W9073A-1FP (W-CDMA)

GSM/EDGE: N/W9071A-2FP (GSM/EDGE)

cdma2000: N/W9072A-2FP (cdma2000)

1xEV-DO: N/W9076A-1FP (1xEV-DO)

Enum keys don't appear on the menu if required licenses are not installed.

Key Path	FREQ Channel, Carrier Setup
Remote Command	[:SENSe] :CARRier:CONFig?
Example	CARR:CONF TC1AFDD CARR:CONF?
Notes	The softkey for NONE is not available.
State Saved	Saved in instrument state
Initial S/W Revision	A.10.00
Modified at S/W Revision	A.12.00, A.13.00

Max W-CDMA Carriers (FDD)

Sets max W-CDMA carriers placed when the carrier configuration preset runs. When this value is changed, the carrier configuration preset is initiated.

Key Path	FREQ Channel, Carrier Setup, Carrier Conf Presets, MSR Test Config, TC1a (FDD)FREQ Channel, Carrier Setup, Carrier Conf Presets, MSR Test Config, TC3a (FDD)FREQ Channel, Carrier Setup, Carrier Conf Presets, MSR Test Config, TC4a (FDD)FREQ Channel, Carrier Setup, Carrier Conf Presets, MSR Test Config, TC4c (FDD)FREQ Channel, Carrier Setup, Carrier Conf Presets, Single RAT Config, W-CDMA
Remote Command	[:SENSe] :CARRier:CONFig:WCDMa:CMAx <integer> [:SENSe] :CARRier:CONFig:WCDMa:CMAx?
Example	CARR:CONF:WCDM:CMAx 8 CARR:CONF:WCDM:CMAx?
Preset	100
State Saved	Saved in instrument state

Min	1
Max	100
Initial S/W Revision	A.10.00

Max LTE FDD Carriers

Sets max LTE FDD carriers placed when the carrier configuration preset runs. When this value is changed, the carrier configuration preset is initiated.

Key Path	FREQ Channel, Carrier Setup, Carrier Conf Presets, MSR Test Config, TC2 (FDD)FREQ Channel, Carrier Setup, Carrier Conf Presets, MSR Test Config, TC3a (FDD)FREQ Channel, Carrier Setup, Carrier Conf Presets, MSR Test Config, TC4b (FDD)FREQ Channel, Carrier Setup, Carrier Conf Presets, MSR Test Config, TC4c (FDD)FREQ Channel, Carrier Setup, Carrier Conf Presets, Single RAT Config, LTE FDD
Remote Command	<code>[:SENSe] :CARRier:CONFig:LTEFdd:CMAX <integer></code> <code>[:SENSe] :CARRier:CONFig:LTEFdd:CMAX?</code>
Example	CARR:CONF:LTEF:CMAX 8 CARR:CONF:LTEF:CMAX?
Preset	100
State Saved	Saved in instrument state
Min	1
Max	100
Initial S/W Revision	A.10.00

LTE FDD BW

Sets bandwidth of LTE FDD carriers placed when the carrier configuration preset runs. When this value is changed, the carrier configuration preset is initiated.

Key Path	FREQ Channel, Carrier Setup, Carrier Conf Presets, MSR Test Config, TC2 (FDD)FREQ Channel, Carrier Setup, Carrier Conf Presets, MSR Test Config, TC3a (FDD)FREQ Channel, Carrier Setup, Carrier Conf Presets, MSR Test Config, TC4b (FDD)FREQ Channel, Carrier Setup, Carrier Conf Presets, MSR Test Config, TC4c (FDD)FREQ Channel, Carrier Setup, Carrier Conf Presets, MSR Test Config, TC4d (FDD)FREQ Channel, Carrier Setup, Carrier Conf Presets, Single RAT Config, LTE FDD
Remote Command	<code>[:SENSe] :CARRier:CONFig:LTEFdd:BANDwidth B1M4 B3M B5M B10M B15M B20M</code> <code>[:SENSe] :CARRier:CONFig:LTEFdd:BANDwidth?</code>
Example	CARR:CONF:LTEF:BAND B5M CARR:CONF:LTEF:BAND?
Preset	B5M

State Saved	Saved in instrument state
Range	1.4MHz 3MHz 5MHz 10MHz 15MHz 20MHz
Readback	The currently selected LTE FDD BW
Initial S/W Revision	A.10.00

Narrowest LTE FDD BW

Sets narrowest bandwidth of LTE FDD carriers placed for TC2 when the carrier configuration preset runs. When this value is changed, the carrier configuration preset is initiated.

Key Path	FREQ Channel, Carrier Setup, Carrier Conf Presets, MSR Test Config, TC2 (FDD)
Remote Command	<code>[:SENSe]:CARRier:CONFig:LTEFdd:BANDwidth:NARRowest B1M4 B3M B5M B10M B15M B20M</code> <code>[:SENSe]:CARRier:CONFig:LTEFdd:BANDwidth:NARRowest?</code>
Example	CARR:CONF:LTEF:BAND:NARR B1M4 CARR:CONF:LTEF:BAND:NARR?
Preset	B1M4
State Saved	Saved in instrument state
Range	1.4MHz 3MHz 5MHz 10MHz 15MHz 20MHz
Readback	The currently selected Narrowest LTE FDD BW
Initial S/W Revision	A.10.00

Max GSM/EDGE Carriers

Sets max GSM/EDGE carriers placed when the carrier configuration preset runs. When this value is changed, the carrier configuration preset is initiated.

Key Path	FREQ Channel, Carrier Setup, Carrier Conf Presets, MSR Test Config, TC4a (FDD)FREQ Channel, Carrier Setup, Carrier Conf Presets, MSR Test Config, TC4b (FDD)FREQ Channel, Carrier Setup, Carrier Conf Presets, MSR Test Config, TC4c (FDD)FREQ Channel, Carrier Setup, Carrier Conf Presets, Single RAT Config, GSM/EDGE
Remote Command	<code>[:SENSe]:CARRier:CONFig:GSM:CMAX <integer></code> <code>[:SENSe]:CARRier:CONFig:GSM:CMAX?</code>
Example	CARR:CONF:GSM:CMAX 8 CARR:CONF:GSM:CMAX?
Preset	100
State Saved	Saved in instrument state
Min	1
Max	100
Initial S/W Revision	A.10.00

LTE FDD Location

Sets the location of LTE FDD carriers when carriers are configured as TC4c. This parameter is effective only for TC4c.

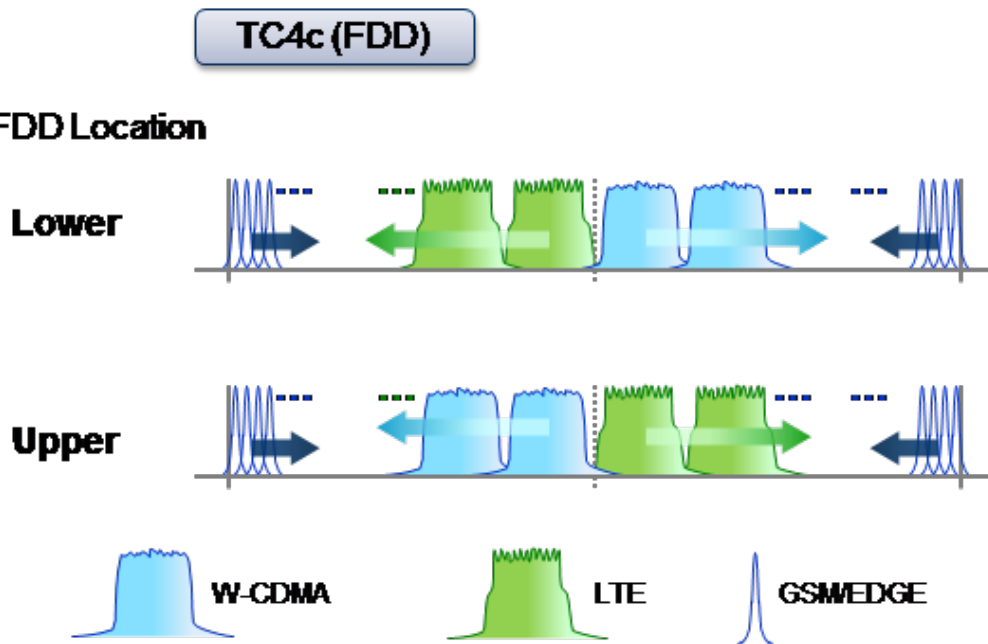

Key Path	FREQ Channel, Carrier Setup, Carrier Conf Presets, MSR Test Config, TC4c (FDD)
Remote Command	<code>[[:SENSE]:CARRier:CONFig:LTEFdd:LOCation UPPer LOWer</code> <code>[[:SENSE]:CARRier:CONFig:LTEFdd:LOCation?</code>
Example	<code>CARR:CONF:LTEF:LOC LOW</code> <code>CARR:CONF:LTEF:LOC?</code>
Notes	This setting is effective only for TC4c.
Preset	UPPer
State Saved	Saved in instrument state
Range	Lower (Lower than W-CDMA) Upper (Higher than W-CDMA)
Initial S/W Revision	A.11.00

MSR Non-Contig Test Config

Accesses the menu to select MSR Non-Contiguous Test Configurations.

Key Path	FREQ Channel, Carrier Setup
Initial S/W Revision	A.13.00

Carrier Conf Presets

Pressing this key pops up Conf Presets. Each parameter under this menu initiate carrier configuration preset when its value is changed.

Appropriate licenses are required to select carrier config enum. Required licenses are shown here. Note that N/W means N or W license, i.e. N/W9073A-1FP means either N9073A-1FP or W9073A-1FP is required.

TC1a (FDD): N/W9073A-1FP (W-CDMA)

TC2 (FDD): N/W9080A-1FP (LTE FDD)

TC3a (FDD): N/W9073A-1FP (W-CDMA) and N9080A-1FP (LTE FDD)

TC4a (FDD): N/W9071A-2FP (GSM/EDGE) and N/W9073A-1FP (W-CDMA)

TC4b (FDD): N/W9071A-2FP (GSM/EDGE) and N9080A-1FP (LTE FDD)

TC4c (FDD): N/W9071A-2FP (GSM/EDGE), N/W9073A-1FP (W-CDMA) and N9080A-1FP (LTE FDD)

TC4d (FDD): N/W9071A-2FP (GSM/EDGE) and N/W9073A-1FP (W-CDMA)

TC4e (FDD): N/W9071A-2FP (GSM/EDGE) and N9080A-1FP (LTE FDD)

TC4a (FDD) Two Carriers: N/W9071A-2FP (GSM/EDGE) and N/W9073A-1FP (W-CDMA)

TC4b (FDD) Two Carriers: N/W9071A-2FP (GSM/EDGE) and N9080A-1FP (LTE FDD)

TC4c (FDD) Two Carriers: N/W9071A-2FP (GSM/EDGE), N/W9073A-1FP (W-CDMA) and N9080A-1FP (LTE FDD)

NTC1a (FDD): N/W9073A-1FP (W-CDMA)

NTC2 (FDD): N/W9080A-1FP (LTE FDD)

NTC3a (FDD): N/W9073A-1FP (W-CDMA) and N9080A-1FP (LTE FDD)

NTC4a (FDD): N/W9071A-2FP (GSM/EDGE) and N/W9073A-1FP (W-CDMA)

NTC4b (FDD): N/W9071A-2FP (GSM/EDGE) and N9080A-1FP (LTE FDD)

NTC4c (FDD): N/W9071A-2FP (GSM/EDGE), N/W9073A-1FP (W-CDMA) and N9080A-1FP (LTE FDD)

LTE FDD: N/W9080A-1FP (LTE FDD)

W-CDMA: N/W9073A-1FP (W-CDMA)

GSM/EDGE: N/W9071A-2FP (GSM/EDGE)

cdma2000: N/W9072A-2FP (cdma2000)

1xEV-DO: N/W9076A-1FP (1xEV-DO)

Enum keys don't appear on the menu if required licenses are not installed.

Key Path	FREQ Channel, Carrier Setup
-----------------	------------------------------------

Remote Command

[:SENSe] :CARRier:CONFig?

Example	CARR:CONF TC1AFDD CARR:CONF?
Notes	The softkey for NONE is not available.
State Saved	Saved in instrument state
Initial S/W Revision	A.10.00
Modified at S/W Revision	A.12.00, A.13.00

LTE FDD BW

Sets bandwidth of LTE FDD carriers placed when the carrier configuration preset runs. When this value is changed, the carrier configuration preset is initiated.

Key Path	FREQ Channel, Carrier Setup, Carrier Conf Presets, MSR Test Config, TC2 (FDD)FREQ Channel, Carrier Setup, Carrier Conf Presets, MSR Test Config, TC3a (FDD)FREQ Channel, Carrier Setup, Carrier Conf Presets, MSR Test Config, TC4b (FDD)FREQ Channel, Carrier Setup, Carrier Conf Presets, MSR Test Config, TC4c (FDD)FREQ Channel, Carrier Setup, Carrier Conf Presets, MSR Test Config, TC4d (FDD)FREQ Channel, Carrier Setup, Carrier Conf Presets, Single RAT Config, LTE FDD
Remote Command	[:SENSe] :CARRier:CONFig:LTEFdd:BANdwidth B1M4 B3M B5M B10M B15M B20M [:SENSe] :CARRier:CONFig:LTEFdd:BANdwidth?
Example	CARR:CONF:LTEF:BAND B5M CARR:CONF:LTEF:BAND?
Preset	B5M
State Saved	Saved in instrument state
Range	1.4MHz 3MHz 5MHz 10MHz 15MHz 20MHz
Readback	The currently selected LTE FDD BW
Initial S/W Revision	A.10.00

NTC4 Carriers

Sets NTC4 carriers placed when the NTC4 carrier configuration preset runs. When this value is changed, the carrier configuration preset is initiated.

Key Path	FREQ Channel, Carrier Setup, Carrier Conf Presets, MSR Non-Contig Test Config, NTC4a (FDD)FREQ Channel, Carrier Setup, Carrier Conf Presets, MSR Non-Contig Test Config, NTC4b (FDD)FREQ Channel, Carrier Setup, Carrier Conf Presets, MSR Non-Contig Test Config, NTC4c(FDD)
Remote Command	[:SENSe] :CARRier:CONFig:NTC4:COUNt <integer> [:SENSe] :CARRier:CONFig:NTC4:COUNt?
Example	CARR:CONF:NTC4:COUN 6 CARR:CONF:NTC4:COUN?

Preset	6
State Saved	Saved in instrument state
Min	3
Max	6
Initial S/W Revision	A.13.00

Single RAT Config

Accesses the menu to select Single RAT Configurations.

Key Path	FREQ Channel, Carrier Setup
Initial S/W Revision	A.10.00

Carrier Conf Presets

Pressing this key pops up Conf Presets. Each parameter under this menu initiate carrier configuration preset when its value is changed.

Appropriate licenses are required to select carrier config enum. Required licenses are shown here. Note that N/W means N or W license, i.e. N/W9073A-1FP means either N9073A-1FP or W9073A-1FP is required.

TC1a (FDD): N/W9073A-1FP (W-CDMA)

TC2 (FDD): N/W9080A-1FP (LTE FDD)

TC3a (FDD): N/W9073A-1FP (W-CDMA) and N9080A-1FP (LTE FDD)

TC4a (FDD): N/W9071A-2FP (GSM/EDGE) and N/W9073A-1FP (W-CDMA)

TC4b (FDD): N/W9071A-2FP (GSM/EDGE) and N9080A-1FP (LTE FDD)

TC4c (FDD): N/W9071A-2FP (GSM/EDGE), N/W9073A-1FP (W-CDMA) and N9080A-1FP (LTE FDD)

TC4d (FDD): N/W9071A-2FP (GSM/EDGE) and N/W9073A-1FP (W-CDMA)

TC4e (FDD): N/W9071A-2FP (GSM/EDGE) and N9080A-1FP (LTE FDD)

TC4a (FDD) Two Carriers: N/W9071A-2FP (GSM/EDGE) and N/W9073A-1FP (W-CDMA)

TC4b (FDD) Two Carriers: N/W9071A-2FP (GSM/EDGE) and N9080A-1FP (LTE FDD)

TC4c (FDD) Two Carriers: N/W9071A-2FP (GSM/EDGE), N/W9073A-1FP (W-CDMA) and N9080A-1FP (LTE FDD)

NTC1a (FDD): N/W9073A-1FP (W-CDMA)

NTC2 (FDD): N/W9080A-1FP (LTE FDD)

NTC3a (FDD): N/W9073A-1FP (W-CDMA) and N9080A-1FP (LTE FDD)

NTC4a (FDD): N/W9071A-2FP (GSM/EDGE) and N/W9073A-1FP (W-CDMA)

NTC4b (FDD): N/W9071A-2FP (GSM/EDGE) and N9080A-1FP (LTE FDD)

NTC4c (FDD): N/W9071A-2FP (GSM/EDGE), N/W9073A-1FP (W-CDMA) and N9080A-1FP (LTE FDD)

LTE FDD: N/W9080A-1FP (LTE FDD)

W-CDMA: N/W9073A-1FP (W-CDMA)

GSM/EDGE: N/W9071A-2FP (GSM/EDGE)

cdma2000: N/W9072A-2FP (cdma2000)

1xEV-DO: N/W9076A-1FP (1xEV-DO)

Enum keys don't appear on the menu if required licenses are not installed.

Key Path	FREQ Channel, Carrier Setup
Remote Command	<code>[:SENSe] :CARRier:CONFig?</code>
Example	CARR:CONF TC1AFDD CARR:CONF?
Notes	The softkey for NONE is not available.
State Saved	Saved in instrument state
Initial S/W Revision	A.10.00
Modified at S/W Revision	A.12.00, A.13.00

Max LTE FDD Carriers

Sets max LTE FDD carriers placed when the carrier configuration preset runs. When this value is changed, the carrier configuration preset is initiated.

Key Path	FREQ Channel, Carrier Setup, Carrier Conf Presets, MSR Test Config, TC2 (FDD)FREQ Channel, Carrier Setup, Carrier Conf Presets, MSR Test Config, TC3a (FDD)FREQ Channel, Carrier Setup, Carrier Conf Presets, MSR Test Config, TC4b (FDD)FREQ Channel, Carrier Setup, Carrier Conf Presets, MSR Test Config, TC4c (FDD)FREQ Channel, Carrier Setup, Carrier Conf Presets, Single RAT Config, LTE FDD
Remote Command	<code>[:SENSe] :CARRier:CONFig:LTEFdd:CMAx <integer></code> <code>[:SENSe] :CARRier:CONFig:LTEFdd:CMAx?</code>
Example	CARR:CONF:LTEF:CMAx 8 CARR:CONF:LTEF:CMAx?
Preset	100
State Saved	Saved in instrument state
Min	1
Max	100
Initial S/W Revision	A.10.00

LTE FDD BW

Sets bandwidth of LTE FDD carriers placed when the carrier configuration preset runs. When this value is changed, the carrier configuration preset is initiated.

Key Path	FREQ Channel, Carrier Setup, Carrier Conf Presets, MSR Test Config, TC2 (FDD)FREQ Channel, Carrier Setup, Carrier Conf Presets, MSR Test Config, TC3a (FDD)FREQ Channel, Carrier Setup, Carrier Conf Presets, MSR Test Config, TC4b (FDD)FREQ Channel, Carrier Setup, Carrier Conf Presets, MSR Test Config, TC4c (FDD)FREQ Channel, Carrier Setup, Carrier Conf Presets, MSR Test Config, TC4d (FDD)FREQ Channel, Carrier Setup, Carrier Conf Presets, Single RAT Config, LTE FDD
Remote Command	<code>[:SENSe] :CARRier:CONFig:LTEFdd:BAWdwidth B1M4 B3M B5M B10M B15M B20M</code> <code>[:SENSe] :CARRier:CONFig:LTEFdd:BAWdwidth?</code>
Example	<code>CARR:CONF:LTEF:BAW B5M</code> <code>CARR:CONF:LTEF:BAW?</code>
Preset	B5M
State Saved	Saved in instrument state
Range	1.4MHz 3MHz 5MHz 10MHz 15MHz 20MHz
Readback	The currently selected LTE FDD BW
Initial S/W Revision	A.10.00

Max W-CDMA Carriers (FDD)

Sets max W-CDMA carriers placed when the carrier configuration preset runs. When this value is changed, the carrier configuration preset is initiated.

Key Path	FREQ Channel, Carrier Setup, Carrier Conf Presets, MSR Test Config, TC1a (FDD)FREQ Channel, Carrier Setup, Carrier Conf Presets, MSR Test Config, TC3a (FDD)FREQ Channel, Carrier Setup, Carrier Conf Presets, MSR Test Config, TC4a (FDD)FREQ Channel, Carrier Setup, Carrier Conf Presets, MSR Test Config, TC4c (FDD)FREQ Channel, Carrier Setup, Carrier Conf Presets, Single RAT Config, W-CDMA
Remote Command	<code>[:SENSe] :CARRier:CONFig:WCDMa:CMAX <integer></code> <code>[:SENSe] :CARRier:CONFig:WCDMa:CMAX?</code>
Example	<code>CARR:CONF:WCDM:CMAX 8</code> <code>CARR:CONF:WCDM:CMAX?</code>
Preset	100
State Saved	Saved in instrument state
Min	1
Max	100
Initial S/W Revision	A.10.00

Max GSM/EDGE Carriers

Sets max GSM/EDGE carriers placed when the carrier configuration preset runs. When this value is changed, the carrier configuration preset is initiated.

Key Path	FREQ Channel, Carrier Setup, Carrier Conf Presets, MSR Test Config, TC4a (FDD)FREQ Channel, Carrier Setup, Carrier Conf Presets, MSR Test Config, TC4b (FDD)FREQ Channel, Carrier Setup, Carrier Conf Presets, MSR Test Config, TC4c (FDD)FREQ Channel, Carrier Setup, Carrier Conf Presets, Single RAT Config, GSM/EDGE
Remote Command	<code>[:SENSe] :CARRier :CONFig :GSM :CMAX <integer></code> <code>[:SENSe] :CARRier :CONFig :GSM :CMAX?</code>
Example	<code>CARR:CONF:GSM:CMAX 8</code> <code>CARR:CONF:GSM:CMAX?</code>
Preset	100
State Saved	Saved in instrument state
Min	1
Max	100
Initial S/W Revision	A.10.00

Max cdma2000 Carriers

Sets max cdma2000 carriers placed when the carrier configuration preset runs. When this value is changed, the carrier configuration preset is initiated.

Key Path	FREQ Channel, Carrier Setup, Carrier Conf Presets, Single RAT Config, cdma2000
Remote Command	<code>[:SENSe] :CARRier :CONFig :CDMA :CMAX <integer></code> <code>[:SENSe] :CARRier :CONFig :CDMA :CMAX?</code>
Example	<code>CARR:CONF:CDMA:CMAX 8</code> <code>CARR:CONF:CDMA:CMAX?</code>
Preset	100
State Saved	Saved in instrument state
Min	1
Max	100
Initial S/W Revision	A.12.00

Max 1xEV-DO Carriers

Sets max 1xEV-DO carriers placed when the carrier configuration preset runs. When this value is changed, the carrier configuration preset is initiated.

Key Path	FREQ Channel, Carrier Setup, Carrier Conf Presets, Single RAT Config, 1xEV-DO
Remote Command	<code>[:SENSe] :CARRier :CONFig :EVDO :CMAX <integer></code>

	<code>[:SENSe] :CARRier:CONFig:EVDO:CMAX?</code>
Example	CARR:CONF:EVDO:CMAX 8 CARR:CONF:EVDO:CMAX?
Preset	100
State Saved	Saved in instrument state
Min	1
Max	100
Initial S/W Revision	A.12.00

Max BS RF Bandwidth

Sets max BS RF bandwidth used when the carrier configuration preset runs. When this value is changed, the carrier configuration preset is initiated.

Key Path	FREQ Channel, Carrier Setup, Carrier Conf Presets
Remote Command	<code>[:SENSe] :CARRier:CONFig:RFBWidth <freq></code> <code>[:SENSe] :CARRier:CONFig:RFBWidth?</code>
Example	CARR:CONF:RFBW 40MHz CARR:CONF:RFBW?
Preset	40MHz
State Saved	Saved in instrument state
Min	600 kHz
Max	200 MHz
Initial S/W Revision	A.10.00

Channel Spacing Delta

Carriers are placed based on channel spacing assigned to the corresponding radio format, when they are configured by the carrier config preset. However, channel spacing can be adjusted using channel spacing delta parameters.

This key accesses the menu to set channel spacing delta of each radio format.

Key Path	FREQ Channel, Carrier Setup, Carrier Conf Presets
Initial S/W Revision	A.10.00

LTE FDD

Sets delta channel spacing for LTE FDD used when the carrier configuration preset runs. Channel spacing for LTE FDD is determined from this value and the default channel spacing defined in the standard, i.e. Channel spacing = (BWchan1 + BWchan2) * 0.5 + [the delta spacing]. Since this value is a difference from

the default spacing, this value can be negative to allow narrower channel spacing. When this value is changed, the carrier configuration preset is initiated.

Key Path	FREQ Channel, Carrier Setup, Carrier Conf Presets, Channel Spacing Delta
Remote Command	[:SENSe] :CARRier:CONFig:LTEFdd:SPACing:DELTA <freq> [:SENSe] :CARRier:CONFig:LTEFdd:SPACing:DELTA?
Example	CARR:CONF:LTEF:SPAC:DELT -200kHz CARR:CONF:LTEF:SPAC:DELT?
Preset	0Hz
State Saved	Saved in instrument state
Min	- 1.0 MHz
Max	10.0 MHz
Initial S/W Revision	A.10.00
Modified at S/W Revision	A.11.00

W-CDMA

Sets delta channel spacing for W-CDMA used when the carrier configuration preset runs. Channel spacing for W-CDMA is determined from this value and the default channel spacing defined in the standard, i.e. Channel spacing = 5.0 MHz + [the delta spacing]. Since this value is a difference from the default spacing, this value can be negative to allow narrower channel spacing. When this value is changed, the carrier configuration preset is initiated.

Key Path	FREQ Channel, Carrier Setup, Carrier Conf Presets, Channel Spacing Delta
Remote Command	[:SENSe] :CARRier:CONFig:WCDMa:SPACing:DELTA <freq> [:SENSe] :CARRier:CONFig:WCDMa:SPACing:DELTA?
Example	CARR:CONF:WCDM:SPAC:DELT 0 CARR:CONF:WCDM:SPAC:DELT?
Preset	0 Hz
State Saved	Saved in instrument state
Min	- 1.0 MHz
Max	10.0 MHz
Initial S/W Revision	A.10.00
Modified at S/W Revision	A.11.00

GSM/EDGE

Sets delta channel spacing for GSM/EDGE used when the carrier configuration preset runs. Channel spacing for GSM/EDGE is determined from this value and the default channel spacing defined in the standard, i.e. Channel spacing = 600 kHz + [the delta spacing]. Since this value is a difference from the default spacing, this value can be negative to allow narrower channel spacing. When this value is changed, the carrier configuration preset is initiated.

Key Path	FREQ Channel, Carrier Setup, Carrier Conf Presets, Channel Spacing Delta
Remote Command	[:SENSe] :CARRier :CONFig :GSM :SPACing :DELTA <freq> [:SENSe] :CARRier :CONFig :GSM :SPACing :DELTA?
Example	CARR:CONF:GSM:SPAC:DELT 0 CARR:CONF:GSM:SPAC:DELT?
Preset	0 Hz
State Saved	Saved in instrument state
Min	- 0.4 MHz
Max	10.0 MHz
Initial S/W Revision	A.10.00
Modified at S/W Revision	A.11.00

cdma2000

Sets delta channel spacing for cdma2000 used when the carrier configuration preset runs. Channel spacing for cdma2000 is determined from this value and the default channel spacing defined in the standard, i.e. Channel spacing = 1.25 MHz + [the delta spacing]. Since this value is a difference from the default spacing, this value can be negative to allow narrower channel spacing.

Key Path	FREQ Channel, Carrier Setup, Carrier Conf Presets, Channel Spacing Delta
Remote Command	[:SENSe] :CARRier :CONFig :CDMA :SPACing :DELTA <freq> [:SENSe] :CARRier :CONFig :CDMA :SPACing :DELTA?
Example	CARR:CONF:CDMA:SPAC:DELT 0 CARR:CONF:CDMA:SPAC:DELT?
Preset	0 Hz
State Saved	Saved in instrument state
Min	-1 MHz
Max	10 MHz
Initial S/W Revision	A.12.00

1xEV-DO

Sets delta channel spacing for 1xEV-DO used when the carrier configuration preset runs. Channel spacing for 1xEV-DO is determined from this value and the default channel spacing defined in the standard, i.e. Channel spacing = 1.25 MHz + [the delta spacing]. Since this value is a difference from the default spacing, this value can be negative to allow narrower channel spacing.

Key Path	FREQ Channel, Carrier Setup, Carrier Conf Presets, Channel Spacing Delta
Remote Command	[:SENSe] :CARRier :CONFig :EVDO :SPACing :DELTA <freq> [:SENSe] :CARRier :CONFig :EVDO :SPACing :DELTA?

Example	CARR:CONF:EVDO:SPAC:DELT 0 CARR:CONF:EVDO:SPAC:DELT?
Preset	0 Hz
State Saved	Saved in instrument state
Min	-1 MHz
Max	10 MHz
Initial S/W Revision	A.12.00

Apply to Meas Offset/Limits

This immediate action key sets the following measurement parameters.

- ACP: Offset and limit parameters under Offset/Limits.
- Spectrum Emission Mask: Offset and limit parameters under Offset/Limits.
- Spurious Emissions: Range frequency and limit parameters under Range Table.

These offset and limit values are determined by the carrier configuration parameters, Band Category and Assumed Adj Channels.

Each of these measurement has a local key, “Apply Carrier Config to ...”, which performs in the same way only for its parameters. So pressing this key is equivalent to pressing “Apply Carrier Config to ...” of all these measurements.

Key Path	FREQ Channel, Carrier Setup
Remote Command	[:SENSe] :MCONdition:IMMediate
Example	MCON:IMM
Initial S/W Revision	A.11.00

RF Bandwidth (Remote Command Only)

Returns the RF bandwidth calculated from the outermost carriers and their Foffset_RAT.

Key Path	SCPI only
Mode	MSR
Remote Command	[:SENSe] :CARRier:RFBWidth?
Example	CARR:RFBW?
Preset	Calculated from preset values of carrier config parameters
State Saved	No
Initial S/W Revision	A.13.00

RF Bandwidth Center (Remote Command Only)

Returns the center frequency of RF bandwidth.

Key Path	SCPI only
Mode	MSR
Remote Command	<code>[:SENSe] :CARRier:RFBwidth:CENTer?</code>
Example	<code>CARR:RFBW:CENT?</code>
Preset	Calculated from preset values of carrier config parameters
State Saved	No
Initial S/W Revision	A.13.00

Sub-block Center (Remote Command Only)

Returns the center frequency of sub-block when Carrier Allocation is Non-Contiguous.

Key Path	SCPI only
Mode	MSR
Remote Command	<code>[:SENSe] :CARRier:SBLOCK[1] 2:CENTer?</code>
Example	<code>CARR:SBL:CENT?</code>
Notes	When Carrier Allocation is Contiguous, 9.91E+37 is returned.
Preset	Calculated from preset values of carrier config parameters
State Saved	No
Initial S/W Revision	A.13.00

Sub-block Bandwidth (Remote Command Only)

Returns the bandwidth of sub-block calculated from outermost carriers and corresponding Foffset_RAT.

Key Path	SCPI only
Mode	MSR
Remote Command	<code>[:SENSe] :CARRier:SBLOCK[1] 2:BWIDth?</code>
Example	<code>CARR:SBL:BWID?</code>
Notes	When Carrier Allocation is Contiguous, 9.91E+37 is returned.
Preset	Calculated from preset values of carrier config parameters
State Saved	No
Initial S/W Revision	A.13.00

Sub-block Gap (Remote Command Only)

Returns the sub-block gap.

Key Path	SCPI only
Mode	MSR
Remote Command	[:SENSe] :CARRier :SBLock :GAP?
Example	CARR:SBL:GAP?
Notes	When Carrier Allocation is Contiguous, 9.91 E+37 is returned.
Preset	Calculated from preset values of carrier config parameters
State Saved	No
Initial S/W Revision	A.13.00

Input/Output

See "Input/Output" on page 190

Marker

Accesses a menu that enables you to select, set up and control the markers for the current measurement.

Key Path	Front-panel key
Initial S/W Revision	Prior to A.02.00

Select Marker

Displays 12 markers available for selection.

Key Path	Marker
Initial S/W Revision	Prior to A.02.00

Marker Type

Sets the marker control mode to **Normal**, **Delta**, **Fixed** or **Off**. All interactions and dependencies detailed under the key description are enforced when the remote command is sent. If the selected marker is Off, pressing Marker sets it to Normal and places it at the center of the screen on the trace determined by the **Marker Trace** rules. At the same time, **Marker X Axis Value** appears on the Active Function area.

The default active function is the active function for the currently selected marker control mode. If the current control mode is Off, there is no active function and the active function is turned off.

Key Path	Marker
Mode	SA, WCDMA, C2K, WIMAX OFDMA, 1xEVDO, DVB-T/H, DTMB (CTTB), ISDB-T, CMMB, LTE, LTETDD, Digital Cable TV, WLAN, MSR, LTEAFDD, LTEATDD
Remote Command	:CALCulate:CHPower:MARKer[1] 2 ... 12:MODE POSITION DELTa OFF :CALCulate:CHPower:MARKer[1] 2 ... 12:MODE?
Example	CALC:CHP:MARK3:MODE POS CALC:CHP:MARK3:MODE?
Notes	If the selected marker is Off, pressing Marker sets it to Normal and places it at the center of the screen on the trace determined by the Marker Trace rules. At the same time, Marker X Axis Value appears on the Active Function area. Default Active Function: the active function for the selected marker's current control mode. If the current control mode is Off, there is no active function and the active function is turned off. Active Function Display: the marker X axis value entered in the active function area displays the marker value to its full entered precision.
Preset	OFF
State Saved	Saved in instrument state.
Range	Normal Delta Off

Initial S/W Revision	Prior to A.02.00
Modified at S/W Revision	A.02.00, A.03.00

Properties

Accesses the marker properties menu.

Key Path	Marker
Initial S/W Revision	Prior to A.02.00

Select Marker

Displays 12 markers available for selection.

Key Path	Marker
Initial S/W Revision	Prior to A.02.00

Relative To

Sets the reference marker to which the selected marker is relative.

Key Path	Marker, Properties
Mode	SA, WCDMA, C2K, WIMAX OFDMA, 1xEVDO, DVB-T/H, DTMB (CTTB), ISDB-T, CMMB, LTE, LTETDD, Digital Cable TV, WLAN, MSR, LTEAFDD, LTEATDD
Remote Command	:CALCulate:CHPower:MARKer[1] 2 ... 12:REFerence <integer> :CALCulate:CHPower:MARKer[1] 2 ... 12:REFerence?
Example	CALC:CHP:MARK:REF 5 CALC:CHP:MARK:REF?
Notes	A marker cannot be relative to itself so that choice is grayed out, and if sent from SCPI generates error -221: "Settings conflict; marker cannot be relative to itself." When queried, a single value is returned (the specified marker numbers relative marker). You must be in the Spectrum Analysis or WCDMA mode to use this command. Use :INSTrument:SElect to set the mode.
Preset	2 3 4 5 6 7 8 9 10 11 12 1
State Saved	Saved in instrument state.
Min	1
Max	12
Initial S/W Revision	Prior to A.02.00
Modified at S/W Revision	A.02.00, A.03.00

All Markers Off

Turns off all markers.

Key Path	Marker
Mode	SA, WCDMA, C2K, WIMAX OFDMA, 1xEVDO, DVB-T/H, DTMB (CTTB), ISDB-T, CMMB, LTE, LTETDD, Digital Cable TV, WLAN, MSR, LTEAFDD, LTEATDD
Remote Command	:CALCulate:CHPower:MARKer:AOFF
Example	CALC:CHP:MARK:AOFF
Initial S/W Revision	Prior to A.02.00
Modified at S/W Revision	A.02.00, A.03.00

Marker X Axis Value (Remote Command Only)

Sets the marker X Axis value in the current marker X Axis Scale unit. It has no effect if the control mode is **Off**, but is the SCPI equivalent of entering an X value if the control mode is **Normal**, **Delta**, or **Fixed**.

Mode	SA, WCDMA, CDMA2K, WIMAXOFDMA, CDMA1XEV, DVB, DTMB, ISDBT, CMMB, LTE, LTETDD, DCTV, WLAN, MSR, LTEAFDD, LTEATDD
Remote Command	:CALCulate:CHPower:MARKer[1] 2 ... 12:X <real> :CALCulate:CHPower:MARKer[1] 2 ... 12:X?
Example	CALC:CHP:MARK3:X 0 CALC:CHP:MARK3:X?
Notes	The query returns the marker's absolute X Axis value if the control mode is Normal , or the offset from the marker's reference marker if the control mode is Delta . The query is returned in the fundamental units for the current marker X Axis scale: Hz for Frequency .
Preset	After a preset, all markers are turned OFF, so Marker X Axis Value query returns a not a number (NAN).
State Saved	Saved in instrument state.
Min	-9.9E+37
Max	9.9E+37
Initial S/W Revision	Prior to A.02.00
Modified at S/W Revision	A.02.00, A.03.00

Marker X Axis Position (Remote Command Only)

Sets the marker X Axis Scale position in trace points. This setting has no effect if the control mode is **Off**, but is the SCPI equivalent of entering a value if the control mode is **Normal** or **Delta**. The entered value is immediately translated into the current X Axis Scale units for setting the value of the marker.

Mode	SA, WCDMA, CDMA2K, WIMAXOFDMA, CDMA1XEV, DVB, DTMB, ISDBT, CMMB, LTE, LTETDD, DCTV, WLAN, MSR, LTEAFDD, LTEATDD
------	---

Remote Command	:CALCulate:CHPower:MARKer[1] 2 ... 12:X:POStion <real> :CALCulate:CHPower:MARKer[1] 2 ... 12:X:POStion?
Example	CALC:CHP:MARK10:X:POS 0 CALC:CHP:MARK10:X:POS?
Notes	The query returns the marker's absolute X Axis value in trace points if the control mode is Normal , or the offset from the marker's reference marker in trace points if the control mode is Delta .
Preset	After a preset, all markers are turned OFF, so Marker X Axis Value query returns a not a number (NAN).
State Saved	Saved in instrument state.
Min	-9.9E+37
Max	9.9E+37
Initial S/W Revision	Prior to A.02.00
Modified at S/W Revision	A.02.00, A.03.00

Marker Y Axis Value (Remote Command only)

Returns the marker Y Axis value in the current marker Y Axis unit.

Mode	SA, WCDMA, CDMA2K, WIMAXOFDMA, CDMA1XEV, DVB, DTMB, ISDBT, CMMB, LTE, LTETDD, DCTV, WLAN, MSR, LTEAFDD, LTEATDD
Remote Command	:CALCulate:CHPower:MARKer[1] 2 ... 12:Y?
Example	CALC:CHP:MARK11:Y?
Preset	Result dependent on Markers setup and signal source.
State Saved	Saved in instrument state.
Initial S/W Revision	Prior to A.02.00
Modified at S/W Revision	A.02.00, A.03.00

Backward Compatibility SCPI Commands

Sets or queries the state of a marker. Setting a marker which is OFF to state ON or 1 puts it in Normal mode and places it at the center of the screen.

Mode	SA, WCDMA, CDMA2K, WIMAXOFDMA, CDMA1XEV, DVB, DTMB, ISDBT, CMMB, LTE, LTETDD, DCTV, WLAN, MSR, LTEAFDD, LTEATDD
Remote Command	:CALCulate:CHPower:MARKer[1] 2 ... 12:STATe OFF ON 0 1 :CALCulate:CHPower:MARKer[1] 2 ... 12:STATe?
Example	CALC:CHP:MARK3:STAT ON CALC:CHP:MARK3:STAT?
Preset	OFF

8 Channel Power Measurement
Marker

State Saved	Saved in instrument state.
Range	On Off
Initial S/W Revision	Prior to A.02.00
Modified at S/W Revision	A.02.00, A.03.00

Marker Function

There are no 'Marker Functions' supported in Channel Power, so this front-panel key displays a blank menu when pressed.

Key Path	Front-panel key
Initial S/W Revision	Prior to A.02.00

Marker To

There is no 'Marker To' functionality supported in Channel Power measurement, so this front-panel key displays a blank key menu when pressed.

Key Path	Front-panel key
Initial S/W Revision	Prior to A.02.00

Meas

The information in this section is common to all measurements. For key and remote command information for a specific measurement, refer to the section that describes the measurement of interest.

Measurements available under the Meas key are specific to the current Mode.

When viewing Help for measurements, note the following:

NOTE

Operation for some keys differs between measurements. The information displayed in Help pertains to the current measurement. To see how a key operates in a different measurement, exit Help (press the Cancel Esc key), select the measurement, then reenter Help (press the Help key) and press that key.

Key Path	Front-panel key
Initial S/W Revision	Prior to A.02.00

Remote Measurement Functions

This section contains the following topics:

"Measurement Group of Commands" on page 2382

"Current Measurement Query (Remote Command Only)" on page 2384

"Limit Test Current Results (Remote Command Only)" on page 2384

"Data Query (Remote Command Only)" on page 2384

"Calculate/Compress Trace Data Query (Remote Command Only)" on page 2385

"Calculate Peaks of Trace Data (Remote Command Only)" on page 2390

"Hardware-Accelerated Fast Power Measurement (Remote Command Only)" on page 2391

"Format Data: Numeric Data (Remote Command Only)" on page 2405

"Format Data: Byte Order (Remote Command Only)" on page 2406

Initial S/W Revision	Prior to A.02.00
----------------------	------------------

Measurement Group of Commands

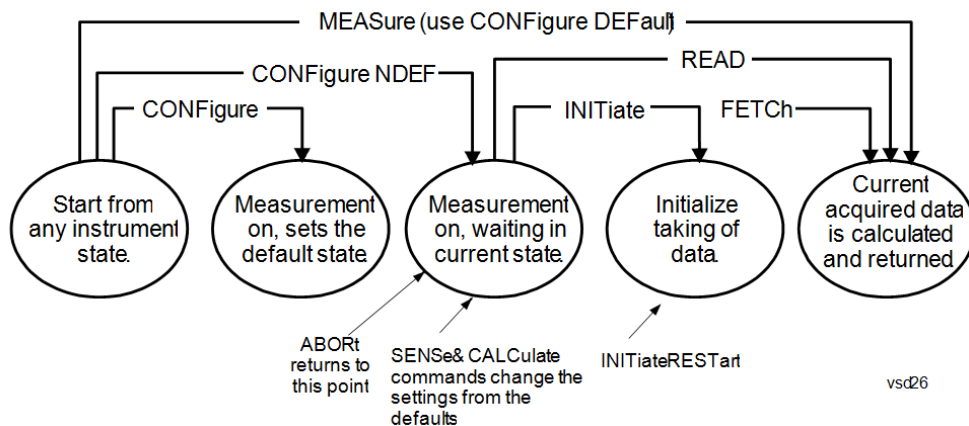

Measure Commands:

:MEASure:<measurement>[n]?

This is a fast single-command way to make a measurement using the factory default instrument settings. These are the settings and units that conform to the Mode Setup settings (e.g. radio standard) that you have currently selected.

- Stops the current measurement (if any) and sets up the instrument for the specified measurement using the factory defaults
- Initiates the data acquisition for the measurement
- Blocks other SCPI communication, waiting until the measurement is complete before returning results.
- If the function does averaging, it is turned on and the number of averages is set to 10.
- After the data is valid it returns the scalar results, or the trace data, for the specified measurement. The type of data returned may be defined by an [n] value that is sent with the command.
- The scalar measurement results will be returned if the optional [n] value is not included, or is set to 1. If the [n] value is set to a value other than 1, the selected trace data results will be returned. See each command for details of what types of scalar results or trace data results are available.
- ASCII is the default format for the data output. (Older versions of Spectrum Analysis and Phase Noise mode measurements only use ASCII.) The binary data formats should be used for handling large blocks of data since they are smaller and faster than the ASCII format. Refer to the FORMat:DATA command for more information.

If you need to change some of the measurement parameters from the factory default settings you can set up the measurement with the CONFigure command. Use the commands in the SENSe:<measurement> and CALCulate:<measurement> subsystems to change the settings. Then you can use the READ? command to initiate the measurement and query the results.

If you need to repeatedly make a given measurement with settings other than the factory defaults, you can use the commands in the SENSe:<measurement> and CALCulate:<measurement> subsystems to set up the measurement. Then use the READ? command to initiate the measurement and query results.

Measurement settings persist if you initiate a different measurement and then return to a previous one. Use READ:<measurement>? if you want to use those persistent settings. If you want to go back to the default settings, use MEASure:<measurement>?.

Configure Commands:

:CONFigure:<measurement>

This command stops the current measurement (if any) and sets up the instrument for the specified measurement using

the factory default instrument settings. It does not initiate the taking of measurement data unless INIT:CONTInuous is ON. If you change any measurement settings after using the CONFigure command, the READ command can be used to initiate a measurement without changing the settings back to their defaults.

In the Swept SA measurement in Spectrum Analyzer mode the CONFigure command also turns the averaging function on and sets the number of averages to 10 for all measurements.

:CONFigure: <measurement>: NDEFault stops the current measurement and changes to the specified measurement. It does not change the settings to the defaults. It does not initiate the taking of measurement data unless INIT:CONTInuous is ON.

The CONFigure? query returns the current measurement name.

The CONFigure:CATalog? query returns a quoted string of all licensed measurement names in the current mode. For example, "SAN, CHP, OBW, ACP, PST, TXP, SPUR, SEM, LIST".

Fetch Commands:

:FETCh:<measurement>[n]?

This command puts selected data from the most recent measurement into the output buffer. Use FETCh if you have already made a good measurement and you want to return several types of data (different [n] values, for example, both scalars and trace data) from a single measurement. FETCh saves you the time of re-making the measurement. You can only FETCh results from the measurement that is currently active, it will not change to a different measurement. An error message is reported if a measurement other than the current one is specified.

If you need to get new measurement data, use the READ command, which is equivalent to an INITiate followed by a FETCh.

The scalar measurement results will be returned if the optional [n] value is not included, or is set to 1. If the [n] value is set to a value other than 1, the selected trace data results will be returned. See each command for details of what types of scalar results or trace data results are available. The binary data formats should be used for handling large blocks of data since they are smaller and transfer faster than the ASCII format. (FORMat:DATA)

FETCh may be used to return results other than those specified with the original READ or MEASure command that you sent.

INITiate Commands:

:INITiate:<measurement>

This command is not available for measurements in all the instrument modes:

- Initiates a trigger cycle for the specified measurement, but does not output any data. You must then use the FETCh<meas> command to return data. If a measurement other than the current one is specified, the instrument will switch to that measurement and then initiate it.
 - For example, suppose you have previously initiated the ACP measurement, but now you are running the channel power measurement. If you send INIT:ACP? it will change from channel power to ACP and will initiate an ACP measurement.
 - Does not change any of the measurement settings. For example, if you have previously started the ACP measurement and you send INIT:ACP? it will initiate a new ACP measurement using the same instrument settings as the last time ACP was run.
 - If your selected measurement is currently active (in the idle state) it triggers the measurement, assuming the trigger conditions are met. Then it completes one trigger cycle. Depending upon the measurement and the number of averages, there may be multiple data acquisitions, with multiple trigger events, for one full trigger cycle. It also holds off additional commands on GPIB until the acquisition is complete.
-

READ Commands:

:READ:<measurement>[n]?

- Does not preset the measurement to the factory default settings. For example, if you have previously initiated the ACP
-

measurement and you send READ:ACP? it will initiate a new measurement using the same instrument settings.

- Initiates the measurement and puts valid data into the output buffer. If a measurement other than the current one is specified, the instrument will switch to that measurement before it initiates the measurement and returns results.
 - For example, suppose you have previously initiated the ACP measurement, but now you are running the channel power measurement. Then you send READ:ACP? It will change from channel power back to ACP and, using the previous ACP settings, will initiate the measurement and return results.
 - Blocks other SCPI communication, waiting until the measurement is complete before returning the results
 - If the optional [n] value is not included, or is set to 1, the scalar measurement results will be returned. If the [n] value is set to a value other than 1, the selected trace data results will be returned. See each command for details of what types of scalar results or trace data results are available. The binary data formats should be used when handling large blocks of data since they are smaller and faster than the ASCII format. (FORMat:DATA)
-

Initial S/W Revision	Prior to A.02.00
----------------------	------------------

Current Measurement Query (Remote Command Only)

This command returns the name of the measurement that is currently running.

Remote Command	:CONFigure?
-----------------------	-------------

Example	CONF?
----------------	-------

Initial S/W Revision	Prior to A.02.00
----------------------	------------------

Limit Test Current Results (Remote Command Only)

Queries the status of the current measurement limit testing. It returns a 0 if the measured results pass when compared with the current limits. It returns a 1 if the measured results fail any limit tests.

Remote Command	:CALCulate:CLIMits:FAIL?
-----------------------	--------------------------

Example	CALC:CLIM:FAIL? queries the current measurement to see if it fails the defined limits. Returns a 0 or 1: 0 it passes, 1 it fails.
----------------	--

Initial S/W Revision	Prior to A.02.00
----------------------	------------------

Data Query (Remote Command Only)

Returns the designated measurement data for the currently selected measurement and subopcode.

n = any valid subopcode for the current measurement. See the measurement command results table for your current measurement, for information about what data is returned for the subopcodes.

This command uses the data setting specified by the FORMat:BORDER and FORMat:DATA commands and can return real or ASCII data. (See the format command descriptions under Input/Output in the Analyzer Setup section.)

Remote Command	:CALCulate:DATA[n]?
Notes	The return trace depends on the measurement. In CALCulate:<meas>:DATA[n], n is any valid subopcode for the current measurement. It returns the same data as the FETCH:<measurement>? query where <measurement> is the current measurement.
Initial S/W Revision	Prior to A.02.00

Calculate/Compress Trace Data Query (Remote Command Only)

Returns compressed data for the currently selected measurement and sub-opcode [n].

n = any valid sub-opcode for that measurement. See the MEASure:<measurement>? command description of your specific measurement for information on the data that can be returned.

The data is returned in the current Y Axis Unit of the analyzer. The command is used with a sub-opcode <n> (default=1) to specify the trace. With trace queries, it is best if the analyzer is not sweeping during the query. Therefore, it is generally advisable to be in Single Sweep, or Update=Off.

This command is used to compress or decimate a long trace to extract and return only the desired data. A typical example would be to acquire N frames of GSM data and return the mean power of the first burst in each frame. The command can also be used to identify the best curve fit for the data.

Remote Command	:CALCulate:DATA<n>:COMPRESS? BLOCK CFIT MAXimum MINimum MEAN DMEan RMS RMSCubed SAMPLE SDEVIation PPHase [,<soffset> [,<length>[,<roffset>[,<rlimit>]]]]
Example	To query the mean power of a set of GSM bursts: Supply a signal that is a set of GSM bursts. Select the IQ Waveform measurement (in IQ Analyzer Mode). Set the sweep time to acquire at least one burst. Set the triggers such that acquisition happens at a known position relative to a burst. Then query the mean burst levels using, CALC:DATA2:COMP? MEAN, 24e-6, 526e-6 (These parameter values correspond to GSM signals, where 526e-6 is the length of the burst in the slot and you just want 1 burst.)
Notes	The command supports 5 parameters. Note that the last 4 (<soffset>, <length>, <roffset>, <rlimit>) are optional. But these optional parameters must be entered in the specified order. For example, if you want to specify <length>, then you must also specify <soffset>. See details below for a definition of each of these parameters. This command uses the data in the format specified by FORMat:DATA, returning either binary or ASCII data.
Initial S/W Revision	Prior to A.02.00

- BLOCK or block data - returns all the data points from the region of the trace data that you specify. For example, it could be used to return the data points of an input signal over several timeslots, excluding the portions of the trace data that you do not want. (This is x,y pairs for trace data and I,Q pairs for complex data.)

- CFIT or curve fit - applies curve fitting routines to the data. <soffset> and <length> are required to define the data that you want. <roffset> is an optional parameter for the desired order of the curve equation. The query will return the following values: the x-offset (in seconds) and the curve coefficients ((order + 1) values).

MIN, MAX, MEAN, DME, RMS, RMSC, SAMP, SDEV and PPH return one data value for each specified region (or <length>) of trace data, for as many regions as possible until you run out of trace data (using <roffset> to specify regions). Or they return the number of regions you specify (using <rlimit>) ignoring any data beyond that.

- MINimum - returns the minimum data point (y value) for the specified region(s) of trace data. For I/Q trace data, the minimum magnitude of the I/Q pairs is returned.
- MAXimum - returns the maximum data point (y value) for the specified region(s) of trace data. For I/Q trace data, the maximum magnitude of the I/Q pairs is returned.
- MEAN - returns a single value that is the arithmetic mean of the data point values (in dB/ dBm) for the specified region(s) of trace data. For I/Q trace data, the mean of the magnitudes of the I/Q pairs is returned. See the following equations.

NOTE If the original trace data is in dB, this function returns the arithmetic mean of those log values, not log of the mean power which is a more useful value. The mean of the log is the better measurement technique when measuring CW signals in the presence of noise. The mean of the power, expressed in dB, is useful in power measurements such as Channel Power. To achieve the mean of the power, use the RMS option.

Equation 1

Mean Value of Data Points for Specified Region(s)

$$MEAN = \frac{1}{n} \sum_{X_i \in \text{region}(s)} X_i$$

where X_i is a data point value, and n is the number of data points in the specified region(s).

Equation 2

Mean Value of I/Q Data Pairs for Specified Region(s)

$$MEAN = \frac{1}{n} \sum_{X_i \in \text{region}(s)} |X_i|$$

where $|X_i|$ is the magnitude of an I/Q pair, and n is the number of I/Q pairs in the specified region(s).

- DMEan - returns a single value that is the mean power (in dB/ dBm) of the data point values for the specified region(s) of trace data. See the following equation:

Equation 3

DMEan Value of Data Points for Specified Region(s)

$$\text{DME} = 10 \times \log_{10} \left(\frac{1}{n} \sum_{X_i \in \text{region}(s)} 10^{\frac{X_i}{10}} \right)$$

- RMS - returns a single value that is the average power on a root-mean-squared voltage scale (arithmetic rms) of the data point values for the specified region(s) of trace data. See the following equation.

NOTE For I/Q trace data, the rms of the magnitudes of the I/Q pairs is returned. See the following equation. This function is very useful for I/Q trace data. However, if the original trace data is in dB, this function returns the rms of the log values which is not usually needed.

Equation 4

RMS Value of Data Points for Specified Region(s)

$$\text{RMS} = \sqrt{\frac{1}{n} \sum_{X_i \in \text{region}(s)} X_i^2}$$

where X_i is a data point value, and n is the number of data points in the specified region(s).

Equation 5

RMS Value of I/Q Data Pairs for Specified Region(s)

$$\text{RMS} = \sqrt{\frac{1}{n} \sum_{X_i \in \text{region}(s)} X_i X_i^*}$$

where X_i is the complex value representation of an I/Q pair, X_i^* its conjugate complex number, and n is the number of I/Q pairs in the specified region(s).

Once you have the rms value for a region of trace data (linear or I/Q), you may want to calculate the mean power. You must convert this rms value (peak volts) to power in dBm:

$$10 \times \log[10 \times (\text{rms value})^2]$$

- SAMPLe - returns the first data value (x,y pair) for the specified region(s) of trace data. For I/Q trace data, the first I/Q pair is returned.
- SDEViation - returns a single value that is the arithmetic standard deviation for the data point values for the specified region(s) of trace data. See the following equation.
- For I/Q trace data, the standard deviation of the magnitudes of the I/Q pairs is returned. See the following equation.

Equation 6

Standard Deviation of Data Point Values for Specified Region(s)

$$\text{SDEV} = \sqrt{\frac{1}{n} \sum_{X_i \in \text{region}(s)} (X_i - \bar{X})^2}$$

where X_i is a data point value, \bar{X} is the arithmetic mean of the data point values for the specified region (s), and n is the number of data points in the specified region(s).

$$\text{SDEV} = \sqrt{\frac{1}{n} \sum_{X_i \in \text{region}(s)} (|X_i| - \bar{X})^2}$$

where $|X_i|$ is the magnitude of an I/Q pair, \bar{X} is the mean of the magnitudes for the specified region(s), and n is the number of data points in the specified region(s).

- PPHase - returns the x,y pairs of both rms power (dBm) and arithmetic mean phase (radian) for every specified region and frequency offset (Hz). The number of pairs is defined by the specified number of regions. This parameter can be used for I/Q vector ($n=0$) in Waveform (time domain) measurement and all parameters are specified by data point in PPHase.

The rms power of the specified region may be expressed as:

$$\text{Power} = 10 \times \log [10 \times (\text{RMS I/Q value})] + 10.$$

The RMS I/Q value (peak volts) is:

$$\sqrt{\frac{1}{n} \sum_{X_i \in \text{region}} X_i X_i^*}$$

where X_i is the complex value representation of an I/Q pair, X_i^* its conjugate complex number, and n is the number of I/Q pairs in the specified region.

The arithmetic mean phase of the specified region may be expressed as:

$$\frac{1}{n} \sum_{Y_i \in \text{region}} Y_i$$

where Y_i is the unwrapped phase of I/Q pair with applying frequency correction and n is the number of I/Q pairs in the specified region.

The frequency correction is made by the frequency offset calculated by the arithmetic mean of every specified region's frequency offset. Each frequency offset is calculated by the least square method against the unwrapped phase of I/Q pair.

Sample Trace Data - Constant Envelope

(See below for explanation of variables.)

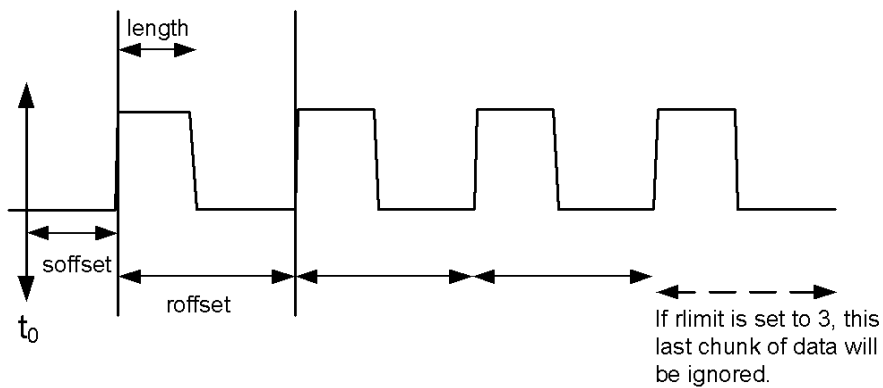

Sample Trace Data - Not Constant Envelope

(See below for explanation of variables.)

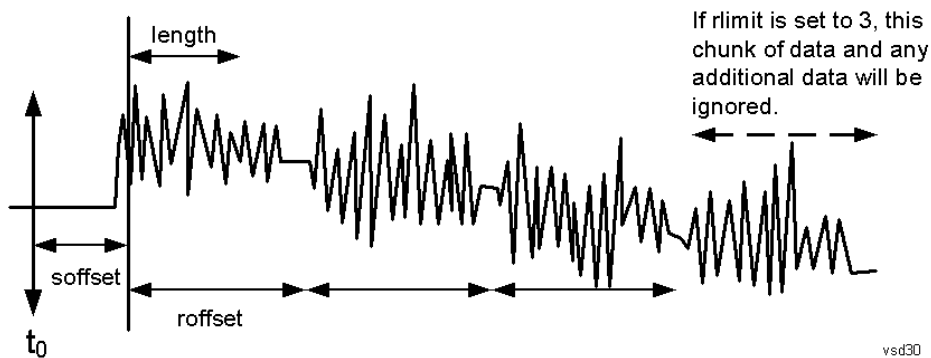

<soffset> - start offset is an optional real number. (It is in seconds for time-domain traces, and is a dimensionless index 0 to Npoints - 1, for frequency-domain traces). It specifies the amount of data at the beginning of the trace that will be ignored before the decimation process starts. It is the time or frequency change from the start of the trace to the point where you want to start using the data. The default value is zero.

<length> - is an optional real number. (It is in seconds for time-domain traces, and is a dimensionless index 0 to Npoints - 1, for frequency-domain traces). It defines how much data will be compressed into one value. This parameter has a default value equal to the current trace length.

<roffset> - repeat offset is an optional real number. (It is in seconds for time-domain traces, and is a dimensionless index 0 to Npoints - 1, for frequency-domain traces). It defines the beginning of the next field of trace elements to be compressed. This is relative to the beginning of the previous field. This parameter has a default value equal to the <length> variable. Note that this parameter is used for a completely different purpose when curve fitting (see CFIT above).

<rlimit> - repeat limit is an optional integer. It specifies the number of data items that you want returned. It will ignore any additional items beyond that number. You can use the Start offset and the Repeat limit to pick out exactly what part of the data you want to use. The default value is all the data.

Calculate Peaks of Trace Data (Remote Command Only)

Returns a list of all the peaks for the currently selected measurement and sub-opcode [n]. The peaks must meet the requirements of the peak threshold and excursion values.

n = any valid sub-opcode for the current measurement. See the MEASure:<measurement> command description of your specific measurement for information on the data that can be returned.

The command can only be used with specific sub-opcodes with measurement results that are trace data. Both real and complex traces can be searched, but complex traces are converted to magnitude in dBm. In many measurements the sub-opcode n=0, is the raw trace data which cannot be searched for peaks. And Sub-opcode n=1, is often calculated results values which also cannot be searched for peaks.

This command uses the data setting specified by the FORMat:BORDER and FORMat:DATA commands and can return real or ASCII data. If the format is set to INT,32, it returns REAL,32 data.

The command has four types of parameters:

- Threshold (in dBm)
- Excursion (in dB)
- Sorting order (amplitude, frequency, time)
- Optional in some measurements: Display line use (all, > display line, < display line)

Remote Command	<p>For Swept SA measurement:</p> <pre>:CALCulate:DATA[1] 2 ... 6:PEAKs? <threshold>,<excursion>[,AMPLitude FREQuency TIME[,ALL GTDLine LTDLine]]</pre> <p>For most other measurements:</p> <pre>:CALCulate:DATA[1] 2 ... 6:PEAKs? <threshold>,<excursion>[,AMPLitude FREQuency TIME]</pre>
-----------------------	--

Example	<p>Example for Swept SA measurement in Spectrum Analyzer Mode:</p> <p>CALC:DATA4:PEAK? -40, 10, FREQ, GTDL This will identify the peaks of trace 4 that are above -40 dBm, with excursions of at least 10 dB. The peaks are returned in order of increasing frequency, starting with the lowest frequency. Only the peaks that are above the display line are returned.</p> <p>Query Results 1:</p> <p>With FORMat:DATA REAL, 32 selected, it returns a list of floating-point numbers. The first value in the list is the number of peak points that are in the following list. A peak point consists of two values: a peak amplitude followed by its corresponding frequency (or time).</p> <p>If no peaks are found the peak list will consist of only the number of peaks, (0).</p>
----------------	---

Notes	<p><n> - is the trace that will be used</p> <p><threshold> - is the level below which trace data peaks are ignored. Note that the threshold value is required and is always used as a peak criterion. To effectively disable the threshold criterion for this command, provide a substantially low threshold value such as -200 dBm. Also note that the threshold value used in this command is independent of and has no effect on the threshold value stored under the Peak Criteria menu.</p> <p><excursion> - is the minimum amplitude variation (rise and fall) required for a signal to be identified as peak. Note that the excursion value is required and is always used as a peak criterion. To effectively disable the excursion criterion for this command, provide the minimum value of 0.0 dB. Also note that the excursion value used in this command is independent of and has no effect on the</p>
--------------	---

excursion value stored under the Peak Criteria menu.

Values must be provided for threshold and excursion. The sorting and display line parameters are optional (defaults are AMPLitude and ALL).

Note that there is always a Y-axis value for the display line, regardless of whether the display line state is on or off. It is the current Y-axis value of the display line which is used by this command to determine whether a peak should be reported. Sorting order:

AMPLitude - lists the peaks in order of descending amplitude, with the highest peak first (default if optional parameter not sent)

FREQUency - lists the peaks in order of occurrence, left to right across the x-axis.

TIME - lists the peaks in order of occurrence, left to right across the x-axis.

Peaks vs. Display Line:

ALL - lists all of the peaks found (default if optional parameter not sent).

GTDLine (greater than display line) - lists all of the peaks found above the display line.

LTDLine (less than display line) - lists all of the peaks found below the display line.

Initial S/W Revision	Prior to A.02.00
----------------------	------------------

Hardware-Accelerated Fast Power Measurement (Remote Command Only)

The Fast Power option (FP2) enables very fast channel power measurements for instruments with the prerequisite hardware (DP2 and/or B40). It accomplishes this by performing real-time overlapped FFTs at the hardware layer, using software for basic post-processing before returning the result to the user. The upshot of this approach is improved throughput for user applications that require many sequential power measurements.

The analysis bandwidth of FP2 is limited by the licenses in the instrument, but its maximum overall analysis bandwidth per acquisition is 40 MHz.

FP2 is remote-only, which means the instrument does not switch to any particular mode or measurement. FP2 commands can be sent while another application is in use on the front panel.

Each Fast Power measurement can be predefined using an array index, and up to 1,000 measurements can be stored. In the following documentation, instances of [1,2,...,999] can be substituted with a particular measurement index, e.g. CALC:FPOW:POW1?, CALC:FPOW:POW2?, CALC:FPOW:POW134?. In this way, power measurements can be defined one time in a batch, and then executed multiple times without having to redefine them, similar to “list mode” on other measurements.

In addition to basic channel power measurements, there are a number of other measurement “functions” for each channel, including peak power, peak frequency, and power spectral density. See the Function parameter for more information.

Reset Fast Power Measurement (Remote Command Only)

Resets the measurement configuration to the defaults.

Mode	All
Remote Command	:CALCulate:FPOWer:POWer[1,2,...,999]:RESet
Example	:CALC:FPOW:POW1:RES

Notes	Option FP2 is required.
Initial S/W Revision	A.14.00

Define Fast Power Measurement (Remote Command Only)

Fast Power acquisitions are configured using the DEFine command. This command accepts a comma-delimited string of configuration parameters and their appropriate values, which are all specified in the subsection below.

Mode	All
Remote Command	:CALCulate:FPOWer:POWer[1,2,...,999]:DEFine "configuration string"
Example	:CALC:FPOW:POW1:DEF "CenterFrequency=2e9, AcquisitionTime=0.005"
Notes	See below for a list of measurement variables that can be defined in the configuration string.
Initial S/W Revision	A.14.00

Acquisition Time

Example	CALC:FPOW:POW1:DEF "AcquisitionTime=0.002"
Notes	The acquisition time parameter sets the time in which the entire spectrum is measured. An increase in the acquisition time yields an improvement in measurement repeatability.
Preset	0.001 s
Range	0 s to 1 s
Default Unit	Time (s)
Initial S/W Revision	A.14.00

Center Frequency

Example	CALC:FPOW:POW1:DEF "CenterFrequency=2e9"
Notes	The center frequency parameter sets the frequency in which the measurement is centered around. The OffsetFrequency parameter is calculated relative to the center frequency.
Preset	1 GHz
Range	0 Hz to maximum instrument frequency
Default Unit	Frequency (Hz)
Initial S/W Revision	A.14.00

DC Coupled

Example	CALC:FPOW:POW1:DEF "DCCoupled=True"
Notes	The DC coupled parameter allows the user to specify whether the DC blocking capacitor is utilized. Set parameter to true when measuring frequencies below 10 MHz.
Preset	False
Range	True (DC Coupled) or False (AC Coupled)
Default Unit	Boolean
Initial S/W Revision	A.14.00

DetectorType

Example	CALC:FPOW:POW1:DEF "DetectorType=Peak"
Notes	Option FP2 is required. The detector type parameter allows the user to choose whether a RMS average or peak value is used during the measurement.
Preset	RmsAverage
Range	RmsAverage, Peak
Initial S/W Revision	A.14.00

Do Noise Correction

Example	CALC:FPOW:POW1:DEF "DoNoiseCorrection=True"
Notes	When noise correction is enabled, the linear noise power contributed by the analyzer is subtracted from all measurements. This effectively lowers the noise floor of the analyzer. When noise correction is enabled, the first measurement for a given set of input parameters will take extra time. This is because the analyzer takes an extra acquisition with the RF input disconnected from the analyzer's front end to measure the noise of just the analyzer. The measured noise floor is stored in a cache so the noise acquisition will occur only once for the same state settings. In other words, if noise correction was turned on and the analyzer made an acquisition at frequency A, then frequency B, and back again to frequency A, the hidden initial noise floor acquisition would only occur for the first acquisition at frequency A and the cached noise floor would be used the second time frequency A was measured.
Preset	False
Range	True (enable noise correction) or False (disable noise correction)
Default Unit	Boolean
Initial S/W Revision	A.14.00

Do Spur Suppression

Example	CALC:FPOW:POW1:DEF "DoSpurSuppression=True"
Notes	<p>When measuring very low level signals, or when large out-of-band inputs are input into the analyzer, sometimes unwanted spurs and residuals can appear in the measured spectrum. Spur suppression is a method to help minimize the levels of these internally generated spurs and residuals.</p> <p>When spur suppression is enabled, the analyzer will automatically take two acquisitions using two different internal analog LO frequencies. The FFT spectrums from both acquisitions are combined by taking the minimum power between both traces on a per FFT bin basis. External signals will have the same amplitude for both traces and therefore will return the expected amplitudes. However, low level spurs and residuals generated internally to the analyzer tend to move to different FFT bins depending on the internal analog LO frequency used, and therefore tend to be suppressed using this spur suppression method.</p> <p>Because two acquisitions, rather than a single acquisition, are made when spur suppression is enabled, the measurement time will always be slower when spur suppression is enabled.</p>
Preset	False
Range	True (enable spur suppression) or False (disable spur suppression)
Default Unit	Boolean
Initial S/W Revision	A.14.00

Electronic Attenuator Bypass

Example	CALC:FPOW:POW1:DEF "ElecAttBypass =False"
Notes	The electronic attenuation bypass parameter allows the user to either utilize or bypass the electronic attenuator. The electronic attenuator is only available for frequencies up to 3.6 GHz. Set parameter to true when using frequencies above 3.6 GHz and set the parameter to false when using the preamp.
Preset	True
Range	True (bypass electronic attenuator) or False (use electronic attenuator)
Default Unit	Boolean
Initial S/W Revision	A.14.00

Electronic Attenuation

Example	CALC:FPOW:POW1:DEF "ElecAttenuation=10"
Notes	<p>Option EA3 is required.</p> <p>The electronic attenuation value parameter sets the amount of electrical attenuation from 0 to 24 dB (1 dB steps).</p> <p>Set "ElecAttBypass=False" to make sure the electronic attenuator path is enabled.</p>
Preset	0 dB
Range	0 – 24 dB (1 dB steps)

Default Unit	dB
Initial S/W Revision	A.14.00

IF Gain

Example	CALC:FPOW:POW1:DEF "IFGain=10"
Notes	The IF gain parameter allows the user to specify the gain at the IF stage anywhere from -6 to 16 dB (1 dB steps). This is an advanced feature, and for most cases this should remain at its default value of 0 dB.
Preset	0 dB
Range	-6 - 16 dB (1 dB steps)
Default Unit	dB
Initial S/W Revision	A.14.00

IF Type

Example	CALC:FPOW:POW1:DEF "IFType=B25M"
Notes	The IF type parameter allows the user to select between different IF paths. For example, if the signal is less than 25 MHz wide, then the user can select the B25M path to take advantage of additional filtering on this analog IF path.
Preset	B40M
Range	B10M, B25M, B40M
Initial S/W Revision	A.14.00

Include Power Spectrum

Example	CALC:FPOW:POW1:DEF "IncludePowerSpectrum=True"
Notes	The power spectrum parameter allows the user to read data on the entire spectrum for diagnostic purposes. It is not recommended for production use. See CALC:FPOW:POW[n]:READ2? for details on the binary format of the response.
Preset	False
Range	True (return both channel power and full power spectrum) or False (returns only channel power)
Default Unit	Boolean
Initial S/W Revision	A.14.00

Mechanical Attenuation

Example	CALC:FPOW:POW1:DEF "MechAttenuation=10"
Notes	The mechanical attenuation value parameter sets the amount of mechanical attenuation anywhere from 0 to 70 dB (2 dB steps).
Preset	0 dB
Range	0 – 70 dB (2 dB steps)
Default Unit	dB
Initial S/W Revision	A.14.00

Preamp Mode

Example	CALC:FPOW:POW1:DEF "PreAmpMode=Low"
Notes	The license for the appropriate preamp is required. The preamp mode parameter specifies whether the preamps are being utilized. Low allows any preamps up to 3.6 GHz, and Full allows all licensed preamps. Set "ElecAttBypass=True" in order to utilize any preamps.
Preset	Off
Range	Off, Low, Full
Initial S/W Revision	A.14.00

Resolution Bandwidth Mode

Example	CALC:FPOW:POW1:DEF "PreAmpMode=Low"
Notes	The resolution bandwidth mode parameter allows the user to choose whether the RBW filter is automatically or manually set. The BestSpeed value minimizes measurement time, while the Narrowest value minimizes RBW size (minimum of two FFT bins per RBW). To manually specify an RBW, set this parameter to Explicit, and set the ResolutionBW parameter to the desired value.
Preset	BestSpeed
Range	BestSpeed, Narrowest, Explicit
Initial S/W Revision	A.14.00

Resolution Bandwidth

Example	CALC:FPOW:POW1:DEF "ResolutionBW=25e3"
Notes	The resolution bandwidth parameter sets the 3-dB bandwidth of the RBW filter. The ResolutionBWMode parameter must be set to Explicit in order to manually set the RBW.

Preset	0 Hz
Default Unit	Hz
Initial S/W Revision	A.14.00

Trigger Delay

Example	CALC:FPOW:POW1:DEF "TriggerDelay=0.025"
Notes	The trigger delay parameter sets the time after an external trigger is detected until the measurement is performed.
Preset	0 s
Range	0 – 1 s
Default Unit	Seconds
Initial S/W Revision	A.14.00

Trigger Level

Example	CALC:FPOW:POW1:DEF "TriggerLevel=2"
Notes	The trigger level parameter sets the voltage value at which an external trigger is detected.
Preset	1.2 V
Range	-5 to 5 V
Default Unit	Volts
Initial S/W Revision	A.14.00

Trigger Slope

Example	CALC:FPOW:POW1:DEF "TriggerSlope=Negative"
Notes	The trigger slope parameter indicates the direction of the edge trigger voltage for detection.
Preset	Positive
Range	Positive, Negative
Initial S/W Revision	A.14.00

Trigger Source

Example	CALC:FPOW:POW1:DEF "TriggerSource=Ext1"
Notes	The trigger source parameter allows the user to choose between measurement's triggering freely or controlled by an external input. Ext1 and Ext2 correspond to Trigger 1 In and Trigger 2 In, respectively.
Preset	Free
Range	Free, Ext1, Ext2
Initial S/W Revision	A.14.00

Trigger Timeout

Example	CALC:FPOW:POW1:DEF "TriggerTimeout=0.1"
Notes	The trigger timeout parameter sets the time in which the analyzer will wait for a trigger before automatically performing the measurement.
Preset	1 s
Range	0 - 1 s
Default Unit	Seconds
Initial S/W Revision	A.14.00

Signal Input

Example	CALC:FPOW:POW1:DEF "SignalInput=Fp50MHzCW"
Notes	The signal input parameter allows the user to select between using the main RF input or the internal analyzer reference CW signal of 50 MHz.
Preset	FpMainRf
Range	FpMainRf, Fp50MHzCW
Initial S/W Revision	A.14.00

Use Preselector

Example	CALC:FPOW:POW1:DEF "UsePreSelector=True"
Notes	The preselector parameter allows the user to either utilize or bypass the front end tunable filter at frequencies above 3.6 GHz. For frequencies below 3.6 GHz, the preselector is automatically bypassed, so you do not need to set this parameter to False in those cases.
Preset	False
Range	True (use preselector above 3.6 GHz), or False (preselector bypassed)

Default Unit	Boolean
Initial S/W Revision	A.14.00

Channel Bandwidth Array

Example	CALC:FPOW:POW1:DEF "Bandwidth=[3.84e6, 5e6, 3.84e6]"
Notes	The bandwidth parameter array defines the bandwidth of each channel that will be measured. All array parameters should have the same number of elements. Alternatively, if all the elements are the same value, a single number with no square brackets can be used to define the parameter.
Preset	[1 e6]
Range	0 to 40 MHz
Default Unit	Hz
Initial S/W Revision	A.14.00

Channel Filter Type Array

Example	CALC:FPOW:POW1:DEF "FilterType=[RRC, IBW, RRC]"
Notes	The filter type parameter allows the user to choose between an integration bandwidth (IBW) filter or a root-raised-cosine (RRC) filter. The integration bandwidth filter weighs all frequencies within the bandwidth equally. The root-raised-cosine filter has an associated shape parameter, defined by the FilterAlpha parameter. All array parameters should have the same number of elements. Alternatively, if all the elements are the same value, a single value with no square brackets can be used to define the parameter.
Preset	[IBW]
Range	IBW, RRC
Initial S/W Revision	A.14.00

Channel Filter Alpha Array

Example	CALC:FPOW:POW1:DEF "FilterAlpha=[0.5, 0.0, 0.5]"
Notes	The filter alpha parameter allows the user to adjust the alpha value associated with the root-raised-cosine (RRC) filter type. Set FilterType to RRC in order to utilize this parameter. All array parameters should have the same number of elements. Alternatively, if all the elements are the same value, a single number with no square brackets can be used to define the parameter.
Preset	[0.22]
Range	0.0 - 1.0

Initial S/W Revision	A.14.00
-------------------------	---------

Channel Measurement Function Array

Example	CALC:FPOW:POW1:DEF "Function=[BandPower, PeakPower, BandPower]"
Notes	<p>This parameter array defines what measurement is being made for each individually-specified channel:</p> <p>BandPower: Total power within the specified bandwidth of the channel (dBm)</p> <p>BandDensity: Total power density within the specified bandwidth of the channel (dBm/Hz)</p> <p>PeakPower: The peak power value within the specified bandwidth of the channel (dBm)</p> <p>PeakFrequency: The frequency which corresponds to the peak power value within the specified bandwidth of the channel. This frequency is relative to the center frequency (Hz)</p> <p>XdBBandwidth: The half power (-3.01 dB) bandwidth of the highest amplitude signal that resides within the channel (Hz), dB is configurable using XdBBandwidth parameter</p> <p>OccupiedBandwidth: The bandwidth at which 99% of the total power resides within the channel (Hz), percentage configurable using OccupiedBandwidthPercent parameter</p> <p>All array parameters should have the same number of elements. Alternatively, if all the elements are the same value, a single value with no square brackets can be used to define the parameter.</p>
Preset	[BandPower]
Range	BandPower, BandDensity, PeakPower, PeakFrequency, XdBBandwidth, OccupiedBandwidth
Initial S/W Revision	A.14.00

Channel Offset Frequency Array

Example	CALC:FPOW:POW1:DEF "OffsetFrequency=[-5e6, 0, 5e6]"
Notes	<p>The offset frequency parameter array defines the difference between the center frequency to the center frequency of each channel.</p> <p>All array parameters should have the same number of elements.</p>
Preset	[0]
Range	0 to 20 MHz
Default Unit	Hz
Initial S/W Revision	A.14.00

Channel Occupied Bandwidth Percent Array

Example	CALC:FPOW:POW1:DEF "OccupiedBandwidthPercent =[0.95, 0.95, 0.95]"
Notes	This parameter only applies for channels whose Function is set to OccupiedBandwidth. The occupied

bandwidth percent parameter specifies the percent of total power in these channels. The valid range for this parameter is 0.0 to 1.0, where 1.0 represents 100%. The default for this parameter is 0.99, which will return the bandwidth that contains 99% of the total channel power.

Preset	[0.99]
Range	0 – 1.0
Initial S/W Revision	A.14.00

Channel x-dB Bandwidth Array

Example	CALC:FPOW:POW1:DEF " XdBBandwidth =[-6.02, -3.01, -1.0]"
Notes	This parameter only applies for channels whose Function is set to XdBBandwidth. The X dB bandwidth parameter is used to specify the power relative to the peak channel power over which the bandwidth is calculated. The parameter value must be a negative number.
Preset	[-3.01]
Range	-200 to 0 dB
Default Unit	dB
Initial S/W Revision	A.14.00

Define Fast Power Measurement Query (Remote Command Only)

The DEFine? command is used to retrieve a list of all defined parameters in an ASCII string format

```

M All
o
d
e
R :CALCulate:FPOWER:POWER[1,2,...,999]:DEFine?
e
m
o
t
e
C
o
m
m
a
n
d
E :CALC:FPOW:POW1:DEF?

```

```
x
a
m
p
l
e
-----
N This command query is used to retrieve a list of all defined parameters in an ASCII format.
o The following is an example of the returned results:
t "DCCoupled=False,ElecAttBypass=True,ElecAttenuation=0,IFGain=0,MechAttenuation=0,PreAmpMode=Off,PreSelectorOffset
e =0,UsePreSelector=False,ExternalReferenceFrequency=10000000,FrequencyReferenceSource=AutoExternalFrequencyRefer
s ence,IFType=B40M,LOMode=SLW,SignalInput=FpMainRf,AcquisitionTime=0.001,CenterFrequency=1000000000,Resolution
BW=0,ResolutionBWMode=BestSpeed,DetectorType=RmsAverage,Bandwidth=[1000000],OffsetFrequency=[0],Function=
[BandPower],FilterType=[IBW],FilterAlpha=[0.22],OccupiedBandwidthPercent=[0.99],XdBBandwidth=[-
3.01],DoNoiseCorrection=False,DoSpurSuppression=False,MeasurementMethod=HardwareFFT,IncludePowerSpectrum=False,
e,TriggerDelay=0,TriggerLevel=1.2,TriggerSlope=Positive,TriggerSource=Free,TriggerTimeout=1 "
-----
I A.14.00
n
i
t
i
a
l

S
/
W

R
e
v
i
s
i
o
n
-----
```

Configure Fast Power Measurement (Remote Command Only)

The configure command begins hardware setup and returns immediately, with no acquisition made. This can be used in parallel with other hardware operations to effectively hide the hardware setup time.

Mode	All
Remote Command	:CALCulate:FPOWER:POWER[1,2,...,999]:CONFigure
Example	:CALC:FPOW:POW1:CONF
Notes	Option FP2 is required.
Initial S/W Revision	A.14.00

Initiate Fast Power Measurement (Remote Command Only)

The INITiate command begins an acquisition and returns immediately. The results of the measurement can be retrieved using FETCh.

Mode	All
Remote Command	:CALCulate:FPOWER:POWER[1,2,...,999]:INITiate
Example	:CALC:FPOW:POW1:INIT
Notes	Option FP2 is required.
Initial S/W Revision	A.14.00

Fetch Fast Power Measurement (Remote Command Only)

The FETCh command query is used to retrieve the results of an acquisition initiated by the INIT command. The returned results are in ASCII string format. The string begins and ends with quotation marks.

Mode	All
Remote Command	:CALCulate:FPOWER:POWER[1,2,...,999]:FETCh?
Example	:CALC:FPOW:POW1:FETC?
Notes	Option FP2 is required. Returns m comma-separated ASCII values, where m corresponds to the number of bandwidths defined. 1. Declared function return in the 1st specified channel 2. Declared function return in the 2nd specified channel ... m. Declared function return in the last specified channel The INIT and FETC? command sequence performs the same functionality of a single CALC:FPOW:POW[n]? query. Units of the returned values are dependent on the Function parameter for each channel.
Initial S/W Revision	A.14.00

Execute Fast Power Measurement (Remote Command Only)

This command query is used as shorthand for an INIT command immediately followed by a FETC? command. The returned results are in ASCII string format. The string begins and ends with quotation marks.

Mode	All
Remote Command	:CALCulate:FPOWER:POWER[1,2,...,999]?
Example	:CALC:FPOW:POW1?

Notes	Option FP2 is required. See notes for Fast Power Fetch for return format.
Initial S/W Revision	A.14.00

Binary Read Fast Power Measurement (Remote Command Only)

This command query is used as shorthand for an INIT command immediately followed by a FETC? command. The returned results are in a binary format.

Mode	All
Remote Command	:CALCulate:FPOWER:POWER[1,2,...,999]:READ? :CALCulate:FPOWER:POWER[1,2,...,999]:READ1?
Example	:CALC:FPOW:POW1:READ? :CALC:FPOW:POW1:READ1?
Notes	Option FP2 is required. Returns m 4 byte floating point binary values (Little-Endian), where m corresponds to the number of bandwidths defined.
Initial S/W Revision	A.14.00

Diagnostic Binary Read Fast Power Measurement (Remote Command Only)

This command query is used as shorthand for an INIT command immediately followed by a FETC? command. The returned results are in a binary format. This command is used primarily for diagnostic purposes to test for ADC overloads and to visibly inspect the spectrum.

Mode	All
Remote Command	:CALCulate:FPOWER:POWER[1,2,...,999]:READ2?
Example	:CALC:FPOW:POW1:READ2?
Notes	Option FP2 is required. Note: Spectrum data is only returned if the IncludePowerSpectrum parameter is set to True. If IncludePowerSpectrum is False, the number of spectrum points will be zero (0). Units of the returned values are dependent on the Function parameter per channel (e.g. dBm for BandPower, Hz for PeakFrequency). Returns binary data (Little-Endian) that contains information on m amount of channels, along with ADC over range and full spectrum data. The following is the binary format of the response. Bandwidth Return Value 1. Number of channels specified, m [4 byte int] 2. Declared function result for the 1st specified channel [4 byte float]

	3. Declared function result for the 2nd specified channel [4 byte float]
	...
	(m + 1). Declared function result for the last (mth) specified channel [4 byte float]
	ADC Over Range
	1. ADC over-range occurred (1: true, 0: false) [2 byte short]
	Spectrum Data
	1. Number of points in the spectrum data, k [4 byte int]
	2. Start frequency of spectrum data (Hz) [8 byte double]
	3. Step frequency of spectrum data (Hz) [8 byte double]
	4. FFT bin at 1st point (dBm) [4 byte float]
	5. FFT bin at 2nd point (dBm) [4 byte float]
	...
	(k + 3). FFT bin at last (kth) point (dBm) [4 byte float]
Initial S/W Revision	A.14.00

Format Data: Numeric Data (Remote Command Only)

This command specifies the format of the trace data input and output. It specifies the formats used for trace data during data transfer across any remote port. It affects only the data format for setting and querying trace data for the :TRACe[:DATA], TRACe[:DATA]?, :CALCulate:DATA[n]? and FETCh:SANalyzer [n]? commands and queries.

Remote Command	:FORMat[:TRACe][:DATA] ASCii INTEger,32 REAL,32 REAL,64 :FORMat[:TRACe][:DATA]?
Notes	The query response is: ASCii: ASC,8 REAL,32: REAL,32 REAL,64: REAL,64 INTEger,32: INT,32 When the numeric data format is REAL or ASCii, data is output in the current Y Axis unit. When the data format is INTEger, data is output in units of m dBm (.001 dBm). The INT,32 format returns binary 32-bit integer values in internal units (m dBm), in a definite length block.
Dependencies	Sending a data format spec with an invalid number (for example, INT,48) generates no error. The analyzer simply uses the default (8 for ASCii, 32 for INTEger, 32 for REAL). Sending data to the analyzer which does not conform to the current FORMat specified, results in an error. Sending ASCII data when a definite block is expected generates message -161 "Invalid Block Data" and sending a definite block when ASCII data is expected generates message -121 "Invalid Character in Number".
Preset	ASCii
Backwards Compatibility	Note that the INT,32 format is only applicable to the command, TRACe:DATA. This preserves

Notes	backwards compatibility for the Swept SA measurement. For all other commands/queries which honor FORMat:DATA, if INT,32 is sent the analyzer will behave as though it were set to REAL,32.
Initial S/W Revision	Prior to A.02.00

The specs for each output type follow:

ASCIi - Amplitude values are in ASCII, in the current Y Axis Unit, one ASCII character per digit, values separated by commas, each value in the form:

SX.YYYYYEsZZ

Where:

S = sign (+ or -)

X = one digit to left of decimal point

Y = 5 digits to right of decimal point

E = E, exponent header

s = sign of exponent (+ or -)

ZZ = two digit exponent

REAL,32 - Binary 32-bit real values in the current Y Axis Unit, in a definite length block.

REAL,64 - Binary 64-bit real values in the current Y Axis Unit, in a definite length block.

Format Data: Byte Order (Remote Command Only)

This command selects the binary data byte order for data transfer and other queries. It controls whether binary data is transferred in normal or swapped mode. This command affects only the byte order for setting and querying trace data for the :TRACe[:DATA], TRACe[:DATA]? , :CALCulate:DATA[n]? and FETCh:SANalyzer[n]? commands and queries.

By definition any command that says it uses FORMat:DATA uses any format supported by FORMat:DATA.

The NORMal order is a byte sequence that begins with the most significant byte (MSB) first, and ends with the least significant byte (LSB) last in the sequence: 1|2|3|4. SWAPped order is when the byte sequence begins with the LSB first, and ends with the MSB last in the sequence: 4|3|2|1.

Remote Command	:FORMat:BORDer NORMal SWAPped :FORMat:BORDer?
Preset	NORMal
Initial S/W Revision	Prior to A.02.00

Meas Setup

Displays the setup menu for the currently selected measurement. The parameters included in this menu are as follows.

Averaging

IF Gain

Channel Power Span

Integrated Bandwidth

Filter Bandwidth

Root Raised Cosine (RRC) Filter

Key Path	Front-panel key
Initial S/W Revision	Prior to A.02.00

Avg/Hold Num

Specifies the number of measurement averages used to calculate the measurement result. The average is displayed at the end of each sweep. After the specified number of average counts, the averaging mode (terminal control) setting determines the averaging action.

Key Path	Meas Setup
Mode	SA, WCDMA, C2K, WIMAX OFDMA, 1xEVDO, DVB-T/H, DTMB (CTTB), ISDB-T, CMMB, LTE, LTETDD, Digital Cable TV, WLAN, MSR, LTEAFDD, LTEATDD
Remote Command	[:SENSe]:CHPower:AVERage:COUNT <integer> [:SENSe]:CHPower:AVERage:COUNT? [:SENSe]:CHPower:AVERage[:STATE] ON OFF 1 0 [:SENSe]:CHPower:AVERage[:STATE]?
Example	CHP:AVER:COUN 15 CHP:AVER:COUN? CHP:AVER ON CHP:AVER?
Notes	You must be in the Spectrum Analysis mode, W-CDMA mode, cdma2000 mode, DVB-T/H mode, DTMB (CTTB) mode, ISDB-T mode, CMMB mode, Digital Cable TV mode, LTE mode, LTE TDD mode 1xEVDO mode or WIMAX OFDMA mode to use this command. Use :INSTRument:SElect to set the mode.
Preset	SA: 10 WCDMA: 200 WIMAX OFDMA, LTE, LTETDD, MSR: 200 CDMA2K: 20 1xEVDO: 20

	DVB-T/H: 20 DTMB (CTTB): 20 ISDB-T: 10 CMMB: 10 Digital Cable TV: 10 WLAN: 10 LTEAFDD, LTEATDD:200 ON
State Saved	Saved in instrument state.
Min	1
Max	10000
Initial S/W Revision	Prior to A.02.00
Modified at S/W Revision	A.02.00, A.03.00

Avg Mode

Allows you to select the type of termination control used for the averaging function. This determines the averaging action after the specified number of data acquisitions (average count) is reached.

When set to Exponential (Exp) the measurement averaging continues using the specified number of averages to compute each exponentially-weighted averaged value. The average is displayed at the end of each sweep.

When set to Repeat, the measurement resets the average counter each time the specified number of averages is reached.

Key Path	Meas Setup
Mode	SA, WCDMA, C2K, WIMAX OFDMA, 1xEVDO, DVB-T/H, DTMB (CTTB), ISDB-T, CMMB, LTE, LTETDD, Digital Cable TV, WLAN, MSR, LTEAFDD, LTEATDD
Remote Command	[:SENSe] :CHPower:AVERage:TCONtrol EXPonential REPeat [:SENSe] :CHPower:AVERage:TCONtrol?
Example	CHP:AVER:TCON EXP CHP:AVER:TCON?
Notes	You must be in the Spectrum Analysis mode, W-CDMA mode, cdma2000 mode, DVB-T/H mode, DTMB (CTTB) mode, ISDB-T mode, CMMB mode, Digital Cable TV mode, LTE mode, LTE TDD mode, WLAN mode, 1xEVDO mode or WIMAX OFDMA mode to use this command. Use :INSTrument:SElect to set the mode.
Preset	EXP
State Saved	Saved in instrument state.
Range	Exp Repeat
Initial S/W Revision	Prior to A.02.00
Modified at S/W Revision	A.02.00, A.03.00

Carrier Results (Only for MSR and LTE-Advanced FDD/TDD)

Enables you to view and scroll through the carrier power results.

Key Path	Meas Setup
Mode	MSR, LTEAFDD, LTEATDD
Couplings	This key will be grayed out if there is only one carrier.
State Saved	No
Initial S/W Revision	A.10.00

PhNoise Opt

Selects the LO (local oscillator) phase noise behavior for various operating conditions. Refer to PhNoise Opt

in the Swept SA measurement for details.

Key Path	Meas Setup
Initial S/W Revision	A.04.20

PhNoise Opt Auto

Selects the LO (local oscillator) phase noise behavior to optimize dynamic range and speed for various instrument operating conditions. Refer to PhNoise Opt Auto State@3215 in the Swept SA measurement for details.

Key Path	Meas Setup
Remote Command	[:SENSe] :CHPower:FREQuency:SYNThesis:AUTO [:STATe] OFF ON 0 1 [:SENSe] :CHPower:FREQuency:SYNThesis:AUTO [:STATe] ?
Example	CHP:FREQ:SYNT:AUTO 1 CHP:FREQ:SYNT:AUTO?
Preset	OFF
State Saved	Saved in instrument state.
Range	Auto Man
Readback Text	"Auto" is underlined when Auto is selected, otherwise Man is underlined.
Initial S/W Revision	A.04.20

PhNoise Opt State

Selects the LO (local oscillator) phase noise behavior for various operating conditions. Refer to PhNoise Opt in the Swept SA measurement for details.

Key Path	Meas Setup
Remote Command	[:SENSe] :CHPower:FREQuency:SYNThesis [:STATe] 1 2 3 [:SENSe] :CHPower:FREQuency:SYNThesis [:STATe] ?
Example	CHP:FREQ:SYNT 1 CHP:FREQ:SYNT?
Notes	Parameter key: <ol style="list-style-type: none"> 1. optimizes phase noise for close-in from the carrier. 2. optimizes phase noise for wide-offset from the carrier. 3. optimizes LO for tuning speed.
Couplings	<p>Best Close-in Φ Noise</p> <p>The frequency below which the phase noise is optimized is model dependent: PXA with option EP1: [offset <140 kHz] Models with option EP2: [offset <70 kHz] CXA with option EP4: [offset <90 kHz] CXA without option EP4: n/a All other models: [offset <20 kHz]</p> <p>Best Wide-offset Φ Noise</p> <p>The frequency below which the phase noise is optimized is model dependent: PXA with option EP1: [offset >160 kHz] Models with option EP2: [offset >100 kHz] CXA with option EP4: [offset >130 kHz] CXA without option EP4: n/a All other models: [offset >30 kHz]</p> <p>Fast Tuning</p> <p>The Fast Tuning details are model dependent: CXA without option EP4: n/a PXA with option EP1: [single loop] Models with option EP2: [medium loop bandwidth] All other models: [same as Close-in]</p>
Preset	3
State Saved	Saved in instrument state.
Range	Best Close-in Φ Noise [offset < 140 kHz] Best Wide-offset Φ Noise [offset > 160 kHz] Fast Tuning [same as Close-in] [] is model dependent. See Couplings for details.
Initial S/W Revision	A.04.20

IF Gain

Sets the IF Gain function to Auto, Low Gain or High Gain. These settings affect sensitivity and IF overloads.

Key Path	Meas Setup
Dependencies	The IF Gain keys (FFT IF Gain and Swept IF Gain) have no effect when the U7227A USB Preamplifier is connected. This is not annotated or reflected on any softkey; there are no keys grayed out nor any SCPI locked out. The analyzer simply behaves as though both FFT IF Gain and Swept IF Gain are set to Low regardless of the setting on the keys.
Initial S/W Revision	Prior to A.02.00

IF Gain Auto

Activates the auto rules for IF Gain. When Auto is active, the IF Gain is set to High Gain under any of the following conditions:

- The input attenuator is set to 0 dB
- The preamp is turned On and the frequency range is under 3.6 GHz

For other settings, Auto sets the IF Gain to Low Gain.

Key Path	Meas Setup, IF Gain
Remote Command	[:SENSe] :CHPower :IF:GAIN:AUTO [:STATe] ON OFF 1 0 [:SENSe] :CHPower :IF:GAIN:AUTO [:STATe] ?
Example	CHP:IF:GAIN:AUTO ON CHP:IF:GAIN:AUTO?
Couplings	When the auto attenuation exists (for example, with an electrical attenuator), IF Gain State differs depending on the condition. Auto sets IF Gain to High Gain under any of the following conditions: The input attenuator is set to 0 dB, or the preamp is turned on and the frequency range is under 3.6 GHz. For other conditions, Auto sets IF Gain to Low Gain.
Preset	OFF
State Saved	Saved in instrument state.
Range	Off On
Initial S/W Revision	Prior to A.02.00

IF Gain State

Selects the range of the IF Gain.

Key Path	Meas Setup, IF Gain
Remote Command	[:SENSe] :CHPower :IF:GAIN [:STATe] ON OFF 1 0 [:SENSe] :CHPower :IF:GAIN [:STATe] ?

Example	CHP:IF:GAIN ONCHP:IF:GAIN?
Notes	ON = high gain OFF = low gain
Couplings	When the auto attenuation exists (for example, with an electrical attenuator), IF Gain State differs depending on the condition. Auto sets IF Gain to High Gain under any of the following conditions: The input attenuator is set to 0 dB, or the preamp is turned on and the frequency range is under 3.6 GHz. For other conditions, Auto sets IF Gain to Low Gain.
Preset	OFF
State Saved	Saved in instrument state.
Range	Low Gain High Gain
Initial S/W Revision	Prior to A.02.00

PSD Unit

Sets the unit bandwidth for Power Spectral Density. The available units are dBm/Hz and dBm/MHz.

Key Path	Meas Setup
Mode	SA, WCDMA, WIMAX OFDMA, 1xEVDO, DVB-T/H, DTMB (CTTB), LTE, LTETDD, Digital Cable TV, WLAN, MSR, LTEAFDD, LTEATDD
Remote Command	:UNIT:CHPower:POWer:PSD DBMHZ DBMMHZ :UNIT:CHPower:POWer:PSD?
Example	UNIT:CHP:POW:PSD DBMMHZ UNIT:CHP:POW:PSD?
Couplings	When the PSD unit is changed, the PSD result of the "MEAS READ FETCH:CHP1?" is also changed by the PSD unit basis (in either dBm/Hz or dBm/MHz).
Preset	DBMHZ WLAN: DBMMHZ
State Saved	Saved in instrument state.
Range	dBm/Hz dBm/MHz
Initial S/W Revision	Prior to A.02.00
Modified at S/W Revision	A.02.00, A.03.00

Meas Preset

Restores all the measurement parameters to their default values.

Key Path	Meas Setup
Mode	SA, WCDMA, C2K, WIMAX OFDMA, 1xEVDO, DVB-T/H, DTMB (CTTB), ISDB-T, CMMB, LTE, LTETDD, Digital Cable TV, WLAN, MSR, LTEAFDD, LTEATDD

Remote Command	:CONFiGure:CHPower
Example	CONF:CHP
Initial S/W Revision	Prior to A.02.00
Modified at S/W Revision	A.02.00, A.03.00

8 Channel Power Measurement
Mode

Mode

See "[Mode](#)" on page 276

Mode Preset

Returns the active mode to a known state.

Mode Preset does the following for the currently active mode:

- Aborts the currently running measurement.
- Brings up the default menu for the mode, with no active function.
- Sets measurement Global settings to their preset values for the active mode only.
- Activates the default measurement.
- Brings up the default menu for the mode.
- Clears the input and output buffers.
- Sets Status Byte to 0.

Mode Preset does not:

- Cause a mode switch
- Affect mode persistent settings
- Affect system settings
- See "[How-To Preset](#)" on page 588 for more information.

Key Path	Front-panel key
Remote Command	:SYSTem:PRESet
Example	:SYST:PRES
Notes	*RST is preferred over :SYST:PRES for remote operation. *RST does a Mode Preset, as done by the :SYST:PRES command, and it sets the measurement mode to Single measurement rather than Continuous for optimal remote control throughput. Clears all pending OPC bits. The Status Byte is set to 0.
Couplings	A Mode Preset aborts the currently running measurement, activates the default measurement, and gets the mode to a consistent state with all of the default couplings set.
Backwards Compatibility Notes	In the X-Series, the legacy "Factory Preset" has been replaced with Mode Preset, which only presets the currently active mode, not the entire instrument. In the X-Series, the way to preset the entire instrument is by using System, Restore System Defaults All, which behaves essentially the same way as restore System Defaults does on ESA and PSA. There is also no "Preset Type" as there is on the PSA. There is a green Mode Preset front-panel key that does a Mode Preset and a white-with-green-letters User Preset front-panel key that does a User Preset. The old PRESet:TYPE command is ignored (without generating an error), and SYST:PRES without a parameter does a Mode Preset, which should cover most backward code compatibility issues. The settings and correction data under the Input/Output front-panel key (examples: Input Z Corr, Ext Amp Gain, etc.) are no longer part of any Mode, so they will not be preset by a Mode Preset. They are preset using Restore Input/Output Defaults, Restore System Defaults All. Note that because User Preset does a Recall State, and all of these settings are saved in State, they ARE recalled when using

	User Preset.
Initial S/W Revision	Prior to A.02.00

How-To Preset

The table below shows all possible presets, their corresponding SCPI commands and front-panel access (key paths). Instrument settings depend on the current measurement context. Some settings are local to the current measurement, some are global (common) across all the measurements in the current mode, and some are global to all the available modes. In a similar way, restoring the settings to their preset state can be done within the different contexts.

Auto Couple - is a measurement local key. It sets all Auto/Man parameter couplings in the measurement to Auto. Any Auto/Man selection that is local to other measurements in the mode will not be affected.

Meas Preset - is a measurement local key. Meas Preset resets all the variables local to the current measurement except the persistent ones.

Mode Preset - resets all the current mode's measurement local and measurement global variables except the persistent ones.

Restore Mode Defaults - resets ALL the Mode variables (and all the Meas global and Meas local variables), including the persistent ones.

Type Of Preset	SCPI Command	Front Panel Access
Auto Couple	:COUPle ALL	Auto Couple front-panel key
Meas Preset	:CONFigure:<Measurement>	Meas Setup Menu
Mode Preset	:SYSTem:PRESet	Mode Preset (green key)
Restore Mode Defaults	:INSTrument:DEFault	Mode Setup Menu
Restore All Mode Defaults	:SYSTem:DEFault MODes	System Menu; Restore System Default Menu
*RST	*RST	not possible (Mode Preset with Single)
Restore Input/Output Defaults	:SYSTem:DEFault INPUt	System Menu; Restore System Default Menu
Restore Power On Defaults	:SYSTem:DEFault PON	System Menu; Restore System Default Menu
Restore Alignment Defaults	:SYSTem:DEFault ALIGN	System Menu; Restore System Default Menu
Restore Miscellaneous Defaults	:SYSTem:DEFault MISC	System Menu; Restore System Default Menu
Restore All System Defaults	:SYSTem:DEFault [ALL] :SYSTem:PRESet:PERsistent	System Menu; Restore System Default Menu
User Preset	:SYSTem:PRESet:USER	User Preset Menu
User Preset All Modes	:SYSTem:PRESet:USER:ALL	User Preset Menu

Power On Mode Preset	:SYSTem:PON:TYPE MODE	System Menu
Power On User Preset	:SYSTem:PON:TYPE USER	System Menu
Power On Last State	:SYSTem:PON:TYPE LAST	System Menu

Preset Type (Remote Command Only)

As stated in the Backward Compatibility section, to be compatible with ESA/PSA the PRESet:TYPE command will be implemented as a no-op.

Mode	All
Remote Command	:SYSTem:PRESet:TYPE FACTory MODE USER :SYSTem:PRESet:TYPE?
Example	:SYST:PRES:TYPE FACT
Notes	This command is supported for backward compatibility only. It is a no-op which does not change the behavior of any preset operation.
Preset	This is unaffected by Preset but is set to Mode on a “Restore System Defaults->All”
State Saved	No
Initial S/W Revision	Prior to A.02.00

Mode Setup

See "[Mode Setup](#)" on page 306

Peak Search

Places the selected marker on the trace point with the maximum y-axis value. Pressing Peak Search with the selected marker Off causes the selected marker to be set to Normal, then a peak search is immediately performed.

Key Path	Front panel key
Mode	SA, WCDMA, C2K, WIMAX OFDMA, 1xEVDO, DVB-T/H, DTMB (CTTB), ISDB-T, CMMB, LTE, LTETDD, Digital Cable TV, WLAN, MSR, LTEAFDD, LTEATDD
Remote Command	:CALCulate:CHPower:MARKer[1 2 ... 12:MAXimum
Example	CALC:CHP:MARK2:MAX
Initial S/W Revision	Prior to A.02.00
Modified at S/W Revision	A.02.00, A.03.00

8 Channel Power Measurement
Print

Print

See "[Print](#) " on page 367

Quick Save

The Quick Save front-panel key repeats the most recent save that was performed from the Save menu, with the following exceptions:

- Register saves are not remembered as Saves for the purpose of the Quick Save function
- If the current measurement does not support the last non-register save that was performed, an informational message is generated, “File type not supported for this measurement”

Quick Save repeats the last type of qualified save (that is, a save qualified by the above criteria) in the last save directory by creating a unique filename using the Auto File Naming algorithm described below.

If Quick Save is pressed after startup and before any qualified Save has been performed, the Quick Save function performs a Screen Image save using the current settings for Screen Image saves (current theme, current directory), which then becomes the “last save” for the purpose of subsequent Quick Saves.

The Auto File Naming feature automatically generates a file name for use when saving a file. The filename consists of a prefix and suffix separated by a dot, as is standard for the Windows® file system. A default prefix exists for each of the available file types:

Type	Default Prefix	Menu
State	State_	(Save/Recall)
Trace + State	State_	(Save/Recall)
Screen	Screen_	(Save/Recall)
Amplitude Corrections	Ampcor_	(Import/Export)
Traces	Trace_	(Import/Export)
Limit Lines	LLine_	(Import/Export)
Measurement Result	MeasR_	(Import/Export)
Capture Buffer	CapBuf_	(Import/Export)

A four digit number is appended to the prefix to create a unique file name. The numbering sequence starts at 0000 within each Mode for each file type and updates incrementally to 9999, then wraps to 0000 again. It remembers where it was through a Mode Preset and when leaving and returning to the Mode. It is reset by Restore Misc Defaults and Restore System Defaults and subsequent running of the instrument application. So, for example, the first auto file name generated for State files is State_0000.state. The next is State_0001, and so forth.

One of the key features of Auto File Name is that we guarantee that the Auto File Name will never conflict with an existing file. The algorithm looks for the next available number. If it gets to 9999, then it looks for holes. If it find no holes, that is no more numbers are available, it gives an error.

For example, if when we get to State_0010.state there is already a State_0010.state file in the current directory, it advances the counter to State_0011.state to ensure that no conflict will exist (and then it verifies that State_0011.state also does not exist in the current directory and advances again if it does, and so forth).

If you enter a file name for a given file type, then the prefix becomes the filename you entered instead of the default prefix, followed by an underscore. The last four letters (the suffix) are the 4-digit number.

For example, if you save a measurement results file as “fred.csv”, then the next auto file name chosen for a measurement results save will be fred_0000.csv.

NOTE

Although 0000 is used in the example above, the number that is used is actually the current number in the Meas Results sequence, that is, the number that would have been used if you had not entered your own file name.

NOTE

If the filename you entered ends with _dddd, where d=any number, making it look just like an auto file name, then the next auto file name picks up where you left off with the suffix being dddd + 1.

Key Path	Front-panel key
Notes	No remote command for this key specifically.
Initial S/W Revision	Prior to A.02.00

Recall

In the MSR mode, two types of recall functions are available under the Data menu: Parameter Sets and Masks. Masks enables setting of a preset limit mask for Power Suite-based measurements, and currently it is available for the SEM, ACP and SPUR measurements in the MSR mode.

Key Path	Front Panel
Mode	MSR
Initial S/W Revision	A.10.00

State

The **Recall State** menu lets you choose a register or file from which to recall the state.

The content of a state file includes all of the settings and data required to return the analyzer as closely as possible to the Mode it was in, with the exact settings that were in place, when the save occurred. The Mode settings in each state file include the settings that are affected by Mode Preset, as well as the additional settings affected by Restore Mode Defaults; all of the Mode's settings. In addition, all of the settings of the **Input/Output** system are included, even though they are outside of the Mode's state, because they are needed to restore the complete setup. Persistent System settings (for example, GPIB address) are not affected by either a Mode Preset or Restore Mode Defaults, nor are they included in a saved State file.

Since each state file is only for one Mode, the settings for other Modes are unaffected when it is loaded. **Recall State** will cause a mode switch if the state being recalled is not from the current active mode.

After the recall completes, the message "File <filename> recalled" or "Recalled State Register <register number>" is displayed.

For rapid recalls, the State menu lists 16 registers that you can choose from to recall. Pressing a Register key initiates the recall. You can also select a file from which to recall.

The default path for all State Files is:

My Documents\<<mode name>\state

where <mode name> is the parameter used to select the mode with the INST:SEL command (for example, SA for the Spectrum Analyzer).

See "[More Information](#)" on page 596.

Key Path	Recall
Mode	All
Remote Command	:MMEMory:LOAD:STATe <filename>
Example	:MMEM:LOAD:STAT "myState.state" This recalls the file myState.state on the default path
Example	MMEM:LOAD:STAT "MyStateFile.state" This loads the state file data (on the default file directory path) into the instrument state.

Notes	<p>When you pick a file to recall, the analyzer first verifies that the file is recallable in the current instrument by checking the software version and model number of the instrument. If everything matches, a full recall proceeds by aborting the currently running measurement, clearing any pending operations, and then loading the State from the saved state file. You can open state files from any mode, so recalling a State file switches to the mode that was active when the save occurred. After switching to the mode of the saved state file, mode settings and data (if any for the mode) are loaded with values from the saved file. The saved measurement of the mode becomes the newly active measurement and the data relevant to the measurement (if there is any) is recalled.</p> <ul style="list-style-type: none"> • If there is a mismatch between file version or model number or instrument version or model number, the recall function tries to recall as much as possible and returns a warning message. It may limit settings that differ based on model number, licensing or version number. <p>After recalling the state, the Recall State function does the following:</p> <ul style="list-style-type: none"> • Makes the saved measurement for the mode the active measurement. • Clears the input and output buffers. • Status Byte is set to 0. • Executes a *CLS <p>If the file specified is empty an error is generated. If the specified file does not exist, another error is generated. If there is a mismatch between the file and the proper file type, an error is generated. If there is a mismatch between file version or model number or instrument version or model number, a warning is displayed. Then it returns to the State menu and File Open dialog goes away.</p> <p>After the Recall, the analyzer exits the Recall menu and returns to the previous menu.</p>
Backwards Compatibility SCPI	<pre>:MMEMory:LOAD:STATe 1,<filename></pre> <p>For backwards compatibility, the above syntax is supported. The "1" is simply ignored.</p>
Initial S/W Revision	Prior to A.02.00

More Information

In measurements that support saving Traces, for example, Swept SA, the Trace data is saved along with the State in the State file. When recalling the State, the Trace data is recalled as well. Traces are recalled exactly as they were stored, including the writing mode and update and display modes. If a Trace was updating and visible when the State was saved, it will come back updating and visible, and its data will be rewritten right away. When you use State to save and recall traces, any trace whose data must be preserved should be placed in View or Blank mode before saving.

The following table describes the Trace Save and Recall possibilities:

You want to recall state and one trace's data, leaving other traces unaffected.	Save Trace+State from 1 trace. Make sure that no other traces are updating (they should all be in View or Blank mode) when the save is performed.	On Recall, specify the trace you want to load the one trace's data into. This trace will load in View. All other traces' data will be unaffected, although their trace mode will be as it was when the state save was performed.
You want to recall all traces	Save Trace+State from ALL traces.	On Recall, all traces will come back in View (or Blank if they were in Blank or Background when

		saved)
You want all traces to load exactly as they were when saved.	Save State	On recall, all traces' mode and data will be exactly as they were when saved. Any traces that were updating will have their data immediately overwritten.

From File...

When you press “From File”, the analyzer brings up a Windows dialog and a menu entitled “File Open.” This menu allows you to navigate to the various fields in the Windows dialog without using a keyboard or mouse. The **Tab** and **Arrow** keys can also be used for dialog navigation.

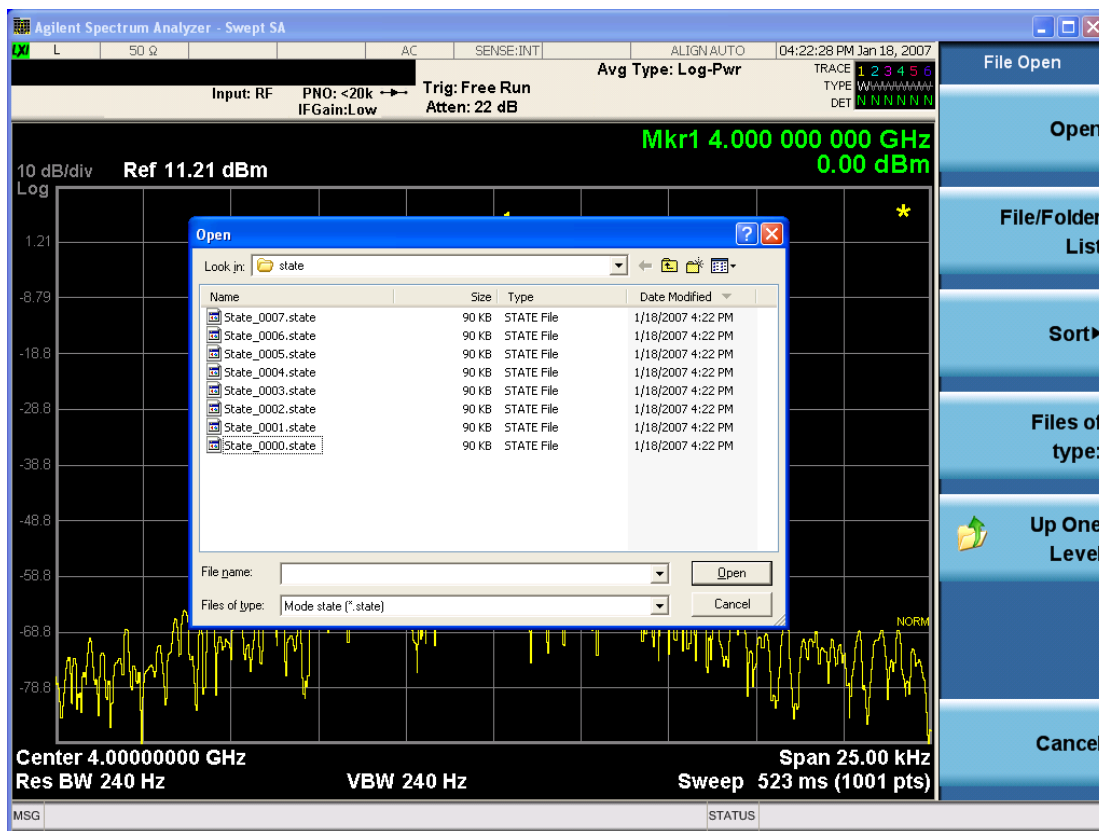

Listed below are the functions of the various fields in the dialog, and the corresponding softkeys:

Open

Performs the recall of the specified file. While the recall is being performed, the floppy icon appears briefly in the Meas bar.

File/Folder List

Enables you to navigate to the center of the dialog that contains the list of files and folders. Once here you can get information about the file and use the tab keys to navigate to the other fields in the dialog, such as Look In.

Look In

The **Look In** field shows the path from which the file will be recalled and allows you to change the path using the up and down arrow keys to navigate to other paths; the Enter key to open a directory; and the Backspace key to go back one directory. The **Look In field** first uses the last path from the Save As dialog **Save In:** path for that same file type. There is no softkey for directly navigating to the Look In field, but you can use the left tab to get here from the File/Folder List.

User specified paths are remembered when you leave and return to a Mode and are reset back to the default using **Restore Mode Defaults**.

Sort

Accesses a menu that enables you to sort the files within the File Open dialog. Only one sorting type can be selected at a time and the sorting happens immediately. The sorting types are **By Date, By Name, By extension, and By Size**.

Files of Type

This field shows the file suffix for the type of file you have selected to recall. For example, if you navigated here while recalling State, "Mode state (*.state)" is in the field. If you navigated here while recalling Trace, ""Mode state (*.trace)" is in the field. If you navigated here while importing a trace data file, "Trace Data (*.csv)" is in the field. For some file types, there is more than one choice in the dropdown menu, which you can select by using the up and down arrow keys and Enter.

Up One Level

This key corresponds to the icon of a folder with the up arrow that is in the tool bar of the dialog. When pressed, it causes the file and folder list to navigate up one level in the directory structure. The Backspace key does the same thing.

Cancel

This key corresponds to the **Cancel** selection in the dialog. It causes the current **Open** request to be cancelled. The ESC key does the same thing.

Key Path	Recall, State
Notes	Brings up the Open dialog for recalling a State Save Type
Initial S/W Revision	Prior to A.02.00

Edit Register Names

You may enter a custom name on any of the Register keys, to help you remember what you are using that state to save. To do this, press the **Edit Register Names** key, choose the register whose name you wish to edit, and then enter the desired label using the Alpha Editor or an external PC keyboard.

The maximum number of characters that can be added is 30. In most cases, 30 characters will fit on two lines of the key.

For more information and the SCPI command, see Edit Register Names under the **Save, State** function.

Key Path	Recall, State
Mode	All
Dependencies	N9060A-7FP or N9060B-2FP license required to edit the register names. When the feature is not licensed, sending the SCPI command generates an error, -221,"Settings conflict;Option not available"
Initial S/W Revision	A.11.00

Register 1 thru Register 16

Selecting any one of these register keys causes the State of the mode from the specified Register to be recalled. Each of the register keys annotates whether it is empty or at what date and time it was last modified. In addition, you can use the **Edit Register Names** key under **Save, State** to enter custom names for each register.

Registers are shared by all modes, so recalling from any one of the registers will cause a mode switch to the mode that was active when the save to the Register occurred.

Although these 16 registers are the only registers available from the front panel, there are 128 state registers available in the instrument. Registers 17–128 are only available from the SCPI interface, using the *RCL command.

After the recall completes, the message "Register <register number> recalled" appears in the message bar. If you are in the Spectrum Analyzer Mode, and you are recalling a register that was saved in the Spectrum Analyzer Mode, then after the recall, you will still be in the Recall Register menu. If the Recall causes you to switch modes, then after the Recall, you will be in the Frequency menu.

If a requested register is empty an error is generated.

Key Path	Recall, State
Example	*RCL 1
Range	1-16 from front panel, 1-128 from SCPI
Readback	Date and time with seconds resolution are displayed on the key OR A custom name of up to 30 characters entered using the Save, State,Edit Register Names key OR “(empty)” if no prior save operation has been performed to this register.
Initial S/W Revision	Prior to A.02.00
Modified at S/W Revision	Prior to A.11.00

Register 1 thru Register 16

Selecting any one of these register keys causes the State of the mode from the specified Register to be recalled. Each of the register keys annotates whether it is empty or at what date and time it was last

modified. In addition, you can use the **Edit Register Names** key under **Save, State** to enter custom names for each register.

Registers are shared by all modes, so recalling from any one of the registers will cause a mode switch to the mode that was active when the save to the Register occurred.

Although these 16 registers are the only registers available from the front panel, there are 128 state registers available in the instrument. Registers 17–128 are only available from the SCPI interface, using the *RCL command.

After the recall completes, the message "Register <register number> recalled" appears in the message bar. If you are in the Spectrum Analyzer Mode, and you are recalling a register that was saved in the Spectrum Analyzer Mode, then after the recall, you will still be in the Recall Register menu. If the Recall causes you to switch modes, then after the Recall, you will be in the Frequency menu.

If a requested register is empty an error is generated.

Key Path	Recall, State
Example	*RCL 1
Range	1–16 from front panel, 1–128 from SCPI
Readback	Date and time with seconds resolution are displayed on the key OR A custom name of up to 30 characters entered using the Save, State, Edit Register Names key OR “(empty)” if no prior save operation has been performed to this register.
Initial S/W Revision	Prior to A.02.00
Modified at S/W Revision	Prior to A.11.00

Data (Import)

Importing a data file loads data that was previously saved from the current measurement or from other measurements and/or modes that produce compatible data files. The Import Menu only contains Data Types that are supported by the current measurement.

Since the commonly exported data files are in .csv format, the data can be edited by the user prior to importing. This allows you to export a data file, manipulate the data in Excel (the most common PC Application for manipulating .csv files) and then import it.

Importing Data loads measurement data from the specified file into the specified or default destination, depending on the data type selected. Selecting an Import Data menu key will not actually cause the importing to occur, since the analyzer still needs to know from where to get the data. Pressing the Open key in this menu brings up the Open dialog and Open menu that provides you with the options from where to recall the data. Once a filename has been selected or entered in the Open menu, the recall occurs as soon as the Open button is pressed.

Key Path	Recall
Mode	All

Notes	The menu is built from whatever data types are available for the mode. Some keys will be missing completely, so the key locations in the sub-menu will vary. No SCPI command directly controls the Data Type that this key controls. The Data Type is included in the MMEM:LOAD commands.
Dependencies	If a file type is not used by a certain measurement, it is grayed out for that measurement. The key for a file type will not show at all if there are no measurements in the Mode that support it.
Preset	Is not affected by Preset or shutdown, but is reset during Restore Mode Defaults
Readback	The data type that is currently selected
Initial S/W Revision	Prior to A.02.00

Parameter Set

Enables you to import format parameter set data to specified format parameter sets. Selecting this key displays a menu that enables you to select the destination parameter set. After making this selection, depress Open... and use the file dialog to select the file you wish to recall.

Supported import file formats are dependent on radio formats.

LTE FDD: Format Parameter Set Files (*.fps), LTE FDD app state files (*.state), 89601 VSA Setup Files (*.set, *.setx) and Signal Studio Setup Files (*.scp)

W-CDMA:Format Parameter Set Files (*.fps) and W-CDMA app state files (*.state)

GSM/EDGE:Format Parameter Set Files (*.fps) and GSM/EDGE app state files (*.state)

cdma2000:Format Parameter Set Files (*.fps) and cdma2000 app state files (*.state)

1xEV-DO:Format Parameter Set Files (*.fps) and 1xEV-DO app state files (*.state)

LTE TDD: Format Parameter Set Files (*.fps), LTE TDD app state files (*.state), 89601 VSA Setup Files (*.set, *.setx) and Signal Studio Setup Files (*.scp)

TD-SCDMA:Format Parameter Set Files (*.fps) and TD-SCDMA app state files (*.state)

Format Parameter Set Files

Extention: fps

Basic file type of format parameter set. This file contains a format parameter set exported using Parameter Set under Recall, Data (Export). It is imported if the radio format of the file matches the destination radio format. If not, an error message, -230 "Data corrupt or stale", is issued with the specified file name.

App State Files

Extention: state

The state file of each mode can be imported to the corresponding parameter set. If the mode name in the state file matches the selected destination format, the state file data are imported. If not, an error message, -230 "Data corrupt or stale", is issued with the specified file name.

The parameters to be imported are ones referred in a particular measurement of each mode. The relevant measurements are listed below.

LTE FDD: Modulation Analysis

W-CDMA: Mod Accuracy

GSM/EDGE: EDGE EVM

cdma2000: Mod Accuracy

1xEV-DO: Mod Accuracy

LTE TDD: Modulation Analysis

TD-SCDMA: Mod Accuracy

Note that Integ BW and Measurement Noise BW parameters of ACP, SEM and CHP are not imported.

89601 VSA Setup Files

Extention: set, setx

The 89600 Vector Signal Analyzer Setup file created using the 89600 Vector Signal Analyzer Option BHD (LTE FDD)/Option BHE (LTE TDD) can be imported as LTE FDD/LTE TDD parameter set. If the setup file is not loaded successfully, an error message, -230 "Data corrupt or stale", is issued with the specified file name.

Signal Studio Setup Files

Extention: scp

The Keysight Signal Studio setup file created using Signal Studio (N7624B/N7625B) can be imported as LTE FDD/LTE TDD parameter set. Supported carrier types are listed in the table below:

<i>Signal Studio</i>	<i>Carrier Type</i>
N7624B Signal Studio for 3GPP LTE	Advanced LTE FDD Downlink (2009-03)
	Advanced LTE FDD Downlink (2009-12)
	Advanced LTE FDD Downlink (2010-06)
	Advanced LTE FDD Uplink (2009-12)
	Advanced LTE FDD Uplink (2010-06)
	Basic LTE FDD Downlink (2009-03)
	Basic LTE FDD Downlink (2009-12)
	Basic LTE FDD Downlink (2010-06)
	Basic LTE FDD Uplink (2009-03)
	Basic LTE FDD Uplink (2009-12)
	Basic LTE FDD Uplink (2010-06)
N7625B Signal Studio for 3GPP LTE TDD	Advanced LTE TDD (2009-03)
	Advanced LTE TDD (2009-12)
	Basic LTE TDD (2009-03)
	Basic LTE TDD (2009-12)
	Basic LTE TDD R9
Advanced LTE TDD R9	

 Basic LTE TDD R9 PRACH

If the setup file is not loaded successfully, an error message, –230 “Data corrupt or stale”, is issued with the specified file name.

Default path of this import type is “My Documents\MSR\data\params” folder. Note that “My Documents” is an alias to a directory and its location depends on which user is logged in. If the file path is specified without root folder, the import file is determined with the default path. For example if “folder1\paramData.prms” is specified, “My Documents\MSR\data\params\folder1\paramData.prms” is imported.

File Dialog Filter

Since supported import file formats differ between radio formats, file filters available in the open file dialog vary depending on the selected radio format. This table below defines file name filters available for each format.

<i>Radio Format</i>	<i>File Name Filters</i>
LTE FDD	All Supported Format Parameter Setup Files (*.fps; *.state; *.set; *.setx; *.scp) Format Parameter Setup Files (*.fps) State Files (*.state) 89601 VSA Setup Files (*.set; *.setx) Signal Studio Setup Files (*.scp)
W-CDMA	All Supported Format Parameter Setup Files (*.fps; *.state) Format Parameter Setup Files (*.fps) W-CDMA State Files (*.state)
GSM/EDGE	All Supported Format Parameter Setup Files (*.fps; *.state) Format Parameter Setup Files (*.fps) State Files (*.state)
cdma2000	All Supported Format Parameter Set Files (*.fps; *.state) Format Parameter Set Files (*.fps) State Files (*.state)
1xEV-DO	All Supported Format Parameter Set Files (*.fps; *.state) Format Parameter Set Files (*.fps) State Files (*.state)
LTE TDD	All Supported Format Parameter Setup Files (*.fps; *.state; *.set; *.setx; *.scp) Format Parameter Setup Files (*.fps) State Files (*.state) 89601 VSA Setup Files (*.set; *.setx) Signal Studio Setup Files (*.scp)
TD-SCDMA	All Supported Format Parameter Set Files (*.fps; *.state) Format Parameter Set Files (*.fps) State Files (*.state)

Key Path	Recall, Data
Mode	MSR
Remote Command	MMEMory:LOAD:PSET LTEFdd1 LTEFdd2 LTEFdd3 WCDMa1 WCDMa2 WCDMa3 GSM1 GSM2 GSM3 CDMA1 CDMA2 CDMA3 EVDO1 EVDO2 EVDO3 LTETdd1 LTETdd2 LTETdd3 TDSCdma1 TDSCdma2 TDSCdma3, <string>
Example	MMEM:LOAD:PSET LTEF1,"LTE FDD.set"
Notes	The first enum selects the destination format parameter set to which the file data are imported.
Initial S/W Revision	A.10.00
Modified at S/W Revision	A.12.00, A.16.00

Masks

This key enables you to recall a preset mask file which contains Offset and Limit settings. Parameters except them will not be overwritten. You cannot change or create preset mask files since they are binary files. This key is valid for the Spectrum Emission Mask, ACP and Spurious Emissions measurements.

Default path: "My Documents\MSR\data\masks"

Note that **"My Documents"** is an alias to a directory and its location depends on which user is logged in. At XSA start up, all of the limit mask files in the current user's "My Documents\MSR\data\masks" directory are overwritten.

File type: Binary

Filename: The filename follows the rule below with the words connected using underscores.

<Measurement>_<Condition>.mask

Where

<Measurement> Measurement the limit mask file is applied to: SEM, ACP or SPUR

<Condition> Condition. It depends on the measurement.

File extension: .mask

File Dialog Filter: Preset Mask Files (*.mask)

Selecting OPEN... under the Import Data menu opens the above directory enabling you to select a mask file.

Details of the masks are provided in a PDF file in the default folder of masks.

Key Path	Recall, Data
Mode	MSR
Remote Command	MMEMory:LOAD:MASK <string>
Example	MMEM:LOAD:MASK "ACP_BS\ACP_BS_3MHz_pairE-UTRA_CatA.mask"

Notes	Parameters related to Limit and Offset are overwritten by the contents of the preset mask file.
Initial S/W Revision	A.10.00

Open...

When you press “Open”, the analyzer brings up a Windows dialog and a menu entitled “**File Open.**” This menu allows you to navigate to the various fields in the Windows dialog without using a keyboard or mouse. The **Tab** and **Arrow** keys can also be used for dialog navigation.

See "[From File...](#)" on page 2454 in **Recall, State**, for a full description of this dialog and menu.

Key Path	Recall, Data
Notes	The key location is mode-dependent and will vary. Brings up Open dialog for recalling a <mode specific> Save Type
Initial S/W Revision	Prior to A.02.00

Restart

The Restart function restarts the current sweep, or measurement, or set of averaged/held sweeps or measurements. If you are Paused, pressing Restart does a Resume.

The Restart function is accessed in several ways:

- Pressing the Restart key
- Sending the remote command INIT:IMMEDIATE
- Sending the remote command INIT:RESTART

See "[More Information](#)" on page 606

Key Path	Front-panel key
Remote Command	:INITiate[:IMMEDIATE] :INITiate:RESTART
Example	:INIT:IMM :INIT:REST
Notes	:INITiate:RESTART and :INITiate:IMMEDIATE perform exactly the same function.
Couplings	Resets average/hold count k. For the first sweep overwrites all active (update=on) traces with new current data. For application modes, it resets other parameters as required by the measurement.
Status Bits/OPC dependencies	This is an Overlapped command. The STATus:OPERation register bits 0 through 8 are cleared. The STATus:QUESTionable register bit 9 (INTEgrity sum) is cleared. The SWEEPING bit is set. The MEASURING bit is set.
Backwards Compatibility Notes	For Spectrum Analysis mode in ESA and PSA, the Restart hardkey and the INITiate:RESTART command restart trace averages (displayed average count reset to 1) for a trace in Clear Write , but did not restart Max Hold and Min Hold . In the X-Series, the Restart hardkey and the INITiate:RESTART command restart not only Trace Average , but MaxHold and MinHold traces as well. For wireless comms modes in ESA and PSA, the Restart hardkey and the INITiate:RESTART command restart every measurement, which includes all traces and numeric results. There is no change to this operation.
Initial S/W Revision	Prior to A.02.00

More Information

The **Restart** function first aborts the current sweep/measurement as quickly as possible. It then resets the sweep and trigger systems, sets up the measurement and initiates a new data measurement sequence with a new data acquisition (sweep) taken once the trigger condition is met.

If the analyzer is in the process of aligning when **Restart** is executed, the alignment finishes before the restart function is performed.

Even when set for Single operation, multiple sweeps may be taken when Restart is pressed (for example, when averaging/holding is on). Thus when we say that **Restart** "restarts a measurement," we may mean:

- It restarts the current sweep
- It restarts the current measurement
- It restarts the current set of sweeps if any trace is in Trace Average, Max Hold or Min Hold
- It restarts the current set of measurements if Averaging, or Max Hold, or Min Hold is on for the measurement
- depending on the current settings.

With **Average/Hold Number** (in **Meas Setup** menu) set to 1, or Averaging off, or no trace in Trace Average or Hold, a single sweep is equivalent to a single measurement. A single sweep is taken after the trigger condition is met; and the analyzer stops sweeping once that sweep has completed. However, with **Average/Hold Number** >1 and at least one trace set to **Trace Average**, **Max Hold**, or **Min Hold (SA Measurement)** or **Averaging on (most other measurements)**, multiple sweeps/data acquisitions are taken for a single measurement. The trigger condition must be met prior to each sweep. The sweep is stopped when the average count k equals the number N set for **Average/Hold Number**. A measurement average usually applies to all traces, marker results, and numeric results; but sometimes it only applies to the numeric results.

Once the full set of sweeps has been taken, the analyzer will go to idle state. To take one more sweep without resetting the average count, increment the average count by 1, by pressing the step up key while **Average/Hold Number** is the active function, or sending the remote command `CALC:AVER:TCON UP`.

Save

In the MSR mode, two types of save functions are available under the Data menu: Parameter Sets and Meas Results.

Key Path	Front Panel
Mode	MSR
Initial S/W Revision	Prior to A.10.00
Modified at S/W Revision	A.10.00

State

The Save State menu lets you choose a register or file for saving the state.

The content of a state file includes all of the settings and data required to return the analyzer as closely as possible to the Mode it was in, with the exact settings which were in place, when the save occurred. The Mode settings in each state file include the settings that are affected by Mode Preset, as well as the additional settings affected by Restore Mode Defaults; all of the Mode's settings. In addition, all of the settings of the **Input/Output** system are included, even though they are outside of the Mode's state, because they are needed to restore the complete setup. Persistent **System** settings (for example, Verbose SCPI) are not affected by either Mode Preset or Restore Mode Defaults, nor are they included in a saved State file.

After the save completes, the message "File <filename> saved" or "State Register <register number> saved" is displayed.

For rapid saving, the State menu lists 16 registers to save to. Pressing a Register key initiates the save. You can also select a file to save to.

The default path for all State Files is:

My Documents\<<mode name>\state

where <mode name> is the parameter used to select the mode with the INST:SEL command (for example, SA for the Spectrum Analyzer).

Key Path	Save
Mode	All
Remote Command	:MMEMory:STORe:STATe <filename>
Example	MMEM:STOR:STATe "MyStateFile.state" This stores the current instrument state data in the file MyStateFile.state in the default directory.
Notes	Both single and double quotes are supported for any filename parameter over remote. After saving to a register, that register's menu key is updated with the date the time, unless a custom label has been entered for that key. After saving to a register, you remain in the Save State menu, so that you can see the Register key update. After saving to a file, the analyzer automatically returns to the previous menu and any Save As dialog goes away.

Backwards Compatibility SCPI	:MMEMory:STORe:STATe 1,<filename> For backwards compatibility, the above syntax is supported. The "1" is simply ignored. The command is sequential.
Initial S/W Revision	Prior to A.02.00

To File . . .

When you press “To File”, the analyzer brings up a Windows dialog and a menu entitled “**Save As.**” This menu allows you to navigate to the various fields in the Windows dialog without using a keyboard or mouse. The **Tab** and **Arrow** keys can also be used for dialog navigation.

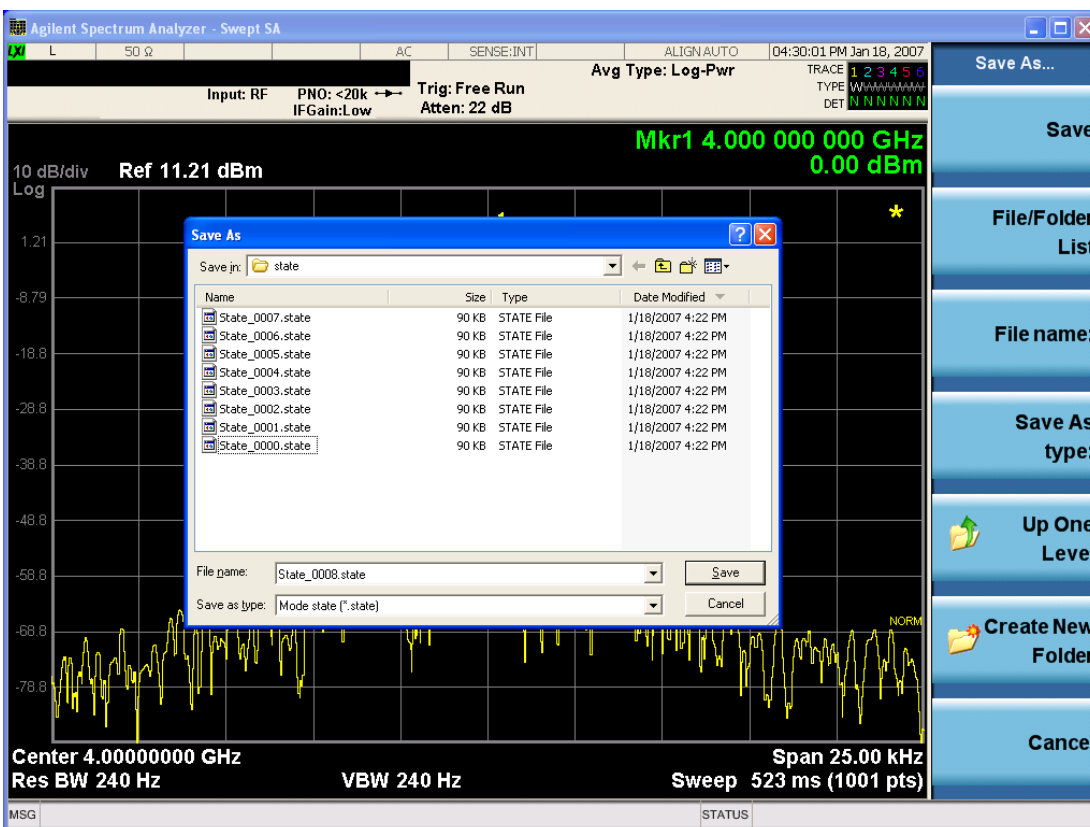

The Listed below

are the functions of the various fields in the dialog, and the corresponding softkeys:

Save

Performs the save to the specified file of the selected type. If the file already exists, a dialog will appear that allows you to replace the existing file by selecting **OK**, or you can **Cancel** the request. If you select **OK**, the file will be overwritten. Using the C: drive is strongly discouraged, since it runs the risk of being overwritten during an instrument software upgrade.

While the save is being performed, the floppy icon appears briefly in the Meas bar.

File/Folder List

Enables you to navigate to the center of the dialog that contains the list of files and folders. Once here you can get information about the file and use the tab keys to navigate to the other fields in the dialog, such as Save In.

Save In

The Save In field shows the path to which the file will be saved and allows you to change the path using the up and down arrow keys to navigate to other paths; the Enter key to open a directory; and the Backspace key to go back one directory. The **Save In field** defaults to the default path for this type of file and remembers the last path you used to save this type of file. There is no softkey for directly navigating to the Save In field but you can use left tab to get here from the File/Folder List.

User specified paths are remembered when you leave and return to a Mode and are reset back to the default using **Restore Mode Defaults**.

File Name

The **File Name** field is initially loaded with an automatically generated filename specific to the appropriate Save Type. The automatically generated filename is guaranteed not to conflict with any filename currently in the directory. You may replace or modify this filename using the File Name key. See the "[Quick Save](#)" on [page 2428](#) documentation for more on the automatic file naming algorithm.

When you press the **File Name** key the analyzer displays the Alpha Editor. Use the knob to choose the letter to add and the front-panel Enter key to add the letter to the file name. The BK character moves you back and the FW character moves you forward in the filename. The Select key on the front panel generates a space character. When you are done entering the filename press the **Done** softkey. This returns back to the **File Open** dialog and menu, but does not cause the save to occur.

Save As Type

This field shows the file suffix for the type of file you have selected to save. For example, if you navigated here while saving State, "Mode state (*.state)" is in the field. If you navigated here from saving Trace, ""Mode state (*.trace)" is in the field. If you navigated here while exporting a trace data file, "Trace Data (*.csv)" is in the field. For some file types, there is more than one choice in the dropdown, which you can select by using the up and down arrow keys and Enter.

Up One Level

This key corresponds to the icon of a folder with the up arrow that is in the tool bar of the dialog. When pressed, it causes the file and folder list to navigate up one level in the directory structure. The Backspace key does the same thing.

Create New Folder

This key corresponds to the icon of a folder with the "*" that is in the tool bar of the dialog. When pressed, a new folder is created in the current directory with the name **New Folder** and you can enter a new folder name using the Alpha Editor.

Cancel

This key corresponds to the **Cancel** selection in the dialog. It causes the current **Save As** request to be cancelled. The ESC key does the same thing.

Key Path	Save, State
----------	--------------------

Mode	All
Notes	Brings up Save As dialog for saving a State Save Type
Initial S/W Revision	Prior to A.02.00

Edit Register Names

You may enter a custom name on any of the Register keys, to help you remember what you are using that state to save. To do this, press the **Edit Register Names** key, choose the register whose name you wish to edit, and then enter the desired label using the Alpha Editor or an external PC keyboard.

The maximum number of characters that can be added is 30. In most cases, 30 characters will fit on two lines of the key.

See ["More Information" on page 611](#)

Key Path	Save, State
Mode	All
Remote Command	:MMEMory:REGister:STATe:LABel <reg number>,"label" :MMEMory:REGister:STATe:LABel? <reg number>
Example	:MMEM:REG:STAT:LAB 1,"my label"
Notes	<reg number> is an integer from 1 to 16. If the SCPI specifies an invalid register number an error message is generated, -222,"Data out of range;Invalid register label number" "label" is a string from 0 to 30 characters in length. If a label exceeds 30 characters, an error message is generated, -150,"String data error;Label clipped to 30 characters" "label" of length 0 erases the custom label and restores the default (time and date) label. E.g.: :MMEM:REG:STAT:LAB 1,""
Dependencies	N9060A-7FP or N9060B-2FP license required to edit the register names. When the feature is not licensed, sending this command generates an error, -221,"Settings conflict;Option not available"
Preset	The names are unaffected by Preset or power cycle but are set to the default label (time and date) on a "Restore System Defaults->Misc"
Initial S/W Revision	A.11.00

More Information

When you edit one of the register names, the time and date field will be replaced by the custom name.

If you delete all the characters in the custom name, it restores the default (time and date).

The register names are stored within the state files, but they are not part of the instrument state; that is, once you have edited a register name, loading a new state will not change that register name. Another consequence of this is that the names will be persistent through a power cycle. Also, if a named state file is transferred to another analyzer, it will bring its custom name along with it.

If you try to edit the name of an empty register, the analyzer will first save the state to have a file to put the name in. If you load a named state file into an analyzer with older firmware it will ignore the metadata.

The *SAV and *RCL commands will not be affected by the custom register names, nor will the MMEM commands.

Register 1 thru Register 16

Selecting any one of these register menu keys causes the State of the currently active mode to be saved to the specified Register. The registers are provided for rapid saving and recalling, since you do not need to specify a filename or navigate to a file. Each of the register menu keys annotates whether it is empty or at what date and time it was last modified. In addition, you can use the **Edit Register Names** key to enter custom names for each register.

Although these 16 registers are the only registers available from the front panel, there are 128 state registers available in the instrument. Registers 17–128 are only available from the SCPI interface, using the *SAV command.

There is one set of 128 state registers in the instrument, not one set for each Mode. When a state is saved, the Mode it was saved from is saved with it; then when it is recalled, the instrument switches to that Mode.

After the save completes, the corresponding register menu key annotation is updated with the date and time and the message "Register <register number> saved" is displayed.

Key Path	Save, State
Mode	All
Example	*SAV 1
Range	1–16 from front panel, 1–128 from SCPI
Readback	Date and time with seconds resolution are displayed on the key OR A custom name of up to 30 characters entered using the Edit Register Names key OR “(empty)” if no prior save operation has been performed to this register.
Initial S/W Revision	Prior to A.02.00
Modified at S/W Revision	A.11.00

Register 1 thru Register 16

Selecting any one of these register menu keys causes the State of the currently active mode to be saved to the specified Register. The registers are provided for rapid saving and recalling, since you do not need to specify a filename or navigate to a file. Each of the register menu keys annotates whether it is empty or at what date and time it was last modified. In addition, you can use the **Edit Register Names** key to enter custom names for each register.

Although these 16 registers are the only registers available from the front panel, there are 128 state registers available in the instrument. Registers 17–128 are only available from the SCPI interface, using the *SAV command.

There is one set of 128 state registers in the instrument, not one set for each Mode. When a state is saved, the Mode it was saved from is saved with it; then when it is recalled, the instrument switches to that Mode.

After the save completes, the corresponding register menu key annotation is updated with the date and time and the message "Register <register number> saved" is displayed.

Key Path	Save, State
Mode	All
Example	*SAV 1
Range	1-16 from front panel, 1-128 from SCPI
Readback	Date and time with seconds resolution are displayed on the key OR A custom name of up to 30 characters entered using the Edit Register Names key OR “(empty)” if no prior save operation has been performed to this register.
Initial S/W Revision	Prior to A.02.00
Modified at S/W Revision	A.11.00

Mass Storage Catalog (Remote Command Only)

Key path	SCPI Only
Remote Command	:MMEMory:CATalog? [<directory_name>]
Notes	The string must be a valid logical path. Queries disk usage information (drive capacity, free space available) and obtains a list of files and directories in a specified directory in the following format: <numeric_value>,<numeric_value>,{<file_entry>} It returns two numeric parameters and as many strings as there are files and directories. The first parameter indicates the total amount of storage currently used in bytes. The second parameter indicates the total amount of storage available, also in bytes. The <file_entry> is a string. Each <file_entry> indicates the name, type, and size of one file in the directory list: <file_name>,<file_type>,<file_size> As the windows file system has an extension that indicates file type, <file_type> is always empty. <file_size> provides the size of the file in bytes. For directories, <file_entry> is surrounded by square brackets and both <file_type> and <file_size> are empty
Initial S/W Revision	Prior to A.02.00

Mass Storage Change Directory (Remote Command Only)

Key path	SCPI Only
Remote Command	:MMEMory:CDIRectory [<directory_name>] :MMEMory:CDIRectory?
Notes	The string must be a valid logical path. Changes the default directory for a mass memory file system. The <directory_name> parameter is a string. If no parameter is specified, the directory is set to the *RST value.

	At *RST, this value is set to the default user data storage area, that is defined as System.Environment.SpecialFolder.Personal. Query returns full path of the default directory.
Initial S/W Revision	Prior to A.02.00

Mass Storage Copy (Remote Command Only)

Key path	SCPI Only
Remote Command	:MMEMory:COpy <string>,<string>[,<string>,<string>]
Notes	<p>The string must be a valid logical path.</p> <p>Copies an existing file to a new file or an existing directory to a new directory.</p> <p>Two forms of parameters are allowed. The first form has two parameters. In this form, the first parameter specifies the source, and the second parameter specifies the destination.</p> <p>The second form has four parameters. In this form, the first and third parameters specify the source. The second and fourth parameters specify the directories. The first pair of parameters specifies the source. The second pair specifies the destination. An error is generated if the source doesn't exist or the destination file already exists.</p> <p>This command will generate an "access denied" error if the destination is a restricted folder (e.g., C:\Windows) and the current user does not have Power User or Administrator privileges.</p>

Mass Storage Device Copy (Remote Command Only)

This command transfers data to/from a file and a peripheral device.

Key path	SCPI Only
Remote Command	:MMEMory:COpy:DEvice <source_string>,<dest_string>
Notes	<p>The strings must be a valid logical path or a valid device keyword. If the dest_string is a device keyword, the data is copied from the source file to the device. If the source_string is a device keyword, the data is copied to the source file from the device.</p> <p>Valid device keywords are:</p> <p>SNS (smart noise source)</p> <p>An error is generated if the file or device is not found.</p>

Mass Storage Delete (Remote Command Only)

Key path	SCPI Only
Remote Command	:MMEMory:DElete <file_name>[,<directory_name>]
Notes	<p>The string must be a valid logical path.</p> <p>Removes a file from the specified directory. The <file_name> parameter specifies the file name to be removed. This command will generate an "access denied" error if the file is in a restricted folder (e.g.,</p>

C:\Windows) and the current user does not have Power User or Administrator privileges.

Initial S/W Revision Prior to A.02.00

Mass Storage Data (Remote Command Only)

Creates a file containing the specified data OR queries the data from an existing file.

Key path	SCPI Only
Remote Command	:MMEMory:DATA <file_name>, <data> :MMEMory:DATA? <file_name>
Notes	The string must be a valid logical path. The command form is MMEMory:DATA <file_name>,<data>. It loads <data> into the file <file_name>. <data> is in 488.2 block format. <file_name> is string data. The query form is MMEMory:DATA? <file_name> with the response being the associated <data> in block format.
Initial S/W Revision	Prior to A.02.00

Mass Storage Make Directory (Remote Command Only)

Key path	SCPI Only
Remote Command	:MMEMory:MDIRectory <directory_name>
Notes	The string must be a valid logical path. Creates a new directory. The <directory_name> parameter specifies the name to be created. This command will generate an “access denied” error if the new directory would be in a restricted folder (e.g., C:\Windows) and the current user does not have Power User or Administrator privileges.
Initial S/W Revision	Prior to A.02.00

Mass Storage Move (Remote Command Only)

Key path	SCPI Only
Remote Command	:MMEMory:MOVE <string>,<string> [,<string>,<string>]
Notes	The string must be a valid logical path. Moves an existing file to a new file or an existing directory to a new directory. Two forms of parameters are allowed. The first form has two parameters. In this form, the first parameter specifies the source, and the second parameter specifies the destination. The second form has four parameters. In this form, the first and third parameters specify the source. The second and fourth parameters specify the directories. The first pair of parameters specifies the source. The second pair specifies the destination. An error is generated if the source doesn't exist or the destination file already exists.

	This command will generate an “access denied” error if the destination is a restricted folder (e.g., C:\Windows) and the current user does not have Power User or Administrator privileges.
Initial S/W Revision	Prior to A.02.00

Mass Storage Remove Directory (Remote Command Only)

Key path	SCPI Only
Remote Command	:MMEMory:RDIRectory <directory_name>
Notes	The string must be a valid logical path. Removes a directory. The <directory_name> parameter specifies the directory name to be removed. All files and directories under the specified directory shall also be removed. This command will generate an “access denied” error if the folder is a restricted folder (e.g., C:\Windows) or is in a restricted folder and the current user does not have Power User or Administrator privileges.
Initial S/W Revision	Prior to A.02.00

Mass Storage Determine Removable Media (Remote Command Only)

This command is used to determine if any removable media devices are connected to the instrument. Primarily, these are USB memory devices plugged-in to the front panel or rear panel USB ports. On instruments with PC6 or PC7 CPU’s, one SD card slot is available for removable media. The instrument’s primary disk drive is not a removable media device.

Key Path	SCPI Only
Remote Command	:MMEMory:RMEDIA:LIST?
Notes	The return value will be a string containing a list of partition identifiers which are removable media devices. Each identifier will be separated by a comma. If no removable media is present, an empty string will be returned. Examples: One removable device present will result in a return string of “F:”. Two removable devices present will result in a return string of “F:,G:”. No removable devices present will result in a return string of “”.
Initial S/W Revision	x.15.00

Mass Storage Determine Removable Media Label (Remote Command Only)

This command is used to set or query a removable media device’s label.

Key Path	SCPI Only
----------	------------------

Remote Command	:MMEMory:RMEDia:LABel <partition>,<string> :MMEMory:RMEDia:LABel? <partition>
Example	MMEM:RMED:LAB "F:","My Device"
Notes	If the <partition> specified does not exist or is not a removable media device the error -252,"Missing Media" will be generated. Setting the removable media label requires Administrative privileges. If the currently logged in user does not have appropriate privileges the error "-221.9900,Settings conflict;Administrator privileges required" is generated.
Initial S/W Revision	x.15.00

Mass Storage Determine Removable Media Write-protect status (Remote Command Only)

This command is used to query a removable media device's write-protect status.

Key Path	SCPI Only
Remote Command	:MMEMory:RMEDia:WPRotect? <partition>
Example	MMEM:RMED:WPR? "F:"
Notes	The return value is 1 if the device is write-protected, and 0 if the device is write-enabled. If the <partition> specified does not exist or is not a removable media device the error -252,"Missing Media" will be generated.
Preset	The return value will be depending on SD card installed.
Initial S/W Revision	x.15.00

Mass Storage Determine Removable Media size (Remote Command Only)

This command is used to query a removable media device's total memory size (not available memory size).

Key Path	SCPI Only
Remote Command	:MMEMory:RMEDia:SIZE? <partition>
Example	MMEM:RMED:SIZE? "F:"
Notes	The return value is integer value in GBytes. Any device which is less than 1 GB will return 0 GB. If the <partition> specified does not exist or is not a removable media device the error -252,"Missing Media" will be generated.
Initial S/W Revision	x.15.00

Trace (+State)

The **Save Trace (+State)** menu lets you choose a register or file specifying where to save the Trace+State state file.

A saved state contains all of the settings and data required to return the analyzer as closely as possible to the exact setup it had when the save occurred. This includes the Input/Output settings, even though they are outside of the Mode's state, because they are needed to restore the complete setup. A Trace+State file also includes trace data from one trace or all traces, which will load in View mode when the Trace+State file is recalled.

After the save completes, the message "File <filename> saved" or "Trace Register <register number> saved" is displayed.

For rapid saves, the Trace (+State) menu lists 5 registers to save to. Pressing a Register key initiates the save. You can also select a file to save to.

The default path for all State Files including .trace files is:

My Documents\<mode name>\state

where <mode name> is the parameter used to select the mode with the INST:SEL command (for example, Basic for the IQAnalyzer).

This key is grayed out for measurements that do not support trace saves. It is blanked for modes that do not support trace saves. Saving **Trace** is identical to saving State except a .trace extension is used on the file instead of .state, and internal flags are set in the file indicating which trace was saved. You may select to save one trace or ALL traces.

Key Path	Save
Mode	SA
Remote Command	:MMEMory:STORe:TRACe TRACE1 TRACE2 TRACE3 TRACE4 TRACE5 TRACE6 ALL,<filename> :MMEMory:STORe:TRACe:REGister TRACE1 TRACE2 TRACE3 TRACE4 TRACE5 TRACE6 ALL,<integer>
Example	:MMEM:STOR:TRAC TRACE1, "myState.trace" saves the file myState.trace on the default path and flags it as a "single trace" file with Trace 1 as the single trace (even though all of the traces are in fact stored). :MMEM:STOR:TRAC ALL, "myState.trace" saves the file myState.trace on the default path and flags it as an "all traces" file :MMEM:STOR:TRAC:REG TRACE1, 2 stores trace 1 data in trace register 2
Notes	This command actually performs a save state, which in the Swept SA measurement includes the trace data. However it flags it (in the file) as a "save trace" file of the specified trace (or all traces). Some modes and measurements do not have available all 6 traces. The Phase Noise mode command, for example, is: MMEMory:STORe:TRACe TRACE1 TRACE2 TRACE3 ALL,<filename> Some modes and measurements have more than 6 traces available. The Realtime SA mode command, for example, is: MMEMory:STORe:TRACe TRACE1 TRACE2 TRACE3 TRACE4 TRACE5 TRACE6 TRACE7 TRACE8 TRACE9 TRACE10 TRACE11 TRACE12 ALL,<filename> The range for the register parameter is 1-5 When you initiate a save, if the file already exists, a dialog will appear that allows you to replace the existing file by selecting OK or you can Cancel the request. If you select OK, the file will be overwritten. Using the C: drive is strongly discouraged, since it runs the risk of being overwritten during an instrument software upgrade. Both single and double quotes are supported for any filename parameter over remote.

After saving to a register, that register's menu key is updated with the date and time of the save.
After saving to a register, you remain in the **Save Trace** menu, so that you can see the Register key update. After saving to a file, the analyzer automatically returns to the previous menu and any Save As dialog goes away.

Initial S/W Revision	Prior to A.02.00
----------------------	------------------

From Trace

Accesses a menu that enables you to select the trace to be saved. Once a trace is selected, the key returns to the Save Trace menu and the selected trace number is annotated on the key. The default is the currently selected trace, selected in this menu or in the Trace/Det, Export Data, Import Data or Recall Trace menus, except if you have chosen All then it remains chosen until you specifically change it to a single trace. To save the Trace you must select the **Save As** key in the Save Trace menu.

When you select a trace, it makes that trace the current trace, so it displays on top of all of the other traces.

Key Path	Save, Trace + State
Mode	SA
Initial S/W Revision	Prior to A.02.00

From File...

When you press "From File", the analyzer brings up a Windows dialog and a menu entitled "**File Open.**" This menu allows you to navigate to the various fields in the Windows dialog without using a keyboard or mouse. The **Tab** and **Arrow** keys can also be used for dialog navigation.

8 Channel Power Measurement

Save

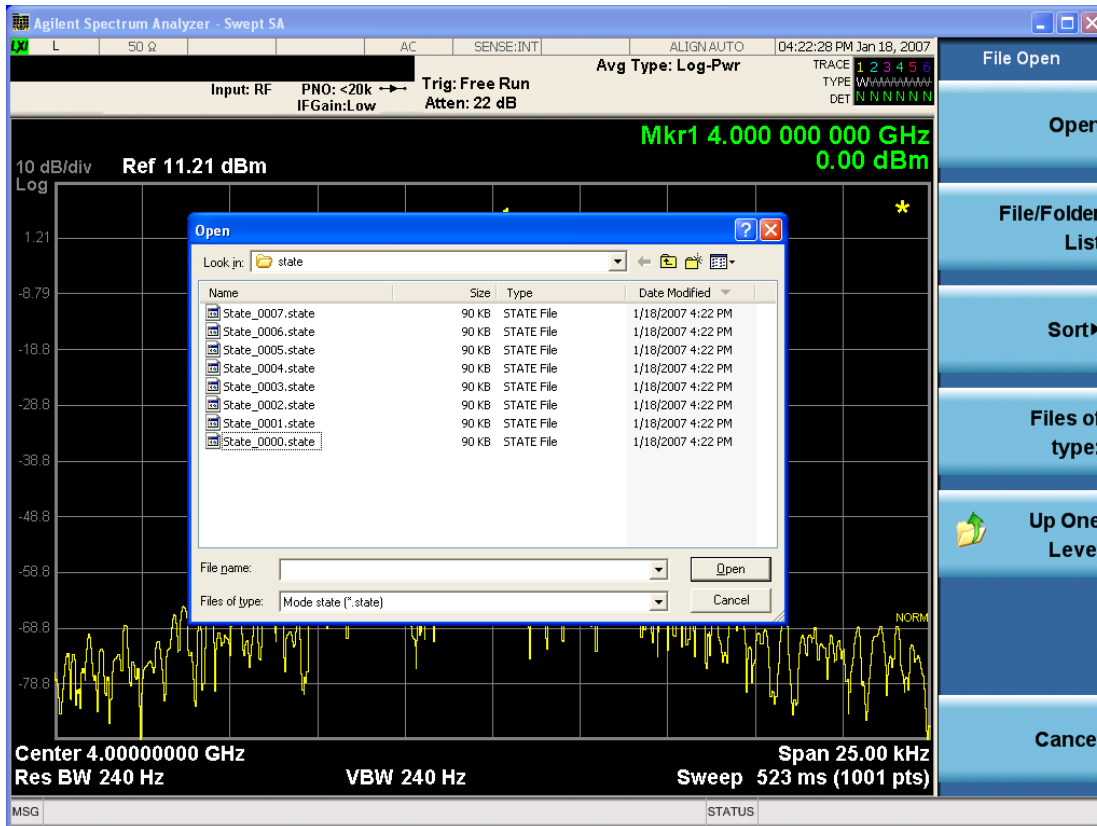

Listed below are the functions of the various fields in the dialog, and the corresponding softkeys:

Open

Performs the recall of the specified file. While the recall is being performed, the floppy icon appears briefly in the Meas bar.

File/Folder List

Enables you to navigate to the center of the dialog that contains the list of files and folders. Once here you can get information about the file and use the tab keys to navigate to the other fields in the dialog, such as Look In.

Look In

The **Look In** field shows the path from which the file will be recalled and allows you to change the path using the up and down arrow keys to navigate to other paths; the Enter key to open a directory; and the Backspace key to go back one directory. The **Look In field** first uses the last path from the Save As dialog **Save In:** path for that same file type. There is no softkey for directly navigating to the Look In field, but you can use the left tab to get here from the File/Folder List.

User specified paths are remembered when you leave and return to a Mode and are reset back to the default using **Restore Mode Defaults**.

Sort

Accesses a menu that enables you to sort the files within the File Open dialog. Only one sorting type can be selected at a time and the sorting happens immediately. The sorting types are **By Date**, **By Name**, **By extension**, and **By Size**.

Files of Type

This field shows the file suffix for the type of file you have selected to recall. For example, if you navigated here while recalling State, "Mode state (*.state)" is in the field. If you navigated here while recalling Trace, ""Mode state (*.trace)" is in the field. If you navigated here while importing a trace data file, "Trace Data (*.csv)" is in the field. For some file types, there is more than one choice in the dropdown menu, which you can select by using the up and down arrow keys and Enter.

Up One Level

This key corresponds to the icon of a folder with the up arrow that is in the tool bar of the dialog. When pressed, it causes the file and folder list to navigate up one level in the directory structure. The Backspace key does the same thing.

Cancel

This key corresponds to the **Cancel** selection in the dialog. It causes the current **Open** request to be cancelled. The ESC key does the same thing.

Key Path	Recall, State
Notes	Brings up the Open dialog for recalling a State Save Type
Initial S/W Revision	Prior to A.02.00

Register 1 thru Register 16

Selecting any one of these register menu keys causes the State of the currently active mode to be saved to the specified Register. The registers are provided for rapid saving and recalling, since you do not need to specify a filename or navigate to a file. Each of the register menu keys annotates whether it is empty or at what date and time it was last modified. In addition, you can use the **Edit Register Names** key to enter custom names for each register.

Although these 16 registers are the only registers available from the front panel, there are 128 state registers available in the instrument. Registers 17–128 are only available from the SCPI interface, using the *SAV command.

There is one set of 128 state registers in the instrument, not one set for each Mode. When a state is saved, the Mode it was saved from is saved with it; then when it is recalled, the instrument switches to that Mode.

After the save completes, the corresponding register menu key annotation is updated with the date and time and the message "Register <register number> saved" is displayed.

Key Path	Save, State
Mode	All
Example	*SAV 1
Range	1–16 from front panel, 1–128 from SCPI

Readback	Date and time with seconds resolution are displayed on the key OR A custom name of up to 30 characters entered using the Edit Register Names key OR “(empty)” if no prior save operation has been performed to this register.
Initial S/W Revision	Prior to A.02.00
Modified at S/W Revision	A.11.00

Data (Export)

Exporting a data file stores data from the current measurement to mass storage files. The Export Menu only contains data types that are supported by the current measurement.

Since the commonly exported data files are in .csv format, the data can be edited by you prior to importing. This allows you to export a data file, manipulate the data in Excel (the most common PC Application for manipulating .csv files) and then import it.

Selecting an Export Data menu key will not actually cause the exporting to occur, since the analyzer still needs to know where you wish to save the data. Pressing the Save As key in this menu brings up the Save As dialog and Save As menu that allows you to specify the destination file and directory. Once a filename has been selected or entered in the Open menu, the export will occur as soon as the Save key is pressed.

Key Path	Save
Mode	All
Notes	The menu is built from whatever data types are available for the mode. So the key locations in the sub menu will vary. No SCPI command directly controls the Data Type that this key controls. The Data Type is included in the MMEM:STORe commands.
Dependencies	If a file type is not used by a certain measurement, that type is grayed out for that measurement. The key for a file type will not show at all if there are no measurements in the Mode that support it.
Preset	Is not affected by a Preset or shutdown, but is reset during Restore Mode Defaults
Readback	The data type that is currently selected
Initial S/W Revision	Prior to A.02.00

Parameter Set

Enables you to export format parameter set data to files. Selecting this key displays a menu that enables you to select the data source. After making this selection, depress Save As... and use the file dialog to enter the file name to save. You can import the exported file by selecting Parameter Set under Recall, Data.

Default path:

Default path of this import type is “My Documents\MSR\data\params” folder. Note that “My Documents” is an alias to a directory and its location depends on which user is logged in. If the file path is specified without root folder, the export file is determined with the default path. For example if “folder1\paramData.prms” is specified, “My Documents\MSR\data\params\folder1\paramData.fps” is exported.

File Extension: fps

Default Prefix: ParamSet_

File Dialog Filter: Format Parameter Set Files (*.fps)

Key Path	Save, Data
Mode	MSR
Remote Command	MMEmory:STOR:pSET LTEFdd1 LTEFdd2 LTEFdd3 WCDma1 WCDma2 WCDma3 GSM1 GSM2 GSM3 CDMA1 CDMA2 CDMA3 EVDO1 EVDO2 EVDO3 LTETdd1 LTETdd2 LTETdd3 TDSCdma1 TDSCdma2 TDSCdma3, <string>
Example	MMEM:STOR:PSET WCDM1, "WCDMA.fps"
Notes	The first enum selects the source format parameter set from which the file data are exported.
Initial S/W Revision	A.10.00
Modified at S/W Revision	A.12.00, A.16.00

Measurement Results

Pressing this key selects Meas Results as the data type to be exported.

The Meas Results file contains information which describes the current state of the analyzer. It is detailed in Meas Result File Contents below.

Key Path	Save, Data
Remote Command	:MMEmory:STOR:RESults <string>
Example	:MMEM:STOR:RES "MeasR_0000.csv"
Notes	<p>If the save is initiated via SCPI and the file already exists, the file will be overwritten.</p> <p>The SCPI command exports Channel Power measurement results to the file specified as the parameter in the current path. The default path is My Documents\<current mode>\data\CHP\results.</p> <p>Using the C: drive is strongly discouraged, since it runs the risk of being overwritten during an instrument software upgrade.</p> <p>The SCPI parameter is a quoted string, which specifies the filename. Both single and double quotes are supported for any filename parameter over SCPI.</p>
Dependencies	The current active measurement must be the Channel Power measurement to use this command.
Status Bits/OPC dependencies	Sequential – waits for the previous measurement to complete.
Initial S/W Revision	Prior to A.02.00

Meas Results File Contents

A Meas Results File contains measurement results with the following information.

- File ID string, which is “MeasResult”
- Measurement ID following Mode ID, which is “SA:CHP” for example.
- Firmware rev and model number
- Option string
- Auto Sweep Time Rules
- Average Mode
- Average Number
- Average State
- Center Frequency
- Detector
- Electrical Atten
- Electrical Atten State
- IFGain
- IFGainAuto
- Impedance
- Integ BW
- Internal Preamp
- Internal Preamp Band
- Mechanical Atten
- MechanicalAttenStepEnum
- PSD Unit
- Resolution Band Width
- Resolution Bandwidth Shape
- RRC Filter Alpha
- RRC Filter BW
- RRC Filter State
- Span
- Sweep Points
- Sweep Time

- Sweep Time Auto
- TriggerSource
- Video Bandwidth
- Y Axis Unit

The file contains these data followed by MeasResult1 and MeasResult2 that flag the start of the measurement results. Each line of Measurement Results consists of two comma separated values, MeasResult1 value and MeasResult2 value. MeasResult1 contains the same results as MEAS/READ/FETCH:CHPower1; MeasResult2, MEAS/READ/FETCH:CHPower2.

Exported file is .csv file. The Meas Results file, when imported into Excel, will show the following data:

MeasResult	
SA:CHP	
A.10.53	N9030A
526 ALV ATP B1X B1Y B25 B40 BBA CR3 CRP DCF DDA DP2 DRD EA3 EDP EMC EP1 ERC ESC ESP EXM FSA LFE LNP MAT MPB NFE NUL P26 PFR PNC RTL RTS S40 SB1 SEC SM1 TVT YAS YAV	1
Auto Sweep Time Rules	Normal
Average Mode	Exponential
Average Number	10
Average State	TRUE
Center Frequency	13255000000
Detector	Average
IFGain	FALSE
IFGainAuto	FALSE
Impedance	50
Integ BW	2000000
Internal Preamp	FALSE
Internal Preamp Band	Low
PSD Unit	DbmHz
Resolution Band Width	27000
Resolution Bandwidth Shape	Gaussian
RRC Filter Alpha	0.22
RRC Filter BW	3840000
RRC Filter State	FALSE
Span	3000000
Sweep Points	1001
Sweep Time	0.004933333

Sweep Time Auto	TRUE
TriggerSource	Free
Video Bandwidth	270000
Y Axis Unit	DecibelMilliwatt
MeasResult1	MeasResult2
-76.8141133132837	-95.29174
-139.824413269924	-94.99601
	-94.95281
	-95.17146

Save As . . .

When you press “Save As”, the analyzer brings up a Windows dialog and a menu entitled “**Save As.**” This menu allows you to navigate to the various fields in the Windows dialog without using a keyboard or mouse. The **Tab** and **Arrow** keys can also be used for dialog navigation.

See "[To File . . .](#)" on page 2444 in **Save, State** for a full description of this dialog and menu.

The default path for saving files is:

For all of the Trace Data Files:

My Documents\<<mode name>\data\traces

For all of the Limit Data Files:

My Documents\<<mode name>\data\limits

For all of the Measurement Results Data Files:

My Documents\<<mode name>\data\<<measurement name>\results

For all of the Capture Buffer Data Files:

My Documents\<<mode name>\data\captureBuffer

Key Path	Save, Data
Mode	All
Notes	The key location is mode-dependent and will vary. Brings up the Save As dialog for saving a <mode specific> Save Type. The save is performed immediately and does not wait until the measurement is complete.
Initial S/W Revision	Prior to A.02.00

Screen Image

Pressing Screen Image accesses a menu of functions that enable you to specify a format and location for the saved screen image. It brings up a menu that allows you to specify the color scheme of the Screen Image (Themes) or navigate to the Save As dialog to perform the actual save.

Screen Image files contain an exact representation of the analyzer display. They cannot be loaded back onto the analyzer, but they can be loaded into your PC for use in many popular applications.

The image to be saved is actually captured when the **Save** front panel key is pressed, and kept in temporary storage to be used if you ask for a Screen Image save. When the Screen Image key is pressed, a "thumbnail" of the captured image is displayed, as shown below:

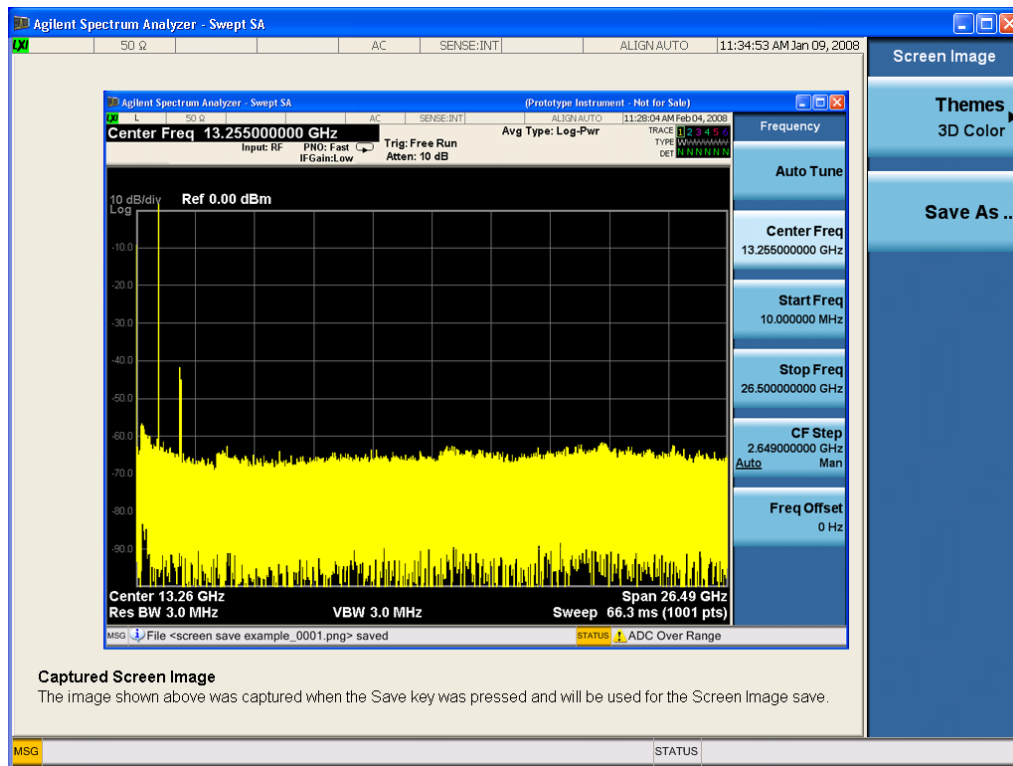

When you continue on into the **Save As** menu and complete the Screen Image save, the image depicted in the thumbnail is the one that gets saved, showing the menus that were on the screen before going into the **Save** menus. The save is performed immediately and does not wait until the measurement is complete.

After you have completed the save, the **Quick Save** front-panel key lets you quickly repeat the last save performed, using an auto-named file, with the current screen data.

NOTE

For versions previous to A.01.55, if you initiate a screen image save by navigating through the Save menus, the image that is saved will contain the Save menu softkeys, not the menus and the active function that were on the screen when you first pressed the Save front panel key.

Key Path	Save
Mode	All

Remote Command	:MMEMory:STORe:SCReen <filename>
Example	:MMEM:STOR:SCR "myScreen.png" This stores the current screen image in the file MyScreenFile.png in the default directory.
Initial S/W Revision	Prior to A.02.00

Themes

Accesses a menu of functions that enable you to choose the theme to be used when saving the screen image.

The **Themes** option is the same as the **Themes** option under the **Display** and **Page Setup** dialogs. It allows you to choose between themes to be used when saving the screen image.

Key Path	Save, Screen Image
Remote Command	:MMEMory:STORe:SCReen:THEMe TDColor TDMonochrome FCOLor FMONochrome :MMEMory:STORe:SCReen:THEMe?
Example	:MMEM:STOR:SCR:THEM TDM
Preset	3D Color; Is not part of Preset, but is reset by Restore Misc Defaults or Restore System Defaults All and survives subsequent running of the modes.
Readback	3D Color 3D Mono Flat Color Flat Mono
Backwards Compatibility Notes	In ESA and PSA we offer the choice of "Reverse Bitmap" or "Reverse Metafile" when saving screen images. This is much like the "Flat Color" theme available in X-Series. Also, if you selected Reverse Bitmap AND a black & white screen image, that would be much like "Flat Monochrome". In other words, each of the X-Series themes has a similar screen image type in ESA/PSA. But they are not identical.
Initial S/W Revision	Prior to A.02.00

3D Color

Selects a standard color theme with each object filled, shaded and colored as designed.

Key Path	Save, Screen Image, Themes
Example	MMEM:STOR:SCR:THEM TDC
Readback	3D Color
Initial S/W Revision	Prior to A.02.00

3D Monochrome

Selects a format that is like 3D color but shades of gray are used instead of colors.

Key Path	Save, Screen Image, Themes
Example	MMEM:STOR:SCR:THEM TDM
Readback	3D Mono
Initial S/W Revision	Prior to A.02.00

Flat Color

Selects a format that is best when the screen is to be printed on an ink printer.

Key Path	Save, Screen Image, Themes
Example	MMEM:STOR:SCR:THEM FCOL
Readback	Flat Color
Initial S/W Revision	Prior to A.02.00

Flat Monochrome

Selects a format that is like Flat Color. But only black is used (no colors, not even gray), and no fill.

Key Path	Save, Screen Image, Themes
Example	MMEM:STOR:SCR:THEM FMON
Readback	Flat Mono
Initial S/W Revision	Prior to A.02.00

Save As...

When you press "Save As", the analyzer brings up a Windows dialog and a menu entitled "**Save As.**" This menu allows you to navigate to the various fields in the Windows dialog without using a keyboard or mouse. The **Tab** and **Arrow** keys can also be used for dialog navigation.

See "[To File . . .](#)" on page 2444 in **Save, State** for a full description of this dialog and menu.

The default path for Screen Images is

My Documents\`<mode name>`\screen.

where `<mode name>` is the parameter used to select the mode with the INST:SEL command (for example, SA for the Spectrum Analyzer).

Key Path	Save, Screen Image
Notes	Brings up Save As dialog for saving a Screen Image Save Type
Initial S/W Revision	Prior to A.02.00

Single (Single Measurement/Sweep)

Sets the analyzer for Single measurement operation. The single/continuous state is Meas Global, so the setting will affect all the measurements. If you are Paused, pressing **Single** does a Resume.

See "[More Information](#)" on page 630

Key Path	Front-panel key
Example	:INIT:CONT OFF
Notes	See Cont key description.
Backwards Compatibility Notes	<p>For Spectrum Analysis mode in ESA and PSA, the Single hardkey and the INITiate:IMM switched from continuous measurement to single measurement and restarted sweeps and averages (displayed average count reset to 1), but did not restart Max Hold and Min Hold. In the X-Series, the Single hardkey and the INITiate:IMM command initiate a sweep/ measurement/ average sequence/hold sequence including MaxHold and MinHold.</p> <p>For Spectrum Analysis mode in ESA and PSA, the Single hardkey restarted the sweep regardless of whether or not you were in an active sweep or sweep sequence. In the X-Series, Restart does this but Single only restarts the sweep or sweep sequence if you are in the idle state.</p> <p>INIT[:IMM] in ESA & PSA Spectrum Analysis Mode does an implied ABORT. In some other PSA Modes, INIT[:IMM] is ignored if not in the idle state. . The X-Series follows the ESA/PSA SA Mode model, which may cause some Modes to have compatibility problems.</p>
Initial S/W Revision	Prior to A.02.00

More Information

See "[Restart](#)" on page 2441 for details on the INIT:IMMEDIATE (Restart) function.

If you are already in single sweep, the INIT:CONT OFF command has no effect.

If you are already in Single Sweep, then pressing the **Single** key in the middle of a sweep does not restart the sweep or sequence. Similarly, pressing the **Single** key does not restart the sweep or sequence if the sweep is not in the idle state (for example, if you are taking a very slow sweep, or the analyzer is waiting for a trigger). Instead, it results in a message. "Already in Single, press Restart to initiate a new sweep or sequence". Even though pressing the **Single** key in the middle of a sweep does not restart the sweep, sending INIT:IMMEDIATE does reset it.

To take one more sweep without resetting the average count, increment the average count by 1, by pressing the step up key while **Average/Hold Number** is the active function, or sending the remote command CALC:AVER:TCON UP.

Source

There is no Source control functionality for this measurement. When this key is pressed, the screen either displays a blank menu, or the previously-selected menu remains unchanged.

Key Path	Front-panel key
----------	-----------------

Span X Scale

Accesses a menu of functions that enable you set the horizontal scale parameters.

Key Path	Front-panel key
Initial S/W Revision	Prior to A.02.00

Sweep/Control

Accesses a menu of functions that enable you to set up and control the sweep time and source for the current measurement. See "[Sweep/Control](#)" on page 2468 for more information.

Key Path	Front-panel key
Initial S/W Revision	Prior to A.02.00

Sweep Time

Selects the length of time that the spectrum analyzer sweeps the displayed frequency span. Additional overhead time, which impacts the sweep rate, is not calculated as part of the sweep time. In fact:

$$\text{sweep rate} = \text{span} / \text{sweep time}$$

$$\text{update rate} = 1 / (\text{sweep time} + \text{overhead})$$

$$\text{sweep cycle time} = \text{sweep time} + \text{overhead}$$

Sweep time is coupled to RBW and VBW, and is impacted by the number of sweep points, so changing those parameters may change the sweep time.

Key Path	Sweep/Control
Mode	SA, WCDMA, C2K, WIMAX OFDMA, 1xEVDO, DVB-T/H, DTMB (CTTB), ISDB-T, CMMB, LTE, LTETDD, Digital Cable TV, WLAN, MSR, LTEAFDD, LTEATDD
Remote Command	[:SENSe] :CHPower:SWEep:TIME <time> [:SENSe] :CHPower:SWEep:TIME? [:SENSe] :CHPower:SWEep:TIME:AUTO OFF ON 0 1 [:SENSe] :CHPower:SWEep:TIME:AUTO?
Example	CHP:SWE:TIME 25ms CHP:SWE:TIME? CHP:SWE:TIME:AUTO OFF CHP:SWE:TIME:AUTO?
Preset	SA, WIMAX OFDMA: Automatically Calculated WCDMA: 1.0 ms CDMA2K: 9.4ms 1xEVDO: 2.66ms DVB-T/H: Automatically Calculated DTMB (CTTB): Automatically Calculated ISDB-T: Automatically Calculated CMMB: Automatically Calculated LTE, MSR: Automatically Calculated LTETDD: Automatically Calculated Digital Cable TV: Automatically Calculated

	WLAN: Automatically Calculated LTEAFDD,LTEATDD:Automatically Calculated
State Saved	Saved in instrument state.
Min	1 ms
Max	4000 s
Initial S/W Revision	Prior to A.02.00
Modified at S/W Revision	A.02.00, A.03.00

Sweep Setup

Accesses a menu that enables you to set the sweep state for the current measurement.

Key Path	Sweep/Control
Initial S/W Revision	Prior to A.02.00

Auto Sweep Time Rules

Switches the analyzer between normal and accuracy sweep states.

Setting **Auto Sweep Time** to **Accy** results in slower sweep times, usually about three times as long, but yields better amplitude accuracy for CW signals. The instrument amplitude accuracy specifications only apply when **Auto Sweep Time** is set to **Accy**.

Additional amplitude errors which occur when **Auto Sweep Time** is set to **Norm** are usually well under 0.1 dB, though this is not guaranteed. Because of the faster sweep times and still low errors, **Norm** is the preferred setting of **Auto Sweep Time**. **Auto Sweep Time** is set to **Norm** on a **Preset** or **Auto Couple**. This means that in the Preset or Auto Coupled state, instrument amplitude accuracy specifications do not apply.

Key Path	Sweep/Control, Sweep Setup
Mode	SA, WCDMA, C2K, WIMAX OFDMA, 1xEVDO, DVB-T/H, DTMB (CTTB), ISDB-T, CMMB, LTE, LTETDD, Digital Cable TV, WLAN, MSR, LTEAFDD, LTEATDD
Remote Command	[:SENSe] :CHPower:SWEep:TIME:AUTO:RULEs NORMal ACCuracy [:SENSe] :CHPower:SWEep:TIME:AUTO:RULEs?
Example	CHP:SWE:TIME:AUTO:RUL NORM CHP:SWE:TIME:AUTO:RUL?
Notes	In Zero Span, this key is irrelevant and inaccessible (because the whole Sweep Setup menu is grayed out in Zero Span), however its settings can be changed remotely with no error indication. Set to Norm when Auto Couple is pressed or sent remotely

Preset	NORMal
State Saved	Saved in instrument state.
Range	Norm Accy
Initial S/W Revision	Prior to A.02.00
Modified at S/W Revision	A.02.00, A.03.00

Pause

Pauses a measurement after the current data acquisition is complete. When Paused, the label on the key changes to Resume. Pressing the Resume key resumes the measurement at the point it was at when paused. See ["Pause/Resume" on page 2468](#) for more details.

Key Path	Sweep/Control
Initial S/W Revision	Prior to A.02.00

Gate

Accesses a menu that enables you to control the gating function. The Gate functionality is used to view signals best viewed by qualifying them with other events.

Gate setup parameters are the same for all measurements – they do not change as you change measurements. Settings like these are called “Meas Global” and are unaffected by Meas Preset.

Note that Sweep Time autocoupling rules and annotation are changed by Gate being on.

Key Path	Sweep/Control
Scope	Meas Global
Readback	The state and method of Gate, as [Off, LO] or [On, Video]. Note that for measurements that only support gated LO, the method is nonetheless read back, but always as LO.
Initial S/W Revision	Prior to A.02.00

Gate On/Off

Turns the gate function on and off.

When the Gate Function is on, the selected Gate Method is used along with the gate settings and the signal at the gate source to control the sweep and video system with the gate signal. Not all measurements allow every type of Gate Methods.

When Gate is on, the annunciation in the measurement bar reflects that it is on and what method is used, as seen in the following "Gate: LO" annunciator graphic.

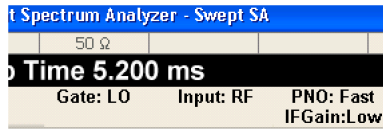

Key Path	Sweep/Control, Gate
Remote Command	[:SENSe] :SWEep:EGATe [:STATe] OFF ON 0 1 [:SENSe] :SWEep:EGATe [:STATe] ?
Example	SWE:EGAT ON SWE:EGAT?
Dependencies	<p>The function is unavailable (grayed out) and Off when:</p> <ul style="list-style-type: none"> • Gate Method is LO or Video and FFT Sweep Type is manually selected. • Gate Method is FFT and Swept Sweep Type is manually selected. • Marker Count is ON. <p>The following are unavailable whenever Gate is on:</p> <ul style="list-style-type: none"> • FFT under Sweep Type when Method=LO or Video or Swept under Sweep Type when Method=FFT • Marker Count <p>While Gate is on, the Auto Rules for Sweep Type are modified so that the choice agrees with the Gate Method: i.e., FFT for Method = FFT and Swept for Method = LO or Video.</p> <p>The Gate softkey and all SCPI under the [:SENSe]:SWEep:EGATe SCPI node are grayed out when Source Mode is Tracking with an external source. This is because the Gate circuitry is used to sync the external source. If the Tracking Source is turned on, the Gate is turned off.</p> <p>When in the ACP measurement:</p> <ul style="list-style-type: none"> • When Meas Method is RBW or FAST, this function is unavailable and the key is grayed out. • Whenever Gate is on, Meas Method, RBW or FAST is unavailable and keys for those are grayed out. • When Gate is on, Offset Res BW and Offset Video BW are ignored (if you set these values) and the measurement works as if all Offset Res BW and all Offset Video BW are coupled with the Res BW and the Video BW under the BW menu. When Gate is on, the Offset BW key in the Offset/Limit menu is grayed out.
Preset	Off LTETDD: On
State Saved	Saved in instrument state
Range	On Off
Backwards Compatibility SCPI	[:SENSe]:SWEep:TIME:GATE[:STATe] ESA compatibility
Backwards Compatibility Notes	In ESA, Trig Delay (On) and Gate (On) could not be active at the same time.. This dependency does not exist in PSA or in the X-Series.
Initial S/W Revision	Prior to A.02.00

Gate View On/Off

Turning on Gate View in the Swept SA measurement provides a single-window gate view display..

Turning on Gate View in other measurements shows the split-screen Gate View. In these measurements, when the Gate View is on, the regular view of the current measurement traces and results are reduced vertically to about 70% of the regular height. The Zero Span window, showing the positions of the Gate, is shown between the Measurement Bar and the reduced measurement window. By reducing the height of the measurement window, some of the annotation on the Data Display may not fit and is not shown.

Key Path	Sweep/Control, Gate
Remote Command	[:SENSe] :SWEep:EGATe:VIEW ON OFF 1 0 [:SENSe] :SWEep:EGATe:VIEW?
Example	SWE:EGAT:VIEW ON turns on the gate view.
Dependencies	In the Swept SA measurement: In Gate View, the regular Sweep Time key is grayed out . When pressed, the grayed out key puts up the informational message "Use Gate View Sweep Time in the Gate menu." In the other measurements: When you turn Gate View on, the lower window takes on the current state of the instrument. Upon leaving Gate View, the instrument takes on the state of the lower window. When you turn Gate View on, the upper window Sweep Time is set to the gate view sweep time.
Couplings	These couplings apply to the Swept SA measurement: <ul style="list-style-type: none"> • When Gate View is turned on, the instrument is set to Zero Span. • Gate View automatically turns off whenever a Span other than Zero is selected. • Gate View automatically turns off if you press the Last Span key while in Gate View, and the instrument returns to the Span it was in before entering Gate View (even if that is Zero Span). • When Gate View is turned on, the sweep time used is the gate view sweep time. This is set according to the rules in section "Gate View Setup" on page 2231 • When Gate View is turned off, Sweep Time is set to the normal Swept SA measurement sweep time. • If Gate View is on and Gate is off, then turning on Gate turns off Gate View.
Preset	OFF
State Saved	Saved in instrument state
Range	On Off
Initial S/W Revision	Prior to A.02.00

A sample of the Gate View screen in the Swept SA measurement is shown in the following graphic :

8 Channel Power Measurement Sweep/Control

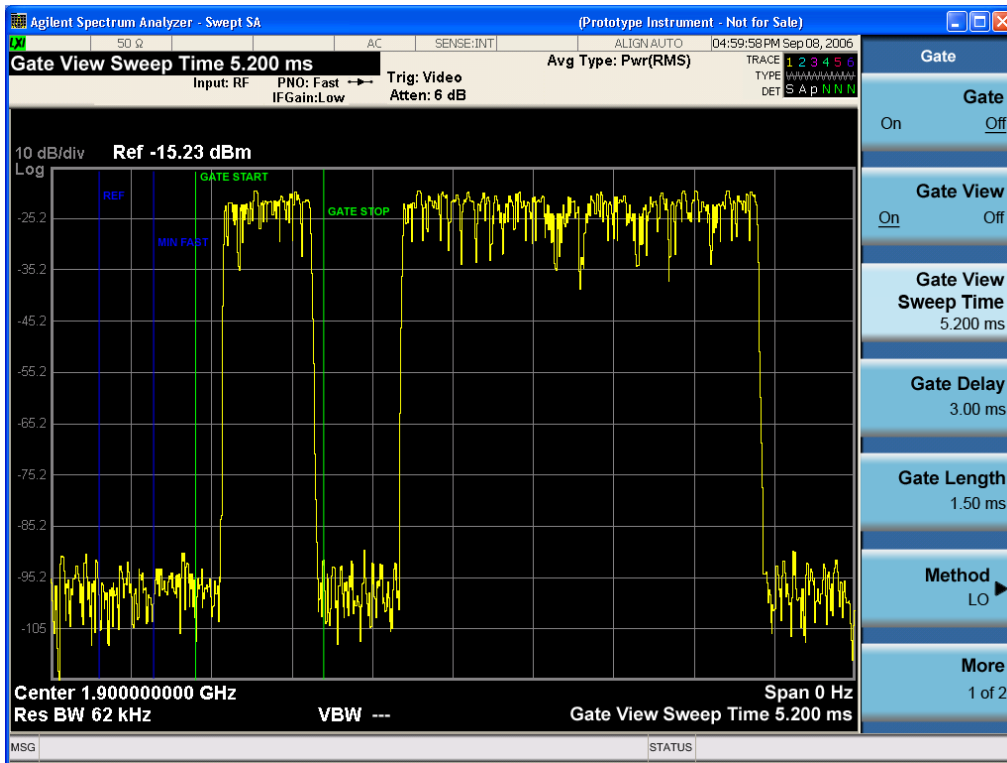

A sample of the Gate View screen in other measurements is shown in the following graphic. This example is for the ACP measurement:

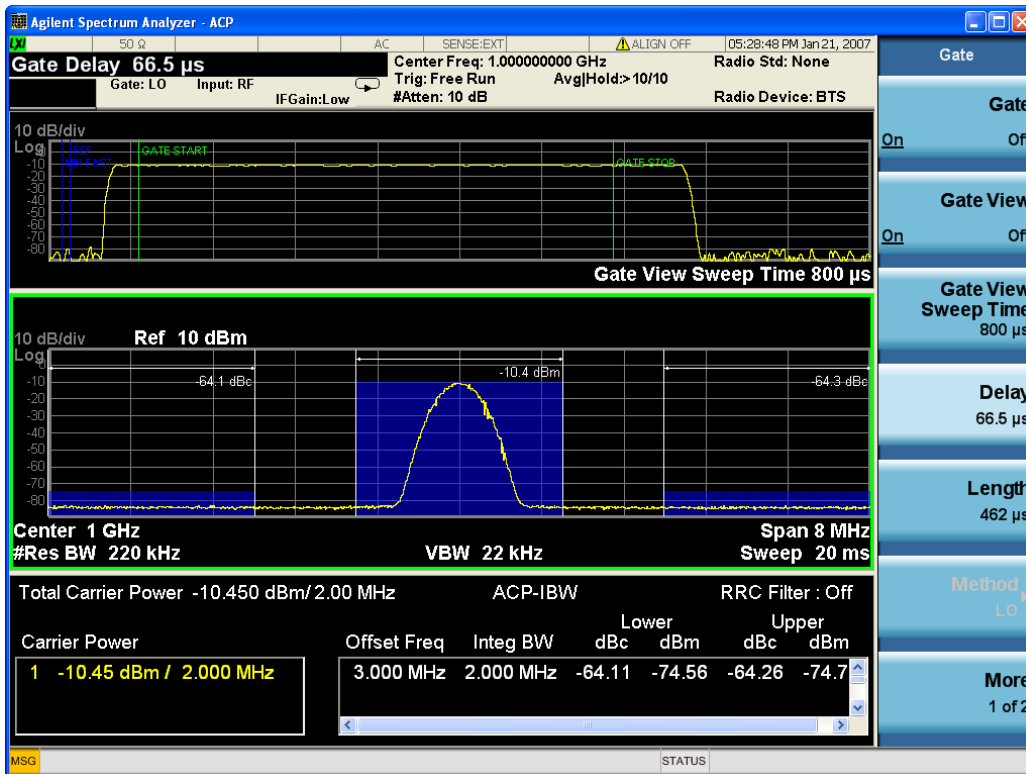

Turning Gate View off returns the analyzer to the Normal measurement view.

In the Swept SA, the normal measurement view is the single-window Swept SA view. When returning to this view, the Swept SA measurement returns to the Span it was in before entering **Gate View** (even if that is Zero Span).

The **Gate View** window is triggered from the Gate Source, with zero trigger delay. Also, when updating the **Gate View** window, the Gate itself must not operate. So it is internally shut off while the gate view window is being updated. For the Swept SA measurement, this means that the Gate is internally shut off whenever the gate view window is displayed. The measurement bar and softkeys continue to show the Trigger source for the main sweep window and give no indication that the Gate is shut off or that the Gate View window is triggered from the Gate Source.

When in **Gate View**, vertical lines are displayed in the Gate View window as follows:

- Green lines are displayed at the gate edges as follows: in Edge Gate, a line is shown for Delay and one for the end of the Gate period, defined by Length. In Level Gate a line is shown only for Delay. You can adjust the position of the green lines by adjusting the gate length and the gate delay. These lines update in the Gate View window as the active function changes, even if the window is not being updated. In Gated LO and Gated Video, these lines are positioned relative to the delay reference line (not relative to 0 time). In Gated FFT, their location is relative to the left edge of the screen.
- A blue line is displayed showing the delay reference, that is, the reference point for the Gate Delay within the Zero Span window. The blue line represents where (in time) the effective location of the gate start would be if the gate were programmed to zero delay.
-
- The second blue line is labeled "MIN FAST" as shown in the figure above because it represents the minimum Gate Delay for fast Gated LO operation. This line is only displayed in Gated LO. You cannot scroll (knob) or decrement (down key) the Gate Delay to less than that represented by the position of this line, it can only be set below this position manually, although once there it can be moved freely with the knob while below the line.
- A yellow line in the Gated Video case only, is displayed at Blength, where Blength is the display point (bucket) length for the swept trace, which is given by the sweep time for that trace divided by number of Points – 1. So it is referenced to 0 time, not to the delay reference. This line is labeled NEXT PT (it is not shown in the figure above because the figure above is for Gated LO).
- The yellow line represents the edge of a display point (bucket). Normally in Gated Video, the bucket length must be selected so that it exceeds the off time of the burst. There is another way to use the analyzer in Gated Video measurements, and that is to set the bucket width much shorter than the off time of the burst. Then use the Max Hold trace function to fill in "missing" buckets more slowly. This allows you to see some of the patterns of the Gated Video results earlier, though seeing a completely filled-in spectrum later.

Gate View Setup

Accesses a menu that enables you to setup parameters relevant to the Gate View

Key Path	Sweep/Control, Gate
Scope	Meas Global
Initial S/W Revision	A.10.00

Gate View Sweep Time

Controls the sweep time in the Gate View window. To provide an optimal view of the gate signal, the analyzer initializes Gate View Sweep Time based on the current settings of Gate Delay and Gate Length.

Key Path	Sweep/Control, Gate, Gate View Setup
Remote Command	[:SENSe] :SWEep:EGATe:TIME <time> [:SENSe] :SWEep:EGATe:TIME?
Example	SWE:EGAT:TIME 500 ms
Dependencies	Gate View Sweep Time is initialized: <ul style="list-style-type: none"> • On Preset (after initializing delay and length). • Every time the Gate Method is set/changed. <p>Additionally, in the Swept SA measurement, whenever you do a Preset, or leave Gate View, the analyzer remembers the Gate Delay and Gate Length settings. Then, when returning to Gate View, if the current Gate Delay and/or Gate Length do not match the remembered values Gate View Sweep Time is re-initialized.</p> <ol style="list-style-type: none"> 1. Compute the location of the "gate stop" line, which you know is at time $t = t_{min} + GateDelay + GateLength$.
Preset	519.3 μ s WiMAX OFDMA: 5 ms GSM/EDGE: 1 ms
State Saved	Saved in instrument state
Max	6000 s
Initial S/W Revision	Prior to A.02.00

Gate View Start Time

Controls the time at the left edge of the Gate View.

Key Path	Sweep/Control, Gate, Gate View Setup
Remote Command	[:SENSe] :SWEep:EGATe:VIEW:STARt <time> [:SENSe] :SWEep:EGATe:VIEW:STARt?
Example	SWE:EGAT:VIEW:STAR 10ms
Notes	Units of time are required or no units; otherwise an invalid suffix error message will be generated. See error -131.
Preset	0 ms
State Saved	Saved in instrument state
Min	0
Max	500 ms
Initial S/W Revision	A.10.00

Gate Delay

Controls the length of time from the time the gate condition goes True until the gate is turned on.

Key Path	Sweep/Control, Gate
Remote Command	[:SENSe] :SWEep:EGATe:DELaY <time> [:SENSe] :SWEep:EGATe:DELaY?
Example	SWE:EGAT:DELaY 500ms SWE:EGAT:DELaY?
Notes	Units of time are required or no units; otherwise an invalid suffix error message will be generated.
Preset	57.7 us WiMAX OFDMA: 71 us GSM/EDGE: 600 us WLAN: 500 us
State Saved	Saved in instrument state
Min	0.0 us
Max	100 s
Backwards Compatibility SCPI	[:SENSe] :SWEep:TIME:GATE:DELaY ESA compatibility
Initial S/W Revision	Prior to A.02.00

Gate Length

Controls the length of time that the gate is on after it opens.

Key Path	Sweep/Control, Gate
Remote Command	[:SENSe] :SWEep:EGATe:LENGth <time> [:SENSe] :SWEep:EGATe:LENGth?
Example	SWE:EGAT:LENG 1 SWE:EGAT:LENG?
Notes	Units of time are required or no units; otherwise an invalid suffix error message will be generated.
Dependencies	<p>Grayed out when Gate Method is set to FFT in which case the label changes to that shown below.</p> <div style="border: 1px solid gray; padding: 5px; display: inline-block;"> Gate Length (=1.83/RBW) 2.8 ms </div> <p style="margin-left: 100px;">vsd 39-1</p> <p>The key is also grayed out if Gate Control = Level.</p>
Preset	461.6 us

	WiMAX OFDMA: 50 us GSM/EDGE: 200 us WLAN: 1.54 ms
State Saved	Saved in instrument state
Min	100 ns
Max	5 s
Backwards Compatibility SCPI	[:SENSe] : SWEep : TIME : GATE : LENGth ESA compatibility
Initial S/W Revision	Prior to A.02.00

Gate Source

The menus under the **Gate Source** key are the same as those under the **Trigger key**, with the exception that neither **Free Run** nor **Video** are available as Gate Source selections. However, a different SCPI command is used to select the Gate Source (see table below) because you may independently set the Gate Source and the Trigger Source.

Any changes to the settings in the setup menus under each Gate Source selection key (for example: Trigger Level, Trigger Delay, etc.) also affect the corresponding settings under the Trigger menu keys. The SCPI commands used for these are the same for Trigger and Gate, since there is only one setting which affects both Gate and Trigger. Example: to set the Trigger Level for External 1 you use the command :TRIG:EXT1:LEV regardless of whether you are using External 1 as a Trigger Source or a Gate Source.

Key Path	Sweep/Control, Gate
Remote Command	[:SENSe] : SWEep : EGATe : SOURce EXTernal1 EXTernal2 LINE FRAME RFBurst [:SENSe] : SWEep : EGATe : SOURce?
Dependencies	In some models, there is no second External input. In these models, the External 2 key is blanked and the EXTernal2 parameter will generate a "Hardware missing; Not available for this model number" error.
Preset	EXTernal 1 GSM/EDGE, MSR: FRAME LTETDD: EXTernal 1When Direction is Downlink, FRAME when Direction is Uplink.
Backwards Compatibility Notes	In ESA, there is a single Gate input port. In PSA, the Gate Source may be taken from one of two specified input ports. In the X-Series, any Trigger Source can be a Gate Source.
Initial S/W Revision	Prior to A.02.00
Modified at S/W Revision	A.03.00, A.14.00

Line

Pressing this key, when it is not selected, selects the line signal as the trigger. A new sweep/measurement will start synchronized with the next cycle of the line voltage. Pressing this key, when it is already selected, access the line trigger setup menu.

Key Path	Trigger
Example	TRIG:SOUR LINE Swept SA measurement TRIG:<meas>:SOUR LINE Measurements other than Swept SA
Dependencies	Line trigger is not available when operating from a "dc power source", for example, when the instrument is powered from batteries.
State Saved	Saved in instrument state
Status Bits/OPC dependencies	The Status Operation Register bit 5 "Waiting for Trigger" is set at the same time as the Sweeping or Measuring bit is set. It is cleared when the trigger actually occurs (that is, after the trigger event occurs and all the applicable trigger criteria have been met). A corresponding pop-up message ("Waiting for trigger") is generated if no trigger signal appears after approximately 2 sec. This message goes away when a trigger signal appears.
Initial S/W Revision	Prior to A.02.00

Trig Slope

Controls the trigger polarity. It is set positive to trigger on a rising edge and negative to trigger on a falling edge.

Key Path	Trigger, Line
Remote Command	:TRIGger[:SEquence]:LINE:SLOPe POSitive NEGative :TRIGger[:SEquence]:LINE:SLOPe?
Example	TRIG:LINE:SLOP NEG
Preset	POSitive
State Saved	Saved in instrument state
Backwards Compatibility Notes	The legacy :TRIGger[:SEquence]:SLOPe command affects the slopes for the VID, LINE, EXT1, EXT2, and RFB triggers.
Initial S/W Revision	Prior to A.02.00

External 1

Pressing this key, when it is not selected, selects an external input signal as the trigger. A new sweep/measurement will start when the external trigger condition is met using the external 1 input connector on the rear panel.

Pressing this key, when it is already selected, accesses the external 1 trigger setup menu.

Key Path	Trigger
Example	TRIG:SOUR EXT1 Swept SA measurement TRIG:<meas>:SOUR EXT1 Measurements other than Swept SA
Dependencies	Grayed out if in use by Point Trigger in the Source Setup menu. Forced to Free Run if already selected and Point Trigger is set to External 1.
State Saved	Saved in instrument state
Status Bits/OPC dependencies	The Status Operation Register bit 5 "Waiting for Trigger" is set at the same time as the Sweeping or Measuring bit is set. It is cleared when the trigger actually occurs (that is, after the trigger event occurs and all the applicable trigger criteria have been met). A corresponding pop-up message ("Waiting for trigger") is generated if no trigger signal appears after approximately 2 sec. This message goes away when a trigger signal appears.
Initial S/W Revision	Prior to A.02.00

Trigger Level

Sets the value where the external 1 trigger input will trigger a new sweep/measurement.

Key Path	Trigger, External 1
Remote Command	:TRIGger[:SEquence]:EXTernal1:LEVel <level> :TRIGger[:SEquence]:EXTernal1:LEVel?
Example	TRIG:EXT1:LEV 0.4 V
Couplings	This same level is used for the Ext1 trigger source in the Trigger menu, for the Ext1 selection in the Periodic Timer sync source (in the Trigger menu and in the Gate Source menu), and also for the Ext1 selection in the Gate Source menu.
Preset	1.2 V
State Saved	Saved in instrument state
Min	-5 V
Max	5 V
Default Unit	V
Backwards Compatibility SCPI	:TRIGger[:SEquence]:EXTernal:LEVel For backward compatibility, the parameter EXTernal is mapped to EXTernal1
Backwards Compatibility SCPI	:TRIGger[:SEquence]:FRAME:EXTernal1:LEVel
Initial S/W Revision	Prior to A.02.00

Trig Slope

Controls the trigger polarity. It is set positive to trigger on a rising edge and negative to trigger on a falling edge.

Key Path	Trigger, External 1
Remote Command	:TRIGger[:SEquence]:EXTernal1:SLOPe POSitive NEGative :TRIGger[:SEquence]:EXTernal1:SLOPe?
Example	TRIG:EXT1:SLOP NEG
Couplings	This same slope is used in the Ext1 selection for the trigger source in the Trigger menu and for the period timer sync source (in the Trigger menu and in the Gate Source menu).
Preset	POSitive
State Saved	Saved in instrument state
Backwards Compatibility SCPI	:TRIGger[:SEquence]:EXTernal:SLOPe For backward compatibility, the parameter EXTernal is mapped to EXTernal1
Backwards Compatibility SCPI	:TRIGger[:SEquence]:FRAMe:EXTernal1:SLOPe
Backwards Compatibility Notes	The legacy :TRIGger[:SEquence]:SLOPe command affects the slopes for the VID, LINE, EXT1, EXT2, and RFB triggers.
Initial S/W Revision	Prior to A.02.00

Zero Span Delay Comp On/Off

In zero span, there is a natural delay in the signal path, which comes from the RBW filter. This is usually desirable, as it allows you to trigger on events and also see those events, because the signal is delayed from the trigger event. However, in some cases it is desirable to eliminate this delay, so that trigger events line up exactly with the zero time point in zero span. You can use the **Zero Span Delay Comp On/Off** feature to enable or disable zero span delay compensation.

Key Path	Trigger, External 1
Remote Command	:TRIGger[:SEquence]:EXTernal1:DELay:COMPensation OFF ON 0 1 :TRIGger[:SEquence]:EXTernal1:DELay:COMPensation?
Example	TRIG:EXT1:DEL:COMP ON
Dependencies	No effect except in zero-span, but not locked out in nonzero spans. Blanked in modes that do not support zero-span measurements. If the SCPI command is sent when the key is blanked, an error is returned: -221, "Settings conflict; Feature not supported for this measurement" In analyzers shipping N9060A, this feature requires N9060A-7FP.
Preset	OFF
State Saved	Saved in instrument state
Initial S/W Revision	A.11.00

External 2

Pressing this key, when it is not selected, selects an external input signal as the trigger. A new sweep/measurement will start when the external trigger condition is met using the external 2 input

connector. The external trigger 2 input connector is on the rear panel.

Pressing this key, when it is already selected, accesses the external 2 trigger setup menu.

Key Path	Trigger
Example	TRIG:SOUR EXT2 Swept SA measurement TRIG:<meas>:SOUR EXT2 Measurements other than Swept SA
Dependencies	In some models, there is no second External input. In these models, the External 2 key is blanked and the EXTernal2 parameter will generate a "Hardware missing; Not available for this model number" message. Grayed out if in use by Point Trigger in the Source Setup menu. Forced to Free Run if already selected and Point Trigger is set to External 2.
State Saved	Saved in instrument state
Status Bits/OPC dependencies	The Status Operation Register bit 5 "Waiting for Trigger" is set at the same time as the Sweeping or Measuring bit is set. It is cleared when the trigger actually occurs (that is, after the trigger event occurs and all the applicable trigger criteria have been met). A corresponding pop-up message ("Waiting for trigger") is generated if no trigger signal appears after approximately 2 sec. This message goes away when a trigger signal appears.
Initial S/W Revision	Prior to A.02.00
Modified at S/W Revision	A.03.00

Trigger Level

Sets the value where the external 2 trigger input will trigger a new sweep/measurement.

Key Path	Trigger, External 2
Remote Command	:TRIGger[:SEquence]:EXTernal2:LEVel :TRIGger[:SEquence]:EXTernal2:LEVel?
Example	TRIG:EXT2:LEV 1.1 V
Couplings	This same level is used for the Ext2 trigger source in the Trigger menu, for the Ext2 selection in the Periodic Timer sync source (in the Trigger menu and in the Gate Source menu), and also for the Ext2 selection in the Gate Source menu.
Preset	1.2 V
State Saved	Saved in instrument state
Min	-5 V
Max	5 V
Default Unit	V
Backwards Compatibility SCPI	:TRIGger[:SEquence]:FRAME:EXTernal2:LEVel
Initial S/W Revision	Prior to A.02.00

Trig Slope

Controls the trigger polarity. It is set positive to trigger on a rising edge and negative to trigger on a falling edge.

Key Path	Trigger, External 2
Remote Command	:TRIGger[:SEquence]:EXTernal2:SLOPe POSitive NEGative :TRIGger[:SEquence]:EXTernal2:SLOPe?
Example	TRIG:EXT2:SLOP NEG
Couplings	This same slope is used in the Ext2 selection for the trigger source in the Trigger menu and for the period timer sync source (in the Trigger menu and in the Gate Source menu).
Preset	POSitive
State Saved	Saved in instrument state
Backwards Compatibility SCPI	:TRIGger[:SEquence]:FRAMe:EXTernal2:SLOPe
Backwards Compatibility Notes	The legacy :TRIGger[:SEquence]:SLOPe command affects the slopes for the VID, LINE, EXT1, EXT2, and RFB triggers.
Initial S/W Revision	Prior to A.02.00

Zero Span Delay Comp On/Off

In zero span, there is a natural delay in the signal path, which comes from the RBW filter. This is usually desirable, as it allows you to trigger on events and also see those events, because the signal is delayed from the trigger event. However, in some cases it is desirable to eliminate this delay, so that trigger events line up exactly with the zero time point in zero span. You can use the **Zero Span Delay Comp On/Off** feature to enable or disable zero span delay compensation.

Key Path	Trigger, External 2
Remote Command	:TRIGger[:SEquence]:EXTernal2:DELAy:COMPensation OFF ON 0 1 :TRIGger[:SEquence]:EXTernal2:DELAy:COMPensation?
Example	TRIG:EXT2:DEL:COMP ON
Dependencies	No effect except in zero-span, but not locked out in nonzero spans. Blanked in modes that do not support zero-span measurements. If the SCPI command is sent when the key is blanked, an error is returned: -221, "Settings conflict; Feature not supported for this measurement" In analyzers shipping N9060A, this feature requires N9060A-7FP.
Preset	OFF
State Saved	Saved in instrument state
Initial S/W Revision	A.11.00

RF Burst

Pressing this key, when it is not selected, selects the RF Burst as the trigger. A new sweep/measurement will start when an RF burst envelope signal is identified from the signal at the RF Input connector. Pressing this key, when it is already selected, accesses the RF Burst trigger setup menu.

In some models, a variety of burst trigger circuitry is available, resulting in various available burst trigger bandwidths. The analyzer automatically chooses the appropriate trigger path based on the hardware configuration and other settings of the analyzer.

Key Path	Trigger
Example	TRIG:SOUR RFB Swept SA measurement TRIG:< meas>:SOUR RFB Measurements other than Swept SA
State Saved	Saved in instrument state
Status Bits/OPC dependencies	The Status Operation Register bit 5 "Waiting for Trigger" is set at the same time as the Sweeping or Measuring bit is set. It is cleared when the trigger actually occurs (that is, after the trigger event occurs and all the applicable trigger criteria have been met). A corresponding pop-up message ("Waiting for trigger") is generated if no trigger signal appears after approximately 2 sec. This message goes away when a trigger signal appears.
Backwards Compatibility Notes	The legacy command: :TRIGger[:SEquence]:RFBurst:FSElectivity[:STATe] OFF ON 0 1 is not supported in the X-Series, as the hardware to do Frequency Selective burst triggers does not exist in X-Series.
Initial S/W Revision	Prior to A.02.00
Modified at S/W Revision	A.04.00

Absolute Trigger Level

Sets the absolute trigger level for the RF burst envelope.

When using the External Mixing path, the Absolute Trigger Level is uncalibrated because the factory default was set to accommodate the expected IF levels for the RF path.

Key Path	Trigger, RF Burst
Scope	Meas Global
Remote Command	:TRIGger[:SEquence]:RFBurst:LEVel:ABSolute <ampl> :TRIGger[:SEquence]:RFBurst:LEVel:ABSolute?
Example	TRIG:RFB:LEV:ABS 10 dBm sets the trigger level of the RF burst envelope signal to the absolute level of 10 dBm
Notes	Sending this command does not switch the setting from relative to absolute; to switch it you need to send the :TRIGger[:SEquence]:RFBurst:LEVel:TYPE command, below. Amplitude Corrections are not taken into account by the Absolute Trigger Level. For example, if you have given yourself effective gain with an amplitude correction factor, the Absolute Trigger will not fire until you have set the trigger level that far below the displayed signal level, rather than simply to

	the displayed signal level. This is only true for Amplitude Corrections, not External Gain or Ref Level Offset functions. If mode is Bluetooth, the default value is -50 dBm.
Couplings	This same level is used for the RF Burst trigger source in the Trigger menu, for the RF Burst selection in the Periodic Timer sync source (in the Trigger menu and in the Gate Source menu), and also for the RF Burst selection in the Gate Source menu
Preset	-20 dBm
State Saved	Saved in instrument state
Min	-200 dBm
Max	100 dBm
Default Unit	depends on the current selected Y-Axis unit
Backwards Compatibility SCPI	<code>:TRIGger[:SEquence]:FRAMe:RFBurst:LEVel:ABSolute</code>
Initial S/W Revision	Prior to A.02.00
Modified at S/W Revision	A.04.00

Key Path	Trigger, RF Burst
Remote Command	<code>:TRIGger[:SEquence]:RFBurst:LEVel:TYPE ABSolute RELative</code> <code>:TRIGger[:SEquence]:RFBurst:LEVel:TYPE?</code>
Example	TRIG:RFB:LEV:TYPE REL sets the trigger level type of the RF burst trigger to Relative.
Preset	ABSolute
State Saved	Saved in instrument state
Initial S/W Revision	Prior to A.02.00
Modified at S/W Revision	A.04.00

Relative Trigger Level

Sets the relative trigger level for the RF burst envelope.

In some models, the relative burst trigger function is implemented in hardware. In other models, without the advanced triggering hardware required, the relative burst trigger function is implemented in software in some measurements, and is unavailable in other measurements.

When implemented in software, the relative RF Burst trigger function is implemented as follows:

1. The measurement starts with the absolute RF Burst trigger setting. If it cannot get a trigger with that level, auto trigger fires and the acquisition starts anyway. After the acquisition, the measurement searches for the peak in the acquired waveform and saves it.

2. Now, in the next cycle of the measurement, the measurement determines a new absolute RF Burst level based on the peak value from the first measurement and the Relative RF Burst Trigger Level (always 0 or negative dB) set by the user. The following formula is used:
 3. absolute RF Burst level = peak level of the previous acquisition + relative RF Burst level
 4. If the new absolute RF Burst level differs from the previous by more than 0.5 dB, the new level is sent to the hardware; otherwise it is not updated (to avoid slowing down the acquisition)
- Steps 2 and 3 repeat for subsequent measurements.

Key Path	Trigger, RF Burst
Scope	Meas Global
Remote Command	:TRIGger[:SEquence]:RFBurst:LEVel:RELative <rel_ampl> :TRIGger[:SEquence]:RFBurst:LEVel:RELative?
Example	TRIG:RFB:LEV:REL -10 dB sets the trigger level of the RF burst envelope signal to the relative level of -10 dB
Notes	Sending this command does not switch the setting from absolute to relative; to switch it you need to send the :TRIGger[:SEquence]:RFBurst:LEVel:TYPE command, above. The relative trigger level is not available in some measurements. In those measurements the RELative parameter, and the :TRIGger[:SEquence]:RFBurst:LEVel:TYPE command (above), will generate an error if sent.
Dependencies	This key is grayed out and Absolute Trigger Level selected if the required hardware is not present in your analyzer and the current measurement does not support Relative triggering.
Preset	-6 dB GSM: -25 dB
State Saved	Saved in instrument state
Min	-45 dB
Max	0 dB
Default Unit	dB or dBc
Backwards Compatibility SCPI	:TRIGger[:SEquence]:RFBurst:LEVel This legacy command is aliased to :TRIGger[:SEquence]:RFBurst:LEVel:RELative because the PSA had ONLY relative burst triggering
Initial S/W Revision	Prior to A.02.00
Modified at S/W Revision	A.04.00

Trigger Slope

It is set positive to trigger on a rising edge and negative to trigger on a falling edge.

Key Path	Trigger, RF Burst
Remote Command	:TRIGger[:SEquence]:RFBurst:SLOPe POSitive NEGative :TRIGger[:SEquence]:RFBurst:SLOPe?

Example	TRIG:RFB:SLOP NEG
Couplings	This same slope is used in the RF Burst selection for the trigger source in the Trigger menu and for the period timer sync source (in the Trigger menu and in the Gate Source menu).
Preset	POSitive
State Saved	Saved in instrument state
Backwards Compatibility SCPI	:TRIGger[:SEQuence]:FRAMe:RFBurst:SLOPe
Backwards Compatibility Notes	The legacy :TRIGger[:SEQuence]:SLOPe command affects the slopes for the VID, LINE, EXT1, EXT2, and RFB triggers.
Initial S/W Revision	Prior to A.02.00

Periodic Timer (Frame Trigger)

Pressing this key, when it is not selected, selects the internal periodic timer signal as the trigger. Triggering occurrences are set by the **Period** parameter, which is modified by the **Sync Source** and **Offset**. Pressing this key, when it is already selected, accesses the periodic timer trigger setup functions.

If you do not have a sync source selected (it is Off), then the internal timer will not be synchronized with any external timing events.

Key Path	Trigger
Example	TRIG:SOUR FRAM Swept SA measurement TRIG:<meas>:SOUR FRAM Measurements other than Swept SA
State Saved	Saved in instrument state
Readback	[Sync: <value of Sync Source>], for example, [Sync: External 1]
Status Bits/OPC dependencies	The Status Operation Register bit 5 "Waiting for Trigger" is set at the same time as the Sweeping or Measuring bit is set. It is cleared when the trigger actually occurs (that is, after the trigger event occurs and all the applicable trigger criteria have been met). A corresponding pop-up message ("Waiting for trigger") is generated if no trigger signal appears after approximately 2 sec. This message goes away when a trigger signal appears.
Initial S/W Revision	Prior to A.02.00

Periodic Timer Triggering:

This feature selects the internal periodic timer signal as the trigger. Trigger occurrences are set by the **Periodic Timer** parameter, which is modified by the **Sync Source** and **Offset**.

The figure below shows the action of the periodic timer trigger. Before reviewing the figure, we'll explain some uses for the periodic trigger.

A common application is measuring periodic burst RF signals for which a trigger signal is not easily available. For example, we might be measuring a TDMA radio which bursts every 20 ms. Let's assume that the 20 ms period is very consistent. Let's also assume that we do not have an external trigger source

available that is synchronized with the period, and that the signal-to-noise ratio of the signal is not high enough to provide a clean RF burst trigger at all of the analysis frequencies. For example, we might want to measure spurious transmissions at an offset from the carrier that is larger than the bandwidth of the RF burst trigger. In this application, we can set the Periodic Timer to a 20.00 ms period and adjust the offset from that timer to position our trigger just where we want it. If we find that the 20.00 ms is not exactly right, we can adjust the period slightly to minimize the drift between the period timer and the signal to be measured.

A second way to use this feature would be to use **Sync Source** temporarily, instead of **Offset**. In this case, we might tune to the signal in a narrow span and use the RF Burst trigger to synchronize the periodic timer. Then we would turn the sync source off so that it would not miss-trigger. Miss-triggering can occur when we are tuned so far away from the RF burst trigger that it is no longer reliable.

A third example would be to synchronize to a signal that has a reference time element of much longer period than the period of interest. In some CDMA applications, it is useful to look at signals with a short periodicity, by synchronizing that periodicity to the "even-second clock" edge that happens every two seconds. Thus, we could connect the even-second clock trigger to Ext1 and use then Ext1 as the sync source for the periodic timer.

The figure below illustrates this third example. The top trace represents the even-second clock. It causes the periodic timer to synchronize with the leading edge shown. The analyzer trigger occurs at a time delayed by the accumulated offset from the period trigger event. The periodic timer continues to run, and triggers continue to occur, with a periodicity determined by the analyzer time base. The timer output (labeled "late event") will drift away from its ideal time due to imperfect matching between the time base of the signal being measured and the time base of the analyzer, and also because of imperfect setting of the period parameter. But the synchronization is restored on the next even-second clock event. ("Accumulated offset" is described in the in the **Offset** function section.)

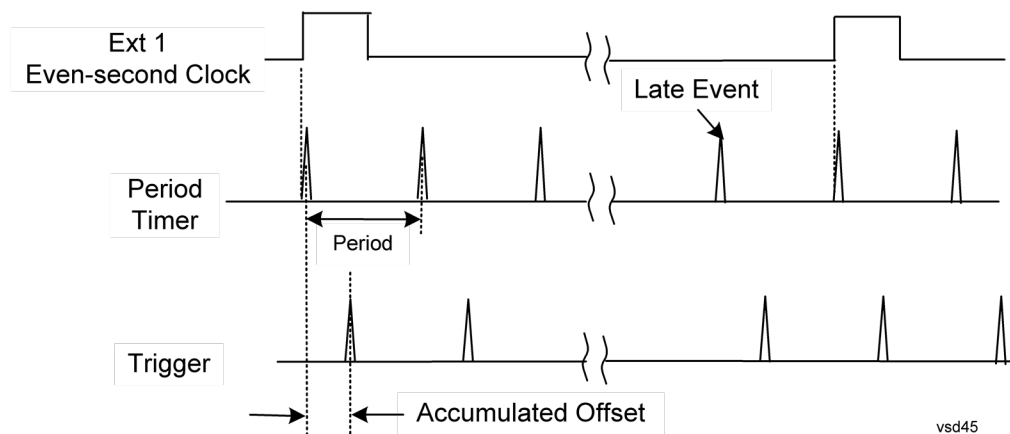

Period

Sets the period of the internal periodic timer clock. For digital communications signals, this is usually set to the frame period of your current input signal. In the case that sync source is not set to OFF, and the external sync source rate is changed for some reason, the periodic timer is synchronized at the every external synchronization pulse by resetting the internal state of the timer circuit.

Key Path	Trigger, Periodic Timer
Remote Command	:TRIGger[:SEquence]:FRAME:PERiod <time>

	:TRIGger[:SEquence]:FRAMe:PERiod?
Example	TRIG:FRAM:PER 100 ms
Dependencies	The invalid data indicator turns on when the period is changed, until the next sweep/measurement completes.
Couplings	The same period is used in the Gate Source selection of the period timer.
Preset	20 ms GSM: 4.615383
State Saved	Saved in instrument state
Min	100.000 ns
Max	559.0000 ms
Default Unit	S
Initial S/W Revision	Prior to A.02.00

Offset

Adjusts the accumulated offset between the periodic timer events and the trigger event. Adjusting the accumulated offset is different than setting an offset, and requires explanation.

The periodic timer is usually not synchronized with any external events, so the timing of its output events has no absolute meaning. Since the timing relative to external events (RF signals) is important, you need to be able to adjust (offset) it. However, you have no direct way to see when the periodic timer events occur. All that you can see is the trigger timing. When you want to adjust the trigger timing, you will be changing the internal offset between the periodic timer events and the trigger event. Because the absolute value of that internal offset is unknown, we will just call that the accumulated offset. Whenever the Offset parameter is changed, you are changing that accumulated offset. You can reset the displayed offset using Reset Offset Display. Changing the display does not change the value of the accumulated offset, and you can still make additional changes to accumulated offset.

To avoid ambiguity, we define that an increase in the "offset" parameter, either from the knob or the SCPI adjust command, serves to delay the timing of the trigger event.

Key Path	Trigger, Periodic Timer
Remote Command	:TRIGger[:SEquence]:FRAMe:OFFSet <time> :TRIGger[:SEquence]:FRAMe:OFFSet?
Example	TRIG:FRAM:OFFS 1.2 ms
Notes	The front panel interface (for example, the knob), and this command, adjust the accumulated offset, which is shown on the active function display. However, the actual amount sent to the hardware each time the offset is updated is the delta value, that is, the current accumulated offset value minus the previous accumulated offset value. Note that the accumulated offset value is essentially arbitrary; it represents the accumulated offset from the last time the offset was zeroed (with the Reset Offset Display key). Note that this command does not change the period of the trigger waveform. Note also that Offset is used only when the sync source is set to OFF, otherwise delay is used, see section "Trig Delay" on page 476.

	An increase in the "offset" parameter, either from the knob or the SCPI adjust command, serves to delay the timing of the trigger event.
Notes	When the SCPI command is sent the value shown on the key (and the Active Function, if this happens to be the active function) is updated with the new value. However, the actual amount sent to the hardware is the delta value, that is, the current accumulated offset value minus the previous accumulated offset value. The SCPI query simply returns the value currently showing on the key.
Dependencies	The invalid data indicator turns on when the offset is changed, until the next sweep/measurement completes.
Couplings	The same offset is used in the Gate Source selection of the period timer.
Preset	0 s
State Saved	Saved in instrument state
Min	-10.000 s
Max	10.000 s
Default Unit	S
Initial S/W Revision	Prior to A.02.00

Offset Adjust (Remote Command Only)

This remote command does not work at all like the related front panel keys. This command lets you advance the phase of the frame trigger by the amount you specify.

It does not change the period of the trigger waveform. If the command is sent multiple times, it advances the phase of the frame trigger an additional amount each time it is sent. Negative numbers are permitted.

Remote Command	:TRIGger[:SEquence]:FRAMe:ADJust <time>
Example	TRIG:FRAM:ADJ 1.2 ms
Notes	Note also that Offset is used only when the sync source is set to OFF, otherwise delay is used, see section " Trig Delay " on page 476 An increase in the "offset" parameter, either from the knob or the SCPI adjust command, serves to delay the timing of the trigger event.
Notes	The front panel interface (for example, the knob) and the :TRIG:FRAM:OFFS command adjust the accumulated offset, which is shown on the active function display. However, the actual amount sent to the hardware is the delta value, that is, the current offset value minus the previous offset value. When the SCPI command is sent the value shown on the key (and the Active Function, if this happens to be the active function) is updated by increasing it (or decreasing it if the value sent is negative) by the amount specified in the SCPI command. This is a "command only" SCPI command, with no query.
Dependencies	The invalid data indicator turns on when the offset is changed, until the next sweep/measurement completes.
Couplings	The same offset is used in the Gate Source selection of the period timer.
Preset	0 s

State Saved	Saved in instrument state
Min	-10.000 s
Max	10.000 s
Default Unit	S
Initial S/W Revision	Prior to A.02.00

Reset Offset Display

Resets the value of the periodic trigger offset display setting to 0.0 seconds. The current displayed trigger location may include an offset value defined with the **Offset** key. Pressing this key redefines the currently displayed trigger location as the new trigger point that is 0.0 s offset. The **Offset** key can then be used to add offset relative to this new timing.

Key Path	Trigger, Periodic Timer
Remote Command	:TRIGger[:SEquence]:FRAMe:OFFSet:DISPlay:RESet
Example	TRIG:FRAM:OFFS:DISP:RES
Initial S/W Revision	Prior to A.02.00

Sync Source

Selects a signal source for you to synchronize your periodic timer trigger to, otherwise you are triggering at some arbitrary location in the frame. Synchronization reduces the precision requirements on the setting of the period.

For convenience you may adjust the level and slope of the selected sync source in a conditional branch setup menu accessed from the Sync Source menu. Note that these settings match those in the **Trigger** and **Gate Source** menus; that is, each trigger source has only one value of level and slope, regardless of which menu it is accessed from.

Key Path	Trigger, Periodic Timer
Remote Command	:TRIGger[:SEquence]:FRAMe:SYNC EXTernal1 EXTernal2 RFBurst OFF :TRIGger[:SEquence]:FRAMe:SYNC?
Example	TRIG:FRAM:SYNC EXT2
Dependencies	In some models, there is no second External input. In these models, the External 2 key is blanked and the EXTernal2 parameter will generate a "Hardware missing; Not available for this model number" message.
Preset	Off GSM/EDGE, MSR,LTE,LTETDD: RFBurst
State Saved	Saved in instrument state
Readback	The current setting is read back to this key and it is also Readback to the previous Periodic Timer trigger key.

Backwards Compatibility SCPI	:TRIGger[:SEquence]:FRAMe:SYNC EXTernal
Initial S/W Revision	Prior to A.02.00
Modified at S/W Revision	A.03.00, A.14.00

Off

Turns off the sync source for your periodic trigger. With the sync source off, the timing will drift unless the signal source frequency is locked to the analyzer frequency reference.

Key Path	Trigger, Periodic Timer, Sync Source
Example	TRIG:FRAM:SYNC OFF
Readback	Off
Initial S/W Revision	Prior to A.02.00

External 1

Pressing this key, when it is not selected, selects an external input signal as the trigger. A new sweep/measurement will start when the external trigger condition is met using the external 1 input connector on the rear panel.

Pressing this key, when it is already selected, accesses the external 1 trigger setup menu.

Key Path	Trigger
Example	TRIG:SOUR EXT1 Swept SA measurement TRIG:<meas>:SOUR EXT1 Measurements other than Swept SA
Dependencies	Grayed out if in use by Point Trigger in the Source Setup menu. Forced to Free Run if already selected and Point Trigger is set to External 1.
State Saved	Saved in instrument state
Status Bits/OPC dependencies	The Status Operation Register bit 5 "Waiting for Trigger" is set at the same time as the Sweeping or Measuring bit is set. It is cleared when the trigger actually occurs (that is, after the trigger event occurs and all the applicable trigger criteria have been met). A corresponding pop-up message ("Waiting for trigger") is generated if no trigger signal appears after approximately 2 sec. This message goes away when a trigger signal appears.
Initial S/W Revision	Prior to A.02.00

Trigger Level

Sets the value where the external 1 trigger input will trigger a new sweep/measurement.

Key Path	Trigger, External 1
Remote Command	:TRIGger[:SEquence]:EXTernal1:LEVel <level> :TRIGger[:SEquence]:EXTernal1:LEVel?
Example	TRIG:EXT1:LEV 0.4 V
Couplings	This same level is used for the Ext1 trigger source in the Trigger menu, for the Ext1 selection in the Periodic Timer sync source (in the Trigger menu and in the Gate Source menu), and also for the Ext1 selection in the Gate Source menu.
Preset	1.2 V
State Saved	Saved in instrument state
Min	-5 V
Max	5 V
Default Unit	V
Backwards Compatibility SCPI	:TRIGger[:SEquence]:EXTernal:LEVel For backward compatibility, the parameter EXTernal is mapped to EXTernal1
Backwards Compatibility SCPI	:TRIGger[:SEquence]:FRAMe:EXTernal1:LEVel
Initial S/W Revision	Prior to A.02.00

Trig Slope

Controls the trigger polarity. It is set positive to trigger on a rising edge and negative to trigger on a falling edge.

Key Path	Trigger, External 1
Remote Command	:TRIGger[:SEquence]:EXTernal1:SLOPe POSitive NEGative :TRIGger[:SEquence]:EXTernal1:SLOPe?
Example	TRIG:EXT1:SLOP NEG
Couplings	This same slope is used in the Ext1 selection for the trigger source in the Trigger menu and for the period timer sync source (in the Trigger menu and in the Gate Source menu).
Preset	POSitive
State Saved	Saved in instrument state
Backwards Compatibility SCPI	:TRIGger[:SEquence]:EXTernal:SLOPe For backward compatibility, the parameter EXTernal is mapped to EXTernal1
Backwards Compatibility SCPI	:TRIGger[:SEquence]:FRAMe:EXTernal1:SLOPe
Backwards Compatibility Notes	The legacy :TRIGger[:SEquence]:SLOPe command affects the slopes for the VID, LINE, EXT1, EXT2, and RFB triggers.
Initial S/W Revision	Prior to A.02.00

External 2

Pressing this key, when it is not selected, selects an external input signal as the trigger. A new sweep/measurement will start when the external trigger condition is met using the external 2 input connector. The external trigger 2 input connector is on the rear panel.

Pressing this key, when it is already selected, accesses the external 2 trigger setup menu.

Key Path	Trigger
Example	TRIG:SOUR EXT2 Swept SA measurement TRIG:<meas>:SOUR EXT2 Measurements other than Swept SA
Dependencies	In some models, there is no second External input. In these models, the External 2 key is blanked and the EXTERNAL2 parameter will generate a "Hardware missing; Not available for this model number" message. Grayed out if in use by Point Trigger in the Source Setup menu. Forced to Free Run if already selected and Point Trigger is set to External 2.
State Saved	Saved in instrument state
Status Bits/OPC dependencies	The Status Operation Register bit 5 "Waiting for Trigger" is set at the same time as the Sweeping or Measuring bit is set. It is cleared when the trigger actually occurs (that is, after the trigger event occurs and all the applicable trigger criteria have been met). A corresponding pop-up message ("Waiting for trigger") is generated if no trigger signal appears after approximately 2 sec. This message goes away when a trigger signal appears.
Initial S/W Revision	Prior to A.02.00
Modified at S/W Revision	A.03.00

Trigger Level

Sets the value where the external 2 trigger input will trigger a new sweep/measurement.

Key Path	Trigger, External 2
Remote Command	:TRIGger[:SEquence]:EXTernal2:LEVel :TRIGger[:SEquence]:EXTernal2:LEVel?
Example	TRIG:EXT2:LEV 1.1 V
Couplings	This same level is used for the Ext2 trigger source in the Trigger menu, for the Ext2 selection in the Periodic Timer sync source (in the Trigger menu and in the Gate Source menu), and also for the Ext2 selection in the Gate Source menu.
Preset	1.2 V
State Saved	Saved in instrument state
Min	-5 V
Max	5 V
Default Unit	V
Backwards Compatibility SCPI	:TRIGger[:SEquence]:FRAME:EXTernal2:LEVel

Initial S/W Revision	Prior to A.02.00
----------------------	------------------

Trig Slope

Controls the trigger polarity. It is set positive to trigger on a rising edge and negative to trigger on a falling edge.

Key Path	Trigger, External 2
Remote Command	:TRIGger[:SEquence]:EXTernal2:SLOPe POSitive NEGative :TRIGger[:SEquence]:EXTernal2:SLOPe?
Example	TRIG:EXT2:SLOP NEG
Couplings	This same slope is used in the Ext2 selection for the trigger source in the Trigger menu and for the period timer sync source (in the Trigger menu and in the Gate Source menu).
Preset	POSitive
State Saved	Saved in instrument state
Backwards Compatibility SCPI	:TRIGger[:SEquence]:FRAMe:EXTernal2:SLOPe
Backwards Compatibility Notes	The legacy :TRIGger[:SEquence]:SLOPe command affects the slopes for the VID, LINE, EXT1, EXT2, and RFB triggers.
Initial S/W Revision	Prior to A.02.00

RF Burst

Pressing this key, when it is not selected, selects the RF Burst as the trigger. A new sweep/measurement will start when an RF burst envelope signal is identified from the signal at the RF Input connector. Pressing this key, when it is already selected, accesses the RF Burst trigger setup menu.

In some models, a variety of burst trigger circuitry is available, resulting in various available burst trigger bandwidths. The analyzer automatically chooses the appropriate trigger path based on the hardware configuration and other settings of the analyzer.

Key Path	Trigger
Example	TRIG:SOUR RFB Swept SA measurement TRIG:<meas>:SOUR RFB Measurements other than Swept SA
State Saved	Saved in instrument state
Status Bits/OPC dependencies	The Status Operation Register bit 5 "Waiting for Trigger" is set at the same time as the Sweeping or Measuring bit is set. It is cleared when the trigger actually occurs (that is, after the trigger event occurs and all the applicable trigger criteria have been met). A corresponding pop-up message ("Waiting for trigger") is generated if no trigger signal appears after approximately 2 sec. This message goes away when a trigger signal appears.
Backwards Compatibility Notes	The legacy command:

	:TRIGger[:SEquence]:RFBurst:FSElectivity[:STATE] OFF ON 0 1 is not supported in the X-Series, as the hardware to do Frequency Selective burst triggers does not exist in X-Series.
Initial S/W Revision	Prior to A.02.00
Modified at S/W Revision	A.04.00

Absolute Trigger Level

Sets the absolute trigger level for the RF burst envelope.

When using the External Mixing path, the Absolute Trigger Level is uncalibrated because the factory default was set to accommodate the expected IF levels for the RF path.

Key Path	Trigger, RF Burst
Scope	Meas Global
Remote Command	:TRIGger[:SEquence]:RFBurst:LEVel:ABSolute <ampl> :TRIGger[:SEquence]:RFBurst:LEVel:ABSolute?
Example	TRIG:RFB:LEV:ABS 10 dBm sets the trigger level of the RF burst envelope signal to the absolute level of 10 dBm
Notes	Sending this command does not switch the setting from relative to absolute; to switch it you need to send the :TRIGger[:SEquence]:RFBurst:LEVel:TYPE command, below. Amplitude Corrections are not taken into account by the Absolute Trigger Level. For example, if you have given yourself effective gain with an amplitude correction factor, the Absolute Trigger will not fire until you have set the trigger level that far below the displayed signal level, rather than simply to the displayed signal level. This is only true for Amplitude Corrections, not External Gain or Ref Level Offset functions. If mode is Bluetooth, the default value is -50 dBm.
Couplings	This same level is used for the RF Burst trigger source in the Trigger menu, for the RF Burst selection in the Periodic Timer sync source (in the Trigger menu and in the Gate Source menu), and also for the RF Burst selection in the Gate Source menu
Preset	-20 dBm
State Saved	Saved in instrument state
Min	-200 dBm
Max	100 dBm
Default Unit	depends on the current selected Y-Axis unit
Backwards Compatibility SCPI	:TRIGger[:SEquence]:FRAMe:RFBurst:LEVel:ABSolute
Initial S/W Revision	Prior to A.02.00
Modified at S/W Revision	A.04.00

Key Path	Trigger, RF Burst
Remote Command	:TRIGger[:SEquence]:RFBurst:LEVel:TYPE ABSolute RELative :TRIGger[:SEquence]:RFBurst:LEVel:TYPE?
Example	TRIG:RFB:LEV:TYPE REL sets the trigger level type of the RF burst trigger to Relative.
Preset	ABSolute
State Saved	Saved in instrument state
Initial S/W Revision	Prior to A.02.00
Modified at S/W Revision	A.04.00

Trigger Slope

It is set positive to trigger on a rising edge and negative to trigger on a falling edge.

Key Path	Trigger, RF Burst
Remote Command	:TRIGger[:SEquence]:RFBurst:SLOPe POSitive NEGative :TRIGger[:SEquence]:RFBurst:SLOPe?
Example	TRIG:RFB:SLOP NEG
Couplings	This same slope is used in the RF Burst selection for the trigger source in the Trigger menu and for the period timer sync source (in the Trigger menu and in the Gate Source menu).
Preset	POSitive
State Saved	Saved in instrument state
Backwards Compatibility SCPI	:TRIGger[:SEquence]:FRAMe:RFBurst:SLOPe
Backwards Compatibility Notes	The legacy :TRIGger[:SEquence]:SLOPe command affects the slopes for the VID, LINE, EXT1, EXT2, and RFB triggers.
Initial S/W Revision	Prior to A.02.00

Sync Holdoff

Sync Holdoff specifies the duration that the sync source signal must be kept false before the transition to true to be recognized as the sync timing. The periodic timer phase is aligned when the sync source signal becomes true, after the Holdoff time is satisfied.

A holdoff of 2 ms will work with most WiMAX signals, but there may be cases where the burst off duration is less than 1 ms and this value will need to be changed.

Key Path	Trigger, Periodic Timer
Remote Command	:TRIGger[:SEquence]:FRAMe:SYNC:HOLDoff <time> :TRIGger[:SEquence]:FRAMe:SYNC:HOLDoff? :TRIGger[:SEquence]:FRAMe:SYNC:HOLDoff:STATe OFF ON 0 1

	:TRIGger[:SEquence]:FRAMe:SYNC:HOLDoff:STATE?
Preset	On, 1.000 ms
State Saved	Saved in instrument state
Min	0 ms
Max	+500 ms
Default Unit	s
Initial S/W Revision	Prior to A.02.00

Aux IO Control (Remote Command Only)

Sets/Queries the value for all 8 data lines.

Key Path	SCPI only
Remote Command	OUTPut:AUX:IO <Value> OUTPut:AUX:IO?
Example	OUTPut:AUX:IO 31
Couplings	State of data 0 to data 7 under the AUX I/O Control panel (Input/Output menu) will change accordingly base on the AUX IO's value that key in.
Preset	31
Min	0
Max	255
Backwards Compatibility SCPI	OUTPut:UPORt <Value>
Initial S/W Revision	A.16.00

Control Edge/Level

Sets the method of controlling the gating function from the gating signal.

Edge

In Edge triggering, the gate opens (after the Delay) on the selected edge (for example, positive) of the gate signal and closes on the alternate edge (for example, negative).

Level

In Level triggering, the gate opens (after the Delay) when the gate signal has achieved a certain level and stays open as long as that level is maintained.

Key Path	Sweep/Control, Gate
Remote Command	[:SENSe]:SWEep:EGATe:CONTRol EDGE LEVel [:SENSe]:SWEep:EGATe:CONTRol?
Example	SWE:EGAT:CONT EDGE
Dependencies	If the Gate Method is FFT the Control key is grayed out and Edge is selected.

	If the Gate Source is TV, Frame or Line, the Control key is grayed out and Edge is selected.
Preset	EDGE
State Saved	Saved in instrument state
Backwards Compatibility SCPI	<code>[:SENSe]:SWEep:TIME:GATE:TYPE</code> ESA Compatibility
Initial S/W Revision	Prior to A.02.00

Gate Holdoff

Lets you increase or decrease the wait time after a gate event ends before the analyzer will respond to the next gate signal.

After any Gate event finishes, the analyzer must wait for the sweep system to settle before it can respond to another Gate signal. The analyzer calculates a "wait time," taking into account a number of factors, including RBW and Phase Noise Optimization settings. The goal is to achieve the same accuracy when gated as in ungated operation. The figure below illustrates this concept:

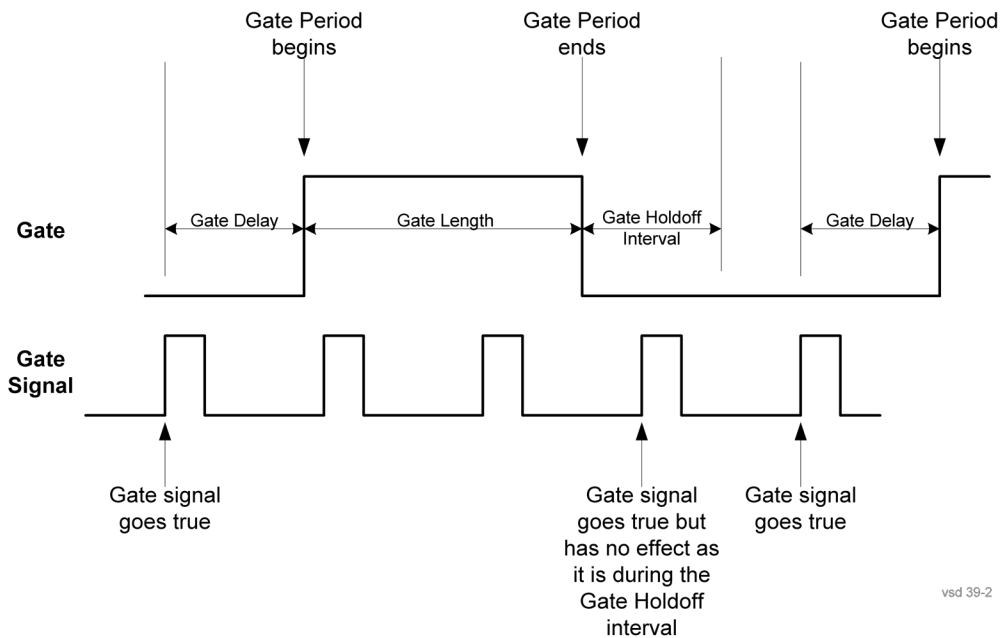

When Gate Holdoff is in Auto, the wait time calculated by the analyzer is used. When Gate Time is in Manual, the user may adjust the wait time, usually decreasing it in order to achieve greater speed, but at the risk of decreasing accuracy.

When the **Method** key is set to **Video** or **FFT**, the **Gate Holdoff** function has no effect.

In measurements that do not support Auto, the value shown when Auto is selected is “---” and the manually set holdoff is returned to a query.

Key Path	Sweep/Control, Gate
----------	----------------------------

Remote Command	<pre>[:SENSe] :SWEep:EGATe:HOLDoff <time> [:SENSe] :SWEep:EGATe:HOLDoff? [:SENSe] :SWEep:EGATe:HOLDoff:AUTO OFF ON 0 1 [:SENSe] :SWEep:EGATe:HOLDoff:AUTO?</pre>
Example	<pre>SWE:EGAT:HOLD 0.0002 SWE:EGAT:HOLD? SWE:EGAT:HOLD:AUTO ON SWE:EGAT:HOLD:AUTO?</pre>
Couplings	<p>When Gate Holdoff is Auto, the Gate Holdoff key shows the value calculated by the analyzer for the wait time.</p> <p>Pressing the Gate Holdoff key while it is in Auto and not selected, causes the key to become selected and allows the user to adjust the value. If the value is adjusted, the setting changes to Man.</p> <p>Pressing the Gate Holdoff key, while it is in Auto and selected, does not change the value of Gate Holdoff, but causes the setting to change to Man. Now the user can adjust the value.</p> <p>Pressing the key while it is in Man and selected, cause the value to change back to Auto.</p> <p>Pressing the key while it is in Man and not selected, causes the key to become selected and allows the user to adjust the value.</p> <p>When Method is set to Video or FFT, the Gate Holdoff function has no effect.</p>
Preset	<pre>Auto Auto/On</pre>
State Saved	Saved in instrument state
Min	1 µsec
Max	1 sec
Initial S/W Revision	Prior to A.02.00

Gate Delay Compensation

This function allows you to select an RBW-dependent value by which to adjust the gate delay, to compensate for changes in the delay caused by RBW effects.

You can select between uncompensated operation and two types of compensation, **Delay Until RBW Settled** and **Compensate for RBW Group Delay**.

See ["More Information" on page 665](#)

Key Path	Sweep/Control, Gate
Scope	Meas Global
Remote Command	<pre>[:SENSe] :SWEep:EGATe:DELAy:COMPensation:TYPE OFF SETTled GDELAy [:SENSe] :SWEep:EGATe:DELAy:COMPensation:TYPE?</pre>
Example	<pre>SWE:EGAT:DEL:COMP:TYPE SETT SWE:EGAT:DEL:COMP:TYPE?</pre>

Notes	<p>Although this function is Meas Global, there are some measurements that do not support this function. In those measurements the operation will be Uncompensated. Going into one of those measurements will not change the Meas Global selection; it will simply display the grayed-out menu key with “Uncompensated” showing as the selection. This is a non-forceful grayout, so the SCPI command is still accepted.</p> <p>If Gate Delay Compensation is not supported at all within a particular mode, the key is not displayed, and if the SCPI command is sent while in a measurement within that mode, an “Undefined Header” message is generated.</p> <p>Measurements that do not support this function include: Swept SA</p>
Preset	<p>TD-SCDMA mode: Compensate for RBW Group Delay</p> <p>All other modes: Delay Until RBW Settled</p>
State Saved	Saved in instrument state
Range	Uncompensated Delay Until RBW Settled Compensate for RBW Group Delay
Readback text	Uncompensated Settled Group Delay
Initial S/W Revision	Prior to A.02.00
Modified at S/W Revision	A.11.0

More Information

Selecting **Uncompensated** means that the actual gate delay is as you sets it.

Selecting **Delay Until RBW Settled** causes the gate delay to be increased above the user setting by an amount equal to $3.06/\text{RBW}$. This compensated delay causes the GATE START and GATE STOP lines on the display to move by the compensation amount, and the actual hardware gate delay to be increased by the same amount. All the other gate lines (for example, MIN FAST) are unaffected. If the RBW subsequently changes, the compensation is readjusted for the new RBW. The value shown on the **Gate Delay** key does NOT change.

Delay Until RBW Settled allows excellent measurements of gated signals, by allowing the IF to settle following any transient that affects the burst. Excellent measurements also require that the analysis region not extend into the region affected by the falling edge of the burst. Thus, excellent measurements can only be made over a width that declines with narrowing RBWs, which is achieved by decreasing the gate length below the user setting by an amount equal to $2.53/\text{RBW}$. Therefore, for general purpose compensation, you will still want to change the gate length with changes in RBW even if the gate delay is compensated. The compensated Gate Length is limited by the analyzer so that it will never go below 10% of the value shown on the Gate Length key, as otherwise the sweep times could get very long. Anytime the **Gate Length and RBW** values combine in such a way that this limiting takes place, a warning is displayed. For measurements which contain multiple sweeps with different RBW like SEM and SPUR, the smallest RBW is used for this limiting.

Selecting **Compensate for RBW Group Delay** causes the gate delay to be increased above the user setting by an amount equal to $1.81/\text{RBW}$. This compensated delay causes the GATE START, GATE STOP lines on the display to move by the compensation amount, and the actual hardware gate delay to be increased by the same amount. All the other gate lines (for example, MIN FAST) are unaffected. If the RBW

subsequently changes, the compensation is readjusted for the new RBW. The value shown on the **Gate Delay** key does NOT change. **Compensate for RBW Group Delay** also includes gate length compensation; the gate length itself is adjusted as necessary to attempt to compensate for delay effects imposed by the RBW.

Compensate for RBW Group Delay is similar to **Delay Until RBW Settled**, but compensates for the group delay of the RBW filter, rather than the filter settling time. As the RBW gets narrow, this can allow the settling tail of the RBW to affect the beginning part of the gated measurement, and allow the beginning of the RBW settling transient to affect the end of the gated measurement. These two effects are symmetric because the RBW response is symmetric. Because the gate length is not automatically compensated, some users might find this compensation to be more intuitive than compensation for RBW settling.

Min Fast Position Query (Remote Command Only)

This command queries the position of the MIN FAST line, relative to the delay reference (REF) line. See section "[Gate View On/Off](#)" on page 2228. If this query is sent while not in gate view, the MinFast calculation is performed based on the current values of the appropriate parameters and the result is returned. Knowing this value lets you set an optimal gate delay value for the current measurement setup.

Remote Command	<code>[:SENSe] :SWEep:EGATe:MINFast?</code>
Example	<code>SWE:EGAT:MIN?</code>
Initial S/W Revision	Prior to A.02.00

Gate Preset (Remote Command Only)

Presets the time-gated spectrum analysis capability.

This command sets gate parameter values to the ESA preset values, as follows:

Gate trigger type = edge

Gate polarity = positive

Gate delay = 1 us

Gate length = 1 us

Remote Command	<code>[:SENSe] :SWEep:TIME:GATE:PRESet ESA Compatibility</code>
Initial S/W Revision	Prior to A.02.00

Gate Level (Remote Command Only)

Sets the gate input transition point level for the external TRIGGER inputs on the front and rear panel. This is a legacy command for PSA compatibility. It is simply an alias to the equivalent trigger level command.

Remote Command	<code>[:SENSe] :SWEep:EGATe:EXTernal [1] 2:LEVel <voltage></code> <code>[:SENSe] :SWEep:EGATe:EXTernal [1] 2:LEVel?</code>
Notes	This command is simply an alias to

	:TRIGger[:SEQuence]:EXTeRnal[1]2:LEVel For details refer
Initial S/W Revision	Prior to A.02.00

Gate Polarity (Remote Command Only)

Sets the polarity for the gate signal. This setup is now done using the gate trigger's slope setting.

When Positive (Pos) is selected, a positive-going edge (Edge) or a high voltage (Level) will satisfy the gate condition, after the delay set with the Gate Delay key. When Negative (Neg) is selected, a negative-going edge (Edge) or a low voltage (Level) will satisfy the gate condition after the delay.

Remote Command	[:SENSe] :SWEep:EGATe:POLarity NEGative POSitive [:SENSe] :SWEep:EGATe:POLarity?
Example	SWE:EGAT:POL NEG SWE:EGAT:POL?
Preset	POSitive
State Saved	Saved in instrument state
Backwards Compatibility SCPI	[:SENSe] :SWEep:TIME:GATE:POLarity ESA compatibility
Initial S/W Revision	Prior to A.02.00

Remote Command	[:SENSe] :SWEep:TIME:GATE:LEVel HIGH LOW [:SENSe] :SWEep:TIME:GATE:LEVel? ESA compatibility
Preset	HIGH
Initial S/W Revision	Prior to A.02.00

Points

Sets the number of points per sweep. The resolution of setting the sweep time depends on the number of points selected. If Preset is selected, the number of points per sweep defaults to 1001. The current value of points is displayed parenthetically, next to the sweep time in the lower-right corner of the display.

Changing the number of points has several effects on the analyzer. Since markers are read at the point location, the marker reading may change. All trace data is cleared.

Key Path	Sweep/Control
Mode	SA, WCDMA, C2K, WIMAX OFDMA, 1xEVDO, DVB-T/H, DTMB (CTTB), ISDB-T, CMMB, LTE, LTE-TDD, Digital Cable TV, WLAN, MSR, LTEAFDD, LTEATDD
Remote Command	[:SENSe] :CHPower:SWEep:POINts <integer>

	<code>[:SENSe] :CHPower:SWEep:POINts?</code>
Example	CHP:SWE:POIN 501 CHP:SWE:POIN?
Notes	Whenever the number of sweep points changes: All trace data is erased Any traces with Update Off also go to Display Off (like going from View to Blank in the older analyzers) Sweep time is re-quantized Any limit lines that are on are updated If averaging/hold is on, averaging/hold starts over
Couplings	Whenever the number of sweep points changes, the sweep time is re-quantized.
Preset	DVB-T/H: 2001 DTMB (CTTB): 2001 Other: 1001 ISDB-T: 2001 CMMB: 2001 1xEVDO: 512 Digital Cable TV: 2001
State Saved	Saved in instrument state.
Min	101
Max	20001
Initial S/W Revision	Prior to A.02.00
Modified at S/W Revision	A.02.00, A.03.00

System

See "System" on page 368

Trace/Detector

Accesses a menu of functions that enable you to control the detectors for the current measurement.

Key Path	Front-panel key
Initial S/W Revision	Prior to A.02.00

Trace Type

Allows you to select the type of trace you want to use for the current measurement. The first page of this menu contains a 1-of-N selection of the trace type (**Clear Write, Average, Max Hold, Min Hold**) for the selected trace.

Key Path	Trace/Detector
Mode	SA, WCDMA, C2K, WIMAX OFDMA, 1xEVDO, DVB-T/H, DTMB (CTTB), ISDB-T, CMMB, LTE, LTETDD, Digital Cable TV, WLAN, MSR, LTEAFDD, LTEATDD
Remote Command	:TRACe:CHPower:TYPE WRITe AVERAge MAXHold MINHold :TRACe:CHPower:TYPE?
Example	TRAC:CHP:TYPE WRIT TRAC:CHP:TYPE?
Notes	WRITe = Clear Write AVERAge = Average MAXHold = Maximum Hold MINHold = Minimum Hold
Couplings	When Detector setting is "Auto" ([[:SENSE]:CHPower:DETECTOR:AUTO?]), Detector ([[:SENSE]:CHPower:DETECTOR:FUNCTION?]) switches aligning with the switch of this parameter: "NORMal" with WRITe (Clear Write), "AVERAge" with AVERAge, "POSitive (peak)" with MAXHold, and "NEGative (peak)" with MINHold.
Preset	AVERAge
State Saved	Saved in instrument state.
Range	ClearWrite Average MaxHold MinHold
Initial S/W Revision	Prior to A.02.00
Modified at S/W Revision	A.02.00, A.03.00

Detector

Accesses a menu of functions that enable you to control the detectors for the current measurement. The following choices are available:

- Auto – the detector selected depends on marker functions, trace functions, average type, and the trace averaging function.

- Normal—the detector determines the peak of the CW-like signals, and it yields alternating maximums and minimums of noise-like signals. This is also referred to as Rosenfell detection.
- Average—the detector determines the average of the signal within the sweep points. The averaging method depends upon the Average Type selection (voltage, power or log scales).
- Peak—the detector determines the maximum of the signal within the sweep points.
- Sample—the detector indicates the instantaneous level of the signal at the center of the sweep points represented by each display point.
- Negative Peak—the detector determines the minimum of the signal within the sweep points.

Key Path	Detector
Initial S/W Revision	Prior to A.02.00

Auto

Sets the detector for the currently selected trace to Auto.

Key Path	Trace/Detector
Mode	SA, WCDMA, C2K, WIMAX OFDMA, 1xEVDO, DVB-T/H, DTMB (CTTB), ISDB-T, CMMB, LTE, LTETDD, Digital Cable TV, WLAN, MSR, LTEAFDD, LTEATDD
Remote Command	<code>[:SENSe] :CHPower:DETECTOR:AUTO ON OFF 1 0</code> <code>[:SENSe] :CHPower:DETECTOR:AUTO?</code>
Example	CHP:DET:AUTO ON CHP:DET:AUTO?
Couplings	When Detector setting is “Auto” (<code>[:SENSe] :CHPower:DETECTOR:AUTO?</code>), Detector (<code>[:SENSe] :CHPower:DETECTOR[:FUNCTION]?</code>) switches aligning with the switch of this parameter: “NORMal” with Clear Write, “AVERage” with AVERage, “POSitive (peak)” with MAXHold, and “NEGative (peak)” with MINHold.
Preset	Others: ON DVB-T/H, DTMB (CTTB), ISDB-T, CMMB, Digital Cable TV: OFF
State Saved	Saved in instrument state.
Initial S/W Revision	Prior to A.02.00
Modified at S/W Revision	A.02.00, A.03.00

Detector Selection

Selects a detector to be used by the analyzer for the current measurement.

Key Path	Trace/Detector
Mode	SA, WCDMA, C2K, WIMAX OFDMA, 1xEVDO, DVB-T/H, DTMB (CTTB), ISDB-T, CMMB, LTE, LTETDD, Digital Cable TV, WLAN, MSR, LTEAFDD, LTEATDD

Remote Command	<code>[[:SENSe]:CHPower:DETEctor[:FUNction] NORMal AVERage POSitive SAMPlE NEGative [:SENSe]:CHPower:DETEctor[:FUNction]?</code>
Example	<code>CHP:DET NORM CHP:DET?</code>
Notes	<p>When you manually select a detector (instead of selecting Auto), that detector is used regardless of other analyzer settings.</p> <p>The Normal detector determines the peak of CW-like signals, and it yields alternating maximums and minimums of noise-like signals. This method of detection is also referred to as Rosenfell detection.</p> <p>The Average detector determines the average of the signal within the sweep points. The averaging method is Power Average (RMS).</p> <p>The Peak detector determines the maximum of the signal within the sweep points.</p> <p>The Sample detector indicates the instantaneous level of the signal at the center of the sweep points represented by each display point.</p> <p>The Negative Peak detector determines the minimum of the signal within the sweep points.</p>
Couplings	When Detector setting is "Auto" (<code>[[:SENSe]:CHPower:DETEctor:AUTO?</code>), Detector (<code>[[:SENSe]:CHPower:DETEctor[:FUNction]?</code>) switches aligning with the switch of this parameter: "NORMal" with Clear Write, "AVERage" with AVERage, "POSitive (peak)" with MAXHold, and "NEGative (peak)" with MINHold.
Preset	AVERage
State Saved	Saved in instrument state.
Range	Normal Average Peak Sample Negative Peak
Initial S/W Revision	Prior to A.02.00
Modified at S/W Revision	A.02.00, A.03.00

Trigger

See ["Trigger" on page 444](#)

Free Run

See ["Free Run " on page 451](#)

Video

See ["Video \(IF Envelope\) " on page 452](#)

Trigger Level

See ["Trigger Level " on page 452](#)

Trig Slope

See ["Trig Slope " on page 453](#)

Trig Delay

See ["Trig Delay " on page 454](#)

Line

See ["Line " on page 2235](#)

Trig Slope

See ["Trig Slope " on page 2235](#)

Trig Delay

See ["Trig Delay " on page 456](#)

External 1

See ["External 1 " on page 2248](#)

Trigger Level

See ["Trigger Level " on page 2248](#)

Trig Slope

See ["Trig Slope " on page 2249](#)

Trig Delay

See ["Trig Delay " on page 459](#)

Zero Span Delay Comp

See ["Zero Span Delay Comp On/Off" on page 2237](#)

External 2

See ["External 2 "](#) on page 2250

Trigger Level

See ["Trigger Level "](#) on page 2250

Trig Slope

See ["Trig Slope "](#) on page 2251

Trig Delay

See ["Trig Delay "](#) on page 461

Zero Span Delay Comp

See ["Zero Span Delay Comp On/Off"](#) on page 2239

RF Burst

See ["RF Burst "](#) on page 2251

Absolute Trigger

See ["Absolute Trigger Level"](#) on page 2252

Relative Trigger

See ["Relative Trigger Level"](#) on page 2241

Trig Slope

See ["Trigger Slope "](#) on page 2253

Trig Delay

See ["Trig Delay "](#) on page 466

Periodic Timer

See ["Periodic Timer \(Frame Trigger\) "](#) on page 2243

Period

See ["Period "](#) on page 2244

Offset

See ["Offset "](#) on page 2245

Reset Offset Display

See ["Reset Offset Display "](#) on page 2247

Sync Source

See ["Sync Source "](#) on page 2247

Off

See ["Off "](#) on page 2248

External 1

See ["External 1 "](#) on page 2248

Trigger Level

See ["Trigger Level "](#) on page 2248

Trig Slope

See ["Trig Slope "](#) on page 2249

External 2

See ["External 2 "](#) on page 2250

Trigger Level

See ["Trigger Level "](#) on page 2250

Trig Slope

See ["Trig Slope "](#) on page 2251

RF Burst

See ["RF Burst "](#) on page 2251

Absolute Trigger

See ["Absolute Trigger Level"](#) on page 2252

Trig Slope

See ["Trigger Slope "](#) on page 2253

Trig Delay

See ["Trig Delay"](#) on page 476

Auto/Holdoff

See ["Auto/Holdoff "](#) on page 477

Auto Trig

See ["Auto Trig "](#) on page 477

Trig Holdoff

See ["Trig Holdoff "](#) on page 478

Holdoff Type

See "[Holdoff Type](#)" on page 478

User Preset

Accesses a menu that gives you the following three choices:

- **User Preset** – recalls a state previously saved using the Save User Preset function.
- **User Preset All Modes** – presets all of the modes in the analyzer
- **Save User Preset**– saves the current state for the current mode

Key Path	Front-panel key
Backwards Compatibility Notes	<p>User Preset is actually loading a state, and in legacy analyzers, it was possible to load a state without affecting the trace data, limit lines or correction data. Similarly it was possible to do a User Preset without affecting the trace data, limit lines or correction data.</p> <p>In the X-Series, “state” always includes all of this data; so whenever state is loaded, or User Preset is executed, all of the traces, limit lines and corrections are affected. Although this differs from previous behavior, it is desirable behavior, and should not cause adverse issues for users.</p> <p>On ESA and PSA, User Preset affected the entire instrument’s state. In the X-Series, User Preset only recalls the state for the active mode. There is a User Preset file for each mode. User Preset can never cause a mode switch as it can in legacy analyzers. If you want to recall all modes to their user preset file state, you will need to do a User Preset after mode switching into each mode.</p> <p>User Preset recalls mode state which can now include data like traces; whereas on ESA and PSA, User Preset did not affect data.</p>
Initial S/W Revision	Prior to A.02.00

User Preset

User Preset sets the state of the currently active mode back to the state that was previously saved for this mode using the Save User Preset menu key or the SCPI command, `SYST:PRES:USER:SAV`. It not only recalls the Mode Preset settings, but it also recalls all of the mode persistent settings, and the Input/Output system setting that existed at the time Save User Preset was executed.

If a Save User Preset has not been done at any time, User Preset recalls the default user preset file for the currently active mode. The default user preset files are created if, at power-on, a mode detects there is no user preset file. There will never be a scenario when there is no user preset file to restore. For each mode, the default user preset state is the same state that would be saved if a Save User Preset is performed in each mode right after doing a Restore Mode Default and after a Restore Input/Output Defaults.

The User Preset function does the following:

- Aborts the currently running measurement.
- Sets the mode State to the values defined by Save User Preset.
- Makes the saved measurement for the currently running mode the active measurement.
- Brings up the saved menu for the power-on mode.
- Clears the input and output buffers.
- Sets the Status Byte to 0.

Key Path	User Preset
Remote Command	:SYSTem:PRESet:USER
Example	:SYST:PRES:USER:SAVE:SYST:PRES:USER
Notes	:SYST:PRES:USER:SAVE is used to save the current state as the user preset state. Clears all pending OPC bits. The Status Byte is set to 0. Pressing the User Preset front-panel key while already in the User Preset menu will cause the User Preset to get executed
Couplings	A user preset will cause the currently running measurement to be aborted and cause the saved measurement to be active. Recalling a User Preset file has the same issues that recalling a Save State file has. Some settings may need to be limited and therefore re-coupled, since the capabilities of the mode may have changes when the User Preset file was last saved.
Initial S/W Revision	Prior to A.02.00

User Preset All Modes

Recalls all of the User Preset files for each mode, switches to the power-on mode, and activates the saved measurement from the power-on mode User Preset file.

NOTE

When the instrument is secured, all of the user preset files are converted back to their default user preset files.

The User Preset function does the following:

- Aborts the currently running measurement.
- Switches the Mode to the power-on mode.
- Restores the User Preset files for each mode.
- Makes the saved measurement for the power-on mode the active measurement.
- Brings up the saved menu for the power-on mode.
- Clears the input and output buffers.
- Sets the Status Byte to 0.

Key Path	User Preset
Remote Command	:SYSTem:PRESet:USER:ALL
Example	:SYST:PRES:USER:SAVE:SYST:PRES:USER:ALL
Notes	Clears all pending OPC bits. The Status Byte is set to 0. :SYST:PRES:USER:SAVE is used to save the current state as the user preset state.
Couplings	A user preset will cause the currently running measurement to be aborted, cause a mode switch to the power-on mode, and cause the saved measurement to be active in the power-on mode. Recalling a User Preset file has the same issues that recalling a Save State file has. Some settings may need to be limited and therefore re-coupled, since the capabilities of the mode may have changes when the User Preset file was last saved.

Initial S/W Revision	Prior to A.02.00
----------------------	------------------

Save User Preset

Saves the currently active mode and its State. You can recall this User Preset file by pressing the User Preset menu key or sending the SYST:PRES:USER remote command. This same state is also saved by the Save State function.

Key Path	User Preset
Remote Command	:SYSTem:PRESet:USER:SAVE
Example	:SYST:PRES:USER:SAVE
Notes	:SYST:PRES:SAVE creates the same file as if the user requested a *SAV or a MMEM:STOR:STAT, except User Preset Save does not allow the user to specify the filename or the location of the file.
Initial S/W Revision	Prior to A.02.00

View/Display

Accesses a menu of functions that enable you to control the instrument display as well as turn the bar graph On and Off.

If current mode is NOT DVB-T/H, DTMB (CTTB), ISDB-T, MSR, LTE-Advanced FDD/TDD or CMMB mode, the front panel views only contain one view: Spectrum View. The results of the measurement can be displayed as a single spectrum trace view or displayed with a Bar Graph trace on the spectrum trace.

Spectrum View with Bar Graph off

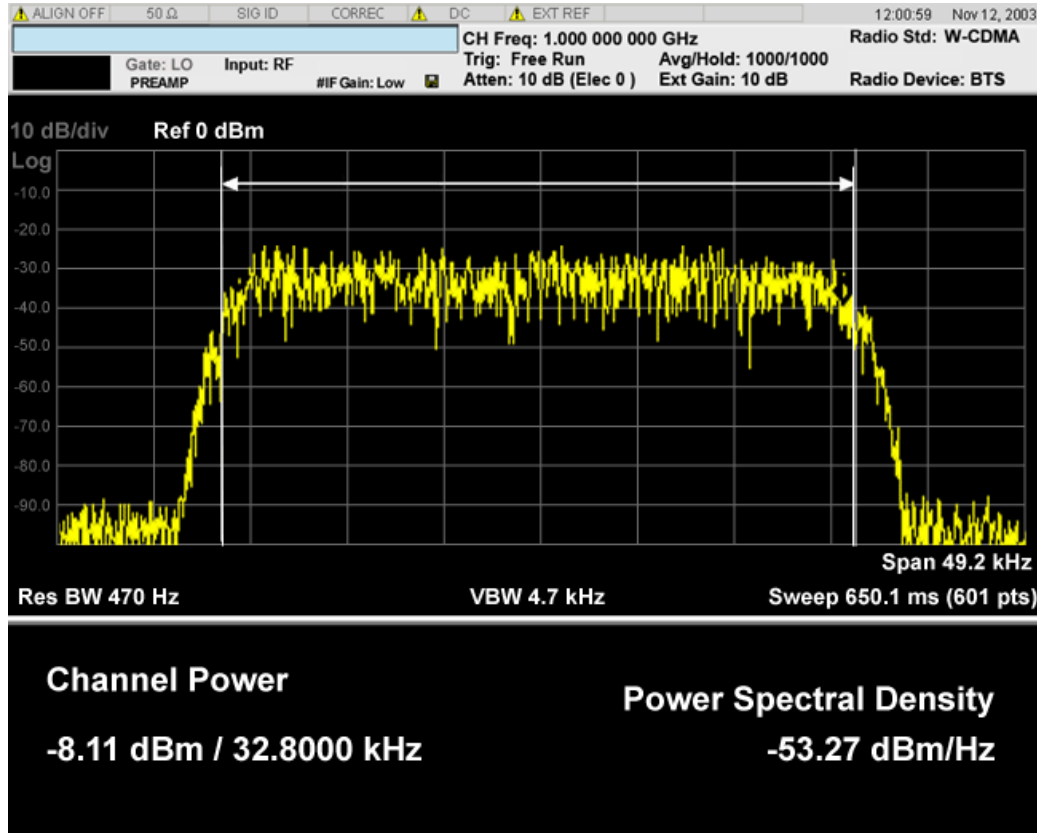

Spectrum View with Bar Graph on

This View is the same as the 'Spectrum' view, but has a blue bar between the markers that indicates the measured output power level. The bar graph is activated when the "Bar Graph" Soft Key is set to ON under the View/Display menu. The actual measured output power level is displayed on the display at the bottom of the bar.

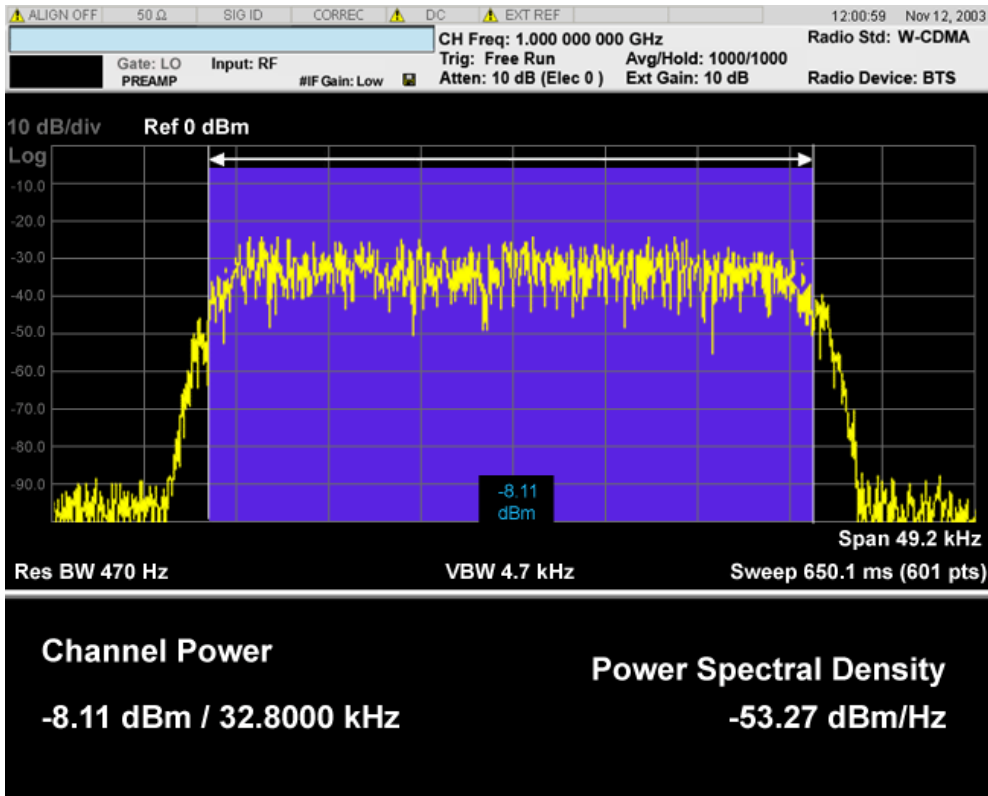

If current mode is MSR and LTE-Advanced FDD/TDD, there are two views, Power Results and Carrier Info. Power Results view is almost the same as the common CHP view.

If the current mode is WLAN and the format is WLAN 802.11ac 80+80 MHz, the spectrum view is changed a little so that the results of both carrier segments can be displayed.

Spectrum View with Bar Graph off for WLAN 802.11ac (80 + 80 MHz):

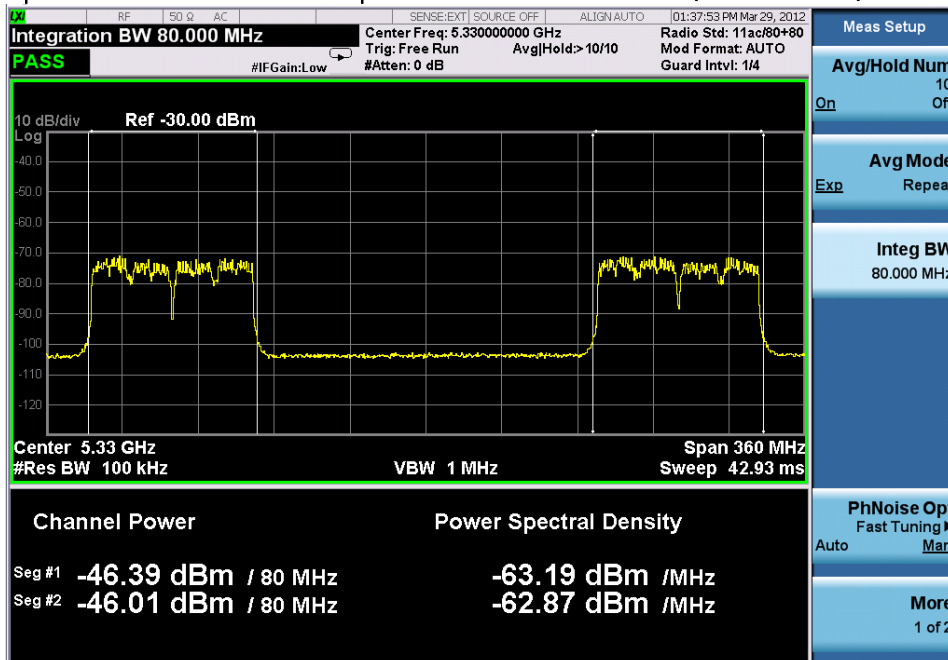

Spectrum View with Bar Graph on for WLAN 802.11ac (80 + 80 MHz):

8 Channel Power Measurement View/Display

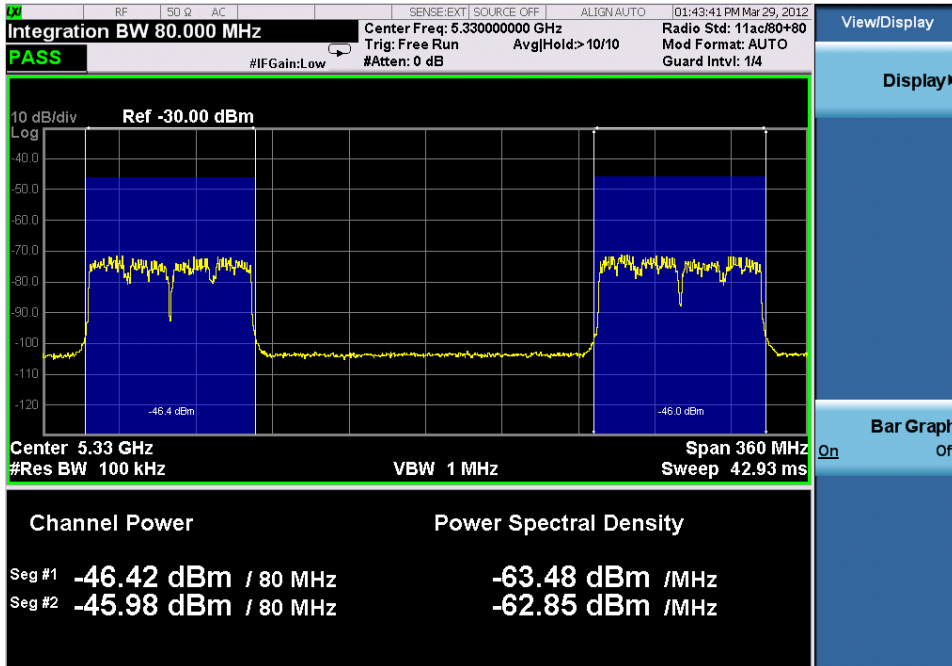

Power Results:

The spectrum trace and power bars are displayed in the upper window. Total carrier power, total PSD and total format carrier power are displayed in the lower window. Total format carrier power is total power of carriers of the same Radio Format. If there is no carrier of the corresponding format, it is not displayed. Thus items in the total format power table changes depending on the carrier configuration. Since the metrics window of MSR and LTE-Advanced FDD/TDD is a bit denser than the common CHP, vertical positions of total power and power spectral density goes up a little bit.

Carrier Info:

The lower window of Power Results view is replaced by the carrier info table in this view. Carrier center frequency can be displayed in either offset or absolute frequency depending on Carrier Freq. The table can be scrolled by Carrier Result on Meas Setup menu or by Select Carrier on Config Carriers menu. The highlighted row changes as either Carrier Result or Select Carrier is changed. The highlighted row and these keys are not coupled.

View selection by name (MSR and LTE-Advanced FDD/TDD only)

Selects the results view. The following SCPI command allows you to select the desired measurement view by enumeration.

Key Path	No equivalent front-panel key
Mode	MSR, LTEAFDD, LTEATDD
Remote Command	:DISPlay:CHPower:VIEW[:SElect] PRESult CINformation :DISPlay:CHPower:VIEW[:SElect]?
Example	:DISP:CHP:VIEW PRES :DISP:CHP:VIEW?

Preset	PRESult
State Saved	Saved in instrument state
Range	Power Results Carrier Info
Initial S/W Revision	A.10.00

Selects the results view. The following SCPI command allows you to select the desired measurement view by enumeration.

Key Path	No equivalent front-panel key
Mode	MSR, LTEAFDD, LTEATDD
Remote Command	:DISPlay:CHPower:VIEW:NSElect <integer> :DISPlay:CHPower:VIEW:NSElect?
Example	DISP:CHP:VIEW:NSEL 1 DISP:CHP:VIEW:NSEL?
Preset	1
State Saved	Saved in instrument state
Min	1
Max	2
Initial S/W Revision	A.10.00

View selection by name (DTMB (CTTB), DVB-T/H only)

Selects the results view. The following SCPI command allows you to select the desired measurement view by enumeration.

Key Path	No equivalent front-panel key
Mode	DVB-T/H, DTMB (CTTB)
Remote Command	:DISPlay:CHPower:VIEW[:SElect] RFSpectrum SHOulder MASK :DISPlay:CHPower:VIEW[:SElect]?
Example	DISP:CHP:VIEW RFSP DISP:CHP:VIEW?
Preset	RFSpectrum
State Saved	Saved in instrument state.
Range	RF Spectrum Shoulder Attenuation Spectrum Mask
Initial S/W Revision	A.02.00

View selection by name (ISDB-T, CMMB only)

Selects the results view. The following SCPI command allows you to select the desired measurement view by enumeration.

Key Path	No equivalent front-panel key
Mode	ISDB-T, CMMB
Remote Command	:DISPlay:CHPower:VIEW[:SElect] RFSPectrum SHOUlder :DISPlay:CHPower:VIEW[:SElect]?
Example	DISP:CHP:VIEW RFSP DISP:CHP:VIEW?
Preset	RFSPectrum
State Saved	Saved in instrument state.
Range	RF Spectrum Shoulder Attenuation
Initial S/W Revision	A.03.00

Key Path	Front-panel key
Initial S/W Revision	Prior to A.02.00

Display

The Display menu is common to most measurements, and is used for configuring items on the display. Some Display menu settings apply to all the measurements in a mode, and some only to the current measurement. Those under the **System Display Settings** key apply to all measurements in all modes.

Key Path	Display
Key Path	View/Display
Initial S/W Revision	Prior to A.02.00

Annotation

Turns on and off various parts of the display annotation. The annotation is divided up into four categories:

1. Meas Bar: This is the measurement bar at the top of the screen. It does not include the settings panel or the Active Function. Turning off the Meas Bar turns off the settings panel and the Active Function. When the Meas Bar is off, the graticule area expands to fill the area formerly occupied by the Meas Bar.
2. Screen Annotation: this is the annotation and annunciation around the graticule, including any annotation on lines (such as the display line, the threshold line, etc.) This does NOT include the marker number or the N dB result. When off, the graticule expands to fill the entire graticule area.
3. Trace annotation: these are the labels on the traces, showing their detector (or their math mode).

4. Active Function annotation: this is the active function display in the meas bar, and all of the active function values displayed on softkeys.

See the figure below. Each type of annotation can be turned on and off individually.

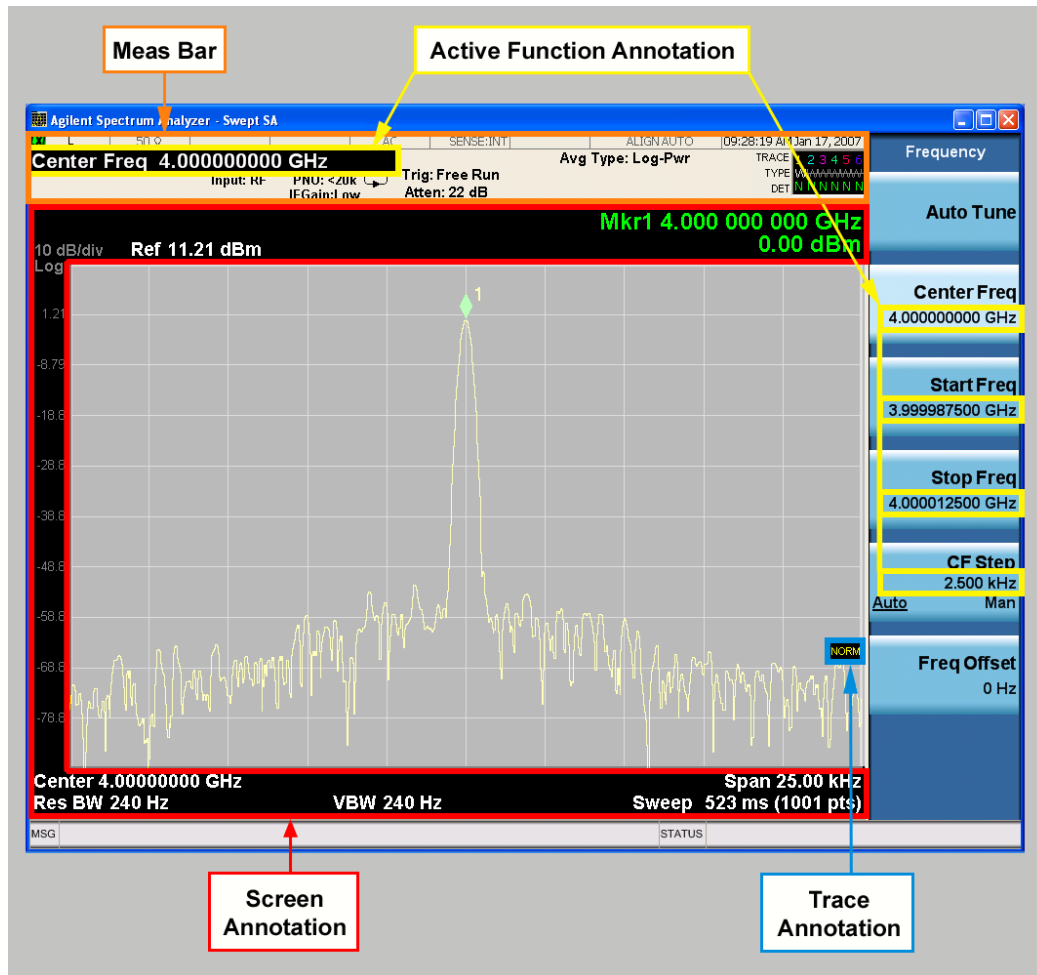

Key Path	View/Display, Display
Initial S/W Revision	Prior to A.02.00

Meas Bar On/Off

This function turns the Measurement Bar on and off, including the settings panel. When off, the graticule area expands to fill the area formerly occupied by the Measurement Bar.

Key Path	View/Display, Display, Annotation
Remote Command	:DISPlay:ANNotation:MBAR[:STATe] OFF ON 0 1 :DISPlay:ANNotation:MBAR[:STATe]?
Example	DISP:ANN:MBAR OFF

Dependencies	Grayed out and forced to OFF when System Display Settings, Annotation is set to Off.
Preset	On This should remain Off through a Preset when System DisplaySettings, Annotation is set to Off.
State Saved	Saved in instrument state.
Initial S/W Revision	Prior to A.02.00

Screen

This controls the display of the annunciation and annotation around the graticule, including any annotation on lines (such as the display line, the threshold line, etc.) and the y-axis annotation. This does NOT include marker annotation (or the N dB result). When off, the graticule expands to fill the entire graticule area, leaving only the 1.5% gap above the graticule as described in the Trace/Detector chapter.

Key Path	View/Display, Display, Annotation
Remote Command	:DISPlay:ANNotation:SCReen[:STATe] OFF ON 0 1 :DISPlay:ANNotation:SCReen[:STATe]?
Example	DISP:ANN:SCR OFF
Dependencies	Grayed-out and forced to OFF when System Display Settings, Annotation is set to Off.
Preset	On This should remain Off through a Preset when System DisplaySettings, Annotation is set to Off
State Saved	Saved in instrument state.
Initial S/W Revision	Prior to A.02.00

Active Function Values On/Off

Turns on and off the active function display in the Meas Bar, and all of the active function values displayed on the softkeys.

Note that all of the softkeys that have active functions have these numeric values blanked when this function is on. This is a security feature..

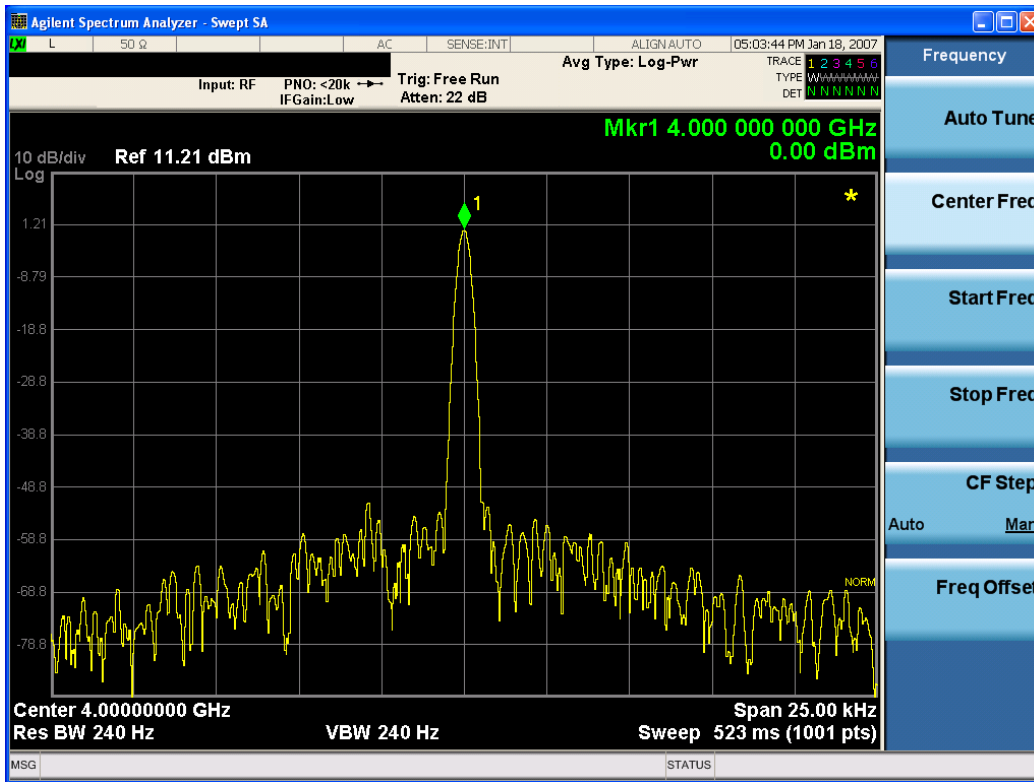

Key Path	View/Display, Display, Annotation
Remote Command	:DISPlay:ACTivefunc[:STATE] ON OFF 1 0 :DISPlay:ACTivefunc[:STATE]?
Example	DISP:ACT OFF
Dependencies	Grayed out and forced to OFF when System Display Settings, Annotation is set to Off.
Preset	On This should remain Off through a Preset when System DisplaySettings, Annotation is set to Off
State Saved	Saved in instrument state.
Initial S/W Revision	Prior to A.02.00

Title

Displays menu keys that enable you to change or clear a title on your display.

Key Path	View/Display, Display
Initial S/W Revision	Prior to A.02.00

Change Title

Writes a title into the "measurement name" field in the banner, for example, "Swept SA".

Press Change Title to enter a new title through the alpha editor. Press Enter or Return to complete the entry. Press ESC to cancel the entry and preserve your existing title.

The display title will replace the measurement name. It remains for this measurement until you press **Change Title** again, or you recall a state, or a Preset is performed. A title can also be cleared by pressing **Title**, **Clear Title**.

NOTE

Notice the inclusion of the <measurement> parameter in the command below. Because each measurement remembers the Display Title, the command must be qualified with the measurement name. For the Swept SA measurement this is not the case; no <measurement> parameter is used when changing the Display Title for the Swept SA measurement.

Key Path	View/Display, Display, Title
Mode	All
Remote Command	:DISPlay:<measurement>:ANNotation:TITLe:DATA <string> :DISPlay:<measurement>:ANNotation:TITLe:DATA?
Example	DISP:ANN:TITL:DATA "This Is My Title" This example is for the Swept SA measurement in the Spectrum Analyzer mode. The SANalyzer <measurement> name is not used. DISP:ACP:ANN:TITL:DATA "This Is My Title" This example is for Measurements other than Swept SA. Both set the title to: This Is My Title
Notes	Pressing this key cancels any active function. When a title is edited the previous title remains intact (it is not cleared) and the cursor goes at the end so that characters can be added or BKSP can be used to go back over previous characters.
Preset	No title (measurement name instead)
State Saved	Saved in instrument state.
Initial S/W Revision	Prior to A.02.00

Clear Title

Clears a title from the front-panel display. Once cleared, the title cannot be retrieved. After the title is cleared, the current Measurement Name replaces it in the title bar.

Key Path	View/Display, Display, Title
Example	The following commands clear the title and restore the measurement's original title: DISP:ANN:TITL:DATA "" This example is for the Swept SA measurement in the Spectrum Analyzer mode. The SANalyzer <measurement> name is not used. DISP:ACP:ANN:TITL:DATA "" This example is for ACP; in measurements other than Swept SA the measurement name is required.
Notes	Uses the :DISPlay:<measurement>:ANNotation:TITLe:DATA <string> command with an empty string (in the Swept SA, the <measurement> is omitted).

Preset	Performed on Preset.
Initial S/W Revision	Prior to A.02.00

Graticule

Pressing Graticule turns the display graticule On or Off. It also turns the graticule y-axis annotation on and off.

Key Path	View/Display, Display
Remote Command	:DISPlay:WINDow[1]:TRACe:GRATicule:GRID[:STATe] OFF ON 0 1 :DISPlay:WINDow[1]:TRACe:GRATicule:GRID[:STATe]?
Example	DISP:WIND:TRAC:GRAT:GRID OFF
Notes	The graticule is the set of horizontal and vertical lines that make up the grid/divisions for the x-axis and y-axis.
Preset	On
State Saved	Saved in instrument state
Initial S/W Revision	Prior to A.02.00

System Display Settings

These settings are "Mode Global" – they affect all modes and measurements and are reset only by **Restore Misc Defaults** or **Restore System Defaults** under System.

Key Path	View/Display, Display
Initial S/W Revision	Prior to A.02.00

Annotation Local Settings

This is a Mode Global override of the meas local annotation settings. When it is **All Off**, it forces **ScreenAnnotation, Meas Bar, Trace, and Active Function Values** settings to be **OFF** for all measurements in all modes. This provides the security based "annotation off" function of previous analyzers; hence it uses the legacy SCPI command.

When it is **All Off**, the **Screen, Meas Bar, Trace, and Active Function Values** keys under the **Display, Annotation** menu are grayed out and forced to **Off**. When **Local Settings** is selected, you are able to set the local annotation settings on a measurement by measurement basis.

Key Path	View/Display, Display, System Display Settings
Remote Command	:DISPlay:WINDow[1]:ANNotation[:ALL] OFF ON 0 1 :DISPlay:WINDow[1]:ANNotation[:ALL]?
Example	:DISP:WIND:ANN OFF

Preset	On (Set by Restore Misc Defaults)
State Saved	Not saved in instrument state.
Backwards Compatibility Notes	The WINDOW parameter and optional subopcode is included for backwards compatibility but ignored - all windows are equally affected.
Initial S/W Revision	Prior to A.02.00

Themes

Accesses a menu of functions that enable you to choose the theme to be used when saving the screen image.

The **Themes** option is the same as the **Themes** option under the **Display** and **Page Setup** dialogs. It allows you to choose between themes to be used when saving the screen image.

Key Path	Save, Screen Image
Remote Command	:MMEMory:STORe:SCReen:THEMe TDColor TDMonochrome FCOLor FMONochrome :MMEMory:STORe:SCReen:THEMe?
Example	:MMEM:STOR:SCR:THEM TDM
Preset	3D Color; Is not part of Preset, but is reset by Restore Misc Defaults or Restore System Defaults All and survives subsequent running of the modes.
Readback	3D Color 3D Mono Flat Color Flat Mono
Backwards Compatibility Notes	In ESA and PSA we offer the choice of "Reverse Bitmap" or "Reverse Metafile" when saving screen images. This is much like the "Flat Color" theme available in X-Series. Also, if you selected Reverse Bitmap AND a black & white screen image, that would be much like "Flat Monochrome". In other words, each of the X-Series themes has a similar screen image type in ESA/PSA. But they are not identical.
Initial S/W Revision	Prior to A.02.00

3D Color

Selects a standard color theme with each object filled, shaded and colored as designed.

Key Path	Save, Screen Image, Themes
Example	MMEM:STOR:SCR:THEM TDC
Readback	3D Color
Initial S/W Revision	Prior to A.02.00

3D Monochrome

Selects a format that is like 3D color but shades of gray are used instead of colors.

Key Path	Save, Screen Image, Themes
Example	MMEM:STOR:SCR:THEM TDM
Readback	3D Mono
Initial S/W Revision	Prior to A.02.00

Flat Color

Selects a format that is best when the screen is to be printed on an ink printer.

Key Path	Save, Screen Image, Themes
Example	MMEM:STOR:SCR:THEM FCOL
Readback	Flat Color
Initial S/W Revision	Prior to A.02.00

Flat Monochrome

Selects a format that is like Flat Color. But only black is used (no colors, not even gray), and no fill.

Key Path	Save, Screen Image, Themes
Example	MMEM:STOR:SCR:THEM FMON
Readback	Flat Mono
Initial S/W Revision	Prior to A.02.00

Backlight

Accesses the display backlight on/off keys. This setting may interact with settings under the Windows "Power" menu.

When the backlight is off, pressing ESC, TAB, SPACE, ENTER, UP, DOWN, LEFT, RIGHT, DEL, BKSP, CTRL, or ALT turns the backlight on without affecting the application. Pressing any other key will turn backlight on and could potentially perform the action as well.

Key Path	View/Display, Display, System Display Settings
Remote Command	:DISPlay:BACKlight ON OFF :DISPlay:BACKlight?
Preset	ON (Set by Restore Misc Defaults)
Initial S/W Revision	Prior to A.02.00

Backlight Intensity

An active function used to set the backlight intensity. It goes from 0 to 100 where 100 is full on and 0 is off. This value is independent of the values set under the Backlight on/off key.

Key Path	View/Display, Display, System Display Settings
Remote Command	:DISPlay:BACKlight:INTensity <integer> :DISPlay:BACKlight:INTensity?
Example	DISP:BACK:INT 50
Preset	100 (Set by Restore Misc Defaults)
Min	0
Max	100
Initial S/W Revision	Prior to A.02.00

Power Results (Only for MSR and LTE-Advanced FDD/TDD)

This view consists of the following two windows:

"Traces Window " on page 693 and "Results Window for MSR" on page 693

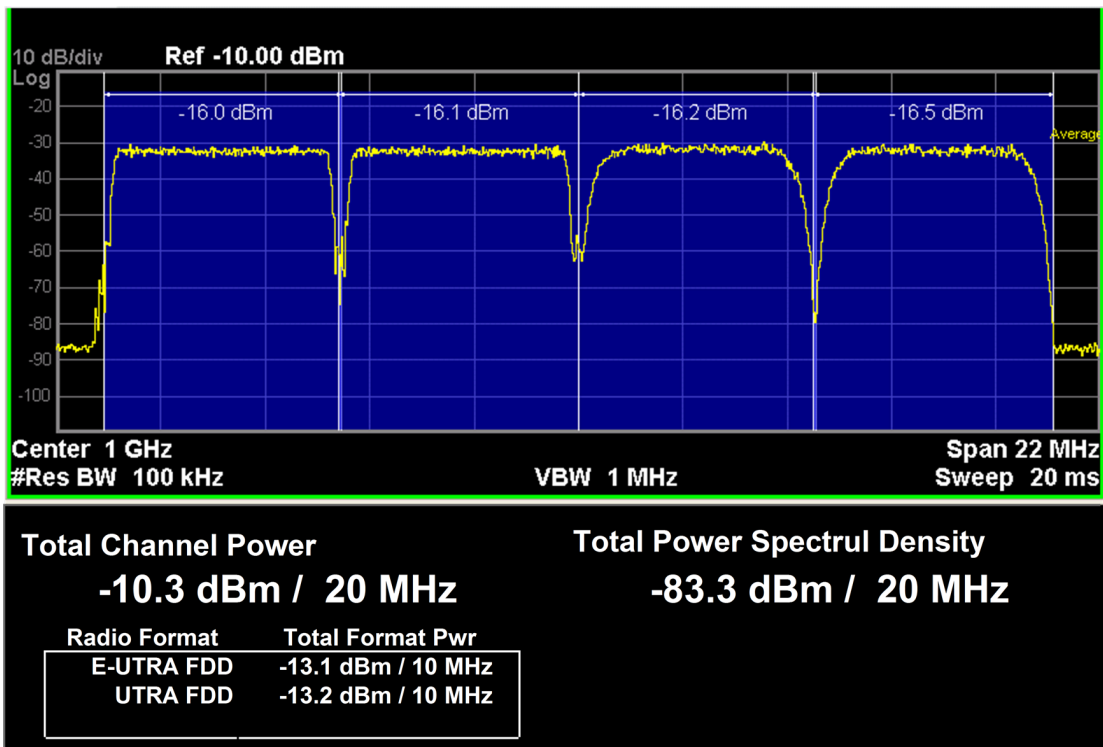

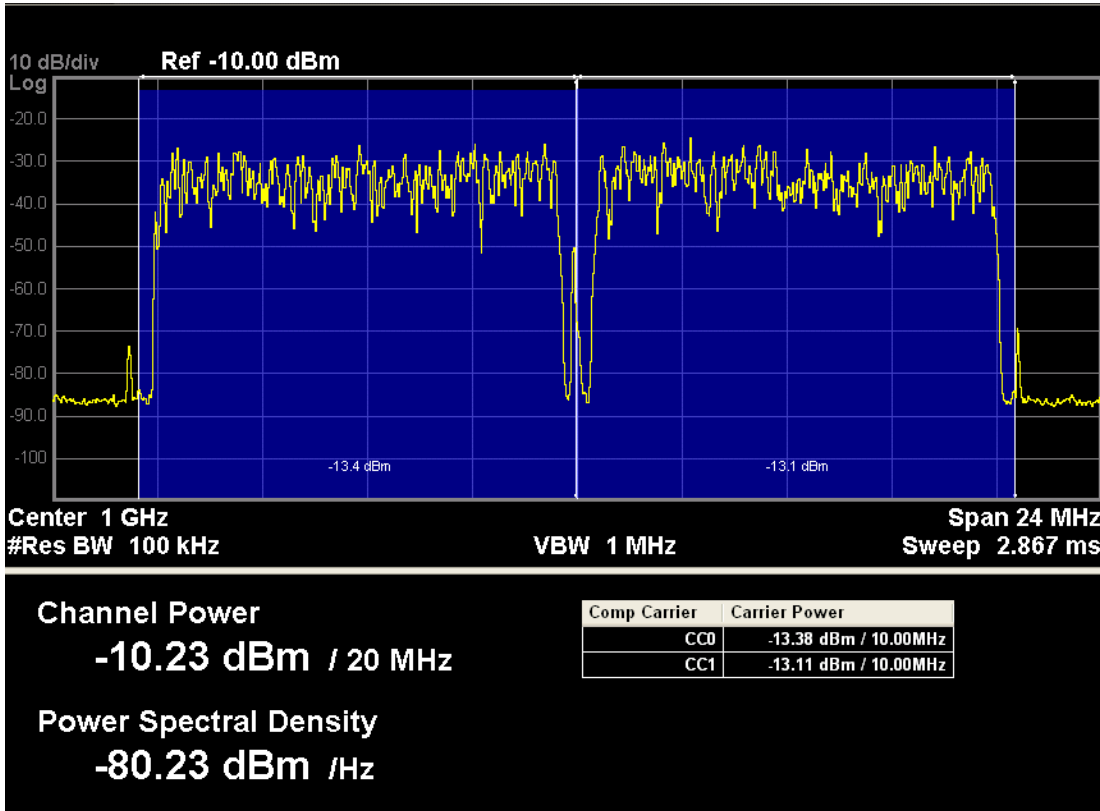

Figure 0-18 Power Results View of LTE-Advanced FDD/TDD CHP

Traces Window

Corresponding Trace	yellow - spectrum trace;
---------------------	--------------------------

Results Window for MSR

Name	Corresponding Results
Total Channel Power	n=1, 1st element Total channel power in the specified integration bandwidth
Total Power Spectral Density	n=1, 2nd element The power in the specified unit bandwidth
Total Format Pwr	n=4 Total powers of corresponding radio format

Results Window for LTE-Advanced FDD/TDD

Name	Corresponding Results
Total Channel Power	n=1, 1st element

	Total channel power in the specified integration bandwidth
Total Power Spectral Density	n=1, 2nd element The power in the specified unit bandwidth
Total Channel Power Per Component Carrier	n=3 Total Channel Power Per Component Carrier

Key Path	View/Display
Initial S/W Revision	A.14.00

Carrier Info (Only for MSR and LTE-Advanced FDD/TDD)

This view consists of the following two windows:

"Traces Window " on page 695 and "Results Window " on page 695

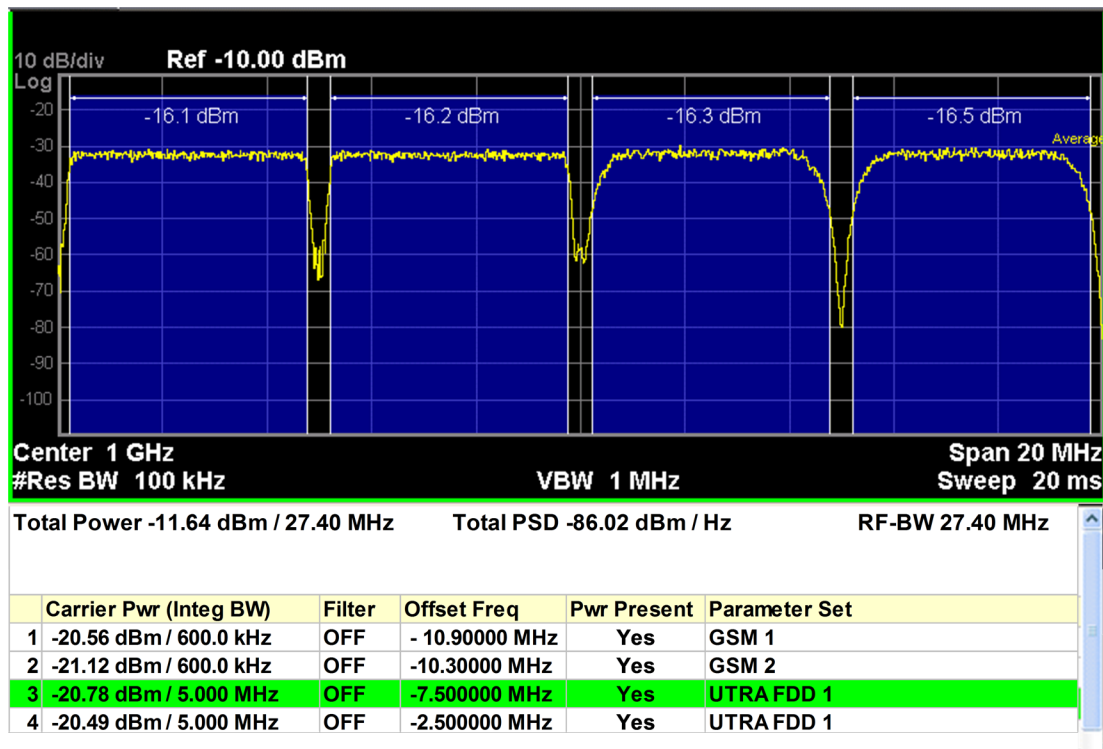

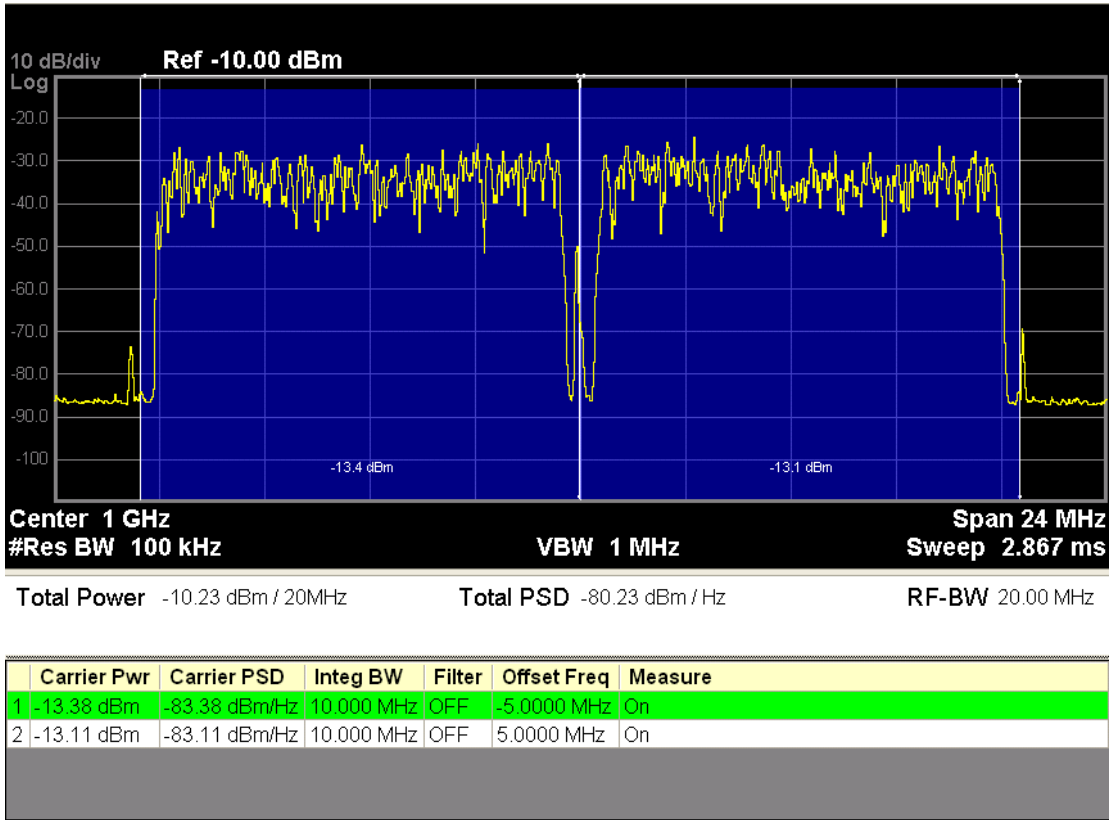

Figure 0-9 Carrier Info view of LTE-Advanced FDD/TDD CHP

Traces Window

Corresponding Trace yellow - spectrum trace;

Results Window

Name	Corresponding Results
Total Channel Power	n=1, 1st element Total channel power in the specified integration bandwidth
Total PSD	n=1, 2nd element The power in the specified unit bandwidth

Key Path	View/Display
Initial S/W Revision	A.14.00

Carrier Freq (Only for MSR and LTE-Advanced FDD/TDD)

Sets the carrier frequency display type.

Offset – The carrier center frequencies are displayed as offset from Carrier Ref Freq.

Absolute – The carrier center frequencies are displayed as absolute frequency.

Key Path	View/Display, Carrier Info
Mode	MSR, LTEAFDD, LTEATDD
Remote Command	:DISPlay:CHPower:VIEW:WINDow:CINFormation:FREQuency OFFSet ABSolute :DISPlay:CHPower:VIEW:WINDow:CINFormation:FREQuency?
Example	DISP:CHP:VIEW:WIND:CINF:FREQ ABS DISP:CHP:VIEW:WIND:CINF:FREQ?
Preset	OFFSet
State Saved	Saved in instrument state
Range	Offset Absolute
Initial S/W Revision	A.10.00

Bar Graph

Turns the Bar Graph On and Off.

Key Path	DVB-T/H, DTMB (CTTB), ISDB-T, CMMB: View/Display, RF SpectrumOthers: View/Display
Mode	SA, WCDMA, C2K, WIMAX OFDMA, 1xEVDO, DVB-T/H, DTMB (CTTB), ISDB-T, CMMB, LTE, LTE-TDD, Digital Cable TV, WLAN, MSR, LTEAFDD, LTEATDD
Remote Command	:DISPlay:CHPower:VIEW[1]:WINDow[1]:BGRaph ON OFF 1 0 :DISPlay:CHPower:VIEW[1]:WINDow[1]:BGRaph?
Example	DISP:CHP:VIEW:WIND:BGR ON DISP:CHP:VIEW:WIND:BGR?
Notes	You must be in the Spectrum Analysis mode, W-CDMA mode, cdma2000 mode, DVB-T/H mode, DTMB (CTTB) mode, ISDB-T mode, CMMB mode, Digital Cable TV mode, LTE mode, LTE TDD mode, WLAN mode, 1xEVDO mode, MSR, LTE-Advanced FDD/TDD mode or WIMAX OFDMA mode to use this command. Use :INSTrument:SElect to set the mode.
Preset	OFF
State Saved	Saved in instrument state.
Range	On Off
Initial S/W Revision	Prior to A.02.00
Modified at S/W Revision	A.02.00, A.03.00

9 Occupied Bandwidth Measurement

The Occupied Bandwidth measurement computes and displays the bandwidth occupied by a given percentage of the total mean power of a signal. For measurement results and views, see [View/Display](#).

This topic contains the following sections:

["Remote Commands for Occupied Bandwidth" on page 698](#)

["Remote Command Results for Occupied Bandwidth Measurement" on page 699](#)

Remote Commands for Occupied Bandwidth

The following commands and queries can be used to retrieve the measurement results:

```
:CONFigure:OBWidth  
:CONFigure:OBWidth:NDEFault  
:INITiate:OBWidth  
:FETCh:OBWidth[n]?  
:MEASure:OBWidth[n]?  
:READ:OBWidth[n]?  
:FETCh:OBWidth:OBWidth?  
:MEASure:OBWidth:OBWidth?  
:READ:OBWidth:OBWidth?  
:FETCh:OBWidth:FERRor?  
:MEASure:OBWidth:FERRor?  
:READ:OBWidth:FERRor?  
:FETCh:OBWidth:XDB?  
:MEASure:OBWidth:XDB?  
:READ:OBWidth:XDB?
```

See also the section, "[Remote Measurement Functions](#)" on page 2381.

Remote Command Results for Occupied Bandwidth Measurement

The following table describes the results returned by the FETCh:OBWidth[n]?, MEASure:OBWidth[n]?, and READ:OBWidth[n]? queries listed above, according to the index value n.

n	Results Returned
n=1 (or not specified)	Returns 7 scalar results, in the following order: <ol style="list-style-type: none"> 1. Occupied bandwidth – Hz 2. Total Power or OBW Power – dBm (Power reference type can be changed with the Power Ref key in Meas Setup. Total Power will be obsolete in TD-SCDMA mode, this place will be replaced by NaN) 3. Span - Hz 4. Spectrum Trace Points - points 5. Res BW – Hz 6. Transmit Frequency Error Hz 7. x DB Bandwidth - Hz
2	Returns the frequency-domain spectrum trace (data array) for the entire frequency range being measured.
3 (Mode = MSR, LTEAFDD, LTEATDD)	1. Number of active carriers Returns number of active carriers within Span in Auto detected mode, otherwise the command is out of scope.
4	Returns OBW Boundaries table results in the following order: <ol style="list-style-type: none"> 1. Occupied bandwidth – Hz 2. Total Power or OBW Power – dBm (Power reference type is changed with Power Ref key in Meas Setup. Total Power will be obsolete in TD-SCDMA mode, this place will be replaced by NaN) 3. x dB Reference Power – dBm 4. x dB Reference Power Frequency - offset frequency [Hz] 5. x dB Reference Power Frequency – absolute frequency [Hz] 6. NaN (9.91E+37) 7. NaN (9.91E+37) 8. NaN (9.91E+37) 9. Lower OBW boundary - offset frequency [Hz] 10. Lower OBW boundary - absolute frequency [Hz] 11. Lower OBW boundary - absolute power [dBm] 12. Lower OBW boundary - relative power [dBc] 13. Upper OBW boundary - offset frequency [Hz] 14. Upper OBW boundary - absolute frequency [Hz] 15. Upper OBW boundary - absolute power [dBm] 16. Upper OBW boundary - relative power [dBc] 17. Lower x dB BW boundary - offset frequency [Hz] 18. Lower x dB BW boundary - absolute frequency [Hz] 19. Lower x dB BW boundary - absolute power [dBm]

n	Results Returned
	20. NaN (9.91E+37)
	21. Upper x dB BW boundary - offset frequency [Hz]
	22. Upper x dB BW boundary - absolute frequency [Hz]
	23. Upper x dB BW boundary - absolute power [dBm]
	24. NaN (9.91E+37)
	The results 6, 7, 8, 20 and 24 always return NaN (9.91E+37)

Key Path	Meas
Initial S/W Revision	Prior to A.02.00
Modified at S/W Revision	A.16.00

AMPTD Y Scale (Amplitude/Y Scale)

Activates the Reference Value function and displays the Amplitude menu keys. These functions control how data on the vertical (Y) axis is displayed and control instrument settings that affect the vertical axis

See AMPTD Y Scale for more information.

Key Path	Front-panel key
Initial S/W Revision	Prior to A.02.00

Ref Value

Sets the absolute power reference value. However, since the Auto Scaling is defaulted to On, this value is automatically determined by the measurement result. When you set a value manually, Auto Scaling automatically changes to Off.

Key Path	AMPTD Y Scale
Mode	SA, WCDMA, C2K, WIMAX OFDMA, TD-SCDMA, 1xEVDO, ISDB-T, CMMB, LTE, LTE-TDD, BLUETOOTH, WLAN, MSR, LTEAFDD, LTEATDD
Remote Command	:DISPlay:OBWidth:VIEW[1]:WINDow[1]:TRACe:Y[:SCALe]:RLEVel <real> :DISPlay:OBWidth:VIEW[1]:WINDow[1]:TRACe:Y[:SCALe]:RLEVel?
Example	DISP:OBW:VIEW:WIND:TRAC:Y:RLEV 125 DISP:OBW:VIEW:WIND:TRAC:Y:RLEV?
Notes	You must be in the Spectrum Analysis mode, W-CDMA mode, cdma2000 mode, TD-SCDMA mode, ISDB-T mode, CMMB mode, BLUETOOTH mode, LTE mode, LTE TDD mode, WLAN mode, 1xEVDO mode, MSR, LTE-Advanced FDD/TDD or WIMAX OFDMA mode to use this command. Use:INSTrument:SElect to set the mode.
Couplings	When the Auto Scaling is On, this value is automatically determined by the measurement result. When you set a value manually, Auto Scaling automatically changes to Off.
Preset	10.00 dBm
State Saved	Saved in instrument state.
Min	-250.00 dBm
Max	250.00 dBm
Initial S/W Revision	Prior to A.02.00
Modified at S/W Revision	A.03.00

Attenuation

This menu controls the attenuator functions and interactions between the attenuation system components.

There are two attenuator configurations in the X-Series. One is a dual attenuator configuration consisting of a mechanical attenuator and an optional electronic attenuator. The other configuration uses a single

attenuator with combined mechanical and electronic sections that controls all the attenuation functions. Different models in the X-Series come with different configurations.

See ["Dual Attenuator Configurations:" on page 702](#)

See ["Single Attenuator Configuration:" on page 703](#)

Most Attenuation settings are the same for all measurements – they do not change as you change measurements. Settings like these are called “Meas Global” and are unaffected by Meas Preset.

Key Path	AMPTD Y Scale
Scope	Meas Global
Dependencies	In measurements that support the I/Q inputs, this key is unavailable when I/Q is the selected input, and is replaced by the Range key in that case.
Readback Line	Contains a summary in [] brackets of the current total attenuation. See the descriptions of the , " (Mech) Atten " on page 2297, and " Enable Elec Atten " on page 2299 keys for more detail on the contributors to the total attenuation. Note that when "Pre-Adjust for Min Clip" is on, this value can change at the start of every measurement.
Initial S/W Revision	Prior to A.02.00
Modified at S/W Revision	A.03.00

Dual Attenuator Configurations:

Configuration 1: Mechanical attenuator + optional electronic attenuator

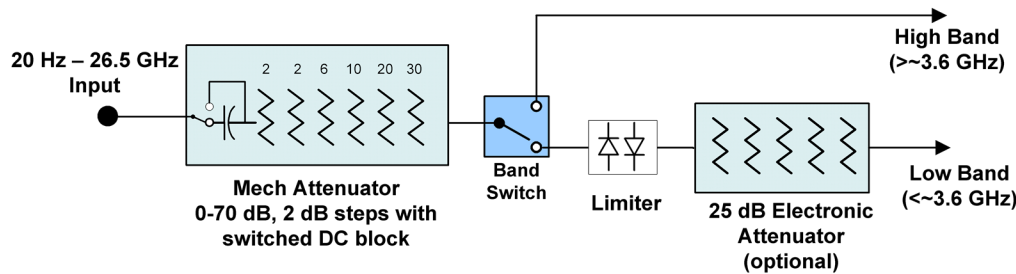

Configuration 2: Mechanical attenuator, no optional electronic attenuator

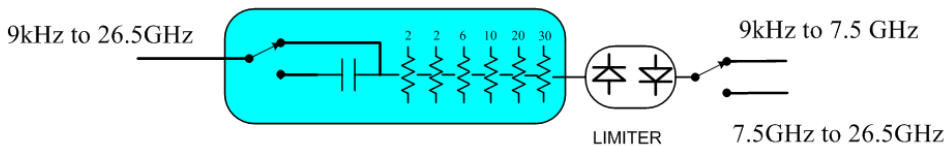

(note that Configuration 2 is not strictly speaking a dual-section attenuator, since there is no electronic section available. However, it behaves exactly like Configuration 1 without the Electronic Attenuator option EA3, therefore for the sake of this document it is grouped into the “Dual Attenuator” configuration)

Single Attenuator Configuration:

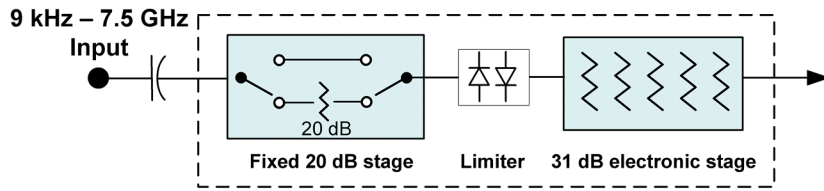

You can tell which attenuator configuration you have by pressing the Attenuation key, which (in most Modes) opens the Attenuation menu. If the first key in the Attenuation menu says **Mech Atten** you have the dual attenuator configuration. If the first key says **Atten** you have the single attenuator configuration.

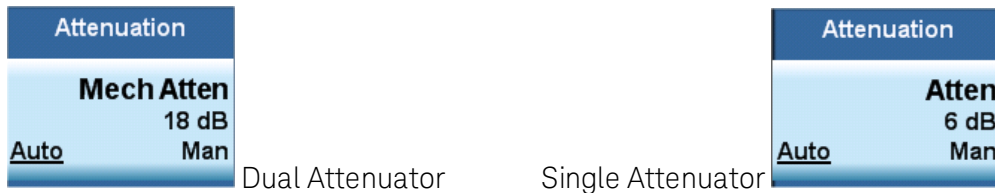

In the single attenuator configuration, you control the attenuation with a single control, as the fixed stage has only two states. In the dual attenuator configuration, both stages have significant range so you are given separate control of the mechanical and electronic attenuator stages.

When you have the dual attenuator configuration, you may still have only a single attenuator, because unless option EA3 (the Electronic Attenuator option) is available, and you purchase it, you will have only the mechanical attenuator.

(Mech) Atten

This key is labeled **Mech Atten** in dual attenuator models and **Atten** in single attenuator models. In the dual attenuator configuration, this key only affects the mechanical attenuator.

This key lets you modify the attenuation applied to the RF input signal path. This value is normally auto coupled to the Ref Level, the Internal Preamp Gain, any External Gain that is entered, and the Max Mixer Level, as described in the table below.

See "[Attenuator Configurations and Auto/Man](#)" on page 705

Key Path	AMPTD Y Scale, Attenuation
Remote Command	<pre>[:SENSe]:POWer[:RF]:ATTenuation <rel_amp1> [:SENSe]:POWer[:RF]:ATTenuation? [:SENSe]:POWer[:RF]:ATTenuation:AUTO OFF ON 0 1 [:SENSe]:POWer[:RF]:ATTenuation:AUTO?</pre>
Example	<p>POW:ATT 20</p> <p>Dual attenuator configuration: sets the mechanical attenuator to 20 dB</p> <p>Single attenuator mode: sets the main attenuation to 20 dB (see below for definition of "main" attenuation).</p> <p>If the attenuator was in Auto, it sets it to Manual.</p>
Dependencies	Some measurements do not support the Auto setting of (Mech) Atten . In these measurements, the

Auto/Man selection is not available, and the Auto/Man line on the key disappears.

In dual attenuator configurations, when the electronic attenuator is enabled, the mechanical attenuator has no auto setting and the Auto/Man line on the key disappears. The state of Auto/Man is remembered and restored when the electronic attenuator is once again disabled. This is described in more detail in the ["Enable Elec Atten" on page 2299](#) key description.

See ["Attenuator Configurations and Auto/Man" on page 705](#) for more information on the Auto/Man functionality of Attenuation.

Couplings

When **(Mech) Atten** is in Auto, it uses the following algorithm to determine a value:

If the USB Preamp is connected to USB, use 0 dB.

Otherwise, $Atten = ReferenceLevel + PreAmpGain + ExternalGain - RefLevelOffset - MaxMixerLevel + IF\ Gain$.

Limit this value to be between 6 dB and the Max value. No value below 6 dB can ever be chosen by Auto.

The resulting value is rounded up to the largest value possible given the attenuation step setting. That is, 50.01 dB would change to 60 dB (for a 10 dB attenuation step).

The "IF Gain" term in the equation above is either 0 dB or +10 dB, depending on the settings of FFT IF Gain, Swept IF Gain, max Ref Level and the Auto/Man setting of Mech Atten.

In External Mixing and BBIQ, where the Attenuator is not in the signal path, the Attenuator setting changes as described above when **(Mech) Atten** is in Auto, but no changes are made to the actual attenuator hardware setting until the input is changed back to the RF Input.

Preset The preset for Mech Attenuation is "Auto."
 The Auto value of attenuation is:
 CXA, EXA, MXA and PXA: 10 dB

State Saved Saved in instrument state

Min 0 dB

The attenuation set by this key cannot be decreased below 6 dB with the knob or step keys. To get to a value below 6 dB it has to be directly entered from the keypad or via SCPI. This protects from adjusting the attenuation to a dangerously small value which can put the instrument at risk of damage to input circuitry. However, if the current mechanical attenuation is below 6 dB it can be increased with the knob and step keys, but not decreased.

Max CXA N9000A-503/507: 50 dB
 CXA N9000A-513/526: 70dB
 EXA: 60 dB
 MXA and PXA: 70 dB

In the single attenuator configuration, the total of ATT and EATT cannot exceed 50 dB, so if the EATT is set to 24 dB first, the main attenuation cannot be greater than 26 dB and will be reduced accordingly; if the main attenuator is set to 40 dB first, EATT cannot be greater than 10 dB.

Initial S/W Revision Prior to A.02.00

Modified at S/W Revision A.03.00

Attenuator Configurations and Auto/Man

As described in the Attenuation key description, there are two distinct attenuator configurations available in the X-Series, the single attenuator and dual attenuator configurations. In dual attenuator configurations, we have the mechanical attenuation and the electronic attenuation, and the current total attenuation is the sum of the electronic + mechanical attenuation. In single attenuator configurations, we refer to the attenuation set using the **(Mech) Atten** key (or POW:ATT SCPI) as the “main” attenuation; and the attenuation that is set by the SCPI command POW:EATT as the “soft” attenuation (the POW:EATT command is honored even in the single attenuator configuration, for compatibility purposes). Then the current total attenuation is the sum of the main + soft attenuation. See the **Elec Atten** key description for more on “soft” attenuation.

In the dual attenuator configuration, when the electronic attenuator is enabled, there is no Auto/Man functionality for the mechanical attenuator, and the third line of the key label (the Auto/Man line) disappears:

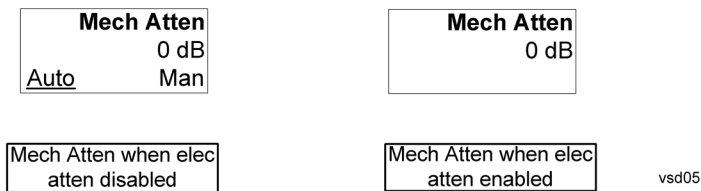

Enable Elec Atten

Enables the Electronic Attenuator.

The electronic attenuator offers finer steps than the mechanical attenuator, has no acoustical noise, is faster, and is less subject to wear. These advantages primarily aid in remote operation and are negligible for front panel use. See ["Using the Electronic Attenuator: Pros and Cons" on page 707](#) for a detailed discussion of the pros and cons of using the electronic attenuator.

For the single attenuator configuration, for SCPI backwards compatibility, the “soft” attenuation feature replaces the dual attenuator configuration’s electronic attenuator. All the same couplings and limitations apply. See ["Attenuator Configurations and Auto/Man" on page 2299](#)

See ["More Information" on page 706](#)

Key Path	AMPTD Y Scale, Attenuation
Remote Command	[:SENSe] :POWer [:RF] :EATTenuation :STATE OFF ON 0 1 [:SENSe] :POWer [:RF] :EATTenuation :STATE ?
Example	POW:EATT:STAT ON
Dependencies	This key only appears in Dual Attenuator models with an Electronic Attenuator installed. It does not appear in models with the Single Attenuator configuration, as in the single attenuator configuration there is no “electronic attenuator” there is only a single integrated attenuator (which has both a mechanical and electronic stage). However, in the single attenuator configuration, EATT SCPI commands are accepted for compatibility with other X-series instruments and set a “soft” attenuation as described in "Attenuator Configurations and Auto/Man" on page 2299 . The electronic attenuator (and the “soft” attenuation function provided in single attenuator configurations) is unavailable above 3.6 GHz. Therefore, if the Stop Frequency of the analyzer is > 3.6 GHz then the Enable Elec Atten key will be OFF and grayed out.

If the Internal Preamp is on, meaning it is set to Low Band or Full, the electronic attenuator (and the “soft” attenuation function provided in single attenuator configurations) is unavailable. In this case the **Enable Elec Atten** key will be OFF and grayed out.

If either of the above is true, if the SCPI command is sent, an error indicating that the electronic attenuator is unavailable will be sent.

If the electronic/soft Attenuator is enabled, then the Stop Freq of the analyzer is limited to 3.6 GHz and the Internal Preamp is unavailable.

The SCPI-only “soft” electronic attenuation for the single-attenuator configuration is not available in all measurements; in particular, it is not available in the Swept SA measurement.

Couplings	Enabling and disabling the Electronic Attenuator affects the setting of the Mechanical Attenuator (in dual attenuator configurations). This is described in more detail below this table.
Preset	OFF for Swept SA measurement; ON for all other measurements that support the electronic attenuator
State Saved	Saved in instrument state
Initial S/W Revision	Prior to A.02.00
Modified at S/W Revision	A.03.00

More Information

Mechanical Attenuator Transition Rules

When the Electronic Attenuator is enabled, the Mechanical Attenuator transitions to a state that has no Auto function. Below are the rules for transitioning the Mechanical Attenuator. NOTE that the information below ONLY applies to the dual attenuator configurations, and ONLY when the Electronic Attenuator is installed:

When the Electronic Attenuation is enabled from a disabled state:

- The Mechanical Attenuator is initialized to 10 dB (this is its optimal performance setting). You can then set it as desired with SCPI, numeric keypad, step keys, or knob, and it behaves as it normally would in manual mode
- The Auto/Man state of (Mech) Atten is saved
- The Auto/Man line on the (Mech) Atten key disappears and the auto rules are disabled
- The Electronic Attenuator is set to 10 dB less than the previous value of the Mechanical Attenuator, within the limitation that it must stay within the range of 0 to 24 dB of attenuation.

Examples in the dual attenuator configuration:

- Mech Atten at 20 dB. Elec Atten enabled, Mech Atten set to 10 dB, and Elec Atten set to 10 dB. New total attenuation equals the value before Elec Atten enabled.
- Mech Atten at 0 dB. Elec Atten enabled, Mech Atten set to 10 dB, and Elec Atten set to 0 dB. New total attenuation does not equal the value before Elec Atten enabled.
- Mech Atten at 40 dB. Elec Atten enabled, Mech Atten set to 10 dB, and Elec Atten set to 24 dB. New total attenuation does not equal the value before Elec Atten enabled.

When the Electronic Attenuation is disabled from an enabled state:

- The Elec Atten key is grayed out
- The Auto/Man state of (Mech) Atten is restored
- If now in Auto, (Mech) Atten recouples
- If now in Man, (Mech) Atten is set to the value of total attenuation that existed before the Elec Atten was disabled. The resulting value is rounded up to the smallest value possible given the (Mech) Atten Step setting - (That is, 57 dB changes to 58 dB when (Mech) Atten Step is 2 dB.)

Using the Electronic Attenuator: Pros and Cons

The electronic attenuator offers finer steps than the mechanical attenuator, has no acoustical noise, is faster, and is less subject to wear.

The “finer steps” advantage of the electronic attenuator is beneficial in optimizing the alignment of the analyzer dynamic range to the signal power in the front panel as well as remote use. Thus, you can achieve improved relative signal measurement accuracy. Compared to a mechanical attenuator with 2 dB steps, the 1 dB resolution of the electronic attenuator only gives better resolution when the odd-decibel steps are used. Those odd-decibel steps are less accurately calibrated than the even-decibel steps, so one tradeoff for this superior relative accuracy is reduced absolute amplitude accuracy.

Another disadvantage of the electronic attenuator is that the spectrum analyzer loses its “Auto” setting, making operation less convenient.

Also, the relationship between the dynamic range specifications (TOI, SHI, compression and noise) and instrument performance are less well-known with the electrical attenuator. With the mechanical attenuator, TOI, SHI and compression threshold levels increase dB-for-dB with increasing attenuation, and the noise floor does as well. With the electronic attenuator, there is an excess attenuation of about 1 to 3 dB between 0 and 3.6 GHz, making the effective TOI, SHI, and so forth, less well known. Excess attenuation is the actual attenuation relative to stated attenuation. Excess attenuation is accounted for in the analyzer calibration

Elec Atten

Controls the Electronic Attenuator in dual attenuator configurations. This key does not appear in single attenuator configurations, as the control of both the mechanical and electronic stages of the single attenuator is integrated into the single **Atten** key.

Key Path	AMPTD Y Scale, Attenuation
Remote Command	<code>[:SENSe] :POWer [:RF] :EATTenuation <rel_ampl></code> <code>[:SENSe] :POWer [:RF] :EATTenuation?</code>
Notes	Electronic Attenuation's specification is defined only when Mechanical Attenuation is 6 dB.
Dependencies	This key only appears in Dual Attenuator models with an Electronic Attenuator installed. It does not appear in models with the Single Attenuator configuration, as in the single attenuator configuration there is no “electronic attenuator” there is only a single integrated attenuator (which has both a mechanical and electronic stage). However, in the single attenuator configuration, EATT SCPI commands are accepted for compatibility with other X-series instruments and set a “soft” attenuation as described in "Attenuator Configurations and Auto/Man" on page 2299 . The “soft” attenuation is treated as an addition to the “main” attenuation value set by the Atten softkey or the

	POW:ATT SCPI command and affects the total attenuation displayed on the Attenuation key and the Meas Bar. When Enable Elec Atten is off or grayed out, the Elec Atten key is grayed out.
Preset	0 dB
State Saved	Saved in instrument state
Min	0 dB
Max	Dual attenuator configuration: 24 dB Single attenuator configuration: the total of ATT and EATT cannot exceed 50 dB, so if the EATT is set to 24 dB first, the main attenuation cannot be greater than 26 dB and will be reduced accordingly; if the main attenuator is set to 40 dB first, EATT cannot be greater than 10 dB
Initial S/W Revision	Prior to A.02.00
Modified at S/W Revision	A.03.00

Adjust Atten for Min Clip

Sets the combination of mechanical and electronic attenuation and gain based on the current measured signal level so that clipping will be at a minimum.

This is an "immediate action" function, that is, it executes once, when the key is pressed.

This key is grayed out in measurements that do not support this functionality. The spectrum analyzer measurement, Swept SA, does not support this functionality.

Key Path	AMPTD Y Scale, Attenuation
Remote Command	<code>[:SENSe] :POWer [:RF] :RANGe :OPTimize IMMEDIATE</code>
Initial S/W Revision	Prior to A.02.00
Modified at S/W Revision	A.03.00

Pre-Adjust for Min Clip

If this function is on, it does the adjustment described under "[Adjust Atten for Min Clip](#)" on page 2302 each time a measurement restarts. Therefore, in Continuous measurement mode, it only executes before the first measurement.

In dual attenuator models, you can set **Elec+Mech Atten**, in which case both attenuators participate in the autoranging, or **Elec Atten Only**, in which case the mechanical attenuator does not participate in the autoranging. This latter case results in less wear on the mechanical attenuator and is usually faster.

This key is grayed out in measurements that do not support this functionality. The spectrum analyzer measurement, Swept SA, does not support this functionality.

Key Path	AMPTD Y Scale, Attenuation
Remote Command	<code>[:SENSe] :POWer [:RF] :RANGe :OPTimize :ATTenuation OFF ELECTRICAL COMBINED</code>

	<code>[:SENSe] :POWer [:RF] :RANGe:OPTimize:ATTenuation?</code>
Notes	The SCPI parameter ELECTrical sets this function to On in single attenuator models. The SCPI parameter COMBined is mapped to ELECTrical in single attenuator models; if you send COMBined , it sets the function to On and returns ELEC to a query.
Dependencies	This key only appears in Dual Attenuator models with an Electronic Attenuator installed. In instruments with Dual Attenuator model, when Enable Elec Atten is off or grayed out, the Pre-Adjust for Min Clip key is grayed out.
Preset	OFF for Swept SA measurement; ON for all other measurements that support Pre-Adjust for Min Clip
State Saved	Saved in instrument state
Range	Dual attenuator models: Off Elec Atten Only Mech + Elec Atten Single attenuator models: Off On
Initial S/W Revision	Prior to A.02.00
Modified at S/W Revision	A.03.00

Remote Command	<code>[:SENSe] :POWer [:RF] :RANGe:AUTO ON OFF 1 0</code> <code>[:SENSe] :POWer [:RF] :RANGe:AUTO?</code>
Notes	ON aliases to "Elec Atten Only" (:POW:RANG:OPT:ATT ELEC) OFF aliases to "Off" (:POW:RANG:OPT:ATT OFF) The query :POW:RANG:AUTO? returns true if :POW:RANG:OPT:ATT is not "Off"
Initial S/W Revision	Prior to A.02.00

Off

Turns **Pre-Adjust for Min Clip** off. This is the default setting.

This key is grayed out in measurements that do not support this functionality. The spectrum analyzer measurement, Swept SA, does not support this functionality.

Key Path	AMPTD Y Scale, Attenuation, Pre-Adjust for Min Clip
Example	:POW:RANGe:OPT:ATT OFF
Initial S/W Revision	Prior to A.02.00

Elec Atten Only

Selects only the electric attenuator to participate in auto ranging. This offers less wear on the mechanical attenuator and is usually faster.

This key is grayed out in measurements that do not support this functionality. The spectrum analyzer measurement, Swept SA, does not support this functionality.

Key Path	AMPTD Y Scale, Attenuation, Pre-Adjust for Min Clip
Example	:POW:RANGe:OPT:ATT ELEC
Initial S/W Revision	Prior to A.02.00

Mech + Elec Atten

In dual attenuator models, this selects both attenuators participate in the autoranging.

This key is grayed out in measurements that do not support this functionality. The spectrum analyzer measurement, Swept SA, does not support this functionality.

Key Path	AMPTD Y Scale, Attenuation, Pre-Adjust for Min Clip
Example	:POW:RANGe:OPT:ATT COMB
Initial S/W Revision	Prior to A.02.00

(Mech) Atten Step

This controls the step size used when making adjustments to the input attenuation.

This key is labeled **Mech Atten Step** in dual attenuator models and **Atten Step** in single attenuator models. In the dual attenuator configuration, this key only affects the step size of the mechanical attenuator.

Key Path	AMPTD Y Scale, Attenuation
Remote Command	[:SENSe] :POWer [:RF] :ATTenuation :STEP [:INCRement] 10 dB 2 dB [:SENSe] :POWer [:RF] :ATTenuation :STEP [:INCRement] ?
Example	POW:ATT:STEP 2
Notes	Note this feature works like a 1-N choice from the front panel, but it takes a specific value (in dB) when used remotely. The only valid values are 2 and 10.
Dependencies	Blanked in CXA and EXA if option FSA (2 dB steps) is not present. If blanked, attempts to set it via SCPI will yield an error.
Couplings	When the attenuation step size changes, the current mechanical attenuation value is adjusted (if necessary) to be quantized to the new step size. That is, if step is set to 10 dB, mech atten is increased if necessary so it is a multiple of 10 dB
Preset	PXA and MXA: 2 dB EXA and CXA: 10 dB (2 dB with option FSA)
State Saved	Saved in instrument state
Initial S/W Revision	Prior to A.02.00
Modified at S/W Revision	A.03.00

Adjust Atten (Remote Command only)

Allows you to select;

-Electric attenuator only

-Combination of Electric attenuator and Mechanical attenuator

when the SCPI command [:SENSe]:POWer[:RF]:RANGe:OPTimize IMMEDIATE is executed.

Remote Command	[:SENSe]:POWer[:RF]:RANGe:OPTimize:TYPE EONLY COMBined [:SENSe]:POWer[:RF]:RANGe:OPTimize:TYPE?
Example	POW:RANG:OPT:TYPE EONL POW:RANG:OPT:TYPE?
Preset	COMBined
State Saved	Saved in instrument state
Initial S/W Revision	A.16.00

Scale/Div

Sets the logarithmic units per vertical graticule division on the display. When the Auto Scaling is On, the Scale/Div is automatically determined by the measurement result. When you set a value manually, Auto Scaling is automatically toggled to Off.

Key Path	AMPTD Y Scale
Mode	SA, WCDMA, C2K, WIMAX OFDMA, TD-SCDMA, 1xEVDO, ISDB-T, CMMB, LTE, LTE TDD, BLUETOOTH, WLAN, MSR, LTEAFDD, LTEATDD
Remote Command	:DISPlay:OBWidth:VIEW[1]:WINDow[1]:TRACe:Y[:SCALe]:PDIVision <rel_ampl> :DISPlay:OBWidth:VIEW[1]:WINDow[1]:TRACe:Y[:SCALe]:PDIVision?
Example	DISP:OBW:VIEW:WIND:TRAC:Y:PDIV 5 DISP:OBW:VIEW:WIND:TRAC:Y:PDIV?
Notes	You must be in the Spectrum Analysis mode, W-CDMA mode, cdma2000 mode, TD-SCDMA mode, ISDB-T mode, CMMB mode, LTE mode, LTE TDD mode, BLUETOOTH mode, WLAN mode, 1xEVDO mode, MSR, LTE-Advanced FDD/TDD or WIMAX OFDMA mode to use this command. Use :INSTrument:SElect to set the mode.
Couplings	When the Auto Scaling is On, this value is automatically determined by the measurement result. When you set a value manually, Auto Scaling automatically changes to Off.
Preset	10.00 dB
State Saved	Saved in instrument state.
Min	0.10 dB
Max	20.00 dB
Initial S/W Revision	Prior to A.02.00
Modified at S/W Revision	A.03.00

Presel Center

When this key is pressed, the centering of the preselector filter is adjusted to optimize the amplitude accuracy at the frequency of the selected marker. If the selected marker is not on when Presel Center is pressed, the analyzer will turn on the selected marker, perform a peak search, and then perform centering on the marker's center frequency. If the selected marker is already on and between the start and stop frequencies of the analyzer, the analyzer performs the preselector calibration on that marker's frequency. If the selected marker is already on, but outside the frequency range between Start Freq and Stop Freq, the analyzer will first perform a peak search, and then perform centering on the marker's center frequency.

The value displayed on the **Presel Adjust** key will change to reflect the new preselector tuning (see **Presel Adjust**).

A number of considerations should be observed to ensure proper operation. See "[Proper Preselector Operation](#)" on page 712.

Key Path	AMPTD Y Scale
Remote Command	<code>[:SENSe] :POWer [:RF] :PCENter</code>
Example	POW:PCEN
Notes	Note that the rules outlined above under the key description apply for the remote command as well as the key. The result of the command is dependent on marker position, and so forth. Any message shown by the key press is also shown in response to the remote command.
Dependencies	<ul style="list-style-type: none"> • Grayed out if the microwave preselector is off.) • If the selected marker's frequency is below Band 1, advisory message 0.5001 is generated and no action is taken. • Grayed out if entirely in Band 0. • Blank in models that do not include a preselector, such as option 503. If the SCPI is sent in these instruments, it is accepted without error, and the query always returns 0. • Grayed out in the Spectrogram View.
Couplings	<p>The active marker position determines where the centering will be attempted.</p> <p>If the analyzer is in a measurement such as averaging when centering is initiated, the act of centering the preselector will restart averaging but the first average trace will not be taken until the centering is completed.</p>
Status Bits/OPC dependencies	<p>When centering the preselector, *OPC will not return true until the process is complete and a subsequent measurement has completed, nor will results be returned to a READ or MEASure command.</p> <p>The Measuring bit should remain set while this command is operating and should not go false until the subsequent sweep/measurement has completed.</p>
Initial S/W Revision	Prior to A.02.00
Modified at S/W Revision	A.03.00

Proper Preselector Operation

A number of considerations should be observed to ensure proper operation:

1. If the selected marker is off, the analyzer will turn on a marker, perform a peak search, and adjust the preselector using the selected marker's frequency. It uses the "highest peak" peak search method unqualified by threshold or excursion, so that there is no chance of a 'no peak found' error. It continues with that peak, even if it is the peak of just noise. Therefore, for this operation to work properly, there should be a signal on screen in a preselected range for the peak search to find.
2. If the selected marker is already on, the analyzer will attempt the centering at that marker's frequency. There is no preselector for signals below about 3.6 GHz, therefore if the marker is on a signal below 3.6 GHz, no centering will be attempted and an advisory message generated
3. In some models, the preselector can be bypassed. If it is bypassed, no centering will be attempted in that range and a message will be generated.

Preselector Adjust

Allows you to manually adjust the preselector filter frequency to optimize its response to the signal of interest. This function is only available when "[Presel Center](#)" on page 2306 is available.

For general purpose signal analysis, using Presel Center is recommended. Centering the filter minimizes the impact of long-term preselector drift. Presel Adjust can be used instead to manually optimize the preselector. One application of manual optimization would be to peak the preselector response, which both optimizes the signal-to-noise ratio and minimizes amplitude variations due to small (short-term) preselector drifting.

Key Path	AMPTD Y Scale
Scope	Meas Global
Remote Command	[:SENSe] :POWer [:RF] :PADJust <freq> [:SENSe] :POWer [:RF] :PADJust?
Example	POW:PADJ 100KHz POW:PADJ?
Notes	The value on the key reads out to 0.1 MHz resolution.
Dependencies	<ul style="list-style-type: none"> • Grayed out if microwave preselector is off.) • Grayed out if entirely in Band 0. • Blank in models that do not include a preselector, such as option 503. If the SCPI is sent in these instruments, it is accepted without error, and the query always returns 0. • Grayed out in the Spectrogram View.
Preset	0 MHz
State Saved	The Presel Adjust value set by Presel Center , or by manually adjusting Presel Adjust , is not saved in instrument state, and does not survive a Preset or power cycle.
Min	-500 MHz
Max	500 MHz
Default Unit	Hz
Backwards Compatibility SCPI	[:SENSe] :POWer [:RF] :MW: PADJust [:SENSe] :POWer [:RF] :MMW: PADJust

	PSA had multiple preselectors, but the X-Series has only one. These commands simply alias to [:SENSe]:POWer[:RF]:PADJust
Initial S/W Revision	Prior to A.02.00
Modified at S/W Revision	A.03.00

Remote Command	[:SENSe]:POWer[:RF]:PADJust:PRESelector MWAVE MMWave EXTERNAL [:SENSe]:POWer[:RF]:PADJust:PRESelector?
Notes	PSA had multiple preselectors, and you could select which preselector to adjust. Since the X-Series has only one mm/uW preselector, the preselector selection softkey is no longer available. However, to provide backward compatibility, we accept the legacy remote commands. The command form has no effect, the query always returns MWAVE
Initial S/W Revision	Prior to A.02.00

μW Path Control

The **μW Path Control** functions include the **μW Preselector Bypass** (Option MPB) and **Low Noise Path** (Option LNP) controls in the High Band path circuits.

When the μW Preselector is bypassed, the user has better flatness, but will be subject to spurs from out of band interfering signals. When the Low Noise Path is enabled, the analyzer automatically switches around certain circuitry in the high frequency bands which can contribute to noise, when it is appropriate based on other analyzer settings.

For most applications, the preset state is Standard Path, which gives the best remote-control throughput, minimizes acoustic noise from switching and minimizes the risk of wear out in the hardware switches. For applications that utilize the wideband IF paths, the preset state is the μW Preselector Bypass path, if option MPB is present. This is because, when using a wideband IF such as the 140 MHz IF, the μW Preselector's bandwidth can be narrower than the available IF bandwidth, causing degraded amplitude flatness and phase linearity, so it is desirable to bypass the preselector in the default case.

Users may choose Low Noise Path Enable. It gives a lower noise floor, especially in the 21–26.5 GHz region, though without improving many measures of dynamic range, and without giving the best possible noise floor. The preamp, if purchased and used, gives better noise floor than does the Low Noise Path, however its compression threshold and third-order intercept are much poorer than that of the non-preamp Low Noise Path. There are some applications, typically for signals around –30 dBm, for which the third-order dynamic range of the standard path is good enough, but the noise floor is not low enough even with 0 dB input attenuation. When the third-order dynamic range of the preamp path is too little and the noise floor of the standard path is too high, the Low Noise Path can provide the best dynamic range.

Key Path	AMPTD Y Scale
Mode	SA, BASIC, PNOISE, VSA, LTE, LTETDD
Scope	Meas Global
Remote Command	[:SENSe]:POWer[:RF]:MW:PATH STD LNPath MPBypass FULL

	[:SENSe] :POWer [:RF] :MW:PATH?
Example	:POW:MW:PATH LNP Enables the Low Noise path
Notes	<p>If a Presel Center is performed, the analyzer will momentarily switch to the Standard Path, regardless of the setting of μW Path Control</p> <p>The DC Block will always be switched in when the low noise path is switched in, to protect succeeding circuitry from DC. Note that this does not mean “when the low noise path is enabled” but when, based on the Low Noise Path rules, the path is actually switched in. This can happen when the selection is Low Noise Path Enable . In the case where the DC Block is switched in the analyzer is now AC coupled. However, if the user has selected DC coupling, the UI will still behave as though it were DC coupled, including all annunciation, warnings, status bits, and responses to SCPI queries. This is because, based on other settings, the analyzer could switch out the low noise path at any time and hence go back to being DC coupled.</p> <p>Alignment switching ignores the settings in this menu, and restores them when finished.</p>
Dependencies	Unavailable in BBIQ and External Mixing
Preset	<p>All modes other than IQ Analyzer mode and VXA: STD</p> <p>IQ Analyzer, VXA and WLAN mode:</p> <p>MPB option present and licensed: MPB</p> <p>MPB option not present and licensed: STD</p>
State Saved	Save in instrument state
Readback	Value selected in the submenu
Initial S/W Revision	A.04.00
Modified at S/W Revision	A.10.00

Standard Path

This path gives the best remote-control throughput, minimizes acoustic noise from switching and minimizes the risk of wear in the hardware switches, particularly in remote test scenarios where both low band and high band setups will follow in rapid succession.

In this path, the bypass of the low band/high band switch and microwave preamp is never activated, which can cause some noise degradation but preserves the life of the bypass switch.

Key Path	AMPTD Y Scale, μW Path Control
Example	:POW:MW:PATH STD
Readback Text	Standard Path
Initial S/W Revision	A.04.00

Low Noise Path Enable

You may choose Low Noise Path Enable, which gives a lower noise floor under some circumstances, particularly when operating in the 21–26.5 GHz region. With the Low Noise Path enabled, the low band/high band switch and microwave preamp are bypassed whenever all of the following are true:

- The analyzer is not in the Low Band, meaning:
- the start frequency is above 3.5 GHz and
- the stop frequency is above 3.6 GHz.
- the internal preamp is not installed or (if installed) is set to **Off** or **Low Band**

Note that this means that, when any part of a sweep is done in Low Band, the Low Noise Path is not used, whether or not the **Low Noise Path Enable** is selected in the user interface. Also, if the preamp is turned on, the Low Noise Path is not used, whether or not the **Low Noise Path Enable** is selected in the user interface. The only time the Low Noise Path is used is when **Low Noise Path Enable** is selected, the sweep is completely in High Band (> 3.6 GHz) and no preamp is in use.

See "[More Information](#)" on page 716

Key Path	AMPTD Y Scale, μW Path Control
Measurement	Swept SA
Example	:POW:MW:PATH LNP
Notes	For measurements that use IQ acquisition, the low noise path is used when the Center Frequency is in High Band (> 3.6 GHz) and no preamp is in use. In other words, the rules above are modified to use only the center frequency to qualify which path to switch in. This is not the case for FFT's in the Swept SA measurement; they use the same rules as swept measurements.
Dependencies	Key is blanked if current mode does not support it. Key is grayed out if mode supports it but current measurement does not support it. Unless Option LNP is present and licensed, key is blank and if SCPI command sent, error -241, "Hardware missing; Option not installed" is generated.
Readback Text	Low Noise Path Enable
Initial S/W Revision	A.04.00

More Information

The user should understand that the Low Noise Path, while giving improved DANL, has the disadvantage of decreased TOI performance and decreased gain compression performance relative to the standard path.

The user should also understand that the bypass switch is a mechanical switch and has finite life, so if the **Low Noise Path** is enabled, it is possible to cause frequent cycling of this switch by frequently changing analyzer settings such that the above conditions hold true only some of the time. A user making tests of this nature should consider opting for the **Standard Path**, which will never throw the bypass switch, at the expense of some degraded noise performance.

The low noise path is useful for situations where the signal level is so low that the analyzer performance is dominated by noise even with 0 dB attenuation, but still high enough that the preamp option would have excessive third-order intermodulation or compression. The preamp, if purchased and used, gives better noise floor than does the "Low Noise Path." However, its compression threshold and third-order intercept are much poorer than that of the non-preamp path. There are some applications, typically for signals around -30 dBm, for which the third-order dynamic range of the standard path is good enough, but the

noise floor is not low enough even with 0 dB input attenuation. When the third-order dynamic range of the preamp path is too little and the noise floor of the standard path is too high, the Low Noise Path can provide the best dynamic range

The graph below illustrates the concept. It shows, in red, the performance of an analyzer at different attenuation settings, both with the preamp on and off, in a measurement that is affected by both analyzer noise and analyzer TOI. The green shows the best available dynamic range, offset by 0.5 dB for clarity. The blue shows how the best available dynamic range improves for moderate signal levels with the low noise path switched in. In this illustration, the preamp improves the noise floor by 15 dB while degrading the third-order intercept by 30 dB, and the low noise path reduces loss by 8 dB. The attenuator step size is 2 dB.

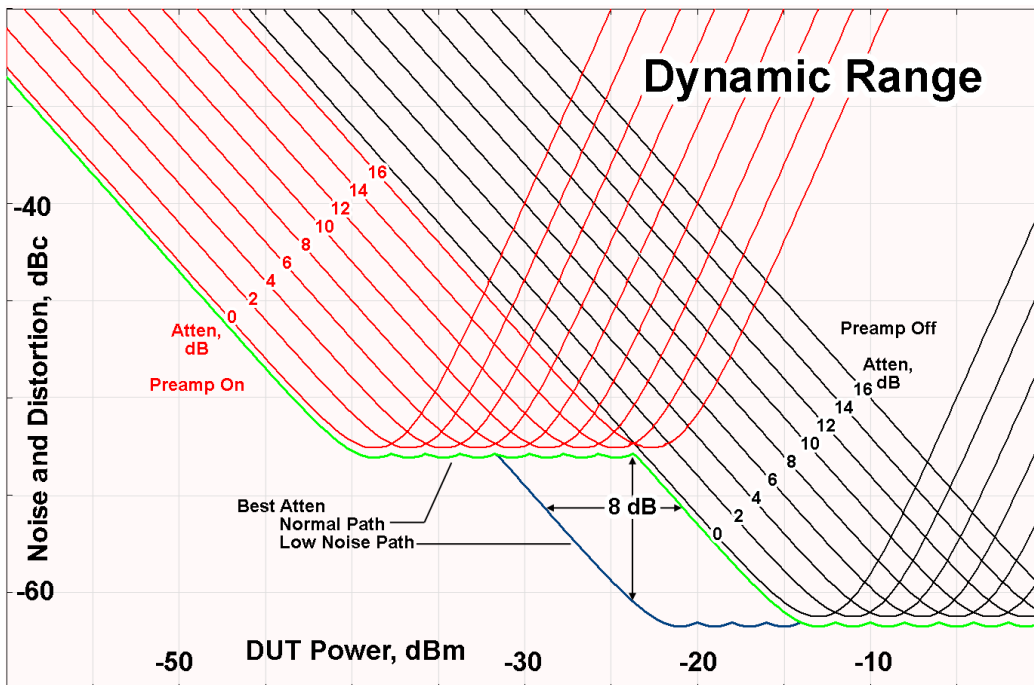

There are other times where selecting the low noise path improves performance, too. Compression-limited measurements such as finding the nulls in a pulsed-RF spectrum can profit from the low noise path in a way similar to the TOI-limited measurement illustrated. Accuracy can be improved when the low noise path allows the optimum attenuation to increase from a small amount like 0, 2 or 4 dB to a larger amount, giving better return loss at the analyzer input. Harmonic measurements, such as second and third harmonic levels, are much improved using the low noise path because of the superiority of that path for harmonic (though not intermodulation) distortion performance.

μW Preselector Bypass

This key toggles the preselector bypass switch for band 1 and higher. When the microwave preselector is on, the signal path is preselected. When the microwave preselector is off, the signal path is not preselected. The preselected path is the normal path for the analyzer.

The preselector is a tunable bandpass filter which prevents signals away from the frequency of interest from combining in the mixer to generate in-band spurious signals (images). The consequences of using a preselector filter are its limited bandwidth, the amplitude and phase ripple in its passband, and any amplitude and phase instability due to center frequency drift.

Option MPB or pre-selector bypass provides an unpreselected input mixer path for certain X-Series signal analyzers with frequency ranges above 3.6 GHz. This signal path allows a wider bandwidth and less amplitude variability, which is an advantage when doing modulation analysis and broadband signal analysis. The disadvantage is that, without the preselector, image signals will be displayed. Another disadvantage of bypassing the preselector is increased LO emission levels at the front panel input port.

Image responses are separated from the real signal by twice the 1st IF. For IF Paths of 10 MHz and 25 MHz, the 1st IF is 322.5 MHz, so the image response and the real signal will be separated by 645 MHz. The 1st IF will be different for other IF Path settings. When viewing a real signal and its corresponding image response in internal mixing, the image response will be to the left of the real signal.

Also, the image response and the real signal typically have the same amplitude and exhibit the same shape factor.

However, if Option FS1, Fast Sweep Capability, is enabled, the image response in the Swept SA measurement will appear lower in amplitude and have a much wider shape factor compared to the real signal.

Key Path	AMPTD Y Scale, μW Path Control
Example	:POW:MW:PATH MPB
Dependencies	Key is blanked if current mode does not support it. Key is grayed out if mode supports it but current measurement does not support it. Key is blank unless Option MPB is present and licensed. If SCPI command sent when MPB not present, error -241, "Hardware missing; Option not installed" is generated.
Readback Text	μ W Preselector Bypass
Initial S/W Revision	A.04.00

Remote Command	[:SENSe] :POWer [:RF] :MW:PRESelector [:STATe] ON OFF 0 1 [:SENSe] :POWer [:RF] :MW:PRESelector [:STATe] ?
Example	:POW:MW:PRES OFF Bypasses the microwave preselector
Notes	The ON parameter sets the STD path (:POW:MW:PATH STD) The OFF parameter sets path MPB (:POW:MW:PATH MPB)
Preset	ON

Internal Preamp

Accesses a menu of keys that control the internal preamps. Turning on the preamp gives a better noise figure, but a poorer TOI to noise floor dynamic range. You can optimize this setting for your particular measurement.

The instrument takes the preamp gain into account as it sweeps. If you sweep outside of the range of the preamp the instrument will also account for that. The displayed result will always reflect the correct gain.

For some measurements, when the preamp is on and any part of the displayed frequency range is below the lowest frequency for which the preamp has specifications, a warning condition message appears in the status line. For example, for a preamp with a 9 kHz lowest specified frequency: "Preamp: Accy unspec'd below 9 kHz".

Key Path	AMPTD Y Scale
Scope	Meas Global
Remote Command	[:SENSe] :POWer [:RF] :GAIN[:STATe] OFF ON 0 1 [:SENSe] :POWer [:RF] :GAIN[:STATe] ?
Dependencies	Preamp is not available on all hardware platforms. If the preamp is not present or is unlicensed, the key is not shown. The preamp is not available when the electronic/soft attenuator is enabled.
Couplings	The act of connecting the U7227A USB Preamplifier to one of the analyzer's USB ports will cause the Internal Preamp to be switched on. When this happens an informational message will be generated: "Internal Preamp turned on for optimal operation with USB Preamp." Note that if the Internal Preamp was already on, there will be no change to the setting, but if it was Off it will be switched On, to Full Range. Note that this same action occurs when the SA mode is selected while the USB Preamp is connected to one of the analyzer's USB ports, if it is the first time that the SA mode has run since powerup, or if the last time the SA mode was running the USB Preamp was NOT connected. Subsequently disconnecting the USB Preamp from USB does not change the Internal Preamp setting nor restore the previous setting.
Preset	OFF
State Saved	Saved in instrument state
Initial S/W Revision	Prior to A.02.00
Modified at S/W Revision	A.14.00

Key Path	AMPTD Y Scale, Internal Preamp
Scope	Meas Global
Remote Command	[:SENSe] :POWer [:RF] :GAIN:BAND LOW FULL [:SENSe] :POWer [:RF] :GAIN:BAND?
Dependencies	Preamp is not available on all hardware platforms. If the preamp is not present or is unlicensed, the key is not shown. If a POW:GAIN:BAND FULL command is sent when a low band preamp is available, the preamp band parameter is to LOW instead of FULL, and an "Option not installed" message is generated.
Preset	LOW
State Saved	Saved in instrument state
Initial S/W Revision	Prior to A.02.00

Off

Turns the internal preamp off

Key Path	AMPTD Y Scale, Internal Preamp
Example	:POW:GAIN OFF
Readback	Off
Initial S/W Revision	Prior to A.02.00

Low Band

Sets the internal preamp to use only the low band.

The frequency range of the installed (optional) low-band preamp is displayed in square brackets on the **Low Band** key label.

Key Path	AMPTD Y Scale, Internal Preamp
Example	:POW:GAIN ON :POW:GAIN:BAND LOW
Readback	Low Band
Initial S/W Revision	Prior to A.02.00

Full Range

Sets the internal preamp to use its full range. The low band (0–3.6 GHz or 0–3GHz, depending on the model) is supplied by the low band preamp and the frequencies above low band are supplied by the high band preamp.

The frequency range of the installed (optional) preamp is displayed in square brackets on the **Full Range** key label. If the high band option is not installed the Full Range key does not appear.

Key Path	AMPTD Y Scale, Internal Preamp
Example	:POW:GAIN ON :POW:GAIN:BAND FULL
Readback	Full Range
Initial S/W Revision	Prior to A.02.00

Ref Position

Positions the reference level at the top, center or bottom of the Y Scale display. Changing the reference position does not change the reference level value.

Key Path	AMPTD Y Scale
Mode	SA, WCDMA, C2K, WIMAX OFDMA, TD-SCDMA, 1xEVDO, ISDB-T, CMMB, LTE, LTETDD, BLUETOOTH, WLAN, MSR, LTEAFDD, LTEATDD
Remote Command	:DISPlay:OBWidth:VIEW[1]:WINDow[1]:TRACe:Y[:SCALe]:RPOSition TOP CENTER BOTTom :DISPlay:OBWidth:VIEW[1]:WINDow[1]:TRACe:Y[:SCALe]:RPOSition?
Example	DISP:OBW:VIEW:WIND:TRAC:Y:RPOS BOTT DISP:OBW:VIEW:WIND:TRAC:Y:RPOS?
Notes	You must be in the Spectrum Analysis mode, W-CDMA mode, cdma2000 mode, TD-SCDMA mode, ISDB-T mode, CMMB mode, LTE mode, LTE TDD mode, BLUETOOTH mode, WLAN mode, 1xEVDO mode, MSR, LTE-Advanced FDD/TDD or WIMAX OFDMA mode to use this command. Use:INSTRument:SElect to set the mode.
Preset	TOP
State Saved	Saved in instrument state.
Range	Top Ctr Bot
Initial S/W Revision	Prior to A.02.00
Modified at S/W Revision	A.03.00

Auto Scaling

Allows you to toggle the Auto Scaling function between On and Off.

Key Path	AMPTD Y Scale
Mode	SA, WCDMA, C2K, WIMAX OFDMA, TD-SCDMA, 1xEVDO, ISDB-T, CMMB, LTE, LTETDD, BLUETOOTH, WLAN, MSR, LTEAFDD, LTEATDD
Remote Command	:DISPlay:OBWidth:VIEW[1]:WINDow[1]:TRACe:Y[:SCALe]:COUPlE 0 1 OFF ON :DISPlay:OBWidth:VIEW[1]:WINDow[1]:TRACe:Y[:SCALe]:COUPlE?
Example	DISP:OBW:VIEW:WIND:TRAC:Y:COUP ON DISP:OBW:VIEW:WIND:TRAC:Y:COUP?
Couplings	When Auto Scaling is On, upon pressing the Restart front-panel key, this function automatically sets the scale per division to 10 dB and determines reference values based on the measurement results. When you set a value to either Scale/Div or Ref Value manually, Auto Scaling automatically changes to Off.
Preset	1
State Saved	Saved in instrument state.
Range	On Off
Initial S/W Revision	Prior to A.02.00
Modified at S/W Revision	A.03.00

Auto Couple

The Auto Couple feature provides a quick and convenient way to automatically couple multiple instrument settings. This helps ensure accurate measurements and optimum dynamic range. When the Auto Couple feature is activated, either from the front panel or remotely, all parameters of the current measurement that have an Auto/Manual mode are set to Auto mode and all measurement settings dependent on (or coupled to) the Auto/Man parameters are automatically adjusted for optimal performance.

However, the Auto Couple key actions are confined to the current measurement only. It does not affect other measurements in the mode, and it does not affect markers, marker functions, or trace or display attributes.

See "[More Information](#)" on page 722

Key Path	Front-panel key
Remote Command	:COUPle ALL NONE
Example	:COUP ALL
Notes	:COUPle ALL puts all Auto/Man parameters in Auto mode (equivalent to pressing the Auto Couple key). :COUPLE NONE puts all Auto/Man parameters in manual mode. It decouples all the coupled instrument parameters and is not recommended for making measurements.
Initial S/W Revision	Prior to A.02.00

More Information

There are two types of functions that have Auto/Manual modes.

Auto/Man Active Function keys

An Auto/Man toggle key controls the binary state associated with an instrument parameter by toggling between **Auto** (where the parameter is automatically coupled to the other parameters it is dependent upon) and **Man** (where the parameter is controlled independent of the other parameters), as well as making the parameter the active function. The current mode is indicated on the softkey with either **Auto** or **Man** underlined as illustrated below.

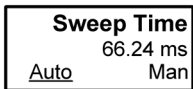

vsd07

Auto/Man 1-of-N keys

An Auto/Man 1-of-N key allows you to manually pick from a list of parameter values, or place the function in Auto, in which case the value is automatically selected (and indicated) as shown below. If in Auto, Auto is underlined on the calling key. If in manual operation, manual is indicated on the calling key. But the calling key does not actually toggle the function, it simply opens the menu.

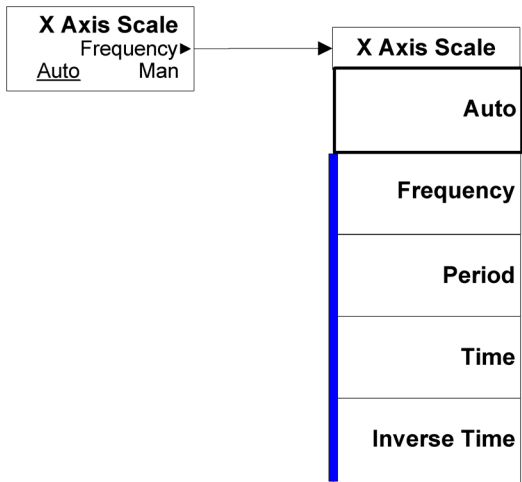

vsd08

BW

Accesses a menu of functions that enable you to specify and control the video and resolution bandwidths. You can also select the type of filter for the measurement.

Key Path	Front-panel key
Initial S/W Revision	Prior to A.02.00

Res BW

Sets the resolution bandwidth for the current measurement. If an unavailable bandwidth is entered with the numeric keypad, the closest available bandwidth is selected.

Key Path	BW
Mode	SA, WCDMA, C2K, WIMAX OFDMA, TD-SCDMA, 1xEVDO, ISDB-T, CMMB, LTE, LTETDD, BLUETOOTH, WLAN, MSR, LTEAFDD, LTEATDD
Remote Command	[:SENSe]:OBWidth:BANDwidth[:RESolution] <bandwidth> [:SENSe]:OBWidth:BANDwidth[:RESolution]? [:SENSe]:OBWidth:BANDwidth[:RESolution]:AUTO ON OFF 1 0 [:SENSe]:OBWidth:BANDwidth[:RESolution]:AUTO?
Example	OBW:BAND 250000 OBW:BAND? OBW:BAND:AUTO OFF OBW:BAND:AUTO?
Notes	You must be in the Spectrum Analysis mode, W-CDMA mode, cdma2000 mode, TD-SCDMA mode, ISDB-T mode, CMMB mode, LTE mode, LTE TDD mode, BLUETOOTH mode, WLAN mode, 1xEVDO mode, MSR, LTE-Advanced FDD/TDD or WIMAX OFDMA mode to use this command. Use:INSTRument:SElect to set the mode.
Couplings	Sweep time is coupled to RBW. As the RBW changes, the sweep time (if set to Auto) is changed to maintain amplitude calibration. Video bandwidth (VBW) is coupled to RBW. As the resolution bandwidth changes, the video bandwidth (if set to Auto) changes to maintain the ratio of VBW/RBW (10:1). When Res BW is set to Auto, the resolution bandwidth is auto-coupled to span. The ratio of Span/RBW is approximately 106:1 when auto coupled. When Res BW is set to Man, bandwidths are entered manually, and these bandwidths are used regardless of other analyzer settings.
Preset	SA: Auto WCDMA: 30 kHz CDMA2K: 12 kHz WIMAX OFDMA: 100 kHz TD-SCDMA: 30 kHz 1xEVDO: 30 kHz ISDB-T: 10 kHz CMMB: 3 kHz

	LTE: 30 kHz LTETDD: 30 kHz BLUETOOTH:10 kHz WLAN: 100kHz MSR: 30 kHz, LTEAFDD, LTEATDD: 30 kHz SA: ON WCDMA, C2K, TD-SCDMA, WIMAX OFDMA, 1xEVDO , ISDB-T, CMMB, LTE, LTETDD, WLAN, MSR, LTEAFDD, LTEATDD: OFF
State Saved	Saved in instrument state.
Min	1 Hz
Max	8 MHz
Backwards Compatibility SCPI	<code>[:SENSe] :OBwidth :BWIDth [:RESolution]</code>
Initial S/W Revision	Prior to A.02.00
Modified at S/W Revision	A.03.00

Video BW

Changes the analyzer post-detection filter.

Key Path	BW
Mode	SA, WCDMA, C2K, WIMAX OFDMA, TD-SCDMA, 1xEVDO, ISDB-T, CMMB, LTE, LTETDD, BLUETOOTH, WLAN, MSR, LTEAFDD, LTEATDD
Remote Command	<code>[:SENSe] :OBwidth :BANDwidth :VIDeo <bandwidth></code> <code>[:SENSe] :OBwidth :BANDwidth :VIDeo?</code> <code>[:SENSe] :OBwidth :BANDwidth :VIDeo :AUTO ON OFF 1 0</code> <code>[:SENSe] :OBwidth :BANDwidth :VIDeo :AUTO?</code>
Example	<code>OBW:BAND:VID 5 MHz</code> <code>OBW:BAND:VID?</code> <code>OBW:BAND:VID:AUTO ON</code> <code>OBW:BAND:VID:AUTO?</code>
Notes	You must be in the Spectrum Analysis mode, W-CDMA mode, cdma2000 mode, TD-SCDMA mode, ISDB-T mode, CMMB mode, LTE mode, LTE TDD mode, BLUETOOTH mode, WLAN mode, 1xEVDO mode, MSR, LTE-Advanced FDD/TDD or WIMAX OFDMA mode to use this command. Use:INSTRument:SElect to set the mode.
Dependencies	When using the average detector with either Sweep Time set to Man, or in zero span, the VBW setting has no effect and is disabled (grayed out).
Couplings	Video bandwidth (VBW) is coupled to RBW. As the resolution bandwidth changes, the video bandwidth (if set to Auto) changes to maintain the ratio set by VBW/RBW. Sweep Time is coupled to Video Bandwidth (VBW). As the VBW is changed, the sweep time (when

set to Auto) is changed to maintain amplitude calibration. This occurs because of common hardware between the two circuits, even though the Video BW filter is not actually “in-circuit” when the detector is set to Average. Because the purpose of the average detector and the VBW filter are the same, either can be used to reduce the variance of the result.

Although the VBW filter is not “in-circuit” when using the average detector, the Video BW key can have an effect on (Auto) sweep time, and is not disabled. In this case, reducing the VBW setting increases the sweep time, which increases the averaging time, producing a lower-variance trace.

When the video bandwidth is AUTO coupled, the video bandwidth value is set to:

Resolution Bandwidth * Video Bandwidth to Resolution Bandwidth Ratio

Preset	SA, LTE, LTETDD, WLAN, MSR, LTEAFDD, LTEATDD: Auto WCDMA: 300 kHz CDMA2K:120 kHz WIMAX OFDMA: 1 MHz TD-SCDMA: 300 kHz 1xEVDO: 300 kHz ISDB-T: 300 Hz CMMB: 3 kHz BLUETOOTH: 30 kHz ON ISDB-T, CMMB: OFF
State Saved	Saved in instrument state.
Min	1 Hz
Max	50 MHz
Backwards Compatibility SCPI	[:SENSe] :OBWidth:BWIDth:VIDeo
Initial S/W Revision	Prior to A.02.00
Modified at S/W Revision	A.03.00

Filter Type

Allows you to select the type of filter to be used for the current measurement. Besides the Gaussian filter shape, there are certain special filter types, such as Flat Top, that are desirable under certain conditions.

Key Path	BW
Mode	SA, WCDMA, C2K, WIMAX OFDMA, TD-SCDMA, 1xEVDO, ISDB-T, CMMB, LTE, LTETDD, BLUETOOTH, WLAN, MSR, LTEAFDD, LTEATDD
Remote Command	[:SENSe] :OBWidth:BANDwidth:SHAPE GAUSSian FLATtop [:SENSe] :OBWidth:BANDwidth:SHAPE?
Example	OBW:BAND:SHAP GAUS OBW:BAND:SHAP?

Preset	GAUSSian
State Saved	Saved in instrument state.
Range	Gaussian Flattop
Backwards Compatibility SCPI	[:SENSe] :OBwidth :BWIDth :SHApe
Initial S/W Revision	Prior to A.02.00
Modified at S/W Revision	A.03.00

Cont (Continuous Measurement/Sweep)

Sets the analyzer for Continuous measurement operation. The single/continuous state is Meas Global so the setting will affect all measurements. If you are Paused, pressing **Cont** does a Resume.

Key Path	Front-panel key
Remote Command	:INITiate:CONTinuous OFF ON 0 1 :INITiate:CONTinuous?
Example	:INIT:CONT 0 puts analyzer in Single measurement operation. :INIT:CONT 1 puts analyzer in Continuous measurement operation
Preset	ON (Note that SYST:PRESet sets INIT:CONT to ON but *RST sets INIT:CONT to OFF)
State Saved	Saved in instrument state
Backwards Compatibility Notes	For Spectrum Analysis mode in ESA and PSA, there is no Cont hardkey, instead there is a Sweep Single/Cont key. In these analyzers, switching the Sweep Single/Cont key from Single to Cont restarts averages (displayed average count reset to 1), but does not restart Max Hold and Min Hold . The X-Series has Single and Cont keys in place of the SweepSingleCont key. In the X-Series, if in single measurement, the Cont key (and INIT:CONT ON) switches to continuous measurement, but never restarts a measurement and never resets a sweep.
Initial S/W Revision	Prior to A.02.00

In Swept SA Measurement (Spectrum Analysis Mode):

The analyzer takes repetitive sweeps, averages, measurements, etc., when in Continuous mode. When the average count reaches the Average/Hold Number the count stops incrementing, but the analyzer keeps sweeping. See the Trace/Detector section for the averaging formula used both before and after the Average/Hold Number is reached. The trigger condition must be met prior to each sweep. The type of trace processing for multiple sweeps, is set under the Trace/Detector key, with choices of **Trace Average**, **Max Hold**, or **Min Hold**.

In Other Measurements/Modes:

With **Avg/Hold Num** (in the **Meas Setup** menu) set to **Off** or set to **On** with a value of 1, a sweep is taken after the trigger condition is met; and the analyzer continues to take new sweeps after the current sweep has completed and the trigger condition is again met. However, with **Avg/Hold Num** set to On with a value >1, multiple sweeps (data acquisitions) are taken for the measurement. The trigger condition must be met prior to each sweep. The sweep is not stopped when the average count k equals the number N set for Avg/Hold Num is reached, but the number k stops incrementing. A measurement average usually applies to all traces, marker results, and numeric results. But sometimes it only applies to the numeric results.

If the analyzer is in Single measurement, pressing the **Cont** key does not change k and does not cause the sweep to be reset; the only action is to put the analyzer into Continuous measurement operation.

If it is already in continuous sweep:

the INIT:CONT 1 command has no effect

the INIT:CONT 0 command will place the analyzer in Single Sweep but will have no effect on the current sequence until $k = N$, at which point the current sequence will stop and the instrument will go to the idle state.

9 Occupied Bandwidth Measurement
File

File

See ["File" on page 362](#)

FREQ Channel

Accesses a menu of keys that allow you to control the Frequency and Channel parameters of the instrument.

Some features in the Frequency menu are the same for all measurements - they do not change as you change measurements. Settings like these are called "Meas Global" and are unaffected by Meas Preset. For example, the Center Freq setting is the same for all measurements - it does not change as you change measurements.

Key Path	Front Panel
Mode	MSR
Initial S/W Revision	A.10.00

Carrier Ref Freq

Sets carrier reference frequency. The center frequencies of carriers are defined as offset frequency from this value. This reference frequency is also the reference of carrier configuration preset.

Key Path	FREQ Channel
Mode	MSR
Measurement	all
Remote Command	<code>[:SENSe] :CARRier:REFeRence <freq></code> <code>[:SENSe] :CARRier:REFeRence?</code>
Example	CARR:REF 2GHz CARR:REF?
Preset	1GHz
State Saved	Saved in instrument state
Min	Depends on instrument minimum center frequency. Same as Center Freq
Max	Depends on instrument maximum center frequency. Same as Center Freq
Initial S/W Revision	A.10.00

Carrier Setup

Accesses the Carrier Setup menu.

Key Path	FREQ Channel
Initial S/W Revision	A.10.00

Carriers

Specifies how many carriers are used in MSR measurements. Base station RF bandwidth is determined from the carrier 1 to the carrier specified by this value whatever carriers' Present Pwr states are. Select Carrier can be select up to this value.

Key Path	FREQ Channel, Carrier Setup
Measurement	All
Remote Command	<code>[:SENSe]:CARRier:COUNt <integer></code> <code>[:SENSe]:CARRier:COUNt?</code>
Example	CARR:COUN 10 CARR:COUN?
Preset	1
State Saved	Saved in instrument state.
Min	1
Max	100
Initial S/W Revision	A.10.00

Configure Carriers

Accesses a menu of commonly used carrier configuration parameters.

Key Path	FREQ Channel, Carrier Setup
Initial S/W Revision	A.10.00

Select Carrier

Selects which carrier's configuration menu is displayed.

This key is also connected to the carrier info tables of some measurements. When the value is changed in a measurement which has carrier table view, the highlight in the table moves to Select Carrier. The highlight of the table and Select Carrier are not coupled.

Key Path	FREQ Channel, Carrier Setup, Configure Carriers
Preset	1
State Saved	No
Min	1
Max	Value of Carriers
Initial S/W Revision	A.10.00

Measure Carrier

Sets whether to measure this carrier or not.

Key Path	FREQ Channel, Carrier Setup, Configure Carriers
Remote Command	<code>[:SENSE] :CARRier<n> [:STATe] OFF ON 0 1</code> <code>[:SENSE] :CARRier<n> [:STATe] ?</code>
Example	CARR10 1 CARR10?
Notes	The command is used with a sub-op code <n> (default=1) to specify the carrier for configuration. The range of the sub-op code is determined by the number of carriers.
Preset	ON
State Saved	Saved in instrument state
Range	On Off
Initial S/W Revision	A.10.00

Carrier Offset

Sets the carrier center frequency as offset from Carrier Ref Frequency.

Key Path	FREQ Channel, Carrier Setup, Configure Carriers
Remote Command	<code>[:SENSe] :CARRier<n> :FREQuency:OFFSet <freq></code> <code>[:SENSe] :CARRier<n> :FREQuency:OFFSet ?</code>
Example	CARR10:FREQ:OFFS 10MHz CARR10:FREQ:OFFS?
Notes	The command is used with a sub-op code <n> (default=1) to specify the carrier for configuration. The range of the sub-op code is determined by the number of carriers.
Preset	0Hz
State Saved	Saved in instrument state
Min	-1GHz
Max	1GHz
Initial S/W Revision	A.10.00

Radio Format

Selects a format parameter set to set the radio format of the selected carrier.

NONE – No format is specified. Channel spacing, measurement BW and FOffset,RAT are values of defaults of LTE FDD 5MHz.

LTE FDD Parameter Set 1 – Selects LTE FDD parameter set 1. LTE FDD (E-UTRA FDD) is the radio format of the carrier.

LTE FDD Parameter Set 2 – Selects LTE FDD parameter set 2. LTE FDD (E-UTRA FDD) is the radio format of the carrier.

LTE FDD Parameter Set 3 – Selects LTE FDD parameter set 3. LTE FDD (E-UTRA FDD) is the radio format of the carrier.

W-CDMA Parameter Set 1 – Selects W-CDMA parameter set 1. W-CDMA (UTRA FDD) is the radio format of the carrier.

W-CDMA Parameter Set 2 – Selects W-CDMA parameter set 2. W-CDMA (UTRA FDD) is the radio format of the carrier.

W-CDMA Parameter Set 3 – Selects W-CDMA parameter set 3. W-CDMA (UTRA FDD) is the radio format of the carrier.

GSM/EDGE Parameter Set 1 – Selects GSM/EDGE parameter set 1. GSM/EDGE is the radio format of the carrier.

GSM/EDGE Parameter Set 2 – Selects GSM/EDGE parameter set 2. GSM/EDGE is the radio format of the carrier.

GSM/EDGE Parameter Set 3 – Selects GSM/EDGE parameter set 3. GSM/EDGE is the radio format of the carrier.

cdma2000 Parameter Set 1 – Selects cdma2000 parameter set 1. cdma2000 is the radio format of the carrier.

cdma2000 Parameter Set 2 – Selects cdma2000 parameter set 2. cdma2000 is the radio format of the carrier.

cdma2000 Parameter Set 3 – Selects cdma2000 parameter set 3. cdma2000 is the radio format of the carrier.

1xEV-DO Parameter Set 1 – Selects 1xEV-DO parameter set 1. 1xEV-DO is the radio format of the carrier.

1xEV-DO Parameter Set 2 – Selects 1xEV-DO parameter set 2. 1xEV-DO is the radio format of the carrier.

1xEV-DO Parameter Set 3 – Selects 1xEV-DO parameter set 3. 1xEV-DO is the radio format of the carrier.

LTE TDD Parameter Set 1 – Selects LTE TDD parameter set 1. LTE TDD (E-UTRA TDD) is the radio format of the carrier.

LTE TDD Parameter Set 2 – Selects LTE TDD parameter set 2. LTE TDD (E-UTRA TDD) is the radio format of the carrier.

LTE TDD Parameter Set 3 – Selects LTE TDD parameter set 3. LTE TDD (E-UTRA TDD) is the radio format of the carrier.

TD-SCDMA Parameter Set 1 – Selects TD-SCDMA parameter set 1. TD-SCDMA (UTRA-TDD LCR) is the radio format of the carrier.

TD-SCDMA Parameter Set 2 – Selects TD-SCDMA parameter set 2. TD-SCDMA (UTRA-TDD LCR) is the radio format of the carrier.

TD-SCDMA Parameter Set 3 – Selects TD-SCDMA parameter set 3. TD-SCDMA (UTRA-TDD LCR) is the radio format of the carrier.

Key Path	FREQ Channel, Carrier Setup, Configure Carriers
Remote Command	[:SENSE]:CARRier<n>:FORMat NONE LTEFdd1 LTEFdd2 LTEFdd3 WCDMa1 WCDMa2 WCDMa3 GSM1 GSM2 GSM3 CDMA1 CDMA2 CDMA3 EVDO1 EVDO2 EVDO3 LTETdd1 LTETdd2 LTETdd3 TDSCdma1 TDSCdma2 TDSCdma3 [:SENSE]:CARRier<n>:FORMat ?
Example	CARR10:FORM LTEF1 CARR10:FORM?
Notes	The command is used with a sub-op code <n> (default=1) to specify the carrier for configuration. The range of the sub-op code is determined by the number of carriers.
Dependencies	The following licenses are required for each key to be displayed. Without the licenses, corresponding enum values cannot be set even via the SCPI command. <ul style="list-style-type: none"> • LTE FDD - N9080A-1FP or W9080A-1FP • W-CDMA - N9073A-1FP or W9073A-1FP • GSM/EDGE - N9071A-2FP or W9071A-2FP • cdma2000 - N9072A-2FP or W9072A-2FP • 1xEV-DO - N9076A-1FP or W9076A-1FP • LTE TDD - N9082A-1FP or W9082A-1FP • TD-SCDMA - N9079A-1FP or W9079A-1FP
State Saved	Saved in instrument state
Range	None LTE FDD [Parameter Set 1] Parameter Set 1 ("LTE FDD 1") Parameter Set 2 ("LTE FDD 2") Parameter Set 3 ("LTE FDD 3") W-CDMA [Parameter Set 1] Parameter Set 1 ("W-CDMA 1") Parameter Set 2 ("W-CDMA 2") Parameter Set 3 ("W-CDMA 3") GSM/EDGE [Parameter Set 1] Parameter Set 1 ("GSM/EDGE 1") Parameter Set 2 ("GSM/EDGE 2") Parameter Set 3 ("GSM/EDGE 3") cdma2000 [Parameter Set 1] Parameter Set 1 ("cdma2000 1") Parameter Set 2 ("cdma2000 2") Parameter Set 3 ("cdma2000 3") 1xEV-DO [Parameter Set 1] Parameter Set 1 ("1xEV-DO 1") Parameter Set 2 ("1xEV-DO 2") Parameter Set 3 ("1xEV-DO 3")

	LTE TDD [Parameter Set 1] Parameter Set 1 ("LTE TDD 1") Parameter Set 2 ("LTE TDD 2") Parameter Set 3 ("LTE TDD 3") TD-SCDMA [Parameter Set 1] Parameter Set 1 ("TD-SCDMA 1") Parameter Set 2 ("TD-SCDMA 2") Parameter Set 3 ("TD-SCDMA 3")
Readback	The readback line on this key shows the currently selected Radio Format in square brackets.
Initial S/W Revision	A.10.00
Modified at S/W Revision	A.12.00, A.16.00

Carrier Allocation

Specifies the carrier frequency allocation. There are two types of allocation, contiguous and non-contiguous. Non-Contiguous frequency allocation is defined as an allocation where two sub-blocks are separated with a sub-block gap.

Contiguous – All the carriers belong to one block and no sub-block gap exists.

Non-Contiguous – Carriers are separated into two sub-blocks. Allocation Break Pt Carrier determines how sub-blocks are configured.

Key Path	FREQ Channel, Carrier Setup
Scope	Meas Global
Remote Command	[:SENSe]:CARRier:CONFig:ALLocation CONTiguous NCONtiguous [:SENSe]:CARRier:CONFig:ALLocation?
Example	CARR:CONF:ALL CONT CARR:CONF:ALL?
Preset	CONTiguous
State Saved	Saved in instrument state.
Range	Contiguous Non-Contiguous
Initial S/W Revision	A.13.00

Non-Contiguous

Opens a menu that enables you to set a non-contiguous parameter.

Key Path	FREQ Channel, Carrier Setup, Carrier Allocation
Initial S/W Revision	A.13.00

Allocation Break Pt Carrier

Specifies an allocation break point in non-contiguous carrier allocation. First sub-block starts from the lowest frequency carrier and stops at the allocation break point carrier. Next sub-block starts from the next upper frequency carrier and ends at the highest frequency carrier.

Two examples are shown below. In these examples carrier indices are not in the order of carrier frequency. In the first example, Allocation Break Pt Carrier is 2. It means that sub-block 1 ends at carrier 2 and sub-block 2 starts at carrier 5. Sub-block gap is located between carrier 2 and 5. In the second example, Allocation Break Pt Carrier is 3 and the sub-block gap comes between carrier 3 and 2.

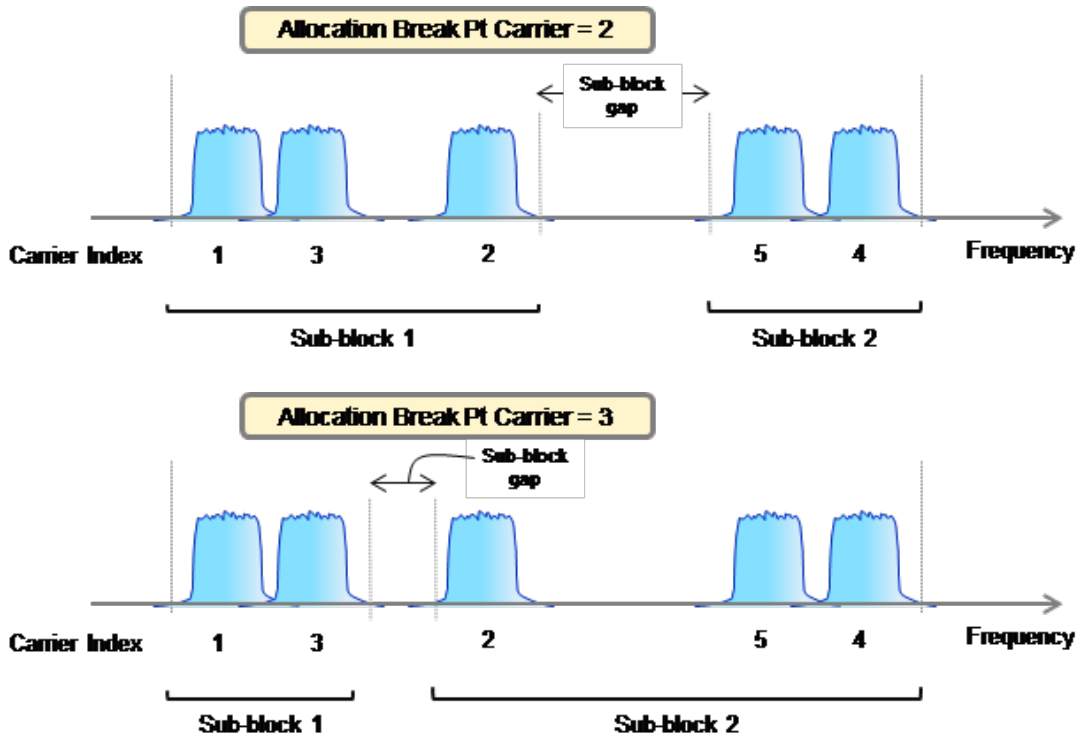

Key Path	FREQ Channel, Carrier Setup, Carrier Allocation, Non-Contiguous
Scope	Meas Global
Remote Command	<code>[[:SENSE]:CARRIER:CONFIG:ALLOCATION:NCONTIGUOUS:ABPOINT <integer></code> <code>[[:SENSE]:CARRIER:CONFIG:ALLOCATION:NCONTIGUOUS:ABPOINT?</code>
Example	<code>CARR:CONF:ALL:NCON:ABP 5</code> <code>CARR:CONF:ALL:NCON:ABP?</code>
Dependencies	The maximum value depends on the number of carriers.
Couplings	This value can change when you decrease the number of carriers.
Preset	1
State Saved	Saved in instrument state.
Min	1
Max	99
Initial S/W Revision	A.13.00

Carrier Conf Presets

Pressing this key pops up Conf Presets. Each parameter under this menu initiate carrier configuration preset when its value is changed.

Appropriate licenses are required to select carrier config enum. Required licenses are shown here. Note that N/W means N or W license, i.e. N/W9073A-1FP means either N9073A-1FP or W9073A-1FP is required.

TC1a (FDD): N/W9073A-1FP (W-CDMA)

TC2 (FDD): N/W9080A-1FP (LTE FDD)

TC3a (FDD): N/W9073A-1FP (W-CDMA) and N9080A-1FP (LTE FDD)

TC4a (FDD): N/W9071A-2FP (GSM/EDGE) and N/W9073A-1FP (W-CDMA)

TC4b (FDD): N/W9071A-2FP (GSM/EDGE) and N9080A-1FP (LTE FDD)

TC4c (FDD): N/W9071A-2FP (GSM/EDGE), N/W9073A-1FP (W-CDMA) and N9080A-1FP (LTE FDD)

TC4d (FDD): N/W9071A-2FP (GSM/EDGE) and N/W9073A-1FP (W-CDMA)

TC4e (FDD): N/W9071A-2FP (GSM/EDGE) and N9080A-1FP (LTE FDD)

TC4a (FDD) Two Carriers: N/W9071A-2FP (GSM/EDGE) and N/W9073A-1FP (W-CDMA)

TC4b (FDD) Two Carriers: N/W9071A-2FP (GSM/EDGE) and N9080A-1FP (LTE FDD)

TC4c (FDD) Two Carriers: N/W9071A-2FP (GSM/EDGE), N/W9073A-1FP (W-CDMA) and N9080A-1FP (LTE FDD)

NTC1a (FDD): N/W9073A-1FP (W-CDMA)

NTC2 (FDD): N/W9080A-1FP (LTE FDD)

NTC3a (FDD): N/W9073A-1FP (W-CDMA) and N9080A-1FP (LTE FDD)

NTC4a (FDD): N/W9071A-2FP (GSM/EDGE) and N/W9073A-1FP (W-CDMA)

NTC4b (FDD): N/W9071A-2FP (GSM/EDGE) and N9080A-1FP (LTE FDD)

NTC4c (FDD): N/W9071A-2FP (GSM/EDGE), N/W9073A-1FP (W-CDMA) and N9080A-1FP (LTE FDD)

LTE FDD: N/W9080A-1FP (LTE FDD)

W-CDMA: N/W9073A-1FP (W-CDMA)

GSM/EDGE: N/W9071A-2FP (GSM/EDGE)

cdma2000: N/W9072A-2FP (cdma2000)

1xEV-DO: N/W9076A-1FP (1xEV-DO)

Enum keys don't appear on the menu if required licenses are not installed.

Key Path	FREQ Channel, Carrier Setup
----------	-----------------------------

Remote Command	<code>[:SENSe] :CARRier:CONFig?</code>
Example	CARR:CONF TC1AFDD CARR:CONF?
Notes	The softkey for NONE is not available.
State Saved	Saved in instrument state
Initial S/W Revision	A.10.00
Modified at S/W Revision	A.12.00, A.13.00

MSR Test Config

Accesses the menu to select MSR Test Configurations.

Key Path	FREQ Channel, Carrier Setup
Initial S/W Revision	A.10.00

Carrier Conf Presets

Pressing this key pops up Conf Presets. Each parameter under this menu initiate carrier configuration preset when its value is changed.

Appropriate licenses are required to select carrier config enum. Required licenses are shown here. Note that N/W means N or W license, i.e. N/W9073A-1FP means either N9073A-1FP or W9073A-1FP is required.

TC1a (FDD): N/W9073A-1FP (W-CDMA)

TC2 (FDD): N/W9080A-1FP (LTE FDD)

TC3a (FDD): N/W9073A-1FP (W-CDMA) and N9080A-1FP (LTE FDD)

TC4a (FDD): N/W9071A-2FP (GSM/EDGE) and N/W9073A-1FP (W-CDMA)

TC4b (FDD): N/W9071A-2FP (GSM/EDGE) and N9080A-1FP (LTE FDD)

TC4c (FDD): N/W9071A-2FP (GSM/EDGE), N/W9073A-1FP (W-CDMA) and N9080A-1FP (LTE FDD)

TC4d (FDD): N/W9071A-2FP (GSM/EDGE) and N/W9073A-1FP (W-CDMA)

TC4e (FDD): N/W9071A-2FP (GSM/EDGE) and N9080A-1FP (LTE FDD)

TC4a (FDD) Two Carriers: N/W9071A-2FP (GSM/EDGE) and N/W9073A-1FP (W-CDMA)

TC4b (FDD) Two Carriers: N/W9071A-2FP (GSM/EDGE) and N9080A-1FP (LTE FDD)

TC4c (FDD) Two Carriers: N/W9071A-2FP (GSM/EDGE), N/W9073A-1FP (W-CDMA) and N9080A-1FP (LTE FDD)

NTC1a (FDD): N/W9073A-1FP (W-CDMA)

NTC2 (FDD): N/W9080A–1FP (LTE FDD)

NTC3a (FDD): N/W9073A–1FP (W-CDMA) and N9080A–1FP (LTE FDD)

NTC4a (FDD): N/W9071A–2FP (GSM/EDGE) and N/W9073A–1FP (W-CDMA)

NTC4b (FDD): N/W9071A–2FP (GSM/EDGE) and N9080A–1FP (LTE FDD)

NTC4c (FDD): N/W9071A–2FP (GSM/EDGE), N/W9073A–1FP (W-CDMA) and N9080A–1FP (LTE FDD)

LTE FDD: N/W9080A–1FP (LTE FDD)

W-CDMA: N/W9073A–1FP (W-CDMA)

GSM/EDGE: N/W9071A–2FP (GSM/EDGE)

cdma2000: N/W9072A–2FP (cdma2000)

1xEV-DO: N/W9076A–1FP (1xEV-DO)

Enum keys don't appear on the menu if required licenses are not installed.

Key Path	FREQ Channel, Carrier Setup
Remote Command	<code>[:SENSe] :CARRier:CONFig?</code>
Example	CARR:CONF TC1AFDD CARR:CONF?
Notes	The softkey for NONE is not available.
State Saved	Saved in instrument state
Initial S/W Revision	A.10.00
Modified at S/W Revision	A.12.00, A.13.00

Max W-CDMA Carriers (FDD)

Sets max W-CDMA carriers placed when the carrier configuration preset runs. When this value is changed, the carrier configuration preset is initiated.

Key Path	FREQ Channel, Carrier Setup, Carrier Conf Presets, MSR Test Config, TC1a (FDD)FREQ Channel, Carrier Setup, Carrier Conf Presets, MSR Test Config, TC3a (FDD)FREQ Channel, Carrier Setup, Carrier Conf Presets, MSR Test Config, TC4a (FDD)FREQ Channel, Carrier Setup, Carrier Conf Presets, MSR Test Config, TC4c (FDD)FREQ Channel, Carrier Setup, Carrier Conf Presets, Single RAT Config, W-CDMA
Remote Command	<code>[:SENSe] :CARRier:CONFig:WCDMa:CMAx <integer></code> <code>[:SENSe] :CARRier:CONFig:WCDMa:CMAx?</code>
Example	CARR:CONF:WCDM:CMAx 8 CARR:CONF:WCDM:CMAx?
Preset	100
State Saved	Saved in instrument state

Min	1
Max	100
Initial S/W Revision	A.10.00

Max LTE FDD Carriers

Sets max LTE FDD carriers placed when the carrier configuration preset runs. When this value is changed, the carrier configuration preset is initiated.

Key Path	FREQ Channel, Carrier Setup, Carrier Conf Presets, MSR Test Config, TC2 (FDD)FREQ Channel, Carrier Setup, Carrier Conf Presets, MSR Test Config, TC3a (FDD)FREQ Channel, Carrier Setup, Carrier Conf Presets, MSR Test Config, TC4b (FDD)FREQ Channel, Carrier Setup, Carrier Conf Presets, MSR Test Config, TC4c (FDD)FREQ Channel, Carrier Setup, Carrier Conf Presets, Single RAT Config, LTE FDD
Remote Command	[:SENSe] :CARRier:CONFig:LTEFdd:CMAx <integer> [:SENSe] :CARRier:CONFig:LTEFdd:CMAx?
Example	CARR:CONF:LTEF:CMAx 8 CARR:CONF:LTEF:CMAx?
Preset	100
State Saved	Saved in instrument state
Min	1
Max	100
Initial S/W Revision	A.10.00

LTE FDD BW

Sets bandwidth of LTE FDD carriers placed when the carrier configuration preset runs. When this value is changed, the carrier configuration preset is initiated.

Key Path	FREQ Channel, Carrier Setup, Carrier Conf Presets, MSR Test Config, TC2 (FDD)FREQ Channel, Carrier Setup, Carrier Conf Presets, MSR Test Config, TC3a (FDD)FREQ Channel, Carrier Setup, Carrier Conf Presets, MSR Test Config, TC4b (FDD)FREQ Channel, Carrier Setup, Carrier Conf Presets, MSR Test Config, TC4c (FDD)FREQ Channel, Carrier Setup, Carrier Conf Presets, MSR Test Config, TC4d (FDD)FREQ Channel, Carrier Setup, Carrier Conf Presets, Single RAT Config, LTE FDD
Remote Command	[:SENSe] :CARRier:CONFig:LTEFdd:BANDwidth B1M4 B3M B5M B10M B15M B20M [:SENSe] :CARRier:CONFig:LTEFdd:BANDwidth?
Example	CARR:CONF:LTEF:BAND B5M CARR:CONF:LTEF:BAND?
Preset	B5M

State Saved	Saved in instrument state
Range	1.4MHz 3MHz 5MHz 10MHz 15MHz 20MHz
Readback	The currently selected LTE FDD BW
Initial S/W Revision	A.10.00

Narrowest LTE FDD BW

Sets narrowest bandwidth of LTE FDD carriers placed for TC2 when the carrier configuration preset runs. When this value is changed, the carrier configuration preset is initiated.

Key Path	FREQ Channel, Carrier Setup, Carrier Conf Presets, MSR Test Config, TC2 (FDD)
Remote Command	<code>[[:SENSe]:CARRier:CONFig:LTEFdd:BANDwidth:NARRowest B1M4 B3M B5M B10M B15M B20M</code> <code>[[:SENSe]:CARRier:CONFig:LTEFdd:BANDwidth:NARRowest?</code>
Example	CARR:CONF:LTEF:BAND:NARR B1M4 CARR:CONF:LTEF:BAND:NARR?
Preset	B1M4
State Saved	Saved in instrument state
Range	1.4MHz 3MHz 5MHz 10MHz 15MHz 20MHz
Readback	The currently selected Narrowest LTE FDD BW
Initial S/W Revision	A.10.00

Max GSM/EDGE Carriers

Sets max GSM/EDGE carriers placed when the carrier configuration preset runs. When this value is changed, the carrier configuration preset is initiated.

Key Path	FREQ Channel, Carrier Setup, Carrier Conf Presets, MSR Test Config, TC4a (FDD)FREQ Channel, Carrier Setup, Carrier Conf Presets, MSR Test Config, TC4b (FDD)FREQ Channel, Carrier Setup, Carrier Conf Presets, MSR Test Config, TC4c (FDD)FREQ Channel, Carrier Setup, Carrier Conf Presets, Single RAT Config, GSM/EDGE
Remote Command	<code>[[:SENSe]:CARRier:CONFig:GSM:CMAx <integer></code> <code>[[:SENSe]:CARRier:CONFig:GSM:CMAx?</code>
Example	CARR:CONF:GSM:CMAx 8 CARR:CONF:GSM:CMAx?
Preset	100
State Saved	Saved in instrument state
Min	1
Max	100
Initial S/W Revision	A.10.00

LTE FDD Location

Sets the location of LTE FDD carriers when carriers are configured as TC4c. This parameter is effective only for TC4c.

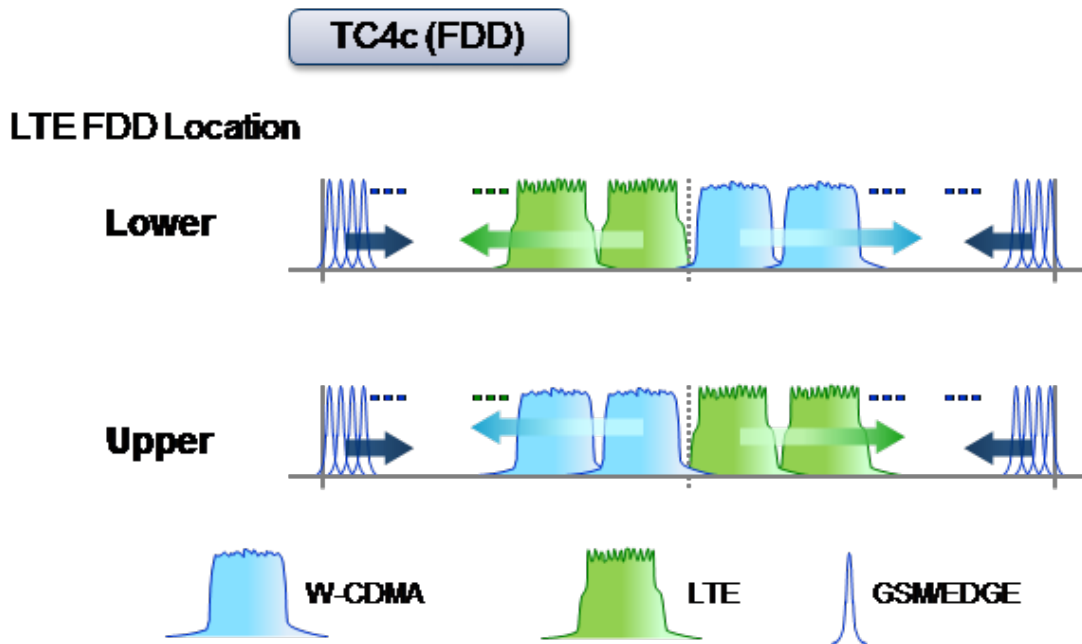

Key Path	FREQ Channel, Carrier Setup, Carrier Conf Presets, MSR Test Config, TC4c (FDD)
Remote Command	<code>[:SENSe] :CARRier:CONFIg:LTEFdd:LOCation UPPer LOWer</code> <code>[:SENSe] :CARRier:CONFIg:LTEFdd:LOCation?</code>
Example	<code>CARR:CONF:LTEF:LOC LOW</code> <code>CARR:CONF:LTEF:LOC?</code>
Notes	This setting is effective only for TC4c.
Preset	UPPer
State Saved	Saved in instrument state
Range	Lower (Lower than W-CDMA) Upper (Higher than W-CDMA)
Initial S/W Revision	A.11.00

MSR Non-Contig Test Config

Accesses the menu to select MSR Non-Contiguous Test Configurations.

Key Path	FREQ Channel, Carrier Setup
Initial S/W Revision	A.13.00

Carrier Conf Presets

Pressing this key pops up Conf Presets. Each parameter under this menu initiate carrier configuration preset when its value is changed.

Appropriate licenses are required to select carrier config enum. Required licenses are shown here. Note that N/W means N or W license, i.e. N/W9073A-1FP means either N9073A-1FP or W9073A-1FP is required.

- TC1a (FDD): N/W9073A-1FP (W-CDMA)
 - TC2 (FDD): N/W9080A-1FP (LTE FDD)
 - TC3a (FDD): N/W9073A-1FP (W-CDMA) and N9080A-1FP (LTE FDD)
 - TC4a (FDD): N/W9071A-2FP (GSM/EDGE) and N/W9073A-1FP (W-CDMA)
 - TC4b (FDD): N/W9071A-2FP (GSM/EDGE) and N9080A-1FP (LTE FDD)
 - TC4c (FDD): N/W9071A-2FP (GSM/EDGE), N/W9073A-1FP (W-CDMA) and N9080A-1FP (LTE FDD)
 - TC4d (FDD): N/W9071A-2FP (GSM/EDGE) and N/W9073A-1FP (W-CDMA)
 - TC4e (FDD): N/W9071A-2FP (GSM/EDGE) and N9080A-1FP (LTE FDD)
 - TC4a (FDD) Two Carriers: N/W9071A-2FP (GSM/EDGE) and N/W9073A-1FP (W-CDMA)
 - TC4b (FDD) Two Carriers: N/W9071A-2FP (GSM/EDGE) and N9080A-1FP (LTE FDD)
 - TC4c (FDD) Two Carriers: N/W9071A-2FP (GSM/EDGE), N/W9073A-1FP (W-CDMA) and N9080A-1FP (LTE FDD)
 - NTC1a (FDD): N/W9073A-1FP (W-CDMA)
 - NTC2 (FDD): N/W9080A-1FP (LTE FDD)
 - NTC3a (FDD): N/W9073A-1FP (W-CDMA) and N9080A-1FP (LTE FDD)
 - NTC4a (FDD): N/W9071A-2FP (GSM/EDGE) and N/W9073A-1FP (W-CDMA)
 - NTC4b (FDD): N/W9071A-2FP (GSM/EDGE) and N9080A-1FP (LTE FDD)
 - NTC4c (FDD): N/W9071A-2FP (GSM/EDGE), N/W9073A-1FP (W-CDMA) and N9080A-1FP (LTE FDD)
 - LTE FDD: N/W9080A-1FP (LTE FDD)
 - W-CDMA: N/W9073A-1FP (W-CDMA)
 - GSM/EDGE: N/W9071A-2FP (GSM/EDGE)
 - cdma2000: N/W9072A-2FP (cdma2000)
 - 1xEV-DO: N/W9076A-1FP (1xEV-DO)
- Enum keys don't appear on the menu if required licenses are not installed.

Key Path	FREQ Channel, Carrier Setup
Remote Command	[:SENSe] :CARRier :CONFig?

Example	CARR:CONF TC1AFDD CARR:CONF?
Notes	The softkey for NONE is not available.
State Saved	Saved in instrument state
Initial S/W Revision	A.10.00
Modified at S/W Revision	A.12.00, A.13.00

LTE FDD BW

Sets bandwidth of LTE FDD carriers placed when the carrier configuration preset runs. When this value is changed, the carrier configuration preset is initiated.

Key Path	FREQ Channel, Carrier Setup, Carrier Conf Presets, MSR Test Config, TC2 (FDD)FREQ Channel, Carrier Setup, Carrier Conf Presets, MSR Test Config, TC3a (FDD)FREQ Channel, Carrier Setup, Carrier Conf Presets, MSR Test Config, TC4b (FDD)FREQ Channel, Carrier Setup, Carrier Conf Presets, MSR Test Config, TC4c (FDD)FREQ Channel, Carrier Setup, Carrier Conf Presets, MSR Test Config, TC4d (FDD)FREQ Channel, Carrier Setup, Carrier Conf Presets, Single RAT Config, LTE FDD
Remote Command	[:SENSe] :CARRier:CONFig:LTEFdd:BANDwidth B1M4 B3M B5M B10M B15M B20M [:SENSe] :CARRier:CONFig:LTEFdd:BANDwidth?
Example	CARR:CONF:LTEF:BAND B5M CARR:CONF:LTEF:BAND?
Preset	B5M
State Saved	Saved in instrument state
Range	1.4MHz 3MHz 5MHz 10MHz 15MHz 20MHz
Readback	The currently selected LTE FDD BW
Initial S/W Revision	A.10.00

NTC4 Carriers

Sets NTC4 carriers placed when the NTC4 carrier configuration preset runs. When this value is changed, the carrier configuration preset is initiated.

Key Path	FREQ Channel, Carrier Setup, Carrier Conf Presets, MSR Non-Contig Test Config, NTC4a (FDD)FREQ Channel, Carrier Setup, Carrier Conf Presets, MSR Non-Contig Test Config, NTC4b (FDD)FREQ Channel, Carrier Setup, Carrier Conf Presets, MSR Non-Contig Test Config, NTC4c(FDD)
Remote Command	[:SENSe] :CARRier:CONFig:NTC4:COUNT <integer> [:SENSe] :CARRier:CONFig:NTC4:COUNT?
Example	CARR:CONF:NTC4:COUN 6 CARR:CONF:NTC4:COUN?

Preset	6
State Saved	Saved in instrument state
Min	3
Max	6
Initial S/W Revision	A.13.00

Single RAT Config

Accesses the menu to select Single RAT Configurations.

Key Path	FREQ Channel, Carrier Setup
Initial S/W Revision	A.10.00

Carrier Conf Presets

Pressing this key pops up Conf Presets. Each parameter under this menu initiate carrier configuration preset when its value is changed.

Appropriate licenses are required to select carrier config enum. Required licenses are shown here. Note that N/W means N or W license, i.e. N/W9073A-1FP means either N9073A-1FP or W9073A-1FP is required.

TC1a (FDD): N/W9073A-1FP (W-CDMA)

TC2 (FDD): N/W9080A-1FP (LTE FDD)

TC3a (FDD): N/W9073A-1FP (W-CDMA) and N9080A-1FP (LTE FDD)

TC4a (FDD): N/W9071A-2FP (GSM/EDGE) and N/W9073A-1FP (W-CDMA)

TC4b (FDD): N/W9071A-2FP (GSM/EDGE) and N9080A-1FP (LTE FDD)

TC4c (FDD): N/W9071A-2FP (GSM/EDGE), N/W9073A-1FP (W-CDMA) and N9080A-1FP (LTE FDD)

TC4d (FDD): N/W9071A-2FP (GSM/EDGE) and N/W9073A-1FP (W-CDMA)

TC4e (FDD): N/W9071A-2FP (GSM/EDGE) and N9080A-1FP (LTE FDD)

TC4a (FDD) Two Carriers: N/W9071A-2FP (GSM/EDGE) and N/W9073A-1FP (W-CDMA)

TC4b (FDD) Two Carriers: N/W9071A-2FP (GSM/EDGE) and N9080A-1FP (LTE FDD)

TC4c (FDD) Two Carriers: N/W9071A-2FP (GSM/EDGE), N/W9073A-1FP (W-CDMA) and N9080A-1FP (LTE FDD)

NTC1a (FDD): N/W9073A-1FP (W-CDMA)

NTC2 (FDD): N/W9080A-1FP (LTE FDD)

NTC3a (FDD): N/W9073A-1FP (W-CDMA) and N9080A-1FP (LTE FDD)

NTC4a (FDD): N/W9071A-2FP (GSM/EDGE) and N/W9073A-1FP (W-CDMA)

NTC4b (FDD): N/W9071A–2FP (GSM/EDGE) and N9080A–1FP (LTE FDD)

NTC4c (FDD): N/W9071A–2FP (GSM/EDGE), N/W9073A–1FP (W-CDMA) and N9080A–1FP (LTE FDD)

LTE FDD: N/W9080A–1FP (LTE FDD)

W-CDMA: N/W9073A–1FP (W-CDMA)

GSM/EDGE: N/W9071A–2FP (GSM/EDGE)

cdma2000: N/W9072A–2FP (cdma2000)

1xEV-DO: N/W9076A–1FP (1xEV-DO)

Enum keys don't appear on the menu if required licenses are not installed.

Key Path	FREQ Channel, Carrier Setup
Remote Command	[:SENSe] :CARRier:CONFIg?
Example	CARR:CONF TC1AFDD CARR:CONF?
Notes	The softkey for NONE is not available.
State Saved	Saved in instrument state
Initial S/W Revision	A.10.00
Modified at S/W Revision	A.12.00, A.13.00

Max LTE FDD Carriers

Sets max LTE FDD carriers placed when the carrier configuration preset runs. When this value is changed, the carrier configuration preset is initiated.

Key Path	FREQ Channel, Carrier Setup, Carrier Conf Presets, MSR Test Config, TC2 (FDD)FREQ Channel, Carrier Setup, Carrier Conf Presets, MSR Test Config, TC3a (FDD)FREQ Channel, Carrier Setup, Carrier Conf Presets, MSR Test Config, TC4b (FDD)FREQ Channel, Carrier Setup, Carrier Conf Presets, MSR Test Config, TC4c (FDD)FREQ Channel, Carrier Setup, Carrier Conf Presets, Single RAT Config, LTE FDD
Remote Command	[:SENSe] :CARRier:CONFIg:LTEFdd:CMAx <integer> [:SENSe] :CARRier:CONFIg:LTEFdd:CMAx?
Example	CARR:CONF:LTEF:CMAx 8 CARR:CONF:LTEF:CMAx?
Preset	100
State Saved	Saved in instrument state
Min	1
Max	100
Initial S/W Revision	A.10.00

LTE FDD BW

Sets bandwidth of LTE FDD carriers placed when the carrier configuration preset runs. When this value is changed, the carrier configuration preset is initiated.

Key Path	FREQ Channel, Carrier Setup, Carrier Conf Presets, MSR Test Config, TC2 (FDD)FREQ Channel, Carrier Setup, Carrier Conf Presets, MSR Test Config, TC3a (FDD)FREQ Channel, Carrier Setup, Carrier Conf Presets, MSR Test Config, TC4b (FDD)FREQ Channel, Carrier Setup, Carrier Conf Presets, MSR Test Config, TC4c (FDD)FREQ Channel, Carrier Setup, Carrier Conf Presets, MSR Test Config, TC4d (FDD)FREQ Channel, Carrier Setup, Carrier Conf Presets, Single RAT Config, LTE FDD
Remote Command	[:SENSe] :CARRier:CONFig:LTEFdd:Bandwidth B1M4 B3M B5M B10M B15M B20M [:SENSe] :CARRier:CONFig:LTEFdd:Bandwidth?
Example	CARR:CONF:LTEF:BAND B5M CARR:CONF:LTEF:BAND?
Preset	B5M
State Saved	Saved in instrument state
Range	1.4MHz 3MHz 5MHz 10MHz 15MHz 20MHz
Readback	The currently selected LTE FDD BW
Initial S/W Revision	A.10.00

Max W-CDMA Carriers (FDD)

Sets max W-CDMA carriers placed when the carrier configuration preset runs. When this value is changed, the carrier configuration preset is initiated.

Key Path	FREQ Channel, Carrier Setup, Carrier Conf Presets, MSR Test Config, TC1a (FDD)FREQ Channel, Carrier Setup, Carrier Conf Presets, MSR Test Config, TC3a (FDD)FREQ Channel, Carrier Setup, Carrier Conf Presets, MSR Test Config, TC4a (FDD)FREQ Channel, Carrier Setup, Carrier Conf Presets, MSR Test Config, TC4c (FDD)FREQ Channel, Carrier Setup, Carrier Conf Presets, Single RAT Config, W-CDMA
Remote Command	[:SENSe] :CARRier:CONFig:WCDMa:CMAx <integer> [:SENSe] :CARRier:CONFig:WCDMa:CMAx?
Example	CARR:CONF:WCDM:CMAx 8 CARR:CONF:WCDM:CMAx?
Preset	100
State Saved	Saved in instrument state
Min	1
Max	100
Initial S/W Revision	A.10.00

Max GSM/EDGE Carriers

Sets max GSM/EDGE carriers placed when the carrier configuration preset runs. When this value is changed, the carrier configuration preset is initiated.

Key Path	FREQ Channel, Carrier Setup, Carrier Conf Presets, MSR Test Config, TC4a (FDD)FREQ Channel, Carrier Setup, Carrier Conf Presets, MSR Test Config, TC4b (FDD)FREQ Channel, Carrier Setup, Carrier Conf Presets, MSR Test Config, TC4c (FDD)FREQ Channel, Carrier Setup, Carrier Conf Presets, Single RAT Config, GSM/EDGE
Remote Command	<code>[:SENSe] :CARRier:CONFig:GSM:CMAX <integer></code> <code>[:SENSe] :CARRier:CONFig:GSM:CMAX?</code>
Example	CARR:CONF:GSM:CMAX 8 CARR:CONF:GSM:CMAX?
Preset	100
State Saved	Saved in instrument state
Min	1
Max	100
Initial S/W Revision	A.10.00

Max cdma2000 Carriers

Sets max cdma2000 carriers placed when the carrier configuration preset runs. When this value is changed, the carrier configuration preset is initiated.

Key Path	FREQ Channel, Carrier Setup, Carrier Conf Presets, Single RAT Config, cdma2000
Remote Command	<code>[:SENSe] :CARRier:CONFig:CDMA:CMAX <integer></code> <code>[:SENSe] :CARRier:CONFig:CDMA:CMAX?</code>
Example	CARR:CONF:CDMA:CMAX 8 CARR:CONF:CDMA:CMAX?
Preset	100
State Saved	Saved in instrument state
Min	1
Max	100
Initial S/W Revision	A.12.00

Max 1xEV-DO Carriers

Sets max 1xEV-DO carriers placed when the carrier configuration preset runs. When this value is changed, the carrier configuration preset is initiated.

Key Path	FREQ Channel, Carrier Setup, Carrier Conf Presets, Single RAT Config, 1xEV-DO
Remote Command	<code>[:SENSe] :CARRier:CONFig:EVDO:CMAX <integer></code>

	<code>[:SENSe] :CARRier:CONFig:EVDO:CMAx?</code>
Example	<code>CARR:CONF:EVDO:CMAx 8</code> <code>CARR:CONF:EVDO:CMAx?</code>
Preset	100
State Saved	Saved in instrument state
Min	1
Max	100
Initial S/W Revision	A.12.00

Max BS RF Bandwidth

Sets max BS RF bandwidth used when the carrier configuration preset runs. When this value is changed, the carrier configuration preset is initiated.

Key Path	FREQ Channel, Carrier Setup, Carrier Conf Presets
Remote Command	<code>[:SENSe] :CARRier:CONFig:RFBWidth <freq></code> <code>[:SENSe] :CARRier:CONFig:RFBWidth?</code>
Example	<code>CARR:CONF:RFBW 40MHz</code> <code>CARR:CONF:RFBW?</code>
Preset	40MHz
State Saved	Saved in instrument state
Min	600 kHz
Max	200 MHz
Initial S/W Revision	A.10.00

Channel Spacing Delta

Carriers are placed based on channel spacing assigned to the corresponding radio format, when they are configured by the carrier config preset. However, channel spacing can be adjusted using channel spacing delta parameters.

This key accesses the menu to set channel spacing delta of each radio format.

Key Path	FREQ Channel, Carrier Setup, Carrier Conf Presets
Initial S/W Revision	A.10.00

LTE FDD

Sets delta channel spacing for LTE FDD used when the carrier configuration preset runs. Channel spacing for LTE FDD is determined from this value and the default channel spacing defined in the standard, i.e. Channel spacing = (BWchan1 + BWchan2) * 0.5 + [the delta spacing]. Since this value is a difference from

the default spacing, this value can be negative to allow narrower channel spacing. When this value is changed, the carrier configuration preset is initiated.

Key Path	FREQ Channel, Carrier Setup, Carrier Conf Presets, Channel Spacing Delta
Remote Command	[:SENSE] :CARRier:CONFig:LTEFdd:SPACing:DELTA <freq> [:SENSE] :CARRier:CONFig:LTEFdd:SPACing:DELTA?
Example	CARR:CONF:LTEF:SPAC:DELTA -200kHz CARR:CONF:LTEF:SPAC:DELTA?
Preset	0Hz
State Saved	Saved in instrument state
Min	- 1.0 MHz
Max	10.0 MHz
Initial S/W Revision	A.10.00
Modified at S/W Revision	A.11.00

W-CDMA

Sets delta channel spacing for W-CDMA used when the carrier configuration preset runs. Channel spacing for W-CDMA is determined from this value and the default channel spacing defined in the standard, i.e. Channel spacing = 5.0 MHz + [the delta spacing]. Since this value is a difference from the default spacing, this value can be negative to allow narrower channel spacing. When this value is changed, the carrier configuration preset is initiated.

Key Path	FREQ Channel, Carrier Setup, Carrier Conf Presets, Channel Spacing Delta
Remote Command	[:SENSE] :CARRier:CONFig:WCDMa:SPACing:DELTA <freq> [:SENSE] :CARRier:CONFig:WCDMa:SPACing:DELTA?
Example	CARR:CONF:WCDM:SPAC:DELTA 0 CARR:CONF:WCDM:SPAC:DELTA?
Preset	0 Hz
State Saved	Saved in instrument state
Min	- 1.0 MHz
Max	10.0 MHz
Initial S/W Revision	A.10.00
Modified at S/W Revision	A.11.00

GSM/EDGE

Sets delta channel spacing for GSM/EDGE used when the carrier configuration preset runs. Channel spacing for GSM/EDGE is determined from this value and the default channel spacing defined in the standard, i.e. Channel spacing = 600 kHz + [the delta spacing]. Since this value is a difference from the default spacing, this value can be negative to allow narrower channel spacing. When this value is changed, the carrier configuration preset is initiated.

Key Path	FREQ Channel, Carrier Setup, Carrier Conf Presets, Channel Spacing Delta
Remote Command	[:SENSe] :CARRier:CONFig:GSM:SPACing:DELTA <freq> [:SENSe] :CARRier:CONFig:GSM:SPACing:DELTA?
Example	CARR:CONF:GSM:SPAC:DELT 0 CARR:CONF:GSM:SPAC:DELT?
Preset	0 Hz
State Saved	Saved in instrument state
Min	- 0.4 MHz
Max	10.0 MHz
Initial S/W Revision	A.10.00
Modified at S/W Revision	A.11.00

cdma2000

Sets delta channel spacing for cdma2000 used when the carrier configuration preset runs. Channel spacing for cdma2000 is determined from this value and the default channel spacing defined in the standard, i.e. Channel spacing = 1.25 MHz + [the delta spacing]. Since this value is a difference from the default spacing, this value can be negative to allow narrower channel spacing.

Key Path	FREQ Channel, Carrier Setup, Carrier Conf Presets, Channel Spacing Delta
Remote Command	[:SENSe] :CARRier:CONFig:CDMA:SPACing:DELTA <freq> [:SENSe] :CARRier:CONFig:CDMA:SPACing:DELTA?
Example	CARR:CONF:CDMA:SPAC:DELT 0 CARR:CONF:CDMA:SPAC:DELT?
Preset	0 Hz
State Saved	Saved in instrument state
Min	-1 MHz
Max	10 MHz
Initial S/W Revision	A.12.00

1xEV-DO

Sets delta channel spacing for 1xEV-DO used when the carrier configuration preset runs. Channel spacing for 1xEV-DO is determined from this value and the default channel spacing defined in the standard, i.e. Channel spacing = 1.25 MHz + [the delta spacing]. Since this value is a difference from the default spacing, this value can be negative to allow narrower channel spacing.

Key Path	FREQ Channel, Carrier Setup, Carrier Conf Presets, Channel Spacing Delta
Remote Command	[:SENSe] :CARRier:CONFig:EVDO:SPACing:DELTA <freq> [:SENSe] :CARRier:CONFig:EVDO:SPACing:DELTA?

Example	CARR:CONF:EVDO:SPAC:DELT 0 CARR:CONF:EVDO:SPAC:DELT?
Preset	0 Hz
State Saved	Saved in instrument state
Min	-1 MHz
Max	10 MHz
Initial S/W Revision	A.12.00

Apply to Meas Offset/Limits

This immediate action key sets the following measurement parameters.

- ACP: Offset and limit parameters under Offset/Limits.
- Spectrum Emission Mask: Offset and limit parameters under Offset/Limits.
- Spurious Emissions: Range frequency and limit parameters under Range Table.

These offset and limit values are determined by the carrier configuration parameters, Band Category and Assumed Adj Channels.

Each of these measurement has a local key, “Apply Carrier Config to ...”, which performs in the same way only for its parameters. So pressing this key is equivalent to pressing “Apply Carrier Config to ...” of all these measurements.

Key Path	FREQ Channel, Carrier Setup
Remote Command	[:SENSe] :MCONdition:IMMEDIATE
Example	MCON:IMM
Initial S/W Revision	A.11.00

RF Bandwidth (Remote Command Only)

Returns the RF bandwidth calculated from the outermost carriers and their Foffset_RAT.

Key Path	SCPI only
Mode	MSR
Remote Command	[:SENSe] :CARRier:RFBWidth?
Example	CARR:RFBW?
Preset	Calculated from preset values of carrier config parameters
State Saved	No
Initial S/W Revision	A.13.00

RF Bandwidth Center (Remote Command Only)

Returns the center frequency of RF bandwidth.

Key Path	SCPI only
Mode	MSR
Remote Command	[:SENSe] :CARRier:RFBWidth:CENTer?
Example	CARR:RFBW:CENT?
Preset	Calculated from preset values of carrier config parameters
State Saved	No
Initial S/W Revision	A.13.00

Sub-block Center (Remote Command Only)

Returns the center frequency of sub-block when Carrier Allocation is Non-Contiguous.

Key Path	SCPI only
Mode	MSR
Remote Command	[:SENSe] :CARRier:SBLOCK[1] 2 :CENTer?
Example	CARR:SBL:CENT?
Notes	When Carrier Allocation is Contiguous, 9.91 E+37 is returned.
Preset	Calculated from preset values of carrier config parameters
State Saved	No
Initial S/W Revision	A.13.00

Sub-block Bandwidth (Remote Command Only)

Returns the bandwidth of sub-block calculated from outermost carriers and corresponding Offset_RAT.

Key Path	SCPI only
Mode	MSR
Remote Command	[:SENSe] :CARRier:SBLOCK[1] 2 :BWIDth?
Example	CARR:SBL:BWID?
Notes	When Carrier Allocation is Contiguous, 9.91 E+37 is returned.
Preset	Calculated from preset values of carrier config parameters
State Saved	No
Initial S/W Revision	A.13.00

Sub-block Gap (Remote Command Only)

Returns the sub-block gap.

Key Path	SCPI only
Mode	MSR
Remote Command	[:SENSe] :CARRier :SBLock :GAP?
Example	CARR:SBL:GAP?
Notes	When Carrier Allocation is Contiguous, 9.91E+37 is returned.
Preset	Calculated from preset values of carrier config parameters
State Saved	No
Initial S/W Revision	A.13.00

Input/Output

See "[Input/Output](#)" on page 190

Marker

Accesses a menu that enables you to select, set up and control the markers for the current measurement.

Key Path	Front-panel key
Initial S/W Revision	Prior to A.02.00

Select Marker

Displays the menu keys that enable you to select, set up and control the markers for the current measurement

Key Path	Marker
Initial S/W Revision	Prior to A.02.00

Select Marker

Displays 12 markers available for selection.

Key Path	Marker, Properties
Initial S/W Revision	Prior to A.02.00

Marker Type

Sets the marker control mode to **Normal**, **Delta** or **Off**. If the selected marker is Off, pressing Marker sets it to Normal and places a single marker at the center of the display. At the same time, **Marker X Axis Value** appears on the Active Function area.

Key Path	Marker
Mode	SA, WCDMA, C2K, WIMAX OFDMA, TD-SCDMA, 1xEVDO, ISDB-T, CMMB, LTE, LTETDD, BLUETOOTH, WLAN, MSR, LTEAFDD, LTEATDD
Remote Command	:CALCulate:OBWidth:MARKer[1] 2 ... 12:MODE POSition DELTa OFF :CALCulate:OBWidth:MARKer[1] 2 ... 12:MODE?
Example	CALC:OBW:MARK:MODE POS CALC:OBW:MARK:MODE?
Notes	If the selected marker is Off, pressing Marker sets it to Normal and places it at the center of the screen on the trace determined by the Marker Trace rules. At the same time, Marker X Axis Value appears on the Active Function area. Default Active Function: the active function for the selected marker's current control mode. If the current control mode is Off, there is no active function and the active function is turned off. Active Function Display: the marker X axis value entered in the active function area displays the marker value to its full entered precision.

Preset	OFF
State Saved	Saved in instrument state.
Range	Normal Delta Off
Initial S/W Revision	Prior to A.02.00
Modified at S/W Revision	A.03.00

Properties

Accesses the marker properties menu.

Key Path	Marker
Initial S/W Revision	Prior to A.02.00

Select Marker

Displays the menu keys that enable you to select, set up and control the markers for the current measurement

Key Path	Marker
Initial S/W Revision	Prior to A.02.00

Select Marker

Displays 12 markers available for selection.

Key Path	Marker, Properties
Initial S/W Revision	Prior to A.02.00

Relative To

Selects the desired marker. The selected marker will be relative to its reference marker.

Key Path	Marker, Properties
Mode	SA, WCDMA, C2K, WIMAX OFDMA, TD-SCDMA, 1xEVDO, ISDB-T, CMMB, LTE, LTETDD, BLUETOOTH, WLAN, MSR, LTEAFDD, LTEATDD
Remote Command	:CALCulate:OBWidth:MARKer[1] 2 ... 12:REFerence <integer> :CALCulate:OBWidth:MARKer[1] 2 ... 12:REFerence?
Example	CALC:OBW:MARK:REF 2

	CALC:OBW:MARK:REF?
Notes	A marker cannot be relative to itself so that choice is grayed out, and if sent from SCPI generates error -221: "Settings conflict; marker cannot be relative to itself." When queried a single value is returned (the specified marker numbers relative marker). You must be in the Spectrum Analysis mode, WCDMA mode, TD-SCDMA mode, 1xEVDO mode, WIMAX OFDMA mode ISDB-T mode, WLAN mode, CMMB mode, LTE mode, LTETDD mode or BLUETOOTH mode to use this command. Use:INSTrument:SElect to set the mode.
Preset	2 3 4 5 6 7 8 9 10 11 12 1
State Saved	Saved in instrument state.
Min	1
Max	12
Readback	Current selected relative to marker number.
Initial S/W Revision	Prior to A.02.00
Modified at S/W Revision	A.03.00

All Markers Off

Turns off all markers.

Key Path	Marker
Mode	SA, WCDMA, C2K, WIMAX OFDMA, TD-SCDMA, 1xEVDO, ISDB-T, CMMB, LTE, LTETDD, BLUETOOTH, WLAN, MSR, LTEAFDD, LTEATDD
Remote Command	:CALCulate:OBWidth:MARKer:AOff
Example	CALC:OBW:MARK:AOff
Initial S/W Revision	Prior to A.02.00
Modified at S/W Revision	A.03.00

Marker X Axis Value (Remote Command Only)

Sets the marker X Axis value in the current marker X Axis Scale unit. It has no effect if the control mode is Off.

Key Path	SCPI only
Mode	SA, WCDMA, C2K, WIMAX OFDMA, TD-SCDMA, 1xEVDO, ISDB-T, CMMB, LTE, LTETDD, BLUETOOTH, WLAN, MSR, LTEAFDD, LTEATDD
Remote Command	:CALCulate:OBWidth:MARKer[1] 2 ... 12:X <freq> :CALCulate:OBWidth:MARKer[1] 2 ... 12:X?
Example	CALC:OBW:MARK3:X 0 CALC:OBW:MARK3:X?
Notes	The query returns the marker's absolute X Axis value if the control mode is Normal , or the offset from

	the marker's reference marker if the control mode is Delta . The query is returned in the fundamental units for the current marker X Axis scale: Hz for Frequency .
Preset	After a preset, all markers are turned OFF, so Marker X Axis Value query returns a not a number (NAN).
State Saved	No
Min	-9.9E+37
Max	9.9E+37
Initial S/W Revision	Prior to A.02.00
Modified at S/W Revision	A.03.00

Marker X Axis Position (Remote Command Only)

Sets the marker X position in trace points. It has no effect if the control mode is **Off**.

Key Path	SCPI only
Mode	SA, WCDMA, C2K, WIMAX OFDMA, TD-SCDMA, 1xEVDO, ISDB-T, CMMB, LTE, LTETDD, BLUETOOTH, WLAN, MSR, LTEAFDD, LTEATDD
Remote Command	:CALCulate:OBWidth:MARKer[1] 2 ... 12:X:POSition <real> :CALCulate:OBWidth:MARKer[1] 2 ... 12:X:POSition?
Example	CALC:OBW:MARK10:X:POS 0 CALC:OBW:MARK10:X:POS?
Notes	The query returns the marker's absolute X Axis value in trace points if the control mode is Normal , or the offset from the marker's reference marker in trace points if the control mode is Delta .
Preset	After a preset, all markers are turned OFF, so Marker X Axis Value query returns a not a number (NAN).
State Saved	No
Min	-9.9E+37
Max	9.9E+37
Initial S/W Revision	Prior to A.02.00
Modified at S/W Revision	A.03.00

Marker Y Axis Value (Remote Command Only)

Returns the marker Y Axis value in the current marker Y Axis unit.

Key Path	SCPI only
Mode	SA, WCDMA, C2K, WIMAX OFDMA, TD-SCDMA, 1xEVDO, ISDB-T, CMMB, LTE, LTETDD, BLUETOOTH, WLAN, MSR, LTEAFDD, LTEATDD
Remote Command	:CALCulate:OBWidth:MARKer[1] 2 ... 12:Y?

Example	CALC:OBW:MARK11:Y?
Preset	Result dependent on Markers setup and signal source.
State Saved	No
Min	-9.9E+37
Max	9.9E+37
Initial S/W Revision	Prior to A.02.00
Modified at S/W Revision	A.03.00

Backward Compatibility SCPI Commands

Sets or queries the state of a marker. Setting a marker which is OFF to state ON or 1 puts it in **Normal** mode and places it at the center of the screen.

Key Path	SCPI only
Mode	SA, WCDMA, C2K, WIMAX OFDMA, TD-SCDMA, 1xEVDO, ISDB-T, CMMB, LTE, LTETDD, BLUETOOTH, WLAN, MSR, LTEAFDD, LTEATDD
Remote Command	:CALCulate:OBWidth:MARKer[1] 2 ... 12:STATe OFF ON 0 1 :CALCulate:OBWidth:MARKer[1] 2 ... 12:STATe?
Example	CALC:OBW:MARK3:STAT ON CALC:OBW:MARK3:STAT?
Preset	OFF
State Saved	Saved in instrument state.
Initial S/W Revision	Prior to A.02.00
Modified at S/W Revision	A.03.00

Marker Function

There are no 'Marker Functions' supported in this measurement. When pressed, this key displays a blank menu.

Key Path	Front panel key
Initial S/W Revision	Prior to A.02.00

Marker To

There is no 'Marker To' functionality supported in this measurement. When pressed, this key displays a blank menu.

Key Path	Front panel key
Initial S/W Revision	Prior to A.02.00

Meas

The information in this section is common to all measurements. For key and remote command information for a specific measurement, refer to the section that describes the measurement of interest.

Measurements available under the Meas key are specific to the current Mode.

When viewing Help for measurements, note the following:

NOTE

Operation for some keys differs between measurements. The information displayed in Help pertains to the current measurement. To see how a key operates in a different measurement, exit Help (press the Cancel Esc key), select the measurement, then reenter Help (press the Help key) and press that key.

Key Path	Front-panel key
Initial S/W Revision	Prior to A.02.00

Remote Measurement Functions

This section contains the following topics:

["Measurement Group of Commands" on page 2382](#)

["Current Measurement Query \(Remote Command Only\)" on page 2384](#)

["Limit Test Current Results \(Remote Command Only\)" on page 2384](#)

["Data Query \(Remote Command Only\)" on page 2384](#)

["Calculate/Compress Trace Data Query \(Remote Command Only\)" on page 2385](#)

["Calculate Peaks of Trace Data \(Remote Command Only\)" on page 2390](#)

["Hardware-Accelerated Fast Power Measurement \(Remote Command Only\)" on page 2391](#)

["Format Data: Numeric Data \(Remote Command Only\)" on page 2405](#)

["Format Data: Byte Order \(Remote Command Only\)" on page 2406](#)

Initial S/W Revision	Prior to A.02.00
----------------------	------------------

Measurement Group of Commands

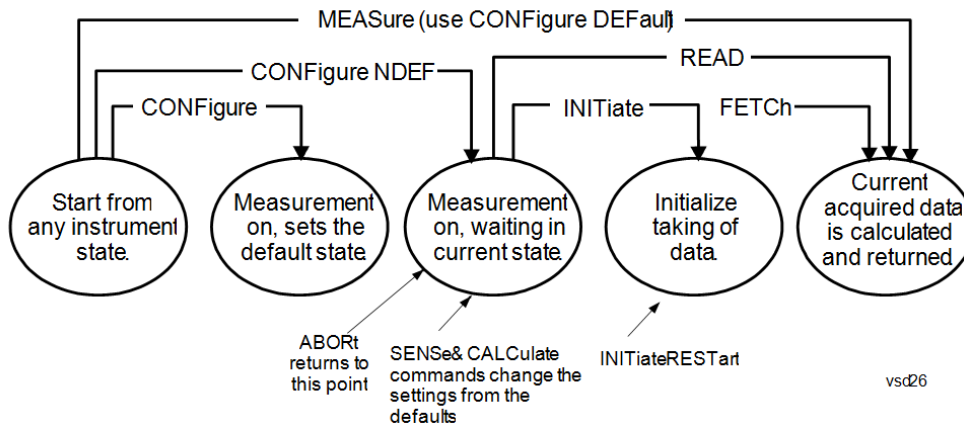

Measure Commands:

:MEASure:<measurement>[n]?

This is a fast single-command way to make a measurement using the factory default instrument settings. These are the settings and units that conform to the Mode Setup settings (e.g. radio standard) that you have currently selected.

- Stops the current measurement (if any) and sets up the instrument for the specified measurement using the factory defaults
- Initiates the data acquisition for the measurement
- Blocks other SCPI communication, waiting until the measurement is complete before returning results.
- If the function does averaging, it is turned on and the number of averages is set to 10.
- After the data is valid it returns the scalar results, or the trace data, for the specified measurement. The type of data returned may be defined by an [n] value that is sent with the command.
- The scalar measurement results will be returned if the optional [n] value is not included, or is set to 1. If the [n] value is set to a value other than 1, the selected trace data results will be returned. See each command for details of what types of scalar results or trace data results are available.
- ASCII is the default format for the data output. (Older versions of Spectrum Analysis and Phase Noise mode measurements only use ASCII.) The binary data formats should be used for handling large blocks of data since they are smaller and faster than the ASCII format. Refer to the FORMat:DATA command for more information.

If you need to change some of the measurement parameters from the factory default settings you can set up the measurement with the CONFigure command. Use the commands in the SENSe:<measurement> and CALCulate:<measurement> subsystems to change the settings. Then you can use the READ? command to initiate the measurement and query the results.

If you need to repeatedly make a given measurement with settings other than the factory defaults, you can use the commands in the SENSe:<measurement> and CALCulate:<measurement> subsystems to set up the measurement. Then use the READ? command to initiate the measurement and query results.

Measurement settings persist if you initiate a different measurement and then return to a previous one. Use READ:<measurement>? if you want to use those persistent settings. If you want to go back to the default settings, use MEASure:<measurement>?.

Configure Commands:

:CONFigure:<measurement>

This command stops the current measurement (if any) and sets up the instrument for the specified measurement using

the factory default instrument settings. It does not initiate the taking of measurement data unless INIT:CONTinuous is ON. If you change any measurement settings after using the CONFigure command, the READ command can be used to initiate a measurement without changing the settings back to their defaults.

In the Swept SA measurement in Spectrum Analyzer mode the CONFigure command also turns the averaging function on and sets the number of averages to 10 for all measurements.

:CONFigure: <measurement>: NDEFault stops the current measurement and changes to the specified measurement. It does not change the settings to the defaults. It does not initiate the taking of measurement data unless INIT:CONTinuous is ON.

The CONFigure? query returns the current measurement name.

The CONFigure:CATalog? query returns a quoted string of all licensed measurement names in the current mode. For example, "SAN, CHP, OBW, ACP, PST, TXP, SPUR, SEM, LIST".

Fetch Commands:

:FETCh:<measurement>[n]?

This command puts selected data from the most recent measurement into the output buffer. Use FETCh if you have already made a good measurement and you want to return several types of data (different [n] values, for example, both scalars and trace data) from a single measurement. FETCh saves you the time of re-making the measurement. You can only FETCh results from the measurement that is currently active, it will not change to a different measurement. An error message is reported if a measurement other than the current one is specified.

If you need to get new measurement data, use the READ command, which is equivalent to an INITiate followed by a FETCh.

The scalar measurement results will be returned if the optional [n] value is not included, or is set to 1. If the [n] value is set to a value other than 1, the selected trace data results will be returned. See each command for details of what types of scalar results or trace data results are available. The binary data formats should be used for handling large blocks of data since they are smaller and transfer faster than the ASCII format. (FORMat:DATA)

FETCh may be used to return results other than those specified with the original READ or MEASure command that you sent.

INITiate Commands:

:INITiate:<measurement>

This command is not available for measurements in all the instrument modes:

- Initiates a trigger cycle for the specified measurement, but does not output any data. You must then use the FETCh<meas> command to return data. If a measurement other than the current one is specified, the instrument will switch to that measurement and then initiate it.
 - For example, suppose you have previously initiated the ACP measurement, but now you are running the channel power measurement. If you send INIT:ACP? it will change from channel power to ACP and will initiate an ACP measurement.
 - Does not change any of the measurement settings. For example, if you have previously started the ACP measurement and you send INIT:ACP? it will initiate a new ACP measurement using the same instrument settings as the last time ACP was run.
 - If your selected measurement is currently active (in the idle state) it triggers the measurement, assuming the trigger conditions are met. Then it completes one trigger cycle. Depending upon the measurement and the number of averages, there may be multiple data acquisitions, with multiple trigger events, for one full trigger cycle. It also holds off additional commands on GPIB until the acquisition is complete.
-

READ Commands:

:READ:<measurement>[n]?

- Does not preset the measurement to the factory default settings. For example, if you have previously initiated the ACP
-

measurement and you send READ:ACP? it will initiate a new measurement using the same instrument settings.

- Initiates the measurement and puts valid data into the output buffer. If a measurement other than the current one is specified, the instrument will switch to that measurement before it initiates the measurement and returns results.
 - For example, suppose you have previously initiated the ACP measurement, but now you are running the channel power measurement. Then you send READ:ACP? It will change from channel power back to ACP and, using the previous ACP settings, will initiate the measurement and return results.
 - Blocks other SCPI communication, waiting until the measurement is complete before returning the results
 - If the optional [n] value is not included, or is set to 1, the scalar measurement results will be returned. If the [n] value is set to a value other than 1, the selected trace data results will be returned. See each command for details of what types of scalar results or trace data results are available. The binary data formats should be used when handling large blocks of data since they are smaller and faster than the ASCII format. (FORMat:DATA)
-

Initial S/W Revision	Prior to A.02.00
----------------------	------------------

Current Measurement Query (Remote Command Only)

This command returns the name of the measurement that is currently running.

Remote Command	:CONFigure?
-----------------------	-------------

Example	CONF?
----------------	-------

Initial S/W Revision	Prior to A.02.00
----------------------	------------------

Limit Test Current Results (Remote Command Only)

Queries the status of the current measurement limit testing. It returns a 0 if the measured results pass when compared with the current limits. It returns a 1 if the measured results fail any limit tests.

Remote Command	:CALCulate:CLIMits:FAIL?
-----------------------	--------------------------

Example	CALC:CLIM:FAIL? queries the current measurement to see if it fails the defined limits. Returns a 0 or 1: 0 it passes, 1 it fails.
----------------	--

Initial S/W Revision	Prior to A.02.00
----------------------	------------------

Data Query (Remote Command Only)

Returns the designated measurement data for the currently selected measurement and subopcode.

n = any valid subopcode for the current measurement. See the measurement command results table for your current measurement, for information about what data is returned for the subopcodes.

This command uses the data setting specified by the FORMat:BORDER and FORMat:DATA commands and can return real or ASCII data. (See the format command descriptions under Input/Output in the Analyzer Setup section.)

Remote Command	:CALCulate:DATA[n]?
Notes	The return trace depends on the measurement. In CALCulate:<meas>:DATA[n], n is any valid subopcode for the current measurement. It returns the same data as the FETCH:<measurement>? query where <measurement> is the current measurement.
Initial S/W Revision	Prior to A.02.00

Calculate/Compress Trace Data Query (Remote Command Only)

Returns compressed data for the currently selected measurement and sub-opcode [n].

n = any valid sub-opcode for that measurement. See the MEASure:<measurement>? command description of your specific measurement for information on the data that can be returned.

The data is returned in the current Y Axis Unit of the analyzer. The command is used with a sub-opcode <n> (default=1) to specify the trace. With trace queries, it is best if the analyzer is not sweeping during the query. Therefore, it is generally advisable to be in Single Sweep, or Update=Off.

This command is used to compress or decimate a long trace to extract and return only the desired data. A typical example would be to acquire N frames of GSM data and return the mean power of the first burst in each frame. The command can also be used to identify the best curve fit for the data.

Remote Command	:CALCulate:DATA<n>:COMPress? BLOCk CFIT MAXimum MINimum MEAN DMEan RMS RMSCubed SAMPlE SDEViation PPHase [,<soffset> [,<length>[,<roffset>[,<rlimit>]]]]
Example	To query the mean power of a set of GSM bursts: Supply a signal that is a set of GSM bursts. Select the IQ Waveform measurement (in IQ Analyzer Mode). Set the sweep time to acquire at least one burst. Set the triggers such that acquisition happens at a known position relative to a burst. Then query the mean burst levels using, CALC:DATA2:COMP? MEAN, 24e-6, 526e-6 (These parameter values correspond to GSM signals, where 526e-6 is the length of the burst in the slot and you just want 1 burst.)
Notes	The command supports 5 parameters. Note that the last 4 (<soffset>, <length>, <roffset>, <rlimit>) are optional. But these optional parameters must be entered in the specified order. For example, if you want to specify <length>, then you must also specify <soffset>. See details below for a definition of each of these parameters. This command uses the data in the format specified by FORMat:DATA, returning either binary or ASCII data.
Initial S/W Revision	Prior to A.02.00

- BLOCk or block data - returns all the data points from the region of the trace data that you specify. For example, it could be used to return the data points of an input signal over several timeslots, excluding the portions of the trace data that you do not want. (This is x,y pairs for trace data and I,Q pairs for complex data.)

- CFIT or curve fit - applies curve fitting routines to the data. <soffset> and <length> are required to define the data that you want. <roffset> is an optional parameter for the desired order of the curve equation. The query will return the following values: the x-offset (in seconds) and the curve coefficients ((order + 1) values).

MIN, MAX, MEAN, DME, RMS, RMSC, SAMP, SDEV and PPH return one data value for each specified region (or <length>) of trace data, for as many regions as possible until you run out of trace data (using <roffset> to specify regions). Or they return the number of regions you specify (using <rlimit>) ignoring any data beyond that.

- MINimum - returns the minimum data point (y value) for the specified region(s) of trace data. For I/Q trace data, the minimum magnitude of the I/Q pairs is returned.
- MAXimum - returns the maximum data point (y value) for the specified region(s) of trace data. For I/Q trace data, the maximum magnitude of the I/Q pairs is returned.
- MEAN - returns a single value that is the arithmetic mean of the data point values (in dB/ dBm) for the specified region(s) of trace data. For I/Q trace data, the mean of the magnitudes of the I/Q pairs is returned. See the following equations.

-

NOTE

If the original trace data is in dB, this function returns the arithmetic mean of those log values, not log of the mean power which is a more useful value. The mean of the log is the better measurement technique when measuring CW signals in the presence of noise. The mean of the power, expressed in dB, is useful in power measurements such as Channel Power. To achieve the mean of the power, use the RMS option.

Equation 1

Mean Value of Data Points for Specified Region(s)

$$\text{MEAN} = \frac{1}{n} \sum_{X_i \in \text{region}(s)} X_i$$

where X_i is a data point value, and n is the number of data points in the specified region(s).

Equation 2

Mean Value of I/Q Data Pairs for Specified Region(s)

$$\text{MEAN} = \frac{1}{n} \sum_{X_i \in \text{region}(s)} |X_i|$$

where $|X_i|$ is the magnitude of an I/Q pair, and n is the number of I/Q pairs in the specified region(s).

- DMEan - returns a single value that is the mean power (in dB/ dBm) of the data point values for the specified region(s) of trace data. See the following equation:

Equation 3

DMEan Value of Data Points for Specified Region(s)

$$\text{DME} = 10 \times \log_{10} \left(\frac{1}{n} \sum_{X_i \in \text{region}(s)} 10^{\frac{X_i}{10}} \right)$$

- RMS - returns a single value that is the average power on a root-mean-squared voltage scale (arithmetic rms) of the data point values for the specified region(s) of trace data. See the following equation.

NOTE For I/Q trace data, the rms of the magnitudes of the I/Q pairs is returned. See the following equation. This function is very useful for I/Q trace data. However, if the original trace data is in dB, this function returns the rms of the log values which is not usually needed.

Equation 4

RMS Value of Data Points for Specified Region(s)

$$\text{RMS} = \sqrt{\frac{1}{n} \sum_{X_i \in \text{region}(s)} X_i^2}$$

where X_i is a data point value, and n is the number of data points in the specified region(s).

Equation 5

RMS Value of I/Q Data Pairs for Specified Region(s)

$$\text{RMS} = \sqrt{\frac{1}{n} \sum_{X_i \in \text{region}(s)} X_i X_i^*}$$

where X_i is the complex value representation of an I/Q pair, X_i^* its conjugate complex number, and n is the number of I/Q pairs in the specified region(s).

Once you have the rms value for a region of trace data (linear or I/Q), you may want to calculate the mean power. You must convert this rms value (peak volts) to power in dBm:

$$10 \times \log[10 \times (\text{rms value})^2]$$

- SAMPlE - returns the first data value (x,y pair) for the specified region(s) of trace data. For I/Q trace data, the first I/Q pair is returned.
- SDEVIation - returns a single value that is the arithmetic standard deviation for the data point values for the specified region(s) of trace data. See the following equation.
- For I/Q trace data, the standard deviation of the magnitudes of the I/Q pairs is returned. See the following equation.

Equation 6

Standard Deviation of Data Point Values for Specified Region(s)

$$\text{SDEV} = \sqrt{\frac{1}{n} \sum_{X_i \in \text{region}(s)} (X_i - \bar{X})^2}$$

where X_i is a data point value, \bar{X} is the arithmetic mean of the data point values for the specified region (s), and n is the number of data points in the specified region(s).

$$\text{SDEV} = \sqrt{\frac{1}{n} \sum_{X_i \in \text{region}(s)} (|X_i| - \bar{X})^2}$$

where $|X_i|$ is the magnitude of an I/Q pair, \bar{X} is the mean of the magnitudes for the specified region(s), and n is the number of data points in the specified region(s).

- PPHase - returns the x,y pairs of both rms power (dBm) and arithmetic mean phase (radian) for every specified region and frequency offset (Hz). The number of pairs is defined by the specified number of regions. This parameter can be used for I/Q vector (n=0) in Waveform (time domain) measurement and all parameters are specified by data point in PPHase.

The rms power of the specified region may be expressed as:

$$\text{Power} = 10 \times \log [10 \times (\text{RMS I/Q value})] + 10.$$

The RMS I/Q value (peak volts) is:

$$\sqrt{\frac{1}{n} \sum_{X_i \in \text{region}} X_i X_i^*}$$

where X_i is the complex value representation of an I/Q pair, X_i^* its conjugate complex number, and n is the number of I/Q pairs in the specified region.

The arithmetic mean phase of the specified region may be expressed as:

$$\frac{1}{n} \sum_{Y_i \in \text{region}} Y_i$$

where Y_i is the unwrapped phase of I/Q pair with applying frequency correction and n is the number of I/Q pairs in the specified region.

The frequency correction is made by the frequency offset calculated by the arithmetic mean of every specified region's frequency offset. Each frequency offset is calculated by the least square method against the unwrapped phase of I/Q pair.

Sample Trace Data - Constant Envelope

(See below for explanation of variables.)

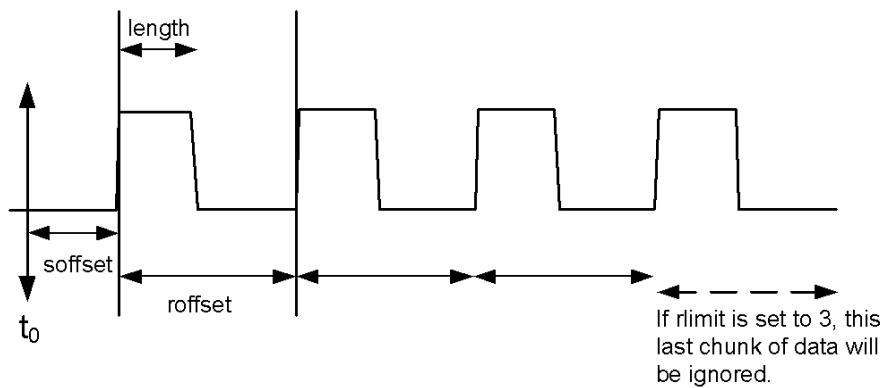

Sample Trace Data - Not Constant Envelope

(See below for explanation of variables.)

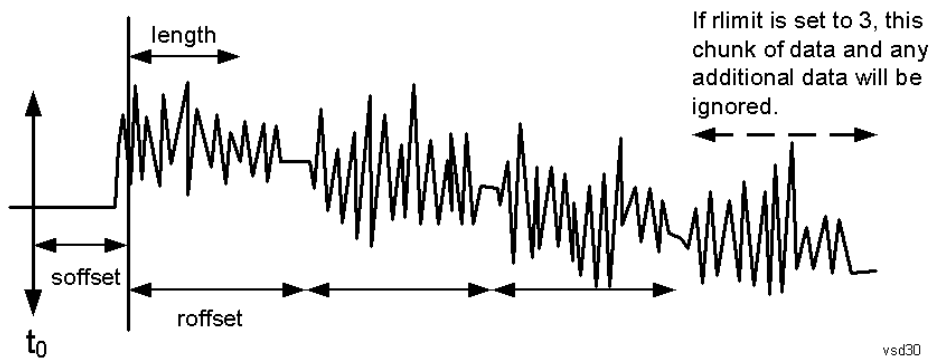

<soffset> - start offset is an optional real number. (It is in seconds for time-domain traces, and is a dimensionless index 0 to Npoints - 1, for frequency-domain traces). It specifies the amount of data at the beginning of the trace that will be ignored before the decimation process starts. It is the time or frequency change from the start of the trace to the point where you want to start using the data. The default value is zero.

<length> - is an optional real number. (It is in seconds for time-domain traces, and is a dimensionless index 0 to Npoints - 1, for frequency-domain traces). It defines how much data will be compressed into one value. This parameter has a default value equal to the current trace length.

<roffset> - repeat offset is an optional real number. (It is in seconds for time-domain traces, and is a dimensionless index 0 to Npoints - 1, for frequency-domain traces). It defines the beginning of the next field of trace elements to be compressed. This is relative to the beginning of the previous field. This parameter has a default value equal to the <length> variable. Note that this parameter is used for a completely different purpose when curve fitting (see CFIT above).

<rlimit> - repeat limit is an optional integer. It specifies the number of data items that you want returned. It will ignore any additional items beyond that number. You can use the Start offset and the Repeat limit to pick out exactly what part of the data you want to use. The default value is all the data.

Calculate Peaks of Trace Data (Remote Command Only)

Returns a list of all the peaks for the currently selected measurement and sub-opcode [n]. The peaks must meet the requirements of the peak threshold and excursion values.

n = any valid sub-opcode for the current measurement. See the MEASure:<measurement> command description of your specific measurement for information on the data that can be returned.

The command can only be used with specific sub-opcodes with measurement results that are trace data. Both real and complex traces can be searched, but complex traces are converted to magnitude in dBm. In many measurements the sub-opcode n=0, is the raw trace data which cannot be searched for peaks. And Sub-opcode n=1, is often calculated results values which also cannot be searched for peaks.

This command uses the data setting specified by the FORMat:BORDER and FORMat:DATA commands and can return real or ASCII data. If the format is set to INT,32, it returns REAL,32 data.

The command has four types of parameters:

- Threshold (in dBm)
- Excursion (in dB)
- Sorting order (amplitude, frequency, time)
- Optional in some measurements: Display line use (all, > display line, < display line)

Remote Command	<p>For Swept SA measurement:</p> <pre>:CALCulate:DATA[1] 2 ... 6:PEAKs? <threshold>,<excursion>[,AMPLitude FREQuency TIME[,ALL GTDLLine LTDLine]]</pre> <p>For most other measurements:</p> <pre>:CALCulate:DATA[1] 2 ... 6:PEAKs? <threshold>,<excursion>[,AMPLitude FREQuency TIME]</pre>
-----------------------	---

Example	<p>Example for Swept SA measurement in Spectrum Analyzer Mode:</p> <p>CALC:DATA4:PEAK? -40, 10, FREQ, GTDL This will identify the peaks of trace 4 that are above -40 dBm, with excursions of at least 10 dB. The peaks are returned in order of increasing frequency, starting with the lowest frequency. Only the peaks that are above the display line are returned.</p> <p>Query Results 1:</p> <p>With FORMat:DATA REAL, 32 selected, it returns a list of floating-point numbers. The first value in the list is the number of peak points that are in the following list. A peak point consists of two values: a peak amplitude followed by its corresponding frequency (or time).</p> <p>If no peaks are found the peak list will consist of only the number of peaks, (0).</p>
----------------	---

Notes	<p><n> - is the trace that will be used</p> <p><threshold> - is the level below which trace data peaks are ignored. Note that the threshold value is required and is always used as a peak criterion. To effectively disable the threshold criterion for this command, provide a substantially low threshold value such as -200 dBm. Also note that the threshold value used in this command is independent of and has no effect on the threshold value stored under the Peak Criteria menu.</p> <p><excursion> - is the minimum amplitude variation (rise and fall) required for a signal to be identified as peak. Note that the excursion value is required and is always used as a peak criterion. To effectively disable the excursion criterion for this command, provide the minimum value of 0.0 dB. Also note that the excursion value used in this command is independent of and has no effect on the</p>
--------------	---

excursion value stored under the Peak Criteria menu.

Values must be provided for threshold and excursion. The sorting and display line parameters are optional (defaults are AMPLitude and ALL).

Note that there is always a Y-axis value for the display line, regardless of whether the display line state is on or off. It is the current Y-axis value of the display line which is used by this command to determine whether a peak should be reported

Sorting order:

AMPLitude - lists the peaks in order of descending amplitude, with the highest peak first (default if optional parameter not sent)

FREQuency - lists the peaks in order of occurrence, left to right across the x-axis.

TIME - lists the peaks in order of occurrence, left to right across the x-axis.

Peaks vs. Display Line:

ALL - lists all of the peaks found (default if optional parameter not sent).

GTDLine (greater than display line) - lists all of the peaks found above the display line.

LTDLine (less than display line) - lists all of the peaks found below the display line.

Initial S/W Revision	Prior to A.02.00
----------------------	------------------

Hardware-Accelerated Fast Power Measurement (Remote Command Only)

The Fast Power option (FP2) enables very fast channel power measurements for instruments with the prerequisite hardware (DP2 and/or B40). It accomplishes this by performing real-time overlapped FFTs at the hardware layer, using software for basic post-processing before returning the result to the user. The upshot of this approach is improved throughput for user applications that require many sequential power measurements.

The analysis bandwidth of FP2 is limited by the licenses in the instrument, but its maximum overall analysis bandwidth per acquisition is 40 MHz.

FP2 is remote-only, which means the instrument does not switch to any particular mode or measurement. FP2 commands can be sent while another application is in use on the front panel.

Each Fast Power measurement can be predefined using an array index, and up to 1,000 measurements can be stored. In the following documentation, instances of [1,2,...,999] can be substituted with a particular measurement index, e.g. CALC:FPOW:POW1?, CALC:FPOW:POW2?, CALC:FPOW:POW134?. In this way, power measurements can be defined one time in a batch, and then executed multiple times without having to redefine them, similar to “list mode” on other measurements.

In addition to basic channel power measurements, there are a number of other measurement “functions” for each channel, including peak power, peak frequency, and power spectral density. See the Function parameter for more information.

Reset Fast Power Measurement (Remote Command Only)

Resets the measurement configuration to the defaults.

Mode	All
Remote Command	:CALCulate:FPOWer:POWer [1, 2, ..., 999] :RESet
Example	:CALC:FPOW:POW1:RES

Notes	Option FP2 is required.
Initial S/W Revision	A.14.00

Define Fast Power Measurement (Remote Command Only)

Fast Power acquisitions are configured using the DEFine command. This command accepts a comma-delimited string of configuration parameters and their appropriate values, which are all specified in the subsection below.

Mode	All
Remote Command	:CALCulate:FPOWer:POWer[1,2,...,999]:DEFine "configuration string"
Example	:CALC:FPOW:POW1:DEF "CenterFrequency=2e9, AcquisitionTime=0.005"
Notes	See below for a list of measurement variables that can be defined in the configuration string.
Initial S/W Revision	A.14.00

Acquisition Time

Example	CALC:FPOW:POW1:DEF "AcquisitionTime=0.002"
Notes	The acquisition time parameter sets the time in which the entire spectrum is measured. An increase in the acquisition time yields an improvement in measurement repeatability.
Preset	0.001 s
Range	0 s to 1 s
Default Unit	Time (s)
Initial S/W Revision	A.14.00

Center Frequency

Example	CALC:FPOW:POW1:DEF "CenterFrequency=2e9"
Notes	The center frequency parameter sets the frequency in which the measurement is centered around. The OffsetFrequency parameter is calculated relative to the center frequency.
Preset	1 GHz
Range	0 Hz to maximum instrument frequency
Default Unit	Frequency (Hz)
Initial S/W Revision	A.14.00

DC Coupled

Example	CALC:FPOW:POW1:DEF "DCCoupled=True"
Notes	The DC coupled parameter allows the user to specify whether the DC blocking capacitor is utilized. Set parameter to true when measuring frequencies below 10 MHz.
Preset	False
Range	True (DC Coupled) or False (AC Coupled)
Default Unit	Boolean
Initial S/W Revision	A.14.00

DetectorType

Example	CALC:FPOW:POW1:DEF "DetectorType=Peak"
Notes	Option FP2 is required. The detector type parameter allows the user to choose whether a RMS average or peak value is used during the measurement.
Preset	RmsAverage
Range	RmsAverage, Peak
Initial S/W Revision	A.14.00

Do Noise Correction

Example	CALC:FPOW:POW1:DEF "DoNoiseCorrection=True"
Notes	When noise correction is enabled, the linear noise power contributed by the analyzer is subtracted from all measurements. This effectively lowers the noise floor of the analyzer. When noise correction is enabled, the first measurement for a given set of input parameters will take extra time. This is because the analyzer takes an extra acquisition with the RF input disconnected from the analyzer's front end to measure the noise of just the analyzer. The measured noise floor is stored in a cache so the noise acquisition will occur only once for the same state settings. In other words, if noise correction was turned on and the analyzer made an acquisition at frequency A, then frequency B, and back again to frequency A, the hidden initial noise floor acquisition would only occur for the first acquisition at frequency A and the cached noise floor would be used the second time frequency A was measured.
Preset	False
Range	True (enable noise correction) or False (disable noise correction)
Default Unit	Boolean
Initial S/W Revision	A.14.00

Do Spur Suppression

Example	CALC:FPOW:POW1:DEF "DoSpurSuppression=True"
Notes	<p>When measuring very low level signals, or when large out-of-band inputs are input into the analyzer, sometimes unwanted spurs and residuals can appear in the measured spectrum. Spur suppression is a method to help minimize the levels of these internally generated spurs and residuals.</p> <p>When spur suppression is enabled, the analyzer will automatically take two acquisitions using two different internal analog LO frequencies. The FFT spectrums from both acquisitions are combined by taking the minimum power between both traces on a per FFT bin basis. External signals will have the same amplitude for both traces and therefore will return the expected amplitudes. However, low level spurs and residuals generated internally to the analyzer tend to move to different FFT bins depending on the internal analog LO frequency used, and therefore tend to be suppressed using this spur suppression method.</p> <p>Because two acquisitions, rather than a single acquisition, are made when spur suppression is enabled, the measurement time will always be slower when spur suppression is enabled.</p>
Preset	False
Range	True (enable spur suppression) or False (disable spur suppression)
Default Unit	Boolean
Initial S/W Revision	A.14.00

Electronic Attenuator Bypass

Example	CALC:FPOW:POW1:DEF "ElecAttBypass =False"
Notes	The electronic attenuation bypass parameter allows the user to either utilize or bypass the electronic attenuator. The electronic attenuator is only available for frequencies up to 3.6 GHz. Set parameter to true when using frequencies above 3.6 GHz and set the parameter to false when using the preamp.
Preset	True
Range	True (bypass electronic attenuator) or False (use electronic attenuator)
Default Unit	Boolean
Initial S/W Revision	A.14.00

Electronic Attenuation

Example	CALC:FPOW:POW1:DEF "ElecAttenuation=10"
Notes	<p>Option EA3 is required.</p> <p>The electronic attenuation value parameter sets the amount of electrical attenuation from 0 to 24 dB (1 dB steps).</p> <p>Set "ElecAttBypass=False" to make sure the electronic attenuator path is enabled.</p>
Preset	0 dB
Range	0 - 24 dB (1 dB steps)

Default Unit	dB
Initial S/W Revision	A.14.00

IF Gain

Example	CALC:FPOW:POW1:DEF "IFGain=10"
Notes	The IF gain parameter allows the user to specify the gain at the IF stage anywhere from -6 to 16 dB (1 dB steps). This is an advanced feature, and for most cases this should remain at its default value of 0 dB.
Preset	0 dB
Range	-6 - 16 dB (1 dB steps)
Default Unit	dB
Initial S/W Revision	A.14.00

IF Type

Example	CALC:FPOW:POW1:DEF "IFType=B25M"
Notes	The IF type parameter allows the user to select between different IF paths. For example, if the signal is less than 25 MHz wide, then the user can select the B25M path to take advantage of additional filtering on this analog IF path.
Preset	B40M
Range	B10M, B25M, B40M
Initial S/W Revision	A.14.00

Include Power Spectrum

Example	CALC:FPOW:POW1:DEF "IncludePowerSpectrum=True"
Notes	The power spectrum parameter allows the user to read data on the entire spectrum for diagnostic purposes. It is not recommended for production use. See CALC:FPOW:POW[n]:READ2? for details on the binary format of the response.
Preset	False
Range	True (return both channel power and full power spectrum) or False (returns only channel power)
Default Unit	Boolean
Initial S/W Revision	A.14.00

Mechanical Attenuation

Example	CALC:FPOW:POW1:DEF "MechAttenuation=10"
Notes	The mechanical attenuation value parameter sets the amount of mechanical attenuation anywhere from 0 to 70 dB (2 dB steps).
Preset	0 dB
Range	0 – 70 dB (2 dB steps)
Default Unit	dB
Initial S/W Revision	A.14.00

Preamp Mode

Example	CALC:FPOW:POW1:DEF "PreAmpMode=Low"
Notes	The license for the appropriate preamp is required. The preamp mode parameter specifies whether the preamps are being utilized. Low allows any preamps up to 3.6 GHz, and Full allows all licensed preamps. Set "ElecAttBypass=True" in order to utilize any preamps.
Preset	Off
Range	Off, Low, Full
Initial S/W Revision	A.14.00

Resolution Bandwidth Mode

Example	CALC:FPOW:POW1:DEF "PreAmpMode=Low"
Notes	The resolution bandwidth mode parameter allows the user to choose whether the RBW filter is automatically or manually set. The BestSpeed value minimizes measurement time, while the Narrowest value minimizes RBW size (minimum of two FFT bins per RBW). To manually specify an RBW, set this parameter to Explicit, and set the ResolutionBW parameter to the desired value.
Preset	BestSpeed
Range	BestSpeed, Narrowest, Explicit
Initial S/W Revision	A.14.00

Resolution Bandwidth

Example	CALC:FPOW:POW1:DEF "ResolutionBW=25e3"
Notes	The resolution bandwidth parameter sets the 3-dB bandwidth of the RBW filter. The ResolutionBWMode parameter must be set to Explicit in order to manually set the RBW.

Preset	0 Hz
Default Unit	Hz
Initial S/W Revision	A.14.00

Trigger Delay

Example	CALC:FPOW:POW1:DEF "TriggerDelay=0.025"
Notes	The trigger delay parameter sets the time after an external trigger is detected until the measurement is performed.
Preset	0 s
Range	0 - 1 s
Default Unit	Seconds
Initial S/W Revision	A.14.00

Trigger Level

Example	CALC:FPOW:POW1:DEF "TriggerLevel=2"
Notes	The trigger level parameter sets the voltage value at which an external trigger is detected.
Preset	1.2 V
Range	-5 to 5 V
Default Unit	Volts
Initial S/W Revision	A.14.00

Trigger Slope

Example	CALC:FPOW:POW1:DEF "TriggerSlope=Negative"
Notes	The trigger slope parameter indicates the direction of the edge trigger voltage for detection.
Preset	Positive
Range	Positive, Negative
Initial S/W Revision	A.14.00

Trigger Source

Example	CALC:FPOW:POW1:DEF "TriggerSource=Ext1"
Notes	The trigger source parameter allows the user to choose between measurement's triggering freely or controlled by an external input. Ext1 and Ext2 correspond to Trigger 1 In and Trigger 2 In, respectively.
Preset	Free
Range	Free, Ext1, Ext2
Initial S/W Revision	A.14.00

Trigger Timeout

Example	CALC:FPOW:POW1:DEF "TriggerTimeout=0.1"
Notes	The trigger timeout parameter sets the time in which the analyzer will wait for a trigger before automatically performing the measurement.
Preset	1 s
Range	0 – 1 s
Default Unit	Seconds
Initial S/W Revision	A.14.00

Signal Input

Example	CALC:FPOW:POW1:DEF "SignalInput=Fp50MHzCW"
Notes	The signal input parameter allows the user to select between using the main RF input or the internal analyzer reference CW signal of 50 MHz.
Preset	FpMainRf
Range	FpMainRf, Fp50MHzCW
Initial S/W Revision	A.14.00

Use Preselector

Example	CALC:FPOW:POW1:DEF "UsePreSelector=True"
Notes	The preselector parameter allows the user to either utilize or bypass the front end tunable filter at frequencies above 3.6 GHz. For frequencies below 3.6 GHz, the preselector is automatically bypassed, so you do not need to set this parameter to False in those cases.
Preset	False
Range	True (use preselector above 3.6 GHz), or False (preselector bypassed)

Default Unit	Boolean
Initial S/W Revision	A.14.00

Channel Bandwidth Array

Example	CALC:FPOW:POW1:DEF "Bandwidth=[3.84e6, 5e6, 3.84e6]"
Notes	The bandwidth parameter array defines the bandwidth of each channel that will be measured. All array parameters should have the same number of elements. Alternatively, if all the elements are the same value, a single number with no square brackets can be used to define the parameter.
Preset	[1e6]
Range	0 to 40 MHz
Default Unit	Hz
Initial S/W Revision	A.14.00

Channel Filter Type Array

Example	CALC:FPOW:POW1:DEF "FilterType=[RRC, IBW, RRC]"
Notes	The filter type parameter allows the user to choose between an integration bandwidth (IBW) filter or a root-raised-cosine (RRC) filter. The integration bandwidth filter weighs all frequencies within the bandwidth equally. The root-raised-cosine filter has an associated shape parameter, defined by the FilterAlpha parameter. All array parameters should have the same number of elements. Alternatively, if all the elements are the same value, a single value with no square brackets can be used to define the parameter.
Preset	[IBW]
Range	IBW, RRC
Initial S/W Revision	A.14.00

Channel Filter Alpha Array

Example	CALC:FPOW:POW1:DEF "FilterAlpha=[0.5, 0.0, 0.5]"
Notes	The filter alpha parameter allows the user to adjust the alpha value associated with the root-raised-cosine (RRC) filter type. Set FilterType to RRC in order to utilize this parameter. All array parameters should have the same number of elements. Alternatively, if all the elements are the same value, a single number with no square brackets can be used to define the parameter.
Preset	[0.22]
Range	0.0 - 1.0

Initial S/W Revision	A.14.00
-------------------------	---------

Channel Measurement Function Array

Example	CALC:FPOW:POW1:DEF "Function=[BandPower, PeakPower, BandPower]"
Notes	<p>This parameter array defines what measurement is being made for each individually-specified channel:</p> <p>BandPower: Total power within the specified bandwidth of the channel (dBm)</p> <p>BandDensity: Total power density within the specified bandwidth of the channel (dBm/Hz)</p> <p>PeakPower: The peak power value within the specified bandwidth of the channel (dBm)</p> <p>PeakFrequency: The frequency which corresponds to the peak power value within the specified bandwidth of the channel. This frequency is relative to the center frequency (Hz)</p> <p>XdBBandwidth: The half power (-3.01 dB) bandwidth of the highest amplitude signal that resides within the channel (Hz), dB is configurable using XdBBandwidth parameter</p> <p>OccupiedBandwidth: The bandwidth at which 99% of the total power resides within the channel (Hz), percentage configurable using OccupiedBandwidthPercent parameter</p> <p>All array parameters should have the same number of elements. Alternatively, if all the elements are the same value, a single value with no square brackets can be used to define the parameter.</p>
Preset	[BandPower]
Range	BandPower, BandDensity, PeakPower, PeakFrequency, XdBBandwidth, OccupiedBandwidth
Initial S/W Revision	A.14.00

Channel Offset Frequency Array

Example	CALC:FPOW:POW1:DEF "OffsetFrequency=[-5e6, 0, 5e6]"
Notes	<p>The offset frequency parameter array defines the difference between the center frequency to the center frequency of each channel.</p> <p>All array parameters should have the same number of elements.</p>
Preset	[0]
Range	0 to 20 MHz
Default Unit	Hz
Initial S/W Revision	A.14.00

Channel Occupied Bandwidth Percent Array

Example	CALC:FPOW:POW1:DEF "OccupiedBandwidthPercent =[0.95, 0.95, 0.95]"
Notes	This parameter only applies for channels whose Function is set to OccupiedBandwidth. The occupied

	bandwidth percent parameter specifies the percent of total power in these channels. The valid range for this parameter is 0.0 to 1.0, where 1.0 represents 100%. The default for this parameter is 0.99, which will return the bandwidth that contains 99% of the total channel power.
Preset	[0.99]
Range	0 - 1.0
Initial S/W Revision	A.14.00

Channel x-dB Bandwidth Array

Example	CALC:FPOW:POW1:DEF " XdBBandwidth =[-6.02, -3.01, -1.0]"
Notes	This parameter only applies for channels whose Function is set to XdBBandwidth. The X dB bandwidth parameter is used to specify the power relative to the peak channel power over which the bandwidth is calculated. The parameter value must be a negative number.
Preset	[-3.01]
Range	-200 to 0 dB
Default Unit	dB
Initial S/W Revision	A.14.00

Define Fast Power Measurement Query (Remote Command Only)

The DEFine? command is used to retrieve a list of all defined parameters in an ASCII string format

```

M All
o
d
e
-----
R :CALCulate:FPOWer:POWer[1,2,...,999]:DEFine?
e
m
o
t
e
C
o
m
m
a
n
d
-----
E :CALC:FPOW:POW1:DEF?

```

x
a
m
p
l
e

N This command query is used to retrieve a list of all defined parameters in an ASCII format.

O The following is an example of the returned results:

S "DCCoupled=False,ElecAttBypass=True,ElecAttenuation=0,IFGain=0,MechAttenuation=0,PreAmpMode=Off,PreSelectorOffset=0,UsePreSelector=False,ExternalReferenceFrequency=1000000,FrequencyReferenceSource=AutoExternalFrequencyReference,IFType=B40M,LOMode=SLW,SignalInput=FpMainRf,AcquisitionTime=0.001,CenterFrequency=100000000,ResolutionBW=0,ResolutionBWMode=BestSpeed,DetectorType=RmsAverage,Bandwidth=[1000000],OffsetFrequency=[0],Function=[BandPower],FilterType=[IBW],FilterAlpha=[0.22],OccupiedBandwidthPercent=[0.99],XdBBandwidth=[-3.01],DoNoiseCorrection=False,DoSpurSuppression=False,MeasurementMethod=HardwareFFT,IncludePowerSpectrum=False,TriggerDelay=0,TriggerLevel=1.2,TriggerSlope=Positive,TriggerSource=Free,TriggerTimeout=1"

I A.14.00

n
i
t
i
a
l

S
/
W

R
e
v
i
s
i
o
n

Configure Fast Power Measurement (Remote Command Only)

The configure command begins hardware setup and returns immediately, with no acquisition made. This can be used in parallel with other hardware operations to effectively hide the hardware setup time.

Mode	All
Remote Command	:CALCulate:FPOWER:POWER[1,2,...,999]:CONFigure
Example	:CALC:FPOW:POW1:CONF
Notes	Option FP2 is required.
Initial S/W Revision	A.14.00

Initiate Fast Power Measurement (Remote Command Only)

The INITiate command begins an acquisition and returns immediately. The results of the measurement can be retrieved using FETCh.

Mode	All
Remote Command	:CALCulate:FPOWER:POWER[1,2,...,999]:INITiate
Example	:CALC:FPOW:POW1:INIT
Notes	Option FP2 is required.
Initial S/W Revision	A.14.00

Fetch Fast Power Measurement (Remote Command Only)

The FETCh command query is used to retrieve the results of an acquisition initiated by the INIT command. The returned results are in ASCII string format. The string begins and ends with quotation marks.

Mode	All
Remote Command	:CALCulate:FPOWER:POWER[1,2,...,999]:FETCh?
Example	:CALC:FPOW:POW1:FETC?
Notes	Option FP2 is required. Returns m comma-separated ASCII values, where m corresponds to the number of bandwidths defined. 1. Declared function return in the 1st specified channel 2. Declared function return in the 2nd specified channel ... m. Declared function return in the last specified channel The INIT and FETC? command sequence performs the same functionality of a single CALC:FPOW:POW[n]? query. Units of the returned values are dependent on the Function parameter for each channel.
Initial S/W Revision	A.14.00

Execute Fast Power Measurement (Remote Command Only)

This command query is used as shorthand for an INIT command immediately followed by a FETC? command. The returned results are in ASCII string format. The string begins and ends with quotation marks.

Mode	All
Remote Command	:CALCulate:FPOWER:POWER[1,2,...,999]?
Example	:CALC:FPOW:POW1?

Notes	Option FP2 is required. See notes for Fast Power Fetch for return format.
Initial S/W Revision	A.14.00

Binary Read Fast Power Measurement (Remote Command Only)

This command query is used as shorthand for an INIT command immediately followed by a FETC? command. The returned results are in a binary format.

Mode	All
Remote Command	:CALCulate:FPOWER:POWER[1,2,...,999]:READ? :CALCulate:FPOWER:POWER[1,2,...,999]:READ1?
Example	:CALC:FPOW:POW1:READ? :CALC:FPOW:POW1:READ1?
Notes	Option FP2 is required. Returns m 4 byte floating point binary values (Little-Endian), where m corresponds to the number of bandwidths defined.
Initial S/W Revision	A.14.00

Diagnostic Binary Read Fast Power Measurement (Remote Command Only)

This command query is used as shorthand for an INIT command immediately followed by a FETC? command. The returned results are in a binary format. This command is used primarily for diagnostic purposes to test for ADC overloads and to visibly inspect the spectrum.

Mode	All
Remote Command	:CALCulate:FPOWER:POWER[1,2,...,999]:READ2?
Example	:CALC:FPOW:POW1:READ2?
Notes	Option FP2 is required. Note: Spectrum data is only returned if the IncludePowerSpectrum parameter is set to True. If IncludePowerSpectrum is False, the number of spectrum points will be zero (0). Units of the returned values are dependent on the Function parameter per channel (e.g. dBm for BandPower, Hz for PeakFrequency). Returns binary data (Little-Endian) that contains information on m amount of channels, along with ADC over range and full spectrum data. The following is the binary format of the response. Bandwidth Return Value 1. Number of channels specified, m [4 byte int] 2. Declared function result for the 1st specified channel [4 byte float]

	3. Declared function result for the 2nd specified channel [4 byte float]
	...
	(m + 1). Declared function result for the last (mth) specified channel [4 byte float]
	ADC Over Range
	1. ADC over-range occurred (1: true, 0: false) [2 byte short]
	Spectrum Data
	1. Number of points in the spectrum data, k [4 byte int]
	2. Start frequency of spectrum data (Hz) [8 byte double]
	3. Step frequency of spectrum data (Hz) [8 byte double]
	4. FFT bin at 1st point (dBm) [4 byte float]
	5. FFT bin at 2nd point (dBm) [4 byte float]
	...
	(k + 3). FFT bin at last (kth) point (dBm) [4 byte float]

Initial S/W Revision	A.14.00
-------------------------	---------

Format Data: Numeric Data (Remote Command Only)

This command specifies the format of the trace data input and output. It specifies the formats used for trace data during data transfer across any remote port. It affects only the data format for setting and querying trace data for the :TRACe[:DATA], TRACe[:DATA]?, :CALCulate:DATA[n]? and FETCh:SANalyzer [n]? commands and queries.

Remote Command	:FORMat [:TRACe] [:DATA] ASCii INTeger, 32 REAL, 32 REAL, 64 :FORMat [:TRACe] [:DATA] ?
Notes	The query response is: ASCii: ASC,8 REAL,32: REAL,32 REAL,64: REAL,64 INTeger,32: INT,32 When the numeric data format is REAL or ASCii, data is output in the current Y Axis unit. When the data format is INTeger, data is output in units of m dBm (.001 dBm). The INT,32 format returns binary 32-bit integer values in internal units (m dBm), in a definite length block.
Dependencies	Sending a data format spec with an invalid number (for example, INT,48) generates no error. The analyzer simply uses the default (8 for ASCii, 32 for INTeger, 32 for REAL). Sending data to the analyzer which does not conform to the current FORMat specified, results in an error. Sending ASCII data when a definite block is expected generates message -161 "Invalid Block Data" and sending a definite block when ASCII data is expected generates message -121 "Invalid Character in Number".
Preset	ASCii
Backwards Compatibility	Note that the INT,32 format is only applicable to the command, TRACe:DATA. This preserves

Notes	backwards compatibility for the Swept SA measurement. For all other commands/queries which honor FORMat:DATA, if INT,32 is sent the analyzer will behave as though it were set to REAL,32.
Initial S/W Revision	Prior to A.02.00

The specs for each output type follow:

ASCIi - Amplitude values are in ASCII, in the current Y Axis Unit, one ASCII character per digit, values separated by commas, each value in the form:

SX.YYYYYEsZZ

Where:

S = sign (+ or -)

X = one digit to left of decimal point

Y = 5 digits to right of decimal point

E = E, exponent header

s = sign of exponent (+ or -)

ZZ = two digit exponent

REAL,32 - Binary 32-bit real values in the current Y Axis Unit, in a definite length block.

REAL,64 - Binary 64-bit real values in the current Y Axis Unit, in a definite length block.

Format Data: Byte Order (Remote Command Only)

This command selects the binary data byte order for data transfer and other queries. It controls whether binary data is transferred in normal or swapped mode. This command affects only the byte order for setting and querying trace data for the :TRACe[:DATA], TRACe[:DATA]? , :CALCulate:DATA[n]? and FETCh:SANalyzer[n]? commands and queries.

By definition any command that says it uses FORMat:DATA uses any format supported by FORMat:DATA.

The NORMAl order is a byte sequence that begins with the most significant byte (MSB) first, and ends with the least significant byte (LSB) last in the sequence: 1|2|3|4. SWAPped order is when the byte sequence begins with the LSB first, and ends with the MSB last in the sequence: 4|3|2|1.

Remote Command	:FORMat:BORDER NORMAl SWAPped :FORMat:BORDER?
Preset	NORMAl
Initial S/W Revision	Prior to A.02.00

Meas Setup

Displays the setup menu for the current measurement. The measurement setup parameters include the number of measurement averages used to calculate the measurement result and the averaging mode. The setup menu also includes the option to reset the measurement settings to their factory defaults.

Key Path	Front-panel key
Initial S/W Revision	Prior to A.02.00

Avg/Hold Num

Specifies the number of measurement averages used when calculating the measurement result. The average is displayed at the end of each sweep.

Initiates an averaging routine that averages the sweep points in a number of successive sweeps, resulting in trace smoothing.

After the specified number of average counts, the average mode (termination control) setting determines the average action.

Key Path	Meas Setup
Mode	SA, WCDMA, C2K, WIMAX OFDMA, TD-SCDMA, 1xEVDO, ISDB-T, CMMB, LTE, LTETDD, BLUETOOTH, WLAN, MSR, LTEAFDD, LTEATDD
Remote Command	[:SENSe] :OBWidth :AVERage :COUNt <integer> [:SENSe] :OBWidth :AVERage :COUNt ? [:SENSe] :OBWidth :AVERage [:STATe] ON OFF 1 0 [:SENSe] :OBWidth :AVERage [:STATe] ?
Example	OBW:AVER:COUN 1500 OBW:AVER:COUN? OBW:AVER ON OBW:AVER?
Notes	You must be in the Spectrum Analysis mode, W-CDMA mode, cdma2000 mode, TD-SCDMA mode, ISDB-T mode, CMMB mode, LTE mode, LTE TDD mode, BLUETOOTH mode, WLAN mode, 1xEVDO mode, MSR, LTE-Advanced FDD/TDD or WIMAX OFDMA mode to use this command. Use:INSTrument:SElect to set the mode.
Couplings	None Averaging state is coupled to Max Hold. If Max Hold is changed from Off to On, Averaging state is automatically set to On.
Preset	10 ON
State Saved	Saved in instrument state.
Min	1
Max	10000

Backwards Compatibility SCPI	<code>[:SENSe] :EBWidth :AVERage :COUNT</code>
Initial S/W Revision	Prior to A.02.00
Modified at S/W Revision	A.03.00

Avg Mode

Enables you to set the averaging mode.

- When set to Exponential (Exp) the measurement averaging continues using the specified number of averages to compute each averaged value. The average is displayed at the end of each sweep.
- When set to Repeat, the measurement resets the average counter each time the specified number of averages is reached.

Key Path	Meas Setup
Mode	SA, WCDMA, C2K, WIMAX OFDMA, TD-SCDMA , 1xEVDO, ISDB-T, CMMB, LTE, LTETDD, BLUETOOTH, WLAN, MSR, LTEAFDD, LTEATDD
Remote Command	<code>[:SENSe] :OBWidth :AVERage :TCONtrol EXPonential REPeat</code> <code>[:SENSe] :OBWidth :AVERage :TCONtrol ?</code>
Example	OBW:AVER:TCON REP OBW:AVER:TCON?
Notes	You must be in the Spectrum Analysis mode, W-CDMA mode, cdma2000 mode, TD-SCDMA mode, ISDB-T mode, CMMB mode, LTE mode, LTE TDD mode, BLUETOOTH mode, WLAN mode, 1xEVDO mode, MSR, LTE-Advanced FDD/TDD or WIMAX OFDMA mode to use this command. Use:INSTRument:SElect to set the mode.
Preset	EXP
State Saved	Saved in instrument state.
Range	Exp Repeat
Initial S/W Revision	Prior to A.02.00
Modified at S/W Revision	A.03.00

Occ BW % Pwr

Assigns the percentage of the total power that is measured within the Occupied Bandwidth for the current measurement. The resulting Occupied Bandwidth limits are displayed by markers placed on the frequencies of the specified percentage.

Key Path	Meas Setup
Mode	SA, WCDMA, C2K, WIMAX OFDMA, TD-SCDMA, 1xEVDO, ISDB-T, CMMB, LTE, LTETDD, BLUETOOTH, WLAN, MSR, LTEAFDD, LTEATDD
Remote Command	<code>[:SENSe] :OBWidth :PERCent <real></code>

	<code>[:SENSe] :OBWidth:PERCent?</code>
Example	OBW:PERC 75 OBW:PERC?
Notes	You must be in the Spectrum Analysis mode, W-CDMA mode, cdma2000 mode, TD-SCDMA mode, ISDB-T mode, CMMB mode, LTE mode, LTE TDD mode, BLUETOOTH mode, WLAN mode, 1xEVDO mode, MSR, LTE-Advanced FDD/TDD or WIMAX OFDMA mode to use this command. Use:INSTrument:SElect to set the mode. If Mode is BLUETOOTH, the key will be grayed out.
Preset	99.00
State Saved	Saved in instrument state.
Min	10
Max	99.99
Initial S/W Revision	Prior to A.02.00
Modified at S/W Revision	A.03.00

x dB

Sets the x dB value used for the "x dB bandwidth" result that measures the bandwidth between two points on the signal which is x dB down from the highest signal point within the OBW Span.

Key Path	Meas Setup
Mode	SA, WCDMA, C2K, WIMAX OFDMA, TD-SCDMA, 1xEVDO, ISDB-T, CMMB, LTE, LTETDD, BLUETOOTH, WLAN, MSR, LTEAFDD, LTEATDD
Remote Command	<code>[:SENSe] :OBWidth:XDB <rel_ampl></code> <code>[:SENSe] :OBWidth:XDB?</code>
Example	OBW:XDB -20 OBW:XDB?
Notes	You must be in the Spectrum Analysis mode, W-CDMA mode, cdma2000 mode, TD-SCDMA mode, ISDB-T mode, CMMB mode, LTE mode, LTE TDD mode, BLUETOOTH mode, WLAN mode, 1xEVDO mode, MSR, LTE-Advanced FDD/TDD or WIMAX OFDMA mode to use this command. Use:INSTrument:SElect to set the mode.
Preset	-26.0 dB BLUETOOTH: -20.0 dB.
State Saved	Saved in instrument state.
Min	-100.0 dB
Max	-0.1 dB
Backwards Compatibility SCPI	<code>[:SENSe] :EBWidth:XDB</code>
Initial S/W Revision	Prior to A.02.00
Modified at S/W Revision	A.03.00

IF Gain

The **IF Gain** key can be used to set the IF Gain function to Auto, Low Gain or High Gain. These settings affect sensitivity and IF overloads.

This only applies to the RF input. It does not apply to baseband I/Q input.

Key Path	Meas Setup, IF Gain
Dependencies	The IF Gain keys (FFT IF Gain and Swept IF Gain) have no effect when the U7227A USB Preamplifier is connected. This is not annotated or reflected on any softkey; there are no keys grayed out nor any SCPI locked out. The analyzer simply behaves as though both FFT IF Gain and Swept IF Gain are set to Low regardless of the setting on the keys.
Initial S/W Revision	Prior to A.02.00

IF Gain Auto

Activates the Auto Rules for IF Gain. When Auto is active, the IF Gain is set to High Gain under and of the following conditions:

- the input attenuator is set to 0 dB
- the preamp is turned On and the frequency range is under 3.6 GHz

For other settings, Auto sets the IF Gain to Low Gain.

Key Path	Meas Setup, IF Gain
Mode	SA, WCDMA, C2K, WIMAX OFDMA, TD-SCDMA, 1xEVDO, ISDB-T, CMMB, LTE, LTE4G, LTE4G, BLUETOOTH, WLAN, MSR, LTEAFDD, LTEATDD
Remote Command	[:SENSe] :OBWidth :IF :GAIN :AUTO [:STATe] ON OFF 1 0 [:SENSe] :OBWidth :IF :GAIN :AUTO [:STATe] ?
Example	OBW : IF : GAIN : AUTO OFF OBW : IF : GAIN : AUTO ?
Couplings	When the auto attenuation exists (for example, with electrical attenuator), the IF Gain setting is changed as following rule. Auto sets IF Gain to High Gain under any of the following conditions: the input attenuator is set to 0 dB, or the preamp is turned on and the frequency range is less than 3.6 GHz. For other settings, Auto sets IF Gain to Low Gain.
Preset	OFF
State Saved	Saved in instrument state.
Range	Off On
Initial S/W Revision	Prior to A.02.00
Modified at S/W Revision	A.03.00

IF Gain State

Selects the range of the IF Gain.

Key Path	Meas Setup, IF Gain
Mode	SA, WCDMA, C2K, WIMAX OFDMA, TD-SCDMA, 1xEVDO, ISDB-T, CMMB, LTE, LTE-TDD, BLUETOOTH, WLAN, MSR, LTEAFDD, LTEATDD
Remote Command	[:SENSe] :OBWidth:IF:GAIN[:STATe] ON OFF 1 0 [:SENSe] :OBWidth:IF:GAIN[:STATe] ?
Example	OBW:IF:GAIN ON OBW:IF:GAIN?
Notes	Where ON = high gain OFF = low gain
Couplings	When the auto attenuation exists (for example, with electrical attenuator), the IF Gain setting is changed as following rule. Auto sets IF Gain to High Gain under any of the following conditions: the input attenuator is set to 0 dB, or the preamp is turned on and the frequency range is less than 3.6 GHz. For other settings, Auto sets IF Gain to Low Gain.
Preset	OFF
State Saved	Saved in instrument state.
Range	Low Gain High Gain
Initial S/W Revision	Prior to A.02.00
Modified at S/W Revision	A.03.00

Limit (for MSR and LTE-Advanced FDD/TDD mode)

Accesses the Limit menu.

Key Path	Meas Setup
Initial S/W Revision	A.10.00

Limit Test

Toggles the limit test.

Key Path	Meas Setup, Limit
Mode	MSR, LTEAFDD, LTEATDD
Remote Command	:CALCulate:OBWidth:LIMit[:TEST] ON OFF 1 0 :CALCulate:OBWidth:LIMit[:TEST] ?
Example	CALC:OBW:LIM 0 CALC:OBW:LIM?
Preset	MSR:OFF LTEAFDD,LTEATDD: ON

State Saved	Saved in instrument state
Range	On Off
Initial S/W Revision	A.10.00

Bandwidth for MSR

Sets OBW limit.

Key Path	Meas Setup, Limit
Mode	MSR
Remote Command	:CALCulate:OBWidth:LIMit:FBLimit <freq> :CALCulate:OBWidth:LIMit:FBLimit?
Example	CALC:OBW:LIM:FBL 10 CALC:OBW:LIM:FBL?
Preset	5.0000 MHz
State Saved	Saved in instrument state
Min	1 kHz
Max	Depends on instrument maximum frequency.
Initial S/W Revision	A.10.00

Meas Preset

Restores all measurement parameters to their default values.

Key Path	Meas Setup
Mode	SA, WCDMA, C2K, WIMAX OFDMA, TD-SCDMA, 1xEVDO, ISDB-T, CMMB, LTE, LTETDD, BLUETOOTH, WLAN, MSR, LTEAFDD, LTEATDD
Remote Command	:CONFigure:OBWidth
Example	CONF:OBW
Initial S/W Revision	Prior to A.02.00
Modified at S/W Revision	A.03.00

Max Hold (Remote Command Only)

When On, Max Hold displays and holds the maximum responses of the current measurement. Turn Max Hold to Off to disable the maximum hold feature.

Key Path	SCPI Only
Mode	SA, WCDMA, C2K, WIMAX OFDMA, TD-SCDMA, 1xEVDO, ISDB-T, CMMB, LTE, LTETDD,

	BLUETOOTH, WLAN, MSR, LTEAFDD, LTEATDD
Remote Command	[:SENSe] :OBWidth:MAXHold ON OFF 1 0 [:SENSe] :OBWidth:MAXHold?
Example	OBW:MAXH ON OBW:MAXH?
Notes	You must be in the Spectrum Analysis mode, W-CDMA mode, cdma2000 mode, TD-SCDMA mode, ISDB-T mode, CMMB mode, LTE mode, LTE TDD mode, BLUETOOTH mode, WLAN mode, 1xEVDO mode, MSR, LTE-Advanced FDD/TDD or WIMAX OFDMA mode to use this command. Use:INSTRument:SElect to set the mode.
Couplings	Max Hold is coupled to Average/Hold state. The Max Hold function is activated only if Average state is On. If Max Hold is changed to On when Average state is Off, Average state is automatically set to On.
Preset	OFF
State Saved	Saved in instrument state.
Range	On Off
Backwards Compatibility SCPI	[:SENSe] :EBWidth:MAXHold
Initial S/W Revision	Prior to A.02.00
Modified at S/W Revision	A.03.00

Mode

See "Mode" on page 276

Mode Preset

Returns the active mode to a known state.

Mode Preset does the following for the currently active mode:

- Aborts the currently running measurement.
- Brings up the default menu for the mode, with no active function.
- Sets measurement Global settings to their preset values for the active mode only.
- Activates the default measurement.
- Brings up the default menu for the mode.
- Clears the input and output buffers.
- Sets Status Byte to 0.

Mode Preset does not:

- Cause a mode switch
- Affect mode persistent settings
- Affect system settings
- See "[How-To Preset](#)" on page 799 for more information.

Key Path	Front-panel key
Remote Command	:SYSTem:PRESet
Example	:SYST:PRES
Notes	*RST is preferred over :SYST : PRES for remote operation. *RST does a Mode Preset, as done by the :SYST:PRES command, and it sets the measurement mode to Single measurement rather than Continuous for optimal remote control throughput. Clears all pending OPC bits. The Status Byte is set to 0.
Couplings	A Mode Preset aborts the currently running measurement, activates the default measurement, and gets the mode to a consistent state with all of the default couplings set.
Backwards Compatibility Notes	In the X-Series, the legacy "Factory Preset" has been replaced with Mode Preset, which only presets the currently active mode, not the entire instrument. In the X-Series, the way to preset the entire instrument is by using System, Restore System Defaults All, which behaves essentially the same way as restore System Defaults does on ESA and PSA. There is also no "Preset Type" as there is on the PSA. There is a green Mode Preset front-panel key that does a Mode Preset and a white-with-green-letters User Preset front-panel key that does a User Preset. The old PRESet:TYPE command is ignored (without generating an error), and SYST:PRES without a parameter does a Mode Preset, which should cover most backward code compatibility issues. The settings and correction data under the Input/Output front-panel key (examples: Input Z Corr, Ext Amp Gain, etc.) are no longer part of any Mode, so they will not be preset by a Mode Preset. They are preset using Restore Input/Output Defaults, Restore System Defaults All. Note that because User Preset does a Recall State, and all of these settings are saved in State, they ARE recalled when using

	User Preset.
Initial S/W Revision	Prior to A.02.00

How-To Preset

The table below shows all possible presets, their corresponding SCPI commands and front-panel access (key paths). Instrument settings depend on the current measurement context. Some settings are local to the current measurement, some are global (common) across all the measurements in the current mode, and some are global to all the available modes. In a similar way, restoring the settings to their preset state can be done within the different contexts.

Auto Couple - is a measurement local key. It sets all Auto/Man parameter couplings in the measurement to Auto. Any Auto/Man selection that is local to other measurements in the mode will not be affected.

Meas Preset - is a measurement local key. Meas Preset resets all the variables local to the current measurement except the persistent ones.

Mode Preset - resets all the current mode's measurement local and measurement global variables except the persistent ones.

Restore Mode Defaults - resets ALL the Mode variables (and all the Meas global and Meas local variables), including the persistent ones.

Type Of Preset	SCPI Command	Front Panel Access
Auto Couple	:COUPlE ALL	Auto Couple front-panel key
Meas Preset	:CONFIgure:<Measurement>	Meas Setup Menu
Mode Preset	:SYSTem:PRESet	Mode Preset (green key)
Restore Mode Defaults	:INSTrument:DEFault	Mode Setup Menu
Restore All Mode Defaults	:SYSTem:DEFault MODEs	System Menu; Restore System Default Menu
*RST	*RST	not possible (Mode Preset with Single)
Restore Input/Output Defaults	:SYSTem:DEFault INPut	System Menu; Restore System Default Menu
Restore Power On Defaults	:SYSTem:DEFault PON	System Menu; Restore System Default Menu
Restore Alignment Defaults	:SYSTem:DEFault ALIGn	System Menu; Restore System Default Menu
Restore Miscellaneous Defaults	:SYSTem:DEFault MISC	System Menu; Restore System Default Menu
Restore All System Defaults	:SYSTem:DEFault [ALL] :SYSTem:PRESet:PERSistent	System Menu; Restore System Default Menu
User Preset	:SYSTem:PRESet:USER	User Preset Menu
User Preset All Modes	:SYSTem:PRESet:USER:ALL	User Preset Menu

9 Occupied Bandwidth Measurement
Mode Preset

Power On Mode Preset	:SYSTem:PON:TYPE MODE	System Menu
Power On User Preset	:SYSTem:PON:TYPE USER	System Menu
Power On Last State	:SYSTem:PON:TYPE LAST	System Menu

Mode Setup

See ["Mode Setup" on page 306](#)

Peak Search

Places the selected marker on the trace point with the maximum y-axis value for that marker's trace. Pressing **Peak Search** with the selected marker off causes the selected marker to be set to Normal, then a peak search is immediately performed.

Key Path	Front panel key
Mode	SA, WCDMA, C2K, WIMAX OFDMA, TD-SCDMA, 1xEVDO, ISDB-T, CMMB, LTE, LTETDD, BLUETOOTH, WLAN, MSR, LTEAFDD, LTEATDD
Remote Command	:CALCulate:OBWidth:MARKer[1] 2 ... 12:MAXimum
Example	CALC:OBW:MARK2:MAX
Initial S/W Revision	Prior to A.02.00
Modified at S/W Revision	A.03.00

Print

See "Print " on page 367

Quick Save

The Quick Save front-panel key repeats the most recent save that was performed from the Save menu, with the following exceptions:

- Register saves are not remembered as Saves for the purpose of the Quick Save function
- If the current measurement does not support the last non-register save that was performed, an informational message is generated, “File type not supported for this measurement”

Quick Save repeats the last type of qualified save (that is, a save qualified by the above criteria) in the last save directory by creating a unique filename using the Auto File Naming algorithm described below.

If Quick Save is pressed after startup and before any qualified Save has been performed, the Quick Save function performs a Screen Image save using the current settings for Screen Image saves (current theme, current directory), which then becomes the “last save” for the purpose of subsequent Quick Saves.

The Auto File Naming feature automatically generates a file name for use when saving a file. The filename consists of a prefix and suffix separated by a dot, as is standard for the Windows® file system. A default prefix exists for each of the available file types:

Type	Default Prefix	Menu
State	State_	(Save/Recall)
Trace + State	State_	(Save/Recall)
Screen	Screen_	(Save/Recall)
Amplitude Corrections	Ampcor_	(Import/Export)
Traces	Trace_	(Import/Export)
Limit Lines	LLine_	(Import/Export)
Measurement Result	MeasR_	(Import/Export)
Capture Buffer	CapBuf_	(Import/Export)

A four digit number is appended to the prefix to create a unique file name. The numbering sequence starts at 0000 within each Mode for each file type and updates incrementally to 9999, then wraps to 0000 again. It remembers where it was through a Mode Preset and when leaving and returning to the Mode. It is reset by Restore Misc Defaults and Restore System Defaults and subsequent running of the instrument application. So, for example, the first auto file name generated for State files is State_0000.state. The next is State_0001, and so forth.

One of the key features of Auto File Name is that we guarantee that the Auto File Name will never conflict with an existing file. The algorithm looks for the next available number. If it gets to 9999, then it looks for holes. If it find no holes, that is no more numbers are available, it gives an error.

For example, if when we get to State_0010.state there is already a State_0010.state file in the current directory, it advances the counter to State_0011.state to ensure that no conflict will exist (and then it verifies that State_0011.state also does not exist in the current directory and advances again if it does, and so forth).

If you enter a file name for a given file type, then the prefix becomes the filename you entered instead of the default prefix, followed by an underscore. The last four letters (the suffix) are the 4-digit number.

For example, if you save a measurement results file as “fred.csv”, then the next auto file name chosen for a measurement results save will be fred_0000.csv.

NOTE Although 0000 is used in the example above, the number that is used is actually the current number in the Meas Results sequence, that is, the number that would have been used if you had not entered your own file name.

NOTE If the filename you entered ends with _dddd, where d=any number, making it look just like an auto file name, then the next auto file name picks up where you left off with the suffix being dddd + 1.

Key Path	Front-panel key
Notes	No remote command for this key specifically.
Initial S/W Revision	Prior to A.02.00

Recall

In the MSR mode, two types of recall functions are available under the Data menu: Parameter Sets and Masks. Masks enables setting of a preset limit mask for Power Suite-based measurements, and currently it is available for the SEM, ACP and SPUR measurements in the MSR mode.

Key Path	Front Panel
Mode	MSR
Initial S/W Revision	A.10.00

State

The **Recall State** menu lets you choose a register or file from which to recall the state.

The content of a state file includes all of the settings and data required to return the analyzer as closely as possible to the Mode it was in, with the exact settings that were in place, when the save occurred. The Mode settings in each state file include the settings that are affected by Mode Preset, as well as the additional settings affected by Restore Mode Defaults; all of the Mode's settings. In addition, all of the settings of the **Input/Output** system are included, even though they are outside of the Mode's state, because they are needed to restore the complete setup. Persistent System settings (for example, GPIB address) are not affected by either a Mode Preset or Restore Mode Defaults, nor are they included in a saved State file.

Since each state file is only for one Mode, the settings for other Modes are unaffected when it is loaded. **Recall State** will cause a mode switch if the state being recalled is not from the current active mode.

After the recall completes, the message "File <filename> recalled" or "Recalled State Register <register number>" is displayed.

For rapid recalls, the State menu lists 16 registers that you can choose from to recall. Pressing a Register key initiates the recall. You can also select a file from which to recall.

The default path for all State Files is:

My Documents\<mode name>\state

where <mode name> is the parameter used to select the mode with the INST:SEL command (for example, SA for the Spectrum Analyzer).

See "[More Information](#)" on page 807.

Key Path	Recall
Mode	All
Remote Command	:MMEMory:LOAD:STATe <filename>
Example	:MMEM:LOAD:STAT "myState.state" This recalls the file myState.state on the default path
Example	MMEM:LOAD:STAT "MyStateFile.state" This loads the state file data (on the default file directory path) into the instrument state.

Notes	<p>When you pick a file to recall, the analyzer first verifies that the file is recallable in the current instrument by checking the software version and model number of the instrument. If everything matches, a full recall proceeds by aborting the currently running measurement, clearing any pending operations, and then loading the State from the saved state file. You can open state files from any mode, so recalling a State file switches to the mode that was active when the save occurred. After switching to the mode of the saved state file, mode settings and data (if any for the mode) are loaded with values from the saved file. The saved measurement of the mode becomes the newly active measurement and the data relevant to the measurement (if there is any) is recalled.</p> <ul style="list-style-type: none"> • If there is a mismatch between file version or model number or instrument version or model number, the recall function tries to recall as much as possible and returns a warning message. It may limit settings that differ based on model number, licensing or version number. <p>After recalling the state, the Recall State function does the following:</p> <ul style="list-style-type: none"> • Makes the saved measurement for the mode the active measurement. • Clears the input and output buffers. • Status Byte is set to 0. • Executes a *CLS <p>If the file specified is empty an error is generated. If the specified file does not exist, another error is generated. If there is a mismatch between the file and the proper file type, an error is generated. If there is a mismatch between file version or model number or instrument version or model number, a warning is displayed. Then it returns to the State menu and File Open dialog goes away.</p> <p>After the Recall, the analyzer exits the Recall menu and returns to the previous menu.</p>
Backwards Compatibility SCPI	<p>:MMEMory:LOAD:STATe 1,<filename></p> <p>For backwards compatibility, the above syntax is supported. The "1" is simply ignored.</p>
Initial S/W Revision	Prior to A.02.00

More Information

In measurements that support saving Traces, for example, Swept SA, the Trace data is saved along with the State in the State file. When recalling the State, the Trace data is recalled as well. Traces are recalled exactly as they were stored, including the writing mode and update and display modes. If a Trace was updating and visible when the State was saved, it will come back updating and visible, and its data will be rewritten right away. When you use State to save and recall traces, any trace whose data must be preserved should be placed in View or Blank mode before saving.

The following table describes the Trace Save and Recall possibilities:

You want to recall state and one trace's data, leaving other traces unaffected.	Save Trace+State from 1 trace. Make sure that no other traces are updating (they should all be in View or Blank mode) when the save is performed.	On Recall, specify the trace you want to load the one trace's data into. This trace will load in View. All other traces' data will be unaffected, although their trace mode will be as it was when the state save was performed.
You want to recall all traces	Save Trace+State from ALL traces.	On Recall, all traces will come back in View (or Blank if they were in Blank or Background when

		saved)
You want all traces to load exactly as they were when saved.	Save State	On recall, all traces' mode and data will be exactly as they were when saved. Any traces that were updating will have their data immediately overwritten.

From File...

When you press “From File”, the analyzer brings up a Windows dialog and a menu entitled “File Open.” This menu allows you to navigate to the various fields in the Windows dialog without using a keyboard or mouse. The **Tab** and **Arrow** keys can also be used for dialog navigation.

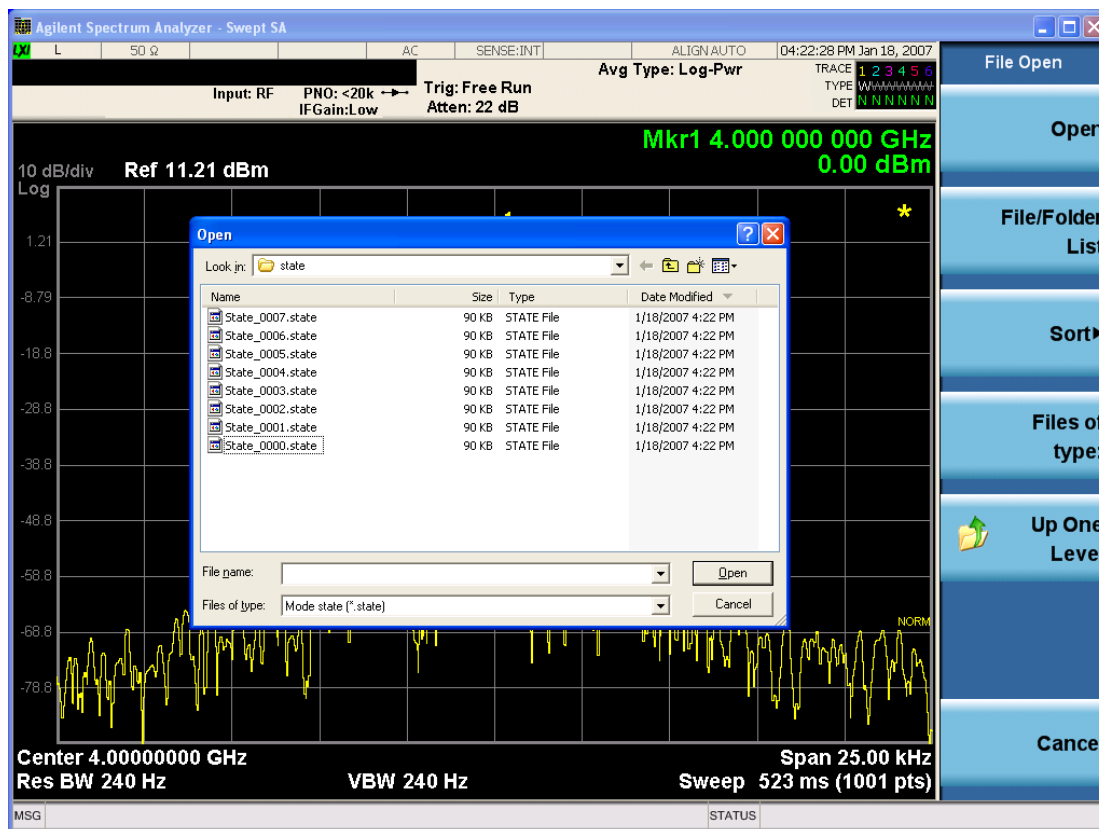

Listed below are the functions of the various fields in the dialog, and the corresponding softkeys:

Open

Performs the recall of the specified file. While the recall is being performed, the floppy icon appears briefly in the Meas bar.

File/Folder List

Enables you to navigate to the center of the dialog that contains the list of files and folders. Once here you can get information about the file and use the tab keys to navigate to the other fields in the dialog, such as Look In.

Look In

The **Look In** field shows the path from which the file will be recalled and allows you to change the path using the up and down arrow keys to navigate to other paths; the Enter key to open a directory; and the Backspace key to go back one directory. The **Look In field** first uses the last path from the Save As dialog **Save In:** path for that same file type. There is no softkey for directly navigating to the Look In field, but you can use the left tab to get here from the File/Folder List.

User specified paths are remembered when you leave and return to a Mode and are reset back to the default using **Restore Mode Defaults**.

Sort

Accesses a menu that enables you to sort the files within the File Open dialog. Only one sorting type can be selected at a time and the sorting happens immediately. The sorting types are **By Date, By Name, By extension, and By Size**.

Files of Type

This field shows the file suffix for the type of file you have selected to recall. For example, if you navigated here while recalling State, "Mode state (*.state)" is in the field. If you navigated here while recalling Trace, ""Mode state (*.trace)" is in the field. If you navigated here while importing a trace data file, "Trace Data (*.csv)" is in the field. For some file types, there is more than one choice in the dropdown menu, which you can select by using the up and down arrow keys and Enter.

Up One Level

This key corresponds to the icon of a folder with the up arrow that is in the tool bar of the dialog. When pressed, it causes the file and folder list to navigate up one level in the directory structure. The Backspace key does the same thing.

Cancel

This key corresponds to the **Cancel** selection in the dialog. It causes the current **Open** request to be cancelled. The ESC key does the same thing.

Key Path	Recall, State
Notes	Brings up the Open dialog for recalling a State Save Type
Initial S/W Revision	Prior to A.02.00

Edit Register Names

You may enter a custom name on any of the Register keys, to help you remember what you are using that state to save. To do this, press the **Edit Register Names** key, choose the register whose name you wish to edit, and then enter the desired label using the Alpha Editor or an external PC keyboard.

The maximum number of characters that can be added is 30. In most cases, 30 characters will fit on two lines of the key.

For more information and the SCPI command, see Edit Register Names under the **Save, State** function.

Key Path	Recall, State
Mode	All
Dependencies	N9060A-7FP or N9060B-2FP license required to edit the register names. When the feature is not licensed, sending the SCPI command generates an error, -221, "Settings conflict;Option not available"
Initial S/W Revision	A.11.00

Register 1 thru Register 16

Selecting any one of these register keys causes the State of the mode from the specified Register to be recalled. Each of the register keys annotates whether it is empty or at what date and time it was last modified. In addition, you can use the **Edit Register Names** key under **Save, State** to enter custom names for each register.

Registers are shared by all modes, so recalling from any one of the registers will cause a mode switch to the mode that was active when the save to the Register occurred.

Although these 16 registers are the only registers available from the front panel, there are 128 state registers available in the instrument. Registers 17-128 are only available from the SCPI interface, using the *RCL command.

After the recall completes, the message "Register <register number> recalled" appears in the message bar. If you are in the Spectrum Analyzer Mode, and you are recalling a register that was saved in the Spectrum Analyzer Mode, then after the recall, you will still be in the Recall Register menu. If the Recall causes you to switch modes, then after the Recall, you will be in the Frequency menu.

If a requested register is empty an error is generated.

Key Path	Recall, State
Example	*RCL 1
Range	1-16 from front panel, 1-128 from SCPI
Readback	Date and time with seconds resolution are displayed on the key OR A custom name of up to 30 characters entered using the Save, State,Edit Register Names key OR “(empty)” if no prior save operation has been performed to this register.
Initial S/W Revision	Prior to A.02.00
Modified at S/W Revision	Prior to A.11.00

Register 1 thru Register 16

Selecting any one of these register keys causes the State of the mode from the specified Register to be recalled. Each of the register keys annotates whether it is empty or at what date and time it was last

modified. In addition, you can use the **Edit Register Names** key under **Save, State** to enter custom names for each register.

Registers are shared by all modes, so recalling from any one of the registers will cause a mode switch to the mode that was active when the save to the Register occurred.

Although these 16 registers are the only registers available from the front panel, there are 128 state registers available in the instrument. Registers 17–128 are only available from the SCPI interface, using the *RCL command.

After the recall completes, the message "Register <register number> recalled" appears in the message bar. If you are in the Spectrum Analyzer Mode, and you are recalling a register that was saved in the Spectrum Analyzer Mode, then after the recall, you will still be in the Recall Register menu. If the Recall causes you to switch modes, then after the Recall, you will be in the Frequency menu.

If a requested register is empty an error is generated.

Key Path	Recall, State
Example	*RCL 1
Range	1–16 from front panel, 1–128 from SCPI
Readback	Date and time with seconds resolution are displayed on the key OR A custom name of up to 30 characters entered using the Save, State,Edit Register Names key OR “(empty)” if no prior save operation has been performed to this register.
Initial S/W Revision	Prior to A.02.00
Modified at S/W Revision	Prior to A.11.00

Data (Import)

Importing a data file loads data that was previously saved from the current measurement or from other measurements and/or modes that produce compatible data files. The Import Menu only contains Data Types that are supported by the current measurement.

Since the commonly exported data files are in .csv format, the data can be edited by the user prior to importing. This allows you to export a data file, manipulate the data in Excel (the most common PC Application for manipulating .csv files) and then import it.

Importing Data loads measurement data from the specified file into the specified or default destination, depending on the data type selected. Selecting an Import Data menu key will not actually cause the importing to occur, since the analyzer still needs to know from where to get the data. Pressing the Open key in this menu brings up the Open dialog and Open menu that provides you with the options from where to recall the data. Once a filename has been selected or entered in the Open menu, the recall occurs as soon as the Open button is pressed.

Key Path	Recall
Mode	All

Notes	The menu is built from whatever data types are available for the mode. Some keys will be missing completely, so the key locations in the sub-menu will vary. No SCPI command directly controls the Data Type that this key controls. The Data Type is included in the MMEM:LOAD commands.
Dependencies	If a file type is not used by a certain measurement, it is grayed out for that measurement. The key for a file type will not show at all if there are no measurements in the Mode that support it.
Preset	Is not affected by Preset or shutdown, but is reset during Restore Mode Defaults
Readback	The data type that is currently selected
Initial S/W Revision	Prior to A.02.00

Parameter Set

Enables you to import format parameter set data to specified format parameter sets. Selecting this key displays a menu that enables you to select the destination parameter set. After making this selection, depress Open... and use the file dialog to select the file you wish to recall.

Supported import file formats are dependent on radio formats.

LTE FDD: Format Parameter Set Files (*.fps), LTE FDD app state files (*.state), 89601 VSA Setup Files (*.set, *.setx) and Signal Studio Setup Files (*.scp)

W-CDMA:Format Parameter Set Files (*.fps) and W-CDMA app state files (*.state)

GSM/EDGE:Format Parameter Set Files (*.fps) and GSM/EDGE app state files (*.state)

cdma2000:Format Parameter Set Files (*.fps) and cdma2000 app state files (*.state)

1xEV-DO:Format Parameter Set Files (*.fps) and 1xEV-DO app state files (*.state)

LTE TDD: Format Parameter Set Files (*.fps), LTE TDD app state files (*.state), 89601 VSA Setup Files (*.set, *.setx) and Signal Studio Setup Files (*.scp)

TD-SCDMA:Format Parameter Set Files (*.fps) and TD-SCDMA app state files (*.state)

Format Parameter Set Files

Extention: fps

Basic file type of format parameter set. This file contains a format parameter set exported using Parameter Set under Recall, Data (Export). It is imported if the radio format of the file matches the destination radio format. If not, an error message, -230 "Data corrupt or stale", is issued with the specified file name.

App State Files

Extention: state

The state file of each mode can be imported to the corresponding parameter set. If the mode name in the state file matches the selected destination format, the state file data are imported. If not, an error message, -230 "Data corrupt or stale", is issued with the specified file name.

The parameters to be imported are ones referred in a particular measurement of each mode. The relevant measurements are listed below.

LTE FDD: Modulation Analysis

W-CDMA: Mod Accuracy

GSM/EDGE: EDGE EVM

cdma2000: Mod Accuracy

1xEV-DO: Mod Accuracy

LTE TDD: Modulation Analysis

TD-SCDMA: Mod Accuracy

Note that Integ BW and Measurement Noise BW parameters of ACP, SEM and CHP are not imported.

89601 VSA Setup Files

Extention: set, setx

The 89600 Vector Signal Analyzer Setup file created using the 89600 Vector Signal Analyzer Option BHD (LTE FDD)/Option BHE (LTE TDD) can be imported as LTE FDD/LTE TDD parameter set. If the setup file is not loaded successfully, an error message, -230 “Data corrupt or stale”, is issued with the specified file name.

Signal Studio Setup Files

Extention: scp

The Keysight Signal Studio setup file created using Signal Studio (N7624B/N7625B) can be imported as LTE FDD/LTE TDD parameter set. Supported carrier types are listed in the table below:

<i>Signal Studio</i>	<i>Carrier Type</i>
N7624B Signal Studio for 3GPP LTE	Advanced LTE FDD Downlink (2009-03)
	Advanced LTE FDD Downlink (2009-12)
	Advanced LTE FDD Downlink (2010-06)
	Advanced LTE FDD Uplink (2009-12)
	Advanced LTE FDD Uplink (2010-06)
	Basic LTE FDD Downlink (2009-03)
	Basic LTE FDD Downlink (2009-12)
	Basic LTE FDD Downlink (2010-06)
	Basic LTE FDD Uplink (2009-03)
	Basic LTE FDD Uplink (2009-12)
	Basic LTE FDD Uplink (2010-06)
N7625B Signal Studio for 3GPP LTE TDD	Advanced LTE TDD (2009-03)
	Advanced LTE TDD (2009-12)
	Basic LTE TDD (2009-03)
	Basic LTE TDD (2009-12)
	Advanced LTE TDD R9

Basic LTE TDD R9 PRACH

If the setup file is not loaded successfully, an error message, -230 “Data corrupt or stale”, is issued with the specified file name.

Default path of this import type is “My Documents\MSR\data\params” folder. Note that “**My Documents**” is an alias to a directory and its location depends on which user is logged in. If the file path is specified without root folder, the import file is determined with the default path. For example if “folder1\paramData.prms” is specified, “My Documents\MSR\data\params\folder1\paramData.prms” is imported.

File Dialog Filter

Since supported import file formats differ between radio formats, file filters available in the open file dialog vary depending on the selected radio format. This table below defines file name filters available for each format.

<i>Radio Format</i>	<i>File Name Filters</i>
LTE FDD	All Supported Format Parameter Setup Files (*.fps; *.state; *.set; *.setx; *.scp) Format Parameter Setup Files (*.fps) State Files (*.state) 89601 VSA Setup Files (*.set; *.setx) Signal Studio Setup Files (*.scp)
W-CDMA	All Supported Format Parameter Setup Files (*.fps; *.state) Format Parameter Setup Files (*.fps) W-CDMA State Files (*.state)
GSM/EDGE	All Supported Format Parameter Setup Files (*.fps; *.state) Format Parameter Setup Files (*.fps) State Files (*.state)
cdma2000	All Supported Format Parameter Set Files (*.fps; *.state) Format Parameter Set Files (*.fps) State Files (*.state)
1xEV-DO	All Supported Format Parameter Set Files (*.fps; *.state) Format Parameter Set Files (*.fps) State Files (*.state)
LTE TDD	All Supported Format Parameter Setup Files (*.fps; *.state; *.set; *.setx; *.scp) Format Parameter Setup Files (*.fps) State Files (*.state) 89601 VSA Setup Files (*.set; *.setx) Signal Studio Setup Files (*.scp)
TD-SCDMA	All Supported Format Parameter Set Files (*.fps; *.state) Format Parameter Set Files (*.fps) State Files (*.state)

Key Path	Recall, Data
Mode	MSR
Remote Command	MMEMoRY:LOAD:PSET LTEFdd1 LTEFdd2 LTEFdd3 WCDMa1 WCDMa2 WCDMa3 GSM1 GSM2 GSM3 CDMA1 CDMA2 CDMA3 EVDO1 EVDO2 EVDO3 LTETdd1 LTETdd2 LTETdd3 TDSCdma1 TDSCdma2 TDSCdma3, <string>
Example	MMEM:LOAD:PSET LTEF1,"LTE FDD.set"
Notes	The first enum selects the destination format parameter set to which the file data are imported.
Initial S/W Revision	A.10.00
Modified at S/W Revision	A.12.00, A.16.00

Masks

This key enables you to recall a preset mask file which contains Offset and Limit settings. Parameters except them will not be overwritten. You cannot change or create preset mask files since they are binary files. This key is valid for the Spectrum Emission Mask, ACP and Spurious Emissions measurements.

Default path: "My Documents\MSR\data\masks"

Note that "My Documents" is an alias to a directory and its location depends on which user is logged in. At XSA start up, all of the limit mask files in the current user's "My Documents\MSR\data\masks" directory are overwritten.

File type: Binary

Filename: The filename follows the rule below with the words connected using underscores.

<Measurement>_<Condition>.mask

Where

<Measurement> Measurement the limit mask file is applied to: SEM, ACP or SPUR

<Condition> Condition. It depends on the measurement.

File extension: .mask

File Dialog Filter: Preset Mask Files (*.mask)

Selecting OPEN... under the Import Data menu opens the above directory enabling you to select a mask file.

Details of the masks are provided in a PDF file in the default folder of masks.

Key Path	Recall, Data
Mode	MSR
Remote Command	MMEMoRY:LOAD:MASK <string>
Example	MMEM:LOAD:MASK "ACP_BS\ACP_BS_3MHz_pairE-UTRA_CatA.mask"

Notes	Parameters related to Limit and Offset are overwritten by the contents of the preset mask file.
Initial S/W Revision	A.10.00

Open...

When you press “Open”, the analyzer brings up a Windows dialog and a menu entitled “**File Open.**” This menu allows you to navigate to the various fields in the Windows dialog without using a keyboard or mouse. The **Tab** and **Arrow** keys can also be used for dialog navigation.

See "[From File...](#)" on page 2454 in **Recall, State**, for a full description of this dialog and menu.

Key Path	Recall, Data
Notes	The key location is mode-dependent and will vary. Brings up Open dialog for recalling a <mode specific> Save Type
Initial S/W Revision	Prior to A.02.00

Restart

The Restart function restarts the current sweep, or measurement, or set of averaged/held sweeps or measurements. If you are Paused, pressing Restart does a Resume.

The Restart function is accessed in several ways:

- Pressing the Restart key
- Sending the remote command INIT:IMMEDIATE
- Sending the remote command INIT:RESTART

See "[More Information](#)" on page 817

Key Path	Front-panel key
Remote Command	:INITiate[:IMMEDIATE] :INITiate:RESTART
Example	:INIT:IMM :INIT:REST
Notes	:INITiate:RESTART and :INITiate:IMMEDIATE perform exactly the same function.
Couplings	Resets average/hold count k. For the first sweep overwrites all active (update=on) traces with new current data. For application modes, it resets other parameters as required by the measurement.
Status Bits/OPC dependencies	This is an Overlapped command. The STATUS:OPERation register bits 0 through 8 are cleared. The STATUS:QUESTIONable register bit 9 (INTEgrity sum) is cleared. The SWEEPING bit is set. The MEASURING bit is set.
Backwards Compatibility Notes	For Spectrum Analysis mode in ESA and PSA, the Restart hardkey and the INITiate:RESTART command restart trace averages (displayed average count reset to 1) for a trace in Clear Write , but did not restart Max Hold and Min Hold . In the X-Series, the Restart hardkey and the INITiate:RESTART command restart not only Trace Average , but MaxHold and MinHold traces as well. For wireless comms modes in ESA and PSA, the Restart hardkey and the INITiate:RESTART command restart every measurement, which includes all traces and numeric results. There is no change to this operation.
Initial S/W Revision	Prior to A.02.00

More Information

The **Restart** function first aborts the current sweep/measurement as quickly as possible. It then resets the sweep and trigger systems, sets up the measurement and initiates a new data measurement sequence with a new data acquisition (sweep) taken once the trigger condition is met.

If the analyzer is in the process of aligning when **Restart** is executed, the alignment finishes before the restart function is performed.

Even when set for Single operation, multiple sweeps may be taken when Restart is pressed (for example, when averaging/holding is on). Thus when we say that **Restart** "restarts a measurement," we may mean:

- It restarts the current sweep
- It restarts the current measurement
- It restarts the current set of sweeps if any trace is in Trace Average, Max Hold or Min Hold
- It restarts the current set of measurements if Averaging, or Max Hold, or Min Hold is on for the measurement
- depending on the current settings.

With **Average/Hold Number** (in **Meas Setup** menu) set to 1, or Averaging off, or no trace in Trace Average or Hold, a single sweep is equivalent to a single measurement. A single sweep is taken after the trigger condition is met; and the analyzer stops sweeping once that sweep has completed. However, with **Average/Hold Number** > 1 and at least one trace set to **Trace Average, Max Hold, or Min Hold (SA Measurement)** or **Averaging on (most other measurements)**, multiple sweeps/data acquisitions are taken for a single measurement. The trigger condition must be met prior to each sweep. The sweep is stopped when the average count k equals the number N set for **Average/Hold Number**. A measurement average usually applies to all traces, marker results, and numeric results; but sometimes it only applies to the numeric results.

Once the full set of sweeps has been taken, the analyzer will go to idle state. To take one more sweep without resetting the average count, increment the average count by 1, by pressing the step up key while **Average/Hold Number** is the active function, or sending the remote command **CALC: AVER: TCON UP**.

Save

In the MSR mode, two types of save functions are available under the Data menu: Parameter Sets and Meas Results.

Key Path	Front Panel
Mode	MSR
Initial S/W Revision	Prior to A.10.00
Modified at S/W Revision	A.10.00

State

The Save State menu lets you choose a register or file for saving the state.

The content of a state file includes all of the settings and data required to return the analyzer as closely as possible to the Mode it was in, with the exact settings which were in place, when the save occurred. The Mode settings in each state file include the settings that are affected by Mode Preset, as well as the additional settings affected by Restore Mode Defaults; all of the Mode's settings. In addition, all of the settings of the **Input/Output** system are included, even though they are outside of the Mode's state, because they are needed to restore the complete setup. Persistent **System** settings (for example, Verbose SCPI) are not affected by either Mode Preset or Restore Mode Defaults, nor are they included in a saved State file.

After the save completes, the message "File <filename> saved" or "State Register <register number> saved" is displayed.

For rapid saving, the State menu lists 16 registers to save to. Pressing a Register key initiates the save. You can also select a file to save to.

The default path for all State Files is:

My Documents\<<mode name>\state

where <mode name> is the parameter used to select the mode with the INST:SEL command (for example, SA for the Spectrum Analyzer).

Key Path	Save
Mode	All
Remote Command	:MMEMory:STORe:STATe <filename>
Example	MMEM:STOR:STATe "MyStateFile.state" This stores the current instrument state data in the file MyStateFile.state in the default directory.
Notes	Both single and double quotes are supported for any filename parameter over remote. After saving to a register, that register's menu key is updated with the date the time, unless a custom label has been entered for that key. After saving to a register, you remain in the Save State menu, so that you can see the Register key update. After saving to a file, the analyzer automatically returns to the previous menu and any Save As dialog goes away.

Backwards Compatibility SCPI	:MMEMory:STORE:STATE 1,<filename> For backwards compatibility, the above syntax is supported. The "1" is simply ignored. The command is sequential.
Initial S/W Revision	Prior to A.02.00

To File . . .

When you press “To File”, the analyzer brings up a Windows dialog and a menu entitled “Save As.” This menu allows you to navigate to the various fields in the Windows dialog without using a keyboard or mouse. The **Tab** and **Arrow** keys can also be used for dialog navigation.

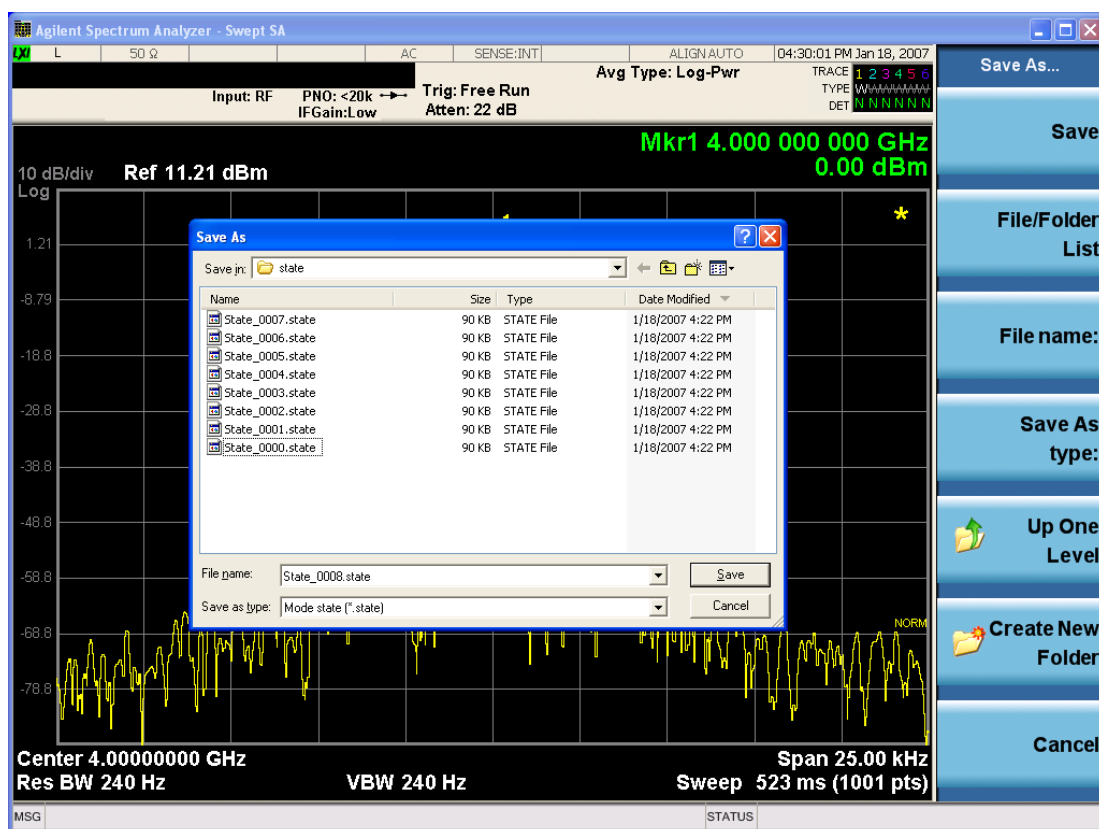

The Listed below

are the functions of the various fields in the dialog, and the corresponding softkeys:

Save

Performs the save to the specified file of the selected type. If the file already exists, a dialog will appear that allows you to replace the existing file by selecting **OK**, or you can Cancel the request. If you select OK, the file will be overwritten. Using the C: drive is strongly discouraged, since it runs the risk of being overwritten during an instrument software upgrade.

While the save is being performed, the floppy icon appears briefly in the Meas bar.

File/Folder List

Enables you to navigate to the center of the dialog that contains the list of files and folders. Once here you can get information about the file and use the tab keys to navigate to the other fields in the dialog, such as Save In.

Save In

The Save In field shows the path to which the file will be saved and allows you to change the path using the up and down arrow keys to navigate to other paths; the Enter key to open a directory; and the Backspace key to go back one directory. The **Save In field** defaults to the default path for this type of file and remembers the last path you used to save this type of file. There is no softkey for directly navigating to the Save In field but you can use left tab to get here from the File/Folder List.

User specified paths are remembered when you leave and return to a Mode and are reset back to the default using **Restore Mode Defaults**.

File Name

The **File Name** field is initially loaded with an automatically generated filename specific to the appropriate Save Type. The automatically generated filename is guaranteed not to conflict with any filename currently in the directory. You may replace or modify this filename using the File Name key. See the "[Quick Save](#)" on [page 2428](#) documentation for more on the automatic file naming algorithm.

When you press the **File Name** key the analyzer displays the Alpha Editor. Use the knob to choose the letter to add and the front-panel Enter key to add the letter to the file name. The BK character moves you back and the FW character moves you forward in the filename. The Select key on the front panel generates a space character. When you are done entering the filename press the **Done** softkey. This returns back to the **File Open** dialog and menu, but does not cause the save to occur.

Save As Type

This field shows the file suffix for the type of file you have selected to save. For example, if you navigated here while saving State, "Mode state (*.state)" is in the field. If you navigated here from saving Trace, ""Mode state (*.trace)" is in the field. If you navigated here while exporting a trace data file, "Trace Data (*.csv)" is in the field. For some file types, there is more than one choice in the dropdown, which you can select by using the up and down arrow keys and Enter.

Up One Level

This key corresponds to the icon of a folder with the up arrow that is in the tool bar of the dialog. When pressed, it causes the file and folder list to navigate up one level in the directory structure. The Backspace key does the same thing.

Create New Folder

This key corresponds to the icon of a folder with the "*" that is in the tool bar of the dialog. When pressed, a new folder is created in the current directory with the name **New Folder** and you can enter a new folder name using the Alpha Editor.

Cancel

This key corresponds to the **Cancel** selection in the dialog. It causes the current **Save As** request to be cancelled. The ESC key does the same thing.

Key Path	Save, State
----------	-------------

Mode	All
Notes	Brings up Save As dialog for saving a State Save Type
Initial S/W Revision	Prior to A.02.00

Edit Register Names

You may enter a custom name on any of the Register keys, to help you remember what you are using that state to save. To do this, press the **Edit Register Names** key, choose the register whose name you wish to edit, and then enter the desired label using the Alpha Editor or an external PC keyboard.

The maximum number of characters that can be added is 30. In most cases, 30 characters will fit on two lines of the key.

See ["More Information" on page 822](#)

Key Path	Save, State
Mode	All
Remote Command	:MMEMory:REGister:STATe:LABel <reg number>,"label" :MMEMory:REGister:STATe:LABel? <reg number>
Example	:MMEM:REG:STAT:LAB 1,"my label"
Notes	<reg number> is an integer from 1 to 16. If the SCPI specifies an invalid register number an error message is generated, -222,"Data out of range;Invalid register label number" "label" is a string from 0 to 30 characters in length. If a label exceeds 30 characters, an error message is generated, -150,"String data error;Label clipped to 30 characters" "label" of length 0 erases the custom label and restores the default (time and date) label. E.g.: :MMEM:REG:STAT:LAB 1,""
Dependencies	N9060A-7FP or N9060B-2FP license required to edit the register names. When the feature is not licensed, sending this command generates an error, -221,"Settings conflict;Option not available"
Preset	The names are unaffected by Preset or power cycle but are set to the default label (time and date) on a "Restore System Defaults->Misc"
Initial S/W Revision	A.11.00

More Information

When you edit one of the register names, the time and date field will be replaced by the custom name.

If you delete all the characters in the custom name, it restores the default (time and date).

The register names are stored within the state files, but they are not part of the instrument state; that is, once you have edited a register name, loading a new state will not change that register name. Another consequence of this is that the names will be persistent through a power cycle. Also, if a named state file is transferred to another analyzer, it will bring its custom name along with it.

If you try to edit the name of an empty register, the analyzer will first save the state to have a file to put the name in. If you load a named state file into an analyzer with older firmware it will ignore the metadata.

The *SAV and *RCL commands will not be affected by the custom register names, nor will the MMEM commands.

Register 1 thru Register 16

Selecting any one of these register menu keys causes the State of the currently active mode to be saved to the specified Register. The registers are provided for rapid saving and recalling, since you do not need to specify a filename or navigate to a file. Each of the register menu keys annotates whether it is empty or at what date and time it was last modified. In addition, you can use the **Edit Register Names** key to enter custom names for each register.

Although these 16 registers are the only registers available from the front panel, there are 128 state registers available in the instrument. Registers 17–128 are only available from the SCPI interface, using the *SAV command.

There is one set of 128 state registers in the instrument, not one set for each Mode. When a state is saved, the Mode it was saved from is saved with it; then when it is recalled, the instrument switches to that Mode.

After the save completes, the corresponding register menu key annotation is updated with the date and time and the message "Register <register number> saved" is displayed.

Key Path	Save, State
Mode	All
Example	*SAV 1
Range	1–16 from front panel, 1–128 from SCPI
Readback	Date and time with seconds resolution are displayed on the key OR A custom name of up to 30 characters entered using the Edit Register Names key OR “(empty)” if no prior save operation has been performed to this register.
Initial S/W Revision	Prior to A.02.00
Modified at S/W Revision	A.11.00

Register 1 thru Register 16

Selecting any one of these register menu keys causes the State of the currently active mode to be saved to the specified Register. The registers are provided for rapid saving and recalling, since you do not need to specify a filename or navigate to a file. Each of the register menu keys annotates whether it is empty or at what date and time it was last modified. In addition, you can use the **Edit Register Names** key to enter custom names for each register.

Although these 16 registers are the only registers available from the front panel, there are 128 state registers available in the instrument. Registers 17–128 are only available from the SCPI interface, using the *SAV command.

There is one set of 128 state registers in the instrument, not one set for each Mode. When a state is saved, the Mode it was saved from is saved with it; then when it is recalled, the instrument switches to that Mode.

After the save completes, the corresponding register menu key annotation is updated with the date and time and the message "Register <register number> saved" is displayed.

Key Path	Save, State
Mode	All
Example	*SAV 1
Range	1-16 from front panel, 1-128 from SCPI
Readback	Date and time with seconds resolution are displayed on the key OR A custom name of up to 30 characters entered using the Edit Register Names key OR “(empty)” if no prior save operation has been performed to this register.
Initial S/W Revision	Prior to A.02.00
Modified at S/W Revision	A.11.00

Mass Storage Catalog (Remote Command Only)

Key path	SCPI Only
Remote Command	:MMEMory:CATalog? [<directory_name>]
Notes	The string must be a valid logical path. Queries disk usage information (drive capacity, free space available) and obtains a list of files and directories in a specified directory in the following format: <numeric_value>,<numeric_value>,{<file_entry>} It returns two numeric parameters and as many strings as there are files and directories. The first parameter indicates the total amount of storage currently used in bytes. The second parameter indicates the total amount of storage available, also in bytes. The <file_entry> is a string. Each <file_entry> indicates the name, type, and size of one file in the directory list: <file_name>,<file_type>,<file_size> As the windows file system has an extension that indicates file type, <file_type> is always empty. <file_size> provides the size of the file in bytes. For directories, <file_entry> is surrounded by square brackets and both <file_type> and <file_size> are empty
Initial S/W Revision	Prior to A.02.00

Mass Storage Change Directory (Remote Command Only)

Key path	SCPI Only
Remote Command	:MMEMory:CDIRectory [<directory_name>] :MMEMory:CDIRectory?
Notes	The string must be a valid logical path. Changes the default directory for a mass memory file system. The <directory_name> parameter is a string. If no parameter is specified, the directory is set to the *RST value.

	At *RST, this value is set to the default user data storage area, that is defined as System.Environment.SpecialFolder.Personal. Query returns full path of the default directory.
Initial S/W Revision	Prior to A.02.00

Mass Storage Copy (Remote Command Only)

Key path	SCPI Only
Remote Command	:MMEMory:COpy <string>,<string>[,<string>,<string>]
Notes	<p>The string must be a valid logical path.</p> <p>Copies an existing file to a new file or an existing directory to a new directory.</p> <p>Two forms of parameters are allowed. The first form has two parameters. In this form, the first parameter specifies the source, and the second parameter specifies the destination.</p> <p>The second form has four parameters. In this form, the first and third parameters specify the source. The second and fourth parameters specify the directories. The first pair of parameters specifies the source. The second pair specifies the destination. An error is generated if the source doesn't exist or the destination file already exists.</p> <p>This command will generate an "access denied" error if the destination is a restricted folder (e.g., C:\Windows) and the current user does not have Power User or Administrator privileges.</p>

Mass Storage Device Copy (Remote Command Only)

This command transfers data to/from a file and a peripheral device.

Key path	SCPI Only
Remote Command	:MMEMory:COpy:DEvice <source_string>,<dest_string>
Notes	<p>The strings must be a valid logical path or a valid device keyword. If the dest_string is a device keyword, the data is copied from the source file to the device. If the source_string is a device keyword, the data is copied to the source file from the device.</p> <p>Valid device keywords are:</p> <p>SNS (smart noise source)</p> <p>An error is generated if the file or device is not found.</p>

Mass Storage Delete (Remote Command Only)

Key path	SCPI Only
Remote Command	:MMEMory:DElete <file_name>[,<directory_name>]
Notes	<p>The string must be a valid logical path.</p> <p>Removes a file from the specified directory. The <file_name> parameter specifies the file name to be removed. This command will generate an "access denied" error if the file is in a restricted folder (e.g.,</p>

	C:\Windows) and the current user does not have Power User or Administrator privileges.
Initial S/W Revision	Prior to A.02.00

Mass Storage Data (Remote Command Only)

Creates a file containing the specified data OR queries the data from an existing file.

Key path	SCPI Only
Remote Command	:MMEMory:DATA <file_name>, <data> :MMEMory:DATA? <file_name>
Notes	The string must be a valid logical path. The command form is MMEMory:DATA <file_name>,<data>. It loads <data> into the file <file_name>. <data> is in 488.2 block format. <file_name> is string data. The query form is MMEMory:DATA? <file_name> with the response being the associated <data> in block format.
Initial S/W Revision	Prior to A.02.00

Mass Storage Make Directory (Remote Command Only)

Key path	SCPI Only
Remote Command	:MMEMory:MDIRectory <directory_name>
Notes	The string must be a valid logical path. Creates a new directory. The <directory_name> parameter specifies the name to be created. This command will generate an “access denied” error if the new directory would be in a restricted folder (e.g., C:\Windows) and the current user does not have Power User or Administrator privileges.
Initial S/W Revision	Prior to A.02.00

Mass Storage Move (Remote Command Only)

Key path	SCPI Only
Remote Command	:MMEMory:MOVE <string>,<string>[,<string>,<string>]
Notes	The string must be a valid logical path. Moves an existing file to a new file or an existing directory to a new directory. Two forms of parameters are allowed. The first form has two parameters. In this form, the first parameter specifies the source, and the second parameter specifies the destination. The second form has four parameters. In this form, the first and third parameters specify the source. The second and fourth parameters specify the directories. The first pair of parameters specifies the source. The second pair specifies the destination. An error is generated if the source doesn't exist or the destination file already exists.

	This command will generate an “access denied” error if the destination is a restricted folder (e.g., C:\Windows) and the current user does not have Power User or Administrator privileges.
Initial S/W Revision	Prior to A.02.00

Mass Storage Remove Directory (Remote Command Only)

Key path	SCPI Only
Remote Command	:MMEMory:RDIrectory <directory_name>
Notes	<p>The string must be a valid logical path.</p> <p>Removes a directory. The <directory_name> parameter specifies the directory name to be removed. All files and directories under the specified directory shall also be removed.</p> <p>This command will generate an “access denied” error if the folder is a restricted folder (e.g., C:\Windows) or is in a restricted folder and the current user does not have Power User or Administrator privileges.</p>
Initial S/W Revision	Prior to A.02.00

Mass Storage Determine Removable Media (Remote Command Only)

This command is used to determine if any removable media devices are connected to the instrument. Primarily, these are USB memory devices plugged-in to the front panel or rear panel USB ports. On instruments with PC6 or PC7 CPU's, one SD card slot is available for removable media. The instrument's primary disk drive is not a removable media device.

Key Path	SCPI Only
Remote Command	:MMEMory:RMEDia:LIST?
Notes	<p>The return value will be a string containing a list of partition identifiers which are removable media devices. Each identifier will be separated by a comma. If no removable media is present, an empty string will be returned.</p> <p>Examples:</p> <p>One removable device present will result in a return string of “F:”.</p> <p>Two removable devices present will result in a return string of “F:,G:”.</p> <p>No removable devices present will result in a return string of “”.</p>
Initial S/W Revision	x.15.00

Mass Storage Determine Removable Media Label (Remote Command Only)

This command is used to set or query a removable media device's label.

Key Path	SCPI Only
----------	------------------

Remote Command	:MMEMory:RMEDia:LABel <partition>,<string> :MMEMory:RMEDia:LABel? <partition>
Example	MMEM:RMED:LAB "F:","My Device"
Notes	If the <partition> specified does not exist or is not a removable media device the error -252,"Missing Media" will be generated. Setting the removable media label requires Administrative privileges. If the currently logged in user does not have appropriate privileges the error "-221.9900,Settings conflict;Administrator privileges required" is generated.
Initial S/W Revision	x.15.00

Mass Storage Determine Removable Media Write-protect status (Remote Command Only)

This command is used to query a removable media device's write-protect status.

Key Path	SCPI Only
Remote Command	:MMEMory:RMEDia:WPRotect? <partition>
Example	MMEM:RMED:WPR? "F:"
Notes	The return value is 1 if the device is write-protected, and 0 if the device is write-enabled. If the <partition> specified does not exist or is not a removable media device the error -252,"Missing Media" will be generated.
Preset	The return value will be depending on SD card installed.
Initial S/W Revision	x.15.00

Mass Storage Determine Removable Media size (Remote Command Only)

This command is used to query a removable media device's total memory size (not available memory size).

Key Path	SCPI Only
Remote Command	:MMEMory:RMEDia:SIZE? <partition>
Example	MMEM:RMED:SIZE? "F:"
Notes	The return value is integer value in GBytes. Any device which is less than 1 GB will return 0 GB. If the <partition> specified does not exist or is not a removable media device the error -252,"Missing Media" will be generated.
Initial S/W Revision	x.15.00

Trace (+State)

The **Save Trace (+State)** menu lets you choose a register or file specifying where to save the Trace+State state file.

A saved state contains all of the settings and data required to return the analyzer as closely as possible to the exact setup it had when the save occurred. This includes the Input/Output settings, even though they are outside of the Mode's state, because they are needed to restore the complete setup. A Trace+State file also includes trace data from one trace or all traces, which will load in View mode when the Trace+State file is recalled.

After the save completes, the message "File <filename> saved" or "Trace Register <register number> saved" is displayed.

For rapid saves, the Trace (+State) menu lists 5 registers to save to. Pressing a Register key initiates the save. You can also select a file to save to.

The default path for all State Files including .trace files is:

My Documents\<mode name>\state

where <mode name> is the parameter used to select the mode with the INST:SEL command (for example, Basic for the IQAnalyzer).

This key is grayed out for measurements that do not support trace saves. It is blanked for modes that do not support trace saves. Saving **Trace** is identical to saving State except a .trace extension is used on the file instead of .state, and internal flags are set in the file indicating which trace was saved. You may select to save one trace or ALL traces.

Key Path	Save
Mode	SA
Remote Command	:MMEMory:STORe:TRACe TRACE1 TRACE2 TRACE3 TRACE4 TRACE5 TRACE6 ALL,<filename> :MMEMory:STORe:TRACe:REGister TRACE1 TRACE2 TRACE3 TRACE4 TRACE5 TRACE6 ALL,<integer>
Example	:MMEM:STOR:TRAC TRACE1, "myState.trace" saves the file myState.trace on the default path and flags it as a "single trace" file with Trace 1 as the single trace (even though all of the traces are in fact stored). :MMEM:STOR:TRAC ALL, "myState.trace" saves the file myState.trace on the default path and flags it as an "all traces" file :MMEM:STOR:TRAC:REG TRACE1, 2 stores trace 1 data in trace register 2
Notes	This command actually performs a save state, which in the Swept SA measurement includes the trace data. However it flags it (in the file) as a "save trace" file of the specified trace (or all traces). Some modes and measurements do not have available all 6 traces. The Phase Noise mode command, for example, is: MMEMory:STORe:TRACe TRACE1 TRACE2 TRACE3 ALL,<filename> Some modes and measurements have more than 6 traces available. The Realtime SA mode command, for example, is: MMEMory:STORe:TRACe TRACE1 TRACE2 TRACE3 TRACE4 TRACE5 TRACE6 TRACE7 TRACE8 TRACE9 TRACE10 TRACE11 TRACE12 ALL,<filename> The range for the register parameter is 1-5 When you initiate a save, if the file already exists, a dialog will appear that allows you to replace the existing file by selecting OK or you can Cancel the request. If you select OK, the file will be overwritten. Using the C: drive is strongly discouraged, since it runs the risk of being overwritten during an instrument software upgrade. Both single and double quotes are supported for any filename parameter over remote.

After saving to a register, that register's menu key is updated with the date and time of the save.
After saving to a register, you remain in the **Save Trace** menu, so that you can see the Register key update. After saving to a file, the analyzer automatically returns to the previous menu and any Save As dialog goes away.

Initial S/W Revision	Prior to A.02.00
----------------------	------------------

From Trace

Accesses a menu that enables you to select the trace to be saved. Once a trace is selected, the key returns to the Save Trace menu and the selected trace number is annotated on the key. The default is the currently selected trace, selected in this menu or in the Trace/Det, Export Data, Import Data or Recall Trace menus, except if you have chosen All then it remains chosen until you specifically change it to a single trace. To save the Trace you must select the **Save As** key in the Save Trace menu.

When you select a trace, it makes that trace the current trace, so it displays on top of all of the other traces.

Key Path	Save, Trace + State
Mode	SA
Initial S/W Revision	Prior to A.02.00

From File...

When you press "From File", the analyzer brings up a Windows dialog and a menu entitled "**File Open.**" This menu allows you to navigate to the various fields in the Windows dialog without using a keyboard or mouse. The **Tab** and **Arrow** keys can also be used for dialog navigation.

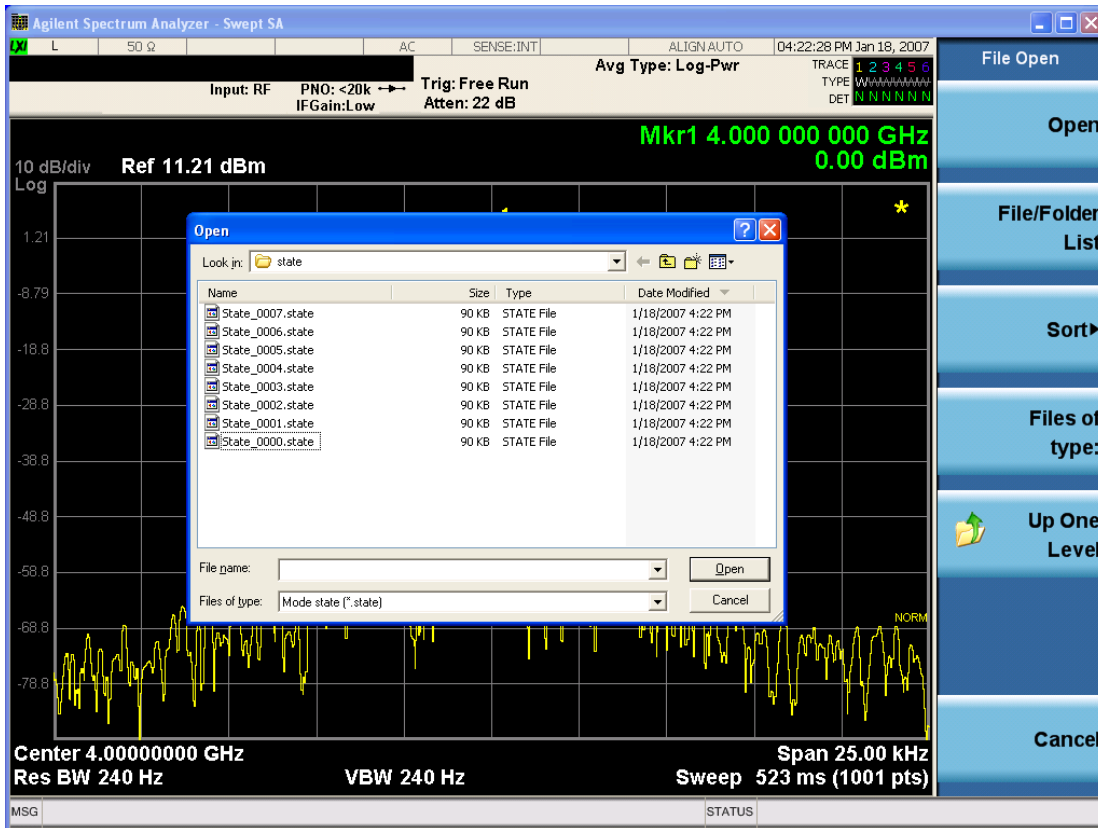

Listed below are the functions of the various fields in the dialog, and the corresponding softkeys:

Open

Performs the recall of the specified file. While the recall is being performed, the floppy icon appears briefly in the Meas bar.

File/Folder List

Enables you to navigate to the center of the dialog that contains the list of files and folders. Once here you can get information about the file and use the tab keys to navigate to the other fields in the dialog, such as Look In.

Look In

The **Look In** field shows the path from which the file will be recalled and allows you to change the path using the up and down arrow keys to navigate to other paths; the Enter key to open a directory; and the Backspace key to go back one directory. The **Look In field** first uses the last path from the Save As dialog **Save In:** path for that same file type. There is no softkey for directly navigating to the Look In field, but you can use the left tab to get here from the File/Folder List.

User specified paths are remembered when you leave and return to a Mode and are reset back to the default using **Restore Mode Defaults**.

Sort

Accesses a menu that enables you to sort the files within the File Open dialog. Only one sorting type can be selected at a time and the sorting happens immediately. The sorting types are **By Date**, **By Name**, **By extension**, and **By Size**.

Files of Type

This field shows the file suffix for the type of file you have selected to recall. For example, if you navigated here while recalling State, "Mode state (*.state)" is in the field. If you navigated here while recalling Trace, ""Mode state (*.trace)" is in the field. If you navigated here while importing a trace data file, "Trace Data (*.csv)" is in the field. For some file types, there is more than one choice in the dropdown menu, which you can select by using the up and down arrow keys and Enter.

Up One Level

This key corresponds to the icon of a folder with the up arrow that is in the tool bar of the dialog. When pressed, it causes the file and folder list to navigate up one level in the directory structure. The Backspace key does the same thing.

Cancel

This key corresponds to the **Cancel** selection in the dialog. It causes the current **Open** request to be cancelled. The ESC key does the same thing.

Key Path	Recall, State
Notes	Brings up the Open dialog for recalling a State Save Type
Initial S/W Revision	Prior to A.02.00

Register 1 thru Register 16

Selecting any one of these register menu keys causes the State of the currently active mode to be saved to the specified Register. The registers are provided for rapid saving and recalling, since you do not need to specify a filename or navigate to a file. Each of the register menu keys annotates whether it is empty or at what date and time it was last modified. In addition, you can use the **Edit Register Names** key to enter custom names for each register.

Although these 16 registers are the only registers available from the front panel, there are 128 state registers available in the instrument. Registers 17–128 are only available from the SCPI interface, using the *SAV command.

There is one set of 128 state registers in the instrument, not one set for each Mode. When a state is saved, the Mode it was saved from is saved with it; then when it is recalled, the instrument switches to that Mode.

After the save completes, the corresponding register menu key annotation is updated with the date and time and the message "Register <register number> saved" is displayed.

Key Path	Save, State
Mode	All
Example	*SAV 1
Range	1–16 from front panel, 1–128 from SCPI

Readback	Date and time with seconds resolution are displayed on the key OR A custom name of up to 30 characters entered using the Edit Register Names key OR “(empty)” if no prior save operation has been performed to this register.
Initial S/W Revision	Prior to A.02.00
Modified at S/W Revision	A.11.00

Data (Export)

Exporting a data file stores data from the current measurement to mass storage files. The Export Menu only contains data types that are supported by the current measurement.

Since the commonly exported data files are in .csv format, the data can be edited by you prior to importing. This allows you to export a data file, manipulate the data in Excel (the most common PC Application for manipulating .csv files) and then import it.

Selecting an Export Data menu key will not actually cause the exporting to occur, since the analyzer still needs to know where you wish to save the data. Pressing the Save As key in this menu brings up the Save As dialog and Save As menu that allows you to specify the destination file and directory. Once a filename has been selected or entered in the Open menu, the export will occur as soon as the Save key is pressed.

Key Path	Save
Mode	All
Notes	The menu is built from whatever data types are available for the mode. So the key locations in the sub menu will vary. No SCPI command directly controls the Data Type that this key controls. The Data Type is included in the MMEM:STORe commands.
Dependencies	If a file type is not used by a certain measurement, that type is grayed out for that measurement. The key for a file type will not show at all if there are no measurements in the Mode that support it.
Preset	Is not affected by a Preset or shutdown, but is reset during Restore Mode Defaults
Readback	The data type that is currently selected
Initial S/W Revision	Prior to A.02.00

Parameter Set

Enables you to export format parameter set data to files. Selecting this key displays a menu that enables you to select the data source. After making this selection, depress Save As... and use the file dialog to enter the file name to save. You can import the exported file by selecting Parameter Set under Recall, Data.

Default path:

Default path of this import type is “My Documents\MSR\data\params” folder. Note that “My Documents” is an alias to a directory and its location depends on which user is logged in. If the file path is specified without root folder, the export file is determined with the default path. For example if “folder1\paramData.prms” is specified, “My Documents\MSR\data\params\folder1\paramData.fps” is exported.

File Extension: fps

Default Prefix: ParamSet_

File Dialog Filter: Format Parameter Set Files (*.fps)

Key Path	Save, Data
Mode	MSR
Remote Command	MMEMory:STORe:PSET LTEFdd1 LTEFdd2 LTEFdd3 WCDMa1 WCDMa2 WCDMa3 GSM1 GSM2 GSM3 CDMA1 CDMA2 CDMA3 EVDO1 EVDO2 EVDO3 LTETdd1 LTETdd2 LTETdd3 TDSCdma1 TDSCdma2 TDSCdma3,<string>
Example	MMEM:STOR:PSET WCDM1,"WCDMA.fps"
Notes	The first enum selects the source format parameter set from which the file data are exported.
Initial S/W Revision	A.10.00
Modified at S/W Revision	A.12.00, A.16.00

Measurement Results

Pressing this key selects Meas Results as the data type to be exported.

The Meas Results file contains measurement result sets, plus information describing the current state of the analyzer, as detailed in "[Meas Results File Definition](#)" on page 835 and "[Meas Results File Example](#)" on page 836 below.

Key Path	Save, Data
Remote Command	:MMEMory:STORe:RESults <string>
Example	:MMEM:STOR:RES "MeasR_0000.csv"
Notes	If the save is initiated via SCPI and the file already exists, the file will be overwritten. The SCPI command exports Occupied Bandwidth measurement results to the file specified as the parameter in the current path. The default path is My Documents\<current mode>\data\OBW\results. Using the C: drive is strongly discouraged, since it runs the risk of being overwritten during an instrument software upgrade. The SCPI parameter is a quoted string that specifies the filename. Both single and double quotes are supported for any filename parameter over SCPI.
Dependencies	The current active measurement must be the Occupied Bandwidth measurement to use this command.
Status Bits/OPC dependencies	Sequential – waits for the previous measurement to complete
Initial S/W Revision	Prior to A.02.00

Meas Results File Definition

The content of a Meas Results File is defined in this section.

The first lines in the file consist of identification and instrument configuration details, as follows.

- File ID string, which is “MeasResult”
- Measurement ID following Mode ID, which is “SA:OBW” for example.
- Firmware rev and model number
- Option string
- Auto Sweep Time Rules
- Average Mode
- Average Number
- Average State
- Center Frequency
- Detector
- Electrical Atten
- Electrical Atten State
- IFGain
- IFGainAuto
- Internal Preamp
- Internal Preamp Band
- Limit
- Limit State
- Max Hold
- Mechanical Atten
- MechanicalAttenStepEnum
- OBW Percent Pwr
- Resolution Band Width
- Resolution Bandwidth Shape
- Span
- Sweep Points
- Sweep Time

- Sweep Time Auto
- TriggerSource
- Video Bandwidth
- x DB

The data above is followed in the file by a line containing “MeasResult1” and “MeasResult2”. This line forms a header for each set of measurement results, which appear in subsequent lines. Each line of Measurement Results consists of two comma-separated values, for MeasResult1 and MeasResult2 respectively.

The MeasResult1 set in the file corresponds to the data returned by MEAS|READ|FETCh:OBWidth1, and the MeasResult2 set corresponds to the data returned by MEAS|READ|FETCh:OBWidth2.

The exported file is in CSV format, with a .csv extension.

Meas Results File Example

When imported into Microsoft Excel, a typical Meas Results CSV file appears as shown in the example below.

MeasResult	
SA:OBW	
A.10.53	N9030A
526 ALV ATP B1X B1Y B25 B40 BBA CR3 CRP DCF DDA DP2 DRD EA3 EDP EMC EP1 ERC ESC ESP EXM FSA LFE LNP MAT MPB NFE NUL P26 PFR PNC RTL RTS S40 SB1 SEC SM1 TVT YAS YAV	1
Auto Sweep Time Rules	Normal
Average Mode	Exponential
Average Number	10
Average State	TRUE
Center Frequency	1.33E+10
Detector	Average
IFGain	FALSE
IFGainAuto	FALSE
Internal Preamp	FALSE
Internal Preamp Band	Low
Limit	5000000
Limit State	FALSE
Max Hold	FALSE
OBW Percent Pwr	99
Resolution Band Width	27000

Resolution Bandwidth Shape	Gaussian
Span	3000000
Sweep Points	1001
Sweep Time	0.004933
Sweep Time Auto	TRUE
TriggerSource	Free
Video Bandwidth	270000
x DB	-26
MeasResult1	MeasResult2
2971020.10835045	-94.3702543927405
-74.9741251886604	-94.1447790390963

Save As . . .

When you press “Save As”, the analyzer brings up a Windows dialog and a menu entitled “**Save As.**” This menu allows you to navigate to the various fields in the Windows dialog without using a keyboard or mouse. The **Tab** and **Arrow** keys can also be used for dialog navigation.

See "[To File . . .](#)" on page 2444 in **Save, State** for a full description of this dialog and menu.

The default path for saving files is:

For all of the Trace Data Files:

My Documents\`<mode name>`\data\traces

For all of the Limit Data Files:

My Documents\`<mode name>`\data\limits

For all of the Measurement Results Data Files:

My Documents\`<mode name>`\data\`<measurement name>`\results

For all of the Capture Buffer Data Files:

My Documents\`<mode name>`\data\captureBuffer

Key Path	Save, Data
Mode	All
Notes	The key location is mode-dependent and will vary. Brings up the Save As dialog for saving a <code><mode specific></code> Save Type. The save is performed immediately and does not wait until the measurement is complete.
Initial S/W Revision	Prior to A.02.00

Screen Image

Pressing Screen Image accesses a menu of functions that enable you to specify a format and location for the saved screen image. It brings up a menu that allows you to specify the color scheme of the Screen Image (Themes) or navigate to the Save As dialog to perform the actual save.

Screen Image files contain an exact representation of the analyzer display. They cannot be loaded back onto the analyzer, but they can be loaded into your PC for use in many popular applications.

The image to be saved is actually captured when the **Save** front panel key is pressed, and kept in temporary storage to be used if you ask for a Screen Image save. When the Screen Image key is pressed, a "thumbnail" of the captured image is displayed, as shown below:

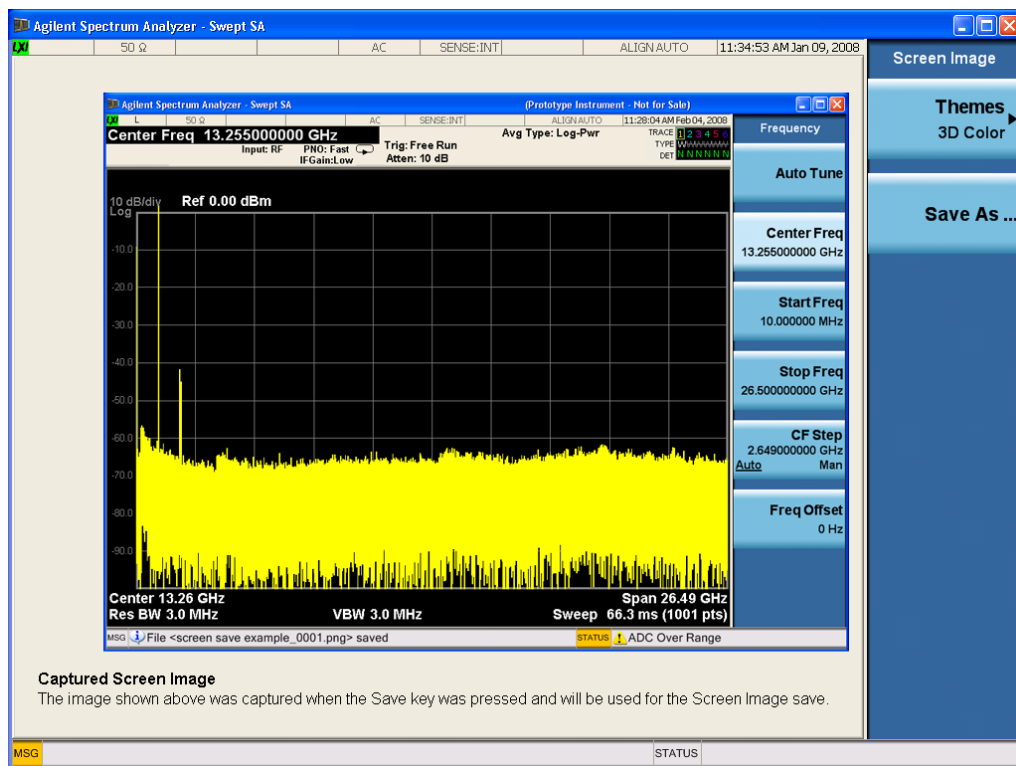

When you continue on into the **Save As** menu and complete the Screen Image save, the image depicted in the thumbnail is the one that gets saved, showing the menus that were on the screen before going into the **Save** menus. The save is performed immediately and does not wait until the measurement is complete.

After you have completed the save, the **Quick Save** front-panel key lets you quickly repeat the last save performed, using an auto-named file, with the current screen data.

NOTE

For versions previous to A.01.55, if you initiate a screen image save by navigating through the Save menus, the image that is saved will contain the Save menu softkeys, not the menus and the active function that were on the screen when you first pressed the Save front panel key.

Key Path	Save
Mode	All

Remote Command	:MMEMory:STORe:SCReen <filename>
Example	:MMEM:STOR:SCR "myScreen.png" This stores the current screen image in the file MyScreenFile.png in the default directory.
Initial S/W Revision	Prior to A.02.00

Themes

Accesses a menu of functions that enable you to choose the theme to be used when saving the screen image.

The **Themes** option is the same as the **Themes** option under the **Display** and **Page Setup** dialogs. It allows you to choose between themes to be used when saving the screen image.

Key Path	Save, Screen Image
Remote Command	:MMEMory:STORe:SCReen:THEMe TDColor TDMonochrome FCOLor FMONochrome :MMEMory:STORe:SCReen:THEMe?
Example	:MMEM:STOR:SCR:THEM TDM
Preset	3D Color; Is not part of Preset, but is reset by Restore Misc Defaults or Restore System Defaults All and survives subsequent running of the modes.
Readback	3D Color 3D Mono Flat Color Flat Mono
Backwards Compatibility Notes	In ESA and PSA we offer the choice of "Reverse Bitmap" or "Reverse Metafile" when saving screen images. This is much like the "Flat Color" theme available in X-Series. Also, if you selected Reverse Bitmap AND a black & white screen image, that would be much like "Flat Monochrome". In other words, each of the X-Series themes has a similar screen image type in ESA/PSA. But they are not identical.
Initial S/W Revision	Prior to A.02.00

3D Color

Selects a standard color theme with each object filled, shaded and colored as designed.

Key Path	Save, Screen Image, Themes
Example	MMEM:STOR:SCR:THEM TDC
Readback	3D Color
Initial S/W Revision	Prior to A.02.00

3D Monochrome

Selects a format that is like 3D color but shades of gray are used instead of colors.

Key Path	Save, Screen Image, Themes
Example	MMEM:STOR:SCR:THEM TDM
Readback	3D Mono
Initial S/W Revision	Prior to A.02.00

Flat Color

Selects a format that is best when the screen is to be printed on an ink printer.

Key Path	Save, Screen Image, Themes
Example	MMEM:STOR:SCR:THEM FCOL
Readback	Flat Color
Initial S/W Revision	Prior to A.02.00

Flat Monochrome

Selects a format that is like Flat Color. But only black is used (no colors, not even gray), and no fill.

Key Path	Save, Screen Image, Themes
Example	MMEM:STOR:SCR:THEM FMON
Readback	Flat Mono
Initial S/W Revision	Prior to A.02.00

Save As...

When you press "Save As", the analyzer brings up a Windows dialog and a menu entitled "**Save As.**" This menu allows you to navigate to the various fields in the Windows dialog without using a keyboard or mouse. The **Tab** and **Arrow** keys can also be used for dialog navigation.

See "[To File . . .](#)" on page 2444 in **Save, State** for a full description of this dialog and menu.

The default path for Screen Images is

My Documents\`<mode name>`\screen.

where `<mode name>` is the parameter used to select the mode with the INST:SEL command (for example, SA for the Spectrum Analyzer).

Key Path	Save, Screen Image
Notes	Brings up Save As dialog for saving a Screen Image Save Type
Initial S/W Revision	Prior to A.02.00

Mass Storage Catalog (Remote Command Only)

Key path	SCPI Only
Remote Command	:MMEMory:CATalog? [<directory_name>]
Notes	<p>The string must be a valid logical path.</p> <p>Queries disk usage information (drive capacity, free space available) and obtains a list of files and directories in a specified directory in the following format: <numeric_value>,<numeric_value>,{<file_entry>}</p> <p>It returns two numeric parameters and as many strings as there are files and directories. The first parameter indicates the total amount of storage currently used in bytes. The second parameter indicates the total amount of storage available, also in bytes. The <file_entry> is a string. Each <file_entry> indicates the name, type, and size of one file in the directory list: <file_name>,<file_type>,<file_size></p> <p>As the windows file system has an extension that indicates file type, <file_type> is always empty. <file_size> provides the size of the file in bytes. For directories, <file_entry> is surrounded by square brackets and both <file_type> and <file_size> are empty</p>
Initial S/W Revision	Prior to A.02.00

Mass Storage Change Directory (Remote Command Only)

Key path	SCPI Only
Remote Command	:MMEMory:CDIRectory [<directory_name>] :MMEMory:CDIRectory?
Notes	<p>The string must be a valid logical path.</p> <p>Changes the default directory for a mass memory file system. The <directory_name> parameter is a string. If no parameter is specified, the directory is set to the *RST value.</p> <p>At *RST, this value is set to the default user data storage area, that is defined as System.Environment.SpecialFolder.Personal.</p> <p>Query returns full path of the default directory.</p>
Initial S/W Revision	Prior to A.02.00

Mass Storage Copy (Remote Command Only)

Key path	SCPI Only
Remote Command	:MMEMory:COPY <string>,<string>[,<string>,<string>]
Notes	<p>The string must be a valid logical path.</p> <p>Copies an existing file to a new file or an existing directory to a new directory.</p> <p>Two forms of parameters are allowed. The first form has two parameters. In this form, the first parameter specifies the source, and the second parameter specifies the destination.</p> <p>The second form has four parameters. In this form, the first and third parameters specify the source. The second and fourth parameters specify the directories. The first pair of parameters specifies the</p>

source. The second pair specifies the destination. An error is generated if the source doesn't exist or the destination file already exists.

This command will generate an "access denied" error if the destination is a restricted folder (e.g., C:\Windows) and the current user does not have Power User or Administrator privileges.

Mass Storage Device Copy (Remote Command Only)

This command transfers data to/from a file and a peripheral device.

Key path	SCPI Only
Remote Command	:MMEMory:COpy:DEvice <source_string>,<dest_string>
Notes	The strings must be a valid logical path or a valid device keyword. If the dest_string is a device keyword, the data is copied from the source file to the device. If the source_string is a device keyword, the data is copied to the source file from the device. Valid device keywords are: SNS (smart noise source) An error is generated if the file or device is not found.

Mass Storage Data (Remote Command Only)

Creates a file containing the specified data OR queries the data from an existing file.

Key path	SCPI Only
Remote Command	:MMEMory:DATA <file_name>, <data> :MMEMory:DATA? <file_name>
Notes	The string must be a valid logical path. The command form is MMEMory:DATA <file_name>,<data>. It loads <data> into the file <file_name>. <data> is in 488.2 block format. <file_name> is string data. The query form is MMEMory:DATA? <file_name> with the response being the associated <data> in block format.
Initial S/W Revision	Prior to A.02.00

Mass Storage Delete (Remote Command Only)

Key path	SCPI Only
Remote Command	:MMEMory:DElete <file_name>[,<directory_name>]
Notes	The string must be a valid logical path. Removes a file from the specified directory. The <file_name> parameter specifies the file name to be removed. This command will generate an "access denied" error if the file is in a restricted folder (e.g., C:\Windows) and the current user does not have Power User or Administrator privileges.
Initial S/W Revision	Prior to A.02.00

Mass Storage Make Directory (Remote Command Only)

Key path	SCPI Only
Remote Command	:MMEMory:MDIRectory <directory_name>
Notes	<p>The string must be a valid logical path.</p> <p>Creates a new directory. The <directory_name> parameter specifies the name to be created.</p> <p>This command will generate an “access denied” error if the new directory would be in a restricted folder (e.g., C:\Windows) and the current user does not have Power User or Administrator privileges.</p>
Initial S/W Revision	Prior to A.02.00

Mass Storage Move (Remote Command Only)

Key path	SCPI Only
Remote Command	:MMEMory:MOVE <string>,<string>[,<string>,<string>]
Notes	<p>The string must be a valid logical path.</p> <p>Moves an existing file to a new file or an existing directory to a new directory.</p> <p>Two forms of parameters are allowed. The first form has two parameters. In this form, the first parameter specifies the source, and the second parameter specifies the destination.</p> <p>The second form has four parameters. In this form, the first and third parameters specify the source. The second and fourth parameters specify the directories. The first pair of parameters specifies the source. The second pair specifies the destination. An error is generated if the source doesn't exist or the destination file already exists.</p> <p>This command will generate an “access denied” error if the destination is a restricted folder (e.g., C:\Windows) and the current user does not have Power User or Administrator privileges.</p>
Initial S/W Revision	Prior to A.02.00

Mass Storage Remove Directory (Remote Command Only)

Key path	SCPI Only
Remote Command	:MMEMory:RDIRectory <directory_name>
Notes	<p>The string must be a valid logical path.</p> <p>Removes a directory. The <directory_name> parameter specifies the directory name to be removed. All files and directories under the specified directory shall also be removed.</p> <p>This command will generate an “access denied” error if the folder is a restricted folder (e.g., C:\Windows) or is in a restricted folder and the current user does not have Power User or Administrator privileges.</p>
Initial S/W Revision	Prior to A.02.00

Single (Single Measurement/Sweep)

Sets the analyzer for Single measurement operation. The single/continuous state is Meas Global, so the setting will affect all the measurements. If you are Paused, pressing **Single** does a Resume.

See "[More Information](#)" on page 844

Key Path	Front-panel key
Example	:INIT:CONT OFF
Notes	See Cont key description.
Backwards Compatibility Notes	<p>For Spectrum Analysis mode in ESA and PSA, the Single hardkey and the INITiate:IMM switched from continuous measurement to single measurement and restarted sweeps and averages (displayed average count reset to 1), but did not restart Max Hold and Min Hold. In the X-Series, the Single hardkey and the INITiate:IMM command initiate a sweep/ measurement/ average sequence/hold sequence including MaxHold and MinHold.</p> <p>For Spectrum Analysis mode in ESA and PSA, the Single hardkey restarted the sweep regardless of whether or not you were in an active sweep or sweep sequence. In the X-Series, Restart does this but Single only restarts the sweep or sweep sequence if you are in the idle state.</p> <p>INIT[:IMM] in ESA & PSA Spectrum Analysis Mode does an implied ABORT. In some other PSA Modes, INIT[:IMM] is ignored if not in the idle state. . The X-Series follows the ESA/PSA SA Mode model, which may cause some Modes to have compatibility problems.</p>
Initial S/W Revision	Prior to A.02.00

More Information

See "[Restart](#)" on page 2441 for details on the INIT:IMMEDIATE (Restart) function.

If you are already in single sweep, the INIT:CONT OFF command has no effect.

If you are already in Single Sweep, then pressing the **Single** key in the middle of a sweep does not restart the sweep or sequence. Similarly, pressing the **Single** key does not restart the sweep or sequence if the sweep is not in the idle state (for example, if you are taking a very slow sweep, or the analyzer is waiting for a trigger). Instead, it results in a message. "Already in Single, press Restart to initiate a new sweep or sequence". Even though pressing the **Single** key in the middle of a sweep does not restart the sweep, sending INIT:IMMEDIATE does reset it.

To take one more sweep without resetting the average count, increment the average count by 1, by pressing the step up key while **Average/Hold Number** is the active function, or sending the remote command CALC:AVER:TCON UP.

Source

There is no Source control functionality for this measurement. When this key is pressed, the screen either displays a blank menu, or the previously-selected menu remains unchanged.

Key Path	Front-panel key
----------	-----------------

Span X Scale

Activates the Span function and displays the menu of span functions. The parameter values are measurement independent.

Key Path	Front-panel key
Initial S/W Revision	Prior to A.02.00

Span

Set the frequency of the occupied bandwidth span for the current measurement.

Key Path	Span X Scale
Mode	SA, WCDMA, C2K, WIMAX OFDMA, TD-SCDMA, 1xEVDO, ISDB-T, CMMB, LTE, LTETDD, BLUETOOTH, WLAN, MSR, LTEAFDD, LTEATDD
Remote Command	[:SENSe] :OBWidth:FREQuency:SPAN <freq> [:SENSe] :OBWidth:FREQuency:SPAN? [:SENSe] :OBWidth:FREQuency:SPAN:AUTO ON OFF 0 1 [:SENSe] :OBWidth:FREQuency:SPAN:AUTO?
Example	OBW:FREQ:SPAN 2.4 MHz OBW:FREQ:SPAN? OBW:FREQ:SPAN:AUTO 0 OBW:FREQ:SPAN:AUTO?
Notes	Span Auto Detector ([:SENSe] :OBWidth:FREQuency:SPAN:AUTO) is only available in MSR and LTE-Advanced FDD/TDD mode. The BAF SCPI is MSR and LTE-Advanced FDD/TDD only.
Couplings	When changing the Occupied Bandwidth Span, the Resolution Bandwidth and Video Bandwidth are set to AUTO to prevent the span from clipping. This is only available in MSR and LTE-Advanced FDD/TDD mode.
Preset	SA: 3 MHz WCDMA: 10 MHz WIMAX OFDMA: 20 MHz CDMA2K: 2 MHz TD-SCDMA: 4.8 MHz 1xEVDO: 3.75 MHz ISDB-T: 20 MHz CMMB: 8 MHz LTE, LTETDD, LTEAFDD, LTEATDD: 10 MHz BLUETOOTH:2 MHz WLAN: If Radio Std is 802.11a/g /j/p 20 MHz 802.11n(20MHz) 802.11ac(20MHz): 25 MHz If Radio Std is 802.11b: 30MHz

	If Radio Std is 802.11n(40MHz), 802.11ac (40MHz): 50 MHz
	If Radio Std is 802.11ac(80MHz): 100MHz
	If Radio Std is 802.11ac(160MHz): 200MHz
	If Radio Std is 802.11ah(1MHz): 1.25MHz
	If Radio Std is 802.11ah(2MHz): 2.5MHz
	If Radio Std is 802.11ah(4MHz): 5MHz
	If Radio Std is 802.11ah(8MHz): 10MHz
	If Radio Std is 802.11ah(16MHz): 20MHz
	If Radio Std is 802.11j/p(10MHz): 12.5MHz
	If Radio Std is 802.11j/p(5MHz): 6.25MHz
	MSR: 20MHz
	ON
State Saved	Saved in instrument state.
Min	100 Hz
Max	Hardware Maximum Span
Backwards Compatibility SCPI	[:SENSe] :EBWidth :FREQuency :SPAN
Initial S/W Revision	Prior to A.02.00
Modified at S/W Revision	A.03.00, A.10.00, A.14.00

Last Span

Changes the measurement frequency span to previous measurement span setting. If there is no existing previous span value then the span remains unchanged.

Key Path	Span X Scale
Mode	SA, WCDMA, C2K, WIMAX OFDMA, ISDB-T, CMMB, LTE, LTE-TDD, BLUETOOTH, WLAN, MSR, LTEAFDD, LTEATDD
Remote Command	[:SENSe] :OBWidth :FREQuency :SPAN :PREVIOUS
Example	OBW:FREQ:SPAN:PREV
Notes	You must be in the Spectrum Analysis mode, W-CDMA mode, ISDB-T mode, CMMB mode, LTE mode, LTE TDD mode, BLUETOOTH mode, WLAN mode, cdma2000 mode, MSR, LTE-Advanced FDD/TDD or WIMAX OFDMA mode to use this command. Use:INSTrument:SElect to set the mode.
Couplings	Selecting last span changes the measurement span value.
Initial S/W Revision	Prior to A.02.00
Modified at S/W Revision	A.03.00

Sweep/Control

Displays a menu of functions that enable you to set up and control the sweep time and source for the current measurement.

For details about this key, see ["Sweep/Control" on page 2468](#).

Key Path	Front-panel key
Initial S/W Revision	Prior to A.02.00

Sweep Time

Selects the length of time in which the spectrum analyzer sweeps the displayed frequency span. Additional overhead time, which impacts the sweep rate, is not calculated as part of the sweep time. In fact:

- sweep rate = span/sweep time
- update rate = 1/(sweep time + overhead)
- sweep cycle time = sweep time + overhead

Sweep time is coupled to RBW and VBW, and is impacted by the number of sweep points, so changing those parameters may change the sweep time.

This function is not available when the selected input is I/Q.

Key Path	Sweep/Control
Mode	SA, WCDMA, C2K, WIMAX OFDMA, TD-SCDMA, 1xEVDO, ISDB-T, CMMB, LTE, LTETDD, BLUETOOTH, WLAN, MSR, LTEAFDD, LTEATDD
Remote Command	[:SENSe]:OBWidth:SWEep:TIME <time> [:SENSe]:OBWidth:SWEep:TIME? [:SENSe]:OBWidth:SWEep:TIME:AUTO OFF ON 0 1 [:SENSe]:OBWidth:SWEep:TIME:AUTO?
Example	OBW:SWE:TIME 50 ms OBW:SWE:TIME? OBW:SWE:TIME:AUTO ON OBW:SWE:TIME:AUTO?
Couplings	When you manually change the Time, this state automatically goes to 'Man'.
Preset	SA, WIMAX OFDMA, C2K, TD-SCDMA, 1xEVDO, ISDB-T, CMMB, LTE, LTETDD, BLUETOOTH, WLAN, MSR, LTEAFDD, LTEATDD: Automatically Calculated WCDMA: 32.6 ms SA, WIMAX OFDMA, C2K, TD-SCDMA, 1xEVDO, ISDB-T, CMMB, LTE, LTETDD, WLAN, MSR, LTEAFDD, LTEATDD: ON WCDMA: OFF

State Saved	Saved in instrument state.
Min	1 ms
Max	4000 s
Initial S/W Revision	Prior to A.02.00
Modified at S/W Revision	A.03.00

Sweep Setup

Accesses the sweep setup settings for the current measurement.

Key Path	Sweep/Control
Initial S/W Revision	Prior to A.02.00

Auto Sweep Time Rules

Switches the analyzer between normal and accuracy sweep states.

Setting Auto Sweep Time to Accy results in slower sweep times, usually about three times as long, but better amplitude accuracy for CW signals. The instrument amplitude accuracy specifications only apply when Auto Sweep Time is set to Accy.

Additional amplitude errors which occur when Auto Sweep Time is set to Norm are usually well under 0.1 dB, though this is not guaranteed. Because of the faster sweep times and still low errors, Norm is the preferred setting of Auto Sweep Time. Auto Sweep Time is set to Norm on a Preset or Auto Couple. This means that in the Preset or Auto Coupled state, instrument amplitude accuracy specifications do not apply.

Key Path	Sweep/Control, Sweep Setup
Mode	SA, WCDMA, C2K, WIMAX OFDMA, TD-SCDMA, 1xEVDO, ISDB-T, CMMB, LTE, LTEFDD, LTEATDD, BLUETOOTH, WLAN, MSR, LTEAFDD, LTEATDD
Remote Command	[:SENSe] :OBWidth :SWEep :TIME :AUTO :RULes NORMal ACCuracy [:SENSe] :OBWidth :SWEep :TIME :AUTO :RULes ?
Example	OBW:SWE:TIME:AUTO:RUL NORM OBW:SWE:TIME:AUTO:RUL ?
Notes	Set to Norm when Auto Couple is pressed or sent remotely.
Preset	NORMal
State Saved	Saved in instrument state.
Range	Norm Accy
Initial S/W Revision	Prior to A.02.00
Modified at S/W Revision	A.03.00

Pause

Pauses the measurement after the current data acquisition is complete.

When Paused, the label on the key changes to **Resume**. Pressing **Resume** resumes the measurement at the point where it had been paused.

See "[Pause/Resume](#)" on page 2468 for more information.

Key Path	Sweep/Control
Initial S/W Revision	Prior to A.02.00

Gate

Accesses a menu that enables you to control the gating function. The Gate functionality is used to view signals best viewed by qualifying them with other events.

Gate setup parameters are the same for all measurements – they do not change as you change measurements. Settings like these are called “Meas Global” and are unaffected by Meas Preset.

Note that Sweep Time autocoupling rules and annotation are changed by Gate being on.

Key Path	Sweep/Control
Scope	Meas Global
Readback	The state and method of Gate, as [Off, LO] or [On, Video]. Note that for measurements that only support gated LO, the method is nonetheless read back, but always as LO.
Initial S/W Revision	Prior to A.02.00

Gate On/Off

Turns the gate function on and off.

When the Gate Function is on, the selected Gate Method is used along with the gate settings and the signal at the gate source to control the sweep and video system with the gate signal. Not all measurements allow every type of Gate Methods.

When Gate is on, the annunciation in the measurement bar reflects that it is on and what method is used, as seen in the following "Gate: LO" annunciator graphic.

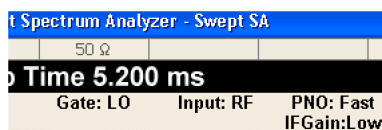

Key Path	Sweep/Control, Gate
Remote Command	[:SENSe] :SWEep:EGATe [:STATe] OFF ON 0 1 [:SENSe] :SWEep:EGATe [:STATe] ?
Example	SWE:EGAT ON SWE:EGAT?
Dependencies	<p>The function is unavailable (grayed out) and Off when:</p> <ul style="list-style-type: none"> • Gate Method is LO or Video and FFT Sweep Type is manually selected. • Gate Method is FFT and Swept Sweep Type is manually selected. • Marker Count is ON. <p>The following are unavailable whenever Gate is on:</p> <ul style="list-style-type: none"> • FFT under Sweep Type when Method=LO or Video or Swept under Sweep Type when Method=FFT • Marker Count <p>While Gate is on, the Auto Rules for Sweep Type are modified so that the choice agrees with the Gate Method: i.e., FFT for Method = FFT and Swept for Method = LO or Video.</p> <p>The Gate softkey and all SCPI under the [:SENSe]:SWEep:EGATe SCPI node are grayed out when Source Mode is Tracking with an external source. This is because the Gate circuitry is used to sync the external source. If the Tracking Source is turned on, the Gate is turned off.</p> <p>When in the ACP measurement:</p> <ul style="list-style-type: none"> • When Meas Method is RBW or FAST, this function is unavailable and the key is grayed out. • Whenever Gate is on, Meas Method, RBW or FAST is unavailable and keys for those are grayed out. • When Gate is on, Offset Res BW and Offset Video BW are ignored (if you set these values) and the measurement works as if all Offset Res BW and all Offset Video BW are coupled with the Res BW and the Video BW under the BW menu. When Gate is on, the Offset BW key in the Offset/Limit menu is grayed out.
Preset	Off LTETDD: On
State Saved	Saved in instrument state
Range	On Off
Backwards Compatibility SCPI	[:SENSe]:SWEep:TIME:GATE[:STATe] ESA compatibility
Backwards Compatibility Notes	In ESA, Trig Delay (On) and Gate (On) could not be active at the same time.. This dependency does not exist in PSA or in the X-Series.
Initial S/W Revision	Prior to A.02.00

Gate View On/Off

Turning on Gate View in the Swept SA measurement provides a single-window gate view display..

Turning on Gate View in other measurements shows the split-screen Gate View. In these measurements, when the Gate View is on, the regular view of the current measurement traces and results are reduced

vertically to about 70% of the regular height. The Zero Span window, showing the positions of the Gate, is shown between the Measurement Bar and the reduced measurement window. By reducing the height of the measurement window, some of the annotation on the Data Display may not fit and is not shown.

Key Path	Sweep/Control, Gate
Remote Command	[:SENSe] :SWEep:EGATe:VIEW ON OFF 1 0 [:SENSe] :SWEep:EGATe:VIEW?
Example	SWE:EGAT:VIEW ON turns on the gate view.
Dependencies	In the Swept SA measurement: In Gate View, the regular Sweep Time key is grayed out . When pressed, the grayed out key puts up the informational message "Use Gate View Sweep Time in the Gate menu." In the other measurements: When you turn Gate View on, the lower window takes on the current state of the instrument. Upon leaving Gate View, the instrument takes on the state of the lower window. When you turn Gate View on, the upper window Sweep Time is set to the gate view sweep time.
Couplings	These couplings apply to the Swept SA measurement: <ul style="list-style-type: none"> • When Gate View is turned on, the instrument is set to Zero Span. • Gate View automatically turns off whenever a Span other than Zero is selected. • Gate View automatically turns off if you press the Last Span key while in Gate View, and the instrument returns to the Span it was in before entering Gate View (even if that is Zero Span). • When Gate View is turned on, the sweep time used is the gate view sweep time. This is set according to the rules in section "Gate View Setup" on page 2231 • When Gate View is turned off, Sweep Time is set to the normal Swept SA measurement sweep time. • If Gate View is on and Gate is off, then turning on Gate turns off Gate View.
Preset	OFF
State Saved	Saved in instrument state
Range	On Off
Initial S/W Revision	Prior to A.02.00

A sample of the Gate View screen in the Swept SA measurement is shown in the following graphic :

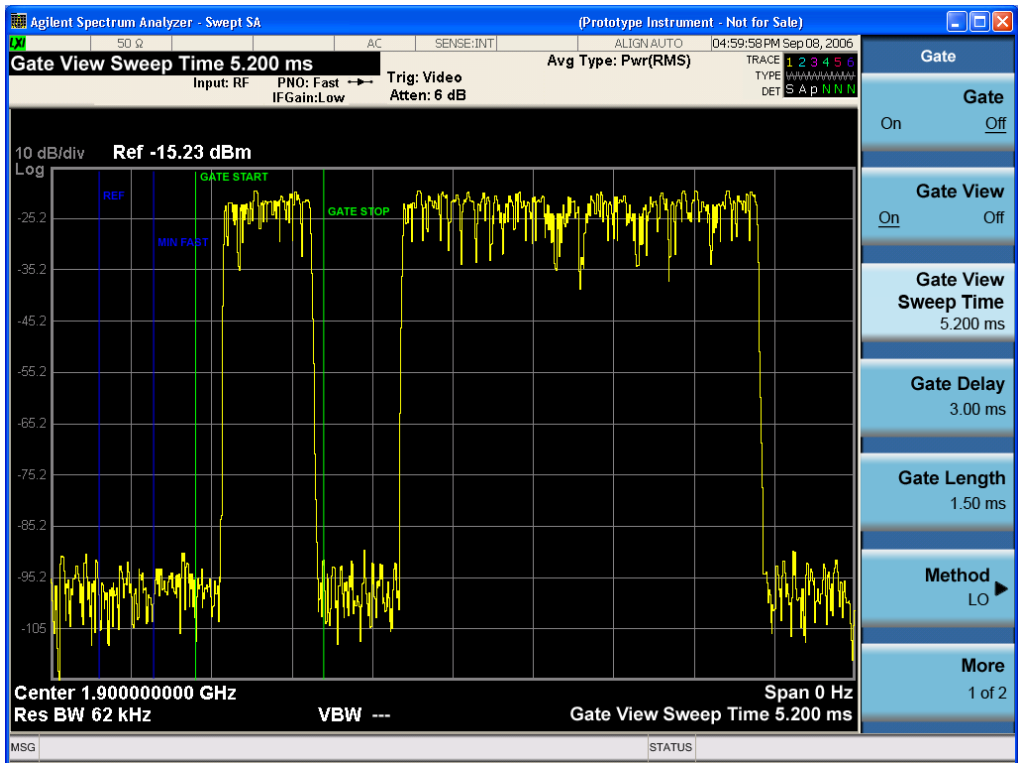

A sample of the Gate View screen in other measurements is shown in the following graphic. This example is for the ACP measurement:

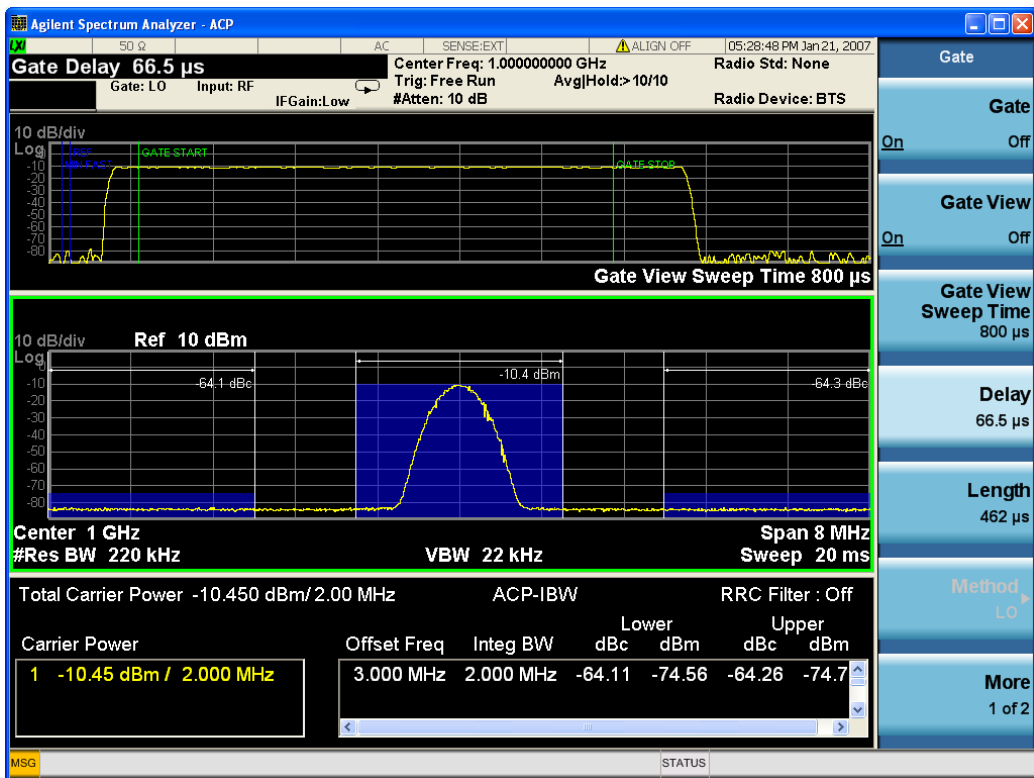

Turning Gate View off returns the analyzer to the Normal measurement view.

In the Swept SA, the normal measurement view is the single-window Swept SA view. When returning to this view, the Swept SA measurement returns to the Span it was in before entering **Gate View** (even if that is Zero Span).

The **Gate View** window is triggered from the Gate Source, with zero trigger delay. Also, when updating the **Gate View** window, the Gate itself must not operate. So it is internally shut off while the gate view window is being updated. For the Swept SA measurement, this means that the Gate is internally shut off whenever the gate view window is displayed. The measurement bar and softkeys continue to show the Trigger source for the main sweep window and give no indication that the Gate is shut off or that the Gate View window is triggered from the Gate Source.

When in **Gate View**, vertical lines are displayed in the Gate View window as follows:

- Green lines are displayed at the gate edges as follows: in Edge Gate, a line is shown for Delay and one for the end of the Gate period, defined by Length. In Level Gate a line is shown only for Delay. You can adjust the position of the green lines by adjusting the gate length and the gate delay. These lines update in the Gate View window as the active function changes, even if the window is not being updated. In Gated LO and Gated Video, these lines are positioned relative to the delay reference line (not relative to 0 time). In Gated FFT, their location is relative to the left edge of the screen.
- A blue line is displayed showing the delay reference, that is, the reference point for the Gate Delay within the Zero Span window. The blue line represents where (in time) the effective location of the gate start would be if the gate were programmed to zero delay.
-
- The second blue line is labeled "MIN FAST" as shown in the figure above because it represents the minimum Gate Delay for fast Gated LO operation. This line is only displayed in Gated LO. You cannot scroll (knob) or decrement (down key) the Gate Delay to less than that represented by the position of this line, it can only be set below this position manually, although once there it can be moved freely with the knob while below the line.
- A yellow line in the Gated Video case only, is displayed at Blength, where Blength is the display point (bucket) length for the swept trace, which is given by the sweep time for that trace divided by number of Points - 1. So it is referenced to 0 time, not to the delay reference. This line is labeled NEXT PT (it is not shown in the figure above because the figure above is for Gated LO).
- The yellow line represents the edge of a display point (bucket). Normally in Gated Video, the bucket length must be selected so that it exceeds the off time of the burst. There is another way to use the analyzer in Gated Video measurements, and that is to set the bucket width much shorter than the off time of the burst. Then use the Max Hold trace function to fill in "missing" buckets more slowly. This allows you to see some of the patterns of the Gated Video results earlier, though seeing a completely filled-in spectrum later.

Gate View Setup

Accesses a menu that enables you to setup parameters relevant to the Gate View

Key Path	Sweep/Control, Gate
Scope	Meas Global
Initial S/W Revision	A.10.00

Gate View Sweep Time

Controls the sweep time in the Gate View window. To provide an optimal view of the gate signal, the analyzer initializes Gate View Sweep Time based on the current settings of Gate Delay and Gate Length.

Key Path	Sweep/Control, Gate, Gate View Setup
Remote Command	[:SENSe] :SWEep:EGATe:TIME <time> [:SENSe] :SWEep:EGATe:TIME?
Example	SWE:EGAT:TIME 500 ms
Dependencies	Gate View Sweep Time is initialized: <ul style="list-style-type: none"> • On Preset (after initializing delay and length). • Every time the Gate Method is set/changed. <p>Additionally, in the Swept SA measurement, whenever you do a Preset, or leave Gate View, the analyzer remembers the Gate Delay and Gate Length settings. Then, when returning to Gate View, if the current Gate Delay and/or Gate Length do not match the remembered values Gate View Sweep Time is re-initialized.</p> <ol style="list-style-type: none"> 1. Compute the location of the "gate stop" line, which you know is at time $t = t_{min} + \text{GateDelay} + \text{GateLength}$.
Preset	519.3 μ s WiMAX OFDMA: 5 ms GSM/EDGE: 1 ms
State Saved	Saved in instrument state
Max	6000 s
Initial S/W Revision	Prior to A.02.00

Gate View Start Time

Controls the time at the left edge of the Gate View.

Key Path	Sweep/Control, Gate, Gate View Setup
Remote Command	[:SENSe] :SWEep:EGATe:VIEW:START <time> [:SENSe] :SWEep:EGATe:VIEW:START?
Example	SWE:EGAT:VIEW:STAR 10ms
Notes	Units of time are required or no units; otherwise an invalid suffix error message will be generated. See error -131.
Preset	0 ms
State Saved	Saved in instrument state
Min	0
Max	500 ms
Initial S/W Revision	A.10.00

Gate Delay

Controls the length of time from the time the gate condition goes True until the gate is turned on.

Key Path	Sweep/Control, Gate
Remote Command	[:SENSe] :SWEep:EGATe:DELay <time> [:SENSe] :SWEep:EGATe:DELay?
Example	SWE:EGAT:DELay 500ms SWE:EGAT:DELay?
Notes	Units of time are required or no units; otherwise an invalid suffix error message will be generated.
Preset	57.7 us WiMAX OFDMA: 71 us GSM/EDGE: 600 us WLAN: 500 us
State Saved	Saved in instrument state
Min	0.0 us
Max	100 s
Backwards Compatibility SCPI	[:SENSe] :SWEep:TIME:GATE:DELay ESA compatibility
Initial S/W Revision	Prior to A.02.00

Gate Length

Controls the length of time that the gate is on after it opens.

Key Path	Sweep/Control, Gate
Remote Command	[:SENSe] :SWEep:EGATe:LENGth <time> [:SENSe] :SWEep:EGATe:LENGth?
Example	SWE:EGAT:LENG 1 SWE:EGAT:LENG?
Notes	Units of time are required or no units; otherwise an invalid suffix error message will be generated.
Dependencies	<p>Grayed out when Gate Method is set to FFT in which case the label changes to that shown below.</p> <div style="border: 1px solid gray; padding: 5px; display: inline-block;"> <p>Gate Length (=1.83/RBW) 2.8 ms</p> </div> <p style="text-align: right; margin-right: 50px;"><small>vsd 39-1</small></p> <p>The key is also grayed out if Gate Control = Level.</p>
Preset	461.6 us

	WiMAX OFDMA: 50 us GSM/EDGE: 200 us WLAN: 1.54 ms
State Saved	Saved in instrument state
Min	100 ns
Max	5 s
Backwards Compatibility SCPI	[:SENSe]:SWEep:TIME:GATE:LENGth ESA compatibility
Initial S/W Revision	Prior to A.02.00

Gate Source

The menus under the **Gate Source** key are the same as those under the **Trigger key**, with the exception that neither **Free Run** nor **Video** are available as Gate Source selections. However, a different SCPI command is used to select the Gate Source (see table below) because you may independently set the Gate Source and the Trigger Source.

Any changes to the settings in the setup menus under each Gate Source selection key (for example: Trigger Level, Trigger Delay, etc.) also affect the corresponding settings under the Trigger menu keys. The SCPI commands used for these are the same for Trigger and Gate, since there is only one setting which affects both Gate and Trigger. Example: to set the Trigger Level for External 1 you use the command :TRIG:EXT1:LEV regardless of whether you are using External 1 as a Trigger Source or a Gate Source.

Key Path	Sweep/Control, Gate
Remote Command	[:SENSe]:SWEep:EGATe:SOURce EXTernal1 EXTernal2 LINE FRAME RFBurst [:SENSe]:SWEep:EGATe:SOURce?
Dependencies	In some models, there is no second External input. In these models, the External 2 key is blanked and the EXTernal2 parameter will generate a “Hardware missing; Not available for this model number” error.
Preset	EXTernal 1 GSM/EDGE, MSR: FRAME LTETDD: EXTernal 1When Direction is Downlink, FRAME when Direction is Uplink.
Backwards Compatibility Notes	In ESA, there is a single Gate input port. In PSA, the Gate Source may be taken from one of two specified input ports. In the X-Series, any Trigger Source can be a Gate Source.
Initial S/W Revision	Prior to A.02.00
Modified at S/W Revision	A.03.00, A.14.00

Line

Pressing this key, when it is not selected, selects the line signal as the trigger. A new sweep/measurement will start synchronized with the next cycle of the line voltage. Pressing this key, when it is already selected, access the line trigger setup menu.

Key Path	Trigger
Example	TRIG:SOUR LINE Swept SA measurement TRIG:<meas>:SOUR LINE Measurements other than Swept SA
Dependencies	Line trigger is not available when operating from a "dc power source", for example, when the instrument is powered from batteries.
State Saved	Saved in instrument state
Status Bits/OPC dependencies	The Status Operation Register bit 5 "Waiting for Trigger" is set at the same time as the Sweeping or Measuring bit is set. It is cleared when the trigger actually occurs (that is, after the trigger event occurs and all the applicable trigger criteria have been met). A corresponding pop-up message ("Waiting for trigger") is generated if no trigger signal appears after approximately 2 sec. This message goes away when a trigger signal appears.
Initial S/W Revision	Prior to A.02.00

Trig Slope

Controls the trigger polarity. It is set positive to trigger on a rising edge and negative to trigger on a falling edge.

Key Path	Trigger, Line
Remote Command	:TRIGger[:SEquence]:LINE:SLOPe POSitive NEGative :TRIGger[:SEquence]:LINE:SLOPe?
Example	TRIG:LINE:SLOP NEG
Preset	POSitive
State Saved	Saved in instrument state
Backwards Compatibility Notes	The legacy :TRIGger[:SEquence]:SLOPe command affects the slopes for the VID, LINE, EXT1, EXT2, and RFB triggers.
Initial S/W Revision	Prior to A.02.00

External 1

Pressing this key, when it is not selected, selects an external input signal as the trigger. A new sweep/measurement will start when the external trigger condition is met using the external 1 input connector on the rear panel.

Pressing this key, when it is already selected, accesses the external 1 trigger setup menu.

Key Path	Trigger
Example	TRIG:SOUR EXT1 Swept SA measurement TRIG:<meas>:SOUR EXT1 Measurements other than Swept SA
Dependencies	Grayed out if in use by Point Trigger in the Source Setup menu. Forced to Free Run if already selected and Point Trigger is set to External 1.
State Saved	Saved in instrument state
Status Bits/OPC dependencies	The Status Operation Register bit 5 "Waiting for Trigger" is set at the same time as the Sweeping or Measuring bit is set. It is cleared when the trigger actually occurs (that is, after the trigger event occurs and all the applicable trigger criteria have been met). A corresponding pop-up message ("Waiting for trigger") is generated if no trigger signal appears after approximately 2 sec. This message goes away when a trigger signal appears.
Initial S/W Revision	Prior to A.02.00

Trigger Level

Sets the value where the external 1 trigger input will trigger a new sweep/measurement.

Key Path	Trigger, External 1
Remote Command	:TRIGger[:SEquence]:EXTernal1:LEVel <level> :TRIGger[:SEquence]:EXTernal1:LEVel?
Example	TRIG:EXT1:LEV 0.4 V
Couplings	This same level is used for the Ext1 trigger source in the Trigger menu, for the Ext1 selection in the Periodic Timer sync source (in the Trigger menu and in the Gate Source menu), and also for the Ext1 selection in the Gate Source menu.
Preset	1.2 V
State Saved	Saved in instrument state
Min	-5 V
Max	5 V
Default Unit	V
Backwards Compatibility SCPI	:TRIGger[:SEquence]:EXTernal:LEVel For backward compatibility, the parameter EXTernal is mapped to EXTernal1
Backwards Compatibility SCPI	:TRIGger[:SEquence]:FRAME:EXTernal1:LEVel
Initial S/W Revision	Prior to A.02.00

Trig Slope

Controls the trigger polarity. It is set positive to trigger on a rising edge and negative to trigger on a falling edge.

Key Path	Trigger, External 1
Remote Command	:TRIGger[:SEquence]:EXTErnal1:SLOPe POSitive NEGative :TRIGger[:SEquence]:EXTErnal1:SLOPe?
Example	TRIG:EXT1:SLOP NEG
Couplings	This same slope is used in the Ext1 selection for the trigger source in the Trigger menu and for the period timer sync source (in the Trigger menu and in the Gate Source menu).
Preset	POSitive
State Saved	Saved in instrument state
Backwards Compatibility SCPI	:TRIGger[:SEquence]:EXTErnal:SLOPe For backward compatibility, the parameter EXTErnal is mapped to EXTErnal1
Backwards Compatibility SCPI	:TRIGger[:SEquence]:FRAME:EXTErnal1:SLOPe
Backwards Compatibility Notes	The legacy :TRIGger[:SEquence]:SLOPe command affects the slopes for the VID, LINE, EXT1, EXT2, and RFB triggers.
Initial S/W Revision	Prior to A.02.00

Zero Span Delay Comp On/Off

In zero span, there is a natural delay in the signal path, which comes from the RBW filter. This is usually desirable, as it allows you to trigger on events and also see those events, because the signal is delayed from the trigger event. However, in some cases it is desirable to eliminate this delay, so that trigger events line up exactly with the zero time point in zero span. You can use the **Zero Span Delay Comp On/Off** feature to enable or disable zero span delay compensation.

Key Path	Trigger, External 1
Remote Command	:TRIGger[:SEquence]:EXTErnal1:DELAy:COMPensation OFF ON 0 1 :TRIGger[:SEquence]:EXTErnal1:DELAy:COMPensation?
Example	TRIG:EXT1:DEL:COMP ON
Dependencies	No effect except in zero-span, but not locked out in nonzero spans. Blanked in modes that do not support zero-span measurements. If the SCPI command is sent when the key is blanked, an error is returned: -221, "Settings conflict; Feature not supported for this measurement" In analyzers shipping N9060A, this feature requires N9060A-7FP.
Preset	OFF
State Saved	Saved in instrument state
Initial S/W Revision	A.11.00

External 2

Pressing this key, when it is not selected, selects an external input signal as the trigger. A new sweep/measurement will start when the external trigger condition is met using the external 2 input

connector. The external trigger 2 input connector is on the rear panel.

Pressing this key, when it is already selected, accesses the external 2 trigger setup menu.

Key Path	Trigger
Example	TRIG:SOUR EXT2 Swept SA measurement TRIG:<meas>:SOUR EXT2 Measurements other than Swept SA
Dependencies	In some models, there is no second External input. In these models, the External 2 key is blanked and the EXTernal2 parameter will generate a "Hardware missing; Not available for this model number" message. Grayed out if in use by Point Trigger in the Source Setup menu. Forced to Free Run if already selected and Point Trigger is set to External 2.
State Saved	Saved in instrument state
Status Bits/OPC dependencies	The Status Operation Register bit 5 "Waiting for Trigger" is set at the same time as the Sweeping or Measuring bit is set. It is cleared when the trigger actually occurs (that is, after the trigger event occurs and all the applicable trigger criteria have been met). A corresponding pop-up message ("Waiting for trigger") is generated if no trigger signal appears after approximately 2 sec. This message goes away when a trigger signal appears.
Initial S/W Revision	Prior to A.02.00
Modified at S/W Revision	A.03.00

Trigger Level

Sets the value where the external 2 trigger input will trigger a new sweep/measurement.

Key Path	Trigger, External 2
Remote Command	:TRIGger[:SEquence]:EXTernal2:LEVel :TRIGger[:SEquence]:EXTernal2:LEVel?
Example	TRIG:EXT2:LEV 1.1 V
Couplings	This same level is used for the Ext2 trigger source in the Trigger menu, for the Ext2 selection in the Periodic Timer sync source (in the Trigger menu and in the Gate Source menu), and also for the Ext2 selection in the Gate Source menu.
Preset	1.2 V
State Saved	Saved in instrument state
Min	-5 V
Max	5 V
Default Unit	V
Backwards Compatibility SCPI	:TRIGger[:SEquence]:FRAMe:EXTernal2:LEVel
Initial S/W Revision	Prior to A.02.00

Trig Slope

Controls the trigger polarity. It is set positive to trigger on a rising edge and negative to trigger on a falling edge.

Key Path	Trigger, External 2
Remote Command	:TRIGger[:SEquence]:EXTernal2:SLOPe POSitive NEGative :TRIGger[:SEquence]:EXTernal2:SLOPe?
Example	TRIG:EXT2:SLOP NEG
Couplings	This same slope is used in the Ext2 selection for the trigger source in the Trigger menu and for the period timer sync source (in the Trigger menu and in the Gate Source menu).
Preset	POSitive
State Saved	Saved in instrument state
Backwards Compatibility SCPI	:TRIGger[:SEquence]:FRAMe:EXTernal2:SLOPe
Backwards Compatibility Notes	The legacy :TRIGger[:SEquence]:SLOPe command affects the slopes for the VID, LINE, EXT1, EXT2, and RFB triggers.
Initial S/W Revision	Prior to A.02.00

Zero Span Delay Comp On/Off

In zero span, there is a natural delay in the signal path, which comes from the RBW filter. This is usually desirable, as it allows you to trigger on events and also see those events, because the signal is delayed from the trigger event. However, in some cases it is desirable to eliminate this delay, so that trigger events line up exactly with the zero time point in zero span. You can use the **Zero Span Delay Comp On/Off** feature to enable or disable zero span delay compensation.

Key Path	Trigger, External 2
Remote Command	:TRIGger[:SEquence]:EXTernal2:DELAy:COMPensation OFF ON 0 1 :TRIGger[:SEquence]:EXTernal2:DELAy:COMPensation?
Example	TRIG:EXT2:DEL:COMP ON
Dependencies	No effect except in zero-span, but not locked out in nonzero spans. Blanked in modes that do not support zero-span measurements. If the SCPI command is sent when the key is blanked, an error is returned: -221, "Settings conflict; Feature not supported for this measurement" In analyzers shipping N9060A, this feature requires N9060A-7FP.
Preset	OFF
State Saved	Saved in instrument state
Initial S/W Revision	A.11.00

RF Burst

Pressing this key, when it is not selected, selects the RF Burst as the trigger. A new sweep/measurement will start when an RF burst envelope signal is identified from the signal at the RF Input connector. Pressing this key, when it is already selected, accesses the RF Burst trigger setup menu.

In some models, a variety of burst trigger circuitry is available, resulting in various available burst trigger bandwidths. The analyzer automatically chooses the appropriate trigger path based on the hardware configuration and other settings of the analyzer.

Key Path	Trigger
Example	TRIG:SOUR RFB Swept SA measurement TRIG:<meas>:SOUR RFB Measurements other than Swept SA
State Saved	Saved in instrument state
Status Bits/OPC dependencies	The Status Operation Register bit 5 "Waiting for Trigger" is set at the same time as the Sweeping or Measuring bit is set. It is cleared when the trigger actually occurs (that is, after the trigger event occurs and all the applicable trigger criteria have been met). A corresponding pop-up message ("Waiting for trigger") is generated if no trigger signal appears after approximately 2 sec. This message goes away when a trigger signal appears.
Backwards Compatibility Notes	The legacy command: :TRIGger[:SEquence]:RFBurst:FSElectivity[:STATe] OFF ON 0 1 is not supported in the X-Series, as the hardware to do Frequency Selective burst triggers does not exist in X-Series.
Initial S/W Revision	Prior to A.02.00
Modified at S/W Revision	A.04.00

Absolute Trigger Level

Sets the absolute trigger level for the RF burst envelope.

When using the External Mixing path, the Absolute Trigger Level is uncalibrated because the factory default was set to accommodate the expected IF levels for the RF path.

Key Path	Trigger, RF Burst
Scope	Meas Global
Remote Command	:TRIGger[:SEquence]:RFBurst:LEVel:ABSolute <amp1> :TRIGger[:SEquence]:RFBurst:LEVel:ABSolute?
Example	TRIG:RFB:LEV:ABS 10 dBm sets the trigger level of the RF burst envelope signal to the absolute level of 10 dBm
Notes	Sending this command does not switch the setting from relative to absolute; to switch it you need to send the :TRIGger[:SEquence]:RFBurst:LEVel:TYPE command, below. Amplitude Corrections are not taken into account by the Absolute Trigger Level. For example, if you have given yourself effective gain with an amplitude correction factor, the Absolute Trigger will not fire until you have set the trigger level that far below the displayed signal level, rather than simply to

	the displayed signal level. This is only true for Amplitude Corrections, not External Gain or Ref Level Offset functions. If mode is Bluetooth, the default value is -50 dBm.
Couplings	This same level is used for the RF Burst trigger source in the Trigger menu, for the RF Burst selection in the Periodic Timer sync source (in the Trigger menu and in the Gate Source menu), and also for the RF Burst selection in the Gate Source menu
Preset	-20 dBm
State Saved	Saved in instrument state
Min	-200 dBm
Max	100 dBm
Default Unit	depends on the current selected Y-Axis unit
Backwards Compatibility SCPI	:TRIGger[:SEquence]:FRAME:RFBurst:LEVel:ABSolute
Initial S/W Revision	Prior to A.02.00
Modified at S/W Revision	A.04.00

Key Path	Trigger, RF Burst
Remote Command	:TRIGger[:SEquence]:RFBurst:LEVel:TYPE ABSolute RELative :TRIGger[:SEquence]:RFBurst:LEVel:TYPE?
Example	TRIG:RFB:LEV:TYPE REL sets the trigger level type of the RF burst trigger to Relative.
Preset	ABSolute
State Saved	Saved in instrument state
Initial S/W Revision	Prior to A.02.00
Modified at S/W Revision	A.04.00

Relative Trigger Level

Sets the relative trigger level for the RF burst envelope.

In some models, the relative burst trigger function is implemented in hardware. In other models, without the advanced triggering hardware required, the relative burst trigger function is implemented in software in some measurements, and is unavailable in other measurements.

When implemented in software, the relative RF Burst trigger function is implemented as follows:

1. The measurement starts with the absolute RF Burst trigger setting. If it cannot get a trigger with that level, auto trigger fires and the acquisition starts anyway. After the acquisition, the measurement searches for the peak in the acquired waveform and saves it.

2. Now, in the next cycle of the measurement, the measurement determines a new absolute RF Burst level based on the peak value from the first measurement and the Relative RF Burst Trigger Level (always 0 or negative dB) set by the user. The following formula is used:
 3. absolute RF Burst level = peak level of the previous acquisition + relative RF Burst level
 4. If the new absolute RF Burst level differs from the previous by more than 0.5 dB, the new level is sent to the hardware; otherwise it is not updated (to avoid slowing down the acquisition)
- Steps 2 and 3 repeat for subsequent measurements.

Key Path	Trigger, RF Burst
Scope	Meas Global
Remote Command	:TRIGger[:SEQuence]:RFBurst:LEVel:RELative <rel_ampl> :TRIGger[:SEQuence]:RFBurst:LEVel:RELative?
Example	TRIG:RFB:LEV:REL -10 dB sets the trigger level of the RF burst envelope signal to the relative level of -10 dB
Notes	Sending this command does not switch the setting from absolute to relative; to switch it you need to send the :TRIGger[:SEQuence]:RFBurst:LEVel:TYPE command, above. The relative trigger level is not available in some measurements. In those measurements the RELative parameter, and the :TRIGger[:SEQuence]:RFBurst:LEVel:TYPE command (above), will generate an error if sent.
Dependencies	This key is grayed out and Absolute Trigger Level selected if the required hardware is not present in your analyzer and the current measurement does not support Relative triggering.
Preset	-6 dB GSM: -25 dB
State Saved	Saved in instrument state
Min	-45 dB
Max	0 dB
Default Unit	dB or dBc
Backwards Compatibility SCPI	:TRIGger[:SEQuence]:RFBurst:LEVel This legacy command is aliased to :TRIGger[:SEQuence]:RFBurst:LEVel:RELative because the PSA had ONLY relative burst triggering
Initial S/W Revision	Prior to A.02.00
Modified at S/W Revision	A.04.00

Trigger Slope

It is set positive to trigger on a rising edge and negative to trigger on a falling edge.

Key Path	Trigger, RF Burst
Remote Command	:TRIGger[:SEQuence]:RFBurst:SLOPe Positive NEGative :TRIGger[:SEQuence]:RFBurst:SLOPe?

Example	TRIG:RFB:SLOP NEG
Couplings	This same slope is used in the RF Burst selection for the trigger source in the Trigger menu and for the period timer sync source (in the Trigger menu and in the Gate Source menu).
Preset	POSitive
State Saved	Saved in instrument state
Backwards Compatibility SCPI	:TRIGger[:SEQuence]:FRAMe:RFBurst:SLOPe
Backwards Compatibility Notes	The legacy :TRIGger[:SEQuence]:SLOPe command affects the slopes for the VID, LINE, EXT1, EXT2, and RFB triggers.
Initial S/W Revision	Prior to A.02.00

Periodic Timer (Frame Trigger)

Pressing this key, when it is not selected, selects the internal periodic timer signal as the trigger. Triggering occurrences are set by the **Period** parameter, which is modified by the **Sync Source** and **Offset**. Pressing this key, when it is already selected, accesses the periodic timer trigger setup functions.

If you do not have a sync source selected (it is Off), then the internal timer will not be synchronized with any external timing events.

Key Path	Trigger
Example	TRIG:SOUR FRAM Swept SA measurement TRIG:<meas>:SOUR FRAM Measurements other than Swept SA
State Saved	Saved in instrument state
Readback	[Sync: <value of Sync Source>], for example, [Sync: External 1]
Status Bits/OPC dependencies	The Status Operation Register bit 5 "Waiting for Trigger" is set at the same time as the Sweeping or Measuring bit is set. It is cleared when the trigger actually occurs (that is, after the trigger event occurs and all the applicable trigger criteria have been met). A corresponding pop-up message ("Waiting for trigger") is generated if no trigger signal appears after approximately 2 sec. This message goes away when a trigger signal appears.
Initial S/W Revision	Prior to A.02.00

Periodic Timer Triggering:

This feature selects the internal periodic timer signal as the trigger. Trigger occurrences are set by the **Periodic Timer** parameter, which is modified by the **Sync Source** and **Offset**.

The figure below shows the action of the periodic timer trigger. Before reviewing the figure, we'll explain some uses for the periodic trigger.

A common application is measuring periodic burst RF signals for which a trigger signal is not easily available. For example, we might be measuring a TDMA radio which bursts every 20 ms. Let's assume that the 20 ms period is very consistent. Let's also assume that we do not have an external trigger source

available that is synchronized with the period, and that the signal-to-noise ratio of the signal is not high enough to provide a clean RF burst trigger at all of the analysis frequencies. For example, we might want to measure spurious transmissions at an offset from the carrier that is larger than the bandwidth of the RF burst trigger. In this application, we can set the Periodic Timer to a 20.00 ms period and adjust the offset from that timer to position our trigger just where we want it. If we find that the 20.00 ms is not exactly right, we can adjust the period slightly to minimize the drift between the period timer and the signal to be measured.

A second way to use this feature would be to use **Sync Source** temporarily, instead of **Offset**. In this case, we might tune to the signal in a narrow span and use the RF Burst trigger to synchronize the periodic timer. Then we would turn the sync source off so that it would not miss-trigger. Miss-triggering can occur when we are tuned so far away from the RF burst trigger that it is no longer reliable.

A third example would be to synchronize to a signal that has a reference time element of much longer period than the period of interest. In some CDMA applications, it is useful to look at signals with a short periodicity, by synchronizing that periodicity to the "even-second clock" edge that happens every two seconds. Thus, we could connect the even-second clock trigger to Ext1 and use then Ext1 as the sync source for the periodic timer.

The figure below illustrates this third example. The top trace represents the even-second clock. It causes the periodic timer to synchronize with the leading edge shown. The analyzer trigger occurs at a time delayed by the accumulated offset from the period trigger event. The periodic timer continues to run, and triggers continue to occur, with a periodicity determined by the analyzer time base. The timer output (labeled "late event") will drift away from its ideal time due to imperfect matching between the time base of the signal being measured and the time base of the analyzer, and also because of imperfect setting of the period parameter. But the synchronization is restored on the next even-second clock event. ("Accumulated offset" is described in the in the **Offset** function section.)

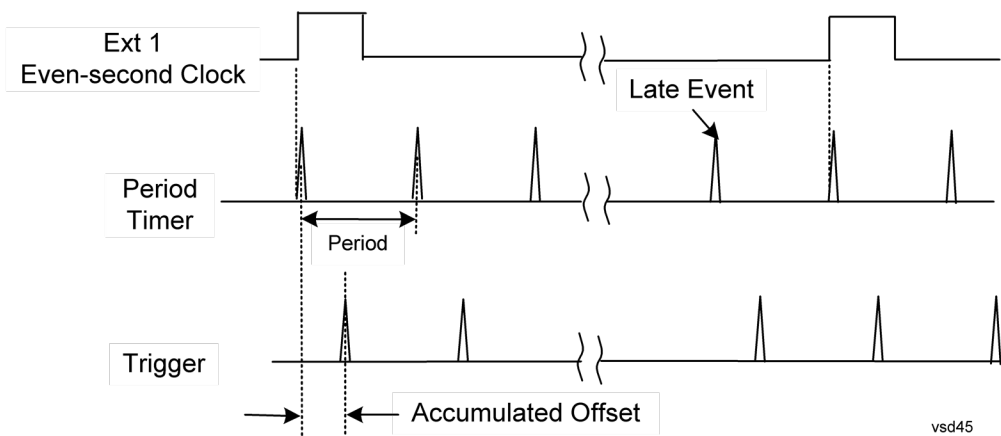

Period

Sets the period of the internal periodic timer clock. For digital communications signals, this is usually set to the frame period of your current input signal. In the case that sync source is not set to OFF, and the external sync source rate is changed for some reason, the periodic timer is synchronized at the every external synchronization pulse by resetting the internal state of the timer circuit.

Key Path	Trigger, Periodic Timer
Remote Command	:TRIGGER[:SEQUENCE]:FRAME:PERIOD <time>

	:TRIGger[:SEquence]:FRAMe:PERiod?
Example	TRIG:FRAM:PER 100 ms
Dependencies	The invalid data indicator turns on when the period is changed, until the next sweep/measurement completes.
Couplings	The same period is used in the Gate Source selection of the period timer.
Preset	20 ms GSM: 4.615383
State Saved	Saved in instrument state
Min	100.000 ns
Max	559.0000 ms
Default Unit	S
Initial S/W Revision	Prior to A.02.00

Offset

Adjusts the accumulated offset between the periodic timer events and the trigger event. Adjusting the accumulated offset is different than setting an offset, and requires explanation.

The periodic timer is usually not synchronized with any external events, so the timing of its output events has no absolute meaning. Since the timing relative to external events (RF signals) is important, you need to be able to adjust (offset) it. However, you have no direct way to see when the periodic timer events occur. All that you can see is the trigger timing. When you want to adjust the trigger timing, you will be changing the internal offset between the periodic timer events and the trigger event. Because the absolute value of that internal offset is unknown, we will just call that the accumulated offset. Whenever the Offset parameter is changed, you are changing that accumulated offset. You can reset the displayed offset using Reset Offset Display. Changing the display does not change the value of the accumulated offset, and you can still make additional changes to accumulated offset.

To avoid ambiguity, we define that an increase in the "offset" parameter, either from the knob or the SCPI adjust command, serves to delay the timing of the trigger event.

Key Path	Trigger, Periodic Timer
Remote Command	:TRIGger[:SEquence]:FRAMe:OFFSet <time> :TRIGger[:SEquence]:FRAMe:OFFSet?
Example	TRIG:FRAM:OFFS 1.2 ms
Notes	The front panel interface (for example, the knob), and this command, adjust the accumulated offset, which is shown on the active function display. However, the actual amount sent to the hardware each time the offset is updated is the delta value, that is, the current accumulated offset value minus the previous accumulated offset value. Note that the accumulated offset value is essentially arbitrary; it represents the accumulated offset from the last time the offset was zeroed (with the Reset Offset Display key). Note that this command does not change the period of the trigger waveform. Note also that Offset is used only when the sync source is set to OFF, otherwise delay is used, see section " Trig Delay " on page 476 .

	An increase in the "offset" parameter, either from the knob or the SCPI adjust command, serves to delay the timing of the trigger event.
Notes	When the SCPI command is sent the value shown on the key (and the Active Function, if this happens to be the active function) is updated with the new value. However, the actual amount sent to the hardware is the delta value, that is, the current accumulated offset value minus the previous accumulated offset value. The SCPI query simply returns the value currently showing on the key.
Dependencies	The invalid data indicator turns on when the offset is changed, until the next sweep/measurement completes.
Couplings	The same offset is used in the Gate Source selection of the period timer.
Preset	0 s
State Saved	Saved in instrument state
Min	-10.000 s
Max	10.000 s
Default Unit	S
Initial S/W Revision	Prior to A.02.00

Offset Adjust (Remote Command Only)

This remote command does not work at all like the related front panel keys. This command lets you advance the phase of the frame trigger by the amount you specify.

It does not change the period of the trigger waveform. If the command is sent multiple times, it advances the phase of the frame trigger an additional amount each time it is sent. Negative numbers are permitted.

Remote Command	:TRIGger[:SEquence]:FRAMe:ADJust <time>
Example	TRIG:FRAM:ADJ 1.2 ms
Notes	Note also that Offset is used only when the sync source is set to OFF, otherwise delay is used, see section " Trig Delay " on page 476 An increase in the "offset" parameter, either from the knob or the SCPI adjust command, serves to delay the timing of the trigger event.
Notes	The front panel interface (for example, the knob) and the :TRIG:FRAM:OFFS command adjust the accumulated offset, which is shown on the active function display. However, the actual amount sent to the hardware is the delta value, that is, the current offset value minus the previous offset value. When the SCPI command is sent the value shown on the key (and the Active Function, if this happens to be the active function) is updated by increasing it (or decreasing it if the value sent is negative) by the amount specified in the SCPI command. This is a "command only" SCPI command, with no query.
Dependencies	The invalid data indicator turns on when the offset is changed, until the next sweep/measurement completes.
Couplings	The same offset is used in the Gate Source selection of the period timer.
Preset	0 s

State Saved	Saved in instrument state
Min	-10.000 s
Max	10.000 s
Default Unit	S
Initial S/W Revision	Prior to A.02.00

Reset Offset Display

Resets the value of the periodic trigger offset display setting to 0.0 seconds. The current displayed trigger location may include an offset value defined with the **Offset** key. Pressing this key redefines the currently displayed trigger location as the new trigger point that is 0.0 s offset. The **Offset** key can then be used to add offset relative to this new timing.

Key Path	Trigger, Periodic Timer
Remote Command	:TRIGger[:SEquence]:FRAMe:OFFSet:DISPlay:RESet
Example	TRIG:FRAM:OFFS:DISP:RES
Initial S/W Revision	Prior to A.02.00

Sync Source

Selects a signal source for you to synchronize your periodic timer trigger to, otherwise you are triggering at some arbitrary location in the frame. Synchronization reduces the precision requirements on the setting of the period.

For convenience you may adjust the level and slope of the selected sync source in a conditional branch setup menu accessed from the Sync Source menu. Note that these settings match those in the **Trigger** and **Gate Source** menus; that is, each trigger source has only one value of level and slope, regardless of which menu it is accessed from.

Key Path	Trigger, Periodic Timer
Remote Command	:TRIGger[:SEquence]:FRAMe:SYNC EXTernal1 EXTernal2 RFBurst OFF :TRIGger[:SEquence]:FRAMe:SYNC?
Example	TRIG:FRAM:SYNC EXT2
Dependencies	In some models, there is no second External input. In these models, the External 2 key is blanked and the EXTernal2 parameter will generate a "Hardware missing; Not available for this model number" message.
Preset	Off GSM/EDGE, MSR,LTE,LTETDD: RFBurst
State Saved	Saved in instrument state
Readback	The current setting is read back to this key and it is also Readback to the previous Periodic Timer trigger key.

Backwards Compatibility SCPI	:TRIGger[:SEquence]:FRAMe:SYNC EXTernal
Initial S/W Revision	Prior to A.02.00
Modified at S/W Revision	A.03.00, A.14.00

Off

Turns off the sync source for your periodic trigger. With the sync source off, the timing will drift unless the signal source frequency is locked to the analyzer frequency reference.

Key Path	Trigger, Periodic Timer, Sync Source
Example	TRIG:FRAM:SYNC OFF
Readback	Off
Initial S/W Revision	Prior to A.02.00

External 1

Pressing this key, when it is not selected, selects an external input signal as the trigger. A new sweep/measurement will start when the external trigger condition is met using the external 1 input connector on the rear panel.

Pressing this key, when it is already selected, accesses the external 1 trigger setup menu.

Key Path	Trigger
Example	TRIG:SOUR EXT1 Swept SA measurement TRIG:<meas>:SOUR EXT1 Measurements other than Swept SA
Dependencies	Grayed out if in use by Point Trigger in the Source Setup menu. Forced to Free Run if already selected and Point Trigger is set to External 1.
State Saved	Saved in instrument state
Status Bits/OPC dependencies	The Status Operation Register bit 5 "Waiting for Trigger" is set at the same time as the Sweeping or Measuring bit is set. It is cleared when the trigger actually occurs (that is, after the trigger event occurs and all the applicable trigger criteria have been met). A corresponding pop-up message ("Waiting for trigger") is generated if no trigger signal appears after approximately 2 sec. This message goes away when a trigger signal appears.
Initial S/W Revision	Prior to A.02.00

Trigger Level

Sets the value where the external 1 trigger input will trigger a new sweep/measurement.

Key Path	Trigger, External 1
Remote Command	:TRIGger[:SEquence]:EXTErnal1:LEVel <level> :TRIGger[:SEquence]:EXTErnal1:LEVel?
Example	TRIG:EXT1:LEV 0.4 V
Couplings	This same level is used for the Ext1 trigger source in the Trigger menu, for the Ext1 selection in the Periodic Timer sync source (in the Trigger menu and in the Gate Source menu), and also for the Ext1 selection in the Gate Source menu.
Preset	1.2 V
State Saved	Saved in instrument state
Min	-5 V
Max	5 V
Default Unit	V
Backwards Compatibility SCPI	:TRIGger[:SEquence]:EXTErnal:LEVel For backward compatibility, the parameter EXTErnal is mapped to EXTErnal1
Backwards Compatibility SCPI	:TRIGger[:SEquence]:FRAME:EXTErnal1:LEVel
Initial S/W Revision	Prior to A.02.00

Trig Slope

Controls the trigger polarity. It is set positive to trigger on a rising edge and negative to trigger on a falling edge.

Key Path	Trigger, External 1
Remote Command	:TRIGger[:SEquence]:EXTErnal1:SLOPe POSitive NEGative :TRIGger[:SEquence]:EXTErnal1:SLOPe?
Example	TRIG:EXT1:SLOP NEG
Couplings	This same slope is used in the Ext1 selection for the trigger source in the Trigger menu and for the period timer sync source (in the Trigger menu and in the Gate Source menu).
Preset	POSitive
State Saved	Saved in instrument state
Backwards Compatibility SCPI	:TRIGger[:SEquence]:EXTErnal:SLOPe For backward compatibility, the parameter EXTErnal is mapped to EXTErnal1
Backwards Compatibility SCPI	:TRIGger[:SEquence]:FRAME:EXTErnal1:SLOPe
Backwards Compatibility Notes	The legacy :TRIGger[:SEquence]:SLOPe command affects the slopes for the VID, LINE, EXT1, EXT2, and RFB triggers.
Initial S/W Revision	Prior to A.02.00

External 2

Pressing this key, when it is not selected, selects an external input signal as the trigger. A new sweep/measurement will start when the external trigger condition is met using the external 2 input connector. The external trigger 2 input connector is on the rear panel.

Pressing this key, when it is already selected, accesses the external 2 trigger setup menu.

Key Path	Trigger
Example	TRIG:SOUR EXT2 Swept SA measurement TRIG:<meas>:SOUR EXT2 Measurements other than Swept SA
Dependencies	In some models, there is no second External input. In these models, the External 2 key is blanked and the EXTernal2 parameter will generate a "Hardware missing; Not available for this model number" message. Grayed out if in use by Point Trigger in the Source Setup menu. Forced to Free Run if already selected and Point Trigger is set to External 2.
State Saved	Saved in instrument state
Status Bits/OPC dependencies	The Status Operation Register bit 5 "Waiting for Trigger" is set at the same time as the Sweeping or Measuring bit is set. It is cleared when the trigger actually occurs (that is, after the trigger event occurs and all the applicable trigger criteria have been met). A corresponding pop-up message ("Waiting for trigger") is generated if no trigger signal appears after approximately 2 sec. This message goes away when a trigger signal appears.
Initial S/W Revision	Prior to A.02.00
Modified at S/W Revision	A.03.00

Trigger Level

Sets the value where the external 2 trigger input will trigger a new sweep/measurement.

Key Path	Trigger, External 2
Remote Command	:TRIGger[:SEquence]:EXTernal2:LEVel :TRIGger[:SEquence]:EXTernal2:LEVel?
Example	TRIG:EXT2:LEV 1.1 V
Couplings	This same level is used for the Ext2 trigger source in the Trigger menu, for the Ext2 selection in the Periodic Timer sync source (in the Trigger menu and in the Gate Source menu), and also for the Ext2 selection in the Gate Source menu.
Preset	1.2 V
State Saved	Saved in instrument state
Min	-5 V
Max	5 V
Default Unit	V
Backwards Compatibility SCPI	:TRIGger[:SEquence]:FRAMe:EXTernal2:LEVel

Initial S/W Revision	Prior to A.02.00
----------------------	------------------

Trig Slope

Controls the trigger polarity. It is set positive to trigger on a rising edge and negative to trigger on a falling edge.

Key Path	Trigger, External 2
Remote Command	:TRIGger[:SEQuence]:EXTernal2:SLOPe POSitive NEGative :TRIGger[:SEQuence]:EXTernal2:SLOPe?
Example	TRIG:EXT2:SLOP NEG
Couplings	This same slope is used in the Ext2 selection for the trigger source in the Trigger menu and for the period timer sync source (in the Trigger menu and in the Gate Source menu).
Preset	POSitive
State Saved	Saved in instrument state
Backwards Compatibility SCPI	:TRIGger[:SEQuence]:FRAMe:EXTernal2:SLOPe
Backwards Compatibility Notes	The legacy :TRIGger[:SEQuence]:SLOPe command affects the slopes for the VID, LINE, EXT1, EXT2, and RFB triggers.
Initial S/W Revision	Prior to A.02.00

RF Burst

Pressing this key, when it is not selected, selects the RF Burst as the trigger. A new sweep/measurement will start when an RF burst envelope signal is identified from the signal at the RF Input connector. Pressing this key, when it is already selected, accesses the RF Burst trigger setup menu.

In some models, a variety of burst trigger circuitry is available, resulting in various available burst trigger bandwidths. The analyzer automatically chooses the appropriate trigger path based on the hardware configuration and other settings of the analyzer.

Key Path	Trigger
Example	TRIG:SOUR RFB Swept SA measurement TRIG:< meas>:SOUR RFB Measurements other than Swept SA
State Saved	Saved in instrument state
Status Bits/OPC dependencies	The Status Operation Register bit 5 "Waiting for Trigger" is set at the same time as the Sweeping or Measuring bit is set. It is cleared when the trigger actually occurs (that is, after the trigger event occurs and all the applicable trigger criteria have been met). A corresponding pop-up message ("Waiting for trigger") is generated if no trigger signal appears after approximately 2 sec. This message goes away when a trigger signal appears.
Backwards Compatibility Notes	The legacy command:

	:TRIGger[:SEquence]:RFBurst:FSElectivity[:STATE] OFF ON 0 1 is not supported in the X-Series, as the hardware to do Frequency Selective burst triggers does not exist in X-Series.
Initial S/W Revision	Prior to A.02.00
Modified at S/W Revision	A.04.00

Absolute Trigger Level

Sets the absolute trigger level for the RF burst envelope.

When using the External Mixing path, the Absolute Trigger Level is uncalibrated because the factory default was set to accommodate the expected IF levels for the RF path.

Key Path	Trigger, RF Burst
Scope	Meas Global
Remote Command	:TRIGger[:SEquence]:RFBurst:LEVel:ABSolute <ampl> :TRIGger[:SEquence]:RFBurst:LEVel:ABSolute?
Example	TRIG:RFB:LEV:ABS 10 dBm sets the trigger level of the RF burst envelope signal to the absolute level of 10 dBm
Notes	Sending this command does not switch the setting from relative to absolute; to switch it you need to send the :TRIGger[:SEquence]:RFBurst:LEVel:TYPE command, below. Amplitude Corrections are not taken into account by the Absolute Trigger Level. For example, if you have given yourself effective gain with an amplitude correction factor, the Absolute Trigger will not fire until you have set the trigger level that far below the displayed signal level, rather than simply to the displayed signal level. This is only true for Amplitude Corrections, not External Gain or Ref Level Offset functions. If mode is Bluetooth, the default value is -50 dBm.
Couplings	This same level is used for the RF Burst trigger source in the Trigger menu, for the RF Burst selection in the Periodic Timer sync source (in the Trigger menu and in the Gate Source menu), and also for the RF Burst selection in the Gate Source menu
Preset	-20 dBm
State Saved	Saved in instrument state
Min	-200 dBm
Max	100 dBm
Default Unit	depends on the current selected Y-Axis unit
Backwards Compatibility SCPI	:TRIGger[:SEquence]:FRAME:RFBurst:LEVel:ABSolute
Initial S/W Revision	Prior to A.02.00
Modified at S/W Revision	A.04.00

Key Path	Trigger, RF Burst
Remote Command	:TRIGger[:SEquence]:RFBurst:LEVel:TYPE ABSolute RELative :TRIGger[:SEquence]:RFBurst:LEVel:TYPE?
Example	TRIG:RFB:LEV:TYPE REL sets the trigger level type of the RF burst trigger to Relative.
Preset	ABSolute
State Saved	Saved in instrument state
Initial S/W Revision	Prior to A.02.00
Modified at S/W Revision	A.04.00

Trigger Slope

It is set positive to trigger on a rising edge and negative to trigger on a falling edge.

Key Path	Trigger, RF Burst
Remote Command	:TRIGger[:SEquence]:RFBurst:SLOPe POSitive NEGative :TRIGger[:SEquence]:RFBurst:SLOPe?
Example	TRIG:RFB:SLOP NEG
Couplings	This same slope is used in the RF Burst selection for the trigger source in the Trigger menu and for the period timer sync source (in the Trigger menu and in the Gate Source menu).
Preset	POSitive
State Saved	Saved in instrument state
Backwards Compatibility SCPI	:TRIGger[:SEquence]:FRAME:RFBurst:SLOPe
Backwards Compatibility Notes	The legacy :TRIGger[:SEquence]:SLOPe command affects the slopes for the VID, LINE, EXT1, EXT2, and RFB triggers.
Initial S/W Revision	Prior to A.02.00

Sync Holdoff

Sync Holdoff specifies the duration that the sync source signal must be kept false before the transition to true to be recognized as the sync timing. The periodic timer phase is aligned when the sync source signal becomes true, after the Holdoff time is satisfied.

A holdoff of 2 ms will work with most WiMAX signals, but there may be cases where the burst off duration is less than 1 ms and this value will need to be changed.

Key Path	Trigger, Periodic Timer
Remote Command	:TRIGger[:SEquence]:FRAME:SYNC:HOLDoff <time> :TRIGger[:SEquence]:FRAME:SYNC:HOLDoff? :TRIGger[:SEquence]:FRAME:SYNC:HOLDoff:STATE OFF ON 0 1

	:TRIGger[:SEquence]:FRAMe:SYNC:HOLDoff:STATe?
Preset	On, 1.000 ms
State Saved	Saved in instrument state
Min	0 ms
Max	+500 ms
Default Unit	s
Initial S/W Revision	Prior to A.02.00

Aux IO Control (Remote Command Only)

Sets/Queries the value for all 8 data lines.

Key Path	SCPI only
Remote Command	OUTPut:AUX:IO <Value> OUTPut:AUX:IO?
Example	OUTPut:AUX:IO 31
Couplings	State of data 0 to data 7 under the AUX I/O Control panel (Input/Output menu) will change accordingly base on the AUX IO's value that key in.
Preset	31
Min	0
Max	255
Backwards Compatibility SCPI	OUTPut:UPORt <Value>
Initial S/W Revision	A.16.00

Control Edge/Level

Sets the method of controlling the gating function from the gating signal.

Edge

In Edge triggering, the gate opens (after the Delay) on the selected edge (for example, positive) of the gate signal and closes on the alternate edge (for example, negative).

Level

In Level triggering, the gate opens (after the Delay) when the gate signal has achieved a certain level and stays open as long as that level is maintained.

Key Path	Sweep/Control, Gate
Remote Command	[:SENSe]:SWEep:EGATe:CONTRol EDGE LEVEl [:SENSe]:SWEep:EGATe:CONTRol?
Example	SWE:EGAT:CONT EDGE
Dependencies	If the Gate Method is FFT the Control key is grayed out and Edge is selected.

	If the Gate Source is TV, Frame or Line, the Control key is grayed out and Edge is selected.
Preset	EDGE
State Saved	Saved in instrument state
Backwards Compatibility SCPI	<code>[:SENSe]:SWEep:TIME:GATE:TYPE</code> ESA Compatibility
Initial S/W Revision	Prior to A.02.00

Gate Holdoff

Lets you increase or decrease the wait time after a gate event ends before the analyzer will respond to the next gate signal.

After any Gate event finishes, the analyzer must wait for the sweep system to settle before it can respond to another Gate signal. The analyzer calculates a "wait time," taking into account a number of factors, including RBW and Phase Noise Optimization settings. The goal is to achieve the same accuracy when gated as in ungated operation. The figure below illustrates this concept:

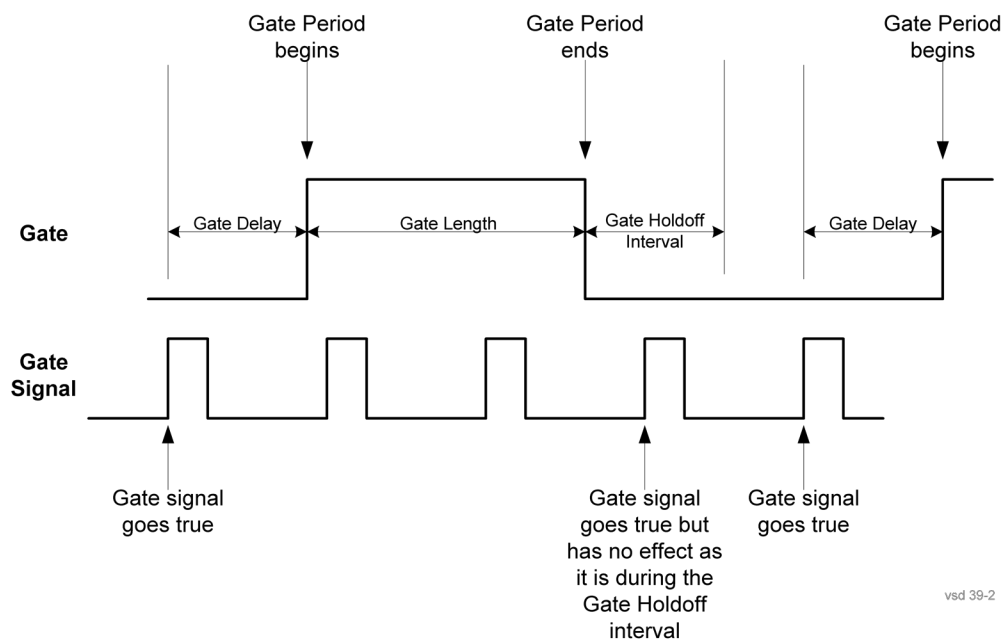

When Gate Holdoff is in Auto, the wait time calculated by the analyzer is used. When Gate Time is in Manual, the user may adjust the wait time, usually decreasing it in order to achieve greater speed, but at the risk of decreasing accuracy.

When the **Method** key is set to **Video** or **FFT**, the **Gate Holdoff** function has no effect.

In measurements that do not support Auto, the value shown when Auto is selected is "---" and the manually set holdoff is returned to a query.

Key Path	Sweep/Control, Gate
----------	----------------------------

Remote Command	<pre>[:SENSe] :SWEep:EGATe:HOLDoff <time> [:SENSe] :SWEep:EGATe:HOLDoff? [:SENSe] :SWEep:EGATe:HOLDoff:AUTO OFF ON 0 1 [:SENSe] :SWEep:EGATe:HOLDoff:AUTO?</pre>
Example	<pre>SWE:EGAT:HOLD 0.0002 SWE:EGAT:HOLD? SWE:EGAT:HOLD:AUTO ON SWE:EGAT:HOLD:AUTO?</pre>
Couplings	<p>When Gate Holdoff is Auto, the Gate Holdoff key shows the value calculated by the analyzer for the wait time.</p> <p>Pressing the Gate Holdoff key while it is in Auto and not selected, causes the key to become selected and allows the user to adjust the value. If the value is adjusted, the setting changes to Man.</p> <p>Pressing the Gate Holdoff key, while it is in Auto and selected, does not change the value of Gate Holdoff, but causes the setting to change to Man. Now the user can adjust the value.</p> <p>Pressing the key while it is in Man and selected, cause the value to change back to Auto.</p> <p>Pressing the key while it is in Man and not selected, causes the key to become selected and allows the user to adjust the value.</p> <p>When Method is set to Video or FFT, the Gate Holdoff function has no effect.</p>
Preset	<p>Auto</p> <p>Auto/On</p>
State Saved	Saved in instrument state
Min	1 μsec
Max	1 sec
Initial S/W Revision	Prior to A.02.00

Gate Delay Compensation

This function allows you to select an RBW-dependent value by which to adjust the gate delay, to compensate for changes in the delay caused by RBW effects.

You can select between uncompensated operation and two types of compensation, **Delay Until RBW Settled** and **Compensate for RBW Group Delay**.

See ["More Information" on page 880](#)

Key Path	Sweep/Control, Gate
Scope	Meas Global
Remote Command	<pre>[:SENSe] :SWEep:EGATe:DELaY:COMPensation:TYPE OFF SETTled GDELaY [:SENSe] :SWEep:EGATe:DELaY:COMPensation:TYPE?</pre>
Example	<pre>SWE:EGAT:DEL:COMP:TYPE SETT SWE:EGAT:DEL:COMP:TYPE?</pre>

Notes	<p>Although this function is Meas Global, there are some measurements that do not support this function. In those measurements the operation will be Uncompensated. Going into one of those measurements will not change the Meas Global selection; it will simply display the grayed-out menu key with "Uncompensated" showing as the selection. This is a non-forceful grayout, so the SCPI command is still accepted.</p> <p>If Gate Delay Compensation is not supported at all within a particular mode, the key is not displayed, and if the SCPI command is sent while in a measurement within that mode, an "Undefined Header" message is generated.</p> <p>Measurements that do not support this function include: Swept SA</p>
Preset	<p>TD-SCDMA mode: Compensate for RBW Group Delay All other modes: Delay Until RBW Settled</p>
State Saved	Saved in instrument state
Range	Uncompensated Delay Until RBW Settled Compensate for RBW Group Delay
Readback text	Uncompensated Settled Group Delay
Initial S/W Revision	Prior to A.02.00
Modified at S/W Revision	A.11.0

More Information

Selecting **Uncompensated** means that the actual gate delay is as you sets it.

Selecting **Delay Until RBW Settled** causes the gate delay to be increased above the user setting by an amount equal to $3.06/\text{RBW}$. This compensated delay causes the GATE START and GATE STOP lines on the display to move by the compensation amount, and the actual hardware gate delay to be increased by the same amount. All the other gate lines (for example, MIN FAST) are unaffected. If the RBW subsequently changes, the compensation is readjusted for the new RBW. The value shown on the **Gate Delay** key does NOT change.

Delay Until RBW Settled allows excellent measurements of gated signals, by allowing the IF to settle following any transient that affects the burst. Excellent measurements also require that the analysis region not extend into the region affected by the falling edge of the burst. Thus, excellent measurements can only be made over a width that declines with narrowing RBWs, which is achieved by decreasing the gate length below the user setting by an amount equal to $2.53/\text{RBW}$. Therefore, for general purpose compensation, you will still want to change the gate length with changes in RBW even if the gate delay is compensated. The compensated Gate Length is limited by the analyzer so that it will never go below 10% of the value shown on the Gate Length key, as otherwise the sweep times could get very long. Anytime the **Gate Length and RBW** values combine in such a way that this limiting takes place, a warning is displayed. For measurements which contain multiple sweeps with different RBW like SEM and SPUR, the smallest RBW is used for this limiting.

Selecting **Compensate for RBW Group Delay** causes the gate delay to be increased above the user setting by an amount equal to $1.81/\text{RBW}$. This compensated delay causes the GATE START, GATE STOP lines on the display to move by the compensation amount, and the actual hardware gate delay to be increased by the same amount. All the other gate lines (for example, MIN FAST) are unaffected. If the RBW

subsequently changes, the compensation is readjusted for the new RBW. The value shown on the **Gate Delay** key does NOT change. **Compensate for RBW Group Delay** also includes gate length compensation; the gate length itself is adjusted as necessary to attempt to compensate for delay effects imposed by the RBW.

Compensate for RBW Group Delay is similar to **Delay Until RBW Settled**, but compensates for the group delay of the RBW filter, rather than the filter settling time. As the RBW gets narrow, this can allow the settling tail of the RBW to affect the beginning part of the gated measurement, and allow the beginning of the RBW settling transient to affect the end of the gated measurement. These two effects are symmetric because the RBW response is symmetric. Because the gate length is not automatically compensated, some users might find this compensation to be more intuitive than compensation for RBW settling.

Min Fast Position Query (Remote Command Only)

This command queries the position of the MIN FAST line, relative to the delay reference (REF) line. See section "[Gate View On/Off](#)" on page 2228. If this query is sent while not in gate view, the MinFast calculation is performed based on the current values of the appropriate parameters and the result is returned. Knowing this value lets you set an optimal gate delay value for the current measurement setup.

Remote Command	[:SENSe] :SWEep:EGATe:MINFast?
Example	SWE:EGAT:MIN?
Initial S/W Revision	Prior to A.02.00

Gate Preset (Remote Command Only)

Presets the time-gated spectrum analysis capability.

This command sets gate parameter values to the ESA preset values, as follows:

Gate trigger type = edge

Gate polarity = positive

Gate delay = 1 us

Gate length = 1 us

Remote Command	[:SENSe] :SWEep:TIME:GATE:PRESet ESA Compatibility
Initial S/W Revision	Prior to A.02.00

Gate Level (Remote Command Only)

Sets the gate input transition point level for the external TRIGGER inputs on the front and rear panel. This is a legacy command for PSA compatibility. It is simply an alias to the equivalent trigger level command.

Remote Command	[:SENSe] :SWEep:EGATe:EXTernal [1] 2 :LEVel <voltage> [:SENSe] :SWEep:EGATe:EXTernal [1] 2 :LEVel?
Notes	This command is simply an alias to

	:TRIGger[:SEQuence]:EXTernal[1]2:LEVel For details refer
Initial S/W Revision	Prior to A.02.00

Gate Polarity (Remote Command Only)

Sets the polarity for the gate signal. This setup is now done using the gate trigger's slope setting.

When Positive (Pos) is selected, a positive-going edge (Edge) or a high voltage (Level) will satisfy the gate condition, after the delay set with the Gate Delay key. When Negative (Neg) is selected, a negative-going edge (Edge) or a low voltage (Level) will satisfy the gate condition after the delay.

Remote Command	[:SENSe] :SWEep:EGATe:POLarity NEGative POSitive [:SENSe] :SWEep:EGATe:POLarity?
Example	SWE:EGAT:POL NEG SWE:EGAT:POL?
Preset	POSitive
State Saved	Saved in instrument state
Backwards Compatibility SCPI	[:SENSe] :SWEep:TIME:GATE:POLarity ESA compatibility
Initial S/W Revision	Prior to A.02.00

Remote Command	[:SENSe] :SWEep:TIME:GATE:LEVel HIGH LOW [:SENSe] :SWEep:TIME:GATE:LEVel? ESA compatibility
Preset	HIGH
Initial S/W Revision	Prior to A.02.00

Points

Sets the number of points per sweep. The resolution of setting the sweep time depends on the number of points selected. The current value of points is displayed parenthetically, next to the sweep time in the lower-right corner of the display.

Key Path	Sweep/Control
Mode	SA, WCDMA, C2K, WIMAX OFDMA, TD-SCDMA, 1xEVDO, ISDB-T, CMMB, LTE, LTETDD, BLUETOOTH, WLAN, MSR, LTEAFDD, LTEATDD
Remote Command	[:SENSe] :OBWidth:SWEep:POINTs <integer> [:SENSe] :OBWidth:SWEep:POINTs?
Example	OBW:SWE:POIN 1500

OBW:SWE:POIN?	
Notes	<p>This function is not available when signal identification is set to On (external mixing).</p> <p>Affected by:</p> <ul style="list-style-type: none"> log sweep <p>Grayed out in measurements that don't support swept</p> <p>Blanked in modes that do not support swept.</p> <p>Whenever the number of sweep points change:</p> <ul style="list-style-type: none"> - All trace data is erased - Any traces with Update Off also go to Display Off (like going from View to Blank in the older analyzers) - Sweep time is re-quantized - Any limit lines that are on are updated - If averaging/hold is on, averaging/hold starts over
Couplings	Whenever the number of sweep points change, the sweep time is re-quantized.
Preset	<p>LTE, LTETDD, MSR, LTEAFDD, LTEATDD: 2001</p> <p>Other: 1001</p>
State Saved	Saved in instrument state.
Min	101
Max	20001
Initial S/W Revision	Prior to A.02.00
Modified at S/W Revision	A.03.00

System

See "[System](#)" on page 368

Trace/Detector

Accesses a menu of functions that enable you to control the detectors for the current measurement.

Key Path	Front-panel key
Initial S/W Revision	Prior to A.02.00

Trace Type

Allows you to select the type of trace you want to use for the current measurement.

The first page of this menu contains a 1–of–N selection of the trace type (Clear Write, Average, Max Hold, Min Hold) for the selected trace.

Key Path	Trace/Detector
Mode	SA, WCDMA, C2K, WIMAX OFDMA, TD-SCDMA, 1xEVDO, ISDB-T, CMMB, LTE, LTETDD, BLUETOOTH, WLAN, MSR, LTEAFDD, LTEATDD
Remote Command	:TRACe:OBWidth:TYPE WRITe AVERAge MAXHold MINHold :TRACe:OBWidth:TYPE?
Example	TRAC:OBW:TYPE MINH TRAC:OBW:TYPE?
Notes	WRITe = Clear Write AVERAge = Average MAXHold = Maximum Hold MINHold = Minimum Hold
Couplings	When Detector setting is “Auto” ([:SENSe]:OBWidth:DETECTOR:AUTO?), Detector ([:SENSe]:OBWidth:DETECTOR[:FUNCTION]?) switches aligning with the switch of this parameter: “NORMal” with WRITe (Clear Write), “AVERAge” with AVERAge, “POSitive (peak)” with MAXHold, and “NEGative (peak)” with MINHold.
Preset	AVERAge BLUETOOTH: MAX HOLD.
State Saved	Saved in instrument state.
Range	WRITe AVERAge MAXHold MINHold
Initial S/W Revision	Prior to A.02.00
Modified at S/W Revision	A.03.00

Detector

Accesses a menu of functions that enables you to control the detectors for the current measurement. The following choices are available:

- **Auto**– the detector selected depends on marker functions, trace functions, average type, and the trace averaging function.

- **Normal**—the detector determines the peak of the CW-like signals, and it yields alternating maximums and minimums of noise-like signals. This is also referred to as Rosenfell detection.
- **Average**—the detector determines the average of the signal within the sweep points. The averaging method depends upon the Average Type selection (voltage, power or log scales).
- **Peak (Positive)**—the detector determines the maximum of the signal within the sweep points.
- **Sample**—the detector indicates the instantaneous level of the signal at the center of the sweep points represented by each display point.
- **Negative Peak**—the detector determines the minimum of the signal within the sweep points.

Key Path	Detector
Initial S/W Revision	Prior to A.02.00

Auto

When the detector choice is Auto, the analyzer selects the detector. The selected detector depends on marker functions, trace functions, and trace averaging functions for the current measurement.

Key Path	Trace/Detector
Remote Command	[[:SENSe]:OBWidth:DETECTOR:AUTO ON OFF 1 0 [:SENSe]:OBWidth:DETECTOR:AUTO?
Example	OBW:DET:AUTO ON OBW:DET:AUTO?
Couplings	When Detector setting is “Auto” ([[:SENSe]:OBWidth:DETECTOR:AUTO?]), Detector ([[:SENSe]:OBWidth:DETECTOR:FUNCTION?]) switches aligning with the switch of this parameter: “NORMal” with Clear Write, “AVERage” with AVERage, “POSitive (peak)” with MAXHold, and “NEGative (peak)” with MINHold.
Preset	ON ISDB-T: OFF
State Saved	Saved in instrument state.
Initial S/W Revision	Prior to A.02.00
Modified at S/W Revision	A.03.00

Detector Selection

Allows you to select a specific detector for the current measurement. When the detector choice is Auto, the analyzer selects the detector. The selected detector depends on marker functions, trace functions, and trace averaging functions for the current measurement.

Key Path	Trace/Detector
Mode	SA, WCDMA, C2K, WIMAX OFDMA, TD-SCDMA, 1xEVDO, ISDB-T, CMMB, LTE, LTETDD, BLUETOOTH, WLAN, MSR, LTEAFDD, LTEATDD

Remote Command	[:SENSe]:OBWidth:DETEctor[:FUNction] NORMal AVERage POSitive SAMPle NEGative [:SENSe]:OBWidth:DETEctor[:FUNction]?
Example	OBW:DET NORM OBW:DET?
Notes	<p>When you manually select a detector (instead of selecting Auto), that detector is used regardless of other analyzer settings.</p> <p>The detector choices are:</p> <p>The Normal detector determines the peak of CW-like signals, and it yields alternating maximums and minimums of noise-like signals. This is also referred to as Rosenfell detection.</p> <p>The Average detector determines the average of the signal within the sweep points. The averaging method is Power Average (RMS).</p> <p>The Peak detector determines the maximum of the signal within the sweep points.</p> <p>The Sample detector indicates the instantaneous level of the signal at the center of the sweep points represented by each display point.</p> <p>The Negative Peak detector determines the minimum of the signal within the sweep points.</p>
Couplings	When Detector setting is "Auto" ([:SENSe]:OBWidth:DETEctor:AUTO?), Detector ([:SENSe]:OBWidth:DETEctor[:FUNction]?) switches aligning with the switch of this parameter: "NORMal" with Clear Write, "AVERage" with AVERage, "POSitive (peak)" with MAXHold, and "NEGative (peak)" with MINHold.
Preset	AVERage ISDB-T: Peak BLUETOOTH: Peak
State Saved	Saved in instrument state.
Range	Normal Average Peak Sample Negative Peak
Initial S/W Revision	Prior to A.02.00
Modified at S/W Revision	A.03.00

Trigger

See ["Trigger" on page 444](#)

Free Run

See ["Free Run " on page 451](#)

Video

See ["Video \(IF Envelope\) " on page 452](#)

Trigger Level

See ["Trigger Level " on page 452](#)

Trig Slope

See ["Trig Slope " on page 453](#)

Trig Delay

See ["Trig Delay " on page 454](#)

Line

See ["Line " on page 2235](#)

Trig Slope

See ["Trig Slope " on page 2235](#)

Trig Delay

See ["Trig Delay " on page 456](#)

External 1

See ["External 1 " on page 2248](#)

Trigger Level

See ["Trigger Level " on page 2248](#)

Trig Slope

See ["Trig Slope " on page 2249](#)

Trig Delay

See ["Trig Delay " on page 459](#)

Zero Span Delay Comp

See ["Zero Span Delay Comp On/Off" on page 2237](#)

External 2

See ["External 2 "](#) on page 2250

Trigger Level

See ["Trigger Level "](#) on page 2250

Trig Slope

See ["Trig Slope "](#) on page 2251

Trig Delay

See ["Trig Delay "](#) on page 461

Zero Span Delay Comp

See ["Zero Span Delay Comp On/Off"](#) on page 2239

RF Burst

See ["RF Burst "](#) on page 2251

Absolute Trigger

See ["Absolute Trigger Level"](#) on page 2252

Relative Trigger

See ["Relative Trigger Level"](#) on page 2241

Trig Slope

See ["Trigger Slope "](#) on page 2253

Trig Delay

See ["Trig Delay "](#) on page 466

Periodic Timer

See ["Periodic Timer \(Frame Trigger\) "](#) on page 2243

Period

See ["Period "](#) on page 2244

Offset

See ["Offset "](#) on page 2245

Reset Offset Display

See ["Reset Offset Display "](#) on page 2247

Sync Source

See ["Sync Source "](#) on page 2247

Off

See ["Off "](#) on page 2248

External 1

See ["External 1 "](#) on page 2248

Trigger Level

See ["Trigger Level "](#) on page 2248

Trig Slope

See ["Trig Slope "](#) on page 2249

External 2

See ["External 2 "](#) on page 2250

Trigger Level

See ["Trigger Level "](#) on page 2250

Trig Slope

See ["Trig Slope "](#) on page 2251

RF Burst

See ["RF Burst "](#) on page 2251

Absolute Trigger

See ["Absolute Trigger Level"](#) on page 2252

Trig Slope

See ["Trigger Slope "](#) on page 2253

Trig Delay

See ["Trig Delay"](#) on page 476

Auto/Holdoff

See ["Auto/Holdoff "](#) on page 477

Auto Trig

See ["Auto Trig "](#) on page 477

Trig Holdoff

See ["Trig Holdoff "](#) on page 478

Holdoff Type

See "Holdoff Type" on page 478

User Preset

Accesses a menu that gives you the following three choices:

- **User Preset** – recalls a state previously saved using the Save User Preset function.
- **User Preset All Modes** – presets all of the modes in the analyzer
- **Save User Preset**– saves the current state for the current mode

Key Path	Front-panel key
Backwards Compatibility Notes	<p>User Preset is actually loading a state, and in legacy analyzers, it was possible to load a state without affecting the trace data, limit lines or correction data. Similarly it was possible to do a User Preset without affecting the trace data, limit lines or correction data.</p> <p>In the X-Series, “state” always includes all of this data; so whenever state is loaded, or User Preset is executed, all of the traces, limit lines and corrections are affected. Although this differs from previous behavior, it is desirable behavior, and should not cause adverse issues for users.</p> <p>On ESA and PSA, User Preset affected the entire instrument’s state. In the X-Series, User Preset only recalls the state for the active mode. There is a User Preset file for each mode. User Preset can never cause a mode switch as it can in legacy analyzers. If you want to recall all modes to their user preset file state, you will need to do a User Preset after mode switching into each mode.</p> <p>User Preset recalls mode state which can now include data like traces; whereas on ESA and PSA, User Preset did not affect data.</p>
Initial S/W Revision	Prior to A.02.00

User Preset

User Preset sets the state of the currently active mode back to the state that was previously saved for this mode using the Save User Preset menu key or the SCPI command, `SYST:PRES:USER:SAV`. It not only recalls the Mode Preset settings, but it also recalls all of the mode persistent settings, and the Input/Output system setting that existed at the time Save User Preset was executed.

If a Save User Preset has not been done at any time, User Preset recalls the default user preset file for the currently active mode. The default user preset files are created if, at power-on, a mode detects there is no user preset file. There will never be a scenario when there is no user preset file to restore. For each mode, the default user preset state is the same state that would be saved if a Save User Preset is performed in each mode right after doing a Restore Mode Default and after a Restore Input/Output Defaults.

The User Preset function does the following:

- Aborts the currently running measurement.
- Sets the mode State to the values defined by Save User Preset.
- Makes the saved measurement for the currently running mode the active measurement.
- Brings up the saved menu for the power-on mode.
- Clears the input and output buffers.
- Sets the Status Byte to 0.

Key Path	User Preset
Remote Command	:SYSTem:PRESet:USER
Example	:SYST:PRES:USER:SAVE:SYST:PRES:USER
Notes	:SYST:PRES:USER:SAVE is used to save the current state as the user preset state. Clears all pending OPC bits. The Status Byte is set to 0. Pressing the User Preset front-panel key while already in the User Preset menu will cause the User Preset to get executed
Couplings	A user preset will cause the currently running measurement to be aborted and cause the saved measurement to be active. Recalling a User Preset file has the same issues that recalling a Save State file has. Some settings may need to be limited and therefore re-coupled, since the capabilities of the mode may have changes when the User Preset file was last saved.
Initial S/W Revision	Prior to A.02.00

User Preset All Modes

Recalls all of the User Preset files for each mode, switches to the power-on mode, and activates the saved measurement from the power-on mode User Preset file.

NOTE

When the instrument is secured, all of the user preset files are converted back to their default user preset files.

The User Preset function does the following:

- Aborts the currently running measurement.
- Switches the Mode to the power-on mode.
- Restores the User Preset files for each mode.
- Makes the saved measurement for the power-on mode the active measurement.
- Brings up the saved menu for the power-on mode.
- Clears the input and output buffers.
- Sets the Status Byte to 0.

Key Path	User Preset
Remote Command	:SYSTem:PRESet:USER:ALL
Example	:SYST:PRES:USER:SAVE:SYST:PRES:USER:ALL
Notes	Clears all pending OPC bits. The Status Byte is set to 0. :SYST:PRES:USER:SAVE is used to save the current state as the user preset state.
Couplings	A user preset will cause the currently running measurement to be aborted, cause a mode switch to the power-on mode, and cause the saved measurement to be active in the power-on mode. Recalling a User Preset file has the same issues that recalling a Save State file has. Some settings may need to be limited and therefore re-coupled, since the capabilities of the mode may have changes when the User Preset file was last saved.

Initial S/W Revision	Prior to A.02.00
----------------------	------------------

Save User Preset

Saves the currently active mode and its State. You can recall this User Preset file by pressing the User Preset menu key or sending the SYST:PRES:USER remote command. This same state is also saved by the Save State function.

Key Path	User Preset
Remote Command	:SYSTem:PRESet:USER:SAVE
Example	:SYST:PRES:USER:SAVE
Notes	:SYST:PRES:SAVE creates the same file as if the user requested a *SAV or a MMEM:STOR:STAT, except User Preset Save does not allow the user to specify the filename or the location of the file.
Initial S/W Revision	Prior to A.02.00

Display

Accesses a menu of functions that enable you to set the display parameters.

See "[Display](#)" on page 2481 for more information.

Key Path	View/Display
Initial S/W Revision	Prior to A.02.00

Display

The Display menu is common to most measurements, and is used for configuring items on the display. Some Display menu settings apply to all the measurements in a mode, and some only to the current measurement. Those under the **System Display Settings** key apply to all measurements in all modes.

Key Path	Display
Key Path	View/Display
Initial S/W Revision	Prior to A.02.00

Annotation

Turns on and off various parts of the display annotation. The annotation is divided up into four categories:

1. Meas Bar: This is the measurement bar at the top of the screen. It does not include the settings panel or the Active Function. Turning off the Meas Bar turns off the settings panel and the Active Function. When the Meas Bar is off, the graticule area expands to fill the area formerly occupied by the Meas Bar.
2. Screen Annotation: this is the annotation and annunciation around the graticule, including any annotation on lines (such as the display line, the threshold line, etc.) This does NOT include the marker number or the N dB result. When off, the graticule expands to fill the entire graticule area.
3. Trace annotation: these are the labels on the traces, showing their detector (or their math mode).
4. Active Function annotation: this is the active function display in the meas bar, and all of the active function values displayed on softkeys.

See the figure below. Each type of annotation can be turned on and off individually.

9 Occupied Bandwidth Measurement Display

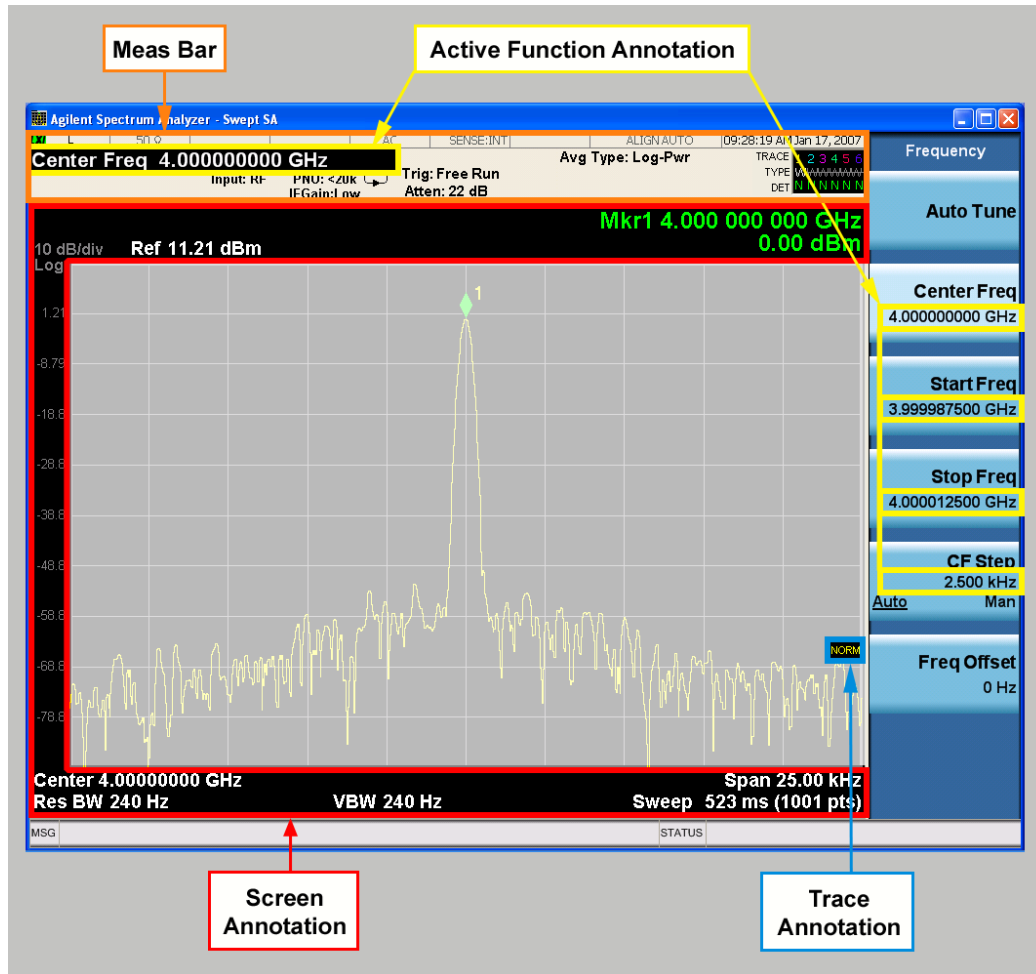

Key Path	View/Display, Display
Initial S/W Revision	Prior to A.02.00

Meas Bar On/Off

This function turns the Measurement Bar on and off, including the settings panel. When off, the graticule area expands to fill the area formerly occupied by the Measurement Bar.

Key Path	View/Display, Display, Annotation
Remote Command	:DISPlay:ANNOtation:MBAR[:STATe] OFF ON 0 1 :DISPlay:ANNOtation:MBAR[:STATe]?
Example	DISP:ANN:MBAR OFF
Dependencies	Grayed out and forced to OFF when System Display Settings, Annotation is set to Off.
Preset	On This should remain Off through a Preset when System DisplaySettings, Annotation is set to Off.

State Saved	Saved in instrument state.
Initial S/W Revision	Prior to A.02.00

Screen

This controls the display of the annunciation and annotation around the graticule, including any annotation on lines (such as the display line, the threshold line, etc.) and the y-axis annotation. This does NOT include marker annotation (or the N dB result). When off, the graticule expands to fill the entire graticule area, leaving only the 1.5% gap above the graticule as described in the Trace/Detector chapter.

Key Path	View/Display, Display, Annotation
Remote Command	:DISPlay:ANNotation:SCReen[:STATe] OFF ON 0 1 :DISPlay:ANNotation:SCReen[:STATe]?
Example	DISP:ANN:SCR OFF
Dependencies	Grayed-out and forced to OFF when System Display Settings, Annotation is set to Off.
Preset	On This should remain Off through a Preset when System DisplaySettings, Annotation is set to Off
State Saved	Saved in instrument state.
Initial S/W Revision	Prior to A.02.00

Active Function Values On/Off

Turns on and off the active function display in the Meas Bar, and all of the active function values displayed on the softkeys.

Note that all of the softkeys that have active functions have these numeric values blanked when this function is on. This is a security feature..

9 Occupied Bandwidth Measurement Display

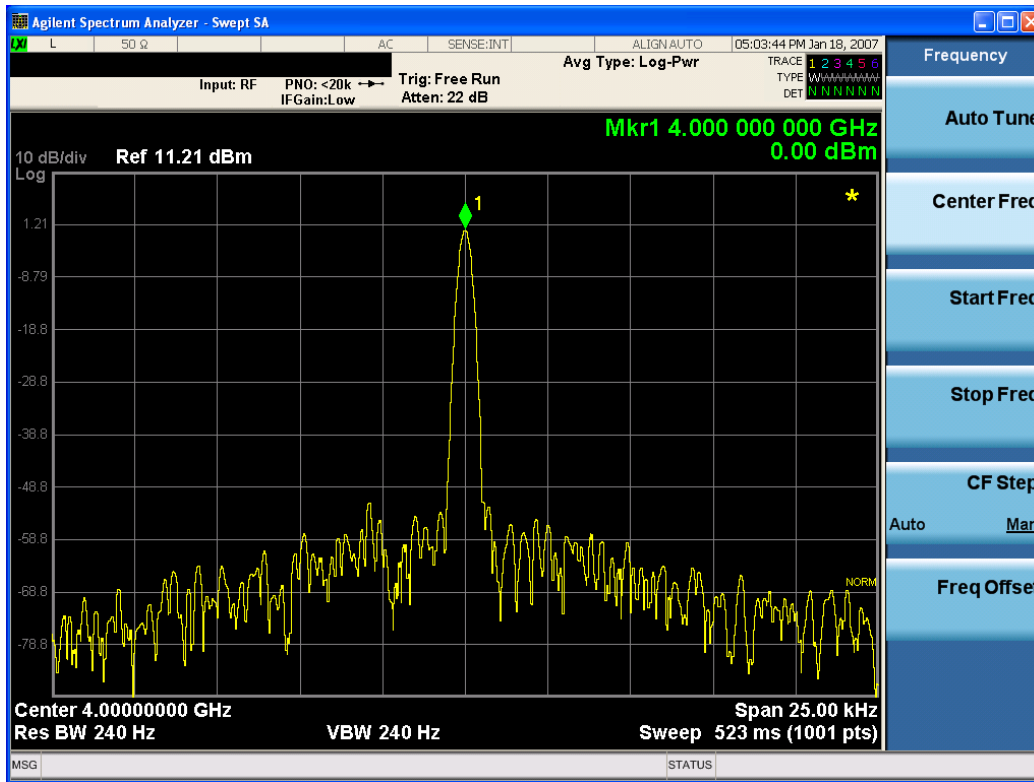

Key Path	View/Display, Display, Annotation
Remote Command	:DISPlay:ACTivefunc[:STATE] ON OFF 1 0 :DISPlay:ACTivefunc[:STATE]?
Example	DISP:ACT OFF
Dependencies	Grayed out and forced to OFF when System Display Settings, Annotation is set to Off.
Preset	On This should remain Off through a Preset when System DisplaySettings, Annotation is set to Off
State Saved	Saved in instrument state.
Initial S/W Revision	Prior to A.02.00

Title

Displays menu keys that enable you to change or clear a title on your display.

Key Path	View/Display, Display
Initial S/W Revision	Prior to A.02.00

Change Title

Writes a title into the "measurement name" field in the banner, for example, "Swept SA".

Press Change Title to enter a new title through the alpha editor. Press Enter or Return to complete the entry. Press ESC to cancel the entry and preserve your existing title.

The display title will replace the measurement name. It remains for this measurement until you press **Change Title** again, or you recall a state, or a Preset is performed. A title can also be cleared by pressing **Title, Clear Title**.

NOTE

Notice the inclusion of the <measurement> parameter in the command below. Because each measurement remembers the Display Title, the command must be qualified with the measurement name. For the Swept SA measurement this is not the case; no <measurement> parameter is used when changing the Display Title for the Swept SA measurement.

Key Path	View/Display, Display, Title
Mode	All
Remote Command	:DISPlay:<measurement>:ANNotation:TITLe:DATA <string> :DISPlay:<measurement>:ANNotation:TITLe:DATA?
Example	DISP:ANN:TITL:DATA "This Is My Title" This example is for the Swept SA measurement in the Spectrum Analyzer mode. The SANalyzer <measurement> name is not used. DISP:ACP:ANN:TITL:DATA "This Is My Title" This example is for Measurements other than Swept SA. Both set the title to: This Is My Title
Notes	Pressing this key cancels any active function. When a title is edited the previous title remains intact (it is not cleared) and the cursor goes at the end so that characters can be added or BKSP can be used to go back over previous characters.
Preset	No title (measurement name instead)
State Saved	Saved in instrument state.
Initial S/W Revision	Prior to A.02.00

Clear Title

Clears a title from the front-panel display. Once cleared, the title cannot be retrieved. After the title is cleared, the current Measurement Name replaces it in the title bar.

Key Path	View/Display, Display, Title
Example	The following commands clear the title and restore the measurement's original title: DISP:ANN:TITL:DATA "" This example is for the Swept SA measurement in the Spectrum Analyzer mode. The SANalyzer <measurement> name is not used. DISP:ACP:ANN:TITL:DATA "" This example is for ACP; in measurements other than Swept SA the measurement name is required.
Notes	Uses the :DISPlay:<measurement>:ANNotation:TITLe:DATA <string> command with an empty string (in the Swept SA, the <measurement> is omitted).

Preset	Performed on Preset.
Initial S/W Revision	Prior to A.02.00

Graticule

Pressing Graticule turns the display graticule On or Off. It also turns the graticule y-axis annotation on and off.

Key Path	View/Display, Display
Remote Command	:DISPlay:WINDow[1]:TRACe:GRATicule:GRID[:STATe] OFF ON 0 1 :DISPlay:WINDow[1]:TRACe:GRATicule:GRID[:STATe]?
Example	DISP:WIND:TRAC:GRAT:GRID OFF
Notes	The graticule is the set of horizontal and vertical lines that make up the grid/divisions for the x-axis and y-axis.
Preset	On
State Saved	Saved in instrument state
Initial S/W Revision	Prior to A.02.00

System Display Settings

These settings are "Mode Global" – they affect all modes and measurements and are reset only by **Restore Misc Defaults** or **Restore System Defaults** under System.

Key Path	View/Display, Display
Initial S/W Revision	Prior to A.02.00

Annotation Local Settings

This is a Mode Global override of the meas local annotation settings. When it is **All Off**, it forces **ScreenAnnotation, Meas Bar, Trace, and Active Function Values** settings to be **OFF** for all measurements in all modes. This provides the security based "annotation off" function of previous analyzers; hence it uses the legacy SCPI command.

When it is **All Off**, the **Screen, Meas Bar, Trace, and Active Function Values** keys under the **Display, Annotation** menu are grayed out and forced to **Off**. When **Local Settings** is selected, you are able to set the local annotation settings on a measurement by measurement basis.

Key Path	View/Display, Display, System Display Settings
Remote Command	:DISPlay:WINDow[1]:ANNotation[:ALL] OFF ON 0 1 :DISPlay:WINDow[1]:ANNotation[:ALL]?
Example	:DISP:WIND:ANN OFF

Preset	On (Set by Restore Misc Defaults)
State Saved	Not saved in instrument state.
Backwards Compatibility Notes	The WINDow parameter and optional subopcode is included for backwards compatibility but ignored – all windows are equally affected.
Initial S/W Revision	Prior to A.02.00

Themes

Accesses a menu of functions that enable you to choose the theme to be used when saving the screen image.

The **Themes** option is the same as the **Themes** option under the **Display** and **Page Setup** dialogs. It allows you to choose between themes to be used when saving the screen image.

Key Path	Save, Screen Image
Remote Command	:MMEMory:STORe:SCReen:THEMe TDColor TDMonochrome FCOlor FMONochrome :MMEMory:STORe:SCReen:THEMe?
Example	:MMEM:STOR:SCR:THEM TDM
Preset	3D Color; Is not part of Preset, but is reset by Restore Misc Defaults or Restore System Defaults All and survives subsequent running of the modes.
Readback	3D Color 3D Mono Flat Color Flat Mono
Backwards Compatibility Notes	In ESA and PSA we offer the choice of "Reverse Bitmap" or "Reverse Metafile" when saving screen images. This is much like the "Flat Color" theme available in X-Series. Also, if you selected Reverse Bitmap AND a black & white screen image, that would be much like "Flat Monochrome". In other words, each of the X-Series themes has a similar screen image type in ESA/PSA. But they are not identical.
Initial S/W Revision	Prior to A.02.00

3D Color

Selects a standard color theme with each object filled, shaded and colored as designed.

Key Path	Save, Screen Image, Themes
Example	MMEM:STOR:SCR:THEM TDC
Readback	3D Color
Initial S/W Revision	Prior to A.02.00

3D Monochrome

Selects a format that is like 3D color but shades of gray are used instead of colors.

Key Path	Save, Screen Image, Themes
Example	MMEM:STOR:SCR:THEM TDM
Readback	3D Mono
Initial S/W Revision	Prior to A.02.00

Flat Color

Selects a format that is best when the screen is to be printed on an ink printer.

Key Path	Save, Screen Image, Themes
Example	MMEM:STOR:SCR:THEM FCOL
Readback	Flat Color
Initial S/W Revision	Prior to A.02.00

Flat Monochrome

Selects a format that is like Flat Color. But only black is used (no colors, not even gray), and no fill.

Key Path	Save, Screen Image, Themes
Example	MMEM:STOR:SCR:THEM FMON
Readback	Flat Mono
Initial S/W Revision	Prior to A.02.00

Backlight

Accesses the display backlight on/off keys. This setting may interact with settings under the Windows "Power" menu.

When the backlight is off, pressing ESC, TAB, SPACE, ENTER, UP, DOWN, LEFT, RIGHT, DEL, BKSP, CTRL, or ALT turns the backlight on without affecting the application. Pressing any other key will turn backlight on and could potentially perform the action as well.

Key Path	View/Display, Display, System Display Settings
Remote Command	:DISPlay:BACKlight ON OFF :DISPlay:BACKlight?
Preset	ON (Set by Restore Misc Defaults)
Initial S/W Revision	Prior to A.02.00

Backlight Intensity

An active function used to set the backlight intensity. It goes from 0 to 100 where 100 is full on and 0 is off. This value is independent of the values set under the Backlight on/off key.

Key Path	View/Display, Display, System Display Settings
Remote Command	:DISPlay:BACKlight:INTensity <integer> :DISPlay:BACKlight:INTensity?
Example	DISP:BACK:INT 50
Preset	100 (Set by Restore Misc Defaults)
Min	0
Max	100
Initial S/W Revision	Prior to A.02.00

View Selection

Enables you to select the view from either OBW Results or OBW Boundaries. There are two available commands; ID string and numeric ID value. For more details of the commands, see:

- ["View Selection by Name" on page 903](#)
- ["View Selection by Number" on page 904](#)

In the following table:

- The Enumerated ID is used with the SCPI Command :DISP:OBW:VIEW[:SEL]
- The Numeric ID is used with the SCPI Command :DISP:OBW:VIEW:NSEL

Enumerated ID	Numeric ID	View Name & Details
OBWResults	1	OBW Results Provides a combination view of the spectrum trace and the measurement summary data.
BOUNDaries	2	OBW Boundaries Provides a combination view of the spectrum trace and the OBW boundaries table. The OBW boundaries table shows Occupied bandwidth and X dB bandwidth for both lower and upper boundaries.

View Selection by Name

Key Path	View/Display
Mode	SA, WCDMA, C2K, 1xEV-DO, WIMAX OFDMA, TD-SCDMA, DVB-T/H, LTE, LTETDD, MSR, LTEAFDD, LTEATDD
Remote Command	:DISPlay:OBwidth:VIEW[:SElect] OBWResults BOUNDaries

	:DISPlay:OBWidth:VIEW[:SElect]?
Example	DISP:OBW:VIEW OBWR DISP:OBW:VIEW?
Preset	OBWResults
State Saved	Saved in instrument state
Range	OBWResults BOUNdaries
Initial S/W Revision	A.16.00

View Selection by Number

Key Path	SCPI only
Mode	SA, WCDMA, C2K, 1xEV-DO,WIMAX OFDMA, TD-SCDMA, DVB-T/H, LTE, LTETDD, MSR, LTEAFDD, LTEATDD
Remote Command	:DISPlay:OBWidth:VIEW:NSElect <integer> :DISPlay:OBWidth:VIEW:NSElect?
Example	DISP:OBW:VIEW:NSEL 2 DISP:OBW:VIEW:NSEL?
Preset	1
State Saved	Saved in instrument state
Min	1
Max	2
Initial S/W Revision	A.16.00

OBW Results

The spectrum trace is displayed in the upper window. Measurement results such as Occupied Bandwidth or Power are displayed in the lower window. For more details, and samples of screen content for each supported mode, see ["Spectrum View" on page 905](#) below.

The following result descriptions are available:

Occupied Bandwidth

The occupied bandwidth result is $f_2 - f_1$, where f_1 and f_2 are the lower and upper carrier boundary point. f_1 and f_2 are calculated with a Occupied Bandwidth algorithms.

Total Power or OBW Power

The total power is the power integrated in the specified span setting. The OBW power is calculated from multiplying the total power by OBW percent power. The user can select the total power or the OBW power with the Power Ref key in Meas Setup.

Transmit Freq Error

The transmit freq error (transmit frequency error) result is calculated as the difference between $(f_2+f_1)/2$ and the tuned center frequency of the signal, where f_1 and f_2 are the lower and upper carrier boundary point.

x dB Bandwidth

The x dB result is a bandwidth measured between two points on the signal which are a certain number of dBs down from the highest signal point within the OBW Span. For example, If the 'x dB' parameter is set to -26 dB, and the 'Occupied BW Span' is set to 10 MHz, then the maximum signal power level is first determined from the 10 MHz wide trace sweep. Next, the two furthest frequencies below (xdb_f1) and above (xdb_f2) the frequency of the maximum level occurrence are found where the signal level is 26 dB below the peak level. This calculation also uses linear interpolation to find the lower and upper carrier boundary point within the width of a sweep point (the span divided by the number of sweep points).

The x dB bandwidth is calculated to be $xdb_f2 - xdb_f1$.

% of OBW Power

This is the setting parameter. See "[Occ BW % Pwr](#)" on page 791.

x dB

This is the setting parameter. See "[x dB](#)" on page 792.

OBW Boundaries

The lower window of OBW Results view is replaced with the OBW boundaries table. Occupied bandwidth and X dB bandwidth for both lower and upper boundaries are displayed.

Occupied Bandwidth

See "[OBW Results](#)" on page 904 above.

Total Power or OBW Power

See "[OBW Results](#)" on page 904 above.

x dB

This is the setting parameter. See "[x dB](#)" on page 792.

x dB Ref PwrThe x dB reference power result shows the power of the highest signal point within the OBW Span. **x dB At Freq**The x dB reference power frequency result shows the frequency of the highest signal point within the OBW Span. They are switched when Boundary Frequency in View/Display is changed.

Spectrum View

For SA, WCDMA, C2K, 1xEVDO, WIMAX OFDMA, WLAN modes:

9 Occupied Bandwidth Measurement Display

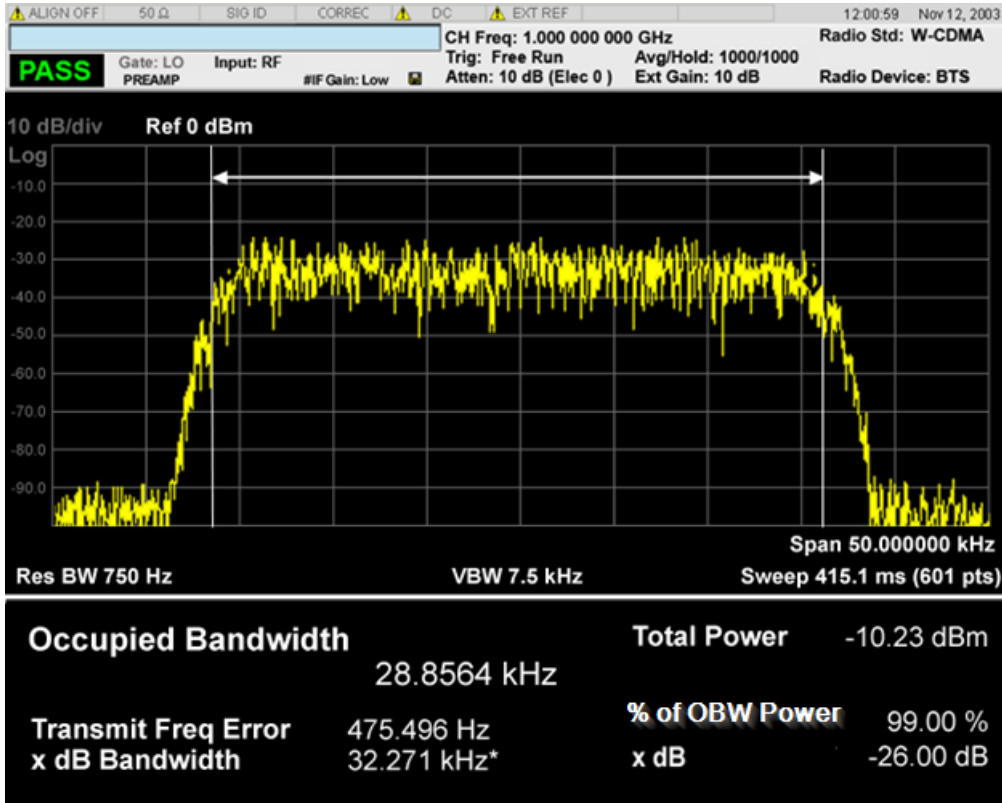

For TD-SCDMA mode only:

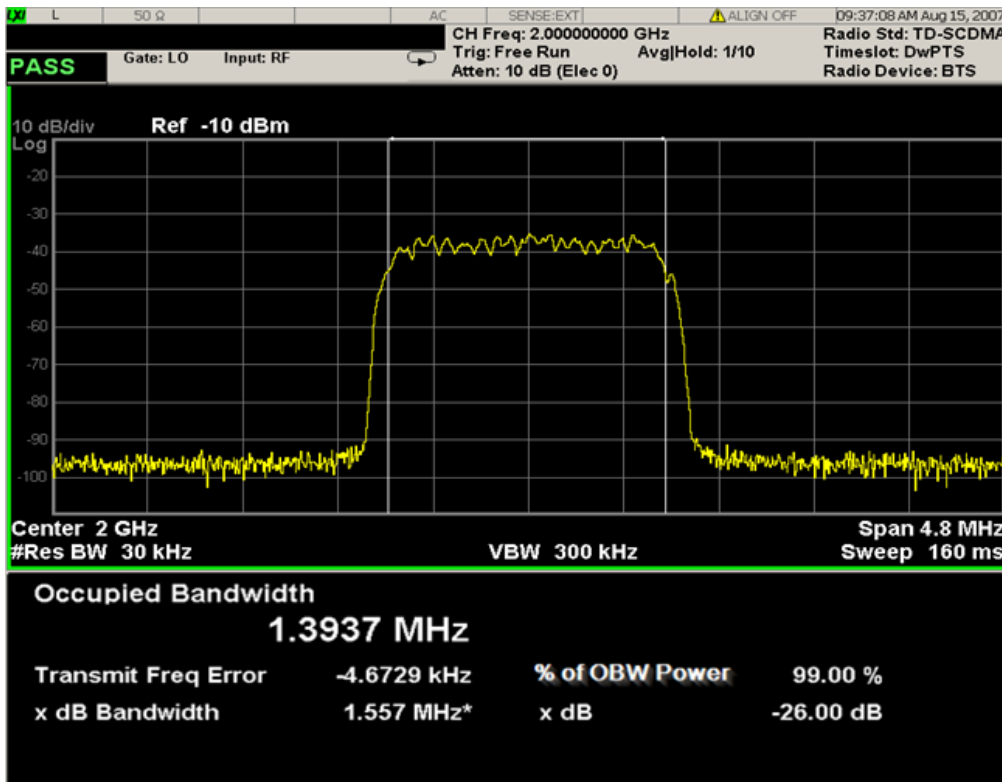

For Bluetooth mode only:

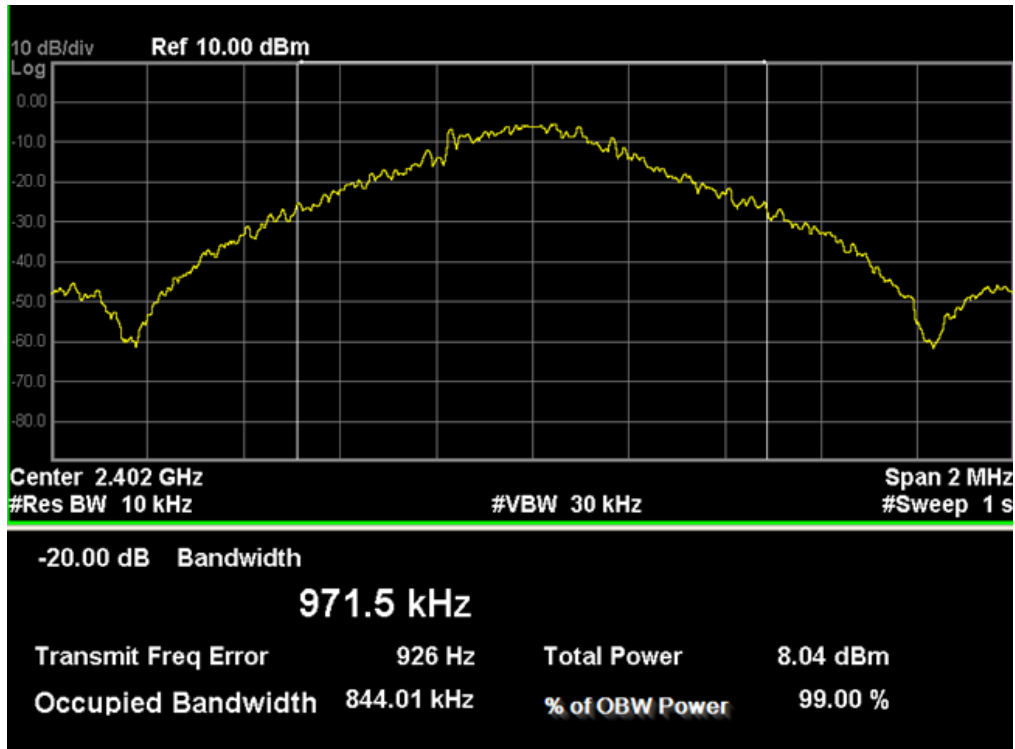

For MSR mode only:

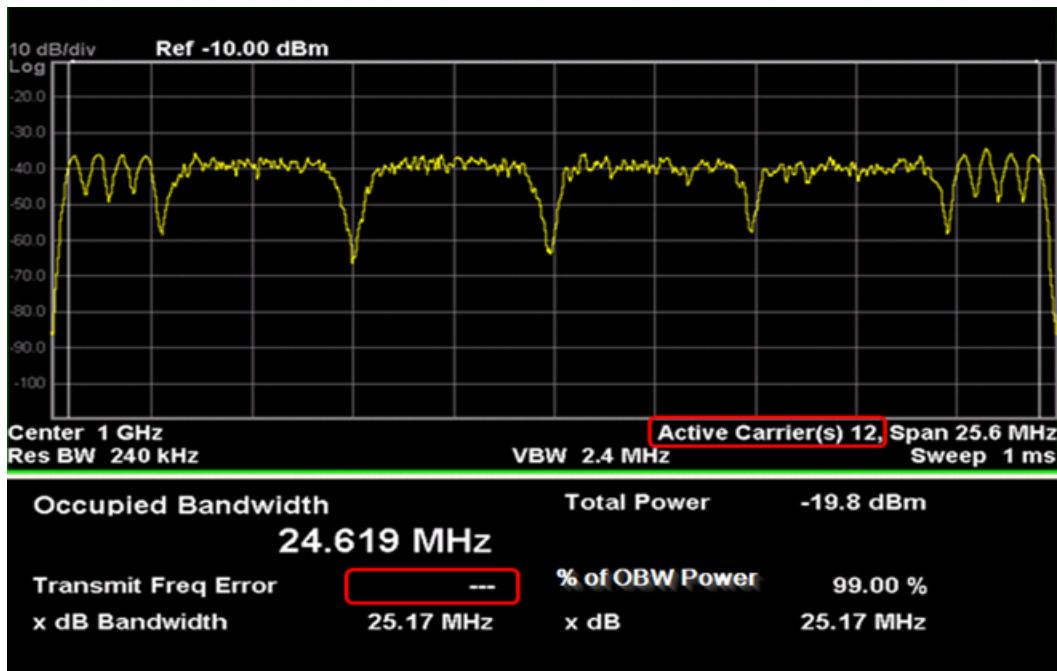

The number of active carriers is displayed. Since span is determined from detected carriers in auto mode, it is necessary to show how many carriers are identified as active., as highlighted above.

When there is one active carrier, Transmit Freq Error is displayed. Otherwise, “---” is displayed, as shown above.

For LTE-Advanced FDD/TDD mode only:

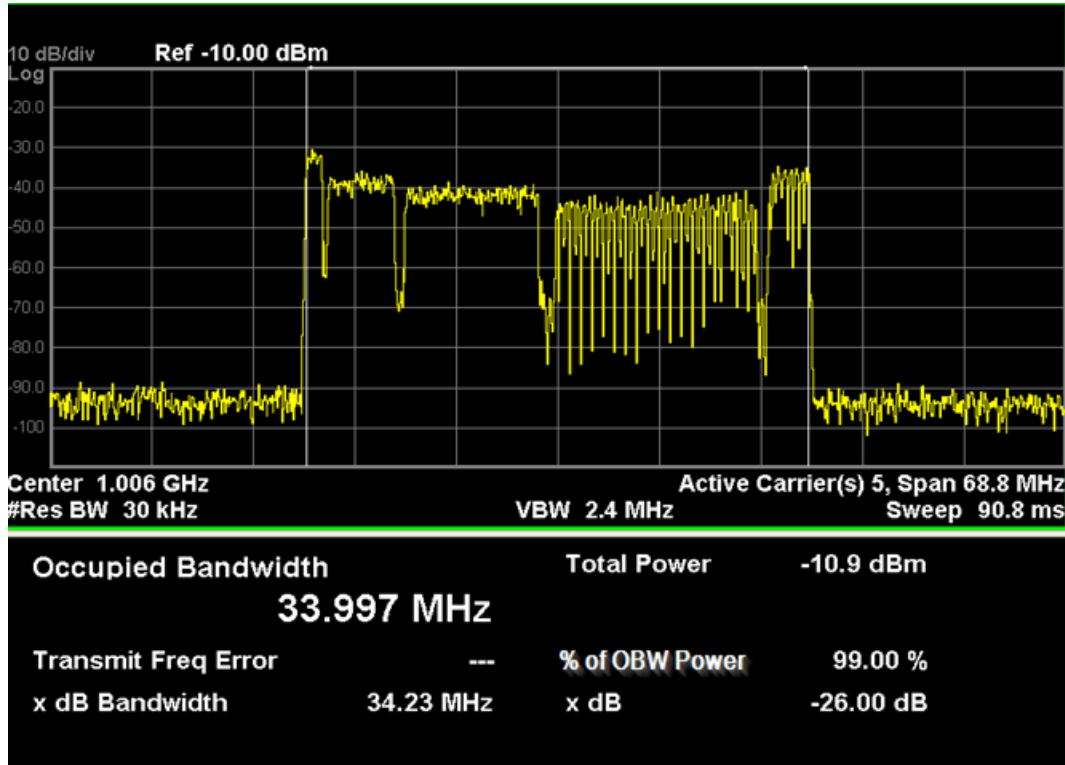

The number of active carriers is displayed to show how many carriers are identified as active in auto detected mode of span, otherwise “-” is displayed to indicate that it is out of scope.

When there is one active carrier, Transmit Freq Error is displayed. Otherwise, “---” is displayed.

OBW Boundaries Results

Name	Corresponding Results
Lower OBW boundary - offset frequency [Hz]	Offset frequency of the lower OBW boundary from center frequency
Lower OBW boundary - absolute power [dB]	Absolute power on the point of lower OBW boundary
Lower OBW boundary - relative power [dBc]	Relative power on the point of lower OBW boundary
Upper OBW boundary - offset frequency [Hz]	Offset frequency of the upper OBW boundary from center frequency
Upper OBW boundary - absolute power [dB]	Absolute power on the point of upper OBW boundary
Upper OBW boundary - relative power [dBc]	Relative power on the point of upper OBW boundary

Name	Corresponding Results
Lower x dB BW boundary - offset frequency [Hz]	Offset frequency of the lower x dB BW boundary from center frequency
Lower x dB BW boundary - absolute power [dB]	Absolute power on the point of lower x dB BW boundary
Upper x dB BW boundary - offset frequency [Hz]	Offset frequency of the lower x dB BW boundary from center frequency
Upper x dB BW boundary - absolute power [dB]	Absolute power on the point of lower x dB BW boundary

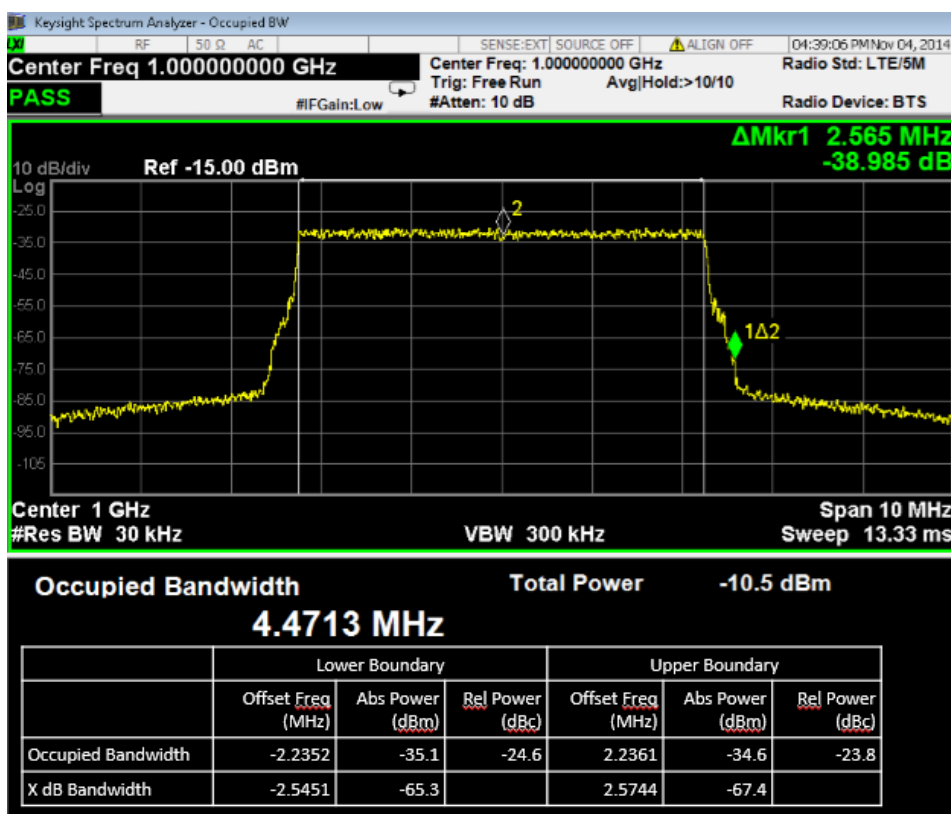

View Selection

Enables you to select the view from either OBW Results or OBW Boundaries. There are two available commands; ID string and numeric ID value. For more details of the commands, see:

- "View Selection by Name" on page 910
- "View Selection by Number" on page 910

In the following table:

- The Enumerated ID is used with the SCPI Command :DISP:OBW:VIEW[:SEL]
- The Numeric ID is used with the SCPI Command :DISP:OBW:VIEW:NSEL

Enumerated ID	Numeric ID	View Name & Details
OBWResults	1	OBW Results Provides a combination view of the spectrum trace and the measurement summary data.
BOUNDaries	2	OBW Boundaries Provides a combination view of the spectrum trace and the OBW boundaries table. The OBW boundaries table shows Occupied bandwidth and X dB bandwidth for both lower and upper boundaries.

View Selection by Name

Key Path	View/Display
Mode	SA, WCDMA, C2K, 1xEV-DO, WIMAX OFDMA, TD-SCDMA, DVB-T/H, LTE, LTEFDD, LTEATDD, LTEATDD
Remote Command	:DISPlay:OBWidth:VIEW[:SElect] OBWResults BOUNDaries :DISPlay:OBWidth:VIEW[:SElect]?
Example	DISP:OBW:VIEW OBWR DISP:OBW:VIEW?
Preset	OBWResults
State Saved	Saved in instrument state
Range	OBWResults BOUNDaries
Initial S/W Revision	A.16.00

View Selection by Number

Key Path	SCPI only
Mode	SA, WCDMA, C2K, 1xEV-DO, WIMAX OFDMA, TD-SCDMA, DVB-T/H, LTE, LTEFDD, LTEATDD, LTEATDD
Remote Command	:DISPlay:OBWidth:VIEW:NSElect <integer> :DISPlay:OBWidth:VIEW:NSElect?
Example	DISP:OBW:VIEW:NSEL 2 DISP:OBW:VIEW:NSEL?
Preset	1
State Saved	Saved in instrument state
Min	1
Max	2
Initial S/W Revision	A.16.00

OBW Results

The spectrum trace is displayed in the upper window. Measurement results such as Occupied Bandwidth or Power are displayed in the lower window. For more details, and samples of screen content for each supported mode, see ["Spectrum View" on page 911](#) below.

The following result descriptions are available:

Occupied Bandwidth

The occupied bandwidth result is $f_2 - f_1$, where f_1 and f_2 are the lower and upper carrier boundary point. f_1 and f_2 are calculated with a Occupied Bandwidth algorithms.

Total Power or OBW Power

The total power is the power integrated in the specified span setting. The OBW power is calculated from multiplying the total power by OBW percent power. The user can select the total power or the OBW power with the Power Ref key in Meas Setup.

Transmit Freq Error

The transmit freq error (transmit frequency error) result is calculated as the difference between $(f_2+f_1)/2$ and the tuned center frequency of the signal, where f_1 and f_2 are the lower and upper carrier boundary point.

x dB Bandwidth

The x dB result is a bandwidth measured between two points on the signal which are a certain number of dBs down from the highest signal point within the OBW Span. For example, If the 'x dB' parameter is set to -26 dB, and the 'Occupied BW Span' is set to 10 MHz, then the maximum signal power level is first determined from the 10 MHz wide trace sweep. Next, the two furthest frequencies below (x_{db_f1}) and above (x_{db_f2}) the frequency of the maximum level occurrence are found where the signal level is 26 dB below the peak level. This calculation also uses linear interpolation to find the lower and upper carrier boundary point within the width of a sweep point (the span divided by the number of sweep points).

The x dB bandwidth is calculated to be $x_{db_f2} - x_{db_f1}$.

% of OBW Power

This is the setting parameter. See ["Occ BW % Pwr" on page 791](#).

x dB

This is the setting parameter. See ["x dB" on page 792](#).

OBW Boundaries

The lower window of OBW Results view is replaced with the OBW boundaries table. Occupied bandwidth and X dB bandwidth for both lower and upper boundaries are displayed.

Occupied Bandwidth

See ["OBW Results" on page 911](#) above.

Total Power or OBW Power

See ["OBW Results" on page 911](#) above.

x dB

This is the setting parameter. See ["x dB" on page 792](#).

x dB Ref Pwr The x dB reference power result shows the power of the highest signal point within the OBW Span. **x dB At Freq** The x dB reference power frequency result shows the frequency of the highest signal point within the OBW Span. They are switched when Boundary Frequency in View/Display is changed.

Spectrum View

For SA, WCDMA, C2K, 1xEVDO, WIMAX OFDMA, WLAN modes:

9 Occupied Bandwidth Measurement Display

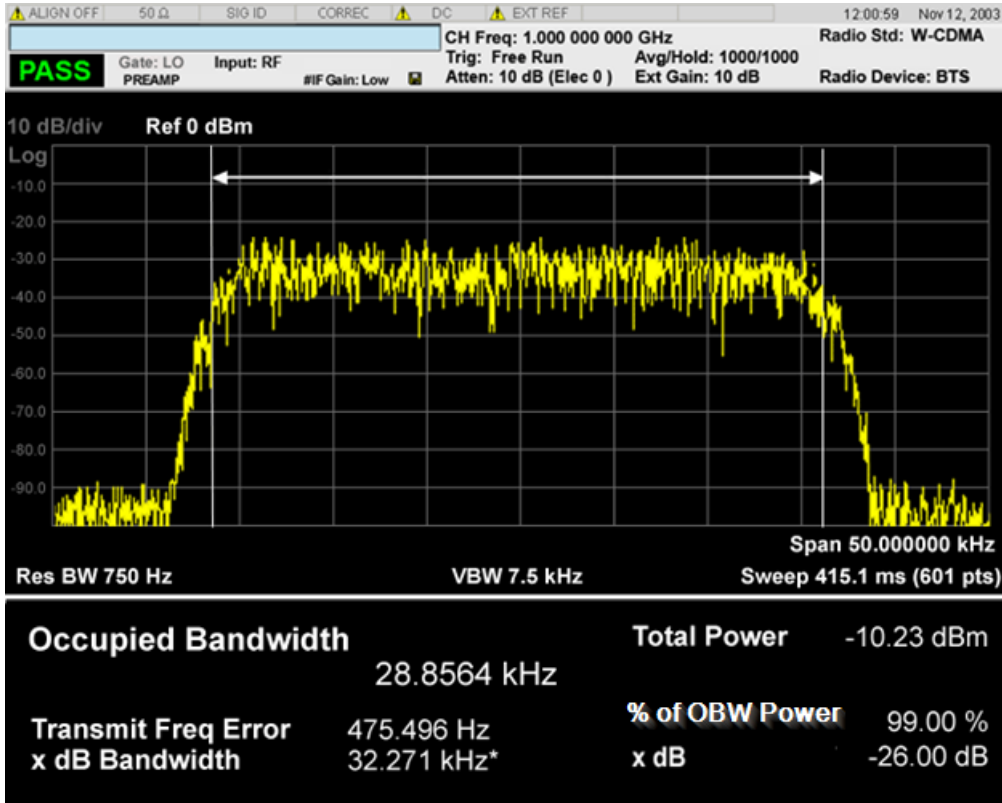

For TD-SCDMA mode only:

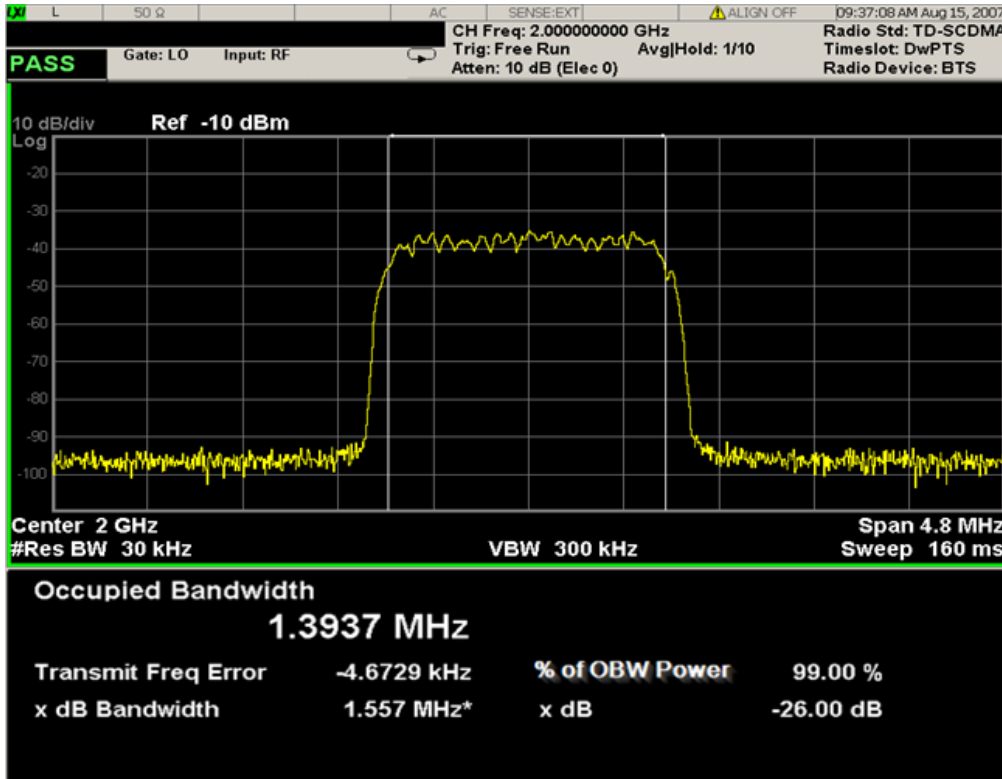

For Bluetooth mode only:

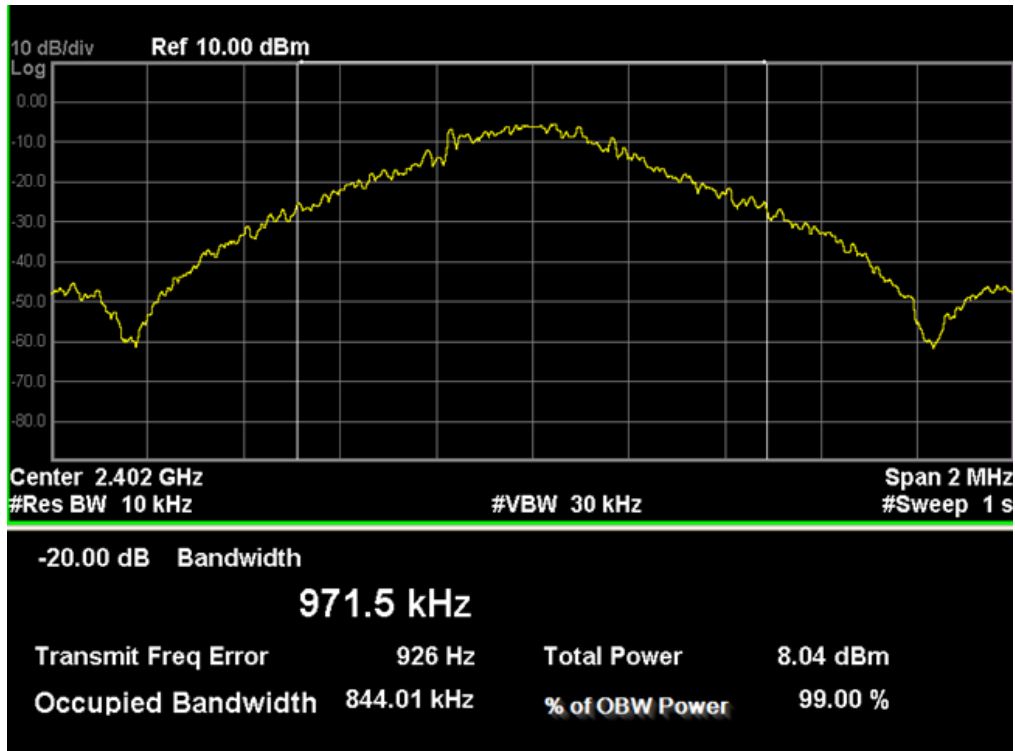

For MSR mode only:

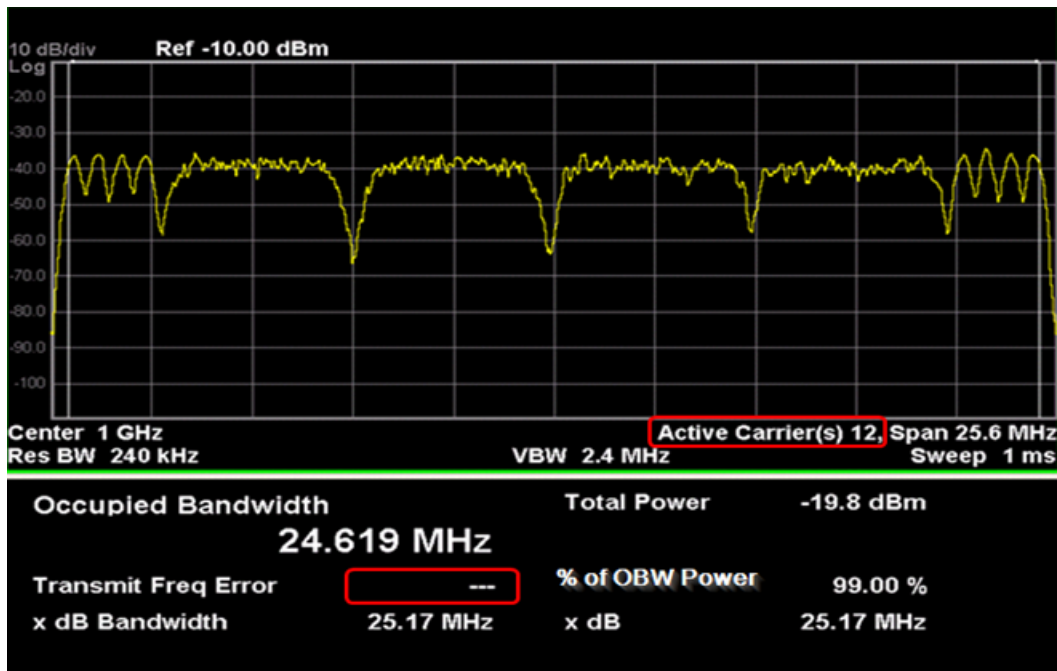

The number of active carriers is displayed. Since span is determined from detected carriers in auto mode, it is necessary to show how many carriers are identified as active., as highlighted above.

When there is one active carrier, Transmit Freq Error is displayed. Otherwise, “---” is displayed, as shown above.

For LTE-Advanced FDD/TDD mode only:

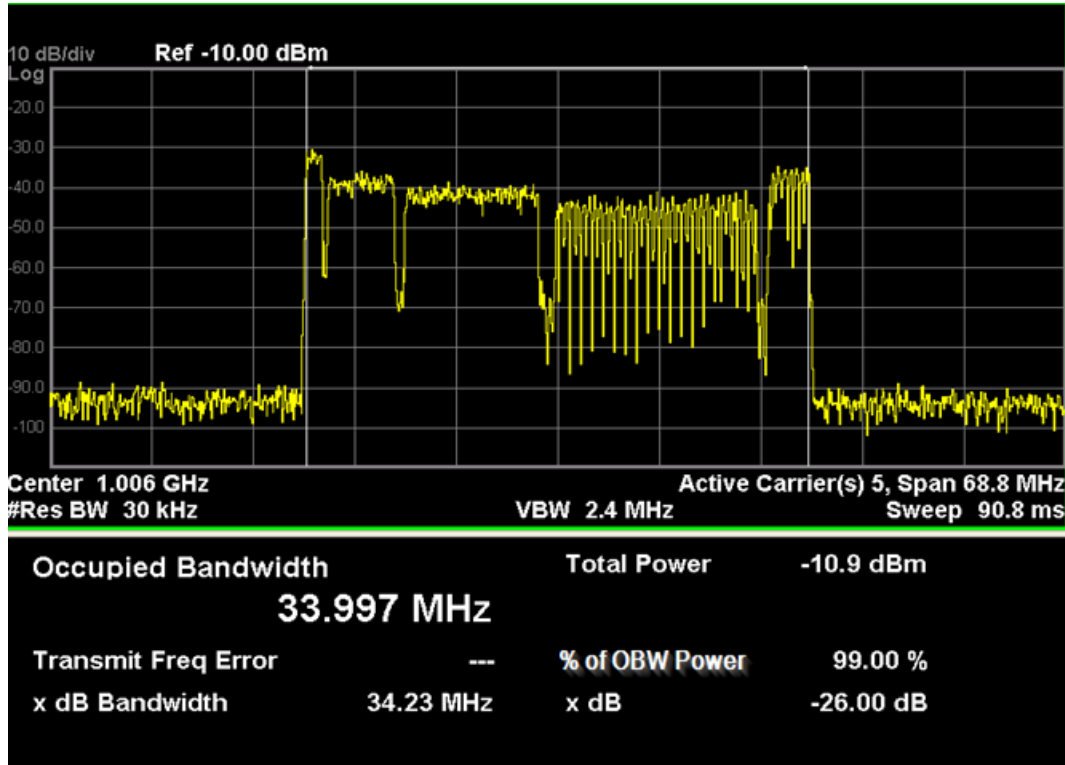

The number of active carriers is displayed to show how many carriers are identified as active in auto detected mode of span, otherwise “-” is displayed to indicate that it is out of scope.

When there is one active carrier, Transmit Freq Error is displayed. Otherwise, “---” is displayed.

OBW Boundaries Results

Name	Corresponding Results
Lower OBW boundary - offset frequency [Hz]	Offset frequency of the lower OBW boundary from center frequency
Lower OBW boundary - absolute power [dB]	Absolute power on the point of lower OBW boundary
Lower OBW boundary - relative power [dBc]	Relative power on the point of lower OBW boundary
Upper OBW boundary - offset frequency [Hz]	Offset frequency of the upper OBW boundary from center frequency
Upper OBW boundary - absolute power [dB]	Absolute power on the point of upper OBW boundary
Upper OBW boundary - relative power [dBc]	Relative power on the point of upper OBW boundary

Name	Corresponding Results
Lower x dB BW boundary - offset frequency [Hz]	Offset frequency of the lower x dB BW boundary from center frequency
Lower x dB BW boundary - absolute power [dB]	Absolute power on the point of lower x dB BW boundary
Upper x dB BW boundary - offset frequency [Hz]	Offset frequency of the lower x dB BW boundary from center frequency
Upper x dB BW boundary - absolute power [dB]	Absolute power on the point of lower x dB BW boundary

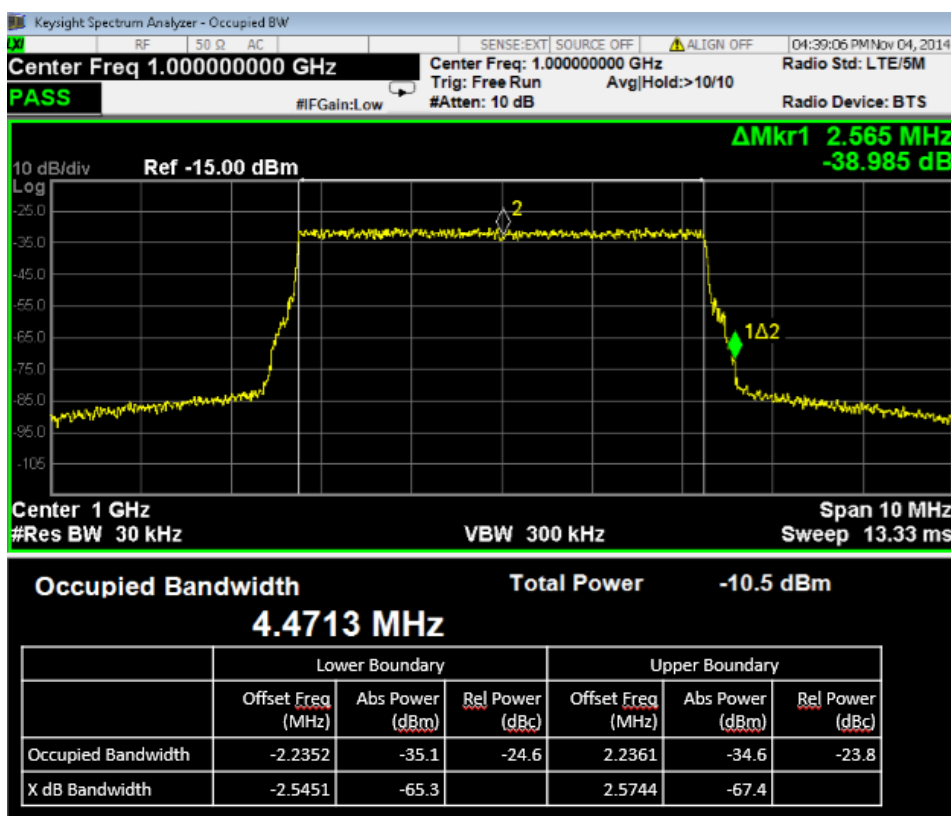

Boundary Frequency

Selects frequency display type from either Offset or Absolute:

- **OFFSet**: offsets from Center Freq to OBW boundary frequency are displayed.
- **ABSolute**: absolute frequencies are displayed.

Key Path	View/Display, OBW Boundaries
Remote Command	:DISPlay:OBwidth:VIEW2:WINDow2:BOUNDaries:FREquency OFFSet ABSolute
	:DISPlay:OBwidth:VIEW2:WINDow2:BOUNDaries:FREquency?

Example	DISP:OBW:VIEW2:WIND2:BOUN:FREQ ABS DISP:OBW:VIEW2:WIND2:BOUN:FREQ?
Preset	OFFSet
State Saved	Saved in instrument state
Range	Offset Absolute
Initial S/W Revision	A.16.00

x dB BW Boundaries

Turns the x dB BW Boundaries On and Off.

Key Path	View/Display
Remote Command	:DISPlay:OBWidth:VIEW:WINDow[1]:XDB 0 1 OFF ON :DISPlay:OBWidth:VIEW:WINDow[1]:XDB?
Example	DISP:OBW:VIEW:WIND:XDB 1 DISP:OBW:VIEW:WIND:XDB?
Preset	0
State Saved	Saved in instrument state
Range	On Off
Initial S/W Revision	A.16.00

10 ACP Measurement

ACP is a measurement of the amount of interference, or power, in an adjacent frequency channel. The results are displayed as a bar graph or as spectrum data, with measurement data at specified offsets. For measurement results and views, see ["View/Display" on page 1173](#).

This topic contains the following sections:

["Measurement Commands for ACP" on page 918](#)

["Remote Command Results for ACP Measurement" on page 919](#)

Measurement Commands for ACP

The following commands are used to retrieve the measurement results:

```
:CONFigure:ACP  
:CONFigure:ACP:NDEFault  
:INITiate:ACP  
:FETCh:ACP [n] ?  
:READ:ACP [n] ?  
:MEASure:ACP [n] ?
```

For more measurement related commands, see the SENSE subsystem, and the section "[Remote Measurement Functions](#)" on page 2381.

Remote Command Results for ACP Measurement

Condition	N	Results Returned
Mode = SA mode, Radio Std = None, Number of carriers = 1 and only offset A is on	Not specified or n = 1	Returns 3 comma-separated values that correspond to: Reference carrier power, lower-adjacent channel power (dBc), and upper-adjacent channel power (dBc).
Mode = DTMB (CTTB) or CMMB, Radio BW = 8 MHz, Number of carriers = 1 and Meas Type = Total power reference	Not specified or n = 1	Returns 32 comma-separated scalar results, in the following order. 1. 0.0 2. Total carrier power (dBm) 3. 0.0 4. Reference carrier power (dBm) 5. Lower offset A - relative power (dB) 6. Lower offset A - absolute power (dBm) 7. Upper offset A - relative power (dB) 8. Upper offset A - absolute power (dBm) 9. Lower offset B - relative power (dB) 10. Lower offset B - absolute power (dBm) 11. Upper offset B - relative power (dB) 12. Upper offset B - absolute power (dBm) ... 25. Lower offset F - relative power (dB) 26. Lower offset F - absolute power (dBm) 27. Upper offset F - relative power (dB) 28. Upper offset F - absolute power (dBm) 29. Inside Adjacent Channel - relative power (dB) 30. Inside Adjacent Channel - absolute power (dBm) 31. Outside Adjacent Channel - relative power (dB) 32. Outside Adjacent Channel - absolute power (dBm) If Radio Device = Exciter, the last four (29, 30, 31 and 32) results returned -999.0. If the results are not available, -999.0 is returned. Note: * Inside Adjacent Channel - absolute power: the maximum of the Lower offset A - absolute power and the Upper offset A - absolute power; ** Inside Adjacent Channel - relative power: the result of Reference carrier power subtracted from Inside Adjacent Channel - absolute power; *** Outside Adjacent Channel - absolute power: the root mean square of the absolute power of the offset B upper/lower, the offset C upper/lower and the offset D upper/lower; **** Outside Adjacent Channel - relative power: the result of Reference carrier power subtracted from Outside Adjacent Channel - absolute power;
Mode = DTMB (CTTB) or	not specified	Returns 32 comma-separated scalar results, in the following order.

Condition	N	Results Returned
CMMB, Radio BW = 8 MHz, Number of carriers = 1 and Meas Type = Power spectral density reference	or n = 1	<ol style="list-style-type: none"> 1. 0.0 2. Total carrier power (dBm/Hz or dBm/MHz) 3. 0.0 4. Reference carrier power (dBm/Hz or dBm/MHz) 5. Lower offset A - relative power (dB) 6. Lower offset A - absolute power (dBm/Hz or dBm/MHz) 7. Upper offset A - relative power (dB) 8. Upper offset A - absolute power (dBm/Hz or dBm/MHz) 9. Lower offset B - relative power (dB) 10. Lower offset B - absolute power (dBm/Hz or dBm/MHz) 11. Upper offset B - relative power (dB) 12. Upper offset B - absolute power (dBm/Hz or dBm/MHz) ... 25. Lower offset F - relative power (dB) 26. Lower offset F - absolute power (dBm/Hz or dBm/MHz) 27. Upper offset F - relative power (dB) 28. Upper offset F - absolute power (dBm/Hz or dBm/MHz) 29. -999.0 30. -999.0 31. -999.0 32. -999.0 <p>The last four (29, 30, 31 and 32) results always returned -999.0. If the results are not available, -999.0 is returned.</p>
Meas Type = Total power reference	Not specified or n = 1	<p>Returns 28 comma-separated scalar results, in the following order.</p> <ol style="list-style-type: none"> 1. 0.0 2. Total carrier power (dBm) 3. 0.0 4. Reference carrier power (dBm) 5. Lower offset A - relative power (dB) 6. Lower offset A - absolute power (dBm) 7. Upper offset A - relative power (dB) 8. Upper offset A - absolute power (dBm) 9. Lower offset B - relative power (dB) 10. Lower offset B - absolute power (dBm) 11. Upper offset B - relative power (dB) 12. Upper offset B - absolute power (dBm) ... 25. Lower offset F - relative power (dB) 26. Lower offset F - absolute power (dBm)

Condition	N	Results Returned
		27. Upper offset F - relative power (dB) 28. Upper offset F - absolute power (dBm) If the results are not available, -999.0 is returned. When in MSR and LTE-Advanced FDD/TDD, this trace includes only outer offset results and their reference value(s).
Meas Type = Power spectral density reference	not specified or n = 1	Returns 28 comma-separated scalar results, in the following order. 1. 0.0 2. Total carrier power (dBm/Hz or dBm/MHz) 3. 0.0 4. Reference carrier power (dBm/Hz or dBm/MHz) 5. Lower offset A - relative power (dB) 6. Lower offset A - absolute power (dBm/Hz or dBm/MHz) 7. Upper offset A - relative power (dB) 8. Upper offset A - absolute power (dBm/Hz or dBm/MHz) 9. Lower offset B - relative power (dB) 10. Lower offset B - absolute power (dBm/Hz or dBm/MHz) 11. Upper offset B - relative power (dB) 12. Upper offset B - absolute power (dBm/Hz or dBm/MHz) ... 25. Lower offset F - relative power (dB) 26. Lower offset F - absolute power (dBm/Hz or dBm/MHz) 27. Upper offset F - relative power (dB) 28. Upper offset F - absolute power (dBm/Hz or dBm/MHz) If the results are not available, -999.0 is returned. When in MSR and LTE-Advanced FDD/TDD, this trace includes only outer offset results and their reference value(s).
Meas Method = FAST	not specified or n = 1	Returns 5 comma-separated results, in the following order: 1. Reference carrier - absolute power (dBm) 2. Lower offset A - absolute power (dBm) 3. Upper offset A - absolute power (dBm) 4. Lower offset B - absolute power (dBm) 5. Upper offset B - absolute power (dBm)
Mode = MSR , LTEAFDD, LTEATDD, Meas Type = Total power reference and Power Ref = Left & Right Carriers	Not specified or n = 1	Returns 28 comma-separated scalar results, in the following order. 1. 0.0 2. Total carrier power (dBm) 3. Left Reference carrier power (dBm) 4. Right Reference carrier power (dBm) 5. Lower offset A - relative power (dB) 6. Lower offset A - absolute power (dBm) 7. Upper offset A - relative power (dB)

Condition	N	Results Returned
		8. Upper offset A - absolute power (dBm) 9. Lower offset B - relative power (dB) 10. Lower offset B - absolute power (dBm) 11. Upper offset B - relative power (dB) 12. Upper offset B - absolute power (dBm) ... 25. Lower offset F - relative power (dB) 26. Lower offset F - absolute power (dBm) 27. Upper offset F - relative power (dB) 28. Upper offset F - absolute power (dBm) If the results are not available, -999.0 is returned.
Mode = MSR , LTEAFDD, LTEATDD, Meas Type = Power spectral density reference and Power Ref = Left & Right Carriers	not specified or n = 1	Returns 28 comma-separated scalar results, in the following order. 1. 0.0 2. Total carrier power (dBm/Hz or dBm/MHz) 3. Left reference carrier power (dBm/Hz or dBm/MHz) 4. Right reference carrier power (dBm/Hz or dBm/MHz) 5. Lower offset A - relative power (dB) 6. Lower offset A - absolute power (dBm/Hz or dBm/MHz) 7. Upper offset A - relative power (dB) 8. Upper offset A - absolute power (dBm/Hz or dBm/MHz) 9. Lower offset B - relative power (dB) 10. Lower offset B - absolute power (dBm/Hz or dBm/MHz) 11. Upper offset B - relative power (dB) 12. Upper offset B - absolute power (dBm/Hz or dBm/MHz) ... 25. Lower offset F - relative power (dB) 26. Lower offset F - absolute power (dBm/Hz or dBm/MHz) 27. Upper offset F - relative power (dB) 28. Upper offset F - absolute power (dBm/Hz or dBm/MHz) If the results are not available, -999.0 is returned. When in MSR and LTE-Advanced FDD/TDD, this trace includes only outer offset results and their reference value(s).
Meas Type = Total power reference	n = 2	Returns 48 scalar results, in the following order: 1. Channel (1) - relative power (dB) 2. Channel (1) - absolute power (dBm) 3. Channel (2) - relative power (dB) 4. Channel (2) - absolute power (dBm) ... 23. Channel (12) - relative power (dB) 24. Channel (12) - absolute power (dBm)

Condition	N	Results Returned
		25. Lower offset A - relative power (dB) 26. Lower offset A - absolute power (dBm) 27. Upper offset A - relative power (dB) 28. Upper offset A - absolute power (dBm) 29. Lower offset B - relative power (dB) 30. Lower offset B - absolute power (dBm) 31. Upper offset B - relative power (dB) 32. Upper offset B - absolute power (dBm) ... 45. Lower offset F - relative power (dB) 46. Lower offset F - absolute power (dBm) 47. Upper offset F - relative power (dB) 48. Upper offset F - absolute power (dBm) If the results are not available, -999.0 is returned. When in MSR and LTE-Advanced FDD/TDD, this trace includes only outer offset results and their reference value(s).
Meas Type = Power spectral density reference	n = 2	Returns 48 scalar results, in the following order: 1. Channel (1) - relative power (dB) 2. Channel (1) - absolute power (dBm/Hz or dBm/MHz) 3. Channel (2) - relative power (dB) 4. Channel (2) - absolute power (dBm/Hz or dBm/MHz) ... 23. Channel (12) - relative power (dB) 24. Channel (12) - absolute power (dBm/Hz or dBm/MHz) 25. Lower offset A - relative power (dB) 26. Lower offset A - absolute power (dBm/Hz or dBm/MHz) 27. Upper offset A - relative power (dB) 28. Upper offset A - absolute power (dBm/Hz or dBm/MHz) 29. Lower offset B - relative power (dB) 30. Lower offset B - absolute power (dBm/Hz or dBm/MHz) 31. Upper offset B - relative power (dB) 32. Upper offset B - absolute power (dBm/Hz or dBm/MHz) ... 45. Lower offset F - relative power (dB) 46. Lower offset F - absolute power (dBm/Hz or dBm/MHz) 47. Upper offset F - relative power (dB) 48. Upper offset F - absolute power (dBm/Hz or dBm/MHz) If the results are not available, -999.0 is returned. When in MSR and LTE-Advanced FDD/TDD, this trace includes only outer offset

Condition	N	Results Returned
Mode = DTMB (CTTB) or CMMB, Radio BW = 8 MHz and Meas Type = Total power reference	n = 3	<p>results.</p> <hr/> <p>Returns 28 scalar values of the pass/fail (0 = passed, or 1 = failed) determined by testing the relative to the reference carrier and by testing the absolute power limit of the offset frequencies (measured as total power in dB):</p> <ol style="list-style-type: none"> 1. Lower offset A - relative limit result 2. Lower offset A - absolute limit result 3. Upper offset A - relative limit result 4. Upper offset A - absolute limit result 5. Lower offset B - relative limit result 6. Lower offset B - absolute limit result 7. Upper offset B - relative limit result 8. Upper offset B - absolute limit result <p>...</p> <ol style="list-style-type: none"> 21. Lower offset F - relative limit result 22. Lower offset F - absolute limit result 23. Upper offset F - relative limit result 24. Upper offset F - absolute limit result 25. Inside Adjacent Channel - relative limit result 26. Inside Adjacent Channel - absolute limit result 27. Outside Adjacent Channel - relative limit result 28. Outside Adjacent Channel - absolute limit result <p>If Radio Device = Exciter, the last four (25, 26, 27 and 28) results returned -999.0.</p>
Mode = DTMB (CTTB) or CMMB, Radio BW = 8 MHz and Meas Type = Power spectral density reference	n = 3	<p>Returns 28 scalar values of the pass/fail (0 = passed, or 1 = failed) determined by testing the relative to the reference carrier and by testing the absolute power limit of the offset frequencies (measured as power spectral density in dB):</p> <ol style="list-style-type: none"> 1. Lower offset A - relative limit result 2. Lower offset A - absolute limit result 3. Upper offset A - relative limit result 4. Upper offset A - absolute limit result 5. Lower offset B - relative limit result 6. Lower offset B - absolute limit result 7. Upper offset B - relative limit result 8. Upper offset B - absolute limit result <p>...</p> <ol style="list-style-type: none"> 21. Lower offset F - relative limit result 22. Lower offset F - absolute limit result 23. Upper offset F - relative limit result 24. Upper offset F - absolute limit result 25. -999.0

Condition	N	Results Returned
		26. -999.0 27. -999.0 28. -999.0 The last four results always returned -999.0.
Meas Type = Total power reference	n = 3	Returns 24 scalar values of the pass/fail (0 = passed, or 1 = failed) determined by testing the relative to the reference carrier and by testing the absolute power limit of the offset frequencies (measured as total power in dB): 1. Lower offset A - relative limit result 2. Lower offset A - absolute limit result 3. Upper offset A - relative limit result 4. Upper offset A - absolute limit result 5. Lower offset B - relative limit result 6. Lower offset B - absolute limit result 7. Upper offset B - relative limit result 8. Upper offset B - absolute limit result ... 21 Lower offset F - relative limit result 22 Lower offset F - absolute limit result 23 Upper offset F - relative limit result 24 Upper offset F - absolute limit result When in MSR and LTE-Advanced FDD/TDD, this trace includes only outer offset results.
Meas Type = Power spectral density reference	n = 3	Returns 24 scalar values of the pass/fail (0 = passed, or 1 = failed) determined by testing the relative to the reference carrier and by testing the absolute power limit of the offset frequencies (measured as power spectral density in dB): 1. Lower offset A - relative limit result 2. Lower offset A - absolute limit result 3. Upper offset A - relative limit result 4. Upper offset A - absolute limit result 5. Lower offset B - relative limit result 6. Lower offset B - absolute limit result 7. Upper offset B - relative limit result 8. Upper offset B - absolute limit result ... 21 Lower offset F - relative limit result 22 Lower offset F - absolute limit result 23 Upper offset F - relative limit result 24 Upper offset F - absolute limit result When in MSR and LTE-Advanced FDD/TDD, this trace includes only outer offset results.

Condition	N	Results Returned
	n = 4	Returns <Num Pts> comma-separated scalar values representing the Y values in Trace 1
	n = 5	Returns <Num Pts> comma-separated scalar values representing the Y values in Trace 2
	n = 6	Returns <Num Pts> comma-separated scalar values representing the Y values in Trace 3
Meas Type = Total power reference	n = 7	<p>Returns (2 * Number of Carriers) scalar results, in the following order:</p> <p>The Number of Carriers is the value filled in Carriers under Carrier Setup menu. If license N9060A-5FP is enabled, max value of Number of Carriers is 18, otherwise, max value of Number of Carriers is 12. In MSR mode, max value of Number of Carriers is 100. In LTE-Advanced FDD/TDD mode, max value of number of carriers is 5.</p> <ol style="list-style-type: none"> 1. Channel (1) - relative power (dB) 2. Channel (1) - absolute power (dBm) 3. Channel (2) - relative power (dB) 4. Channel (2) - absolute power (dBm) <p>...</p> <p>2 * Number of Carriers -1. Channel (Number of Carriers) - relative power (dB)</p> <p>2 * Number of Carriers. Channel (Number of Carriers) - absolute power (dBm)</p> <p>If the results are not available, 9.91E+37 is returned.</p>
Meas Type = Power spectral density reference	n = 7	<p>Returns (2 * Number of Carriers) scalar results, in the following order: The Number of Carriers is the value filled in Carriers under Carrier Setup menu.</p> <p>If license N9060A-5FP is enabled, max value of Number of Carriers is 18, otherwise, max value of Number of Carriers is 12. In MSR mode, max value of Number of Carriers is 100. In LTE-Advanced FDD/TDD mode, max value of number of carriers is 5.</p> <ol style="list-style-type: none"> 1. Channel (1) - relative power (dB) 2. Channel (1) - absolute power (dBm/Hz or dBm/MHz) 3. Channel (2) - relative power (dB) 4. Channel (2) - absolute power (dBm/Hz or dBm/MHz) <p>...</p> <p>2 * Number of Carriers -1. Channel (Number of Carriers) - relative power (dB)</p> <p>2 * Number of Carriers. Channel (Number of Carriers) - absolute power (dBm/Hz or dBm/MHz)</p> <p>If the results are not available, 9.91E+37 is returned</p>
Mode = MSR,LTEAFDD,LTEATDD	n = 8	<p>Returns scalar results, in the following order:</p> <ol style="list-style-type: none"> 1. 0.0 2. Total carrier power (dBm) 3. 0.0

Condition	N	Results Returned
		<p>4. Reference carrier power (dBm, dBm/Hz or dBm/MHz)</p> <p>5. Inner Lower offset A - relative power (dB)</p> <p>6. Inner Lower offset A - absolute power (dBm, dBm/Hz or dBm/MHz)</p> <p>7. Inner Upper offset A - relative power (dB)</p> <p>8. Inner Upper offset A - absolute power (dBm, dBm/Hz or dBm/MHz)</p> <p>9. Inner Lower offset B - relative power (dB)</p> <p>10. Inner Lower offset B - absolute power (dBm, dBm/Hz or dBm/MHz)</p> <p>11. Inner Upper offset B - relative power (dB)</p> <p>12. Inner Upper offset B - absolute power (dBm, dBm/Hz or dBm/MHz)</p> <p>...</p> <p>25. Inner Lower offset F - relative power (dB)</p> <p>26. Inner Lower offset F - absolute power (dBm, dBm/Hz or dBm/MHz)</p> <p>27. Inner Upper offset F - relative power (dB)</p> <p>28. Inner Upper offset F - absolute power (dBm, dBm/Hz or dBm/MHz)</p> <p>When Power Ref is either Left & Right Carriers or Max Power Carrier in Sub-block, the first four values are</p> <p>1. 0.0</p> <p>2. Total carrier power (dBm)</p> <p>3. Reference carrier in the lower sub-block (dBm, dBm/Hz or dBm/MHz)</p> <p>4. Reference carrier in the upper sub-block (dBm, dBm/Hz or dBm/MHz)</p> <p>Unit of absolute power results.</p> <p>dBm: Meas Type = Total Pwr Ref</p> <p>dBm/Hz: Meas Type = PSD Ref, PSD Unit = dBm/Hz</p> <p>dBm/MHz: Meas Type = PSD Ref, PSD Unit = dBm/MHz</p> <p>If the results are not available, 9.91E+37 is returned.</p>
Mode = MSR, LTEAFDD,LTEATDD	n = 9	<p>Returns scalar values of the pass/fail (0 = passed, or 1 = failed) determined by testing the relative to the reference carrier and by testing the absolute power limit of the offset frequencies.</p> <p>1. Inner Lower offset A - relative limit result</p> <p>2. Inner Lower offset A - absolute limit result</p> <p>3. Inner Upper offset A - relative limit result</p> <p>4. Inner Upper offset A - absolute limit result</p> <p>5. Inner Lower offset B - relative limit result</p> <p>6. Inner Lower offset B - absolute limit result</p> <p>7. Inner Upper offset B - relative limit result</p> <p>8. Inner Upper offset B - absolute limit result</p> <p>...</p> <p>21. Inner Lower offset F - relative limit result</p> <p>22. Inner Lower offset F - absolute limit result</p> <p>23. Inner Upper offset F - relative limit result</p>

Condition	N	Results Returned
		24. Inner Upper offset F - absolute limit result
Mode = MSR, LTEAFDD,LTEATDD	n = 10	<p>Returns scalar values of offset results. Numbers returned in this trace is 10 x actually measured offsets. Note that upper and lower sides of an offset are returned separately. For example, when only outer offset A is measured with offset side both, $10 \times 2 = 20$ values are returned.</p> <ol style="list-style-type: none"> 1. Inner = 1 or Outer = 2. 2. Offset A~F. (A=1, B=2, ... F=6) 3. Offset Side. Lower=1 or Upper=2 4. Relative power or relative PSD (dBc or dB) 5. Absolute power (dBm) or absolute PSD (dBm/Hz or dBm/MHz) 6. Reference power (dBm) or reference PSD (dBm/Hz or dBm/MHz) 7. Reference Index 1 8. Reference Index 2 9. 0 (Reserved) 10. 0 (Reserved) <p>...</p> <ol style="list-style-type: none"> 10(n-1)+1. Inner = 1 or Outer = 2. 10(n-1)+2. Offset A~F. (A=1, B=2, ... F=6) 10(n-1)+3. Offset Side. Lower=1 or Upper=2 10(n-1)+4. Relative power or relative PSD (dBc or dB) 10(n-1)+5. Absolute power (dBm) or absolute PSD (dBm/Hz or dBm/MHz) 10(n-1)+6. Reference power (dBm) or reference PSD (dBm/Hz or dBm/MHz) 10(n-1)+7. Reference Index 1 10(n-1)+8. Reference Index 2 10(n-1)+9. 0 (Reserved) 10(n-1)+10. 0 (Reserved) <p>Where n is number of offsets.</p> <p>Meas Type determines which type of power result is returned, i.e. power or PSD. Unit for PSD results is determined by PSD Unit.</p> <p>If result is not available, 9.91E+37 is returned.</p>

Key Path	Front-panel key
Initial S/W Revision	Prior to A.02.00
Modified at S/W Revision	A.13.00

AMPTD Y Scale

Accesses a menu of functions that enable you to set the vertical scale parameters. The parameter values are measurement independent, except all Attenuation values and the Internal Preamp selections, which are the same across all measurements.

Key Path	Front-panel key
Initial S/W Revision	Prior to A.02.00

Ref Value

Sets the value for the absolute power reference. However, since the Auto Scaling is defaulted to On, this value is automatically determined by the measurement result. When you set a value manually, Auto Scaling automatically changes to Off.

Key Path	AMPTD Y Scale
Mode	SA, WCDMA, C2K, WIMAX OFDMA, TD-SCDMA, 1xEVDO, DVB-T/H, DTMB (CTTB), ISDB-T, CMMB, LTE, LTE-TDD, Digital Cable TV, MSR, LTEAFDD, LTEATDD
Remote Command	:DISPlay:ACPower:VIEW[1]:WINDow[1]:TRACe:Y[:SCALE]:RLEVel <real> :DISPlay:ACPower:VIEW[1]:WINDow[1]:TRACe:Y[:SCALE]:RLEVel?
Example	DISP:ACP:VIEW:WIND:TRAC:Y:RLEV 100 DISP:ACP:VIEW:WIND:TRAC:Y:RLEV?
Notes	You must be in the mode that includes ACP measurements to use this command. Use :INSTrument:SElect to set the mode.
Couplings	When the Auto Scaling is On, this value is automatically determined by the measurement result. When you set a value manually, Auto Scaling automatically changes to Off.
Preset	10dBm
State Saved	Saved in instrument state.
Min	-250.00 dBm
Max	250.00 dBm
Initial S/W Revision	Prior to A.02.00
Modified at S/W Revision	A.02.00, A.03.00

Attenuation

This menu controls the attenuator functions and interactions between the attenuation system components.

There are two attenuator configurations in the X-Series. One is a dual attenuator configuration consisting of a mechanical attenuator and an optional electronic attenuator. The other configuration uses a single attenuator with combined mechanical and electronic sections that controls all the attenuation functions. Different models in the X-Series come with different configurations.

See "[Dual Attenuator Configurations:](#)" on page 930

See "Single Attenuator Configuration:" on page 931

Most Attenuation settings are the same for all measurements – they do not change as you change measurements. Settings like these are called “Meas Global” and are unaffected by Meas Preset.

Key Path	AMPTD Y Scale
Scope	Meas Global
Dependencies	In measurements that support the I/Q inputs, this key is unavailable when I/Q is the selected input, and is replaced by the Range key in that case.
Readback Line	Contains a summary in [] brackets of the current total attenuation. See the descriptions of the , " (Mech) Atten " on page 2297, and " Enable Elec Atten " on page 2299 keys for more detail on the contributors to the total attenuation. Note that when "Pre-Adjust for Min Clip" is on, this value can change at the start of every measurement.
Initial S/W Revision	Prior to A.02.00
Modified at S/W Revision	A.03.00

Dual Attenuator Configurations:

Configuration 1: Mechanical attenuator + optional electronic attenuator

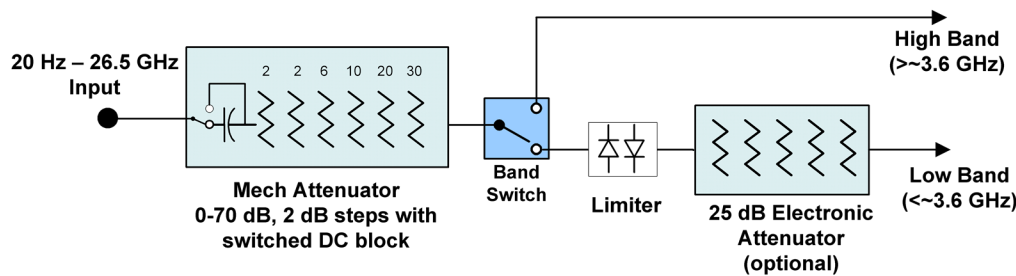

Configuration 2: Mechanical attenuator, no optional electronic attenuator

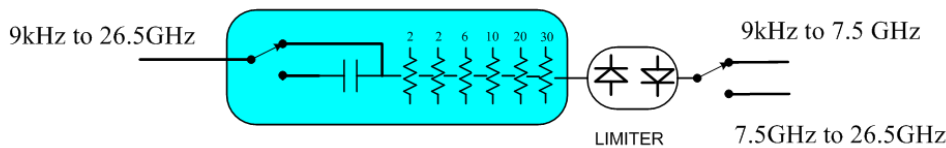

(note that Configuration 2 is not strictly speaking a dual-section attenuator, since there is no electronic section available. However, it behaves exactly like Configuration 1 without the Electronic Attenuator option EA3, therefore for the sake of this document it is grouped into the “Dual Attenuator” configuration)

Single Attenuator Configuration:

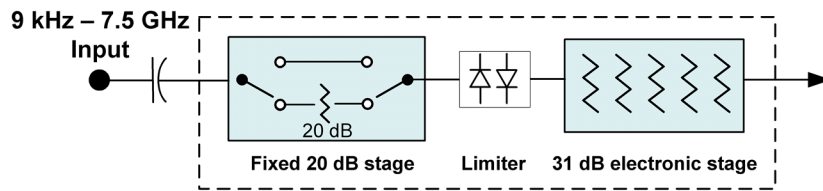

You can tell which attenuator configuration you have by pressing the Attenuation key, which (in most Modes) opens the Attenuation menu. If the first key in the Attenuation menu says **Mech Atten** you have the dual attenuator configuration. If the first key says **Atten** you have the single attenuator configuration.

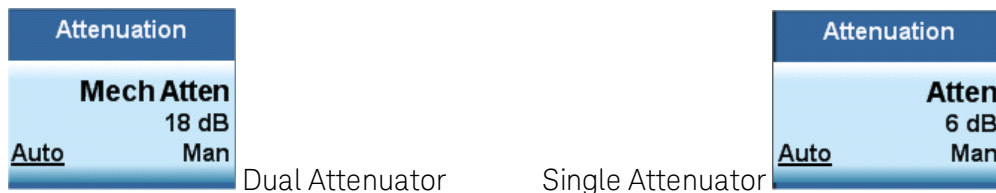

In the single attenuator configuration, you control the attenuation with a single control, as the fixed stage has only two states. In the dual attenuator configuration, both stages have significant range so you are given separate control of the mechanical and electronic attenuator stages.

When you have the dual attenuator configuration, you may still have only a single attenuator, because unless option EA3 (the Electronic Attenuator option) is available, and you purchase it, you will have only the mechanical attenuator.

(Mech) Atten

This key is labeled **Mech Atten** in dual attenuator models and **Atten** in single attenuator models. In the dual attenuator configuration, this key only affects the mechanical attenuator.

This key lets you modify the attenuation applied to the RF input signal path. This value is normally auto coupled to the Ref Level, the Internal Preamp Gain, any External Gain that is entered, and the Max Mixer Level, as described in the table below.

See "[Attenuator Configurations and Auto/Man](#)" on page 933

Key Path	AMPTD Y Scale, Attenuation
Remote Command	<pre>[:SENSe]:POWer[:RF]:ATTenuation <rel_amp1></pre> <pre>[:SENSe]:POWer[:RF]:ATTenuation?</pre> <pre>[:SENSe]:POWer[:RF]:ATTenuation:AUTO OFF ON 0 1</pre> <pre>[:SENSe]:POWer[:RF]:ATTenuation:AUTO?</pre>
Example	<p>POW:ATT 20</p> <p>Dual attenuator configuration: sets the mechanical attenuator to 20 dB</p> <p>Single attenuator mode: sets the main attenuation to 20 dB (see below for definition of "main" attenuation).</p> <p>If the attenuator was in Auto, it sets it to Manual.</p>
Dependencies	Some measurements do not support the Auto setting of (Mech) Atten . In these measurements, the

Auto/Man selection is not available, and the Auto/Man line on the key disappears.

In dual attenuator configurations, when the electronic attenuator is enabled, the mechanical attenuator has no auto setting and the Auto/Man line on the key disappears. The state of Auto/Man is remembered and restored when the electronic attenuator is once again disabled. This is described in more detail in the ["Enable Elec Atten" on page 2299](#) key description.

See ["Attenuator Configurations and Auto/Man" on page 933](#) for more information on the Auto/Man functionality of Attenuation.

Couplings

When **(Mech) Atten** is in Auto, it uses the following algorithm to determine a value:

If the USB Preamp is connected to USB, use 0 dB.

Otherwise, $Atten = ReferenceLevel + PreAmpGain + ExternalGain - RefLevelOffset - MaxMixerLevel + IF\ Gain$.

Limit this value to be between 6 dB and the Max value. No value below 6 dB can ever be chosen by Auto.

The resulting value is rounded up to the largest value possible given the attenuation step setting. That is, 50.01 dB would change to 60 dB (for a 10 dB attenuation step).

The "IF Gain" term in the equation above is either 0 dB or +10 dB, depending on the settings of FFT IF Gain, Swept IF Gain, max Ref Level and the Auto/Man setting of Mech Atten.

In External Mixing and BBIQ, where the Attenuator is not in the signal path, the Attenuator setting changes as described above when **(Mech) Atten** is in Auto, but no changes are made to the actual attenuator hardware setting until the input is changed back to the RF Input.

Preset The preset for Mech Attenuation is "Auto."
 The Auto value of attenuation is:
 CXA, EXA, MXA and PXA: 10 dB

State Saved Saved in instrument state

Min 0 dB

The attenuation set by this key cannot be decreased below 6 dB with the knob or step keys. To get to a value below 6 dB it has to be directly entered from the keypad or via SCPI. This protects from adjusting the attenuation to a dangerously small value which can put the instrument at risk of damage to input circuitry. However, if the current mechanical attenuation is below 6 dB it can be increased with the knob and step keys, but not decreased.

Max CXA N9000A-503/507: 50 dB
 CXA N9000A-513/526: 70dB
 EXA: 60 dB
 MXA and PXA: 70 dB

In the single attenuator configuration, the total of ATT and EATT cannot exceed 50 dB, so if the EATT is set to 24 dB first, the main attenuation cannot be greater than 26 dB and will be reduced accordingly; if the main attenuator is set to 40 dB first, EATT cannot be greater than 10 dB.

Initial S/W Revision Prior to A.02.00

Modified at S/W Revision A.03.00

Attenuator Configurations and Auto/Man

As described in the Attenuation key description, there are two distinct attenuator configurations available in the X-Series, the single attenuator and dual attenuator configurations. In dual attenuator configurations, we have the mechanical attenuation and the electronic attenuation, and the current total attenuation is the sum of the electronic + mechanical attenuation. In single attenuator configurations, we refer to the attenuation set using the **(Mech) Atten** key (or POW:ATT SCPI) as the “main” attenuation; and the attenuation that is set by the SCPI command POW:EATT as the “soft” attenuation (the POW:EATT command is honored even in the single attenuator configuration, for compatibility purposes). Then the current total attenuation is the sum of the main + soft attenuation. See the **Elec Atten** key description for more on “soft” attenuation.

In the dual attenuator configuration, when the electronic attenuator is enabled, there is no Auto/Man functionality for the mechanical attenuator, and the third line of the key label (the Auto/Man line) disappears:

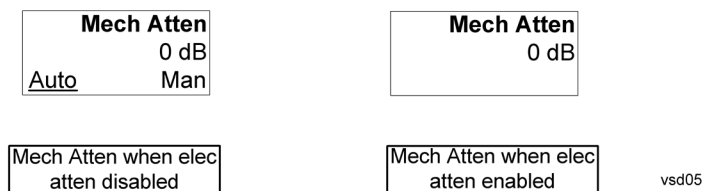

Enable Elec Atten

Enables the Electronic Attenuator.

The electronic attenuator offers finer steps than the mechanical attenuator, has no acoustical noise, is faster, and is less subject to wear. These advantages primarily aid in remote operation and are negligible for front panel use. See ["Using the Electronic Attenuator: Pros and Cons" on page 935](#) for a detailed discussion of the pros and cons of using the electronic attenuator.

For the single attenuator configuration, for SCPI backwards compatibility, the “soft” attenuation feature replaces the dual attenuator configuration’s electronic attenuator. All the same couplings and limitations apply. See ["Attenuator Configurations and Auto/Man" on page 2299](#)

See ["More Information" on page 934](#)

Key Path	AMPTD Y Scale, Attenuation
Remote Command	[:SENSe] :POWer [:RF] :EATTenuation :STATE OFF ON 0 1 [:SENSe] :POWer [:RF] :EATTenuation :STATE ?
Example	POW:EATT:STAT ON
Dependencies	This key only appears in Dual Attenuator models with an Electronic Attenuator installed. It does not appear in models with the Single Attenuator configuration, as in the single attenuator configuration there is no “electronic attenuator” there is only a single integrated attenuator (which has both a mechanical and electronic stage). However, in the single attenuator configuration, EATT SCPI commands are accepted for compatibility with other X-series instruments and set a “soft” attenuation as described in "Attenuator Configurations and Auto/Man" on page 2299 . The electronic attenuator (and the “soft” attenuation function provided in single attenuator configurations) is unavailable above 3.6 GHz. Therefore, if the Stop Frequency of the analyzer is > 3.6 GHz then the Enable Elec Atten key will be OFF and grayed out.

If the Internal Preamp is on, meaning it is set to Low Band or Full, the electronic attenuator (and the “soft” attenuation function provided in single attenuator configurations) is unavailable. In this case the **Enable Elec Atten** key will be OFF and grayed out.

If either of the above is true, if the SCPI command is sent, an error indicating that the electronic attenuator is unavailable will be sent.

If the electronic/soft Attenuator is enabled, then the Stop Freq of the analyzer is limited to 3.6 GHz and the Internal Preamp is unavailable.

The SCPI-only “soft” electronic attenuation for the single-attenuator configuration is not available in all measurements; in particular, it is not available in the Swept SA measurement.

Couplings	Enabling and disabling the Electronic Attenuator affects the setting of the Mechanical Attenuator (in dual attenuator configurations). This is described in more detail below this table.
Preset	OFF for Swept SA measurement; ON for all other measurements that support the electronic attenuator
State Saved	Saved in instrument state
Initial S/W Revision	Prior to A.02.00
Modified at S/W Revision	A.03.00

More Information

Mechanical Attenuator Transition Rules

When the Electronic Attenuator is enabled, the Mechanical Attenuator transitions to a state that has no Auto function. Below are the rules for transitioning the Mechanical Attenuator. NOTE that the information below ONLY applies to the dual attenuator configurations, and ONLY when the Electronic Attenuator is installed:

When the Electronic Attenuation is enabled from a disabled state:

- The Mechanical Attenuator is initialized to 10 dB (this is its optimal performance setting). You can then set it as desired with SCPI, numeric keypad, step keys, or knob, and it behaves as it normally would in manual mode
- The Auto/Man state of (Mech) Atten is saved
- The Auto/Man line on the (Mech) Atten key disappears and the auto rules are disabled
- The Electronic Attenuator is set to 10 dB less than the previous value of the Mechanical Attenuator, within the limitation that it must stay within the range of 0 to 24 dB of attenuation.

Examples in the dual attenuator configuration:

- Mech Atten at 20 dB. Elec Atten enabled, Mech Atten set to 10 dB, and Elec Atten set to 10 dB. New total attenuation equals the value before Elec Atten enabled.
- Mech Atten at 0 dB. Elec Atten enabled, Mech Atten set to 10 dB, and Elec Atten set to 0 dB. New total attenuation does not equal the value before Elec Atten enabled.
- Mech Atten at 40 dB. Elec Atten enabled, Mech Atten set to 10 dB, and Elec Atten set to 24 dB. New total attenuation does not equal the value before Elec Atten enabled.

When the Electronic Attenuation is disabled from an enabled state:

- The Elec Atten key is grayed out
- The Auto/Man state of (Mech) Atten is restored
- If now in Auto, (Mech) Atten recouples
- If now in Man, (Mech) Atten is set to the value of total attenuation that existed before the Elec Atten was disabled. The resulting value is rounded up to the smallest value possible given the (Mech) Atten Step setting - (That is, 57 dB changes to 58 dB when (Mech) Atten Step is 2 dB.)

Using the Electronic Attenuator: Pros and Cons

The electronic attenuator offers finer steps than the mechanical attenuator, has no acoustical noise, is faster, and is less subject to wear.

The “finer steps” advantage of the electronic attenuator is beneficial in optimizing the alignment of the analyzer dynamic range to the signal power in the front panel as well as remote use. Thus, you can achieve improved relative signal measurement accuracy. Compared to a mechanical attenuator with 2 dB steps, the 1 dB resolution of the electronic attenuator only gives better resolution when the odd-decibel steps are used. Those odd-decibel steps are less accurately calibrated than the even-decibel steps, so one tradeoff for this superior relative accuracy is reduced absolute amplitude accuracy.

Another disadvantage of the electronic attenuator is that the spectrum analyzer loses its “Auto” setting, making operation less convenient.

Also, the relationship between the dynamic range specifications (TOI, SHI, compression and noise) and instrument performance are less well-known with the electrical attenuator. With the mechanical attenuator, TOI, SHI and compression threshold levels increase dB-for-dB with increasing attenuation, and the noise floor does as well. With the electronic attenuator, there is an excess attenuation of about 1 to 3 dB between 0 and 3.6 GHz, making the effective TOI, SHI, and so forth, less well known. Excess attenuation is the actual attenuation relative to stated attenuation. Excess attenuation is accounted for in the analyzer calibration

Elec Atten

Controls the Electronic Attenuator in dual attenuator configurations. This key does not appear in single attenuator configurations, as the control of both the mechanical and electronic stages of the single attenuator is integrated into the single **Atten** key.

Key Path	AMPTD Y Scale, Attenuation
Remote Command	<code>[:SENSe] :POWer [:RF] :EATTenuation <rel_ampl></code> <code>[:SENSe] :POWer [:RF] :EATTenuation?</code>
Notes	Electronic Attenuation's specification is defined only when Mechanical Attenuation is 6 dB.
Dependencies	This key only appears in Dual Attenuator models with an Electronic Attenuator installed. It does not appear in models with the Single Attenuator configuration, as in the single attenuator configuration there is no “electronic attenuator” there is only a single integrated attenuator (which has both a mechanical and electronic stage). However, in the single attenuator configuration, EATT SCPI commands are accepted for compatibility with other X-series instruments and set a “soft” attenuation as described in "Attenuator Configurations and Auto/Man" on page 2299 . The “soft” attenuation is treated as an addition to the “main” attenuation value set by the Atten softkey or the

	POW:ATT SCPI command and affects the total attenuation displayed on the Attenuation key and the Meas Bar. When Enable Elec Atten is off or grayed out, the Elec Atten key is grayed out.
Preset	0 dB
State Saved	Saved in instrument state
Min	0 dB
Max	Dual attenuator configuration: 24 dB Single attenuator configuration: the total of ATT and EATT cannot exceed 50 dB, so if the EATT is set to 24 dB first, the main attenuation cannot be greater than 26 dB and will be reduced accordingly; if the main attenuator is set to 40 dB first, EATT cannot be greater than 10 dB
Initial S/W Revision	Prior to A.02.00
Modified at S/W Revision	A.03.00

Adjust Atten for Min Clip

Sets the combination of mechanical and electronic attenuation and gain based on the current measured signal level so that clipping will be at a minimum.

This is an "immediate action" function, that is, it executes once, when the key is pressed.

This key is grayed out in measurements that do not support this functionality. The spectrum analyzer measurement, Swept SA, does not support this functionality.

Key Path	AMPTD Y Scale, Attenuation
Remote Command	<code>[:SENSe] :POWer [:RF] :RANGe :OPTimize IMMEDIATE</code>
Initial S/W Revision	Prior to A.02.00
Modified at S/W Revision	A.03.00

Pre-Adjust for Min Clip

If this function is on, it does the adjustment described under "[Adjust Atten for Min Clip](#)" on page 2302 each time a measurement restarts. Therefore, in Continuous measurement mode, it only executes before the first measurement.

In dual attenuator models, you can set **Elec+Mech Atten**, in which case both attenuators participate in the autoranging, or **Elec Atten Only**, in which case the mechanical attenuator does not participate in the autoranging. This latter case results in less wear on the mechanical attenuator and is usually faster.

This key is grayed out in measurements that do not support this functionality. The spectrum analyzer measurement, Swept SA, does not support this functionality.

Key Path	AMPTD Y Scale, Attenuation
Remote Command	<code>[:SENSe] :POWer [:RF] :RANGe :OPTimize :ATTenuation OFF ELECTRICAL COMBINED</code>

	<code>[:SENSe] :POWer [:RF] :RANGe:OPTimize:ATTenuation?</code>
Notes	The SCPI parameter ELECTrical sets this function to On in single attenuator models. The SCPI parameter COMBined is mapped to ELECTrical in single attenuator models; if you send COMBined , it sets the function to On and returns ELEC to a query.
Dependencies	This key only appears in Dual Attenuator models with an Electronic Attenuator installed. In instruments with Dual Attenuator model, when Enable Elec Atten is off or grayed out, the Pre-Adjust for Min Clip key is grayed out.
Preset	OFF for Swept SA measurement; ON for all other measurements that support Pre-Adjust for Min Clip
State Saved	Saved in instrument state
Range	Dual attenuator models: Off Elec Atten Only Mech + Elec Atten Single attenuator models: Off On
Initial S/W Revision	Prior to A.02.00
Modified at S/W Revision	A.03.00

Remote Command	<code>[:SENSe] :POWer [:RF] :RANGe:AUTO ON OFF 1 0</code> <code>[:SENSe] :POWer [:RF] :RANGe:AUTO?</code>
Notes	ON aliases to "Elec Atten Only" (:POW:RANG:OPT:ATT ELEC) OFF aliases to "Off" (:POW:RANG:OPT:ATT OFF) The query :POW:RANG:AUTO? returns true if :POW:RANG:OPT:ATT is not "Off"
Initial S/W Revision	Prior to A.02.00

Off

Turns **Pre-Adjust for Min Clip** off. This is the default setting.

This key is grayed out in measurements that do not support this functionality. The spectrum analyzer measurement, Swept SA, does not support this functionality.

Key Path	AMPTD Y Scale, Attenuation, Pre-Adjust for Min Clip
Example	:POW:RANGe:OPT:ATT OFF
Initial S/W Revision	Prior to A.02.00

Elec Atten Only

Selects only the electric attenuator to participate in auto ranging. This offers less wear on the mechanical attenuator and is usually faster.

This key is grayed out in measurements that do not support this functionality. The spectrum analyzer measurement, Swept SA, does not support this functionality.

Key Path	AMPTD Y Scale, Attenuation, Pre-Adjust for Min Clip
Example	:POW:RANGe:OPT:ATT ELEC
Initial S/W Revision	Prior to A.02.00

Mech + Elec Atten

In dual attenuator models, this selects both attenuators participate in the autoranging.

This key is grayed out in measurements that do not support this functionality. The spectrum analyzer measurement, Swept SA, does not support this functionality.

Key Path	AMPTD Y Scale, Attenuation, Pre-Adjust for Min Clip
Example	:POW:RANGe:OPT:ATT COMB
Initial S/W Revision	Prior to A.02.00

(Mech) Atten Step

This controls the step size used when making adjustments to the input attenuation.

This key is labeled **Mech Atten Step** in dual attenuator models and **Atten Step** in single attenuator models. In the dual attenuator configuration, this key only affects the step size of the mechanical attenuator.

Key Path	AMPTD Y Scale, Attenuation
Remote Command	[:SENSe] :POWer [:RF] :ATTenuation :STEP [:INCRement] 10 dB 2 dB [:SENSe] :POWer [:RF] :ATTenuation :STEP [:INCRement] ?
Example	POW:ATT:STEP 2
Notes	Note this feature works like a 1-N choice from the front panel, but it takes a specific value (in dB) when used remotely. The only valid values are 2 and 10.
Dependencies	Blanked in CXA and EXA if option FSA (2 dB steps) is not present. If blanked, attempts to set it via SCPI will yield an error.
Couplings	When the attenuation step size changes, the current mechanical attenuation value is adjusted (if necessary) to be quantized to the new step size. That is, if step is set to 10 dB, mech atten is increased if necessary so it is a multiple of 10 dB
Preset	PXA and MXA: 2 dB EXA and CXA: 10 dB (2 dB with option FSA)
State Saved	Saved in instrument state
Initial S/W Revision	Prior to A.02.00
Modified at S/W Revision	A.03.00

Adjust Atten (Remote Command only)

Allows you to select;

-Electric attenuator only

-Combination of Electric attenuator and Mechanical attenuator

when the SCPI command [:SENSe]:POWer[:RF]:RANGe:OPTimize IMMEDIATE is executed.

Remote Command	[:SENSe]:POWer[:RF]:RANGe:OPTimize:TYPE EONLY COMBined [:SENSe]:POWer[:RF]:RANGe:OPTimize:TYPE?
Example	POW:RANG:OPT:TYPE EONL POW:RANG:OPT:TYPE?
Preset	COMBined
State Saved	Saved in instrument state
Initial S/W Revision	A.16.00

Scale/Div

Sets the units-per-division of the vertical scale in the logarithmic display. However, since the Auto Scaling is defaulted to On, this value is automatically determined by the measurement result. When you set a value manually, Auto Scaling automatically changes to Off.

Key Path	AMPTD Y Scale
Mode	SA, WCDMA, C2K, WIMAX OFDMA, TD-SCDMA, 1xEVDO, DVB-T/H, DTMB (CTTB), ISDB-T, CMMB, LTE, LTEFDD, Digital Cable TV, MSR, LTEAFDD, LTEATDD
Remote Command	:DISPlay:ACPower:VIEW[1]:WINDow[1]:TRACe:Y[:SCALE]:PDIVision <rel_ampl> :DISPlay:ACPower:VIEW[1]:WINDow[1]:TRACe:Y[:SCALE]:PDIVision?
Example	DISP:ACP:VIEW:WIND:TRAC:Y:PDIV 5 DISP:ACP:VIEW:WIND:TRAC:Y:PDIV?
Notes	You must be in the mode that includes ACP measurements to use this command. Use :INSTrument:SElect to set the mode.
Couplings	When the Auto Scaling is On, this value is automatically determined by the measurement result. When you set a value manually, Auto Scaling automatically changes to Off.
Preset	10.00 dB
State Saved	Saved in instrument state.
Min	0.10 dB
Max	20.00 dB
Initial S/W Revision	Prior to A.02.00
Modified at S/W Revision	A.02.00, A.03.00

Presel Center

When this key is pressed, the centering of the preselector filter is adjusted to optimize the amplitude accuracy at the frequency of the selected marker. If the selected marker is not on when Presel Center is pressed, the analyzer will turn on the selected marker, perform a peak search, and then perform centering on the marker's center frequency. If the selected marker is already on and between the start and stop frequencies of the analyzer, the analyzer performs the preselector calibration on that marker's frequency. If the selected marker is already on, but outside the frequency range between Start Freq and Stop Freq, the analyzer will first perform a peak search, and then perform centering on the marker's center frequency.

The value displayed on the **Presel Adjust** key will change to reflect the new preselector tuning (see **Presel Adjust**).

A number of considerations should be observed to ensure proper operation. See "[Proper Preselector Operation](#)" on page 940.

Key Path	AMPTD Y Scale
Remote Command	[:SENSe] :POWer [:RF] :PCENter
Example	POW:PCEN
Notes	Note that the rules outlined above under the key description apply for the remote command as well as the key. The result of the command is dependent on marker position, and so forth. Any message shown by the key press is also shown in response to the remote command.
Dependencies	<ul style="list-style-type: none"> • Grayed out if the microwave preselector is off.) • If the selected marker's frequency is below Band 1, advisory message 0.5001 is generated and no action is taken. • Grayed out if entirely in Band 0. • Blank in models that do not include a preselector, such as option 503. If the SCPI is sent in these instruments, it is accepted without error, and the query always returns 0. • Grayed out in the Spectrogram View.
Couplings	<p>The active marker position determines where the centering will be attempted.</p> <p>If the analyzer is in a measurement such as averaging when centering is initiated, the act of centering the preselector will restart averaging but the first average trace will not be taken until the centering is completed.</p>
Status Bits/OPC dependencies	<p>When centering the preselector, *OPC will not return true until the process is complete and a subsequent measurement has completed, nor will results be returned to a READ or MEASure command.</p> <p>The Measuring bit should remain set while this command is operating and should not go false until the subsequent sweep/measurement has completed.</p>
Initial S/W Revision	Prior to A.02.00
Modified at S/W Revision	A.03.00

Proper Preselector Operation

A number of considerations should be observed to ensure proper operation:

1. If the selected marker is off, the analyzer will turn on a marker, perform a peak search, and adjust the preselector using the selected marker's frequency. It uses the "highest peak" peak search method unqualified by threshold or excursion, so that there is no chance of a 'no peak found' error. It continues with that peak, even if it is the peak of just noise. Therefore, for this operation to work properly, there should be a signal on screen in a preselected range for the peak search to find.
2. If the selected marker is already on, the analyzer will attempt the centering at that marker's frequency. There is no preselector for signals below about 3.6 GHz, therefore if the marker is on a signal below 3.6 GHz, no centering will be attempted and an advisory message generated
3. In some models, the preselector can be bypassed. If it is bypassed, no centering will be attempted in that range and a message will be generated.

Preselector Adjust

Allows you to manually adjust the preselector filter frequency to optimize its response to the signal of interest. This function is only available when "[Presel Center](#)" on page 2306 is available.

For general purpose signal analysis, using Presel Center is recommended. Centering the filter minimizes the impact of long-term preselector drift. Presel Adjust can be used instead to manually optimize the preselector. One application of manual optimization would be to peak the preselector response, which both optimizes the signal-to-noise ratio and minimizes amplitude variations due to small (short-term) preselector drifting.

Key Path	AMPTD Y Scale
Scope	Meas Global
Remote Command	<code>[:SENSe] :POWer [:RF] :PADJust <freq></code> <code>[:SENSe] :POWer [:RF] :PADJust?</code>
Example	POW:PADJ 100KHz POW:PADJ?
Notes	The value on the key reads out to 0.1 MHz resolution.
Dependencies	<ul style="list-style-type: none"> • Grayed out if microwave preselector is off.) • Grayed out if entirely in Band 0. • Blank in models that do not include a preselector, such as option 503. If the SCPI is sent in these instruments, it is accepted without error, and the query always returns 0. • Grayed out in the Spectrogram View.
Preset	0 MHz
State Saved	The Presel Adjust value set by Presel Center , or by manually adjusting Presel Adjust , is not saved in instrument state, and does not survive a Preset or power cycle.
Min	-500 MHz
Max	500 MHz
Default Unit	Hz
Backwards Compatibility SCPI	<code>[:SENSe] :POWer [:RF] :MW:PADJust</code> <code>[:SENSe] :POWer [:RF] :MMW:PADJust</code>

	PSA had multiple preselectors, but the X-Series has only one. These commands simply alias to [:SENSe]:POWer[:RF]:PADJust
Initial S/W Revision	Prior to A.02.00
Modified at S/W Revision	A.03.00

Remote Command	[:SENSe]:POWer[:RF]:PADJust:PRESelector MWAVE MMWave EXTERNAL [:SENSe]:POWer[:RF]:PADJust:PRESelector?
Notes	PSA had multiple preselectors, and you could select which preselector to adjust. Since the X-Series has only one mm/uW preselector, the preselector selection softkey is no longer available. However, to provide backward compatibility, we accept the legacy remote commands. The command form has no effect, the query always returns MWAVE
Initial S/W Revision	Prior to A.02.00

μW Path Control

The **μW Path Control** functions include the **μW Preselector Bypass** (Option MPB) and **Low Noise Path** (Option LNP) controls in the High Band path circuits.

When the μW Preselector is bypassed, the user has better flatness, but will be subject to spurs from out of band interfering signals. When the Low Noise Path is enabled, the analyzer automatically switches around certain circuitry in the high frequency bands which can contribute to noise, when it is appropriate based on other analyzer settings.

For most applications, the preset state is Standard Path, which gives the best remote-control throughput, minimizes acoustic noise from switching and minimizes the risk of wear out in the hardware switches. For applications that utilize the wideband IF paths, the preset state is the μW Preselector Bypass path, if option MPB is present. This is because, when using a wideband IF such as the 140 MHz IF, the μW Preselector's bandwidth can be narrower than the available IF bandwidth, causing degraded amplitude flatness and phase linearity, so it is desirable to bypass the preselector in the default case.

Users may choose Low Noise Path Enable. It gives a lower noise floor, especially in the 21–26.5 GHz region, though without improving many measures of dynamic range, and without giving the best possible noise floor. The preamp, if purchased and used, gives better noise floor than does the Low Noise Path, however its compression threshold and third-order intercept are much poorer than that of the non-preamp Low Noise Path. There are some applications, typically for signals around –30 dBm, for which the third-order dynamic range of the standard path is good enough, but the noise floor is not low enough even with 0 dB input attenuation. When the third-order dynamic range of the preamp path is too little and the noise floor of the standard path is too high, the Low Noise Path can provide the best dynamic range.

Key Path	AMPTD Y Scale
Mode	SA, BASIC, PNOISE, VSA, LTE, LTETDD
Scope	Meas Global
Remote Command	[:SENSe]:POWer[:RF]:MW:PATH STD LNPath MPBypass FULL

	[:SENSe] :POWer [:RF] :MW:PATH?
Example	:POW:MW:PATH LNP Enables the Low Noise path
Notes	<p>If a Presel Center is performed, the analyzer will momentarily switch to the Standard Path, regardless of the setting of μW Path Control</p> <p>The DC Block will always be switched in when the low noise path is switched in, to protect succeeding circuitry from DC. Note that this does not mean “when the low noise path is enabled” but when, based on the Low Noise Path rules, the path is actually switched in. This can happen when the selection is Low Noise Path Enable . In the case where the DC Block is switched in the analyzer is now AC coupled. However, if the user has selected DC coupling, the UI will still behave as though it were DC coupled, including all annunciation, warnings, status bits, and responses to SCPI queries. This is because, based on other settings, the analyzer could switch out the low noise path at any time and hence go back to being DC coupled.</p> <p>Alignment switching ignores the settings in this menu, and restores them when finished.</p>
Dependencies	Unavailable in BBIQ and External Mixing
Preset	<p>All modes other than IQ Analyzer mode and VXA: STD</p> <p>IQ Analyzer, VXA and WLAN mode:</p> <p>MPB option present and licensed: MPB</p> <p>MPB option not present and licensed: STD</p>
State Saved	Save in instrument state
Readback	Value selected in the submenu
Initial S/W Revision	A.04.00
Modified at S/W Revision	A.10.00

Standard Path

This path gives the best remote-control throughput, minimizes acoustic noise from switching and minimizes the risk of wear in the hardware switches, particularly in remote test scenarios where both low band and high band setups will follow in rapid succession.

In this path, the bypass of the low band/high band switch and microwave preamp is never activated, which can cause some noise degradation but preserves the life of the bypass switch.

Key Path	AMPTD Y Scale, μW Path Control
Example	:POW:MW:PATH STD
Readback Text	Standard Path
Initial S/W Revision	A.04.00

Low Noise Path Enable

You may choose Low Noise Path Enable, which gives a lower noise floor under some circumstances, particularly when operating in the 21–26.5 GHz region. With the Low Noise Path enabled, the low band/high band switch and microwave preamp are bypassed whenever all of the following are true:

- The analyzer is not in the Low Band, meaning:
- the start frequency is above 3.5 GHz and
- the stop frequency is above 3.6 GHz.
- the internal preamp is not installed or (if installed) is set to **Off** or **Low Band**

Note that this means that, when any part of a sweep is done in Low Band, the Low Noise Path is not used, whether or not the **Low Noise Path Enable** is selected in the user interface. Also, if the preamp is turned on, the Low Noise Path is not used, whether or not the **Low Noise Path Enable** is selected in the user interface. The only time the Low Noise Path is used is when **Low Noise Path Enable** is selected, the sweep is completely in High Band (> 3.6 GHz) and no preamp is in use.

See "[More Information](#)" on page 944

Key Path	AMPTD Y Scale, μW Path Control
Measurement	Swept SA
Example	:POW:MW:PATH LNP
Notes	For measurements that use IQ acquisition, the low noise path is used when the Center Frequency is in High Band (> 3.6 GHz) and no preamp is in use. In other words, the rules above are modified to use only the center frequency to qualify which path to switch in. This is not the case for FFT's in the Swept SA measurement; they use the same rules as swept measurements.
Dependencies	Key is blanked if current mode does not support it. Key is grayed out if mode supports it but current measurement does not support it. Unless Option LNP is present and licensed, key is blank and if SCPI command sent, error -241, "Hardware missing; Option not installed" is generated.
Readback Text	Low Noise Path Enable
Initial S/W Revision	A.04.00

More Information

The user should understand that the Low Noise Path, while giving improved DANL, has the disadvantage of decreased TOI performance and decreased gain compression performance relative to the standard path.

The user should also understand that the bypass switch is a mechanical switch and has finite life, so if the **Low Noise Path** is enabled, it is possible to cause frequent cycling of this switch by frequently changing analyzer settings such that the above conditions hold true only some of the time. A user making tests of this nature should consider opting for the **Standard Path**, which will never throw the bypass switch, at the expense of some degraded noise performance.

The low noise path is useful for situations where the signal level is so low that the analyzer performance is dominated by noise even with 0 dB attenuation, but still high enough that the preamp option would have excessive third-order intermodulation or compression. The preamp, if purchased and used, gives better noise floor than does the "Low Noise Path." However, its compression threshold and third-order intercept are much poorer than that of the non-preamp path. There are some applications, typically for signals around -30 dBm, for which the third-order dynamic range of the standard path is good enough, but the

noise floor is not low enough even with 0 dB input attenuation. When the third-order dynamic range of the preamp path is too little and the noise floor of the standard path is too high, the Low Noise Path can provide the best dynamic range

The graph below illustrates the concept. It shows, in red, the performance of an analyzer at different attenuation settings, both with the preamp on and off, in a measurement that is affected by both analyzer noise and analyzer TOI. The green shows the best available dynamic range, offset by 0.5 dB for clarity. The blue shows how the best available dynamic range improves for moderate signal levels with the low noise path switched in. In this illustration, the preamp improves the noise floor by 15 dB while degrading the third-order intercept by 30 dB, and the low noise path reduces loss by 8 dB. The attenuator step size is 2 dB.

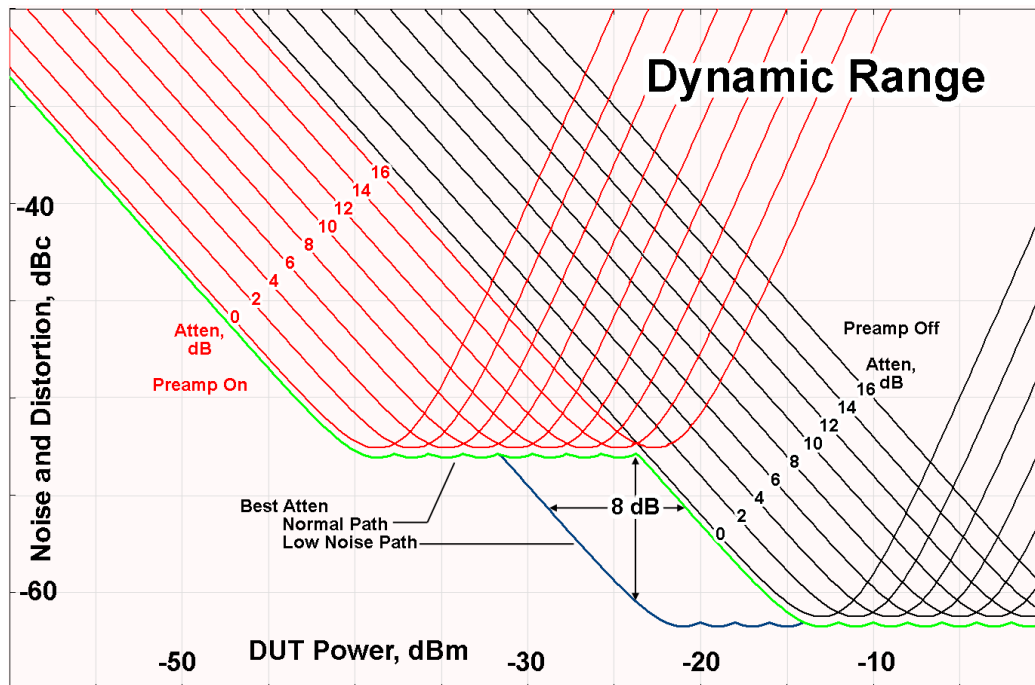

There are other times where selecting the low noise path improves performance, too. Compression-limited measurements such as finding the nulls in a pulsed-RF spectrum can profit from the low noise path in a way similar to the TOI-limited measurement illustrated. Accuracy can be improved when the low noise path allows the optimum attenuation to increase from a small amount like 0, 2 or 4 dB to a larger amount, giving better return loss at the analyzer input. Harmonic measurements, such as second and third harmonic levels, are much improved using the low noise path because of the superiority of that path for harmonic (though not intermodulation) distortion performance.

μ W Preselector Bypass

This key toggles the preselector bypass switch for band 1 and higher. When the microwave preselector is on, the signal path is preselected. When the microwave preselector is off, the signal path is not preselected. The preselected path is the normal path for the analyzer.

The preselector is a tunable bandpass filter which prevents signals away from the frequency of interest from combining in the mixer to generate in-band spurious signals (images). The consequences of using a preselector filter are its limited bandwidth, the amplitude and phase ripple in its passband, and any amplitude and phase instability due to center frequency drift.

Option MPB or pre-selector bypass provides an unpreselected input mixer path for certain X-Series signal analyzers with frequency ranges above 3.6 GHz. This signal path allows a wider bandwidth and less amplitude variability, which is an advantage when doing modulation analysis and broadband signal analysis. The disadvantage is that, without the preselector, image signals will be displayed. Another disadvantage of bypassing the preselector is increased LO emission levels at the front panel input port.

Image responses are separated from the real signal by twice the 1st IF. For IF Paths of 10 MHz and 25 MHz, the 1st IF is 322.5 MHz, so the image response and the real signal will be separated by 645 MHz. The 1st IF will be different for other IF Path settings. When viewing a real signal and its corresponding image response in internal mixing, the image response will be to the left of the real signal.

Also, the image response and the real signal typically have the same amplitude and exhibit the same shape factor.

However, if Option FS1, Fast Sweep Capability, is enabled, the image response in the Swept SA measurement will appear lower in amplitude and have a much wider shape factor compared to the real signal.

Key Path	AMPTD Y Scale, μW Path Control
Example	:POW:MW:PATH MPB
Dependencies	Key is blanked if current mode does not support it. Key is grayed out if mode supports it but current measurement does not support it. Key is blank unless Option MPB is present and licensed. If SCPI command sent when MPB not present, error -241, "Hardware missing; Option not installed" is generated.
Readback Text	μ W Preselector Bypass
Initial S/W Revision	A.04.00

Remote Command	[:SENSE] :POWER [:RF] :MW:PRESelector [:STATE] ON OFF 0 1 [:SENSE] :POWER [:RF] :MW:PRESelector [:STATE] ?
Example	:POW:MW:PRES OFF Bypasses the microwave preselector
Notes	The ON parameter sets the STD path (:POW:MW:PATH STD) The OFF parameter sets path MPB (:POW:MW:PATH MPB)
Preset	ON

Internal Preamp

Accesses a menu of keys that control the internal preamps. Turning on the preamp gives a better noise figure, but a poorer TOI to noise floor dynamic range. You can optimize this setting for your particular measurement.

The instrument takes the preamp gain into account as it sweeps. If you sweep outside of the range of the preamp the instrument will also account for that. The displayed result will always reflect the correct gain.

For some measurements, when the preamp is on and any part of the displayed frequency range is below the lowest frequency for which the preamp has specifications, a warning condition message appears in the status line. For example, for a preamp with a 9 kHz lowest specified frequency: "Preamp: Accy unspec'd below 9 kHz".

Key Path	AMPTD Y Scale
Scope	Meas Global
Remote Command	[:SENSe] :POWer [:RF] :GAIN [:STATe] OFF ON 0 1 [:SENSe] :POWer [:RF] :GAIN [:STATe] ?
Dependencies	Preamp is not available on all hardware platforms. If the preamp is not present or is unlicensed, the key is not shown. The preamp is not available when the electronic/soft attenuator is enabled.
Couplings	The act of connecting the U7227A USB Preamplifier to one of the analyzer's USB ports will cause the Internal Preamp to be switched on. When this happens an informational message will be generated: "Internal Preamp turned on for optimal operation with USB Preamp." Note that if the Internal Preamp was already on, there will be no change to the setting, but if it was Off it will be switched On, to Full Range. Note that this same action occurs when the SA mode is selected while the USB Preamp is connected to one of the analyzer's USB ports, if it is the first time that the SA mode has run since powerup, or if the last time the SA mode was running the USB Preamp was NOT connected. Subsequently disconnecting the USB Preamp from USB does not change the Internal Preamp setting nor restore the previous setting.
Preset	OFF
State Saved	Saved in instrument state
Initial S/W Revision	Prior to A.02.00
Modified at S/W Revision	A.14.00

Key Path	AMPTD Y Scale, Internal Preamp
Scope	Meas Global
Remote Command	[:SENSe] :POWer [:RF] :GAIN :BAND LOW FULL [:SENSe] :POWer [:RF] :GAIN :BAND ?
Dependencies	Preamp is not available on all hardware platforms. If the preamp is not present or is unlicensed, the key is not shown. If a POW:GAIN:BAND FULL command is sent when a low band preamp is available, the preamp band parameter is to LOW instead of FULL, and an "Option not installed" message is generated.
Preset	LOW
State Saved	Saved in instrument state
Initial S/W Revision	Prior to A.02.00

Off

Turns the internal preamp off

Key Path	AMPTD Y Scale, Internal Preamp
Example	:POW:GAIN OFF
Readback	Off
Initial S/W Revision	Prior to A.02.00

Low Band

Sets the internal preamp to use only the low band.

The frequency range of the installed (optional) low-band preamp is displayed in square brackets on the **Low Band** key label.

Key Path	AMPTD Y Scale, Internal Preamp
Example	:POW:GAIN ON :POW:GAIN:BAND LOW
Readback	Low Band
Initial S/W Revision	Prior to A.02.00

Full Range

Sets the internal preamp to use its full range. The low band (0–3.6 GHz or 0–3GHz, depending on the model) is supplied by the low band preamp and the frequencies above low band are supplied by the high band preamp.

The frequency range of the installed (optional) preamp is displayed in square brackets on the **Full Range** key label. If the high band option is not installed the Full Range key does not appear.

Key Path	AMPTD Y Scale, Internal Preamp
Example	:POW:GAIN ON :POW:GAIN:BAND FULL
Readback	Full Range
Initial S/W Revision	Prior to A.02.00

Ref Position

Positions the reference level at the top, center, or bottom of the Y- scale display. Changing the reference position does not change the reference level value.

Key Path	AMPTD Y Scale
Mode	SA, WCDMA, C2K, WIMAX OFDMA, TD-SCDMA, 1xEVDO, DVB-T/H, DTMB (CTTB), ISDB-T, CMMB, LTE, LTE-TDD, Digital Cable TV, MSR, LTEAFDD, LTEATDD
Remote Command	:DISPlay:ACPowEr:VIEW[1]:WINDow[1]:TRACe:Y[:SCALe]:RPOSition TOP CENTER BOTTom :DISPlay:ACPowEr:VIEW[1]:WINDow[1]:TRACe:Y[:SCALe]:RPOSition?
Example	DISP:ACP:VIEW:WIND:TRAC:Y:RPOS CENT DISP:ACP:VIEW:WIND:TRAC:Y:RPOS?
Notes	You must be in the mode that includes ACP measurements to use this command. Use :INSTrument:SElect to set the mode.
Preset	TOP
State Saved	Saved in instrument state.
Range	Top Ctr Bot
Initial S/W Revision	Prior to A.02.00
Modified at S/W Revision	A.02.00, A.03.00

Auto Scaling

Toggles the Auto Scaling function between On and Off.

Key Path	AMPTD Y Scale
Mode	SA, WCDMA, C2K, WIMAX OFDMA, TD-SCDMA, 1xEVDO, DVB-T/H, DTMB (CTTB), ISDB-T, CMMB, LTE, LTE-TDD, Digital Cable TV, MSR, LTEAFDD, LTEATDD
Remote Command	:DISPlay:ACPowEr:VIEW[1]:WINDow[1]:TRACe:Y[:SCALe]:COUPle 0 1 OFF ON :DISPlay:ACPowEr:VIEW[1]:WINDow[1]:TRACe:Y[:SCALe]:COUPle?
Example	DISP:ACP:VIEW:WIND:TRAC:Y:COUP ON DISP:ACP:VIEW:WIND:TRAC:Y:COUP?
Notes	You must be in the mode that includes ACP measurements to use this command. Use :INSTrument:SElect to set the mode.
Couplings	When Auto Scaling is On and the Restart front-panel key is pressed, this function automatically determines the scale per division and reference values based on the measurement results. When you set a value to either Scale/Div or Ref Value manually, Auto Scaling automatically changes to Off.
Preset	ON
State Saved	Saved in instrument state.
Range	On Off
Initial S/W Revision	Prior to A.02.00
Modified at S/W Revision	A.02.00, A.03.00

Auto Couple

The Auto Couple feature provides a quick and convenient way to automatically couple multiple instrument settings. This helps ensure accurate measurements and optimum dynamic range. When the Auto Couple feature is activated, either from the front panel or remotely, all parameters of the current measurement that have an Auto/Manual mode are set to Auto mode and all measurement settings dependent on (or coupled to) the Auto/Man parameters are automatically adjusted for optimal performance.

However, the Auto Couple key actions are confined to the current measurement only. It does not affect other measurements in the mode, and it does not affect markers, marker functions, or trace or display attributes.

See ["More Information" on page 950](#)

Key Path	Front-panel key
Remote Command	:COUPle ALL NONE
Example	:COUP ALL
Notes	:COUPle ALL puts all Auto/Man parameters in Auto mode (equivalent to pressing the Auto Couple key). :COUPLE NONE puts all Auto/Man parameters in manual mode. It decouples all the coupled instrument parameters and is not recommended for making measurements.
Initial S/W Revision	Prior to A.02.00

More Information

There are two types of functions that have Auto/Manual modes.

Auto/Man Active Function keys

An Auto/Man toggle key controls the binary state associated with an instrument parameter by toggling between **Auto** (where the parameter is automatically coupled to the other parameters it is dependent upon) and **Man** (where the parameter is controlled independent of the other parameters), as well as making the parameter the active function. The current mode is indicated on the softkey with either **Auto** or **Man** underlined as illustrated below.

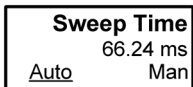

vsd07

Auto/Man 1-of-N keys

An Auto/Man 1-of-N key allows you to manually pick from a list of parameter values, or place the function in Auto, in which case the value is automatically selected (and indicated) as shown below. If in Auto, Auto is underlined on the calling key. If in manual operation, manual is indicated on the calling key. But the calling key does not actually toggle the function, it simply opens the menu.

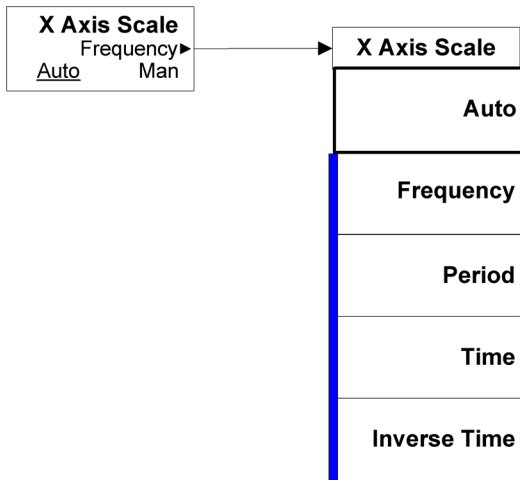

vsd08

BW

Accesses a menu of functions that enable you to specify and control the video and resolution bandwidths. You can also select the type of filter for the measurement and set the filter bandwidth.

Key Path	Front-panel key
Initial S/W Revision	Prior to A.02.00

Res BW

Sets the value of the resolution bandwidth. If an unavailable bandwidth is entered with the numeric keypad, the closest available bandwidth is selected.

LTE-Advanced FDD/TDD Auto RBW:

Bandwidth	RBW (KHz)
1.4MHz	51KHz
3MHz	
5MHz	100 KHz
10MHz	
15MHz	
20MHz	

the resolution bandwidth is predefined based on the corresponding bandwidth of the single LTE carrier, which is listed above. When ResBW mode is Auto, the narrowest RBW over the active carriers is selected for Multi-carriers.

Key Path	BW
Mode	SA, WCDMA, C2K, WIMAX OFDMA, TD-SCDMA, 1xEVDO, DVB-T/H, DTMB (CTTB), ISDB-T, CMMB, LTE, LTETDD, Digital Cable TV, MSR, LTEAFDD,LTEATDD
Remote Command	[:SENSe]:ACPpower:BANDwidth[:RESolution] <freq> [:SENSe]:ACPpower:BANDwidth[:RESolution]? [:SENSe]:ACPpower:BANDwidth[:RESolution]:AUTO ON OFF 1 0 [:SENSe]:ACPpower:BANDwidth[:RESolution]:AUTO?
Example	ACP:BAND 25kHz ACP:BAND? ACP:BAND:AUTO ON ACP:BAND:AUTO?
Notes	This key is available only in IBW mode. This parameter is preset by the Meas Method selection. Preset values are as follows: IBW: 100 kHz

	<p>IBWR: 27 kHz</p> <p>FAST (WCDMA): 390 kHz</p> <p>When Meas Method is "Fast Power" and Fast Power RBW mode is "Speed," RBW is calculated as follows:</p> $RBW = \text{Span} \times 2.442 \times 10^{-3}$ <p>You must be in the mode that includes ACP measurements to use this command. Use :INSTrument:SElect to set the mode.</p>
Dependencies	When Meas Method is RBW, FAST, or Fast Power and Fast Power RBW mode is Speed, this key is grayed out and disabled. If the key is pressed, an advisory message is generated. If the equivalent remote command is sent, a "Setting conflict" warning is generated.
Couplings	The resolution bandwidth is coupled to the video bandwidth based on the video to resolution bandwidth ratio setting if AUTO is selected.
Preset	<p>SA: 220 kHz</p> <p>WCDMA: 100 kHz</p> <p>WIMAX OFDMA: 100 kHz</p> <p>C2K: 15 kHz</p> <p>TD-SCDMA: 30 kHz</p> <p>1xEVDO: 30 kHz</p> <p>DVB-T/H: 39 kHz</p> <p>DTMB (CTTB): 39 kHz</p> <p>ISDB-T: 39 kHz</p> <p>CMMB: 39 kHz</p> <p>LTE: 100 kHz</p> <p>LTETDD: 100 kHz</p> <p>Digital Cable TV: 39 kHz</p> <p>MSR: 100 kHz</p> <p>LTEAFDD, LTEATDD: 100kHz</p> <p>LTE, LTETDD, LTEAFDD, LTEATDD: 1</p> <p>Others:0</p>
State Saved	Saved in instrument state.
Min	1 Hz
Max	8 MHz
Backwards Compatibility SCPI	<pre>[:SENSe] :ACPower:BWIDth [:RESolution] [:SENSe] :ACP:SWEep:BAWdwidth BWIDth [:RESolution] (PSA W-CDMA, PSA cdma2000)</pre>
Initial S/W Revision	Prior to A.02.00
Modified at S/W Revision	A.02.00, A.03.00

Video BW

Changes the analyzer post-detection filter (VBW).

Key Path	BW
Mode	SA, WCDMA, C2K, WIMAX OFDMA, TD-SCDMA, 1xEVDO, DVB-T/H, DTMB (CTTB), ISDB-T, CMMB, LTE, LTETDD, Digital Cable TV, MSR, LTEAFDD, LTEATDD
Remote Command	[:SENSe]:ACPower:BANDwidth:VIDeo <freq> [:SENSe]:ACPower:BANDwidth:VIDeo? [:SENSe]:ACPower:BANDwidth:VIDeo:AUTO OFF ON 0 1 [:SENSe]:ACPower:BANDwidth:VIDeo:AUTO?
Example	ACP:BAND:VID 1kHz ACP:BAND:VID? ACP:BWID:VID:AUTO ON ACP:BWID:VID:AUTO?
Notes	The values shown in this table reflect the conditions after a Mode Preset.
Dependencies	When Meas Method is RBW, FAST, or Fast Power this key is grayed out and disabled. If the key is pressed, an advisory message is generated. If the equivalent remote command is sent, a "Setting conflict" warning is generated.
Preset	SA: 22 kHz WCDMA, WIMAX OFDMA: 1 MHz C2K: Method RBW: grayed out (1.2 MHz) Method IBW: 150 kHz TD-SCDMA: 300 kHz 1xEVDO: 300 kHz DVB-T/H: 390 kHz DTMB (CTTB): 390 kHz ISDB-T: 390 kHz CMMB: 390 kHz LTE, LTETDD, MSR: Auto LTETDD: 1 MHz Digital Cable TV: 390 kHz LTEAFDD, LTEATDD: Auto SA: ON WCDMA: OFF WIMAX OFDMA: OFF TD-SCDMA: OFF DVB-T/H: OFF DTMB (CTTB): OFF CDMA1xEVDO: OFF ISDB-T: OFF CMMB: OFF LTE, MSR: ON

	LTETDD: ON Digital Cable TV: OFF LTEAFDD, LTEATDD: ON
State Saved	Saved in instrument state.
Min	1 Hz
Max	50 MHz
Backwards Compatibility SCPI	[:SENSe] :ACPower :BWIDth :VIDeo
Initial S/W Revision	Prior to A.02.00
Modified at S/W Revision	A.02.00, A.03.00

RBW Control

Accesses a menu that enables you to select the filter bandwidth and type.

Key Path	BW
Initial S/W Revision	Prior to A.02.00

Filter Type

Selects the type of bandwidth filter that is used. The choices are Gaussian or Flat top.

Key Path	BW, RBW Control
Mode	SA, WCDMA, C2K, WIMAX OFDMA, TD-SCDMA, 1xEVDO, DVB-T/H, DTMB (CTTB), ISDB-T, CMMB, LTE, LTETDD, Digital Cable TV, MSR, LTEAFDD, LTEATDD
Remote Command	[:SENSe] :ACPower :BANDwidth :SHAPE GAUSSian FLATtop [:SENSe] :ACPower :BANDwidth :SHAPE?
Example	ACP:BAND:SHAP GAUS ACP:BAND:SHAP?
Dependencies	When Meas Method is FASTor Fast Power, this key is grayed out and disabled. If the key is pressed, an advisory message is generated. If the equivalent remote command is sent, a "Setting conflict" warning is generated.
Preset	GAUSSian C2K: FLATtop
State Saved	Saved in instrument state.
Range	Gaussian (Normal) Flattop
Backwards Compatibility SCPI	[:SENSe] :ACPower :BWIDth :SHAPE
Initial S/W Revision	Prior to A.02.00
Modified at S/W Revision	A.02.00, A.03.00

Filter BW

Selects a Gaussian filter based on its -3 dB (Normal) bandwidth or its -6 dB bandwidth.

Key Path	BW, RBW Control
Mode	SA, WCDMA, C2K, WIMAX OFDMA, TD-SCDMA, 1xEVDO, DVB-T/H, DTMB (CTTB), ISDB-T, CMMB, LTE, LTETDD, Digital Cable TV, MSR, LTEAFDD, LTEATDD
Remote Command	[:SENSe] :ACPower:BAWdwidth:TYPE DB3 DB6 [:SENSe] :ACPower:BAWdwidth:TYPE?
Example	ACP:BAWd:TYPE DB3 ACP:BAWd:TYPE?
Dependencies	When Filter Type is Flattop or Meas Method is RBW, FAST, or Fast Power, this key is grayed out and disabled. If the key is pressed, an advisory message is generated. If the equivalent remote command is sent, a "Setting conflict" warning is generated.
Preset	DB3
State Saved	Saved in instrument state.
Range	-3 dB (Normal) -6 dB
Backwards Compatibility SCPI	[:SENSe] :ACPower:BWIDth:TYPE
Initial S/W Revision	Prior to A.02.00
Modified at S/W Revision	A.02.00, A.03.00

Cont (Continuous Measurement/Sweep)

Sets the analyzer for Continuous measurement operation. The single/continuous state is Meas Global so the setting will affect all measurements. If you are Paused, pressing **Cont** does a Resume.

Key Path	Front-panel key
Remote Command	:INITiate:CONTinuous OFF ON 0 1 :INITiate:CONTinuous?
Example	:INIT:CONT 0 puts analyzer in Single measurement operation. :INIT:CONT 1 puts analyzer in Continuous measurement operation
Preset	ON (Note that SYST:PRESet sets INIT:CONT to ON but *RST sets INIT:CONT to OFF)
State Saved	Saved in instrument state
Backwards Compatibility Notes	For Spectrum Analysis mode in ESA and PSA, there is no Cont hardkey, instead there is a Sweep Single/Cont key. In these analyzers, switching the Sweep Single/Cont key from Single to Cont restarts averages (displayed average count reset to 1), but does not restart Max Hold and Min Hold . The X-Series has Single and Cont keys in place of the SweepSingleCont key. In the X-Series, if in single measurement, the Cont key (and INIT:CONT ON) switches to continuous measurement, but never restarts a measurement and never resets a sweep.
Initial S/W Revision	Prior to A.02.00

In Swept SA Measurement (Spectrum Analysis Mode):

The analyzer takes repetitive sweeps, averages, measurements, etc., when in Continuous mode. When the average count reaches the Average/Hold Number the count stops incrementing, but the analyzer keeps sweeping. See the Trace/Detector section for the averaging formula used both before and after the Average/Hold Number is reached. The trigger condition must be met prior to each sweep. The type of trace processing for multiple sweeps, is set under the Trace/Detector key, with choices of **Trace Average**, **Max Hold**, or **Min Hold**.

In Other Measurements/Modes:

With **Avg/Hold Num** (in the **Meas Setup** menu) set to **Off** or set to **On** with a value of 1, a sweep is taken after the trigger condition is met; and the analyzer continues to take new sweeps after the current sweep has completed and the trigger condition is again met. However, with **Avg/Hold Num** set to On with a value >1, multiple sweeps (data acquisitions) are taken for the measurement. The trigger condition must be met prior to each sweep. The sweep is not stopped when the average count k equals the number N set for Avg/Hold Num is reached, but the number k stops incrementing. A measurement average usually applies to all traces, marker results, and numeric results. But sometimes it only applies to the numeric results.

If the analyzer is in Single measurement, pressing the **Cont** key does not change k and does not cause the sweep to be reset; the only action is to put the analyzer into Continuous measurement operation.

If it is already in continuous sweep:

the INIT:CONT 1 command has no effect

10 ACP Measurement
Cont (Continuous Measurement/Sweep)

the INIT:CONT 0 command will place the analyzer in Single Sweep but will have no effect on the current sequence until $k = N$, at which point the current sequence will stop and the instrument will go to the idle state.

File

See "File" on page 362

FREQ Channel

Accesses a menu of keys that allow you to control the Frequency and Channel parameters of the instrument.

Some features in the Frequency menu are the same for all measurements - they do not change as you change measurements. Settings like these are called "Meas Global" and are unaffected by Meas Preset. For example, the Center Freq setting is the same for all measurements - it does not change as you change measurements.

Key Path	Front Panel
Mode	MSR
Initial S/W Revision	A.10.00

Carrier Ref Freq

Sets carrier reference frequency. The center frequencies of carriers are defined as offset frequency from this value. This reference frequency is also the reference of carrier configuration preset.

Key Path	FREQ Channel
Mode	MSR
Measurement	all
Remote Command	<code>[:SENSe] :CARRier:REFerence <freq></code> <code>[:SENSe] :CARRier:REFerence?</code>
Example	CARR:REF 2GHz CARR:REF?
Preset	1GHz
State Saved	Saved in instrument state
Min	Depends on instrument minimum center frequency. Same as Center Freq
Max	Depends on instrument maximum center frequency. Same as Center Freq
Initial S/W Revision	A.10.00

Carrier Setup

Accesses the Carrier Setup menu.

Key Path	FREQ Channel
Initial S/W Revision	A.10.00

Carriers

Specifies how many carriers are used in MSR measurements. Base station RF bandwidth is determined from the carrier 1 to the carrier specified by this value whatever carriers' Present Pwr states are. Select Carrier can be select up to this value.

Key Path	FREQ Channel, Carrier Setup
Measurement	All
Remote Command	<code>[:SENSe] :CARRier:COUNT <integer></code> <code>[:SENSe] :CARRier:COUNT?</code>
Example	CARR:COUN 10 CARR:COUN?
Preset	1
State Saved	Saved in instrument state.
Min	1
Max	100
Initial S/W Revision	A.10.00

Configure Carriers

Accesses a menu of commonly used carrier configuration parameters.

Key Path	FREQ Channel, Carrier Setup
Initial S/W Revision	A.10.00

Select Carrier

Selects which carrier's configuration menu is displayed.

This key is also connected to the carrier info tables of some measurements. When the value is changed in a measurement which has carrier table view, the highlight in the table moves to Select Carrier. The highlight of the table and Select Carrier are not coupled.

Key Path	FREQ Channel, Carrier Setup, Configure Carriers
Preset	1
State Saved	No
Min	1
Max	Value of Carriers
Initial S/W Revision	A.10.00

Measure Carrier

Sets whether to measure this carrier or not.

Key Path	FREQ Channel, Carrier Setup, Configure Carriers
Remote Command	<code>[:SENSe] :CARRier<n> [:STATe] OFF ON 0 1</code> <code>[:SENSe] :CARRier<n> [:STATe] ?</code>
Example	CARR10 1 CARR10?
Notes	The command is used with a sub-op code <n> (default=1) to specify the carrier for configuration. The range of the sub-op code is determined by the number of carriers.
Preset	ON
State Saved	Saved in instrument state
Range	On Off
Initial S/W Revision	A.10.00

Carrier Offset

Sets the carrier center frequency as offset from Carrier Ref Frequency.

Key Path	FREQ Channel, Carrier Setup, Configure Carriers
Remote Command	<code>[:SENSe] :CARRier<n> :FREQuency:OFFSet <freq></code> <code>[:SENSe] :CARRier<n> :FREQuency:OFFSet ?</code>
Example	CARR10:FREQ:OFFS 10MHz CARR10:FREQ:OFFS?
Notes	The command is used with a sub-op code <n> (default=1) to specify the carrier for configuration. The range of the sub-op code is determined by the number of carriers.
Preset	0Hz
State Saved	Saved in instrument state
Min	-1GHz
Max	1GHz
Initial S/W Revision	A.10.00

Radio Format

Selects a format parameter set to set the radio format of the selected carrier.

NONE – No format is specified. Channel spacing, measurement BW and FOffset,RAT are values of defaults of LTE FDD 5MHz.

LTE FDD Parameter Set 1 – Selects LTE FDD parameter set 1. LTE FDD (E-UTRA FDD) is the radio format of the carrier.

LTE FDD Parameter Set 2 – Selects LTE FDD parameter set 2. LTE FDD (E-UTRA FDD) is the radio format of the carrier.

LTE FDD Parameter Set 3 – Selects LTE FDD parameter set 3. LTE FDD (E-UTRA FDD) is the radio format of the carrier.

W-CDMA Parameter Set 1 – Selects W-CDMA parameter set 1. W-CDMA (UTRA FDD) is the radio format of the carrier.

W-CDMA Parameter Set 2 – Selects W-CDMA parameter set 2. W-CDMA (UTRA FDD) is the radio format of the carrier.

W-CDMA Parameter Set 3 – Selects W-CDMA parameter set 3. W-CDMA (UTRA FDD) is the radio format of the carrier.

GSM/EDGE Parameter Set 1 – Selects GSM/EDGE parameter set 1. GSM/EDGE is the radio format of the carrier.

GSM/EDGE Parameter Set 2 – Selects GSM/EDGE parameter set 2. GSM/EDGE is the radio format of the carrier.

GSM/EDGE Parameter Set 3 – Selects GSM/EDGE parameter set 3. GSM/EDGE is the radio format of the carrier.

cdma2000 Parameter Set 1 – Selects cdma2000 parameter set 1. cdma2000 is the radio format of the carrier.

cdma2000 Parameter Set 2 – Selects cdma2000 parameter set 2. cdma2000 is the radio format of the carrier.

cdma2000 Parameter Set 3 – Selects cdma2000 parameter set 3. cdma2000 is the radio format of the carrier.

1xEV-DO Parameter Set 1 – Selects 1xEV-DO parameter set 1. 1xEV-DO is the radio format of the carrier.

1xEV-DO Parameter Set 2 – Selects 1xEV-DO parameter set 2. 1xEV-DO is the radio format of the carrier.

1xEV-DO Parameter Set 3 – Selects 1xEV-DO parameter set 3. 1xEV-DO is the radio format of the carrier.

LTE TDD Parameter Set 1 – Selects LTE TDD parameter set 1. LTE TDD (E-UTRA TDD) is the radio format of the carrier.

LTE TDD Parameter Set 2 – Selects LTE TDD parameter set 2. LTE TDD (E-UTRA TDD) is the radio format of the carrier.

LTE TDD Parameter Set 3 – Selects LTE TDD parameter set 3. LTE TDD (E-UTRA TDD) is the radio format of the carrier.

TD-SCDMA Parameter Set 1 – Selects TD-SCDMA parameter set 1. TD-SCDMA (UTRA-TDD LCR) is the radio format of the carrier.

TD-SCDMA Parameter Set 2 – Selects TD-SCDMA parameter set 2. TD-SCDMA (UTRA-TDD LCR) is the radio format of the carrier.

TD-SCDMA Parameter Set 3 – Selects TD-SCDMA parameter set 3. TD-SCDMA (UTRA-TDD LCR) is the radio format of the carrier.

Key Path	FREQ Channel, Carrier Setup, Configure Carriers
Remote Command	[:SENSe]:CARRier<n>:FORMat NONE LTEFdd1 LTEFdd2 LTEFdd3 WCDMa1 WCDMa2 WCDMa3 GSM1 GSM2 GSM3 CDMA1 CDMA2 CDMA3 EVDO1 EVDO2 EVDO3 LTETdd1 LTETdd2 LTETdd3 TDSCdma1 TDSCdma2 TDSCdma3 [:SENSe]:CARRier<n>:FORMat ?
Example	CARR10:FORM LTEF1 CARR10:FORM?
Notes	The command is used with a sub-op code <n> (default=1) to specify the carrier for configuration. The range of the sub-op code is determined by the number of carriers.
Dependencies	The following licenses are required for each key to be displayed. Without the licenses, corresponding enum values cannot be set even via the SCPI command. <ul style="list-style-type: none"> • LTE FDD - N9080A-1FP or W9080A-1FP • W-CDMA - N9073A-1FP or W9073A-1FP • GSM/EDGE - N9071A-2FP or W9071A-2FP • cdma2000 - N9072A-2FP or W9072A-2FP • 1xEV-DO - N9076A-1FP or W9076A-1FP • LTE TDD - N9082A-1FP or W9082A-1FP • TD-SCDMA - N9079A-1FP or W9079A-1FP
State Saved	Saved in instrument state
Range	None LTE FDD [Parameter Set 1] Parameter Set 1 ("LTE FDD 1") Parameter Set 2 ("LTE FDD 2") Parameter Set 3 ("LTE FDD 3") W-CDMA [Parameter Set 1] Parameter Set 1 ("W-CDMA 1") Parameter Set 2 ("W-CDMA 2") Parameter Set 3 ("W-CDMA 3") GSM/EDGE [Parameter Set 1] Parameter Set 1 ("GSM/EDGE 1") Parameter Set 2 ("GSM/EDGE 2") Parameter Set 3 ("GSM/EDGE 3") cdma2000 [Parameter Set 1] Parameter Set 1 ("cdma2000 1") Parameter Set 2 ("cdma2000 2") Parameter Set 3 ("cdma2000 3") 1xEV-DO [Parameter Set 1] Parameter Set 1 ("1xEV-DO 1") Parameter Set 2 ("1xEV-DO 2") Parameter Set 3 ("1xEV-DO 3")

	LTE TDD [Parameter Set 1] Parameter Set 1 ("LTE TDD 1") Parameter Set 2 ("LTE TDD 2") Parameter Set 3 ("LTE TDD 3") TD-SCDMA [Parameter Set 1] Parameter Set 1 ("TD-SCDMA 1") Parameter Set 2 ("TD-SCDMA 2") Parameter Set 3 ("TD-SCDMA 3")
Readback	The readback line on this key shows the currently selected Radio Format in square brackets.
Initial S/W Revision	A.10.00
Modified at S/W Revision	A.12.00, A.16.00

Carrier Allocation

Specifies the carrier frequency allocation. There are two types of allocation, contiguous and non-contiguous. Non-Contiguous frequency allocation is defined as an allocation where two sub-blocks are separated with a sub-block gap.

Contiguous – All the carriers belong to one block and no sub-block gap exists.

Non-Contiguous – Carriers are separated into two sub-blocks. Allocation Break Pt Carrier determines how sub-blocks are configured.

Key Path	FREQ Channel, Carrier Setup
Scope	Meas Global
Remote Command	[:SENSe]:CARRier:CONFig:ALLocation CONTiguous NCONtiguous [:SENSe]:CARRier:CONFig:ALLocation?
Example	CARR:CONF:ALL CONT CARR:CONF:ALL?
Preset	CONTiguous
State Saved	Saved in instrument state.
Range	Contiguous Non-Contiguous
Initial S/W Revision	A.13.00

Non-Contiguous

Opens a menu that enables you to set a non-contiguous parameter.

Key Path	FREQ Channel, Carrier Setup, Carrier Allocation
Initial S/W Revision	A.13.00

Allocation Break Pt Carrier

Specifies an allocation break point in non-contiguous carrier allocation. First sub-block starts from the lowest frequency carrier and stops at the allocation break point carrier. Next sub-block starts from the next upper frequency carrier and ends at the highest frequency carrier.

Two examples are shown below. In these examples carrier indices are not in the order of carrier frequency. In the first example, Allocation Break Pt Carrier is 2. It means that sub-block 1 ends at carrier 2 and sub-block 2 starts at carrier 5. Sub-block gap is located between carrier 2 and 5. In the second example, Allocation Break Pt Carrier is 3 and the sub-block gap comes between carrier 3 and 2.

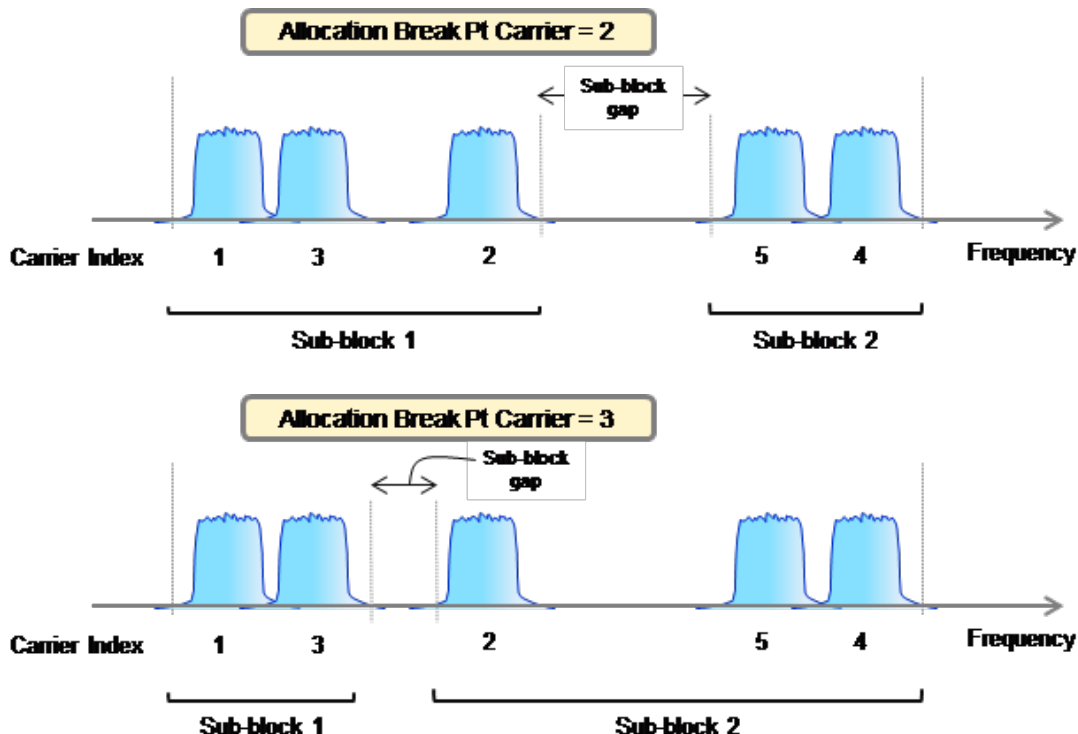

Key Path	FREQ Channel, Carrier Setup, Carrier Allocation, Non-Contiguous
Scope	Meas Global
Remote Command	[[:SENSE]:CARRIER:CONFIG:ALLOCATION:NCONTIGUOUS:ABPOINT <integer> [:SENSE]:CARRIER:CONFIG:ALLOCATION:NCONTIGUOUS:ABPOINT?
Example	CARR:CONF:ALL:NCON:ABP 5 CARR:CONF:ALL:NCON:ABP?
Dependencies	The maximum value depends on the number of carriers.
Couplings	This value can change when you decrease the number of carriers.
Preset	1
State Saved	Saved in instrument state.
Min	1
Max	99
Initial S/W Revision	A.13.00

Carrier Conf Presets

Pressing this key pops up Conf Presets. Each parameter under this menu initiate carrier configuration preset when its value is changed.

Appropriate licenses are required to select carrier config enum. Required licenses are shown here. Note that N/W means N or W license, i.e. N/W9073A-1FP means either N9073A-1FP or W9073A-1FP is required.

TC1a (FDD): N/W9073A-1FP (W-CDMA)

TC2 (FDD): N/W9080A-1FP (LTE FDD)

TC3a (FDD): N/W9073A-1FP (W-CDMA) and N9080A-1FP (LTE FDD)

TC4a (FDD): N/W9071A-2FP (GSM/EDGE) and N/W9073A-1FP (W-CDMA)

TC4b (FDD): N/W9071A-2FP (GSM/EDGE) and N9080A-1FP (LTE FDD)

TC4c (FDD): N/W9071A-2FP (GSM/EDGE), N/W9073A-1FP (W-CDMA) and N9080A-1FP (LTE FDD)

TC4d (FDD): N/W9071A-2FP (GSM/EDGE) and N/W9073A-1FP (W-CDMA)

TC4e (FDD): N/W9071A-2FP (GSM/EDGE) and N9080A-1FP (LTE FDD)

TC4a (FDD) Two Carriers: N/W9071A-2FP (GSM/EDGE) and N/W9073A-1FP (W-CDMA)

TC4b (FDD) Two Carriers: N/W9071A-2FP (GSM/EDGE) and N9080A-1FP (LTE FDD)

TC4c (FDD) Two Carriers: N/W9071A-2FP (GSM/EDGE), N/W9073A-1FP (W-CDMA) and N9080A-1FP (LTE FDD)

NTC1a (FDD): N/W9073A-1FP (W-CDMA)

NTC2 (FDD): N/W9080A-1FP (LTE FDD)

NTC3a (FDD): N/W9073A-1FP (W-CDMA) and N9080A-1FP (LTE FDD)

NTC4a (FDD): N/W9071A-2FP (GSM/EDGE) and N/W9073A-1FP (W-CDMA)

NTC4b (FDD): N/W9071A-2FP (GSM/EDGE) and N9080A-1FP (LTE FDD)

NTC4c (FDD): N/W9071A-2FP (GSM/EDGE), N/W9073A-1FP (W-CDMA) and N9080A-1FP (LTE FDD)

LTE FDD: N/W9080A-1FP (LTE FDD)

W-CDMA: N/W9073A-1FP (W-CDMA)

GSM/EDGE: N/W9071A-2FP (GSM/EDGE)

cdma2000: N/W9072A-2FP (cdma2000)

1xEV-DO: N/W9076A-1FP (1xEV-DO)

Enum keys don't appear on the menu if required licenses are not installed.

Key Path	FREQ Channel, Carrier Setup
----------	------------------------------------

Remote Command	<code>[:SENSe] :CARRier :CONFig?</code>
Example	CARR:CONF TC1AFDD CARR:CONF?
Notes	The softkey for NONE is not available.
State Saved	Saved in instrument state
Initial S/W Revision	A.10.00
Modified at S/W Revision	A.12.00, A.13.00

MSR Test Config

Accesses the menu to select MSR Test Configurations.

Key Path	FREQ Channel, Carrier Setup
Initial S/W Revision	A.10.00

Carrier Conf Presets

Pressing this key pops up Conf Presets. Each parameter under this menu initiate carrier configuration preset when its value is changed.

Appropriate licenses are required to select carrier config enum. Required licenses are shown here. Note that N/W means N or W license, i.e. N/W9073A-1FP means either N9073A-1FP or W9073A-1FP is required.

TC1a (FDD): N/W9073A-1FP (W-CDMA)

TC2 (FDD): N/W9080A-1FP (LTE FDD)

TC3a (FDD): N/W9073A-1FP (W-CDMA) and N9080A-1FP (LTE FDD)

TC4a (FDD): N/W9071A-2FP (GSM/EDGE) and N/W9073A-1FP (W-CDMA)

TC4b (FDD): N/W9071A-2FP (GSM/EDGE) and N9080A-1FP (LTE FDD)

TC4c (FDD): N/W9071A-2FP (GSM/EDGE), N/W9073A-1FP (W-CDMA) and N9080A-1FP (LTE FDD)

TC4d (FDD): N/W9071A-2FP (GSM/EDGE) and N/W9073A-1FP (W-CDMA)

TC4e (FDD): N/W9071A-2FP (GSM/EDGE) and N9080A-1FP (LTE FDD)

TC4a (FDD) Two Carriers: N/W9071A-2FP (GSM/EDGE) and N/W9073A-1FP (W-CDMA)

TC4b (FDD) Two Carriers: N/W9071A-2FP (GSM/EDGE) and N9080A-1FP (LTE FDD)

TC4c (FDD) Two Carriers: N/W9071A-2FP (GSM/EDGE), N/W9073A-1FP (W-CDMA) and N9080A-1FP (LTE FDD)

NTC1a (FDD): N/W9073A-1FP (W-CDMA)

NTC2 (FDD): N/W9080A-1FP (LTE FDD)

NTC3a (FDD): N/W9073A-1FP (W-CDMA) and N9080A-1FP (LTE FDD)

NTC4a (FDD): N/W9071A-2FP (GSM/EDGE) and N/W9073A-1FP (W-CDMA)

NTC4b (FDD): N/W9071A-2FP (GSM/EDGE) and N9080A-1FP (LTE FDD)

NTC4c (FDD): N/W9071A-2FP (GSM/EDGE), N/W9073A-1FP (W-CDMA) and N9080A-1FP (LTE FDD)

LTE FDD: N/W9080A-1FP (LTE FDD)

W-CDMA: N/W9073A-1FP (W-CDMA)

GSM/EDGE: N/W9071A-2FP (GSM/EDGE)

cdma2000: N/W9072A-2FP (cdma2000)

1xEV-DO: N/W9076A-1FP (1xEV-DO)

Enum keys don't appear on the menu if required licenses are not installed.

Key Path	FREQ Channel, Carrier Setup
Remote Command	<code>[:SENSe] :CARRier:CONFig?</code>
Example	CARR:CONF TC1AFDD CARR:CONF?
Notes	The softkey for NONE is not available.
State Saved	Saved in instrument state
Initial S/W Revision	A.10.00
Modified at S/W Revision	A.12.00, A.13.00

Max W-CDMA Carriers (FDD)

Sets max W-CDMA carriers placed when the carrier configuration preset runs. When this value is changed, the carrier configuration preset is initiated.

Key Path	FREQ Channel, Carrier Setup, Carrier Conf Presets, MSR Test Config, TC1a (FDD)FREQ Channel, Carrier Setup, Carrier Conf Presets, MSR Test Config, TC3a (FDD)FREQ Channel, Carrier Setup, Carrier Conf Presets, MSR Test Config, TC4a (FDD)FREQ Channel, Carrier Setup, Carrier Conf Presets, MSR Test Config, TC4c (FDD)FREQ Channel, Carrier Setup, Carrier Conf Presets, Single RAT Config, W-CDMA
Remote Command	<code>[:SENSe] :CARRier:CONFig:WCDMa:CMAx <integer></code> <code>[:SENSe] :CARRier:CONFig:WCDMa:CMAx?</code>
Example	CARR:CONF:WCDM:CMAx 8 CARR:CONF:WCDM:CMAx?
Preset	100
State Saved	Saved in instrument state

Min	1
Max	100
Initial S/W Revision	A.10.00

Max LTE FDD Carriers

Sets max LTE FDD carriers placed when the carrier configuration preset runs. When this value is changed, the carrier configuration preset is initiated.

Key Path	FREQ Channel, Carrier Setup, Carrier Conf Presets, MSR Test Config, TC2 (FDD)FREQ Channel, Carrier Setup, Carrier Conf Presets, MSR Test Config, TC3a (FDD)FREQ Channel, Carrier Setup, Carrier Conf Presets, MSR Test Config, TC4b (FDD)FREQ Channel, Carrier Setup, Carrier Conf Presets, MSR Test Config, TC4c (FDD)FREQ Channel, Carrier Setup, Carrier Conf Presets, Single RAT Config, LTE FDD
Remote Command	<code>[:SENSe] :CARRier:CONFig:LTEFdd:CMAX <integer></code> <code>[:SENSe] :CARRier:CONFig:LTEFdd:CMAX?</code>
Example	CARR:CONF:LTEF:CMAX 8 CARR:CONF:LTEF:CMAX?
Preset	100
State Saved	Saved in instrument state
Min	1
Max	100
Initial S/W Revision	A.10.00

LTE FDD BW

Sets bandwidth of LTE FDD carriers placed when the carrier configuration preset runs. When this value is changed, the carrier configuration preset is initiated.

Key Path	FREQ Channel, Carrier Setup, Carrier Conf Presets, MSR Test Config, TC2 (FDD)FREQ Channel, Carrier Setup, Carrier Conf Presets, MSR Test Config, TC3a (FDD)FREQ Channel, Carrier Setup, Carrier Conf Presets, MSR Test Config, TC4b (FDD)FREQ Channel, Carrier Setup, Carrier Conf Presets, MSR Test Config, TC4c (FDD)FREQ Channel, Carrier Setup, Carrier Conf Presets, MSR Test Config, TC4d (FDD)FREQ Channel, Carrier Setup, Carrier Conf Presets, Single RAT Config, LTE FDD
Remote Command	<code>[:SENSe] :CARRier:CONFig:LTEFdd:BANDwidth B1M4 B3M B5M B10M B15M B20M</code> <code>[:SENSe] :CARRier:CONFig:LTEFdd:BANDwidth?</code>
Example	CARR:CONF:LTEF:BAND B5M CARR:CONF:LTEF:BAND?
Preset	B5M

State Saved	Saved in instrument state
Range	1.4MHz 3MHz 5MHz 10MHz 15MHz 20MHz
Readback	The currently selected LTE FDD BW
Initial S/W Revision	A.10.00

Narrowest LTE FDD BW

Sets narrowest bandwidth of LTE FDD carriers placed for TC2 when the carrier configuration preset runs. When this value is changed, the carrier configuration preset is initiated.

Key Path	FREQ Channel, Carrier Setup, Carrier Conf Presets, MSR Test Config, TC2 (FDD)
Remote Command	<code>[:SENSe] :CARRier:CONFig:LTEFdd:BAWdwidth:NARRowest B1M4 B3M B5M B10M B15M B20M</code> <code>[:SENSe] :CARRier:CONFig:LTEFdd:BAWdwidth:NARRowest?</code>
Example	CARR:CONF:LTEF:BAND:NARR B1M4 CARR:CONF:LTEF:BAND:NARR?
Preset	B1M4
State Saved	Saved in instrument state
Range	1.4MHz 3MHz 5MHz 10MHz 15MHz 20MHz
Readback	The currently selected Narrowest LTE FDD BW
Initial S/W Revision	A.10.00

Max GSM/EDGE Carriers

Sets max GSM/EDGE carriers placed when the carrier configuration preset runs. When this value is changed, the carrier configuration preset is initiated.

Key Path	FREQ Channel, Carrier Setup, Carrier Conf Presets, MSR Test Config, TC4a (FDD)FREQ Channel, Carrier Setup, Carrier Conf Presets, MSR Test Config, TC4b (FDD)FREQ Channel, Carrier Setup, Carrier Conf Presets, MSR Test Config, TC4c (FDD)FREQ Channel, Carrier Setup, Carrier Conf Presets, Single RAT Config, GSM/EDGE
Remote Command	<code>[:SENSe] :CARRier:CONFig:GSM:CMAX <integer></code> <code>[:SENSe] :CARRier:CONFig:GSM:CMAX?</code>
Example	CARR:CONF:GSM:CMAX 8 CARR:CONF:GSM:CMAX?
Preset	100
State Saved	Saved in instrument state
Min	1
Max	100
Initial S/W Revision	A.10.00

LTE FDD Location

Sets the location of LTE FDD carriers when carriers are configured as TC4c. This parameter is effective only for TC4c.

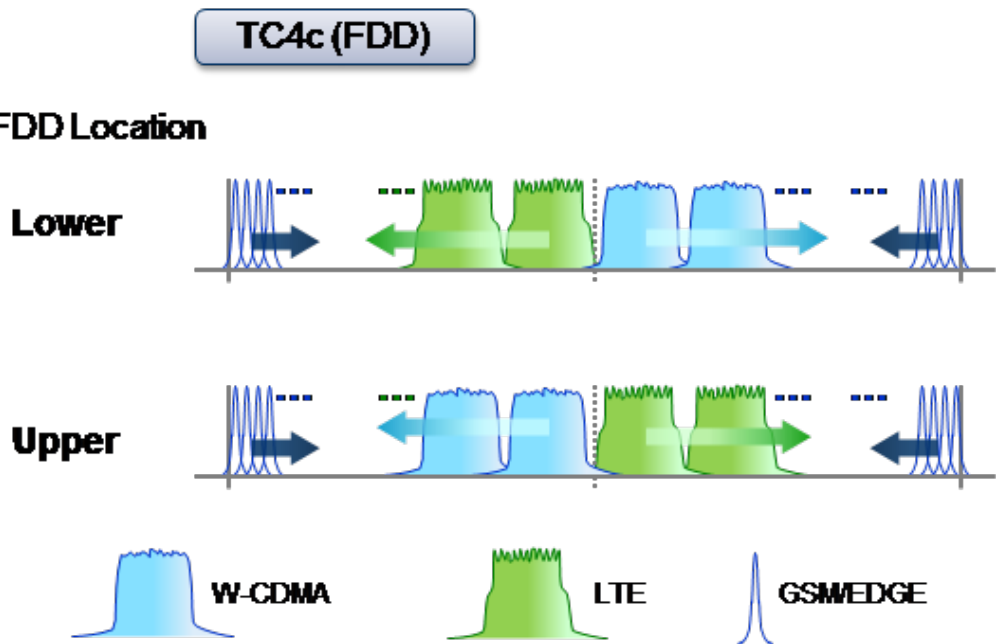

Key Path	FREQ Channel, Carrier Setup, Carrier Conf Presets, MSR Test Config, TC4c (FDD)
Remote Command	<code>[[:SENSE]:CARRier:CONFig:LTEFdd:LOCation UPPer LOWer [:SENSE]:CARRier:CONFig:LTEFdd:LOCation?</code>
Example	<code>CARR:CONF:LTEF:LOC LOW CARR:CONF:LTEF:LOC?</code>
Notes	This setting is effective only for TC4c.
Preset	UPPer
State Saved	Saved in instrument state
Range	Lower (Lower than W-CDMA) Upper (Higher than W-CDMA)
Initial S/W Revision	A.11.00

MSR Non-Contig Test Config

Accesses the menu to select MSR Non-Contiguous Test Configurations.

Key Path	FREQ Channel, Carrier Setup
Initial S/W Revision	A.13.00

Carrier Conf Presets

Pressing this key pops up Conf Presets. Each parameter under this menu initiate carrier configuration preset when its value is changed.

Appropriate licenses are required to select carrier config enum. Required licenses are shown here. Note that N/W means N or W license, i.e. N/W9073A-1FP means either N9073A-1FP or W9073A-1FP is required.

TC1a (FDD): N/W9073A-1FP (W-CDMA)

TC2 (FDD): N/W9080A-1FP (LTE FDD)

TC3a (FDD): N/W9073A-1FP (W-CDMA) and N9080A-1FP (LTE FDD)

TC4a (FDD): N/W9071A-2FP (GSM/EDGE) and N/W9073A-1FP (W-CDMA)

TC4b (FDD): N/W9071A-2FP (GSM/EDGE) and N9080A-1FP (LTE FDD)

TC4c (FDD): N/W9071A-2FP (GSM/EDGE), N/W9073A-1FP (W-CDMA) and N9080A-1FP (LTE FDD)

TC4d (FDD): N/W9071A-2FP (GSM/EDGE) and N/W9073A-1FP (W-CDMA)

TC4e (FDD): N/W9071A-2FP (GSM/EDGE) and N9080A-1FP (LTE FDD)

TC4a (FDD) Two Carriers: N/W9071A-2FP (GSM/EDGE) and N/W9073A-1FP (W-CDMA)

TC4b (FDD) Two Carriers: N/W9071A-2FP (GSM/EDGE) and N9080A-1FP (LTE FDD)

TC4c (FDD) Two Carriers: N/W9071A-2FP (GSM/EDGE), N/W9073A-1FP (W-CDMA) and N9080A-1FP (LTE FDD)

NTC1a (FDD): N/W9073A-1FP (W-CDMA)

NTC2 (FDD): N/W9080A-1FP (LTE FDD)

NTC3a (FDD): N/W9073A-1FP (W-CDMA) and N9080A-1FP (LTE FDD)

NTC4a (FDD): N/W9071A-2FP (GSM/EDGE) and N/W9073A-1FP (W-CDMA)

NTC4b (FDD): N/W9071A-2FP (GSM/EDGE) and N9080A-1FP (LTE FDD)

NTC4c (FDD): N/W9071A-2FP (GSM/EDGE), N/W9073A-1FP (W-CDMA) and N9080A-1FP (LTE FDD)

LTE FDD: N/W9080A-1FP (LTE FDD)

W-CDMA: N/W9073A-1FP (W-CDMA)

GSM/EDGE: N/W9071A-2FP (GSM/EDGE)

cdma2000: N/W9072A-2FP (cdma2000)

1xEV-DO: N/W9076A-1FP (1xEV-DO)

Enum keys don't appear on the menu if required licenses are not installed.

Key Path	FREQ Channel, Carrier Setup
----------	-----------------------------

Remote Command

[:SENSe] :CARRier:CONFig?

Example	CARR:CONF TC1AFDD CARR:CONF?
Notes	The softkey for NONE is not available.
State Saved	Saved in instrument state
Initial S/W Revision	A.10.00
Modified at S/W Revision	A.12.00, A.13.00

LTE FDD BW

Sets bandwidth of LTE FDD carriers placed when the carrier configuration preset runs. When this value is changed, the carrier configuration preset is initiated.

Key Path	FREQ Channel, Carrier Setup, Carrier Conf Presets, MSR Test Config, TC2 (FDD)FREQ Channel, Carrier Setup, Carrier Conf Presets, MSR Test Config, TC3a (FDD)FREQ Channel, Carrier Setup, Carrier Conf Presets, MSR Test Config, TC4b (FDD)FREQ Channel, Carrier Setup, Carrier Conf Presets, MSR Test Config, TC4c (FDD)FREQ Channel, Carrier Setup, Carrier Conf Presets, MSR Test Config, TC4d (FDD)FREQ Channel, Carrier Setup, Carrier Conf Presets, Single RAT Config, LTE FDD
Remote Command	[:SENSe] :CARRier:CONFig:LTEFdd:BANDwidth B1M4 B3M B5M B10M B15M B20M [:SENSe] :CARRier:CONFig:LTEFdd:BANDwidth?
Example	CARR:CONF:LTEF:BAND B5M CARR:CONF:LTEF:BAND?
Preset	B5M
State Saved	Saved in instrument state
Range	1.4MHz 3MHz 5MHz 10MHz 15MHz 20MHz
Readback	The currently selected LTE FDD BW
Initial S/W Revision	A.10.00

NTC4 Carriers

Sets NTC4 carriers placed when the NTC4 carrier configuration preset runs. When this value is changed, the carrier configuration preset is initiated.

Key Path	FREQ Channel, Carrier Setup, Carrier Conf Presets, MSR Non-Contig Test Config, NTC4a (FDD)FREQ Channel, Carrier Setup, Carrier Conf Presets, MSR Non-Contig Test Config, NTC4b (FDD)FREQ Channel, Carrier Setup, Carrier Conf Presets, MSR Non-Contig Test Config, NTC4c(FDD)
Remote Command	[:SENSe] :CARRier:CONFig:NTC4:COUNT <integer> [:SENSe] :CARRier:CONFig:NTC4:COUNT?
Example	CARR:CONF:NTC4:COUN 6 CARR:CONF:NTC4:COUN?

Preset	6
State Saved	Saved in instrument state
Min	3
Max	6
Initial S/W Revision	A.13.00

Single RAT Config

Accesses the menu to select Single RAT Configurations.

Key Path	FREQ Channel, Carrier Setup
Initial S/W Revision	A.10.00

Carrier Conf Presets

Pressing this key pops up Conf Presets. Each parameter under this menu initiate carrier configuration preset when its value is changed.

Appropriate licenses are required to select carrier config enum. Required licenses are shown here. Note that N/W means N or W license, i.e. N/W9073A-1FP means either N9073A-1FP or W9073A-1FP is required.

TC1a (FDD): N/W9073A-1FP (W-CDMA)

TC2 (FDD): N/W9080A-1FP (LTE FDD)

TC3a (FDD): N/W9073A-1FP (W-CDMA) and N9080A-1FP (LTE FDD)

TC4a (FDD): N/W9071A-2FP (GSM/EDGE) and N/W9073A-1FP (W-CDMA)

TC4b (FDD): N/W9071A-2FP (GSM/EDGE) and N9080A-1FP (LTE FDD)

TC4c (FDD): N/W9071A-2FP (GSM/EDGE), N/W9073A-1FP (W-CDMA) and N9080A-1FP (LTE FDD)

TC4d (FDD): N/W9071A-2FP (GSM/EDGE) and N/W9073A-1FP (W-CDMA)

TC4e (FDD): N/W9071A-2FP (GSM/EDGE) and N9080A-1FP (LTE FDD)

TC4a (FDD) Two Carriers: N/W9071A-2FP (GSM/EDGE) and N/W9073A-1FP (W-CDMA)

TC4b (FDD) Two Carriers: N/W9071A-2FP (GSM/EDGE) and N9080A-1FP (LTE FDD)

TC4c (FDD) Two Carriers: N/W9071A-2FP (GSM/EDGE), N/W9073A-1FP (W-CDMA) and N9080A-1FP (LTE FDD)

NTC1a (FDD): N/W9073A-1FP (W-CDMA)

NTC2 (FDD): N/W9080A-1FP (LTE FDD)

NTC3a (FDD): N/W9073A-1FP (W-CDMA) and N9080A-1FP (LTE FDD)

NTC4a (FDD): N/W9071A-2FP (GSM/EDGE) and N/W9073A-1FP (W-CDMA)

NTC4b (FDD): N/W9071A-2FP (GSM/EDGE) and N9080A-1FP (LTE FDD)

NTC4c (FDD): N/W9071A-2FP (GSM/EDGE), N/W9073A-1FP (W-CDMA) and N9080A-1FP (LTE FDD)

LTE FDD: N/W9080A-1FP (LTE FDD)

W-CDMA: N/W9073A-1FP (W-CDMA)

GSM/EDGE: N/W9071A-2FP (GSM/EDGE)

cdma2000: N/W9072A-2FP (cdma2000)

1xEV-DO: N/W9076A-1FP (1xEV-DO)

Enum keys don't appear on the menu if required licenses are not installed.

Key Path	FREQ Channel, Carrier Setup
Remote Command	<code>[:SENSe] :CARRier:CONFig?</code>
Example	CARR:CONF TC1AFDD CARR:CONF?
Notes	The softkey for NONE is not available.
State Saved	Saved in instrument state
Initial S/W Revision	A.10.00
Modified at S/W Revision	A.12.00, A.13.00

Max LTE FDD Carriers

Sets max LTE FDD carriers placed when the carrier configuration preset runs. When this value is changed, the carrier configuration preset is initiated.

Key Path	FREQ Channel, Carrier Setup, Carrier Conf Presets, MSR Test Config, TC2 (FDD)FREQ Channel, Carrier Setup, Carrier Conf Presets, MSR Test Config, TC3a (FDD)FREQ Channel, Carrier Setup, Carrier Conf Presets, MSR Test Config, TC4b (FDD)FREQ Channel, Carrier Setup, Carrier Conf Presets, MSR Test Config, TC4c (FDD)FREQ Channel, Carrier Setup, Carrier Conf Presets, Single RAT Config, LTE FDD
Remote Command	<code>[:SENSe] :CARRier:CONFig:LTEFdd:CMAx <integer></code> <code>[:SENSe] :CARRier:CONFig:LTEFdd:CMAx?</code>
Example	CARR:CONF:LTEF:CMAx 8 CARR:CONF:LTEF:CMAx?
Preset	100
State Saved	Saved in instrument state
Min	1
Max	100
Initial S/W Revision	A.10.00

LTE FDD BW

Sets bandwidth of LTE FDD carriers placed when the carrier configuration preset runs. When this value is changed, the carrier configuration preset is initiated.

Key Path	FREQ Channel, Carrier Setup, Carrier Conf Presets, MSR Test Config, TC2 (FDD)FREQ Channel, Carrier Setup, Carrier Conf Presets, MSR Test Config, TC3a (FDD)FREQ Channel, Carrier Setup, Carrier Conf Presets, MSR Test Config, TC4b (FDD)FREQ Channel, Carrier Setup, Carrier Conf Presets, MSR Test Config, TC4c (FDD)FREQ Channel, Carrier Setup, Carrier Conf Presets, MSR Test Config, TC4d (FDD)FREQ Channel, Carrier Setup, Carrier Conf Presets, Single RAT Config, LTE FDD
Remote Command	<code>[:SENSe] :CARRier:CONFig:LTEFdd:BAWdwidth B1M4 B3M B5M B10M B15M B20M</code> <code>[:SENSe] :CARRier:CONFig:LTEFdd:BAWdwidth?</code>
Example	<code>CARR:CONF:LTEF:BAWd B5M</code> <code>CARR:CONF:LTEF:BAWd?</code>
Preset	B5M
State Saved	Saved in instrument state
Range	1.4MHz 3MHz 5MHz 10MHz 15MHz 20MHz
Readback	The currently selected LTE FDD BW
Initial S/W Revision	A.10.00

Max W-CDMA Carriers (FDD)

Sets max W-CDMA carriers placed when the carrier configuration preset runs. When this value is changed, the carrier configuration preset is initiated.

Key Path	FREQ Channel, Carrier Setup, Carrier Conf Presets, MSR Test Config, TC1a (FDD)FREQ Channel, Carrier Setup, Carrier Conf Presets, MSR Test Config, TC3a (FDD)FREQ Channel, Carrier Setup, Carrier Conf Presets, MSR Test Config, TC4a (FDD)FREQ Channel, Carrier Setup, Carrier Conf Presets, MSR Test Config, TC4c (FDD)FREQ Channel, Carrier Setup, Carrier Conf Presets, Single RAT Config, W-CDMA
Remote Command	<code>[:SENSe] :CARRier:CONFig:WCDMa:CMAX <integer></code> <code>[:SENSe] :CARRier:CONFig:WCDMa:CMAX?</code>
Example	<code>CARR:CONF:WCDM:CMAX 8</code> <code>CARR:CONF:WCDM:CMAX?</code>
Preset	100
State Saved	Saved in instrument state
Min	1
Max	100
Initial S/W Revision	A.10.00

Max GSM/EDGE Carriers

Sets max GSM/EDGE carriers placed when the carrier configuration preset runs. When this value is changed, the carrier configuration preset is initiated.

Key Path	FREQ Channel, Carrier Setup, Carrier Conf Presets, MSR Test Config, TC4a (FDD)FREQ Channel, Carrier Setup, Carrier Conf Presets, MSR Test Config, TC4b (FDD)FREQ Channel, Carrier Setup, Carrier Conf Presets, MSR Test Config, TC4c (FDD)FREQ Channel, Carrier Setup, Carrier Conf Presets, Single RAT Config, GSM/EDGE
Remote Command	<code>[:SENSe] :CARRier :CONFig :GSM :CMAX <integer></code> <code>[:SENSe] :CARRier :CONFig :GSM :CMAX?</code>
Example	<code>CARR:CONF:GSM:CMAX 8</code> <code>CARR:CONF:GSM:CMAX?</code>
Preset	100
State Saved	Saved in instrument state
Min	1
Max	100
Initial S/W Revision	A.10.00

Max cdma2000 Carriers

Sets max cdma2000 carriers placed when the carrier configuration preset runs. When this value is changed, the carrier configuration preset is initiated.

Key Path	FREQ Channel, Carrier Setup, Carrier Conf Presets, Single RAT Config, cdma2000
Remote Command	<code>[:SENSe] :CARRier :CONFig :CDMA :CMAX <integer></code> <code>[:SENSe] :CARRier :CONFig :CDMA :CMAX?</code>
Example	<code>CARR:CONF:CDMA:CMAX 8</code> <code>CARR:CONF:CDMA:CMAX?</code>
Preset	100
State Saved	Saved in instrument state
Min	1
Max	100
Initial S/W Revision	A.12.00

Max 1xEV-DO Carriers

Sets max 1xEV-DO carriers placed when the carrier configuration preset runs. When this value is changed, the carrier configuration preset is initiated.

Key Path	FREQ Channel, Carrier Setup, Carrier Conf Presets, Single RAT Config, 1xEV-DO
Remote Command	<code>[:SENSe] :CARRier :CONFig :EVDO :CMAX <integer></code>

	<code>[:SENSe] :CARRier:CONFig:EVDO:CMAX?</code>
Example	CARR:CONF:EVDO:CMAX 8 CARR:CONF:EVDO:CMAX?
Preset	100
State Saved	Saved in instrument state
Min	1
Max	100
Initial S/W Revision	A.12.00

Max BS RF Bandwidth

Sets max BS RF bandwidth used when the carrier configuration preset runs. When this value is changed, the carrier configuration preset is initiated.

Key Path	FREQ Channel, Carrier Setup, Carrier Conf Presets
Remote Command	<code>[:SENSe] :CARRier:CONFig:RFBWidth <freq></code> <code>[:SENSe] :CARRier:CONFig:RFBWidth?</code>
Example	CARR:CONF:RFBW 40MHz CARR:CONF:RFBW?
Preset	40MHz
State Saved	Saved in instrument state
Min	600 kHz
Max	200 MHz
Initial S/W Revision	A.10.00

Channel Spacing Delta

Carriers are placed based on channel spacing assigned to the corresponding radio format, when they are configured by the carrier config preset. However, channel spacing can be adjusted using channel spacing delta parameters.

This key accesses the menu to set channel spacing delta of each radio format.

Key Path	FREQ Channel, Carrier Setup, Carrier Conf Presets
Initial S/W Revision	A.10.00

LTE FDD

Sets delta channel spacing for LTE FDD used when the carrier configuration preset runs. Channel spacing for LTE FDD is determined from this value and the default channel spacing defined in the standard, i.e. Channel spacing = (BWchan1 + BWchan2) * 0.5 + [the delta spacing]. Since this value is a difference from

the default spacing, this value can be negative to allow narrower channel spacing. When this value is changed, the carrier configuration preset is initiated.

Key Path	FREQ Channel, Carrier Setup, Carrier Conf Presets, Channel Spacing Delta
Remote Command	[:SENSe] :CARRier:CONFig:LTEFdd:SPACing:DELTA <freq> [:SENSe] :CARRier:CONFig:LTEFdd:SPACing:DELTA?
Example	CARR:CONF:LTEF:SPAC:DELT -200kHz CARR:CONF:LTEF:SPAC:DELT?
Preset	0Hz
State Saved	Saved in instrument state
Min	- 1.0 MHz
Max	10.0 MHz
Initial S/W Revision	A.10.00
Modified at S/W Revision	A.11.00

W-CDMA

Sets delta channel spacing for W-CDMA used when the carrier configuration preset runs. Channel spacing for W-CDMA is determined from this value and the default channel spacing defined in the standard, i.e. Channel spacing = 5.0 MHz + [the delta spacing]. Since this value is a difference from the default spacing, this value can be negative to allow narrower channel spacing. When this value is changed, the carrier configuration preset is initiated.

Key Path	FREQ Channel, Carrier Setup, Carrier Conf Presets, Channel Spacing Delta
Remote Command	[:SENSe] :CARRier:CONFig:WCDMa:SPACing:DELTA <freq> [:SENSe] :CARRier:CONFig:WCDMa:SPACing:DELTA?
Example	CARR:CONF:WCDM:SPAC:DELT 0 CARR:CONF:WCDM:SPAC:DELT?
Preset	0 Hz
State Saved	Saved in instrument state
Min	- 1.0 MHz
Max	10.0 MHz
Initial S/W Revision	A.10.00
Modified at S/W Revision	A.11.00

GSM/EDGE

Sets delta channel spacing for GSM/EDGE used when the carrier configuration preset runs. Channel spacing for GSM/EDGE is determined from this value and the default channel spacing defined in the standard, i.e. Channel spacing = 600 kHz + [the delta spacing]. Since this value is a difference from the default spacing, this value can be negative to allow narrower channel spacing. When this value is changed, the carrier configuration preset is initiated.

Key Path	FREQ Channel, Carrier Setup, Carrier Conf Presets, Channel Spacing Delta
Remote Command	[:SENSe] :CARRier :CONFig :GSM :SPACing :DELTA <freq> [:SENSe] :CARRier :CONFig :GSM :SPACing :DELTA?
Example	CARR:CONF:GSM:SPAC:DELT 0 CARR:CONF:GSM:SPAC:DELT?
Preset	0 Hz
State Saved	Saved in instrument state
Min	- 0.4 MHz
Max	10.0 MHz
Initial S/W Revision	A.10.00
Modified at S/W Revision	A.11.00

cdma2000

Sets delta channel spacing for cdma2000 used when the carrier configuration preset runs. Channel spacing for cdma2000 is determined from this value and the default channel spacing defined in the standard, i.e. Channel spacing = 1.25 MHz + [the delta spacing]. Since this value is a difference from the default spacing, this value can be negative to allow narrower channel spacing.

Key Path	FREQ Channel, Carrier Setup, Carrier Conf Presets, Channel Spacing Delta
Remote Command	[:SENSe] :CARRier :CONFig :CDMA :SPACing :DELTA <freq> [:SENSe] :CARRier :CONFig :CDMA :SPACing :DELTA?
Example	CARR:CONF:CDMA:SPAC:DELT 0 CARR:CONF:CDMA:SPAC:DELT?
Preset	0 Hz
State Saved	Saved in instrument state
Min	-1 MHz
Max	10 MHz
Initial S/W Revision	A.12.00

1xEV-DO

Sets delta channel spacing for 1xEV-DO used when the carrier configuration preset runs. Channel spacing for 1xEV-DO is determined from this value and the default channel spacing defined in the standard, i.e. Channel spacing = 1.25 MHz + [the delta spacing]. Since this value is a difference from the default spacing, this value can be negative to allow narrower channel spacing.

Key Path	FREQ Channel, Carrier Setup, Carrier Conf Presets, Channel Spacing Delta
Remote Command	[:SENSe] :CARRier :CONFig :EVDO :SPACing :DELTA <freq> [:SENSe] :CARRier :CONFig :EVDO :SPACing :DELTA?

Example	CARR:CONF:EVDO:SPAC:DELT 0 CARR:CONF:EVDO:SPAC:DELT?
Preset	0 Hz
State Saved	Saved in instrument state
Min	-1 MHz
Max	10 MHz
Initial S/W Revision	A.12.00

Apply to Meas Offset/Limits

This immediate action key sets the following measurement parameters.

- ACP: Offset and limit parameters under Offset/Limits.
- Spectrum Emission Mask: Offset and limit parameters under Offset/Limits.
- Spurious Emissions: Range frequency and limit parameters under Range Table.

These offset and limit values are determined by the carrier configuration parameters, Band Category and Assumed Adj Channels.

Each of these measurement has a local key, “Apply Carrier Config to ...”, which performs in the same way only for its parameters. So pressing this key is equivalent to pressing “Apply Carrier Config to ...” of all these measurements.

Key Path	FREQ Channel, Carrier Setup
Remote Command	[:SENSe] :MCONdition:IMMediate
Example	MCON:IMM
Initial S/W Revision	A.11.00

RF Bandwidth (Remote Command Only)

Returns the RF bandwidth calculated from the outermost carriers and their Foffset_RAT.

Key Path	SCPI only
Mode	MSR
Remote Command	[:SENSe] :CARRier:RFBWidth?
Example	CARR:RFBW?
Preset	Calculated from preset values of carrier config parameters
State Saved	No
Initial S/W Revision	A.13.00

RF Bandwidth Center (Remote Command Only)

Returns the center frequency of RF bandwidth.

Key Path	SCPI only
Mode	MSR
Remote Command	<code>[:SENSe] :CARRier:RFBWidth:CENTer?</code>
Example	<code>CARR:RFBW:CEN?</code>
Preset	Calculated from preset values of carrier config parameters
State Saved	No
Initial S/W Revision	A.13.00

Sub-block Center (Remote Command Only)

Returns the center frequency of sub-block when Carrier Allocation is Non-Contiguous.

Key Path	SCPI only
Mode	MSR
Remote Command	<code>[:SENSe] :CARRier:SBLock [1] 2 :CENTer?</code>
Example	<code>CARR:SBL:CEN?</code>
Notes	When Carrier Allocation is Contiguous, 9.91E+37 is returned.
Preset	Calculated from preset values of carrier config parameters
State Saved	No
Initial S/W Revision	A.13.00

Sub-block Bandwidth (Remote Command Only)

Returns the bandwidth of sub-block calculated from outermost carriers and corresponding Foffset_RAT.

Key Path	SCPI only
Mode	MSR
Remote Command	<code>[:SENSe] :CARRier:SBLock [1] 2 :BWIDth?</code>
Example	<code>CARR:SBL:BWID?</code>
Notes	When Carrier Allocation is Contiguous, 9.91E+37 is returned.
Preset	Calculated from preset values of carrier config parameters
State Saved	No
Initial S/W Revision	A.13.00

Sub-block Gap (Remote Command Only)

Returns the sub-block gap.

Key Path	SCPI only
Mode	MSR
Remote Command	[:SENSe] :CARRier :SBLock :GAP?
Example	CARR:SBL:GAP?
Notes	When Carrier Allocation is Contiguous, 9.91 E+37 is returned.
Preset	Calculated from preset values of carrier config parameters
State Saved	No
Initial S/W Revision	A.13.00

Input/Output

See "Input/Output" on page 190

Marker

Accesses a menu that enables you to select, set up and control the markers for the current measurement. Note that this hard key and all sub keys are unavailable when **"Meas Method" on page 1058** is set to RBW.

Key Path	Front-panel key
Initial S/W Revision	Prior to A.02.00

Select Marker

Displays 12 markers available for selection. Note that this key is unavailable when **"Meas Method" on page 1058** is set to RBW.

Key Path	Marker
Initial S/W Revision	Prior to A.02.00

Marker Type

Sets the marker control mode to **Normal**, **Delta**, **Fixed** or **Off**. All interactions and dependencies detailed under the key description are enforced when the remote command is sent. If the selected marker is Off, pressing Marker sets it to Normal and places it at the center of the screen on the trace determined by the **Marker Trace** rules. At the same time, **Marker X Axis Value** appears on the Active Function area.

The default active function is the active function for the currently selected marker control mode. If the current control mode is Off, there is no active function and the active function is turned off.

Key Path	Marker
Mode	SA, WCDMA, C2K, WIMAX OFDMA, TD-SCDMA, 1xEVDO, DVB-T/H, DTMB (CTTB), ISDB-T, CMMB, LTE, LTE-TDD, Digital Cable TV, MSR, LTEAFDD, LTEATDD
Remote Command	:CALCulate:ACPower:MARKer[1] 2 ... 12:MODE POSition DELTA OFF :CALCulate:ACPower:MARKer[1] 2 ... 12:MODE?
Example	CALC:ACP:MARK2:MODE DELT CALC:ACP:MARK2:MODE?
Notes	<p>If the selected marker is Off, pressing Marker sets it to Normal and places it at the center of the screen on the trace determined by the Marker Trace rules. At the same time, Marker X Axis Value appears on the Active Function area.</p> <p>Default Active Function: the active function for the selected marker's current control mode. If the current control mode is Off, there is no active function and the active function is turned off.</p> <p>Active Function Display: the marker X axis value entered in the active function area will display the marker value to its full entered precision.</p> <p>You must be in the mode that includes ACP measurements to use this command. Use :INSTrument:SElect to set the mode.</p>
Dependencies	This key is unavailable when "Meas Method" on page 1058 is set to RBW.

Preset	OFF OFF OFF OFF OFF OFF OFF OFF OFF OFF OFF OFF
State Saved	Saved in instrument state.
Range	Normal Delta Off
Initial S/W Revision	Prior to A.02.00
Modified at S/W Revision	A.02.00, A.03.00

Properties

Accesses the marker properties menu. Note that this key is unavailable when "Meas Method" on page 1058 is set to RBW.

Key Path	Marker
Initial S/W Revision	Prior to A.02.00

Select Marker

Displays 12 markers available for selection. Note that this key is unavailable when "Meas Method" on page 1058 is set to RBW.

Key Path	Marker
Initial S/W Revision	Prior to A.02.00

Relative To

Selects the desired marker. The selected marker will be relative to its reference marker.

Key Path	Marker, Properties
Mode	SA, WCDMA, C2K, WIMAX OFDMA, TD-SCDMA, 1xEVDO, DVB-T/H, DTMB (CTTB), ISDB-T, CMMB, LTE, LTE-TDD, Digital Cable TV, MSR, LTEAFDD, LTEATDD
Remote Command	:CALCulate:ACPpower:MARKer[1] 2 ... 12:REFerence <integer> :CALCulate:ACPpower:MARKer[1] 2 ... 12:REFerence?
Example	CALC:ACP:MARK2:REF 6 CALC:ACP:MARK2:REF?
Notes	A marker cannot be relative to itself so that choice is grayed out, and if sent from a remote command, generates error -221: "Settings conflict; marker cannot be relative to itself." When queried a single value will be returned (the specified marker numbers relative marker). You must be in the mode that includes ACP measurements to use this command. Use :INSTrument:SELect to set the mode.
Dependencies	This key is unavailable when "Meas Method" on page 1058 is set to RBW.

Preset	2 3 4 5 6 7 8 9 10 11 12 1
State Saved	Saved in instrument state.
Min	1
Max	12
Initial S/W Revision	Prior to A.02.00
Modified at S/W Revision	A.02.00, A.03.00

Marker Trace

Selects the trace that you want your marker to be placed on. A marker is associated with one and only one trace. This trace is used to determine the placement, result, and X Axis Scale of the marker. All markers have an associated trace, even **Fixed** markers; it is from that trace that they determine their attributes and behaviors, and it is to that trace that they go when they become Normal or Delta markers.

Key Path	Marker, Properties
Mode	SA, WCDMA, C2K, WIMAX OFDMA, TD-SCDMA, 1xEVDO, DVB-T/H, DTMB (CTTB), ISDB-T, CMMB, LTE, LTETDD, Digital Cable TV, MSR, LTEAFDD, LTEATDD
Remote Command	:CALCulate:ACPower:MARKer[1] 2 ... 12:TRACe 1 2 3 :CALCulate:ACPower:MARKer[1] 2 ... 12:TRACe?
Example	CALC:ACP:MARK2:TRAC 2 CALC:ACP:MARK2:TRAC?
Notes	If the selected marker is Off, pressing Marker sets it to Normal and places it at the center of the screen on the trace determined by the Marker Trace rules. At the same time, Marker X Axis Value appears on the Active Function area. Default Active Function: the active function for the selected marker's current control mode. If the current control mode is Off, there is no active function and the active function is turned off. Active Function Display: the marker X axis value entered in the active function area will display the marker value to its full entered precision.
Dependencies	This key is unavailable when " Meas Method " on page 1058 is set to RBW.
Couplings	This is not affected by Auto Coupling. Sending the remote command causes the addressed marker to become selected.
Preset	All Markers Off
State Saved	Saved in instrument state.
Range	1 2 3
Initial S/W Revision	Prior to A.02.00
Modified at S/W Revision	A.02.00, A.03.00

Couple Markers

When this function is On, moving any marker causes an equal X axis movement of every other marker which is not **Off**. By “equal X axis movement” we mean that we preserve the difference between each marker’s X axis value (in the fundamental x-axis units of the trace that marker is on) and the X axis value of the marker being moved (in the same fundamental x-axis units).

Key Path	Marker
Mode	SA, WCDMA, C2K, WIMAX OFDMA, TD-SCDMA, 1xEVDO, DVB-T/H, DTMB (CTTB), ISDB-T, CMMB, LTE, LTE-TDD, Digital Cable TV, MSR, LTEAFDD, LTEATDD
Remote Command	:CALCulate:ACPower:MARKer:COUple[:STATE] ON OFF 1 0 :CALCulate:ACPower:MARKer:COUple[:STATE]?
Example	CALC:ACP:MARK:COUP ON
Dependencies	This key is unavailable when " Meas Method " on page 1058 is set to RBW.
Preset	OFF
State Saved	Saved in instrument state.
Range	On Off
Initial S/W Revision	Prior to A.02.00
Modified at S/W Revision	A.02.00, A.03.00

Marker All Off

Turns all active markers off.

Key Path	Marker
Mode	SA, WCDMA, C2K, WIMAX OFDMA, TD-SCDMA, 1xEVDO, DVB-T/H, DTMB (CTTB), ISDB-T, CMMB, LTE, LTE-TDD, Digital Cable TV, MSR, LTEAFDD, LTEATDD
Remote Command	:CALCulate:ACPower:MARKer:AOff
Example	CALC:ACP:MARK:AOff
Dependencies	This key is unavailable when " Meas Method " on page 1058 is set to RBW.
Initial S/W Revision	Prior to A.02.00
Modified at S/W Revision	A.02.00, A.03.00

Marker X Axis Value (Remote Command only)

Sets the marker X axis value in the current marker X Axis Scale unit. This value has no effect if the control mode is **Off**, but is the SCPI equivalent of entering an X value if the control mode is **Normal**, **Delta** or **Fixed**.

Mode	SA, WCDMA, C2K, WIMAX OFDMA, TD-SCDMA, 1xEVDO, DVB-T/H, DTMB (CTTB), ISDB-T, CMMB, LTE, LTE-TDD, Digital Cable TV, MSR, LTEAFDD, LTEATDD
Remote Command	:CALCulate:ACPower:MARKer[1] 2 ... 12:X <freq> :CALCulate:ACPower:MARKer[1] 2 ... 12:X?

Example	CALC:ACP:MARK3:X 0 CALC:ACP:MARK3:X?
Notes	The query returns the marker's absolute X Axis value if the control mode is Normal , or the offset from the marker's reference marker if the control mode is Delta . If the marker is Off the response is not a number.
Dependencies	Unavailable when " Meas Method " on page 1058 is set to RBW.
Preset	After a preset, all Markers are turned OFF, so Marker X Axis Value query will return a not a number (NAN).
State Saved	No
Min	-9.9E+37
Max	9.9E+37
Initial S/W Revision	Prior to A.02.00
Modified at S/W Revision	A.02.00, A.03.00

Marker X Axis Position (Remote Command only)

Sets the marker X position in trace points. It has no effect if the control mode is **Off**, but is the SCPI equivalent of entering a value if the control mode is **Normal**, **Delta** or **Fixed**. The entered value is immediately translated into the current X Axis Scale units for setting the value of the marker.

Mode	SA, WCDMA, C2K, WIMAX OFDMA, TD-SCDMA, 1xEVDO, DVB-T/H, DTMB (CTTB), ISDB-T, CMMB, LTE, LTE-TDD, Digital Cable TV, MSR, LTEAFDD, LTEATDD
Remote Command	:CALCulate:ACPower:MARKer[1] 2 ... 12:X:POSition <real> :CALCulate:ACPower:MARKer[1] 2 ... 12:X:POSition?
Example	CALC:ACP:MARK10:X:POS 0 CALC:ACP:MARK10:X:POS?
Notes	The query returns the marker's absolute X Axis value in trace points if the control mode is Normal , or the offset from the marker's reference marker in trace points if the control mode is Delta . The value is returned as a real number, not an integer, corresponding to the translation from X Axis Scale units to trace points (see "Fractional Trace Points"). If the marker is Off the response is not a number. When a Marker is turned on, it is placed center of the screen on the trace. Therefore the default value depends on instrument condition, although the Preset/Default is defined as 500 (this value might be expected value when all offset is on).
Dependencies	Unavailable when " Meas Method " on page 1058 is set to RBW.
Preset	After a preset, all Markers are turned OFF, so Marker X Axis Value query will return a not a number (NAN).
State Saved	No
Min	-9.9E+37
Max	9.9E+37
Initial S/W Revision	Prior to A.02.00
Modified at S/W Revision	A.02.00, A.03.00

Marker Y Axis Value (Remote Command only)

Returns the marker Y axis value in the current marker Y axis unit.

Mode	SA, WCDMA, C2K, WIMAX OFDMA, TD-SCDMA, 1xEVDO, DVB-T/H, DTMB (CTTB), ISDB-T, CMMB, LTE, LTE-TDD, Digital Cable TV, MSR, LTEAFDD, LTEATDD
Remote Command	:CALCulate:ACPower:MARKer [1] 2 ... 12 : Y ?
Example	CALC:ACP:MARK11:Y?
Notes	Since the result value is always calculated from acquisition data, the default value is arbitrary. Although the Preset/Default values are defined.
Dependencies	Unavailable when " Meas Method " on page 1058 is set to RBW.
Preset	Result dependent on markers setup and signal source.
State Saved	No
Backwards Compatibility SCPI	:CALCulate:ACPower:MARKer [1] 2 ... 12 : FUNCTION:RESULT?
Initial S/W Revision	Prior to A.02.00
Modified at S/W Revision	A.02.00, A.03.00

Backward Compatibility Remote Commands

Sets or queries the state of a marker. Setting a marker which is off to the on state or 1 puts it in Normal mode and places it at the center of the screen.

Mode	SA, WCDMA, WIMAX OFDMA, CDMA2K, TDSCDMA, CDMA1XEV, DVB, DTMB, ISDBT, CMMB, LTE, LTE-TDD, DCTV, MSR, LTEAFDD, LTEATDD
Remote Command	:CALCulate:ACPower:MARKer [1] 2 ... 12 : STATE OFF ON 0 1 :CALCulate:ACPower:MARKer [1] 2 ... 12 : STATE ?
Example	CALC:ACP:MARK2:STAT ON CALC:ACP:MARK2:STAT?
Notes	This parameter is also accessed from Marker, Properties, 1 You must be in the mode that includes ACP measurements to use this command. Use :INSTRument:SElect to set the mode.
Preset	OFF OFF OFF OFF OFF OFF OFF OFF OFF OFF OFF OFF
State Saved	Saved in instrument state.
Range	On Off
Initial S/W Revision	Prior to A.02.00
Modified at S/W Revision	A.02.00, A.03.00

Marker Function

There are no Marker Functions supported in the ACP measurement. The front-panel key will display a blank key menu when pressed.

Key Path	Front-panel key
Initial S/W Revision	Prior to A.02.00

Marker To

There is no Marker To functionality supported in ACP. The front-panel key will display a blank key menu when pressed.

Key Path	Front-panel key
Initial S/W Revision	Prior to A.02.00

Meas

The information in this section is common to all measurements. For key and remote command information for a specific measurement, refer to the section that describes the measurement of interest.

Measurements available under the Meas key are specific to the current Mode.

When viewing Help for measurements, note the following:

NOTE

Operation for some keys differs between measurements. The information displayed in Help pertains to the current measurement. To see how a key operates in a different measurement, exit Help (press the Cancel Esc key), select the measurement, then reenter Help (press the Help key) and press that key.

Key Path	Front-panel key
Initial S/W Revision	Prior to A.02.00

Remote Measurement Functions

This section contains the following topics:

["Measurement Group of Commands" on page 2382](#)

["Current Measurement Query \(Remote Command Only\)" on page 2384](#)

["Limit Test Current Results \(Remote Command Only\)" on page 2384](#)

["Data Query \(Remote Command Only\)" on page 2384](#)

["Calculate/Compress Trace Data Query \(Remote Command Only\)" on page 2385](#)

["Calculate Peaks of Trace Data \(Remote Command Only\)" on page 2390](#)

["Hardware-Accelerated Fast Power Measurement \(Remote Command Only\)" on page 2391](#)

["Format Data: Numeric Data \(Remote Command Only\)" on page 2405](#)

["Format Data: Byte Order \(Remote Command Only\)" on page 2406](#)

Initial S/W Revision	Prior to A.02.00
----------------------	------------------

Measurement Group of Commands

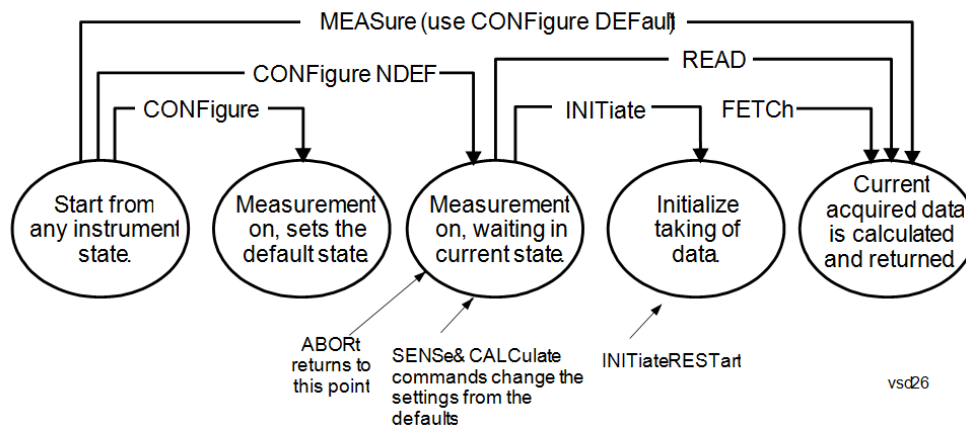

Measure Commands:

:MEASure:<measurement>[n]?

This is a fast single-command way to make a measurement using the factory default instrument settings. These are the settings and units that conform to the Mode Setup settings (e.g. radio standard) that you have currently selected.

- Stops the current measurement (if any) and sets up the instrument for the specified measurement using the factory defaults
- Initiates the data acquisition for the measurement
- Blocks other SCPI communication, waiting until the measurement is complete before returning results.
- If the function does averaging, it is turned on and the number of averages is set to 10.
- After the data is valid it returns the scalar results, or the trace data, for the specified measurement. The type of data returned may be defined by an [n] value that is sent with the command.
- The scalar measurement results will be returned if the optional [n] value is not included, or is set to 1. If the [n] value is set to a value other than 1, the selected trace data results will be returned. See each command for details of what types of scalar results or trace data results are available.
- ASCII is the default format for the data output. (Older versions of Spectrum Analysis and Phase Noise mode measurements only use ASCII.) The binary data formats should be used for handling large blocks of data since they are smaller and faster than the ASCII format. Refer to the FORMat:DATA command for more information.

If you need to change some of the measurement parameters from the factory default settings you can set up the measurement with the CONFigure command. Use the commands in the SENSe:<measurement> and CALCulate:<measurement> subsystems to change the settings. Then you can use the READ? command to initiate the measurement and query the results.

If you need to repeatedly make a given measurement with settings other than the factory defaults, you can use the commands in the SENSe:<measurement> and CALCulate:<measurement> subsystems to set up the measurement. Then use the READ? command to initiate the measurement and query results.

Measurement settings persist if you initiate a different measurement and then return to a previous one. Use READ:<measurement>? if you want to use those persistent settings. If you want to go back to the default settings, use MEASure:<measurement>?.

Configure Commands:

:CONFigure:<measurement>

This command stops the current measurement (if any) and sets up the instrument for the specified measurement using

the factory default instrument settings. It does not initiate the taking of measurement data unless INIT:CONTinuous is ON. If you change any measurement settings after using the CONFigure command, the READ command can be used to initiate a measurement without changing the settings back to their defaults.

In the Swept SA measurement in Spectrum Analyzer mode the CONFigure command also turns the averaging function on and sets the number of averages to 10 for all measurements.

:CONFigure: <measurement>: NDEFault stops the current measurement and changes to the specified measurement. It does not change the settings to the defaults. It does not initiate the taking of measurement data unless INIT:CONTinuous is ON.

The CONFigure? query returns the current measurement name.

The CONFigure:CATalog? query returns a quoted string of all licensed measurement names in the current mode. For example, "SAN, CHP, OBW, ACP, PST, TXP, SPUR, SEM, LIST".

Fetch Commands:

:FETCh:<measurement>[n]?

This command puts selected data from the most recent measurement into the output buffer. Use FETCh if you have already made a good measurement and you want to return several types of data (different [n] values, for example, both scalars and trace data) from a single measurement. FETCh saves you the time of re-making the measurement. You can only FETCh results from the measurement that is currently active, it will not change to a different measurement. An error message is reported if a measurement other than the current one is specified.

If you need to get new measurement data, use the READ command, which is equivalent to an INITiate followed by a FETCh.

The scalar measurement results will be returned if the optional [n] value is not included, or is set to 1. If the [n] value is set to a value other than 1, the selected trace data results will be returned. See each command for details of what types of scalar results or trace data results are available. The binary data formats should be used for handling large blocks of data since they are smaller and transfer faster than the ASCII format. (FORMat:DATA)

FETCh may be used to return results other than those specified with the original READ or MEASure command that you sent.

INITiate Commands:

:INITiate:<measurement>

This command is not available for measurements in all the instrument modes:

- Initiates a trigger cycle for the specified measurement, but does not output any data. You must then use the FETCh<meas> command to return data. If a measurement other than the current one is specified, the instrument will switch to that measurement and then initiate it.
 - For example, suppose you have previously initiated the ACP measurement, but now you are running the channel power measurement. If you send INIT:ACP? it will change from channel power to ACP and will initiate an ACP measurement.
 - Does not change any of the measurement settings. For example, if you have previously started the ACP measurement and you send INIT:ACP? it will initiate a new ACP measurement using the same instrument settings as the last time ACP was run.
 - If your selected measurement is currently active (in the idle state) it triggers the measurement, assuming the trigger conditions are met. Then it completes one trigger cycle. Depending upon the measurement and the number of averages, there may be multiple data acquisitions, with multiple trigger events, for one full trigger cycle. It also holds off additional commands on GPIB until the acquisition is complete.
-

READ Commands:

:READ:<measurement>[n]?

- Does not preset the measurement to the factory default settings. For example, if you have previously initiated the ACP
-

measurement and you send READ:ACP? it will initiate a new measurement using the same instrument settings.

- Initiates the measurement and puts valid data into the output buffer. If a measurement other than the current one is specified, the instrument will switch to that measurement before it initiates the measurement and returns results.
 - For example, suppose you have previously initiated the ACP measurement, but now you are running the channel power measurement. Then you send READ:ACP? It will change from channel power back to ACP and, using the previous ACP settings, will initiate the measurement and return results.
 - Blocks other SCPI communication, waiting until the measurement is complete before returning the results
 - If the optional [n] value is not included, or is set to 1, the scalar measurement results will be returned. If the [n] value is set to a value other than 1, the selected trace data results will be returned. See each command for details of what types of scalar results or trace data results are available. The binary data formats should be used when handling large blocks of data since they are smaller and faster than the ASCII format. (FORMat:DATA)
-

Initial S/W Revision	Prior to A.02.00
----------------------	------------------

Current Measurement Query (Remote Command Only)

This command returns the name of the measurement that is currently running.

Remote Command	:CONFigure?
-----------------------	-------------

Example	CONF?
----------------	-------

Initial S/W Revision	Prior to A.02.00
----------------------	------------------

Limit Test Current Results (Remote Command Only)

Queries the status of the current measurement limit testing. It returns a 0 if the measured results pass when compared with the current limits. It returns a 1 if the measured results fail any limit tests.

Remote Command	:CALCulate:CLIMits:FAIL?
-----------------------	--------------------------

Example	CALC:CLIM:FAIL? queries the current measurement to see if it fails the defined limits. Returns a 0 or 1: 0 it passes, 1 it fails.
----------------	--

Initial S/W Revision	Prior to A.02.00
----------------------	------------------

Data Query (Remote Command Only)

Returns the designated measurement data for the currently selected measurement and subopcode.

n = any valid subopcode for the current measurement. See the measurement command results table for your current measurement, for information about what data is returned for the subopcodes.

This command uses the data setting specified by the FORMat:BORDER and FORMat:DATA commands and can return real or ASCII data. (See the format command descriptions under Input/Output in the Analyzer Setup section.)

Remote Command	:CALCulate:DATA[n]?
Notes	The return trace depends on the measurement. In CALCulate:<meas>:DATA[n], n is any valid subopcode for the current measurement. It returns the same data as the FETCH:<measurement>? query where <measurement> is the current measurement.
Initial S/W Revision	Prior to A.02.00

Calculate/Compress Trace Data Query (Remote Command Only)

Returns compressed data for the currently selected measurement and sub-opcode [n].

n = any valid sub-opcode for that measurement. See the MEASure:<measurement>? command description of your specific measurement for information on the data that can be returned.

The data is returned in the current Y Axis Unit of the analyzer. The command is used with a sub-opcode <n> (default=1) to specify the trace. With trace queries, it is best if the analyzer is not sweeping during the query. Therefore, it is generally advisable to be in Single Sweep, or Update=Off.

This command is used to compress or decimate a long trace to extract and return only the desired data. A typical example would be to acquire N frames of GSM data and return the mean power of the first burst in each frame. The command can also be used to identify the best curve fit for the data.

Remote Command	:CALCulate:DATA<n>:COMPRESS? BLOCK CFIT MAXimum MINimum MEAN DMEan RMS RMSCubed SAMPLE SDEVIation PPHase [,<soffset> [,<length>[,<roffset>[,<rlimit>]]]]
Example	To query the mean power of a set of GSM bursts: Supply a signal that is a set of GSM bursts. Select the IQ Waveform measurement (in IQ Analyzer Mode). Set the sweep time to acquire at least one burst. Set the triggers such that acquisition happens at a known position relative to a burst. Then query the mean burst levels using, CALC:DATA2:COMP? MEAN, 24e-6, 526e-6 (These parameter values correspond to GSM signals, where 526e-6 is the length of the burst in the slot and you just want 1 burst.)
Notes	The command supports 5 parameters. Note that the last 4 (<soffset>, <length>, <roffset>, <rlimit>) are optional. But these optional parameters must be entered in the specified order. For example, if you want to specify <length>, then you must also specify <soffset>. See details below for a definition of each of these parameters. This command uses the data in the format specified by FORMat:DATA, returning either binary or ASCII data.
Initial S/W Revision	Prior to A.02.00

- BLOCK or block data - returns all the data points from the region of the trace data that you specify. For example, it could be used to return the data points of an input signal over several timeslots, excluding the portions of the trace data that you do not want. (This is x,y pairs for trace data and I,Q pairs for complex data.)

- CFIT or curve fit - applies curve fitting routines to the data. <soffset> and <length> are required to define the data that you want. <roffset> is an optional parameter for the desired order of the curve equation. The query will return the following values: the x-offset (in seconds) and the curve coefficients ((order + 1) values).

MIN, MAX, MEAN, DME, RMS, RMSC, SAMP, SDEV and PPH return one data value for each specified region (or <length>) of trace data, for as many regions as possible until you run out of trace data (using <roffset> to specify regions). Or they return the number of regions you specify (using <rlimit>) ignoring any data beyond that.

- MINimum - returns the minimum data point (y value) for the specified region(s) of trace data. For I/Q trace data, the minimum magnitude of the I/Q pairs is returned.
- MAXimum - returns the maximum data point (y value) for the specified region(s) of trace data. For I/Q trace data, the maximum magnitude of the I/Q pairs is returned.
- MEAN - returns a single value that is the arithmetic mean of the data point values (in dB/ dBm) for the specified region(s) of trace data. For I/Q trace data, the mean of the magnitudes of the I/Q pairs is returned. See the following equations.

-

NOTE

If the original trace data is in dB, this function returns the arithmetic mean of those log values, not log of the mean power which is a more useful value. The mean of the log is the better measurement technique when measuring CW signals in the presence of noise. The mean of the power, expressed in dB, is useful in power measurements such as Channel Power. To achieve the mean of the power, use the RMS option.

Equation 1

Mean Value of Data Points for Specified Region(s)

$$\text{MEAN} = \frac{1}{n} \sum_{X_i \in \text{region}(s)} X_i$$

where X_i is a data point value, and n is the number of data points in the specified region(s).

Equation 2

Mean Value of I/Q Data Pairs for Specified Region(s)

$$\text{MEAN} = \frac{1}{n} \sum_{X_i \in \text{region}(s)} |X_i|$$

where $|X_i|$ is the magnitude of an I/Q pair, and n is the number of I/Q pairs in the specified region(s).

- DMEan - returns a single value that is the mean power (in dB/ dBm) of the data point values for the specified region(s) of trace data. See the following equation:

Equation 3

DMEan Value of Data Points for Specified Region(s)

$$\text{DME} = 10 \times \log_{10} \left(\frac{1}{n} \sum_{X_i \in \text{region}(s)} 10^{\frac{X_i}{10}} \right)$$

- RMS - returns a single value that is the average power on a root-mean-squared voltage scale (arithmetic rms) of the data point values for the specified region(s) of trace data. See the following equation.

NOTE For I/Q trace data, the rms of the magnitudes of the I/Q pairs is returned. See the following equation. This function is very useful for I/Q trace data. However, if the original trace data is in dB, this function returns the rms of the log values which is not usually needed.

Equation 4

RMS Value of Data Points for Specified Region(s)

$$\text{RMS} = \sqrt{\frac{1}{n} \sum_{X_i \in \text{region}(s)} X_i^2}$$

where X_i is a data point value, and n is the number of data points in the specified region(s).

Equation 5

RMS Value of I/Q Data Pairs for Specified Region(s)

$$\text{RMS} = \sqrt{\frac{1}{n} \sum_{X_i \in \text{region}(s)} X_i X_i^*}$$

where X_i is the complex value representation of an I/Q pair, X_i^* its conjugate complex number, and n is the number of I/Q pairs in the specified region(s).

Once you have the rms value for a region of trace data (linear or I/Q), you may want to calculate the mean power. You must convert this rms value (peak volts) to power in dBm:

$$10 \times \log[10 \times (\text{rms value})^2]$$

- SAMPlE - returns the first data value (x,y pair) for the specified region(s) of trace data. For I/Q trace data, the first I/Q pair is returned.
- SDEVIation - returns a single value that is the arithmetic standard deviation for the data point values for the specified region(s) of trace data. See the following equation.
- For I/Q trace data, the standard deviation of the magnitudes of the I/Q pairs is returned. See the following equation.

Equation 6

Standard Deviation of Data Point Values for Specified Region(s)

$$\text{SDEV} = \sqrt{\frac{1}{n} \sum_{X_i \in \text{region}(s)} (X_i - \bar{X})^2}$$

where X_i is a data point value, \bar{X} is the arithmetic mean of the data point values for the specified region (s), and n is the number of data points in the specified region(s).

$$\text{SDEV} = \sqrt{\frac{1}{n} \sum_{X_i \in \text{region}(s)} (|X_i| - \bar{X})^2}$$

where $|X_i|$ is the magnitude of an I/Q pair, \bar{X} is the mean of the magnitudes for the specified region(s), and n is the number of data points in the specified region(s).

- PPHase - returns the x,y pairs of both rms power (dBm) and arithmetic mean phase (radian) for every specified region and frequency offset (Hz). The number of pairs is defined by the specified number of regions. This parameter can be used for I/Q vector (n=0) in Waveform (time domain) measurement and all parameters are specified by data point in PPHase.

The rms power of the specified region may be expressed as:

$$\text{Power} = 10 \times \log [10 \times (\text{RMS I/Q value})] + 10.$$

The RMS I/Q value (peak volts) is:

$$\sqrt{\frac{1}{n} \sum_{X_i \in \text{region}} X_i X_i^*}$$

where X_i is the complex value representation of an I/Q pair, X_i^* its conjugate complex number, and n is the number of I/Q pairs in the specified region.

The arithmetic mean phase of the specified region may be expressed as:

$$\frac{1}{n} \sum_{Y_i \in \text{region}} Y_i$$

where Y_i is the unwrapped phase of I/Q pair with applying frequency correction and n is the number of I/Q pairs in the specified region.

The frequency correction is made by the frequency offset calculated by the arithmetic mean of every specified region's frequency offset. Each frequency offset is calculated by the least square method against the unwrapped phase of I/Q pair.

Sample Trace Data - Constant Envelope

(See below for explanation of variables.)

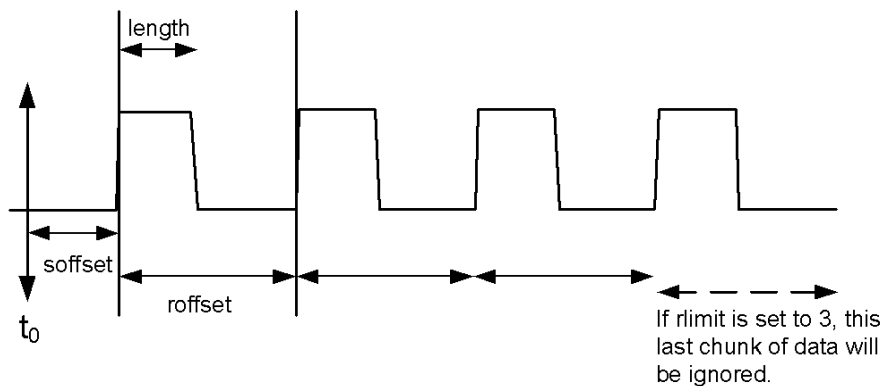

Sample Trace Data - Not Constant Envelope

(See below for explanation of variables.)

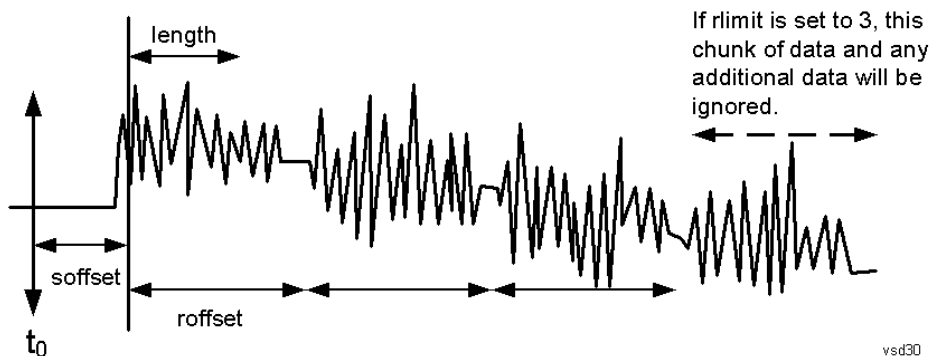

<soffset> - start offset is an optional real number. (It is in seconds for time-domain traces, and is a dimensionless index 0 to Npoints - 1, for frequency-domain traces). It specifies the amount of data at the beginning of the trace that will be ignored before the decimation process starts. It is the time or frequency change from the start of the trace to the point where you want to start using the data. The default value is zero.

<length> - is an optional real number. (It is in seconds for time-domain traces, and is a dimensionless index 0 to Npoints - 1, for frequency-domain traces). It defines how much data will be compressed into one value. This parameter has a default value equal to the current trace length.

<roffset> - repeat offset is an optional real number. (It is in seconds for time-domain traces, and is a dimensionless index 0 to Npoints - 1, for frequency-domain traces). It defines the beginning of the next field of trace elements to be compressed. This is relative to the beginning of the previous field. This parameter has a default value equal to the <length> variable. Note that this parameter is used for a completely different purpose when curve fitting (see CFIT above).

<rlimit> - repeat limit is an optional integer. It specifies the number of data items that you want returned. It will ignore any additional items beyond that number. You can use the Start offset and the Repeat limit to pick out exactly what part of the data you want to use. The default value is all the data.

Calculate Peaks of Trace Data (Remote Command Only)

Returns a list of all the peaks for the currently selected measurement and sub-opcode [n]. The peaks must meet the requirements of the peak threshold and excursion values.

n = any valid sub-opcode for the current measurement. See the MEASure:<measurement> command description of your specific measurement for information on the data that can be returned.

The command can only be used with specific sub-opcodes with measurement results that are trace data. Both real and complex traces can be searched, but complex traces are converted to magnitude in dBm. In many measurements the sub-opcode n=0, is the raw trace data which cannot be searched for peaks. And Sub-opcode n=1, is often calculated results values which also cannot be searched for peaks.

This command uses the data setting specified by the FORMat:BORDER and FORMat:DATA commands and can return real or ASCII data. If the format is set to INT,32, it returns REAL,32 data.

The command has four types of parameters:

- Threshold (in dBm)
- Excursion (in dB)
- Sorting order (amplitude, frequency, time)
- Optional in some measurements: Display line use (all, > display line, < display line)

Remote Command	<p>For Swept SA measurement:</p> <pre>:CALCulate:DATA[1] 2 ... 6:PEAKs? <threshold>,<excursion>[,AMPLitude FREQuency TIME[,ALL GTDLLine LTDLine]]</pre> <p>For most other measurements:</p> <pre>:CALCulate:DATA[1] 2 ... 6:PEAKs? <threshold>,<excursion>[,AMPLitude FREQuency TIME]</pre>
-----------------------	---

Example	<p>Example for Swept SA measurement in Spectrum Analyzer Mode:</p> <p>CALC:DATA4:PEAK? -40, 10, FREQ, GTDL This will identify the peaks of trace 4 that are above -40 dBm, with excursions of at least 10 dB. The peaks are returned in order of increasing frequency, starting with the lowest frequency. Only the peaks that are above the display line are returned.</p> <p>Query Results 1:</p> <p>With FORMat:DATA REAL, 32 selected, it returns a list of floating-point numbers. The first value in the list is the number of peak points that are in the following list. A peak point consists of two values: a peak amplitude followed by its corresponding frequency (or time).</p> <p>If no peaks are found the peak list will consist of only the number of peaks, (0).</p>
----------------	---

Notes	<p><n> - is the trace that will be used</p> <p><threshold> - is the level below which trace data peaks are ignored. Note that the threshold value is required and is always used as a peak criterion. To effectively disable the threshold criterion for this command, provide a substantially low threshold value such as -200 dBm. Also note that the threshold value used in this command is independent of and has no effect on the threshold value stored under the Peak Criteria menu.</p> <p><excursion> - is the minimum amplitude variation (rise and fall) required for a signal to be identified as peak. Note that the excursion value is required and is always used as a peak criterion. To effectively disable the excursion criterion for this command, provide the minimum value of 0.0 dB. Also note that the excursion value used in this command is independent of and has no effect on the</p>
--------------	---

excursion value stored under the Peak Criteria menu.

Values must be provided for threshold and excursion. The sorting and display line parameters are optional (defaults are AMPLitude and ALL).

Note that there is always a Y-axis value for the display line, regardless of whether the display line state is on or off. It is the current Y-axis value of the display line which is used by this command to determine whether a peak should be reported

Sorting order:

AMPLitude - lists the peaks in order of descending amplitude, with the highest peak first (default if optional parameter not sent)

FREQuency - lists the peaks in order of occurrence, left to right across the x-axis.

TIME - lists the peaks in order of occurrence, left to right across the x-axis.

Peaks vs. Display Line:

ALL - lists all of the peaks found (default if optional parameter not sent).

GTDLine (greater than display line) - lists all of the peaks found above the display line.

LTDLine (less than display line) - lists all of the peaks found below the display line.

Initial S/W Revision	Prior to A.02.00
----------------------	------------------

Hardware-Accelerated Fast Power Measurement (Remote Command Only)

The Fast Power option (FP2) enables very fast channel power measurements for instruments with the prerequisite hardware (DP2 and/or B40). It accomplishes this by performing real-time overlapped FFTs at the hardware layer, using software for basic post-processing before returning the result to the user. The upshot of this approach is improved throughput for user applications that require many sequential power measurements.

The analysis bandwidth of FP2 is limited by the licenses in the instrument, but its maximum overall analysis bandwidth per acquisition is 40 MHz.

FP2 is remote-only, which means the instrument does not switch to any particular mode or measurement. FP2 commands can be sent while another application is in use on the front panel.

Each Fast Power measurement can be predefined using an array index, and up to 1,000 measurements can be stored. In the following documentation, instances of [1,2,...,999] can be substituted with a particular measurement index, e.g. CALC:FPOW:POW1?, CALC:FPOW:POW2?, CALC:FPOW:POW134?. In this way, power measurements can be defined one time in a batch, and then executed multiple times without having to redefine them, similar to “list mode” on other measurements.

In addition to basic channel power measurements, there are a number of other measurement “functions” for each channel, including peak power, peak frequency, and power spectral density. See the Function parameter for more information.

Reset Fast Power Measurement (Remote Command Only)

Resets the measurement configuration to the defaults.

Mode	All
Remote Command	:CALCulate:FPOWer:POWer [1, 2, ..., 999] :RESet
Example	:CALC:FPOW:POW1:RES

Notes	Option FP2 is required.
Initial S/W Revision	A.14.00

Define Fast Power Measurement (Remote Command Only)

Fast Power acquisitions are configured using the DEFine command. This command accepts a comma-delimited string of configuration parameters and their appropriate values, which are all specified in the subsection below.

Mode	All
Remote Command	:CALCulate:FPOWer:POWer[1,2,...,999]:DEFine "configuration string"
Example	:CALC:FPOW:POW1:DEF "CenterFrequency=2e9, AcquisitionTime=0.005"
Notes	See below for a list of measurement variables that can be defined in the configuration string.
Initial S/W Revision	A.14.00

Acquisition Time

Example	CALC:FPOW:POW1:DEF "AcquisitionTime=0.002"
Notes	The acquisition time parameter sets the time in which the entire spectrum is measured. An increase in the acquisition time yields an improvement in measurement repeatability.
Preset	0.001 s
Range	0 s to 1 s
Default Unit	Time (s)
Initial S/W Revision	A.14.00

Center Frequency

Example	CALC:FPOW:POW1:DEF "CenterFrequency=2e9"
Notes	The center frequency parameter sets the frequency in which the measurement is centered around. The OffsetFrequency parameter is calculated relative to the center frequency.
Preset	1 GHz
Range	0 Hz to maximum instrument frequency
Default Unit	Frequency (Hz)
Initial S/W Revision	A.14.00

DC Coupled

Example	CALC:FPOW:POW1:DEF "DCCoupled=True"
Notes	The DC coupled parameter allows the user to specify whether the DC blocking capacitor is utilized. Set parameter to true when measuring frequencies below 10 MHz.
Preset	False
Range	True (DC Coupled) or False (AC Coupled)
Default Unit	Boolean
Initial S/W Revision	A.14.00

DetectorType

Example	CALC:FPOW:POW1:DEF "DetectorType=Peak"
Notes	Option FP2 is required. The detector type parameter allows the user to choose whether a RMS average or peak value is used during the measurement.
Preset	RmsAverage
Range	RmsAverage, Peak
Initial S/W Revision	A.14.00

Do Noise Correction

Example	CALC:FPOW:POW1:DEF "DoNoiseCorrection=True"
Notes	When noise correction is enabled, the linear noise power contributed by the analyzer is subtracted from all measurements. This effectively lowers the noise floor of the analyzer. When noise correction is enabled, the first measurement for a given set of input parameters will take extra time. This is because the analyzer takes an extra acquisition with the RF input disconnected from the analyzer's front end to measure the noise of just the analyzer. The measured noise floor is stored in a cache so the noise acquisition will occur only once for the same state settings. In other words, if noise correction was turned on and the analyzer made an acquisition at frequency A, then frequency B, and back again to frequency A, the hidden initial noise floor acquisition would only occur for the first acquisition at frequency A and the cached noise floor would be used the second time frequency A was measured.
Preset	False
Range	True (enable noise correction) or False (disable noise correction)
Default Unit	Boolean
Initial S/W Revision	A.14.00

Do Spur Suppression

Example	CALC:FPOW:POW1:DEF "DoSpurSuppression=True"
Notes	<p>When measuring very low level signals, or when large out-of-band inputs are input into the analyzer, sometimes unwanted spurs and residuals can appear in the measured spectrum. Spur suppression is a method to help minimize the levels of these internally generated spurs and residuals.</p> <p>When spur suppression is enabled, the analyzer will automatically take two acquisitions using two different internal analog LO frequencies. The FFT spectrums from both acquisitions are combined by taking the minimum power between both traces on a per FFT bin basis. External signals will have the same amplitude for both traces and therefore will return the expected amplitudes. However, low level spurs and residuals generated internally to the analyzer tend to move to different FFT bins depending on the internal analog LO frequency used, and therefore tend to be suppressed using this spur suppression method.</p> <p>Because two acquisitions, rather than a single acquisition, are made when spur suppression is enabled, the measurement time will always be slower when spur suppression is enabled.</p>
Preset	False
Range	True (enable spur suppression) or False (disable spur suppression)
Default Unit	Boolean
Initial S/W Revision	A.14.00

Electronic Attenuator Bypass

Example	CALC:FPOW:POW1:DEF "ElecAttBypass =False"
Notes	The electronic attenuation bypass parameter allows the user to either utilize or bypass the electronic attenuator. The electronic attenuator is only available for frequencies up to 3.6 GHz. Set parameter to true when using frequencies above 3.6 GHz and set the parameter to false when using the preamp.
Preset	True
Range	True (bypass electronic attenuator) or False (use electronic attenuator)
Default Unit	Boolean
Initial S/W Revision	A.14.00

Electronic Attenuation

Example	CALC:FPOW:POW1:DEF "ElecAttenuation=10"
Notes	<p>Option EA3 is required.</p> <p>The electronic attenuation value parameter sets the amount of electrical attenuation from 0 to 24 dB (1 dB steps).</p> <p>Set "ElecAttBypass=False" to make sure the electronic attenuator path is enabled.</p>
Preset	0 dB
Range	0 - 24 dB (1 dB steps)

Default Unit	dB
Initial S/W Revision	A.14.00

IF Gain

Example	CALC:FPOW:POW1:DEF "IFGain=10"
Notes	The IF gain parameter allows the user to specify the gain at the IF stage anywhere from -6 to 16 dB (1 dB steps). This is an advanced feature, and for most cases this should remain at its default value of 0 dB.
Preset	0 dB
Range	-6 - 16 dB (1 dB steps)
Default Unit	dB
Initial S/W Revision	A.14.00

IF Type

Example	CALC:FPOW:POW1:DEF "IFType=B25M"
Notes	The IF type parameter allows the user to select between different IF paths. For example, if the signal is less than 25 MHz wide, then the user can select the B25M path to take advantage of additional filtering on this analog IF path.
Preset	B40M
Range	B10M, B25M, B40M
Initial S/W Revision	A.14.00

Include Power Spectrum

Example	CALC:FPOW:POW1:DEF "IncludePowerSpectrum=True"
Notes	The power spectrum parameter allows the user to read data on the entire spectrum for diagnostic purposes. It is not recommended for production use. See CALC:FPOW:POW[n]:READ2? for details on the binary format of the response.
Preset	False
Range	True (return both channel power and full power spectrum) or False (returns only channel power)
Default Unit	Boolean
Initial S/W Revision	A.14.00

Mechanical Attenuation

Example	CALC:FPOW:POW1:DEF "MechAttenuation=10"
Notes	The mechanical attenuation value parameter sets the amount of mechanical attenuation anywhere from 0 to 70 dB (2 dB steps).
Preset	0 dB
Range	0 – 70 dB (2 dB steps)
Default Unit	dB
Initial S/W Revision	A.14.00

Preamp Mode

Example	CALC:FPOW:POW1:DEF "PreAmpMode=Low"
Notes	The license for the appropriate preamp is required. The preamp mode parameter specifies whether the preamps are being utilized. Low allows any preamps up to 3.6 GHz, and Full allows all licensed preamps. Set "ElecAttBypass=True" in order to utilize any preamps.
Preset	Off
Range	Off, Low, Full
Initial S/W Revision	A.14.00

Resolution Bandwidth Mode

Example	CALC:FPOW:POW1:DEF "PreAmpMode=Low"
Notes	The resolution bandwidth mode parameter allows the user to choose whether the RBW filter is automatically or manually set. The BestSpeed value minimizes measurement time, while the Narrowest value minimizes RBW size (minimum of two FFT bins per RBW). To manually specify an RBW, set this parameter to Explicit, and set the ResolutionBW parameter to the desired value.
Preset	BestSpeed
Range	BestSpeed, Narrowest, Explicit
Initial S/W Revision	A.14.00

Resolution Bandwidth

Example	CALC:FPOW:POW1:DEF "ResolutionBW=25e3"
Notes	The resolution bandwidth parameter sets the 3-dB bandwidth of the RBW filter. The ResolutionBWMode parameter must be set to Explicit in order to manually set the RBW.

Preset	0 Hz
Default Unit	Hz
Initial S/W Revision	A.14.00

Trigger Delay

Example	CALC:FPOW:POW1:DEF "TriggerDelay=0.025"
Notes	The trigger delay parameter sets the time after an external trigger is detected until the measurement is performed.
Preset	0 s
Range	0 - 1 s
Default Unit	Seconds
Initial S/W Revision	A.14.00

Trigger Level

Example	CALC:FPOW:POW1:DEF "TriggerLevel=2"
Notes	The trigger level parameter sets the voltage value at which an external trigger is detected.
Preset	1.2 V
Range	-5 to 5 V
Default Unit	Volts
Initial S/W Revision	A.14.00

Trigger Slope

Example	CALC:FPOW:POW1:DEF "TriggerSlope=Negative"
Notes	The trigger slope parameter indicates the direction of the edge trigger voltage for detection.
Preset	Positive
Range	Positive, Negative
Initial S/W Revision	A.14.00

Trigger Source

Example	CALC:FPOW:POW1:DEF "TriggerSource=Ext1"
Notes	The trigger source parameter allows the user to choose between measurement's triggering freely or controlled by an external input. Ext1 and Ext2 correspond to Trigger 1 In and Trigger 2 In, respectively.
Preset	Free
Range	Free, Ext1, Ext2
Initial S/W Revision	A.14.00

Trigger Timeout

Example	CALC:FPOW:POW1:DEF "TriggerTimeout=0.1"
Notes	The trigger timeout parameter sets the time in which the analyzer will wait for a trigger before automatically performing the measurement.
Preset	1 s
Range	0 – 1 s
Default Unit	Seconds
Initial S/W Revision	A.14.00

Signal Input

Example	CALC:FPOW:POW1:DEF "SignalInput=Fp50MHzCW"
Notes	The signal input parameter allows the user to select between using the main RF input or the internal analyzer reference CW signal of 50 MHz.
Preset	FpMainRf
Range	FpMainRf, Fp50MHzCW
Initial S/W Revision	A.14.00

Use Preselector

Example	CALC:FPOW:POW1:DEF "UsePreSelector=True"
Notes	The preselector parameter allows the user to either utilize or bypass the front end tunable filter at frequencies above 3.6 GHz. For frequencies below 3.6 GHz, the preselector is automatically bypassed, so you do not need to set this parameter to False in those cases.
Preset	False
Range	True (use preselector above 3.6 GHz), or False (preselector bypassed)

Default Unit	Boolean
Initial S/W Revision	A.14.00

Channel Bandwidth Array

Example	CALC:FPOW:POW1:DEF "Bandwidth=[3.84e6, 5e6, 3.84e6]"
Notes	The bandwidth parameter array defines the bandwidth of each channel that will be measured. All array parameters should have the same number of elements. Alternatively, if all the elements are the same value, a single number with no square brackets can be used to define the parameter.
Preset	[1e6]
Range	0 to 40 MHz
Default Unit	Hz
Initial S/W Revision	A.14.00

Channel Filter Type Array

Example	CALC:FPOW:POW1:DEF "FilterType=[RRC, IBW, RRC]"
Notes	The filter type parameter allows the user to choose between an integration bandwidth (IBW) filter or a root-raised-cosine (RRC) filter. The integration bandwidth filter weighs all frequencies within the bandwidth equally. The root-raised-cosine filter has an associated shape parameter, defined by the FilterAlpha parameter. All array parameters should have the same number of elements. Alternatively, if all the elements are the same value, a single value with no square brackets can be used to define the parameter.
Preset	[IBW]
Range	IBW, RRC
Initial S/W Revision	A.14.00

Channel Filter Alpha Array

Example	CALC:FPOW:POW1:DEF "FilterAlpha=[0.5, 0.0, 0.5]"
Notes	The filter alpha parameter allows the user to adjust the alpha value associated with the root-raised-cosine (RRC) filter type. Set FilterType to RRC in order to utilize this parameter. All array parameters should have the same number of elements. Alternatively, if all the elements are the same value, a single number with no square brackets can be used to define the parameter.
Preset	[0.22]
Range	0.0 - 1.0

Initial S/W Revision	A.14.00
-------------------------	---------

Channel Measurement Function Array

Example	CALC:FPOW:POW1:DEF "Function=[BandPower, PeakPower, BandPower]"
Notes	<p>This parameter array defines what measurement is being made for each individually-specified channel:</p> <p>BandPower: Total power within the specified bandwidth of the channel (dBm)</p> <p>BandDensity: Total power density within the specified bandwidth of the channel (dBm/Hz)</p> <p>PeakPower: The peak power value within the specified bandwidth of the channel (dBm)</p> <p>PeakFrequency: The frequency which corresponds to the peak power value within the specified bandwidth of the channel. This frequency is relative to the center frequency (Hz)</p> <p>XdBBandwidth: The half power (-3.01 dB) bandwidth of the highest amplitude signal that resides within the channel (Hz), dB is configurable using XdBBandwidth parameter</p> <p>OccupiedBandwidth: The bandwidth at which 99% of the total power resides within the channel (Hz), percentage configurable using OccupiedBandwidthPercent parameter</p> <p>All array parameters should have the same number of elements. Alternatively, if all the elements are the same value, a single value with no square brackets can be used to define the parameter.</p>
Preset	[BandPower]
Range	BandPower, BandDensity, PeakPower, PeakFrequency, XdBBandwidth, OccupiedBandwidth
Initial S/W Revision	A.14.00

Channel Offset Frequency Array

Example	CALC:FPOW:POW1:DEF "OffsetFrequency=[-5e6, 0, 5e6]"
Notes	<p>The offset frequency parameter array defines the difference between the center frequency to the center frequency of each channel.</p> <p>All array parameters should have the same number of elements.</p>
Preset	[0]
Range	0 to 20 MHz
Default Unit	Hz
Initial S/W Revision	A.14.00

Channel Occupied Bandwidth Percent Array

Example	CALC:FPOW:POW1:DEF "OccupiedBandwidthPercent =[0.95, 0.95, 0.95]"
Notes	This parameter only applies for channels whose Function is set to OccupiedBandwidth. The occupied

	bandwidth percent parameter specifies the percent of total power in these channels. The valid range for this parameter is 0.0 to 1.0, where 1.0 represents 100%. The default for this parameter is 0.99, which will return the bandwidth that contains 99% of the total channel power.
Preset	[0.99]
Range	0 - 1.0
Initial S/W Revision	A.14.00

Channel x-dB Bandwidth Array

Example	CALC:FPOW:POW1:DEF " XdBBandwidth =[-6.02, -3.01, -1.0]"
Notes	This parameter only applies for channels whose Function is set to XdBBandwidth. The X dB bandwidth parameter is used to specify the power relative to the peak channel power over which the bandwidth is calculated. The parameter value must be a negative number.
Preset	[-3.01]
Range	-200 to 0 dB
Default Unit	dB
Initial S/W Revision	A.14.00

Define Fast Power Measurement Query (Remote Command Only)

The DEFine? command is used to retrieve a list of all defined parameters in an ASCII string format

```

M All
o
d
e
-----
R :CALCulate:FPOWer:POWer[1,2,...,999]:DEFine?
e
m
o
t
e
C
o
m
m
a
n
d
-----
E :CALC:FPOW:POW1:DEF?

```

x
a
m
p
l
e

N This command query is used to retrieve a list of all defined parameters in an ASCII format.

O The following is an example of the returned results:

t "DCCoupled=False,ElecAttBypass=True,ElecAttenuation=0,IFGain=0,MechAttenuation=0,PreAmpMode=Off,PreSelectorOffset=0,UsePreSelector=False,ExternalReferenceFrequency=1000000,FrequencyReferenceSource=AutoExternalFrequencyReference,IFType=B40M,LOMode=SLW,SignalInput=FpMainRf,AcquisitionTime=0.001,CenterFrequency=100000000,ResolutionBW=0,ResolutionBWMode=BestSpeed,DetectorType=RmsAverage,Bandwidth=[1000000],OffsetFrequency=[0],Function=[BandPower],FilterType=[IBW],FilterAlpha=[0.22],OccupiedBandwidthPercent=[0.99],XdBBandwidth=[-3.01],DoNoiseCorrection=False,DoSpurSuppression=False,MeasurementMethod=HardwareFFT,IncludePowerSpectrum=False,TriggerDelay=0,TriggerLevel=1.2,TriggerSlope=Positive,TriggerSource=Free,TriggerTimeout=1"

I A.14.00

n
i
t
i
a
l

S
/
W

R
e
v
i
s
i
o
n

Configure Fast Power Measurement (Remote Command Only)

The configure command begins hardware setup and returns immediately, with no acquisition made. This can be used in parallel with other hardware operations to effectively hide the hardware setup time.

Mode	All
Remote Command	:CALCulate:FPOWER:POWER[1,2,...,999]:CONFigure
Example	:CALC:FPOW:POW1:CONF
Notes	Option FP2 is required.
Initial S/W Revision	A.14.00

Initiate Fast Power Measurement (Remote Command Only)

The INITiate command begins an acquisition and returns immediately. The results of the measurement can be retrieved using FETCh.

Mode	All
Remote Command	:CALCulate:FPOWER:POWER[1,2,...,999]:INITiate
Example	:CALC:FPOW:POW1:INIT
Notes	Option FP2 is required.
Initial S/W Revision	A.14.00

Fetch Fast Power Measurement (Remote Command Only)

The FETCh command query is used to retrieve the results of an acquisition initiated by the INIT command. The returned results are in ASCII string format. The string begins and ends with quotation marks.

Mode	All
Remote Command	:CALCulate:FPOWER:POWER[1,2,...,999]:FETCh?
Example	:CALC:FPOW:POW1:FETC?
Notes	Option FP2 is required. Returns m comma-separated ASCII values, where m corresponds to the number of bandwidths defined. 1. Declared function return in the 1st specified channel 2. Declared function return in the 2nd specified channel ... m. Declared function return in the last specified channel The INIT and FETC? command sequence performs the same functionality of a single CALC:FPOW:POW[n]? query. Units of the returned values are dependent on the Function parameter for each channel.
Initial S/W Revision	A.14.00

Execute Fast Power Measurement (Remote Command Only)

This command query is used as shorthand for an INIT command immediately followed by a FETC? command. The returned results are in ASCII string format. The string begins and ends with quotation marks.

Mode	All
Remote Command	:CALCulate:FPOWER:POWER[1,2,...,999]?
Example	:CALC:FPOW:POW1?

Notes	Option FP2 is required. See notes for Fast Power Fetch for return format.
Initial S/W Revision	A.14.00

Binary Read Fast Power Measurement (Remote Command Only)

This command query is used as shorthand for an INIT command immediately followed by a FETC? command. The returned results are in a binary format.

Mode	All
Remote Command	:CALCulate:FPOWER:POWer[1,2,...,999]:READ? :CALCulate:FPOWER:POWer[1,2,...,999]:READ1?
Example	:CALC:FPOW:POW1:READ? :CALC:FPOW:POW1:READ1?
Notes	Option FP2 is required. Returns m 4 byte floating point binary values (Little-Endian), where m corresponds to the number of bandwidths defined.
Initial S/W Revision	A.14.00

Diagnostic Binary Read Fast Power Measurement (Remote Command Only)

This command query is used as shorthand for an INIT command immediately followed by a FETC? command. The returned results are in a binary format. This command is used primarily for diagnostic purposes to test for ADC overloads and to visibly inspect the spectrum.

Mode	All
Remote Command	:CALCulate:FPOWER:POWer[1,2,...,999]:READ2?
Example	:CALC:FPOW:POW1:READ2?
Notes	Option FP2 is required. Note: Spectrum data is only returned if the IncludePowerSpectrum parameter is set to True. If IncludePowerSpectrum is False, the number of spectrum points will be zero (0). Units of the returned values are dependent on the Function parameter per channel (e.g. dBm for BandPower, Hz for PeakFrequency). Returns binary data (Little-Endian) that contains information on m amount of channels, along with ADC over range and full spectrum data. The following is the binary format of the response. Bandwidth Return Value 1. Number of channels specified, m [4 byte int] 2. Declared function result for the 1st specified channel [4 byte float]

	3. Declared function result for the 2nd specified channel [4 byte float]
	...
	(m + 1). Declared function result for the last (mth) specified channel [4 byte float]
	ADC Over Range
	1. ADC over-range occurred (1: true, 0: false) [2 byte short]
	Spectrum Data
	1. Number of points in the spectrum data, k [4 byte int]
	2. Start frequency of spectrum data (Hz) [8 byte double]
	3. Step frequency of spectrum data (Hz) [8 byte double]
	4. FFT bin at 1st point (dBm) [4 byte float]
	5. FFT bin at 2nd point (dBm) [4 byte float]
	...
	(k + 3). FFT bin at last (kth) point (dBm) [4 byte float]

Initial S/W Revision	A.14.00
-------------------------	---------

Format Data: Numeric Data (Remote Command Only)

This command specifies the format of the trace data input and output. It specifies the formats used for trace data during data transfer across any remote port. It affects only the data format for setting and querying trace data for the :TRACe[:DATA], TRACe[:DATA]?, :CALCulate:DATA[n]? and FETCh:SANalyzer [n]? commands and queries.

Remote Command	:FORMat [:TRACe] [:DATA] ASCii INTeger, 32 REAL, 32 REAL, 64 :FORMat [:TRACe] [:DATA] ?
Notes	The query response is: ASCii: ASC,8 REAL,32: REAL,32 REAL,64: REAL,64 INTeger,32: INT,32 When the numeric data format is REAL or ASCii, data is output in the current Y Axis unit. When the data format is INTeger, data is output in units of m dBm (.001 dBm). The INT,32 format returns binary 32-bit integer values in internal units (m dBm), in a definite length block.
Dependencies	Sending a data format spec with an invalid number (for example, INT,48) generates no error. The analyzer simply uses the default (8 for ASCii, 32 for INTeger, 32 for REAL). Sending data to the analyzer which does not conform to the current FORMat specified, results in an error. Sending ASCII data when a definite block is expected generates message -161 "Invalid Block Data" and sending a definite block when ASCII data is expected generates message -121 "Invalid Character in Number".
Preset	ASCii
Backwards Compatibility	Note that the INT,32 format is only applicable to the command, TRACe:DATA. This preserves

Notes	backwards compatibility for the Swept SA measurement. For all other commands/queries which honor FORMat:DATA, if INT,32 is sent the analyzer will behave as though it were set to REAL,32.
Initial S/W Revision	Prior to A.02.00

The specs for each output type follow:

ASCIi - Amplitude values are in ASCII, in the current Y Axis Unit, one ASCII character per digit, values separated by commas, each value in the form:

SX.YYYYYEsZZ

Where:

S = sign (+ or -)

X = one digit to left of decimal point

Y = 5 digits to right of decimal point

E = E, exponent header

s = sign of exponent (+ or -)

ZZ = two digit exponent

REAL,32 - Binary 32-bit real values in the current Y Axis Unit, in a definite length block.

REAL,64 - Binary 64-bit real values in the current Y Axis Unit, in a definite length block.

Format Data: Byte Order (Remote Command Only)

This command selects the binary data byte order for data transfer and other queries. It controls whether binary data is transferred in normal or swapped mode. This command affects only the byte order for setting and querying trace data for the :TRACe[:DATA], TRACe[:DATA]? , :CALCulate:DATA[n]? and FETCh:SANalyzer[n]? commands and queries.

By definition any command that says it uses FORMat:DATA uses any format supported by FORMat:DATA.

The NORMal order is a byte sequence that begins with the most significant byte (MSB) first, and ends with the least significant byte (LSB) last in the sequence: 1|2|3|4. SWAPped order is when the byte sequence begins with the LSB first, and ends with the MSB last in the sequence: 4|3|2|1.

Remote Command	:FORMat:BORDER NORMal SWAPped :FORMat:BORDER?
Preset	NORMal
Initial S/W Revision	Prior to A.02.00

Meas Setup

Displays the setup menu for the currently selected measurement. The functions included in the measurement setup menu include setting the parameters for the carriers, offsets, bandwidths, measurement methods and types. This menu also allows you to turn noise correction on and off.

Key Path	Front-panel key
Initial S/W Revision	Prior to A.02.00

Average/Hold Number

Specifies the number of measurement averages used to calculate the measurement result. The average will be displayed at the end of each sweep. After the specified number of average counts, the average mode (termination control) setting determines the average action.

Key Path	Meas Setup
Mode	SA, WCDMA, C2K, WIMAX OFDMA, TD-SCDMA, 1xEVDO, DVB-T/H, DTMB (CTTB), ISDB-T, CMMB, LTE, LTETDD, Digital Cable TV, MSR, LTEAFDD, LTEATDD
Remote Command	[:SENSe]:ACPpower:AVERage:COUNT <integer> [:SENSe]:ACPpower:AVERage:COUNT? [:SENSe]:ACPpower:AVERage[:STATe] OFF ON 0 1 [:SENSe]:ACPpower:AVERage[:STATe]?
Example	ACP:AVER:COUN 250 ACP:AVER:COUN? ACP:AVER OFF ACP:AVER?
Notes	You must be in the mode that includes ACP measurements to use this command. Use :INSTrument:SElect to set the mode.
Preset	10 ON
State Saved	Saved in instrument state.
Min	1
Max	1000
Backwards Compatibility SCPI	[:SENSe]:ACPR:AVERage:COUNT [:SENSe]:MCPower:AVERage:COUNT (PSA Power Suite, PSA W-CDMA, PSA cdma2000)
Initial S/W Revision	Prior to A.02.00
Modified at S/W Revision	A.02.00, A.03.00

Avg Mode

Enables you to set the averaging mode. This determines the averaging action after the specified number of data acquisitions (average count) is reached.

When set to Exponential (Exp) the measurement averaging continues using the specified number of averages to compute each averaged value. The average will be displayed at the end of each sweep.

When set to Repeat, the measurement resets the average counter each time the specified number of averages is reached.

Key Path	Meas Setup
Mode	SA, WCDMA, C2K, WIMAX OFDMA, TD-SCDMA, 1xEVDO, DVB-T/H, DTMB (CTTB), ISDB-T, CMMB, LTE, LTE-TDD, Digital Cable TV, MSR, LTEAFDD, LTEATDD
Remote Command	[:SENSe] :ACPower:AVERage:TCONtrol EXPonential REPeat [:SENSe] :ACPower:AVERage:TCONtrol?
Example	ACP:AVER:TCON EXP ACP:AVER:TCON?
Notes	You must be in the mode that includes ACP measurements to use this command. Use :INSTrument:SElect to set the mode.
Preset	EXPonential
State Saved	Saved in instrument state.
Range	Exp Repeat
Backwards Compatibility SCPI	[:SENSe] :ACPR:AVERage:TCONtrol
Initial S/W Revision	Prior to A.02.00
Modified at S/W Revision	A.02.00, A.03.00

Power Ref (MSR Only)

Selects the power reference type.

Left & Right Carriers – Powers of leftmost and rightmost carriers with Measure Carrier On in a sub-block are the references of left and right sides respectively. Left and right carriers are determined based on the carrier center frequencies. If Measure Carriers of all the carriers in the sub-block are off, the reference power in the sub-block and all the relative power results are NaN. Relative limits are not evaluated.

Max Power Carrier – Maximum carrier power among the carriers of Measure Carrier On is the reference of measurement. If Measure Carriers of all the carriers are off, the reference power and all the relative power results are NaN. Relative limits are not evaluated.

Carrier Index – Power of the specified carrier is the reference of measurement. If Measure Carriers of this carrier index is off, the reference power and all the relative power results are NaN. Relative limits are not evaluated.

Manual – Power or PSD specified by the user is the reference of measurement.

Max Power Carrier in Sub-block – Maximum carrier power among the sub-block carriers of Measure Carrier On is the reference of measurement. If Measure Carriers of all the carriers in a sub-block are off, the reference power of the sub-block and all the relative power results referring to this sub-block are NaN, and these relative limits are not evaluated.

Total Multicarriers – Total power of multi carriers is the power reference of measurement. Each carrier power is calculated with its own carrier configuration settings.

Key Path	Meas Setup
Mode	MSR
Remote Command	[[:SENSe]:ACPower:CARRier:PREFERENCE:TYPE LRCarriers MPCarrier CINDEX MANual MPCSubblock TMCarriers [:SENSe]:ACPower:CARRier:PREFERENCE:TYPE?
Example	ACP:CARR:PREF:TYPE CIND ACP:CARR:PREF:TYPE?
Notes	This command is available only in MSR. You must be in the MSR mode.
Preset	MPCarrier
State Saved	Saved in instrument state
Range	Left & Right Carriers Max Power Carriers Carrier Index Manual Max Power Carrier in Sub-block Total Multicarriers
Readback	Indirect readback as below: <div style="display: flex; justify-content: space-around; align-items: center;"> <div style="border: 1px solid black; padding: 5px; text-align: center;"> Power Ref [Max Power▶ Carrier] </div> <div style="border: 1px solid black; padding: 5px; text-align: center;"> Power Ref [Left & Right▶ Carriers] </div> <div style="border: 1px solid black; padding: 5px; text-align: center;"> Power Ref [Carrier Index▶ 1] </div> <div style="border: 1px solid black; padding: 5px; text-align: center;"> Power Ref [Total▶ Multicarriers] </div> </div> <div style="display: flex; justify-content: space-around; align-items: center;"> <div style="border: 1px solid black; padding: 5px; text-align: center;"> Power Ref [Manual Power▶ -10 dBm] </div> <div style="border: 1px solid black; padding: 5px; text-align: center;"> Power Ref [Manual PSD▶ -80 dBm/Hz] </div> <div style="border: 1px solid black; padding: 5px; text-align: center;"> Power Ref [Max Power▶ Carrier in SB] </div> </div>
Initial S/W Revision	A.10.00
Modified at S/W Revision	A.13.00, A.16.00

Carrier Index

Sets carrier index of the reference power. The power of the carrier selected by this index becomes reference power when Power Ref is Carrier Index.

Any value up to the MAX can be set though the measurement only deals with number of carriers specified by Carrier. If the index is larger than Carrier, reference power in this measurement becomes NaN and therefore all relative power results are NaN.

Key Path	Meas Setup, Power Ref
Mode	MSR, LTEAFDD,LTEATDD
Remote Command	[[:SENSe]:ACPower:CARRier:INDEX <integer> [:SENSe]:ACPower:CARRier:INDEX?

Example	ACP:CARR:IND 1 ACP:CARR:IND?
Notes	This command is available only in MSR, LTE and LTE-Advanced FDD/TDD.
Preset	1
State Saved	Saved in instrument state
Min	1
Max	MSR: 100 LTEAFDD, LTEATDD: Dependent on Num Component Carriers under Mode Setup.
Initial S/W Revision	A.10.00

Manual

Accesses a menu that sets the manual reference power that is used to compute the relative values for the offsets.

Key Path	Meas Setup, Power Ref
Initial S/W Revision	A.10.00

Total Power

Sets manual total power reference. This is used when Power Ref is Manual and Meas Type is Total Power.

When set to Auto, the carrier power result reflects the measured power value in the selected reference carrier.

When set to Man, the result is referenced to the last measured value, or you may specify the reference for the multi-carrier power measurement. Relative values are displayed, referenced to the “Power Reference” value.

Total Power

Key Path	Meas Setup, Power Ref, Manual
Mode	SA, WCDMA, C2K, WIMAX OFDMA, TD-SCDMA, DVB-T/H, DTMB (CTTB), ISDB-T, CMMB, LTE, LTEATDD, Digital Cable TV, MSR, LTEAFDD, LTEATDD
Remote Command	[[:SENSe]:ACPower:CARRier[1] 2[:POWer] <real> [:SENSe]:ACPower:CARRier[1] 2[:POWer]? [:SENSe]:ACPower:CARRier[1] 2:AUTO[:STATe] OFF ON 0 1 [:SENSe]:ACPower:CARRier[1] 2:AUTO[:STATe]?
Example	ACP:CARR 10 ACP:CARR? ACP:CARR:AUTO OFF

	ACP:CARR:AUTO?
Notes	<p>Although the default value is defined, the value is recalculated by the measurement result just after measurement.</p> <p>Carrier sub op code: 1 for BTS, 2 for MS. Default is BTS.</p> <p>Carrier sub op code 2 is supported only in Non-SA modes.</p> <p>MS is not supported in MSR. In the SA mode, Carrier sub op code 1 is used for both BTS and MS.</p> <p>The Unit Terminator keys differ depending on whether or not the mode supports Y Axis Unit and also which Y Axis Unit is selected.</p> <p>You must be in the mode that includes ACP measurements to use this command. Use :INSTrument:SElect to set the mode.</p> <p>Power Ref State ([:SENSe]:ACPower:CARRier[1] 2:AUTO[:STATe]) is not available in MSR and LTE-Advanced FDD/TDD mode.</p>
Dependencies	This key is available only when the Meas Type is TPreF. If the Meas Type is not TPreF, this key is grayed out.
Preset	0.0 ON
State Saved	Saved in instrument state.
Min	-200 dBm
Max	200 dBm
Backwards Compatibility SCPI	<code>[:SENSe]:MCPower:CARRier[1] 2[:POWer]</code>
Initial S/W Revision	Prior to A.02.00
Modified at S/W Revision	A.02.00, A.03.00, A.04.00, A.10.00

PSD

Sets manual PSD reference. This is used when Power Ref is Manual and Meas Type is PSD.

Sets the power spectral density in the carrier (main channel) that is used to compute the relative power spectral density values for the offsets when Meas Type is set to PSD Ref. When the PSD Ref state is set to Auto, this will be set to the measured carrier power spectral density.

Key Path	Meas Setup, Power Ref, Manual
Mode	SA, WCDMA, C2K, WIMAX OFDMA, TD-SCDMA, DVB-T/H, DTMB (CTTB), ISDB-T, CMMB, LTE, LTETDD, Digital Cable TV, MSR, LTEAFDD, LTEATDD
Remote Command	<pre>[:SENSe]:ACPower:CARRier[1] 2:CPSD <real></pre> <pre>[:SENSe]:ACPower:CARRier[1] 2:CPSD?</pre>
Example	<pre>ACP:CARR:CPSD 25</pre> <pre>ACP:CARR:CPSD?</pre>
Notes	<p>Although the default value is defined, the value is recalculated by the measurement result just after measurement.</p> <p>Carrier sub op code. 1 for BTS, 2 for MS. Default is BTS.</p>

	MS is not supported in MSR. Note that Carrier sub op code 2 is supported only in Non-SA modes. In the SA mode, Carrier sub op code 1 is used for both BTS and MS. You must be in the mode that includes ACP measurements to use this command. Use :INSTrument:SElect to set the mode.
Dependencies	This key is available only when the Meas Type is PSDRef. If the Meas Type is not PSDRef, this key is grayed out.
Couplings	The value of PSD is automatically converted when PSD Unit is changed.
Preset	0.0
State Saved	Saved in instrument state.
Min	-999
Max	999
Initial S/W Revision	Prior to A.02.00
Modified at S/W Revision	A.02.00, A.03.00, A.04.00, A.10.00

Offset/Limits

Accesses a menu of functions that contains Offset, Offset Freq/Offset To Edge, Offset Integ BW, Upper Offset Limit and Lower Offset parameters. When in the MSR and LTE-Advanced FDD/TDD mode, the softkey label changes to Outer Offset/Limits.

Key Path	Meas Setup
Initial S/W Revision	Prior to A.02.00
Modified at S/W Revision	A.13.00

Select Offset

Selects the offset to configure.

Key Path	Meas Setup, Offset/Limits, Limits
Mode	SA, WCDMA, C2K, WIMAX OFDMA, TD-SCDMA, 1xEVDO, DVB-T/H, DTMB (CTTB), ISDB-T, CMMB, LTE, LTE-TDD, Digital Cable TV, MSR, LTEAFDD, LTEATDD
Preset	A
State Saved	Saved in instrument state.
Range	Offset A Offset B Offset C Offset D Offset E Offset F
Initial S/W Revision	Prior to A.02.00
Modified at S/W Revision	A.02.00, A.03.00, A.13.00

Offset Freq

This parameter determines the frequency difference between the center of the main channel and the center of the carrier.

Each Offset Freq state value is entered individually by selecting the desired carrier on the carrier menu key using the up down arrows, RPG or numeric keypad. Then enter the Offset Freq State using the Offset Frequency key.

The list contains up to six (6) entries, depending on the mode selected, for offset frequencies. Each offset frequency in the list corresponds to a reference bandwidth in the bandwidth list.

An offset frequency of zero turns the display of the measurement for that offset off, but the measurement is still made and reported. You can turn off (not use) specific offsets with the [:SENSe]:ACP:OFFSet:LIST:STATe command.

Turning the offset off has the same effect as setting the frequency of the offset to 0 Hz and will cause it to be removed from the results screen.

Key Path	Meas Setup, Offset/Limits
Mode	SA, WCDMA, C2K, WIMAX OFDMA, TD-SCDMA, 1xEVDO, DVB-T/H, DTMB (CTTB), ISDB-T, CMMB, LTE, LTE-TDD, Digital Cable TV, MSR, LTEAFDD, LTEATDD
Remote Command	<pre>[:SENSe]:ACP:OFFSet [1] 2 [:OUTer]:LIST[:FREQuency] <freq>, <freq>, <freq>, <freq>, <freq></pre> <pre>[:SENSe]:ACP:OFFSet [1] 2 [:OUTer]:LIST[:FREQuency] ?</pre> <pre>[:SENSe]:ACP:OFFSet [1] 2 [:OUTer]:LIST:STATe OFF ON 0 1, OFF ON 0 1, OFF ON 0 1, OFF ON 0 1, OFF ON 0 1, OFF ON 0 1</pre> <pre>[:SENSe]:ACP:OFFSet [1] 2 [:OUTer]:LIST:STATe ?</pre>
Example	<pre>ACP:OFFS1:LIST 0,0,0,0,0</pre> <pre>ACP:OFFS1:LIST?</pre> <pre>ACP:OFFS2:LIST:STAT 1,1,0,0,0</pre> <pre>ACP:OFFS2:LIST:STAT?</pre>
Notes	<p>The label for this menu key will change depending on the currently selected radio standard or mode. For cdma2000 the label for the menu key will be Offset to Edge. For all other supported standards the label will be Offset Freq.</p> <p>When setting these values remotely, the position in the list sent corresponds to the offset. Missing values are not permitted, unless the number of values sent is greater than the number of carriers, then subsequent values will be ignored.</p> <p>Offset sub op code. 1 for BTS, 2 for MS. Default is BTS.</p> <p>Note that Offset sub op code 2 is supported only in Non-SA modes.</p> <p>In the SA mode, Offset sub op code 1 is used for both BTS and MS.</p> <p>You must be in the mode that includes ACP measurements to use this command. Use :INSTrument:SElect to set the mode.</p>
Couplings	Changing Offset Frequency might affect the Span. See the Span key section for details.
Preset	<pre>SA: 3 MHz, 0 Hz, 0 Hz, 0 Hz, 0 Hz, 0 Hz 3 MHz, 0 Hz, 0 Hz, 0 Hz, 0 Hz, 0 Hz</pre> <pre>WCDMA: 5.0 MHz, 10.0 MHz, 0 Hz, 0 Hz, 0 Hz, 0 Hz 5.0 MHz, 10.0 MHz, 0 Hz, 0 Hz, 0 Hz, 0 Hz</pre>

WIMAX OFDMA: 10 MHz, 20 MHz, 0 Hz, 0 Hz, 0 Hz, 0 Hz| 10 MHz, 20 MHz, 0 Hz, 0 Hz, 0 Hz, 0 Hz
 C2K:750KHz, 1.980 MHz, 0 Hz, 0 Hz, 0 Hz, 0 Hz| 885 kHz, 1.980 MHz, 0 Hz, 0 Hz, 0 Hz, 0 Hz
 TD-SCDMA: 1.6 MHz, 3.2 MHz, 0 Hz, 0 Hz, 0 Hz, 0 Hz|1.6 MHz, 3.2 MHz, 0 Hz, 0 Hz, 0 Hz, 0 Hz
 1xEVDO: 750KHz, 1.98MHz, 3.125MHz, 4.000MHz, 7.500MHz, 7.500MHz|885KHz, 1.98MHz,
 3.125MHz, 4.000MHz, 7.500MHz, 7.500MHz
 DVB-T/H: 8 MHz, 16 MHz, 0 Hz, 0 Hz, 0 Hz, 0 Hz| 8 MHz, 16 MHz, 0 Hz, 0 Hz, 0 Hz, 0 Hz
 DTMB (CTTB): 8 MHz, 16 MHz, 24 MHz, 32 MHz, 0 Hz, 0 Hz| 8 MHz, 16 MHz, 24 MHz, 32 MHz, 0
 Hz, 0 Hz
 ISDB-T: 6 MHz, 12 MHz, 0 Hz, 0 Hz, 0 Hz, 0 Hz| 6 MHz, 12 MHz, 0 Hz, 0 Hz, 0 Hz, 0 Hz
 CMMB: 8 MHz, 16 MHz, 24 MHz, 32 MHz, 0 Hz, 0 Hz| 8 MHz, 16 MHz, 24 MHz, 32 MHz, 0 Hz, 0
 Hz
 LTE, LTETDD, MSR, LTEAFDD, LTEATDD: 5 MHz, 10 MHz, 0, 0, 0, 0|5 MHz, 10 MHz, 0, 0, 0, 0
 Digital Cable TV: 8 MHz, 16 MHz, 0 Hz, 0 Hz, 0 Hz, 0 Hz|8 MHz, 16 MHz, 0 Hz, 0 Hz, 0 Hz, 0 Hz
 SA: ON, OFF, OFF, OFF, OFF, OFF|ON, OFF, OFF, OFF, OFF, OFF
 WCDMA: ON, ON, OFF, OFF, OFF, OFF|ON, ON, OFF, OFF, OFF, OFF
 WIMAX OFDMA: ON, ON, OFF, OFF, OFF, OFF|ON, ON, OFF, OFF, OFF, OFF
 TD-SCDMA: ON, ON, OFF, OFF, OFF, OFF|ON, ON, OFF, OFF, OFF, OFF
 DVB-T/H: ON, ON, OFF, OFF, OFF, OFF|ON, ON, OFF, OFF, OFF, OFF
 DTMB (CTTB): ON, ON, OFF, OFF, OFF, OFF|ON, ON, OFF, OFF, OFF, OFF
 CDMA1xEVDO: ON, ON, OFF, OFF, OFF, OFF| ON, ON, OFF, OFF, OFF, OFF
 ISDB-T: ON, ON, OFF, OFF, OFF, OFF|ON, ON, OFF, OFF, OFF, OFF
 CMMB: ON, ON, ON, ON, OFF, OFF|ON, ON, ON, ON, OFF, OFF
 LTE, LTETDD, MSR, LTEAFDD, LTEATDD: ON, ON, OFF, OFF, OFF, OFF|ON, OFF, OFF, OFF, OFF, OFF
 Digital Cable TV: ON, ON, OFF, OFF, OFF, OFF|ON, ON, OFF, OFF, OFF, OFF

State Saved	Saved in instrument state.
Min	0 Hz
Max	Depends on instrument maximum frequency. Same as the Max Span of Swept SA Measurement.
Backwards Compatibility SCPI	<code>[[:SENSe]:MCPower:OFFSet[1] 2:LIST[:FREQuency] (PSA Power Suite)</code>
Initial S/W Revision	Prior to A.02.00
Modified at S/W Revision	A.02.00, A.03.00, A.13.00, A.16.00

Integ BW

Sets the Integration Bandwidth for the offsets. Each resolution bandwidth in the list corresponds to an offset frequency in the list defined by `[[:SENSe]:ACP:OFFSet[n]:OUTer]:LIST[:FREQuency]`.

Enter each value individually by selecting the desired offset on the offset menu key using the up down arrows, the knob, or the numeric keypad, then enter the Offset Integration Bandwidth using the Offset Integration Bandwidth menu key.

You can turn off (not use) specific offsets with the `[[:SENSe]:ACP:OFFSet[n]:OUTer]:LIST:STATe` command.

Key Path	Meas Setup, Offset/Limits
Mode	SA, WCDMA, C2K, WIMAX OFDMA, TD-SCDMA, 1xEVDO, DVB-T/H, DTMB (CTTB), ISDB-T, CMMB, LTE, LTETDD, Digital Cable TV, MSR, LTEAFDD, LTEATDD
Remote Command	<code>[[:SENSe]:ACPower:OFFSet [1] 2[:OUTer]:LIST:BANDwidth[:INTEgration] <freq>, <freq>, <freq>, <freq>, <freq>, <freq></code> <code>[[:SENSe]:ACPower:OFFSet [1] 2[:OUTer]:LIST:BANDwidth[:INTEgration]?</code>
Example	ACP:OFFS2:LIST:BAND 2MHz, 2MHz, 2MHz, 2MHz, 2MHz, 2MHz ACP:OFFS2:LIST:BAND?
Notes	<p>When setting these values remotely, the position in the list sent corresponds to the offset. Missing values are not permitted i.e. if you want to change the second value, you must send all values up to it. Subsequent values will remain unchanged, unless the number of values sent is greater than the number of carriers, then subsequent values will be ignored.</p> <p>Offset sub op code. 1 for BTS, 2 for MS. Default is BTS.</p> <p>Note that Offset sub op code 2 is supported only in Non-SA modes.</p> <p>In the SA mode, Offset sub op code 1 is used for both BTS and MS.</p> <p>You must be in the mode that includes ACP measurements to use this command. Use :INSTrument:SElect to set the mode.</p>
Couplings	Changing Integ BW might affect the Span. See Span section for details.
Preset	<p>SA: 2 MHz, 2 MHz, 2 MHz, 2 MHz, 2 MHz, 2 MHz 2 MHz, 2 MHz, 2 MHz, 2 MHz, 2 MHz, 2 MHz</p> <p>WCDMA: 3.84 MHz, 3.84 MHz, 3.84 MHz, 3.84 MHz, 3.84 MHz, 3.84 MHz 3.84 MHz, 3.84 MHz, 3.84 MHz, 3.84 MHz</p> <p>WIMAX OFDMA: 10 MHz, 10 MHz, 10 MHz, 10 MHz, 10 MHz, 10 MHz 10 MHz, 10 MHz, 10 MHz, 10 MHz, 10 MHz, 10 MHz</p> <p>C2K: 30 kHz, 30 kHz, 30 kHz, 30 kHz, 30 kHz, 30 kHz 30 kHz, 30 kHz, 30 kHz, 30 kHz, 30 kHz, 30 kHz</p> <p>TD-SCDMA: 1.28 MHz, 1.28 MHz, 1.28 MHz, 1.28 MHz, 1.28 MHz, 1.28 MHz</p> <p>1xEVDO: C2K: 30 kHz, 30 kHz, 30 kHz, 30 kHz, 30 kHz, 30 kHz 30 kHz, 30 kHz, 30 kHz, 30 kHz, 30 kHz, 30 kHz</p> <p>DVB-T/H: 7.61 MHz, 7.61 MHz, 7.61 MHz, 7.61 MHz, 7.61 MHz, 7.61 MHz 7.61 MHz, 7.61 MHz, 7.61 MHz, 7.61 MHz</p> <p>DTMB (CTTB): 7.56 MHz, 7.56 MHz, 7.56 MHz, 7.56 MHz, 7.56 MHz, 7.56 MHz 7.56 MHz, 7.56 MHz, 7.56 MHz, 7.56 MHz, 7.56 MHz</p> <p>ISDB-T: 5.6 MHz, 5.6 MHz, 5.6 MHz, 5.6 MHz, 5.6 MHz, 5.6 MHz 5.6 MHz, 5.6 MHz, 5.6 MHz, 5.6 MHz, 5.6 MHz, 5.6 MHz</p> <p>CMMB: 7.512 MHz, 7.512 MHz, 7.512 MHz, 7.512 MHz, 7.512 MHz, 7.512 MHz 7.512 MHz, 7.512 MHz, 7.512 MHz, 7.512 MHz, 7.512 MHz</p> <p>LTE, LTETDD, MSR, LTEAFDD, LTEATDD: 4.515 MHz, 4.515 MHz, 4.515 MHz, 4.515 MHz, 4.515 MHz, 4.515 MHz 4.5 MHz, 4.5 MHz, 4.5 MHz, 4.5 MHz, 4.5 MHz, 4.5 MHz</p> <p>Digital Cable TV: 8.0 MHz, 8.0 MHz, 8.0 MHz, 8.0 MHz, 8.0 MHz, 8.0 MHz 8.0 MHz, 8.0 MHz, 8.0 MHz, 8.0 MHz, 8.0 MHz, 8.0 MHz</p>
State Saved	Saved in instrument state.
Min	10 Hz

Max	Depends on instrument maximum frequency. Same as the Max Span on Swept SA Measurement.
Backwards Compatibility SCPI	[:SENSe]:ACPower:OFFSet[1] 2:LIST:BWIDth[:INTEgration] [:SENSe]:ACPR:OFFSet[1] 2:LIST:BANDwidth [:SENSe]:ACPR:OFFSet[1] 2:LIST:BWIDth [:SENSe]:MCPower:OFFSet[1] 2:LIST:BANDwidth[:INTEgration] (PSA Power Suite) [:SENSe]:MCPower:OFFSet[1] 2:LIST:BWIDth[:INTEgration] (PSA Power Suite)
Initial S/W Revision	Prior to A.02.00
Modified at S/W Revision	A.02.00, A.03.00, A.13.00, A.16.00

Offset BW

Accesses the offset bandwidth menu.

Key Path	Meas Setup, Offset/Limits
Initial S/W Revision	Prior to A.02.00

Res BW

Sets the resolution bandwidth. If an unavailable bandwidth is entered with the numeric keypad, the closest available bandwidth is selected.

Key Path	Meas Setup, Offset/Limits
Mode	SA, WCDMA, C2K, WIMAX OFDMA, TD-SCDMA, 1xEVDO, DVB-T/H, DTMB (CTTB), ISDB-T, CMMB, LTE, LTE-TDD, Digital Cable TV, MSR, LTEAFDD, LTEATDD
Remote Command	[:SENSe]:ACPower:OFFSet[1] 2[:OUTer]:LIST:BANDwidth:RESolution <freq>, <freq>, <freq>, <freq>, <freq> [:SENSe]:ACPower:OFFSet[1] 2[:OUTer]:LIST:BANDwidth:RESolution? [:SENSe]:ACPower:OFFSet[1] 2[:OUTer]:LIST:BANDwidth:RESolution:AUTO ON OFF 1 0, ON OFF 1 0, ON OFF 1 0, ON OFF 1 0, ON OFF 1 0, ON OFF 1 0 [:SENSe]:ACPower:OFFSet[1] 2[:OUTer]:LIST:BANDwidth:RESolution:AUTO?
Example	ACP:OFFS2:LIST:BAND:RES 220kHz, 220kHz, 220kHz, 220kHz, 220kHz ACP:OFFS2:LIST:BAND:RES? ACP:OFFS2:LIST:BAND:RES:AUTO 1,1,1,1,1 ACP:OFFS2:LIST:BAND:RES:AUTO?
Notes	Offset sub op code. 1 for BTS, 2 for MS. Default is BTS. Note that Offset sub op code 2 is supported only in Non-SA modes. In the SA mode, Offset sub op code 1 is used for both BTS and MS.

	You must be in the mode that includes ACP measurements to use this command. Use :INSTrument:SElect to set the mode.
Dependencies	When Meas Method is RBW, FAST or Fast Power, this key is grayed out and disabled. If the key is pressed, an advisory message is generated. If the equivalent remote command is sent, a "Setting conflict" warning is generated.
Couplings	When Res BW Mode is AUTO, this value is exactly same as Res BW under BW key. And when this value is changed by user, Res BW Mode is also changed to Man.
Preset	SA: 220 kHz, 220 kHz, 220 kHz, 220 kHz, 220 kHz, 220 kHz WCDMA: 100 kHz, 100 kHz, 100 kHz, 100 kHz, 100 kHz, 100 kHz WIMAX OFDMA: 100 kHz, 100 kHz, 100 kHz, 100 kHz, 100 kHz, 100 kHz C2K: Method:RBW 30 kHz Method: IBW C2K: 15 kHz, 15 kHz, 15 kHz, 15 kHz, 15 kHz, 15 kHz 15 kHz, 15 kHz, 15 kHz, 15 kHz, 15 kHz, 15 kHz TD-SCDMA: 30 kHz, 30 kHz, 30 kHz, 30 kHz, 30 kHz, 30 kHz 1xEVDO: 30KHz, 30KHz, 30KHz, 30KHz, 30KHz, 30KHz 30KHz, 30KHz, 30KHz, 30KHz, 30KHz, 30KHz DVB-T/H: 39 kHz, 39 kHz, 39 kHz, 39 kHz, 39 kHz, 39 kHz 39 kHz, 39 kHz, 39 kHz, 39 kHz, 39 kHz, 39 kHz DTMB (CTTB): 39 kHz, 39 kHz, 39 kHz, 39 kHz, 39 kHz, 39 kHz 39 kHz, 39 kHz, 39 kHz, 39 kHz, 39 kHz, 39 kHz ISDB-T: 39 kHz, 39 kHz, 39 kHz, 39 kHz, 39 kHz, 39 kHz 39 kHz, 39 kHz, 39 kHz, 39 kHz, 39 kHz, 39 kHz CMMB: 39 kHz, 39 kHz, 39 kHz, 39 kHz, 39 kHz, 39 kHz 39 kHz, 39 kHz, 39 kHz, 39 kHz, 39 kHz, 39 kHz LTE, LTETDD, MSR, LTEAFDD, LTEATDD: 100 kHz, 100 kHz, 100 kHz, 100 kHz, 100kHz, 100 kHz 100 kHz, 100 kHz, 100 kHz, 100 kHz, 100 kHz, 100 kHz Digital Cable TV: 39 kHz, 39 kHz, 39 kHz, 39 kHz, 39 kHz, 39 kHz 39 kHz, 39 kHz, 39 kHz, 39 kHz, 39 kHz, 39 kHz 1, 1, 1, 1, 1, 1
State Saved	Saved in instrument state.
Min	1 Hz
Max	8 MHz
Backwards Compatibility SCPI	[:SENSe] :ACPower:OFFSet [1] 2 :LIST:BWIDth:RESolution
Initial S/W Revision	Prior to A.02.00
Modified at S/W Revision	A.02.00, A.03.00, A.13.00

Video BW

Enables you to change the analyzer post-detection filter (VBW).

Key Path	Meas Setup, Offset/Limits, Offset BW
Mode	SA, WCDMA, C2K, WIMAX OFDMA, TD-SCDMA, 1xEVDO, DVB-T/H, DTMB (CTTB), ISDB-T, CMMB, LTE, LTE-TDD, Digital Cable TV, MSR, LTEAFDD, LTEATDD
Remote Command	<pre>[:SENSe]:ACPower:OFFSet [1] 2[:OUTer]:LIST:BANDwidth:VIDeo <freq>, <freq>, <freq>, <freq>, <freq> [:SENSe]:ACPower:OFFSet [1] 2[:OUTer]:LIST:BANDwidth:VIDeo? [:SENSe]:ACPower:OFFSet [1] 2[:OUTer]:LIST:BANDwidth:VIDeo:AUTO OFF ON 0 1, OFF ON 0 1, OFF ON 0 1, OFF ON 0 1, OFF ON 0 1, OFF ON 0 1 [:SENSe]:ACPower:OFFSet [1] 2[:OUTer]:LIST:BANDwidth:VIDeo:AUTO?</pre>
Example	<pre>ACP:OFFS2:LIST:BAND:VID 5MHz, 5MHz, 5MHz, 5MHz, 5MHz, 5MHz ACP:OFFS2:LIST:BAND:VID? ACP:OFFS2:LIST:BAND:VID:AUTO 0,0,0,0,1,1 ACP:OFFS2:LIST:BAND:VID:AUTO?</pre>
Notes	<p>The values shown in this table reflect the conditions after a Mode Preset.</p> <p>Offset sub op code. 1 for BTS, 2 for MS. Default is BTS.</p> <p>Note that Offset sub op code 2 is supported only in Non-SA modes.</p> <p>In the SA mode, Offset sub op code 1 is used for both BTS and MS.</p> <p>You must be in the mode that includes ACP measurements to use this command. Use :INSTrument:SElect to set the mode.</p>
Dependencies	When Meas Method is RBW or FAST or Fast Power, this key is grayed out and disabled. If the key is pressed, an advisory message is generated. If the equivalent remote command is sent, a "Setting conflict" warning is generated.
Preset	<pre>SA: 22 kHz, 22 kHz, 22 kHz, 22 kHz, 22 kHz, 22 kHz WCDMA, WIMAX OFDMA: 1 MHz, 1 MHz, 1 MHz, 1 MHz, 1 MHz, 1 MHz C2K: 150 kHz, 150 kHz, 150 kHz, 150 kHz, 150 kHz, 150 kHz 150 kHz, 150 kHz, 150 kHz, 1150 kHz, 1150 kHz, 150 kHz TD-SCDMA: 300 kHz, 300 kHz, 300 kHz, 300 kHz, 300 kHz, 300 kHz 1xEVDO: 300KHz, 300KHz, 300KHz, 300KHz, 300KHz, 300KHz 300KHz, 300KHz, 300KHz, 300KHz, 300KHz, 300KHz DVB-T/H: 390 kHz, 390 kHz, 390 kHz, 390 kHz, 390 kHz, 390 kHz 390 kHz, 390 kHz, 390 kHz, 390 kHz, 390 kHz, 390 kHz DTMB (CTTB): 390 kHz, 390 kHz, 390 kHz, 390 kHz, 390 kHz, 390 kHz 390 kHz, 390 kHz, 390 kHz, 390 kHz, 390 kHz, 390 kHz ISDB-T: 390 kHz, 390 kHz, 390 kHz, 390 kHz, 390 kHz, 390 kHz 390 kHz, 390 kHz, 390 kHz, 390 kHz, 390 kHz, 390 kHz CMMB: 390 kHz, 390 kHz, 390 kHz, 390 kHz, 390 kHz, 390 kHz 390 kHz, 390 kHz, 390 kHz, 390 kHz, 390 kHz, 390 kHz LTE, LTE-TDD, MSR, LTEAFDD, LTEATDD: 1 MHz, 1 MHz, 1 MHz, 1 MHz, 1 MHz, 1 MHz Digital Cable TV: 390 kHz, 390 kHz, 390 kHz, 390 kHz, 390 kHz, 390 kHz 390 kHz, 390 kHz, 390 kHz, 390 kHz, 390 kHz, 390 kHz ON, ON, ON, ON, ON, ON</pre>

State Saved	Saved in instrument state.
Min	1 Hz
Max	50 MHz
Backwards Compatibility SCPI	<code>[:SENSe] :ACPower:OFFSet [1] 2 :LIST:BWIDth:VIDeo</code>
Initial S/W Revision	Prior to A.02.00
Modified at S/W Revision	A.02.00, A.03.00, A.13.00

RBW Control

Accesses the resolution bandwidth control menu.

Key Path	Meas Setup, Offset/Limits, Offset BW
Initial S/W Revision	Prior to A.02.00

Filter Type

Selects the type of bandwidth filter that is used.

Key Path	Meas Setup, Offset/Limits, Offset BW, RBW Control
Mode	SA, WCDMA, C2K, WIMAX OFDMA, TD-SCDMA, 1xEVDO, DVB-T/H, DTMB (CTTB), ISDB-T, CMMB, LTE, LTEFDD, Digital Cable TV, MSR, LTEAFDD, LTEATDD
Remote Command	<code>[:SENSe] :ACPower:OFFSet [1] 2 [:OUTer] :LIST:BWIDth:SHAPE GAUSSian FLATtop, GAUSSian FLATtop, GAUSSian FLATtop, GAUSSian FLATtop, GAUSSian FLATtop, GAUSSian FLATtop</code> <code>[:SENSe] :ACPower:OFFSet [1] 2 [:OUTer] :LIST:BWIDth:SHAPE?</code>
Example	ACP:OFFS2:LIST:BAND:SHAP FLAT, GAUS, GAUS, GAUS, GAUS, GAUS ACP:OFFS2:LIST:BAND:SHAP?
Notes	Offset sub op code. 1 for BTS, 2 for MS. Default is BTS. Note that Offset sub op code 2 is supported only in Non-SA modes. In the SA mode, Offset sub op code 1 is used for both BTS and MS. You must be in the mode that includes ACP measurements to use this command. Use :INSTrument:SELEct to set the mode.
Dependencies	When Res BW Mode for the offset is Auto, this key is grayed out and disabled. Since Res BW Mode for the offset is preset to Auto on changing Meas Method to RBW, FAST or Fast Power, this key is grayed out and disabled too. If the key is pressed, an advisory message is generated. If the equivalent remote command is sent, a "Setting conflict" warning is generated.
Couplings	See the description above
Preset	GAUSSian, GAUSSian, GAUSSian, GAUSSian, GAUSSian, GAUSSian
State Saved	Saved in instrument state.
Range	GAUSSian FLATtop

Backwards Compatibility SCPI	<code>[:SENSe] :ACPower :OFFSet [1] 2 :LIST :BWIDth :SHAPE</code>
Initial S/W Revision	Prior to A.02.00
Modified at S/W Revision	A.02.00, A.03.00, A.13.00

Filter BW

Selects a Gaussian filter based on its -3 dB (Normal) bandwidth or its -6 dB bandwidth.

Key Path	Meas Setup, Offset/Limits, Offset BW, RBW Control
Mode	SA, WCDMA, C2K, WIMAX OFDMA, TD-SCDMA, 1xEVDO, DVB-T/H, DTMB (CTTB), ISDB-T, CMMB, LTE, LTE-TDD, Digital Cable TV, MSR, LTEAFDD, LTEATDD
Remote Command	<code>[:SENSe] :ACPower :OFFSet [1] 2 [:OUTer] :LIST :BANDwidth :TYPE DB3 DB6, DB3 DB6, DB3 DB6, DB3 DB6, DB3 DB6, DB3 DB6</code> <code>[:SENSe] :ACPower :OFFSet [1] 2 [:OUTer] :LIST :BANDwidth :TYPE?</code>
Example	ACP:OFFS2:LIST:BAND:TYPE DB3, DB3, DB3, DB3, DB3, DB3 ACP:OFFS2:LIST:BAND:TYPE?
Notes	Offset sub op code. 1 for BTS, 2 for MS. Default is BTS. Note that Offset sub op code 2 is supported only in Non-SA modes. In the SA mode, Offset sub op code 1 is used for both BTS and MS. You must be in the mode that includes ACP measurements to use this command. Use :INSTRument:SElect to set the mode.
Dependencies	When Filter Type is Flattop or Res BW Mode for the offset is Auto, this key is grayed out and disabled. Since Res BW Mode for the offset is preset to Auto on changing Meas Method to RBW, FAST or Fast Power, this key is grayed out and disabled too. If the key is pressed, an advisory message is generated. If the equivalent remote command is sent, a "Setting conflict" warning is generated.
Preset	DB3, DB3, DB3, DB3, DB3, DB3
State Saved	Saved in instrument state.
Range	-3 dB (Normal) -6 dB
Backwards Compatibility SCPI	<code>[:SENSe] :ACPower :OFFSet [1] 2 :LIST :BWIDth :TYPE</code>
Initial S/W Revision	Prior to A.02.00
Modified at S/W Revision	A.02.00, A.03.00, A.13.00

Limits

Limits key accesses a menu of functions that contains Select Offset, Abs Limit, Rel Limit and Fail Mask parameters.

Key Path	Meas Setup, Offset/Limits
Initial S/W Revision	A.03.00

Select Offset

Selects the offset to configure.

Key Path	Meas Setup, Offset/Limits, Limits
Mode	SA, WCDMA, C2K, WIMAX OFDMA, TD-SCDMA, 1xEVDO, DVB-T/H, DTMB (CTTB), ISDB-T, CMMB, LTE, LTETDD, Digital Cable TV, MSR, LTEAFDD, LTEATDD
Preset	A
State Saved	Saved in instrument state.
Range	Offset A Offset B Offset C Offset D Offset E Offset F
Initial S/W Revision	Prior to A.02.00
Modified at S/W Revision	A.02.00, A.03.00, A.13.00

Abs Limit

Enters an absolute limit value, which sets the absolute amplitude levels to test against for each of the custom offsets. The list must contain six (6) entries. If there is more than one offset, the offset closest to the carrier channel is the first one in the list. [:SENSe]:ACP:OFFSet[n][:OUTer]:LIST:TEST selects the type of testing to be done at each offset.

You can turn off (not use) specific offsets with the [:SENSe]:ACP:OFFSet[n][:OUTer]:LIST:STATe command.

The query returns the six (6) sets of real numbers that are the current absolute amplitude test limits.

Key Path	Meas Setup, Offset/Limits, Limits
Mode	SA, WCDMA, C2K, WIMAX OFDMA, TD-SCDMA, 1xEVDO, DVB-T/H, DTMB (CTTB), ISDB-T, CMMB, LTE, LTETDD, Digital Cable TV, MSR, LTEAFDD, LTEATDD
Remote Command	[:SENSe]:ACP:Power:OFFSet[1] 2[:OUTer]:LIST:ABSolute <real>, <real>, <real>, <real>, <real>, <real> [:SENSe]:ACP:Power:OFFSet[1] 2[:OUTer]:LIST:ABSolute?
Example	ACP:OFFS2:LIST:ABS -10, -10, -10, -10, -10, -10 ACP:OFFS2:LIST:ABS?
Notes	Offset sub op code. 1 for BTS, 2 for MS. Default is BTS. Note that Offset sub op code 2 is supported only in Non-SA modes. In the SA mode, Offset sub op code 1 is used for both BTS and MS. You must be in the mode that includes ACP measurements to use this command. Use :INSTrument:SElect to set the mode.
Couplings	None If current mode is DTMB (CTTB) or CMMB and current device type is Transmitter, the value from position 2 to position 4 are coupled, changing any one will change the others.
Preset	SA: 0dBm, 0 dBm, 0 dBm, 0 dBm, 0 dBm, 0 dBm 0dBm, 0 dBm, 0 dBm, 0 dBm, 0 dBm, 0 dBm WCDMA: 50 dBm, 50 dBm, 50 dBm, 50 dBm, 50 dBm, 50 dBm 50 dBm, 50 dBm, 50 dBm, 50 dBm, 50 dBm, 50 dBm

	<p>C2K: 50 dBm, 50 dBm, 50 dBm, 50 dBm, 50 dBm, 50 dBm 50 dBm, 50 dBm, 50 dBm, 50 dBm, 50 dBm, 50 dBm</p> <p>WIMAX OFDMA: 50,50,50,50,50,50</p> <p>TD-SCDMA: 50 dBm, 50 dBm, 50 dBm, 50 dBm, 50 dBm, 50 dBm 50 dBm, 50 dBm, 50 dBm, 50 dBm, 50 dBm, 50 dBm</p> <p>1xEVDO: -27dBm, -27dBm, -13dBm, -13dBm, -13dBm, -13dBm -27dBm, -27dBm, -13dBm, -13dBm, -13dBm, -13dBm</p> <p>DVB-T/H: 50 dBm, 50 dBm, 50 dBm, 50 dBm, 50 dBm, 50 dBm 50 dBm, 50 dBm, 50 dBm, 50 dBm, 50 dBm, 50 dBm</p> <p>DTMB (CTTB): 11.14 dBm, 11.14dBm, 11.14 dBm, 11.14 dBm, 50 dBm, 50 dBm 11.14 dBm, 11.14 dBm, 11.14 dBm, 11.14 dBm, 50 dBm, 50 dBm</p> <p>ISDB-T: 50 dBm, 50 dBm, 50 dBm, 50 dBm, 50 dBm, 50 dBm 50 dBm, 50 dBm, 50 dBm, 50 dBm, 50 dBm, 50 dBm</p> <p>CMMB: 11.14 dBm, 11.14dBm, 11.14 dBm, 11.14 dBm, 50 dBm, 50 dBm 11.14 dBm, 11.14 dBm, 11.14 dBm, 11.14 dBm, 50 dBm, 50 dBm</p> <p>LTE, LTE-TDD, MSR, LTEAFDD, LTEATDD: -8.45, -8.45, -8.45, -8.45, -8.45, -8.45 -50.0, -50.0, -50.0, -50.0, -50.0, -50.0</p> <p>Digital Cable TV: 50 dBm, 50 dBm, 50 dBm, 50 dBm, 50 dBm, 50 dBm 50 dBm, 50 dBm, 50 dBm, 50 dBm, 50 dBm, 50 dBm</p>
State Saved	Saved in instrument state.
Min	-200.0 dBm
Max	50.0 dBm
Backwards Compatibility SCPI	<pre>[:SENSe] :ACPR :OFFSet [1] 2 :LIST :ABSolute (PSA W-CDMA, PSA cdma2000)</pre> <pre>[:SENSe] :MCPower :OFFSet [1] 2 :LIST :ABSolute (PSA W-CDMA)</pre>
Initial S/W Revision	Prior to A.02.00
Modified at S/W Revision	A.02.00, A.03.00, A.13.00

Rel Lim (Car)

Enters a relative limit value for the carrier level. This sets the amplitude levels to test against for the specified offsets.

The amplitude level is relative to the carrier amplitude. If multiple offsets are available, the list contains six (6) entries. The offset closest to the carrier channel is the first one in the list.

`[:SENSe] :ACP :OFFSet [n] [:OUTer] :LIST :TEST` selects the type of testing to be done at each offset.

You can turn off (not use) specific offsets with the `[:SENSe] :ACP :OFFSet [n] [:OUTer] :LIST :STATe` command.

The query returns the six (6) sets of real numbers that are the current amplitude test limits, relative to the carrier, for each offset.

Offset [n] n = 1 is base station and n = 2 is mobiles. The default is base station (1).

Key Path	Meas Setup, Offset/Limits, Limits,
----------	---

Mode	SA, WCDMA, C2K, WIMAX OFDMA, TD-SCDMA, 1xEVDO, DVB-T/H, DTMB (CTTB), ISDB-T, CMMB, LTE, LTE-TDD, Digital Cable TV, MSR, LTEAFDD, LTEATDD
Remote Command	<code>[[:SENSe]:ACPower:OFFSet[1] 2[:OUTer]:LIST:RCARrier <real>, <real>, <real>, <real>, <real></code> <code>[[:SENSe]:ACPower:OFFSet[1] 2[:OUTer]:LIST:RCARrier?</code>
Example	ACP:OFFS2:LIST:RCAR 0,0,0,0,0 ACP:OFFS2:LIST:RCAR?
Notes	Offset sub op code. 1 for BTS, 2 for MS. Default is BTS. Note that Offset sub op code 2 is supported only in Non-SA modes. In the SA mode, Offset sub op code 1 is used for both BTS and MS. You must be in the mode that includes ACP measurements to use this command. Use :INSTrument:SElect to set the mode.
Couplings	None If current mode is DTMB (CTTB) or CMMB and current device type is Transmitter, the value from position 2 to position 4 are coupled, changing any one will change the others.
Preset	SA: -45, -60, 0, 0, 0, 0 -45, -60, 0, 0, 0, 0 WCDMA: -44.2, -49.2, -49.2, -49.2, -49.2, -49.2 -32.2, -42.2, -42.2, -42.2, -42.2, -42.2 C2K: 0, 0, 0, 0, 0, 0 0, 0, 0, 0, 0, 0 WIMAX OFDMA: -50, -60, 0, 0, 0, 0 TD-SCDMA: -40, -45, -45, -45, -45, -45 -33, -43, -43, -43, -43, -43 1xEVDO: -45, -55, -55, -55, -55, -55 -45, -55, -55, -55, -55, -55 DVB-T/H: -60, -60, 0, 0, 0, 0 -60, -60, 0, 0, 0, 0 DTMB (CTTB): -45, -60, -60, -60, 50, 50 -45, -60, -60, -60, 50, 50 ISDB-T: -60, -60, 0, 0, 0, 0 -60, -60, 0, 0, 0, 0 CMMB: -45, -60, -60, -60, 50, 50 -45, -60, -60, -60, 50, 50 LTE, LTE-TDD, MSR, LTEAFDD, LTEATDD: -44.2, -44.2, -44.2, -44.2, -44.2, -44.2 -29.2, -29.2, -29.2, -29.2, -29.2, -29.2 Digital Cable TV: -58, -62, -65, -73, -73, -73 -58, -62, -65, -73, -73, -73
State Saved	Saved in instrument state.
Min	-150
Max	50.0
Backwards Compatibility SCPI	<code>[[:SENSe]:MCPower:OFFSet[1] 2:LIST:RCARrier (PSA WCDMA)</code>
Initial S/W Revision	Prior to A.02.00
Modified at S/W Revision	A.02.00, A.03.00, A.04.00, A.13.00

Positive Offset Limit (SCPI only)

Enables you to set the upper limit for the upper segment of the specified offset pair.

Mode	SA, WCDMA, CDMA2K, WIMAXOFDMA, TDSCDMA, CDMA1XEV, DVB, DTMB, LTE, LTETDD, DCTV, MSR, LTEAFDD,LTEATDD
Remote Command	:CALCulate:ACPower:OFFSet[:OUTer]:LIST:LIMit:POSitive[:UPPer]:DATA <real>, <real>, <real>, <real>, <real>, <real> :CALCulate:ACPower:OFFSet[:OUTer]:LIST:LIMit:POSitive[:UPPer]:DATA?
Example	CALC:ACP:OFFS:LIST:LIM:POS:DATA 0, 0, 0, 0, 0, 0 CALC:ACP:OFFS:LIST:LIM:POS:DATA?
Notes	SCPI only command
Preset	SA: -45, -60, 0, 0, 0, 0 -45, -60, 0, 0, 0, 0 WCDMA: -44.2, -49.2, -49.2, -49.2, -49.2, -49.2 -32.2, -42.2, -42.2, -42.2, -42.2, -42.2 C2K: 0, 0, 0, 0, 0, 0 0, 0, 0, 0, 0, 0 WIMAX OFDMA: -50, -60, 0, 0, 0, 0 TD-SCDMA: -40, -45, -45, -45, -45, -45 -33, -43, -43, -43, -43, -43 1xEVDO: -45, -55, -55, -55, -55, -55 -45, -55, -55, -55, -55, -55 DVB-T/H: -60, -60, 0, 0, 0, 0 -60, -60, 0, 0, 0, 0 DTMB (CTTB): -45, -60, -60, -60, 0, 0 -45, -60, -60, -60, 0, 0 Digital Cable TV: -58, -62, -65, -73, -73, -73 -58, -62, -65, -73, -73, -73 LTE, LTETDD, MSR, LTEAFDD, LTEATDD: -44.2, -44.2, -44.2, -44.2, -44.2, -44.2 -29.2, -29.2, -29.2, -29.2, -29.2, -29.2
State Saved	Saved in instrument state.
Min	-150.0
Max	50.0
Backwards Compatibility SCPI	:CALCulate:MCPower:OFFSet:LIST:LIMit:POSitive[:UPPer]:DATA (PSA Power Suite)
Initial S/W Revision	A.04.00
Modified at S/W Revision	A.13.00

Negative Offset Limit

Enables you to set the upper limit for the lower segment of the specified offset pair.

Mode	SA, WCDMA, CDMA2K, WIMAXOFDMA, TDSCDMA, CDMA1XEV, DVB, DTMB, LTE, LTETDD, DCTV, MSR, LTEAFDD,LTEATDD
Remote Command	:CALCulate:ACPower:OFFSet[:OUTer]:LIST:LIMit:NEGative[:UPPer]:DATA <real>, <real>, <real>, <real>, <real>, <real> :CALCulate:ACPower:OFFSet[:OUTer]:LIST:LIMit:NEGative[:UPPer]:DATA?
Example	CALC:ACP:OFFS:LIST:LIM:NEG:DATA 0, 0, 0, 0, 0, 0 CALC:ACP:OFFS:LIST:LIM:NEG:DATA?
Notes	SCPI only command
Preset	SA: -45, -60, 0, 0, 0, 0 -45, -60, 0, 0, 0, 0 WCDMA: -44.2, -49.2, -49.2, -49.2, -49.2, -49.2 -32.2, -42.2, -42.2, -42.2, -42.2, -42.2

	C2K: 0, 0, 0, 0, 0, 0 0, 0, 0, 0, 0, 0 WIMAX OFDMA: -50, -60, 0, 0, 0, 0 TD-SCDMA: -40, -45, -45, -45, -45, -45 -33, -43, -43, -43, -43, -43 1xEVDO: -45, -55, -55, -55, -55, -55 -45, -55, -55, -55, -55, -55 DVB-T/H: -60, -60, 0, 0, 0, 0 -60, -60, 0, 0, 0, 0 DTMB (CTTB): -45, -60, -60, -60, 0, 0 -45, -60, -60, -60, 0, 0 Digital Cable TV: -58, -62, -65, -73, -73, -73 -58, -62, -65, -73, -73, -73 LTE, LTETDD, MSR, LTEAFDD, LTEATDD: -44.2, -44.2, -44.2, -44.2, -44.2, -44.2 -29.2, -29.2, -29.2, -29.2, -29.2, -29.2
State Saved	Saved in instrument state.
Min	-150.0
Max	50.0
Backwards Compatibility SCPI	:CALCulate:MCPower:OFFSet:LIST:LIMit:NEGative[:UPPer]:DATA (PSA Power Suite)
Initial S/W Revision	A.04.00
Modified at S/W Revision	A.13.00

Rel Limit (PSD)

Enters a relative limit value for the level of the power spectral density. This sets the amplitude levels to test against for any custom offsets. The amplitude level is relative to the power spectral density. If multiple offsets are available, the list contains six (6) entries. The offset closest to the carrier channel is the first one in the list.

[[:SENSe]:ACP:OFFSet[n]::OUTer]:LIST:TEST selects the type of testing to be done at each offset.

You can turn off (not use) specific offsets with the [[:SENSe]:ACP:OFFSet[n]::OUTer]:LIST:STATe command.

The query returns the six (6) sets of real numbers that are the current amplitude test limits, relative to the power spectral density, for each offset.

Offset[n] n = 1 is base station and n = 2 is mobiles. The default is base station (1).

Key Path	Meas Setup, Offset/Limits, Limits
Mode	SA, WCDMA, C2K, WIMAX OFDMA, TD-SCDMA, 1xEVDO, DVB-T/H, DTMB (CTTB), ISDB-T, CMMB, LTE, LTETDD, Digital Cable TV, MSR, LTEAFDD, LTEATDD
Remote Command	[[:SENSe]:ACP:OFFSet[1] 2[:OUTer]:LIST:RPSDensity <rel_ampl>, <rel_ampl>, <rel_ampl>, <rel_ampl>, <rel_ampl>, <rel_ampl> [:SENSe]:ACP:OFFSet[1] 2[:OUTer]:LIST:RPSDensity?
Example	ACP:OFFS2:LIST:RPSD 10,10,10,10,10,10 ACP:OFFS2:LIST:RPSD?
Notes	Offset sub op code. 1 for BTS, 2 for MS. Default is BTS. Note that Offset sub op code 2 is supported only in Non-SA modes. In the SA mode, Offset sub op code 1 is used for both BTS and MS.

	You must be in the mode that includes ACP measurements to use this command. Use :INSTRument:SElect to set the mode.
Preset	SA: -28.87 dB, -43.87 dB, 0 dB, 0 dB, 0 dB -28.87 dB, -43.87 dB, 0 dB, 0 dB, 0 dB WCDMA: -44.2 dB, -49.2 dB, -49.2 dB, -49.2 dB, -49.2 dB, -49.2 dB -32.2 dB, -42.2 dB, -42.2 dB, -42.2 dB, -42.2 dB C2K: 0 dB, 0 dB, 0 dB, 0 dB, 0 dB, 0 dB 0 dB, 0 dB, 0 dB, 0 dB, 0 dB, 0 dB WIMAX OFDMA: -25, -35, 0, 0, 0, 0 TD-SCDMA: -40 dB, -45 dB, -45 dB, -45 dB, -45 dB, -45 dB -33 dB, -43 dB, -43 dB, -43 dB, -43 dB, -43 dB 1xEVDO: -45, -55, -55, -55, -55, -55 -45, -55, -55, -55, -55, -55 DVB-T/H: -60 dB, -60 dB, 0 dB, 0 dB, 0 dB, 0 dB -60 dB, -60 dB, 0 dB, 0 dB, 0 dB, 0 dB DTMB (CTTB): 50 dB, 50 dB, 50 dB, 50 dB, 50 dB, 50 dB 50 dB, 50 dB, 50 dB, 50 dB, 50 dB, 50 dB ISDB-T: -60 dB, -60 dB, 0 dB, 0 dB, 0 dB, 0 dB -60 dB, -60 dB, 0 dB, 0 dB, 0 dB, 0 dB CMMB: 50 dB, 50 dB, 50 dB, 50 dB, 50 dB, 50 dB 50 dB, 50 dB, 50 dB, 50 dB, 50 dB, 50 dB LTE, LTEFDD, MSR, LTEAFDD, LTEATDD: 0, 0, 0, 0, 0, 0 0, 0, 0, 0, 0, 0 Digital Cable TV: 50 dB, 50 dB, 50 dB, 50 dB, 50 dB, 50 dB 50 dB, 50 dB, 50 dB, 50 dB, 50 dB, 50 dB
State Saved	Saved in instrument state.
Min	-150.0 dB
Max	50.0 dB
Initial S/W Revision	Prior to A.02.00
Modified at S/W Revision	A.02.00, A.03.00, A.13.00

Fail Mask

Accesses a menu that enables you to select one of the logic keys for the fail conditions between the measurement results and the test limits. The setting defines the type of testing to be done at any custom offset frequencies. The measured powers are tested against the absolute values defined with [:SENSe]:ACP:OFFSet[n][:OUTer]:LIST:ABSolute, or the relative values defined with [:SENSe]:ACP:OFFSet[n][:OUTer]:LIST:RPSDensity and [:SENSe]:ACP:OFFSet[n][:OUTer]:LIST:RCARrier.

You can turn off (not use) specific offsets with the [:SENSe]:ACP:OFFSet[n][:OUTer]:LIST:STATe command.

- Absolute – Fail is shown if one of the absolute ACP measurement results is larger than the limit for Abs Limit.
- Relative – Fail is shown if one of the relative ACP measurement results is larger than the limit for Rel Lim (Car) or Rel Lim (PSD).
- Abs AND Rel – Fail is shown if one of the absolute ACP measurement results is larger than the limit for Abs Limit AND one of the relative ACP measurement results is larger than the limit for Rel Lim (Car) or Rel Lim (PSD).
- Abs OR Rel – Fail is shown if one of the absolute ACP measurement results is larger than the limit for Abs Limit OR one of the relative ACP measurement results is larger than the limit for Rel Lim (Car) or Rel Lim (PSD).

Key Path	Meas Setup, Offset/Limits, Limits
Mode	SA, WCDMA, C2K, WIMAX OFDMA, TD-SCDMA, 1xEVDO, DVB-T/H, DTMB (CTTB), ISDB-T, CMMB, LTE, LTETDD, Digital Cable TV, MSR, LTEAFDD, LTEATDD
Remote Command	[:SENSe]:ACPower:OFFSet[1] 2[:OUTer]:LIST:TEST ABSolute AND OR RELative, ABSolute AND OR RELative, ABSolute AND OR RELative, ABSolute AND OR RELative [:SENSe]:ACPower:OFFSet[1] 2[:OUTer]:LIST:TEST?
Example	ACP:OFFS2:LIST:TEST ABS, ABS, ABS, ABS, ABS, ABS ACP:OFFS2:LIST:TEST?
Notes	Offset sub op code. 1 for BTS, 2 for MS. Default is BTS. Note that Offset sub op code 2 is supported only in Non-SA modes. In the SA mode, Offset sub op code 1 is used for both BTS and MS. You must be in the mode that includes ACP measurements to use this command. Use :INSTrument:SElect to set the mode.
Couplings	None If current mode is DTMB (CTTB) or CMMB and current device type is Transmitter, the value from position 2 to position 4 are coupled, changing any one will change the others.
Preset	SA, WCDMA, C2K, TD-SCDMA: REL, REL, REL, REL, REL, REL REL, REL, REL, REL, REL, REL WIMAX OFDMA: REL, REL, REL, REL, REL, REL DVB-T/H: REL, REL, REL, REL, REL, REL DTMB (CTTB): OR,AND, AND,AND, REL, REL CDMA1xEVDO: REL, REL, ABS, REL, REL, REL REL, REL, ABS, REL, REL, REL ISDB-T : REL, REL, REL, REL, REL, REL CMMB : OR,AND, AND,AND, REL, REL LTE, LTETDD, MSR, LTEAFDD, LTEATDD: AND, AND, AND, AND, AND, AND AND, AND, AND, AND, AND, AND Digital Cable TV: REL, REL, REL, REL, REL, REL
State Saved	Saved in instrument state.
Range	Absolute Relative Abs AND Rel (fail if both fail) Abs OR Rel (fail if either fails)
Backwards Compatibility SCPI	[:SENSe]:MCPower:OFFSet[1] 2:LIST:TEST
Initial S/W Revision	Prior to A.02.00
Modified at S/W Revision	A.02.00, A.03.00, A.04.00, A13.00

Offset Side

Enables you to turn off (not use) specific offsets with [:SENSe]:ACPower:OFFSet[1]|2[:Outer]:LIST:SIDE.

- NEGative - Negative (lower) sideband only
- BOTH - Both of the negative (lower) and positive (upper) sidebands
- POSitive - Positive (upper) sideband only

The figure below shows the relation between the negative/positive offset side setups and the upper/lower results in the MSR and LTE-Advanced FDD/TDD.

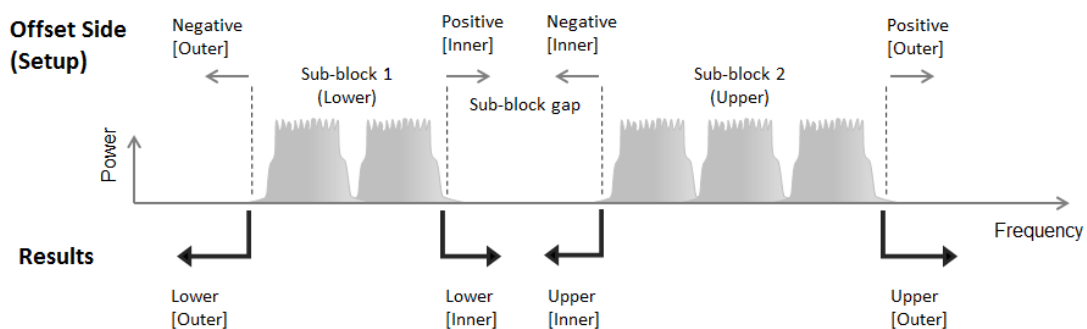

Key Path	Meas Setup, Offset/Limits
Mode	SA, WCDMA, C2K, WIMAX OFDMA, TD-SCDMA, 1xEVDO, DTMB (CTTB), DVB-T/H, LTE, LTETDD, Digital Cable TV, MSR, LTEAFDD, LTEATDD
Remote Command	<code>[[:SENSe]:ACPower:OFFSet[1] 2[:OUTer]:LIST:SIDE NEGative BOTH POSitive,NEGative BOTH POSitive,NEGative BOTH POSitive,NEGative BOTH POSitive,NEGative BOTH POSitive,NEGative BOTH POSitive</code> <code>[[:SENSe]:ACPower:OFFSet[1] 2[:OUTer]:LIST:SIDE?</code>
Example	ACP:OFFS:LIST:SIDE BOTH ACP:OFFS:LIST:SIDE?
Notes	OFFSet1 is for BTS, 2 for MS. Default is BTS. You must be in the Spectrum Analysis mode, W-CDMA mode, cdma2000 mode, TD-SCDMA mode, DTMB (CTTB) mode, DVB-T/H mode, ISDB-T mode, CMMB mode, Digital Cable TV mode, 1xEVDO mode, WIMAX OFDMA mode, LTE mode, LTETDD, LTEAFDD, LTEATDD or MSR mode to use this command. Use :INSTrument:SElect to set the mode. If you set POS or NEG in an offset, result of the inactive side will return -999.
Preset	BOTH, BOTH, BOTH, BOTH, BOTH, BOTH BOTH, BOTH, BOTH, BOTH, BOTH, BOTH
State Saved	Saved in instrument state.
Range	Neg Both Pos
Initial S/W Revision	A.03.00
Modified at S/W Revision	A.13.00

Method for Offset

This key allows you to turn RRC filtering of each offset on or off. The value (roll off) for the filter will be set to the value of the Filter Alpha parameter.

Key Path	Meas Setup, Offset/Limits
Mode	SA, WCDMA, WIMAX OFDMA, TD-SCDMA, DVB-T/H, DTMB (CTTB), ISDB-T, CMMB, LTE, LTETDD, Digital Cable TV, MSR, LTEAFDD, LTEATDD
Remote Command	<code>[[:SENSe]:ACPower:OFFSet[1] 2[:OUTer]:LIST:FILTer[:RRC][:STATe] ON OFF</code> <code> 1 0, ON OFF 1 0, ON OFF 1 0, ON OFF 1 0, ON OFF</code>

	1 0, ON OFF 1 0 [:SENSe]:ACPpower:OFFSet [1] 2 [:OUTer]:LIST:FILTer[:RRC] [:STATe] ?
Example	ACP:OFFS:LIST:FILT 1,0,0 ACP:OFFS:LIST:FILT?
Notes	1 ON = RRC Weighted, 0 OFF = Integ BW This parameter is not available for cdma2000 and 1xEVDO. You must be in the mode that includes ACP measurements to use this command. Use :INSTrument:SElect to set the mode.
Preset	SA: 0, 0, 0, 0, 0, 0 0, 0, 0, 0, 0, 0 WCDMA:1, 1, 1, 1, 1, 1 1, 1, 1, 1, 1, 1 C2K: NO WIMAX OFDMA: 0, 0, 0, 0, 0, 0 0, 0, 0, 0, 0, 0 TD-SCDMA: 1, 1, 1, 1, 1, 1 1, 1, 1, 1, 1, 1 DVB-T/H: 0, 0, 0, 0, 0, 0 0, 0, 0, 0, 0, 0 DTMB (CTTB): 1, 1, 1, 1, 1, 1 1, 1, 1, 1, 1, 1 ISDB-T: 0, 0, 0, 0, 0, 0 0, 0, 0, 0, 0, 0 CMMB: 1, 1, 1, 1, 1, 1 1, 1, 1, 1, 1, 1 LTE: 0, 0, 0, 0, 0, 0 0, 0, 0, 0, 0, 0 LTETDD: 0, 0, 0, 0, 0, 0 0, 0, 0, 0, 0, 0 Digital Cable TV: 0, 0, 0, 0, 0, 0 0, 0, 0, 0, 0, 0 MSR, LTEAFDD, LTEATDD: 0, 0, 0, 0, 0, 0 0, 0, 0, 0, 0, 0
State Saved	Saved in instrument state.
Range	Integ BW RRC Weighted
Initial S/W Revision	A.03.00
Modified at S/W Revision	A.13.00

Method for Offset

This key allows you to turn RRC filtering of each offset on or off. The value (roll off) for the filter will be set to the value of the Filter Alpha parameter.

Key Path	Meas Setup, Offset/Limits
Mode	SA, WCDMA, WIMAX OFDMA, TD-SCDMA, DVB-T/H, DTMB (CTTB), ISDB-T, CMMB, LTE, LTETDD, Digital Cable TV, MSR, LTEAFDD, LTEATDD
Remote Command	[:SENSe]:ACPpower:OFFSet [1] 2 [:OUTer]:LIST:FILTer[:RRC] [:STATe] ON OFF 1 0, ON OFF 1 0, ON OFF 1 0, ON OFF 1 0, ON OFF 1 0, ON OFF 1 0 [:SENSe]:ACPpower:OFFSet [1] 2 [:OUTer]:LIST:FILTer[:RRC] [:STATe] ?
Example	ACP:OFFS:LIST:FILT 1,0,0 ACP:OFFS:LIST:FILT?
Notes	1 ON = RRC Weighted, 0 OFF = Integ BW

	This parameter is not available for cdma2000 and 1xEVDO. You must be in the mode that includes ACP measurements to use this command. Use :INSTrument:SElect to set the mode.
Preset	SA: 0, 0, 0, 0, 0, 0 0, 0, 0, 0, 0, 0 WCDMA:1, 1, 1, 1, 1, 1 1, 1, 1, 1, 1, 1 C2K: NO WIMAX OFDMA: 0, 0, 0, 0, 0, 0 0, 0, 0, 0, 0, 0 TD-SCDMA: 1, 1, 1, 1, 1, 1 1, 1, 1, 1, 1, 1 DVB-T/H: 0, 0, 0, 0, 0, 0 0, 0, 0, 0, 0, 0 DTMB (CTTB): 1, 1, 1, 1, 1, 1 1, 1, 1, 1, 1, 1 ISDB-T: 0, 0, 0, 0, 0, 0 0, 0, 0, 0, 0, 0 CMMB: 1, 1, 1, 1, 1, 1 1, 1, 1, 1, 1, 1 LTE: 0, 0, 0, 0, 0, 0 0, 0, 0, 0, 0, 0 LTETDD: 0, 0, 0, 0, 0, 0 0, 0, 0, 0, 0, 0 Digital Cable TV: 0, 0, 0, 0, 0, 0 0, 0, 0, 0, 0, 0 MSR, LTEAFDD, LTEATDD: 0, 0, 0, 0, 0, 0 0, 0, 0, 0, 0, 0
State Saved	Saved in instrument state.
Range	Integ BW RRC Weighted
Initial S/W Revision	A.03.00
Modified at S/W Revision	A.13.00

Filter Alpha for Offset

Sets the alpha value for the RRC Filter for each offset.

Key Path	Meas Setup, Offset/Limits, Method, RRC Weighted
Mode	SA, WCDMA, WIMAX OFDMA, TD-SCDMA, DVB-T/H, DTMB (CTTB), ISDB-T, CMMB, LTE, LTETDD, Digital Cable TV, MSR, LTEAFDD, LTEATDD
Remote Command	[:SENSe] :ACPoweR:OFFSet [1] 2[:OUTer]:LIST:FILTer:ALPHa <real>, <real>, <real>, <real>, <real> [:SENSe] :ACPoweR:OFFSet [1] 2[:OUTer]:LIST:FILTer:ALPHa?
Example	ACP:OFFS:LIST:FILT:ALPH 0.5, 0.5, 0.5, 0.5, 0.5, 0.5 ACP:OFFS:LIST:FILT:ALPH?
Notes	This parameter is not available for cdma2000 and 1xEVDO. You must be in the mode that includes ACP measurements to use this command. Use :INSTrument:SElect to set the mode.
Preset	SA: 0.22, 0.22, 0.22, 0.22, 0.22, 0.22 0.22, 0.22, 0.22, 0.22, 0.22, 0.22 WCDMA: 0.22, 0.22, 0.22, 0.22, 0.22, 0.22 0.22, 0.22, 0.22, 0.22, 0.22, 0.22 WIMAX OFDMA: 0.22, 0.22, 0.22, 0.22, 0.22, 0.22 0.22, 0.22, 0.22, 0.22, 0.22, 0.22 C2K: NO TD-SCDMA: 0.22, 0.22, 0.22, 0.22, 0.22, 0.22 0.22, 0.22, 0.22, 0.22, 0.22, 0.22

	DVB-T/H: 0.22, 0.22, 0.22, 0.22, 0.22, 0.22 0.22, 0.22, 0.22, 0.22, 0.22, 0.22 DTMB (CTTB): 0.05, 0.05, 0.05, 0.05, 0.05, 0.05 0.05, 0.05, 0.05, 0.05, 0.05, 0.05 ISDB-T : 0.22, 0.22, 0.22, 0.22, 0.22, 0.22 0.22, 0.22, 0.22, 0.22, 0.22, 0.22 CMMB : 0.22, 0.22, 0.22, 0.22, 0.22, 0.22 0.22, 0.22, 0.22, 0.22, 0.22, 0.22 LTE: 0.22, 0.22, 0.22, 0.22, 0.22, 0.22 0.22, 0.22, 0.22, 0.22, 0.22, 0.22 LTETDD: 0.22, 0.22, 0.22, 0.22, 0.22, 0.22 0.22, 0.22, 0.22, 0.22, 0.22, 0.22 Digital Cable TV: 0.15, 0.15, 0.15, 0.15, 0.15, 0.15 0.15, 0.15, 0.15, 0.15, 0.15, 0.15 MSR, LTEAFDD, LTEATDD: 0.22, 0.22, 0.22, 0.22, 0.22, 0.22 0.22, 0.22, 0.22, 0.22, 0.22, 0.22
State Saved	Saved in instrument state.
Min	0.01
Max	1.00
Initial S/W Revision	A.03.00
Modified at S/W Revision	A.13.00

Offset Frequency Define

This key allows you to select “Offset” definition. Each standard defines each “Offset” from Carrier.

3GPP2 requires the “From Carrier Center to MeasBW Closer Edge” definition. LTE conformance test requires “From Carrier Edge to MeasBW Center” and/or “From Carrier Edge to MeasBW Closer Edge” definition.

- CTOCenter – From the center of the carrier closest to the adjacent channel to the center of the adjacent channel Offset Integ BW
- CTOEdge - From the center of the carrier closest to the adjacent channel to the edge of the closest adjacent channel Offset Integ BW
- ETOCenter – From Center Frequency - Carrier Spacing / 2 (for lower offset), Center Frequency + Carrier Spacing / 2 (for upper offset) of the carrier closest to the adjacent channel's to the center of the adjacent channel Offset Integ BW
- ETOEdge - From Center Frequency - Carrier Spacing / 2 (for lower offset), Center Frequency + Carrier Spacing / 2 (for upper offset) of the carrier closest to the adjacent channel's to the edge of the closest adjacent channel Offset Integ BW

Key Path	Meas Setup, Offset/Limits
Mode	SA, WCDMA, C2K, WIMAX OFDMA, TD-SCDMA, 1xEVDO, DVB-T/H, DTMB (CTTB), ISDB-T, CMMB, LTE, LTETDD, Digital Cable TV, MSR,LTEAFDD,LTEATDD
Remote Command	[:SENSe]:ACPower:OFFSet [1] 2[:OUTer]:TYPE CTOCenter CTOEdge ETOCenter ETOEdge [:SENSe]:ACPower:OFFSet [1] 2[:OUTer]:TYPE?
Example	ACP:OFFS:TYPE ETOC ACP:OFFS:TYPE?
Notes	You must be in the mode that includes ACP measurements to use this command. Use

	:INSTRUMENT:SElect to set the mode.
Preset	All Except C2K and 1xEVDO: CTOCenter C2K and 1xEVDO: CTOEdge
State Saved	Saved in instrument state.
Range	Carrier Center To Meas BW Center Carrier Center To Meas BW Edge Carrier Edge To Meas BW Center Carrier Edge To Meas BW Edge
Initial S/W Revision	A.03.00
Modified at S/W Revision	A.13.00

Inner Offset/Limits

Accesses a menu of functions that contains Offset, Offset Freq/Offset To Edge, Offset Integ BW, Upper Offset Limit and Lower Offset parameters.

Key Path	Meas Setup
Initial S/W Revision	A.13.00

Select Inner Offset

Selects the Inner Offset to configure.

Key Path	Meas Setup, Inner Offset/Limits
Mode	MSR,LTEAFDD,LTEATDD
Preset	A
State Saved	Saved in instrument state.
Range	Offset A Offset B Offset C Offset D Offset E Offset F
Initial S/W Revision	A.13.00

Offset Freq

This parameter determines the frequency difference between the center of the main channel and the center of the carrier. When set to Offset to Edge, this parameter determines the frequency difference between the center of the main channel and the near edge of the offset

Each Offset Freq state value is entered individually by selecting the desired carrier on the carrier menu key using the up down arrows, RPG or numeric keypad. Then enter the Offset Freq State using the Offset Frequency softkey.

The list contains up to six (6) entries, depending on the mode selected, for offset frequencies. Each offset frequency in the list corresponds to a reference bandwidth in the bandwidth list.

An offset frequency of zero turns the display of the measurement for that offset off, but the measurement is still made and reported. You can turn off (not use) specific offsets with the [:SENSE]:ACP:OFFSet [n]:INNER:LIST:STATE command.

Turning the offset off has the same effect as setting the frequency of the offset to 0 Hz and will cause it to be removed from the results screen.

Key Path	Meas Setup, Inner Offset/Limits
Mode	MSR, LTEAFDD,LTEATDD
Remote Command	<pre>[:SENSE]:ACPower:OFFSet [1] 2:INNER:LIST[:FREQUENCY] <freq>, <freq>, <freq>, <freq>, <freq>, <freq> [:SENSE]:ACPower:OFFSet [1] 2:INNER:LIST[:FREQUENCY]? [:SENSE]:ACPower:OFFSet [1] 2:INNER:LIST:STATE OFF ON 0 1, OFF ON 0 1, OFF ON 0 1, OFF ON 0 1, OFF ON 0 1, OFF ON 0 1 [:SENSE]:ACPower:OFFSet [1] 2:INNER:LIST:STATE?</pre>
Example	<pre>ACP:OFFS1:INN:LIST 0,0,0,0,0 ACP:OFFS1:INN:LIST? ACP:OFFS2:INN:LIST:STAT 1,1,0,0,0 ACP:OFFS2:INN:LIST:STAT?</pre>
Notes	<p>When setting these values remotely, the position in the list sent corresponds to the offset. Missing values are not permitted, unless the number of values sent is greater than the number of carriers, then subsequent values will be ignored.</p> <p>Offset sub op code. 1 for BTS, 2 for MS. Default is BTS.</p> <p>You must be in the MSR and LTE-Advanced FDD/TDD mode to use this command. Use :INSTrument:SElect to set the mode.</p>
Couplings	Changing Offset Frequency might affect the Span. See the Span key section for details.
Preset	2.5MHz, 7.5MHz, 0, 0, 0, 0 2.5MHz, 7.5MHz, 0, 0, 0, 0 ON, ON, OFF, OFF, OFF, OFF ON, OFF, OFF, OFF, OFF, OFF
State Saved	Saved in instrument state.
Min	0 Hz
Max	Depends on instrument maximum frequency. Same as the Max Span of Swept SA Measurement.
Initial S/W Revision	A.13.00
Modified at S/W Revision	A.16.00

Integ BW

Sets the Integration Bandwidth for the offsets. Each resolution bandwidth in the list corresponds to an offset frequency in the list defined by [:SENSE]:ACP:OFFSet[n]:INNER:LIST[:FREQUENCY].

Enter each value individually by selecting the desired offset on the offset menu key using the up down arrows, the knob, or the numeric keypad, then enter the Offset Integration Bandwidth using the Offset Integration Bandwidth menu key.

You can turn off (not use) specific offsets with the [:SENSE]:ACP:OFFSet[n]:INNER:LIST:STATE command.

Key Path	Meas Setup, Inner Offset/Limits
Mode	MSR, LTEAFDD,LTEATDD
Remote Command	<code>[:SENSe]:ACPower:OFFSet [1] 2:INNeR:LIST:BANDwidth[:INTEgration] <freq>, <freq>, <freq>, <freq>, <freq></code> <code>[:SENSe]:ACPower:OFFSet [1] 2:INNeR:LIST:BANDwidth[:INTEgration]?</code>
Example	ACP:OFFS2:INN:LIST:BAND 2MHz, 2MHz, 2MHz, 2MHz, 2MHz, 2MHz ACP:OFFS2:INN:LIST:BAND?
Notes	When setting these values remotely, the position in the list sent corresponds to the offset. Missing values are not permitted i.e. if you want to change the second value you must send all values up to it. Subsequent values will remain unchanged. Offset sub op code. 1 for BTS, 2 for MS. Default is BTS. You must be in the MSR and LTE-Advanced FDD/TDD mode to use this command. Use :INSTrument:SElect to set the mode.
Couplings	Changing Integ BW might affect the Span. See Span section for details.
Preset	LTEAFDD:3.84MHz, 3.84MHz, 3.84MHz, 3.84MHz, 3.84MHz, 3.84MHz 3.84MHz, 3.84MHz, 3.84MHz, 3.84MHz MSR, LTEATDD: 4.515MHz, 4.515MHz, 4.515MHz, 4.515MHz, 4.515MHz, 4.515MHz 4.5MHz, 4.5MHz, 4.5MHz, 4.5MHz, 4.5MHz
State Saved	Saved in instrument state.
Min	10 Hz
Max	Depends on instrument maximum frequency. Same as the Max Span on Swept SA Measurement.
Initial S/W Revision	A.13.00, A.16.00

Offset BW

Accesses the offset bandwidth menu.

Key Path	Meas Setup, Inner Offset/Limits
Initial S/W Revision	A.13.00

Res BW

Sets the resolution bandwidth. If an unavailable bandwidth is entered with the numeric keypad, the closest available bandwidth is selected.

Key Path	Meas Setup, Inner Offset/Limits
Mode	MSR, LTEAFDD,LTEATDD
Remote Command	<code>[:SENSe]:ACPower:OFFSet [1] 2:INNeR:LIST:BANDwidth:RESolution <freq>, <freq>, <freq>, <freq>, <freq></code> <code>[:SENSe]:ACPower:OFFSet [1] 2:INNeR:LIST:BANDwidth:RESolution?</code>

	<pre>[:SENSe] :ACPower:OFFSet [1] 2:INNeR:LIST:BAWdwidth:RESolution:AUTO ON OFF 1 0, ON OFF 1 0, ON OFF 1 0, ON OFF 1 0, ON OFF 1 0, ON OFF 1 0 [:SENSe] :ACPower:OFFSet [1] 2:INNeR:LIST:BAWdwidth:RESolution:AUTO?</pre>
Example	<pre>ACP:OFFS2:INN:LIST:BAWd:RES 220kHz, 220kHz, 220kHz, 220kHz, 220kHz, 220kHz ACP:OFFS2:INN:LIST:BAWd:RES? ACP:OFFS2:INN:LIST:BAWd:RES:AUTO 1, 1, 1, 1, 1, 1 ACP:OFFS2:INN:LIST:BAWd:RES:AUTO?</pre>
Notes	<p>Offset sub op code. 1 for BTS, 2 for MS. Default is BTS.</p> <p>You must be in the MSR and LTE-Advanced FDD/TDD mode to use this command. Use :INSTrument:SElect to set the mode.</p>
Dependencies	<p>When Meas Method is RBW, FAST or Fast Power, this key is grayed out and disabled. If the key is pressed, an advisory message is generated. If the equivalent remote command is sent, a "Setting conflict" warning is generated.</p>
Couplings	<p>When Res BW Mode is AUTO, this value is exactly the same as Res BW under the BW key. When this value is changed by the user, Res BW Mode is also changed to Man.</p>
Preset	<pre>100 kHz, 100 kHz, 100 kHz, 100 kHz, 100kHz, 100 kHz 100 kHz, 100 kHz, 100 kHz, 100 kHz, 100 kHz, 100 kHz 1, 1, 1, 1, 1, 1</pre>
State Saved	<p>Saved in instrument state.</p>
Min	<p>1 Hz</p>
Max	<p>8 MHz</p>
Initial S/W Revision	<p>A.13.00</p>

Video BW

Enables you to change the analyzer post-detection filter (VBW).

Key Path	<p>Meas Setup, Inner Offset/Limits, Offset BW</p>
Mode	<p>MSR, LTEAFDD,LTEATDD</p>
Remote Command	<pre>[:SENSe] :ACPower:OFFSet [1] 2:INNeR:LIST:BAWdwidth:VIDeo <freq>, <freq>, <freq>, <freq>, <freq>, <freq> [:SENSe] :ACPower:OFFSet [1] 2:INNeR:LIST:BAWdwidth:VIDeo? [:SENSe] :ACPower:OFFSet [1] 2:INNeR:LIST:BAWdwidth:VIDeo:AUTO OFF ON 0 1, OFF ON 0 1, OFF ON 0 1, OFF ON 0 1, OFF ON 0 1, OFF ON 0 1 [:SENSe] :ACPower:OFFSet [1] 2:INNeR:LIST:BAWdwidth:VIDeo:AUTO?</pre>
Example	<pre>ACP:OFFS2:INN:LIST:BAWd:VID 5MHz, 5MHz, 5MHz, 5MHz, 5MHz, 5MHz ACP:OFFS2:INN:LIST:BAWd:VID? ACP:OFFS2:INN:LIST:BAWd:VID:AUTO 0, 0, 0, 0, 1, 1 ACP:OFFS2:INN:LIST:BAWd:VID:AUTO?</pre>

Notes	The values shown in this table reflect the conditions after a Mode Preset. Offset sub op code. 1 for BTS, 2 for MS. Default is BTS. You must be in the MSR and LTE-Advanced FDD/TDD mode to use this command. Use :INSTrument:SElect to set the mode.
Dependencies	When Meas Method is RBW, FAST or Fast Power, this key is grayed out and disabled. If the key is pressed, an advisory message is generated. If the equivalent remote command is sent, a "Setting conflict" warning is generated..
Preset	1 MHz,1 MHz,1 MHz,1 MHz,1 MHz,1 MHz ON, ON, ON, ON, ON, ON
State Saved	Saved in instrument state.
Min	1 Hz
Max	50 MHz
Initial S/W Revision	A.13.00

RBW Control

Accesses the resolution bandwidth control menu.

Key Path	Meas Setup, Inner Offset/Limits, Offset BW
Initial S/W Revision	A.13.00

Filter Type

Selects the type of bandwidth filter that is used.

Key Path	Meas Setup, Inner Offset/Limits, Offset BW, RBW Control
Mode	MSR, LTEAFDD,LTEATDD
Remote Command	<code>[:SENSe] :ACPower:OFFSet [1] 2:INNeR:LIST:BAWdwidth:SHApe GAUSSian FLATtop, GAUSSian FLATtop, GAUSSian FLATtop, GAUSSian FLATtop, GAUSSian FLATtop, GAUSSian FLATtop</code> <code>[:SENSe] :ACPower:OFFSet [1] 2:INNeR:LIST:BAWdwidth:SHApe?</code>
Example	ACP:OFFS2:INN:LIST:BAND:SHAP FLAT, GAUS, GAUS, GAUS, GAUS, GAUS ACP:OFFS2:INN:LIST:BAND:SHAP?
Notes	Offset sub op code. 1 for BTS, 2 for MS. Default is BTS. You must be in the MSR and LTE-Advanced FDD/TDD mode to use this command. Use :INSTrument:SElect to set the mode.
Dependencies	When Res BW Mode for the offset is Auto, this key is grayed out and disabled. Since Res BW Mode for the offset is preset to Auto on changing Meas Method to RBW, FAST or Fast Power, this key is grayed out and disabled. If the key is pressed, an advisory message is generated. If the equivalent remote command is sent, a "Setting conflict" warning is generated.
Preset	GAUSSian, GAUSSian, GAUSSian, GAUSSian, GAUSSian, GAUSSian

State Saved	Saved in instrument state.
Range	GAUSSian FLATtop
Initial S/W Revision	A.13.00

Filter BW

Selects a Gaussian filter based on its -3 dB (Normal) bandwidth or its -6 dB bandwidth.

Key Path	Meas Setup, Inner Offset/Limits, Offset BW, RBW Control
Mode	MSR, LTEAFDD,LTEATDD
Remote Command	[[:SENSE]:ACPower:OFFSet[1] 2:INNER:LIST:BANDwidth:TYPE DB3 DB6, DB3 DB6, DB3 DB6, DB3 DB6, DB3 DB6, DB3 DB6 [:SENSE]:ACPower:OFFSet[1] 2:INNER:LIST:BANDwidth:TYPE?
Example	ACP:OFFS2:INN:LIST:BAND:TYPE DB3, DB3, DB3, DB3, DB3, DB3 ACP:OFFS2:INN:LIST:BAND:TYPE?
Notes	Offset sub op code. 1 for BTS, 2 for MS. Default is BTS. You must be in the MSR and LTE-Advanced FDD/TDD mode to use this command. Use :INSTRUMENT:SElect to set the mode.
Dependencies	When Filter Type if Flattop or Res BW Mode for the offset is Auto, this key is grayed out and disabled. Since Res BW Mode for the offset is preset to Auto on changing Meas Method to RBW, FAST, or Fast Power, this key is grayed out and disabled too. If the key is pressed, an advisory message is generated. If the equivalent remote command is sent, a "Setting conflict" warning is generated.
Preset	DB3, DB3, DB3, DB3, DB3, DB3
State Saved	Saved in instrument state.
Range	-3 dB (Normal) -6 dB
Initial S/W Revision	A.13.00

Limits

Limits key accesses a menu of functions that contains Select Offset, Abs Limit, Rel Limit and Fail Mask parameters.

Key Path	Meas Setup, Inner Offset/Limits
Initial S/W Revision	A.13.00

Select Inner Offset

Selects the Inner Offset to configure.

Key Path	Meas Setup, Inner Offset/Limits
----------	--

Mode	MSR,LTEAFDD,LTEATDD
Preset	A
State Saved	Saved in instrument state.
Range	Offset A Offset B Offset C Offset D Offset E Offset F
Initial S/W Revision	A.13.00

Abs Limit

Enters an absolute limit value, which sets the absolute amplitude levels to test against for each of the custom offsets. The list must contain six (6) entries. If there is more than one offset, the offset closest to the carrier channel is the first one in the list. [:SENSe]:ACP:OFFSet[n]:INNer:LIST:TEST selects the type of testing to be done at each offset.

You can turn off (not use) specific offsets with the [:SENSe]:ACP:OFFSet[n]:INNer:LIST:STATe command.

The query returns the six (6) sets of real numbers that are the current absolute amplitude test limits.

Key Path	Meas Setup, Inner Offset/Limits, Limits
Mode	MSR, LTEAFDD,LTEATDD
Remote Command	[:SENSe]:ACP:Power:OFFSet[1] 2:INNer:LIST:ABSolute <real>, <real>, <real>, <real>, <real>, <real> [:SENSe]:ACP:Power:OFFSet[1] 2:INNer:LIST:ABSolute?
Example	ACP:OFFS2:INN:LIST:ABS -10, -10, -10, -10, -10, -10 ACP:OFFS2:INN:LIST:ABS?
Notes	Offset sub op code. 1 for BTS, 2 for MS. Default is BTS. You must be in the MSR and LTE-Advanced FDD/TDD mode to use this command. Use :INSTrument:SElect to set the mode.
Preset	-8.45, -8.45, -8.45, -8.45, -8.45, -8.45 -50.0, -50.0, -50.0, -50.0, -50.0, -50.0
State Saved	Saved in instrument state.
Min	-200.0 dBm
Max	50.0 dBm
Initial S/W Revision	A.13.00

Rel Limit (Car)

Enters a relative limit value for the carrier level. This sets the amplitude levels to test against for the specified offsets.

The amplitude level is relative to the carrier amplitude. If multiple offsets are available, the list contains six (6) entries. The offset closest to the carrier channel is the first one in the list. [:SENSe]:ACP:OFFSet[n]:INNer:LIST:TEST selects the type of testing to be done at each offset.

You can turn off (not use) specific offsets with the [:SENSe]:ACP:OFFSet[n]:INNer:LIST:STATe command.

The query returns the six (6) sets of real numbers that are the current amplitude test limits, relative to the carrier, for each offset.

Offset[n] n = 1 is base station and n = 2 is mobiles. The default is base station (1).

Key Path	Meas Setup, Inner Offset/Limits, Limits
Mode	MSR, LTEAFDD,LTEATDD
Remote Command	[:SENSe] :ACPower:OFFSet [1] 2:INNeR:LIST:RCARrier <real>, <real>, <real>, <real>, <real>, <real> [:SENSe] :ACPower:OFFSet [1] 2:INNeR:LIST:RCARrier?
Example	ACP:OFFS2:INN:LIST:RCAR 0,0,0,0,0,0 ACP:OFFS2:INN:LIST:RCAR?
Notes	Offset sub op code. 1 for BTS, 2 for MS. Default is BTS. You must be in the MSR and LTE-Advanced FDD/TDD mode to use this command. Use :INSTrument:SElect to set the mode.
Preset	-44.2, -44.2, -44.2, -44.2, -44.2, -44.2 -29.2, -29.2, -29.2, -29.2, -29.2, -29.2
State Saved	Saved in instrument state.
Min	-150
Max	50.0
Initial S/W Revision	A.13.00

Rel Limit (PSD)

Enters a relative limit value for the level of the power spectral density. This sets the amplitude levels to test against for any custom offsets. The amplitude level is relative to the power spectral density. If multiple offsets are available, the list contains six (6) entries. The offset closest to the carrier channel is the first one in the list.

[:SENSe] :ACP:OFFSet[n]:INNeR:LIST:TEST selects the type of testing to be done at each offset.

You can turn off (not use) specific offsets with the [:SENSe] :ACP:OFFSet[n]:INNeR:LIST:STATe command.

The query returns the six (6) sets of real numbers that are the current amplitude test limits, relative to the power spectral density, for each offset.

Offset[n] n = 1 is base station and n = 2 is mobiles. The default is base station (1).

Key Path	Meas Setup, Inner Offset/Limits, Limits
Mode	MSR
Remote Command	[:SENSe] :ACPower:OFFSet [1] 2:INNeR:LIST:RPSDensity <rel_ampl>, <rel_ampl>, <rel_ampl>, <rel_ampl>, <rel_ampl>, <rel_ampl> [:SENSe] :ACPower:OFFSet [1] 2:INNeR:LIST:RPSDensity?
Example	ACP:OFFS2:INN:LIST:RPSD 10, 10, 10, 10, 10, 10 ACP:OFFS2:INN:LIST:RPSD?
Notes	Offset sub op code. 1 for BTS, 2 for MS. Default is BTS.

	You must be in the MSR and LTE-Advanced FDD/TDD mode to use this command. Use :INSTRUMENT:SElect to set the mode.
Preset	0, 0, 0, 0, 0, 0 0, 0, 0, 0, 0, 0
State Saved	Saved in instrument state.
Min	-150.0 dB
Max	50.0 dB
Initial S/W Revision	A.13.00

Fail Mask

Accesses a menu that enables you to select one of the logic keys for the fail conditions between the measurement results and the test limits. The setting defines the type of testing to be done at any custom offset frequencies. The measured powers are tested against the absolute values defined with [:SENSe]:ACP:OFFSet[n]:INNeR:LIST:ABSolute, or the relative values defined with [:SENSe]:ACP:OFFSet[n]:INNeR:LIST:RPSDensity and [:SENSe]:ACP:OFFSet[n]:INNeR:LIST:RCARrier.

You can turn off (not use) specific offsets with the [:SENSe]:ACP:OFFSet[n]:INNeR:LIST:STATe command.

- Absolute – Fail is shown if one of the absolute ACP measurement results is larger than the limit for Abs Limit.
- Relative – Fail is shown if one of the relative ACP measurement results is larger than the limit for Rel Lim (Car) or Rel Lim (PSD).
- Abs AND Rel – Fail is shown if one of the absolute ACP measurement results is larger than the limit for Abs Limit AND one of the relative ACP measurement results is larger than the limit for Rel Lim (Car) or Rel Lim (PSD).
- Abs OR Rel – Fail is shown if one of the absolute ACP measurement results is larger than the limit for Abs Limit OR one of the relative ACP measurement results is larger than the limit for Rel Lim (Car) or Rel Lim (PSD).

Key Path	Meas Setup, Inner Offset/Limits, Limits
Mode	MSR
Remote Command	[:SENSe]:ACP:Power:OFFSet[1] 2:INNeR:LIST:TEST ABSolute AND OR RELative, ABSolute AND OR RELative, ABSolute AND OR RELative, ABSolute AND OR RELative, ABSolute AND OR RELative [:SENSe]:ACP:Power:OFFSet[1] 2:INNeR:LIST:TEST?
Example	ACP:OFFS2:INN:LIST:TEST ABS, ABS, ABS, ABS, ABS, ABS ACP:OFFS2:INN:LIST:TEST?
Notes	Offset sub op code. 1 for BTS, 2 for MS. Default is BTS. You must be in the MSR and LTE-Advanced FDD/TDD mode to use this command. Use :INSTRUMENT:SElect to set the mode.
Preset	AND, AND, AND, AND, AND, AND AND, AND, AND, AND, AND, AND

State Saved	Saved in instrument state.
Range	Absolute Relative Abs AND Rel (fail if both fail) Abs OR Rel (fail if either fails)
Initial S/W Revision	A.13.00

Offset Side

Enables you to turn off (not use) specific offsets with [:SENSE]:ACPpower:OFFSet[1]|2:INNeR:LIST:SIDE.

- NEGative – The upper side in the sub-block gap only (i.e. negative sideband of the upper sub-block) is enabled.
- BOTH – Both sides in the sub-block gap are enabled.
- POSitive – The lower side in the sub-block gap only (i.e. positive sideband of the lower sub-block) is enabled.

The figure below shows the relation between the negative/positive offset side setups and the upper/lower results in the MSR and LTE-Advanced FDD/TDD.

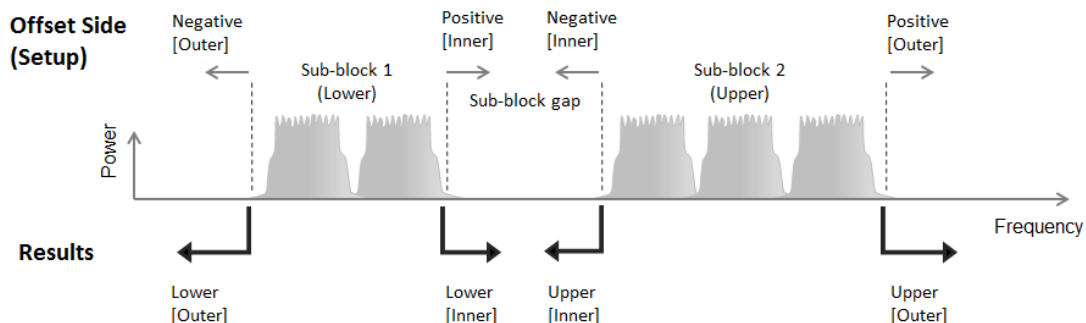

Key Path	Meas Setup, Inner Offset/Limits
Mode	MSR, LTEAFDD,LTEATDD
Remote Command	[:SENSE]:ACPpower:OFFSet[1] 2:INNeR:LIST:SIDE NEGative BOTH POSitive,NEGative BOTH POSitive,NEGative BOTH POSitive,NEGative BOTH POSitive,NEGative BOTH POSitive [:SENSE]:ACPpower:OFFSet[1] 2:INNeR:LIST:SIDE?
Example	ACP:OFFS:INN:LIST:SIDE BOTH ACP:OFFS:INN:LIST:SIDE?
Notes	OFFSet1 is for BTS, 2 for MS. Default is BTS. If you set POS or NEG in an offset, result of the inactive side will return -999. You must be in the MSR and LTE-Advanced FDD/TDD mode to use this command. Use :INSTrument:SElect to set the mode.
Preset	BOTH, BOTH, BOTH, BOTH, BOTH, BOTH BOTH, BOTH, BOTH, BOTH, BOTH, BOTH
State Saved	Saved in instrument state.
Range	Neg Both Pos
Initial S/W Revision	A.13.00

Method for Offset

Enables you to turn RRC filtering of each offset on or off. The value (roll off) for the filter will be set to the value of the Filter Alpha parameter.

Key Path	Meas Setup, Inner Offset/Limits
Mode	MSR, LTEAFDD,LTEATDD
Remote Command	[:SENSe]:ACPower:OFFSet [1] 2:INNeR:LIST:FILTer[:RRC] [:STATe] ON OFF 1 0, ON OFF 1 0, ON OFF 1 0, ON OFF 1 0, ON OFF 1 0, ON OFF 1 0 [:SENSe]:ACPower:OFFSet [1] 2:INNeR:LIST:FILTer[:RRC] [:STATe] ?
Example	ACP:OFFS:INN:LIST:FILT 1,0,0 ACP:OFFS:INN:LIST:FILT?
Notes	1 ON = RRC Weighted, 0 OFF = Integ BW You must be in the MSR and LTE-Advanced FDD/TDD mode to use this command. Use :INSTRument:SElect to set the mode.
Preset	LTEAFDD: 1,1,1,1,1,1 1,1,1,1,1,1 MSR, LTEATDD:0,0,0,0,0,0 0,0,0,0,0,0
State Saved	Saved in instrument state.
Range	Integ BW RRC Weighted
Initial S/W Revision	A.13.00

Filter Alpha for Offset

Sets the alpha value for the RRC Filter for each offset.

Key Path	Meas Setup, Inner Offset/Limits, Method, RRC Weighted
Mode	MSR, LTEAFDD,LTEATDD
Remote Command	[:SENSe]:ACPower:OFFSet [1] 2:INNeR:LIST:FILTer:ALPHa <real>, <real>, <real>, <real>, <real>, <real> [:SENSe]:ACPower:OFFSet [1] 2:INNeR:LIST:FILTer:ALPHa ?
Example	ACP:OFFS:INN:LIST:FILT:ALPH 0.5, 0.5, 0.5, 0.5, 0.5, 0.5 ACP:OFFS:INN:LIST:FILT:ALPH?
Notes	You must be in the MSR and LTE-Advanced FDD/TDD mode to use this command. Use :INSTRument:SElect to set the mode.
Preset	0.22, 0.22, 0.22, 0.22, 0.22, 0.22 0.22, 0.22, 0.22, 0.22, 0.22, 0.22
State Saved	Saved in instrument state.
Min	0.01
Max	1.00
Initial S/W Revision	A.13.00

Power Ref Type

Enables you to set reference types of inner offsets.

- Cumulative – Cumulated power of the upper and lower sub-block carriers is the reference level. This selection is effective only when Power Ref is Left & Right Carriers or Max Power Carrier in Sub-block. When one of the other Power Ref values is selected, carrier powers are not cumulated and the reference level is equivalent to Normal.
- Normal – Power of specified carrier or the manual reference level is the reference level.

Key Path	Meas Setup, Inner Offset/Limits																												
Mode	MSR, LTEAFDD,LTEATDD																												
Remote Command	<pre>[[:SENSE]:ACPower:OFFSet[1]]2:INNER:LIST:PREference CUMulative NORMal, CUMulative NORMal, CUMulative NORMal, CUMulative NORMal, CUMulative NORMal, CUMulative NORMal [:SENSE]:ACPower:OFFSet[1]]2:INNER:LIST:PREference? [:SENSE]:ACPower:OFFSet[1]]2:INNER:LIST:PREference:AUTO OFF ON 0 1, OFF ON 0 1, OFF ON 0 1, OFF ON 0 1, OFF ON 0 1, OFF ON 0 1 [:SENSE]:ACPower:OFFSet[1]]2:INNER:LIST:PREference:AUTO?</pre>																												
Example	<pre>ACP:OFFS:INN:LIST:PREF CUM, CUM, NORM, NORM, NORM, NORM ACP:OFFS:INN:LIST:PREF?</pre>																												
Notes	<p>You must be in the MSR and LTE-Advanced FDD/TDD mode to use this command. Use :INSTrument:SElect to set the mode.</p> <p>Power Ref Type Auto/Man State ([:SENSE]:ACPower:OFFSet[1]]2:INNER:LIST:PREference:AUTO) is only available in LTE/LTE-Advanced FDD and LTE/LTE-Advanced TDD modes. The BAF SCPI is LTE/LTE-Advanced FDD and LTE/LTE-Advanced TDD modes only.</p>																												
Dependencies	<p>When in LTE-Advanced FDD/TDD mode, the inner power ref type is set automatically when the power ref type state is auto according to the scopes of the sub-block gap in the following table.</p> <table border="1"> <thead> <tr> <th>Wgap</th> <th>Carrier</th> <th>Reference Type</th> </tr> </thead> <tbody> <tr> <td rowspan="2">Wgap < 5MHz</td> <td>1st (2.5MHz)</td> <td>Normal</td> </tr> <tr> <td>2nd (7.5MHz)</td> <td>Normal</td> </tr> <tr> <td rowspan="2">5MHz ≤ Wgap < 10MHz</td> <td>1st (2.5MHz)</td> <td>Cumulative</td> </tr> <tr> <td>2nd (7.5MHz)</td> <td>Normal</td> </tr> <tr> <td rowspan="2">10MHz ≤ Wgap < 15MHz</td> <td>1st (2.5MHz)</td> <td>Cumulative</td> </tr> <tr> <td>2nd (7.5MHz)</td> <td>Cumulative</td> </tr> <tr> <td rowspan="2">15MHz ≤ Wgap < 20MHz</td> <td>1st (2.5MHz)</td> <td>Normal</td> </tr> <tr> <td>2nd (7.5MHz)</td> <td>Cumulative</td> </tr> <tr> <td rowspan="2">20MHz ≤ Wgap</td> <td>1st (2.5MHz)</td> <td>Normal</td> </tr> <tr> <td>2nd (7.5MHz)</td> <td>Normal</td> </tr> </tbody> </table>	Wgap	Carrier	Reference Type	Wgap < 5MHz	1st (2.5MHz)	Normal	2nd (7.5MHz)	Normal	5MHz ≤ Wgap < 10MHz	1st (2.5MHz)	Cumulative	2nd (7.5MHz)	Normal	10MHz ≤ Wgap < 15MHz	1st (2.5MHz)	Cumulative	2nd (7.5MHz)	Cumulative	15MHz ≤ Wgap < 20MHz	1st (2.5MHz)	Normal	2nd (7.5MHz)	Cumulative	20MHz ≤ Wgap	1st (2.5MHz)	Normal	2nd (7.5MHz)	Normal
Wgap	Carrier	Reference Type																											
Wgap < 5MHz	1st (2.5MHz)	Normal																											
	2nd (7.5MHz)	Normal																											
5MHz ≤ Wgap < 10MHz	1st (2.5MHz)	Cumulative																											
	2nd (7.5MHz)	Normal																											
10MHz ≤ Wgap < 15MHz	1st (2.5MHz)	Cumulative																											
	2nd (7.5MHz)	Cumulative																											
15MHz ≤ Wgap < 20MHz	1st (2.5MHz)	Normal																											
	2nd (7.5MHz)	Cumulative																											
20MHz ≤ Wgap	1st (2.5MHz)	Normal																											
	2nd (7.5MHz)	Normal																											
Preset	NORMal, NORMal, NORMal, NORMal, NORMal, NORMal																												

	ON, ON, ON, ON, ON, ON ON, ON, ON, ON, ON, ON
State Saved	Saved in instrument state.
Range	Cumulative Normal
Initial S/W Revision	A.13.00
Modified S/W Revision	A. 16.00

Offset Frequency Define for Inner Offset (MSR and LTE-Advanced FDD/TDD only)

This key allows you to select “Offset” definition.

- CTOC – From the center of the carrier to the center of the adjacent channel Offset Integ BW.
- CTOE – From the center of the carrier to the edge of the closest adjacent channel Offset Integ BW.
- ETOC – From Center Frequency - Carrier Spacing / 2 (for upper offset), Center Frequency + Carrier Spacing / 2 (for lower offset) of the carrier to the center of the adjacent channel Offset Integ BW.
- ETOE – From Center Frequency - Carrier Spacing / 2 (for upper offset), Center Frequency + Carrier Spacing / 2 (for lower offset) of the carrier to the edge of the closest adjacent channel Offset Integ BW.
- STOC – From the sub-block edge to the center of the adjacent channel Offset Integ BW.
- STOE – From the sub-block edge to the edge of the closest adjacent channel Offset Integ BW.

Key Path	Meas Setup, Inner Offset/Limits
Mode	MSR, LTEAFDD, LTEATDD
Remote Command	ACP:OFFS:INN:TYPE ETOC ACP:OFFS:INN:TYPE?
Notes	You must be in the MSR and LTE-Advanced FDD/TDD mode.
Preset	STOC
State Saved	Saved in instrument state.
Range	Carrier Center To Meas BW Center Carrier Center To Meas BW Edge Carrier Edge To Meas BW Center Carrier Edge To Meas BW Edge Sub-block Edge To Meas BW Center Sub-block Edge To Meas BW Edge
Initial S/W Revision	A.13.00

Carrier Result

Allows you to view and scroll through the carrier power results.

Key Path	Meas Setup
Mode	SA, WCDMA, C2K, WIMAX OFDMA, TD-SCDMA, 1xEVDO, DVB-T/H, DTMB (CTTB), ISDB-T, CMMB, LTE, LTEATDD, Digital Cable TV, MSR, LTEAFDD, LTEATDD

Couplings	This key will be grayed out if there is only one carrier.
Preset	1
State Saved	No
Min	1
Max	Number of carriers.
Initial S/W Revision	Prior to A.02.00
Modified at S/W Revision	A.02.00, A.03.00

Meas Method

Sets the desired method to measure ACP.

Integration BW – one sweep of the trace is taken, and the band power for each offset is computed. Depending on the status of the Meas Type parameter (Total Power Reference or PSD Reference), results are displayed relative to the total power or the power spectral density. The display reflects either the current trace or a bar graph view.

Filtered IBW (max dynamic range) – the ACP Path is used to compute ACP when an ACP path is available. This method increases dynamic range, but increases measurement time as it limits the resolution bandwidth. This method is useful for improving dynamic range on a W-CDMA signal because a sharp cutoff bandpass filter is used. The accuracy of the adjacent channel power ratio is not degraded by this method, but the absolute accuracy of both adjacent channel power and carrier power are degraded by up to about 0.5 dB.

RBW – the algorithm uses zero-span and an appropriate RBW setting to capture all of the power in the carrier channel and the offsets. The zero-span algorithm (RBW method) is slower than the IBW method, but greatly improves repeatability.

Fast (in WCDMA mode or SA mode with 3GPP WCDMA radio standard selected) – this provides the same method as the Integration BW method, but is optimized for speed to measure a W-CDMA signal.

Fast (in CDMA2K mode or SA mode with CDMA2K radio standard selected) – this provides faster measurement using the FFT method with a limited parameter flexibility. When this is selected, CDMA2K preset offsets are given and control of the following are grayed out:

BW menu, Sweep/Control menu except Pause/Resume, Trace/Detector menu, Carrier Setup, Offset Limit, RRC Weighting, Filter Alpha, and Noise Correction softkeys in Meas Setup menu.

Fast Power (option FP2 required) – this provides faster measurement using the Hardware accelerated FFT method with a limited parameter flexibility. When this is selected, the following parameters are grayed out:

Sweep/Control menu except Pause/Resume, Select Trace key under Trace/Detector, Span key under Span X Scale, Offset BW key of Offset/Limits key under Meas Setup.

For Trigger, only Free Run, External 1 and External 2 are supported.

(note) This is available with the instrument version A.16.00 or later.

Key Path	Meas Setup
Mode	SA, WCDMA, C2K, WIMAX OFDMA, 1xEVDO, DVB-T/H, DTMB (CTTB), ISDB-T, CMMB, LTE, LTETDD, Digital Cable TV, MSR, LTEAFDD, LTEATDD
Remote Command	[:SENSe] :ACPower:METhod IBW IBWRange FAST RBW FPOWer [:SENSe] :ACPower:METhod?
Example	ACP:METh IBW ACP:METh?
Notes	<p>FAST mode is only supported for WCDMA and C2K signal. You must be in the WCDMA or C2K mode or SA mode with 3GPP WCDMA or CDMA2K radio standard. Otherwise a setting conflict error message will be reported.</p> <p>In the TDSCDMA mode, only the IBW method is available to use. Therefore, the measure method key is not displayed in the TD-SCDMA mode.</p> <p>CDMA1xEVDO mode supports only RBW and Integration BW method.</p> <p>C2K mode supports only RBW, Integration BW, FAST and Fast Power method.</p> <p>LTETDD mode supports only Integration BW, Filtered IBW and Fast Power method.</p> <p>MSR mode supports only Integration BW, Filtered IBW and Fast Power method.</p> <p>LTE-Advanced TDD/FDD mode support only IBW, Filtered IBW and Fast Power method.</p> <p>You must be in the mode that includes ACP measurements to use this command. Use :INSTrument:SElect to set the mode.</p>
Dependencies	<p>When RBW, FAST or Fast Power is selected, Gate function is not available. If you try to turn Gate On while Meas Method is RBW, FAST or Fast Power, an error is generated.</p> <p>When Gate function is ON, RBW, FAST and Fast Power are not available. If you try to change Meas Method to RBW, FAST or Fast Power, an error is generated.</p>
Couplings	IBW (Range) restricts the Res BW available for making this measurement to 30 kHz. When selected, the Res BW is clipped to this value if required and an error number displayed.
Preset	SA, LTE, LTETDD, MSR, LTEAFDD, LTEATDD: IBW WCDMA: IBW C2K: RBW WIMAX OFDMA: IBW 1xEVDO: IBW DVB-T/H: IBW DTMB (CTTB): IBW ISDB-T: IBW CMMB: IBW Digital Cable TV: IBW
State Saved	Saved in instrument state.
Range	Integration BW Filtered IBW (max dynamic range) RBW Fast Fast Power
Readback Text	IBW Filtered IBW RBW Fast Fast Power
Backwards	[:SENSe] :ACPR:SWEep:TYPE

Compatibility SCPI	<code>[:SENSe] :MCPower :METHod (PSA Power Suite)</code>
Initial S/W Revision	Prior to A.02.00
Modified at S/W Revision	A.02.00, A.03.00, A.16.00

Meas Type

Changes the reference used for the measurement. This allows you to make absolute and relative power measurements of either total power or the power normalized to the measurement bandwidth.

Total Pwr Ref (TPR) sets the reference to the total carrier power. PSD Ref (PSDR) sets the reference to the power spectral density of the carrier.

Key Path	Meas Setup
Mode	SA, WCDMA, C2K, WIMAX OFDMA, TD-SCDMA, 1xEVDO, DVB-T/H, DTMB (CTTB), ISDB-T, CMMB, LTE, LTETDD, Digital Cable TV, MSR, LTEAFDD, LTEATDD
Remote Command	<code>[:SENSe] :ACPower :TYPE TPreRef PSDRef</code> <code>[:SENSe] :ACPower :TYPE?</code>
Example	ACP:TYPE PSDR ACP:TYPE?
Notes	You must be in the mode that includes ACP measurements to use this command. Use <code>:INSTrument:SElect</code> to set the mode.
Preset	TPRef
State Saved	Saved in instrument state.
Range	Total Power Ref PSD Ref
Initial S/W Revision	Prior to A.02.00
Modified at S/W Revision	A.02.00, A.03.00

PSD Ref

Sets the unit bandwidth for Power Spectral Density. The available units are dBm/Hz and dBm/MHz.

Key Path	Meas Setup
Mode	A, WCDMA, C2K, WIMAX OFDMA, TD-SCDMA, 1xEVDO, DVB-T/H, DTMB (CTTB), ISDB-T, CMMB, LTE, LTETDD, Digital Cable TV, MSR, LTEAFDD, LTEATDD
Remote Command	<code>:UNIT :ACPower :POWer :PSD DBMHZ DBMMHZ</code> <code>:UNIT :ACPower :POWer :PSD?</code>
Example	UNIT:ACP:POW:PSD DBMMHZ UNIT:ACP:POW:PSD?
Couplings	When the PSD unit is changed, the PSD reference result of the “MEAS READ FETCH:ACP[n]?” is also changed by the PSD unit basis (in either dBm/Hz or dBm/MHz).
Preset	DBMHZ

State Saved	Saved in instrument state.
Range	dBm/Hz dBm/MHz
Initial S/W Revision	Prior to A.02.00
Modified at S/W Revision	A.02.00, A.03.00

Limit Test

Turns limit checking for each offset On or Off. The limits may be specified within the Offset menu, for each offset, both sides of the carrier. For results that fail the limit, a red F is appended. In the Combined view, the bar turns red.

Key Path	Meas Setup
Mode	SA, WCDMA, C2K, WIMAX OFDMA, TD-SCDMA, 1xEVDO, DVB-T/H, DTMB (CTTB), ISDB-T, CMMB, LTE, LTETDD, Digital Cable TV, MSR, LTEAFDD, LTEATDD
Remote Command	:CALCulate:ACPower:LIMit:STATe OFF ON 0 1 :CALCulate:ACPower:LIMit:STATe?
Example	CALC:ACP:LIM:STAT OFF CALC:ACP:LIM:STAT?
Notes	You must be in the mode that includes ACP measurements to use this command. Use :INSTrument:SElect to set the mode.
Preset	SA: OFF WCDMA: ON C2K: ON WIMAX OFDMA: OFF TD-SCDMA: ON 1xEVDO: ON DVB-T/H: OFF DTMB (CTTB): ON ISDB-T: OFF CMMB: ON LTE, LTETDD, MSR, LTEAFDD, LTEATDD: ON Digital Cable TV: OFF
State Saved	Saved in instrument state.
Range	On Off
Backwards Compatibility SCPI	[:SENSe] :MCPower :LIMit [:STATe] [:SENSe] :ACPower :LIMit [:STATe]
Initial S/W Revision	Prior to A.02.00
Modified at S/W Revision	A.02.00, A.03.00

Noise Correction

Sets the measurement noise floor correction function to On or Off. On enables measurement noise correction when the measured power in the reference channel or any offset is close to the noise floor of the analyzer. Off turns these corrections off.

In analyzers with the noise floor extensions option (option NFE) enabled, there are two ways to compensate for the analyzer noise floor: through the NFE and through this noise corrections key. The techniques are results are similar but not identical. NFE uses a model of the analyzer noise floor, adapted to the current conditions such as center frequency, RBW and ambient temperature. The parameters of this model are measured in the factory or field calibration in a highly averaged measurement. So they are consistent. However, because the model is imperfect, the corrections are imperfect. Using NFE is very convenient; the user need not wait for the ACP noise corrections calibration to occur. The ACP NC calibration, though, has advantages of being measured very recently, at the current ambient, and the exact center frequency, with no requirement that the model be perfect. So it will often (but not always) have slightly better dynamic range. If both ACP NC is turned on and NFE is turned on, the analyzer uses only the ACP NC. When ACP NC is turned off but NFE is on, NFE is used and performance should still be excellent.

When Meas Method is Fast Power, it has HW supported noise correction and it works either Noise Correction or NFE on.

Key Path	Meas Setup
Mode	SA, WCDMA, C2K, WIMAX OFDMA, TD-SCDMA, 1xEVDO, DVB-T/H, DTMB (CTTB), ISDB-T, CMMB, LTE, LTETDD, Digital Cable TV, MSR, LTEAFDD, LTEATDD
Remote Command	[:SENSe] :ACPpower:CORRection:NOISe [:AUTO] OFF ON 0 1 [:SENSe] :ACPpower:CORRection:NOISe [:AUTO] ?
Example	ACP:CORR:NOIS OFF ACP:CORR:NOIS?
Notes	You must be in the mode that includes ACP measurements to use this command. Use :INSTrument:SElect to set the mode.
Dependencies	This parameter is unavailable when Meas Method is set to RBW or Fast.
Preset	0
State Saved	Saved in instrument state.
Range	On Off
Initial S/W Revision	Prior to A.02.00
Modified at S/W Revision	A.02.00, A.03.00, A.04.00

Apply Carrier Config to Offset/Limits (Only for MSR)

Sets offset and limit parameters under Range Table. The range frequency and limit values are determined by the carrier configuration parameters, Band Category and Assumed Adj Channels.

Key Path	Meas Setup
Mode	MSR

Remote Command	<code>[:SENSe] :ACPower :MCONdition :IMMediate</code>
Example	ACP:MCON:IMM
Initial S/W Revision	A.11.00

PhNoise Opt

Selects the LO (local oscillator) phase noise behavior for various operating conditions.

Key Path	Meas Setup
Initial S/W Revision	Prior to A.02.00

PhNoise Opt Auto

Selects the best LO (local oscillator) phase noise behavior for the ACP measurement.

Key Path	Meas Setup
Mode	SA, WCDMA, C2K, WIMAX OFDMA, TD-SCDMA, 1xEVDO, DVB-T/H, DTMB (CTTB), ISDB-T, CMMB, LTE, LTE-TDD, Digital Cable TV, MSR, LTEAFDD, LTEATDD
Remote Command	<code>[:SENSe] :ACPower :FREQuency :SYNThesis :AUTO [:STATe] OFF ON 0 1</code> <code>[:SENSe] :ACPower :FREQuency :SYNThesis :AUTO [:STATe] ?</code>
Example	ACP:FREQ:SYNT:AUTO 1 ACP:FREQ:SYNT:AUTO?
Preset	ON
State Saved	Saved in instrument state.
Range	Auto Man
Initial S/W Revision	Prior to A.02.00
Modified at S/W Revision	A.02.00, A.03.00, A.04.00

PhNoise Opt State

Selects the LO (local oscillator) phase noise behavior for various operating conditions.

Key Path	Meas Setup
Mode	SA, WCDMA, C2K, WIMAX OFDMA, TD-SCDMA, 1xEVDO, DVB-T/H, DTMB (CTTB), ISDB-T, CMMB, LTE, LTE-TDD, Digital Cable TV, MSR, LTEAFDD, LTEATDD
Remote Command	<code>[:SENSe] :ACPower :FREQuency :SYNThesis [:STATe] 1 2 3</code> <code>[:SENSe] :ACPower :FREQuency :SYNThesis [:STATe] ?</code>
Example	ACP:FREQ:SYNT 1 ACP:FREQ:SYNT?

Notes	<p>Parameter key:</p> <p>1 - optimizes phase noise for close-in from the carrier.</p> <p>2 - optimizes phase noise for wide-offset from the carrier.</p> <p>3 - optimizes LO for tuning speed.</p>
Couplings	<p>Best Close-in Φ Noise</p> <p>The frequency below which the phase noise is optimized is model dependent:</p> <p>PXA with option EP1: [offset <140 kHz]</p> <p>Models with option EP2: [offset <70 kHz]</p> <p>CXA with option EP4: [offset <90 kHz]</p> <p>CXA without option EP4: n/a</p> <p>All other models: [offset <20 kHz]</p> <p>Best Wide-offset Φ Noise</p> <p>The frequency below which the phase noise is optimized is model dependent:</p> <p>PXA with option EP1: [offset >160 kHz]</p> <p>Models with option EP2: [offset >100 kHz]</p> <p>CXA with option EP4: [offset >130 kHz]</p> <p>CXA without option EP4: n/a</p> <p>All other models: [offset >30 kHz]</p> <p>Fast Tuning</p> <p>The Fast Tuning details are model dependent:</p> <p>CXA without option EP4: n/a</p> <p>PXA with option EP1: [single loop]</p> <p>Models with option EP2: [medium loop bandwidth]</p> <p>All other models: [same as Close-in]</p>
Preset	Because this function is in Auto after preset, the state of this function after Preset will be automatically calculated.
State Saved	Saved in instrument state.
Range	Best Close-in Φ Noise [offset < 140 kHz] Best Wide-offset Φ Noise [offset > 160 kHz] Fast Tuning [same as Close-in] [] is model dependent. See Couplings for details.
Initial S/W Revision	Prior to A.02.00
Modified at S/W Revision	A.02.00, A.03.00, A.04.00

Meas Preset

Restores all the measurement parameters to their default values.

Key Path	Meas Setup
Mode	SA, WCDMA, C2K, WIMAX OFDMA, TD-SCDMA, 1xEVDO, DVB-T/H, DTMB (CTTB), ISDB-T, CMMB,

	LTE, LTE-TDD, Digital Cable TV, MSR, LTEAFDD, LTEATDD
Remote Command	:CONFigure:ACPower
Example	CONF:ACP
Notes	You must be in the mode that includes ACP measurements to use this command. Use :INSTrument:SElect to set the mode.
Couplings	Selecting Meas Preset will restore all measurement parameters to their default values.
Initial S/W Revision	Prior to A.02.00
Modified at S/W Revision	A.02.00, A.03.00

Offset RRC Weighting (Backward Compatibility SCPI)

Mode	SA, WCDMA, TD-SCDMA, WIMAX OFDMA, DVB-T/H, DTMB (CTTB), ISDB-T, CMMB, LTE, LTE-TDD, Digital Cable TV, MSR, LTEAFDD, LTEATDD
Remote Command	[:SENSe] :ACPower :FILTer [:RRC] [:STATe] OFF ON 0 1 [:SENSe] :ACPower :FILTer [:RRC] [:STATe] ?
Example	ACP:FILT OFF ACP:FILT?
Notes	This parameter is not available for cdma2000 and 1xEVDO The backwards Compatibility SCPI command, [:SENSe]:ACPR:FILTer[:RRC][:STATe], is provided to support same functionality as [:SENSe]:ACPr:FILTer[:RRC][:STATe] (PSA W-CDMA, PSA cdma2000 and PSA 1xEVDO) due to ACPr node conflicts with ACPower node. You must be in the mode that includes ACP measurements to use this command. Use :INSTrument:SElect to set the mode.
Couplings	This command is an alias to [:SENSe]:ACPower:OFFSet[1]2:LIST:FILTer[:RRC][:STATe] Sending the commands to set values of all offsets for BS and MS, however, sending the query always return a value of BS Offset A.
Preset	SA, WIMAX OFDMA, LTE, LTE-TDD, MSR: OFF WCDMA: ON C2K: NO TD-SCDMA: ON DVB-T/H: OFF DTMB (CTTB): ON ISDB-T: OFF CMMB: OFF Digital Cable TV: ON LTEAFDD, LTEATDD: OFF
State Saved	Saved in instrument state.
Backwards	[:SENSe] :ACPR :FILTer [:RRC] [:STATe]

Compatibility SCPI	<code>[:SENSe] :MCPower :FILTer [:RRC] [:STATe]</code>
Initial S/W Revision	Prior to A.02.00
Modified at S/W Revision	A.03.00

Offset Filter Alpha (Backward Compatibility SCPI)

Mode	SA, WCDMA, WIMAX OFDMA, TD-SCDMA, DVB-T/H, DTMB (CTTB), ISDB-T, CMMB, LTE, LTETDD, Digital Cable TV, MSR, LTEAFDD,LTEATDD
Remote Command	<code>[:SENSe] :ACPPower :FILTer [:RRC] :ALPHa <real></code> <code>[:SENSe] :ACPPower :FILTer [:RRC] :ALPHa?</code>
Example	ACP:FILT:ALPH 0.5 ACP:FILT:ALPH?
Notes	This parameter is not available for cdma2000 and 1xEVDO The backwards Compatibility SCPI command, <code>[:SENSe] :ACPR :FILTer [:RRC] :ALPHa</code> , is provided to support same functionality as <code>[:SENSe] :ACPr :FILTer [:RRC] :ALPHa</code> (PSA W-CDMA, PSA cdma2000 and PSA 1xEVDO) due to ACPr node conflicts with ACPower node. You must be in the mode that includes ACP measurements to use this command. Use <code>:INSTrument:SElect</code> to set the mode.
Couplings	This command is an alias to <code>[:SENSe] :ACPPower :OFFSet [1] 2 :LIST :FILTer :ALPHa</code> Sending the commands to set values of all offsets for BS and MS, however, sending the query always return a value of BS Offset A.
Preset	SA, WCDMA, WIMAX OFDMA, TD-SCDMA, DVB-T/H, ISDB-T, CMMB, LTE, LTETDD, MSR: 0.22 C2K: NO DTMB (CTTB): 0.05 Digital Cable TV: 0.15 LTEAFDD,LTEATDD: 0.22
State Saved	Saved in instrument state.
Min	0.01
Max	1.00
Backwards Compatibility SCPI	<code>[:SENSe] :ACPR :FILTer [:RRC] :ALPHa</code> <code>[:SENSe] :MCPower :FILTer [:RRC] :ALPHa</code>
Initial S/W Revision	Prior to A.02.00
Modified at S/W Revision	A.03.00

Method for Carrier (Backward Compatibility SCPI)

Mode	SA, WCDMA, WIMAX OFDMA, TD-SCDMA, DVB-T/H, DTMB (CTTB), ISDB-T, CMMB, LTE, LTETDD, Digital Cable TV, MSR
------	--

Remote Command	<code>[:SENSe] :ACPower :CARRier [1] 2 :LIST :METHod IBW RRC, ...</code> <code>[:SENSe] :ACPower :CARRier [1] 2 :LIST :METHod ?</code>
Example	ACP:CARR2:LIST:METH RRC ACP:CARR2:LIST:METH?
Notes	You must be in the mode that includes ACP measurements to use this command. Use :INSTrument:SElect to set the mode. Maximum of Array length depends on the number of carriers.
Couplings	This command is an alias to <code>[:SENSe] :ACPower :CARRier [1] 2 :LIST :FILTer [:RRC] [:STATE]</code> The enum value translates as follows: RRC Weighted = 1 ON Integ BW = 0 OFF Maximum of Array length depends on the number of carriers.
Preset	SA: IBW WCDMA: RRC WIMAX OFDMA: IBW TD-SCDMA: RRC DVB-T/H: IBW DTMB (CTTB): RRC ISDB-T: IBW CMMB: IBW LTE, MSR: IBW LTETDD: IBW Digital Cable TV: RRC
State Saved	Saved in instrument state.
Initial S/W Revision	Prior to A.02.00
Modified at S/W Revision	A.03.00

10 ACP Measurement
Mode

Mode

See "[Mode](#)" on page 276

Mode Preset

Returns the active mode to a known state.

Mode Preset does the following for the currently active mode:

- Aborts the currently running measurement.
- Brings up the default menu for the mode, with no active function.
- Sets measurement Global settings to their preset values for the active mode only.
- Activates the default measurement.
- Brings up the default menu for the mode.
- Clears the input and output buffers.
- Sets Status Byte to 0.

Mode Preset does not:

- Cause a mode switch
- Affect mode persistent settings
- Affect system settings
- See "[How-To Preset](#)" on page 1070 for more information.

Key Path	Front-panel key
Remote Command	:SYSTem:PRESet
Example	:SYST:PRES
Notes	*RST is preferred over :SYST:PRES for remote operation. *RST does a Mode Preset, as done by the :SYST:PRES command, and it sets the measurement mode to Single measurement rather than Continuous for optimal remote control throughput. Clears all pending OPC bits. The Status Byte is set to 0.
Couplings	A Mode Preset aborts the currently running measurement, activates the default measurement, and gets the mode to a consistent state with all of the default couplings set.
Backwards Compatibility Notes	In the X-Series, the legacy "Factory Preset" has been replaced with Mode Preset, which only presets the currently active mode, not the entire instrument. In the X-Series, the way to preset the entire instrument is by using System, Restore System Defaults All, which behaves essentially the same way as restore System Defaults does on ESA and PSA. There is also no "Preset Type" as there is on the PSA. There is a green Mode Preset front-panel key that does a Mode Preset and a white-with-green-letters User Preset front-panel key that does a User Preset. The old PRESet:TYPE command is ignored (without generating an error), and SYST:PRES without a parameter does a Mode Preset, which should cover most backward code compatibility issues. The settings and correction data under the Input/Output front-panel key (examples: Input Z Corr, Ext Amp Gain, etc.) are no longer part of any Mode, so they will not be preset by a Mode Preset. They are preset using Restore Input/Output Defaults, Restore System Defaults All. Note that because User Preset does a Recall State, and all of these settings are saved in State, they ARE recalled when using

	User Preset.
Initial S/W Revision	Prior to A.02.00

How-To Preset

The table below shows all possible presets, their corresponding SCPI commands and front-panel access (key paths). Instrument settings depend on the current measurement context. Some settings are local to the current measurement, some are global (common) across all the measurements in the current mode, and some are global to all the available modes. In a similar way, restoring the settings to their preset state can be done within the different contexts.

Auto Couple - is a measurement local key. It sets all Auto/Man parameter couplings in the measurement to Auto. Any Auto/Man selection that is local to other measurements in the mode will not be affected.

Meas Preset - is a measurement local key. Meas Preset resets all the variables local to the current measurement except the persistent ones.

Mode Preset - resets all the current mode's measurement local and measurement global variables except the persistent ones.

Restore Mode Defaults - resets ALL the Mode variables (and all the Meas global and Meas local variables), including the persistent ones.

Type Of Preset	SCPI Command	Front Panel Access
Auto Couple	:COUPle ALL	Auto Couple front-panel key
Meas Preset	:CONFigure:<Measurement>	Meas Setup Menu
Mode Preset	:SYSTem:PRESet	Mode Preset (green key)
Restore Mode Defaults	:INSTrument:DEFault	Mode Setup Menu
Restore All Mode Defaults	:SYSTem:DEFault MODes	System Menu; Restore System Default Menu
*RST	*RST	not possible (Mode Preset with Single)
Restore Input/Output Defaults	:SYSTem:DEFault INPUt	System Menu; Restore System Default Menu
Restore Power On Defaults	:SYSTem:DEFault PON	System Menu; Restore System Default Menu
Restore Alignment Defaults	:SYSTem:DEFault ALIGN	System Menu; Restore System Default Menu
Restore Miscellaneous Defaults	:SYSTem:DEFault MISC	System Menu; Restore System Default Menu
Restore All System Defaults	:SYSTem:DEFault [ALL] :SYSTem:PRESet:PERsistent	System Menu; Restore System Default Menu
User Preset	:SYSTem:PRESet:USER	User Preset Menu
User Preset All Modes	:SYSTem:PRESet:USER:ALL	User Preset Menu

Power On Mode Preset	:SYSTem:PON:TYPE MODE	System Menu
Power On User Preset	:SYSTem:PON:TYPE USER	System Menu
Power On Last State	:SYSTem:PON:TYPE LAST	System Menu

Preset Type (Remote Command Only)

As stated in the Backward Compatibility section, to be compatible with ESA/PSA the PRESet:TYPE command will be implemented as a no-op.

Mode	All
Remote Command	:SYSTem:PRESet:TYPE FACTory MODE USER :SYSTem:PRESet:TYPE?
Example	:SYST:PRESet:TYPE FACT
Notes	This command is supported for backward compatibility only. It is a no-op which does not change the behavior of any preset operation.
Preset	This is unaffected by Preset but is set to Mode on a "Restore System Defaults->All"
State Saved	No
Initial S/W Revision	Prior to A.02.00

10 ACP Measurement
Mode Setup

Mode Setup

See "[Mode Setup](#)" on page 306

Peak Search

Places the selected marker on the trace point with the maximum y-axis value.

Key Path	Peak Search
Mode	SA, WCDMA, C2K, WIMAX OFDMA, TD-SCDMA, 1xEVDO, DVB-T/H, DTMB (CTTB), ISDB-T, CMMB, LTE, LTE-TDD, Digital Cable TV, MSR, LTEAFDD, LTEATDD
Remote Command	:CALCulate:ACPower:MARKer [1] 2 . . . 12 :MAXimum
Example	CALC:ACP:MARK2:MAX
Initial S/W Revision	Prior to A.02.00
Modified at S/W Revision	A.02.00, A.03.00

Next Peak

Moves the selected marker to the peak that has the next highest amplitude.

Key Path	Peak Search
Mode	SA, WCDMA, C2K, WIMAX OFDMA, TD-SCDMA, 1xEVDO, DVB-T/H, DTMB (CTTB), ISDB-T, CMMB, LTE, LTE-TDD, Digital Cable TV, MSR, LTEAFDD, LTEATDD
Remote Command	:CALCulate:ACPower:MARKer [1] 2 . . . 12 :MAXimum:NEXT
Example	CALC:ACP:MARK2:MAX:NEXT
Initial S/W Revision	Prior to A.02.00
Modified at S/W Revision	A.02.00, A.03.00

Next Pk Right

Moves the selected marker to the nearest peak to the right of the current marker that meets all enabled peak criteria.

Key Path	Peak Search
Mode	SA, WCDMA, C2K, WIMAX OFDMA, TD-SCDMA, 1xEVDO, DVB-T/H, DTMB (CTTB), ISDB-T, CMMB, LTE, LTE-TDD, Digital Cable TV, MSR, LTEAFDD, LTEATDD
Remote Command	:CALCulate:ACPower:MARKer [1] 2 . . . 12 :MAXimum:RIGHT
Example	CALC:ACP:MARK2:MAX:RIGH
Initial S/W Revision	Prior to A.02.00
Modified at S/W Revision	A.02.00, A.03.00

Next Pk Left

Moves the selected marker to the nearest peak to the left of the current marker that meets all enabled peak criteria.

Key Path	Peak Search
Mode	SA, WCDMA, C2K, WIMAX OFDMA, TD-SCDMA, 1xEVDO, DVB-T/H, DTMB (CTTB), ISDB-T, CMMB, LTE, LTETDD, Digital Cable TV, MSR, LTEAFDD, LTEATDD
Remote Command	:CALCulate:ACPower:MARKer[1] 2 ... 12:MAXimum:LEFT
Example	CALC:ACP:MARK2:MAX:LEFT
Initial S/W Revision	Prior to A.02.00
Modified at S/W Revision	A.02.00, A.03.00

Marker Delta

Sets the control mode for the selected marker to Delta mode.

See Marker Delta in the "Marker Functions" section for more information.

Key Path	Peak Search
Initial S/W Revision	Prior to A.02.00

Pk-Pk Search

Finds and displays the amplitude and frequency (or time, if in zero span) differences between the highest and lowest y-axis value.

Key Path	Peak Search
Mode	SA, WCDMA, C2K, WIMAX OFDMA, TD-SCDMA, 1xEVDO, DVB-T/H, DTMB (CTTB), ISDB-T, CMMB, LTE, LTETDD, Digital Cable TV, MSR, LTEAFDD, LTEATDD
Remote Command	:CALCulate:ACPower:MARKer[1] 2 ... 12:PTPeak
Example	CALC:ACP:MARK:PTP
Notes	Turns on the Marker Δ active function.
Couplings	This key is not available (key is grayed out) when Coupled Markers is on.
Initial S/W Revision	Prior to A.02.00
Modified at S/W Revision	A.02.00, A.03.00

Min Search

Moves the selected marker to the minimum y-axis value on the current trace.

Key Path	Peak Search
Mode	SA, WCDMA, C2K, WIMAX OFDMA, TD-SCDMA, 1xEVDO, DVB-T/H, DTMB (CTTB), ISDB-T, CMMB, LTE, LTETDD, Digital Cable TV, MSR, LTEAFDD, LTEATDD
Remote Command	:CALCulate:ACPower:MARKer[1] 2 ... 12:MINimum

Example	CALC:ACP:MARK:MIN
Initial S/W Revision	Prior to A.02.00
Modified at S/W Revision	A.02.00, A.03.00

10 ACP Measurement
Print

Print

See "[Print](#) " on page 367

Quick Save

The Quick Save front-panel key repeats the most recent save that was performed from the Save menu, with the following exceptions:

- Register saves are not remembered as Saves for the purpose of the Quick Save function
- If the current measurement does not support the last non-register save that was performed, an informational message is generated, “File type not supported for this measurement”

Quick Save repeats the last type of qualified save (that is, a save qualified by the above criteria) in the last save directory by creating a unique filename using the Auto File Naming algorithm described below.

If Quick Save is pressed after startup and before any qualified Save has been performed, the Quick Save function performs a Screen Image save using the current settings for Screen Image saves (current theme, current directory), which then becomes the “last save” for the purpose of subsequent Quick Saves.

The Auto File Naming feature automatically generates a file name for use when saving a file. The filename consists of a prefix and suffix separated by a dot, as is standard for the Windows® file system. A default prefix exists for each of the available file types:

Type	Default Prefix	Menu
State	State_	(Save/Recall)
Trace + State	State_	(Save/Recall)
Screen	Screen_	(Save/Recall)
Amplitude Corrections	Ampcor_	(Import/Export)
Traces	Trace_	(Import/Export)
Limit Lines	LLine_	(Import/Export)
Measurement Result	MeasR_	(Import/Export)
Capture Buffer	CapBuf_	(Import/Export)

A four digit number is appended to the prefix to create a unique file name. The numbering sequence starts at 0000 within each Mode for each file type and updates incrementally to 9999, then wraps to 0000 again. It remembers where it was through a Mode Preset and when leaving and returning to the Mode. It is reset by Restore Misc Defaults and Restore System Defaults and subsequent running of the instrument application. So, for example, the first auto file name generated for State files is State_0000.state. The next is State_0001, and so forth.

One of the key features of Auto File Name is that we guarantee that the Auto File Name will never conflict with an existing file. The algorithm looks for the next available number. If it gets to 9999, then it looks for holes. If it find no holes, that is no more numbers are available, it gives an error.

For example, if when we get to State_0010.state there is already a State_0010.state file in the current directory, it advances the counter to State_0011.state to ensure that no conflict will exist (and then it verifies that State_0011.state also does not exist in the current directory and advances again if it does, and so forth).

If you enter a file name for a given file type, then the prefix becomes the filename you entered instead of the default prefix, followed by an underscore. The last four letters (the suffix) are the 4-digit number.

For example, if you save a measurement results file as “fred.csv”, then the next auto file name chosen for a measurement results save will be fred_0000.csv.

NOTE

Although 0000 is used in the example above, the number that is used is actually the current number in the Meas Results sequence, that is, the number that would have been used if you had not entered your own file name.

NOTE

If the filename you entered ends with _dddd, where d=any number, making it look just like an auto file name, then the next auto file name picks up where you left off with the suffix being dddd + 1.

Key Path	Front-panel key
Notes	No remote command for this key specifically.
Initial S/W Revision	Prior to A.02.00

Recall

In the MSR mode, two types of recall functions are available under the Data menu: Parameter Sets and Masks. Masks enables setting of a preset limit mask for Power Suite-based measurements, and currently it is available for the SEM, ACP and SPUR measurements in the MSR mode.

Key Path	Front Panel
Mode	MSR
Initial S/W Revision	A.10.00

State

The **Recall State** menu lets you choose a register or file from which to recall the state.

The content of a state file includes all of the settings and data required to return the analyzer as closely as possible to the Mode it was in, with the exact settings that were in place, when the save occurred. The Mode settings in each state file include the settings that are affected by Mode Preset, as well as the additional settings affected by Restore Mode Defaults; all of the Mode's settings. In addition, all of the settings of the **Input/Output** system are included, even though they are outside of the Mode's state, because they are needed to restore the complete setup. Persistent System settings (for example, GPIB address) are not affected by either a Mode Preset or Restore Mode Defaults, nor are they included in a saved State file.

Since each state file is only for one Mode, the settings for other Modes are unaffected when it is loaded. **Recall State** will cause a mode switch if the state being recalled is not from the current active mode.

After the recall completes, the message "File <filename> recalled" or "Recalled State Register <register number>" is displayed.

For rapid recalls, the State menu lists 16 registers that you can choose from to recall. Pressing a Register key initiates the recall. You can also select a file from which to recall.

The default path for all State Files is:

My Documents\<<mode name>\state

where <mode name> is the parameter used to select the mode with the INST:SEL command (for example, SA for the Spectrum Analyzer).

See "[More Information](#)" on page 1080.

Key Path	Recall
Mode	All
Remote Command	:MMEMory:LOAD:STATe <filename>
Example	:MMEM:LOAD:STAT "myState.state" This recalls the file myState.state on the default path
Example	MMEM:LOAD:STAT "MyStateFile.state" This loads the state file data (on the default file directory path) into the instrument state.

Notes	<p>When you pick a file to recall, the analyzer first verifies that the file is recallable in the current instrument by checking the software version and model number of the instrument. If everything matches, a full recall proceeds by aborting the currently running measurement, clearing any pending operations, and then loading the State from the saved state file. You can open state files from any mode, so recalling a State file switches to the mode that was active when the save occurred. After switching to the mode of the saved state file, mode settings and data (if any for the mode) are loaded with values from the saved file. The saved measurement of the mode becomes the newly active measurement and the data relevant to the measurement (if there is any) is recalled.</p> <ul style="list-style-type: none"> • If there is a mismatch between file version or model number or instrument version or model number, the recall function tries to recall as much as possible and returns a warning message. It may limit settings that differ based on model number, licensing or version number. <p>After recalling the state, the Recall State function does the following:</p> <ul style="list-style-type: none"> • Makes the saved measurement for the mode the active measurement. • Clears the input and output buffers. • Status Byte is set to 0. • Executes a *CLS <p>If the file specified is empty an error is generated. If the specified file does not exist, another error is generated. If there is a mismatch between the file and the proper file type, an error is generated. If there is a mismatch between file version or model number or instrument version or model number, a warning is displayed. Then it returns to the State menu and File Open dialog goes away.</p> <p>After the Recall, the analyzer exits the Recall menu and returns to the previous menu.</p>
Backwards Compatibility SCPI	<pre>:MMEMory:LOAD:STATe 1,<filename></pre> <p>For backwards compatibility, the above syntax is supported. The "1" is simply ignored.</p>
Initial S/W Revision	Prior to A.02.00

More Information

In measurements that support saving Traces, for example, Swept SA, the Trace data is saved along with the State in the State file. When recalling the State, the Trace data is recalled as well. Traces are recalled exactly as they were stored, including the writing mode and update and display modes. If a Trace was updating and visible when the State was saved, it will come back updating and visible, and its data will be rewritten right away. When you use State to save and recall traces, any trace whose data must be preserved should be placed in View or Blank mode before saving.

The following table describes the Trace Save and Recall possibilities:

You want to recall state and one trace's data, leaving other traces unaffected.	Save Trace+State from 1 trace. Make sure that no other traces are updating (they should all be in View or Blank mode) when the save is performed.	On Recall, specify the trace you want to load the one trace's data into. This trace will load in View. All other traces' data will be unaffected, although their trace mode will be as it was when the state save was performed.
You want to recall all traces	Save Trace+State from ALL traces.	On Recall, all traces will come back in View (or Blank if they were in Blank or Background when

		saved)
You want all traces to load exactly as they were when saved.	Save State	On recall, all traces' mode and data will be exactly as they were when saved. Any traces that were updating will have their data immediately overwritten.

From File...

When you press “From File”, the analyzer brings up a Windows dialog and a menu entitled “File Open.” This menu allows you to navigate to the various fields in the Windows dialog without using a keyboard or mouse. The **Tab** and **Arrow** keys can also be used for dialog navigation.

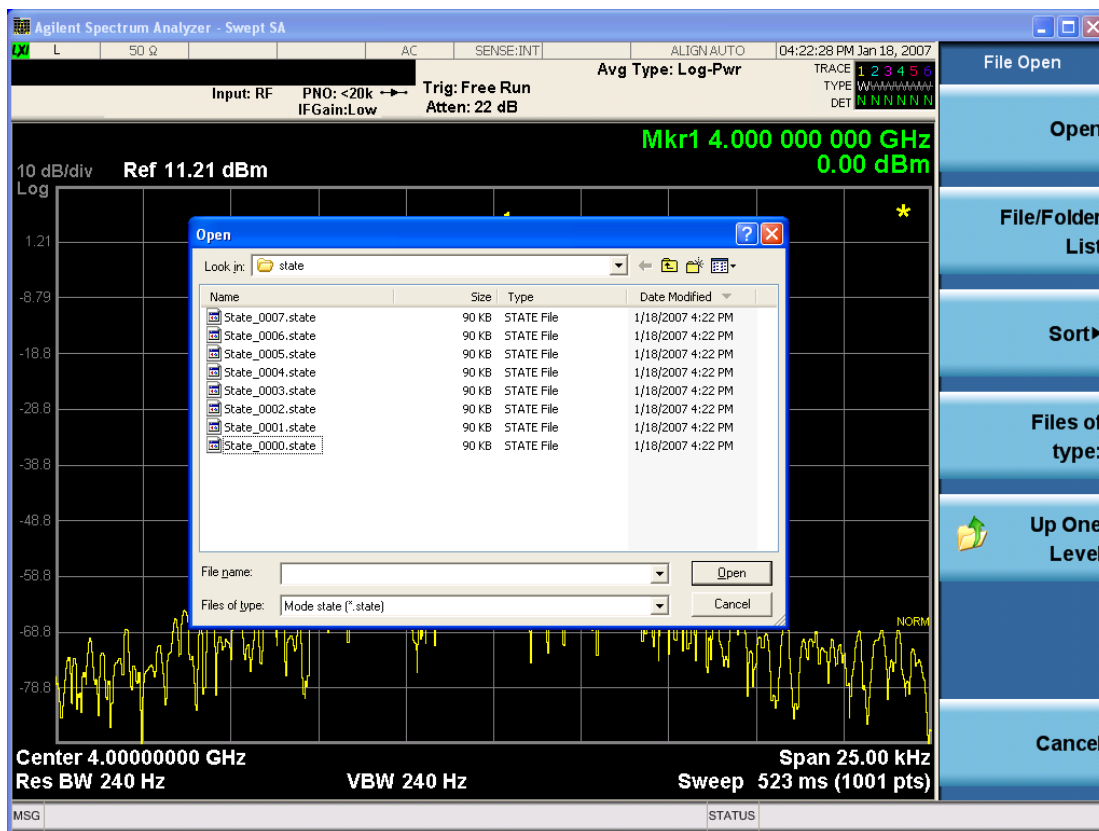

Listed below are the functions of the various fields in the dialog, and the corresponding softkeys:

Open

Performs the recall of the specified file. While the recall is being performed, the floppy icon appears briefly in the Meas bar.

File/Folder List

Enables you to navigate to the center of the dialog that contains the list of files and folders. Once here you can get information about the file and use the tab keys to navigate to the other fields in the dialog, such as Look In.

Look In

The **Look In** field shows the path from which the file will be recalled and allows you to change the path using the up and down arrow keys to navigate to other paths; the Enter key to open a directory; and the Backspace key to go back one directory. The **Look In field** first uses the last path from the Save As dialog **Save In:** path for that same file type. There is no softkey for directly navigating to the Look In field, but you can use the left tab to get here from the File/Folder List.

User specified paths are remembered when you leave and return to a Mode and are reset back to the default using **Restore Mode Defaults**.

Sort

Accesses a menu that enables you to sort the files within the File Open dialog. Only one sorting type can be selected at a time and the sorting happens immediately. The sorting types are **By Date, By Name, By extension, and By Size**.

Files of Type

This field shows the file suffix for the type of file you have selected to recall. For example, if you navigated here while recalling State, "Mode state (*.state)" is in the field. If you navigated here while recalling Trace, ""Mode state (*.trace)" is in the field. If you navigated here while importing a trace data file, "Trace Data (*.csv)" is in the field. For some file types, there is more than one choice in the dropdown menu, which you can select by using the up and down arrow keys and Enter.

Up One Level

This key corresponds to the icon of a folder with the up arrow that is in the tool bar of the dialog. When pressed, it causes the file and folder list to navigate up one level in the directory structure. The Backspace key does the same thing.

Cancel

This key corresponds to the **Cancel** selection in the dialog. It causes the current **Open** request to be cancelled. The ESC key does the same thing.

Key Path	Recall, State
Notes	Brings up the Open dialog for recalling a State Save Type
Initial S/W Revision	Prior to A.02.00

Edit Register Names

You may enter a custom name on any of the Register keys, to help you remember what you are using that state to save. To do this, press the **Edit Register Names** key, choose the register whose name you wish to edit, and then enter the desired label using the Alpha Editor or an external PC keyboard.

The maximum number of characters that can be added is 30. In most cases, 30 characters will fit on two lines of the key.

For more information and the SCPI command, see Edit Register Names under the **Save, State** function.

Key Path	Recall, State
Mode	All
Dependencies	N9060A-7FP or N9060B-2FP license required to edit the register names. When the feature is not licensed, sending the SCPI command generates an error, -221,"Settings conflict;Option not available"
Initial S/W Revision	A.11.00

Register 1 thru Register 16

Selecting any one of these register keys causes the State of the mode from the specified Register to be recalled. Each of the register keys annotates whether it is empty or at what date and time it was last modified. In addition, you can use the **Edit Register Names** key under **Save, State** to enter custom names for each register.

Registers are shared by all modes, so recalling from any one of the registers will cause a mode switch to the mode that was active when the save to the Register occurred.

Although these 16 registers are the only registers available from the front panel, there are 128 state registers available in the instrument. Registers 17–128 are only available from the SCPI interface, using the *RCL command.

After the recall completes, the message "Register <register number> recalled" appears in the message bar. If you are in the Spectrum Analyzer Mode, and you are recalling a register that was saved in the Spectrum Analyzer Mode, then after the recall, you will still be in the Recall Register menu. If the Recall causes you to switch modes, then after the Recall, you will be in the Frequency menu.

If a requested register is empty an error is generated.

Key Path	Recall, State
Example	*RCL 1
Range	1-16 from front panel, 1-128 from SCPI
Readback	Date and time with seconds resolution are displayed on the key OR A custom name of up to 30 characters entered using the Save, State,Edit Register Names key OR “(empty)” if no prior save operation has been performed to this register.
Initial S/W Revision	Prior to A.02.00
Modified at S/W Revision	Prior to A.11.00

Register 1 thru Register 16

Selecting any one of these register keys causes the State of the mode from the specified Register to be recalled. Each of the register keys annotates whether it is empty or at what date and time it was last

modified. In addition, you can use the **Edit Register Names** key under **Save, State** to enter custom names for each register.

Registers are shared by all modes, so recalling from any one of the registers will cause a mode switch to the mode that was active when the save to the Register occurred.

Although these 16 registers are the only registers available from the front panel, there are 128 state registers available in the instrument. Registers 17–128 are only available from the SCPI interface, using the *RCL command.

After the recall completes, the message "Register <register number> recalled" appears in the message bar. If you are in the Spectrum Analyzer Mode, and you are recalling a register that was saved in the Spectrum Analyzer Mode, then after the recall, you will still be in the Recall Register menu. If the Recall causes you to switch modes, then after the Recall, you will be in the Frequency menu.

If a requested register is empty an error is generated.

Key Path	Recall, State
Example	*RCL 1
Range	1–16 from front panel, 1–128 from SCPI
Readback	Date and time with seconds resolution are displayed on the key OR A custom name of up to 30 characters entered using the Save, State, Edit Register Names key OR “(empty)” if no prior save operation has been performed to this register.
Initial S/W Revision	Prior to A.02.00
Modified at S/W Revision	Prior to A.11.00

Data (Import)

Importing a data file loads data that was previously saved from the current measurement or from other measurements and/or modes that produce compatible data files. The Import Menu only contains Data Types that are supported by the current measurement.

Since the commonly exported data files are in .csv format, the data can be edited by the user prior to importing. This allows you to export a data file, manipulate the data in Excel (the most common PC Application for manipulating .csv files) and then import it.

Importing Data loads measurement data from the specified file into the specified or default destination, depending on the data type selected. Selecting an Import Data menu key will not actually cause the importing to occur, since the analyzer still needs to know from where to get the data. Pressing the Open key in this menu brings up the Open dialog and Open menu that provides you with the options from where to recall the data. Once a filename has been selected or entered in the Open menu, the recall occurs as soon as the Open button is pressed.

Key Path	Recall
Mode	All

Notes	The menu is built from whatever data types are available for the mode. Some keys will be missing completely, so the key locations in the sub-menu will vary. No SCPI command directly controls the Data Type that this key controls. The Data Type is included in the MMEM:LOAD commands.
Dependencies	If a file type is not used by a certain measurement, it is grayed out for that measurement. The key for a file type will not show at all if there are no measurements in the Mode that support it.
Preset	Is not affected by Preset or shutdown, but is reset during Restore Mode Defaults
Readback	The data type that is currently selected
Initial S/W Revision	Prior to A.02.00

Parameter Set

Enables you to import format parameter set data to specified format parameter sets. Selecting this key displays a menu that enables you to select the destination parameter set. After making this selection, depress Open... and use the file dialog to select the file you wish to recall.

Supported import file formats are dependent on radio formats.

LTE FDD: Format Parameter Set Files (*.fps), LTE FDD app state files (*.state), 89601 VSA Setup Files (*.set, *.setx) and Signal Studio Setup Files (*.scp)

W-CDMA:Format Parameter Set Files (*.fps) and W-CDMA app state files (*.state)

GSM/EDGE:Format Parameter Set Files (*.fps) and GSM/EDGE app state files (*.state)

cdma2000:Format Parameter Set Files (*.fps) and cdma2000 app state files (*.state)

1xEV-DO:Format Parameter Set Files (*.fps) and 1xEV-DO app state files (*.state)

LTE TDD: Format Parameter Set Files (*.fps), LTE TDD app state files (*.state), 89601 VSA Setup Files (*.set, *.setx) and Signal Studio Setup Files (*.scp)

TD-SCDMA:Format Parameter Set Files (*.fps) and TD-SCDMA app state files (*.state)

Format Parameter Set Files

Extention: fps

Basic file type of format parameter set. This file contains a format parameter set exported using Parameter Set under Recall, Data (Export). It is imported if the radio format of the file matches the destination radio format. If not, an error message, -230 "Data corrupt or stale", is issued with the specified file name.

App State Files

Extention: state

The state file of each mode can be imported to the corresponding parameter set. If the mode name in the state file matches the selected destination format, the state file data are imported. If not, an error message, -230 "Data corrupt or stale", is issued with the specified file name.

The parameters to be imported are ones referred in a particular measurement of each mode. The relevant measurements are listed below.

LTE FDD: Modulation Analysis

W-CDMA: Mod Accuracy

GSM/EDGE: EDGE EVM

cdma2000: Mod Accuracy

1xEV-DO: Mod Accuracy

LTE TDD: Modulation Analysis

TD-SCDMA: Mod Accuracy

Note that Integ BW and Measurement Noise BW parameters of ACP, SEM and CHP are not imported.

89601 VSA Setup Files

Extention: set, setx

The 89600 Vector Signal Analyzer Setup file created using the 89600 Vector Signal Analyzer Option BHD (LTE FDD)/Option BHE (LTE TDD) can be imported as LTE FDD/LTE TDD parameter set. If the setup file is not loaded successfully, an error message, -230 "Data corrupt or stale", is issued with the specified file name.

Signal Studio Setup Files

Extention: scp

The Keysight Signal Studio setup file created using Signal Studio (N7624B/N7625B) can be imported as LTE FDD/LTE TDD parameter set. Supported carrier types are listed in the table below:

<i>Signal Studio</i>	<i>Carrier Type</i>
N7624B Signal Studio for 3GPP LTE	Advanced LTE FDD Downlink (2009-03)
	Advanced LTE FDD Downlink (2009-12)
	Advanced LTE FDD Downlink (2010-06)
	Advanced LTE FDD Uplink (2009-12)
	Advanced LTE FDD Uplink (2010-06)
	Basic LTE FDD Downlink (2009-03)
	Basic LTE FDD Downlink (2009-12)
	Basic LTE FDD Downlink (2010-06)
	Basic LTE FDD Uplink (2009-03)
	Basic LTE FDD Uplink (2009-12)
	Basic LTE FDD Uplink (2010-06)
N7625B Signal Studio for 3GPP LTE TDD	Advanced LTE TDD (2009-03)
	Advanced LTE TDD (2009-12)
	Basic LTE TDD (2009-03)
	Basic LTE TDD (2009-12)
	Basic LTE TDD R9
Advanced LTE TDD R9	

 Basic LTE TDD R9 PRACH

If the setup file is not loaded successfully, an error message, –230 “Data corrupt or stale”, is issued with the specified file name.

Default path of this import type is “My Documents\MSR\data\params” folder. Note that “My Documents” is an alias to a directory and its location depends on which user is logged in. If the file path is specified without root folder, the import file is determined with the default path. For example if “folder1\paramData.prms” is specified, “My Documents\MSR\data\params\folder1\paramData.prms” is imported.

File Dialog Filter

Since supported import file formats differ between radio formats, file filters available in the open file dialog vary depending on the selected radio format. This table below defines file name filters available for each format.

<i>Radio Format</i>	<i>File Name Filters</i>
LTE FDD	All Supported Format Parameter Setup Files (*.fps; *.state; *.set; *.setx; *.scp) Format Parameter Setup Files (*.fps) State Files (*.state) 89601 VSA Setup Files (*.set; *.setx) Signal Studio Setup Files (*.scp)
W-CDMA	All Supported Format Parameter Setup Files (*.fps; *.state) Format Parameter Setup Files (*.fps) W-CDMA State Files (*.state)
GSM/EDGE	All Supported Format Parameter Setup Files (*.fps; *.state) Format Parameter Setup Files (*.fps) State Files (*.state)
cdma2000	All Supported Format Parameter Set Files (*.fps; *.state) Format Parameter Set Files (*.fps) State Files (*.state)
1xEV-DO	All Supported Format Parameter Set Files (*.fps; *.state) Format Parameter Set Files (*.fps) State Files (*.state)
LTE TDD	All Supported Format Parameter Setup Files (*.fps; *.state; *.set; *.setx; *.scp) Format Parameter Setup Files (*.fps) State Files (*.state) 89601 VSA Setup Files (*.set; *.setx) Signal Studio Setup Files (*.scp)
TD-SCDMA	All Supported Format Parameter Set Files (*.fps; *.state) Format Parameter Set Files (*.fps) State Files (*.state)

Key Path	Recall, Data
Mode	MSR
Remote Command	MMEMory:LOAD:PSET LTEFdd1 LTEFdd2 LTEFdd3 WCDMa1 WCDMa2 WCDMa3 GSM1 GSM2 GSM3 CDMA1 CDMA2 CDMA3 EVDO1 EVDO2 EVDO3 LTETdd1 LTETdd2 LTETdd3 TDSCdma1 TDSCdma2 TDSCdma3, <string>
Example	MMEM:LOAD:PSET LTEF1,"LTE FDD.set"
Notes	The first enum selects the destination format parameter set to which the file data are imported.
Initial S/W Revision	A.10.00
Modified at S/W Revision	A.12.00, A.16.00

Masks

This key enables you to recall a preset mask file which contains Offset and Limit settings. Parameters except them will not be overwritten. You cannot change or create preset mask files since they are binary files. This key is valid for the Spectrum Emission Mask, ACP and Spurious Emissions measurements.

Default path: "My Documents\MSR\data\masks"

Note that **"My Documents"** is an alias to a directory and its location depends on which user is logged in. At XSA start up, all of the limit mask files in the current user's "My Documents\MSR\data\masks" directory are overwritten.

File type: Binary

Filename: The filename follows the rule below with the words connected using underscores.

<Measurement>_<Condition>.mask

Where

<Measurement> Measurement the limit mask file is applied to: SEM, ACP or SPUR

<Condition> Condition. It depends on the measurement.

File extension: .mask

File Dialog Filter: Preset Mask Files (*.mask)

Selecting OPEN... under the Import Data menu opens the above directory enabling you to select a mask file.

Details of the masks are provided in a PDF file in the default folder of masks.

Key Path	Recall, Data
Mode	MSR
Remote Command	MMEMory:LOAD:MASK <string>
Example	MMEM:LOAD:MASK "ACP_BS\ACP_BS_3MHz_pairE-UTRA_CatA.mask"

Notes	Parameters related to Limit and Offset are overwritten by the contents of the preset mask file.
Initial S/W Revision	A.10.00

Open...

When you press “Open”, the analyzer brings up a Windows dialog and a menu entitled “**File Open.**” This menu allows you to navigate to the various fields in the Windows dialog without using a keyboard or mouse. The **Tab** and **Arrow** keys can also be used for dialog navigation.

See "[From File...](#)" on page 2454 in **Recall, State**, for a full description of this dialog and menu.

Key Path	Recall, Data
Notes	The key location is mode-dependent and will vary. Brings up Open dialog for recalling a <mode specific> Save Type
Initial S/W Revision	Prior to A.02.00

Restart

The Restart function restarts the current sweep, or measurement, or set of averaged/held sweeps or measurements. If you are Paused, pressing Restart does a Resume.

The Restart function is accessed in several ways:

- Pressing the Restart key
- Sending the remote command INIT:IMMEDIATE
- Sending the remote command INIT:RESTART

See "[More Information](#)" on page 1090

Key Path	Front-panel key
Remote Command	:INITiate[:IMMEDIATE] :INITiate:RESTART
Example	:INIT:IMM :INIT:REST
Notes	:INITiate:RESTART and :INITiate:IMMEDIATE perform exactly the same function.
Couplings	Resets average/hold count k. For the first sweep overwrites all active (update=on) traces with new current data. For application modes, it resets other parameters as required by the measurement.
Status Bits/OPC dependencies	This is an Overlapped command. The STATus:OPERation register bits 0 through 8 are cleared. The STATus:QUESTionable register bit 9 (INTEgrity sum) is cleared. The SWEEPING bit is set. The MEASURING bit is set.
Backwards Compatibility Notes	For Spectrum Analysis mode in ESA and PSA, the Restart hardkey and the INITiate:RESTART command restart trace averages (displayed average count reset to 1) for a trace in Clear Write , but did not restart Max Hold and Min Hold . In the X-Series, the Restart hardkey and the INITiate:RESTART command restart not only Trace Average , but MaxHold and MinHold traces as well. For wireless comms modes in ESA and PSA, the Restart hardkey and the INITiate:RESTART command restart every measurement, which includes all traces and numeric results. There is no change to this operation.
Initial S/W Revision	Prior to A.02.00

More Information

The **Restart** function first aborts the current sweep/measurement as quickly as possible. It then resets the sweep and trigger systems, sets up the measurement and initiates a new data measurement sequence with a new data acquisition (sweep) taken once the trigger condition is met.

If the analyzer is in the process of aligning when **Restart** is executed, the alignment finishes before the restart function is performed.

Even when set for Single operation, multiple sweeps may be taken when Restart is pressed (for example, when averaging/holding is on). Thus when we say that **Restart** "restarts a measurement," we may mean:

- It restarts the current sweep
- It restarts the current measurement
- It restarts the current set of sweeps if any trace is in Trace Average, Max Hold or Min Hold
- It restarts the current set of measurements if Averaging, or Max Hold, or Min Hold is on for the measurement
- depending on the current settings.

With **Average/Hold Number** (in **Meas Setup** menu) set to 1, or Averaging off, or no trace in Trace Average or Hold, a single sweep is equivalent to a single measurement. A single sweep is taken after the trigger condition is met; and the analyzer stops sweeping once that sweep has completed. However, with **Average/Hold Number** >1 and at least one trace set to **Trace Average**, **Max Hold**, or **Min Hold (SA Measurement)** or **Averaging on (most other measurements)**, multiple sweeps/data acquisitions are taken for a single measurement. The trigger condition must be met prior to each sweep. The sweep is stopped when the average count k equals the number N set for **Average/Hold Number**. A measurement average usually applies to all traces, marker results, and numeric results; but sometimes it only applies to the numeric results.

Once the full set of sweeps has been taken, the analyzer will go to idle state. To take one more sweep without resetting the average count, increment the average count by 1, by pressing the step up key while **Average/Hold Number** is the active function, or sending the remote command CALC:AVER:TCON UP.

Save

In the MSR mode, two types of save functions are available under the Data menu: Parameter Sets and Meas Results.

Key Path	Front Panel
Mode	MSR
Initial S/W Revision	Prior to A.10.00
Modified at S/W Revision	A.10.00

State

The Save State menu lets you choose a register or file for saving the state.

The content of a state file includes all of the settings and data required to return the analyzer as closely as possible to the Mode it was in, with the exact settings which were in place, when the save occurred. The Mode settings in each state file include the settings that are affected by Mode Preset, as well as the additional settings affected by Restore Mode Defaults; all of the Mode's settings. In addition, all of the settings of the **Input/Output** system are included, even though they are outside of the Mode's state, because they are needed to restore the complete setup. Persistent **System** settings (for example, Verbose SCPI) are not affected by either Mode Preset or Restore Mode Defaults, nor are they included in a saved State file.

After the save completes, the message "File <filename> saved" or "State Register <register number> saved" is displayed.

For rapid saving, the State menu lists 16 registers to save to. Pressing a Register key initiates the save. You can also select a file to save to.

The default path for all State Files is:

My Documents\<<mode name>\state

where <mode name> is the parameter used to select the mode with the INST:SEL command (for example, SA for the Spectrum Analyzer).

Key Path	Save
Mode	All
Remote Command	:MMEMory:STORe:STATe <filename>
Example	MMEM:STOR:STATe "MyStateFile.state" This stores the current instrument state data in the file MyStateFile.state in the default directory.
Notes	Both single and double quotes are supported for any filename parameter over remote. After saving to a register, that register's menu key is updated with the date the time, unless a custom label has been entered for that key. After saving to a register, you remain in the Save State menu, so that you can see the Register key update. After saving to a file, the analyzer automatically returns to the previous menu and any Save As dialog goes away.

Backwards Compatibility SCPI	:MMEMory:STORe:STATe 1,<filename> For backwards compatibility, the above syntax is supported. The "1" is simply ignored. The command is sequential.
Initial S/W Revision	Prior to A.02.00

To File . . .

When you press “To File”, the analyzer brings up a Windows dialog and a menu entitled “**Save As.**” This menu allows you to navigate to the various fields in the Windows dialog without using a keyboard or mouse. The **Tab** and **Arrow** keys can also be used for dialog navigation.

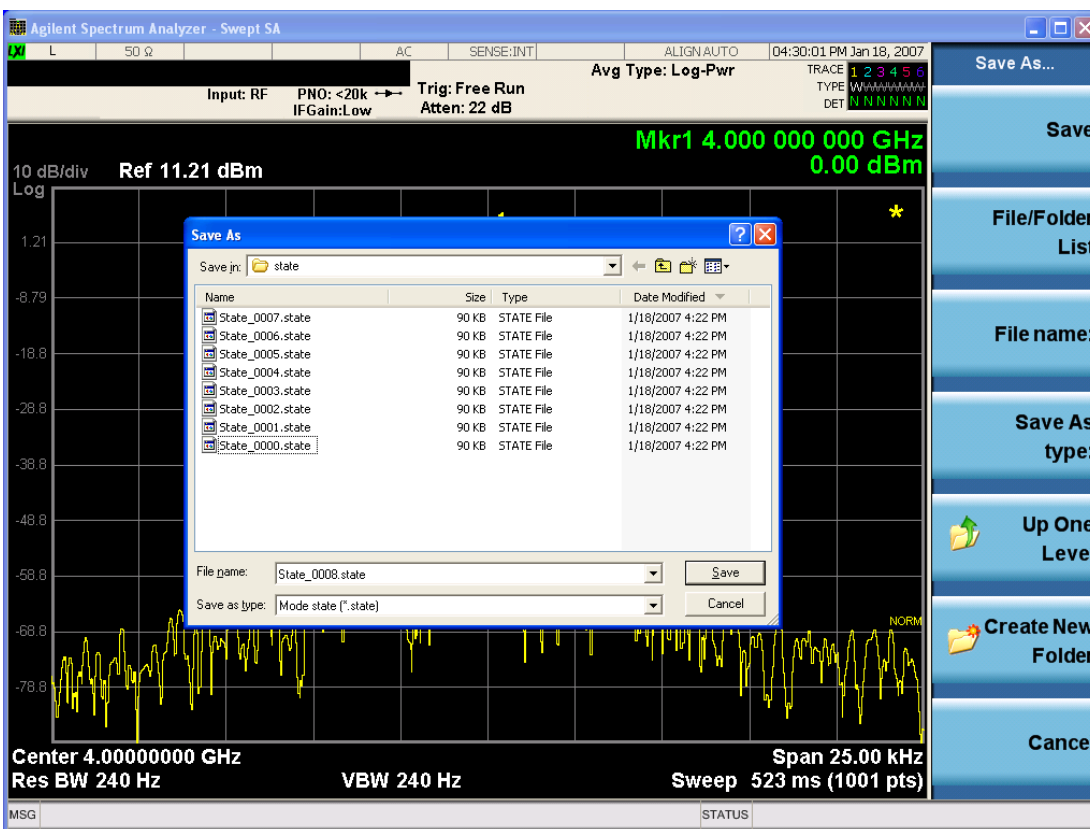

The Listed below

are the functions of the various fields in the dialog, and the corresponding softkeys:

Save

Performs the save to the specified file of the selected type. If the file already exists, a dialog will appear that allows you to replace the existing file by selecting **OK**, or you can **Cancel** the request. If you select **OK**, the file will be overwritten. Using the C: drive is strongly discouraged, since it runs the risk of being overwritten during an instrument software upgrade.

While the save is being performed, the floppy icon appears briefly in the Meas bar.

File/Folder List

Enables you to navigate to the center of the dialog that contains the list of files and folders. Once here you can get information about the file and use the tab keys to navigate to the other fields in the dialog, such as Save In.

Save In

The Save In field shows the path to which the file will be saved and allows you to change the path using the up and down arrow keys to navigate to other paths; the Enter key to open a directory; and the Backspace key to go back one directory. The **Save In field** defaults to the default path for this type of file and remembers the last path you used to save this type of file. There is no softkey for directly navigating to the Save In field but you can use left tab to get here from the File/Folder List.

User specified paths are remembered when you leave and return to a Mode and are reset back to the default using **Restore Mode Defaults**.

File Name

The **File Name** field is initially loaded with an automatically generated filename specific to the appropriate Save Type. The automatically generated filename is guaranteed not to conflict with any filename currently in the directory. You may replace or modify this filename using the File Name key. See the "[Quick Save](#)" on [page 2428](#) documentation for more on the automatic file naming algorithm.

When you press the **File Name** key the analyzer displays the Alpha Editor. Use the knob to choose the letter to add and the front-panel Enter key to add the letter to the file name. The BK character moves you back and the FW character moves you forward in the filename. The Select key on the front panel generates a space character. When you are done entering the filename press the **Done** softkey. This returns back to the **File Open** dialog and menu, but does not cause the save to occur.

Save As Type

This field shows the file suffix for the type of file you have selected to save. For example, if you navigated here while saving State, "Mode state (*.state)" is in the field. If you navigated here from saving Trace, ""Mode state (*.trace)" is in the field. If you navigated here while exporting a trace data file, "Trace Data (*.csv)" is in the field. For some file types, there is more than one choice in the dropdown, which you can select by using the up and down arrow keys and Enter.

Up One Level

This key corresponds to the icon of a folder with the up arrow that is in the tool bar of the dialog. When pressed, it causes the file and folder list to navigate up one level in the directory structure. The Backspace key does the same thing.

Create New Folder

This key corresponds to the icon of a folder with the "*" that is in the tool bar of the dialog. When pressed, a new folder is created in the current directory with the name **New Folder** and you can enter a new folder name using the Alpha Editor.

Cancel

This key corresponds to the **Cancel** selection in the dialog. It causes the current **Save As** request to be cancelled. The ESC key does the same thing.

Key Path	Save, State
----------	--------------------

Mode	All
Notes	Brings up Save As dialog for saving a State Save Type
Initial S/W Revision	Prior to A.02.00

Edit Register Names

You may enter a custom name on any of the Register keys, to help you remember what you are using that state to save. To do this, press the **Edit Register Names** key, choose the register whose name you wish to edit, and then enter the desired label using the Alpha Editor or an external PC keyboard.

The maximum number of characters that can be added is 30. In most cases, 30 characters will fit on two lines of the key.

See ["More Information" on page 1095](#)

Key Path	Save, State
Mode	All
Remote Command	:MMEMory:REGister:STATe:LABel <reg number>,"label" :MMEMory:REGister:STATe:LABel? <reg number>
Example	:MMEM:REG:STAT:LAB 1,"my label"
Notes	<reg number> is an integer from 1 to 16. If the SCPI specifies an invalid register number an error message is generated, -222,"Data out of range;Invalid register label number" "label" is a string from 0 to 30 characters in length. If a label exceeds 30 characters, an error message is generated, -150,"String data error;Label clipped to 30 characters" "label" of length 0 erases the custom label and restores the default (time and date) label. E.g.: :MMEM:REG:STAT:LAB 1,""
Dependencies	N9060A-7FP or N9060B-2FP license required to edit the register names. When the feature is not licensed, sending this command generates an error, -221,"Settings conflict;Option not available"
Preset	The names are unaffected by Preset or power cycle but are set to the default label (time and date) on a "Restore System Defaults->Misc"
Initial S/W Revision	A.11.00

More Information

When you edit one of the register names, the time and date field will be replaced by the custom name.

If you delete all the characters in the custom name, it restores the default (time and date).

The register names are stored within the state files, but they are not part of the instrument state; that is, once you have edited a register name, loading a new state will not change that register name. Another consequence of this is that the names will be persistent through a power cycle. Also, if a named state file is transferred to another analyzer, it will bring its custom name along with it.

If you try to edit the name of an empty register, the analyzer will first save the state to have a file to put the name in. If you load a named state file into an analyzer with older firmware it will ignore the metadata.

The *SAV and *RCL commands will not be affected by the custom register names, nor will the MMEM commands.

Register 1 thru Register 16

Selecting any one of these register menu keys causes the State of the currently active mode to be saved to the specified Register. The registers are provided for rapid saving and recalling, since you do not need to specify a filename or navigate to a file. Each of the register menu keys annotates whether it is empty or at what date and time it was last modified. In addition, you can use the **Edit Register Names** key to enter custom names for each register.

Although these 16 registers are the only registers available from the front panel, there are 128 state registers available in the instrument. Registers 17–128 are only available from the SCPI interface, using the *SAV command.

There is one set of 128 state registers in the instrument, not one set for each Mode. When a state is saved, the Mode it was saved from is saved with it; then when it is recalled, the instrument switches to that Mode.

After the save completes, the corresponding register menu key annotation is updated with the date and time and the message "Register <register number> saved" is displayed.

Key Path	Save, State
Mode	All
Example	*SAV 1
Range	1–16 from front panel, 1–128 from SCPI
Readback	Date and time with seconds resolution are displayed on the key OR A custom name of up to 30 characters entered using the Edit Register Names key OR “(empty)” if no prior save operation has been performed to this register.
Initial S/W Revision	Prior to A.02.00
Modified at S/W Revision	A.11.00

Register 1 thru Register 16

Selecting any one of these register menu keys causes the State of the currently active mode to be saved to the specified Register. The registers are provided for rapid saving and recalling, since you do not need to specify a filename or navigate to a file. Each of the register menu keys annotates whether it is empty or at what date and time it was last modified. In addition, you can use the **Edit Register Names** key to enter custom names for each register.

Although these 16 registers are the only registers available from the front panel, there are 128 state registers available in the instrument. Registers 17–128 are only available from the SCPI interface, using the *SAV command.

There is one set of 128 state registers in the instrument, not one set for each Mode. When a state is saved, the Mode it was saved from is saved with it; then when it is recalled, the instrument switches to that Mode.

After the save completes, the corresponding register menu key annotation is updated with the date and time and the message "Register <register number> saved" is displayed.

Key Path	Save, State
Mode	All
Example	*SAV 1
Range	1-16 from front panel, 1-128 from SCPI
Readback	Date and time with seconds resolution are displayed on the key OR A custom name of up to 30 characters entered using the Edit Register Names key OR “(empty)” if no prior save operation has been performed to this register.
Initial S/W Revision	Prior to A.02.00
Modified at S/W Revision	A.11.00

Mass Storage Catalog (Remote Command Only)

Key path	SCPI Only
Remote Command	:MMEMory:CATalog? [<directory_name>]
Notes	The string must be a valid logical path. Queries disk usage information (drive capacity, free space available) and obtains a list of files and directories in a specified directory in the following format: <numeric_value>,<numeric_value>,{<file_entry>} It returns two numeric parameters and as many strings as there are files and directories. The first parameter indicates the total amount of storage currently used in bytes. The second parameter indicates the total amount of storage available, also in bytes. The <file_entry> is a string. Each <file_entry> indicates the name, type, and size of one file in the directory list: <file_name>,<file_type>,<file_size> As the windows file system has an extension that indicates file type, <file_type> is always empty. <file_size> provides the size of the file in bytes. For directories, <file_entry> is surrounded by square brackets and both <file_type> and <file_size> are empty
Initial S/W Revision	Prior to A.02.00

Mass Storage Change Directory (Remote Command Only)

Key path	SCPI Only
Remote Command	:MMEMory:CDIRectory [<directory_name>] :MMEMory:CDIRectory?
Notes	The string must be a valid logical path. Changes the default directory for a mass memory file system. The <directory_name> parameter is a string. If no parameter is specified, the directory is set to the *RST value.

	At *RST, this value is set to the default user data storage area, that is defined as System.Environment.SpecialFolder.Personal. Query returns full path of the default directory.
Initial S/W Revision	Prior to A.02.00

Mass Storage Copy (Remote Command Only)

Key path	SCPI Only
Remote Command	:MMEMory:COpy <string>,<string>[,<string>,<string>]
Notes	<p>The string must be a valid logical path.</p> <p>Copies an existing file to a new file or an existing directory to a new directory.</p> <p>Two forms of parameters are allowed. The first form has two parameters. In this form, the first parameter specifies the source, and the second parameter specifies the destination.</p> <p>The second form has four parameters. In this form, the first and third parameters specify the source. The second and fourth parameters specify the directories. The first pair of parameters specifies the source. The second pair specifies the destination. An error is generated if the source doesn't exist or the destination file already exists.</p> <p>This command will generate an "access denied" error if the destination is a restricted folder (e.g., C:\Windows) and the current user does not have Power User or Administrator privileges.</p>

Mass Storage Device Copy (Remote Command Only)

This command transfers data to/from a file and a peripheral device.

Key path	SCPI Only
Remote Command	:MMEMory:COpy:DEvice <source_string>,<dest_string>
Notes	<p>The strings must be a valid logical path or a valid device keyword. If the dest_string is a device keyword, the data is copied from the source file to the device. If the source_string is a device keyword, the data is copied to the source file from the device.</p> <p>Valid device keywords are:</p> <p>SNS (smart noise source)</p> <p>An error is generated if the file or device is not found.</p>

Mass Storage Delete (Remote Command Only)

Key path	SCPI Only
Remote Command	:MMEMory:DElete <file_name>[,<directory_name>]
Notes	<p>The string must be a valid logical path.</p> <p>Removes a file from the specified directory. The <file_name> parameter specifies the file name to be removed. This command will generate an "access denied" error if the file is in a restricted folder (e.g.,</p>

C:\Windows) and the current user does not have Power User or Administrator privileges.

Initial S/W Revision Prior to A.02.00

Mass Storage Data (Remote Command Only)

Creates a file containing the specified data OR queries the data from an existing file.

Key path	SCPI Only
Remote Command	:MMEMory:DATA <file_name>, <data> :MMEMory:DATA? <file_name>
Notes	The string must be a valid logical path. The command form is MMEMory:DATA <file_name>,<data>. It loads <data> into the file <file_name>. <data> is in 488.2 block format. <file_name> is string data. The query form is MMEMory:DATA? <file_name> with the response being the associated <data> in block format.
Initial S/W Revision	Prior to A.02.00

Mass Storage Make Directory (Remote Command Only)

Key path	SCPI Only
Remote Command	:MMEMory:MDIRectory <directory_name>
Notes	The string must be a valid logical path. Creates a new directory. The <directory_name> parameter specifies the name to be created. This command will generate an “access denied” error if the new directory would be in a restricted folder (e.g., C:\Windows) and the current user does not have Power User or Administrator privileges.
Initial S/W Revision	Prior to A.02.00

Mass Storage Move (Remote Command Only)

Key path	SCPI Only
Remote Command	:MMEMory:MOVE <string>,<string> [,<string>,<string>]
Notes	The string must be a valid logical path. Moves an existing file to a new file or an existing directory to a new directory. Two forms of parameters are allowed. The first form has two parameters. In this form, the first parameter specifies the source, and the second parameter specifies the destination. The second form has four parameters. In this form, the first and third parameters specify the source. The second and fourth parameters specify the directories. The first pair of parameters specifies the source. The second pair specifies the destination. An error is generated if the source doesn't exist or the destination file already exists.

	This command will generate an “access denied” error if the destination is a restricted folder (e.g., C:\Windows) and the current user does not have Power User or Administrator privileges.
Initial S/W Revision	Prior to A.02.00

Mass Storage Remove Directory (Remote Command Only)

Key path	SCPI Only
Remote Command	:MMEMory:RDIRectory <directory_name>
Notes	The string must be a valid logical path. Removes a directory. The <directory_name> parameter specifies the directory name to be removed. All files and directories under the specified directory shall also be removed. This command will generate an “access denied” error if the folder is a restricted folder (e.g., C:\Windows) or is in a restricted folder and the current user does not have Power User or Administrator privileges.
Initial S/W Revision	Prior to A.02.00

Mass Storage Determine Removable Media (Remote Command Only)

This command is used to determine if any removable media devices are connected to the instrument. Primarily, these are USB memory devices plugged-in to the front panel or rear panel USB ports. On instruments with PC6 or PC7 CPU’s, one SD card slot is available for removable media. The instrument’s primary disk drive is not a removable media device.

Key Path	SCPI Only
Remote Command	:MMEMory:RMEDIA:LIST?
Notes	The return value will be a string containing a list of partition identifiers which are removable media devices. Each identifier will be separated by a comma. If no removable media is present, an empty string will be returned. Examples: One removable device present will result in a return string of “F:”. Two removable devices present will result in a return string of “F:,G:”. No removable devices present will result in a return string of “”.
Initial S/W Revision	x.15.00

Mass Storage Determine Removable Media Label (Remote Command Only)

This command is used to set or query a removable media device’s label.

Key Path	SCPI Only
----------	------------------

Remote Command	:MMEMory:RMEDia:LABel <partition>,<string> :MMEMory:RMEDia:LABel? <partition>
Example	MMEM:RMED:LAB "F:","My Device"
Notes	If the <partition> specified does not exist or is not a removable media device the error -252,"Missing Media" will be generated. Setting the removable media label requires Administrative privileges. If the currently logged in user does not have appropriate privileges the error "-221.9900,Settings conflict;Administrator privileges required" is generated.
Initial S/W Revision	x.15.00

Mass Storage Determine Removable Media Write-protect status (Remote Command Only)

This command is used to query a removable media device's write-protect status.

Key Path	SCPI Only
Remote Command	:MMEMory:RMEDia:WPRotect? <partition>
Example	MMEM:RMED:WPR? "F:"
Notes	The return value is 1 if the device is write-protected, and 0 if the device is write-enabled. If the <partition> specified does not exist or is not a removable media device the error -252,"Missing Media" will be generated.
Preset	The return value will be depending on SD card installed.
Initial S/W Revision	x.15.00

Mass Storage Determine Removable Media size (Remote Command Only)

This command is used to query a removable media device's total memory size (not available memory size).

Key Path	SCPI Only
Remote Command	:MMEMory:RMEDia:SIZE? <partition>
Example	MMEM:RMED:SIZE? "F:"
Notes	The return value is integer value in GBytes. Any device which is less than 1 GB will return 0 GB. If the <partition> specified does not exist or is not a removable media device the error -252,"Missing Media" will be generated.
Initial S/W Revision	x.15.00

Trace (+State)

The **Save Trace (+State)** menu lets you choose a register or file specifying where to save the Trace+State state file.

A saved state contains all of the settings and data required to return the analyzer as closely as possible to the exact setup it had when the save occurred. This includes the Input/Output settings, even though they are outside of the Mode's state, because they are needed to restore the complete setup. A Trace+State file also includes trace data from one trace or all traces, which will load in View mode when the Trace+State file is recalled.

After the save completes, the message "File <filename> saved" or "Trace Register <register number> saved" is displayed.

For rapid saves, the Trace (+State) menu lists 5 registers to save to. Pressing a Register key initiates the save. You can also select a file to save to.

The default path for all State Files including .trace files is:

My Documents\<mode name>\state

where <mode name> is the parameter used to select the mode with the INST:SEL command (for example, Basic for the IQAnalyzer).

This key is grayed out for measurements that do not support trace saves. It is blanked for modes that do not support trace saves. Saving **Trace** is identical to saving State except a .trace extension is used on the file instead of .state, and internal flags are set in the file indicating which trace was saved. You may select to save one trace or ALL traces.

Key Path	Save
Mode	SA
Remote Command	:MMEMory:STORe:TRACe TRACE1 TRACE2 TRACE3 TRACE4 TRACE5 TRACE6 ALL,<filename> :MMEMory:STORe:TRACe:REGister TRACE1 TRACE2 TRACE3 TRACE4 TRACE5 TRACE6 ALL,<integer>
Example	:MMEM:STOR:TRAC TRACE1, "myState.trace" saves the file myState.trace on the default path and flags it as a "single trace" file with Trace 1 as the single trace (even though all of the traces are in fact stored). :MMEM:STOR:TRAC ALL, "myState.trace" saves the file myState.trace on the default path and flags it as an "all traces" file :MMEM:STOR:TRAC:REG TRACE1, 2 stores trace 1 data in trace register 2
Notes	This command actually performs a save state, which in the Swept SA measurement includes the trace data. However it flags it (in the file) as a "save trace" file of the specified trace (or all traces). Some modes and measurements do not have available all 6 traces. The Phase Noise mode command, for example, is: MMEMory:STORe:TRACe TRACE1 TRACE2 TRACE3 ALL,<filename> Some modes and measurements have more than 6 traces available. The Realtime SA mode command, for example, is: MMEMory:STORe:TRACe TRACE1 TRACE2 TRACE3 TRACE4 TRACE5 TRACE6 TRACE7 TRACE8 TRACE9 TRACE10 TRACE11 TRACE12 ALL,<filename> The range for the register parameter is 1-5 When you initiate a save, if the file already exists, a dialog will appear that allows you to replace the existing file by selecting OK or you can Cancel the request. If you select OK, the file will be overwritten. Using the C: drive is strongly discouraged, since it runs the risk of being overwritten during an instrument software upgrade. Both single and double quotes are supported for any filename parameter over remote.

After saving to a register, that register's menu key is updated with the date and time of the save. After saving to a register, you remain in the **Save Trace** menu, so that you can see the Register key update. After saving to a file, the analyzer automatically returns to the previous menu and any Save As dialog goes away.

Initial S/W Revision	Prior to A.02.00
----------------------	------------------

From Trace

Accesses a menu that enables you to select the trace to be saved. Once a trace is selected, the key returns to the Save Trace menu and the selected trace number is annotated on the key. The default is the currently selected trace, selected in this menu or in the Trace/Det, Export Data, Import Data or Recall Trace menus, except if you have chosen All then it remains chosen until you specifically change it to a single trace. To save the Trace you must select the **Save As** key in the Save Trace menu.

When you select a trace, it makes that trace the current trace, so it displays on top of all of the other traces.

Key Path	Save, Trace + State
Mode	SA
Initial S/W Revision	Prior to A.02.00

From File...

When you press "From File", the analyzer brings up a Windows dialog and a menu entitled "**File Open.**" This menu allows you to navigate to the various fields in the Windows dialog without using a keyboard or mouse. The **Tab** and **Arrow** keys can also be used for dialog navigation.

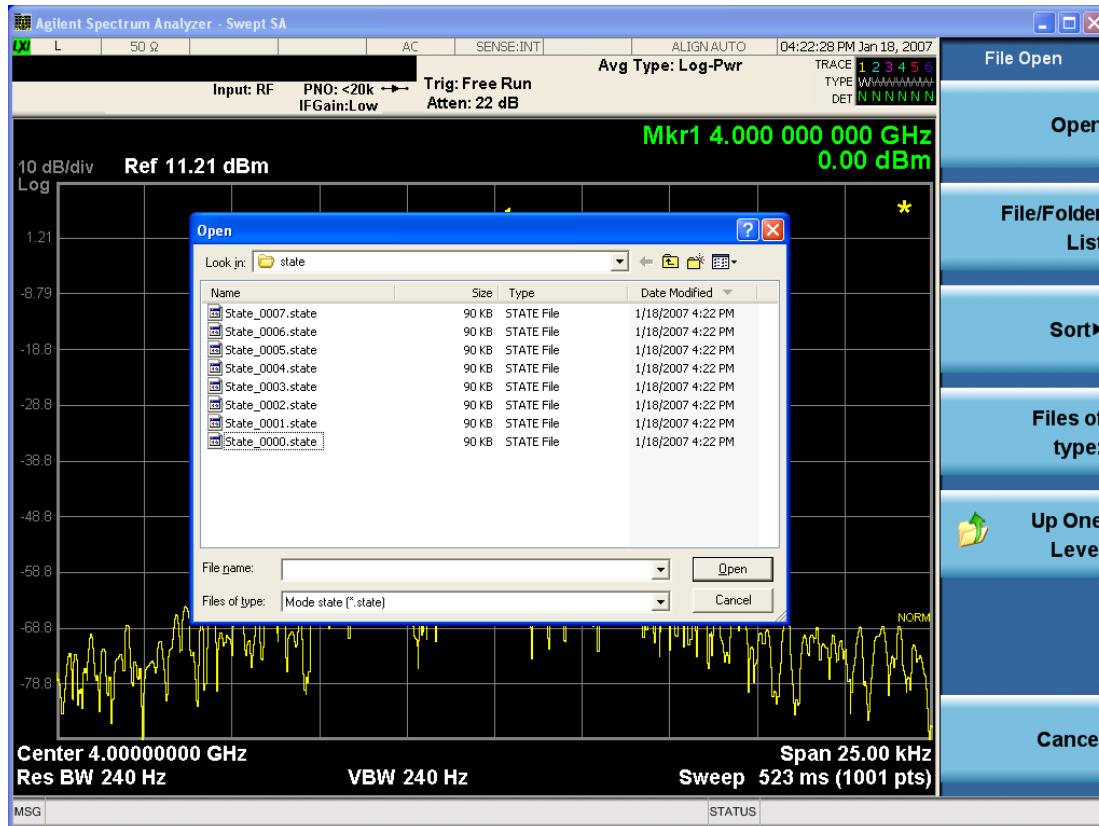

Listed below are the functions of the various fields in the dialog, and the corresponding softkeys:

Open

Performs the recall of the specified file. While the recall is being performed, the floppy icon appears briefly in the Meas bar.

File/Folder List

Enables you to navigate to the center of the dialog that contains the list of files and folders. Once here you can get information about the file and use the tab keys to navigate to the other fields in the dialog, such as Look In.

Look In

The **Look In** field shows the path from which the file will be recalled and allows you to change the path using the up and down arrow keys to navigate to other paths; the Enter key to open a directory; and the Backspace key to go back one directory. The **Look In field** first uses the last path from the Save As dialog **Save In:** path for that same file type. There is no softkey for directly navigating to the Look In field, but you can use the left tab to get here from the File/Folder List.

User specified paths are remembered when you leave and return to a Mode and are reset back to the default using **Restore Mode Defaults**.

Sort

Accesses a menu that enables you to sort the files within the File Open dialog. Only one sorting type can be selected at a time and the sorting happens immediately. The sorting types are **By Date**, **By Name**, **By extension**, and **By Size**.

Files of Type

This field shows the file suffix for the type of file you have selected to recall. For example, if you navigated here while recalling State, "Mode state (*.state)" is in the field. If you navigated here while recalling Trace, ""Mode state (*.trace)" is in the field. If you navigated here while importing a trace data file, "Trace Data (*.csv)" is in the field. For some file types, there is more than one choice in the dropdown menu, which you can select by using the up and down arrow keys and Enter.

Up One Level

This key corresponds to the icon of a folder with the up arrow that is in the tool bar of the dialog. When pressed, it causes the file and folder list to navigate up one level in the directory structure. The Backspace key does the same thing.

Cancel

This key corresponds to the **Cancel** selection in the dialog. It causes the current **Open** request to be cancelled. The ESC key does the same thing.

Key Path	Recall, State
Notes	Brings up the Open dialog for recalling a State Save Type
Initial S/W Revision	Prior to A.02.00

Register 1 thru Register 16

Selecting any one of these register menu keys causes the State of the currently active mode to be saved to the specified Register. The registers are provided for rapid saving and recalling, since you do not need to specify a filename or navigate to a file. Each of the register menu keys annotates whether it is empty or at what date and time it was last modified. In addition, you can use the **Edit Register Names** key to enter custom names for each register.

Although these 16 registers are the only registers available from the front panel, there are 128 state registers available in the instrument. Registers 17–128 are only available from the SCPI interface, using the *SAV command.

There is one set of 128 state registers in the instrument, not one set for each Mode. When a state is saved, the Mode it was saved from is saved with it; then when it is recalled, the instrument switches to that Mode.

After the save completes, the corresponding register menu key annotation is updated with the date and time and the message "Register <register number> saved" is displayed.

Key Path	Save, State
Mode	All
Example	*SAV 1
Range	1–16 from front panel, 1–128 from SCPI

Readback	Date and time with seconds resolution are displayed on the key OR A custom name of up to 30 characters entered using the Edit Register Names key OR “(empty)” if no prior save operation has been performed to this register.
Initial S/W Revision	Prior to A.02.00
Modified at S/W Revision	A.11.00

Data (Export)

Exporting a data file stores data from the current measurement to mass storage files. The Export Menu only contains data types that are supported by the current measurement.

Since the commonly exported data files are in .csv format, the data can be edited by you prior to importing. This allows you to export a data file, manipulate the data in Excel (the most common PC Application for manipulating .csv files) and then import it.

Selecting an Export Data menu key will not actually cause the exporting to occur, since the analyzer still needs to know where you wish to save the data. Pressing the Save As key in this menu brings up the Save As dialog and Save As menu that allows you to specify the destination file and directory. Once a filename has been selected or entered in the Open menu, the export will occur as soon as the Save key is pressed.

Key Path	Save
Mode	All
Notes	The menu is built from whatever data types are available for the mode. So the key locations in the sub menu will vary. No SCPI command directly controls the Data Type that this key controls. The Data Type is included in the MMEM:STORe commands.
Dependencies	If a file type is not used by a certain measurement, that type is grayed out for that measurement. The key for a file type will not show at all if there are no measurements in the Mode that support it.
Preset	Is not affected by a Preset or shutdown, but is reset during Restore Mode Defaults
Readback	The data type that is currently selected
Initial S/W Revision	Prior to A.02.00

Parameter Set

Enables you to export format parameter set data to files. Selecting this key displays a menu that enables you to select the data source. After making this selection, depress Save As... and use the file dialog to enter the file name to save. You can import the exported file by selecting Parameter Set under Recall, Data.

Default path:

Default path of this import type is “My Documents\MSR\data\params” folder. Note that “My Documents” is an alias to a directory and its location depends on which user is logged in. If the file path is specified without root folder, the export file is determined with the default path. For example if “folder1\paramData.prms” is specified, “My Documents\MSR\data\params\folder1\paramData.fps” is exported.

File Extension: fps

Default Prefix: ParamSet_

File Dialog Filter: Format Parameter Set Files (*.fps)

Key Path	Save, Data
Mode	MSR
Remote Command	MMEmory:STOR:PSET LTEFdd1 LTEFdd2 LTEFdd3 WCDma1 WCDma2 WCDma3 GSM1 GSM2 GSM3 CDMA1 CDMA2 CDMA3 EVDO1 EVDO2 EVDO3 LTETdd1 LTETdd2 LTETdd3 TDSCdma1 TDSCdma2 TDSCdma3, <string>
Example	MMEM:STOR:PSET WCDM1, "WCDMA.fps"
Notes	The first enum selects the source format parameter set from which the file data are exported.
Initial S/W Revision	A.10.00
Modified at S/W Revision	A.12.00, A.16.00

Measurement Results

Pressing this key selects Meas Results as the data type to be exported.

The Meas Results file contains information which describes the current state of the analyzer. It is detailed in Meas Result File Contents below.

Key Path	Save, Data
Remote Command	:MMEmory:STOR:RESults <string>
Example	:MMEM:STOR:RES "MeasR_0000.csv"
Notes	If the save is initiated via SCPI and the file already exists, the file will be overwritten. The SCPI command exports ACP measurement results to the file specified as the parameter in the current path. The default path is My Documents\<current mode>\data\ACP\results. Using the C: drive is strongly discouraged, since it runs the risk of being overwritten during an instrument software upgrade. The SCPI parameter is a quoted string that specifies the filename. Both single and double quotes are supported for any filename parameter over SCPI.
Dependencies	The current active measurement must be the ACP measurement to use this command.
Status Bits/OPC dependencies	Sequential – waits for the previous measurement to complete
Initial S/W Revision	Prior to A.02.00

Meas Results File Contents

A Meas Results File contains measurement results with the following information.

- File ID string, which is “MeasResult”
- Measurement ID following Mode ID, which is “SA:ACP” for example.
- Firmware rev and model number
- Option string
- Auto Scaling
- Auto Sweep Time Rules
- Automatic Trigger Time
- Automatic Trigger Time State
- Average Mode
- Average Number
- Average State
- Bar Graph
- Carrier Coupling
- Carrier Pwr Present
- Carrier Spacing
- Carriers
- Center Frequency
- Center Frequency Step
- Center Frequency Step State
- Detector Auto
- Detector Selection
- Electrical Atten
- Electrical Atten State
- External Array Trigger Delay
- External Array Trigger Delay State
- External Array Trigger Level
- External Array Trigger Slope
- Filter Alpha
- Filter BW

- Filter Type
- Internal Preamp
- Internal Preamp Band
- Limit Test
- Line Trigger Delay
- Line Trigger Delay State
- Line Trigger Slope
- Meas Method
- Meas Type
- Measurement Noise Bandwidth
- Mechanical Atten
- MechanicalAttenStepEnum
- Method
- Noise Correction
- Offset Abs Limit
- Offset Fail
- Offset Filter Alpha
- Offset Filter BW
- Offset Filter Type
- Offset Freq
- Offset Freq State
- Offset Integ BW
- Offset Method
- Offset Rel Lim (Car)
- Offset Rel Lim (PSD)
- Offset Res BW
- Offset Res BW Mode
- Offset Video BW
- Offset Video BW Mode
- Periodic Timer Period
- Periodic Timer Sync Source

- Periodic Timer Trigger Delay
- Periodic Timer Trigger Delay State
- Points
- Power Ref
- Power Ref State
- Preselector Adjust
- PSD Ref
- PSD Unit
- Ref Car Freq
- Ref Car Freq State
- Ref Carrier
- Ref Carrier Mode
- Ref Position
- Ref Value
- Res BW
- Res BW Mode
- RFBurst Trigger Delay
- RFBurst Trigger Delay State
- RFBurst Trigger Level Abs
- RFBurst Trigger Level Rel
- RFBurst Trigger Level Type
- RFBurst Trigger Slope
- Scale/Div
- Span
- Sweep Time
- Sweep Time Auto
- Trigger Holdoff
- Trigger Holdoff State
- Trigger Source
- Video BW
- Video BW Auto

The file contains these data followed by MeasResult1, MeasResult2, and MeasResult3 that flag the start of the measurement results. Each line of Measurement Results consists of three comma separated values, MeasResult1 value, MeasResult2 value, and MeasResult3 value. MeasResult1 contains the same result as MEAS/READ/FETCH:ACPower1; MeasResult2, MEAS/READ/FETCH:ACPower2; MeasResult3, MEAS/READ/FETCH:ACPower3.

Exported file is .csv file. The Meas Results file, when imported into Excel, will show the following data:

MeasResult												
SA:ACP												
A.10.53	N9030A											
526 ALV ATP	1											
B1X B1Y B25												
B40 BBA CR3												
CRP DCF DDA												
DP2 DRD EA3												
EDP EMC EP1												
ERC ESC ESP												
EXM FSA LFE												
LNP MAT MPB												
NFE NUL P26												
PFR PNC RTL												
RTS S40 SB1												
SEC SM1 TVT												
YAS YAV												
Auto Scaling	TRUE											
Auto Sweep Time Rules	Accy											
Automatic Trigger Time	0.1											
Automatic Trigger Time State	FALSE											
Average Mode	Exponential											
Average Number	10											
Average State	TRUE											
Bar Graph	TRUE											
Carrier Coupling	TRUE	TRUE	TRUE	TRUE	TRUE	TRUE	TRUE	TRUE	TRUE	TRUE	TRUE	TRUE
Carrier Pwr Present	Yes	Yes	Yes	Yes	Yes	Yes	Yes	Yes	Yes	Yes	Yes	Yes
Carrier Spacing	5000000	500000	500000	500000	500000	500000	500000	500000	500000	500000	500000	500000
Carriers	1											

Center Frequency	1.33E+10												
Center Frequency Step	800000												
Center Frequency Step State	TRUE												
Detector Auto	TRUE												
Detector Selection	Average												
Electrical Atten	0												
Electrical Atten State	FALSE												
External Array Trigger Delay	1.00E-06	1.00E-06											
External Array Trigger Delay State	FALSE	FALSE											
External Array Trigger Level	1.2	1.2											
External Array Trigger Slope	Positive	Positive											
Filter Alpha	0.22	0.22	0.22	0.22	0.22	0.22	0.22	0.22	0.22	0.22	0.22	0.22	0.22
Filter BW	Minus3dB												
Filter Type	Gaussian												
Internal Preamp	FALSE												
Internal Preamp Band	Low												
Limit Test	FALSE												
Line Trigger Delay	1.00E-06												
Line Trigger Delay State	FALSE												
Line Trigger Slope	Positive												
Meas Method	IbwSpeed												
Meas Type	TPRef												
Measurement	2000000	2000	200	200	200	200	200	200	200	200	200	200	200

Noise Bandwidth	000	000	000	000	000	000	000	000	000	000	000	000
Mechanical Atten	10	0	0	0	0	0	0	0	0	0	0	0
MechanicalAttenStepEnum	S2dB											
Method	IBW	IBW	IBW	IBW	IBW	IBW	IBW	IBW	IBW	IBW	IBW	IBW
Noise Correction	FALSE											
Offset Abs Limit	0	0	0	0	0	0						
Offset Fail	Relative	Relative	Relative	Relative	Relative	Relative						
Offset Filter Alpha	0.22											
Offset Filter BW	Minus3dB	Minus3dB	Minus3dB	Minus3dB	Minus3dB	Minus3dB						
Offset Filter Type	Gaussian	Gaussian	Gaussian	Gaussian	Gaussian	Gaussian						
Offset Freq	3000000	0	0	0	0	0						
Offset Freq State	TRUE	FALSE	FALSE	FALSE	FALSE	FALSE						
Offset Integ BW	2000000	2000000	200000	200000	200000	200000						
Offset Method	FALSE											
Offset Rel Lim (Car)	-45	-60	0	0	0	0						
Offset Rel Lim (PSD)	-28.87	-43.87	0	0	0	0						
Offset Res BW	220000	220000	220000	220000	220000	220000						
Offset Res BW Mode	TRUE	TRUE	TRUE	TRUE	TRUE	TRUE						
Offset Video BW	22000	22000	22000	22000	22000	22000						
Offset Video BW Mode	TRUE	TRUE	TRUE	TRUE	TRUE	TRUE						
Periodic Timer Period	0.02											
Periodic Timer	None											

Sync Source	
Periodic Timer Trigger Delay	1.00E-06
Periodic Timer Trigger Delay State	FALSE
Points	1001
Power Ref	-76.81 dBm
Power Ref State	On
Preselector Adjust	0
PSD Ref	-139.82 dBm/Hz
PSD Unit	DbmHz
Ref Car Freq	13.25500 0000 GHz
Ref Car Freq State	On
Ref Carrier	1
Ref Carrier Mode	On
Ref Position	Top
Ref Value	-30
Res BW	220000
Res BW Mode	FALSE
RFBurst Trigger Delay	1.00E-06
RFBurst Trigger Delay State	FALSE
RFBurst Trigger Level Abs	-20
RFBurst Trigger Level Rel	-6
RFBurst Trigger Level Type	Absolute
RFBurst	Positive

Trigger Slope		
Scale/Div	10	
Span	8000000	
Sweep Time	0.02	
Sweep Time Auto	TRUE	
Trigger Holdoff	0.1	
Trigger Holdoff State	FALSE	
Trigger Source	Free	
Video BW	22000	
Video BW Auto	TRUE	
MeasResult1	MeasResult 2	Meas Result 3
-	0	1
76.80585177 44559		
0.084790019 950006	- 76.80585 17744559	0
0.028392912 8313787	-999	1
	-999	0
	-999	1

Save As . . .

When you press “Save As”, the analyzer brings up a Windows dialog and a menu entitled “**Save As.**” This menu allows you to navigate to the various fields in the Windows dialog without using a keyboard or mouse. The **Tab** and **Arrow** keys can also be used for dialog navigation.

See ["To File . . ." on page 2444](#) in **Save, State** for a full description of this dialog and menu.

The default path for saving files is:

For all of the Trace Data Files:

My Documents\`<mode name>`\data\traces

For all of the Limit Data Files:

My Documents\`<mode name>`\data\limits

For all of the Measurement Results Data Files:

My Documents\`<mode name>`\data\`<measurement name>`\results

For all of the Capture Buffer Data Files:

My Documents\`<mode name>`\data\captureBuffer

Key Path	Save, Data
Mode	All
Notes	The key location is mode-dependent and will vary. Brings up the Save As dialog for saving a <code><mode specific></code> Save Type. The save is performed immediately and does not wait until the measurement is complete.
Initial S/W Revision	Prior to A.02.00

Screen Image

Pressing Screen Image accesses a menu of functions that enable you to specify a format and location for the saved screen image. It brings up a menu that allows you to specify the color scheme of the Screen Image (Themes) or navigate to the Save As dialog to perform the actual save.

Screen Image files contain an exact representation of the analyzer display. They cannot be loaded back onto the analyzer, but they can be loaded into your PC for use in many popular applications.

The image to be saved is actually captured when the **Save** front panel key is pressed, and kept in temporary storage to be used if you ask for a Screen Image save. When the Screen Image key is pressed, a "thumbnail" of the captured image is displayed, as shown below:

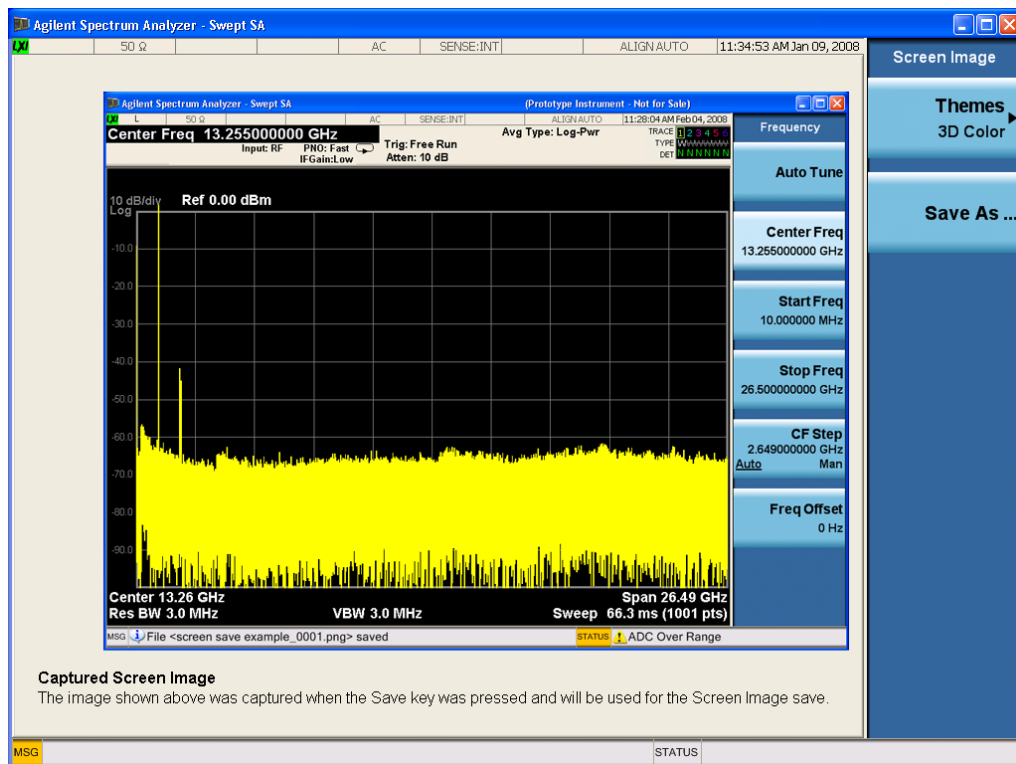

When you continue on into the **Save As** menu and complete the Screen Image save, the image depicted in the thumbnail is the one that gets saved, showing the menus that were on the screen before going into the **Save** menus. The save is performed immediately and does not wait until the measurement is complete.

After you have completed the save, the **Quick Save** front-panel key lets you quickly repeat the last save performed, using an auto-named file, with the current screen data.

NOTE

For versions previous to A.01.55, if you initiate a screen image save by navigating through the Save menus, the image that is saved will contain the Save menu softkeys, not the menus and the active function that were on the screen when you first pressed the Save front panel key.

Key Path	Save
Mode	All
Remote Command	:MMEMory:STORe:SCReen <filename>
Example	:MMEM:STOR:SCR "myScreen.png" This stores the current screen image in the file MyScreenFile.png in the default directory.
Initial S/W Revision	Prior to A.02.00

Themes

Accesses a menu of functions that enable you to choose the theme to be used when saving the screen image.

The **Themes** option is the same as the **Themes** option under the **Display** and **Page Setup** dialogs. It allows you to choose between themes to be used when saving the screen image.

Key Path	Save, Screen Image
Remote Command	:MMEMory:STORe:SCReen:THEMe TDColor TDMonochrome FCOlor FMONochrome :MMEMory:STORe:SCReen:THEMe?
Example	:MMEM:STOR:SCR:THEM TDM
Preset	3D Color; Is not part of Preset, but is reset by Restore Misc Defaults or Restore System Defaults All and survives subsequent running of the modes.
Readback	3D Color 3D Mono Flat Color Flat Mono
Backwards Compatibility Notes	In ESA and PSA we offer the choice of "Reverse Bitmap" or "Reverse Metafile" when saving screen images. This is much like the "Flat Color" theme available in X-Series. Also, if you selected Reverse Bitmap AND a black & white screen image, that would be much like "Flat Monochrome". In other words, each of the X-Series themes has a similar screen image type in ESA/PSA. But they are not identical.
Initial S/W Revision	Prior to A.02.00

3D Color

Selects a standard color theme with each object filled, shaded and colored as designed.

Key Path	Save, Screen Image, Themes
Example	MMEM:STOR:SCR:THEM TDC
Readback	3D Color
Initial S/W Revision	Prior to A.02.00

3D Monochrome

Selects a format that is like 3D color but shades of gray are used instead of colors.

Key Path	Save, Screen Image, Themes
Example	MMEM:STOR:SCR:THEM TDM
Readback	3D Mono
Initial S/W Revision	Prior to A.02.00

Flat Color

Selects a format that is best when the screen is to be printed on an ink printer.

Key Path	Save, Screen Image, Themes
Example	MMEM:STOR:SCR:THEM FCOL
Readback	Flat Color
Initial S/W Revision	Prior to A.02.00

Flat Monochrome

Selects a format that is like Flat Color. But only black is used (no colors, not even gray), and no fill.

Key Path	Save, Screen Image, Themes
Example	MMEM:STOR:SCR:THEM FMON
Readback	Flat Mono
Initial S/W Revision	Prior to A.02.00

Save As...

When you press "Save As", the analyzer brings up a Windows dialog and a menu entitled "**Save As.**" This menu allows you to navigate to the various fields in the Windows dialog without using a keyboard or mouse. The **Tab** and **Arrow** keys can also be used for dialog navigation.

See "[To File . . .](#)" on page 2444 in **Save, State** for a full description of this dialog and menu.

The default path for Screen Images is

My Documents\`<mode name>`\screen.

where `<mode name>` is the parameter used to select the mode with the INST:SEL command (for example, SA for the Spectrum Analyzer).

Key Path	Save, Screen Image
Notes	Brings up Save As dialog for saving a Screen Image Save Type
Initial S/W Revision	Prior to A.02.00

Single (Single Measurement/Sweep)

Sets the analyzer for Single measurement operation. The single/continuous state is Meas Global, so the setting will affect all the measurements. If you are Paused, pressing **Single** does a Resume.

See "[More Information](#)" on page 1120

Key Path	Front-panel key
Example	:INIT:CONT OFF
Notes	See Cont key description.
Backwards Compatibility Notes	<p>For Spectrum Analysis mode in ESA and PSA, the Single hardkey and the INITiate:IMM switched from continuous measurement to single measurement and restarted sweeps and averages (displayed average count reset to 1), but did not restart Max Hold and Min Hold. In the X-Series, the Single hardkey and the INITiate:IMM command initiate a sweep/ measurement/ average sequence/hold sequence including MaxHold and MinHold.</p> <p>For Spectrum Analysis mode in ESA and PSA, the Single hardkey restarted the sweep regardless of whether or not you were in an active sweep or sweep sequence. In the X-Series, Restart does this but Single only restarts the sweep or sweep sequence if you are in the idle state.</p> <p>INIT[:IMM] in ESA & PSA Spectrum Analysis Mode does an implied ABORT. In some other PSA Modes, INIT[:IMM] is ignored if not in the idle state. . The X-Series follows the ESA/PSA SA Mode model, which may cause some Modes to have compatibility problems.</p>
Initial S/W Revision	Prior to A.02.00

More Information

See "[Restart](#)" on page 2441 for details on the INIT:IMMEDIATE (Restart) function.

If you are already in single sweep, the INIT:CONT OFF command has no effect.

If you are already in Single Sweep, then pressing the **Single** key in the middle of a sweep does not restart the sweep or sequence. Similarly, pressing the **Single** key does not restart the sweep or sequence if the sweep is not in the idle state (for example, if you are taking a very slow sweep, or the analyzer is waiting for a trigger). Instead, it results in a message. "Already in Single, press Restart to initiate a new sweep or sequence". Even though pressing the **Single** key in the middle of a sweep does not restart the sweep, sending INIT:IMMEDIATE does reset it.

To take one more sweep without resetting the average count, increment the average count by 1, by pressing the step up key while **Average/Hold Number** is the active function, or sending the remote command CALC:AVER:TCON UP.

Source

There is no Source control functionality for this measurement. When this key is pressed, the screen either displays a blank menu, or the previously-selected menu remains unchanged.

Key Path	Front-panel key
----------	-----------------

SPAN X Scale

Accesses a menu of functions that enable you set the horizontal scale parameters.

Key Path	Front-panel key
Initial S/W Revision	Prior to A.02.00

Span

Changes the frequency range symmetrically about the center frequency.

The default (and minimum) span is calculated using the number of carriers and the carrier width where;

$$\text{Span} = (\text{Upper Carrier Freq} + (\text{max offset IBW} * (1 + \alpha)) / 2) - (\text{Lower Carrier Freq} - (\text{max offset IBW} * (1 + \alpha)) / 2)$$

The span is increased by a factor of 1 + Filter Alpha if the RRC Filter in on.

Key Path	SPAN X Scale
Mode	SA, WCDMA, C2K, WIMAX OFDMA, TD-SCDMA, 1xEVDO, DVB-T/H, DTMB (CTTB), ISDB-T, CMMB, LTE, LTEFDD, Digital Cable TV, MSR, LTEAFDD, LTEATDD
Remote Command	[:SENSe] :ACPowEr:FREQuency:SPAN <freq> [:SENSe] :ACPowEr:FREQuency:SPAN?
Example	ACP:FREQ:SPAN 25MHz ACP:FREQ:SPAN?
Notes	You must be in the mode that includes ACP measurements to use this command. Use :INSTrument:SElect to set the mode.
Couplings	The span value is clipped when the carrier settings and/or the offset settings are changed. The value is changed to satisfy following formula: $\text{Span} = (\text{Upper Carrier Freq} + (\text{max offset IBW} * (1 + \alpha)) / 2) - (\text{Lower Carrier Freq} - (\text{max offset IBW} * (1 + \alpha)) / 2)$ This parameter is unavailable when Meas Method is Fast Power. In that case, the span is fixed by the formula above and also, the maximum span should be less than or equal to 40 MHz to gain valid results.
Preset	SA: 8 MHz WCDMA: 24.6848 MHz WIMAX OFDMA: 50 MHz C2K: 4.5 MHz TD-SCDMA: 8 MHz 1xEVDO: 4.05 MHz DVB-T/H: 40 MHz DTMB (CTTB): 72 MHz ISDB-T: 30 MHz CMMB: 72 MHz

	LTE, LTE-TDD, MSR: 25 MHz Digital Cable TV: 40 MHz LTE-AFDD, LTE-TDD: 25MHz
State Saved	Saved in instrument state.
Min	10 Hz
Max	Hardware Dependent: Option 503 = 3.7 GHz Option 507 = 7.1 GHz Option 508 = 8.5 GHz Option 513 = 13.8 GHz Option 526 = 27.0 GHz
Initial S/W Revision	Prior to A.02.00
Modified at S/W Revision	A.02.00, A.03.00

Last Span

Changes the span to the previous span setting. If no previous span value exists, then the span will remain unchanged.

Key Path	SPAN X Scale
Mode	SA, WCDMA, C2K, WIMAX OFDMA, TD-SCDMA, 1xEVDO, DVB-T/H, DTMB (CTTB), ISDB-T, CMMB, LTE, LTE-TDD, Digital Cable TV, MSR, LTE-AFDD, LTE-TDD
Remote Command	[:SENSE] :ACPower:FREQUENCY:SPAN:PREVIOUS
Example	ACP:FREQ:SPAN:PREV
Notes	You must be in the mode that includes ACP measurements to use this command. Use :INSTRUMENT:SELECT to set the mode.
Initial S/W Revision	Prior to A.02.00
Modified at S/W Revision	A.02.00, A.03.00

Sweep/Control

Accesses a menu of functions that enable you to set up and control the sweep time, and source.

See "[Sweep/Control](#)" on page 2468 for more information.

Key Path	Front-panel key
Initial S/W Revision	Prior to A.02.00

Sweep Time

Selects the length of time in which the spectrum analyzer sweeps the displayed frequency span. In swept spans, the sweep time varies from 1 millisecond to 2000 seconds. Additional overhead time, which impacts the sweep rate, is not calculated as part of the sweep time. In fact:

sweep rate = span/sweep time

update rate = 1/(sweep time + overhead)

sweep cycle time = sweep time + overhead

Sweep time is coupled to RBW and VBW, and is impacted by the number of sweep points, so changing those parameters may change the sweep time.

If you increase the sweep time, you increase the length of the time data captured and the number of points measured. You might need to specify a specific sweep speed to accommodate a specific condition in your transmitter. For example, you may have a burst signal and need to measure an exact portion of the burst.

Selecting a specific sweep time may result in a long measurement time since the resulting number of data points may not be the optimum 2n. Use [:SENSe]:ACP:OFFSet:LIST:SWEEp:TIME to set the number of points used for measuring the offset channels for Basic and cdmaOne.

For cdma2000 and W-CDMA, this command sets the sweep time when using the sweep mode. See [:SENSe]:ACP:SWEEp:TYPE

Key Path	Sweep/Control
Mode	SA, WCDMA, C2K, WIMAX OFDMA, TD-SCDMA, 1xEVDO, DVB-T/H, DTMB (CTTB), ISDB-T, CMMB, LTE, LTETDD, Digital Cable TV, MSR, LTEAFDD, LTEATDD
Remote Command	[:SENSe]:ACP:Power:SWEEp:TIME <time> [:SENSe]:ACP:Power:SWEEp:TIME? [:SENSe]:ACP:Power:SWEEp:TIME:AUTO OFF ON 0 1 [:SENSe]:ACP:Power:SWEEp:TIME:AUTO?
Example	ACP:SWE:TIME 50ms ACP:SWE:TIME? ACP:SWE:TIME:AUTO OFF ACP:SWE:TIME:AUTO?
Notes	This parameter is preset by Meas Method selection. Preset values are as follows:

	IBW: 29 ms IBWR: 108 ms FAST (WCDMA): 7.5 ms
Preset	SA, LTE, LTETDD, MSR: Automatically calculated WCDMA: 29 ms WIMAX OFDMA: Automatically calculated C2K: Automatically calculated TD-SCDMA: Automatically calculated 1xEVDO: Automatically calculated DVB-T/H: Automatically calculated DTMB (CTTB): Automatically calculated ISDB-T: Automatically calculated CMMB: Automatically calculated Digital Cable TV: Automatically calculated LTEAFDD, LTEATDD: Automatically calculated SA, LTE, LTETDD, MSR, LTEAFDD, LTEATDD: ON WCDMA: OFF C2K: OFF (mehtod IBW) WIMAX OFDMA: ON TD-SCDMA: ON DVB-T/H: ON DTMB (CTTB): ON ISDB-T: ON CMMB: ON Digital Cable TV: ON
State Saved	Saved in instrument state.
Min	Min value depends on Meas Method. Meas Method is NOT FastPower: 1 ms Meas Method is FastPower: Automatically calculated (depends on Span)
Max	4000 s
Initial S/W Revision	Prior to A.02.00
Modified at S/W Revision	A.02.00, A.03.00

Sweep Setup

Accesses the sweep setup menu.

Key Path	Sweep/Control
Initial S/W Revision	Prior to A.02.00

Auto Sweep Time Rules

Switches the analyzer between normal and accuracy sweep states.

Key Path	Sweep/Control, Sweep Setup
Mode	SA, WCDMA, C2K, WIMAX OFDMA, TD-SCDMA, 1xEVDO, DVB-T/H, DTMB (CTTB), ISDB-T, CMMB, LTE, LTETDD, Digital Cable TV, MSR, LTEAFDD, LTEATDD
Remote Command	[:SENSe] :ACPoweR:SWEep:TIME:AUTO:RULEs NORMal ACCuracy [:SENSe] :ACPoweR:SWEep:TIME:AUTO:RULEs?
Example	ACP:SWE:TIME:AUTO:RUL NORM ACP:SWE:TIME:AUTO:RUL?
Notes	Set to Norm when Auto Couple is pressed or sent remotely.
Preset	SA, WCDMA, C2K, TD-SCDMA, 1xEVDO, DTMB (CTTB), LTE, LTETDD, MSR, LTEAFDD, LTEATDD: ACCuracy WIMAX OFDMA, DVB-T/H: NORMal ISDB-T, CMMB: NORMal Digital Cable TV: NORMal
State Saved	Saved in instrument state.
Range	Norm Accy
Initial S/W Revision	Prior to A.02.00
Modified at S/W Revision	A.02.00, A.03.00

Pause

Pauses a measurement after the current data acquisition is complete. When Paused, the label on the key changes to Resume. Pressing the Resume key resumes the measurement at the point where it was paused. When Paused, pressing **Restart**, **Single**, or **Cont** does a Resume

See "[Pause/Resume](#)" on page 2468 for more details.

Key Path	Sweep/Control
Initial S/W Revision	Prior to A.02.00

Gate

Accesses a menu that enables you to control the gating function. The Gate functionality is used to view signals best viewed by qualifying them with other events.

Gate setup parameters are the same for all measurements – they do not change as you change measurements. Settings like these are called “Meas Global” and are unaffected by Meas Preset.

Note that Sweep Time autocoupling rules and annotation are changed by Gate being on.

Key Path	Sweep/Control
Scope	Meas Global
Readback	The state and method of Gate, as [Off, LO] or [On, Video]. Note that for measurements that only support gated LO, the method is nonetheless read back, but always as LO.
Initial S/W Revision	Prior to A.02.00

Gate On/Off

Turns the gate function on and off.

When the Gate Function is on, the selected Gate Method is used along with the gate settings and the signal at the gate source to control the sweep and video system with the gate signal. Not all measurements allow every type of Gate Methods.

When Gate is on, the annunciation in the measurement bar reflects that it is on and what method is used, as seen in the following "Gate: LO" annunciator graphic.

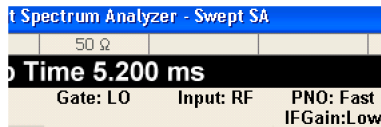

Key Path	Sweep/Control, Gate
Remote Command	<code>[:SENSe] :SWEep:EGATe [:STATe] OFF ON 0 1</code> <code>[:SENSe] :SWEep:EGATe [:STATe] ?</code>
Example	SWE:EGAT ON SWE:EGAT?

Dependencies

The function is unavailable (grayed out) and Off when:

- Gate Method is LO or Video and FFT Sweep Type is manually selected.
- Gate Method is FFT and Swept Sweep Type is manually selected.
- Marker Count is ON.

The following are unavailable whenever Gate is on:

- FFT under Sweep Type when Method=LO or Video or Swept under Sweep Type when Method=FFT
- **Marker Count**

While Gate is on, the Auto Rules for Sweep Type are modified so that the choice agrees with the Gate Method: i.e., FFT for Method = FFT and Swept for Method = LO or Video.

The Gate softkey and all SCPI under the [:SENSe]:SWEep:EGATe SCPI node are grayed out when

	<p>Source Mode is Tracking with an external source. This is because the Gate circuitry is used to sync the external source. If the Tracking Source is turned on, the Gate is turned off.</p> <p>When in the ACP measurement:</p> <ul style="list-style-type: none"> • When Meas Method is RBW or FAST, this function is unavailable and the key is grayed out. • Whenever Gate is on, Meas Method, RBW or FAST is unavailable and keys for those are grayed out. • When Gate is on, Offset Res BW and Offset Video BW are ignored (if you set these values) and the measurement works as if all Offset Res BW and all Offset Video BW are coupled with the Res BW and the Video BW under the BW menu. When Gate is on, the Offset BW key in the Offset/Limit menu is grayed out.
Preset	Off LTETDD: On
State Saved	Saved in instrument state
Range	On Off
Backwards Compatibility SCPI	[:SENSe]:SWEep:TIME:GATE[:STATe] ESA compatibility
Backwards Compatibility Notes	In ESA, Trig Delay (On) and Gate (On) could not be active at the same time.. This dependency does not exist in PSA or in the X-Series.
Initial S/W Revision	Prior to A.02.00

Gate View On/Off

Turning on Gate View in the Swept SA measurement provides a single-window gate view display..

Turning on Gate View in other measurements shows the split-screen Gate View. In these measurements, when the Gate View is on, the regular view of the current measurement traces and results are reduced vertically to about 70% of the regular height. The Zero Span window, showing the positions of the Gate, is shown between the Measurement Bar and the reduced measurement window. By reducing the height of the measurement window, some of the annotation on the Data Display may not fit and is not shown.

Key Path	Sweep/Control, Gate
Remote Command	[:SENSe]:SWEep:EGATe:VIEW ON OFF 1 0 [:SENSe]:SWEep:EGATe:VIEW?
Example	SWE:EGAT:VIEW ON turns on the gate view.
Dependencies	<p>In the Swept SA measurement:</p> <p>In Gate View, the regular Sweep Time key is grayed out . When pressed, the grayed out key puts up the informational message "Use Gate View Sweep Time in the Gate menu."</p> <p>In the other measurements:</p> <p>When you turn Gate View on, the lower window takes on the current state of the instrument. Upon leaving Gate View, the instrument takes on the state of the lower window.</p> <p>When you turn Gate View on, the upper window Sweep Time is set to the gate view sweep time.</p>
Couplings	<p>These couplings apply to the Swept SA measurement:</p> <ul style="list-style-type: none"> • When Gate View is turned on, the instrument is set to Zero Span.

- Gate View automatically turns off whenever a Span other than Zero is selected.
- Gate View automatically turns off if you press the Last Span key while in Gate View, and the instrument returns to the Span it was in before entering Gate View (even if that is Zero Span).
- When Gate View is turned on, the sweep time used is the gate view sweep time. This is set according to the rules in section "Gate View Setup" on page 2231
- When Gate View is turned off, Sweep Time is set to the normal Swept SA measurement sweep time.
- If Gate View is on and Gate is off, then turning on Gate turns off Gate View.

Preset	OFF
State Saved	Saved in instrument state
Range	On Off
Initial S/W Revision	Prior to A.02.00

A sample of the Gate View screen in the Swept SA measurement is shown in the following graphic :

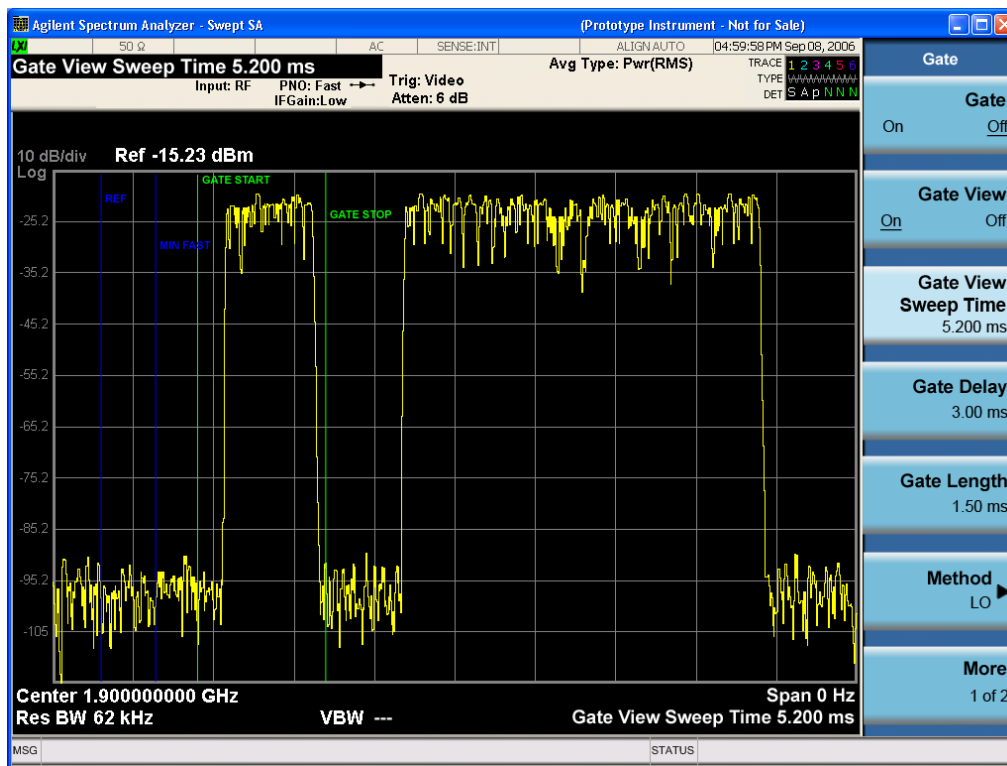

A sample of the Gate View screen in other measurements is shown in the following graphic . This example is for the ACP measurement:

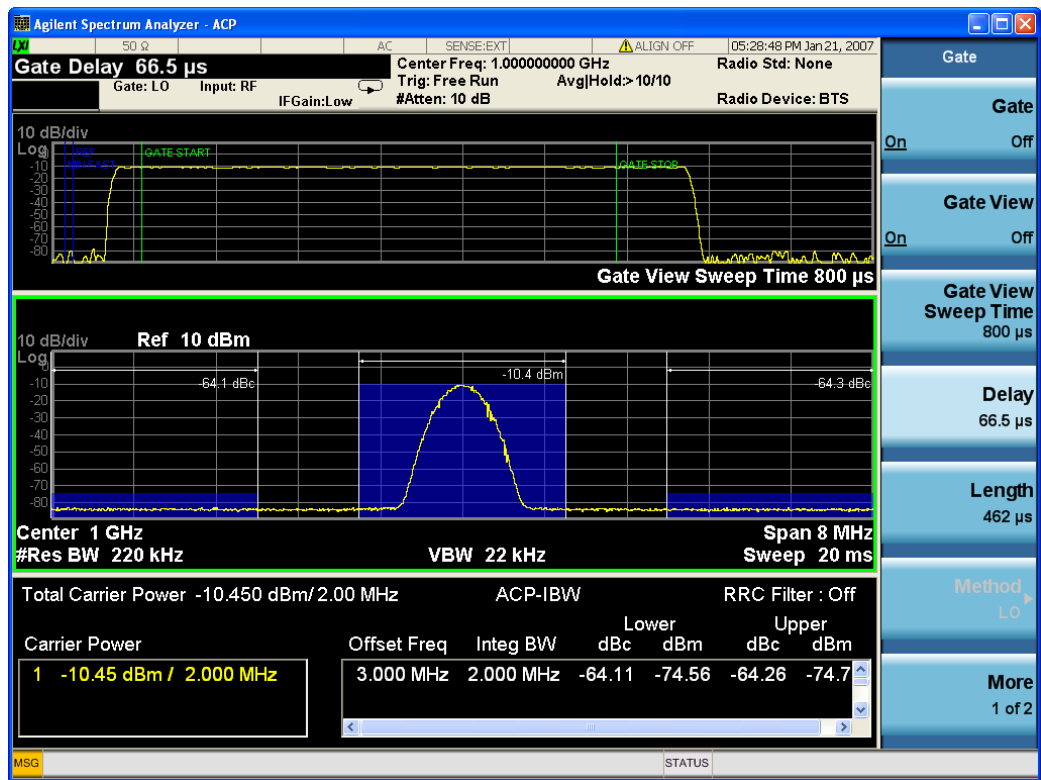

Turning Gate View off returns the analyzer to the Normal measurement view.

In the Swept SA, the normal measurement view is the single-window Swept SA view. When returning to this view, the Swept SA measurement returns to the Span it was in before entering **Gate View** (even if that is Zero Span).

The **Gate View** window is triggered from the Gate Source, with zero trigger delay. Also, when updating the **Gate View** window, the Gate itself must not operate. So it is internally shut off while the gate view window is being updated. For the Swept SA measurement, this means that the Gate is internally shut off whenever the gate view window is displayed. The measurement bar and softkeys continue to show the Trigger source for the main sweep window and give no indication that the Gate is shut off or that the Gate View window is triggered from the Gate Source.

When in **Gate View**, vertical lines are displayed in the Gate View window as follows:

- Green lines are displayed at the gate edges as follows: in Edge Gate, a line is shown for Delay and one for the end of the Gate period, defined by Length. In Level Gate a line is shown only for Delay. You can adjust the position of the green lines by adjusting the gate length and the gate delay. These lines update in the Gate View window as the active function changes, even if the window is not being updated. In Gated LO and Gated Video, these lines are positioned relative to the delay reference line (not relative to 0 time). In Gated FFT, their location is relative to the left edge of the screen.
- A blue line is displayed showing the delay reference, that is, the reference point for the Gate Delay within the Zero Span window. The blue line represents where (in time) the effective location of the gate start would be if the gate were programmed to zero delay.

- The second blue line is labeled "MIN FAST" as shown in the figure above because it represents the minimum Gate Delay for fast Gated LO operation. This line is only displayed in Gated LO. You cannot scroll (knob) or decrement (down key) the Gate Delay to less than that represented by the position of this line, it can only be set below this position manually, although once there it can be moved freely with the knob while below the line.
- A yellow line in the Gated Video case only, is displayed at $Blength$, where $Blength$ is the display point (bucket) length for the swept trace, which is given by the sweep time for that trace divided by number of Points – 1. So it is referenced to 0 time, not to the delay reference. This line is labeled NEXT PT (it is not shown in the figure above because the figure above is for Gated LO).
- The yellow line represents the edge of a display point (bucket). Normally in Gated Video, the bucket length must be selected so that it exceeds the off time of the burst. There is another way to use the analyzer in Gated Video measurements, and that is to set the bucket width much shorter than the off time of the burst. Then use the Max Hold trace function to fill in "missing" buckets more slowly. This allows you to see some of the patterns of the Gated Video results earlier, though seeing a completely filled-in spectrum later.

Gate View Setup

Accesses a menu that enables you to setup parameters relevant to the Gate View

Key Path	Sweep/Control, Gate
Scope	Meas Global
Initial S/W Revision	A.10.00

Gate View Sweep Time

Controls the sweep time in the Gate View window. To provide an optimal view of the gate signal, the analyzer initializes Gate View Sweep Time based on the current settings of Gate Delay and Gate Length.

Key Path	Sweep/Control, Gate, Gate View Setup
Remote Command	<code>[:SENSe] :SWEep:EGATe:TIME <time></code> <code>[:SENSe] :SWEep:EGATe:TIME?</code>
Example	SWE:EGAT:TIME 500 ms
Dependencies	Gate View Sweep Time is initialized: <ul style="list-style-type: none"> • On Preset (after initializing delay and length). • Every time the Gate Method is set/changed. <p>Additionally, in the Swept SA measurement, whenever you do a Preset, or leave Gate View, the analyzer remembers the Gate Delay and Gate Length settings. Then, when returning to Gate View, if the current Gate Delay and/or Gate Length do not match the remembered values Gate View Sweep Time is re-initialized.</p> <ol style="list-style-type: none"> 1. Compute the location of the "gate stop" line, which you know is at time $t = t_{min} + GateDelay + GateLength$.
Preset	519.3 μ s

	WiMAX OFDMA: 5 ms GSM/EDGE: 1 ms
State Saved	Saved in instrument state
Max	6000 s
Initial S/W Revision	Prior to A.02.00

Gate View Start Time

Controls the time at the left edge of the Gate View.

Key Path	Sweep/Control, Gate, Gate View Setup
Remote Command	[:SENSe] :SWEep:EGATe:VIEW:STARt <time> [:SENSe] :SWEep:EGATe:VIEW:STARt?
Example	SWE:EGAT:VIEW:STAR 10ms
Notes	Units of time are required or no units; otherwise an invalid suffix error message will be generated. See error -131.
Preset	0 ms
State Saved	Saved in instrument state
Min	0
Max	500 ms
Initial S/W Revision	A.10.00

Gate Delay

Controls the length of time from the time the gate condition goes True until the gate is turned on.

Key Path	Sweep/Control, Gate
Remote Command	[:SENSe] :SWEep:EGATe:DELay <time> [:SENSe] :SWEep:EGATe:DELay?
Example	SWE:EGAT:DELay 500ms SWE:EGAT:DELay?
Notes	Units of time are required or no units; otherwise an invalid suffix error message will be generated.
Preset	57.7 us WiMAX OFDMA: 71 us GSM/EDGE: 600 us WLAN: 500 us
State Saved	Saved in instrument state
Min	0.0 us

Max	100 s
Backwards Compatibility SCPI	[:SENSe]:SWEep:TIME:GATE:DELay ESA compatibility
Initial S/W Revision	Prior to A.02.00

Gate Length

Controls the length of time that the gate is on after it opens.

Key Path	Sweep/Control, Gate
Remote Command	[:SENSe]:SWEep:EGATe:LENGth <time> [:SENSe]:SWEep:EGATe:LENGth?
Example	SWE:EGAT:LENG 1 SWE:EGAT:LENG?
Notes	Units of time are required or no units; otherwise an invalid suffix error message will be generated.
Dependencies	

Grayed out when Gate Method is set to FFT in which case the label changes to that shown below.

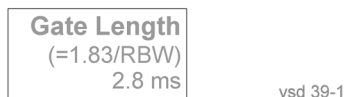

The key is also grayed out if Gate Control = Level.

Preset	461.6 us WiMAX OFDMA: 50 us GSM/EDGE: 200 us WLAN: 1.54 ms
State Saved	Saved in instrument state
Min	100 ns
Max	5 s
Backwards Compatibility SCPI	[:SENSe]:SWEep:TIME:GATE:LENGth ESA compatibility
Initial S/W Revision	Prior to A.02.00

Gate Source

The menus under the **Gate Source** key are the same as those under the **Trigger key**, with the exception that neither **Free Run** nor **Video** are available as Gate Source selections. However, a different SCPI command is used to select the Gate Source (see table below) because you may independently set the Gate Source and the Trigger Source.

Any changes to the settings in the setup menus under each Gate Source selection key (for example: Trigger Level, Trigger Delay, etc.) also affect the corresponding settings under the Trigger menu keys. The SCPI commands used for these are the same for Trigger and Gate, since there is only one setting which affects both Gate and Trigger. Example: to set the Trigger Level for External 1 you use the command :TRIG:EXT1:LEV regardless of whether you are using External 1 as a Trigger Source or a Gate Source.

Key Path	Sweep/Control, Gate
Remote Command	[:SENSe] :SWEep:EGATe:SOURce EXTernal1 EXTernal2 LINE FRAME RFBurst [:SENSe] :SWEep:EGATe:SOURce?
Dependencies	In some models, there is no second External input. In these models, the External 2 key is blanked and the EXTernal2 parameter will generate a "Hardware missing; Not available for this model number" error.
Preset	EXTernal 1 GSM/EDGE, MSR: FRAME LTETDD: EXTernal 1When Direction is Downlink, FRAME when Direction is Uplink.
Backwards Compatibility Notes	In ESA, there is a single Gate input port. In PSA, the Gate Source may be taken from one of two specified input ports. In the X-Series, any Trigger Source can be a Gate Source.
Initial S/W Revision	Prior to A.02.00
Modified at S/W Revision	A.03.00, A.14.00

Line

Pressing this key, when it is not selected, selects the line signal as the trigger. A new sweep/measurement will start synchronized with the next cycle of the line voltage. Pressing this key, when it is already selected, access the line trigger setup menu.

Key Path	Trigger
Example	TRIG:SOUR LINE Swept SA measurement TRIG:< meas > :SOUR LINE Measurements other than Swept SA
Dependencies	Line trigger is not available when operating from a "dc power source", for example, when the instrument is powered from batteries.
State Saved	Saved in instrument state
Status Bits/OPC dependencies	The Status Operation Register bit 5 "Waiting for Trigger" is set at the same time as the Sweeping or Measuring bit is set. It is cleared when the trigger actually occurs (that is, after the trigger event occurs and all the applicable trigger criteria have been met). A corresponding pop-up message ("Waiting for trigger") is generated if no trigger signal appears after approximately 2 sec. This message goes away when a trigger signal appears.
Initial S/W Revision	Prior to A.02.00

Trig Slope

Controls the trigger polarity. It is set positive to trigger on a rising edge and negative to trigger on a falling edge.

Key Path	Trigger, Line
Remote Command	:TRIGger[:SEquence]:LINE:SLOPe POSitive NEGative :TRIGger[:SEquence]:LINE:SLOPe?
Example	TRIG:LINE:SLOP NEG
Preset	POSitive
State Saved	Saved in instrument state
Backwards Compatibility Notes	The legacy :TRIGger[:SEquence]:SLOPe command affects the slopes for the VID, LINE, EXT1, EXT2, and RFB triggers.
Initial S/W Revision	Prior to A.02.00

External 1

Pressing this key, when it is not selected, selects an external input signal as the trigger. A new sweep/measurement will start when the external trigger condition is met using the external 1 input connector on the rear panel.

Pressing this key, when it is already selected, accesses the external 1 trigger setup menu.

Key Path	Trigger
Example	TRIG:SOUR EXT1 Swept SA measurement TRIG:<meas>:SOUR EXT1 Measurements other than Swept SA
Dependencies	Grayed out if in use by Point Trigger in the Source Setup menu. Forced to Free Run if already selected and Point Trigger is set to External 1.
State Saved	Saved in instrument state
Status Bits/OPC dependencies	The Status Operation Register bit 5 "Waiting for Trigger" is set at the same time as the Sweeping or Measuring bit is set. It is cleared when the trigger actually occurs (that is, after the trigger event occurs and all the applicable trigger criteria have been met). A corresponding pop-up message ("Waiting for trigger") is generated if no trigger signal appears after approximately 2 sec. This message goes away when a trigger signal appears.
Initial S/W Revision	Prior to A.02.00

Trigger Level

Sets the value where the external 1 trigger input will trigger a new sweep/measurement.

Key Path	Trigger, External 1
Remote Command	:TRIGger[:SEquence]:EXTernal1:LEVel <level>

	:TRIGger[:SEquence]:EXTernal:LEVel?
Example	TRIG:EXT1:LEV 0.4 V
Couplings	This same level is used for the Ext1 trigger source in the Trigger menu, for the Ext1 selection in the Periodic Timer sync source (in the Trigger menu and in the Gate Source menu), and also for the Ext1 selection in the Gate Source menu.
Preset	1.2 V
State Saved	Saved in instrument state
Min	-5 V
Max	5 V
Default Unit	V
Backwards Compatibility SCPI	:TRIGger[:SEquence]:EXTernal:LEVel
Backwards Compatibility SCPI	For backward compatibility, the parameter EXTernal is mapped to EXTernal1
Backwards Compatibility SCPI	:TRIGger[:SEquence]:FRAMe:EXTernal1:LEVel
Initial S/W Revision	Prior to A.02.00

Trig Slope

Controls the trigger polarity. It is set positive to trigger on a rising edge and negative to trigger on a falling edge.

Key Path	Trigger, External 1
Remote Command	:TRIGger[:SEquence]:EXTernal:SLOPe POSitive NEGative :TRIGger[:SEquence]:EXTernal:SLOPe?
Example	TRIG:EXT1:SLOP NEG
Couplings	This same slope is used in the Ext1 selection for the trigger source in the Trigger menu and for the period timer sync source (in the Trigger menu and in the Gate Source menu).
Preset	POSitive
State Saved	Saved in instrument state
Backwards Compatibility SCPI	:TRIGger[:SEquence]:EXTernal:SLOPe
Backwards Compatibility SCPI	For backward compatibility, the parameter EXTernal is mapped to EXTernal1
Backwards Compatibility SCPI	:TRIGger[:SEquence]:FRAMe:EXTernal1:SLOPe
Backwards Compatibility Notes	The legacy :TRIGger[:SEquence]:SLOPe command affects the slopes for the VID, LINE, EXT1, EXT2, and RFB triggers.
Initial S/W Revision	Prior to A.02.00

Zero Span Delay Comp On/Off

In zero span, there is a natural delay in the signal path, which comes from the RBW filter. This is usually desirable, as it allows you to trigger on events and also see those events, because the signal is delayed from the trigger event. However, in some cases it is desirable to eliminate this delay, so that trigger events line up exactly with the zero time point in zero span. You can use the **Zero Span Delay Comp On/Off** feature to enable or disable zero span delay compensation.

Key Path	Trigger, External 1
Remote Command	:TRIGger[:SEquence]:EXTernal1:DElay:COMPensation OFF ON 0 1 :TRIGger[:SEquence]:EXTernal1:DElay:COMPensation?
Example	TRIG:EXT1:DEL:COMP ON
Dependencies	No effect except in zero-span, but not locked out in nonzero spans. Blanked in modes that do not support zero-span measurements. If the SCPI command is sent when the key is blanked, an error is returned: -221, "Settings conflict; Feature not supported for this measurement" In analyzers shipping N9060A, this feature requires N9060A-7FP.
Preset	OFF
State Saved	Saved in instrument state
Initial S/W Revision	A.11.00

External 2

Pressing this key, when it is not selected, selects an external input signal as the trigger. A new sweep/measurement will start when the external trigger condition is met using the external 2 input connector. The external trigger 2 input connector is on the rear panel.

Pressing this key, when it is already selected, accesses the external 2 trigger setup menu.

Key Path	Trigger
Example	TRIG:SOUR EXT2 Swept SA measurement TRIG:<meas>:SOUR EXT2 Measurements other than Swept SA
Dependencies	In some models, there is no second External input. In these models, the External 2 key is blanked and the EXTernal2 parameter will generate a "Hardware missing; Not available for this model number" message. Grayed out if in use by Point Trigger in the Source Setup menu. Forced to Free Run if already selected and Point Trigger is set to External 2.
State Saved	Saved in instrument state
Status Bits/OPC dependencies	The Status Operation Register bit 5 "Waiting for Trigger" is set at the same time as the Sweeping or Measuring bit is set. It is cleared when the trigger actually occurs (that is, after the trigger event occurs and all the applicable trigger criteria have been met). A corresponding pop-up message ("Waiting for trigger") is generated if no trigger signal appears after approximately 2 sec. This message goes away when a trigger signal appears.

Initial S/W Revision	Prior to A.02.00
Modified at S/W Revision	A.03.00

Trigger Level

Sets the value where the external 2 trigger input will trigger a new sweep/measurement.

Key Path	Trigger, External 2
Remote Command	:TRIGger[:SEquence]:EXTernal2:LEVel :TRIGger[:SEquence]:EXTernal2:LEVel?
Example	TRIG:EXT2:LEV 1.1 V
Couplings	This same level is used for the Ext2 trigger source in the Trigger menu, for the Ext2 selection in the Periodic Timer sync source (in the Trigger menu and in the Gate Source menu), and also for the Ext2 selection in the Gate Source menu.
Preset	1.2 V
State Saved	Saved in instrument state
Min	-5 V
Max	5 V
Default Unit	V
Backwards Compatibility SCPI	:TRIGger[:SEquence]:FRAMe:EXTernal2:LEVel
Initial S/W Revision	Prior to A.02.00

Trig Slope

Controls the trigger polarity. It is set positive to trigger on a rising edge and negative to trigger on a falling edge.

Key Path	Trigger, External 2
Remote Command	:TRIGger[:SEquence]:EXTernal2:SLOPe POSitive NEGative :TRIGger[:SEquence]:EXTernal2:SLOPe?
Example	TRIG:EXT2:SLOP NEG
Couplings	This same slope is used in the Ext2 selection for the trigger source in the Trigger menu and for the period timer sync source (in the Trigger menu and in the Gate Source menu).
Preset	POSitive
State Saved	Saved in instrument state
Backwards Compatibility SCPI	:TRIGger[:SEquence]:FRAMe:EXTernal2:SLOPe
Backwards Compatibility Notes	The legacy :TRIGger[:SEquence]:SLOPe command affects the slopes for the VID, LINE, EXT1, EXT2, and RFB triggers.
Initial S/W Revision	Prior to A.02.00

Zero Span Delay Comp On/Off

In zero span, there is a natural delay in the signal path, which comes from the RBW filter. This is usually desirable, as it allows you to trigger on events and also see those events, because the signal is delayed from the trigger event. However, in some cases it is desirable to eliminate this delay, so that trigger events line up exactly with the zero time point in zero span. You can use the **Zero Span Delay Comp On/Off** feature to enable or disable zero span delay compensation.

Key Path	Trigger, External 2
Remote Command	:TRIGger[:SEquence]:EXTernal2:DElay:COMPensation OFF ON 0 1 :TRIGger[:SEquence]:EXTernal2:DElay:COMPensation?
Example	TRIG:EXT2:DEL:COMP ON
Dependencies	No effect except in zero-span, but not locked out in nonzero spans. Blanked in modes that do not support zero-span measurements. If the SCPI command is sent when the key is blanked, an error is returned: -221, "Settings conflict; Feature not supported for this measurement" In analyzers shipping N9060A, this feature requires N9060A-7FP.
Preset	OFF
State Saved	Saved in instrument state
Initial S/W Revision	A.11.00

RF Burst

Pressing this key, when it is not selected, selects the RF Burst as the trigger. A new sweep/measurement will start when an RF burst envelope signal is identified from the signal at the RF Input connector. Pressing this key, when it is already selected, accesses the RF Burst trigger setup menu.

In some models, a variety of burst trigger circuitry is available, resulting in various available burst trigger bandwidths. The analyzer automatically chooses the appropriate trigger path based on the hardware configuration and other settings of the analyzer.

Key Path	Trigger
Example	TRIG:SOUR RFB Swept SA measurement TRIG:<meas>:SOUR RFB Measurements other than Swept SA
State Saved	Saved in instrument state
Status Bits/OPC dependencies	The Status Operation Register bit 5 "Waiting for Trigger" is set at the same time as the Sweeping or Measuring bit is set. It is cleared when the trigger actually occurs (that is, after the trigger event occurs and all the applicable trigger criteria have been met). A corresponding pop-up message ("Waiting for trigger") is generated if no trigger signal appears after approximately 2 sec. This message goes away when a trigger signal appears.
Backwards Compatibility Notes	The legacy command: :TRIGger[:SEquence]:RFBurst:FSElectivity[:STATe] OFF ON 0 1

	is not supported in the X-Series, as the hardware to do Frequency Selective burst triggers does not exist in X-Series.
Initial S/W Revision	Prior to A.02.00
Modified at S/W Revision	A.04.00

Absolute Trigger Level

Sets the absolute trigger level for the RF burst envelope.

When using the External Mixing path, the Absolute Trigger Level is uncalibrated because the factory default was set to accommodate the expected IF levels for the RF path.

Key Path	Trigger, RF Burst
Scope	Meas Global
Remote Command	:TRIGger[:SEquence]:RFBurst:LEVel:ABSolute <ampl> :TRIGger[:SEquence]:RFBurst:LEVel:ABSolute?
Example	TRIG:RFB:LEV:ABS 10 dBm sets the trigger level of the RF burst envelope signal to the absolute level of 10 dBm
Notes	Sending this command does not switch the setting from relative to absolute; to switch it you need to send the :TRIGger[:SEquence]:RFBurst:LEVel:TYPE command, below. Amplitude Corrections are not taken into account by the Absolute Trigger Level. For example, if you have given yourself effective gain with an amplitude correction factor, the Absolute Trigger will not fire until you have set the trigger level that far below the displayed signal level, rather than simply to the displayed signal level. This is only true for Amplitude Corrections, not External Gain or Ref Level Offset functions. If mode is Bluetooth, the default value is -50 dBm.
Couplings	This same level is used for the RF Burst trigger source in the Trigger menu, for the RF Burst selection in the Periodic Timer sync source (in the Trigger menu and in the Gate Source menu), and also for the RF Burst selection in the Gate Source menu
Preset	-20 dBm
State Saved	Saved in instrument state
Min	-200 dBm
Max	100 dBm
Default Unit	depends on the current selected Y-Axis unit
Backwards Compatibility SCPI	:TRIGger[:SEquence]:FRAMe:RFBurst:LEVel:ABSolute
Initial S/W Revision	Prior to A.02.00
Modified at S/W Revision	A.04.00

Key Path	Trigger, RF Burst
Remote Command	:TRIGger[:SEquence]:RFBurst:LEVel:TYPE ABSolute RELative

	<code>:TRIGger[:SEquence]:RFBurst:LEVel:TYPE?</code>
Example	TRIG:RFB:LEV:TYPE REL sets the trigger level type of the RF burst trigger to Relative.
Preset	ABSolute
State Saved	Saved in instrument state
Initial S/W Revision	Prior to A.02.00
Modified at S/W Revision	A.04.00

Relative Trigger Level

Sets the relative trigger level for the RF burst envelope.

In some models, the relative burst trigger function is implemented in hardware. In other models, without the advanced triggering hardware required, the relative burst trigger function is implemented in software in some measurements, and is unavailable in other measurements.

When implemented in software, the relative RF Burst trigger function is implemented as follows:

1. The measurement starts with the absolute RF Burst trigger setting. If it cannot get a trigger with that level, auto trigger fires and the acquisition starts anyway. After the acquisition, the measurement searches for the peak in the acquired waveform and saves it.
2. Now, in the next cycle of the measurement, the measurement determines a new absolute RF Burst level based on the peak value from the first measurement and the Relative RF Burst Trigger Level (always 0 or negative dB) set by the user. The following formula is used:
3. absolute RF Burst level = peak level of the previous acquisition + relative RF Burst level
4. If the new absolute RF Burst level differs from the previous by more than 0.5 dB, the new level is sent to the hardware; otherwise it is not updated (to avoid slowing down the acquisition)

Steps 2 and 3 repeat for subsequent measurements.

Key Path	Trigger, RF Burst
Scope	Meas Global
Remote Command	<code>:TRIGger[:SEquence]:RFBurst:LEVel:RELative <rel_amp></code> <code>:TRIGger[:SEquence]:RFBurst:LEVel:RELative?</code>
Example	TRIG:RFB:LEV:REL -10 dB sets the trigger level of the RF burst envelope signal to the relative level of -10 dB
Notes	Sending this command does not switch the setting from absolute to relative; to switch it you need to send the <code>:TRIGger[:SEquence]:RFBurst:LEVel:TYPE</code> command, above. The relative trigger level is not available in some measurements. In those measurements the RELative parameter, and the <code>:TRIGger[:SEquence]:RFBurst:LEVel:TYPE</code> command (above), will generate an error if sent.
Dependencies	This key is grayed out and Absolute Trigger Level selected if the required hardware is not present in your analyzer and the current measurement does not support Relative triggering.

Preset	-6 dB GSM: -25 dB
State Saved	Saved in instrument state
Min	-45 dB
Max	0 dB
Default Unit	dB or dBc
Backwards Compatibility SCPI	:TRIGger[:SEquence]:RFBurst:LEVel This legacy command is aliased to :TRIGger[:SEquence]:RFBurst:LEVel:RELative because the PSA had ONLY relative burst triggering
Initial S/W Revision	Prior to A.02.00
Modified at S/W Revision	A.04.00

Trigger Slope

It is set positive to trigger on a rising edge and negative to trigger on a falling edge.

Key Path	Trigger, RF Burst
Remote Command	:TRIGger[:SEquence]:RFBurst:SLOPe POSitive NEGative :TRIGger[:SEquence]:RFBurst:SLOPe?
Example	TRIG:RFB:SLOP NEG
Couplings	This same slope is used in the RF Burst selection for the trigger source in the Trigger menu and for the period timer sync source (in the Trigger menu and in the Gate Source menu).
Preset	POSitive
State Saved	Saved in instrument state
Backwards Compatibility SCPI	:TRIGger[:SEquence]:FRAMe:RFBurst:SLOPe
Backwards Compatibility Notes	The legacy :TRIGger[:SEquence]:SLOPe command affects the slopes for the VID, LINE, EXT1, EXT2, and RFB triggers.
Initial S/W Revision	Prior to A.02.00

Periodic Timer (Frame Trigger)

Pressing this key, when it is not selected, selects the internal periodic timer signal as the trigger. Triggering occurrences are set by the **Period** parameter, which is modified by the **Sync Source** and **Offset**. Pressing this key, when it is already selected, accesses the periodic timer trigger setup functions.

If you do not have a sync source selected (it is Off), then the internal timer will not be synchronized with any external timing events.

Key Path	Trigger
Example	TRIG:SOUR FRAM Swept SA measurement

	TRIG:<meas>:SOUR FRAM Measurements other than Swept SA
State Saved	Saved in instrument state
Readback	[Sync: <value of Sync Source>], for example, [Sync: External 1]
Status Bits/OPC dependencies	The Status Operation Register bit 5 "Waiting for Trigger" is set at the same time as the Sweeping or Measuring bit is set. It is cleared when the trigger actually occurs (that is, after the trigger event occurs and all the applicable trigger criteria have been met). A corresponding pop-up message ("Waiting for trigger") is generated if no trigger signal appears after approximately 2 sec. This message goes away when a trigger signal appears.
Initial S/W Revision	Prior to A.02.00

Periodic Timer Triggering:

This feature selects the internal periodic timer signal as the trigger. Trigger occurrences are set by the **Periodic Timer** parameter, which is modified by the **Sync Source** and **Offset**.

The figure below shows the action of the periodic timer trigger. Before reviewing the figure, we'll explain some uses for the periodic trigger.

A common application is measuring periodic burst RF signals for which a trigger signal is not easily available. For example, we might be measuring a TDMA radio which bursts every 20 ms. Let's assume that the 20 ms period is very consistent. Let's also assume that we do not have an external trigger source available that is synchronized with the period, and that the signal-to-noise ratio of the signal is not high enough to provide a clean RF burst trigger at all of the analysis frequencies. For example, we might want to measure spurious transmissions at an offset from the carrier that is larger than the bandwidth of the RF burst trigger. In this application, we can set the Periodic Timer to a 20.00 ms period and adjust the offset from that timer to position our trigger just where we want it. If we find that the 20.00 ms is not exactly right, we can adjust the period slightly to minimize the drift between the period timer and the signal to be measured.

A second way to use this feature would be to use **Sync Source** temporarily, instead of **Offset**. In this case, we might tune to the signal in a narrow span and use the RF Burst trigger to synchronize the periodic timer. Then we would turn the sync source off so that it would not miss-trigger. Miss-triggering can occur when we are tuned so far away from the RF burst trigger that it is no longer reliable.

A third example would be to synchronize to a signal that has a reference time element of much longer period than the period of interest. In some CDMA applications, it is useful to look at signals with a short periodicity, by synchronizing that periodicity to the "even-second clock" edge that happens every two seconds. Thus, we could connect the even-second clock trigger to Ext1 and use then Ext1 as the sync source for the periodic timer.

The figure below illustrates this third example. The top trace represents the even-second clock. It causes the periodic timer to synchronize with the leading edge shown. The analyzer trigger occurs at a time delayed by the accumulated offset from the period trigger event. The periodic timer continues to run, and triggers continue to occur, with a periodicity determined by the analyzer time base. The timer output (labeled "late event") will drift away from its ideal time due to imperfect matching between the time base of the signal being measured and the time base of the analyzer, and also because of imperfect setting of the

period parameter. But the synchronization is restored on the next even-second clock event. ("Accumulated offset" is described in the in the **Offset** function section.)

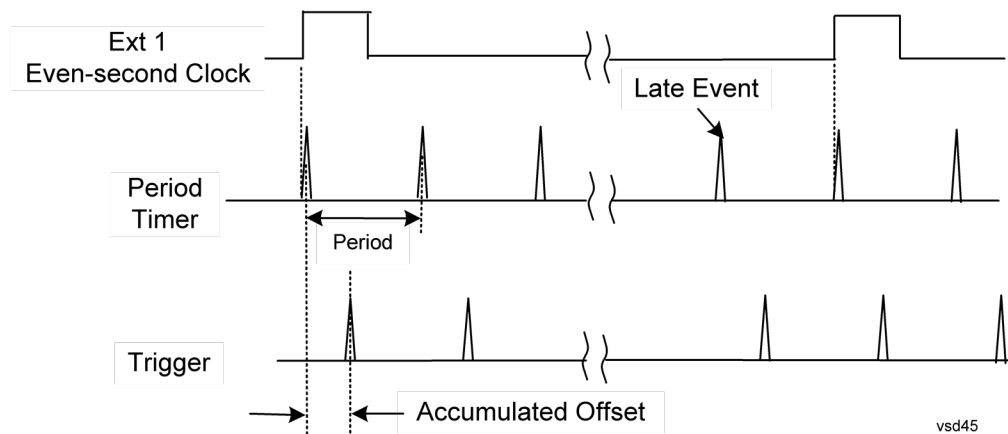

Period

Sets the period of the internal periodic timer clock. For digital communications signals, this is usually set to the frame period of your current input signal. In the case that sync source is not set to OFF, and the external sync source rate is changed for some reason, the periodic timer is synchronized at the every external synchronization pulse by resetting the internal state of the timer circuit.

Key Path	Trigger, Periodic Timer
Remote Command	:TRIGger[:SEquence]:FRAMe:PERiod <time> :TRIGger[:SEquence]:FRAMe:PERiod?
Example	TRIG:FRAM:PER 100 ms
Dependencies	The invalid data indicator turns on when the period is changed, until the next sweep/measurement completes.
Couplings	The same period is used in the Gate Source selection of the period timer.
Preset	20 ms GSM: 4.615383
State Saved	Saved in instrument state
Min	100.000 ns
Max	559.0000 ms
Default Unit	S
Initial S/W Revision	Prior to A.02.00

Offset

Adjusts the accumulated offset between the periodic timer events and the trigger event. Adjusting the accumulated offset is different than setting an offset, and requires explanation.

The periodic timer is usually not synchronized with any external events, so the timing of its output events has no absolute meaning. Since the timing relative to external events (RF signals) is important, you need to

be able to adjust (offset) it. However, you have no direct way to see when the periodic timer events occur. All that you can see is the trigger timing. When you want to adjust the trigger timing, you will be changing the internal offset between the periodic timer events and the trigger event. Because the absolute value of that internal offset is unknown, we will just call that the accumulated offset. Whenever the Offset parameter is changed, you are changing that accumulated offset. You can reset the displayed offset using Reset Offset Display. Changing the display does not change the value of the accumulated offset, and you can still make additional changes to accumulated offset.

To avoid ambiguity, we define that an increase in the "offset" parameter, either from the knob or the SCPI adjust command, serves to delay the timing of the trigger event.

Key Path	Trigger, Periodic Timer
Remote Command	:TRIGger[:SEquence]:FRAMe:OFFSet <time> :TRIGger[:SEquence]:FRAMe:OFFSet?
Example	TRIG:FRAM:OFFS 1.2 ms
Notes	<p>The front panel interface (for example, the knob), and this command, adjust the accumulated offset, which is shown on the active function display. However, the actual amount sent to the hardware each time the offset is updated is the delta value, that is, the current accumulated offset value minus the previous accumulated offset value. Note that the accumulated offset value is essentially arbitrary; it represents the accumulated offset from the last time the offset was zeroed (with the Reset Offset Display key).</p> <p>Note that this command does not change the period of the trigger waveform. Note also that Offset is used only when the sync source is set to OFF, otherwise delay is used, see section "Trig Delay" on page 476.</p> <p>An increase in the "offset" parameter, either from the knob or the SCPI adjust command, serves to delay the timing of the trigger event.</p>
Notes	<p>When the SCPI command is sent the value shown on the key (and the Active Function, if this happens to be the active function) is updated with the new value. However, the actual amount sent to the hardware is the delta value, that is, the current accumulated offset value minus the previous accumulated offset value.</p> <p>The SCPI query simply returns the value currently showing on the key.</p>
Dependencies	The invalid data indicator turns on when the offset is changed, until the next sweep/measurement completes.
Couplings	The same offset is used in the Gate Source selection of the period timer.
Preset	0 s
State Saved	Saved in instrument state
Min	-10.000 s
Max	10.000 s
Default Unit	S
Initial S/W Revision	Prior to A.02.00

Offset Adjust (Remote Command Only)

This remote command does not work at all like the related front panel keys. This command lets you advance the phase of the frame trigger by the amount you specify.

It does not change the period of the trigger waveform. If the command is sent multiple times, it advances the phase of the frame trigger an additional amount each time it is sent. Negative numbers are permitted.

Remote Command	:TRIGger[:SEquence]:FRAMe:ADJust <time>
Example	TRIG:FRAM:ADJ 1.2 ms
Notes	Note also that Offset is used only when the sync source is set to OFF, otherwise delay is used, see section "Trig Delay" on page 476 An increase in the "offset" parameter, either from the knob or the SCPI adjust command, serves to delay the timing of the trigger event.
Notes	The front panel interface (for example, the knob) and the :TRIG:FRAM:OFFS command adjust the accumulated offset, which is shown on the active function display. However, the actual amount sent to the hardware is the delta value, that is, the current offset value minus the previous offset value. When the SCPI command is sent the value shown on the key (and the Active Function, if this happens to be the active function) is updated by increasing it (or decreasing it if the value sent is negative) by the amount specified in the SCPI command. This is a "command only" SCPI command, with no query.
Dependencies	The invalid data indicator turns on when the offset is changed, until the next sweep/measurement completes.
Couplings	The same offset is used in the Gate Source selection of the period timer.
Preset	0 s
State Saved	Saved in instrument state
Min	-10.000 s
Max	10.000 s
Default Unit	S
Initial S/W Revision	Prior to A.02.00

Reset Offset Display

Resets the value of the periodic trigger offset display setting to 0.0 seconds. The current displayed trigger location may include an offset value defined with the **Offset** key. Pressing this key redefines the currently displayed trigger location as the new trigger point that is 0.0 s offset. The **Offset** key can then be used to add offset relative to this new timing.

Key Path	Trigger, Periodic Timer
Remote Command	:TRIGger[:SEquence]:FRAMe:OFFSet:DISPlay:RESet
Example	TRIG:FRAM:OFFS:DISP:RES
Initial S/W Revision	Prior to A.02.00

Sync Source

Selects a signal source for you to synchronize your periodic timer trigger to, otherwise you are triggering at some arbitrary location in the frame. Synchronization reduces the precision requirements on the setting of the period.

For convenience you may adjust the level and slope of the selected sync source in a conditional branch setup menu accessed from the Sync Source menu. Note that these settings match those in the **Trigger** and **Gate Source** menus; that is, each trigger source has only one value of level and slope, regardless of which menu it is accessed from.

Key Path	Trigger, Periodic Timer
Remote Command	:TRIGger[:SEquence]:FRAMe:SYNC EXTernal1 EXTernal2 RFBurst OFF :TRIGger[:SEquence]:FRAMe:SYNC?
Example	TRIG:FRAM:SYNC EXT2
Dependencies	In some models, there is no second External input. In these models, the External 2 key is blanked and the EXTernal2 parameter will generate a "Hardware missing; Not available for this model number" message.
Preset	Off GSM/EDGE, MSR,LTE,LTETDD: RFBurst
State Saved	Saved in instrument state
Readback	The current setting is read back to this key and it is also Readback to the previous Periodic Timer trigger key.
Backwards Compatibility SCPI	:TRIGger[:SEquence]:FRAMe:SYNC EXTernal For backward compatibility, the parameter EXTernal is mapped to EXTernal1
Initial S/W Revision	Prior to A.02.00
Modified at S/W Revision	A.03.00, A.14.00

Off

Turns off the sync source for your periodic trigger. With the sync source off, the timing will drift unless the signal source frequency is locked to the analyzer frequency reference.

Key Path	Trigger, Periodic Timer, Sync Source
Example	TRIG:FRAM:SYNC OFF
Readback	Off
Initial S/W Revision	Prior to A.02.00

External 1

Pressing this key, when it is not selected, selects an external input signal as the trigger. A new sweep/measurement will start when the external trigger condition is met using the external 1 input connector on the rear panel.

Pressing this key, when it is already selected, accesses the external 1 trigger setup menu.

Key Path	Trigger
Example	TRIG:SOUR EXT1 Swept SA measurement

	TRIG:<meas>:SOUR EXT1 Measurements other than Swept SA
Dependencies	Grayed out if in use by Point Trigger in the Source Setup menu. Forced to Free Run if already selected and Point Trigger is set to External 1.
State Saved	Saved in instrument state
Status Bits/OPC dependencies	The Status Operation Register bit 5 "Waiting for Trigger" is set at the same time as the Sweeping or Measuring bit is set. It is cleared when the trigger actually occurs (that is, after the trigger event occurs and all the applicable trigger criteria have been met). A corresponding pop-up message ("Waiting for trigger") is generated if no trigger signal appears after approximately 2 sec. This message goes away when a trigger signal appears.
Initial S/W Revision	Prior to A.02.00

Trigger Level

Sets the value where the external 1 trigger input will trigger a new sweep/measurement.

Key Path	Trigger, External 1
Remote Command	:TRIGger[:SEquence]:EXTernal1:LEVel <level> :TRIGger[:SEquence]:EXTernal1:LEVel?
Example	TRIG:EXT1:LEV 0.4 V
Couplings	This same level is used for the Ext1 trigger source in the Trigger menu, for the Ext1 selection in the Periodic Timer sync source (in the Trigger menu and in the Gate Source menu), and also for the Ext1 selection in the Gate Source menu.
Preset	1.2 V
State Saved	Saved in instrument state
Min	-5 V
Max	5 V
Default Unit	V
Backwards Compatibility SCPI	:TRIGger[:SEquence]:EXTernal:LEVel For backward compatibility, the parameter EXTernal is mapped to EXTernal1
Backwards Compatibility SCPI	:TRIGger[:SEquence]:FRAMe:EXTernal1:LEVel
Initial S/W Revision	Prior to A.02.00

Trig Slope

Controls the trigger polarity. It is set positive to trigger on a rising edge and negative to trigger on a falling edge.

Key Path	Trigger, External 1
Remote Command	:TRIGger[:SEquence]:EXTernal1:SLOPe POSitive NEGative

	:TRIGger[:SEQuence]:EXTernal1:SLOPe?
Example	TRIG:EXT1:SLOP NEG
Couplings	This same slope is used in the Ext1 selection for the trigger source in the Trigger menu and for the period timer sync source (in the Trigger menu and in the Gate Source menu).
Preset	POSitive
State Saved	Saved in instrument state
Backwards Compatibility SCPI	:TRIGger[:SEQuence]:EXTernal:SLOPe For backward compatibility, the parameter EXTernal is mapped to EXTernal1
Backwards Compatibility SCPI	:TRIGger[:SEQuence]:FRAMe:EXTernal1:SLOPe
Backwards Compatibility Notes	The legacy :TRIGger[:SEQuence]:SLOPe command affects the slopes for the VID, LINE, EXT1, EXT2, and RFB triggers.
Initial S/W Revision	Prior to A.02.00

External 2

Pressing this key, when it is not selected, selects an external input signal as the trigger. A new sweep/measurement will start when the external trigger condition is met using the external 2 input connector. The external trigger 2 input connector is on the rear panel.

Pressing this key, when it is already selected, accesses the external 2 trigger setup menu.

Key Path	Trigger
Example	TRIG:SOUR EXT2 Swept SA measurement TRIG:<meas>:SOUR EXT2 Measurements other than Swept SA
Dependencies	In some models, there is no second External input. In these models, the External 2 key is blanked and the EXTernal2 parameter will generate a "Hardware missing; Not available for this model number" message. Grayed out if in use by Point Trigger in the Source Setup menu. Forced to Free Run if already selected and Point Trigger is set to External 2.
State Saved	Saved in instrument state
Status Bits/OPC dependencies	The Status Operation Register bit 5 "Waiting for Trigger" is set at the same time as the Sweeping or Measuring bit is set. It is cleared when the trigger actually occurs (that is, after the trigger event occurs and all the applicable trigger criteria have been met). A corresponding pop-up message ("Waiting for trigger") is generated if no trigger signal appears after approximately 2 sec. This message goes away when a trigger signal appears.
Initial S/W Revision	Prior to A.02.00
Modified at S/W Revision	A.03.00

Trigger Level

Sets the value where the external 2 trigger input will trigger a new sweep/measurement.

Key Path	Trigger, External 2
Remote Command	:TRIGger[:SEquence]:EXTernal2:LEVel :TRIGger[:SEquence]:EXTernal2:LEVel?
Example	TRIG:EXT2:LEV 1.1 V
Couplings	This same level is used for the Ext2 trigger source in the Trigger menu, for the Ext2 selection in the Periodic Timer sync source (in the Trigger menu and in the Gate Source menu), and also for the Ext2 selection in the Gate Source menu.
Preset	1.2 V
State Saved	Saved in instrument state
Min	-5 V
Max	5 V
Default Unit	V
Backwards Compatibility SCPI	:TRIGger[:SEquence]:FRAMe:EXTernal2:LEVel
Initial S/W Revision	Prior to A.02.00

Trig Slope

Controls the trigger polarity. It is set positive to trigger on a rising edge and negative to trigger on a falling edge.

Key Path	Trigger, External 2
Remote Command	:TRIGger[:SEquence]:EXTernal2:SLOPe POSitive NEGative :TRIGger[:SEquence]:EXTernal2:SLOPe?
Example	TRIG:EXT2:SLOP NEG
Couplings	This same slope is used in the Ext2 selection for the trigger source in the Trigger menu and for the period timer sync source (in the Trigger menu and in the Gate Source menu).
Preset	POSitive
State Saved	Saved in instrument state
Backwards Compatibility SCPI	:TRIGger[:SEquence]:FRAMe:EXTernal2:SLOPe
Backwards Compatibility Notes	The legacy :TRIGger[:SEquence]:SLOPe command affects the slopes for the VID, LINE, EXT1, EXT2, and RFB triggers.
Initial S/W Revision	Prior to A.02.00

RF Burst

Pressing this key, when it is not selected, selects the RF Burst as the trigger. A new sweep/measurement will start when an RF burst envelope signal is identified from the signal at the RF Input connector. Pressing this key, when it is already selected, accesses the RF Burst trigger setup menu.

In some models, a variety of burst trigger circuitry is available, resulting in various available burst trigger bandwidths. The analyzer automatically chooses the appropriate trigger path based on the hardware configuration and other settings of the analyzer.

Key Path	Trigger
Example	TRIG:SOUR RFB Swept SA measurement TRIG:<meas>:SOUR RFB Measurements other than Swept SA
State Saved	Saved in instrument state
Status Bits/OPC dependencies	The Status Operation Register bit 5 "Waiting for Trigger" is set at the same time as the Sweeping or Measuring bit is set. It is cleared when the trigger actually occurs (that is, after the trigger event occurs and all the applicable trigger criteria have been met). A corresponding pop-up message ("Waiting for trigger") is generated if no trigger signal appears after approximately 2 sec. This message goes away when a trigger signal appears.
Backwards Compatibility Notes	The legacy command: :TRIGger[:SEquence]:RFBurst:FSElectivity[:STATe] OFF ON 0 1 is not supported in the X-Series, as the hardware to do Frequency Selective burst triggers does not exist in X-Series.
Initial S/W Revision	Prior to A.02.00
Modified at S/W Revision	A.04.00

Absolute Trigger Level

Sets the absolute trigger level for the RF burst envelope.

When using the External Mixing path, the Absolute Trigger Level is uncalibrated because the factory default was set to accommodate the expected IF levels for the RF path.

Key Path	Trigger, RF Burst
Scope	Meas Global
Remote Command	:TRIGger[:SEquence]:RFBurst:LEVel:ABSolute <ampl> :TRIGger[:SEquence]:RFBurst:LEVel:ABSolute?
Example	TRIG:RFB:LEV:ABS 10 dBm sets the trigger level of the RF burst envelope signal to the absolute level of 10 dBm
Notes	Sending this command does not switch the setting from relative to absolute; to switch it you need to send the :TRIGger[:SEquence]:RFBurst:LEVel:TYPE command, below. Amplitude Corrections are not taken into account by the Absolute Trigger Level. For example, if you have given yourself effective gain with an amplitude correction factor, the Absolute Trigger will not fire until you have set the trigger level that far below the displayed signal level, rather than simply to the displayed signal level. This is only true for Amplitude Corrections, not External Gain or Ref Level Offset functions. If mode is Bluetooth, the default value is -50 dBm.
Couplings	This same level is used for the RF Burst trigger source in the Trigger menu, for the RF Burst selection in the Periodic Timer sync source (in the Trigger menu and in the Gate Source menu), and also for the

	RF Burst selection in the Gate Source menu
Preset	-20 dBm
State Saved	Saved in instrument state
Min	-200 dBm
Max	100 dBm
Default Unit	depends on the current selected Y-Axis unit
Backwards Compatibility SCPI	:TRIGger[:SEquence]:FRAMe:RFBurst:LEVel:ABSolute
Initial S/W Revision	Prior to A.02.00
Modified at S/W Revision	A.04.00

Key Path	Trigger, RF Burst
Remote Command	:TRIGger[:SEquence]:RFBurst:LEVel:TYPE ABSolute RELative :TRIGger[:SEquence]:RFBurst:LEVel:TYPE?
Example	TRIG:RFB:LEV:TYPE REL sets the trigger level type of the RF burst trigger to Relative.
Preset	ABSolute
State Saved	Saved in instrument state
Initial S/W Revision	Prior to A.02.00
Modified at S/W Revision	A.04.00

Trigger Slope

It is set positive to trigger on a rising edge and negative to trigger on a falling edge.

Key Path	Trigger, RF Burst
Remote Command	:TRIGger[:SEquence]:RFBurst:SLOPe POSitive NEGative :TRIGger[:SEquence]:RFBurst:SLOPe?
Example	TRIG:RFB:SLOP NEG
Couplings	This same slope is used in the RF Burst selection for the trigger source in the Trigger menu and for the period timer sync source (in the Trigger menu and in the Gate Source menu).
Preset	POSitive
State Saved	Saved in instrument state
Backwards Compatibility SCPI	:TRIGger[:SEquence]:FRAMe:RFBurst:SLOPe
Backwards Compatibility Notes	The legacy :TRIGger[:SEquence]:SLOPe command affects the slopes for the VID, LINE, EXT1, EXT2, and RFB triggers.
Initial S/W Revision	Prior to A.02.00

Sync Holdoff

Sync Holdoff specifies the duration that the sync source signal must be kept false before the transition to true to be recognized as the sync timing. The periodic timer phase is aligned when the sync source signal becomes true, after the Holdoff time is satisfied.

A holdoff of 2 ms will work with most WiMAX signals, but there may be cases where the burst off duration is less than 1 ms and this value will need to be changed.

Key Path	Trigger, Periodic Timer
Remote Command	:TRIGger[:SEQuence]:FRAMe:SYNC:HOLDoff <time> :TRIGger[:SEQuence]:FRAMe:SYNC:HOLDoff? :TRIGger[:SEQuence]:FRAMe:SYNC:HOLDoff:STATe OFF ON 0 1 :TRIGger[:SEQuence]:FRAMe:SYNC:HOLDoff:STATe?
Preset	On, 1.000 ms
State Saved	Saved in instrument state
Min	0 ms
Max	+500 ms
Default Unit	s
Initial S/W Revision	Prior to A.02.00

Aux IO Control (Remote Command Only)

Sets/Queries the value for all 8 data lines.

Key Path	SCPI only
Remote Command	OUTPut:AUX:IO <Value> OUTPut:AUX:IO?
Example	OUTPut:AUX:IO 31
Couplings	State of data 0 to data 7 under the AUX I/O Control panel (Input/Output menu) will change accordingly base on the AUX IO's value that key in.
Preset	31
Min	0
Max	255
Backwards Compatibility SCPI	OUTPut:UPORt <Value>
Initial S/W Revision	A.16.00

Control Edge/Level

Sets the method of controlling the gating function from the gating signal.

Edge

In Edge triggering, the gate opens (after the Delay) on the selected edge (for example, positive) of the gate signal and closes on the alternate edge (for example, negative).

Level

In Level triggering, the gate opens (after the Delay) when the gate signal has achieved a certain level and stays open as long as that level is maintained.

Key Path	Sweep/Control, Gate
Remote Command	[:SENSe] :SWEep:EGATe:CONTrol EDGE LEVEl [:SENSe] :SWEep:EGATe:CONTrol?
Example	SWE:EGAT:CONT EDGE
Dependencies	If the Gate Method is FFT the Control key is grayed out and Edge is selected. If the Gate Source is TV, Frame or Line, the Control key is grayed out and Edge is selected.
Preset	EDGE
State Saved	Saved in instrument state
Backwards Compatibility SCPI	[:SENSe] :SWEep:TIME:GATE:TYPE ESA Compatibility
Initial S/W Revision	Prior to A.02.00

Gate Holdoff

Lets you increase or decrease the wait time after a gate event ends before the analyzer will respond to the next gate signal.

After any Gate event finishes, the analyzer must wait for the sweep system to settle before it can respond to another Gate signal. The analyzer calculates a "wait time," taking into account a number of factors, including RBW and Phase Noise Optimization settings. The goal is to achieve the same accuracy when gated as in ungated operation. The figure below illustrates this concept:

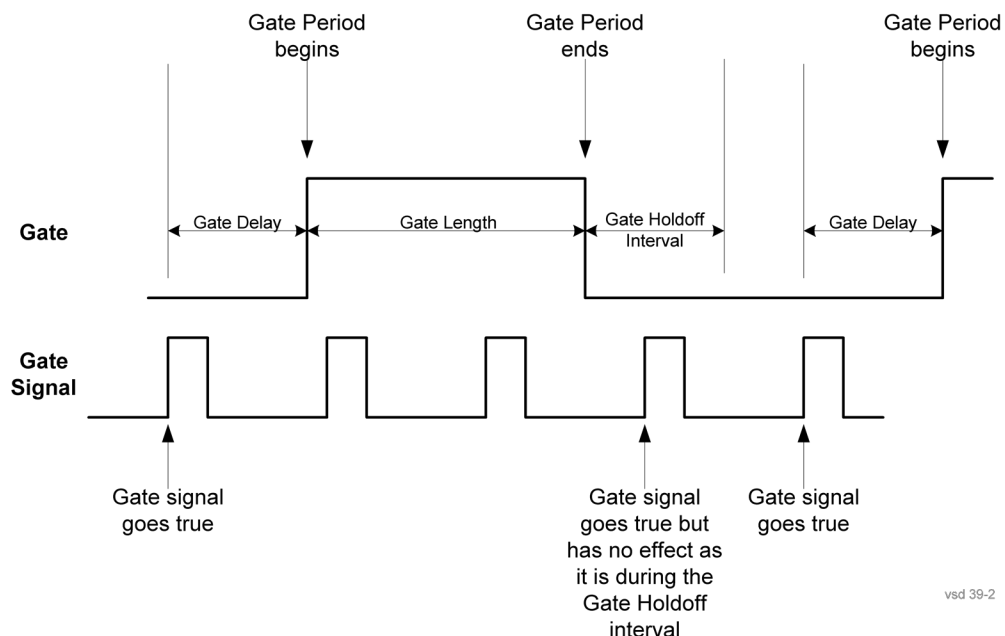

vsd 39-2

When Gate Holdoff is in Auto, the wait time calculated by the analyzer is used. When Gate Time is in Manual, the user may adjust the wait time, usually decreasing it in order to achieve greater speed, but at the risk of decreasing accuracy.

When the **Method** key is set to **Video** or **FFT**, the **Gate Holdoff** function has no effect.

In measurements that do not support Auto, the value shown when Auto is selected is “---” and the manually set holdoff is returned to a query.

Key Path	Sweep/Control, Gate
Remote Command	[:SENSe] :SWEep:EGATe:HOLDoFF <time> [:SENSe] :SWEep:EGATe:HOLDoFF? [:SENSe] :SWEep:EGATe:HOLDoFF:AUTO OFF ON 0 1 [:SENSe] :SWEep:EGATe:HOLDoFF:AUTO?
Example	SWE:EGAT:HOLD 0.0002 SWE:EGAT:HOLD? SWE:EGAT:HOLD:AUTO ON SWE:EGAT:HOLD:AUTO?
Couplings	When Gate Holdoff is Auto , the Gate Holdoff key shows the value calculated by the analyzer for the wait time. Pressing the Gate Holdoff key while it is in Auto and not selected, causes the key to become selected and allows the user to adjust the value. If the value is adjusted, the setting changes to Man . Pressing the Gate Holdoff key, while it is in Auto and selected, does not change the value of Gate Holdoff , but causes the setting to change to Man . Now the user can adjust the value. Pressing the key while it is in Man and selected, cause the value to change back to Auto . Pressing the key while it is in Man and not selected, causes the key to become selected and allows the user to adjust the value. When Method is set to Video or FFT , the Gate Holdoff function has no effect.
Preset	Auto Auto/On
State Saved	Saved in instrument state
Min	1 μ sec
Max	1 sec
Initial S/W Revision	Prior to A.02.00

Gate Delay Compensation

This function allows you to select an RBW-dependent value by which to adjust the gate delay, to compensate for changes in the delay caused by RBW effects.

You can select between uncompensated operation and two types of compensation, **Delay Until RBW Settled** and **Compensate for RBW Group Delay**.

See ["More Information" on page 1156](#)

Key Path	Sweep/Control, Gate
Scope	Meas Global
Remote Command	[:SENSe] :SWEep:EGATe:DELay:COMPensation:TYPE OFF SETTled GDELay [:SENSe] :SWEep:EGATe:DELay:COMPensation:TYPE?
Example	SWE:EGAT:DEL:COMP:TYPE SETT SWE:EGAT:DEL:COMP:TYPE?
Notes	<p>Although this function is Meas Global, there are some measurements that do not support this function. In those measurements the operation will be Uncompensated. Going into one of those measurements will not change the Meas Global selection; it will simply display the grayed-out menu key with “Uncompensated” showing as the selection. This is a non-forceful grayout, so the SCPI command is still accepted.</p> <p>If Gate Delay Compensation is not supported at all within a particular mode, the key is not displayed, and if the SCPI command is sent while in a measurement within that mode, an “Undefined Header” message is generated.</p> <p>Measurements that do not support this function include: Swept SA</p>
Preset	TD-SCDMA mode: Compensate for RBW Group Delay All other modes: Delay Until RBW Settled
State Saved	Saved in instrument state
Range	Uncompensated Delay Until RBW Settled Compensate for RBW Group Delay
Readback text	Uncompensated Settled Group Delay
Initial S/W Revision	Prior to A.02.00
Modified at S/W Revision	A.11.0

More Information

Selecting **Uncompensated** means that the actual gate delay is as you sets it.

Selecting **Delay Until RBW Settled** causes the gate delay to be increased above the user setting by an amount equal to $3.06/\text{RBW}$. This compensated delay causes the GATE START and GATE STOP lines on the display to move by the compensation amount, and the actual hardware gate delay to be increased by the same amount. All the other gate lines (for example, MIN FAST) are unaffected. If the RBW subsequently changes, the compensation is readjusted for the new RBW. The value shown on the **Gate Delay** key does NOT change.

Delay Until RBW Settled allows excellent measurements of gated signals, by allowing the IF to settle following any transient that affects the burst. Excellent measurements also require that the analysis region not extend into the region affected by the falling edge of the burst. Thus, excellent measurements can only be made over a width that declines with narrowing RBWs, which is achieved by decreasing the gate length below the user setting by an amount equal to $2.53/\text{RBW}$. Therefore, for general purpose compensation, you will still want to change the gate length with changes in RBW even if the gate delay is compensated. The compensated Gate Length is limited by the analyzer so that it will never go below 10% of the value shown on the Gate Length key, as otherwise the sweep times could get very long. Anytime

the **Gate Length and RBW** values combine in such a way that this limiting takes place, a warning is displayed. For measurements which contain multiple sweeps with different RBW like SEM and SPUR, the smallest RBW is used for this limiting.

Selecting **Compensate for RBW Group Delay** causes the gate delay to be increased above the user setting by an amount equal to $1.81/\text{RBW}$. This compensated delay causes the GATE START, GATE STOP lines on the display to move by the compensation amount, and the actual hardware gate delay to be increased by the same amount. All the other gate lines (for example, MIN FAST) are unaffected. If the RBW subsequently changes, the compensation is readjusted for the new RBW. The value shown on the **Gate Delay** key does NOT change. **Compensate for RBW Group Delay** also includes gate length compensation; the gate length itself is adjusted as necessary to attempt to compensate for delay effects imposed by the RBW.

Compensate for RBW Group Delay is similar to **Delay Until RBW Settled**, but compensates for the group delay of the RBW filter, rather than the filter settling time. As the RBW gets narrow, this can allow the settling tail of the RBW to affect the beginning part of the gated measurement, and allow the beginning of the RBW settling transient to affect the end of the gated measurement. These two effects are symmetric because the RBW response is symmetric. Because the gate length is not automatically compensated, some users might find this compensation to be more intuitive than compensation for RBW settling.

Min Fast Position Query (Remote Command Only)

This command queries the position of the MIN FAST line, relative to the delay reference (REF) line. See section "[Gate View On/Off](#)" on page 2228. If this query is sent while not in gate view, the MinFast calculation is performed based on the current values of the appropriate parameters and the result is returned. Knowing this value lets you set an optimal gate delay value for the current measurement setup.

Remote Command	[:SENSe] :SWEep:EGATe:MINFast?
Example	SWE:EGAT:MIN?
Initial S/W Revision	Prior to A.02.00

Gate Preset (Remote Command Only)

Presets the time-gated spectrum analysis capability.

This command sets gate parameter values to the ESA preset values, as follows:

Gate trigger type = edge

Gate polarity = positive

Gate delay = 1 us

Gate length = 1 us

Remote Command	[:SENSe] :SWEep:TIME:GATE:PRESet ESA Compatibility
Initial S/W Revision	Prior to A.02.00

Gate Level (Remote Command Only)

Sets the gate input transition point level for the external TRIGGER inputs on the front and rear panel. This is a legacy command for PSA compatibility. It is simply an alias to the equivalent trigger level command.

Remote Command	<code>[:SENSe] :SWEep:EGATe:EXTeRnal [1] 2 :LEVeL <voltage></code> <code>[:SENSe] :SWEep:EGATe:EXTeRnal [1] 2 :LEVeL ?</code>
Notes	This command is simply an alias to <code>:TRIGger[:SEQuence]:EXTeRnal[1] 2:LEVeL</code> For details refer
Initial S/W Revision	Prior to A.02.00

Gate Polarity (Remote Command Only)

Sets the polarity for the gate signal. This setup is now done using the gate trigger's slope setting.

When Positive (Pos) is selected, a positive-going edge (Edge) or a high voltage (Level) will satisfy the gate condition, after the delay set with the Gate Delay key. When Negative (Neg) is selected, a negative-going edge (Edge) or a low voltage (Level) will satisfy the gate condition after the delay.

Remote Command	<code>[:SENSe] :SWEep:EGATe:POLarity NEGative POSitive</code> <code>[:SENSe] :SWEep:EGATe:POLarity ?</code>
Example	<code>SWE:EGAT:POL NEG</code> <code>SWE:EGAT:POL ?</code>
Preset	POSitive
State Saved	Saved in instrument state
Backwards Compatibility SCPI	<code>[:SENSe] :SWEep:TIME:GATE:POLarity</code> ESA compatibility
Initial S/W Revision	Prior to A.02.00

Remote Command	<code>[:SENSe] :SWEep:TIME:GATE:LEVeL HIGH LOW</code> <code>[:SENSe] :SWEep:TIME:GATE:LEVeL ?</code> ESA compatibility
Preset	HIGH
Initial S/W Revision	Prior to A.02.00

Points

Sets the number of points per sweep, from 1 to 20001. The sweep time resolution setting will depend on the number of points selected.

Key Path	Sweep/Control
Mode	SA, WCDMA, C2K, WIMAX OFDMA, TD-SCDMA, 1xEVDO, DVB-T/H, DTMB (CTTB), ISDB-T, CMMB, LTE, LTE-TDD, Digital Cable TV, MSR, LTEAFDD, LTEATDD
Remote Command	[:SENSe] :ACPower:SWEep:POINts <integer> [:SENSe] :ACPower:SWEep:POINts?
Example	ACP:SWE:POIN 500 ACP:SWE:POIN?
Notes	Whenever the number of sweep points changes: <ul style="list-style-type: none"> • All trace data is erased • Any traces with Update Off will also go to Display Off (like going from View to Blank in the older analyzers) • Sweep time is re-quantized • Any limit lines that are on will be updated • If averaging/hold is on, averaging/hold starts over
Dependencies	This parameter is automatically calculated and not configurable when Meas Method is set to Fast Power.
Couplings	Whenever the number of sweep points changes, the sweep time is re-quantized.
Preset	Others: 1001 DVB-T/H:2001 DTMB (CTTB): 2001 ISDB-T: 2001 CMMB: 2001 Digital Cable TV: 2001
State Saved	Saved in instrument state.
Min	1
Max	20001
Initial S/W Revision	Prior to A.02.00
Modified at S/W Revision	A.02.00, A.03.00

10 ACP Measurement
System

System

See "[System](#)" on page 368

Trace/Detector

Accesses a menu of functions that enable you to control the detectors for the current measurement.

Key Path	Front-panel key
Initial S/W Revision	Prior to A.02.00

Select Trace (Front-panel Only)

This key selects which trace the other parameters under the Trace/Detector menu will apply to.

Key Path	Trace/Detector
Notes	Front-panel only.
Couplings	When Meas Method is RBW, FASTor Fast Power, Select Trace is disabled.
Preset	1
State Saved	Saved in instrument state.
Range	1 2 3
Initial S/W Revision	Prior to A.02.00

Trace Type

Allows you to select the type of trace for the current measurement. The first page of this menu contains a selection of the trace type (Clear Write, Trace Average, Max Hold, Min Hold) for the selected trace.

Key Path	Trace/Detector
Mode	SA, WCDMA, C2K, WIMAX OFDMA, TD-SCDMA, 1xEVDO, DVB-T/H, DTMB (CTTB), ISDB-T, CMMB, LTE, LTE-TDD, Digital Cable TV, MSR, LTEAFDD, LTEATDD
Remote Command	:TRACe[1] 2 3 :ACPoweR :TYPE WRITe AVERAge MAXHold MINHold :TRACe[1] 2 3 :ACPoweR :TYPE?
Example	TRAC:ACP:TYPE MINH TRAC:ACP:TYPE?
Notes	WRITe = Clear Write AVERAge = Average MAXHold = Maximum Hold MINHold = Minimum Hold
Couplings	When Detector setting is "Auto" (:SENSe]:ACPoweR:DETECTOR:AUTO?), Detector is set to what the Radio Standard defaults states (see detector section below) for all conditions of Trace Type and for all traces. When set to Manual, all Traces use the same detector type. When Average State = Off then Trace Types AVERAge, MaxHold and MinHold will not function, since Averaging is required to be 'on' for them to operate.

	When Meas Method is RBW or FAST, Trace Type is disabled.
Preset	AVERage
State Saved	Saved in instrument state.
Initial S/W Revision	Prior to A.02.00
Modified at S/W Revision	A.02.00, A.03.00

View/Blank

Enables you to select how to view the displayed trace.

Key Path	Trace/Detector
Mode	SA,WCDMA, C2K, WIMAX OFDMA, TD-SCDMA, 1xEVDO, DVB-T/H, DTMB (CTTB), ISDB-T, CMMB, LTE, LTETDD, Digital Cable TV, MSR, LTEAFDD,LTEATDD
Notes	No remote control. Front panel only.
Couplings	The four states of this 1-of-N actually set two variables, Update and Display, to their four possible combinations. Trace On: Update and Display both On View: Update Off and Display On (Not implemented) Blank: Update Off and Display Off Background: Update On, Display Off (Not implemented) See tables below for detail on remote commands to control these two variables. Selecting a trace type (Clear Write, Trace Average, Max Hold, Min Hold) for a trace (pressing the key or sending the equivalent remote command) puts the trace in 'Trace On' state (Update On and Display On), even if that trace type was already selected. When Meas Method is RBW or FAST, this key is grayed out.
Preset	Trace On
State Saved	Saved in instrument state.
Range	Trace On Blank
Initial S/W Revision	Prior to A.02.00
Modified at S/W Revision	A.03.00

Key Path	Trace/Detector
Mode	WCDMA, C2K, WIMAX OFDMA, TD-SCDMA, 1xEVDO, DVB-T/H, DTMB (CTTB), ISDB-T, CMMB, LTE, LTETDD, Digital Cable TV, MSR, LTEAFDD,LTEATDD
Remote Command	:TRACe [1] 2 3 :ACPowe:r:UPDate [:STATe] ON OFF 0 1 :TRACe [1] 2 3 :ACPowe:r:UPDate [:STATe] ?
Example	TRAC:ACP:UPD ON TRAC:ACP:UPD?
Couplings	Whenever you set Update to On for any trace, the Display is set to On for that trace. When Meas Method is RBW or FAST, Trace Update is disabled.

Preset	1 0 0 (On for Trace 1; Off for 2 &3)
State Saved	Saved in instrument state.
Range	0 1
Initial S/W Revision	Prior to A.02.00
Modified at S/W Revision	A.03.00

Key Path	Trace/Detector
Mode	WCDMA, C2K, WIMAX OFDMA, TD-SCDMA, 1xEVDO, DVB-T/H, DTMB (CTTB), ISDB-T, CMMB, LTE, LTETDD, Digital Cable TV, MSR, LTEAFDD,LTEATDD
Remote Command	:TRACe[1] 2 3:ACPowEr:DISPly[:STATe] ON OFF 0 1 :TRACe[1] 2 3:ACPowEr:DISPly[:STATe]?
Example	TRAC:ACP:DISP ON TRAC:ACP:DISP?
Couplings	Whenever you set Update to On for any trace, the Display is set to On for that trace. When Meas Method is RBW or FAST, Trace Display is disabled.
Preset	1 0 0 (On for Trace 1; Off for 2 &3)
State Saved	Saved in instrument state.
Range	0 1
Initial S/W Revision	Prior to A.02.00
Modified at S/W Revision	A.03.00

Detector

Accesses a menu of functions that enables you to control the detectors for the current measurement. Allows up to three (3) traces, but each use the same detector type choice. The following choices are available:

- Auto– the detector selected is set to AVERage, unless the Radio Standard defaults state otherwise e.g. it is set to Peak for Radio Standard = PDC when Device = both MS and BTS, and when Radio Standard = NADC and Device = MS.
- Normal–the detector determines the peak of the CW-like signals, and it yields alternating maximums and minimums of noise-like signals. This is also referred to as Rosenfell detection.
- Average–the detector determines the average of the signal within the sweep points. The averaging method is Power (RMS).
- Peak–the detector determines the maximum of the signal within the sweep points.
- Sample–the detector indicates the instantaneous level of the signal at the center of the sweep points represented by each display point.
- Negative Peak–the detector determines the minimum of the signal within the sweep points.

In swept analysis, the time interval of the data collection for the display sweep points also represents a frequency interval. In FFT analysis, the sweep points represents just a frequency interval. The detector determines the relationship between the spectrum computed by the FFT and the single data point displayed for the sweep points. When Meas Method is Fast Power, Auto, Peak and Average are selectable.

Key Path	Trace/Detector
Initial S/W Revision	Prior to A.02.00

Auto

Sets the detector for the currently selected trace to auto.

Key Path	Trace/Detector
Mode	SA, WCDMA, C2K, WIMAX OFDMA, TD-SCDMA, 1xEVDO, DVB-T/H, DTMB (CTTB), ISDB-T, CMMB, LTE, LTE-TDD, Digital Cable TV, MSR, LTEAFDD, LTEATDD
Remote Command	<code>[[:SENSe]:ACPower:DETECTOR:AUTO ON OFF 1 0</code> <code>[[:SENSe]:ACPower:DETECTOR:AUTO?</code>
Example	ACP:DET:AUTO 1 ACP:DET?
Couplings	When Detector setting is "Auto" (<code>[[:SENSe]:ACPower:DETECTOR:AUTO?</code>), Detector is set to what the Radio Standard defaults states (see detector section) for all conditions of Trace Type and for all traces. When set to Manual, all Traces use the same detector type. When Average State = Off then Trace Types AVERage, MaxHold and MinHold will not function, since Averaging is required to be 'on' for them to operate.
Preset	ON
State Saved	Saved in instrument state.
Range	ON OFF
Initial S/W Revision	Prior to A.02.00
Modified at S/W Revision	A.02.00, A.03.00

Detector Selection

Selects a detector to be used by the analyzer for the current measurement. All traces will use the same detector type, similar to Monitor Spectrum measurement

Key Path	Trace/Detector
Mode	SA, WCDMA, C2K, WIMAX OFDMA, TD-SCDMA, 1xEVDO, DVB-T/H, DTMB (CTTB), ISDB-T, CMMB, LTE, LTE-TDD, Digital Cable TV, MSR, LTEAFDD, LTEATDD
Remote Command	<code>[[:SENSe]:ACPower:DETECTOR[:FUNCTION] AVERage NEGative NORMal POSitive SAMPlE</code> <code>[[:SENSe]:ACPower:DETECTOR[:FUNCTION]?</code>
Example	ACP:DET NORM

	ACP:DET?
Notes	<p>When you manually select a detector (instead of selecting Auto), that detector is used regardless of other analyzer settings.</p> <p>The detector choices are:</p> <ul style="list-style-type: none"> • The Normal detector determines the peak of CW-like signals, and it yields alternating maximums and minimums of noise-like signals. This is also referred to as Rosenfell detection. • The Average detector determines the average of the signal within the data range. The averaging method is Power (RMS). • The Peak detector determines the maximum of the signal within the data range. • The Sample detector indicates the instantaneous level of the signal at the center of the data represented by each display point. • The Negative Peak detector determines the minimum of the signal within the data range. <p>Because they may not find a spectral component's true peak, neither average nor sample detectors measure amplitudes of CW signals as accurately as peak or normal, but they do measure noise without the biases of peak detection.</p> <p>When Meas Method is Fast Power, Peak and Average are selectable.</p> <p>When a detector selection is made, the menu returns to the previous menu.</p>
Couplings	<p>When Detector setting is "Auto" ([:SENSe]:ACPower:DETECTOR:AUTO?), Detector is set to what the Radio Standard defaults states (see detector section) for all conditions of Trace Type and for all traces. When set to Manual, all Traces use the same detector type. When Average State = Off then Trace Types AVERage, MaxHold and MinHold will not function, since Averaging is required to be 'on' for them to operate.</p> <p>Only one detector type for all 3 traces is allowed.</p> <p>When Meas Method is RBW or FAST, Detector is disabled.</p>
Preset	AVERage
State Saved	Saved in instrument state.
Range	Normal Average Peak Sample Negative Peak
Backwards Compatibility SCPI	<code>[:SENSe] :ACPR :SWEep :DETECTOR [:FUNction]</code>
Initial S/W Revision	Prior to A.02.00
Modified at S/W Revision	A.02.00, A.03.00

Trigger

See ["Trigger" on page 444](#)

Free Run

See ["Free Run " on page 451](#)

Video

See ["Video \(IF Envelope\) " on page 452](#)

Trigger Level

See ["Trigger Level " on page 452](#)

Trig Slope

See ["Trig Slope " on page 453](#)

Trig Delay

See ["Trig Delay " on page 454](#)

Line

See ["Line " on page 2235](#)

Trig Slope

See ["Trig Slope " on page 2235](#)

Trig Delay

See ["Trig Delay " on page 456](#)

External 1

See ["External 1 " on page 2248](#)

Trigger Level

See ["Trigger Level " on page 2248](#)

Trig Slope

See ["Trig Slope " on page 2249](#)

Trig Delay

See ["Trig Delay " on page 459](#)

Zero Span Delay Comp

See ["Zero Span Delay Comp On/Off" on page 2237](#)

External 2

See ["External 2 "](#) on page 2250

Trigger Level

See ["Trigger Level "](#) on page 2250

Trig Slope

See ["Trig Slope "](#) on page 2251

Trig Delay

See ["Trig Delay "](#) on page 461

Zero Span Delay Comp

See ["Zero Span Delay Comp On/Off"](#) on page 2239

RF Burst

See ["RF Burst "](#) on page 2251

Absolute Trigger

See ["Absolute Trigger Level"](#) on page 2252

Relative Trigger

See ["Relative Trigger Level"](#) on page 2241

Trig Slope

See ["Trigger Slope "](#) on page 2253

Trig Delay

See ["Trig Delay "](#) on page 466

Periodic Timer

See ["Periodic Timer \(Frame Trigger\) "](#) on page 2243

Period

See ["Period "](#) on page 2244

Offset

See ["Offset "](#) on page 2245

Reset Offset Display

See ["Reset Offset Display "](#) on page 2247

Sync Source

See "[Sync Source](#) " on page 2247

Off

See "[Off](#) " on page 2248

External 1

See "[External 1](#) " on page 2248

Trigger Level

See "[Trigger Level](#) " on page 2248

Trig Slope

See "[Trig Slope](#) " on page 2249

External 2

See "[External 2](#) " on page 2250

Trigger Level

See "[Trigger Level](#) " on page 2250

Trig Slope

See "[Trig Slope](#) " on page 2251

RF Burst

See "[RF Burst](#) " on page 2251

Absolute Trigger

See "[Absolute Trigger Level](#)" on page 2252

Trig Slope

See "[Trigger Slope](#) " on page 2253

Trig Delay

See "[Trig Delay](#)" on page 476

Auto/Holdoff

See "[Auto/Holdoff](#) " on page 477

Auto Trig

See "[Auto Trig](#) " on page 477

Trig Holdoff

See "[Trig Holdoff](#) " on page 478

Holdoff Type

See "Holdoff Type" on page 478

User Preset

Accesses a menu that gives you the following three choices:

- **User Preset** – recalls a state previously saved using the Save User Preset function.
- **User Preset All Modes** – presets all of the modes in the analyzer
- **Save User Preset**– saves the current state for the current mode

Key Path	Front-panel key
Backwards Compatibility Notes	<p>User Preset is actually loading a state, and in legacy analyzers, it was possible to load a state without affecting the trace data, limit lines or correction data. Similarly it was possible to do a User Preset without affecting the trace data, limit lines or correction data.</p> <p>In the X-Series, “state” always includes all of this data; so whenever state is loaded, or User Preset is executed, all of the traces, limit lines and corrections are affected. Although this differs from previous behavior, it is desirable behavior, and should not cause adverse issues for users.</p> <p>On ESA and PSA, User Preset affected the entire instrument’s state. In the X-Series, User Preset only recalls the state for the active mode. There is a User Preset file for each mode. User Preset can never cause a mode switch as it can in legacy analyzers. If you want to recall all modes to their user preset file state, you will need to do a User Preset after mode switching into each mode.</p> <p>User Preset recalls mode state which can now include data like traces; whereas on ESA and PSA, User Preset did not affect data.</p>
Initial S/W Revision	Prior to A.02.00

User Preset

User Preset sets the state of the currently active mode back to the state that was previously saved for this mode using the Save User Preset menu key or the SCPI command, `SYST:PRES:USER:SAV`. It not only recalls the Mode Preset settings, but it also recalls all of the mode persistent settings, and the Input/Output system setting that existed at the time Save User Preset was executed.

If a Save User Preset has not been done at any time, User Preset recalls the default user preset file for the currently active mode. The default user preset files are created if, at power-on, a mode detects there is no user preset file. There will never be a scenario when there is no user preset file to restore. For each mode, the default user preset state is the same state that would be saved if a Save User Preset is performed in each mode right after doing a Restore Mode Default and after a Restore Input/Output Defaults.

The User Preset function does the following:

- Aborts the currently running measurement.
- Sets the mode State to the values defined by Save User Preset.
- Makes the saved measurement for the currently running mode the active measurement.
- Brings up the saved menu for the power-on mode.
- Clears the input and output buffers.
- Sets the Status Byte to 0.

Key Path	User Preset
Remote Command	:SYSTem:PRESet:USER
Example	:SYST:PRES:USER:SAVE:SYST:PRES:USER
Notes	:SYST:PRES:USER:SAVE is used to save the current state as the user preset state. Clears all pending OPC bits. The Status Byte is set to 0. Pressing the User Preset front-panel key while already in the User Preset menu will cause the User Preset to get executed
Couplings	A user preset will cause the currently running measurement to be aborted and cause the saved measurement to be active. Recalling a User Preset file has the same issues that recalling a Save State file has. Some settings may need to be limited and therefore re-coupled, since the capabilities of the mode may have changes when the User Preset file was last saved.
Initial S/W Revision	Prior to A.02.00

User Preset All Modes

Recalls all of the User Preset files for each mode, switches to the power-on mode, and activates the saved measurement from the power-on mode User Preset file.

NOTE

When the instrument is secured, all of the user preset files are converted back to their default user preset files.

The User Preset function does the following:

- Aborts the currently running measurement.
- Switches the Mode to the power-on mode.
- Restores the User Preset files for each mode.
- Makes the saved measurement for the power-on mode the active measurement.
- Brings up the saved menu for the power-on mode.
- Clears the input and output buffers.
- Sets the Status Byte to 0.

Key Path	User Preset
Remote Command	:SYSTem:PRESet:USER:ALL
Example	:SYST:PRES:USER:SAVE:SYST:PRES:USER:ALL
Notes	Clears all pending OPC bits. The Status Byte is set to 0. :SYST:PRES:USER:SAVE is used to save the current state as the user preset state.
Couplings	A user preset will cause the currently running measurement to be aborted, cause a mode switch to the power-on mode, and cause the saved measurement to be active in the power-on mode. Recalling a User Preset file has the same issues that recalling a Save State file has. Some settings may need to be limited and therefore re-coupled, since the capabilities of the mode may have changes when the User Preset file was last saved.

Initial S/W Revision	Prior to A.02.00
----------------------	------------------

Save User Preset

Saves the currently active mode and its State. You can recall this User Preset file by pressing the User Preset menu key or sending the SYST:PRES:USER remote command. This same state is also saved by the Save State function.

Key Path	User Preset
Remote Command	:SYSTem:PRESet:USER:SAVE
Example	:SYST:PRES:USER:SAVE
Notes	:SYST:PRES:SAVE creates the same file as if the user requested a *SAV or a MMEM:STOR:STAT, except User Preset Save does not allow the user to specify the filename or the location of the file.
Initial S/W Revision	Prior to A.02.00

View/Display

Accesses a menu of functions that enable you to control the instrument display as well as turn the bar graph On and Off.

If current mode is NOT MSR and LTE-Advanced FDD/TDD mode, the front panel views only contain one view: Spectrum View.

The results of the measurement can be displayed as a single spectrum trace view or displayed with a Bar Graph trace on the spectrum trace.

The display consists of the following two windows:

"Spectrum Window" on page 1175

"Results Window" on page 1175



The following two views are only for DTMB (CTTB) and CMMB:

DTMB and CMMB Transmitter:

10 ACP Measurement
View/Display

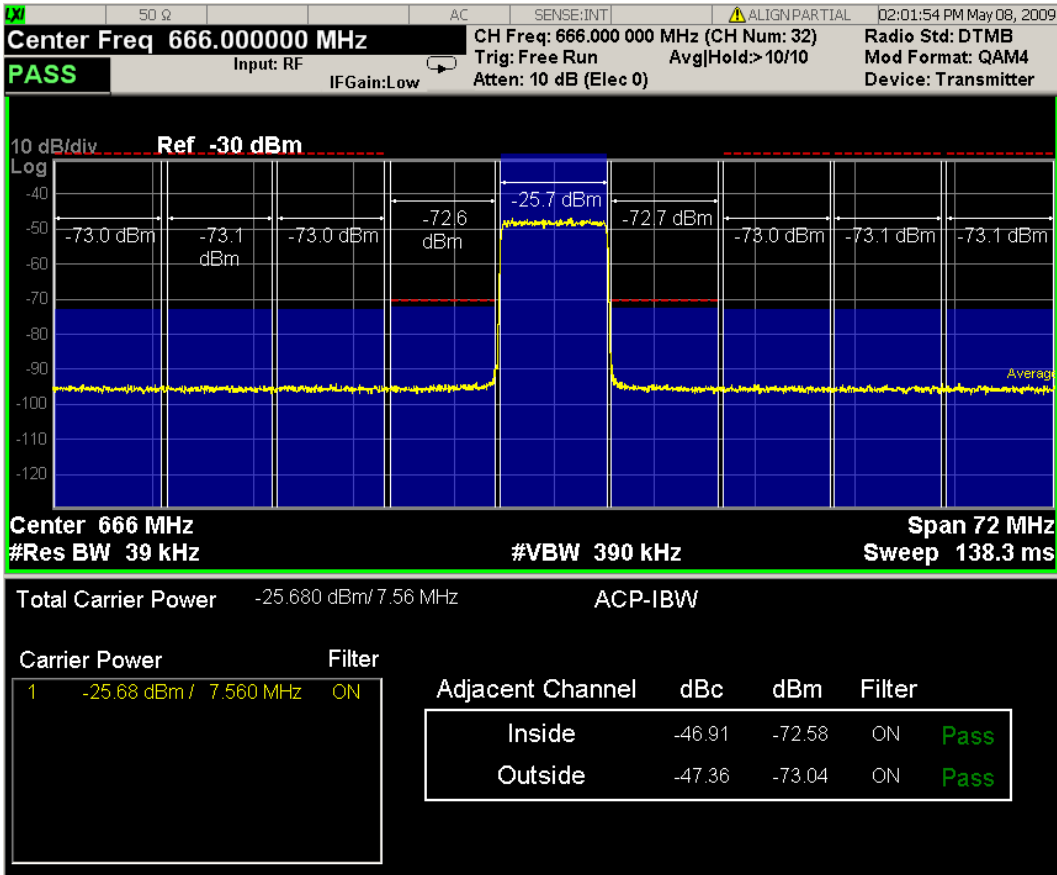

DTMB and CMMB Exciter:

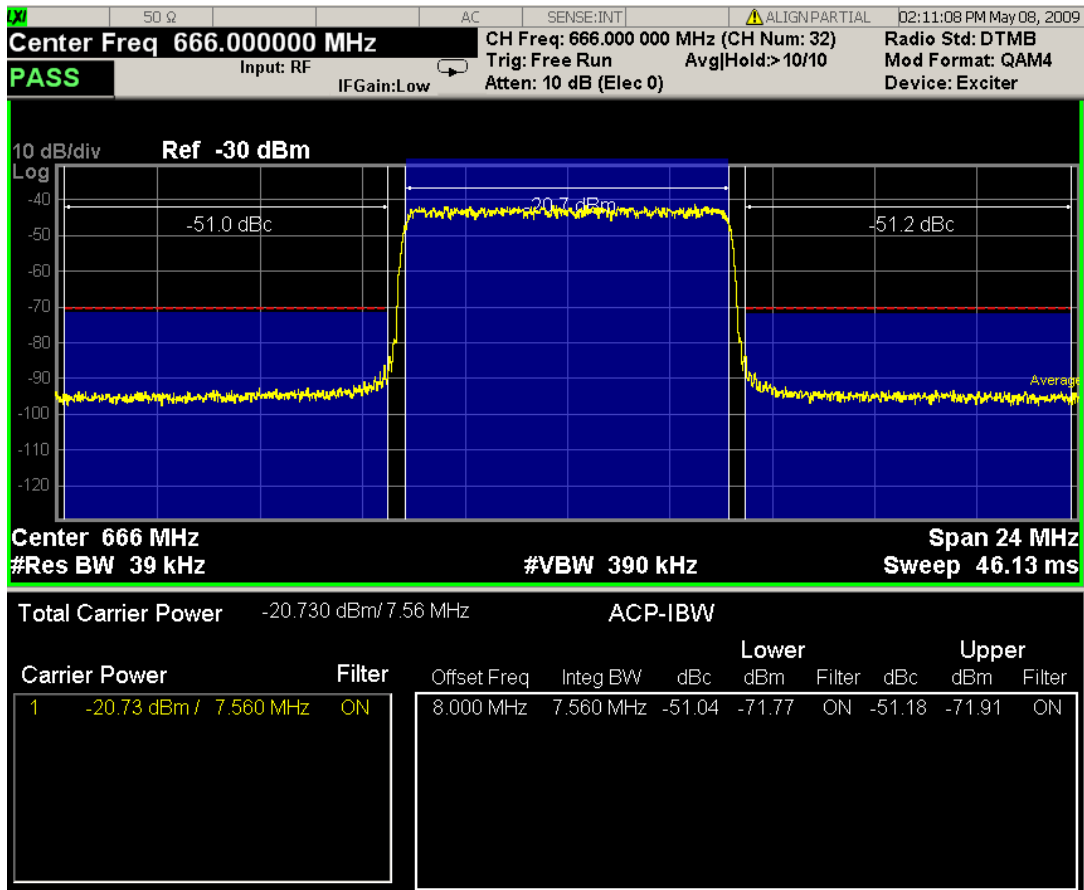

Spectrum Window

When the Bar Graph is On and Limit Test is On, the color of each bar graph reflects the limit test result. When the limit test fails, the bar color is red, and when limit test passes, the bar color is blue.

When RBW is selected as the measurement method, the spectrum trace is not displayed, only the bar graph is displayed. In addition, the Bar Graph key (under the View/Display front-panel key) is set to ON and is grayed out.

The RRC Filter display item is only displayed when RRC filter is on.

Results Window

The text window displays the following results:

Total Carrier Power

This is the total power of all the carriers with carrier power present set to yes. The power is calculated by integrating across the bandwidth declared by the Carrier Integ Bw parameter for each carrier and then totaling the sums. The total integration bandwidth is shown as part of the result. This will be the total of the Carrier Integ Bw of the carriers used in calculating the total carrier power. If the RRC Filter is on, then the integration bandwidth used is $(1 + \alpha)/T$ where $T = 1/(\text{Carrier Integ Bw})$ multiplied by the number of carriers with carrier power present set to yes.

Ref Carrier Power

This is the power in the reference carrier. The power is calculated by integrating across the bandwidth declared by the Carrier Integ Bw parameter for that carrier. The integration bandwidth is shown as part of the result. This is the value of the Carrier Integ Bw for that carrier unless the RRC Filter is on, then the integration bandwidth used is the displayed value, which is $(1 + \alpha)/T$ where $T = 1/(\text{Carrier Integ Bw})$.

Carrier Power

This is the power in all the currently defined carriers. If the carrier has carrier power present, the power will be absolute. If the carrier is defined as not having power present, the power will be relative to the reference carrier. The power is calculated by integrating across the bandwidth declared by the Carrier Integ Bw parameter. The integration bandwidth is shown as part of the result. This is the value of the Carrier Integ Bw for the carrier unless the RRC Filter is on, then the integration bandwidth used is the displayed value, which is $(1 + \alpha)/T$ where $T = 1/(\text{Carrier Integ Bw})$.

As there are potentially more results than can be easily viewed on the display, a scrollable list is used to display all results. The Carrier Results menu key is used to index the carrier amplitude results. This key is grayed out unless the measurement is in single mode (as in continual measurement mode). The display is continuously updating and will not need to be accessed. The currently selected Carrier Result is displayed on the last line of the carrier power result list unless:

- The selected Carrier Result is 4 or less in normal multi carrier power results view. In this case the first 4 carrier power results will be displayed.
- The selected Carrier Result is 9 or greater in normal multi carrier power results view. In this case the last 4 carrier power results will be displayed.
- The zoom mode is selected. In this case all carrier power ranges can be displayed.

Offset Relative Power

This is the power in the offsets relative to the reference carrier. The power is calculated by integrating across the bandwidth declared by the Offset Integ Bw parameter. The offset integration bandwidth is shown as part of the result. This is the value on the Offset Integ Bw menu key unless the RRC Filter is on, then the integration bandwidth used is the displayed value, which is $(1 + \alpha)/T$ where $T = 1/(\text{Offset Integ Bw})$.

Offset Absolute Power

This is the absolute power in the offsets. The power is calculated by integrating across the bandwidth declared by the Offset Integ Bw parameter. The offset integration bandwidth is shown as part of the result. This is the value on the Offset Integ Bw menu key unless the RRC Filter is on, then the integration bandwidth used is the displayed value, which is $(1 + \alpha)/T$ where $T = 1/(\text{Offset Integ Bw})$.

Inside Adjacent Channel Power (DTMB (CTTB) and CMMB only)

This result is only valid for DTMB (CTTB) transmitter and CMMB transmitter. It contains two parts: Relative Power and Absolute Power. The power is calculated by integrating across the bandwidth (Integ Bw) at the frequency Offset A.

Inside Absolute Power = $\text{MAX}(P_{\text{Lower Offset A}}, P_{\text{Upper Offset A}})$;

Inside Relative Power = Inside Absolute Power – Carrier Power;

Outside Adjacent Channel Absolute Power (DTMB (CTTB) and CMMB only)

This result is only valid for DTMB (CTTB) transmitter and CMMB transmitter. It contains two parts: Relative Power and Absolute Power. The power is the Root-Mean-Square of the power calculated by integrating across the bandwidth (Integ Bw) at frequency Offset B, C and D.

$$\text{Outside Absolute Power} = \sqrt{\frac{P_{\text{Lower Offset B}}^2 + P_{\text{Upper Offset B}}^2 + P_{\text{Lower Offset C}}^2 + P_{\text{Upper Offset C}}^2 + P_{\text{Lower Offset D}}^2 + P_{\text{Upper Offset D}}^2}{6}}$$

Outside Relative Power = Outside Absolute Power – Carrier Power;

If current mode is MSR, there are two views, Result Trace and Carrier Info.

NOTE

Y Scale/Div, Y Ref Position, Y Auto Scale, Y Ref Value and Bar Graph affect both views. For example, power bars on the traces in both views appear or disappear when Bar Graph is toggled.

View Selection by Name (MSR and LTE-Advanced FDD/TDD Only)

Selects the results view. The following SCPI command allows you to select the desired measurement view by enumeration.

Key Path	No equivalent front-panel key
Mode	MSR, LTEAFDD,LTEATDD
Remote Command	:DISPlay:ACPower:VIEW[:SElect] PRESult CINformation :DISPlay:ACPower:VIEW[:SElect]?
Example	DISP:ACP:VIEW PRES DISP:ACP:VIEW?
Notes	This SCPI is only available in MSR and LTE-Advanced FDD/TDD.
Preset	PRESult
State Saved	Saved in instrument state
Range	Power Results Carrier Info
Initial S/W Revision	A.10.00

Key Path	No equivalent front-panel key
Mode	MSR, LTEAFDD,LTEATDD
Remote Command	:DISPlay:ACPower:VIEW:NSElect <integer> :DISPlay:ACPower:VIEW:NSElect?
Example	DISP:ACP:VIEW:NSEL 1 DISP:ACP:VIEW:NSEL?
Notes	This SCPI is only available in MSR and LTE-Advanced FDD/TDD.
Preset	1
State Saved	Saved in instrument state
Min	1
Max	2
Initial S/W Revision	A.10.00

Key Path	Front-panel key
Initial S/W Revision	Prior to A.02.00

Display

The Display menu is common to most measurements, and is used for configuring items on the display. Some Display menu settings apply to all the measurements in a mode, and some only to the current measurement. Those under the **System Display Settings** key apply to all measurements in all modes.

Key Path	Display
Key Path	View/Display
Initial S/W Revision	Prior to A.02.00

Annotation

Turns on and off various parts of the display annotation. The annotation is divided up into four categories:

1. Meas Bar: This is the measurement bar at the top of the screen. It does not include the settings panel or the Active Function. Turning off the Meas Bar turns off the settings panel and the Active Function. When the Meas Bar is off, the graticule area expands to fill the area formerly occupied by the Meas Bar.
2. Screen Annotation: this is the annotation and annunciation around the graticule, including any annotation on lines (such as the display line, the threshold line, etc.) This does NOT include the marker number or the N dB result. When off, the graticule expands to fill the entire graticule area.
3. Trace annotation: these are the labels on the traces, showing their detector (or their math mode).
4. Active Function annotation: this is the active function display in the meas bar, and all of the active function values displayed on softkeys.

See the figure below. Each type of annotation can be turned on and off individually.

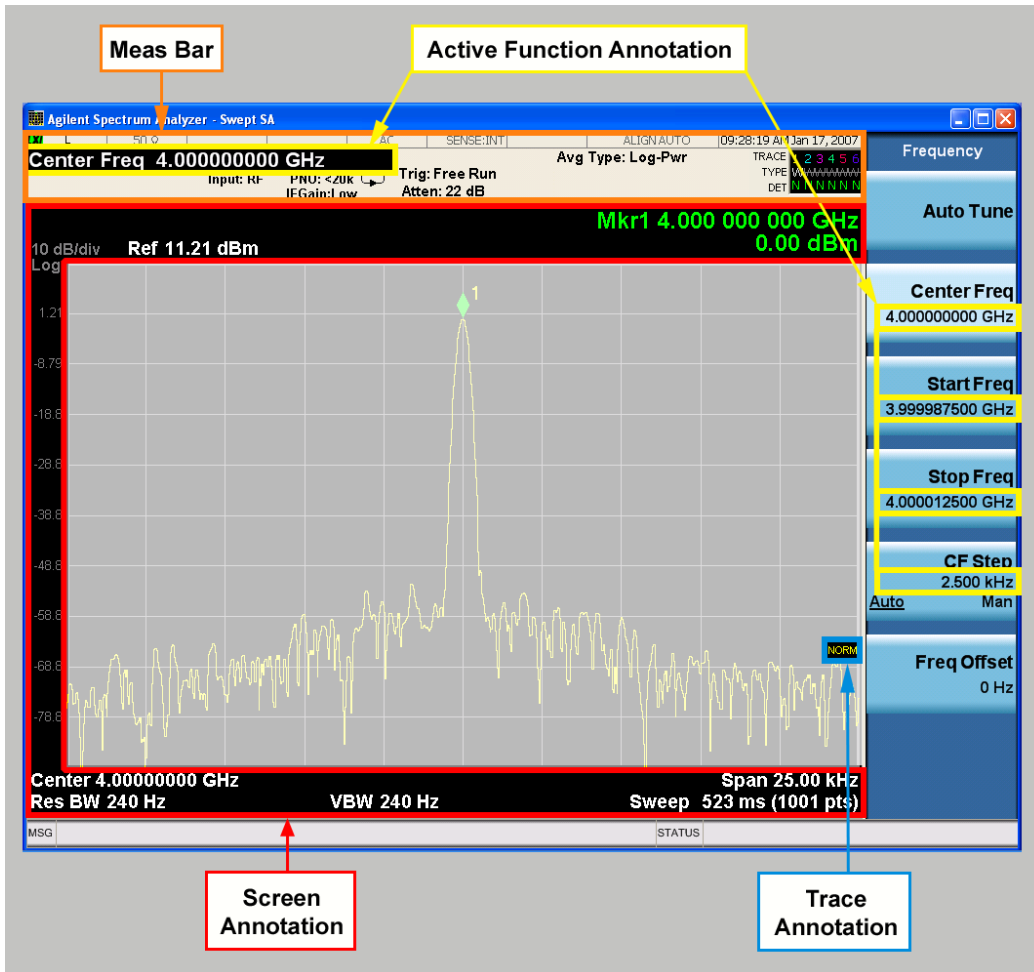

Key Path	View/Display, Display
Initial S/W Revision	Prior to A.02.00

Meas Bar On/Off

This function turns the Measurement Bar on and off, including the settings panel. When off, the graticule area expands to fill the area formerly occupied by the Measurement Bar.

Key Path	View/Display, Display, Annotation
Remote Command	:DISPlay:ANNotation:MBAR[:STATE] OFF ON 0 1 :DISPlay:ANNotation:MBAR[:STATE]?
Example	DISP:ANN:MBAR OFF
Dependencies	Grayed out and forced to OFF when System Display Settings, Annotation is set to Off.
Preset	On This should remain Off through a Preset when System DisplaySettings, Annotation is set to Off.

State Saved	Saved in instrument state.
Initial S/W Revision	Prior to A.02.00

Screen

This controls the display of the annunciation and annotation around the graticule, including any annotation on lines (such as the display line, the threshold line, etc.) and the y-axis annotation. This does NOT include marker annotation (or the N dB result). When off, the graticule expands to fill the entire graticule area, leaving only the 1.5% gap above the graticule as described in the Trace/Detector chapter.

Key Path	View/Display, Display, Annotation
Remote Command	:DISPlay:ANNotation:SCReen[:STATe] OFF ON 0 1 :DISPlay:ANNotation:SCReen[:STATe]?
Example	DISP:ANN:SCR OFF
Dependencies	Grayed-out and forced to OFF when System Display Settings, Annotation is set to Off.
Preset	On This should remain Off through a Preset when System DisplaySettings, Annotation is set to Off
State Saved	Saved in instrument state.
Initial S/W Revision	Prior to A.02.00

Active Function Values On/Off

Turns on and off the active function display in the Meas Bar, and all of the active function values displayed on the softkeys.

Note that all of the softkeys that have active functions have these numeric values blanked when this function is on. This is a security feature..

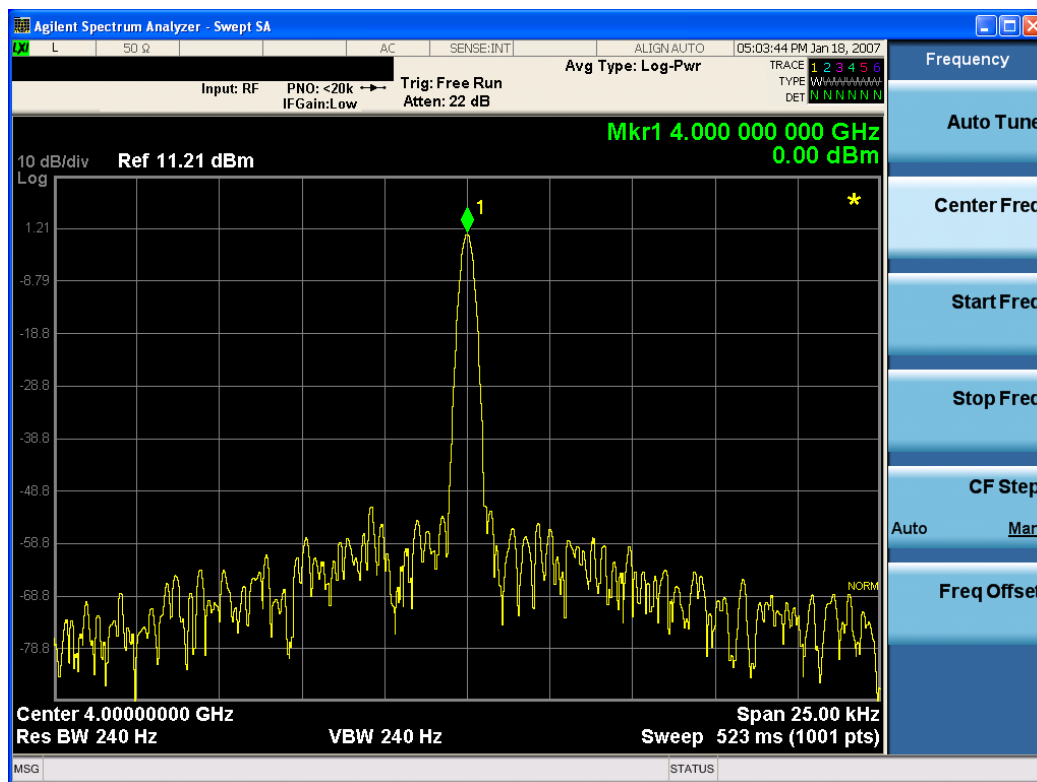

Key Path	View/Display, Display, Annotation
Remote Command	:DISPlay:ACTivefunc[:STATE] ON OFF 1 0 :DISPlay:ACTivefunc[:STATE]?
Example	DISP:ACT OFF
Dependencies	Grayed out and forced to OFF when System Display Settings, Annotation is set to Off.
Preset	On This should remain Off through a Preset when System DisplaySettings, Annotation is set to Off
State Saved	Saved in instrument state.
Initial S/W Revision	Prior to A.02.00

Title

Displays menu keys that enable you to change or clear a title on your display.

Key Path	View/Display, Display
Initial S/W Revision	Prior to A.02.00

Change Title

Writes a title into the "measurement name" field in the banner, for example, "Swept SA".

Press Change Title to enter a new title through the alpha editor. Press Enter or Return to complete the entry. Press ESC to cancel the entry and preserve your existing title.

The display title will replace the measurement name. It remains for this measurement until you press **Change Title** again, or you recall a state, or a Preset is performed. A title can also be cleared by pressing **Title**, **Clear Title**.

NOTE

Notice the inclusion of the <measurement> parameter in the command below. Because each measurement remembers the Display Title, the command must be qualified with the measurement name. For the Swept SA measurement this is not the case; no <measurement> parameter is used when changing the Display Title for the Swept SA measurement.

Key Path	View/Display, Display, Title
Mode	All
Remote Command	:DISPlay:<measurement>:ANNotation:TITLe:DATA <string> :DISPlay:<measurement>:ANNotation:TITLe:DATA?
Example	DISP:ANN:TITL:DATA "This Is My Title" This example is for the Swept SA measurement in the Spectrum Analyzer mode. The SANalyzer <measurement> name is not used. DISP:ACP:ANN:TITL:DATA "This Is My Title" This example is for Measurements other than Swept SA. Both set the title to: This Is My Title
Notes	Pressing this key cancels any active function. When a title is edited the previous title remains intact (it is not cleared) and the cursor goes at the end so that characters can be added or BKSP can be used to go back over previous characters.
Preset	No title (measurement name instead)
State Saved	Saved in instrument state.
Initial S/W Revision	Prior to A.02.00

Clear Title

Clears a title from the front-panel display. Once cleared, the title cannot be retrieved. After the title is cleared, the current Measurement Name replaces it in the title bar.

Key Path	View/Display, Display, Title
Example	The following commands clear the title and restore the measurement's original title: DISP:ANN:TITL:DATA "" This example is for the Swept SA measurement in the Spectrum Analyzer mode. The SANalyzer <measurement> name is not used. DISP:ACP:ANN:TITL:DATA "" This example is for ACP; in measurements other than Swept SA the measurement name is required.
Notes	Uses the :DISPlay:<measurement>:ANNotation:TITLe:DATA <string> command with an empty string (in the Swept SA, the <measurement> is omitted).

Preset	Performed on Preset.
Initial S/W Revision	Prior to A.02.00

Graticule

Pressing Graticule turns the display graticule On or Off. It also turns the graticule y-axis annotation on and off.

Key Path	View/Display, Display
Remote Command	:DISPlay:WINDow[1]:TRACe:GRATicule:GRID[:STATe] OFF ON 0 1 :DISPlay:WINDow[1]:TRACe:GRATicule:GRID[:STATe]?
Example	DISP:WIND:TRAC:GRAT:GRID OFF
Notes	The graticule is the set of horizontal and vertical lines that make up the grid/divisions for the x-axis and y-axis.
Preset	On
State Saved	Saved in instrument state
Initial S/W Revision	Prior to A.02.00

System Display Settings

These settings are "Mode Global" – they affect all modes and measurements and are reset only by **Restore Misc Defaults** or **Restore System Defaults** under System.

Key Path	View/Display, Display
Initial S/W Revision	Prior to A.02.00

Annotation Local Settings

This is a Mode Global override of the meas local annotation settings. When it is **All Off**, it forces **ScreenAnnotation, Meas Bar, Trace, and Active Function Values** settings to be **OFF** for all measurements in all modes. This provides the security based "annotation off" function of previous analyzers; hence it uses the legacy SCPI command.

When it is **All Off**, the **Screen, Meas Bar, Trace, and Active Function Values** keys under the **Display, Annotation** menu are grayed out and forced to **Off**. When **Local Settings** is selected, you are able to set the local annotation settings on a measurement by measurement basis.

Key Path	View/Display, Display, System Display Settings
Remote Command	:DISPlay:WINDow[1]:ANNOtation[:ALL] OFF ON 0 1 :DISPlay:WINDow[1]:ANNOtation[:ALL]?
Example	:DISP:WIND:ANN OFF

Preset	On (Set by Restore Misc Defaults)
State Saved	Not saved in instrument state.
Backwards Compatibility Notes	The WINDOW parameter and optional subopcode is included for backwards compatibility but ignored - all windows are equally affected.
Initial S/W Revision	Prior to A.02.00

Themes

Accesses a menu of functions that enable you to choose the theme to be used when saving the screen image.

The **Themes** option is the same as the **Themes** option under the **Display** and **Page Setup** dialogs. It allows you to choose between themes to be used when saving the screen image.

Key Path	Save, Screen Image
Remote Command	:MMEMory:STORe:SCReen:THEMe TDColor TDMonochrome FCOLor FMONochrome :MMEMory:STORe:SCReen:THEMe?
Example	:MMEM:STOR:SCR:THEM TDM
Preset	3D Color; Is not part of Preset, but is reset by Restore Misc Defaults or Restore System Defaults All and survives subsequent running of the modes.
Readback	3D Color 3D Mono Flat Color Flat Mono
Backwards Compatibility Notes	In ESA and PSA we offer the choice of "Reverse Bitmap" or "Reverse Metafile" when saving screen images. This is much like the "Flat Color" theme available in X-Series. Also, if you selected Reverse Bitmap AND a black & white screen image, that would be much like "Flat Monochrome". In other words, each of the X-Series themes has a similar screen image type in ESA/PSA. But they are not identical.
Initial S/W Revision	Prior to A.02.00

3D Color

Selects a standard color theme with each object filled, shaded and colored as designed.

Key Path	Save, Screen Image, Themes
Example	MMEM:STOR:SCR:THEM TDC
Readback	3D Color
Initial S/W Revision	Prior to A.02.00

3D Monochrome

Selects a format that is like 3D color but shades of gray are used instead of colors.

Key Path	Save, Screen Image, Themes
Example	MMEM:STOR:SCR:THEM TDM
Readback	3D Mono
Initial S/W Revision	Prior to A.02.00

Flat Color

Selects a format that is best when the screen is to be printed on an ink printer.

Key Path	Save, Screen Image, Themes
Example	MMEM:STOR:SCR:THEM FCOL
Readback	Flat Color
Initial S/W Revision	Prior to A.02.00

Flat Monochrome

Selects a format that is like Flat Color. But only black is used (no colors, not even gray), and no fill.

Key Path	Save, Screen Image, Themes
Example	MMEM:STOR:SCR:THEM FMON
Readback	Flat Mono
Initial S/W Revision	Prior to A.02.00

Backlight

Accesses the display backlight on/off keys. This setting may interact with settings under the Windows "Power" menu.

When the backlight is off, pressing ESC, TAB, SPACE, ENTER, UP, DOWN, LEFT, RIGHT, DEL, BKSP, CTRL, or ALT turns the backlight on without affecting the application. Pressing any other key will turn backlight on and could potentially perform the action as well.

Key Path	View/Display, Display, System Display Settings
Remote Command	:DISPlay:BACKlight ON OFF :DISPlay:BACKlight?
Preset	ON (Set by Restore Misc Defaults)
Initial S/W Revision	Prior to A.02.00

Backlight Intensity

An active function used to set the backlight intensity. It goes from 0 to 100 where 100 is full on and 0 is off. This value is independent of the values set under the Backlight on/off key.

Key Path	View/Display, Display, System Display Settings
Remote Command	:DISPlay:BACKlight:INTensity <integer> :DISPlay:BACKlight:INTensity?
Example	DISP:BACK:INT 50
Preset	100 (Set by Restore Misc Defaults)
Min	0
Max	100
Initial S/W Revision	Prior to A.02.00

Power Results (MSR and LTE-Advanced FDD/TDD Only)

The spectrum trace and power bars are displayed in the upper window. Carrier and offset powers are summarized in the lower window. See "Spectrum Window" on page 1175 and "Results Window" on page 1175 for more information.

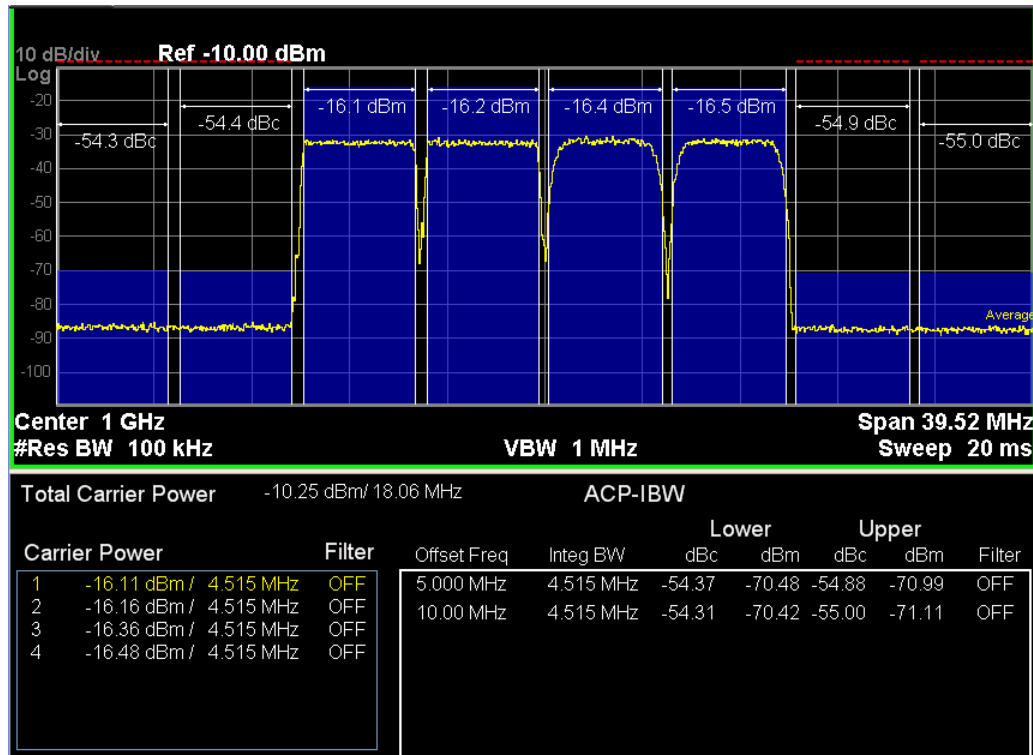

Key Path	View/Display
Initial S/W Revision	A.10.00

Power Result Type (MSR and LTE-Advanced FDD/TDD Only)

This key enables you to select Power Result Type.

- Outer – Results of outer offsets and carrier powers are shown in this view. Inner offset results are not shown even when Carrier Allocation is Non-Contiguous.
- Outer & Inner – Results of both inner and outer offsets are shown in this view.

Key Path	View/Display
Mode	MSR, LTEAFDD,LTEATDD
Remote Command	:DISPlay:ACPower:VIEW:RTYPe OUTer OINNeR :DISPlay:ACPower:VIEW:RTYPe
Example	DISP:ACP:VIEW:RTYP OUT DISP:ACP:VIEW:RTYP?
Notes	This key is blank in the mode other than MSR and LTE-Advanced FDD/TDD.
Preset	OUTer
State Saved	Saved in instrument state
Range	Outer Outer & Inner
Initial S/W Revision	A.13.00

Carrier Info (MSR and LTE-Advanced FDD/TDD Only)

The lower window of Power Results view is replaced by the carrier info table in this view. Carrier center frequency can be displayed in either offset or absolute frequency depending on Carrier Freq. The table can be scrolled by Carrier Result on Meas Setup menu or by Select Carrier on Config Carriers menu. The highlighted row changes as either Carrier Result or Select Carrier is changed. The highlighted row and these keys are not coupled.

10 ACP Measurement
View/Display

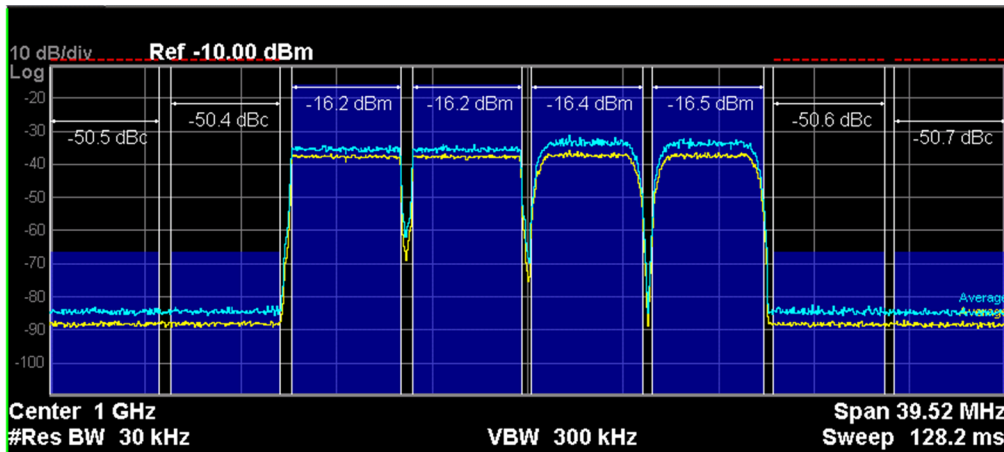

Total Power		X.XX dBm		Total PSD		X.XX dBm/Hz		RF-BW XX.XX MHz		
Carrier Pwr	Integ BW	Filter	Offset Freq	Sub-block	Measure	Parameter Set				
1	4.538 dBm	300 kHz	OFF	-19.800 MHz	1	On	GSM/EDGE 1			
2	15.61 dBm	3.840 MHz	RRC	-12.600 MHz	1	On	W-CDMA			
3	16.31 dBm	4.515 MHz	OFF	2.5000 MHz	2	On	LTE FDD1			

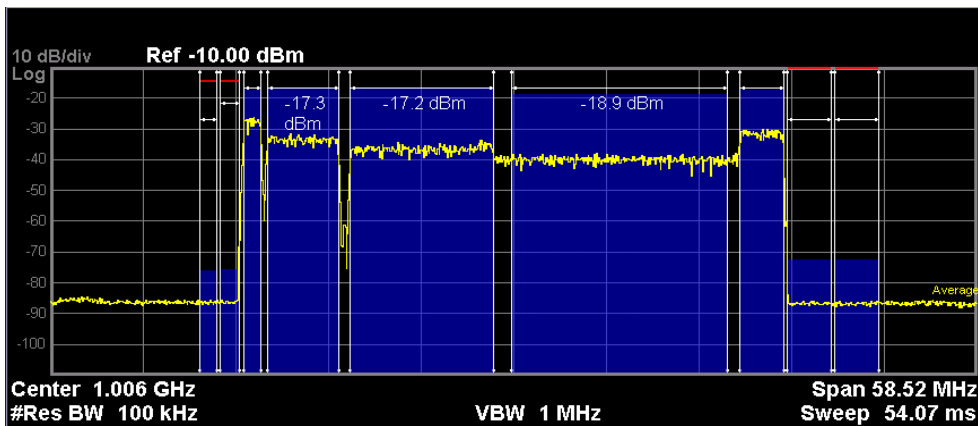

Total Power -10.66 dBm / 30.86MHz RF-BW 34.40 MHz

Ref Carrier Power: -17.55 dBm / 1.095 MHz (Carrier #1:Left)
-17.52 dBm / 2.715 MHz (Carrier #5:Right)

Carrier Pwr	Carrier PSD	Integ BW	Filter	Offset Freq	Measure
1 -17.55 dBm	-77.95 dBm/Hz	1.095 MHz	OFF	-10.700 MHz	On
2 -17.30 dBm	-83.85 dBm/Hz	4.515 MHz	OFF	-7.5000 MHz	On
3 -17.17 dBm	-86.72 dBm/Hz	9.015 MHz	OFF	0.0000 Hz	On
4 -18.92 dBm	-90.23 dBm/Hz	13.515 MHz	OFF	12.500 MHz	On
5 -17.52 dBm	-81.86 dBm/Hz	2.715 MHz	OFF	21.500 MHz	On

Key Path View/Display

Initial S/W Revision A.10.00

Carrier Freq (MSR and LTE-Advanced FDD/TDD Only)

Sets the carrier frequency display type.

Offset – The carrier center frequencies are displayed as offset from Carrier Ref Freq.

Absolute – The carrier center frequencies are displayed as absolute frequency.

Key Path	View/Display, Carrier Info
Mode	MSR, LTEAFDD, LTEATDD
Remote Command	:DISPlay:ACPower:VIEW:WINDow:CINFormation:FREQuency OFFSet ABSolute :DISPlay:ACPower:VIEW:WINDow:CINFormation:FREQuency?
Example	DISP:ACP:VIEW:WIND:CINF:FREQ ABS DISP:ACP:VIEW:WIND:CINF:FREQ?
Notes	This key is blank in mode other than MSR and LTE-Advanced FDD/TDD.
Preset	OFFSet
State Saved	Saved in instrument state
Range	Offset Absolute
Initial S/W Revision	A.10.00

Bar Graph

Turns the Bar Graph On and Off.

Key Path	View/Display
Mode	SA, WCDMA, C2K, WIMAX OFDMA, TD-SCDMA, 1xEVDO, DVB-T/H, DTMB (CTTB), ISDB-T, CMMB, LTE, LTE-TDD, Digital Cable TV, MSR, LTEAFDD, LTEATDD
Remote Command	:DISPlay:ACPower:VIEW[1]:WINDow[1]:BGRaph OFF ON 0 1 :DISPlay:ACPower:VIEW[1]:WINDow[1]:BGRaph?
Example	DISP:ACP:VIEW:WIND:BGR OFF DISP:ACP:VIEW:WIND:BGR?
Notes	You must be in the mode that includes ACP measurements to use this command. Use :INSTrument:SElect to set the mode.
Dependencies	When the method is RBW, this key is always set to On and grayed out.
Preset	ON
State Saved	Saved in instrument state.
Range	On Off
Initial S/W Revision	Prior to A.02.00
Modified at S/W Revision	A.02.00, A.03.00

11 Spectrum Emission Mask Measurement

The spectrum emission mask measures spurious signal levels in up to six pairs of offset frequencies and relates them to the carrier power. For measurement results and views, see ["View/Display" on page 1465](#).

This topic contains the following sections:

["Measurement Commands for Spectrum Emission Mask" on page 1192](#)

["Remote Command Results for Spectrum Emission Mask Measurement" on page 1193](#)

["Number of Offsets" on page 1212](#)

Measurement Commands for Spectrum Emission Mask

Offsets that are turned off (inactive) return -999.0 when their results are queried via SCPI.

```
:CONFigure:SEMask  
:CONFigure:SEMask:NDEFault  
:INITiate:SEMask  
:FETCh:SEMask[n]?  
:MEASure:SEMask[n]?  
:READ:SEMask[n]?
```

For more measurement related commands, see the SENSE subsystem, and the section "[Remote Measurement Functions](#)" on page 2381.

Remote Command Results for Spectrum Emission Mask Measurement

The following table describes the results returned by the FETCh, MEASure, and READ queries listed above, according to the index value n:

Modes	n	Return Value
All except MSR, WLAN, LTEAFDD, LTEATDD	1	<p>Meas Type: Total Power Reference</p> <p>Returns 82 comma-separated scalar results, in the following order:</p> <ol style="list-style-type: none"> 1. Reserved for the future use, returns -999.0 2. Absolute power at the center frequency (reference) area (dBm) 3. Reserved for the future use, returns -999.0 4. Reserved for the future use, returns -999.0 5. Peak frequency in the center frequency (reference) area (Hz) 6. Reserved for the future use, returns -999.0 7. Reserved for the future use, returns -999.0 8. Reserved for the future use, returns -999.0 9. Reserved for the future use, returns -999.0 10. Reserved for the future use, returns -999.0 11. Relative integrated power on the negative offset A (dBc) 12. Absolute integrated power on the negative offset A (dBm) 13. Relative peak power on the negative offset A (dBc) 14. Absolute peak power on the negative offset A (dBm) 15. Peak power offset frequency from the center or carrier edge frequency in the negative offset A, depending on Offset Frequency Define settings (Hz) 16. Relative integrated power on the positive offset A (dBc) 17. Absolute integrated power on the positive offset A (dBm) 18. Relative peak power on the positive offset A (dBc) 19. Absolute peak power on the positive offset A (dBm) 20. Peak power offset frequency from the center or carrier edge frequency in the positive offset A, depending on Offset Frequency Define settings (Hz) 21. Relative integrated power on the negative offset B (dBc) --- 69. Absolute peak power on the positive offset F (dBm) 70. Peak power offset frequency from the center or carrier edge frequency in the positive offset F, depending on Offset Frequency Define settings (Hz) 71. Minimum margin from limit line on the negative offset A (dB) 72. Minimum margin from limit line on the positive offset A (dB) 73. Minimum margin from limit line on the negative offset B (dB) 74. Minimum margin from limit line on the positive offset B (dB) 75. Minimum margin from limit line on the negative offset C (dB) 76. Minimum margin from limit line on the positive offset C (dB)

Modes	n	Return Value
		77. Minimum margin from limit line on the negative offset D (dB) 78. Minimum margin from limit line on the positive offset D (dB) 79. Minimum margin from limit line on the negative offset E (dB) 80. Minimum margin from limit line on the positive offset E (dB) 81. Minimum margin from limit line on the negative offset F (dB) 82. Minimum margin from limit line on the positive offset F (dB)
All except MSR, WLAN, LTEAFDD, LTEATDD	1	Meas Type: Power Spectral Density Reference Returns 82 comma-separated scalar results, in the following order: 1. Reserved for the future use, returns -999.0 2. Absolute power at the center frequency (reference) area (dBm/Hz) 3. Reserved for the future use, returns -999.0 4. Reserved for the future use, returns -999.0 5. Peak frequency in the center frequency (reference) area (Hz) 6. Reserved for the future use, returns -999.0 7. Reserved for the future use, returns -999.0 8. Reserved for the future use, returns -999.0 9. Reserved for the future use, returns -999.0 10. Reserved for the future use, returns -999.0 11. Relative integrated power on the negative offset A (dB) 12. Absolute integrated power on the negative offset A (dBm/Hz) 13. Relative peak power on the negative offset A (dB) 14. Absolute peak power on the negative offset A (dBm/Hz) 15. Peak power offset frequency from the center or carrier edge frequency in the negative offset A, depending on Offset Frequency Define settings (Hz) 16. Relative integrated power on the positive offset A (dB) 17. Absolute integrated power on the positive offset A (dBm/Hz) 18. Relative peak power on the positive offset A (dB) 19. Absolute peak power on the positive offset A (dBm/Hz) 20. Peak power offset frequency from the center or carrier edge frequency in the positive offset A, depending on Offset Frequency Define settings (Hz) 21. Relative integrated power on the negative offset B (dB) --- 69. Absolute peak power on the positive offset F (dBm/Hz) 70. Peak power offset frequency from the center or carrier edge frequency in the positive offset F, depending on Offset Frequency Define settings (Hz) 71. Minimum margin from limit line on the negative offset A (dB) 72. Minimum margin from limit line on the positive offset A (dB) 73. Minimum margin from limit line on the negative offset B (dB) 74. Minimum margin from limit line on the positive offset B (dB)

Modes	n	Return Value
		75. Minimum margin from limit line on the negative offset C (dB)
		76. Minimum margin from limit line on the positive offset C (dB)
		77. Minimum margin from limit line on the negative offset D (dB)
		78. Minimum margin from limit line on the positive offset D (dB)
		79. Minimum margin from limit line on the negative offset E (dB)
		80. Minimum margin from limit line on the positive offset E (dB)
		81. Minimum margin from limit line on the negative offset F (dB)
		82. Minimum margin from limit line on the positive offset F (dB)
All except MSR, WLAN, LTEAFDD, LTEATDD	1	<p>Meas Type: Spectrum Peak Reference Returns 82 comma-separated scalar results, in the following order:</p> <ol style="list-style-type: none"> 1. Reserved for the future use, returns -999.0 2. Peak power at the center frequency (reference) area (dBm) 3. Reserved for the future use, returns -999.0 4. Reserved for the future use, returns -999.0 5. Peak frequency in the center frequency (reference) area (Hz) 6. Reserved for the future use, returns -999.0 7. Reserved for the future use, returns -999.0 8. Reserved for the future use, returns -999.0 9. Reserved for the future use, returns -999.0 10. Reserved for the future use, returns -999.0 11. Reserved for the future use, returns -999.0 12. Reserved for the future use, returns -999.0 13. Relative peak power on the negative offset A (dB) 14. Absolute peak power on the negative offset A (dBm) 15. Peak power offset frequency from the center or carrier edge frequency in the negative offset A, depending on Offset Frequency Define settings (Hz) 16. Reserved for the future use, returns -999.0 17. Reserved for the future use, returns -999.0 18. Relative peak power on the positive offset A (dB) 19. Absolute peak power on the positive offset A (dBm) 20. Peak power offset frequency from the center or carrier edge frequency in the positive offset A, depending on Offset Frequency Define settings (Hz) 21. Reserved for the future use, returns -999.0 <p>---</p> <ol style="list-style-type: none"> 69. Absolute peak power on the positive offset F (dBm) 70. Peak power offset frequency from the center or carrier edge frequency in the positive offset F, depending on Offset Frequency Define settings (Hz) 71. Minimum margin from limit line on the negative offset A (dB) 72. Minimum margin from limit line on the positive offset A (dB)

Modes	n	Return Value
		73. Minimum margin from limit line on the negative offset B (dB)
		74. Minimum margin from limit line on the positive offset B (dB)
		75. Minimum margin from limit line on the negative offset C (dB)
		76. Minimum margin from limit line on the positive offset C (dB)
		77. Minimum margin from limit line on the negative offset D (dB)
		78. Minimum margin from limit line on the positive offset D (dB)
		79. Minimum margin from limit line on the negative offset E (dB)
		80. Minimum margin from limit line on the positive offset E (dB)
		81. Minimum margin from limit line on the negative offset F (dB)
		82. Minimum margin from limit line on the positive offset F (dB)
MSR, LTEAFDD, LTEATDD	1	<p>Meas Type: Total Power Reference Returns outer offset results when Non-Contiguous Meas Region is set to Outer, and returns inner offset results when it is set to Inner, in the following order.</p> <ol style="list-style-type: none"> 1. Total Absolute power of carriers of Measure Carrier On if available. Otherwise -999.0 is returned. 2. Absolute reference power. Absolute power at the left reference carrier if Power Ref type is "Left & Right Carriers." Absolute power at the reference carrier of the left sub-block if Power Ref type is "Max Power Carrier in Sub-block." (dBm) 3. Absolute power at the right reference carrier if Power Ref type is "Left & Right Carriers." Absolute power at the reference carrier of the right sub-block if Power Ref type is "Max Power Carrier in Sub-block." Otherwise -999.0 is returned. (dBm) 4. Reserved for the future use, returns -999.0 5. Peak frequency in the ref carrier channel spacing frequency range. Peak frequency in the left ref carrier frequency range if Power Ref Type is "Left & Right Carriers." Peak frequency in the ref carrier frequency range of the left sub-block if Power Ref type is "Max Power Carrier in Sub-block." 6. Peak frequency in the right ref carrier channel spacing frequency range if Power Ref type is "Left & Right Carriers." Peak frequency in the ref carrier frequency range of the right sub-block if Power Ref type is "Max Power Carrier in Sub-block." Otherwise -999.0 is returned. 7. Reserved for the future use, returns -999.0 8. Reserved for the future use, returns -999.0 9. Reserved for the future use, returns -999.0 10. Reserved for the future use, returns -999.0 11. Relative integrated power on the negative offset A (dBc) 12. Absolute integrated power on the negative offset A (dBm) 13. Relative peak power on the negative offset A (dBc) 14. Absolute peak power on the negative offset A (dBm) 15. Peak power offset frequency from the center or carrier edge frequency in the negative offset A, depending on Offset Frequency Define settings (Hz) 16. Relative integrated power on the positive offset A (dBc) 17. Absolute integrated power on the positive offset A (dBm) 18. Relative peak power on the positive offset A (dBc) 19. Absolute peak power on the positive offset A (dBm)

Modes	n	Return Value
		20. Peak power offset frequency from the center or carrier edge frequency in the positive offset A, depending on Offset Frequency Define settings (Hz)
		21. Relative integrated power on the negative offset B (dBc)

		69. Absolute peak power on the positive offset F (dBm)
		70. Peak power offset frequency from the center or carrier edge frequency in the positive offset F, depending on Offset Frequency Define settings (Hz)
		71. Minimum margin from limit line on the negative offset A (dB)
		72. Minimum margin from limit line on the positive offset A (dB)
		73. Minimum margin from limit line on the negative offset B (dB)
		74. Minimum margin from limit line on the positive offset B (dB)
		75. Minimum margin from limit line on the negative offset C (dB)
		76. Minimum margin from limit line on the positive offset C (dB)
		77. Minimum margin from limit line on the negative offset D (dB)
		78. Minimum margin from limit line on the positive offset D (dB)
		79. Minimum margin from limit line on the negative offset E (dB)
		80. Minimum margin from limit line on the positive offset E (dB)
		81. Minimum margin from limit line on the negative offset F (dB)
		82. Minimum margin from limit line on the positive offset F (dB)
MSR, LTEAFDD, LTEATDD	1	<p>Meas Type: Power Spectral Density Reference</p> <p>Returns outer offset results when Non-Contiguous Meas Region is set to Outer, and returns inner offset results when it is set to Inner, in the following order.</p> <ol style="list-style-type: none"> 1. Total Absolute power of carriers of Measure Carrier On if available. Otherwise -999.0 is returned. (dBm) 2. Absolute reference power. Absolute power at the left reference carrier if Power Ref type is "Left & Right Carriers." Absolute power at the reference carrier of the left sub-block if Power Ref type is "Max Power Carrier in Sub-block." (dBm/Hz) 3. Absolute power at the right reference carrier if Power Ref type is "Left & Right Carriers." Absolute power at the reference carrier of the right sub-block if Power Ref type is "Max Power Carrier in Sub-block." Otherwise -999.0 is returned. (dBm/Hz) 4. Reserved for the future use, returns -999.0 5. Peak frequency in the ref carrier channel spacing frequency range . Peak frequency in the left ref carrier frequency range if Power Ref type is "Left & Right Carriers." Peak frequency in the ref carrier frequency range of the left sub-block if Power Ref type is "Max Power Carrier in Sub-block." 6. Peak frequency in the right ref carrier channel spacing frequency range if Power Ref type is "Left & Right Carriers." Peak frequency in the ref carrier frequency range of the right sub-block if Power Ref type is "Max Power Carrier in Sub-block." Otherwise -999.0 is returned. 7. Reserved for the future use, returns -999.0 8. Reserved for the future use, returns -999.0 9. Reserved for the future use, returns -999.0 10. Reserved for the future use, returns -999.0

Modes	n	Return Value
		11. Relative integrated power on the negative offset A (dBc) 12. Absolute integrated power on the negative offset A (dBm/Hz) 13. Relative peak power on the negative offset A (dBc) 14. Absolute peak power on the negative offset A (dBm/Hz) 15. Peak power offset frequency from the center or carrier edge frequency in the negative offset A, depending on Offset Frequency Define settings (Hz) 16. Relative integrated power on the positive offset A (dBc) 17. Absolute integrated power on the positive offset A (dBm/Hz) 18. Relative peak power on the positive offset A (dBc) 19. Absolute peak power on the positive offset A (dBm/Hz) 20. Peak power offset frequency from the center or carrier edge frequency in the positive offset A, depending on Offset Frequency Define settings (Hz) 21. Relative integrated power on the negative offset B (dBc) --- 69. Absolute peak power on the positive offset F (dBm/Hz) 70. Peak power offset frequency from the center or carrier edge frequency in the positive offset F, depending on Offset Frequency Define settings (Hz) 71. Minimum margin from limit line on the negative offset A (dB) 72. Minimum margin from limit line on the positive offset A (dB) 73. Minimum margin from limit line on the negative offset B (dB) 74. Minimum margin from limit line on the positive offset B (dB) 75. Minimum margin from limit line on the negative offset C (dB) 76. Minimum margin from limit line on the positive offset C (dB) 77. Minimum margin from limit line on the negative offset D (dB) 78. Minimum margin from limit line on the positive offset D (dB) 79. Minimum margin from limit line on the negative offset E (dB) 80. Minimum margin from limit line on the positive offset E (dB) 81. Minimum margin from limit line on the negative offset F (dB) 82. Minimum margin from limit line on the positive offset F (dB)
MSR, LTEAFDD, LTEATDD	1	<p>Meas Type: Spectrum Peak Reference</p> <p>Returns outer offset results when Non-Contiguous Meas Region is set to Outer, and returns inner offset results when it is set to Inner, in the following order.</p> <ol style="list-style-type: none"> 1. Total Absolute power of carriers of Measure Carrier On if available. Otherwise -999.0 is returned. (dBm) 2. Peak reference power. Peak power at the left reference carrier if Power Ref type is "Left & Right Carriers." Peak power at the reference carrier of the left sub-block if Power Ref type is "Max Power Carrier in Sub-block." (dBm) 3. Peak power at the right reference carrier if Power Ref type is "Left & Right Carriers." Peak power at the reference carrier of the right sub-block if Power Ref type is "Max Power Carrier in Sub-block." Otherwise -999.0 is returned. (dBm)

Modes	n	Return Value
		4. Reserved for the future use, returns -999.0
		5. Peak frequency in the ref carrier channel spacing frequency range. Peak frequency in the left ref carrier frequency range if Power Ref type is "Left & Right Carriers." Peak frequency in the ref carrier frequency range of the left sub-block if Power Ref type is "Max Power Carrier in Sub-block."
		6. Peak frequency in the right ref carrier channel spacing frequency range if Power Ref type is "Left & Right Carriers." Peak frequency in the ref carrier frequency range of the right sub-block if Power Ref type is "Max Power Carrier in Sub-block." Otherwise -999.0 is returned.
		7. Reserved for the future use, returns -999.0
		8. Reserved for the future use, returns -999.0
		9. Reserved for the future use, returns -999.0
		10. Reserved for the future use, returns -999.0
		11. Relative integrated power on the negative offset A (dBc)
		12. Absolute integrated power on the negative offset A (dBm)
		13. Relative peak power on the negative offset A (dBc)
		14. Absolute peak power on the negative offset A (dBm)
		15. Peak power offset frequency from the center or carrier edge frequency in the negative offset A, depending on Offset Frequency Define settings (Hz)
		16. Relative integrated power on the positive offset A (dBc)
		17. Absolute integrated power on the positive offset A (dBm)
		18. Relative peak power on the positive offset A (dBc)
		19. Absolute peak power on the positive offset A (dBm)
		20. Peak power offset frequency from the center or carrier edge frequency in the positive offset A, depending on Offset Frequency Define settings (Hz)
		21. Relative integrated power on the negative offset B (dBc)

		69. Absolute peak power on the positive offset F (dBm)
		70. Peak power offset frequency from the center or carrier edge frequency in the positive offset F, depending on Offset Frequency Define settings (Hz)
		71. Minimum margin from limit line on the negative offset A (dB)
		72. Minimum margin from limit line on the positive offset A (dB)
		73. Minimum margin from limit line on the negative offset B (dB)
		74. Minimum margin from limit line on the positive offset B (dB)
		75. Minimum margin from limit line on the negative offset C (dB)
		76. Minimum margin from limit line on the positive offset C (dB)
		77. Minimum margin from limit line on the negative offset D (dB)
		78. Minimum margin from limit line on the positive offset D (dB)
		79. Minimum margin from limit line on the negative offset E (dB)
		80. Minimum margin from limit line on the positive offset E (dB)
		81. Minimum margin from limit line on the negative offset F (dB)
		82. Minimum margin from limit line on the positive offset F (dB)
WLAN,	1	

Modes	n	Return Value
with radio standard 802.11 ac (80 MHz + 80 MHz)		<p>Meas Type: Total Power Reference Returns 82 comma-separated scalar results, in the following order:</p> <ol style="list-style-type: none"> 1. Reserved for the future use, returns -999.0 2. Absolute reference power (dBm) 3. Absolute power of the carrier of which the frequency is indicated by Freq Segment 1 (dBm) 4. Absolute power of the carrier of which the frequency is indicated by Freq Segment 2 (dBm) 5. Peak frequency in the center frequency (reference) area (Hz) 6. Reserved for the future use, returns -999.0 7. Reserved for the future use, returns -999.0 8. Reserved for the future use, returns -999.0 9. Reserved for the future use, returns -999.0 10. Reserved for the future use, returns -999.0 11. Relative integrated power on the negative offset A (dBc) 12. Absolute integrated power on the negative offset A (dBm) 13. Relative peak power on the negative offset A (dBc) 14. Absolute peak power on the negative offset A (dBm) 15. Peak power offset frequency from the center or carrier edge frequency in the negative offset A, depending on Offset Frequency Define settings (Hz) 16. Relative integrated power on the positive offset A (dBc) 17. Absolute integrated power on the positive offset A (dBm) 18. Relative peak power on the positive offset A (dBc) 19. Absolute peak power on the positive offset A (dBm) 20. Peak power offset frequency from the center or carrier edge frequency in the positive offset A, depending on Offset Frequency Define settings (Hz) 21. Relative integrated power on the negative offset B (dBc) --- 69. Absolute peak power on the positive offset F (dBm) 70. Peak power offset frequency from the center or carrier edge frequency in the positive offset F, depending on Offset Frequency Define settings (Hz) 71. Minimum margin from limit line on the negative offset A (dB) 72. Minimum margin from limit line on the positive offset A (dB) 73. Minimum margin from limit line on the negative offset B (dB) 74. Minimum margin from limit line on the positive offset B (dB) 75. Minimum margin from limit line on the negative offset C (dB) 76. Minimum margin from limit line on the positive offset C (dB) 77. Minimum margin from limit line on the negative offset D (dB) 78. Minimum margin from limit line on the positive offset D (dB) 79. Minimum margin from limit line on the negative offset E (dB) 80. Minimum margin from limit line on the positive offset E (dB) 81. Minimum margin from limit line on the negative offset F (dB)

Modes	n	Return Value
		82. Minimum margin from limit line on the positive offset F (dB)
WLAN, with radio standard 802.11 ac (80 MHz + 80 MHz)	1	<p>Meas Type: Power Spectral Density Reference Returns 82 comma-separated scalar results, in the following order:</p> <ol style="list-style-type: none"> 1. Reserved for the future use, returns -999.0 2. Absolute reference power (dBm/Hz) 3. Absolute power of the carrier of which the frequency is indicated by Freq Segment 1 (dBm/Hz) 4. Absolute power of the carrier of which the frequency is indicated by Freq Segment 2 (dBm/Hz) 5. Peak frequency in the center frequency (reference) area (Hz) 6. Reserved for the future use, returns -999.0 7. Reserved for the future use, returns -999.0 8. Reserved for the future use, returns -999.0 9. Reserved for the future use, returns -999.0 10. Reserved for the future use, returns -999.0 11. Relative integrated power on the negative offset A (dB) 12. Absolute integrated power on the negative offset A (dBm/Hz) 13. Relative peak power on the negative offset A (dB) 14. Absolute peak power on the negative offset A (dBm/Hz) 15. Peak power offset frequency from the center or carrier edge frequency in the negative offset A, depending on Offset Frequency Define settings (Hz) 16. Relative integrated power on the positive offset A (dB) 17. Absolute integrated power on the positive offset A (dBm/Hz) 18. Relative peak power on the positive offset A (dB) 19. Absolute peak power on the positive offset A (dBm/Hz) 20. Peak power offset frequency from the center or carrier edge frequency in the positive offset A, depending on Offset Frequency Define settings (Hz) 21. Relative integrated power on the negative offset B (dB) <p>---</p> <ol style="list-style-type: none"> 69. Absolute peak power on the positive offset F (dBm/Hz) 70. Peak power offset frequency from the center or carrier edge frequency in the positive offset F, depending on Offset Frequency Define settings (Hz) 71. Minimum margin from limit line on the negative offset A (dB) 72. Minimum margin from limit line on the positive offset A (dB) 73. Minimum margin from limit line on the negative offset B (dB) 74. Minimum margin from limit line on the positive offset B (dB) 75. Minimum margin from limit line on the negative offset C (dB) 76. Minimum margin from limit line on the positive offset C (dB) 77. Minimum margin from limit line on the negative offset D (dB) 78. Minimum margin from limit line on the positive offset D (dB) 79. Minimum margin from limit line on the negative offset E (dB)

Modes	n	Return Value
		80. Minimum margin from limit line on the positive offset E (dB) 81. Minimum margin from limit line on the negative offset F (dB) 82. Minimum margin from limit line on the positive offset F (dB)
All	2	Returns the displayed frequency domain spectrum trace data separated by comma. The number of data points is 2001.
All	3	Returns the displayed frequency domain absolute limit trace data separated by comma. The number of data points is 2001.
All	4	Returns the displayed frequency domain relative limit trace data separated by comma. The number of data points is 2001.
All (see details)	5	<p>Meas Type: Total Power Reference Returns comma-separated scalar values (in dBm) of the absolute integrated power of the segment frequencies. The length of the result depends on the number of available offset (See "Number of Offsets" on page 1212).</p> <ol style="list-style-type: none"> Total power reference (dBm) Reserved for the future use, returns -999.0 Absolute integrated power at negative offset frequency (A) Absolute integrated power at positive offset frequency (A) --- Absolute integrated power at negative offset frequency (L) Absolute integrated power at positive offset frequency (L) <p>In MSR and LTE-Advanced FDD/TDD mode. Returns outer offset results when Non-Contiguous Meas Region is set to Outer, and returns inner offset results when it is set to Inner, in the following order.</p> <ol style="list-style-type: none"> Ref carrier power. Left ref carrier power if Power Ref type is "Left & Right Carriers." Ref carrier power of the left sub-block if Power Ref type is "Max Power Carrier in Sub-block." (dBm) Right ref carrier power if Ref channel type is "Left & Right Carriers." Ref carrier power of the right sub-block if Power Ref type is "Max Power Carrier in Sub-block." Otherwise -999.0 is returned. (dBm) Absolute integrated power at negative offset frequency (A) Absolute integrated power at positive offset frequency (A) --- Absolute integrated power at negative offset frequency (L) Absolute integrated power at positive offset frequency (L) <p>In WLAN mode. Returns 26 comma-separated scalar values (in dBm) of the absolute integrated power of the segment frequencies:</p> <ol style="list-style-type: none"> Ref carrier power (dBm) Reserved for the future use, returns -999.0 Absolute integrated power at negative offset frequency (A) Absolute integrated power at positive offset frequency (A) ---

Modes	n	Return Value
		<p>25. Absolute integrated power at negative offset frequency (L)</p> <p>26. Absolute integrated power at positive offset frequency (L)</p> <p>If the result is not available, -999.0 is returned.</p> <p>The number of values returned is subject to change in future releases.</p>
All (see details)	5	<p>Meas Type: Power Spectral Density Reference</p> <p>Returns comma-separated scalar values (in dBm/Hz) of the absolute integrated power of the segment frequencies. The length of the result depends on the number of available offset (See "Number of Offsets" on page 1212).</p> <ol style="list-style-type: none"> 1. Power spectral density reference (dBm/Hz) 2. Reserved for the future use, returns -999.0 3. Absolute integrated power at negative offset frequency (A) 4. Absolute integrated power at positive offset frequency (A) <p>---</p> <ol style="list-style-type: none"> 25. Absolute integrated power at negative offset frequency (L) 26. Absolute integrated power at positive offset frequency (L) <p>In MSR and LTE-Advanced FDD/TDD mode.</p> <p>Returns outer offset results when Non-Contiguous Meas Region is set to Outer, and returns inner offset results when it is set to Inner, in the following order.</p> <ol style="list-style-type: none"> 1. Ref carrier power. Left ref carrier power if Power Ref type is "Left & Right Carriers" Ref carrier power of the left sub-block if Power Ref type is "Max Power Carrier in Sub-block." (dBm/Hz) 2. Right ref carrier power if Power Ref type is "Left & Right Carriers." Ref carrier power of the right sub-block if Power Ref type is "Max Power Carrier in Sub-block." Otherwise -999.0 is returned. (dBm/Hz) 3. Absolute integrated power at negative offset frequency (A) 4. Absolute integrated power at positive offset frequency (A) <p>---</p> <ol style="list-style-type: none"> 25. Absolute integrated power at negative offset frequency (L) 26. Absolute integrated power at positive offset frequency (L) <p>In WLAN mode.</p> <p>Returns 26 comma-separated scalar values (in dBm/Hz) of the absolute integrated power of the segment frequencies:</p> <ol style="list-style-type: none"> 1. Ref carrier power (dBm/Hz) 2. Reserved for the future use, returns -999.0 3. Absolute integrated power at negative offset frequency (A) 4. Absolute integrated power at positive offset frequency (A) <p>---</p> <ol style="list-style-type: none"> 25. Absolute integrated power at negative offset frequency (L) 26. Absolute integrated power at positive offset frequency (L) <p>If the result is not available, -999.0 is returned.</p> <p>The number of values returned is subject to change in future releases.</p>
All (see details)	5	

Modes	n	Return Value
		<p>Meas Type: Spectrum Peak Reference Returns comma-separated scalar values (in dBm) of the absolute peak power of the segment frequencies. The length of the result depends on the number of available offset (See "Number of Offsets" on page 1212).</p> <ol style="list-style-type: none"> 1. Spectrum Peak Power reference (dBm) 2. Reserved for the future use, returns -999.0 3. Absolute peak power at negative offset frequency (A) 4. Absolute peak power at positive offset frequency (A) <p>---</p> <ol style="list-style-type: none"> 25. Absolute peak power at negative offset frequency (L) 26. Absolute peak power at positive offset frequency (L) <p>In MSR and LTE-Advanced FDD/TDD mode. Returns outer offset results when Non-Contiguous Meas Region is set to Outer, and returns inner offset results when it is set to Inner, in the following order.</p> <ol style="list-style-type: none"> 1. Spectrum Peak Power reference of ref carrier. Spectrum Peak Power reference of left ref carrier if Power Ref type is "Left & Right Carriers." Spectrum Peak Power reference of the left sub-block if Power Ref type is "Max Power Carrier in Sub-block." (dBm) 2. Spectrum Peak Power reference of right ref carrier power if Power Ref type is "Left & Right carriers." Spectrum Peak Power reference of the right sub-block if Power Ref type is "Max Power Carrier in Sub-block." Otherwise -999.0 is returned. (dBm) 3. Absolute peak power at negative offset frequency (A) 4. Absolute peak power at positive offset frequency (A) <p>---</p> <ol style="list-style-type: none"> 25. Absolute peak power at negative offset frequency (L) 26. Absolute peak power at positive offset frequency (L) <p>If the result is not available, -999.0 is returned. The number of values returned is subject to change in future releases.</p>
All	6	<p>Meas Type: Total Power Reference Returns comma-separated scalar values (in dBc) of the integrated power relative to the carrier at the segment frequencies. The length of the result depends on the number of available offset (See "Number of Offsets" on page 1212).</p> <p>When in the MSR and LTE-Advanced FDD/TDD mode, returns outer offset results when Non-Contiguous Meas Region is set to Outer, and returns inner offset results when it is set to Inner, in the following order.</p> <ol style="list-style-type: none"> 1. Reserved for the future use, returns -999.0 2. Reserved for the future use, returns -999.0 3. Relative integrated power at negative offset frequency (A) 4. Relative integrated power at positive offset frequency (A) <p>---</p> <ol style="list-style-type: none"> 25. Relative integrated power at negative offset frequency (L) 26. Relative integrated power at positive offset frequency (L) <p>If the result is not available, -999.0 is returned.</p>

Modes	n	Return Value
All	6	<p>The number of values returned is subject to change in future releases.</p> <hr/> <p>Meas Type: Power Spectral Density Reference Returns comma-separated scalar values (in dBc/Hz) of the integrated power relative to the carrier at the segment frequencies. The length of the result depends on the number of available offset (See "Number of Offsets" on page 1212).</p> <p>When in the MSR and LTE-Advanced FDD/TDD mode, returns outer offset results when Non-Contiguous Meas Region is set to Outer, and returns inner offset results when it is set to Inner, in the following order. Returns -999.0 for the offsets if in WLAN:</p> <ol style="list-style-type: none"> 1. Reserved for the future use, returns -999.0 2. Reserved for the future use, returns -999.0 3. Relative integrated power at negative offset frequency (A) 4. Relative integrated power at positive offset frequency (A) <p>---</p> <ol style="list-style-type: none"> 25. Relative integrated power at negative offset frequency (L) 26. Relative integrated power at positive offset frequency (L) <p>If the result is not available, -999.0 is returned. The number of values returned is subject to change in future releases.</p>
All	6	<p>Meas Type: Spectrum Peak Reference Returns comma-separated scalar values (in dB) of the integrated power relative to the carrier at the segment frequencies. The length of the result depends on the number of available offset (See "Number of Offsets" on page 1212).</p> <p>When in the MSR and LTE-Advanced FDD/TDD mode, returns outer offset results when Non-Contiguous Meas Region is set to Outer, and returns inner offset results when it is set to Inner, in the following order.</p> <ol style="list-style-type: none"> 1. Reserved for the future use, returns -999.0 2. Reserved for the future use, returns -999.0 3. Relative peak power at negative offset frequency (A) 4. Relative peak power at positive offset frequency (A) <p>---</p> <ol style="list-style-type: none"> 25. Relative peak power at negative offset frequency (L) 26. Relative peak power at positive offset frequency (L) <p>If the result is not available, -999.0 is returned. The number of values returned is subject to change in future releases.</p>
All	7	<p>Returns comma-separated pass/fail test results (0=passed, or 1=failed) determined by testing the minimum margin point from the limit line that is determined each offset's Limits setting. The length of the result depends on the number of available offset (See "Number of Offsets" on page 1212).</p> <p>When in the MSR and LTE-Advanced FDD/TDD mode, returns outer offset results when Non-Contiguous Meas Region is set to Outer, and returns inner offset results when it is set to Inner, in the following order.</p> <ol style="list-style-type: none"> 1. Reserved for the future use, returns -999.0 2. Reserved for the future use, returns -999.0

Modes	n	Return Value
		3. At negative offset frequency (A) 4. At positive offset frequency (A) --- 25. At negative offset frequency (L) 26. At positive offset frequency (L) The number of values returned is subject to change in future releases.
All	8	Offset Pass/Fail. Returns comma-separated pass/fail test results (0=passed, or 1=failed) determined by testing the minimum margin point from the limit line that is determined each offset's Limits setting. The length of the result depends on the number of available offset (See " Number of Offsets " on page 1212). When in the MSR and LTE-Advanced FDD/TDD mode, returns outer offset results when Non-Contiguous Meas Region is set to Outer, and returns inner offset results when it is set to Inner, in the following order. Note: These results (n=8) are the same as n=7 result. 1. Reserved for the future use, returns -999.0 2. Reserved for the future use, returns -999.0 3. At negative offset frequency (A) 4. At positive offset frequency (A) --- 25. At negative offset frequency (L) 26. At positive offset frequency (L) The number of values returned is subject to change in future releases.
All	9	Offset Peak Power Freq. Returns comma-separated scalar values of frequency (in Hz) that have peak power from center or carrier edge frequency in each offset, depending on Offset Frequency Define settings. The length of the result depends on the number of available offset (See " Number of Offsets " on page 1212). When in the MSR and LTE-Advanced FDD/TDD mode, returns outer offset results when Non-Contiguous Meas Region is set to Outer, and returns inner offset results when it is set to Inner, in the following order. 1. Reserved for the future use, returns -999.0 2. Reserved for the future use, returns -999.0 3. Negative offset frequency (A) 4. Positive offset frequency (A) --- 25. Negative offset frequency (L) 26. Positive offset frequency (L) If the result is not available, -999.0 is returned. The number of values returned is subject to change in future releases.
All	10	Offset Abs Peak Power. Returns comma-separated scalar values (in dBm) of the absolute peak power of the segment frequencies. The length of the result depends on the number of available offset (See " Number of Offsets " on page 1212). When in the MSR and LTE-Advanced FDD/TDD mode, returns outer offset results when Non-Contiguous

Modes	n	Return Value
		<p>Meas Region is set to Outer, and returns inner offset results when it is set to Inner, in the following order.</p> <ol style="list-style-type: none"> 1. Reserved for the future use, returns -999.0 2. Reserved for the future use, returns -999.0 3. At negative offset frequency (A) 4. At positive offset frequency (A) <p>---</p> <ol style="list-style-type: none"> 25. At negative offset frequency (L) 26. At positive offset frequency (L) <p>If the result is not available, -999.0 is returned.</p> <p>The number of values returned is subject to change in future releases.</p>
All	11	<p>Offset Rel Peak Power.</p> <p>Returns comma-separated scalar values in dBc (dB if MeasType = PSD) of the peak power relative to the carrier at the segment frequencies. The length of the result depends on the number of available offset (See "Number of Offsets" on page 1212).</p> <p>When in the MSR and LTE-Advanced FDD/TDD mode, returns outer offset results when Non-Contiguous Meas Region is set to Outer, and returns inner offset results when it is set to Inner, in the following order.</p> <ol style="list-style-type: none"> 1. Reserved for the future use, returns -999.0 2. Reserved for the future use, returns -999.0 3. At negative offset frequency (A) 4. At positive offset frequency (A) <p>---</p> <ol style="list-style-type: none"> 25. At negative offset frequency (L) 26. At positive offset frequency (L) <p>If the result is not available, -999.0 is returned.</p> <p>The number of values returned is subject to change in future releases.</p>
All	12	<p>Returns the power result (the peak power of the signal in the ref channel) when Meas Type is Spectrum Peak reference. Otherwise, the value returned will be -999.0.</p> <p>When in the MSR and LTE-Advanced FDD/TDD mode, returns outer offset results when Non-Contiguous Meas Region is set to Outer, and returns inner offset results when it is set to Inner, in the following order.</p>
MSR, LTEAFDD, LTEATDD only	13	<p>Meas Type: Total Power Reference</p> <p>Returns outer offset results when Non-Contiguous Meas Region is set to Outer, and returns inner offset results when it is set to Inner, in the following order.</p> <ol style="list-style-type: none"> 1. Total Absolute power of carriers of Measure Carrier On if Power Ref Type is "Max Power Carrier," "Max Power Carrier in Sub-block," or "RF Bandwidth." Otherwise NaN (9.91E+37) is returned. (dBm) 2. Absolute reference power. Absolute power at the left reference carrier if Power Ref type is "Left & Right Carriers." Absolute power at the reference carrier of the left sub-block if Power Ref type is "Max Power Carrier in Sub-block." (dBm) 3. Absolute power at the right reference carrier if Power Ref type is "Left & Right Carriers." Absolute power at the reference carrier of the right sub-block if Power Ref type is "Max Power Carrier in Sub-block." Otherwise NaN (9.91E+37) is returned. (dBm)

Modes	n	Return Value
MSR, LTEAFDD, LTEATDD only	13	<p>4. Peak frequency in the measured ref carrier frequency range. Peak frequency in the left ref carrier frequency range if Power Ref type is “Left & Right Carriers.” Peak frequency in the ref carrier frequency range of the left sub-block if Power Ref type is “Max Power Carrier in Sub-block.” (Hz)</p> <p>5. Peak frequency in the right ref carrier frequency range if Power Ref type is “Left & Right Carriers.” Peak frequency in the ref carrier frequency range of the right sub-block if Power Ref type is “Max Power Carrier in Sub-block.” Otherwise NaN (9.91E+37) is returned. (Hz)</p> <p>If the result is not available, NaN (9.91E+37) is returned.</p> <p>The number of values returned is subject to change in future releases.</p>
MSR, LTEAFDD, LTEATDD only	13	<p>Meas Type: Power Spectral Density Reference</p> <p>Returns outer offset results when Non-Contiguous Meas Region is set to Outer, and returns inner offset results when it is set to Inner, in the following order.</p> <p>1. Total Absolute power of carriers of Measure Carrier On if Power Ref Type is “Max Power Carrier,” “Max Power Carrier in Sub-block,” or “RF Bandwidth.” Otherwise NaN (9.91E+37) is returned. (dBm)</p> <p>2. Absolute reference power. Absolute power at the left reference carrier if Power Ref type is “Left & Right Carriers.” Absolute power at the reference carrier of the left sub-block if Power Ref type is “Max Power Carrier in Sub-block.” (dBm/Hz)</p> <p>3. Absolute power at the right reference carrier if Power Ref type is “Left & Right Carriers.” Absolute power at the reference carrier of the right sub-block if Power Ref type is “Max Power Carrier in Sub-block.” Otherwise NaN (9.91E+37) is returned. (dBm/Hz)</p> <p>4. Peak frequency in the measured ref carrier frequency range. Peak frequency in the left ref carrier frequency range if Power Ref type is “Left & Right Carriers.” Peak frequency in the ref carrier frequency range of the left sub-block if Power Ref type is “Max Power Carrier in Sub-block.” (Hz)</p> <p>5. Peak frequency in the right ref carrier frequency range if Power Ref type is “Left & Right Carriers.” Peak frequency in the ref carrier frequency range of the right sub-block if Power Ref type is “Max Power Carrier in Sub-block.” Otherwise NaN (9.91E+37) is returned. (Hz)</p> <p>If the result is not available, NaN (9.91E+37) is returned.</p> <p>The number of values returned is subject to change in future releases.</p>
MSR, LTEAFDD, LTEATDD only	13	<p>Meas Type: Power Spectrum Peak Reference</p> <p>Returns outer offset results when Non-Contiguous Meas Region is set to Outer, and returns inner offset results when it is set to Inner, in the following order.</p> <p>1. Total Absolute power of carriers of Measure Carrier On if Power Ref Type is “Max Power Carrier,” “Max Power Carrier in Sub-block,” or “RF Bandwidth.” Otherwise NaN (9.91E+37) is returned. (dBm)</p> <p>2. Peak reference power. Peak power at the left reference carrier if Power Ref type is “Left & Right Carriers.” Peak power at the reference carrier of the left sub-block if Power Ref type is “Max Power Carrier in Sub-block.” (dBm)</p> <p>3. Peak power at the right reference carrier if Power Ref type is “Left & Right Carriers.” Peak power at the reference carrier of the right sub-block if Power Ref type is “Max Power Carrier in Sub-block.” Otherwise NaN (9.91E+37) is returned. (dBm)</p> <p>4. Peak frequency in the measured ref carrier frequency range. Peak frequency in the left ref carrier frequency range if Power Ref type is “Left & Right Carriers.” Peak frequency in the ref carrier frequency</p>

Modes	n	Return Value
		<p>range of the left sub-block if Power Ref type is "Max Power Carrier in Sub-block." (Hz)</p> <p>5. Peak frequency in the right ref carrier frequency range if Power Ref type is "Left & Right Carriers" Peak frequency in the ref carrier frequency range of the right sub-block if Power Ref type is "Max Power Carrier in Sub-block." Otherwise NaN (9.91E+37) is returned. (Hz)</p> <p>If the result is not available, NaN (9.91E+37) is returned.</p> <p>The number of values returned is subject to change in future releases.</p>
All	14	<p>Meas Type: Total Power Reference</p> <p>Returns comma-separated scalar results, in the following order:</p> <p>When in the MSR and LTE-Advanced FDD/TDD mode, returns outer offset results when Non-Contiguous Meas Region is set to Outer, and returns inner offset results when it is set to Inner, in the following order.</p> <ol style="list-style-type: none"> 1. Relative integrated power on the negative offset A (dBc) 2. Absolute integrated power on the negative offset A (dBm) 3. Relative peak power on the negative offset A (dBc) 4. Absolute peak power on the negative offset A (dBm) 5. Peak power offset frequency from the center or carrier edge frequency in the negative offset A, depending on Offset Frequency Define settings (Hz) 6. Relative integrated power on the positive offset A (dBc) 7. Absolute integrated power on the positive offset A (dBm) 8. Relative peak power on the positive offset A (dBc) 9. Absolute peak power on the positive offset A (dBm) 10. Peak power offset frequency from the center or carrier edge frequency in the positive offset A, depending on Offset Frequency Define settings (Hz) 11. Relative integrated power on the negative offset B (dBc) <p>---</p> <ol style="list-style-type: none"> 119. Absolute peak power on the positive offset L (dBm) 120. Peak power offset frequency from the center or carrier edge frequency in the positive offset L, depending on Offset Frequency Define settings (Hz) <p>If the result is not available, NaN (9.91E+37) is returned.</p> <p>The length of the result depends on the number of available offset (See "Number of Offsets" on page 1212).</p> <p>The number of values returned is subject to change in future releases.</p>
All	14	<p>Meas Type: Power Spectral Density Reference</p> <p>Returns comma-separated scalar results, in the following order:</p> <p>When in the MSR and LTE-Advanced FDD/TDD mode, returns outer offset results when Non-Contiguous Meas Region is set to Outer, and returns inner offset results when it is set to Inner, in the following order.</p> <ol style="list-style-type: none"> 1. Relative integrated power on the negative offset A (dB) 2. Absolute integrated power on the negative offset A (dBm/Hz) 3. Relative peak power on the negative offset A (dB)

Modes	n	Return Value
		<p>4. Absolute peak power on the negative offset A (dBm/Hz)</p> <p>5. Peak power offset frequency from the center or carrier edge frequency in the negative offset A, depending on Offset Frequency Define settings (Hz)</p> <p>6. Relative integrated power on the positive offset A (dB)</p> <p>7. Absolute integrated power on the positive offset A (dBm/Hz)</p> <p>8. Relative peak power on the positive offset A (dB)</p> <p>9. Absolute peak power on the positive offset A (dBm/Hz)</p> <p>10. Peak power offset frequency from the center or carrier edge frequency in the positive offset A, depending on Offset Frequency Define settings (Hz)</p> <p>11. Relative integrated power on the negative offset B (dB)</p> <p>---</p> <p>119. Absolute peak power on the positive offset L (dBm/Hz)</p> <p>120. Peak power offset frequency from the center or carrier edge frequency in the positive offset L, depending on Offset Frequency Define settings (Hz)</p> <p>If the result is not available, NaN (9.91E+37) is returned.</p> <p>The length of the result depends on the number of available offset (See "Number of Offsets" on page 1212).</p> <p>The number of values returned is subject to change in future releases.</p>
All	14	<p>Meas Type: Spectrum Peak Reference</p> <p>Returns comma-separated scalar results, in the following order:</p> <p>When in the MSR and LTE-Advanced FDD/TDD mode, returns outer offset results when Non-Contiguous Meas Region is set to Outer, and returns inner offset results when it is set to Inner, in the following order.</p> <ol style="list-style-type: none"> 1. Reserved for the future use, returns NaN (9.91E+37) 2. Reserved for the future use, returns NaN (9.91E+37) 3. Relative peak power on the negative offset A (dB) 4. Absolute peak power on the negative offset A (dBm) 5. Peak power offset frequency from the center or carrier edge frequency in the negative offset A, depending on Offset Frequency Define settings (Hz) 6. Reserved for the future use, returns NaN (9.91E+37) 7. Reserved for the future use, returns NaN (9.91E+37) 8. Relative peak power on the positive offset A (dB) 9. Absolute peak power on the positive offset A (dBm) 10. Peak power offset frequency from the center or carrier edge frequency in the positive offset A, depending on Offset Frequency Define settings (Hz) 11. Relative integrated power on the negative offset B (dB) <p>---</p> <p>119. Absolute peak power on the positive offset L (dBm)</p> <p>120. Peak power offset frequency from the center or carrier edge frequency in the positive offset L, depending on Offset Frequency Define settings (Hz)</p> <p>If the result is not available, NaN (9.91E+37) is returned.</p>

Modes	n	Return Value
		<p>The length of the result depends on the number of available offset (See "Number of Offsets" on page 1212).</p> <p>The number of values returned is subject to change in future releases.</p>
All	15	<p>Meas Type: Total Power Reference</p> <p>Returns comma-separated scalar results, in the following order:</p> <p>When in the MSR and LTE-Advanced FDD/TDD mode, returns outer offset results when Non-Contiguous Meas Region is set to Outer, and returns inner offset results when it is set to Inner, in the following order.</p> <ol style="list-style-type: none"> 1. Minimum margin from limit line on the negative offset A (dB) 2. Minimum margin from limit line on the positive offset A (dB) 3. Minimum margin from limit line on the negative offset B (dB) 4. Minimum margin from limit line on the positive offset B (dB) <p>---</p> <ol style="list-style-type: none"> 23. Minimum margin from limit line on the negative offset L (dB) 24. Minimum margin from limit line on the positive offset L (dB) <p>If the result is not available, NaN (9.91E+37) is returned.</p> <p>The length of the result depends on the number of available offset (See "Number of Offsets" on page 1212).</p> <p>The number of values returned is subject to change in future releases.</p>
MSR, LTEAFDD, LTEATDD only	16	<p>Returns number of carriers comma-separated scalar results, in the following order:</p> <ol style="list-style-type: none"> 1. Absolute power of carrier 1 (dBm) 2. Absolute power of carrier 2 (dBm) <p>---</p> <p>number of carriers-1. Absolute power of carrier (number of carriers)-1 (dBm)</p> <p>number of carriers. Absolute power of carrier (number of carriers)-1 (dBm)</p> <p>If Measure Carrier of the corresponding carrier is no, NaN (9.91E+37) is returned.</p>
WLAN only	16	<p>Returns two carriers comma-separated scalar results when the radio standard is 802.11 ac 80+80 MHz. And returns NaN otherwise.</p> <ol style="list-style-type: none"> 1. Absolute power of carrier segment 1 (dBm) 2. Absolute power of carrier segment 2 (dBm)
MSR, LTEAFDD, LTEATDD only	17	<p>Returns the displayed frequency domain combined limit trace data separated by comma. Combined trace is a mixed trace of both absolute limit trace and relative limit trace according to the fail mask condition. The number of data points is 2001.</p>

Number of Offsets

The number of available offsets varies depending on the mode and option as below.

Mode	The number of available offsets
MSR, LTEAFDD, LTEATDD	12 (Offset A to L)
WLAN	12 (Offset A to L)
Other modes with option N9060A-7FP	12 (Offset A to L)
Other modes without option N9060A-7FP	6 (Offset A to F)

Key Path	Meas
Initial S/W Revision	Prior to A.02.00
Modified at S/W Revision	A.11.00, A.14.00

AMPTD Y Scale

Accesses a menu of functions that enable you to set the vertical scale parameters. The parameter values are measurement independent except all Attenuation values and Internal Preamp selections that are measurement global.

Key Path	Front-panel key
Initial S/W Revision	Prior to A.02.00

Ref Value

Sets the value for the absolute power reference. However, since Auto Scaling defaults to On, this value is automatically determined by the measurement result. When you set a value manually, Auto Scaling automatically changes to Off.

Key Path	AMPTD Y Scale
Mode	SA, WCDMA, C2K, WIMAX OFDMA, TD-SCDMA, 1xEVDO, DTMB (CTTB), DVB-T/H, ISDB-T, CMMB, LTE, LTEFDD, Digital Cable TV, WLAN, MSR, LTEAFDD, LTEATDD
Remote Command	:DISPlay:SEMask:VIEW[1]:WINDow[1]:TRACe:Y[:SCALE]:RLEVel <real> :DISPlay:SEMask:VIEW[1]:WINDow[1]:TRACe:Y[:SCALE]:RLEVel?
Example	DISP:SEM:VIEW:WIND:TRAC:Y:RLEV 100 DISP:SEM:VIEW:WIND:TRAC:Y:RLEV?
Notes	You must be in the mode that includes SEM measurement to use this command. Use :INSTrument:SElect to set the mode.
Couplings	When the Auto Scaling is On, this value is automatically determined by the measurement result. When you set a value manually, Auto Scaling automatically changed to Off.
Preset	10.0 dBm
State Saved	Saved in instrument state.
Min	-250 dBm
Max	250 dBm
Initial S/W Revision	Prior to A.02.00
Modified at S/W Revision	A.02.00, A.03.00

Attenuation

This menu controls the attenuator functions and interactions between the attenuation system components.

There are two attenuator configurations in the X-Series. One is a dual attenuator configuration consisting of a mechanical attenuator and an optional electronic attenuator. The other configuration uses a single attenuator with combined mechanical and electronic sections that controls all the attenuation functions. Different models in the X-Series come with different configurations.

See "[Dual Attenuator Configurations:](#)" on page 1214

See "Single Attenuator Configuration:" on page 1215

Most Attenuation settings are the same for all measurements – they do not change as you change measurements. Settings like these are called “Meas Global” and are unaffected by Meas Preset.

Key Path	AMPTD Y Scale
Scope	Meas Global
Dependencies	In measurements that support the I/Q inputs, this key is unavailable when I/Q is the selected input, and is replaced by the Range key in that case.
Readback Line	Contains a summary in [] brackets of the current total attenuation. See the descriptions of the , " (Mech) Atten " on page 2297, and " Enable Elec Atten " on page 2299 keys for more detail on the contributors to the total attenuation. Note that when "Pre-Adjust for Min Clip" is on, this value can change at the start of every measurement.
Initial S/W Revision	Prior to A.02.00
Modified at S/W Revision	A.03.00

Dual Attenuator Configurations:

Configuration 1: Mechanical attenuator + optional electronic attenuator

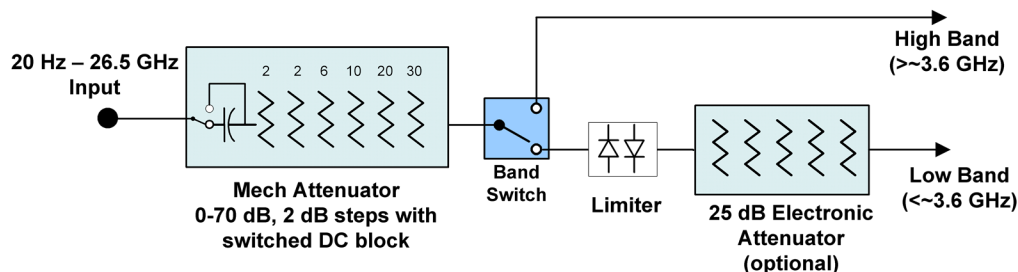

Configuration 2: Mechanical attenuator, no optional electronic attenuator

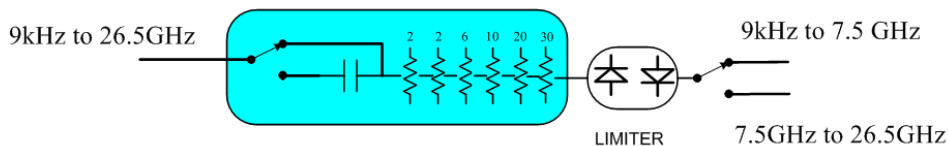

(note that Configuration 2 is not strictly speaking a dual-section attenuator, since there is no electronic section available. However, it behaves exactly like Configuration 1 without the Electronic Attenuator option EA3, therefore for the sake of this document it is grouped into the “Dual Attenuator” configuration)

Single Attenuator Configuration:

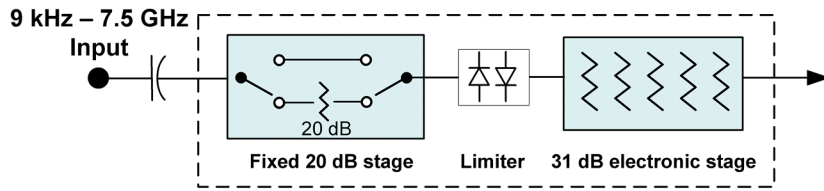

You can tell which attenuator configuration you have by pressing the Attenuation key, which (in most Modes) opens the Attenuation menu. If the first key in the Attenuation menu says **Mech Atten** you have the dual attenuator configuration. If the first key says **Atten** you have the single attenuator configuration.

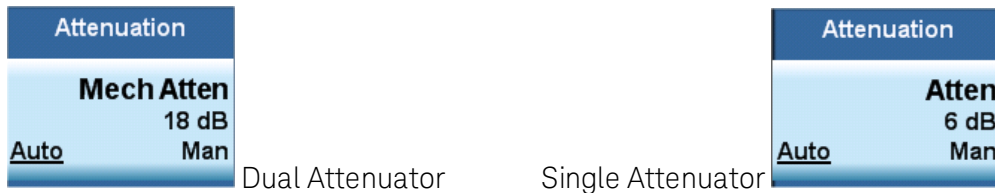

In the single attenuator configuration, you control the attenuation with a single control, as the fixed stage has only two states. In the dual attenuator configuration, both stages have significant range so you are given separate control of the mechanical and electronic attenuator stages.

When you have the dual attenuator configuration, you may still have only a single attenuator, because unless option EA3 (the Electronic Attenuator option) is available, and you purchase it, you will have only the mechanical attenuator.

(Mech) Atten

This key is labeled **Mech Atten** in dual attenuator models and **Atten** in single attenuator models. In the dual attenuator configuration, this key only affects the mechanical attenuator.

This key lets you modify the attenuation applied to the RF input signal path. This value is normally auto coupled to the Ref Level, the Internal Preamp Gain, any External Gain that is entered, and the Max Mixer Level, as described in the table below.

See "[Attenuator Configurations and Auto/Man](#)" on page 1217

Key Path	AMPTD Y Scale, Attenuation
Remote Command	<pre>[:SENSe]:POWer[:RF]:ATTenuation <rel_amp1></pre> <pre>[:SENSe]:POWer[:RF]:ATTenuation?</pre> <pre>[:SENSe]:POWer[:RF]:ATTenuation:AUTO OFF ON 0 1</pre> <pre>[:SENSe]:POWer[:RF]:ATTenuation:AUTO?</pre>
Example	<p>POW:ATT 20</p> <p>Dual attenuator configuration: sets the mechanical attenuator to 20 dB</p> <p>Single attenuator mode: sets the main attenuation to 20 dB (see below for definition of "main" attenuation).</p> <p>If the attenuator was in Auto, it sets it to Manual.</p>
Dependencies	Some measurements do not support the Auto setting of (Mech) Atten . In these measurements, the

Auto/Man selection is not available, and the Auto/Man line on the key disappears.

In dual attenuator configurations, when the electronic attenuator is enabled, the mechanical attenuator has no auto setting and the Auto/Man line on the key disappears. The state of Auto/Man is remembered and restored when the electronic attenuator is once again disabled. This is described in more detail in the ["Enable Elec Atten" on page 2299](#) key description.

See ["Attenuator Configurations and Auto/Man" on page 1217](#) for more information on the Auto/Man functionality of Attenuation.

Couplings

When **(Mech) Atten** is in Auto, it uses the following algorithm to determine a value:

If the USB Preamp is connected to USB, use 0 dB.

Otherwise, $Atten = ReferenceLevel + PreAmpGain + ExternalGain - RefLevelOffset - MaxMixerLevel + IF\ Gain$.

Limit this value to be between 6 dB and the Max value. No value below 6 dB can ever be chosen by Auto.

The resulting value is rounded up to the largest value possible given the attenuation step setting. That is, 50.01 dB would change to 60 dB (for a 10 dB attenuation step).

The "IF Gain" term in the equation above is either 0 dB or +10 dB, depending on the settings of FFT IF Gain, Swept IF Gain, max Ref Level and the Auto/Man setting of Mech Atten.

In External Mixing and BBIQ, where the Attenuator is not in the signal path, the Attenuator setting changes as described above when **(Mech) Atten** is in Auto, but no changes are made to the actual attenuator hardware setting until the input is changed back to the RF Input.

Preset The preset for Mech Attenuation is "Auto."
 The Auto value of attenuation is:
 CXA, EXA, MXA and PXA: 10 dB

State Saved Saved in instrument state

Min 0 dB

The attenuation set by this key cannot be decreased below 6 dB with the knob or step keys. To get to a value below 6 dB it has to be directly entered from the keypad or via SCPI. This protects from adjusting the attenuation to a dangerously small value which can put the instrument at risk of damage to input circuitry. However, if the current mechanical attenuation is below 6 dB it can be increased with the knob and step keys, but not decreased.

Max CXA N9000A-503/507: 50 dB
 CXA N9000A-513/526: 70dB
 EXA: 60 dB
 MXA and PXA: 70 dB

In the single attenuator configuration, the total of ATT and EATT cannot exceed 50 dB, so if the EATT is set to 24 dB first, the main attenuation cannot be greater than 26 dB and will be reduced accordingly; if the main attenuator is set to 40 dB first, EATT cannot be greater than 10 dB.

Initial S/W Revision Prior to A.02.00

Modified at S/W Revision A.03.00

Attenuator Configurations and Auto/Man

As described in the Attenuation key description, there are two distinct attenuator configurations available in the X-Series, the single attenuator and dual attenuator configurations. In dual attenuator configurations, we have the mechanical attenuation and the electronic attenuation, and the current total attenuation is the sum of the electronic + mechanical attenuation. In single attenuator configurations, we refer to the attenuation set using the **(Mech) Atten** key (or POW:ATT SCPI) as the “main” attenuation; and the attenuation that is set by the SCPI command POW:EATT as the “soft” attenuation (the POW:EATT command is honored even in the single attenuator configuration, for compatibility purposes). Then the current total attenuation is the sum of the main + soft attenuation. See the **Elec Atten** key description for more on “soft” attenuation.

In the dual attenuator configuration, when the electronic attenuator is enabled, there is no Auto/Man functionality for the mechanical attenuator, and the third line of the key label (the Auto/Man line) disappears:

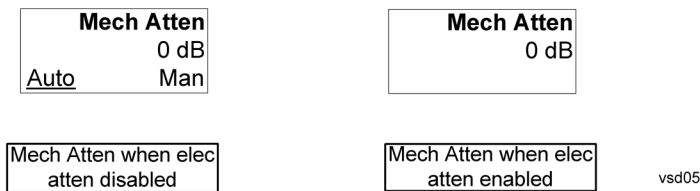

Enable Elec Atten

Enables the Electronic Attenuator.

The electronic attenuator offers finer steps than the mechanical attenuator, has no acoustical noise, is faster, and is less subject to wear. These advantages primarily aid in remote operation and are negligible for front panel use. See ["Using the Electronic Attenuator: Pros and Cons" on page 1219](#) for a detailed discussion of the pros and cons of using the electronic attenuator.

For the single attenuator configuration, for SCPI backwards compatibility, the “soft” attenuation feature replaces the dual attenuator configuration’s electronic attenuator. All the same couplings and limitations apply. See ["Attenuator Configurations and Auto/Man" on page 2299](#)

See ["More Information" on page 1218](#)

Key Path	AMPTD Y Scale, Attenuation
Remote Command	[:SENSe] :POWer [:RF] :EATTenuation :STATE OFF ON 0 1 [:SENSe] :POWer [:RF] :EATTenuation :STATE ?
Example	POW:EATT:STAT ON
Dependencies	This key only appears in Dual Attenuator models with an Electronic Attenuator installed. It does not appear in models with the Single Attenuator configuration, as in the single attenuator configuration there is no “electronic attenuator” there is only a single integrated attenuator (which has both a mechanical and electronic stage). However, in the single attenuator configuration, EATT SCPI commands are accepted for compatibility with other X-series instruments and set a “soft” attenuation as described in "Attenuator Configurations and Auto/Man" on page 2299 . The electronic attenuator (and the “soft” attenuation function provided in single attenuator configurations) is unavailable above 3.6 GHz. Therefore, if the Stop Frequency of the analyzer is > 3.6 GHz then the Enable Elec Atten key will be OFF and grayed out.

If the Internal Preamp is on, meaning it is set to Low Band or Full, the electronic attenuator (and the “soft” attenuation function provided in single attenuator configurations) is unavailable. In this case the **Enable Elec Atten** key will be OFF and grayed out.

If either of the above is true, if the SCPI command is sent, an error indicating that the electronic attenuator is unavailable will be sent.

If the electronic/soft Attenuator is enabled, then the Stop Freq of the analyzer is limited to 3.6 GHz and the Internal Preamp is unavailable.

The SCPI-only “soft” electronic attenuation for the single-attenuator configuration is not available in all measurements; in particular, it is not available in the Swept SA measurement.

Couplings	Enabling and disabling the Electronic Attenuator affects the setting of the Mechanical Attenuator (in dual attenuator configurations). This is described in more detail below this table.
Preset	OFF for Swept SA measurement; ON for all other measurements that support the electronic attenuator
State Saved	Saved in instrument state
Initial S/W Revision	Prior to A.02.00
Modified at S/W Revision	A.03.00

More Information

Mechanical Attenuator Transition Rules

When the Electronic Attenuator is enabled, the Mechanical Attenuator transitions to a state that has no Auto function. Below are the rules for transitioning the Mechanical Attenuator. NOTE that the information below ONLY applies to the dual attenuator configurations, and ONLY when the Electronic Attenuator is installed:

When the Electronic Attenuation is enabled from a disabled state:

- The Mechanical Attenuator is initialized to 10 dB (this is its optimal performance setting). You can then set it as desired with SCPI, numeric keypad, step keys, or knob, and it behaves as it normally would in manual mode
- The Auto/Man state of (Mech) Atten is saved
- The Auto/Man line on the (Mech) Atten key disappears and the auto rules are disabled
- The Electronic Attenuator is set to 10 dB less than the previous value of the Mechanical Attenuator, within the limitation that it must stay within the range of 0 to 24 dB of attenuation.

Examples in the dual attenuator configuration:

- Mech Atten at 20 dB. Elec Atten enabled, Mech Atten set to 10 dB, and Elec Atten set to 10 dB. New total attenuation equals the value before Elec Atten enabled.
- Mech Atten at 0 dB. Elec Atten enabled, Mech Atten set to 10 dB, and Elec Atten set to 0 dB. New total attenuation does not equal the value before Elec Atten enabled.
- Mech Atten at 40 dB. Elec Atten enabled, Mech Atten set to 10 dB, and Elec Atten set to 24 dB. New total attenuation does not equal the value before Elec Atten enabled.

When the Electronic Attenuation is disabled from an enabled state:

- The Elec Atten key is grayed out
- The Auto/Man state of (Mech) Atten is restored
- If now in Auto, (Mech) Atten recouples
- If now in Man, (Mech) Atten is set to the value of total attenuation that existed before the Elec Atten was disabled. The resulting value is rounded up to the smallest value possible given the (Mech) Atten Step setting - (That is, 57 dB changes to 58 dB when (Mech) Atten Step is 2 dB.)

Using the Electronic Attenuator: Pros and Cons

The electronic attenuator offers finer steps than the mechanical attenuator, has no acoustical noise, is faster, and is less subject to wear.

The “finer steps” advantage of the electronic attenuator is beneficial in optimizing the alignment of the analyzer dynamic range to the signal power in the front panel as well as remote use. Thus, you can achieve improved relative signal measurement accuracy. Compared to a mechanical attenuator with 2 dB steps, the 1 dB resolution of the electronic attenuator only gives better resolution when the odd-decibel steps are used. Those odd-decibel steps are less accurately calibrated than the even-decibel steps, so one tradeoff for this superior relative accuracy is reduced absolute amplitude accuracy.

Another disadvantage of the electronic attenuator is that the spectrum analyzer loses its “Auto” setting, making operation less convenient.

Also, the relationship between the dynamic range specifications (TOI, SHI, compression and noise) and instrument performance are less well-known with the electrical attenuator. With the mechanical attenuator, TOI, SHI and compression threshold levels increase dB-for-dB with increasing attenuation, and the noise floor does as well. With the electronic attenuator, there is an excess attenuation of about 1 to 3 dB between 0 and 3.6 GHz, making the effective TOI, SHI, and so forth, less well known. Excess attenuation is the actual attenuation relative to stated attenuation. Excess attenuation is accounted for in the analyzer calibration

Elec Atten

Controls the Electronic Attenuator in dual attenuator configurations. This key does not appear in single attenuator configurations, as the control of both the mechanical and electronic stages of the single attenuator is integrated into the single **Atten** key.

Key Path	AMPTD Y Scale, Attenuation
Remote Command	<code>[:SENSe] :POWer [:RF] :EATTenuation <rel_ampl></code> <code>[:SENSe] :POWer [:RF] :EATTenuation?</code>
Notes	Electronic Attenuation’s specification is defined only when Mechanical Attenuation is 6 dB.
Dependencies	This key only appears in Dual Attenuator models with an Electronic Attenuator installed. It does not appear in models with the Single Attenuator configuration, as in the single attenuator configuration there is no “electronic attenuator” there is only a single integrated attenuator (which has both a mechanical and electronic stage). However, in the single attenuator configuration, EATT SCPI commands are accepted for compatibility with other X-series instruments and set a “soft” attenuation as described in "Attenuator Configurations and Auto/Man" on page 2299 . The “soft” attenuation is treated as an addition to the “main” attenuation value set by the Atten softkey or the

	<p>POW:ATT SCPI command and affects the total attenuation displayed on the Attenuation key and the Meas Bar.</p> <p>When Enable Elec Atten is off or grayed out, the Elec Atten key is grayed out.</p>
Preset	0 dB
State Saved	Saved in instrument state
Min	0 dB
Max	<p>Dual attenuator configuration: 24 dB</p> <p>Single attenuator configuration: the total of ATT and EATT cannot exceed 50 dB, so if the EATT is set to 24 dB first, the main attenuation cannot be greater than 26 dB and will be reduced accordingly; if the main attenuator is set to 40 dB first, EATT cannot be greater than 10 dB</p>
Initial S/W Revision	Prior to A.02.00
Modified at S/W Revision	A.03.00

Adjust Atten for Min Clip

Sets the combination of mechanical and electronic attenuation and gain based on the current measured signal level so that clipping will be at a minimum.

This is an "immediate action" function, that is, it executes once, when the key is pressed.

This key is grayed out in measurements that do not support this functionality. The spectrum analyzer measurement, Swept SA, does not support this functionality.

Key Path	AMPTD Y Scale, Attenuation
Remote Command	<code>[:SENSe] :POWer [:RF] :RANGe :OPTimize IMMEDIATE</code>
Initial S/W Revision	Prior to A.02.00
Modified at S/W Revision	A.03.00

Pre-Adjust for Min Clip

If this function is on, it does the adjustment described under ["Adjust Atten for Min Clip" on page 2302](#) each time a measurement restarts. Therefore, in Continuous measurement mode, it only executes before the first measurement.

In dual attenuator models, you can set **Elec+Mech Atten**, in which case both attenuators participate in the autoranging, or **Elec Atten Only**, in which case the mechanical attenuator does not participate in the autoranging. This latter case results in less wear on the mechanical attenuator and is usually faster.

This key is grayed out in measurements that do not support this functionality. The spectrum analyzer measurement, Swept SA, does not support this functionality.

Key Path	AMPTD Y Scale, Attenuation
Remote Command	<code>[:SENSe] :POWer [:RF] :RANGe :OPTimize :ATTenuation OFF ELECTRical COMBined</code>

	<code>[:SENSe] :POWer [:RF] :RANGe:OPTimize:ATTenuation?</code>
Notes	The SCPI parameter ELECTrical sets this function to On in single attenuator models. The SCPI parameter COMBined is mapped to ELECTrical in single attenuator models; if you send COMBined , it sets the function to On and returns ELEC to a query.
Dependencies	This key only appears in Dual Attenuator models with an Electronic Attenuator installed. In instruments with Dual Attenuator model, when Enable Elec Atten is off or grayed out, the Pre-Adjust for Min Clip key is grayed out.
Preset	OFF for Swept SA measurement; ON for all other measurements that support Pre-Adjust for Min Clip
State Saved	Saved in instrument state
Range	Dual attenuator models: Off Elec Atten Only Mech + Elec Atten Single attenuator models: Off On
Initial S/W Revision	Prior to A.02.00
Modified at S/W Revision	A.03.00

Remote Command	<code>[:SENSe] :POWer [:RF] :RANGe:AUTO ON OFF 1 0</code> <code>[:SENSe] :POWer [:RF] :RANGe:AUTO?</code>
Notes	ON aliases to "Elec Atten Only" (:POW:RANG:OPT:ATT ELEC) OFF aliases to "Off" (:POW:RANG:OPT:ATT OFF) The query :POW:RANG:AUTO? returns true if :POW:RANG:OPT:ATT is not "Off"
Initial S/W Revision	Prior to A.02.00

Off

Turns **Pre-Adjust for Min Clip** off. This is the default setting.

This key is grayed out in measurements that do not support this functionality. The spectrum analyzer measurement, Swept SA, does not support this functionality.

Key Path	AMPTD Y Scale, Attenuation, Pre-Adjust for Min Clip
Example	<code>:POW:RANGe:OPT:ATT OFF</code>
Initial S/W Revision	Prior to A.02.00

Elec Atten Only

Selects only the electric attenuator to participate in auto ranging. This offers less wear on the mechanical attenuator and is usually faster.

This key is grayed out in measurements that do not support this functionality. The spectrum analyzer measurement, Swept SA, does not support this functionality.

Key Path	AMPTD Y Scale, Attenuation, Pre-Adjust for Min Clip
Example	:POW:RANGe:OPT:ATT ELEC
Initial S/W Revision	Prior to A.02.00

Mech + Elec Atten

In dual attenuator models, this selects both attenuators participate in the autoranging.

This key is grayed out in measurements that do not support this functionality. The spectrum analyzer measurement, Swept SA, does not support this functionality.

Key Path	AMPTD Y Scale, Attenuation, Pre-Adjust for Min Clip
Example	:POW:RANGe:OPT:ATT COMB
Initial S/W Revision	Prior to A.02.00

(Mech) Atten Step

This controls the step size used when making adjustments to the input attenuation.

This key is labeled **Mech Atten Step** in dual attenuator models and **Atten Step** in single attenuator models. In the dual attenuator configuration, this key only affects the step size of the mechanical attenuator.

Key Path	AMPTD Y Scale, Attenuation
Remote Command	[:SENSe] : POWer [:RF] : ATTenuation : STEP [:INCRement] 10 dB 2 dB [:SENSe] : POWer [:RF] : ATTenuation : STEP [:INCRement] ?
Example	POW:ATT:STEP 2
Notes	Note this feature works like a 1-N choice from the front panel, but it takes a specific value (in dB) when used remotely. The only valid values are 2 and 10.
Dependencies	Blanked in CXA and EXA if option FSA (2 dB steps) is not present. If blanked, attempts to set it via SCPI will yield an error.
Couplings	When the attenuation step size changes, the current mechanical attenuation value is adjusted (if necessary) to be quantized to the new step size. That is, if step is set to 10 dB, mech atten is increased if necessary so it is a multiple of 10 dB
Preset	PXA and MXA: 2 dB EXA and CXA: 10 dB (2 dB with option FSA)
State Saved	Saved in instrument state
Initial S/W Revision	Prior to A.02.00
Modified at S/W Revision	A.03.00

Adjust Atten (Remote Command only)

Allows you to select;

-Electric attenuator only

-Combination of Electric attenuator and Mechanical attenuator

when the SCPI command [:SENSe]:POWer[:RF]:RANGe:OPTimize IMMEDIATE is executed.

Remote Command	[:SENSe]:POWer[:RF]:RANGe:OPTimize:TYPE EONLY COMBined [:SENSe]:POWer[:RF]:RANGe:OPTimize:TYPE?
Example	POW:RANG:OPT:TYPE EONL POW:RANG:OPT:TYPE?
Preset	COMBined
State Saved	Saved in instrument state
Initial S/W Revision	A.16.00

Scale/Div

Sets the units-per-division of the vertical scale in the logarithmic display. When Auto Scaling is On, the scale per division value is automatically determined by the measurement result. When you set a value manually, Auto Scaling automatically changes to Off.

Key Path	AMPTD Y Scale
Mode	SA, WCDMA, C2K, WIMAX OFDMA, TD-SCDMA, 1xEVDO, DTMB (CTTB), DVB-T/H, ISDB-T, CMMB, LTE, LTEFDD, Digital Cable TV, WLAN, MSR, LTEAFDD, LTEATDD
Remote Command	:DISPlay:SEMAsk:VIEW[1]:WINDow[1]:TRACe:Y[:SCALe]:PDIVision <rel_ampl> :DISPlay:SEMAsk:VIEW[1]:WINDow[1]:TRACe:Y[:SCALe]:PDIVision?
Example	DISP:SEM:VIEW:WIND:TRAC:Y:PDIV 15dB DISP:SEM:VIEW:WIND:TRAC:Y:PDIV?
Notes	You must be in the mode that includes SEM measurement to use this command. Use :INSTrument:SElect to set the mode.
Couplings	When the Auto Scaling is On, this value is automatically determined by the measurement result. When you set a value manually, Auto Scaling automatically changes to Off.
Preset	10 dB
State Saved	Saved in instrument state
Min	0.10 dB
Max	20.00 dB
Initial S/W Revision	Prior to A.02.00
Modified at S/W Revision	A.02.00, A.03.00

Presel Center

When this key is pressed, the centering of the preselector filter is adjusted to optimize the amplitude accuracy at the frequency of the selected marker. If the selected marker is not on when Presel Center is pressed, the analyzer will turn on the selected marker, perform a peak search, and then perform centering on the marker's center frequency. If the selected marker is already on and between the start and stop frequencies of the analyzer, the analyzer performs the preselector calibration on that marker's frequency. If the selected marker is already on, but outside the frequency range between Start Freq and Stop Freq, the analyzer will first perform a peak search, and then perform centering on the marker's center frequency.

The value displayed on the **Presel Adjust** key will change to reflect the new preselector tuning (see **Presel Adjust**).

A number of considerations should be observed to ensure proper operation. See "[Proper Preselector Operation](#)" on page 1224.

Key Path	AMPTD Y Scale
Remote Command	[:SENSe] :POWer [:RF] :PCENter
Example	POW:PCEN
Notes	Note that the rules outlined above under the key description apply for the remote command as well as the key. The result of the command is dependent on marker position, and so forth. Any message shown by the key press is also shown in response to the remote command.
Dependencies	<ul style="list-style-type: none"> • Grayed out if the microwave preselector is off.) • If the selected marker's frequency is below Band 1, advisory message 0.5001 is generated and no action is taken. • Grayed out if entirely in Band 0. • Blank in models that do not include a preselector, such as option 503. If the SCPI is sent in these instruments, it is accepted without error, and the query always returns 0. • Grayed out in the Spectrogram View.
Couplings	<p>The active marker position determines where the centering will be attempted.</p> <p>If the analyzer is in a measurement such as averaging when centering is initiated, the act of centering the preselector will restart averaging but the first average trace will not be taken until the centering is completed.</p>
Status Bits/OPC dependencies	<p>When centering the preselector, *OPC will not return true until the process is complete and a subsequent measurement has completed, nor will results be returned to a READ or MEASure command.</p> <p>The Measuring bit should remain set while this command is operating and should not go false until the subsequent sweep/measurement has completed.</p>
Initial S/W Revision	Prior to A.02.00
Modified at S/W Revision	A.03.00

Proper Preselector Operation

A number of considerations should be observed to ensure proper operation:

1. If the selected marker is off, the analyzer will turn on a marker, perform a peak search, and adjust the preselector using the selected marker's frequency. It uses the "highest peak" peak search method unqualified by threshold or excursion, so that there is no chance of a 'no peak found' error. It continues with that peak, even if it is the peak of just noise. Therefore, for this operation to work properly, there should be a signal on screen in a preselected range for the peak search to find.
2. If the selected marker is already on, the analyzer will attempt the centering at that marker's frequency. There is no preselector for signals below about 3.6 GHz, therefore if the marker is on a signal below 3.6 GHz, no centering will be attempted and an advisory message generated
3. In some models, the preselector can be bypassed. If it is bypassed, no centering will be attempted in that range and a message will be generated.

Preselector Adjust

Allows you to manually adjust the preselector filter frequency to optimize its response to the signal of interest. This function is only available when "[Presel Center](#)" on page 2306 is available.

For general purpose signal analysis, using Presel Center is recommended. Centering the filter minimizes the impact of long-term preselector drift. Presel Adjust can be used instead to manually optimize the preselector. One application of manual optimization would be to peak the preselector response, which both optimizes the signal-to-noise ratio and minimizes amplitude variations due to small (short-term) preselector drifting.

Key Path	AMPTD Y Scale
Scope	Meas Global
Remote Command	[:SENSe] :POWer [:RF] :PADJust <freq> [:SENSe] :POWer [:RF] :PADJust?
Example	POW:PADJ 100KHz POW:PADJ?
Notes	The value on the key reads out to 0.1 MHz resolution.
Dependencies	<ul style="list-style-type: none"> • Grayed out if microwave preselector is off.) • Grayed out if entirely in Band 0. • Blank in models that do not include a preselector, such as option 503. If the SCPI is sent in these instruments, it is accepted without error, and the query always returns 0. • Grayed out in the Spectrogram View.
Preset	0 MHz
State Saved	The Presel Adjust value set by Presel Center , or by manually adjusting Presel Adjust , is not saved in instrument state, and does not survive a Preset or power cycle.
Min	-500 MHz
Max	500 MHz
Default Unit	Hz
Backwards Compatibility SCPI	[:SENSe] :POWer [:RF] :MW:PADJust [:SENSe] :POWer [:RF] :MMW:PADJust

	PSA had multiple preselectors, but the X-Series has only one. These commands simply alias to [:SENSe]:POWer[:RF]:PADJust
Initial S/W Revision	Prior to A.02.00
Modified at S/W Revision	A.03.00

Remote Command	[:SENSe]:POWer[:RF]:PADJust:PRESelector MWAVE MMWave EXTERNAL [:SENSe]:POWer[:RF]:PADJust:PRESelector?
Notes	PSA had multiple preselectors, and you could select which preselector to adjust. Since the X-Series has only one mm/uW preselector, the preselector selection softkey is no longer available. However, to provide backward compatibility, we accept the legacy remote commands. The command form has no effect, the query always returns MWAVE
Initial S/W Revision	Prior to A.02.00

μW Path Control

The **μW Path Control** functions include the **μW Preselector Bypass** (Option MPB) and **Low Noise Path** (Option LNP) controls in the High Band path circuits.

When the μW Preselector is bypassed, the user has better flatness, but will be subject to spurs from out of band interfering signals. When the Low Noise Path is enabled, the analyzer automatically switches around certain circuitry in the high frequency bands which can contribute to noise, when it is appropriate based on other analyzer settings.

For most applications, the preset state is Standard Path, which gives the best remote-control throughput, minimizes acoustic noise from switching and minimizes the risk of wear out in the hardware switches. For applications that utilize the wideband IF paths, the preset state is the μW Preselector Bypass path, if option MPB is present. This is because, when using a wideband IF such as the 140 MHz IF, the μW Preselector's bandwidth can be narrower than the available IF bandwidth, causing degraded amplitude flatness and phase linearity, so it is desirable to bypass the preselector in the default case.

Users may choose Low Noise Path Enable. It gives a lower noise floor, especially in the 21–26.5 GHz region, though without improving many measures of dynamic range, and without giving the best possible noise floor. The preamp, if purchased and used, gives better noise floor than does the Low Noise Path, however its compression threshold and third-order intercept are much poorer than that of the non-preamp Low Noise Path. There are some applications, typically for signals around –30 dBm, for which the third-order dynamic range of the standard path is good enough, but the noise floor is not low enough even with 0 dB input attenuation. When the third-order dynamic range of the preamp path is too little and the noise floor of the standard path is too high, the Low Noise Path can provide the best dynamic range.

Key Path	AMPTD Y Scale
Mode	SA, BASIC, PNOISE, VSA, LTE, LTETDD
Scope	Meas Global
Remote Command	[:SENSe]:POWer[:RF]:MW:PATH STD LNPath MPBypass FULL

	[:SENSe] :POWer [:RF] :MW: PATH?
Example	:POW:MW:PATH LNP Enables the Low Noise path
Notes	<p>If a Presel Center is performed, the analyzer will momentarily switch to the Standard Path, regardless of the setting of μW Path Control</p> <p>The DC Block will always be switched in when the low noise path is switched in, to protect succeeding circuitry from DC. Note that this does not mean “when the low noise path is enabled” but when, based on the Low Noise Path rules, the path is actually switched in. This can happen when the selection is Low Noise Path Enable . In the case where the DC Block is switched in the analyzer is now AC coupled. However, if the user has selected DC coupling, the UI will still behave as though it were DC coupled, including all annunciation, warnings, status bits, and responses to SCPI queries. This is because, based on other settings, the analyzer could switch out the low noise path at any time and hence go back to being DC coupled.</p> <p>Alignment switching ignores the settings in this menu, and restores them when finished.</p>
Dependencies	Unavailable in BBIQ and External Mixing
Preset	<p>All modes other than IQ Analyzer mode and VXA: STD</p> <p>IQ Analyzer, VXA and WLAN mode:</p> <p>MPB option present and licensed: MPB</p> <p>MPB option not present and licensed: STD</p>
State Saved	Save in instrument state
Readback	Value selected in the submenu
Initial S/W Revision	A.04.00
Modified at S/W Revision	A.10.00

Standard Path

This path gives the best remote-control throughput, minimizes acoustic noise from switching and minimizes the risk of wear in the hardware switches, particularly in remote test scenarios where both low band and high band setups will follow in rapid succession.

In this path, the bypass of the low band/high band switch and microwave preamp is never activated, which can cause some noise degradation but preserves the life of the bypass switch.

Key Path	AMPTD Y Scale, μW Path Control
Example	:POW:MW:PATH STD
Readback Text	Standard Path
Initial S/W Revision	A.04.00

Low Noise Path Enable

You may choose Low Noise Path Enable, which gives a lower noise floor under some circumstances, particularly when operating in the 21–26.5 GHz region. With the Low Noise Path enabled, the low band/high band switch and microwave preamp are bypassed whenever all of the following are true:

- The analyzer is not in the Low Band, meaning:
- the start frequency is above 3.5 GHz and
- the stop frequency is above 3.6 GHz.
- the internal preamp is not installed or (if installed) is set to **Off** or **Low Band**

Note that this means that, when any part of a sweep is done in Low Band, the Low Noise Path is not used, whether or not the **Low Noise Path Enable** is selected in the user interface. Also, if the preamp is turned on, the Low Noise Path is not used, whether or not the **Low Noise Path Enable** is selected in the user interface. The only time the Low Noise Path is used is when **Low Noise Path Enable** is selected, the sweep is completely in High Band (> 3.6 GHz) and no preamp is in use.

See "[More Information](#)" on page 1228

Key Path	AMPTD Y Scale, μW Path Control
Measurement	Swept SA
Example	:POW:MW:PATH LNP
Notes	<p>For measurements that use IQ acquisition, the low noise path is used when the Center Frequency is in High Band (> 3.6 GHz) and no preamp is in use.</p> <p>In other words, the rules above are modified to use only the center frequency to qualify which path to switch in.</p> <p>This is not the case for FFT's in the Swept SA measurement; they use the same rules as swept measurements.</p>
Dependencies	<p>Key is blanked if current mode does not support it.</p> <p>Key is grayed out if mode supports it but current measurement does not support it.</p> <p>Unless Option LNP is present and licensed, key is blank and if SCPI command sent, error -241, "Hardware missing; Option not installed" is generated.</p>
Readback Text	Low Noise Path Enable
Initial S/W Revision	A.04.00

More Information

The user should understand that the Low Noise Path, while giving improved DANL, has the disadvantage of decreased TOI performance and decreased gain compression performance relative to the standard path.

The user should also understand that the bypass switch is a mechanical switch and has finite life, so if the **Low Noise Path** is enabled, it is possible to cause frequent cycling of this switch by frequently changing analyzer settings such that the above conditions hold true only some of the time. A user making tests of this nature should consider opting for the **Standard Path**, which will never throw the bypass switch, at the expense of some degraded noise performance.

The low noise path is useful for situations where the signal level is so low that the analyzer performance is dominated by noise even with 0 dB attenuation, but still high enough that the preamp option would have excessive third-order intermodulation or compression. The preamp, if purchased and used, gives better noise floor than does the "Low Noise Path." However, its compression threshold and third-order intercept are much poorer than that of the non-preamp path. There are some applications, typically for signals around -30 dBm, for which the third-order dynamic range of the standard path is good enough, but the

noise floor is not low enough even with 0 dB input attenuation. When the third-order dynamic range of the preamp path is too little and the noise floor of the standard path is too high, the Low Noise Path can provide the best dynamic range

The graph below illustrates the concept. It shows, in red, the performance of an analyzer at different attenuation settings, both with the preamp on and off, in a measurement that is affected by both analyzer noise and analyzer TOI. The green shows the best available dynamic range, offset by 0.5 dB for clarity. The blue shows how the best available dynamic range improves for moderate signal levels with the low noise path switched in. In this illustration, the preamp improves the noise floor by 15 dB while degrading the third-order intercept by 30 dB, and the low noise path reduces loss by 8 dB. The attenuator step size is 2 dB.

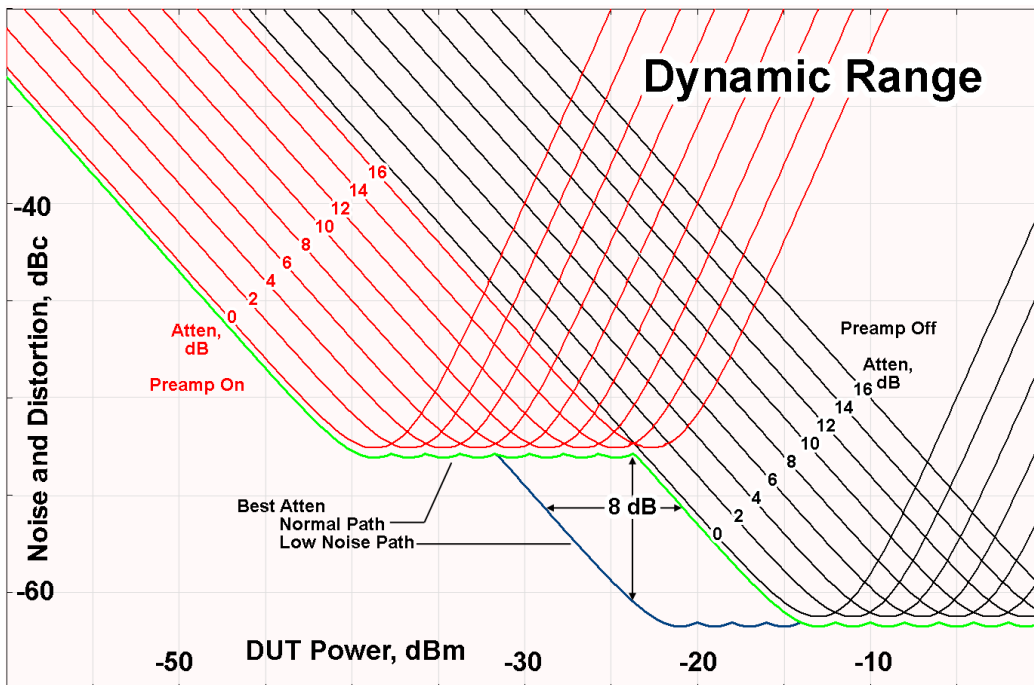

There are other times where selecting the low noise path improves performance, too. Compression-limited measurements such as finding the nulls in a pulsed-RF spectrum can profit from the low noise path in a way similar to the TOI-limited measurement illustrated. Accuracy can be improved when the low noise path allows the optimum attenuation to increase from a small amount like 0, 2 or 4 dB to a larger amount, giving better return loss at the analyzer input. Harmonic measurements, such as second and third harmonic levels, are much improved using the low noise path because of the superiority of that path for harmonic (though not intermodulation) distortion performance.

μW Preselector Bypass

This key toggles the preselector bypass switch for band 1 and higher. When the microwave preselector is on, the signal path is preselected. When the microwave preselector is off, the signal path is not preselected. The preselected path is the normal path for the analyzer.

The preselector is a tunable bandpass filter which prevents signals away from the frequency of interest from combining in the mixer to generate in-band spurious signals (images). The consequences of using a preselector filter are its limited bandwidth, the amplitude and phase ripple in its passband, and any amplitude and phase instability due to center frequency drift.

Option MPB or pre-selector bypass provides an unpreselected input mixer path for certain X-Series signal analyzers with frequency ranges above 3.6 GHz. This signal path allows a wider bandwidth and less amplitude variability, which is an advantage when doing modulation analysis and broadband signal analysis. The disadvantage is that, without the preselector, image signals will be displayed. Another disadvantage of bypassing the preselector is increased LO emission levels at the front panel input port.

Image responses are separated from the real signal by twice the 1st IF. For IF Paths of 10 MHz and 25 MHz, the 1st IF is 322.5 MHz, so the image response and the real signal will be separated by 645 MHz. The 1st IF will be different for other IF Path settings. When viewing a real signal and its corresponding image response in internal mixing, the image response will be to the left of the real signal.

Also, the image response and the real signal typically have the same amplitude and exhibit the same shape factor.

However, if Option FS1, Fast Sweep Capability, is enabled, the image response in the Swept SA measurement will appear lower in amplitude and have a much wider shape factor compared to the real signal.

Key Path	AMPTD Y Scale, μW Path Control
Example	:POW:MW:PATH MPB
Dependencies	Key is blanked if current mode does not support it. Key is grayed out if mode supports it but current measurement does not support it. Key is blank unless Option MPB is present and licensed. If SCPI command sent when MPB not present, error -241, "Hardware missing; Option not installed" is generated.
Readback Text	μ W Preselector Bypass
Initial S/W Revision	A.04.00

Remote Command	[:SENSE] :POWER [:RF] :MW:PRESelector [:STATE] ON OFF 0 1 [:SENSE] :POWER [:RF] :MW:PRESelector [:STATE] ?
Example	:POW:MW:PRES OFF Bypasses the microwave preselector
Notes	The ON parameter sets the STD path (:POW:MW:PATH STD) The OFF parameter sets path MPB (:POW:MW:PATH MPB)
Preset	ON

Internal Preamp

Accesses a menu of keys that control the internal preamps. Turning on the preamp gives a better noise figure, but a poorer TOI to noise floor dynamic range. You can optimize this setting for your particular measurement.

The instrument takes the preamp gain into account as it sweeps. If you sweep outside of the range of the preamp the instrument will also account for that. The displayed result will always reflect the correct gain.

For some measurements, when the preamp is on and any part of the displayed frequency range is below the lowest frequency for which the preamp has specifications, a warning condition message appears in the status line. For example, for a preamp with a 9 kHz lowest specified frequency: "Preamp: Accy unspec'd below 9 kHz".

Key Path	AMPTD Y Scale
Scope	Meas Global
Remote Command	[:SENSe] :POWer [:RF] :GAIN[:STATe] OFF ON 0 1 [:SENSe] :POWer [:RF] :GAIN[:STATe] ?
Dependencies	Preamp is not available on all hardware platforms. If the preamp is not present or is unlicensed, the key is not shown. The preamp is not available when the electronic/soft attenuator is enabled.
Couplings	The act of connecting the U7227A USB Preamplifier to one of the analyzer's USB ports will cause the Internal Preamp to be switched on. When this happens an informational message will be generated: "Internal Preamp turned on for optimal operation with USB Preamp." Note that if the Internal Preamp was already on, there will be no change to the setting, but if it was Off it will be switched On, to Full Range. Note that this same action occurs when the SA mode is selected while the USB Preamp is connected to one of the analyzer's USB ports, if it is the first time that the SA mode has run since powerup, or if the last time the SA mode was running the USB Preamp was NOT connected. Subsequently disconnecting the USB Preamp from USB does not change the Internal Preamp setting nor restore the previous setting.
Preset	OFF
State Saved	Saved in instrument state
Initial S/W Revision	Prior to A.02.00
Modified at S/W Revision	A.14.00

Key Path	AMPTD Y Scale, Internal Preamp
Scope	Meas Global
Remote Command	[:SENSe] :POWer [:RF] :GAIN:BAND LOW FULL [:SENSe] :POWer [:RF] :GAIN:BAND?
Dependencies	Preamp is not available on all hardware platforms. If the preamp is not present or is unlicensed, the key is not shown. If a POW:GAIN:BAND FULL command is sent when a low band preamp is available, the preamp band parameter is to LOW instead of FULL, and an "Option not installed" message is generated.
Preset	LOW
State Saved	Saved in instrument state
Initial S/W Revision	Prior to A.02.00

Off

Turns the internal preamp off

Key Path	AMPTD Y Scale, Internal Preamp
Example	:POW:GAIN OFF
Readback	Off
Initial S/W Revision	Prior to A.02.00

Low Band

Sets the internal preamp to use only the low band.

The frequency range of the installed (optional) low-band preamp is displayed in square brackets on the **Low Band** key label.

Key Path	AMPTD Y Scale, Internal Preamp
Example	:POW:GAIN ON :POW:GAIN:BAND LOW
Readback	Low Band
Initial S/W Revision	Prior to A.02.00

Full Range

Sets the internal preamp to use its full range. The low band (0–3.6 GHz or 0–3GHz, depending on the model) is supplied by the low band preamp and the frequencies above low band are supplied by the high band preamp.

The frequency range of the installed (optional) preamp is displayed in square brackets on the **Full Range** key label. If the high band option is not installed the Full Range key does not appear.

Key Path	AMPTD Y Scale, Internal Preamp
Example	:POW:GAIN ON :POW:GAIN:BAND FULL
Readback	Full Range
Initial S/W Revision	Prior to A.02.00

Ref Position

Positions the reference level at the top, center or bottom of the Y scale display. Changing the reference position does not affect the reference level value.

Key Path	AMPTD Y Scale
Mode	SA, WCDMA, C2K, WIMAX OFDMA, TD-SCDMA, 1xEVDO, DTMB (CTTB), DVB-T/H, ISDB-T, CMMB, LTE, LTEFDD, Digital Cable TV, WLAN, MSR, LTEAFDD, LTEATDD
Remote Command	:DISPlay:SEMask:VIEW[1]:WINDow[1]:TRACe:Y[:SCALe]:RPOSition TOP CENTER BOTTom :DISPlay:SEMask:VIEW[1]:WINDow[1]:TRACe:Y[:SCALe]:RPOSition?
Example	DISP:SEM:VIEW:WIND:TRAC:Y:RPOS BOTT DISP:SEM:VIEW:WIND:TRAC:Y:RPOS?
Notes	You must be in the mode that includes SEM measurement to use this command. Use :INSTrument:SElect to set the mode.
Preset	TOP
State Saved	Saved in instrument state
Range	Top Ctr Bot
Initial S/W Revision	Prior to A.02.00
Modified at S/W Revision	A.02.00, A.03.00

Auto Scaling

Toggles the Auto Scaling function between On and Off.

When Auto Scaling is On and the Restart front-panel key is pressed, the analyzer automatically determines the scale per division and reference values based on the measurement results. When you set a value to either Scale/Div or Ref Value manually, Auto Scaling automatically changes to Off.

Key Path	AMPTD Y Scale
Mode	SA, WCDMA, C2K, WIMAX OFDMA, TD-SCDMA, 1xEVDO, DTMB (CTTB), DVB-T/H, ISDB-T, CMMB, LTE, LTEFDD, Digital Cable TV, WLAN, MSR, LTEAFDD, LTEATDD
Remote Command	:DISPlay:SEMask:VIEW[1]:WINDow[1]:TRACe:Y[:SCALe]:COUPle 0 1 ON OFF :DISPlay:SEMask:VIEW[1]:WINDow[1]:TRACe:Y[:SCALe]:COUPle?
Example	DISP:SEM:VIEW:WIND:TRAC:Y:COUP OFF DISP:SEM:VIEW:WIND:TRAC:Y:COUP?
Notes	You must be in the mode that includes SEM measurement to use this command. Use :INSTrument:SElect to set the mode.
Couplings	When Auto Scaling is On, upon pressing the Restart front-panel key, this function automatically determines the scale per division and reference values based on the measurement results. When you set a value to either Scale/Div or Ref Value manually, Auto Scaling automatically changes to Off.
Preset	ON
State Saved	Saved in instrument state
Range	On Off

11 Spectrum Emission Mask Measurement
AMPTD Y Scale

Initial S/W Revision	Prior to A.02.00
Modified at S/W Revision	A.02.00, A.03.00

Auto Couple

The Auto Couple feature provides a quick and convenient way to automatically couple multiple instrument settings. This helps ensure accurate measurements and optimum dynamic range. When the Auto Couple feature is activated, either from the front panel or remotely, all parameters of the current measurement that have an Auto/Manual mode are set to Auto mode and all measurement settings dependent on (or coupled to) the Auto/Man parameters are automatically adjusted for optimal performance.

However, the Auto Couple key actions are confined to the current measurement only. It does not affect other measurements in the mode, and it does not affect markers, marker functions, or trace or display attributes.

See "[More Information](#)" on page 1235

Key Path	Front-panel key
Remote Command	:COUPle ALL NONE
Example	:COUP ALL
Notes	:COUPle ALL puts all Auto/Man parameters in Auto mode (equivalent to pressing the Auto Couple key). :COUPLE NONE puts all Auto/Man parameters in manual mode. It decouples all the coupled instrument parameters and is not recommended for making measurements.
Initial S/W Revision	Prior to A.02.00

More Information

There are two types of functions that have Auto/Manual modes.

Auto/Man Active Function keys

An Auto/Man toggle key controls the binary state associated with an instrument parameter by toggling between **Auto** (where the parameter is automatically coupled to the other parameters it is dependent upon) and **Man** (where the parameter is controlled independent of the other parameters), as well as making the parameter the active function. The current mode is indicated on the softkey with either **Auto** or **Man** underlined as illustrated below.

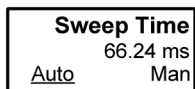

vsd07

Auto/Man 1-of-N keys

An Auto/Man 1-of-N key allows you to manually pick from a list of parameter values, or place the function in Auto, in which case the value is automatically selected (and indicated) as shown below. If in Auto, Auto is underlined on the calling key. If in manual operation, manual is indicated on the calling key. But the calling key does not actually toggle the function, it simply opens the menu.

11 Spectrum Emission Mask Measurement
Auto Couple

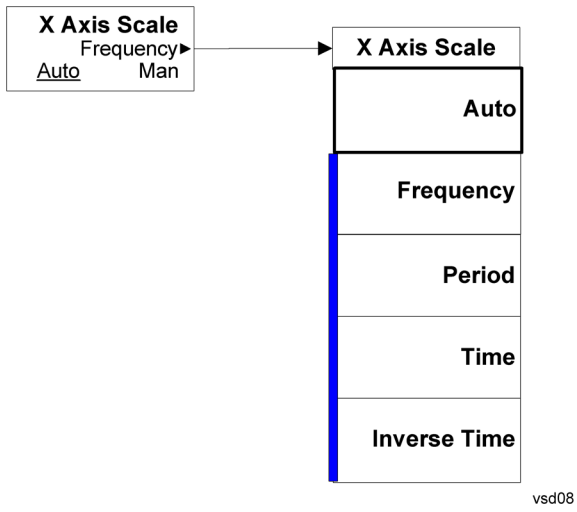

BW

Accesses a menu of functions that enable you to select the type of filter for the measurement.

Key Path	Front-panel key
Initial S/W Revision	Prior to A.02.00
Modified at S/W Revision	A.03.00

Filter Type

Selects the type of bandwidth filter that is used in Carrier and Offsets.

When Gaussian or Flattop is selected, selected filter is applied to carriers and all offsets.

When Auto Sense is selected, filter type is automatically selected for each carriers and offsets, so that measurement speed and accuracy is optimized.

Key Path	BW
Mode	SA, WCDMA, C2K, WIMAX OFDMA, TD-SCDMA, 1xEVDO, DVB-T/H, DTMB (CTTB), ISDB-T, CMMB, LTE, LTE-TDD, Digital Cable TV, WLAN, MSR, LTEAFDD, LTEATDD
Remote Command	[:SENSe] :SEMask :BANDwidth :SHAPE ASENse GAUSSsian FLATtop [:SENSe] :SEMask :BANDwidth :SHAPE?
Example	SEM:BAND:SHAP GAUS SEM:BAND:SHAP?
Couplings	See the description above
Preset	ASENse
State Saved	Saved in instrument state
Range	Auto Sense (each offset and carrier) Gaussian (all offsets and carriers) Flattop (all offsets and carriers)
Initial S/W Revision	A.03.00

Cont (Continuous Measurement/Sweep)

Sets the analyzer for Continuous measurement operation. The single/continuous state is Meas Global so the setting will affect all measurements. If you are Paused, pressing **Cont** does a Resume.

Key Path	Front-panel key
Remote Command	:INITiate:CONTinuous OFF ON 0 1 :INITiate:CONTinuous?
Example	:INIT:CONT 0 puts analyzer in Single measurement operation. :INIT:CONT 1 puts analyzer in Continuous measurement operation
Preset	ON (Note that SYST:PRESet sets INIT:CONT to ON but *RST sets INIT:CONT to OFF)
State Saved	Saved in instrument state
Backwards Compatibility Notes	For Spectrum Analysis mode in ESA and PSA, there is no Cont hardkey, instead there is a Sweep Single/Cont key. In these analyzers, switching the Sweep Single/Cont key from Single to Cont restarts averages (displayed average count reset to 1), but does not restart Max Hold and Min Hold . The X-Series has Single and Cont keys in place of the SweepSingleCont key. In the X-Series, if in single measurement, the Cont key (and INIT:CONT ON) switches to continuous measurement, but never restarts a measurement and never resets a sweep.
Initial S/W Revision	Prior to A.02.00

In Swept SA Measurement (Spectrum Analysis Mode):

The analyzer takes repetitive sweeps, averages, measurements, etc., when in Continuous mode. When the average count reaches the Average/Hold Number the count stops incrementing, but the analyzer keeps sweeping. See the Trace/Detector section for the averaging formula used both before and after the Average/Hold Number is reached. The trigger condition must be met prior to each sweep. The type of trace processing for multiple sweeps, is set under the Trace/Detector key, with choices of **Trace Average**, **Max Hold**, or **Min Hold**.

In Other Measurements/Modes:

With **Avg/Hold Num** (in the **Meas Setup** menu) set to **Off** or set to **On** with a value of 1, a sweep is taken after the trigger condition is met; and the analyzer continues to take new sweeps after the current sweep has completed and the trigger condition is again met. However, with **Avg/Hold Num** set to On with a value >1, multiple sweeps (data acquisitions) are taken for the measurement. The trigger condition must be met prior to each sweep. The sweep is not stopped when the average count k equals the number N set for Avg/Hold Num is reached, but the number k stops incrementing. A measurement average usually applies to all traces, marker results, and numeric results. But sometimes it only applies to the numeric results.

If the analyzer is in Single measurement, pressing the **Cont** key does not change k and does not cause the sweep to be reset; the only action is to put the analyzer into Continuous measurement operation.

If it is already in continuous sweep:

the INIT:CONT 1 command has no effect

the INIT:CONT 0 command will place the analyzer in Single Sweep but will have no effect on the current sequence until $k = N$, at which point the current sequence will stop and the instrument will go to the idle state.

11 Spectrum Emission Mask Measurement
File

File

See "File" on page 362

FREQ Channel

Accesses a menu of keys that allow you to control the Frequency and Channel parameters of the instrument.

Some features in the Frequency menu are the same for all measurements - they do not change as you change measurements. Settings like these are called "Meas Global" and are unaffected by Meas Preset. For example, the Center Freq setting is the same for all measurements - it does not change as you change measurements.

Key Path	Front Panel
Mode	MSR
Initial S/W Revision	A.10.00

Carrier Ref Freq

Sets carrier reference frequency. The center frequencies of carriers are defined as offset frequency from this value. This reference frequency is also the reference of carrier configuration preset.

Key Path	FREQ Channel
Mode	MSR
Measurement	all
Remote Command	<code>[:SENSe] :CARRier:REFerence <freq></code> <code>[:SENSe] :CARRier:REFerence?</code>
Example	CARR:REF 2GHz CARR:REF?
Preset	1GHz
State Saved	Saved in instrument state
Min	Depends on instrument minimum center frequency. Same as Center Freq
Max	Depends on instrument maximum center frequency. Same as Center Freq
Initial S/W Revision	A.10.00

Carrier Setup

Accesses the Carrier Setup menu.

Key Path	FREQ Channel
Initial S/W Revision	A.10.00

Carriers

Specifies how many carriers are used in MSR measurements. Base station RF bandwidth is determined from the carrier 1 to the carrier specified by this value whatever carriers' Present Pwr states are. Select Carrier can be select up to this value.

Key Path	FREQ Channel, Carrier Setup
Measurement	All
Remote Command	<code>[:SENSe]:CARRier:COUNt <integer></code> <code>[:SENSe]:CARRier:COUNt?</code>
Example	CARR:COUN 10 CARR:COUN?
Preset	1
State Saved	Saved in instrument state.
Min	1
Max	100
Initial S/W Revision	A.10.00

Configure Carriers

Accesses a menu of commonly used carrier configuration parameters.

Key Path	FREQ Channel, Carrier Setup
Initial S/W Revision	A.10.00

Select Carrier

Selects which carrier's configuration menu is displayed.

This key is also connected to the carrier info tables of some measurements. When the value is changed in a measurement which has carrier table view, the highlight in the table moves to Select Carrier. The highlight of the table and Select Carrier are not coupled.

Key Path	FREQ Channel, Carrier Setup, Configure Carriers
Preset	1
State Saved	No
Min	1
Max	Value of Carriers
Initial S/W Revision	A.10.00

Measure Carrier

Sets whether to measure this carrier or not.

Key Path	FREQ Channel, Carrier Setup, Configure Carriers
Remote Command	<code>[:SENSe]:CARRier<n>[:STATe] OFF ON 0 1</code> <code>[:SENSe]:CARRier<n>[:STATe]?</code>
Example	CARR10 1 CARR10?
Notes	The command is used with a sub-op code <n> (default=1) to specify the carrier for configuration. The range of the sub-op code is determined by the number of carriers.
Preset	ON
State Saved	Saved in instrument state
Range	On Off
Initial S/W Revision	A.10.00

Carrier Offset

Sets the carrier center frequency as offset from Carrier Ref Frequency.

Key Path	FREQ Channel, Carrier Setup, Configure Carriers
Remote Command	<code>[:SENSe]:CARRier<n>:FREQuency:OFFSet <freq></code> <code>[:SENSe]:CARRier<n>:FREQuency:OFFSet?</code>
Example	CARR10:FREQ:OFFS 10MHz CARR10:FREQ:OFFS?
Notes	The command is used with a sub-op code <n> (default=1) to specify the carrier for configuration. The range of the sub-op code is determined by the number of carriers.
Preset	0Hz
State Saved	Saved in instrument state
Min	-1GHz
Max	1GHz
Initial S/W Revision	A.10.00

Radio Format

Selects a format parameter set to set the radio format of the selected carrier.

NONE – No format is specified. Channel spacing, measurement BW and FOffset,RAT are values of defaults of LTE FDD 5MHz.

LTE FDD Parameter Set 1 – Selects LTE FDD parameter set 1. LTE FDD (E-UTRA FDD) is the radio format of the carrier.

LTE FDD Parameter Set 2 – Selects LTE FDD parameter set 2. LTE FDD (E-UTRA FDD) is the radio format of the carrier.

LTE FDD Parameter Set 3 – Selects LTE FDD parameter set 3. LTE FDD (E-UTRA FDD) is the radio format of the carrier.

W-CDMA Parameter Set 1 – Selects W-CDMA parameter set 1. W-CDMA (UTRA FDD) is the radio format of the carrier.

W-CDMA Parameter Set 2 – Selects W-CDMA parameter set 2. W-CDMA (UTRA FDD) is the radio format of the carrier.

W-CDMA Parameter Set 3 – Selects W-CDMA parameter set 3. W-CDMA (UTRA FDD) is the radio format of the carrier.

GSM/EDGE Parameter Set 1 – Selects GSM/EDGE parameter set 1. GSM/EDGE is the radio format of the carrier.

GSM/EDGE Parameter Set 2 – Selects GSM/EDGE parameter set 2. GSM/EDGE is the radio format of the carrier.

GSM/EDGE Parameter Set 3 – Selects GSM/EDGE parameter set 3. GSM/EDGE is the radio format of the carrier.

cdma2000 Parameter Set 1 – Selects cdma2000 parameter set 1. cdma2000 is the radio format of the carrier.

cdma2000 Parameter Set 2 – Selects cdma2000 parameter set 2. cdma2000 is the radio format of the carrier.

cdma2000 Parameter Set 3 – Selects cdma2000 parameter set 3. cdma2000 is the radio format of the carrier.

1xEV-DO Parameter Set 1 – Selects 1xEV-DO parameter set 1. 1xEV-DO is the radio format of the carrier.

1xEV-DO Parameter Set 2 – Selects 1xEV-DO parameter set 2. 1xEV-DO is the radio format of the carrier.

1xEV-DO Parameter Set 3 – Selects 1xEV-DO parameter set 3. 1xEV-DO is the radio format of the carrier.

LTE TDD Parameter Set 1 – Selects LTE TDD parameter set 1. LTE TDD (E-UTRA TDD) is the radio format of the carrier.

LTE TDD Parameter Set 2 – Selects LTE TDD parameter set 2. LTE TDD (E-UTRA TDD) is the radio format of the carrier.

LTE TDD Parameter Set 3 – Selects LTE TDD parameter set 3. LTE TDD (E-UTRA TDD) is the radio format of the carrier.

TD-SCDMA Parameter Set 1 – Selects TD-SCDMA parameter set 1. TD-SCDMA (UTRA-TDD LCR) is the radio format of the carrier.

TD-SCDMA Parameter Set 2 – Selects TD-SCDMA parameter set 2. TD-SCDMA (UTRA-TDD LCR) is the radio format of the carrier.

TD-SCDMA Parameter Set 3 – Selects TD-SCDMA parameter set 3. TD-SCDMA (UTRA-TDD LCR) is the radio format of the carrier.

Key Path	FREQ Channel, Carrier Setup, Configure Carriers
Remote Command	[:SENSE]:CARRier<n>:FORMat NONE LTEFdd1 LTEFdd2 LTEFdd3 WCDMa1 WCDMa2 WCDMa3 GSM1 GSM2 GSM3 CDMA1 CDMA2 CDMA3 EVDO1 EVDO2 EVDO3 LTETdd1 LTETdd2 LTETdd3 TDSCdma1 TDSCdma2 TDSCdma3 [:SENSE]:CARRier<n>:FORMat ?
Example	CARR10:FORM LTEF1 CARR10:FORM?
Notes	The command is used with a sub-op code <n> (default=1) to specify the carrier for configuration. The range of the sub-op code is determined by the number of carriers.
Dependencies	The following licenses are required for each key to be displayed. Without the licenses, corresponding enum values cannot be set even via the SCPI command. <ul style="list-style-type: none"> • LTE FDD - N9080A-1FP or W9080A-1FP • W-CDMA - N9073A-1FP or W9073A-1FP • GSM/EDGE - N9071A-2FP or W9071A-2FP • cdma2000 - N9072A-2FP or W9072A-2FP • 1xEV-DO - N9076A-1FP or W9076A-1FP • LTE TDD - N9082A-1FP or W9082A-1FP • TD-SCDMA - N9079A-1FP or W9079A-1FP
State Saved	Saved in instrument state
Range	None LTE FDD [Parameter Set 1] Parameter Set 1 ("LTE FDD 1") Parameter Set 2 ("LTE FDD 2") Parameter Set 3 ("LTE FDD 3") W-CDMA [Parameter Set 1] Parameter Set 1 ("W-CDMA 1") Parameter Set 2 ("W-CDMA 2") Parameter Set 3 ("W-CDMA 3") GSM/EDGE [Parameter Set 1] Parameter Set 1 ("GSM/EDGE 1") Parameter Set 2 ("GSM/EDGE 2") Parameter Set 3 ("GSM/EDGE 3") cdma2000 [Parameter Set 1] Parameter Set 1 ("cdma2000 1") Parameter Set 2 ("cdma2000 2") Parameter Set 3 ("cdma2000 3") 1xEV-DO [Parameter Set 1] Parameter Set 1 ("1xEV-DO 1") Parameter Set 2 ("1xEV-DO 2") Parameter Set 3 ("1xEV-DO 3")

	LTE TDD [Parameter Set 1] Parameter Set 1 ("LTE TDD 1") Parameter Set 2 ("LTE TDD 2") Parameter Set 3 ("LTE TDD 3") TD-SCDMA [Parameter Set 1] Parameter Set 1 ("TD-SCDMA 1") Parameter Set 2 ("TD-SCDMA 2") Parameter Set 3 ("TD-SCDMA 3")
Readback	The readback line on this key shows the currently selected Radio Format in square brackets.
Initial S/W Revision	A.10.00
Modified at S/W Revision	A.12.00, A.16.00

Carrier Allocation

Specifies the carrier frequency allocation. There are two types of allocation, contiguous and non-contiguous. Non-Contiguous frequency allocation is defined as an allocation where two sub-blocks are separated with a sub-block gap.

Contiguous – All the carriers belong to one block and no sub-block gap exists.

Non-Contiguous – Carriers are separated into two sub-blocks. Allocation Break Pt Carrier determines how sub-blocks are configured.

Key Path	FREQ Channel, Carrier Setup
Scope	Meas Global
Remote Command	[:SENSe]:CARRier:CONFig:ALLocation CONTiguous NCONtiguous [:SENSe]:CARRier:CONFig:ALLocation?
Example	CARR:CONF:ALL CONT CARR:CONF:ALL?
Preset	CONTiguous
State Saved	Saved in instrument state.
Range	Contiguous Non-Contiguous
Initial S/W Revision	A.13.00

Non-Contiguous

Opens a menu that enables you to set a non-contiguous parameter.

Key Path	FREQ Channel, Carrier Setup, Carrier Allocation
Initial S/W Revision	A.13.00

Allocation Break Pt Carrier

Specifies an allocation break point in non-contiguous carrier allocation. First sub-block starts from the lowest frequency carrier and stops at the allocation break point carrier. Next sub-block starts from the next upper frequency carrier and ends at the highest frequency carrier.

Two examples are shown below. In these examples carrier indices are not in the order of carrier frequency. In the first example, Allocation Break Pt Carrier is 2. It means that sub-block 1 ends at carrier 2 and sub-block 2 starts at carrier 5. Sub-block gap is located between carrier 2 and 5. In the second example, Allocation Break Pt Carrier is 3 and the sub-block gap comes between carrier 3 and 2.

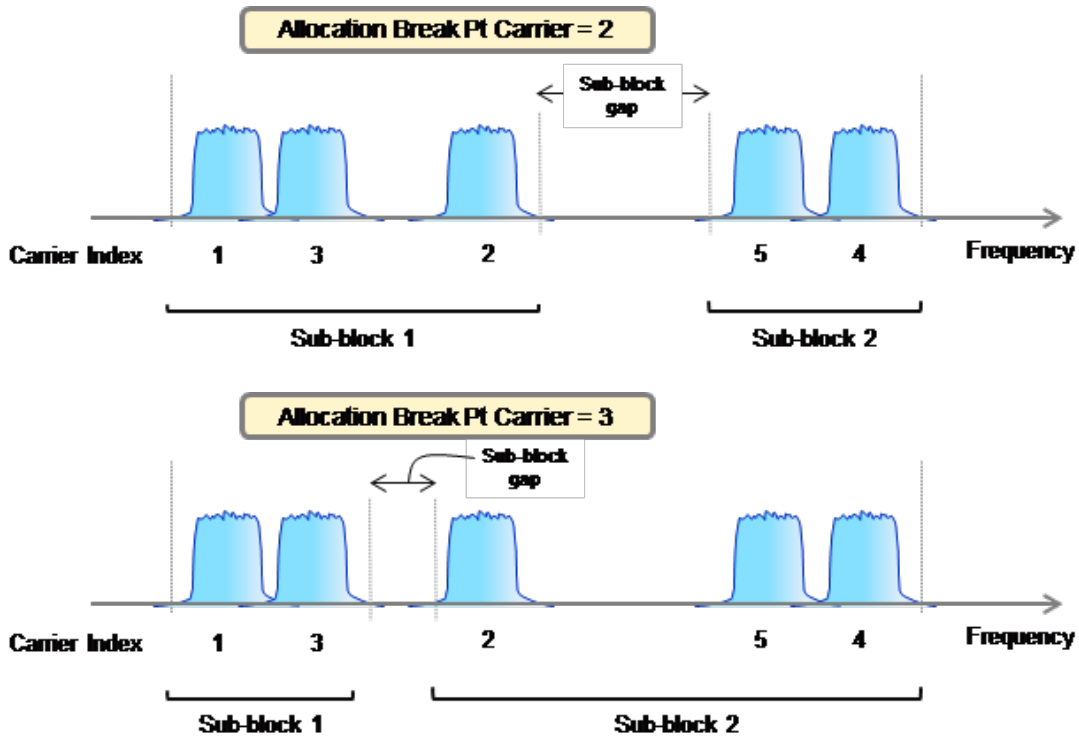

Key Path	FREQ Channel, Carrier Setup, Carrier Allocation, Non-Contiguous
Scope	Meas Global
Remote Command	[[:SENSE]:CARRIER:CONFIG:ALLOCATION:NCONTIGUOUS:ABPOINT <integer> [:SENSE]:CARRIER:CONFIG:ALLOCATION:NCONTIGUOUS:ABPOINT?
Example	CARR:CONF:ALL:NCON:ABP 5 CARR:CONF:ALL:NCON:ABP?
Dependencies	The maximum value depends on the number of carriers.
Couplings	This value can change when you decrease the number of carriers.
Preset	1
State Saved	Saved in instrument state.
Min	1
Max	99
Initial S/W Revision	A.13.00

Carrier Conf Presets

Pressing this key pops up Conf Presets. Each parameter under this menu initiate carrier configuration preset when its value is changed.

Appropriate licenses are required to select carrier config enum. Required licenses are shown here. Note that N/W means N or W license, i.e. N/W9073A-1FP means either N9073A-1FP or W9073A-1FP is required.

TC1a (FDD): N/W9073A-1FP (W-CDMA)

TC2 (FDD): N/W9080A-1FP (LTE FDD)

TC3a (FDD): N/W9073A-1FP (W-CDMA) and N9080A-1FP (LTE FDD)

TC4a (FDD): N/W9071A-2FP (GSM/EDGE) and N/W9073A-1FP (W-CDMA)

TC4b (FDD): N/W9071A-2FP (GSM/EDGE) and N9080A-1FP (LTE FDD)

TC4c (FDD): N/W9071A-2FP (GSM/EDGE), N/W9073A-1FP (W-CDMA) and N9080A-1FP (LTE FDD)

TC4d (FDD): N/W9071A-2FP (GSM/EDGE) and N/W9073A-1FP (W-CDMA)

TC4e (FDD): N/W9071A-2FP (GSM/EDGE) and N9080A-1FP (LTE FDD)

TC4a (FDD) Two Carriers: N/W9071A-2FP (GSM/EDGE) and N/W9073A-1FP (W-CDMA)

TC4b (FDD) Two Carriers: N/W9071A-2FP (GSM/EDGE) and N9080A-1FP (LTE FDD)

TC4c (FDD) Two Carriers: N/W9071A-2FP (GSM/EDGE), N/W9073A-1FP (W-CDMA) and N9080A-1FP (LTE FDD)

NTC1a (FDD): N/W9073A-1FP (W-CDMA)

NTC2 (FDD): N/W9080A-1FP (LTE FDD)

NTC3a (FDD): N/W9073A-1FP (W-CDMA) and N9080A-1FP (LTE FDD)

NTC4a (FDD): N/W9071A-2FP (GSM/EDGE) and N/W9073A-1FP (W-CDMA)

NTC4b (FDD): N/W9071A-2FP (GSM/EDGE) and N9080A-1FP (LTE FDD)

NTC4c (FDD): N/W9071A-2FP (GSM/EDGE), N/W9073A-1FP (W-CDMA) and N9080A-1FP (LTE FDD)

LTE FDD: N/W9080A-1FP (LTE FDD)

W-CDMA: N/W9073A-1FP (W-CDMA)

GSM/EDGE: N/W9071A-2FP (GSM/EDGE)

cdma2000: N/W9072A-2FP (cdma2000)

1xEV-DO: N/W9076A-1FP (1xEV-DO)

Enum keys don't appear on the menu if required licenses are not installed.

Key Path	FREQ Channel, Carrier Setup
----------	-----------------------------

Remote Command	
	[:SENSe] :CARRier:CONFig?
Example	CARR:CONF TC1AFDD CARR:CONF?
Notes	The softkey for NONE is not available.
State Saved	Saved in instrument state
Initial S/W Revision	A.10.00
Modified at S/W Revision	A.12.00, A.13.00

MSR Test Config

Accesses the menu to select MSR Test Configurations.

Key Path	FREQ Channel, Carrier Setup
Initial S/W Revision	A.10.00

Carrier Conf Presets

Pressing this key pops up Conf Presets. Each parameter under this menu initiate carrier configuration preset when its value is changed.

Appropriate licenses are required to select carrier config enum. Required licenses are shown here. Note that N/W means N or W license, i.e. N/W9073A-1FP means either N9073A-1FP or W9073A-1FP is required.

TC1a (FDD): N/W9073A-1FP (W-CDMA)

TC2 (FDD): N/W9080A-1FP (LTE FDD)

TC3a (FDD): N/W9073A-1FP (W-CDMA) and N9080A-1FP (LTE FDD)

TC4a (FDD): N/W9071A-2FP (GSM/EDGE) and N/W9073A-1FP (W-CDMA)

TC4b (FDD): N/W9071A-2FP (GSM/EDGE) and N9080A-1FP (LTE FDD)

TC4c (FDD): N/W9071A-2FP (GSM/EDGE), N/W9073A-1FP (W-CDMA) and N9080A-1FP (LTE FDD)

TC4d (FDD): N/W9071A-2FP (GSM/EDGE) and N/W9073A-1FP (W-CDMA)

TC4e (FDD): N/W9071A-2FP (GSM/EDGE) and N9080A-1FP (LTE FDD)

TC4a (FDD) Two Carriers: N/W9071A-2FP (GSM/EDGE) and N/W9073A-1FP (W-CDMA)

TC4b (FDD) Two Carriers: N/W9071A-2FP (GSM/EDGE) and N9080A-1FP (LTE FDD)

TC4c (FDD) Two Carriers: N/W9071A-2FP (GSM/EDGE), N/W9073A-1FP (W-CDMA) and N9080A-1FP (LTE FDD)

NTC1a (FDD): N/W9073A-1FP (W-CDMA)

NTC2 (FDD): N/W9080A–1FP (LTE FDD)

NTC3a (FDD): N/W9073A–1FP (W-CDMA) and N9080A–1FP (LTE FDD)

NTC4a (FDD): N/W9071A–2FP (GSM/EDGE) and N/W9073A–1FP (W-CDMA)

NTC4b (FDD): N/W9071A–2FP (GSM/EDGE) and N9080A–1FP (LTE FDD)

NTC4c (FDD): N/W9071A–2FP (GSM/EDGE), N/W9073A–1FP (W-CDMA) and N9080A–1FP (LTE FDD)

LTE FDD: N/W9080A–1FP (LTE FDD)

W-CDMA: N/W9073A–1FP (W-CDMA)

GSM/EDGE: N/W9071A–2FP (GSM/EDGE)

cdma2000: N/W9072A–2FP (cdma2000)

1xEV-DO: N/W9076A–1FP (1xEV-DO)

Enum keys don't appear on the menu if required licenses are not installed.

Key Path	FREQ Channel, Carrier Setup
Remote Command	<code>[:SENSe] :CARRier:CONFig?</code>
Example	CARR:CONF TC1AFDD CARR:CONF?
Notes	The softkey for NONE is not available.
State Saved	Saved in instrument state
Initial S/W Revision	A.10.00
Modified at S/W Revision	A.12.00, A.13.00

Max W-CDMA Carriers (FDD)

Sets max W-CDMA carriers placed when the carrier configuration preset runs. When this value is changed, the carrier configuration preset is initiated.

Key Path	FREQ Channel, Carrier Setup, Carrier Conf Presets, MSR Test Config, TC1a (FDD)FREQ Channel, Carrier Setup, Carrier Conf Presets, MSR Test Config, TC3a (FDD)FREQ Channel, Carrier Setup, Carrier Conf Presets, MSR Test Config, TC4a (FDD)FREQ Channel, Carrier Setup, Carrier Conf Presets, MSR Test Config, TC4c (FDD)FREQ Channel, Carrier Setup, Carrier Conf Presets, Single RAT Config, W-CDMA
Remote Command	<code>[:SENSe] :CARRier:CONFig:WCDMa:CMAx <integer></code> <code>[:SENSe] :CARRier:CONFig:WCDMa:CMAx?</code>
Example	CARR:CONF:WCDM:CMAx 8 CARR:CONF:WCDM:CMAx?
Preset	100
State Saved	Saved in instrument state

Min	1
Max	100
Initial S/W Revision	A.10.00

Max LTE FDD Carriers

Sets max LTE FDD carriers placed when the carrier configuration preset runs. When this value is changed, the carrier configuration preset is initiated.

Key Path	FREQ Channel, Carrier Setup, Carrier Conf Presets, MSR Test Config, TC2 (FDD)FREQ Channel, Carrier Setup, Carrier Conf Presets, MSR Test Config, TC3a (FDD)FREQ Channel, Carrier Setup, Carrier Conf Presets, MSR Test Config, TC4b (FDD)FREQ Channel, Carrier Setup, Carrier Conf Presets, MSR Test Config, TC4c (FDD)FREQ Channel, Carrier Setup, Carrier Conf Presets, Single RAT Config, LTE FDD
Remote Command	[:SENSe] :CARRier:CONFig:LTEFdd:CMAx <integer> [:SENSe] :CARRier:CONFig:LTEFdd:CMAx?
Example	CARR:CONF:LTEF:CMAx 8 CARR:CONF:LTEF:CMAx?
Preset	100
State Saved	Saved in instrument state
Min	1
Max	100
Initial S/W Revision	A.10.00

LTE FDD BW

Sets bandwidth of LTE FDD carriers placed when the carrier configuration preset runs. When this value is changed, the carrier configuration preset is initiated.

Key Path	FREQ Channel, Carrier Setup, Carrier Conf Presets, MSR Test Config, TC2 (FDD)FREQ Channel, Carrier Setup, Carrier Conf Presets, MSR Test Config, TC3a (FDD)FREQ Channel, Carrier Setup, Carrier Conf Presets, MSR Test Config, TC4b (FDD)FREQ Channel, Carrier Setup, Carrier Conf Presets, MSR Test Config, TC4c (FDD)FREQ Channel, Carrier Setup, Carrier Conf Presets, MSR Test Config, TC4d (FDD)FREQ Channel, Carrier Setup, Carrier Conf Presets, Single RAT Config, LTE FDD
Remote Command	[:SENSe] :CARRier:CONFig:LTEFdd:BANDwidth B1M4 B3M B5M B10M B15M B20M [:SENSe] :CARRier:CONFig:LTEFdd:BANDwidth?
Example	CARR:CONF:LTEF:BAND B5M CARR:CONF:LTEF:BAND?
Preset	B5M

State Saved	Saved in instrument state
Range	1.4MHz 3MHz 5MHz 10MHz 15MHz 20MHz
Readback	The currently selected LTE FDD BW
Initial S/W Revision	A.10.00

Narrowest LTE FDD BW

Sets narrowest bandwidth of LTE FDD carriers placed for TC2 when the carrier configuration preset runs. When this value is changed, the carrier configuration preset is initiated.

Key Path	FREQ Channel, Carrier Setup, Carrier Conf Presets, MSR Test Config, TC2 (FDD)
Remote Command	[:SENSe] :CARRier:CONFig:LTEFdd:BANDwidth:NARRowest B1M4 B3M B5M B10M B15M B20M [:SENSe] :CARRier:CONFig:LTEFdd:BANDwidth:NARRowest?
Example	CARR:CONF:LTEF:BAND:NARR B1M4 CARR:CONF:LTEF:BAND:NARR?
Preset	B1M4
State Saved	Saved in instrument state
Range	1.4MHz 3MHz 5MHz 10MHz 15MHz 20MHz
Readback	The currently selected Narrowest LTE FDD BW
Initial S/W Revision	A.10.00

Max GSM/EDGE Carriers

Sets max GSM/EDGE carriers placed when the carrier configuration preset runs. When this value is changed, the carrier configuration preset is initiated.

Key Path	FREQ Channel, Carrier Setup, Carrier Conf Presets, MSR Test Config, TC4a (FDD)FREQ Channel, Carrier Setup, Carrier Conf Presets, MSR Test Config, TC4b (FDD)FREQ Channel, Carrier Setup, Carrier Conf Presets, MSR Test Config, TC4c (FDD)FREQ Channel, Carrier Setup, Carrier Conf Presets, Single RAT Config, GSM/EDGE
Remote Command	[:SENSe] :CARRier:CONFig:GSM:CMAx <integer> [:SENSe] :CARRier:CONFig:GSM:CMAx?
Example	CARR:CONF:GSM:CMAx 8 CARR:CONF:GSM:CMAx?
Preset	100
State Saved	Saved in instrument state
Min	1
Max	100
Initial S/W Revision	A.10.00

LTE FDD Location

Sets the location of LTE FDD carriers when carriers are configured as TC4c. This parameter is effective only for TC4c.

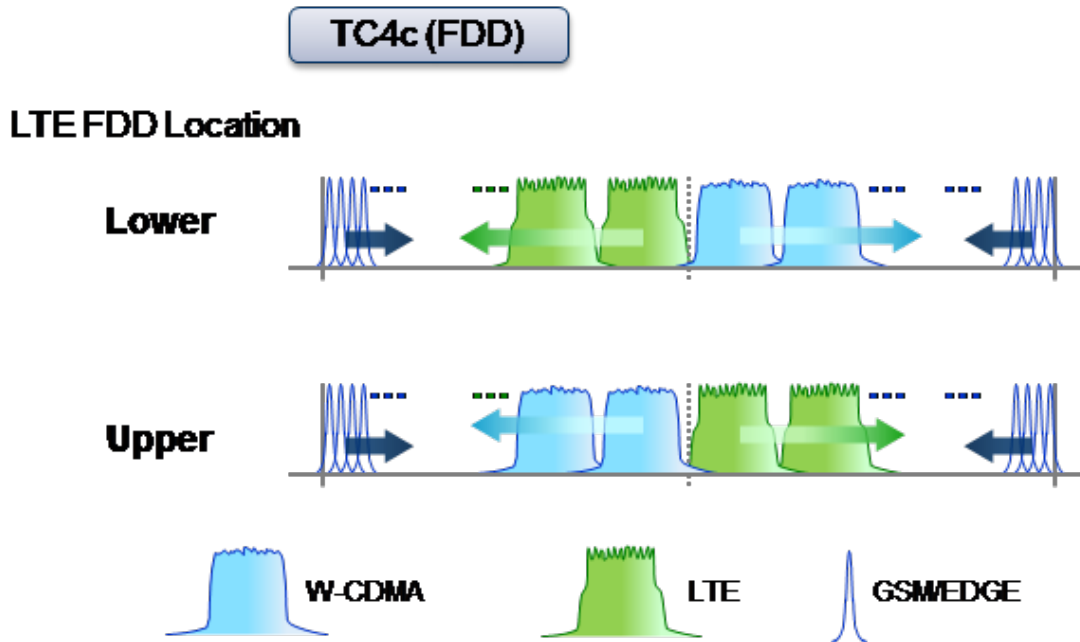

Key Path	FREQ Channel, Carrier Setup, Carrier Conf Presets, MSR Test Config, TC4c (FDD)
Remote Command	<code>[:SENSe] :CARRier:CONFIg:LTEFdd:LOCation UPPER LOWer</code> <code>[:SENSe] :CARRier:CONFIg:LTEFdd:LOCation?</code>
Example	<code>CARR:CONF:LTEF:LOC LOW</code> <code>CARR:CONF:LTEF:LOC?</code>
Notes	This setting is effective only for TC4c.
Preset	UPPer
State Saved	Saved in instrument state
Range	Lower (Lower than W-CDMA) Upper (Higher than W-CDMA)
Initial S/W Revision	A.11.00

MSR Non-Contig Test Config

Accesses the menu to select MSR Non-Contiguous Test Configurations.

Key Path	FREQ Channel, Carrier Setup
Initial S/W Revision	A.13.00

Carrier Conf Presets

Pressing this key pops up Conf Presets. Each parameter under this menu initiate carrier configuration preset when its value is changed.

Appropriate licenses are required to select carrier config enum. Required licenses are shown here. Note that N/W means N or W license, i.e. N/W9073A-1FP means either N9073A-1FP or W9073A-1FP is required.

- TC1a (FDD): N/W9073A-1FP (W-CDMA)
 - TC2 (FDD): N/W9080A-1FP (LTE FDD)
 - TC3a (FDD): N/W9073A-1FP (W-CDMA) and N9080A-1FP (LTE FDD)
 - TC4a (FDD): N/W9071A-2FP (GSM/EDGE) and N/W9073A-1FP (W-CDMA)
 - TC4b (FDD): N/W9071A-2FP (GSM/EDGE) and N9080A-1FP (LTE FDD)
 - TC4c (FDD): N/W9071A-2FP (GSM/EDGE), N/W9073A-1FP (W-CDMA) and N9080A-1FP (LTE FDD)
 - TC4d (FDD): N/W9071A-2FP (GSM/EDGE) and N/W9073A-1FP (W-CDMA)
 - TC4e (FDD): N/W9071A-2FP (GSM/EDGE) and N9080A-1FP (LTE FDD)
 - TC4a (FDD) Two Carriers: N/W9071A-2FP (GSM/EDGE) and N/W9073A-1FP (W-CDMA)
 - TC4b (FDD) Two Carriers: N/W9071A-2FP (GSM/EDGE) and N9080A-1FP (LTE FDD)
 - TC4c (FDD) Two Carriers: N/W9071A-2FP (GSM/EDGE), N/W9073A-1FP (W-CDMA) and N9080A-1FP (LTE FDD)
 - NTC1a (FDD): N/W9073A-1FP (W-CDMA)
 - NTC2 (FDD): N/W9080A-1FP (LTE FDD)
 - NTC3a (FDD): N/W9073A-1FP (W-CDMA) and N9080A-1FP (LTE FDD)
 - NTC4a (FDD): N/W9071A-2FP (GSM/EDGE) and N/W9073A-1FP (W-CDMA)
 - NTC4b (FDD): N/W9071A-2FP (GSM/EDGE) and N9080A-1FP (LTE FDD)
 - NTC4c (FDD): N/W9071A-2FP (GSM/EDGE), N/W9073A-1FP (W-CDMA) and N9080A-1FP (LTE FDD)
 - LTE FDD: N/W9080A-1FP (LTE FDD)
 - W-CDMA: N/W9073A-1FP (W-CDMA)
 - GSM/EDGE: N/W9071A-2FP (GSM/EDGE)
 - cdma2000: N/W9072A-2FP (cdma2000)
 - 1xEV-DO: N/W9076A-1FP (1xEV-DO)
- Enum keys don't appear on the menu if required licenses are not installed.

Key Path	FREQ Channel, Carrier Setup
Remote Command	[:SENSE] :CARRier:CONFig?

Example	CARR:CONF TC1AFDD CARR:CONF?
Notes	The softkey for NONE is not available.
State Saved	Saved in instrument state
Initial S/W Revision	A.10.00
Modified at S/W Revision	A.12.00, A.13.00

LTE FDD BW

Sets bandwidth of LTE FDD carriers placed when the carrier configuration preset runs. When this value is changed, the carrier configuration preset is initiated.

Key Path	FREQ Channel, Carrier Setup, Carrier Conf Presets, MSR Test Config, TC2 (FDD)FREQ Channel, Carrier Setup, Carrier Conf Presets, MSR Test Config, TC3a (FDD)FREQ Channel, Carrier Setup, Carrier Conf Presets, MSR Test Config, TC4b (FDD)FREQ Channel, Carrier Setup, Carrier Conf Presets, MSR Test Config, TC4c (FDD)FREQ Channel, Carrier Setup, Carrier Conf Presets, MSR Test Config, TC4d (FDD)FREQ Channel, Carrier Setup, Carrier Conf Presets, Single RAT Config, LTE FDD
Remote Command	[:SENSe] :CARRier:CONFig:LTEFdd:BANDwidth B1M4 B3M B5M B10M B15M B20M [:SENSe] :CARRier:CONFig:LTEFdd:BANDwidth?
Example	CARR:CONF:LTEF:BAND B5M CARR:CONF:LTEF:BAND?
Preset	B5M
State Saved	Saved in instrument state
Range	1.4MHz 3MHz 5MHz 10MHz 15MHz 20MHz
Readback	The currently selected LTE FDD BW
Initial S/W Revision	A.10.00

NTC4 Carriers

Sets NTC4 carriers placed when the NTC4 carrier configuration preset runs. When this value is changed, the carrier configuration preset is initiated.

Key Path	FREQ Channel, Carrier Setup, Carrier Conf Presets, MSR Non-Contig Test Config, NTC4a (FDD)FREQ Channel, Carrier Setup, Carrier Conf Presets, MSR Non-Contig Test Config, NTC4b (FDD)FREQ Channel, Carrier Setup, Carrier Conf Presets, MSR Non-Contig Test Config, NTC4c(FDD)
Remote Command	[:SENSe] :CARRier:CONFig:NTC4:COUNT <integer> [:SENSe] :CARRier:CONFig:NTC4:COUNT?
Example	CARR:CONF:NTC4:COUN 6 CARR:CONF:NTC4:COUN?

Preset	6
State Saved	Saved in instrument state
Min	3
Max	6
Initial S/W Revision	A.13.00

Single RAT Config

Accesses the menu to select Single RAT Configurations.

Key Path	FREQ Channel, Carrier Setup
Initial S/W Revision	A.10.00

Carrier Conf Presets

Pressing this key pops up Conf Presets. Each parameter under this menu initiate carrier configuration preset when its value is changed.

Appropriate licenses are required to select carrier config enum. Required licenses are shown here. Note that N/W means N or W license, i.e. N/W9073A-1FP means either N9073A-1FP or W9073A-1FP is required.

TC1a (FDD): N/W9073A-1FP (W-CDMA)

TC2 (FDD): N/W9080A-1FP (LTE FDD)

TC3a (FDD): N/W9073A-1FP (W-CDMA) and N9080A-1FP (LTE FDD)

TC4a (FDD): N/W9071A-2FP (GSM/EDGE) and N/W9073A-1FP (W-CDMA)

TC4b (FDD): N/W9071A-2FP (GSM/EDGE) and N9080A-1FP (LTE FDD)

TC4c (FDD): N/W9071A-2FP (GSM/EDGE), N/W9073A-1FP (W-CDMA) and N9080A-1FP (LTE FDD)

TC4d (FDD): N/W9071A-2FP (GSM/EDGE) and N/W9073A-1FP (W-CDMA)

TC4e (FDD): N/W9071A-2FP (GSM/EDGE) and N9080A-1FP (LTE FDD)

TC4a (FDD) Two Carriers: N/W9071A-2FP (GSM/EDGE) and N/W9073A-1FP (W-CDMA)

TC4b (FDD) Two Carriers: N/W9071A-2FP (GSM/EDGE) and N9080A-1FP (LTE FDD)

TC4c (FDD) Two Carriers: N/W9071A-2FP (GSM/EDGE), N/W9073A-1FP (W-CDMA) and N9080A-1FP (LTE FDD)

NTC1a (FDD): N/W9073A-1FP (W-CDMA)

NTC2 (FDD): N/W9080A-1FP (LTE FDD)

NTC3a (FDD): N/W9073A-1FP (W-CDMA) and N9080A-1FP (LTE FDD)

NTC4a (FDD): N/W9071A-2FP (GSM/EDGE) and N/W9073A-1FP (W-CDMA)

NTC4b (FDD): N/W9071A–2FP (GSM/EDGE) and N9080A–1FP (LTE FDD)

NTC4c (FDD): N/W9071A–2FP (GSM/EDGE), N/W9073A–1FP (W-CDMA) and N9080A–1FP (LTE FDD)

LTE FDD: N/W9080A–1FP (LTE FDD)

W-CDMA: N/W9073A–1FP (W-CDMA)

GSM/EDGE: N/W9071A–2FP (GSM/EDGE)

cdma2000: N/W9072A–2FP (cdma2000)

1xEV-DO: N/W9076A–1FP (1xEV-DO)

Enum keys don't appear on the menu if required licenses are not installed.

Key Path	FREQ Channel, Carrier Setup
Remote Command	[:SENSe] :CARRier:CONFig?
Example	CARR:CONF TC1AFDD CARR:CONF?
Notes	The softkey for NONE is not available.
State Saved	Saved in instrument state
Initial S/W Revision	A.10.00
Modified at S/W Revision	A.12.00, A.13.00

Max LTE FDD Carriers

Sets max LTE FDD carriers placed when the carrier configuration preset runs. When this value is changed, the carrier configuration preset is initiated.

Key Path	FREQ Channel, Carrier Setup, Carrier Conf Presets, MSR Test Config, TC2 (FDD)FREQ Channel, Carrier Setup, Carrier Conf Presets, MSR Test Config, TC3a (FDD)FREQ Channel, Carrier Setup, Carrier Conf Presets, MSR Test Config, TC4b (FDD)FREQ Channel, Carrier Setup, Carrier Conf Presets, MSR Test Config, TC4c (FDD)FREQ Channel, Carrier Setup, Carrier Conf Presets, Single RAT Config, LTE FDD
Remote Command	[:SENSe] :CARRier:CONFig:LTEFdd:CMAx <integer> [:SENSe] :CARRier:CONFig:LTEFdd:CMAx?
Example	CARR:CONF:LTEF:CMAx 8 CARR:CONF:LTEF:CMAx?
Preset	100
State Saved	Saved in instrument state
Min	1
Max	100
Initial S/W Revision	A.10.00

LTE FDD BW

Sets bandwidth of LTE FDD carriers placed when the carrier configuration preset runs. When this value is changed, the carrier configuration preset is initiated.

Key Path	FREQ Channel, Carrier Setup, Carrier Conf Presets, MSR Test Config, TC2 (FDD)FREQ Channel, Carrier Setup, Carrier Conf Presets, MSR Test Config, TC3a (FDD)FREQ Channel, Carrier Setup, Carrier Conf Presets, MSR Test Config, TC4b (FDD)FREQ Channel, Carrier Setup, Carrier Conf Presets, MSR Test Config, TC4c (FDD)FREQ Channel, Carrier Setup, Carrier Conf Presets, MSR Test Config, TC4d (FDD)FREQ Channel, Carrier Setup, Carrier Conf Presets, Single RAT Config, LTE FDD
Remote Command	[:SENSe] :CARRier:CONFig:LTEFdd:BA NDwidth B1M4 B3M B5M B10M B15M B20M [:SENSe] :CARRier:CONFig:LTEFdd:BA NDwidth?
Example	CARR:CONF:LTEF:BA ND B5M CARR:CONF:LTEF:BA ND?
Preset	B5M
State Saved	Saved in instrument state
Range	1.4MHz 3MHz 5MHz 10MHz 15MHz 20MHz
Readback	The currently selected LTE FDD BW
Initial S/W Revision	A.10.00

Max W-CDMA Carriers (FDD)

Sets max W-CDMA carriers placed when the carrier configuration preset runs. When this value is changed, the carrier configuration preset is initiated.

Key Path	FREQ Channel, Carrier Setup, Carrier Conf Presets, MSR Test Config, TC1a (FDD)FREQ Channel, Carrier Setup, Carrier Conf Presets, MSR Test Config, TC3a (FDD)FREQ Channel, Carrier Setup, Carrier Conf Presets, MSR Test Config, TC4a (FDD)FREQ Channel, Carrier Setup, Carrier Conf Presets, MSR Test Config, TC4c (FDD)FREQ Channel, Carrier Setup, Carrier Conf Presets, Single RAT Config, W-CDMA
Remote Command	[:SENSe] :CARRier:CONFig:WCDMa:CMAX <integer> [:SENSe] :CARRier:CONFig:WCDMa:CMAX?
Example	CARR:CONF:WCDM:CMAX 8 CARR:CONF:WCDM:CMAX?
Preset	100
State Saved	Saved in instrument state
Min	1
Max	100
Initial S/W Revision	A.10.00

Max GSM/EDGE Carriers

Sets max GSM/EDGE carriers placed when the carrier configuration preset runs. When this value is changed, the carrier configuration preset is initiated.

Key Path	FREQ Channel, Carrier Setup, Carrier Conf Presets, MSR Test Config, TC4a (FDD)FREQ Channel, Carrier Setup, Carrier Conf Presets, MSR Test Config, TC4b (FDD)FREQ Channel, Carrier Setup, Carrier Conf Presets, MSR Test Config, TC4c (FDD)FREQ Channel, Carrier Setup, Carrier Conf Presets, Single RAT Config, GSM/EDGE
Remote Command	<code>[:SENSe] :CARRier:CONFig:GSM:CMAX <integer></code> <code>[:SENSe] :CARRier:CONFig:GSM:CMAX?</code>
Example	<code>CARR:CONF:GSM:CMAX 8</code> <code>CARR:CONF:GSM:CMAX?</code>
Preset	100
State Saved	Saved in instrument state
Min	1
Max	100
Initial S/W Revision	A.10.00

Max cdma2000 Carriers

Sets max cdma2000 carriers placed when the carrier configuration preset runs. When this value is changed, the carrier configuration preset is initiated.

Key Path	FREQ Channel, Carrier Setup, Carrier Conf Presets, Single RAT Config, cdma2000
Remote Command	<code>[:SENSe] :CARRier:CONFig:CDMA:CMAX <integer></code> <code>[:SENSe] :CARRier:CONFig:CDMA:CMAX?</code>
Example	<code>CARR:CONF:CDMA:CMAX 8</code> <code>CARR:CONF:CDMA:CMAX?</code>
Preset	100
State Saved	Saved in instrument state
Min	1
Max	100
Initial S/W Revision	A.12.00

Max 1xEV-DO Carriers

Sets max 1xEV-DO carriers placed when the carrier configuration preset runs. When this value is changed, the carrier configuration preset is initiated.

Key Path	FREQ Channel, Carrier Setup, Carrier Conf Presets, Single RAT Config, 1xEV-DO
Remote Command	<code>[:SENSe] :CARRier:CONFig:EVDO:CMAX <integer></code>

	<code>[:SENSe] :CARRier:CONFig:EVDO:CMAx?</code>
Example	<code>CARR:CONF:EVDO:CMAx 8</code> <code>CARR:CONF:EVDO:CMAx?</code>
Preset	100
State Saved	Saved in instrument state
Min	1
Max	100
Initial S/W Revision	A.12.00

Max BS RF Bandwidth

Sets max BS RF bandwidth used when the carrier configuration preset runs. When this value is changed, the carrier configuration preset is initiated.

Key Path	FREQ Channel, Carrier Setup, Carrier Conf Presets
Remote Command	<code>[:SENSe] :CARRier:CONFig:RFBWidth <freq></code> <code>[:SENSe] :CARRier:CONFig:RFBWidth?</code>
Example	<code>CARR:CONF:RFBW 40MHz</code> <code>CARR:CONF:RFBW?</code>
Preset	40MHz
State Saved	Saved in instrument state
Min	600 kHz
Max	200 MHz
Initial S/W Revision	A.10.00

Channel Spacing Delta

Carriers are placed based on channel spacing assigned to the corresponding radio format, when they are configured by the carrier config preset. However, channel spacing can be adjusted using channel spacing delta parameters.

This key accesses the menu to set channel spacing delta of each radio format.

Key Path	FREQ Channel, Carrier Setup, Carrier Conf Presets
Initial S/W Revision	A.10.00

LTE FDD

Sets delta channel spacing for LTE FDD used when the carrier configuration preset runs. Channel spacing for LTE FDD is determined from this value and the default channel spacing defined in the standard, i.e. Channel spacing = (BWchan1 + BWchan2) * 0.5 + [the delta spacing]. Since this value is a difference from

the default spacing, this value can be negative to allow narrower channel spacing. When this value is changed, the carrier configuration preset is initiated.

Key Path	FREQ Channel, Carrier Setup, Carrier Conf Presets, Channel Spacing Delta
Remote Command	[:SENSE] :CARRier:CONFig:LTEFdd:SPACing:DELTA <freq> [:SENSE] :CARRier:CONFig:LTEFdd:SPACing:DELTA?
Example	CARR:CONF:LTEF:SPAC:DELT -200kHz CARR:CONF:LTEF:SPAC:DELT?
Preset	0Hz
State Saved	Saved in instrument state
Min	- 1.0 MHz
Max	10.0 MHz
Initial S/W Revision	A.10.00
Modified at S/W Revision	A.11.00

W-CDMA

Sets delta channel spacing for W-CDMA used when the carrier configuration preset runs. Channel spacing for W-CDMA is determined from this value and the default channel spacing defined in the standard, i.e. Channel spacing = 5.0 MHz + [the delta spacing]. Since this value is a difference from the default spacing, this value can be negative to allow narrower channel spacing. When this value is changed, the carrier configuration preset is initiated.

Key Path	FREQ Channel, Carrier Setup, Carrier Conf Presets, Channel Spacing Delta
Remote Command	[:SENSE] :CARRier:CONFig:WCDMa:SPACing:DELTA <freq> [:SENSE] :CARRier:CONFig:WCDMa:SPACing:DELTA?
Example	CARR:CONF:WCDM:SPAC:DELT 0 CARR:CONF:WCDM:SPAC:DELT?
Preset	0 Hz
State Saved	Saved in instrument state
Min	- 1.0 MHz
Max	10.0 MHz
Initial S/W Revision	A.10.00
Modified at S/W Revision	A.11.00

GSM/EDGE

Sets delta channel spacing for GSM/EDGE used when the carrier configuration preset runs. Channel spacing for GSM/EDGE is determined from this value and the default channel spacing defined in the standard, i.e. Channel spacing = 600 kHz + [the delta spacing]. Since this value is a difference from the default spacing, this value can be negative to allow narrower channel spacing. When this value is changed, the carrier configuration preset is initiated.

Key Path	FREQ Channel, Carrier Setup, Carrier Conf Presets, Channel Spacing Delta
Remote Command	<code>[:SENSe] :CARRier:CONFig:GSM:SPACing:DELTA <freq></code> <code>[:SENSe] :CARRier:CONFig:GSM:SPACing:DELTA?</code>
Example	CARR:CONF:GSM:SPAC:DELT 0 CARR:CONF:GSM:SPAC:DELT?
Preset	0 Hz
State Saved	Saved in instrument state
Min	- 0.4 MHz
Max	10.0 MHz
Initial S/W Revision	A.10.00
Modified at S/W Revision	A.11.00

cdma2000

Sets delta channel spacing for cdma2000 used when the carrier configuration preset runs. Channel spacing for cdma2000 is determined from this value and the default channel spacing defined in the standard, i.e. Channel spacing = 1.25 MHz + [the delta spacing]. Since this value is a difference from the default spacing, this value can be negative to allow narrower channel spacing.

Key Path	FREQ Channel, Carrier Setup, Carrier Conf Presets, Channel Spacing Delta
Remote Command	<code>[:SENSe] :CARRier:CONFig:CDMA:SPACing:DELTA <freq></code> <code>[:SENSe] :CARRier:CONFig:CDMA:SPACing:DELTA?</code>
Example	CARR:CONF:CDMA:SPAC:DELT 0 CARR:CONF:CDMA:SPAC:DELT?
Preset	0 Hz
State Saved	Saved in instrument state
Min	-1 MHz
Max	10 MHz
Initial S/W Revision	A.12.00

1xEV-DO

Sets delta channel spacing for 1xEV-DO used when the carrier configuration preset runs. Channel spacing for 1xEV-DO is determined from this value and the default channel spacing defined in the standard, i.e. Channel spacing = 1.25 MHz + [the delta spacing]. Since this value is a difference from the default spacing, this value can be negative to allow narrower channel spacing.

Key Path	FREQ Channel, Carrier Setup, Carrier Conf Presets, Channel Spacing Delta
Remote Command	<code>[:SENSe] :CARRier:CONFig:EVDO:SPACing:DELTA <freq></code> <code>[:SENSe] :CARRier:CONFig:EVDO:SPACing:DELTA?</code>

Example	CARR:CONF:EVDO:SPAC:DELT 0 CARR:CONF:EVDO:SPAC:DELT?
Preset	0 Hz
State Saved	Saved in instrument state
Min	-1 MHz
Max	10 MHz
Initial S/W Revision	A.12.00

Apply to Meas Offset/Limits

This immediate action key sets the following measurement parameters.

- ACP: Offset and limit parameters under Offset/Limits.
- Spectrum Emission Mask: Offset and limit parameters under Offset/Limits.
- Spurious Emissions: Range frequency and limit parameters under Range Table.

These offset and limit values are determined by the carrier configuration parameters, Band Category and Assumed Adj Channels.

Each of these measurement has a local key, “Apply Carrier Config to ...”, which performs in the same way only for its parameters. So pressing this key is equivalent to pressing “Apply Carrier Config to ...” of all these measurements.

Key Path	FREQ Channel, Carrier Setup
Remote Command	[:SENSe] :MCONdition:IMMEDIATE
Example	MCON:IMM
Initial S/W Revision	A.11.00

RF Bandwidth (Remote Command Only)

Returns the RF bandwidth calculated from the outermost carriers and their Foffset_RAT.

Key Path	SCPI only
Mode	MSR
Remote Command	[:SENSe] :CARRier:RFBWidth?
Example	CARR:RFBW?
Preset	Calculated from preset values of carrier config parameters
State Saved	No
Initial S/W Revision	A.13.00

RF Bandwidth Center (Remote Command Only)

Returns the center frequency of RF bandwidth.

Key Path	SCPI only
Mode	MSR
Remote Command	[:SENSe] :CARRier:RFBWidth:CENTer?
Example	CARR:RFBW:CENT?
Preset	Calculated from preset values of carrier config parameters
State Saved	No
Initial S/W Revision	A.13.00

Sub-block Center (Remote Command Only)

Returns the center frequency of sub-block when Carrier Allocation is Non-Contiguous.

Key Path	SCPI only
Mode	MSR
Remote Command	[:SENSe] :CARRier:SBLoCk[1] 2 :CENTer?
Example	CARR:SBL:CENT?
Notes	When Carrier Allocation is Contiguous, 9.91 E+37 is returned.
Preset	Calculated from preset values of carrier config parameters
State Saved	No
Initial S/W Revision	A.13.00

Sub-block Bandwidth (Remote Command Only)

Returns the bandwidth of sub-block calculated from outermost carriers and corresponding Foffset_RAT.

Key Path	SCPI only
Mode	MSR
Remote Command	[:SENSe] :CARRier:SBLoCk[1] 2 :BWIDth?
Example	CARR:SBL:BWID?
Notes	When Carrier Allocation is Contiguous, 9.91 E+37 is returned.
Preset	Calculated from preset values of carrier config parameters
State Saved	No
Initial S/W Revision	A.13.00

Sub-block Gap (Remote Command Only)

Returns the sub-block gap.

Key Path	SCPI only
Mode	MSR
Remote Command	[:SENSe] :CARRier :SBLock :GAP?
Example	CARR:SBL:GAP?
Notes	When Carrier Allocation is Contiguous, 9.91E+37 is returned.
Preset	Calculated from preset values of carrier config parameters
State Saved	No
Initial S/W Revision	A.13.00

11 Spectrum Emission Mask Measurement
Input/Output

Input/Output

See "[Input/Output](#)" on page 190

Marker

Accesses a menu that enables you to select, set up and control the markers for the current measurement. If there are no active markers, **Marker** selects marker 1, sets it to Normal and places it at the center of the display. You can turn on and control up to 12 markers.

Key Path	Front-panel key
Initial S/W Revision	Prior to A.02.00

Select Marker

Displays 12 markers available for selection.

Key Path	Marker
Initial S/W Revision	Prior to A.02.00

Marker Type

Sets the marker control mode to Normal and Off. If the selected marker is Off, pressing Marker sets it to Normal and places it at the center of the screen on the trace determined by the **Marker Trace** rules. At the same time, **Marker X Axis Value** appears on the Active Function area. The marker X axis value entered in the active function area will display the marker value to its full entered precision. If the current control mode for the measurement is Off, there is no active function and the active function is turned off.

Key Path	Marker
Mode	SA, WCDMA, C2K, WIMAX OFDMA, TD-SCDMA, 1xEVDO, DTMB (CTTB), DVB-T/H, ISDB-T, CMMB, LTE, LTE-TDD, Digital Cable TV, WLAN, MSR, LTEAFDD, LTEATDD
Remote Command	:CALCulate:SEMask:MARKer[1] 2 ... 12:MODE POSition OFF :CALCulate:SEMask:MARKer[1] 2 ... 12:MODE?
Example	CALC:SEM:MARK:MODE POS CALC:SEM:MARK:MODE?
Notes	If the selected marker is Off, pressing Marker sets it to Normal and places it at the center of the screen on the trace determined by the Marker Trace rules. At the same time, Marker X Axis Value appears on the Active Function area. Default Active Function: the active function for the selected marker's current control mode. Note that if the current control mode is Off, there is no active function and the active function is turned off. Active Function Display: the marker X axis value entered in the active function area will display the marker value to its full entered precision.
Preset	OFF OFF OFF OFF OFF OFF OFF OFF OFF OFF OFF OFF
State Saved	Saved in instrument state
Range	Normal Off
Initial S/W Revision	Prior to A.02.00
Modified at S/W Revision	A.02.00, A.03.00

Couple Markers

When this function is true, moving any marker causes an equal X Axis movement of every other marker that is not **Off**. By “equal X Axis movement” we mean that we preserve the difference between each marker’s X Axis value (in the fundamental x-axis units of the trace that marker is on) and the X Axis value of the marker being moved (in the same fundamental x-axis units).

Key Path	Marker
Mode	SA, WCDMA, C2K, WIMAX OFDMA, TD-SCDMA, 1xEVDO, DTMB (CTTB), DVB-T/H, ISDB-T, CMMB, LTE, LTETDD, Digital Cable TV, WLAN, MSR, LTEAFDD, LTEATDD
Remote Command	:CALCulate:SEMask:MARKer:COUPle[:STATe] ON OFF 1 0 :CALCulate:SEMask:MARKer:COUPle[:STATe]?
Example	CALC:SEM:MARK:COUP ON CALC:SEM:MARK:COUP?
Preset	OFF
State Saved	Saved in instrument state
Range	On Off
Initial S/W Revision	Prior to A.02.00
Modified at S/W Revision	A.02.00, A.03.00

All Markers Off

Turns all active markers off in all views.

Key Path	Marker
Mode	SA, WCDMA, C2K, WIMAX OFDMA, TD-SCDMA, 1xEVDO, DTMB (CTTB), DVB-T/H, ISDB-T, CMMB, LTE, LTETDD, Digital Cable TV, WLAN, MSR, LTEAFDD, LTEATDD
Remote Command	:CALCulate:SEMask:MARKer:AOFF
Example	CALC:SEM:MARK:AOFF
Initial S/W Revision	Prior to A.02.00
Modified at S/W Revision	A.02.00, A.03.00

Marker X Axis Value (Remote Command Only)

Sets the marker X Axis value in the current marker X Axis Scale unit. It has no effect if the control mode is Off, but is the SCPI equivalent of entering an X value if the control mode is **Normal**.

Mode	SA, WCDMA, C2K, WIMAX OFDMA, TD-SCDMA, 1xEVDO, DTMB (CTTB), DVB-T/H ISDB-T, CMMB, LTE, LTETDD, Digital Cable TV, WLAN, MSR, LTEAFDD, LTEATDD
Remote Command	:CALCulate:SEMask:MARKer[1] 2 ... 12:X <freq>

	:CALCulate:SEMask:MARKer[1] 2 ... 12:X?
Example	CALC:SEM:MARK3:X 1.0 GHz CALC:SEM:MARK3:X?
Notes	If no suffix is sent it will use the fundamental units for the current marker X Axis Scale. If a suffix is sent that does not match the current marker X Axis Scale unit, an error "Invalid suffix" will be generated. The query returns the marker's absolute X Axis value if the control mode is Normal . The query is returned in the fundamental units for the current marker X Axis scale. If the marker is Off the response is not a number. When a Marker is turned on, it is placed center of the screen on the trace.
Preset	After a preset, all Markers are turned OFF, so a Marker X Axis Value query will return a not a number (NAN).
State Saved	No
Min	-9.9E+37
Max	9.9E+37
Initial S/W Revision	Prior to A.02.00
Modified at S/W Revision	A.02.00, A.03.00

Marker X Axis Position (Remote Command Only)

Sets the marker X position in trace points. It has no effect if the control mode is **Off**, but is the SCPI equivalent of entering a value if the control mode is **Normal**, except in trace points rather than X Axis Scale units. The entered value is immediately translated into the current X Axis Scale units for setting the value of the marker.

Mode	SA, WCDMA, C2K, WIMAX OFDMA, TD-SCDMA, 1xEVDO, DTMB (CTTB), DVB-T/H, ISDB-T, CMMB, LTE, LTE-TDD, Digital Cable TV, WLAN, MSR, LTEAFDD, LTEATDD
Remote Command	:CALCulate:SEMask:MARKer[1] 2 ... 12:X:POsition <real> :CALCulate:SEMask:MARKer[1] 2 ... 12:X:POsition?
Example	CALC:SEM:MARK10:X:POS 1001 CALC:SEM:MARK10:X:POS?
Notes	The query returns the marker's absolute X Axis value in trace points if the control mode is Normal . The value is returned as a real number, not an integer, corresponding to the translation from X Axis Scale units to trace points . If the marker is Off the response is not a number. When a Marker is turned on, it is placed center of the screen on the trace.
Preset	After a preset, all Markers are turned OFF, so a Marker X Axis Value query will return a not a number (NAN).
State Saved	No
Min	-9.9E+37
Max	9.9E+37

Initial S/W Revision	Prior to A.02.00
Modified at S/W Revision	A.02.00, A.03.00

Marker Y Axis Value (Remote Command Only)

Returns the marker Y Axis value in the current marker Y Axis unit.

Mode	SA, WCDMA, C2K, WIMAX OFDMA, TD-SCDMA, 1xEVDO, DTMB (CTTB), DVB-T/H, ISDB-T, CMMB, LTE, LTETDD, Digital Cable TV, WLAN, MSR, LTEAFDD, LTEATDD
Remote Command	:CALCulate:SEMAsk:MARKer[1] 2 ... 12:Y?
Example	CALC:SEM:MARK11:Y 10 dBm CALC:SEM:MARK11:Y?
Notes	Since the result value is always calculated from acquisition data, the default value is arbitrary, although the Preset/Default values is defined.
Preset	Result dependent on markers setup and signal source
State Saved	No
Backwards Compatibility SCPI	:CALCulate:SEMAsk:MARKer[1] 2 ... 12:FUNction:RESult?
Initial S/W Revision	Prior to A.02.00
Modified at S/W Revision	A.02.00, A.03.00

Marker Function

There are no 'Marker Functions' supported in Spectrum Emission Mask so this front-panel key displays a blank menu when pressed.

Key Path	Front-panel key
Initial S/W Revision	Prior to A.02.00

Marker To

There is no 'Marker To' functionality supported in Spectrum Emission Mask so this front-panel key displays a blank menu when pressed.

Key Path	Front-panel key
Initial S/W Revision	Prior to A.02.00

Meas

The information in this section is common to all measurements. For key and remote command information for a specific measurement, refer to the section that describes the measurement of interest.

Measurements available under the Meas key are specific to the current Mode.

When viewing Help for measurements, note the following:

NOTE

Operation for some keys differs between measurements. The information displayed in Help pertains to the current measurement. To see how a key operates in a different measurement, exit Help (press the Cancel Esc key), select the measurement, then reenter Help (press the Help key) and press that key.

Key Path	Front-panel key
Initial S/W Revision	Prior to A.02.00

Remote Measurement Functions

This section contains the following topics:

"Measurement Group of Commands" on page 2382

"Current Measurement Query (Remote Command Only)" on page 2384

"Limit Test Current Results (Remote Command Only)" on page 2384

"Data Query (Remote Command Only)" on page 2384

"Calculate/Compress Trace Data Query (Remote Command Only)" on page 2385

"Calculate Peaks of Trace Data (Remote Command Only)" on page 2390

"Hardware-Accelerated Fast Power Measurement (Remote Command Only)" on page 2391

"Format Data: Numeric Data (Remote Command Only)" on page 2405

"Format Data: Byte Order (Remote Command Only)" on page 2406

Initial S/W Revision	Prior to A.02.00
----------------------	------------------

Measurement Group of Commands

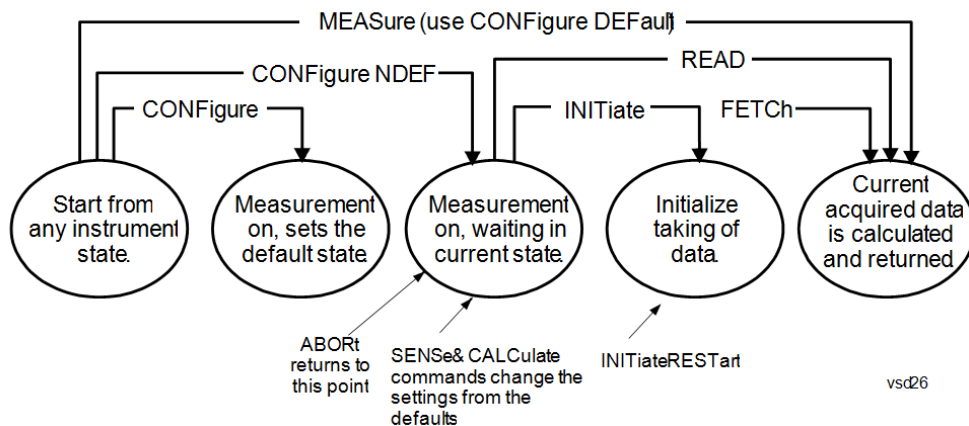

Measure Commands:

:MEASure:<measurement>[n]?

This is a fast single-command way to make a measurement using the factory default instrument settings. These are the settings and units that conform to the Mode Setup settings (e.g. radio standard) that you have currently selected.

- Stops the current measurement (if any) and sets up the instrument for the specified measurement using the factory defaults
- Initiates the data acquisition for the measurement
- Blocks other SCPI communication, waiting until the measurement is complete before returning results.
- If the function does averaging, it is turned on and the number of averages is set to 10.
- After the data is valid it returns the scalar results, or the trace data, for the specified measurement. The type of data returned may be defined by an [n] value that is sent with the command.
- The scalar measurement results will be returned if the optional [n] value is not included, or is set to 1. If the [n] value is set to a value other than 1, the selected trace data results will be returned. See each command for details of what types of scalar results or trace data results are available.
- ASCII is the default format for the data output. (Older versions of Spectrum Analysis and Phase Noise mode measurements only use ASCII.) The binary data formats should be used for handling large blocks of data since they are smaller and faster than the ASCII format. Refer to the FORMat:DATA command for more information.

If you need to change some of the measurement parameters from the factory default settings you can set up the measurement with the CONFigure command. Use the commands in the SENSE:<measurement> and CALCulate:<measurement> subsystems to change the settings. Then you can use the READ? command to initiate the measurement and query the results.

If you need to repeatedly make a given measurement with settings other than the factory defaults, you can use the commands in the SENSE:<measurement> and CALCulate:<measurement> subsystems to set up the measurement. Then use the READ? command to initiate the measurement and query results.

Measurement settings persist if you initiate a different measurement and then return to a previous one. Use READ:<measurement>? if you want to use those persistent settings. If you want to go back to the default settings, use MEASure:<measurement>?.

Configure Commands:

:CONFigure:<measurement>

This command stops the current measurement (if any) and sets up the instrument for the specified measurement using

the factory default instrument settings. It does not initiate the taking of measurement data unless INIT:CONTinuous is ON. If you change any measurement settings after using the CONFigure command, the READ command can be used to initiate a measurement without changing the settings back to their defaults.

In the Swept SA measurement in Spectrum Analyzer mode the CONFigure command also turns the averaging function on and sets the number of averages to 10 for all measurements.

:CONFigure: <measurement>: NDEFault stops the current measurement and changes to the specified measurement. It does not change the settings to the defaults. It does not initiate the taking of measurement data unless INIT:CONTinuous is ON.

The CONFigure? query returns the current measurement name.

The CONFigure:CATalog? query returns a quoted string of all licensed measurement names in the current mode. For example, "SAN, CHP, OBW, ACP, PST, TXP, SPUR, SEM, LIST".

Fetch Commands:

:FETCh:<measurement>[n]?

This command puts selected data from the most recent measurement into the output buffer. Use FETCh if you have already made a good measurement and you want to return several types of data (different [n] values, for example, both scalars and trace data) from a single measurement. FETCh saves you the time of re-making the measurement. You can only FETCh results from the measurement that is currently active, it will not change to a different measurement. An error message is reported if a measurement other than the current one is specified.

If you need to get new measurement data, use the READ command, which is equivalent to an INITiate followed by a FETCh.

The scalar measurement results will be returned if the optional [n] value is not included, or is set to 1. If the [n] value is set to a value other than 1, the selected trace data results will be returned. See each command for details of what types of scalar results or trace data results are available. The binary data formats should be used for handling large blocks of data since they are smaller and transfer faster than the ASCII format. (FORMat:DATA)

FETCh may be used to return results other than those specified with the original READ or MEASure command that you sent.

INITiate Commands:

:INITiate:<measurement>

This command is not available for measurements in all the instrument modes:

- Initiates a trigger cycle for the specified measurement, but does not output any data. You must then use the FETCh<meas> command to return data. If a measurement other than the current one is specified, the instrument will switch to that measurement and then initiate it.
- For example, suppose you have previously initiated the ACP measurement, but now you are running the channel power measurement. If you send INIT:ACP? it will change from channel power to ACP and will initiate an ACP measurement.
- Does not change any of the measurement settings. For example, if you have previously started the ACP measurement and you send INIT:ACP? it will initiate a new ACP measurement using the same instrument settings as the last time ACP was run.
- If your selected measurement is currently active (in the idle state) it triggers the measurement, assuming the trigger conditions are met. Then it completes one trigger cycle. Depending upon the measurement and the number of averages, there may be multiple data acquisitions, with multiple trigger events, for one full trigger cycle. It also holds off additional commands on GPIB until the acquisition is complete.

READ Commands:

:READ:<measurement>[n]?

- Does not preset the measurement to the factory default settings. For example, if you have previously initiated the ACP
-

measurement and you send READ:ACP? it will initiate a new measurement using the same instrument settings.

- Initiates the measurement and puts valid data into the output buffer. If a measurement other than the current one is specified, the instrument will switch to that measurement before it initiates the measurement and returns results.
 - For example, suppose you have previously initiated the ACP measurement, but now you are running the channel power measurement. Then you send READ:ACP? It will change from channel power back to ACP and, using the previous ACP settings, will initiate the measurement and return results.
 - Blocks other SCPI communication, waiting until the measurement is complete before returning the results
 - If the optional [n] value is not included, or is set to 1, the scalar measurement results will be returned. If the [n] value is set to a value other than 1, the selected trace data results will be returned. See each command for details of what types of scalar results or trace data results are available. The binary data formats should be used when handling large blocks of data since they are smaller and faster than the ASCII format. (FORMat:DATA)
-

Initial S/W Revision	Prior to A.02.00
----------------------	------------------

Current Measurement Query (Remote Command Only)

This command returns the name of the measurement that is currently running.

Remote Command	:CONFigure?
-----------------------	-------------

Example	CONF?
----------------	-------

Initial S/W Revision	Prior to A.02.00
----------------------	------------------

Limit Test Current Results (Remote Command Only)

Queries the status of the current measurement limit testing. It returns a 0 if the measured results pass when compared with the current limits. It returns a 1 if the measured results fail any limit tests.

Remote Command	:CALCulate:CLIMits:FAIL?
-----------------------	--------------------------

Example	CALC:CLIM:FAIL? queries the current measurement to see if it fails the defined limits. Returns a 0 or 1: 0 it passes, 1 it fails.
----------------	--

Initial S/W Revision	Prior to A.02.00
----------------------	------------------

Data Query (Remote Command Only)

Returns the designated measurement data for the currently selected measurement and subopcode.

n = any valid subopcode for the current measurement. See the measurement command results table for your current measurement, for information about what data is returned for the subopcodes.

This command uses the data setting specified by the FORMat:BORDER and FORMat:DATA commands and can return real or ASCII data. (See the format command descriptions under Input/Output in the Analyzer Setup section.)

Remote Command	:CALCulate:DATA[n]?
Notes	The return trace depends on the measurement. In CALCulate:<meas>:DATA[n], n is any valid subopcode for the current measurement. It returns the same data as the FETCH:<measurement>? query where <measurement> is the current measurement.
Initial S/W Revision	Prior to A.02.00

Calculate/Compress Trace Data Query (Remote Command Only)

Returns compressed data for the currently selected measurement and sub-opcode [n].

n = any valid sub-opcode for that measurement. See the MEASure:<measurement>? command description of your specific measurement for information on the data that can be returned.

The data is returned in the current Y Axis Unit of the analyzer. The command is used with a sub-opcode <n> (default=1) to specify the trace. With trace queries, it is best if the analyzer is not sweeping during the query. Therefore, it is generally advisable to be in Single Sweep, or Update=Off.

This command is used to compress or decimate a long trace to extract and return only the desired data. A typical example would be to acquire N frames of GSM data and return the mean power of the first burst in each frame. The command can also be used to identify the best curve fit for the data.

Remote Command	:CALCulate:DATA<n>:COMPRESS? BLOCK CFIT MAXimum MINimum MEAN DMEan RMS RMSCubed SAMPLE SDEVIation PPHase [,<soffset> [,<length>[,<roffset>[,<rlimit>]]]]
Example	To query the mean power of a set of GSM bursts: Supply a signal that is a set of GSM bursts. Select the IQ Waveform measurement (in IQ Analyzer Mode). Set the sweep time to acquire at least one burst. Set the triggers such that acquisition happens at a known position relative to a burst. Then query the mean burst levels using, CALC:DATA2:COMP? MEAN, 24e-6, 526e-6 (These parameter values correspond to GSM signals, where 526e-6 is the length of the burst in the slot and you just want 1 burst.)
Notes	The command supports 5 parameters. Note that the last 4 (<soffset>, <length>, <roffset>, <rlimit>) are optional. But these optional parameters must be entered in the specified order. For example, if you want to specify <length>, then you must also specify <soffset>. See details below for a definition of each of these parameters. This command uses the data in the format specified by FORMat:DATA, returning either binary or ASCII data.
Initial S/W Revision	Prior to A.02.00

- BLOCK or block data - returns all the data points from the region of the trace data that you specify. For example, it could be used to return the data points of an input signal over several timeslots, excluding the portions of the trace data that you do not want. (This is x,y pairs for trace data and I,Q pairs for complex data.)

- CFIT or curve fit - applies curve fitting routines to the data. <soffset> and <length> are required to define the data that you want. <roffset> is an optional parameter for the desired order of the curve equation. The query will return the following values: the x-offset (in seconds) and the curve coefficients ((order + 1) values).

MIN, MAX, MEAN, DME, RMS, RMSC, SAMP, SDEV and PPH return one data value for each specified region (or <length>) of trace data, for as many regions as possible until you run out of trace data (using <roffset> to specify regions). Or they return the number of regions you specify (using <rlimit>) ignoring any data beyond that.

- MINimum - returns the minimum data point (y value) for the specified region(s) of trace data. For I/Q trace data, the minimum magnitude of the I/Q pairs is returned.
- MAXimum - returns the maximum data point (y value) for the specified region(s) of trace data. For I/Q trace data, the maximum magnitude of the I/Q pairs is returned.
- MEAN - returns a single value that is the arithmetic mean of the data point values (in dB/ dBm) for the specified region(s) of trace data. For I/Q trace data, the mean of the magnitudes of the I/Q pairs is returned. See the following equations.

NOTE If the original trace data is in dB, this function returns the arithmetic mean of those log values, not log of the mean power which is a more useful value. The mean of the log is the better measurement technique when measuring CW signals in the presence of noise. The mean of the power, expressed in dB, is useful in power measurements such as Channel Power. To achieve the mean of the power, use the RMS option.

Equation 1

Mean Value of Data Points for Specified Region(s)

$$\text{MEAN} = \frac{1}{n} \sum_{X_i \in \text{region}(s)} X_i$$

where X_i is a data point value, and n is the number of data points in the specified region(s).

Equation 2

Mean Value of I/Q Data Pairs for Specified Region(s)

$$\text{MEAN} = \frac{1}{n} \sum_{X_i \in \text{region}(s)} |X_i|$$

where $|X_i|$ is the magnitude of an I/Q pair, and n is the number of I/Q pairs in the specified region(s).

- DMEan - returns a single value that is the mean power (in dB/ dBm) of the data point values for the specified region(s) of trace data. See the following equation:

Equation 3

DMEan Value of Data Points for Specified Region(s)

$$\text{DME} = 10 \times \log_{10} \left(\frac{1}{n} \sum_{X_i \in \text{region}(s)} 10^{\frac{X_i}{10}} \right)$$

- RMS - returns a single value that is the average power on a root-mean-squared voltage scale (arithmetic rms) of the data point values for the specified region(s) of trace data. See the following equation.

NOTE For I/Q trace data, the rms of the magnitudes of the I/Q pairs is returned. See the following equation. This function is very useful for I/Q trace data. However, if the original trace data is in dB, this function returns the rms of the log values which is not usually needed.

Equation 4

RMS Value of Data Points for Specified Region(s)

$$\text{RMS} = \sqrt{\frac{1}{n} \sum_{X_i \in \text{region}(s)} X_i^2}$$

where X_i is a data point value, and n is the number of data points in the specified region(s).

Equation 5

RMS Value of I/Q Data Pairs for Specified Region(s)

$$\text{RMS} = \sqrt{\frac{1}{n} \sum_{X_i \in \text{region}(s)} X_i X_i^*}$$

where X_i is the complex value representation of an I/Q pair, X_i^* its conjugate complex number, and n is the number of I/Q pairs in the specified region(s).

Once you have the rms value for a region of trace data (linear or I/Q), you may want to calculate the mean power. You must convert this rms value (peak volts) to power in dBm:

$$10 \times \log[10 \times (\text{rms value})^2]$$

- SAMPLe - returns the first data value (x,y pair) for the specified region(s) of trace data. For I/Q trace data, the first I/Q pair is returned.
- SDEViation - returns a single value that is the arithmetic standard deviation for the data point values for the specified region(s) of trace data. See the following equation.
- For I/Q trace data, the standard deviation of the magnitudes of the I/Q pairs is returned. See the following equation.

Equation 6

Standard Deviation of Data Point Values for Specified Region(s)

$$\text{SDEV} = \sqrt{\frac{1}{n} \sum_{X_i \in \text{region}(s)} (X_i - \bar{X})^2}$$

where X_i is a data point value, \bar{X} is the arithmetic mean of the data point values for the specified region (s), and n is the number of data points in the specified region(s).

$$\text{SDEV} = \sqrt{\frac{1}{n} \sum_{X_i \in \text{region}(s)} (|X_i| - \bar{X})^2}$$

where $|X_i|$ is the magnitude of an I/Q pair, \bar{X} is the mean of the magnitudes for the specified region(s), and n is the number of data points in the specified region(s).

- PPHase - returns the x,y pairs of both rms power (dBm) and arithmetic mean phase (radian) for every specified region and frequency offset (Hz). The number of pairs is defined by the specified number of regions. This parameter can be used for I/Q vector ($n=0$) in Waveform (time domain) measurement and all parameters are specified by data point in PPHase.

The rms power of the specified region may be expressed as:

$$\text{Power} = 10 \times \log [10 \times (\text{RMS I/Q value})] + 10.$$

The RMS I/Q value (peak volts) is:

$$\sqrt{\frac{1}{n} \sum_{X_i \in \text{region}} X_i X_i^*}$$

where X_i is the complex value representation of an I/Q pair, X_i^* its conjugate complex number, and n is the number of I/Q pairs in the specified region.

The arithmetic mean phase of the specified region may be expressed as:

$$\frac{1}{n} \sum_{Y_i \in \text{region}} Y_i$$

where Y_i is the unwrapped phase of I/Q pair with applying frequency correction and n is the number of I/Q pairs in the specified region.

The frequency correction is made by the frequency offset calculated by the arithmetic mean of every specified region's frequency offset. Each frequency offset is calculated by the least square method against the unwrapped phase of I/Q pair.

Sample Trace Data - Constant Envelope

(See below for explanation of variables.)

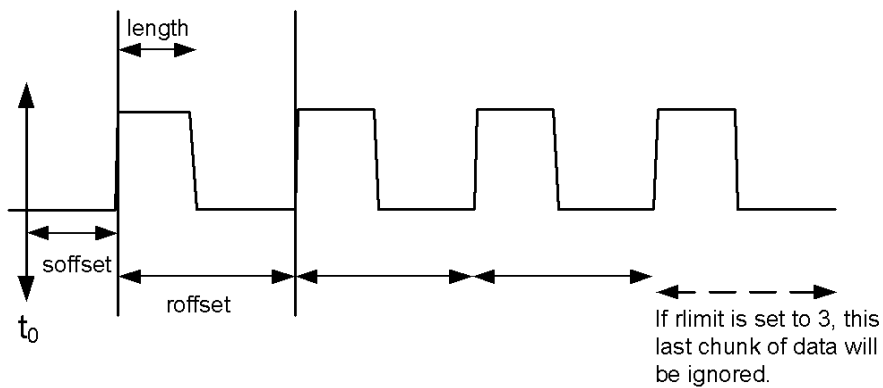

Sample Trace Data - Not Constant Envelope

(See below for explanation of variables.)

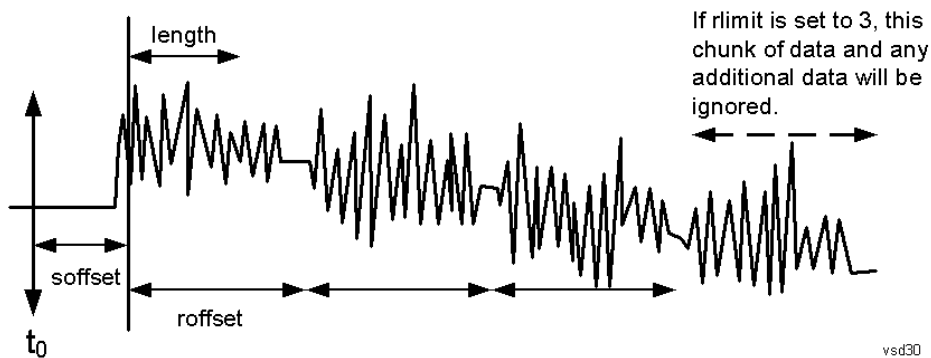

<soffset> - start offset is an optional real number. (It is in seconds for time-domain traces, and is a dimensionless index 0 to Npoints - 1, for frequency-domain traces). It specifies the amount of data at the beginning of the trace that will be ignored before the decimation process starts. It is the time or frequency change from the start of the trace to the point where you want to start using the data. The default value is zero.

<length> - is an optional real number. (It is in seconds for time-domain traces, and is a dimensionless index 0 to Npoints - 1, for frequency-domain traces). It defines how much data will be compressed into one value. This parameter has a default value equal to the current trace length.

<roffset> - repeat offset is an optional real number. (It is in seconds for time-domain traces, and is a dimensionless index 0 to Npoints - 1, for frequency-domain traces). It defines the beginning of the next field of trace elements to be compressed. This is relative to the beginning of the previous field. This parameter has a default value equal to the <length> variable. Note that this parameter is used for a completely different purpose when curve fitting (see CFIT above).

<rlimit> - repeat limit is an optional integer. It specifies the number of data items that you want returned. It will ignore any additional items beyond that number. You can use the Start offset and the Repeat limit to pick out exactly what part of the data you want to use. The default value is all the data.

Calculate Peaks of Trace Data (Remote Command Only)

Returns a list of all the peaks for the currently selected measurement and sub-opcode [n]. The peaks must meet the requirements of the peak threshold and excursion values.

n = any valid sub-opcode for the current measurement. See the MEASure:<measurement> command description of your specific measurement for information on the data that can be returned.

The command can only be used with specific sub-opcodes with measurement results that are trace data. Both real and complex traces can be searched, but complex traces are converted to magnitude in dBm. In many measurements the sub-opcode n=0, is the raw trace data which cannot be searched for peaks. And Sub-opcode n=1, is often calculated results values which also cannot be searched for peaks.

This command uses the data setting specified by the FORMat:BORDER and FORMat:DATA commands and can return real or ASCII data. If the format is set to INT,32, it returns REAL,32 data.

The command has four types of parameters:

- Threshold (in dBm)
- Excursion (in dB)
- Sorting order (amplitude, frequency, time)
- Optional in some measurements: Display line use (all, > display line, < display line)

Remote Command	<p>For Swept SA measurement:</p> <pre>:CALCulate:DATA[1] 2 ... 6:PEAKs? <threshold>,<excursion>[,AMPLitude FREQuency TIME[,ALL GTDLine LTDLine]]</pre> <p>For most other measurements:</p> <pre>:CALCulate:DATA[1] 2 ... 6:PEAKs? <threshold>,<excursion>[,AMPLitude FREQuency TIME]</pre>
-----------------------	--

Example	<p>Example for Swept SA measurement in Spectrum Analyzer Mode:</p> <p>CALC:DATA4:PEAK? -40, 10, FREQ, GTDL This will identify the peaks of trace 4 that are above -40 dBm, with excursions of at least 10 dB. The peaks are returned in order of increasing frequency, starting with the lowest frequency. Only the peaks that are above the display line are returned.</p> <p>Query Results 1:</p> <p>With FORMat:DATA REAL, 32 selected, it returns a list of floating-point numbers. The first value in the list is the number of peak points that are in the following list. A peak point consists of two values: a peak amplitude followed by its corresponding frequency (or time).</p> <p>If no peaks are found the peak list will consist of only the number of peaks, (0).</p>
----------------	---

Notes	<p><n> - is the trace that will be used</p> <p><threshold> - is the level below which trace data peaks are ignored. Note that the threshold value is required and is always used as a peak criterion. To effectively disable the threshold criterion for this command, provide a substantially low threshold value such as -200 dBm. Also note that the threshold value used in this command is independent of and has no effect on the threshold value stored under the Peak Criteria menu.</p> <p><excursion> - is the minimum amplitude variation (rise and fall) required for a signal to be identified as peak. Note that the excursion value is required and is always used as a peak criterion. To effectively disable the excursion criterion for this command, provide the minimum value of 0.0 dB. Also note that the excursion value used in this command is independent of and has no effect on the</p>
--------------	---

excursion value stored under the Peak Criteria menu.

Values must be provided for threshold and excursion. The sorting and display line parameters are optional (defaults are AMPLitude and ALL).

Note that there is always a Y-axis value for the display line, regardless of whether the display line state is on or off. It is the current Y-axis value of the display line which is used by this command to determine whether a peak should be reported

Sorting order:

AMPLitude - lists the peaks in order of descending amplitude, with the highest peak first (default if optional parameter not sent)

FREQUENCY - lists the peaks in order of occurrence, left to right across the x-axis.

TIME - lists the peaks in order of occurrence, left to right across the x-axis.

Peaks vs. Display Line:

ALL - lists all of the peaks found (default if optional parameter not sent).

GTDLine (greater than display line) - lists all of the peaks found above the display line.

LTDLine (less than display line) - lists all of the peaks found below the display line.

Initial S/W Revision	Prior to A.02.00
----------------------	------------------

Hardware-Accelerated Fast Power Measurement (Remote Command Only)

The Fast Power option (FP2) enables very fast channel power measurements for instruments with the prerequisite hardware (DP2 and/or B40). It accomplishes this by performing real-time overlapped FFTs at the hardware layer, using software for basic post-processing before returning the result to the user. The upshot of this approach is improved throughput for user applications that require many sequential power measurements.

The analysis bandwidth of FP2 is limited by the licenses in the instrument, but its maximum overall analysis bandwidth per acquisition is 40 MHz.

FP2 is remote-only, which means the instrument does not switch to any particular mode or measurement. FP2 commands can be sent while another application is in use on the front panel.

Each Fast Power measurement can be predefined using an array index, and up to 1,000 measurements can be stored. In the following documentation, instances of [1,2,...,999] can be substituted with a particular measurement index, e.g. CALC:FPOW:POW1?, CALC:FPOW:POW2?, CALC:FPOW:POW134?. In this way, power measurements can be defined one time in a batch, and then executed multiple times without having to redefine them, similar to “list mode” on other measurements.

In addition to basic channel power measurements, there are a number of other measurement “functions” for each channel, including peak power, peak frequency, and power spectral density. See the Function parameter for more information.

Reset Fast Power Measurement (Remote Command Only)

Resets the measurement configuration to the defaults.

Mode	All
Remote Command	:CALCulate:FPOWer:POWer [1, 2, ..., 999] :RESet
Example	:CALC:FPOW:POW1:RES

Notes	Option FP2 is required.
Initial S/W Revision	A.14.00

Define Fast Power Measurement (Remote Command Only)

Fast Power acquisitions are configured using the DEFine command. This command accepts a comma-delimited string of configuration parameters and their appropriate values, which are all specified in the subsection below.

Mode	All
Remote Command	:CALCulate:FPOWer:POWer[1,2,...,999]:DEFine "configuration string"
Example	:CALC:FPOW:POW1:DEF "CenterFrequency=2e9, AcquisitionTime=0.005"
Notes	See below for a list of measurement variables that can be defined in the configuration string.
Initial S/W Revision	A.14.00

Acquisition Time

Example	CALC:FPOW:POW1:DEF "AcquisitionTime=0.002"
Notes	The acquisition time parameter sets the time in which the entire spectrum is measured. An increase in the acquisition time yields an improvement in measurement repeatability.
Preset	0.001 s
Range	0 s to 1 s
Default Unit	Time (s)
Initial S/W Revision	A.14.00

Center Frequency

Example	CALC:FPOW:POW1:DEF "CenterFrequency=2e9"
Notes	The center frequency parameter sets the frequency in which the measurement is centered around. The OffsetFrequency parameter is calculated relative to the center frequency.
Preset	1 GHz
Range	0 Hz to maximum instrument frequency
Default Unit	Frequency (Hz)
Initial S/W Revision	A.14.00

DC Coupled

Example	CALC:FPOW:POW1:DEF "DCCoupled=True"
Notes	The DC coupled parameter allows the user to specify whether the DC blocking capacitor is utilized. Set parameter to true when measuring frequencies below 10 MHz.
Preset	False
Range	True (DC Coupled) or False (AC Coupled)
Default Unit	Boolean
Initial S/W Revision	A.14.00

DetectorType

Example	CALC:FPOW:POW1:DEF "DetectorType=Peak"
Notes	Option FP2 is required. The detector type parameter allows the user to choose whether a RMS average or peak value is used during the measurement.
Preset	RmsAverage
Range	RmsAverage, Peak
Initial S/W Revision	A.14.00

Do Noise Correction

Example	CALC:FPOW:POW1:DEF "DoNoiseCorrection=True"
Notes	When noise correction is enabled, the linear noise power contributed by the analyzer is subtracted from all measurements. This effectively lowers the noise floor of the analyzer. When noise correction is enabled, the first measurement for a given set of input parameters will take extra time. This is because the analyzer takes an extra acquisition with the RF input disconnected from the analyzer's front end to measure the noise of just the analyzer. The measured noise floor is stored in a cache so the noise acquisition will occur only once for the same state settings. In other words, if noise correction was turned on and the analyzer made an acquisition at frequency A, then frequency B, and back again to frequency A, the hidden initial noise floor acquisition would only occur for the first acquisition at frequency A and the cached noise floor would be used the second time frequency A was measured.
Preset	False
Range	True (enable noise correction) or False (disable noise correction)
Default Unit	Boolean
Initial S/W Revision	A.14.00

Do Spur Suppression

Example	CALC:FPOW:POW1:DEF "DoSpurSuppression=True"
Notes	<p>When measuring very low level signals, or when large out-of-band inputs are input into the analyzer, sometimes unwanted spurs and residuals can appear in the measured spectrum. Spur suppression is a method to help minimize the levels of these internally generated spurs and residuals.</p> <p>When spur suppression is enabled, the analyzer will automatically take two acquisitions using two different internal analog LO frequencies. The FFT spectrums from both acquisitions are combined by taking the minimum power between both traces on a per FFT bin basis. External signals will have the same amplitude for both traces and therefore will return the expected amplitudes. However, low level spurs and residuals generated internally to the analyzer tend to move to different FFT bins depending on the internal analog LO frequency used, and therefore tend to be suppressed using this spur suppression method.</p> <p>Because two acquisitions, rather than a single acquisition, are made when spur suppression is enabled, the measurement time will always be slower when spur suppression is enabled.</p>
Preset	False
Range	True (enable spur suppression) or False (disable spur suppression)
Default Unit	Boolean
Initial S/W Revision	A.14.00

Electronic Attenuator Bypass

Example	CALC:FPOW:POW1:DEF "ElecAttBypass =False"
Notes	The electronic attenuation bypass parameter allows the user to either utilize or bypass the electronic attenuator. The electronic attenuator is only available for frequencies up to 3.6 GHz. Set parameter to true when using frequencies above 3.6 GHz and set the parameter to false when using the preamp.
Preset	True
Range	True (bypass electronic attenuator) or False (use electronic attenuator)
Default Unit	Boolean
Initial S/W Revision	A.14.00

Electronic Attenuation

Example	CALC:FPOW:POW1:DEF "ElecAttenuation=10"
Notes	<p>Option EA3 is required.</p> <p>The electronic attenuation value parameter sets the amount of electrical attenuation from 0 to 24 dB (1 dB steps).</p> <p>Set "ElecAttBypass=False" to make sure the electronic attenuator path is enabled.</p>
Preset	0 dB
Range	0 – 24 dB (1 dB steps)

Default Unit	dB
Initial S/W Revision	A.14.00

IF Gain

Example	CALC:FPOW:POW1:DEF "IFGain=10"
Notes	The IF gain parameter allows the user to specify the gain at the IF stage anywhere from -6 to 16 dB (1 dB steps). This is an advanced feature, and for most cases this should remain at its default value of 0 dB.
Preset	0 dB
Range	-6 - 16 dB (1 dB steps)
Default Unit	dB
Initial S/W Revision	A.14.00

IF Type

Example	CALC:FPOW:POW1:DEF "IFType=B25M"
Notes	The IF type parameter allows the user to select between different IF paths. For example, if the signal is less than 25 MHz wide, then the user can select the B25M path to take advantage of additional filtering on this analog IF path.
Preset	B40M
Range	B10M, B25M, B40M
Initial S/W Revision	A.14.00

Include Power Spectrum

Example	CALC:FPOW:POW1:DEF "IncludePowerSpectrum=True"
Notes	The power spectrum parameter allows the user to read data on the entire spectrum for diagnostic purposes. It is not recommended for production use. See CALC:FPOW:POW[n]:READ2? for details on the binary format of the response.
Preset	False
Range	True (return both channel power and full power spectrum) or False (returns only channel power)
Default Unit	Boolean
Initial S/W Revision	A.14.00

Mechanical Attenuation

Example	CALC:FPOW:POW1:DEF "MechAttenuation=10"
Notes	The mechanical attenuation value parameter sets the amount of mechanical attenuation anywhere from 0 to 70 dB (2 dB steps).
Preset	0 dB
Range	0 – 70 dB (2 dB steps)
Default Unit	dB
Initial S/W Revision	A.14.00

Preamp Mode

Example	CALC:FPOW:POW1:DEF "PreAmpMode=Low"
Notes	The license for the appropriate preamp is required. The preamp mode parameter specifies whether the preamps are being utilized. Low allows any preamps up to 3.6 GHz, and Full allows all licensed preamps. Set "ElecAttBypass=True" in order to utilize any preamps.
Preset	Off
Range	Off, Low, Full
Initial S/W Revision	A.14.00

Resolution Bandwidth Mode

Example	CALC:FPOW:POW1:DEF "PreAmpMode=Low"
Notes	The resolution bandwidth mode parameter allows the user to choose whether the RBW filter is automatically or manually set. The BestSpeed value minimizes measurement time, while the Narrowest value minimizes RBW size (minimum of two FFT bins per RBW). To manually specify an RBW, set this parameter to Explicit, and set the ResolutionBW parameter to the desired value.
Preset	BestSpeed
Range	BestSpeed, Narrowest, Explicit
Initial S/W Revision	A.14.00

Resolution Bandwidth

Example	CALC:FPOW:POW1:DEF "ResolutionBW=25e3"
Notes	The resolution bandwidth parameter sets the 3-dB bandwidth of the RBW filter. The ResolutionBWMode parameter must be set to Explicit in order to manually set the RBW.

Preset	0 Hz
Default Unit	Hz
Initial S/W Revision	A.14.00

Trigger Delay

Example	CALC:FPOW:POW1:DEF "TriggerDelay=0.025"
Notes	The trigger delay parameter sets the time after an external trigger is detected until the measurement is performed.
Preset	0 s
Range	0 – 1 s
Default Unit	Seconds
Initial S/W Revision	A.14.00

Trigger Level

Example	CALC:FPOW:POW1:DEF "TriggerLevel=2"
Notes	The trigger level parameter sets the voltage value at which an external trigger is detected.
Preset	1.2 V
Range	-5 to 5 V
Default Unit	Volts
Initial S/W Revision	A.14.00

Trigger Slope

Example	CALC:FPOW:POW1:DEF "TriggerSlope=Negative"
Notes	The trigger slope parameter indicates the direction of the edge trigger voltage for detection.
Preset	Positive
Range	Positive, Negative
Initial S/W Revision	A.14.00

Trigger Source

Example	CALC:FPOW:POW1:DEF "TriggerSource=Ext1"
Notes	The trigger source parameter allows the user to choose between measurement's triggering freely or controlled by an external input. Ext1 and Ext2 correspond to Trigger 1 In and Trigger 2 In, respectively.
Preset	Free
Range	Free, Ext1, Ext2
Initial S/W Revision	A.14.00

Trigger Timeout

Example	CALC:FPOW:POW1:DEF "TriggerTimeout=0.1"
Notes	The trigger timeout parameter sets the time in which the analyzer will wait for a trigger before automatically performing the measurement.
Preset	1 s
Range	0 - 1 s
Default Unit	Seconds
Initial S/W Revision	A.14.00

Signal Input

Example	CALC:FPOW:POW1:DEF "SignalInput=Fp50MHzCW"
Notes	The signal input parameter allows the user to select between using the main RF input or the internal analyzer reference CW signal of 50 MHz.
Preset	FpMainRf
Range	FpMainRf, Fp50MHzCW
Initial S/W Revision	A.14.00

Use Preselector

Example	CALC:FPOW:POW1:DEF "UsePreSelector=True"
Notes	The preselector parameter allows the user to either utilize or bypass the front end tunable filter at frequencies above 3.6 GHz. For frequencies below 3.6 GHz, the preselector is automatically bypassed, so you do not need to set this parameter to False in those cases.
Preset	False
Range	True (use preselector above 3.6 GHz), or False (preselector bypassed)

Default Unit	Boolean
Initial S/W Revision	A.14.00

Channel Bandwidth Array

Example	CALC:FPOW:POW1:DEF "Bandwidth=[3.84e6, 5e6, 3.84e6]"
Notes	The bandwidth parameter array defines the bandwidth of each channel that will be measured. All array parameters should have the same number of elements. Alternatively, if all the elements are the same value, a single number with no square brackets can be used to define the parameter.
Preset	[1 e6]
Range	0 to 40 MHz
Default Unit	Hz
Initial S/W Revision	A.14.00

Channel Filter Type Array

Example	CALC:FPOW:POW1:DEF "FilterType=[RRC, IBW, RRC]"
Notes	The filter type parameter allows the user to choose between an integration bandwidth (IBW) filter or a root-raised-cosine (RRC) filter. The integration bandwidth filter weighs all frequencies within the bandwidth equally. The root-raised-cosine filter has an associated shape parameter, defined by the FilterAlpha parameter. All array parameters should have the same number of elements. Alternatively, if all the elements are the same value, a single value with no square brackets can be used to define the parameter.
Preset	[IBW]
Range	IBW, RRC
Initial S/W Revision	A.14.00

Channel Filter Alpha Array

Example	CALC:FPOW:POW1:DEF "FilterAlpha=[0.5, 0.0, 0.5]"
Notes	The filter alpha parameter allows the user to adjust the alpha value associated with the root-raised-cosine (RRC) filter type. Set FilterType to RRC in order to utilize this parameter. All array parameters should have the same number of elements. Alternatively, if all the elements are the same value, a single number with no square brackets can be used to define the parameter.
Preset	[0.22]
Range	0.0 - 1.0

Initial S/W Revision	A.14.00
-------------------------	---------

Channel Measurement Function Array

Example	CALC:FPOW:POW1:DEF "Function=[BandPower, PeakPower, BandPower]"
Notes	<p>This parameter array defines what measurement is being made for each individually-specified channel:</p> <p>BandPower: Total power within the specified bandwidth of the channel (dBm)</p> <p>BandDensity: Total power density within the specified bandwidth of the channel (dBm/Hz)</p> <p>PeakPower: The peak power value within the specified bandwidth of the channel (dBm)</p> <p>PeakFrequency: The frequency which corresponds to the peak power value within the specified bandwidth of the channel. This frequency is relative to the center frequency (Hz)</p> <p>XdBBandwidth: The half power (-3.01 dB) bandwidth of the highest amplitude signal that resides within the channel (Hz), dB is configurable using XdBBandwidth parameter</p> <p>OccupiedBandwidth: The bandwidth at which 99% of the total power resides within the channel (Hz), percentage configurable using OccupiedBandwidthPercent parameter</p> <p>All array parameters should have the same number of elements. Alternatively, if all the elements are the same value, a single value with no square brackets can be used to define the parameter.</p>
Preset	[BandPower]
Range	BandPower, BandDensity, PeakPower, PeakFrequency, XdBBandwidth, OccupiedBandwidth
Initial S/W Revision	A.14.00

Channel Offset Frequency Array

Example	CALC:FPOW:POW1:DEF "OffsetFrequency=[-5e6, 0, 5e6]"
Notes	<p>The offset frequency parameter array defines the difference between the center frequency to the center frequency of each channel.</p> <p>All array parameters should have the same number of elements.</p>
Preset	[0]
Range	0 to 20 MHz
Default Unit	Hz
Initial S/W Revision	A.14.00

Channel Occupied Bandwidth Percent Array

Example	CALC:FPOW:POW1:DEF "OccupiedBandwidthPercent =[0.95, 0.95, 0.95]"
Notes	This parameter only applies for channels whose Function is set to OccupiedBandwidth. The occupied

	bandwidth percent parameter specifies the percent of total power in these channels. The valid range for this parameter is 0.0 to 1.0, where 1.0 represents 100%. The default for this parameter is 0.99, which will return the bandwidth that contains 99% of the total channel power.
Preset	[0.99]
Range	0 – 1.0
Initial S/W Revision	A.14.00

Channel x-dB Bandwidth Array

Example	CALC:FPOW:POW1:DEF " XdBBandwidth =[-6.02, -3.01, -1.0]"
Notes	This parameter only applies for channels whose Function is set to XdBBandwidth. The X dB bandwidth parameter is used to specify the power relative to the peak channel power over which the bandwidth is calculated. The parameter value must be a negative number.
Preset	[-3.01]
Range	-200 to 0 dB
Default Unit	dB
Initial S/W Revision	A.14.00

Define Fast Power Measurement Query (Remote Command Only)

The DEFine? command is used to retrieve a list of all defined parameters in an ASCII string format

```

M All
o
d
e
R :CALCulate:FPOWER:POWer[1,2,...,999]:DEFine?
e
m
o
t
e
C
o
m
m
a
n
d
E :CALC:FPOW:POW1:DEF?

```

```
x
a
m
p
l
e
-----
N This command query is used to retrieve a list of all defined parameters in an ASCII format.
o The following is an example of the returned results:
t "DCCoupled=False,ElecAttBypass=True,ElecAttenuation=0,IFGain=0,MechAttenuation=0,PreAmpMode=Off,PreSelectorOffset
e =0,UsePreSelector=False,ExternalReferenceFrequency=10000000,FrequencyReferenceSource=AutoExternalFrequencyRefer
s ence,IFType=B40M,LOMode=SLW,SignalInput=FpMainRf,AcquisitionTime=0.001,CenterFrequency=1000000000,Resolution
BW=0,ResolutionBWMode=BestSpeed,DetectorType=RmsAverage,Bandwidth=[1000000],OffsetFrequency=[0],Function=
[BandPower],FilterType=[IBW],FilterAlpha=[0.22],OccupiedBandwidthPercent=[0.99],XdBBandwidth=[-
3.01],DoNoiseCorrection=False,DoSpurSuppression=False,MeasurementMethod=HardwareFFT,IncludePowerSpectrum=False,
e,TriggerDelay=0,TriggerLevel=1.2,TriggerSlope=Positive,TriggerSource=Free,TriggerTimeout=1"
-----
I A.14.00
n
i
t
i
a
l

S
/
W

R
e
v
i
s
i
o
n
-----
```

Configure Fast Power Measurement (Remote Command Only)

The configure command begins hardware setup and returns immediately, with no acquisition made. This can be used in parallel with other hardware operations to effectively hide the hardware setup time.

Mode	All
Remote Command	:CALCulate:FPOWER:POWER[1,2,...,999]:CONFigure
Example	:CALC:FPOW:POW1:CONF
Notes	Option FP2 is required.
Initial S/W Revision	A.14.00

Initiate Fast Power Measurement (Remote Command Only)

The INITiate command begins an acquisition and returns immediately. The results of the measurement can be retrieved using FETCh.

Mode	All
Remote Command	:CALCulate:FPOWER:POWer[1,2,...,999]:INITiate
Example	:CALC:FPOW:POW1:INIT
Notes	Option FP2 is required.
Initial S/W Revision	A.14.00

Fetch Fast Power Measurement (Remote Command Only)

The FETCh command query is used to retrieve the results of an acquisition initiated by the INIT command. The returned results are in ASCII string format. The string begins and ends with quotation marks.

Mode	All
Remote Command	:CALCulate:FPOWER:POWer[1,2,...,999]:FETCh?
Example	:CALC:FPOW:POW1:FETC?
Notes	Option FP2 is required. Returns m comma-separated ASCII values, where m corresponds to the number of bandwidths defined. 1. Declared function return in the 1st specified channel 2. Declared function return in the 2nd specified channel ... m. Declared function return in the last specified channel The INIT and FETC? command sequence performs the same functionality of a single CALC:FPOW:POW[n]? query. Units of the returned values are dependent on the Function parameter for each channel.
Initial S/W Revision	A.14.00

Execute Fast Power Measurement (Remote Command Only)

This command query is used as shorthand for an INIT command immediately followed by a FETC? command. The returned results are in ASCII string format. The string begins and ends with quotation marks.

Mode	All
Remote Command	:CALCulate:FPOWER:POWer[1,2,...,999]?
Example	:CALC:FPOW:POW1?

Notes	Option FP2 is required. See notes for Fast Power Fetch for return format.
Initial S/W Revision	A.14.00

Binary Read Fast Power Measurement (Remote Command Only)

This command query is used as shorthand for an INIT command immediately followed by a FETC? command. The returned results are in a binary format.

Mode	All
Remote Command	:CALCulate:FPOWER:POWER[1,2,...,999]:READ? :CALCulate:FPOWER:POWER[1,2,...,999]:READ1?
Example	:CALC:FPOW:POW1:READ? :CALC:FPOW:POW1:READ1?
Notes	Option FP2 is required. Returns m 4 byte floating point binary values (Little-Endian), where m corresponds to the number of bandwidths defined.
Initial S/W Revision	A.14.00

Diagnostic Binary Read Fast Power Measurement (Remote Command Only)

This command query is used as shorthand for an INIT command immediately followed by a FETC? command. The returned results are in a binary format. This command is used primarily for diagnostic purposes to test for ADC overloads and to visibly inspect the spectrum.

Mode	All
Remote Command	:CALCulate:FPOWER:POWER[1,2,...,999]:READ2?
Example	:CALC:FPOW:POW1:READ2?
Notes	Option FP2 is required. Note: Spectrum data is only returned if the IncludePowerSpectrum parameter is set to True. If IncludePowerSpectrum is False, the number of spectrum points will be zero (0). Units of the returned values are dependent on the Function parameter per channel (e.g. dBm for BandPower, Hz for PeakFrequency). Returns binary data (Little-Endian) that contains information on m amount of channels, along with ADC over range and full spectrum data. The following is the binary format of the response. Bandwidth Return Value 1. Number of channels specified, m [4 byte int] 2. Declared function result for the 1st specified channel [4 byte float]

	3. Declared function result for the 2nd specified channel [4 byte float]
	...
	(m + 1). Declared function result for the last (mth) specified channel [4 byte float]
	ADC Over Range
	1. ADC over-range occurred (1: true, 0: false) [2 byte short]
	Spectrum Data
	1. Number of points in the spectrum data, k [4 byte int]
	2. Start frequency of spectrum data (Hz) [8 byte double]
	3. Step frequency of spectrum data (Hz) [8 byte double]
	4. FFT bin at 1st point (dBm) [4 byte float]
	5. FFT bin at 2nd point (dBm) [4 byte float]
	...
	(k + 3). FFT bin at last (kth) point (dBm) [4 byte float]

Initial S/W Revision	A.14.00
-------------------------	---------

Format Data: Numeric Data (Remote Command Only)

This command specifies the format of the trace data input and output. It specifies the formats used for trace data during data transfer across any remote port. It affects only the data format for setting and querying trace data for the :TRACe[:DATA], TRACe[:DATA]?, :CALCulate:DATA[n]? and FETCh:SANalyzer [n]? commands and queries.

Remote Command	:FORMat[:TRACe][:DATA] ASCii INTEger,32 REAL,32 REAL,64 :FORMat[:TRACe][:DATA]?
Notes	The query response is: ASCii: ASC,8 REAL,32: REAL,32 REAL,64: REAL,64 INTEger,32: INT,32 When the numeric data format is REAL or ASCii, data is output in the current Y Axis unit. When the data format is INTEger, data is output in units of m dBm (.001 dBm). The INT,32 format returns binary 32-bit integer values in internal units (m dBm), in a definite length block.
Dependencies	Sending a data format spec with an invalid number (for example, INT,48) generates no error. The analyzer simply uses the default (8 for ASCii, 32 for INTEger, 32 for REAL). Sending data to the analyzer which does not conform to the current FORMat specified, results in an error. Sending ASCII data when a definite block is expected generates message -161 "Invalid Block Data" and sending a definite block when ASCII data is expected generates message -121 "Invalid Character in Number".
Preset	ASCii
Backwards Compatibility	Note that the INT,32 format is only applicable to the command, TRACe:DATA. This preserves

Notes	backwards compatibility for the Swept SA measurement. For all other commands/queries which honor FORMat:DATA, if INT,32 is sent the analyzer will behave as though it were set to REAL,32.
Initial S/W Revision	Prior to A.02.00

The specs for each output type follow:

ASCIi - Amplitude values are in ASCII, in the current Y Axis Unit, one ASCII character per digit, values separated by commas, each value in the form:

SX.YYYYYEsZZ

Where:

S = sign (+ or -)

X = one digit to left of decimal point

Y = 5 digits to right of decimal point

E = E, exponent header

s = sign of exponent (+ or -)

ZZ = two digit exponent

REAL,32 - Binary 32-bit real values in the current Y Axis Unit, in a definite length block.

REAL,64 - Binary 64-bit real values in the current Y Axis Unit, in a definite length block.

Format Data: Byte Order (Remote Command Only)

This command selects the binary data byte order for data transfer and other queries. It controls whether binary data is transferred in normal or swapped mode. This command affects only the byte order for setting and querying trace data for the :TRACe[:DATA], TRACe[:DATA]? , :CALCulate:DATA[n]? and FETCh:SANalyzer[n]? commands and queries.

By definition any command that says it uses FORMat:DATA uses any format supported by FORMat:DATA.

The NORMal order is a byte sequence that begins with the most significant byte (MSB) first, and ends with the least significant byte (LSB) last in the sequence: 1|2|3|4. SWAPped order is when the byte sequence begins with the LSB first, and ends with the MSB last in the sequence: 4|3|2|1.

Remote Command	:FORMat:BORDer NORMal SWAPped :FORMat:BORDer?
Preset	NORMal
Initial S/W Revision	Prior to A.02.00

Meas Setup

Displays the setup menu for the currently selected measurement.

Key Path	Front-panel key
Initial S/W Revision	Prior to A.02.00

Avg/Hold Num

Toggles averaging On or Off in addition to enabling you to set the number of measurement averages used to calculate the measurement result. The average is displayed at the end of each sweep. After the specified number of average counts, the average mode (termination control) setting determines the average action.

In the remote mode, use the Average State command to turn averaging on or off.

Key Path	Meas Setup
Mode	SA, WCDMA, C2K, WIMAX OFDMA, TD-SCDMA, 1xEVDO, DTMB (CTTB), DVB-T/H, ISDB-T, CMMB, LTE, LTE-TDD, Digital Cable TV, WLAN, MSR, LTEAFDD, LTEATDD
Remote Command	[:SENSe]:SEMask:AVERage:COUNT <integer> [:SENSe]:SEMask:AVERage:COUNT? [:SENSe]:SEMask:AVERage[:STATe] ON OFF 1 0 [:SENSe]:SEMask:AVERage[:STATe]?
Example	SEM:AVER:COUN 100 SEM:AVER:COUN? SEM:AVER ON SEM:AVER?
Notes	You must be in the mode that includes SEM measurement to use this command. Use :INSTrument:SElect to set the mode.
Preset	10 OFF
State Saved	Saved in instrument state.
Min	1
Max	10000
Initial S/W Revision	Prior to A.02.00
Modified at S/W Revision	A.02.00, A.03.00

Meas Type

Accesses a menu that enables you to select one of the following measurement reference types:

- Total Pwr Ref – Sets the reference to the total carrier power and the measured data is shown in dBc and dBm.
- PSD Ref – Sets the reference to the mean power spectral density of the carrier and the measured data is shown in dB and dBm/Hz.
- Spectrum Peak Ref – Sets the reference to the spectrum peak power of the carrier and the measured data is shown in dB and dBm.

Key Path	Meas Setup
Mode	SA, WCDMA, C2K, WIMAX OFDMA, TD-SCDMA, 1xEVDO, DTMB (CTTB), DVB-T/H, ISDB-T, CMMB, LTE, LTETDD, Digital Cable TV, WLAN, MSR, LTEAFDD, LTEATDD
Remote Command	[:SENSe] :SEMAsk:TYPE PSDRef TPreRef SPRef [:SENSe] :SEMAsk:TYPE?
Example	SEM:TYPE PSDR SEM:TYPE?
Notes	You must be in the mode that includes SEM measurement to use this command. Use :INSTRument:SElect to set the mode.
Preset	SA, WCDMA, C2K, TD-SCDMA, 1xEVDO, DTMB (CTTB), DVB-T/H, ISDB-T, CMMB, LTE, LTETDD, Digital Cable TV, MSR, LTEAFDD, LTEATDD: TPreRef WIMAX OFDMA, WLAN: SPRef
State Saved	Saved in instrument state.
Range	Total Pwr Ref PSD Ref Spectrum Peak Ref
Initial S/W Revision	Prior to A.02.00
Modified at S/W Revision	A.02.00, A.03.00

Ref Channel

Accesses a menu that enables you to set up the measurement parameters used to calculate the power in the reference channel.

Key Path	Meas Setup
Initial S/W Revision	Prior to A.02.00

Sweep Time

Sets the sweep time used to calculate the power in the reference channel. Sweep Time can be set manually or put in auto mode.

Key Path	Meas Setup, Ref Channel
Mode	SA, WCDMA, C2K, WIMAX OFDMA, TD-SCDMA, 1xEVDO, DTMB (CTTB), DVB-T/H, ISDB-T, CMMB, LTE, LTETDD, Digital Cable TV, WLAN, MSR, LTEAFDD, LTEATDD
Remote Command	[:SENSe] :SEMAsk:SWEep [1] 2:TIME <time>

	[:SENSe]:SEMask:SWEep[1] 2:TIME?
	[:SENSe]:SEMask:SWEep[1] 2:TIME:AUTO OFF 0 ON 1
	[:SENSe]:SEMask:SWEep[1] 2:TIME:AUTO?
Example	SEM:SWE:TIME 9ms SEM:SWE:TIME? SEM:SWE:TIME:AUTO OFF SEM:SWE:TIME:AUTO?
Notes	Sub op code, 1 is for BTS, 2 for MS. Default is BTS. Note that Sweep sub op code 2 is supported only in Non-SA modes. In the SA mode, Sweep sub op code 1 is used for both BTS and MS. You must be in the mode that includes SEM measurement to use this command. Use :INSTrument:SElect to set the mode.
Couplings	When the time is set manually, Auto is set to OFF. Value is coupled with Channel Detector selection, Channel Resolution BW, Channel Video BW if the state is Auto. When set to Auto, the sweep Time is automatically calculated.
Preset	Automatically calculated ON
State Saved	Saved in instrument state.
Min	X-Series HW: Depends on Channel Sweep Type Sweep Type "Swept": 1ms Sweep Type "FFT": 100ns E6630A_E6640A_M90XA:TBD E7515A: 39.2 usec
Max	4000 s
Initial S/W Revision	Prior to A.02.00
Modified at S/W Revision	A.02.00, A.03.00, A.16.00

Sweep Type

Chooses between the FFT and Sweep types of sweep.

Sweep Type refers to whether or not the instrument is in Swept or FFT analysis. When in Auto, the selection of sweep type is governed by two different sets of rules, depending on whether you want to optimize for dynamic range or for speed.

FFT "sweeps" should not be used when making EMI measurements; therefore, when a CISPR detector (Quasi Peak, EMI Average, RMS Average) is selected for any active trace (one for which Update is on), the

FFT key in the Sweep Type menu is grayed out, and the Auto Rules only choose Swept. If Sweep Type is manually selected to be FFT, the CISPR detectors are all grayed out.

FFT sweeps will never be auto-selected when Screen Video, Log Video or Linear Video are the selected Analog Output.

Key Path	Sweep/Control, Sweep Setup
Remote Command	<code>[:SENSe] :SWEep:TYPE FFT SWEep</code> <code>[:SENSe] :SWEep:TYPE?</code>
Dependencies	In Zero Span, this key is irrelevant and cannot be accessed (because the whole Sweep Setup menu is grayed out in Zero Span), however its settings can be changed remotely with no error indication. When Gate is on, Gate Method selection affects Sweep Type: Method FFT&Sweep menu FFT - Swept grayed out and rules choose FFT Video - FFT grayed out and rules choose Swept LO - FFT grayed out and rules choose Swept
Preset	AUTO
Backwards Compatibility SCPI	<code>[:SENSe] :SWEep:TYPE AUTO</code> sets sweep type Auto to On but the query will return either FFT or SWE depending on the auto setting. <code>[:SENSe] :SWEep:TYPE SWP</code> selects sweep type Swept but will return SWE on a query
Initial S/W Revision	Prior to A.02.00

Auto

When in Auto, the selection of sweep type is governed by two different sets of rules, depending on whether you want to optimize for dynamic range or for speed. These rules are chosen under the **Sweep Type Rules** key.

Key Path	Sweep/Control, Sweep Setup, Sweep Type
Remote Command	<code>[:SENSe] :SWEep:TYPE:AUTO OFF ON 0 1</code> <code>[:SENSe] :SWEep:TYPE:AUTO?</code>
Example	<code>:SWE:TYPE:AUTO ON</code>
Couplings	Pressing Auto Couple always sets Sweep Type to Auto. Swept is always chosen whenever any form of Signal ID is on, or the Source Mode is set to Tracking, or any EMI detector is selected, or the RF Preselector is ON.
Preset	ON
State Saved	Saved in instrument state
Initial S/W Revision	Prior to A.02.00

Swept

Manually selects swept analysis, so it cannot change automatically to FFT.

Key Path	Sweep/Control, Sweep Setup, Sweep Type
Example	SWE:TYPE SWE
Dependencies	Grayed out while in Gated FFT (meaning Gate is ON and Gate Method is FFT). If this key is selected, the gate method Gated FFT is grayed out.
Couplings	This selection is chosen automatically if any of the CISPR detectors is chosen for any active trace, in which case the FFT Sweep Type selection is also grayed out.
State Saved	Saved in instrument state
Readback	Swept
Initial S/W Revision	Prior to A.02.00
Modified at S/W Revision	A.02.00

FFT

Manually selects FFT analysis, so it cannot change automatically to Swept.

Key Path	Sweep/Control, Sweep Setup, Sweep Type
Example	SWE:TYPE FFT
Dependencies	When a CISPR detector (Quasi Peak, EMI Average, RMS Average) is selected for any active trace, the FFT key is grayed out. When the RF Preselector is on, the FFT key is grayed out. When Source Mode is set to Tracking, Manual FFT is grayed out. When Signal ID is on, Manual FFT is grayed out. Grayed out while in Gated LO (meaning Gate is ON and Gate Method is LO). Grayed out while in Gated Video (meaning Gate is ON and Gate Method is Video).
State Saved	Saved in instrument state
Readback	FFT
Initial S/W Revision	Prior to A.02.00

Power Ref (Only for MSR and LTE-Advanced FDD/TDD)

Selects the power reference type.

- Left & Right Carriers – Powers of leftmost and rightmost carriers with Measure Carrier On in a sub-block are the references of left and right sides respectively. Only the frequency ranges of leftmost and rightmost carriers are swept and measured, and other frequency ranges in the RFBW are not measured. Left and right carriers are determined based on the carrier center frequencies. If Measure Carriers of all the carriers in a sub-block are off, the reference power in a sub-block and all the relative power results are NaN. Relative limits are not evaluated.

- Max Power Carrier – Maximum carrier power is the reference of measurement. All the configured carriers are measured. If Measure Carriers of all the carriers are off, the reference power and all the relative power results are NaN. Relative limits are not evaluated.
- Carrier Index – Power of the specified carrier is the reference of measurement. Only the frequency range of the specified carrier is swept and measured, and other frequency ranges in the RFBW are not measured. If Measure Carriers of this carrier index is off, the reference power and all the relative power results are NaN. Relative limits are not evaluated.
- Manual – Power or PSD specified by the user is the reference of measurement. No carriers are measured and the manually specified value is used as reference.
- Max Power Carrier in Sub-block – Maximum carrier power among the sub-block carriers with Measure Carrier On is the reference of measurement. All the configured carriers are measured. If Measure Carriers of all the carriers in a sub-block are off, the reference power of the sub-block and all the relative power results referring to this sub-block are NaN, and these relative limits are not evaluated.
- RF Bandwidth – Power or PSD of total of the RF bandwidth is the reference of measurement. Power not only in the carrier bands but also carrier gaps is integrated into the reference power. Measure Carrier On/Off doesn't affect this selection because RF bandwidth is determined by the carrier configuration.

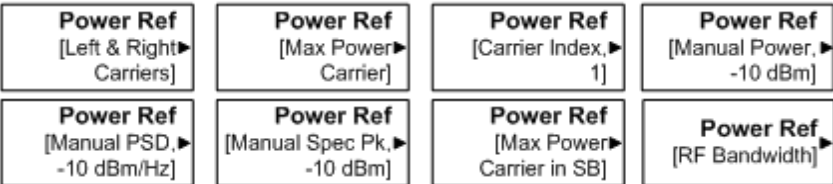
Key Path	Meas Setup, Ref Channel
Mode	MSR, LTEAFDD, LTEATDD
Remote Command	[:SENSe] :SEMAsk :CARRier :PREFereNce :TYPE LRCarriers MPCarrier CINDEX MANual MPCSubblock RFBandwidth [:SENSe] :SEMAsk :CARRier :PREFereNce :TYPE?
Example	SEM:CARR:PREF:TYPE CIND SEM:CARR:PREF:TYPE?
Notes	You must be in the MSR and LTE-Advanced FDD/TDD mode to use this command. Use :INSTrument:SELEct to set the mode. E7515A does not support the MSR mode.
Preset	MPCarrier
State Saved	Saved in instrument state
Range	Left & Right Carriers Max Power Carriers Carrier Index Manual Max Power Carrier in Sub-block RF Bandwidth
Readback	Indirect readback as below: 
Initial S/W Revision	A.10.00

Carrier Index (Only for MSR and LTE-Advanced FDD/TDD)

Sets carrier index of the reference power. The power of the carrier selected by this index becomes reference power when Power Ref is Carrier Index.

Key Path	Meas Setup, Ref Channel, Power Ref
Mode	MSR, LTEAFDD, LTEATDD
Remote Command	[:SENSe] :SEMAsk :CARRier :INDex <integer> [:SENSe] :SEMAsk :CARRier :INDex?
Example	SEM:CARR:IND 1 SEM:CARR:IND?
Notes	You must be in the MSR and LTE-Advanced FDD/TDDmode to use this command. Use :INSTrument:SElect to set the mode.
Preset	1
State Saved	Saved in instrument state
Min	1
Max	MSR:100 LTEAFDD,LTEATDD:5
Initial S/W Revision	A.10.00

Manual (Only for MSR and LTE-Advanced FDD/TDD)

Accesses a menu that sets the manual reference power that is used to compute the relative values for the offsets.

Key Path	Meas Setup, Power Ref
Initial S/W Revision	A.10.00

Total Power

Sets manual total power reference. This is used when Power Ref is Manual and Meas Type is Total Power.

See **Total Power** for more information.

Key Path	Meas Setup, Ref Channel, Power Ref, Manual
Initial S/W Revision	A.10.00

PSD

Sets manual PSD reference. This is used when Power Ref is Manual and Meas Type is PSD.

See **PSD** for more information.

Key Path	Meas Setup, Ref Channel, Power Ref, Manual
Initial S/W Revision	A.10.00

Spectrum Peak

Sets manual Spectrum Peak reference. This is used when Power Ref is Manual and Meas Type is Spectrum Peak.

See [Spectrum Peak](#) for more information.

Key Path	Meas Setup, Ref Channel, Power Ref, Manual
Initial S/W Revision	A.10.00

Res BW

Sets the resolution bandwidth used to calculate the power in the reference channel. The Channel Resolution BW can be set manually or put in to auto mode.

MSR Auto RBW:

In the MSR resolution bandwidth is predefined for each radio format. When carriers are configured with multiple radio formats, the narrowest RBW is selected.

LTE	1.4 MHz	13
	3 MHz	27
	5 MHz	47
	10 MHz	91
	15 MHz	150
	20 MHz	180
W-CDMA		75
GSM		30

In LTE-Advanced FDD/TDD, the resolution bandwidth is predefined based on the corresponding bandwidth of the single LTE carrier, which is listed above. When ResBW mode is Auto, the narrowest RBW is selected.

Key Path	Meas Setup, Ref Channel
Mode	SA, WCDMA, C2K, WIMAX OFDMA, TD-SCDMA, 1xEVDO, DTMB (CTTB), DVB-T/H, ISDB-T, CMMB, LTE, LTETDD, Digital Cable TV, WLAN, MSR, LTEAFDD, LTEATDD
Remote Command	[[:SENSe]:SEMask:BANDwidth[1] 2[:RESolution] <bandwidth> [:SENSe]:SEMask:BANDwidth[1] 2[:RESolution]? [:SENSe]:SEMask:BANDwidth[1] 2[:RESolution]:AUTO OFF ON 1 0

	<code>[:SENSe] :SEMask :BANDwidth [1] 2 [:RESolution] :AUTO?</code>
Example	SEM:BAND 100 kHz SEM:BAND? SEM:BAND:AUTO ON SEM:BAND:AUTO?
Notes	Bandwidth sub op code, 1 is for BTS, 2 for MS. Default is BTS. Note that Bandwidth sub op code 2 is supported only in Non-SA modes. In the SA mode, Bandwidth sub op code 1 is used for both BTS and MS. You must be in the mode that includes SEM measurement to use this command. Use :INSTrument:SElect to set the mode.
Couplings	When Res BW is set manually, Channel Resolution BW Mode is set to MANual. Value is coupled with Channel Detector selection, Channel sweep Time, Channel Video BW. When set to Auto, the resolution bandwidth is automatically calculated.
Preset	SA: 100 kHz WCDMA: 75 kHz C2K: 24 kHz WIMAX OFDMA: 100 kHz TD-SCDMA: 30 kHz 1xEVDO: 30.0 KHz DTMB (CTTB): 3.9 kHz DVB-T/H: 3.9 kHz ISDB-T: 10 kHz CMMB: 3.9 kHz LTE, LTEFDD, MSR, LTEAFDD, LTEATDD:Auto (47 kHz) Digital Cable TV: 3.9 kHz WLAN: 100 kHz ON
State Saved	Saved in instrument state.
Min	1 Hz
Max	8 MHz
Backwards Compatibility SCPI	<code>[:SENSe] :SEMask :BWIDth [1] 2 [:RESolution]</code>
Initial S/W Revision	Prior to A.02.00
Modified at S/W Revision	A.02.00, A.03.00

Video BW

Sets the video bandwidth used to calculate the power in the reference channel. The Channel Video BW can be set manually or put in to auto mode.

Key Path	Meas Setup, Ref Channel
Mode	SA, WCDMA, C2K, WIMAX OFDMA, TD-SCDMA, 1xEVDO, DTMB (CTTB), DVB-T/H, ISDB-T, CMMB, LTE, LTETDD, Digital Cable TV, WLAN, MSR, LTEAFDD, LTEATDD
Remote Command	[:SENSe]:SEMAsk:BANDwidth[1] 2:VIDeo <bandwidth> [:SENSe]:SEMAsk:BANDwidth[1] 2:VIDeo? [:SENSe]:SEMAsk:BANDwidth[1] 2:VIDeo:AUTO OFF ON 1 0 [:SENSe]:SEMAsk:BANDwidth[1] 2:VIDeo:AUTO?
Example	SEM:BAND:VID 100 kHz SEM:BAND:VID? SEM:BAND:VID:AUTO ON SEM:BAND:VID:AUTO?
Notes	Bandwidth sub op code, 1 is for BTS, 2 for MS. Default is BTS. Note that Bandwidth sub op code 2 is supported only in Non-SA modes. In the SA mode, Bandwidth sub op code 1 is used for both BTS and MS. You must be in the mode that includes SEM measurement to use this command. Use :INSTrument:SElect to set the mode.
Couplings	When Video BW is set manually, Channel Video BW Mode is set to MANUAL Value is coupled with Channel Detector selection, Channel Sweep Time, Channel Resolution BW. When set to Auto, the video bandwidth is automatically calculated.
Preset	SA: 100 kHz WCDMA: 75 kHz C2K: 24 kHz WIMAX OFDMA: 30 kHz TD-SCDMA: 300 kHz 1xEVDO: 300.0 kHz DTMB (CTTB): 39 kHz DVB-T/H: 39 kHz ISDB-T: 1 kHz CMMB: 39 kHz LTE, MSR, LTEAFDD, LTEATDD: Auto LTETDD: Auto Digital Cable TV: 39 kHz WLAN: Auto ON
State Saved	Saved in instrument state.
Min	1 Hz
Max	50 MHz
Backwards Compatibility SCPI	[:SENSe]:SEMAsk:BWIDth[1] 2:VIDeo
Initial S/W Revision	Prior to A.02.00
Modified at S/W Revision	A.02.00, A.03.00

VBW/RBW

Sets the Video BW/Resolution BW Ratio to calculate the Channel Resolution BW and Channel Video BW. The VBW/RBW Ratio can be set manually or put in to auto mode.

Key Path	Meas Setup, Ref Channel
Mode	SA, WCDMA, C2K, WIMAX OFDMA, TD-SCDMA mode, 1xEVDO, DTMB (CTTB), DVB-T/H, ISDB-T, CMMB, LTE, LTETDD, Digital Cable TV, WLAN, MSR, LTEAFDD, LTEATDD
Remote Command	[:SENSe]:SEMask:BANDwidth[1] 2:VIDeo:RATio <real> [:SENSe]:SEMask:BANDwidth[1] 2:VIDeo:RATio [:SENSe]:SEMask:BANDwidth[1] 2:VIDeo:RATio:AUTO OFF ON 1 0 [:SENSe]:SEMask:BANDwidth[1] 2:VIDeo:RATio:AUTO?
Example	SEM:BAND:VID:RAT 0.1 SEM:BAND:VID:RAT? SEM:BAND:VID:RAT:AUTO ON SEM:BAND:VID:RAT:AUTO?
Notes	Bandwidth sub op code, 1 is for BTS, 2 for MS. Default is BTS. Note that Bandwidth sub op code 2 is supported only in Non-SA modes. In the SA mode, Bandwidth sub op code 1 is used for both BTS and MS. You must be in the mode that includes SEM measurement to use this command. Use :INSTRument:SElect to set the mode.
Couplings	When Video BW/Res BW is set manually, Channel VBW/RBW Ratio Mode is set to MANual When set to Auto, the VBW/RBW Ratio is automatically calculated.
Preset	SA, WCDMA, C2K: 1.0 WIMAX OFDMA: 0.3 TD-SCDMA: 10 1xEVDO: 10.0 DTMB (CTTB): 10 DVB-T/H: 10 ISDB-T: 0.1 CMMB: 10 LTE, MSR: Auto LTEAFDD,LTEATDD:Auto LTETDD: Auto Digital Cable TV: 10 WLAN: Auto ON
State Saved	Saved in instrument state.
Min	0.00001
Max	3000000

Backwards Compatibility SCPI	<code>[:SENSe] :SEMAsk:BWIDth [1] 2 :VIDeo:RATio</code>
Initial S/W Revision	Prior to A.02.00
Modified at S/W Revision	A.02.00, A.03.00

Offset/Limits

Accesses a menu that enables you to set up the measurement parameters for offset pairs. For example, you can assign the start and stop frequencies, select the resolution bandwidth, and set the sweep time. When in the MSR and LTE-Advanced FDD/TDD mode, the softkey label changes to Outer Offset/Limits.

Key Path	Meas Setup
Initial S/W Revision	Prior to A.02.00
Modified at S/W Revision	A.14.00

Select Offset

Selects the offset (upper and lower) and displays the memory selection menu that enables you to store a set of parameter values for the offset, such as Start Freq, Stop Freq, sweep Time, Res BW, Meas BW, Abs Start, and Abs Stop. Only one selection at a time is shown on this menu key label.

Key Path	Meas Setup, Offset/Limits
Mode	SA, WCDMA, C2K, WIMAX OFDMA, TD-SCDMA, 1xEVDO, DTMB (CTTB), DVB-T/H, ISDB-T, CMMB, LTE, LTE-TDD, Digital Cable TV, WLAN, MSR, LTEAFDD, LTEATDD
Preset	A
Range	MSR, LTEATDD, LTEAFDD, WLAN: A B C D E F G H J K L Other modes without option N9060A-7FP: A B C D E F Other modes with option N9060A-7FP: A B C D E F G H J K L
Initial S/W Revision	Prior to A.02.00
Modified at S/W Revision	A.02.00, A.03.00, A.10.00, A.11.00, A.14.00

Start Freq

Specifies the start frequency for the currently selected offset. Also enables you to toggle that offset between On and Off.

Missing values are not permitted; that is, if you want to change values 2 and 6, you must send all values up to 6. Subsequent values will remain as they were. The query for this parameter always returns 12 values.

Key Path	Meas Setup, Offset/Limits
Mode	SA, WCDMA, C2K, WIMAX OFDMA, TD-SCDMA, 1xEVDO, DTMB (CTTB), DVB-T/H, ISDB-T, CMMB,

	LTE, LTE-TDD, Digital Cable TV, WLAN, MSR, LTE-AFDD, LTE-TDD
Remote Command	<pre>[:SENSe]:SEMask:OFFSet[1] 2[:OUTer]:LIST:FREQuency:STARt <freq>, ... [:SENSe]:SEMask:OFFSet[1] 2[:OUTer]:LIST:FREQuency:STARt? [:SENSe]:SEMask:OFFSet[1] 2[:OUTer]:LIST:STATe ON OFF 1 0, ... [:SENSe]:SEMask:OFFSet[1] 2[:OUTer]:LIST:STATe?</pre>
Example	<pre>SEM:OFFS2:LIST:FREQ:STAR 2.515 MHz, 2.715 MHz, 3.515 MHz, 4.00 MHz, 8.00 MHz, 12.50 MHz SEM:OFFS2:LIST:FREQ:STAR? SEM:OFFS:LIST:STAT ON, ON, ON, OFF, OFF, OFF SEM:OFFS:LIST:STAT?</pre>
Notes	<p>Comma separated list of values. OFFSet1 is for BTS, 2 for MS. Default is BTS. Note that Offset sub op code 2 is supported only in Non-SA modes. In the SA mode, Offset sub op code 1 is used for both BTS and MS. If the offset is outside of the frequency range, the result spectrum will be invalid. You must be in the mode that includes SEM measurement to use this command. Use :INSTrument:SElect to set the mode.</p>
Couplings	<p>Coupled to Stop Freq. When the start freq goes above the stop freq, the stop freq is automatically adjusted to the start freq plus 100 Hz. If the current mode is DVB-T/H, this value will be modified automatically according to the limit type and the output power of the transmitter which is less or more than 25 W. If the current mode is ISDB-T, this value will be modified automatically according to the limit type.</p>
Preset	<p>For modes (except MSR, LTE-AFDD, LTE-TDD and WLAN) without option N9060A-7FP, the preset value is as follows.</p> <p>SA: 2.515 MHz, 2.715 MHz, 3.515 MHz, 4.00 MHz, 8.00 MHz, 12.50 MHz WCDMA: 2.515 MHz, 2.715 MHz, 3.515 MHz, 4.000 MHz, 8.000 MHz, 12.50 MHz 2.515MHz, 4.000 MHz, 7.500 MHz, 8.500 MHz, 12.5 MHz, 15 MHz C2K: 750.0 kHz, 780.0 kHz, 1.980 MHz, 3.25 MHz, 7.0 MHz, 7.0 MHz 885 kHz, 1.980 MHz, 2.250 MHz, 8.0 MHz, 12.0 MHz, 12.0 MHz WIMAX OFDMA: 4.75 MHz, 5.45 MHz, 9.75 MHz, 14.75 MHz, 19.75 MHz, 24.75 MHz 4.75 MHz, 5.45 MHz, 9.75 MHz, 14.75 MHz, 19.75 MHz, 24.75 MHz TD-SCDMA: 81 5kHz, 1015 kHz, 1815 kHz, 2.3 MHz, 2.3 MHz, 2.3 MHz, 815 kHz, 1.8 MHz, 2.9 MHz, 2.9 MHz, 2.9 MHz, 2.9 MHz 1xEVDO: 750.0 kHz, 780.0 kHz, 1.98 MHz, 3.25 MHz, 7 MHz, 7 MHz 885.0 kHz, 1.98 MHz, 1.98 MHz, 1.98 MHz, 1.98 MHz, 1.98 MHz DTMB (CTTB): 3.8 MHz, 4.2 MHz, 6 MHz, 6 MHz, 6 MHz, 6 MHz 6MHz, 6MHz, 6MHz, 6MHz, 6MHz, 6MHz DVB-T/H: 3.81 MHz, 4.2 MHz, 6 MHz, 6 MHz, 6 MHz, 6 MHz 6MHz, 6MHz, 6MHz, 6MHz, 6MHz, 6MHz ISDB-T: 2.79 MHz, 2.86 MHz, 3.0 MHz, 4.36 MHz, 6 MHz, 6 MHz 6MHz, 6MHz, 6MHz, 6MHz, 6MHz, 6MHz</p>

CMMB: 3.8 MHz, 4.2 MHz, 8.0 MHz, 6 MHz, 6 MHz, 6 MHz |6MHz, 6MHz, 6MHz, 6MHz, 6MHz, 6MHz

LTE, LTE-TDD: 50 kHz, 5.05 MHz, 10.5 MHz, 15.00 MHz, 30 MHz, 40 MHz |15.00 kHz, 1.5 MHz, 5.5 MHz, 6.5 MHz, 10 MHz, 20MHz

Digital Cable TV: 3.8 MHz, 4.2 MHz, 6 MHz, 6 MHz, 6 MHz, 6 MHz |6MHz, 6MHz, 6MHz, 6MHz, 6MHz, 6MHz

When option N9060A-7FP is installed in these modes, the preset value of Offset G ~ L is the same as the Offset F value.

WLAN:

if Radio Std is 802.11a/g(OFDM/DSSS-OFDM)/802.11n(20MHz): 9 MHz, 11 MHz, 20 MHz, 30 MHz, 50 MHz, 216 MHz, 216 MHz, 216 MHz, 216 MHz, 216 MHz, 216 MHz, 216 MHz

if Radio Std is 802.11b/g(DSSS/CCK/PBCC): 11 MHz, 22 MHz, 50 MHz, 70 MHz, 90 MHz, 100 MHz, 100 MHz, 100 MHz, 100 MHz, 100 MHz, 100 MHz

if Radio Std is 802.11n(20MHz): 9 MHz, 11 MHz, 20 MHz, 30 MHz, 50 MHz, 100 MHz, 100 MHz, 100 MHz, 100 MHz, 100 MHz, 100 MHz

if Radio Std is 802.11n(40MHz): 19 MHz, 21 MHz, 40 MHz, 60 MHz, 100 MHz, 200 MHz, 200 MHz, 200 MHz, 200 MHz, 200 MHz, 200 MHz

if Radio Std is 802.11ac(20MHz): 9 MHz, 11 MHz, 20 MHz, 30 MHz, 30 MHz, 30 MHz, 30 MHz, 30 MHz, 30 MHz, 30 MHz, 30 MHz

if Radio Std is 802.11ac(40MHz): 19 MHz, 21 MHz, 40 MHz, 60 MHz, 60 MHz, 60 MHz, 60 MHz, 60 MHz, 60 MHz, 60 MHz, 60 MHz

if Radio Std is 802.11ac(80MHz): 39 MHz, 41 MHz, 80 MHz, 120 MHz, 120 MHz, 120 MHz, 120 MHz, 120 MHz, 120 MHz, 120 MHz, 120 MHz

if Radio Std is 802.11ac(160MHz): 79 MHz, 81 MHz, 160 MHz, 240 MHz, 240 MHz, 240 MHz, 240 MHz, 240 MHz, 240 MHz, 240 MHz, 240 MHz

if Radio Std is 802.11ac(80 MHz + 80MHz): 0MHz, 0 MHz, 40 MHz, 79 MHz, 159 MHz, 161 MHz, 200 MHz, 240 MHz, 240 MHz, 240 MHz, 240 MHz, 240 MHz

if Radio Std is 802.11ah(1MHz): 0.45 MHz, 0.6 MHz, 1 MHz, 1.5 MHz, 1.5 MHz, 1.5 MHz, 1.5 MHz, 1.5 MHz, 1.5 MHz, 1.5 MHz, 1.5 MHz

if Radio Std is 802.11ah(2MHz): 0.9 MHz, 1.1 MHz, 2 MHz, 3 MHz, 3 MHz, 3 MHz, 3 MHz, 3 MHz, 3 MHz, 3 MHz, 3 MHz

if Radio Std is 802.11ah(4MHz): 1.9 MHz, 2.1 MHz, 4 MHz, 6 MHz, 6 MHz, 6 MHz, 6 MHz, 6 MHz, 6 MHz, 6 MHz, 6 MHz

if Radio Std is 802.11ah(8MHz): 3.9 MHz, 4.1 MHz, 8 MHz, 12 MHz, 12 MHz, 12 MHz, 12 MHz, 12 MHz, 12 MHz, 12 MHz, 12 MHz

if Radio Std is 802.11ah(16MHz): 7.9 MHz, 8.1 MHz, 16 MHz, 24 MHz, 24 MHz, 24 MHz, 24 MHz, 24 MHz, 24 MHz, 24 MHz, 24 MHz

if Radio Std is 802.11j/p(10MHz): 4.5 MHz, 5MHz, 5.5 MHz, 10 MHz, 15 MHz, 216 MHz, 216MHz, 216 MHz, 216MHz, 216MHz, 216MHz

if Radio Std is 802.11p(5MHz): 2.25 MHz, 2.5MHz, 2.75 MHz, 5 MHz, 7.5 MHz, 216 MHz, 216MHz, 216 MHz, 216MHz, 216MHz, 216MHz

MSR:15 kHz, 215kHz, 1.015MHz, 1.5MHz, 10.5MHz, 15.00MHz, 30MHz, 30MHz, 30MHz, 30MHz, 30MHz | 15kHz, 215kHz, 1.015MHz, 1.5MHz, 10.5MHz, 15.00MHz, 30MHz, 30MHz, 30MHz, 30MHz, 30MHz

LTEAFDD, LTEATDD: 50 kHz, 5.05 MHz, 10.5 MHz, 15.00 MHz, 30 MHz, 40 MHz, 40 MHz, 40 MHz, 40 MHz, 40 MHz, 40 MHz | 15.00 kHz, 1.5 MHz, 5.5 MHz, 6.5 MHz, 10 MHz, 20MHz, 20MHz, 20MHz, 20MHz, 20MHz, 20MHz, 20MHz

For modes (except MSR, LTEAFDD, LTEATDD and WLAN) without option N9060A-7FP, the preset value is as follows.

SA: ON, ON, ON, ON, ON, OFF

WCDMA: ON, ON, ON, ON, ON, OFF|ON, ON, ON, ON, OFF, OFF

C2K: ON, ON, ON, OFF, OFF, OFF|ON, ON, OFF, OFF, OFF, OFF

WIMAX OFDMA: ON, ON, ON, OFF, OFF, OFF|ON, ON, ON, OFF, OFF, OFF

TD-SCDMA: ON, ON, ON, ON, OFF, OFF|ON, ON, ON, OFF, OFF, OFF

1xEVDO: ON, ON, ON, OFF, OFF, OFF|ON, ON, OFF, OFF, OFF, OFF

DTMB (CTTB), DVB-T/H, CMMB, Digital Cable TV: ON, ON, ON, OFF, OFF, OFF

ISDB-T: ON, ON, ON, ON, OFF, OFF

LTE, LTE-TDD: ON, ON, ON, OFF, OFF, OFF|ON, ON, ON, ON, OFF, OFF

When option N9060A-7FP is installed in these modes, the preset value of Offset G ~ L is the same as the Offset F value.

WLAN:

if Radio Std is 802.11b/g(DSSS/CCK/PBCC): ON, ON, OFF, OFF, OFF, OFF, OFF, OFF, OFF, OFF, OFF, OFF, OFF, OFF

if Radio Std is 802.11a/g(OFDM/DSSS-OFDM)/802.11n(20MHz/40MHz): ON, ON, ON, ON, OFF, OFF, OFF, OFF, OFF, OFF, OFF, OFF

if Radio Std is 802.11ac (20 MHz/ 40 MHz/ 80 MHz/ 160 MHz): ON, ON, ON, ON, OFF, OFF, OFF, OFF, OFF, OFF, OFF, OFF

if Radio Std is 802.11ac (80 MHz + 80 MHz): OFF, ON, ON, ON, ON, ON, ON, ON, OFF, OFF, OFF, OFF, OFF, OFF

MSR:ON, ON, ON, ON, ON, OFF, OFF, OFF, OFF, OFF, OFF, OFF, OFF, OFF|ON, ON, ON, ON, ON, OFF, OFF, OFF, OFF, OFF, OFF, OFF, OFF

LTEAFDD, LTEATDD: ON, ON, ON, OFF, OFF, OFF, OFF, OFF, OFF, OFF, OFF, OFF, OFF | ON, ON, ON, ON, OFF, OFF, OFF, OFF, OFF, OFF, OFF, OFF

State Saved	Saved in instrument state.
Min	0 Hz
Max	Depends on instrument maximum frequency. It's always Offset Stop Freq (100 Hz
Initial S/W Revision	Prior to A.02.00
Modified at S/W Revision	A.02.00, A.03.00, A.10.00, A.11.00, A.14.00, A.16.00

Stop Freq

Specifies the stop frequency for the currently selected offset.

Missing values are not permitted; that is, if you want to change values 2 and 6, you must send all values up to 6. Subsequent values will remain as they were. The query for this parameter always returns 12 values.

Key Path	Meas Setup, Offset/Limits
Mode	SA, WCDMA, C2K, WIMAX OFDMA, TD-SCDMA, 1xEVDO, DTMB (CTTB), DVB-T/H, ISDB-T, CMMB, LTE, LTETDD, Digital Cable TV, WLAN, MSR, LTEAFDD, LTEATDD
Remote Command	[[:SENSe]:SEMAsk:OFFSet[1] 2[:OUTer]:LIST:FREQuency:STOP <freq>, ... [:SENSe]:SEMAsk:OFFSet[1] 2[:OUTer]:LIST:FREQuency:STOP?
Example	SEM:OFFS:LIST:FREQ:STOP 2.715 MHz, 3.515 MHz, 4.00 MHz, 8.00 MHz, 12.50 MHz, 15.0 MHz SEM:OFFS:LIST:FREQ:STOP?
Notes	<p>Comma separated list of values.</p> <p>OFFSet1 is for BTS, 2 for MS. Default is BTS.</p> <p>Note that Offset sub op code 2 is supported only in Non-SA modes.</p> <p>In the SA mode, Offset sub op code 1 is used for both BTS and MS.</p> <p>If the offset is outside of the frequency range, the result spectrum will be invalid.</p> <p>You must be in the mode that includes SEM measurement to use this command. Use :INSTrument:SElect to set the mode.</p>
Couplings	<p>Coupled to Start Freq. When the stop freq goes below the start freq, the start freq is automatically adjusted to the stop freq minus 100 Hz.</p> <p>If the current mode is DVB-T/H, this value will be modified automatically according to the limit type and the output power of the transmitter which is less or more than 25 W.</p> <p>If the current mode is ISDB-T, this value will be modified automatically according to the limit type.</p>
Preset	<p>For modes (except MSR, LTEAFDD, LTEATDD and WLAN) without option N9060A-7FP, the preset value is as follows.</p> <p>SA: 2.715 MHz, 3.515 MHz, 4.00 MHz, 8.00 MHz, 12.50 MHz, 15.0 MHz</p> <p>WCDMA: 2.715 MHz, 3.515 MHz, 4.000 MHz, 8.000 MHz, 12.50 MHz, 15.0 MHz 3.485 MHz, 7.500 MHz, 8.500 MHz, 12.00 MHz, 15.00 MHz, 18.0 MHz</p> <p>C2K: 780.0kHz, 1.980 MHz, 4.0 MHz, 4.0 MHz, 12.0 MHz, 12.0 MHz 1.980 MHz, 4.0 MHz, 4.0 MHz, 11.5 MHz, 14.5 MHz, 14.5 MHz</p> <p>WIMAX OFDMA: 5.45 MHz, 9.75 MHz, 14.75 MHz, 19.75 MHz, 24.75 MHz, 29.75 MHz 5.45 MHz, 9.75 MHz, 14.75 MHz, 19.75 MHz, 24.75 MHz, 29.75 MHz</p> <p>TD-SCDMA:</p> <p>1015 kHz, 1815kHz, 2.3 MHz, 4 MHz, 4 MHz, 4 MHz 1.8 MHz, 2385 kHz, 3.5 MHz, 3.5 MHz, 3.5 MHz, 3.5 MHz</p> <p>1xEVDO: 780.0 kHz, 1.98 MHz, 4.0 MHz, 4.0 MHz, 12 MHz, 12 MHz 1.98 MHz, 4.0 MHz, 4.0 MHz, 4.0 MHz, 4.0 MHz, 4.0 MHz</p> <p>DTMB (CTTB): 4.2 MHz, 6 MHz, 12 MHz, 12 MHz, 12 MHz, 12 MHz 12 MHz, 12 MHz, 12 MHz, 12 MHz, 12 MHz, 12 MHz</p> <p>DVB-T/H: 4.2 MHz, 6 MHz, 12 MHz, 12 MHz, 12 MHz, 12 MHz 12 MHz, 12 MHz, 12 MHz, 12 MHz, 12 MHz, 12 MHz</p> <p>ISDB-T: 2.86 MHz, 3.0 MHz, 4.36 MHz, 15.0 MHz, 15.0 MHz, 15.0 MHz 15MHz, 15MHz, 15MHz, 15MHz, 15MHz, 15MHz</p> <p>CMMB: 4.2 MHz, 8.0 MHz, 12.0 MHz, 12.0 MHz, 12.0 MHz, 12.0 MHz 12 MHz, 12 MHz, 12 MHz, 12 MHz, 12 MHz, 12 MHz</p> <p>LTE, LTETDD: 5.05 MHz, 10.05 MHz, 15 MHz, 30 MHz, 40 MHz, 50 MHz 985.0 kHz, 4.50 MHz,</p>

5.5001 MHz, 9.50 MHz, 20 MHz, 40 MHz

Digital Cable TV: 4.2 MHz, 6.0 MHz, 12.0 MHz, 12.0 MHz, 12.0 MHz, 12.0 MHz, 12 MHz, 12 MHz, 12 MHz, 12 MHz, 12 MHz, 12 MHz

When option N9060A-7FP is installed in these modes, the preset value of Offset G ~ L is the same as the Offset F value.

WLAN:

if Radio Std is 802.11a/g(OFDM/DSSS-OFDM)/802.11n(20MHz): 11 MHz, 20 MHz, 30 MHz, 50 MHz, 100 MHz, 250 MHz, 250 MHz, 250 MHz, 250 MHz, 250 MHz, 250 MHz, 250 MHz

if Radio Std is 802.11b/g(DSSS/CCK/PBCC): 22 MHz, 50 MHz, 70 MHz, 90 MHz, 100 MHz, 120 MHz, 120 MHz, 120 MHz, 120 MHz, 120 MHz, 120 MHz, 120 MHz

if Radio Std is 802.11n(20MHz): 11 MHz, 20 MHz, 30 MHz, 50 MHz, 100 MHz, 200 MHz, 200 MHz, 200 MHz, 200 MHz, 200 MHz

if Radio Std is 802.11n(40MHz): 21 MHz, 40 MHz, 60 MHz, 100 MHz, 200 MHz, 300 MHz, 300 MHz, 300 MHz, 300 MHz, 300 MHz

if Radio Std is 802.11ac(20MHz): 11 MHz, 20 MHz, 30 MHz, 50 MHz, 50 MHz, 50 MHz, 50 MHz, 50 MHz, 50 MHz, 50 MHz, 50 MHz

if Radio Std is 802.11ac(40MHz): 21 MHz, 40 MHz, 60 MHz, 100 MHz, 100 MHz, 100 MHz, 100 MHz, 100 MHz, 100 MHz, 100 MHz, 100 MHz

if Radio Std is 802.11ac(80MHz): 41 MHz, 80 MHz, 120 MHz, 200 MHz, 200 MHz, 200 MHz, 200 MHz, 200 MHz, 200 MHz, 200 MHz, 200 MHz

if Radio Std is 802.11ac(160MHz): 81 MHz, 160 MHz, 240 MHz, 400 MHz, 400 MHz, 400 MHz, 400 MHz, 400 MHz, 400 MHz, 400 MHz

if Radio Std is 802.11ac(80 MHz + 80MHz): 100MHz, 40 MHz, 79 MHz, 81 MHz, 161 MHz, 200 MHz, 240 MHz, 260 MHz, 260 MHz, 260 MHz, 260 MHz, 260 MHz

if Radio Std is 802.11ah(1MHz): 0.6MHz, 1 MHz, 1.5 MHz, 2.5MHz, 2.5 MHz, 2.5 MHz, 2.5 MHz, 2.5 MHz, 2.5 MHz, 2.5 MHz, 2.5 MHz

if Radio Std is 802.11ah(2MHz): 1.1 MHz, 2 MHz, 3 MHz, 5MHz, 5 MHz, 5 MHz, 5 MHz, 5 MHz, 5 MHz, 5 MHz, 5 MHz

if Radio Std is 802.11ah(4MHz): 2.1 MHz, 4 MHz, 6 MHz, 10 MHz, 10 MHz, 10 MHz, 10 MHz, 10 MHz, 10 MHz, 10 MHz, 10 MHz

if Radio Std is 802.11ah(8MHz): 4.1 MHz, 8 MHz, 12 MHz, 20 MHz, 20 MHz, 20 MHz, 20 MHz, 20 MHz, 20 MHz, 20 MHz, 20 MHz

if Radio Std is 802.11ah(16MHz): 8.1 MHz, 16 MHz, 24 MHz, 40 MHz, 40 MHz, 40 MHz, 40 MHz, 40 MHz, 40 MHz, 40 MHz, 40 MHz

if Radio Std is 802.11j/p(20MHz): 10MHz, 11 MHz, 20 MHz, 30 MHz, 50MHz, 50 MHz, 50 MHz, 50 MHz, 50 MHz, 50 MHz, 50 MHz

if Radio Std is 802.11j/p(10MHz): 5MHz, 5.5 MHz, 10 MHz, 15 MHz, 25MHz, 250MHz, 250MHz, 250MHz, 250 MHz, 250MHz, 250MHz, 250MHz

if Radio Std is 802.11p(5MHz): 2.5MHz, 2.75MHz, 5 MHz, 7.5 MHz, 12.5MHz, 250MHz, 250MHz, 250MHz, 250 MHz, 250MHz, 250MHz, 250MHz

MSR: 215kHz, 1.015MHz, 1.5MHz, 10.5MHz, 50MHz, 50MHz, 50MHz, 50MHz, 50MHz, 50MHz, 50MHz, 50MHz

LTEAFDD, LTEATDD: 5.05 MHz, 10.05 MHz, 15 MHz, 30 MHz, 40 MHz, 50 MHz, 50 MHz, 50 MHz, 50 MHz, 50 MHz, 50 MHz | 985.0 kHz, 4.50 MHz, 5.5001 MHz, 9.50 MHz, 20 MHz, 40

	MHz , 40 MHz, 40 MHz, 40 MHz, 40 MHz, 40 MHz, 40 MHz
State Saved	Saved in instrument state.
Min	100 Hz
Max	Depends on instrument maximum frequency. Same as the Max Span on Swept SA Measurement.
Initial S/W Revision	Prior to A.02.00
Modified at S/W Revision	A.02.00, A.03.00, A.10.00, A.11.00, A.14.00, A.16.00

Sweep Time

Specifies the sweep time for the currently selected offset and enables you to toggle the sweep Time mode between Auto and Man.

Missing values are not permitted; that is, if you want to change values 2 and 6, you must send all values up to 6. Subsequent values will remain as they were. The query for this parameter always returns 12 values.

Key Path	Meas Setup, Offset/Limits
Mode	SA, WCDMA, C2K, WIMAX OFDMA, TD-SCDMA, 1xEVDO, DTMB (CTTB), DVB-T/H, ISDB-T, CMMB, LTE, LTEFDD, Digital Cable TV, WLAN, MSR, LTEAFDD, LTEATDD
Remote Command	[:SENSE]:SEMask:OFFSet[1] 2[:OUTer]:LIST:SWEep:TIME <time>, ... [:SENSE]:SEMask:OFFSet[1] 2[:OUTer]:LIST:SWEep:TIME? [:SENSE]:SEMask:OFFSet[1] 2[:OUTer]:LIST:SWEep:TIME:AUTO ON OFF 1 0, ... [:SENSE]:SEMask:OFFSet[1] 2[:OUTer]:LIST:SWEep:TIME:AUTO?
Example	SEM:OFFS2:LIST:SWE:TIME 1.0 ms, 3.4 ms, 2.08 ms, 1.0 ms, 1.0 ms, 1.0 ms SEM:OFFS2:LIST:SWE:TIME? SEM:OFFS2:LIST:SWE:TIME:AUTO ON, ON, ON, ON, OFF, OFF SEM:OFFS2:LIST:SWE:TIME:AUTO?
Notes	Comma separated list of values. OFFSet1 is for BTS, 2 for MS. Default is BTS. Note that Offset sub op code 2 is supported only in Non-SA modes. In the SA mode, Offset sub op code 1 is used for both BTS and MS. You must be in the mode that includes SEM measurement to use this command. Use :INSTrument:SElect to set the mode.
Couplings	When the sweep time is set manually, sweep Time Mode is set to MANUAL. If the current mode is DVB-T/H, this value will be modified automatically according to the output power of the transmitter which is less or more than 25W. If the current mode is ISDB-T, this value will be modified automatically according to the limit type.
Preset	Automatically calculated Modes (except MSR, LTEAFDD, LTEATDD and WLAN) without option N9060A-7FP: ON, ON, ON,

	Method FFT&Sweep menu FFT - Swept grayed out and rules choose FFT Video - FFT grayed out and rules choose Swept LO - FFT grayed out and rules choose Swept
Preset	AUTO
Backwards Compatibility SCPI	<code>[:SENSe] :SWEep:TYPE AUTO</code> sets sweep type Auto to On but the query will return either FFT or SWE depending on the auto setting. <code>[:SENSe] :SWEep:TYPE SWP</code> selects sweep type Swept but will return SWE on a query
Initial S/W Revision	Prior to A.02.00

Auto

When in Auto, the selection of sweep type is governed by two different sets of rules, depending on whether you want to optimize for dynamic range or for speed. These rules are chosen under the **Sweep Type Rules** key.

Key Path	Sweep/Control, Sweep Setup, Sweep Type
Remote Command	<code>[:SENSe] :SWEep:TYPE:AUTO OFF ON 0 1</code> <code>[:SENSe] :SWEep:TYPE:AUTO?</code>
Example	:SWE:TYPE:AUTO ON
Couplings	Pressing Auto Couple always sets Sweep Type to Auto. Swept is always chosen whenever any form of Signal ID is on, or the Source Mode is set to Tracking, or any EMI detector is selected, or the RF Preselector is ON.
Preset	ON
State Saved	Saved in instrument state
Initial S/W Revision	Prior to A.02.00

Swept

Manually selects swept analysis, so it cannot change automatically to FFT.

Key Path	Sweep/Control, Sweep Setup, Sweep Type
Example	SWE:TYPE SWE
Dependencies	Grayed out while in Gated FFT (meaning Gate is ON and Gate Method is FFT). If this key is selected, the gate method Gated FFT is grayed out.
Couplings	This selection is chosen automatically if any of the CISPR detectors is chosen for any active trace, in which case the FFT Sweep Type selection is also grayed out.
State Saved	Saved in instrument state

Readback	Swept
Initial S/W Revision	Prior to A.02.00
Modified at S/W Revision	A.02.00

FFT

Manually selects FFT analysis, so it cannot change automatically to Swept.

Key Path	Sweep/Control, Sweep Setup, Sweep Type
Example	SWE:TYPE FFT
Dependencies	<p>When a CISPR detector (Quasi Peak, EMI Average, RMS Average) is selected for any active trace, the FFT key is grayed out.</p> <p>When the RF Preselector is on, the FFT key is grayed out.</p> <p>When Source Mode is set to Tracking, Manual FFT is grayed out.</p> <p>When Signal ID is on, Manual FFT is grayed out.</p> <p>Grayed out while in Gated LO (meaning Gate is ON and Gate Method is LO).</p> <p>Grayed out while in Gated Video (meaning Gate is ON and Gate Method is Video).</p>
State Saved	Saved in instrument state
Readback	FFT
Initial S/W Revision	Prior to A.02.00

Offset Side

Specifies which offset side to measure.

You can turn off (not use) specific offsets with [:SENSE]:SEMask:OFFSet[n][:OUTer]:LIST:STATe.

- **BOTH** – Both of the negative (lower) and positive (upper) sidebands
- **NEGative** – Negative (lower) sideband only
- **POSitive** – Positive (upper) sideband only

Missing values are not permitted; that is, if you want to change values 2 and 6, you must send all values up to 6. Subsequent values will remain as they were. The query for this parameter always returns 12 values.

The figure below shows the relation between the negative/positive offset side setups and the upper/lower results in the MSR and LTE-Advanced FDD/TDD.

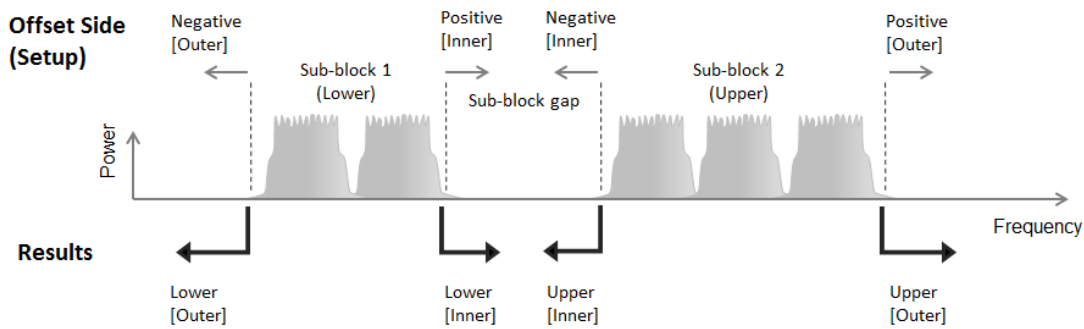

Key Path	Meas Setup, Offset/Limits
Mode	SA, WCDMA, C2K, WIMAX OFDMA, TD-SCDMA, 1xEVDO, DTMB (CTTB), DVB-T/H, ISDB-T, CMMB, LTE, LTE-TDD, Digital Cable TV, WLAN, MSR, LTEAFDD, LTEATDD
Remote Command	[:SENSe]:SEMAsk:OFFSet[1] 2[:OUTer]:LIST:SIDE BOTH NEGative POSitive, ... [:SENSe]:SEMAsk:OFFSet[1] 2[:OUTer]:LIST:SIDE?
Example	SEM:OFFS:LIST:SIDE BOTH, NEG, NEG, POS, POS, POS SEM:OFFS:LIST:SIDE?
Notes	Comma separated list of values. OFFSet1 is for BTS, 2 for MS. Default is BTS. Note that Offset sub op code 2 is supported only in Non-SA modes. In the SA mode, Offset sub op code 1 is used for both BTS and MS. You must be in the mode that includes SEM measurement to use this command. Use :INSTrument:SElect to set the mode.
Preset	Modes (except MSR, LTEAFDD, LTEATDD and WLAN) without option N9060A-7FP: BOTH, BOTH, BOTH, BOTH, BOTH, BOTH Modes (except MSR, LTEAFDD, LTEATDD and WLAN) with option N9060A-7FP: BOTH, BOTH, BOTH, BOTH, BOTH, BOTH, BOTH, BOTH, BOTH, BOTH, BOTH, BOTH, BOTH, BOTH, BOTH, BOTH MSR: BOTH, BOTH, BOTH, BOTH, BOTH, BOTH, BOTH, BOTH, BOTH, BOTH, BOTH, BOTH, BOTH, BOTH, BOTH, BOTH LTEAFDD, LTEATDD: BOTH, BOTH, BOTH, BOTH, BOTH, BOTH, BOTH, BOTH, BOTH, BOTH, BOTH, BOTH, BOTH, BOTH, BOTH, BOTH BOTH, BOTH, BOTH, BOTH, BOTH, BOTH, BOTH, BOTH, BOTH, BOTH, BOTH, BOTH, BOTH, BOTH, BOTH, BOTH WLAN: BOTH, BOTH, BOTH, BOTH, BOTH, BOTH, BOTH, BOTH, BOTH, BOTH, BOTH, BOTH, BOTH, BOTH, BOTH, BOTH
State Saved	Saved in instrument state.
Range	Neg Both Pos
Initial S/W Revision	Prior to A.02.00
Modified at S/W Revision	A.02.00, A.03.00, A.10.00, A.11.00, A.14.00

Res BW

Specifies which Resolution BW filter to use when measuring the currently selected offset.

Offset Res BW Mode allows the instrument to determine the optimum Resolution BW filter to use when measuring the currently selected offset.. When changing the Meas BW parameter, if the Res BW needs to be changed to adhere to the rule

$(N \times \text{Res BW}) \leq (\text{Stop freq of the offset} - \text{Start freq of the offset}),$

where N is the multiplier, this setting will automatically be changed to manual.

Missing values are not permitted; that is, if you want to change values 2 and 6, you must send all values up to 6. Subsequent values will remain as they were. The query for this parameter always returns 12 values.

Key Path	Meas Setup, Offset/Limits
Mode	SA, WCDMA, C2K, WIMAX OFDMA, TD-SCDMA, 1xEVDO mode, DTMB (CTTB), DVB-T/H, ISDB-T, CMMB, LTE, LTE-TDD, Digital Cable TV, WLAN, MSR, LTEAFDD, LTEATDD
Remote Command	<pre>[:SENSe]:SEMask:OFFSet[1] 2[:OUTer]:LIST:BANDwidth[:RESolution] <bandwidth>, ... [:SENSe]:SEMask:OFFSet[1] 2[:OUTer]:LIST:BANDwidth[:RESolution]? [:SENSe]:SEMask:OFFSet[1] 2[:OUTer]:LIST:BANDwidth[:RESolution]:AUTO OFF ON 1 0, ... [:SENSe]:SEMask:OFFSet[1] 2[:OUTer]:LIST:BANDwidth[:RESolution]:AUTO?</pre>
Example	<pre>SEM:OFFS2:LIST:BAND 30.0 kHz, 30.0 kHz, 30.0 kHz, 1.00 MHz, 1.00 MHz, 1.00 MHz SEM:OFFS2:LIST:BAND? SEM:OFFS:LIST:BAND:AUTO 1,1,1,1,1,1 SEM:OFFS:LIST:BAND:AUTO?</pre>
Notes	<p>Comma separated list of values.</p> <p>OFFSet1 is for BTS, 2 for MS. Default is BTS.</p> <p>Note that Offset sub op code 2 is supported only in Non-SA modes.</p> <p>In the SA mode, Offset sub op code 1 is used for both BTS and MS.</p> <p>You must be in the mode that includes SEM measurement to use this command. Use :INSTrument:SElect to set the mode.</p>
Couplings	<p>Coupled to Start and Stop offset and Meas BW multiplier. This parameter must adhere to the rule $(N \times \text{Res BW}) \leq (\text{Stop freq of the offset} - \text{Start freq of the offset})$, where N is the multiplier. If the multiplier is changed, the Res BW will be changed to ensure this. When set manually, Res BW Coupling is set to manual.</p> <p>The resolution bandwidth is coupled to the offset width determined by the start frequency and stop frequency.</p>
Preset	<p>For modes (except MSR, LTEAFDD, LTEATDD and WLAN) without option N9060A-7FP, the preset value is as follows.</p> <p>SA: 30.0 kHz, 30.0 kHz, 30.0 kHz, 1.00 MHz, 1.00 MHz, 1.00 MHz</p> <p>WCDMA: 30.00 kHz, 30.00 kHz, 30.00 kHz, 100.00 kHz, 1.000 MHz, 1.00 MHz 30.00 kHz, 1.000 MHz, 1.000 MHz, 1.000 MHz, 1.00 MHz</p> <p>C2K: 3.00 kHz, 30.00 kHz, 30.00 kHz, 6.2 kHz, 1.000 MHz, 1.00 MHz 30.00 kHz, 30.00 kHz, 6.2 kHz, 1.000 MHz, 1.000 MHz, 1.00 MHz</p> <p>WIMAX OFDMA: 100 KHz, 100 KHz, 100 KHz, 100 KHz, 100 KHz, 100 KHz 100 KHz, 100 KHz, 100 KHz, 100 KHz</p> <p>TD-SCDMA: 30 kHz, 30 kHz, 30 kHz, 50 kHz, 1 MHz, 1 MHz 30 kHz, 30 kHz, 50 kHz, 1 MHz, 1</p>

MHz, 1 MHz
 1xEVDO: 30.00 kHz, 30.00 kHz, 30.00 kHz, 6.2 kHz, 1.000 MHz, 1.000 MHz|30.00 kHz, 30.00 kHz, 30.00 kHz, 30.00 kHz, 30.00 kHz
 DTMB (CTTB), DVB-T/H, CMMB, Digital Cable TV: 3.9 kHz, 3.9 kHz, 3.9 kHz, 3.9 kHz, 3.9 kHz, 3.9 kHz |30.00 kHz, 1.000 MHz, 1.000 MHz, 1.000 MHz, 1.000 MHz, 1.00 MHz
 ISDB-T: 10.0 kHz, 10.0 kHz, 10.0 kHz, 10.0 kHz, 10. kHz, 10.0 kHz |30.00 kHz, 1.000 MHz, 1.000 MHz, 1.000 MHz, 1.000 MHz, 1.00 MHz
 LTE, LTE-TDD: 51 kHz, 100 kHz, 1.0 MHz, 1.0 MHz, 1.0 MHz, 1.0 MHz|15.0 kHz, 510 kHz, 1.0 MHz, 1.0 MHz, 1.0 MHz, 1.0 MHz
 When option N9060A-7FP is installed in these modes, the preset value of Offset G ~ L is the same as the Offset F value.

 WLAN:
 If radio std is 802.11ah: 10 KHz, 10 KHz, 10 KHz, 10 KHz, 10 KHz, 10 KHz, 10 KHz, 10 KHz, 10 KHz, 10 KHz, 10 KHz, 10 KHz
 For other radio std: 100 KHz, 100 KHz, 100 KHz, 100 KHz, 100 KHz, 100 KHz, 100 KHz, 100 KHz, 100 KHz, 100 KHz, 100 KHz, 100 KHz
 MSR: 30kHz, 30kHz, 30kHz, 1.0MHz, 1.0MHz, 1.0MHz, 1.0MHz, 1.0MHz, 1.0MHz, 1.0MHz, 1.0MHz, 1.0MHz | 30kHz, 30kHz, 30kHz, 1.0MHz, 1.0MHz, 1.0MHz, 1.0MHz, 1.0MHz, 1.0MHz, 1.0MHz, 1.0MHz
 LTEAFDD, LTEATDD: 51 kHz, 100 kHz, 1.0 MHz, 1.0 MHz, 1.0 MHz, 1.0 MHz, 1.0 MHz, 1.0 MHz, 1.0 MHz, 1.0 MHz, 1.0 MHz | 15.0 kHz, 510 kHz, 1.0 MHz, 1.0 MHz, 1.0 MHz, 1.0 MHz, 1.0 MHz, 1.0 MHz, 1.0 MHz, 1.0 MHz
 Modes (except MSR, LTEAFDD, LTEATDD and WLAN) without option N9060A-7FP: OFF, OFF, OFF, OFF, OFF, OFF, OFF, OFF, OFF, OFF, OFF, OFF
 Modes (except MSR, LTEAFDD, LTEATDD and WLAN) with option N9060A-7FP: OFF, OFF
 MSR: OFF, OFF
 LTEAFDD, LTEATDD: OFF, OFF
 WLAN: OFF, OFF

State Saved	Saved in instrument state.
Min	1 Hz
Max	8 MHz
Backwards Compatibility SCPI	[:SENSe] :SEMask:OFFSet [1] 2 :LIST:BWIDth [:RESolution]
Initial S/W Revision	Prior to A.02.00
Modified at S/W Revision	A.02.00, A.03.00, A.10.00, A.11.00, A.14.00

Meas BW

Allows you to specify a multiplier of Res BW for the measurement integration bandwidth.

Meas BW is multiplier integer number. It shows a ratio between Integration BW and Resolution BW of the measurement result.

Integ BW = Meas BW * Resolution BW

Integration BW is desired resolution bandwidth and Resolution BW is actual bandwidth for sweep. Measurement sweeps with Resolution BW and Meas BW compensates sweep resolution bandwidth to Integration BW.

If you set this parameter greater than 1, you can set Resolution BW narrower to avoid carrier power leakage effect to the offset power integration.

Missing values are not permitted; that is, if you want to change values 2 and 6, you must send all values up to 6. Subsequent values will remain as they were. The query for this parameter always returns 12 values.

Key Path	Meas Setup, Offset/Limits
Mode	SA, WCDMA, C2K, WIMAX OFDMA, TD-SCDMA, 1xEVDO, DTMB (CTTB), DVB-T/HISDB-T, CMMB, LTE, LTE-TDD, Digital Cable TV, WLAN
Remote Command	<code>[:SENSe] :SEMAsk:OFFSet [1] 2 [:OUTer] :LIST:BAWdth:IMULti <integer>, ...</code> <code>[:SENSe] :SEMAsk:OFFSet [1] 2 [:OUTer] :LIST:BAWdth:IMULti?</code>
Example	SEM:OFFS2:LIST:BAND:IMUL 1,1,1,1,1,1 SEM:OFFS2:LIST:BAND:IMUL?
Notes	Comma separated list of values. OFFSet1 is for BTS, 2 for MS. Default is BTS. Note that Offset sub op code 2 is supported only in Non-SA modes. In the SA mode, Offset sub op code 1 is used for both BTS and MS. You must be in the mode that includes SEM measurement to use this command. Use :INSTrument:SElect to set the mode.
Couplings	This parameter must adhere to the rule $(N \times \text{Res BW}) \leq (\text{Stop freq of the offset} - \text{Start freq of the offset})$, where N is the multiplier. If the Res Bw is changed, the multiplier will be changed to ensure this.
Preset	For modes (except MSR, LTEAFDD, LTEATDD and WLAN) without option N9060A-7FP, the preset value is as follows. SA: 1, 1, 1, 1, 1, 1 WCDMA: 1, 1, 1, 10, 1, 1 1, 1, 1, 1, 1, 1 C2K: 10, 1, 1, 1, 1, 1 1, 1, 1, 1, 1, 1 WIMAX OFDMA, 1xEVDO: 1, 1, 1, 1, 1, 1 1, 1, 1, 1, 1, 1 TD-SCDMA: 1, 1, 1, 20, 1, 1 1, 1, 20, 1, 1, 1 DTMB (CTTB), DVB-T/H, ISDB-T, CMMB, Digital Cable TV: 1, 1, 1, 1, 1, 1 1, 1, 1, 1, 1, 1 LTE, LTE-TDD: 2, 1, 1, 1, 1, 1 2, 2, 1, 1, 1, 1 When option N9060A-7FP is installed in these modes, the preset value of Offset G ~ L is the same as the Offset F value. -----

Start, and Abs Stop. Only one selection at a time is shown on this menu key label.

Key Path	Meas Setup, Offset/Limits
Mode	SA, WCDMA, C2K, WIMAX OFDMA, TD-SCDMA, 1xEVDO, DTMB (CTTB), DVB-T/H, ISDB-T, CMMB, LTE, LTE-TDD, Digital Cable TV, WLAN, MSR, LTEAFDD, LTEATDD
Preset	A
Range	MSR, LTEATDD, LTEAFDD, WLAN: A B C D E F G H J K L Other modes without option N9060A-7FP: A B C D E F Other modes with option N9060A-7FP: A B C D E F G H J K L
Initial S/W Revision	Prior to A.02.00
Modified at S/W Revision	A.02.00, A.03.00, A.10.00, A.11.00, A.14.00

Abs Start

Sets the absolute power level limit at the start frequency for the selected offset. The absolute power level limit ranges from -200 to +50 dBm.

The fail condition for each offset channel is set remotely by [:SENSE]:SEMASK:OFFSet[n] [:OUTer]:LIST:TEST.

You can turn off (not use) specific offset channels remotely with [:SENSE]:SEMASK:OFFSet[n] [:OUTer]:LIST:STATE.

The SCPI query returns values currently set to the absolute power test limits.

Missing values are not permitted; that is, if you want to change values 2 and 6, you must send all values up to 6. Subsequent values will remain as they were. The query for this parameter always returns 12 values.

Key Path	Meas Setup, Offset/Limit, Limits
Mode	SA, WCDMA, C2K, WIMAX OFDMA, TD-SCDMA, 1xEVDO, DTMB (CTTB), DVB-T/H, ISDB-T, CMMA, LTE, LTE-TDD, Digital Cable TV, WLAN, MSR, LTEAFDD, LTEATDD
Remote Command	[:SENSE]:SEMASK:OFFSet [1] 2 [:OUTer]:LIST:STARt:ABSolute <real>, ... [:SENSE]:SEMASK:OFFSet [1] 2 [:OUTer]:LIST:STARt:ABSolute?
Example	SEM:OFFS2:LIST:STAR:ABS -12.50 dBm, -12.50 dBm, -24.50 dBm, -11.50 dBm, -11.50 dBm, -11.50 dBm SEM:OFFS2:LIST:STAR:ABS?
Notes	Comma separated list of values. OFFSet1 is for BTS, 2 for MS. Default is BTS. Note that Offset sub op code 2 is supported only in Non-SA modes. In the SA mode, Offset sub op code 1 is used for both BTS and MS. You must be in the mode that includes SEM measurement to use this command. Use :INSTrument:SElect to set the mode.
Couplings	If the current mode is DVB-T/H, this value will be modified automatically according to the limit type and the output power of the transmitter which is less or more than 25W.

	If the current mode is ISDB-T, this value will be modified automatically according to the limit type.
Presets	<p>For modes (except MSR, LTEAFDD, LTEATDD and WLAN) without option N9060A-7FP, the preset value is as follows.</p> <p>SA, WIMAX OFDMA: -14.00 dBm , -14.00 dBm , -26.00 dBm , -13.00 dBm , -13.00 dBm, -13.00 dBm</p> <p>WCDMA: -12.50 dBm, -12.50 dBm, -24.50 dBm, -11.50 dBm, -11.50 dBm, -11.50 dBm -69.6 dBm, -54.3 dBm, -54.3 dBm, -54.3 dBm, -54.3 dBm, -54.3 dBm</p> <p>C2K: -27.00 dBm, -27.00 dBm, -27.00 dBm, -46.00 dBm, -13.00 dBm, -13.00 dBm -70.13 dBm, -70.13 dBm, -35.00 dBm, -13.00 dBm, -13.00 dBm, -13.00 dBm</p> <p>TD-SCDMA: -28 dBm, -28 dBm, -36 dBm, -21 dBm, -21 dBm, -21 dBm -71.3 dBm, -71.3 dBm, -56.07 dBm, -56.07 dBm, -56.07 dBm, -56.07 dBm</p> <p>1xEVDO: -27.0dBm, -27.00 dBm, -27.00 dBm, -46.00 dBm, -13.00 dBm, -13.00 dBm -70.13 dBm, -70.13 dBm, -70.13 dBm, -70.13 dBm, -70.13 dBm, -70.13 dBm</p> <p>DTMB (CTTB): -14.0 dBm, -14.0 dBm, -26.0 dBm, -13.0 dBm, -13.0 dBm, -13.0 dBm -13.0 dBm, -13.0 dBm, -13.0 dBm, -13.0 dBm, -13.0 dBm, -13.0 dBm</p> <p>DVB-T/H: 11.2 dBm, -29 dBm, -41 dBm, -66 dBm, -82 dBm, -82 dBm -82 dBm, -82 dBm, -82 dBm, -82 dBm, -82 dBm, -82 dBm</p> <p>ISDB-T, CMMB, Digital Cable TV: 50.0 dBm, 50.0 dBm, 50.0 dBm, 50.0 dBm, 50.0 dBm, 50.0 dBm 50.0 dBm, 50.0 dBm, 50.0 dBm, 50.0 dBm, 50.0 dBm, 50.0 dBm</p> <p>LTE, LTE-TDD: -5.5 dBm, -12.5 dBm, -15.0 dBm, -15.0 dBm, -15.0 dBm, -15.0 dBm -13.5 dBm, -8.5 dBm, -11.5 dBm, -23.5 dBm, -23.5 dBm, -23.5 dBm</p> <p>When option N9060A-7FP is installed in these modes, the preset value of Offset G ~ L is the same as the Offset F value.</p> <p>-----</p> <p>WLAN:</p> <p>if Radio Std is 802.11b/g(DSSS/CCK/PBCC): -10 dBm, -30 dBm, -30 dBm, -30 dBm, -30 dBm, -30 dBm, -30 dBm, -30 dBm, -30 dBm, -30 dBm, -30 dBm, -30 dBm, -30 dBm, -30 dBm, -30 dBm, -30 dBm</p> <p>if Radio Std is 802.11a/g(OFDM/DSSS-OFDM), 802.11n(20MHz) or 802.11ac(20MHz): 16.00 dBm, -4.00 dBm, -12.00 dBm, -63.00 dBm, -63.00 dBm, -63.00 dBm, -63.00 dBm, -63.00 dBm, -63.00 dBm, -63.00 dBm, -63.00 dBm, -63.00 dBm, -63.00 dBm, -63.00 dBm, -63.00 dBm</p> <p>if Radio Std is 802.11n(40MHz) or 802.11ac(40MHz): 16.00 dBm, -4.00 dBm, -12.00 dBm, -66.00 dBm, -66.00 dBm, -66.00 dBm, -66.00 dBm, -66.00 dBm, -66.00 dBm, -66.00 dBm, -66.00 dBm, -66.00 dBm, -66.00 dBm, -66.00 dBm, -66.00 dBm</p> <p>if Radio Std is 802.11ac(80MHz/160MHz): 16.00 dBm, -4.00 dBm, -12.00 dBm, -69.00 dBm, -69.00 dBm, -69.00 dBm, -69.00 dBm, -69.00 dBm, -69.00 dBm, -69.00 dBm, -69.00 dBm, -69.00 dBm, -69.00 dBm, -69.00 dBm, -69.00 dBm</p> <p>if Radio Std is 802.11ac (80 MHz + 80 MHz): -69.00 dBm, -69.00 dBm, -69.00 dBm, -69.00 dBm, -69.00 dBm, -69.00 dBm, -69.00 dBm, -69.00 dBm, -69.00 dBm, -69.00 dBm, -69.00 dBm, -69.00 dBm, -69.00 dBm, -69.00 dBm, -69.00 dBm</p> <p>if Radio Std is 802.11ah(1MHz): 16.00 dBm, -4.00 dBm, -12.00 dBm, -60.00 dBm, -60.00 dBm, -60.00 dBm, -60.00 dBm, -60.00 dBm, -60.00 dBm, -60.00 dBm, -60.00 dBm, -60.00 dBm, -60.00 dBm, -60.00 dBm, -60.00 dBm</p> <p>if Radio Std is 802.11ah(2MHz): 16.00 dBm, -4.00 dBm, -12.00 dBm, -63.00 dBm, -63.00 dBm, -63.00 dBm, -63.00 dBm, -63.00 dBm, -63.00 dBm, -63.00 dBm, -63.00 dBm, -63.00 dBm, -63.00 dBm, -63.00 dBm, -63.00 dBm</p> <p>if Radio Std is 802.11ah(4MHz): 16.00 dBm, -4.00 dBm, -12.00 dBm, -66.00 dBm, -66.00 dBm, -66.00 dBm, -66.00 dBm, -66.00 dBm, -66.00 dBm, -66.00 dBm, -66.00 dBm, -66.00 dBm, -66.00 dBm, -66.00 dBm, -66.00 dBm</p>

	<p>11.50 dBm SEM:OFFS1:LIST:STOP:ABS? SEM:OFFS:LIST:STOP:ABS:COUP ON, OFF, ON, ON, ON, ON SEM:OFFS:LIST:STOP:ABS:COUP?</p>
Notes	<p>Comma separated list of values. OFFSet1 is for BTS, 2 for MS. Default is BTS. Note that Offset sub op code 2 is supported only in Non-SA modes. In the SA mode, Offset sub op code 1 is used for both BTS and MS. You must be in the mode that includes SEM measurement to use this command. Use :INSTrument:SElect to set the mode.</p>
Couplings	<p>Coupled to Abs Start if "Auto" is selected, that is, the Stop value is equal to the Start value. If the current mode is DVB-T/H, this value will be modified automatically according to the limit type and the output power of the transmitter which is less or more than 25W. If the current mode is ISDB-T, this value will be modified automatically according to the limit type.</p>
Preset	<p>For modes (except MSR, LTEAFDD, LTEATDD and WLAN) without option N9060A-7FP, the preset value is as follows. SA, WIMAX OFDMA: -14.00 dBm, -26.00 dBm, -26.00 dBm, -13.00 dBm, -13.00 dBm, -13.00 dBm WCDMA: -12.50 dBm, -24.50 dBm, -24.50 dBm, -11.50 dBm, -11.50 dBm, -11.50 dBm -69.6 dBm, -54.3 dBm, -54.3 dBm, -54.3 dBm, -54.3 dBm, -54.3 dBm C2K: -27.00 dBm, -27.00 dBm, -27.00 dBm, -46.00 dBm, -13.00 dBm, -13.00 dBm -70.13 dBm, -70.13 dBm, -35.00 dBm, -13.00 dBm, -13.00 dBm, -13.00 dBm TD-SCDMA: -28 dBm, -36 dBm, -36 dBm, -21 dBm, -21 dBm, -21 dBm -71.3 dBm, -71.3 dBm, -56.07 dBm, -56.07 dBm, -56.07 dBm, -56.07 dBm 1xEVDO: -27dBm, -27.00 dBm, -27.00 dBm, -46.00 dBm, -13.00 dBm, -13.00 dBm -70.13 dBm, -70.13 dBm, -70.13 dBm, -70.13 dBm, -70.13 dBm, -70.13 dBm DTMB (CTTB): -14.0 dBm, -26.0 dBm, -26.0 dBm, -13.0 dBm, -13.0 dBm, -13.0 dBm -13.0 dBm, -13.0 dBm, -13.0 dBm, -13.0 dBm, -13.0 dBm, -13.0 dBm DVB-T/H: -29 dBm, -41 dBm, -66 dBm, -82 dBm, -82 dBm, -82 dBm -82 dBm, -82 dBm, -82 dBm, -82 dBm, -82 dBm, -82 dBm ISDB-TCMMB, Digital Cable TV: 50.0 dBm, 50.0 dBm, 50.0 dBm, 50.0 dBm, 50.0 dBm 50.0 dBm, 50.0 dBm, 50.0 dBm, 50.0 dBm, 50.0 dBm, 50.0 dBm LTE, LTEFDD:-12.5 dBm, -12.5 dBm, -15.0 dBm, -15.0 dBm, -15.0 dBm, -15.0 dBm -13.5 dBm, -8.5 dBm, -11.5 dBm, -23.5 dBm, -23.5 dBm, -23.5 dBm When option N9060A-7FP is installed in these modes, the preset value of Offset G ~ L is the same as the Offset F value. ----- WLAN: if Radio Std is 802.11b/g(DSSS/CCK/PBCC): -10 dBm, -30 dBm, -30 dBm, -30 dBm, -30 dBm, -30 dBm, -30 dBm, -30 dBm, -30 dBm, -30 dBm, -30 dBm, -30 dBm, -30 dBm, -30 dBm if Radio Std is 802.11a/g(OFDM/DSSS-OFDM), 802.11n(20MHz) or 802.11ac(20MHz): -4.00 dBm, -12.00 dBm, -24.00 dBm, -63.00 dBm, -63.00 dBm, -63.00 dBm, -63.00 dBm, -63.00 dBm, -63.00 dBm, -63.00 dBm, -63.00 dBm, -63.00 dBm, -63.00 dBm, -63.00 dBm</p>

	if Radio Std is 802.11a/g(OFDM/DSSS-OFDM)/802.11n(20MHz/40MHz)/802.11 ac (20MHz/40MHz/80MHz/160MHz) or 802.11ah(1MHz/2MHz/4MHz/8MHz/16MHz): OFF, OFF, OFF, ON, ON, ON, ON, ON, ON, ON, ON, ON if Radio Std is 802.11 ac(80+80 MHz): ON, ON, ON, ON, ON, ON, ON, ON, ON, ON, ON, ON if Radio Std is 802.11b/g(DSSS/CCK/PBCC): ON, ON, ON, ON, ON, ON, ON, ON, ON, ON, ON, ON if Radio Std is 802.11j/p 20M, j/p 10M, p5M : OFF, OFF, OFF, ON, ON, ON, ON, ON, ON, ON, ON, ON MSR: ON, OFF, OFF, OFF, ON, OFF, OFF, OFF, OFF, OFF, OFF, OFF, ON, OFF, OFF, OFF, OFF, OFF, OFF, OFF LTEAFDD, LTEATDD: OFF, ON
State Saved	Saved in instrument state.
Min	-200 dBm
Max	50 dBm
Initial S/W Revision	Prior to A.02.00
Modified at S/W Revision	A.02.00, A.03.00, A.10.00, A.11.00, A.14.00

Rel Start

Sets a relative power level limit at the start frequency for the selected offset. The relative power level limit ranges from -200 to +50 dBc.

The fail condition is set remotely by [:SENSe]:SEMask:OFFSet[n][:OUTer]:LIST:TEST for each offset channel test.

You can turn off (not use) specific offset channels remotely with [:SENSe]:SEMask:OFFSet[n][:OUTer]:LIST:STATE.

The SCPI query returns values currently set to the relative power test limits.

Missing values are not permitted; that is, if you want to change values 2 and 6, you must send all values up to 6. Subsequent values will remain as they were. The query for this parameter always returns 12 values.

Key Path	Meas Setup, Offset/Limits, Limits
Mode	SA, WCDMA, C2K, WIMAX OFDMA, TD-SCDMA, 1xEVDO, DTMB (CTTB), DVB-T/H, ISDB-T, CMMB, LTE, LTE-TDD, Digital Cable TV, WLAN, MSR, LTEAFDD, LTEATDD
Remote Command	[:SENSe]:SEMask:OFFSet[1] 2[:OUTer]:LIST:STARt:RCARrier <rel_ampl>, ... [:SENSe]:SEMask:OFFSet[1] 2[:OUTer]:LIST:STARt:RCARrier?
Example	SEM:OFFS:LIST:STAR:RCAR -30, -30, -30, -30, -30, -30 SEM:OFFS:LIST:STAR:RCAR?
Notes	Comma separated list of values. OFFSet1 is for BTS, 2 for MS. Default is BTS. Note that Offset sub op code 2 is supported only in Non-SA modes.

	<p>In the SA mode, Offset sub op code 1 is used for both BTS and MS.</p> <p>You must be in the mode that includes SEM measurement to use this command. Use :INSTrument:SElect to set the mode.</p>
Couplings	<p>If the current mode is DVB-T/H, this value will be modified automatically according to the limit type the output power of the transmitter which is less or more than 25W.</p> <p>If the current mode is ISDB-T, this value will be modified automatically according to the limit type.</p> <p>If the current mode is WLAN and radio std is 802.11n, Rel Start limits will be set to following values when frequency changed to above 5GHz: 0 dB, -20.00 dB, -28.00 dB, -40.00 dB, -40.00 dB, -40.00 dB, -40.00 dB, -40.00 dB, -40.00 dB, -40.00 dB, -40.00 dB</p>
Preset	<p>For modes (except MSR, LTEAFDD, LTEATDD and WLAN) without option N9060A-7FP, the preset value is as follows.</p> <p>SA: -30.00 dB, -30.00 dB, -30.00 dB, -30.00 dB, -30.00 dB, -30.00 dB</p> <p>WCDMA: -30.00 dB, -30.00 dB, -30.00 dB, -30.00 dB, -30.00 dB, -30.00 dB -33.73 dB, -34.00 dB, -37.50 dB, -47.50 dB, -47.50 dB, -47.50 dB</p> <p>C2K: -45.00 dB, -45.00 dB, -55.00 dB, -55.00 dB, -55.00 dB, -55.00 dB -42.00 dB, -54.00 dB, -54.00 dB, -54.00 dB, -54.00 dB</p> <p>WIMAX OFDMA: 0 dB, -25 dB, -32 dB, -50 dB, -50 dB, -50 dB</p> <p>TD-SCDMA: -54.00 dB, -54.00 dB, -62.00 dB, -47.00 dB, -47.00 dB, -47.00 dB -35.21 dB, -49.00 dB, -44.00 dB, -44.00 dB, -44.00 dB, -44.00 dB</p> <p>1xEVDO: -45dBc, -45.00 dB, -55.00 dB, -55.00 dB, -55.00 dB, -55.00 dB -42dBc, -54.00 dB, -54.00 dB, -54.00 dB, -54.00 dB</p> <p>DTMB (CTTB): -32.8 dB, -83 dB, -95 dB, -120 dB, -120 dB, -120 dB -120 dB, -120 dB, -120 dB, -120 dB, -120 dB, -120 dB</p> <p>DVB-T/H: -30 dB, -30 dB, -30 dB, -30 dB, -30 dB, -30 dB -30 dB, -30 dB, -30 dB, -30 dB, -30 dB, -30 dB</p> <p>ISDB-T: -27.4 dB, -47.4 dB, -54.4 dB, XXX, 50 dB, 50 dB 50 dB, 50 dB, 50 dB, 50 dB, 50 dB, 50 dB; XXX is coupled with the total power reference, it is -57.4 dB when $P \leq 0.025$ W, -67.4 dB when $P = 0.25$ W, $-(73.4 + 10 \log P)$ dB when 0.25 W $< P \leq 2.5$ W or 0.025 W $< P < 0.25$ W, -77.4 dB when $P > 2.5$ W.</p> <p>CMMB: -37 dB, -72 dB, -84 dB, -90 dB, -90 dB, -90 dB -90 dB, -90 dB, -90 dB, -90 dB, -90 dB, -90 dB</p> <p>LTE, LTEATDD: 0 dB, 0 dB, 0 dB, 0 dB, 0 dB, 0 dB 0 dB, 0 dB, 0 dB, 0 dB, 0 dB, 0 dB</p> <p>Digital Cable TV: 0 dB, 0 dB, 0 dB, 0 dB, 0 dB, 0 dB 0 dB, 0 dB, 0 dB, 0 dB, 0 dB, 0 dB</p> <p>When option N9060A-7FP is installed in these modes, the preset value of Offset G ~ L is the same as the Offset F value.</p> <p>-----</p> <p>WLAN:</p> <p>if Radio Std is 802.11a/g(OFDM/DSSS-OFDM): 0 dB, -20.00 dB, -28.00 dB, -40.00 dB, -40.00 dB, -47.00 dB, -47.00 dB, -47.00 dB, -47.00 dB, -47.00 dB, -47.00 dB, -47.00 dB</p> <p>if Radio Std is 802.11b/g(DSSS/CCK/PBCC): -30 dB, -50 dB, -50 dB, -50 dB, -50 dB, -50 dB, -50 dB, -50 dB, -50 dB, -50 dB, -50 dB, -50 dB</p> <p>if Radio Std is 802.11n(20MHz/40MHz): 0 dB, -20.00 dB, -28.00 dB, -45.00 dB, -45.00 dB, -</p>

SEM:OFFS:LIST:STOP:RCAR:COUP ON, ON, ON, ON, ON, ON
SEM:OFFS:LIST:STOP:RCAR:COUP?

Notes

Comma separated list of values.
OFFSet1 is for BTS, 2 for MS. Default is BTS.
Note that Offset sub op code 2 is supported only in Non-SA modes.
In the SA mode, Offset sub op code 1 is used for both BTS and MS.
You must be in the mode that includes SEM measurement to use this command. Use :INSTrument:SElect to set the mode.

Couplings

Coupled to Rel Start if "Auto" is selected, that is, Start is made the same as Stop.
If the current mode is DVB-T/H, this value will be modified automatically according to the limit type and the output power of the transmitter which is less or more than 25W.
If the current mode is ISDB-T, this value will be modified automatically according to the limit type.
If the current mode is WLAN and radio std is 802.11n, Rel Stop limits will be set to following values when frequency changed to above 5GHz:
-20.00 dB, -28.00 dB, -40.00 dB, -40.00 dB, -40.00 dB, -40.00 dB, -40.00 dB, -40.00 dB, -40.00 dB, -40.00 dB, -40.00 dB, -40.00 dB

Preset

For modes (except MSR, LTEAFDD, LTEATDD and WLAN) without option N9060A-7FP, the preset value is as follows.
SA: -30.00 dB, -30.00 dB, -30.00 dB, -30.00 dB, -30.00 dB, -30.00 dB
WCDMA: -30.00 dB, -30.00 dB, -30.00 dB, -30.00 dB, -30.00 dB, -30.00 dB|-48.28 dB, -37.50 dB, -47.50 dB, -47.50 dB, -47.50 dB, -47.50 dB
C2K: -45.00 dB, -45.00 dB, -55.00 dB, -55.00 dB, -55.00 dB, -55.00 dB|-42.00 dB, -54.00 dB, -54.00 dB, -54.00 dB, -54.00 dB
WIMAX OFDMA: -25 dB, -32 dB, -50 dB, -50 dB, -50 dB, -50 dB
TD-SCDMA: -54.00 dB, -62.00 dB, -62.00 dB, -47.00 dB, -47.00 dB, -47.00 dB|-49.00 dB, -58.945 dB, -44.00 dB, -44.00 dB, -44.00 dB, -44.00 dB
1xEVDO: -45dB, -45.00 dB, -55.00 dB, -55.00 dB, -55.00 dB, -55.00 dB|-42dB, -54.00 dB, -54.00 dB, -54.00 dB, -54.00 dB
DTMB (CTTB): -83 dB, -95 dB, -120 dB, -120 dB, -120 dB, -120 dB|-120 dB, -120 dB, -120 dB, -120 dB, -120 dB
DVB-T/H: -73 dB, -85 dB, -110 dB, -126 dB, -126 dB, -126 dB|-126 dB, -126 dB, -126 dB, -126 dB, -126 dB
ISDB-T: -47.4 dB, -54.4 dB, XXX, 50 dB, 50 dB, 50 dB|50 dB, 50 dB, 50 dB, 50 dB, 50 dB, 50 dB; XXX is coupled with the total power reference P, it is -57.4 dB when $P \leq 0.025$ W, -67.4 dB when $P = 0.25$ W, $-(73.4 + 10 \log P)$ dB when 0.25 W $< P < 2.5$ W or 0.025 W $< P < 0.25$ W, -77.4 dB when $P > 2.5$ W.
CMMB: -72 dB, -84 dB, -90 dB, -90 dB, -90 dB, -90 dB|-90 dB, -90 dB, -90 dB, -90 dB, -90 dB, -90 dB
LTE, LTE TDD: 0 dB, 0 dB, 0 dB, 0 dB, 0 dB, 0 dB
Digital Cable TV: 0 dB, 0 dB, 0 dB, 0 dB, 0 dB, 0 dB|0 dB, 0 dB, 0 dB, 0 dB, 0 dB, 0 dB
When option N9060A-7FP is installed in these modes, the preset value of Offset G ~ L is the same as the Offset F value.

	<p>In the SA mode, Offset sub op code 1 is used for both BTS and MS.</p> <p>You must be in the mode that includes SEM measurement to use this command. Use :INSTRument:SElect to set the mode.</p>
Couplings	<p>None</p> <p>If the current mode is DVB-T/H, this value will be modified automatically according to the limit type and the output power of the transmitter which is less or more than 25W.</p>
Preset	<p>For modes (except MSR, LTEAFDD, LTEATDD and WLAN) without option N9060A-7FP, the preset value is as follows.</p> <p>SA: ABS, ABS, ABS, ABS, ABS, ABS</p> <p>WCDMA: ABS, ABS, ABS, ABS, ABS, ABS AND, AND, AND, AND, AND, AND</p> <p>C2K: REL, REL, REL, ABS, REL, REL AND, AND, ABS, REL, REL, REL</p> <p>WIMAX OFDMA: REL, REL, REL, REL, REL, REL REL, REL, REL, REL, REL, REL</p> <p>TD-SCDMA: ABS, ABS, ABS, ABS, ABS, ABS AND, AND, AND, AND, AND, AND</p> <p>1xEVDO: REL, REL, REL, ABS, REL, REL AND, AND, AND, OR, AND, AND</p> <p>DTMB (CTTB), ISDB-T, CMMB: REL, REL, REL, REL, REL, REL REL, REL, REL, REL, REL, REL</p> <p>DVB-T/H: ABS, ABS, ABS, ABS, ABS, ABS ABS, ABS, ABS, ABS, ABS, ABS</p> <p>LTE, LTDTDD: ABS, ABS, ABS, ABS, ABS, ABS</p> <p>Digital Cable TV: REL, REL, REL, REL, REL, REL REL, REL, REL, REL, REL, REL</p> <p>When option N9060A-7FP is installed in these modes, the preset value of Offset G ~ L is the same as the Offset F value.</p> <p>-----</p> <p>WLAN:</p> <p>if Radio Std is 802.11b/g(DSSS/CCK/PBCC): REL, REL, REL, REL, REL, REL, REL, REL, REL, REL, REL</p> <p>if Radio Std is 802.11a/g(OFDM/DSSS-OFDM) or 802.11n(20MHz/40MHz): REL, REL, REL, AND, AND, AND, AND, AND, AND, AND, AND</p> <p>if Radio Std is 802.11ac (20 MHz/ 40 MHz/ 80 MHz/ 160 MHz): REL, REL, REL, AND, AND, AND, AND, AND, AND, AND, AND</p> <p>if Radio Std is 802.11ac (80 MHz + 80MHz): AND, REL, REL, REL, REL, REL, REL, AND, AND, AND, AND, AND</p> <p>if Radio Std is 802.11ah (1MHz/2 MHz/ 4 MHz/ 8 MHz/ 16 MHz): REL, REL, REL, AND, AND, AND, AND, AND, AND, AND, AND</p> <p>if Radio Std is 802.11j/p 10M, p5M: REL, REL, REL, AND , AND, AND, AND, AND, AND, AND, AND, AND</p> <p>MSR, LTEAFDD, LTEATDD: ABS, ABS, ABS, ABS, ABS, ABS, ABS, ABS, ABS, ABS, ABS, ABS, ABS</p>
State Saved	Saved in instrument state.
Range	Absolute Relative Abs AND Rel Abs OR Rel
Initial S/W Revision	Prior to A.02.00
Modified at S/W Revision	A.02.00, A.03.00, A.10.00, A.11.00, A.14.00

Offset Freq Define (Only for MSR and LTE-Advanced FDD/TDD)

This key enables you to select “Offset” definition. Each standard defines each “Offset” from Carrier.

Meas BW Edge means the edge of resolution band width that is represented by Meas BW and Res BW settings. Actual center frequency of Meas BW and the limit line have $\frac{1}{2}$ Meas BW offset when the Meas BW Edge is selected.

3GPP2 requires the “Carrier Center to Meas BW Edge” definition, and LTE conformance test requires “Carrier Edge to Meas BW Center” and/or “Carrier Edge to Meas BW Edge” definition. MSR standard requires “RFBW Edge to Meas BW Center” and/or “RFBW Edge to Meas Edge” definition.

- **CTOC** – From the lowermost carrier frequency (for lower offset), the uppermost carrier frequency (for upper offset) to the center of offset measuring filter*
- **CTOE** – From the lowermost carrier frequency (for lower offset), the uppermost carrier frequency (for upper offset) to the nominal -3 dB point of the offset measuring filter* closer to the carrier
- **ETOC** – From the lowermost carrier frequency - spacing of this carrier $/2$ (for lower offset), the uppermost carrier frequency + spacing of this carrier $/2$ (for upper offset) to the center of offset measuring filter*
- **ETOE** – From the lowermost carrier frequency - spacing of this carrier $/2$ (for lower offset), the uppermost carrier frequency + spacing of this carrier $/2$ (for upper offset) to the nominal -3 dB point of the offset measuring filter* closer to the carrier
- **RTOC** – From either the lower or upper RFBW edges to the center of offset measuring filter*
- **RTOE** – From either the lower or upper RFBW edges to the nominal -3 dB point of the offset measuring filter* closer to the carrier

*Measuring filter = Meas BW (N x Res BW)

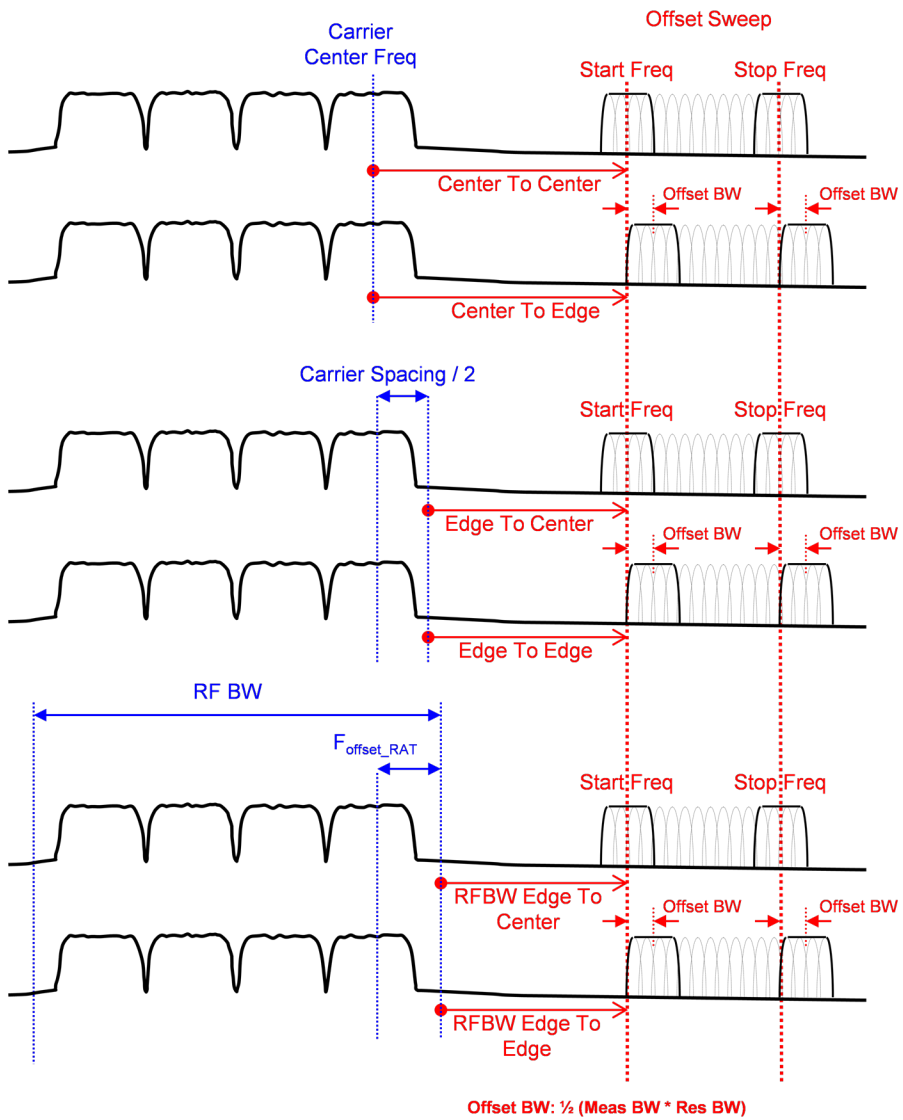

Offset Freq Definition in SEM Measurement

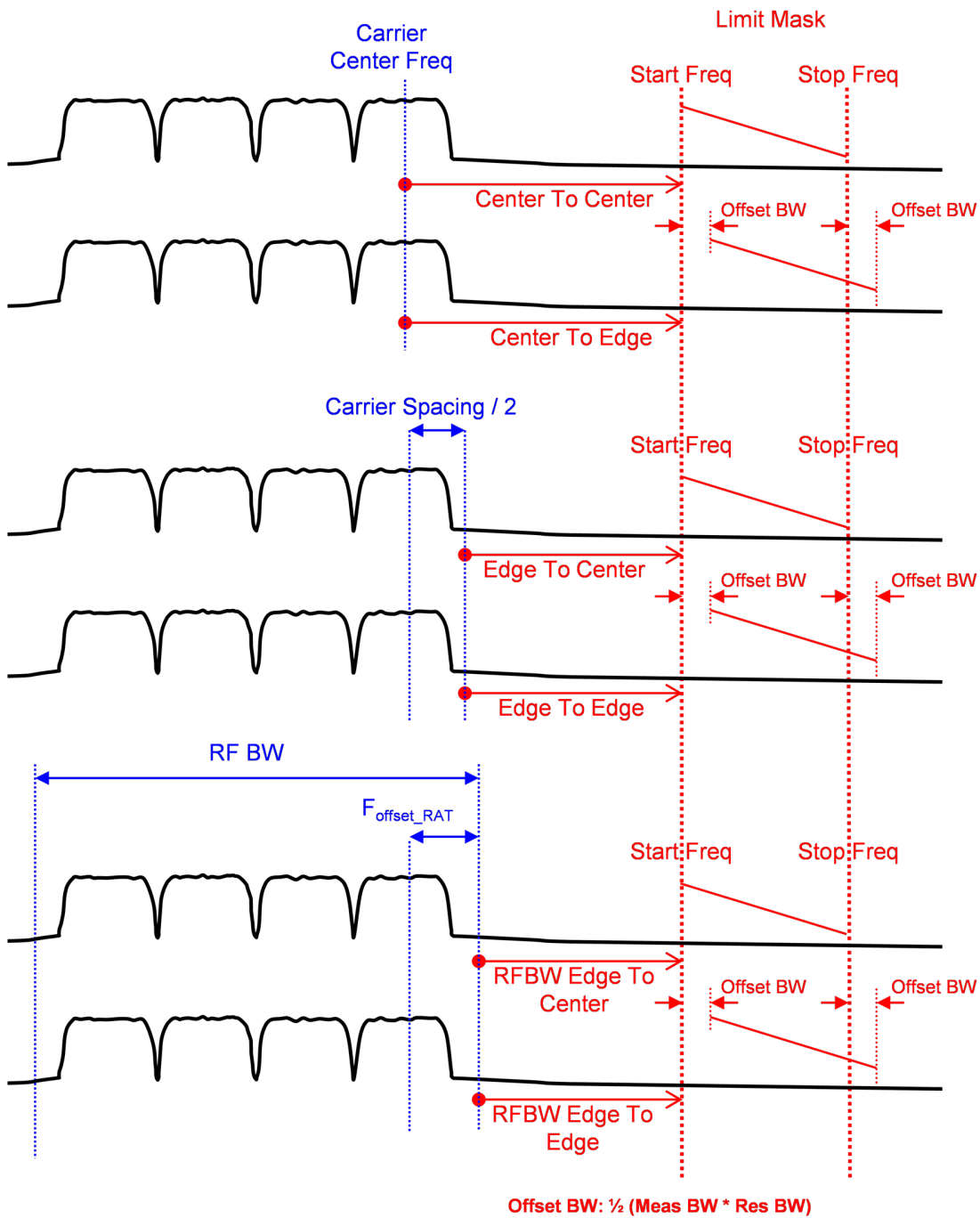

Offset Freq Definition (Limit Mask) in SEM measurement

Key Path	Meas Setup, Offset/Limits
Mode	MSR, LTEAFDD, LTEATDD
Remote Command	[[:SENSe]:SEMask:OFFSet[1] 2[:OUTer]:TYPE CTOC CTOE ETOC ETOE RTOC RTOE [:SENSe]:SEMask:OFFSet[1] 2[:OUTer]:TYPE?

Example	SEM:OFFS:TYPE ETOC SEM:OFFS:TYPE?
Notes	You must be in the MSR and LTE-Advanced FDD/TDD mode to use this command. Use :INSTRument:SElect to set the mode. For other modes, see Offset Freq Define .
Preset	MSR:RTOC LTEAFDD, LTEATDD: ETOC
State Saved	Saved in instrument state.
Range	Carrier Center To Meas BW Center Carrier Center To Meas BW Edge Carrier Edge To Meas BW Center Carrier Edge To Meas BW Edge RFBW Edge To Meas BW Center RFBW Edge To Meas BW Edge
Readback	Center to Center Center to Edge Edge to Center Edge to Edge R Edge to Center R Edge to Edge
Backwards Compatibility SCPI	[:SENSe] :SEMAsk :OFFSet [1] 2 :TYPE CTOCenter CTOEdge ETOCenter ETOEdge
Initial S/W Revision	A.10.00
Modified at S/W Revision	A.14.00

Inner Offset/Limits (Only for MSR and LTE-Advanced FDD/TDD)

Accesses a menu that enables you to set up the measurement parameters for offset pairs. For example, you can assign the start and stop frequencies, select the resolution bandwidth, and set the sweep time.

Until now, the latest LTE-Advanced FDD/TDD standards give the test specification requirements for BS intra-band contiguous aggregation and intra-band non-contiguous aggregation modes. However for UE, they just define the requirements of intra-band contiguous aggregation modes. So the standards don't support to do the measurement in UE intra-band non-contiguous aggregation mode for LTE-Advanced FDD/TDD, then the preset values of Inner Offset/Limits are temporarily set as those of Outer Offset/Limits for UE.

Limits for Inner Offsets

Since inner offsets are defined from the sub-block edges to the gap, limits from two sub-blocks overlap each other. Therefore the limit used for inner offsets are the cumulative sum of limits from the both sub-blocks. Offsets can have different RBWs, which must be compensated when accumulated.

For example, when offset A and D overlap, the limit of offset A is calculated as follows.

$$\text{Cumulated Limit of Offset A} = 10^{\frac{[\text{Offset A Limit in dBm}]}{10}} + \frac{\text{Offset A RBW}}{\text{Offset D RBW}} 10^{\frac{[\text{Offset D Limit in dBm}]}{10}}$$

Key Path	Meas Setup
Initial S/W Revision	A.14.00

Select Offset

Selects the offset (upper and lower) and displays the memory selection menu that enables you to store a set of parameter values for the offset, such as Start Freq, Stop Freq, Sweep Time, Res BW, Meas BW, Abs Start, and Abs Stop. Only one selection at a time is shown on this menu key label.

Key Path	Meas Setup, Inner Offset/Limits
Mode	MSR, LTEAFDD, LTEATDD
Preset	A
Range	A B C D E F G H J K L
Initial S/W Revision	A.14.00

Start Freq

Specifies the start frequency for the currently selected offset. Also, enables you to toggle that offset between On and Off. Missing values are not permitted; that is, if you want to change values 2 and 6, you must send all values up to 6. Subsequent values will remain as they were. The query for this parameter always returns 12 values.

Key Path	Meas Setup, Inner Offset/Limits
Mode	MSR, LTEAFDD, LTEATDD
Remote Command	[:SENSe]:SEMask:OFFSet [1] 2:INNer:LIST:FREQuency:STARt <freq>, ... [:SENSe]:SEMask:OFFSet [1] 2:INNer:LIST:FREQuency:STARt? [:SENSe]:SEMask:OFFSet [1] 2:INNer:LIST:STATe ON OFF 1 0, ... [:SENSe]:SEMask:OFFSet [1] 2:INNer:LIST:STATe?
Example	SEM:OFFS2:INN:LIST:FREQ:STAR 2.515 MHz, 2.715 MHz, 3.515 MHz, 4.00 MHz, 8.00 MHz, 12.50 MHz SEM:OFFS2:INN:LIST:FREQ:STAR? SEM:OFFS:INN:LIST:STAT ON, ON, ON, OFF, OFF, OFF SEM:OFFS:INN:LIST:STAT?
Notes	Comma separated list of values. OFFSet1 is for BTS, 2 for MS. Default is BTS. If the offset is outside of the frequency range, the result spectrum will be invalid. You must be in the MSR and LTE-Advanced FDD/TDD modes to use this command. Use :INSTrument:SElect to set the mode.
Couplings	Coupled to Stop Freq. When the start freq goes above the stop freq, the stop freq is automatically adjusted to the start freq plus 100Hz.
Preset	MSR:15 kHz, 215 kHz, 1.015 MHz, 1.5 MHz, 10.5 MHz, 15.00 MHz, 30 MHz, 30 MHz, 30 MHz, 30 MHz, 30 MHz 15 kHz, 215 kHz, 1.015 MHz, 1.5 MHz, 10.5 MHz, 15.00 MHz, 30 MHz, 30 MHz, 30 MHz, 30 MHz, 30 MHz LTEAFDD, LTEATDD: 50 kHz, 5.05 MHz, 10.5 MHz, 15.00 MHz, 30 MHz, 40 MHz, 40 MHz, 40 MHz, 40 MHz, 40 MHz 15.00 kHz, 1.5 MHz, 5.5 MHz, 6.5 MHz, 10 MHz, 20MHz, 20MHz, 20MHz, 20MHz, 20MHz, 20MHz, 20MHz

	MSR:ON, ON, ON, ON, ON, OFF, OFF, OFF, OFF, OFF, OFF, OFF ON, ON, ON, ON, ON, OFF, OFF, OFF, OFF, OFF, OFF, OFF LTEAFDD, LTEATDD: ON, ON, ON, OFF, OFF, OFF, OFF, OFF, OFF, OFF, OFF, OFF ON, ON, ON, ON, OFF, OFF, OFF, OFF, OFF, OFF, OFF
State Saved	Saved in instrument state.
Min	0 Hz
Max	Depends on instrument maximum frequency. It's always Offset Stop Freq – 100 Hz
Initial S/W Revision	A.14.00, A.16.00

Stop Freq

Specifies the stop frequency for the currently selected offset.

Missing values are not permitted; that is, if you want to change values 2 and 6 you must send all values up to 6. Subsequent values will remain as they were. The query for this parameter always returns 12 values.

Key Path	Meas Setup, Inner Offset/Limits
Mode	MSR, LTEAFDD, LTEATDD
Remote Command	[:SENSe] :SEMAsk:OFFSet [1] 2 :INNer:LIST:FREQuency:STOP <freq>, ... [:SENSe] :SEMAsk:OFFSet [1] 2 :INNer:LIST:FREQuency:STOP?
Example	SEM:OFFS:INN:LIST:FREQ:STOP 2.715 MHz, 3.515 MHz, 4.00 MHz, 8.00 MHz, 12.50 MHz, 15.0 MHz SEM:OFFS:INN:LIST:FREQ:STOP?
Notes	Comma separated list of values. OFFSet1 is for BTS, 2 for MS. Default is BTS. If the offset is outside of the frequency range, the result spectrum will be invalid. You must be in the MSR and LTE-Advanced FDD/TDD mode to use this command. Use :INSTrument:SElect to set the mode.
Couplings	Coupled to Start Freq. When the stop freq goes below the start freq, the start freq is automatically adjusted to the stop freq minus 100 Hz.
Preset	MSR:215 kHz, 1.015 MHz, 1.5 MHz, 10.5 MHz, 50 MHz, 50 MHz, 50 MHz, 50 MHz, 50 MHz, 50 MHz, 50 MHz, 50 MHz LTEAFDD, LTEATDD: 5.05 MHz, 10.05 MHz, 15 MHz, 30 MHz, 40 MHz, 50 MHz, 50 MHz, 50 MHz, 50 MHz, 50 MHz, 50 MHz 985.0 kHz, 4.50 MHz, 5.5001 MHz, 9.50 MHz, 20 MHz, 40 MHz, 40 MHz, 40 MHz, 40 MHz, 40 MHz, 40 MHz, 40 MHz
State Saved	Saved in instrument state.
Min	100 Hz
Max	Depends on instrument maximum frequency. Same as the Max Span on Swept SA Measurement.
Initial S/W Revision	A.14.00
Modified at S/W Revision	A.16.00

Sweep Time

Specifies the sweep time for the currently selected offset and enables you to toggle the sweep Time mode between Auto and Man.

Missing values are not permitted; that is, if you want to change values 2 and 6, you must send all values up to 6. Subsequent values will remain as they were. The query for this parameter always returns 12 values.

Key Path	Meas Setup, Inner Offset/Limits
Mode	MSR, LTEAFDD, LTEATDD
Remote Command	<pre>[:SENSe] :SEMask:OFFSet [1] 2 :INNeR:LIST:SWEep:TIME <time>, ... [:SENSe] :SEMask:OFFSet [1] 2 :INNeR:LIST:SWEep:TIME? [:SENSe] :SEMask:OFFSet [1] 2 :INNeR:LIST:SWEep:TIME:AUTO ON OFF 1 0, ... [:SENSe] :SEMask:OFFSet [1] 2 :INNeR:LIST:SWEep:TIME:AUTO?</pre>
Example	<pre>SEM:OFFS2:INN:LIST:SWE:TIME 1.0 ms, 3.4 ms, 2.08 ms, 1.0 ms, 1.0 ms, 1.0 ms SEM:OFFS2:INN:LIST:SWE:TIME? SEM:OFFS2:INN:LIST:SWE:TIME:AUTO ON, ON, ON, ON, OFF, OFF SEM:OFFS2:INN:LIST:SWE:TIME:AUTO?</pre>
Notes	<p>OFFSet1 is for BTS, 2 for MS. Default is BTS.</p> <p>You must be in the MSR and LTE-Advanced FDD/TDD modes to use this command. Use :INSTRument:SElect to set the mode.</p>
Couplings	When the sweep time is set manually, Sweep Time Mode is set to MANual.
Preset	<p>Automatically calculated</p> <p>MSR:ON,ON,ON,ON,ON,ON,ON,ON,ON,ON,ON,ON,ON</p> <p>LTEAFDD, LTEATDD: ON, ON, ON, ON, ON, ON, ON, ON, ON, ON, ON, ON ON, ON, ON, ON, ON, ON, ON, ON, ON, ON, ON, ON</p>
State Saved	Saved in instrument state.
Min	<p>X-Series HW:</p> <p>Depends on Sweep Type</p> <p>Sweep Type "Swept": 1ms</p> <p>Sweep Type "FFT": 100ns</p> <p>E6630A_E6640A_M90XA:TBD</p> <p>E7515A: 39.2 usec</p>
Max	10 s
Initial S/W Revision	A.14.00, A.16.00

Sweep Type

Chooses between the FFT and Sweep types of sweep.

Sweep Type refers to whether or not the instrument is in Swept or FFT analysis. When in Auto, the selection of sweep type is governed by two different sets of rules, depending on whether you want to optimize for dynamic range or for speed.

FFT “sweeps” should not be used when making EMI measurements; therefore, when a CISPR detector (Quasi Peak, EMI Average, RMS Average) is selected for any active trace (one for which Update is on), the FFT key in the Sweep Type menu is grayed out, and the Auto Rules only choose Swept. If Sweep Type is manually selected to be FFT, the CISPR detectors are all grayed out.

FFT sweeps will never be auto-selected when Screen Video, Log Video or Linear Video are the selected Analog Output.

Key Path	Sweep/Control, Sweep Setup
Remote Command	<code>[:SENSe] :SWEep:TYPE FFT SWEep</code> <code>[:SENSe] :SWEep:TYPE?</code>
Dependencies	In Zero Span, this key is irrelevant and cannot be accessed (because the whole Sweep Setup menu is grayed out in Zero Span), however its settings can be changed remotely with no error indication. When Gate is on, Gate Method selection affects Sweep Type: Method FFT&Sweep menu FFT - Swept grayed out and rules choose FFT Video - FFT grayed out and rules choose Swept LO - FFT grayed out and rules choose Swept
Preset	AUTO
Backwards Compatibility SCPI	<code>[:SENSe] :SWEep:TYPE AUTO</code> sets sweep type Auto to On but the query will return either FFT or SWE depending on the auto setting. <code>[:SENSe] :SWEep:TYPE SWP</code> selects sweep type Swept but will return SWE on a query
Initial S/W Revision	Prior to A.02.00

Auto

When in Auto, the selection of sweep type is governed by two different sets of rules, depending on whether you want to optimize for dynamic range or for speed. These rules are chosen under the **Sweep Type Rules** key.

Key Path	Sweep/Control, Sweep Setup, Sweep Type
Remote Command	<code>[:SENSe] :SWEep:TYPE:AUTO OFF ON 0 1</code> <code>[:SENSe] :SWEep:TYPE:AUTO?</code>
Example	<code>:SWE:TYPE:AUTO ON</code>
Couplings	Pressing Auto Couple always sets Sweep Type to Auto. Swept is always chosen whenever any form of Signal ID is on, or the Source Mode is set to Tracking, or any EMI detector is selected, or the RF Preselector is ON.

Preset	ON
State Saved	Saved in instrument state
Initial S/W Revision	Prior to A.02.00

Swept

Manually selects swept analysis, so it cannot change automatically to FFT.

Key Path	Sweep/Control, Sweep Setup, Sweep Type
Example	SWE:TYPE SWE
Dependencies	Grayed out while in Gated FFT (meaning Gate is ON and Gate Method is FFT). If this key is selected, the gate method Gated FFT is grayed out.
Couplings	This selection is chosen automatically if any of the CISPR detectors is chosen for any active trace, in which case the FFT Sweep Type selection is also grayed out.
State Saved	Saved in instrument state
Readback	Swept
Initial S/W Revision	Prior to A.02.00
Modified at S/W Revision	A.02.00

FFT

Manually selects FFT analysis, so it cannot change automatically to Swept.

Key Path	Sweep/Control, Sweep Setup, Sweep Type
Example	SWE:TYPE FFT
Dependencies	When a CISPR detector (Quasi Peak, EMI Average, RMS Average) is selected for any active trace, the FFT key is grayed out. When the RF Preselector is on, the FFT key is grayed out. When Source Mode is set to Tracking, Manual FFT is grayed out. When Signal ID is on, Manual FFT is grayed out. Grayed out while in Gated LO (meaning Gate is ON and Gate Method is LO). Grayed out while in Gated Video (meaning Gate is ON and Gate Method is Video).
State Saved	Saved in instrument state
Readback	FFT
Initial S/W Revision	Prior to A.02.00

Offset Side

Specifies which offset side to measure.

You can turn off (not use) specific offsets with [:SENSE]:SEMask:OFFSet[n]:INNER:LIST:STATe.

- BOTH – Both sides in the sub-block gap are enabled.
- NEGative – The upper side in the sub-block gap only (i.e. negative sideband of the upper sub-block) is enabled
- POSitive – The lower side in the sub-block gap only (i.e. positive sideband of the lower sub-block) is enabled.

Missing values are not permitted; that is, if you want to change values 2 and 6, you must send all values up to 6. Subsequent values will remain as they were. The query for this parameter always returns 12 values.

The figure below shows the relation between the negative/positive offset side setups and the upper/lower results in the MSR and LTE-Advanced FDD/TDD.

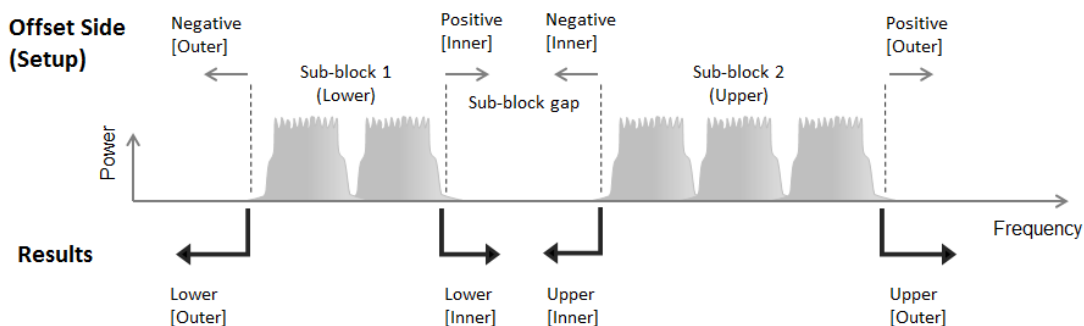

Key Path	Meas Setup, Inner Offset/Limits
Mode	MSR, LTEAFDD, LTEATDD
Remote Command	[:SENSE]:SEMask:OFFSet[1] 2:INNER:LIST:SIDE BOTH NEGative POSitive, ... [:SENSE]:SEMask:OFFSet[1] 2:INNER:LIST:SIDE?
Example	SEM:OFFS:INN:LIST:SIDE BOTH, NEG, NEG, POS, POS, POS SEM:OFFS:INN:LIST:SIDE?
Notes	Comma separated list of values. OFFSet1 is for BTS, 2 for MS. Default is BTS. You must be in the MSR and LTE-Advanced FDD/TDD modes to use this command. Use :INSTrument:SElect to set the mode.
Preset	MSR: BOTH, BOTH, BOTH, BOTH, BOTH, BOTH, BOTH, BOTH, BOTH, BOTH, BOTH, BOTH LTEAFDD, LTEATDD: BOTH, BOTH, BOTH, BOTH, BOTH, BOTH, BOTH, BOTH, BOTH, BOTH, BOTH, BOTH, BOTH BOTH, BOTH, BOTH, BOTH, BOTH, BOTH, BOTH, BOTH, BOTH, BOTH, BOTH, BOTH
State Saved	Saved in instrument state.
Range	Neg Both Pos
Initial S/W Revision	A.14.00

Res BW

Specifies which Resolution BW filter to use when measuring the currently selected offset.

Offset Res BW Mode allows the instrument to determine the optimum Resolution BW filter to use when measuring the currently selected offset. using front panel and all the offsets using SCPI. When changing the Meas BW parameter, if the Res BW needs to be changed to adhere to the rule

$(N \times \text{Res BW}) \leq (\text{Stop freq of the offset} - \text{Start freq of the offset})$,

where N is the multiplier, this setting will automatically be changed to manual.

Missing values are not permitted; that is, if you want to change values 2 and 6, you must send all values up to 6. Subsequent values will remain as they were. The query for this parameter always returns 12 values.

Key Path	Meas Setup, Inner Offset/Limits
Mode	MSR, LTEAFDD, LTEATDD
Remote Command	<pre>[:SENSe] :SEMask:OFFSet [1] 2 :INNeR:LIST:BAWdth [:RESolution] <bandwidth>, ... [:SENSe] :SEMask:OFFSet [1] 2 :INNeR:LIST:BAWdth [:RESolution] ? [:SENSe] :SEMask:OFFSet [1] 2 :INNeR:LIST:BAWdth [:RESolution] :AUTO OFF ON 1 0, ... [:SENSe] :SEMask:OFFSet [1] 2 :INNeR:LIST:BAWdth [:RESolution] :AUTO?</pre>
Example	<pre>SEM:OFFS2:INN:LIST:BAND 30.0 kHz, 30.0 kHz, 30.0 kHz, 1.00 MHz, 1.00 MHz, 1.00 MHz SEM:OFFS2:INN:LIST:BAND? SEM:OFFS:INN:LIST:BAND:AUTO 1,1,1,1,1,1 SEM:OFFS:INN:LIST:BAND:AUTO?</pre>
Notes	<p>Comma separated list of values.</p> <p>OFFSet1 is for BTS, 2 for MS. Default is BTS.</p> <p>You must be in the MSR and LTE-Advanced FDD/TDD modes to use this command. Use :INSTRument:SElect to set the mode.</p>
Couplings	<p>Coupled to Start and Stop offset and Meas BW multiplier. This parameter must adhere to the rule $(N \times \text{Res BW}) \leq (\text{Stop freq of the offset} - \text{Start freq of the offset})$, where N is the multiplier. If the multiplier is changed, the Res BW will be changed to ensure this. When set manually, Res BW Coupling is set to manual.</p> <p>The resolution bandwidth is coupled to the offset width determined by the start frequency and stop frequency.</p>
Preset	<pre>MSR:30 kHz, 30 kHz, 30 kHz, 1.0 MHz, 1.0 MHz, 1.0 MHz, 1.0 MHz, 1.0 MHz, 1.0 MHz, 1.0 MHz, 1.0 MHz, 1.0 MHz 30 kHz, 30 kHz, 30 kHz, 1.0 MHz, 1.0 MHz, 1.0 MHz, 1.0 MHz, 1.0 MHz, 1.0 MHz, 1.0 MHz, 1.0 MHz, 1.0 MHz LTEAFDD, LTEATDD: 51 kHz, 100 kHz, 1.0 MHz, 1.0 MHz, 1.0 MHz, 1.0 MHz, 1.0 MHz, 1.0 MHz, 1.0 MHz, 1.0 MHz, 1.0 MHz, 1.0 MHz 15.0 kHz, 510 kHz, 1.0 MHz, 1.0 MHz, 1.0 MHz, 1.0 MHz, 1.0 MHz, 1.0 MHz, 1.0 MHz, 1.0 MHz, 1.0 MHz, 1.0 MHz OFF, OFF, OFF, OFF, OFF, OFF, OFF, OFF, OFF, OFF, OFF, OFF OFF, OFF, OFF, OFF, OFF, OFF, OFF, OFF, OFF, OFF, OFF, OFF</pre>
State Saved	Saved in instrument state.

Min	1 Hz
Max	8 MHz
Initial S/W Revision	A.14.00

Meas BW

Allows you to specify a multiplier of Res BW for the measurement integration bandwidth.

Meas BW is multiplier integer number. It shows a ratio between Integration BW and Resolution BW of the measurement result.

Integ BW = Meas BW * Resolution BW

Integration BW is desired resolution bandwidth and Resolution BW is actual bandwidth for sweep. Measurement sweeps with Resolution BW and Meas BW compensates sweep resolution bandwidth to Integration BW.

If you set this parameter greater than 1, you can set Resolution BW narrower to avoid carrier power leakage effect to the offset power integration.

Missing values are not permitted; that is, if you want to change values 2 and 6, you must send all values up to 6. Subsequent values will remain as they were. The query for this parameter always returns 12 values.

Key Path	Meas Setup, Inner Offset/Limits
Mode	MSR, LTEAFDD, LTEATDD
Remote Command	<code>[:SENSE] :SEMAsk:OFFSet [1] 2 :INNer:LIST:BANdwidth:IMULti <integer>, ...</code> <code>[:SENSE] :SEMAsk:OFFSet [1] 2 :INNer:LIST:BANdwidth:IMULti?</code>
Example	SEM:OFFS2:INN:LIST:BAND:IMUL 1,1,1,1,1,1 SEM:OFFS2:INN:LIST:BAND:IMUL?
Notes	Comma separated list of values. OFFSet1 is for BTS, 2 for MS. Default is BTS. You must be in the MSR and LTE-Advanced FDD/TDD modes to use this command. Use :INSTrument:SElect to set the mode.
Couplings	This parameter must adhere to the rule $(N \times \text{Res BW}) \leq (\text{Stop freq of the offset} - \text{Start freq of the offset})$, where N is the multiplier. If the Res Bw is changed, the multiplier will be changed to ensure this.
Preset	MSR:1, 1, 1, 1, 1, 1, 1, 1, 1, 1, 1 1, 1, 1, 1, 1, 1, 1, 1, 1, 1, 1, 1 LTEAFDD, LTEATDD: 2, 1, 1, 1, 1, 1, 1, 1, 1, 1, 1 2, 2, 1, 1, 1, 1, 1, 1, 1, 1, 1, 1
State Saved	Saved in instrument state.
Min	1
Max	1000
Initial S/W Revision	A.14.00

Video BW

Changes the analyzer post-detection filter.

Missing values are not permitted; that is, if you want to change values 2 and 6, you must send all values up to 6. Subsequent values will remain as they were. The query for this parameter always returns 12 values.

Key Path	Meas Setup, Inner Offset/Limits
Mode	MSR, LTEAFDD, LTEATDD
Remote Command	[:SENSe]:SEMask:OFFSet[1] 2:INNeR:LIST:BANDwidth:VIDeo <freq>, ... [:SENSe]:SEMask:OFFSet[1] 2:INNeR:LIST:BANDwidth:VIDeo? [:SENSe]:SEMask:OFFSet[1] 2:INNeR:LIST:BANDwidth:VIDeo:AUTO OFF ON 0 1, ... [:SENSe]:SEMask:OFFSet[1] 2:INNeR:LIST:BANDwidth:VIDeo:AUTO?
Example	SEM:OFFS2:INN:LIST:BAND:VID 3.00 kHz, 3.00 kHz, 3.00 kHz, 100.0 kHz, 100.0 kHz, 100.0 kHz SEM:OFFS2:INN:LIST:BAND:VID? SEM:OFFS2:INN:LIST:BAND:VID:AUTO ON, ON, ON, ON, ON, ON SEM:OFFS2:INN:LIST:BAND:VID:AUTO?
Notes	Comma separated list of values. OFFSet1 is for BTS, 2 for MS. Default is BTS. You must be in the MSR and LTE-Advanced FDD/TDD modes to use this command. Use :INSTrument:SElect to set the mode.
Couplings	This parameter is basically coupled with other parameters like Spectrum Analyzer. When the Auto State is ON, Video BW is basically coupled with other parameters like Spectrum Analyzer.
Preset	Automatically Calculated ON, ON, ON, ON, ON, ON, ON, ON, ON, ON, ON, ON ON, ON, ON, ON, ON, ON, ON, ON, ON, ON, ON, ON
State Saved	Saved in instrument state.
Min	1 Hz
Max	50 MHz
Initial S/W Revision	A.14.00

VBW/RBW

Selects the ratio between the video and resolution bandwidths.

Missing values are not permitted; that is, if you want to change values 2 and 6, you must send all values up to 6. Subsequent values will remain as they were. The query for this parameter always returns 12 values.

Key Path	Meas Setup, Inner Offset/Limits
Mode	MSR, LTEAFDD, LTEATDD
Remote Command	[:SENSe]:SEMask:OFFSet[1] 2:INNeR:LIST:BANDwidth:VIDeo:RATio <real>, ...

	[:SENSe]:SEMask:OFFSet[1] 2:INNeR:LIST:BANDwidth:VIDeo:RATio?
	[:SENSe]:SEMask:OFFSet[1] 2:INNeR:LIST:BANDwidth:VIDeo:RATio:AUTO OFF ON 0 1, ...
	[:SENSe]:SEMask:OFFSet[1] 2:INNeR:LIST:BANDwidth:VIDeo:RATio:AUTO?
Example	SEM:OFFS2:INN:LIST:BAND:VID:RAT 0.1, 0.1, 0.1, 0.1, 0.1, 0.1 SEM:OFFS2:INN:LIST:BAND:VID:RAT? SEM:OFFS:INN:LIST:BAND:VID:RAT:AUTO ON, ON, ON, ON, ON, ON SEM:OFFS:INN:LIST:BAND:VID:RAT:AUTO?
Notes	Comma separated list of values. OFFSet1 is for BTS, 2 for MS. Default is BTS. You must be in the MSR and LTE-Advanced FDD/TDD modes to use this command. Use :INSTRument:SElect to set the mode.
Couplings	This parameter is basically coupled with other parameters like Spectrum Analyzer. When the Auto State is ON, the VBW/RBW is basically coupled with other parameters like Spectrum Analyzer.
Preset	0.01, 0.01, 0.01, 0.01, 0.01, 0.01, 0.01, 0.01, 0.01, 0.01, 0.01, 0.01 0.01, 0.01, 0.01, 0.01, 0.01, 0.01, 0.01, 0.01, 0.01, 0.01 OFF, OFF, OFF, OFF, OFF, OFF, OFF, OFF, OFF, OFF, OFF, OFF OFF, OFF, OFF, OFF, OFF, OFF, OFF, OFF, OFF, OFF, OFF, OFF
State Saved	Saved in instrument state.
Min	0.00001
Max	3000000
Initial S/W Revision	A.14.00

Limits

Accesses a menu that enables you to set the power limits for start and stop frequencies of the selected offsets.

Key Path	Meas Setup
Initial S/W Revision	A.14.00

Select Offset

Selects the offset (upper and lower) and displays the memory selection menu that enables you to store a set of parameter values for the offset, such as Start Freq, Stop Freq, Sweep Time, Res BW, Meas BW, Abs Start, and Abs Stop. Only one selection at a time is shown on this menu key label.

Key Path	Meas Setup, Inner Offset/Limits
Mode	MSR, LTEAFDD, LTEATDD

Preset	A
Range	A B C D E F G H J K L
Initial S/W Revision	A.14.00

Abs Start

Sets the absolute power level limit at the start frequency for the selected offset. The absolute power level limit ranges from -200 to +50 dBm.

The fail condition for each offset channel is set remotely by [:SENSe]:SEMAsk:OFFSet[n]:INNer:LIST:TEST.

You can turn off (not use) specific offset channels remotely with [:SENSe]:SEMAsk:OFFSet [n]:INNer:LIST:STATe.

The SCPI query returns values currently set to the absolute power test limits.

Missing values are not permitted; that is, if you want to change values 2 and 6, you must send all values up to 6. Subsequent values will remain as they were. The query for this parameter always returns 12 values.

Key Path	Meas Setup, Inner Offset/Limits, Limits
Mode	MSR, LTEAFDD, LTEATDD
Remote Command	[:SENSe]:SEMAsk:OFFSet [1] 2:INNer:LIST:STARt:ABSolute <real>, ... [:SENSe]:SEMAsk:OFFSet [1] 2:INNer:LIST:STARt:ABSolute?
Example	SEM:OFFS2:INN:LIST:STAR:ABS -12.50 dBm, -12.50 dBm, -24.50 dBm, -11.50 dBm, -11.50 dBm, -11.50 dBm SEM:OFFS2:INN:LIST:STAR:ABS?
Notes	Comma separated list of values. OFFSet1 is for BTS, 2 for MS. Default is BTS. You must be in the MSR and LTE-Advanced FDD/TDD modes to use this command. Use :INSTRument:SElect to set the mode.
Preset	MSR: -12.5 dBm, -12.5 dBm, -24.5 dBm, -11.5 dBm, -15.0 dBm, -15.0 dBm, -15.0 dBm, -15.0 dBm, -15.0 dBm, -15.0 dBm, -15.0 dBm, -15.0 dBm -12.5 dBm, -12.5 dBm, -24.5 dBm, -11.5 dBm, -15.0 dBm, -15.0 dBm, -15.0 dBm, -15.0 dBm, -15.0 dBm, -15.0 dBm, -15.0 dBm, -15.0 dBm LTEAFDD, LTEATDD: -5.5 dBm, -12.5 dBm, -15.0 dBm, -15.0 dBm, -15.0 dBm, -15.0 dBm, -15.0 dBm, -15.0 dBm, -15.0 dBm, -15.0 dBm, -15.0 dBm -13.5 dBm, -8.5 dBm, -11.5 dBm, -23.5 dBm, -23.5 dBm, -23.5 dBm, -23.5 dBm, -23.5 dBm, -23.5 dBm, -23.5 dBm, -23.5 dBm, -23.5 dBm, -23.5 dBm
State Saved	Saved in instrument state.
Min	-200 dBm
Max	50 dBm
Initial S/W Revision	A.14.00

Abs Stop

Allows you to enter an absolute level limit at Stop Freq ranging from -200 to +50 dBm, and to toggle this function between Couple and Man. If set to Couple, this is coupled to Abs Start to make a flat limit line. If set to Man, Abs Start and Abs Stop can take different values to make a sloped limit line.

Sets the absolute power level limit at the stop frequency for the selected offset. The absolute power level limit ranges from -200 to +50 dBm. You can also toggle this function between couple and manual. If set to Couple, the Abs Stop power level limit is coupled to Abs Start to result in a flat limit line. If set to Man, Abs Start and Abs Stop take different values to result in a sloped limit line.

The SCPI query returns values currently set to the offset stop absolute power limits.

Missing values are not permitted; that is, if you want to change values 2 and 6, you must send all values up to 6. Subsequent values will remain as they were. The query for this parameter always returns 12 values.

Key Path	Meas Setup, Inner Offset/Limits, Limits
Mode	MSR, LTEAFDD, LTEATDD
Remote Command	[:SENSE]:SEMAsk:OFFSet[1] 2:INNeR:LIST:STOP:ABSolute <real>, ... [:SENSE]:SEMAsk:OFFSet[1] 2:INNeR:LIST:STOP:ABSolute? [:SENSE]:SEMAsk:OFFSet[1] 2:INNeR:LIST:STOP:ABSolute:COUPle ON OFF 1 0, ... [:SENSE]:SEMAsk:OFFSet[1] 2:INNeR:LIST:STOP:ABSolute:COUPle?
Example	SEM:OFFS:INN:LIST:STOP:ABS -12.50 dBm, -24.50 dBm, -24.50 dBm, -11.50 dBm, -11.50 dBm, -11.50 dBm SEM:OFFS1:INN:LIST:STOP:ABS? SEM:OFFS:INN:LIST:STOP:ABS:COUP ON, OFF, ON, ON, ON, ON SEM:OFFS:INN:LIST:STOP:ABS:COUP?
Notes	Comma separated list of values. OFFSet1 is for BTS, 2 for MS. Default is BTS. You must be in the MSR and LTE-Advanced FDD/TDD modes to use this command. Use :INSTrument:SElect to set the mode.
Couplings	Coupled to Abs Start if "Auto" is selected, that is, the Stop value is equal to the Start value.
Preset	MSR:-12.5 dBm, -24.5 dBm, -11.5 dBm, -15.0 dBm, -15.0 dBm, -15.0 dBm, -15.0 dBm, -15.0 dBm, -15.0 dBm, -15.0 dBm, -15.0 dBm, -15.0 dBm -12.5 dBm, -24.5 dBm, -11.5 dBm, -15.0 dBm, -15.0 dBm, -15.0 dBm, -15.0 dBm, -15.0 dBm, -15.0 dBm, -15.0 dBm, -15.0 dBm, -15.0 dBm, -15.0 dBm LTEAFDD, LTEATDD:-12.5 dBm, -12.5 dBm, -15.0 dBm, -15.0 dBm, -15.0 dBm, -15.0 dBm, -15.0 dBm, -15.0 dBm, -15.0 dBm, -15.0 dBm, -15.0 dBm, -15.0 dBm -13.5 dBm, -8.5 dBm, -11.5 dBm, -23.5 dBm, -23.5 dBm, -23.5 dBm -23.5 dBm, -23.5 dBm, -23.5 dBm, -23.5 dBm, -23.5 dBm, -23.5 dBm, -23.5 dBm, -23.5 dBm MSR:ON, OFF, OFF, OFF, ON, OFF, OFF, OFF, OFF, OFF, OFF, OFF ON, OFF, OFF, OFF, ON, OFF, OFF, OFF, OFF, OFF, OFF, OFF LTEAFDD, LTEATDD: OFF, ON, ON, ON, ON, ON, ON, ON, ON, ON, ON, ON ON, ON, ON, ON, ON, ON, ON, ON, ON, ON, ON, ON, ON, ON, ON, ON
State Saved	Saved in instrument state.

Min	-200 dBm
Max	50 dBm
Initial S/W Revision	A.14.00

Rel Start

Allows you to enter a relative level limit at Start Freq ranging from -200 to +50 dBc.

Sets a relative power level limit at the start frequency for the selected offset. The relative power level limit ranges from -200 to +50 dBc.

The fail condition is set remotely by [:SENSE]:SEMask:OFFSet[n]:INNER:LIST:TEST for each offset channel test.

You can turn off (not use) specific offset channels remotely with [:SENSE]:SEMask:OFFSet [n]:INNER:LIST:STATE.

The SCPI query returns values currently set to the relative power test limits.

Missing values are not permitted; that is, if you want to change values 2 and 6, you must send all values up to 6. Subsequent values will remain as they were. The query for this parameter always returns 12 values.

Key Path	Meas Setup, Inner Offset/Limits, Limits
Mode	MSR, LTEAFDD, LTEATDD
Remote Command	[:SENSE]:SEMask:OFFSet [1] 2:INNER:LIST:START:RCARrier <rel_ampl>, ... [:SENSE]:SEMask:OFFSet [1] 2:INNER:LIST:START:RCARrier?
Example	SEM:OFFS:INN:LIST:STAR:RCAR -30, -30, -30, -30, -30, -30 SEM:OFFS:INN:LIST:STAR:RCAR?
Notes	Comma separated list of values. OFFSet1 is for BTS, 2 for MS. Default is BTS. You must be in the MSR and LTE-Advanced FDD/TDD modes to use this command. Use :INSTrument:SElect to set the mode.
Preset	0 dB, 0 dB, 0 dB, 0 dB, 0 dB, 0 dB, 0 dB, 0 dB, 0 dB, 0 dB, 0 dB 0 dB, 0 dB, 0 dB, 0 dB, 0 dB, 0 dB, 0 dB, 0 dB, 0 dB, 0 dB, 0 dB
State Saved	Saved in instrument state.
Min	-200 dB
Max	50 dB
Initial S/W Revision	A.14.00

Rel Stop

Sets a relative power level limit at the stop frequency for the selected offset. The relative power level limit ranges from -200 to +50 dBc.

The fail condition is set remotely by [:SENSE]:SEMask:OFFSet[n]:INNER:LIST:TEST for each offset channel.

You can turn off (not use) specific offset channels remotely with [:SENSe]:SEMask:OFFSet [n]:INNeR:LIST:STATe.

The SCPI query returns values currently set to the offset stop relative power limits.

Missing values are not permitted; that is, if you want to change values 2 and 6, you must send all values up to 6. Subsequent values will remain as they were. The query for this parameter always returns 12 values.

Key Path	Meas Setup, Inner Offset/Limits, Limits
Mode	MSR, LTEAFDD, LTEATDD
Remote Command	[:SENSe]:SEMask:OFFSet [1] 2:INNeR:LIST:STOP:RCARrier <rel_ampl>, ... [:SENSe]:SEMask:OFFSet [1] 2:INNeR:LIST:STOP:RCARrier? [:SENSe]:SEMask:OFFSet [1] 2:INNeR:LIST:STOP:RCARrier:COUPle ON OFF 1 0, ... [:SENSe]:SEMask:OFFSet [1] 2:INNeR:LIST:STOP:RCARrier:COUPle?
Example	SEM:OFFS:INN:LIST:STOP:RCAR -30, -30, -30, -30, -30, -30 SEM:OFFS:INN:LIST:STOP:RCAR? SEM:OFFS:INN:LIST:STOP:RCAR:COUP ON, ON, ON, ON, ON, ON SEM:OFFS:INN:LIST:STOP:RCAR:COUP?
Notes	Comma separated list of values. OFFSet1 is for BTS, 2 for MS. Default is BTS. You must be in the MSR and LTE-Advanced FDD/TDD modes to use this command. Use :INSTrument:SElect to set the mode.
Couplings	Coupled to Rel Start if "Auto" is selected, that is, Start is made the same as Stop.
Preset	0 dB, 0 dB, 0 dB, 0 dB, 0 dB, 0 dB, 0 dB, 0 dB, 0 dB, 0 dB, 0 dB, 0 dB 0 dB, 0 dB, 0 dB, 0 dB, 0 dB, 0 dB, 0 dB, 0 dB, 0 dB, 0 dB, 0 dB, 0 dB ON, ON, ON, ON, ON, ON, ON, ON, ON, ON, ON, ON ON, ON, ON, ON, ON, ON, ON, ON, ON, ON, ON, ON, ON, ON
State Saved	Saved in instrument state.
Min	-200 dB
Max	50 dB
Initial S/W Revision	A.14.00

Fail Mask

Selects one of the logic keys for fail conditions between the measurement results and the test limits:

- Absolute and Relative both check the results against the respective limit.
- OR checks against both limits, failing if either of the limits is broken.
- AND will only display a fail if both of the limits are broken.

The absolute or relative power limit value for each offset channel can be set remotely with [:SENSe]:SEMask:OFFSet[n]:INNeR:LIST:ABSolute or [:SENSe]:SEMask:OFFSet[n]:INNeR:LIST:RCARrier.

You can turn off (not use) specific offset channels remotely with [:SENSe]:SEMAsk:OFFSet [n]:INNer:LIST:STATe.

Missing values are not permitted; that is, if you want to change values 2 and 6, you must send all values up to 6. Subsequent values will remain as they were. The query for this parameter always returns 12 values.

Key Path	Meas Setup, Inner Offset/Limits, Limits
Mode	MSR, LTEAFDD, LTEATDD
Remote Command	[:SENSe]:SEMAsk:OFFSet [1] 2:INNer:LIST:TEST ABSolute AND OR RELative, ... [:SENSe]:SEMAsk:OFFSet [1] 2:INNer:LIST:TEST?
Example	SEM:OFFS:INN:LIST:TEST ABS, ABS, ABS, ABS, ABS, ABS SEM:OFFS:INN:LIST:TEST?
Notes	Comma separated list of values. You must be in the MSR and LTE-Advanced FDD/TDD modes to use this command. Use :INSTrument:SElect to set the mode.
Preset	ABS, ABS, ABS, ABS, ABS, ABS, ABS, ABS, ABS, ABS, ABS, ABS
State Saved	Saved in instrument state.
Range	Absolute Relative Abs AND Rel Abs OR Rel
Initial S/W Revision	A.14.00

Offset Freq Define

This key enables you to select “Offset” definition. Each standard defines each “Offset” from Carrier.

Meas BW Edge means the edge of resolution band width that is represented by Meas BW and Res BW settings. Actual center frequency of Meas BW and the limit line have ½ Meas BW offset when the Meas BW Edge is selected.

3GPP2 requires the “Carrier Center to Meas BW Edge” definition, and LTE conformance test requires “Carrier Edge to Meas BW Center” and/or “Carrier Edge to Meas BW Edge” definition. MSR standard requires “RFBW Edge to Meas BW Center” and/or “RFBW Edge to Meas Edge” definition.

- **CTOC** – From the lowermost carrier frequency (for lower offset), the uppermost carrier frequency (for upper offset) to the center of offset measuring filter*
- **CTOE** – From the lowermost carrier frequency (for lower offset), the uppermost carrier frequency (for upper offset) to the nominal –3 dB point of the offset measuring filter* closer to the carrier
- **ETOC** – From the lowermost carrier frequency – spacing of this carrier /2 (for lower offset), the uppermost carrier frequency + spacing of this carrier /2 (for upper offset) to the center of offset measuring filter*
- **ETOE** – From the lowermost carrier frequency – spacing of this carrier /2 (for lower offset), the uppermost carrier frequency + spacing of this carrier /2 (for upper offset) to the nominal –3 dB point of the offset measuring filter* closer to the carrier
- **STOC** – From either the lower or upper sub-block edges to the center of offset measuring filter*

- **STOE** – From either the lower or upper sub-block edges to the nominal -3 dB point of the offset measuring filter* closer to the carrier

*Measuring filter = Meas BW (N) x Res BW

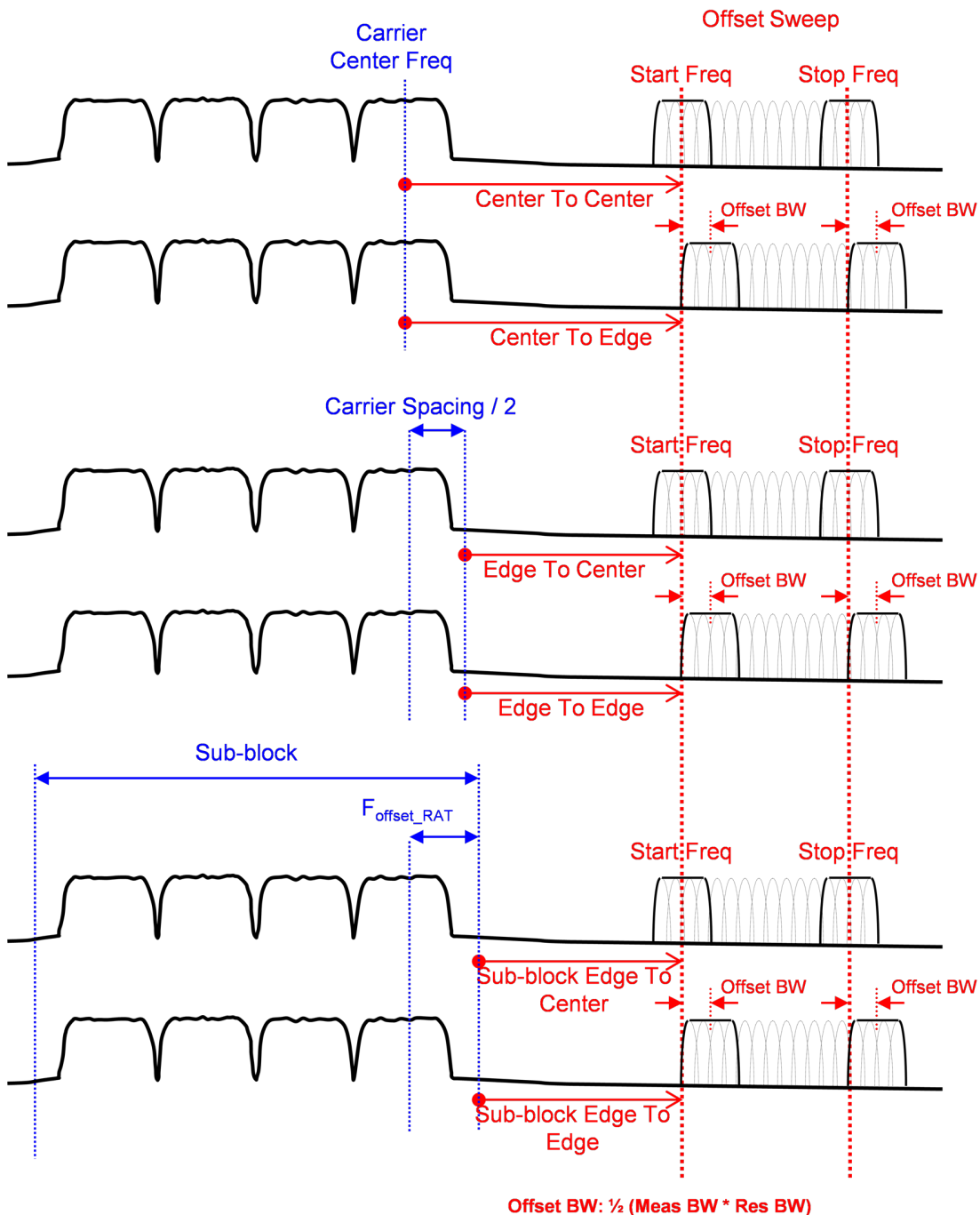

Offset Freq Definition in SEM Measurement

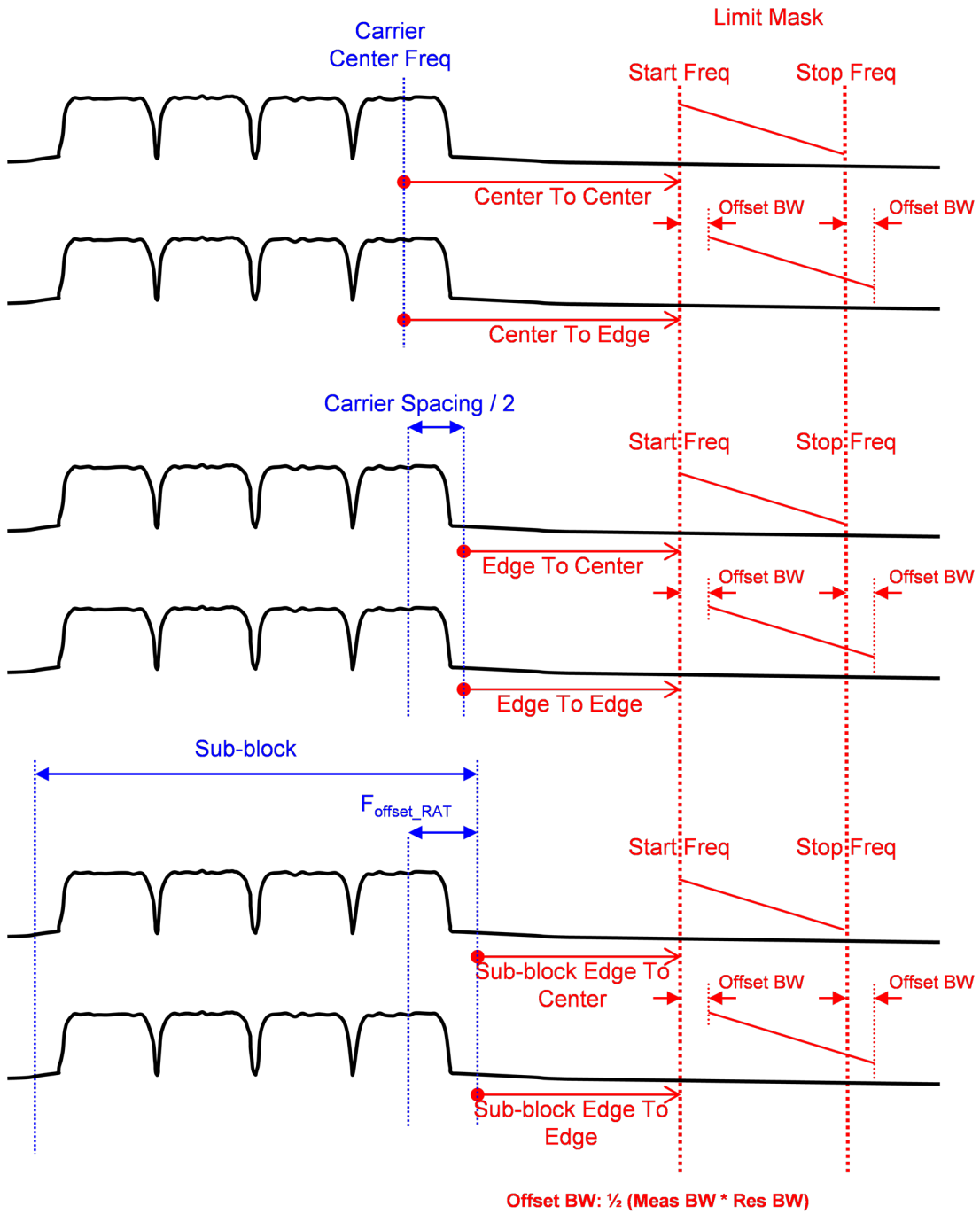

Offset Freq Definition (Limit Mask) in SEM measurement

Key Path	Meas Setup, Inner Offset/Limits
Mode	MSR, LTEAFDD, LTEATDD
Remote Command	[[:SENSE]:SEMask:OFFSet [1] 2:INNER:TYPE CTOC CTOE ETOC ETOE STOC STO]
	[[:SENSE]:SEMask:OFFSet [1] 2:INNER:TYPE?

Example	SEM:OFFS:INN:TYPE ETOC SEM:OFFS:INN:TYPE?
Notes	You must be in the MSR and LTE-Advanced FDD/TDD modes to use this command. Use :INSTrument:SElect to set the mode.
Preset	STOC
State Saved	Saved in instrument state.
Range	Carrier Center To Meas BW Center Carrier Center To Meas BW Edge Carrier Edge To Meas BW Center Carrier Edge To Meas BW Edge Sub-block Edge To Meas BW Center Sub-block Edge To Meas BW Edge
Readback	Center to Center Center to Edge Edge to Center Edge to Edge S Edge to Center S Edge to Edge
Initial S/W Revision	A.14.00

Cumulate Mask

Selects whether inner offset limit masks are cumulated or not.

Key Path	Meas Setup, Inner Offset/Limits
Mode	MSR, LTEAFDD, LTEATDD
Remote Command	[:SENSe] :SEMAsk:OFFSet [1] 2 :INNer:CMASk [:STATe] ON OFF 0 1 [:SENSe] :SEMAsk:OFFSet [1] 2 :INNer:CMASk [:STATe] ?
Example	SEM:OFFS:INN:CMAS 0 SEM:OFFS:INN:CMAS?
Notes	OFFSet1 is for BTS, 2 for MS. Default is BTS. You must be in the MSR and LTE-Advanced FDD/TDD modes to use this command. Use :INSTrument:SElect to set the mode.
Preset	1
State Saved	Saved in instrument state.
Range	ON OFF
Initial S/W Revision	A.14.00

Cumulate Mask Stop Frequency

Specifies stop frequency of summing limit masks. For outside of the stop frequency, the limit masks are not cumulated.

Key Path	Meas Setup, Inner Offset/Limits
Mode	MSR, LTEAFDD, LTEATDD
Remote Command	[:SENSe] :SEMAsk:OFFSet [1] 2 :INNer:CMASk:FREQuency:STOP <freq> [:SENSe] :SEMAsk:OFFSet [1] 2 :INNer:CMASk:FREQuency:STOP?
Example	SEM:OFFS:INN:CMAS:FREQ:STOP 500E6

	SEM:OFFS:INN:CMAS:FREQ:STOP?
Notes	OFFSet1 is for BTS, 2 for MS. Default is BTS. You must be in the MSR and LTE-Advanced FDD/TDD modes to use this command. Use :INSTrument:SElect to set the mode.
Dependencies	This parameter is valid only when Cumulate Mask is On.
Preset	10.5 MHz
State Saved	Saved in instrument state.
Min	0 Hz
Max	500 MHz
Initial S/W Revision	A.14.00

Non-Contiguous Meas Region

Selects the region to measure for the non-contiguous frequency allocation from either inner or outer.

Key Path	Meas Setup
Mode	MSR, LTEAFDD, LTEATDD
Remote Command	[:SENSe] :SEMAsk:NCONtiguous:REGion INNer OUTer [:SENSe] :SEMAsk:NCONtiguous:REGion?
Example	SEM:NCON:REG INN SEM:NCON:REG?
Notes	You must be in the MSR and LTE-Advanced FDD/TDD modes to use this command. Use :INSTrument:SElect to set the mode.
Preset	INNer
State Saved	Saved in instrument state.
Range	Inner Outer
Initial S/W Revision	A.14.00

Method

Sets the measurement method:

- **Integ BW**—enables you to set the channel integration bandwidth.
- **RRC Weight**—selects Root Raised Cosine (RRC) filtering of the carriers. The α value (rolloff) for the filter is set to the value of the Filter Alpha parameter.

Key Path	Meas Setup
Mode	SA, WCDMA, WIMAX OFDMA, TD-SCDMA, DTMB (CTTB), DVB-T/H, ISDB-T, CMMB, LTE, LTETDD, Digital Cable TV, WLAN, MSR, LTEAFDD, LTEATDD
Remote Command	[:SENSe] :SEMAsk:FILTer [:RRC] [:STATe] OFF ON 0 1

	<code>[:SENSe] :SEMAsk:FILTEr [:RRC] [:STATe] ?</code>
Example	SEM:FILT ON SEM:FILT?
Notes	For the C2K and 1xEVDO mode, this key is not available. 1 ON = RRC Weight, 0 OFF = IntegBW You must be in the mode that includes SEM measurement to use this command. Use :INSTrument:SElect to set the mode.
Dependencies	WLAN: RRC Weight is not supported when the radio standard is WLAN 802.11ac (80+80MHz).
Preset	SA, WIMAX OFDMA, DVB-T/H, ISDB-T, CMMB, LTE, LTETDD, WLAN, MSR, LTEAFDD, LTEATDD: OFF WCDMA, TD-SCDMA, DTMB (CTTB), Digital Cable TV: ON
State Saved	Saved in instrument state.
Range	RRCWeight IntegBW
Initial S/W Revision	Prior to A.02.00
Modified at S/W Revision	A.02.00, A.03.00

Filter Alpha

Sets the alpha value for the RRC Filter.

Key Path	Meas Setup
Mode	SA, WCDMA, WIMAX OFDMA, TD-SCDMA, DTMB (CTTB), DVB-T/H, ISDB-T, CMMB, LTE, LTETDD, Digital Cable TV, MSR, LTEAFDD, LTEATDD
Remote Command	<code>[:SENSe] :SEMAsk:FILTEr [:RRC] :ALPHa <real></code> <code>[:SENSe] :SEMAsk:FILTEr [:RRC] :ALPHa?</code>
Example	SEM:FILT:ALPH 0.3 SEM:FILT:ALPH?
Notes	For the C2K and 1xEVDO mode, this key is not available. You must be in the mode that includes SEM measurement to use this command. Use :INSTrument:SElect to set the mode.
Preset	0.22 DTMB (CTTB): 0.05 Digital Cable TV: 0.15
State Saved	Saved in instrument state.
Min	0.01
Max	1.0
Initial S/W Revision	Prior to A.02.00
Modified at S/W Revision	A.02.00, A.03.00

Apply Carrier Config to Offset/Limits (Only for MSR) [XA11]

Sets offset and limit parameters under Offset/Limits. The offset and limit values are determined by the carrier configuration parameters and Band Category.

Key Path	Meas Setup
Mode	MSR
Remote Command	<code>[:SENSe] :SEMAsk :MCONdition :IMMediate</code>
Example	SEM:MCON:IMM
Initial S/W Revision	A.11.00

Meas Preset

Restores all the measurement parameters to their default values.

Key Path	Meas Setup
Mode	SA, WCDMA, C2K, WIMAX OFDMA, TD-SCDMA, 1xEVDO, DTMB (CTTB), DVB-T/H, ISDB-T, CMMB, LTE, LTE-TDD, Digital Cable TV, WLAN, MSR, LTEAFDD, LTEATDD
Remote Command	<code>:CONFigure :SEMAsk</code>
Example	CONF:SEM
Notes	You must be in the mode that includes SEM measurement to use this command. Use <code>:INSTrument:SElect</code> to set the mode.
Couplings	Selecting Meas Preset will restore all measurement parameters to their default values.
Initial S/W Revision	Prior to A.02.00
Modified at S/W Revision	A.02.00, A.03.00

11 Spectrum Emission Mask Measurement
Mode

Mode

See "[Mode](#)" on page 276

Mode Preset

Returns the active mode to a known state.

Mode Preset does the following for the currently active mode:

- Aborts the currently running measurement.
- Brings up the default menu for the mode, with no active function.
- Sets measurement Global settings to their preset values for the active mode only.
- Activates the default measurement.
- Brings up the default menu for the mode.
- Clears the input and output buffers.
- Sets Status Byte to 0.

Mode Preset does not:

- Cause a mode switch
- Affect mode persistent settings
- Affect system settings
- See "[How-To Preset](#)" on page 1366 for more information.

Key Path	Front-panel key
Remote Command	:SYSTem:PRESet
Example	:SYST:PRES
Notes	*RST is preferred over :SYST:PRES for remote operation. *RST does a Mode Preset, as done by the :SYST:PRES command, and it sets the measurement mode to Single measurement rather than Continuous for optimal remote control throughput. Clears all pending OPC bits. The Status Byte is set to 0.
Couplings	A Mode Preset aborts the currently running measurement, activates the default measurement, and gets the mode to a consistent state with all of the default couplings set.
Backwards Compatibility Notes	In the X-Series, the legacy "Factory Preset" has been replaced with Mode Preset, which only presets the currently active mode, not the entire instrument. In the X-Series, the way to preset the entire instrument is by using System, Restore System Defaults All, which behaves essentially the same way as restore System Defaults does on ESA and PSA. There is also no "Preset Type" as there is on the PSA. There is a green Mode Preset front-panel key that does a Mode Preset and a white-with-green-letters User Preset front-panel key that does a User Preset. The old PRESet:TYPE command is ignored (without generating an error), and SYST:PRES without a parameter does a Mode Preset, which should cover most backward code compatibility issues. The settings and correction data under the Input/Output front-panel key (examples: Input Z Corr, Ext Amp Gain, etc.) are no longer part of any Mode, so they will not be preset by a Mode Preset. They are preset using Restore Input/Output Defaults, Restore System Defaults All. Note that because User Preset does a Recall State, and all of these settings are saved in State, they ARE recalled when using

	User Preset.
Initial S/W Revision	Prior to A.02.00

How-To Preset

The table below shows all possible presets, their corresponding SCPI commands and front-panel access (key paths). Instrument settings depend on the current measurement context. Some settings are local to the current measurement, some are global (common) across all the measurements in the current mode, and some are global to all the available modes. In a similar way, restoring the settings to their preset state can be done within the different contexts.

Auto Couple - is a measurement local key. It sets all Auto/Man parameter couplings in the measurement to Auto. Any Auto/Man selection that is local to other measurements in the mode will not be affected.

Meas Preset - is a measurement local key. Meas Preset resets all the variables local to the current measurement except the persistent ones.

Mode Preset - resets all the current mode's measurement local and measurement global variables except the persistent ones.

Restore Mode Defaults - resets ALL the Mode variables (and all the Meas global and Meas local variables), including the persistent ones.

Type Of Preset	SCPI Command	Front Panel Access
Auto Couple	:COUPle ALL	Auto Couple front-panel key
Meas Preset	:CONFigure:<Measurement>	Meas Setup Menu
Mode Preset	:SYSTem:PRESet	Mode Preset (green key)
Restore Mode Defaults	:INSTrument:DEFault	Mode Setup Menu
Restore All Mode Defaults	:SYSTem:DEFault MODes	System Menu; Restore System Default Menu
*RST	*RST	not possible (Mode Preset with Single)
Restore Input/Output Defaults	:SYSTem:DEFault INPUt	System Menu; Restore System Default Menu
Restore Power On Defaults	:SYSTem:DEFault PON	System Menu; Restore System Default Menu
Restore Alignment Defaults	:SYSTem:DEFault ALIGN	System Menu; Restore System Default Menu
Restore Miscellaneous Defaults	:SYSTem:DEFault MISC	System Menu; Restore System Default Menu
Restore All System Defaults	:SYSTem:DEFault [ALL] :SYSTem:PRESet:PERsistent	System Menu; Restore System Default Menu
User Preset	:SYSTem:PRESet:USER	User Preset Menu
User Preset All Modes	:SYSTem:PRESet:USER:ALL	User Preset Menu

Power On Mode Preset	:SYSTem:PON:TYPE MODE	System Menu
Power On User Preset	:SYSTem:PON:TYPE USER	System Menu
Power On Last State	:SYSTem:PON:TYPE LAST	System Menu

Preset Type (Remote Command Only)

As stated in the Backward Compatibility section, to be compatible with ESA/PSA the PRESet:TYPE command will be implemented as a no-op.

Mode	All
Remote Command	:SYSTem:PRESet:TYPE FACTory MODE USER :SYSTem:PRESet:TYPE?
Example	:SYST:PRES:TYPE FACT
Notes	This command is supported for backward compatibility only. It is a no-op which does not change the behavior of any preset operation.
Preset	This is unaffected by Preset but is set to Mode on a “Restore System Defaults->All”
State Saved	No
Initial S/W Revision	Prior to A.02.00

Mode Setup

See "[Mode Setup](#)" on page 306

Peak Search

There is no 'Peak Search' supported in Spectrum Emission Mask so this front-panel key displays a blank menu when pressed.

Key Path	Front-panel key
Initial S/W Revision	Prior to A.02.00

11 Spectrum Emission Mask Measurement
Print

Print

See "[Print](#) " on page 367

Quick Save

The Quick Save front-panel key repeats the most recent save that was performed from the Save menu, with the following exceptions:

- Register saves are not remembered as Saves for the purpose of the Quick Save function
- If the current measurement does not support the last non-register save that was performed, an informational message is generated, “File type not supported for this measurement”

Quick Save repeats the last type of qualified save (that is, a save qualified by the above criteria) in the last save directory by creating a unique filename using the Auto File Naming algorithm described below.

If Quick Save is pressed after startup and before any qualified Save has been performed, the Quick Save function performs a Screen Image save using the current settings for Screen Image saves (current theme, current directory), which then becomes the “last save” for the purpose of subsequent Quick Saves.

The Auto File Naming feature automatically generates a file name for use when saving a file. The filename consists of a prefix and suffix separated by a dot, as is standard for the Windows® file system. A default prefix exists for each of the available file types:

Type	Default Prefix	Menu
State	State_	(Save/Recall)
Trace + State	State_	(Save/Recall)
Screen	Screen_	(Save/Recall)
Amplitude Corrections	Ampcor_	(Import/Export)
Traces	Trace_	(Import/Export)
Limit Lines	LLine_	(Import/Export)
Measurement Result	MeasR_	(Import/Export)
Capture Buffer	CapBuf_	(Import/Export)

A four digit number is appended to the prefix to create a unique file name. The numbering sequence starts at 0000 within each Mode for each file type and updates incrementally to 9999, then wraps to 0000 again. It remembers where it was through a Mode Preset and when leaving and returning to the Mode. It is reset by Restore Misc Defaults and Restore System Defaults and subsequent running of the instrument application. So, for example, the first auto file name generated for State files is State_0000.state. The next is State_0001, and so forth.

One of the key features of Auto File Name is that we guarantee that the Auto File Name will never conflict with an existing file. The algorithm looks for the next available number. If it gets to 9999, then it looks for holes. If it find no holes, that is no more numbers are available, it gives an error.

For example, if when we get to State_0010.state there is already a State_0010.state file in the current directory, it advances the counter to State_0011.state to ensure that no conflict will exist (and then it verifies that State_0011.state also does not exist in the current directory and advances again if it does, and so forth).

If you enter a file name for a given file type, then the prefix becomes the filename you entered instead of the default prefix, followed by an underscore. The last four letters (the suffix) are the 4-digit number.

For example, if you save a measurement results file as “fred.csv”, then the next auto file name chosen for a measurement results save will be fred_0000.csv.

NOTE Although 0000 is used in the example above, the number that is used is actually the current number in the Meas Results sequence, that is, the number that would have been used if you had not entered your own file name.

NOTE If the filename you entered ends with _dddd, where d=any number, making it look just like an auto file name, then the next auto file name picks up where you left off with the suffix being dddd + 1.

Key Path	Front-panel key
Notes	No remote command for this key specifically.
Initial S/W Revision	Prior to A.02.00

Recall

In the MSR mode, two types of recall functions are available under the Data menu: Parameter Sets and Masks. Masks enables setting of a preset limit mask for Power Suite-based measurements, and currently it is available for the SEM, ACP and SPUR measurements in the MSR mode.

Key Path	Front Panel
Mode	MSR
Initial S/W Revision	A.10.00

State

The **Recall State** menu lets you choose a register or file from which to recall the state.

The content of a state file includes all of the settings and data required to return the analyzer as closely as possible to the Mode it was in, with the exact settings that were in place, when the save occurred. The Mode settings in each state file include the settings that are affected by Mode Preset, as well as the additional settings affected by Restore Mode Defaults; all of the Mode's settings. In addition, all of the settings of the **Input/Output** system are included, even though they are outside of the Mode's state, because they are needed to restore the complete setup. Persistent System settings (for example, GPIB address) are not affected by either a Mode Preset or Restore Mode Defaults, nor are they included in a saved State file.

Since each state file is only for one Mode, the settings for other Modes are unaffected when it is loaded. **Recall State** will cause a mode switch if the state being recalled is not from the current active mode.

After the recall completes, the message "File <filename> recalled" or "Recalled State Register <register number>" is displayed.

For rapid recalls, the State menu lists 16 registers that you can choose from to recall. Pressing a Register key initiates the recall. You can also select a file from which to recall.

The default path for all State Files is:

My Documents\<<mode name>\state

where <mode name> is the parameter used to select the mode with the INST:SEL command (for example, SA for the Spectrum Analyzer).

See "[More Information](#)" on page 1374.

Key Path	Recall
Mode	All
Remote Command	:MMEMory:LOAD:STATe <filename>
Example	:MMEM:LOAD:STAT "myState.state" This recalls the file myState.state on the default path
Example	MMEM:LOAD:STAT "MyStateFile.state" This loads the state file data (on the default file directory path) into the instrument state.

Notes	<p>When you pick a file to recall, the analyzer first verifies that the file is recallable in the current instrument by checking the software version and model number of the instrument. If everything matches, a full recall proceeds by aborting the currently running measurement, clearing any pending operations, and then loading the State from the saved state file. You can open state files from any mode, so recalling a State file switches to the mode that was active when the save occurred. After switching to the mode of the saved state file, mode settings and data (if any for the mode) are loaded with values from the saved file. The saved measurement of the mode becomes the newly active measurement and the data relevant to the measurement (if there is any) is recalled.</p> <ul style="list-style-type: none"> • If there is a mismatch between file version or model number or instrument version or model number, the recall function tries to recall as much as possible and returns a warning message. It may limit settings that differ based on model number, licensing or version number. <p>After recalling the state, the Recall State function does the following:</p> <ul style="list-style-type: none"> • Makes the saved measurement for the mode the active measurement. • Clears the input and output buffers. • Status Byte is set to 0. • Executes a *CLS <p>If the file specified is empty an error is generated. If the specified file does not exist, another error is generated. If there is a mismatch between the file and the proper file type, an error is generated. If there is a mismatch between file version or model number or instrument version or model number, a warning is displayed. Then it returns to the State menu and File Open dialog goes away.</p> <p>After the Recall, the analyzer exits the Recall menu and returns to the previous menu.</p>
Backwards Compatibility SCPI	<p>:MMEMory:LOAD:STATe 1,<filename></p> <p>For backwards compatibility, the above syntax is supported. The "1" is simply ignored.</p>
Initial S/W Revision	Prior to A.02.00

More Information

In measurements that support saving Traces, for example, Swept SA, the Trace data is saved along with the State in the State file. When recalling the State, the Trace data is recalled as well. Traces are recalled exactly as they were stored, including the writing mode and update and display modes. If a Trace was updating and visible when the State was saved, it will come back updating and visible, and its data will be rewritten right away. When you use State to save and recall traces, any trace whose data must be preserved should be placed in View or Blank mode before saving.

The following table describes the Trace Save and Recall possibilities:

You want to recall state and one trace's data, leaving other traces unaffected.	Save Trace+State from 1 trace. Make sure that no other traces are updating (they should all be in View or Blank mode) when the save is performed.	On Recall, specify the trace you want to load the one trace's data into. This trace will load in View. All other traces' data will be unaffected, although their trace mode will be as it was when the state save was performed.
You want to recall all traces	Save Trace+State from ALL traces.	On Recall, all traces will come back in View (or Blank if they were in Blank or Background when

		saved)
You want all traces to load exactly as they were when saved.	Save State	On recall, all traces' mode and data will be exactly as they were when saved. Any traces that were updating will have their data immediately overwritten.

From File...

When you press “From File”, the analyzer brings up a Windows dialog and a menu entitled “File Open.” This menu allows you to navigate to the various fields in the Windows dialog without using a keyboard or mouse. The **Tab** and **Arrow** keys can also be used for dialog navigation.

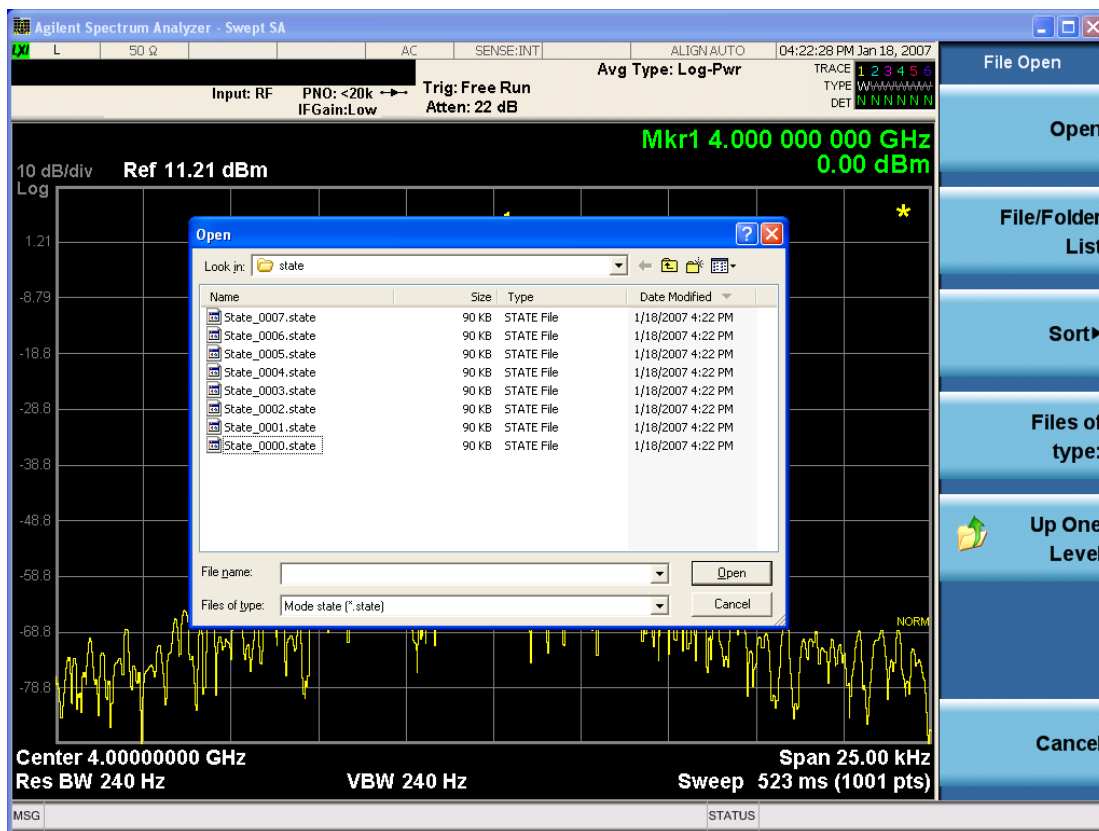

Listed below are the functions of the various fields in the dialog, and the corresponding softkeys:

Open

Performs the recall of the specified file. While the recall is being performed, the floppy icon appears briefly in the Meas bar.

File/Folder List

Enables you to navigate to the center of the dialog that contains the list of files and folders. Once here you can get information about the file and use the tab keys to navigate to the other fields in the dialog, such as Look In.

Look In

The **Look In** field shows the path from which the file will be recalled and allows you to change the path using the up and down arrow keys to navigate to other paths; the Enter key to open a directory; and the Backspace key to go back one directory. The **Look In field** first uses the last path from the Save As dialog **Save In:** path for that same file type. There is no softkey for directly navigating to the Look In field, but you can use the left tab to get here from the File/Folder List.

User specified paths are remembered when you leave and return to a Mode and are reset back to the default using **Restore Mode Defaults**.

Sort

Accesses a menu that enables you to sort the files within the File Open dialog. Only one sorting type can be selected at a time and the sorting happens immediately. The sorting types are **By Date, By Name, By extension, and By Size**.

Files of Type

This field shows the file suffix for the type of file you have selected to recall. For example, if you navigated here while recalling State, "Mode state (*.state)" is in the field. If you navigated here while recalling Trace, ""Mode state (*.trace)" is in the field. If you navigated here while importing a trace data file, "Trace Data (*.csv)" is in the field. For some file types, there is more than one choice in the dropdown menu, which you can select by using the up and down arrow keys and Enter.

Up One Level

This key corresponds to the icon of a folder with the up arrow that is in the tool bar of the dialog. When pressed, it causes the file and folder list to navigate up one level in the directory structure. The Backspace key does the same thing.

Cancel

This key corresponds to the **Cancel** selection in the dialog. It causes the current **Open** request to be cancelled. The ESC key does the same thing.

Key Path	Recall, State
Notes	Brings up the Open dialog for recalling a State Save Type
Initial S/W Revision	Prior to A.02.00

Edit Register Names

You may enter a custom name on any of the Register keys, to help you remember what you are using that state to save. To do this, press the **Edit Register Names** key, choose the register whose name you wish to edit, and then enter the desired label using the Alpha Editor or an external PC keyboard.

The maximum number of characters that can be added is 30. In most cases, 30 characters will fit on two lines of the key.

For more information and the SCPI command, see Edit Register Names under the **Save, State** function.

Key Path	Recall, State
Mode	All
Dependencies	N9060A-7FP or N9060B-2FP license required to edit the register names. When the feature is not licensed, sending the SCPI command generates an error, -221,"Settings conflict;Option not available"
Initial S/W Revision	A.11.00

Register 1 thru Register 16

Selecting any one of these register keys causes the State of the mode from the specified Register to be recalled. Each of the register keys annotates whether it is empty or at what date and time it was last modified. In addition, you can use the **Edit Register Names** key under **Save, State** to enter custom names for each register.

Registers are shared by all modes, so recalling from any one of the registers will cause a mode switch to the mode that was active when the save to the Register occurred.

Although these 16 registers are the only registers available from the front panel, there are 128 state registers available in the instrument. Registers 17–128 are only available from the SCPI interface, using the *RCL command.

After the recall completes, the message "Register <register number> recalled" appears in the message bar. If you are in the Spectrum Analyzer Mode, and you are recalling a register that was saved in the Spectrum Analyzer Mode, then after the recall, you will still be in the Recall Register menu. If the Recall causes you to switch modes, then after the Recall, you will be in the Frequency menu.

If a requested register is empty an error is generated.

Key Path	Recall, State
Example	*RCL 1
Range	1-16 from front panel, 1-128 from SCPI
Readback	Date and time with seconds resolution are displayed on the key OR A custom name of up to 30 characters entered using the Save, State,Edit Register Names key OR “(empty)” if no prior save operation has been performed to this register.
Initial S/W Revision	Prior to A.02.00
Modified at S/W Revision	Prior to A.11.00

Register 1 thru Register 16

Selecting any one of these register keys causes the State of the mode from the specified Register to be recalled. Each of the register keys annotates whether it is empty or at what date and time it was last

modified. In addition, you can use the **Edit Register Names** key under **Save, State** to enter custom names for each register.

Registers are shared by all modes, so recalling from any one of the registers will cause a mode switch to the mode that was active when the save to the Register occurred.

Although these 16 registers are the only registers available from the front panel, there are 128 state registers available in the instrument. Registers 17–128 are only available from the SCPI interface, using the *RCL command.

After the recall completes, the message "Register <register number> recalled" appears in the message bar. If you are in the Spectrum Analyzer Mode, and you are recalling a register that was saved in the Spectrum Analyzer Mode, then after the recall, you will still be in the Recall Register menu. If the Recall causes you to switch modes, then after the Recall, you will be in the Frequency menu.

If a requested register is empty an error is generated.

Key Path	Recall, State
Example	*RCL 1
Range	1–16 from front panel, 1–128 from SCPI
Readback	Date and time with seconds resolution are displayed on the key OR A custom name of up to 30 characters entered using the Save, State, Edit Register Names key OR “(empty)” if no prior save operation has been performed to this register.
Initial S/W Revision	Prior to A.02.00
Modified at S/W Revision	Prior to A.11.00

Data (Import)

Importing a data file loads data that was previously saved from the current measurement or from other measurements and/or modes that produce compatible data files. The Import Menu only contains Data Types that are supported by the current measurement.

Since the commonly exported data files are in .csv format, the data can be edited by the user prior to importing. This allows you to export a data file, manipulate the data in Excel (the most common PC Application for manipulating .csv files) and then import it.

Importing Data loads measurement data from the specified file into the specified or default destination, depending on the data type selected. Selecting an Import Data menu key will not actually cause the importing to occur, since the analyzer still needs to know from where to get the data. Pressing the Open key in this menu brings up the Open dialog and Open menu that provides you with the options from where to recall the data. Once a filename has been selected or entered in the Open menu, the recall occurs as soon as the Open button is pressed.

Key Path	Recall
Mode	All

Notes	The menu is built from whatever data types are available for the mode. Some keys will be missing completely, so the key locations in the sub-menu will vary. No SCPI command directly controls the Data Type that this key controls. The Data Type is included in the MMEM:LOAD commands.
Dependencies	If a file type is not used by a certain measurement, it is grayed out for that measurement. The key for a file type will not show at all if there are no measurements in the Mode that support it.
Preset	Is not affected by Preset or shutdown, but is reset during Restore Mode Defaults
Readback	The data type that is currently selected
Initial S/W Revision	Prior to A.02.00

Parameter Set

Enables you to import format parameter set data to specified format parameter sets. Selecting this key displays a menu that enables you to select the destination parameter set. After making this selection, depress Open... and use the file dialog to select the file you wish to recall.

Supported import file formats are dependent on radio formats.

LTE FDD: Format Parameter Set Files (*.fps), LTE FDD app state files (*.state), 89601 VSA Setup Files (*.set, *.setx) and Signal Studio Setup Files (*.scp)

W-CDMA:Format Parameter Set Files (*.fps) and W-CDMA app state files (*.state)

GSM/EDGE:Format Parameter Set Files (*.fps) and GSM/EDGE app state files (*.state)

cdma2000:Format Parameter Set Files (*.fps) and cdma2000 app state files (*.state)

1xEV-DO:Format Parameter Set Files (*.fps) and 1xEV-DO app state files (*.state)

LTE TDD: Format Parameter Set Files (*.fps), LTE TDD app state files (*.state), 89601 VSA Setup Files (*.set, *.setx) and Signal Studio Setup Files (*.scp)

TD-SCDMA:Format Parameter Set Files (*.fps) and TD-SCDMA app state files (*.state)

Format Parameter Set Files

Extention: fps

Basic file type of format parameter set. This file contains a format parameter set exported using Parameter Set under Recall, Data (Export). It is imported if the radio format of the file matches the destination radio format. If not, an error message, -230 "Data corrupt or stale", is issued with the specified file name.

App State Files

Extention: state

The state file of each mode can be imported to the corresponding parameter set. If the mode name in the state file matches the selected destination format, the state file data are imported. If not, an error message, -230 "Data corrupt or stale", is issued with the specified file name.

The parameters to be imported are ones referred in a particular measurement of each mode. The relevant measurements are listed below.

LTE FDD: Modulation Analysis

W-CDMA: Mod Accuracy

GSM/EDGE: EDGE EVM

cdma2000: Mod Accuracy

1xEV-DO: Mod Accuracy

LTE TDD: Modulation Analysis

TD-SCDMA: Mod Accuracy

Note that Integ BW and Measurement Noise BW parameters of ACP, SEM and CHP are not imported.

89601 VSA Setup Files

Extention: set, setx

The 89600 Vector Signal Analyzer Setup file created using the 89600 Vector Signal Analyzer Option BHD (LTE FDD)/Option BHE (LTE TDD) can be imported as LTE FDD/LTE TDD parameter set. If the setup file is not loaded successfully, an error message, -230 "Data corrupt or stale", is issued with the specified file name.

Signal Studio Setup Files

Extention: scp

The Keysight Signal Studio setup file created using Signal Studio (N7624B/N7625B) can be imported as LTE FDD/LTE TDD parameter set. Supported carrier types are listed in the table below:

<i>Signal Studio</i>	<i>Carrier Type</i>
N7624B Signal Studio for 3GPP LTE	Advanced LTE FDD Downlink (2009-03)
	Advanced LTE FDD Downlink (2009-12)
	Advanced LTE FDD Downlink (2010-06)
	Advanced LTE FDD Uplink (2009-12)
	Advanced LTE FDD Uplink (2010-06)
	Basic LTE FDD Downlink (2009-03)
	Basic LTE FDD Downlink (2009-12)
	Basic LTE FDD Downlink (2010-06)
	Basic LTE FDD Uplink (2009-03)
	Basic LTE FDD Uplink (2009-12)
	Basic LTE FDD Uplink (2010-06)
N7625B Signal Studio for 3GPP LTE TDD	Advanced LTE TDD (2009-03)
	Advanced LTE TDD (2009-12)
	Basic LTE TDD (2009-03)
	Basic LTE TDD (2009-12)
	Basic LTE TDD R9
Advanced LTE TDD R9	

Basic LTE TDD R9 PRACH

If the setup file is not loaded successfully, an error message, -230 “Data corrupt or stale”, is issued with the specified file name.

Default path of this import type is “My Documents\MSR\data\params” folder. Note that “My Documents” is an alias to a directory and its location depends on which user is logged in. If the file path is specified without root folder, the import file is determined with the default path. For example if “folder1\paramData.prms” is specified, “My Documents\MSR\data\params\folder1\paramData.prms” is imported.

File Dialog Filter

Since supported import file formats differ between radio formats, file filters available in the open file dialog vary depending on the selected radio format. This table below defines file name filters available for each format.

<i>Radio Format</i>	<i>File Name Filters</i>
LTE FDD	All Supported Format Parameter Setup Files (*.fps; *.state; *.set; *.setx; *.scp) Format Parameter Setup Files (*.fps) State Files (*.state) 89601 VSA Setup Files (*.set; *.setx) Signal Studio Setup Files (*.scp)
W-CDMA	All Supported Format Parameter Setup Files (*.fps; *.state) Format Parameter Setup Files (*.fps) W-CDMA State Files (*.state)
GSM/EDGE	All Supported Format Parameter Setup Files (*.fps; *.state) Format Parameter Setup Files (*.fps) State Files (*.state)
cdma2000	All Supported Format Parameter Set Files (*.fps; *.state) Format Parameter Set Files (*.fps) State Files (*.state)
1xEV-DO	All Supported Format Parameter Set Files (*.fps; *.state) Format Parameter Set Files (*.fps) State Files (*.state)
LTE TDD	All Supported Format Parameter Setup Files (*.fps; *.state; *.set; *.setx; *.scp) Format Parameter Setup Files (*.fps) State Files (*.state) 89601 VSA Setup Files (*.set; *.setx) Signal Studio Setup Files (*.scp)
TD-SCDMA	All Supported Format Parameter Set Files (*.fps; *.state) Format Parameter Set Files (*.fps) State Files (*.state)

Key Path	Recall, Data
Mode	MSR
Remote Command	MMEMory:LOAD:PSET LTEFdd1 LTEFdd2 LTEFdd3 WCDMa1 WCDMa2 WCDMa3 GSM1 GSM2 GSM3 CDMA1 CDMA2 CDMA3 EVDO1 EVDO2 EVDO3 LTETdd1 LTETdd2 LTETdd3 TDSCdma1 TDSCdma2 TDSCdma3, <string>
Example	MMEM:LOAD:PSET LTEF1,"LTE FDD.set"
Notes	The first enum selects the destination format parameter set to which the file data are imported.
Initial S/W Revision	A.10.00
Modified at S/W Revision	A.12.00, A.16.00

Masks

This key enables you to recall a preset mask file which contains Offset and Limit settings. Parameters except them will not be overwritten. You cannot change or create preset mask files since they are binary files. This key is valid for the Spectrum Emission Mask, ACP and Spurious Emissions measurements.

Default path: "My Documents\MSR\data.masks"

Note that "My Documents" is an alias to a directory and its location depends on which user is logged in. At XSA start up, all of the limit mask files in the current user's "My Documents\MSR\data.masks" directory are overwritten.

File type: Binary

Filename: The filename follows the rule below with the words connected using underscores.

<Measurement>_<Condition>.mask

Where

<Measurement> Measurement the limit mask file is applied to: SEM, ACP or SPUR

<Condition> Condition. It depends on the measurement.

File extension: .mask

File Dialog Filter: Preset Mask Files (*.mask)

Selecting OPEN... under the Import Data menu opens the above directory enabling you to select a mask file.

Details of the masks are provided in a PDF file in the default folder of masks.

Key Path	Recall, Data
Mode	MSR
Remote Command	MMEMory:LOAD:MASK <string>
Example	MMEM:LOAD:MASK "ACP_BS\ACP_BS_3MHz_pairE-UTRA_CatA.mask"

Notes	Parameters related to Limit and Offset are overwritten by the contents of the preset mask file.
Initial S/W Revision	A.10.00

Open...

When you press “Open”, the analyzer brings up a Windows dialog and a menu entitled “**File Open.**” This menu allows you to navigate to the various fields in the Windows dialog without using a keyboard or mouse. The **Tab** and **Arrow** keys can also be used for dialog navigation.

See "[From File...](#)" on page 2454 in **Recall, State**, for a full description of this dialog and menu.

Key Path	Recall, Data
Notes	The key location is mode-dependent and will vary. Brings up Open dialog for recalling a <mode specific> Save Type
Initial S/W Revision	Prior to A.02.00

Restart

The Restart function restarts the current sweep, or measurement, or set of averaged/held sweeps or measurements. If you are Paused, pressing Restart does a Resume.

The Restart function is accessed in several ways:

- Pressing the Restart key
- Sending the remote command INIT:IMMEDIATE
- Sending the remote command INIT:RESTART

See "[More Information](#)" on page 1384

Key Path	Front-panel key
Remote Command	:INITiate[:IMMEDIATE] :INITiate:RESTART
Example	:INIT:IMM :INIT:REST
Notes	:INITiate:RESTART and :INITiate:IMMEDIATE perform exactly the same function.
Couplings	Resets average/hold count k. For the first sweep overwrites all active (update=on) traces with new current data. For application modes, it resets other parameters as required by the measurement.
Status Bits/OPC dependencies	This is an Overlapped command. The STATus:OPERation register bits 0 through 8 are cleared. The STATus:QUESTionable register bit 9 (INTEgrity sum) is cleared. The SWEEPING bit is set. The MEASURING bit is set.
Backwards Compatibility Notes	For Spectrum Analysis mode in ESA and PSA, the Restart hardkey and the INITiate:RESTART command restart trace averages (displayed average count reset to 1) for a trace in Clear Write , but did not restart Max Hold and Min Hold . In the X-Series, the Restart hardkey and the INITiate:RESTART command restart not only Trace Average , but MaxHold and MinHold traces as well. For wireless comms modes in ESA and PSA, the Restart hardkey and the INITiate:RESTART command restart every measurement, which includes all traces and numeric results. There is no change to this operation.
Initial S/W Revision	Prior to A.02.00

More Information

The **Restart** function first aborts the current sweep/measurement as quickly as possible. It then resets the sweep and trigger systems, sets up the measurement and initiates a new data measurement sequence with a new data acquisition (sweep) taken once the trigger condition is met.

If the analyzer is in the process of aligning when **Restart** is executed, the alignment finishes before the restart function is performed.

Even when set for Single operation, multiple sweeps may be taken when Restart is pressed (for example, when averaging/holding is on). Thus when we say that **Restart** "restarts a measurement," we may mean:

- It restarts the current sweep
- It restarts the current measurement
- It restarts the current set of sweeps if any trace is in Trace Average, Max Hold or Min Hold
- It restarts the current set of measurements if Averaging, or Max Hold, or Min Hold is on for the measurement
- depending on the current settings.

With **Average/Hold Number** (in **Meas Setup** menu) set to 1, or Averaging off, or no trace in Trace Average or Hold, a single sweep is equivalent to a single measurement. A single sweep is taken after the trigger condition is met; and the analyzer stops sweeping once that sweep has completed. However, with **Average/Hold Number** >1 and at least one trace set to **Trace Average**, **Max Hold**, or **Min Hold (SA Measurement)** or **Averaging on (most other measurements)**, multiple sweeps/data acquisitions are taken for a single measurement. The trigger condition must be met prior to each sweep. The sweep is stopped when the average count k equals the number N set for **Average/Hold Number**. A measurement average usually applies to all traces, marker results, and numeric results; but sometimes it only applies to the numeric results.

Once the full set of sweeps has been taken, the analyzer will go to idle state. To take one more sweep without resetting the average count, increment the average count by 1, by pressing the step up key while **Average/Hold Number** is the active function, or sending the remote command `CALC:AVER:TCON UP`.

Save

In the MSR mode, two types of save functions are available under the Data menu: Parameter Sets and Meas Results.

Key Path	Front Panel
Mode	MSR
Initial S/W Revision	Prior to A.10.00
Modified at S/W Revision	A.10.00

State

The Save State menu lets you choose a register or file for saving the state.

The content of a state file includes all of the settings and data required to return the analyzer as closely as possible to the Mode it was in, with the exact settings which were in place, when the save occurred. The Mode settings in each state file include the settings that are affected by Mode Preset, as well as the additional settings affected by Restore Mode Defaults; all of the Mode's settings. In addition, all of the settings of the **Input/Output** system are included, even though they are outside of the Mode's state, because they are needed to restore the complete setup. Persistent **System** settings (for example, Verbose SCPI) are not affected by either Mode Preset or Restore Mode Defaults, nor are they included in a saved State file.

After the save completes, the message "File <filename> saved" or "State Register <register number> saved" is displayed.

For rapid saving, the State menu lists 16 registers to save to. Pressing a Register key initiates the save. You can also select a file to save to.

The default path for all State Files is:

My Documents\<<mode name>\state

where <mode name> is the parameter used to select the mode with the INST:SEL command (for example, SA for the Spectrum Analyzer).

Key Path	Save
Mode	All
Remote Command	:MMEMory:STORe:STATe <filename>
Example	MMEM:STOR:STATe "MyStateFile.state" This stores the current instrument state data in the file MyStateFile.state in the default directory.
Notes	Both single and double quotes are supported for any filename parameter over remote. After saving to a register, that register's menu key is updated with the date the time, unless a custom label has been entered for that key. After saving to a register, you remain in the Save State menu, so that you can see the Register key update. After saving to a file, the analyzer automatically returns to the previous menu and any Save As dialog goes away.

Backwards Compatibility SCPI	:MMEMory:STORe:STATe 1,<filename> For backwards compatibility, the above syntax is supported. The "1" is simply ignored. The command is sequential.
Initial S/W Revision	Prior to A.02.00

To File . . .

When you press “To File”, the analyzer brings up a Windows dialog and a menu entitled “**Save As.**” This menu allows you to navigate to the various fields in the Windows dialog without using a keyboard or mouse. The **Tab** and **Arrow** keys can also be used for dialog navigation.

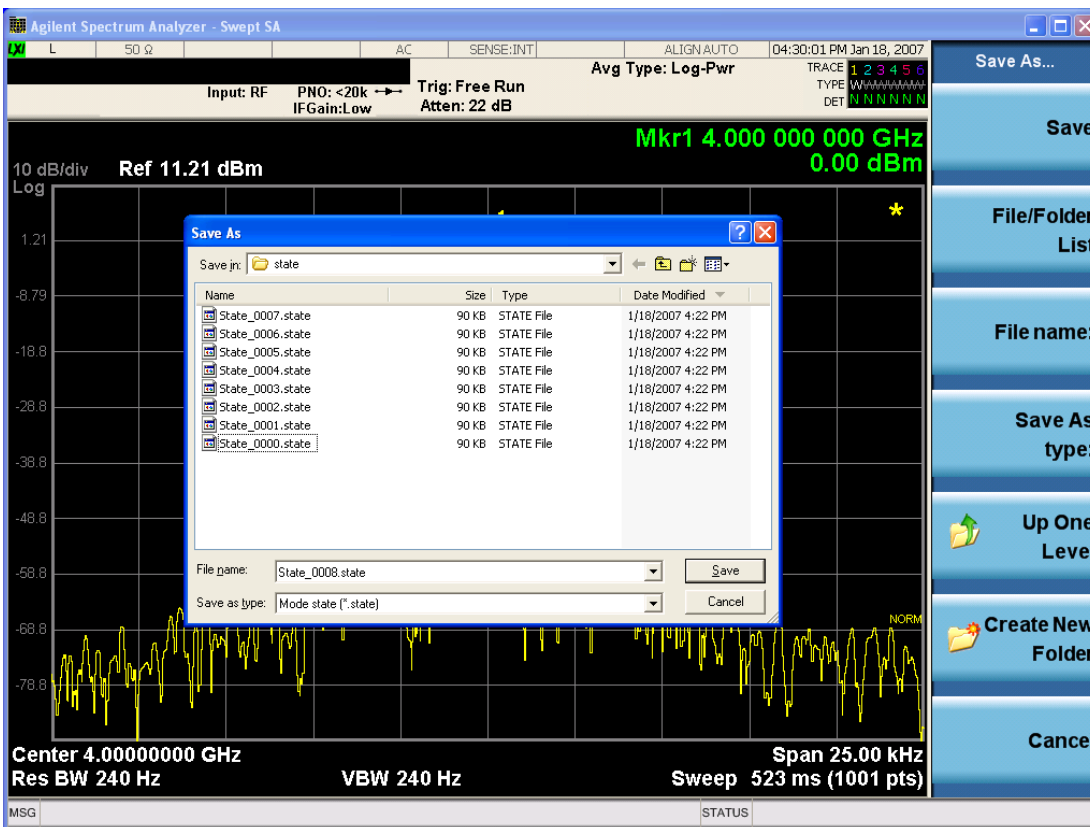

The Listed below

are the functions of the various fields in the dialog, and the corresponding softkeys:

Save

Performs the save to the specified file of the selected type. If the file already exists, a dialog will appear that allows you to replace the existing file by selecting **OK**, or you can **Cancel** the request. If you select **OK**, the file will be overwritten. Using the C: drive is strongly discouraged, since it runs the risk of being overwritten during an instrument software upgrade.

While the save is being performed, the floppy icon appears briefly in the Meas bar.

File/Folder List

Enables you to navigate to the center of the dialog that contains the list of files and folders. Once here you can get information about the file and use the tab keys to navigate to the other fields in the dialog, such as Save In.

Save In

The Save In field shows the path to which the file will be saved and allows you to change the path using the up and down arrow keys to navigate to other paths; the Enter key to open a directory; and the Backspace key to go back one directory. The **Save In field** defaults to the default path for this type of file and remembers the last path you used to save this type of file. There is no softkey for directly navigating to the Save In field but you can use left tab to get here from the File/Folder List.

User specified paths are remembered when you leave and return to a Mode and are reset back to the default using **Restore Mode Defaults**.

File Name

The **File Name** field is initially loaded with an automatically generated filename specific to the appropriate Save Type. The automatically generated filename is guaranteed not to conflict with any filename currently in the directory. You may replace or modify this filename using the File Name key. See the "[Quick Save](#)" on [page 2428](#) documentation for more on the automatic file naming algorithm.

When you press the **File Name** key the analyzer displays the Alpha Editor. Use the knob to choose the letter to add and the front-panel Enter key to add the letter to the file name. The BK character moves you back and the FW character moves you forward in the filename. The Select key on the front panel generates a space character. When you are done entering the filename press the **Done** softkey. This returns back to the **File Open** dialog and menu, but does not cause the save to occur.

Save As Type

This field shows the file suffix for the type of file you have selected to save. For example, if you navigated here while saving State, "Mode state (*.state)" is in the field. If you navigated here from saving Trace, ""Mode state (*.trace)" is in the field. If you navigated here while exporting a trace data file, "Trace Data (*.csv)" is in the field. For some file types, there is more than one choice in the dropdown, which you can select by using the up and down arrow keys and Enter.

Up One Level

This key corresponds to the icon of a folder with the up arrow that is in the tool bar of the dialog. When pressed, it causes the file and folder list to navigate up one level in the directory structure. The Backspace key does the same thing.

Create New Folder

This key corresponds to the icon of a folder with the "*" that is in the tool bar of the dialog. When pressed, a new folder is created in the current directory with the name **New Folder** and you can enter a new folder name using the Alpha Editor.

Cancel

This key corresponds to the **Cancel** selection in the dialog. It causes the current **Save As** request to be cancelled. The ESC key does the same thing.

Key Path	Save, State
----------	--------------------

Mode	All
Notes	Brings up Save As dialog for saving a State Save Type
Initial S/W Revision	Prior to A.02.00

Edit Register Names

You may enter a custom name on any of the Register keys, to help you remember what you are using that state to save. To do this, press the **Edit Register Names** key, choose the register whose name you wish to edit, and then enter the desired label using the Alpha Editor or an external PC keyboard.

The maximum number of characters that can be added is 30. In most cases, 30 characters will fit on two lines of the key.

See ["More Information" on page 1389](#)

Key Path	Save, State
Mode	All
Remote Command	:MMEMory:REGister:STATe:LABel <reg number>,"label" :MMEMory:REGister:STATe:LABel? <reg number>
Example	:MMEM:REG:STAT:LAB 1,"my label"
Notes	<reg number> is an integer from 1 to 16. If the SCPI specifies an invalid register number an error message is generated, -222,"Data out of range;Invalid register label number" "label" is a string from 0 to 30 characters in length. If a label exceeds 30 characters, an error message is generated, -150,"String data error;Label clipped to 30 characters" "label" of length 0 erases the custom label and restores the default (time and date) label. E.g.: :MMEM:REG:STAT:LAB 1,""
Dependencies	N9060A-7FP or N9060B-2FP license required to edit the register names. When the feature is not licensed, sending this command generates an error, -221,"Settings conflict;Option not available"
Preset	The names are unaffected by Preset or power cycle but are set to the default label (time and date) on a "Restore System Defaults->Misc"
Initial S/W Revision	A.11.00

More Information

When you edit one of the register names, the time and date field will be replaced by the custom name.

If you delete all the characters in the custom name, it restores the default (time and date).

The register names are stored within the state files, but they are not part of the instrument state; that is, once you have edited a register name, loading a new state will not change that register name. Another consequence of this is that the names will be persistent through a power cycle. Also, if a named state file is transferred to another analyzer, it will bring its custom name along with it.

If you try to edit the name of an empty register, the analyzer will first save the state to have a file to put the name in. If you load a named state file into an analyzer with older firmware it will ignore the metadata.

The *SAV and *RCL commands will not be affected by the custom register names, nor will the MMEM commands.

Register 1 thru Register 16

Selecting any one of these register menu keys causes the State of the currently active mode to be saved to the specified Register. The registers are provided for rapid saving and recalling, since you do not need to specify a filename or navigate to a file. Each of the register menu keys annotates whether it is empty or at what date and time it was last modified. In addition, you can use the **Edit Register Names** key to enter custom names for each register.

Although these 16 registers are the only registers available from the front panel, there are 128 state registers available in the instrument. Registers 17–128 are only available from the SCPI interface, using the *SAV command.

There is one set of 128 state registers in the instrument, not one set for each Mode. When a state is saved, the Mode it was saved from is saved with it; then when it is recalled, the instrument switches to that Mode.

After the save completes, the corresponding register menu key annotation is updated with the date and time and the message "Register <register number> saved" is displayed.

Key Path	Save, State
Mode	All
Example	*SAV 1
Range	1–16 from front panel, 1–128 from SCPI
Readback	Date and time with seconds resolution are displayed on the key OR A custom name of up to 30 characters entered using the Edit Register Names key OR “(empty)” if no prior save operation has been performed to this register.
Initial S/W Revision	Prior to A.02.00
Modified at S/W Revision	A.11.00

Register 1 thru Register 16

Selecting any one of these register menu keys causes the State of the currently active mode to be saved to the specified Register. The registers are provided for rapid saving and recalling, since you do not need to specify a filename or navigate to a file. Each of the register menu keys annotates whether it is empty or at what date and time it was last modified. In addition, you can use the **Edit Register Names** key to enter custom names for each register.

Although these 16 registers are the only registers available from the front panel, there are 128 state registers available in the instrument. Registers 17–128 are only available from the SCPI interface, using the *SAV command.

There is one set of 128 state registers in the instrument, not one set for each Mode. When a state is saved, the Mode it was saved from is saved with it; then when it is recalled, the instrument switches to that Mode.

After the save completes, the corresponding register menu key annotation is updated with the date and time and the message "Register <register number> saved" is displayed.

Key Path	Save, State
Mode	All
Example	*SAV 1
Range	1-16 from front panel, 1-128 from SCPI
Readback	Date and time with seconds resolution are displayed on the key OR A custom name of up to 30 characters entered using the Edit Register Names key OR “(empty)” if no prior save operation has been performed to this register.
Initial S/W Revision	Prior to A.02.00
Modified at S/W Revision	A.11.00

Mass Storage Catalog (Remote Command Only)

Key path	SCPI Only
Remote Command	:MMEMory:CATalog? [<directory_name>]
Notes	The string must be a valid logical path. Queries disk usage information (drive capacity, free space available) and obtains a list of files and directories in a specified directory in the following format: <numeric_value>,<numeric_value>,{<file_entry>} It returns two numeric parameters and as many strings as there are files and directories. The first parameter indicates the total amount of storage currently used in bytes. The second parameter indicates the total amount of storage available, also in bytes. The <file_entry> is a string. Each <file_entry> indicates the name, type, and size of one file in the directory list: <file_name>,<file_type>,<file_size> As the windows file system has an extension that indicates file type, <file_type> is always empty. <file_size> provides the size of the file in bytes. For directories, <file_entry> is surrounded by square brackets and both <file_type> and <file_size> are empty
Initial S/W Revision	Prior to A.02.00

Mass Storage Change Directory (Remote Command Only)

Key path	SCPI Only
Remote Command	:MMEMory:CDIRectory [<directory_name>] :MMEMory:CDIRectory?
Notes	The string must be a valid logical path. Changes the default directory for a mass memory file system. The <directory_name> parameter is a string. If no parameter is specified, the directory is set to the *RST value.

	At *RST, this value is set to the default user data storage area, that is defined as System.Environment.SpecialFolder.Personal. Query returns full path of the default directory.
Initial S/W Revision	Prior to A.02.00

Mass Storage Copy (Remote Command Only)

Key path	SCPI Only
Remote Command	:MMEMory:COpy <string>,<string>[,<string>,<string>]
Notes	<p>The string must be a valid logical path.</p> <p>Copies an existing file to a new file or an existing directory to a new directory.</p> <p>Two forms of parameters are allowed. The first form has two parameters. In this form, the first parameter specifies the source, and the second parameter specifies the destination.</p> <p>The second form has four parameters. In this form, the first and third parameters specify the source. The second and fourth parameters specify the directories. The first pair of parameters specifies the source. The second pair specifies the destination. An error is generated if the source doesn't exist or the destination file already exists.</p> <p>This command will generate an "access denied" error if the destination is a restricted folder (e.g., C:\Windows) and the current user does not have Power User or Administrator privileges.</p>

Mass Storage Device Copy (Remote Command Only)

This command transfers data to/from a file and a peripheral device.

Key path	SCPI Only
Remote Command	:MMEMory:COpy:DEvice <source_string>,<dest_string>
Notes	<p>The strings must be a valid logical path or a valid device keyword. If the dest_string is a device keyword, the data is copied from the source file to the device. If the source_string is a device keyword, the data is copied to the source file from the device.</p> <p>Valid device keywords are:</p> <p>SNS (smart noise source)</p> <p>An error is generated if the file or device is not found.</p>

Mass Storage Delete (Remote Command Only)

Key path	SCPI Only
Remote Command	:MMEMory:DElete <file_name>[,<directory_name>]
Notes	<p>The string must be a valid logical path.</p> <p>Removes a file from the specified directory. The <file_name> parameter specifies the file name to be removed. This command will generate an "access denied" error if the file is in a restricted folder (e.g.,</p>

	C:\Windows) and the current user does not have Power User or Administrator privileges.
Initial S/W Revision	Prior to A.02.00

Mass Storage Data (Remote Command Only)

Creates a file containing the specified data OR queries the data from an existing file.

Key path	SCPI Only
Remote Command	:MMEMory:DATA <file_name>, <data> :MMEMory:DATA? <file_name>
Notes	The string must be a valid logical path. The command form is MMEMory:DATA <file_name>,<data>. It loads <data> into the file <file_name>. <data> is in 488.2 block format. <file_name> is string data. The query form is MMEMory:DATA? <file_name> with the response being the associated <data> in block format.
Initial S/W Revision	Prior to A.02.00

Mass Storage Make Directory (Remote Command Only)

Key path	SCPI Only
Remote Command	:MMEMory:MDIRectory <directory_name>
Notes	The string must be a valid logical path. Creates a new directory. The <directory_name> parameter specifies the name to be created. This command will generate an “access denied” error if the new directory would be in a restricted folder (e.g., C:\Windows) and the current user does not have Power User or Administrator privileges.
Initial S/W Revision	Prior to A.02.00

Mass Storage Move (Remote Command Only)

Key path	SCPI Only
Remote Command	:MMEMory:MOVE <string>,<string> [,<string>,<string>]
Notes	The string must be a valid logical path. Moves an existing file to a new file or an existing directory to a new directory. Two forms of parameters are allowed. The first form has two parameters. In this form, the first parameter specifies the source, and the second parameter specifies the destination. The second form has four parameters. In this form, the first and third parameters specify the source. The second and fourth parameters specify the directories. The first pair of parameters specifies the source. The second pair specifies the destination. An error is generated if the source doesn't exist or the destination file already exists.

	This command will generate an “access denied” error if the destination is a restricted folder (e.g., C:\Windows) and the current user does not have Power User or Administrator privileges.
Initial S/W Revision	Prior to A.02.00

Mass Storage Remove Directory (Remote Command Only)

Key path	SCPI Only
Remote Command	:MMEMory:RDIRectory <directory_name>
Notes	The string must be a valid logical path. Removes a directory. The <directory_name> parameter specifies the directory name to be removed. All files and directories under the specified directory shall also be removed. This command will generate an “access denied” error if the folder is a restricted folder (e.g., C:\Windows) or is in a restricted folder and the current user does not have Power User or Administrator privileges.
Initial S/W Revision	Prior to A.02.00

Mass Storage Determine Removable Media (Remote Command Only)

This command is used to determine if any removable media devices are connected to the instrument. Primarily, these are USB memory devices plugged-in to the front panel or rear panel USB ports. On instruments with PC6 or PC7 CPU’s, one SD card slot is available for removable media. The instrument’s primary disk drive is not a removable media device.

Key Path	SCPI Only
Remote Command	:MMEMory:RMEDIA:LIST?
Notes	The return value will be a string containing a list of partition identifiers which are removable media devices. Each identifier will be separated by a comma. If no removable media is present, an empty string will be returned. Examples: One removable device present will result in a return string of “F:”. Two removable devices present will result in a return string of “F:,G:”. No removable devices present will result in a return string of “”.
Initial S/W Revision	x.15.00

Mass Storage Determine Removable Media Label (Remote Command Only)

This command is used to set or query a removable media device’s label.

Key Path	SCPI Only
----------	------------------

Remote Command	:MMEMory:RMEDia:LABel <partition>,<string> :MMEMory:RMEDia:LABel? <partition>
Example	MMEM:RMED:LAB "F:","My Device"
Notes	If the <partition> specified does not exist or is not a removable media device the error -252,"Missing Media" will be generated. Setting the removable media label requires Administrative privileges. If the currently logged in user does not have appropriate privileges the error "-221.9900,Settings conflict;Administrator privileges required" is generated.
Initial S/W Revision	x.15.00

Mass Storage Determine Removable Media Write-protect status (Remote Command Only)

This command is used to query a removable media device's write-protect status.

Key Path	SCPI Only
Remote Command	:MMEMory:RMEDia:WPRotect? <partition>
Example	MMEM:RMED:WPR? "F:"
Notes	The return value is 1 if the device is write-protected, and 0 if the device is write-enabled. If the <partition> specified does not exist or is not a removable media device the error -252,"Missing Media" will be generated.
Preset	The return value will be depending on SD card installed.
Initial S/W Revision	x.15.00

Mass Storage Determine Removable Media size (Remote Command Only)

This command is used to query a removable media device's total memory size (not available memory size).

Key Path	SCPI Only
Remote Command	:MMEMory:RMEDia:SIZE? <partition>
Example	MMEM:RMED:SIZE? "F:"
Notes	The return value is integer value in GBytes. Any device which is less than 1 GB will return 0 GB. If the <partition> specified does not exist or is not a removable media device the error -252,"Missing Media" will be generated.
Initial S/W Revision	x.15.00

Trace (+State)

The **Save Trace (+State)** menu lets you choose a register or file specifying where to save the Trace+State state file.

A saved state contains all of the settings and data required to return the analyzer as closely as possible to the exact setup it had when the save occurred. This includes the Input/Output settings, even though they are outside of the Mode's state, because they are needed to restore the complete setup. A Trace+State file also includes trace data from one trace or all traces, which will load in View mode when the Trace+State file is recalled.

After the save completes, the message "File <filename> saved" or "Trace Register <register number> saved" is displayed.

For rapid saves, the Trace (+State) menu lists 5 registers to save to. Pressing a Register key initiates the save. You can also select a file to save to.

The default path for all State Files including .trace files is:

My Documents\<mode name>\state

where <mode name> is the parameter used to select the mode with the INST:SEL command (for example, Basic for the IQAnalyzer).

This key is grayed out for measurements that do not support trace saves. It is blanked for modes that do not support trace saves. Saving **Trace** is identical to saving State except a .trace extension is used on the file instead of .state, and internal flags are set in the file indicating which trace was saved. You may select to save one trace or ALL traces.

Key Path	Save
Mode	SA
Remote Command	:MMEMory:STORe:TRACe TRACE1 TRACE2 TRACE3 TRACE4 TRACE5 TRACE6 ALL,<filename> :MMEMory:STORe:TRACe:REGister TRACE1 TRACE2 TRACE3 TRACE4 TRACE5 TRACE6 ALL,<integer>
Example	:MMEM:STOR:TRAC TRACE1, "myState.trace" saves the file myState.trace on the default path and flags it as a "single trace" file with Trace 1 as the single trace (even though all of the traces are in fact stored). :MMEM:STOR:TRAC ALL, "myState.trace" saves the file myState.trace on the default path and flags it as an "all traces" file :MMEM:STOR:TRAC:REG TRACE1, 2 stores trace 1 data in trace register 2
Notes	This command actually performs a save state, which in the Swept SA measurement includes the trace data. However it flags it (in the file) as a "save trace" file of the specified trace (or all traces). Some modes and measurements do not have available all 6 traces. The Phase Noise mode command, for example, is: MMEMory:STORe:TRACe TRACE1 TRACE2 TRACE3 ALL,<filename> Some modes and measurements have more than 6 traces available. The Realtime SA mode command, for example, is: MMEMory:STORe:TRACe TRACE1 TRACE2 TRACE3 TRACE4 TRACE5 TRACE6 TRACE7 TRACE8 TRACE9 TRACE10 TRACE11 TRACE12 ALL,<filename> The range for the register parameter is 1-5 When you initiate a save, if the file already exists, a dialog will appear that allows you to replace the existing file by selecting OK or you can Cancel the request. If you select OK, the file will be overwritten. Using the C: drive is strongly discouraged, since it runs the risk of being overwritten during an instrument software upgrade. Both single and double quotes are supported for any filename parameter over remote.

After saving to a register, that register's menu key is updated with the date and time of the save.
After saving to a register, you remain in the **Save Trace** menu, so that you can see the Register key update. After saving to a file, the analyzer automatically returns to the previous menu and any Save As dialog goes away.

Initial S/W Revision	Prior to A.02.00
----------------------	------------------

From Trace

Accesses a menu that enables you to select the trace to be saved. Once a trace is selected, the key returns to the Save Trace menu and the selected trace number is annotated on the key. The default is the currently selected trace, selected in this menu or in the Trace/Det, Export Data, Import Data or Recall Trace menus, except if you have chosen All then it remains chosen until you specifically change it to a single trace. To save the Trace you must select the **Save As** key in the Save Trace menu.

When you select a trace, it makes that trace the current trace, so it displays on top of all of the other traces.

Key Path	Save, Trace + State
Mode	SA
Initial S/W Revision	Prior to A.02.00

From File...

When you press "From File", the analyzer brings up a Windows dialog and a menu entitled "**File Open.**" This menu allows you to navigate to the various fields in the Windows dialog without using a keyboard or mouse. The **Tab** and **Arrow** keys can also be used for dialog navigation.

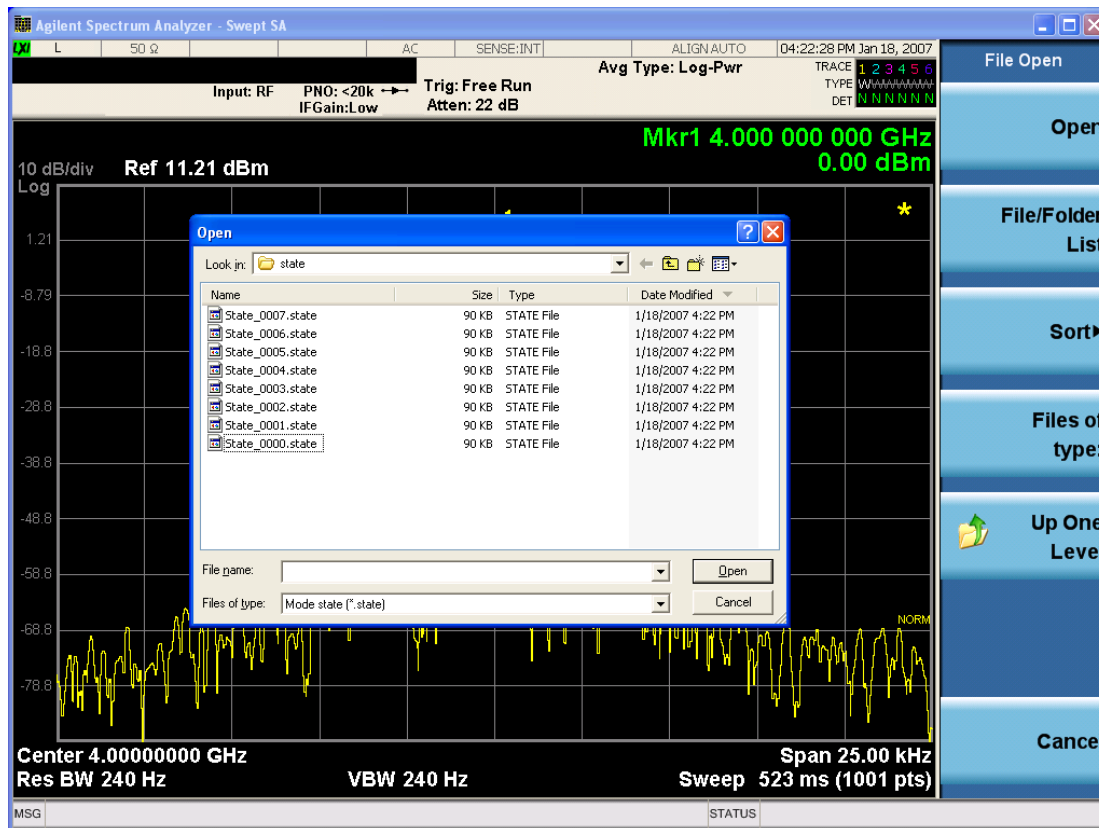

Listed below are the functions of the various fields in the dialog, and the corresponding softkeys:

Open

Performs the recall of the specified file. While the recall is being performed, the floppy icon appears briefly in the Meas bar.

File/Folder List

Enables you to navigate to the center of the dialog that contains the list of files and folders. Once here you can get information about the file and use the tab keys to navigate to the other fields in the dialog, such as Look In.

Look In

The **Look In** field shows the path from which the file will be recalled and allows you to change the path using the up and down arrow keys to navigate to other paths; the Enter key to open a directory; and the Backspace key to go back one directory. The **Look In field** first uses the last path from the Save As dialog **Save In:** path for that same file type. There is no softkey for directly navigating to the Look In field, but you can use the left tab to get here from the File/Folder List.

User specified paths are remembered when you leave and return to a Mode and are reset back to the default using **Restore Mode Defaults**.

Sort

Accesses a menu that enables you to sort the files within the File Open dialog. Only one sorting type can be selected at a time and the sorting happens immediately. The sorting types are **By Date**, **By Name**, **By extension**, and **By Size**.

Files of Type

This field shows the file suffix for the type of file you have selected to recall. For example, if you navigated here while recalling State, "Mode state (*.state)" is in the field. If you navigated here while recalling Trace, ""Mode state (*.trace)" is in the field. If you navigated here while importing a trace data file, "Trace Data (*.csv)" is in the field. For some file types, there is more than one choice in the dropdown menu, which you can select by using the up and down arrow keys and Enter.

Up One Level

This key corresponds to the icon of a folder with the up arrow that is in the tool bar of the dialog. When pressed, it causes the file and folder list to navigate up one level in the directory structure. The Backspace key does the same thing.

Cancel

This key corresponds to the **Cancel** selection in the dialog. It causes the current **Open** request to be cancelled. The ESC key does the same thing.

Key Path	Recall, State
Notes	Brings up the Open dialog for recalling a State Save Type
Initial S/W Revision	Prior to A.02.00

Register 1 thru Register 16

Selecting any one of these register menu keys causes the State of the currently active mode to be saved to the specified Register. The registers are provided for rapid saving and recalling, since you do not need to specify a filename or navigate to a file. Each of the register menu keys annotates whether it is empty or at what date and time it was last modified. In addition, you can use the **Edit Register Names** key to enter custom names for each register.

Although these 16 registers are the only registers available from the front panel, there are 128 state registers available in the instrument. Registers 17–128 are only available from the SCPI interface, using the *SAV command.

There is one set of 128 state registers in the instrument, not one set for each Mode. When a state is saved, the Mode it was saved from is saved with it; then when it is recalled, the instrument switches to that Mode.

After the save completes, the corresponding register menu key annotation is updated with the date and time and the message "Register <register number> saved" is displayed.

Key Path	Save, State
Mode	All
Example	*SAV 1
Range	1–16 from front panel, 1–128 from SCPI

Readback	Date and time with seconds resolution are displayed on the key OR A custom name of up to 30 characters entered using the Edit Register Names key OR “(empty)” if no prior save operation has been performed to this register.
Initial S/W Revision	Prior to A.02.00
Modified at S/W Revision	A.11.00

Data (Export)

Exporting a data file stores data from the current measurement to mass storage files. The Export Menu only contains data types that are supported by the current measurement.

Since the commonly exported data files are in .csv format, the data can be edited by you prior to importing. This allows you to export a data file, manipulate the data in Excel (the most common PC Application for manipulating .csv files) and then import it.

Selecting an Export Data menu key will not actually cause the exporting to occur, since the analyzer still needs to know where you wish to save the data. Pressing the Save As key in this menu brings up the Save As dialog and Save As menu that allows you to specify the destination file and directory. Once a filename has been selected or entered in the Open menu, the export will occur as soon as the Save key is pressed.

Key Path	Save
Mode	All
Notes	The menu is built from whatever data types are available for the mode. So the key locations in the sub menu will vary. No SCPI command directly controls the Data Type that this key controls. The Data Type is included in the MMEM:STORe commands.
Dependencies	If a file type is not used by a certain measurement, that type is grayed out for that measurement. The key for a file type will not show at all if there are no measurements in the Mode that support it.
Preset	Is not affected by a Preset or shutdown, but is reset during Restore Mode Defaults
Readback	The data type that is currently selected
Initial S/W Revision	Prior to A.02.00

Parameter Set

Enables you to export format parameter set data to files. Selecting this key displays a menu that enables you to select the data source. After making this selection, depress Save As... and use the file dialog to enter the file name to save. You can import the exported file by selecting Parameter Set under Recall, Data.

Default path:

Default path of this import type is “My Documents\MSR\data\params” folder. Note that “My Documents” is an alias to a directory and its location depends on which user is logged in. If the file path is specified without root folder, the export file is determined with the default path. For example if “folder1\paramData.prms” is specified, “My Documents\MSR\data\params\folder1\paramData.fps” is exported.

File Extension: fps

Default Prefix: ParamSet_

File Dialog Filter: Format Parameter Set Files (*.fps)

Key Path	Save, Data
Mode	MSR
Remote Command	MMEMOry:STORe:PSET LTEFdd1 LTEFdd2 LTEFdd3 WCDma1 WCDma2 WCDma3 GSM1 GSM2 GSM3 CDMA1 CDMA2 CDMA3 EVDO1 EVDO2 EVDO3 LTETdd1 LTETdd2 LTETdd3 TDSCdma1 TDSCdma2 TDSCdma3,<string>
Example	MME:STOR:PSET WCDM1,"WCDMA.fps"
Notes	The first enum selects the source format parameter set from which the file data are exported.
Initial S/W Revision	A.10.00
Modified at S/W Revision	A.12.00, A.16.00

Measurement Results

Pressing this key selects Meas Results as the data type to be exported.

The Meas Results file contains information that describes the current state of the analyzer. It is detailed in ["Meas Results File Contents" on page 1402](#) below.

Key Path	Save, Data
Remote Command	:MMEMOry:STORe:RESuLts <string>
Example	:MME:STOR:RES "MeasR_0000.csv"
Notes	If the save is initiated via SCPI and the file already exists, the file will be overwritten. The SCPI command exports Spectrum Emission Mask measurement results to the file specified as the parameter in the current path. The default path is My Documents\ <current mode>\data\sem\results.<br=""></current> Using the C: drive is strongly discouraged, since it runs the risk of being overwritten during an instrument software upgrade. The SCPI parameter is a quoted string that specifies the filename. Both single and double quotes are supported for any filename parameter over SCPI.
Dependencies	The current active measurement must be the Spectrum Emission Mask measurement to use this command.
Status Bits/OPC dependencies	Sequential – waits for the previous measurement to complete
Initial S/W Revision	Prior to A.02.00

Meas Results File Contents

A Meas Results File contains measurement results with the following information.

- File ID string, which is “MeasResult”
- Measurement ID following Mode ID, which is “SA:SEM” for example.
- Firmware rev and model number
- Option string
- Automatic Trigger Time
- Automatic Trigger Time State
- Center Frequency
- ChanIntegBW
- ChannelDetector
- ChannelDetectorState
- ChanPwrRefAuto
- ChanResBW
- ChanResBWAuto
- ChanSpan
- ChanSweepTime
- ChanSweepTimeAuto
- ChanVbwRbwRatio
- ChanVbwRbwRatioAuto
- ChanVideoBW
- ChanVideoBWAuto
- Electrical Atten
- Electrical Atten Bypass
- Electrical Atten State
- External1 Trigger Delay
- External1 Trigger Delay State
- External1 Trigger Level
- External1 Trigger Slope
- External2 Trigger Delay

- External2 Trigger Delay State
- External2 Trigger Level
- External2 Trigger Slope
- FilterAlpha
- Internal Preamp
- Internal Preamp Band
- Line Trigger Delay
- Line Trigger Delay State
- Line Trigger Slope
- Mechanical Atten
- Mechanical Atten Auto
- OffsetDetector
- OffsetDetectorState
- OffsetLimitAbsStartBTS
- OffsetLimitAbsStartMS
- OffsetLimitAbsStopBTS
- OffsetLimitAbsStopMS
- OffsetLimitFailMaskBTS
- OffsetLimitFailMaskMS
- OffsetLimitRelStartBTS
- OffsetLimitRelStartMS
- OffsetLimitRelStopBTS
- OffsetLimitRelStopMS
- OffsetMeasBWBTS
- OffsetMeasBWMS
- OffsetResolutionBWAutoBTS
- OffsetResolutionBWAutoMS
- OffsetResolutionBWBTS
- OffsetResolutionBWMS
- OffsetSideBTS
- OffsetSideMS

- OffsetStartFrequencyBTS
- OffsetStartFrequencyMS
- OffsetStateBTS
- OffsetStateMS
- OffsetStopFrequencyBTS
- OffsetStopFrequencyMS
- OffsetSweepTimeAutoBTS
- OffsetSweepTimeAutoMS
- OffsetSweepTimeBTS
- OffsetSweepTimeMS
- OffsetVbwRbwRatioAutoBTS
- OffsetVbwRbwRatioAutoMS
- OffsetVbwRbwRatioBTS
- OffsetVbwRbwRatioMS
- OffsetVideoBWAUTOBTS
- OffsetVideoBWAUTOMS
- OffsetVideoBWBT
- OffsetVideoBWMS
- PeakReference
- Periodic Timer Period
- Periodic Timer Sync Source
- Periodic Timer Trigger Delay
- Periodic Timer Trigger Delay State
- PowerReference
- PSDReference
- Radio Device
- RFBurst Trigger Delay
- RFBurst Trigger Delay State
- RFBurst Trigger Level Abs
- RFBurst Trigger Level Rel
- RFBurst Trigger Level Type

- RFBurst Trigger Slope
- RrcFilter
- SemAverageNumber
- SemAverageState
- TotalAtten
- Trigger Holdoff
- Trigger Holdoff State
- TriggerSource
- Video Trigger Delay
- Video Trigger Delay State
- Video Trigger Level
- Video Trigger Slope
- ViewSelection

The file contains these data followed by MeasResult1 to MeasResult12 that flag the start of the measurement results. Each line of Measurement Results consists of twelve comma separated values from MeasResult1 value to MeasResult12 value. MeasResult1 contains the same results as MEAS/READ/FETCH:SEMAsk1; MeasResult2, MEAS/READ/FETCH:SEMAsk2; MeasResult3, MEAS/READ/FETCH:SEMAsk3;... (continues in the same manner)

The exported file is in CSV format, with a.csv extension. The Meas Results file, when imported into Excel, shows the following data:

MeasResult	
SA:SEM	
A.10.53	N90 30A
526 ALV ATP	1
B1X B1Y B25	
B40 BBA CR3	
CRP DCF DDA	
DP2 DRD EA3	
EDP EMC EP1	
ERC ESC ESP	
EXM FSA LFE	
LNP MAT	
MPB NFE	
NUL P26 PFR	
PNC RTL RTS	
S40 SB1 SEC	
SM1 TVT YAS	
YAV	

11 Spectrum Emission Mask Measurement
Save

Automatic Trigger Time	0.1	
Automatic Trigger Time State	FALS E	
Center Frequency	1.33 E+10	
ChanIntegBW	384 000 0	384 000 0
ChannelDetector	Average	
ChannelDetectorState	TRUE	
ChanPwrRefAuto	TRUE	
ChanResBW	100 000	100 000
ChanResBWAuto	FALS E	FALS E
ChanSpan	500 000 0	500 000 0
ChanSweepTime	0.00 250 7	0.00 250 7
ChanSweepTimeAuto	TRUE	TRUE
ChanVbwRbwRatio	1	1
ChanVbwRbwRatioAuto	FALS E	FALS E
ChanVideoBW	100 000	100 000
ChanVideoBWAuto	TRUE	TRUE
Electrical Atten	0	
Electrical Atten Bypass	TRUE	
Electrical Atten State	FALS E	
External1 Trigger Delay	1.00 E-06	

External1 Trigger Delay State	FALS E					
External1 Trigger Level	1.2					
External1 Trigger Slope	Posit ive					
External2 Trigger Delay	1.00 E-06					
External2 Trigger Delay State	FALS E					
External2 Trigger Level	1.2					
External2 Trigger Slope	Posit ive					
FilterAlpha	0.22					
Internal Preamp	FALS E					
Internal Preamp Band	Low					
Line Trigger Delay	1.00 E-06					
Line Trigger Delay State	FALS E					
Line Trigger Slope	Posit ive					
Mechanical Atten	10					
Mechanical Atten Auto	TRUE					
OffsetDetecto r	Peak					
OffsetDetecto rState	TRUE					
OffsetLimitAb sStartBTS	-14	-14	-26	-13	-13	-13
OffsetLimitAb sStartMS	-14	-14	-26	-13	-13	-13
OffsetLimitAb sStopBTS	-14	-26	-26	-13	-13	-13
OffsetLimitAb sStopMS	-14	-26	-26	-13	-13	-13

OffsetLimitFailMaskBTS	ABSolute	ABSolute	ABSolute	ABSolute	ABSolute	ABSolute
OffsetLimitFailMaskMS	ABSolute	ABSolute	ABSolute	ABSolute	ABSolute	ABSolute
OffsetLimitRelStartBTS	-30	-30	-30	-30	-30	-30
OffsetLimitRelStartMS	-30	-30	-30	-30	-30	-30
OffsetLimitRelStopBTS	-30	-30	-30	-30	-30	-30
OffsetLimitRelStopMS	-30	-30	-30	-30	-30	-30
OffsetMeasBWBTS	1	1	1	1	1	1
OffsetMeasBWMMS	1	1	1	1	1	1
OffsetResolutionBWAutoBTS	FALSE	FALSE	FALSE	FALSE	FALSE	FALSE
OffsetResolutionBWAutoMS	FALSE	FALSE	FALSE	FALSE	FALSE	FALSE
OffsetResolutionBWBTSS	30000	30000	30000	1000000	1000000	1000000
OffsetResolutionBWMS	30000	30000	30000	1000000	1000000	1000000
OffsetSideBTS	Both	Both	Both	Both	Both	Both
OffsetSideMS	Both	Both	Both	Both	Both	Both
OffsetStartFrequencyBTS	25150000	27150000	35150000	4000000	8000000	12500000
OffsetStartFrequencyMS	25150000	27150000	35150000	4000000	8000000	12500000
OffsetStateBTS	TRUE	TRUE	TRUE	TRUE	TRUE	FALSE
OffsetStateMS	TRUE	TRUE	TRUE	TRUE	TRUE	FALSE
OffsetStopFrequencyBTS	27150000	35150000	4000000	8000000	12500000	15000000
OffsetStopFrequencyMS	27150000	35150000	4000000	8000000	12500000	15000000

	0	0	0		00	00
OffsetSweepTimeAutoBTS	TRUE	TRUE	TRUE	TRUE	TRUE	TRUE
OffsetSweepTimeAutoMS	TRUE	TRUE	TRUE	TRUE	TRUE	TRUE
OffsetSweepTimeBTS	0.01 733 3	0.06 932	0.04 202 7	0.002053	0.00 225 3	0.00 125 3
OffsetSweepTimeMS	0.01 733 3	0.06 932	0.04 202 7	0.002053	0.00 225 3	0.00 125 3
OffsetVbwRbwRatioAutoBTS	FALSE	FALSE	FALSE	FALSE	FALSE	FALSE
OffsetVbwRbwRatioAutoMS	FALSE	FALSE	FALSE	FALSE	FALSE	FALSE
OffsetVbwRbwRatioBTS	0.01	0.01	0.01	0.01	0.01	0.01
OffsetVbwRbwRatioMS	0.01	0.01	0.01	0.01	0.01	0.01
OffsetVideoBWAutoBTS	TRUE	TRUE	TRUE	TRUE	TRUE	TRUE
OffsetVideoBWAutoMS	TRUE	TRUE	TRUE	TRUE	TRUE	TRUE
OffsetVideoBWAutoBTS	300	300	300	10000	100 00	100 00
OffsetVideoBWAutoMS	300	300	300	10000	100 00	100 00
PeakReference	- 82.9 957					
Periodic Timer Period	0.02					
Periodic Timer Sync Source	None					
Periodic Timer Trigger Delay	1.00 E-06					
Periodic Timer Trigger Delay State	FALSE					
PowerReference	-					

11 Spectrum Emission Mask Measurement
Save

ce	73.6 966
PSDReferenc e	- 139. 54
Radio Device	Bts
RFBurst Trigger Delay	1.00 E-06
RFBurst Trigger Delay State	FALS E
RFBurst Trigger Level Abs	-20
RFBurst Trigger Level Rel	-6
RFBurst Trigger Level Type	Absol ute
RFBurst Trigger Slope	Posit ive
RrcFilter	FALS E
SemAverageN umber	10
SemAverageS tate	FALS E
TotalAtten	10
Trigger Holdoff	0.1
Trigger Holdoff State	FALS E
TriggerSource	Free
Video Trigger Delay	1.00 E-06
Video Trigger Delay State	FALS E
Video Trigger Level	-25
Video Trigger Slope	Posit ive
Video	AbsP

Selection	wrFr eq										
MeasResult1	Meas Resul t2	Meas Resul t3	Meas Resul t4	MeasResu lt5	Meas Resul t6	Meas Resul t7	Meas Resul t8	Meas Resul t9	Meas Result 10	Meas Result 11	Meas Result 12
-999	- 78.8 935 9	-13	999	- 73.6966 3340998 79	-999	-999	-999	-999	-999	-999	-999
- 73.6966334 099879	- 78.9 523 5	-13	999	-999	-999	-999	-999	-999	-999	-999	

Save As . . .

When you press “Save As”, the analyzer brings up a Windows dialog and a menu entitled “**Save As.**” This menu allows you to navigate to the various fields in the Windows dialog without using a keyboard or mouse. The **Tab** and **Arrow** keys can also be used for dialog navigation.

See "[To File . . .](#)" on page 2444 in **Save, State** for a full description of this dialog and menu.

The default path for saving files is:

For all of the Trace Data Files:

My Documents\<<mode name>\data\traces

For all of the Limit Data Files:

My Documents\<<mode name>\data\limits

For all of the Measurement Results Data Files:

My Documents\<<mode name>\data\<<measurement name>\results

For all of the Capture Buffer Data Files:

My Documents\<<mode name>\data\captureBuffer

Key Path	Save, Data
Mode	All
Notes	The key location is mode-dependent and will vary. Brings up the Save As dialog for saving a <mode specific> Save Type. The save is performed immediately and does not wait until the measurement is complete.
Initial S/W Revision	Prior to A.02.00

Screen Image

Pressing Screen Image accesses a menu of functions that enable you to specify a format and location for the saved screen image. It brings up a menu that allows you to specify the color scheme of the Screen Image (Themes) or navigate to the Save As dialog to perform the actual save.

Screen Image files contain an exact representation of the analyzer display. They cannot be loaded back onto the analyzer, but they can be loaded into your PC for use in many popular applications.

The image to be saved is actually captured when the **Save** front panel key is pressed, and kept in temporary storage to be used if you ask for a Screen Image save. When the Screen Image key is pressed, a "thumbnail" of the captured image is displayed, as shown below:

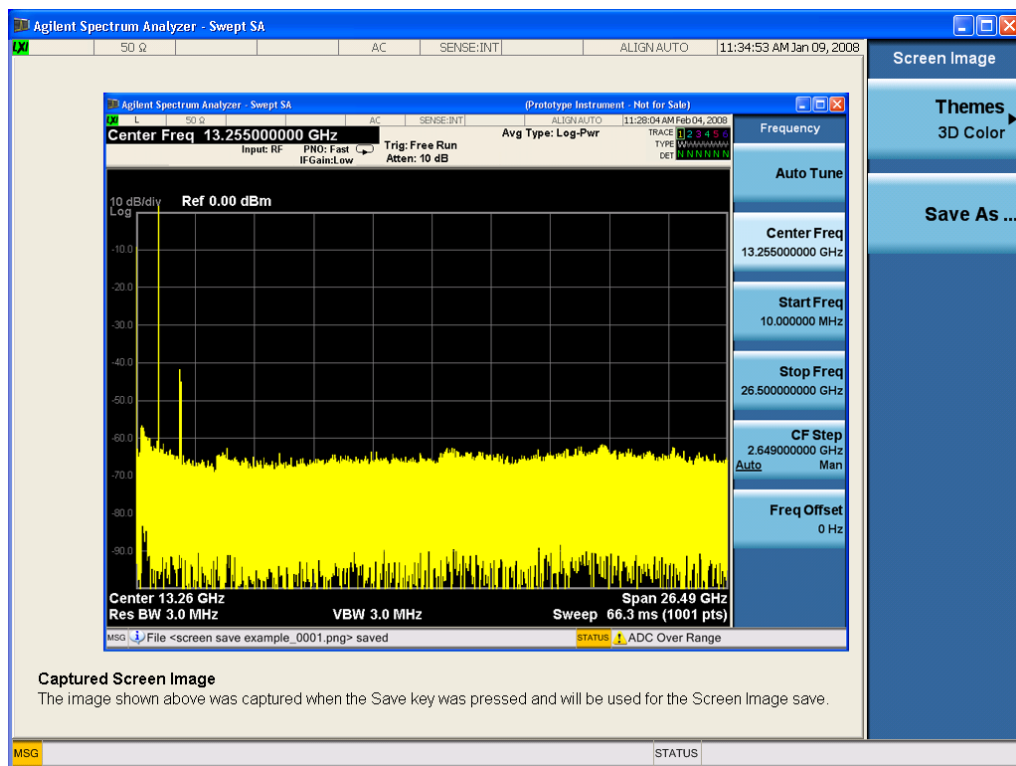

When you continue on into the **Save As** menu and complete the Screen Image save, the image depicted in the thumbnail is the one that gets saved, showing the menus that were on the screen before going into the **Save** menus. The save is performed immediately and does not wait until the measurement is complete.

After you have completed the save, the **Quick Save** front-panel key lets you quickly repeat the last save performed, using an auto-named file, with the current screen data.

NOTE

For versions previous to A.01.55, if you initiate a screen image save by navigating through the Save menus, the image that is saved will contain the Save menu softkeys, not the menus and the active function that were on the screen when you first pressed the Save front panel key.

Key Path	Save
Mode	All

Remote Command	:MMEMory:STORe:SCReen <filename>
Example	:MMEM:STOR:SCR "myScreen.png" This stores the current screen image in the file MyScreenFile.png in the default directory.
Initial S/W Revision	Prior to A.02.00

Themes

Accesses a menu of functions that enable you to choose the theme to be used when saving the screen image.

The **Themes** option is the same as the **Themes** option under the **Display** and **Page Setup** dialogs. It allows you to choose between themes to be used when saving the screen image.

Key Path	Save, Screen Image
Remote Command	:MMEMory:STORe:SCReen:THEME TDColor TDMonochrome FCOLOR FMONochrome :MMEMory:STORe:SCReen:THEMe?
Example	:MMEM:STOR:SCR:THEM TDM
Preset	3D Color; Is not part of Preset, but is reset by Restore Misc Defaults or Restore System Defaults All and survives subsequent running of the modes.
Readback	3D Color 3D Mono Flat Color Flat Mono
Backwards Compatibility Notes	In ESA and PSA we offer the choice of "Reverse Bitmap" or "Reverse Metafile" when saving screen images. This is much like the "Flat Color" theme available in X-Series. Also, if you selected Reverse Bitmap AND a black & white screen image, that would be much like "Flat Monochrome". In other words, each of the X-Series themes has a similar screen image type in ESA/PSA. But they are not identical.
Initial S/W Revision	Prior to A.02.00

3D Color

Selects a standard color theme with each object filled, shaded and colored as designed.

Key Path	Save, Screen Image, Themes
Example	MMEM:STOR:SCR:THEM TDC
Readback	3D Color
Initial S/W Revision	Prior to A.02.00

3D Monochrome

Selects a format that is like 3D color but shades of gray are used instead of colors.

Key Path	Save, Screen Image, Themes
Example	MMEM:STOR:SCR:THEM TDM
Readback	3D Mono
Initial S/W Revision	Prior to A.02.00

Flat Color

Selects a format that is best when the screen is to be printed on an ink printer.

Key Path	Save, Screen Image, Themes
Example	MMEM:STOR:SCR:THEM FCOL
Readback	Flat Color
Initial S/W Revision	Prior to A.02.00

Flat Monochrome

Selects a format that is like Flat Color. But only black is used (no colors, not even gray), and no fill.

Key Path	Save, Screen Image, Themes
Example	MMEM:STOR:SCR:THEM FMON
Readback	Flat Mono
Initial S/W Revision	Prior to A.02.00

Save As...

When you press "Save As", the analyzer brings up a Windows dialog and a menu entitled "**Save As.**" This menu allows you to navigate to the various fields in the Windows dialog without using a keyboard or mouse. The **Tab** and **Arrow** keys can also be used for dialog navigation.

See "[To File . . .](#)" on page 2444 in **Save, State** for a full description of this dialog and menu.

The default path for Screen Images is

My Documents\`<mode name>`\screen.

where `<mode name>` is the parameter used to select the mode with the INST:SEL command (for example, SA for the Spectrum Analyzer).

Key Path	Save, Screen Image
Notes	Brings up Save As dialog for saving a Screen Image Save Type
Initial S/W Revision	Prior to A.02.00

Single (Single Measurement/Sweep)

Sets the analyzer for Single measurement operation. The single/continuous state is Meas Global, so the setting will affect all the measurements. If you are Paused, pressing **Single** does a Resume.

See "[More Information](#)" on page 1415

Key Path	Front-panel key
Example	:INIT:CONT OFF
Notes	See Cont key description.
Backwards Compatibility Notes	<p>For Spectrum Analysis mode in ESA and PSA, the Single hardkey and the INITiate:IMM switched from continuous measurement to single measurement and restarted sweeps and averages (displayed average count reset to 1), but did not restart Max Hold and Min Hold. In the X-Series, the Single hardkey and the INITiate:IMM command initiate a sweep/ measurement/ average sequence/hold sequence including MaxHold and MinHold.</p> <p>For Spectrum Analysis mode in ESA and PSA, the Single hardkey restarted the sweep regardless of whether or not you were in an active sweep or sweep sequence. In the X-Series, Restart does this but Single only restarts the sweep or sweep sequence if you are in the idle state.</p> <p>INIT[:IMM] in ESA & PSA Spectrum Analysis Mode does an implied ABORt. In some other PSA Modes, INIT[:IMM] is ignored if not in the idle state. . The X-Series follows the ESA/PSA SA Mode model, which may cause some Modes to have compatibility problems.</p>
Initial S/W Revision	Prior to A.02.00

More Information

See "[Restart](#)" on page 2441 for details on the INIT:IMMEDIATE (Restart) function.

If you are already in single sweep, the INIT:CONT OFF command has no effect.

If you are already in Single Sweep, then pressing the **Single** key in the middle of a sweep does not restart the sweep or sequence. Similarly, pressing the **Single** key does not restart the sweep or sequence if the sweep is not in the idle state (for example, if you are taking a very slow sweep, or the analyzer is waiting for a trigger). Instead, it results in a message. "Already in Single, press Restart to initiate a new sweep or sequence". Even though pressing the **Single** key in the middle of a sweep does not restart the sweep, sending INIT:IMMEDIATE does reset it.

To take one more sweep without resetting the average count, increment the average count by 1, by pressing the step up key while **Average/Hold Number** is the active function, or sending the remote command CALC:AVER:TCON UP.

Source

There is no Source control functionality for this measurement. When this key is pressed, the screen either displays a blank menu, or the previously-selected menu remains unchanged.

Key Path	Front-panel key
----------	-----------------

Span X Scale

Accesses a menu of functions that enable you to set the horizontal scale parameters.

Key Path	Front-panel key
Initial S/W Revision	A.11.00

Ref Value

Sets the X reference value.

Key Path	SPAN X Scale
Mode	BASIC, PNOISE, WCDMA, C2K, GSM, WIMAXOFDMA, TDSCDMA, 1XEVD0, DVB, DTMB, ISDBT, CMMB, LTE, LTETDD, DCTV, WLAN, MSR, LTEAFDD, LTEATDD
Remote Command	:DISPlay:SEMask:VIEW[1]:WINDow[1]:TRACe:X[:SCALe]:RLEVel <freq> :DISPlay:SEMask:VIEW[1]:WINDow[1]:TRACe:X[:SCALe]:RLEVel?
Example	DISP:SEM:VIEW:WIND:TRAC:X:RLEV 10 DISP:SEM:VIEW:WIND:TRAC:X:RLEV?
Notes	You must be in the mode that includes SEM measurement to use this command. Use :INSTrument:SElect to set the mode.
Couplings	If Auto Scaling is set to On, this value is automatically determined by the measurement result. When you set this value manually, Auto Scaling automatically changes to Off.
Preset	1.0 GHz
State Saved	Saved in instrument state.
Min	-1000 GHz
Max	1000 GHz
Default Unit	Hz
Initial S/W Revision	A.11.00

Scale/Div

Sets the horizontal scale.

Key Path	SPAN X Scale
Mode	BASIC, PNOISE, WCDMA, C2K, GSM, WIMAXOFDMA, TDSCDMA, 1XEVD0, DVB, DTMB, ISDBT, CMMB, LTE, LTETDD, DCTV, WLAN, MSR, LTEAFDD, LTEATDD
Remote Command	:DISPlay:SEMask:VIEW[1]:WINDow[1]:TRACe:X[:SCALe]:PDIVision <freq> :DISPlay:SEMask:VIEW[1]:WINDow[1]:TRACe:X[:SCALe]:PDIVision ?
Example	DISP:SEM:VIEW:WIND:TRAC:X:PDIV 500 DISP:SEM:VIEW:WIND:TRAC:X:PDIV?
Notes	You must be in a mode that includes the SEM measurement to use this command. Use

	INSTRument:SElect to set the mode.
Couplings	If Auto Scaling is set to On, this value is automatically determined by the measurement result. When you set this value manually, Auto Scaling automatically changes to Off.
Preset	Automatically Calculated
State Saved	Yes Saved in instrument state.
Min	1 Hz
Max	10.0 GHz
Initial S/W Revision	A.11.00

Ref Position

Sets the reference position for the X axis to Left, Center or Right.

Key Path	SPAN X Scale
Mode	BASIC, PNOISE, WCDMA, C2K, GSM, WIMAXOFDMA, TDSCDMA, 1XEVD0, DVB, DTMB, ISDBT, CMMB, LTE, LTETDD, DCTV, WLAN, MSR, LTEAFDD, LTEATDD
Remote Command	:DISPlay:SEMask:VIEW[1]:WINDow[1]:TRACe:X[:SCALe]:RPOStion LEFT CENTER RIGHT :DISPlay:SEMask:VIEW[1]:WINDow[1]:TRACe:X[:SCALe]:RPOStion?
Example	DISP:SEM:VIEW:WIND:TRAC:X:RPOS LEFT DISP:SEM:VIEW:WIND:TRAC:X:RPOS?
Notes	You must be in a mode that includes the SEM measurement to use this command. Use INSTRument:SElect to set the mode.
Preset	CENTER
State Saved	Yes Saved in instrument state.
Range	Left Ctr Right
Initial S/W Revision	A.11.00

Auto Scaling

Toggles the scale coupling function between On and Off.

Key Path	SPAN X Scale
Mode	BASIC, PNOISE, WCDMA, C2K, GSM, WIMAXOFDMA, TDSCDMA, 1XEVD0, DVB, DTMB, ISDBT, CMMB, LTE, LTETDD, DCTV, WLAN, MSR, LTEAFDD, LTEATDD
Remote Command	:DISPlay:SEMask:VIEW[1]:WINDow[1]:TRACe:X[:SCALe]:COUPle 0 1 OFF ON :DISPlay:SEMask:VIEW[1]:WINDow[1]:TRACe:X[:SCALe]:COUPle?
Example	DISP:SEM:VIEW:WIND:TRAC:X:COUP ON DISP:SEM:VIEW:WIND:TRAC:X:COUP?

Notes	You must be in a mode that includes the SEM measurement to use this command. Use INSTRument:SElect to set the mode.
Couplings	When Auto Scaling is On and the Restart front-panel key is pressed, this function automatically determines the scale per division and reference values based on the measurement results. When you set a value to either Scale/Div or Ref Value manually, Auto Scaling automatically changes to Off.
Preset	1
State Saved	Yes Saved in instrument state.
Range	On Off
Initial S/W Revision	A.11.00

Sweep/Control

Displays a menu that enables you to set up and control the sweep time, gate method, and source of the current measurement. See ["Sweep/Control" on page 2468](#) for more information.

Key Path	Front-panel key
Initial S/W Revision	Prior to A.02.00

Pause

Pauses a measurement after the current data acquisition is complete. When Paused, the label on the key changes to Resume. Pressing the Resume key resumes the measurement at the point it was at when paused. See ["Pause/Resume" on page 2468](#) for more details.

Key Path	Sweep/Control
Initial S/W Revision	Prior to A.02.00

Gate

Accesses a menu that enables you to control the gating function. The Gate functionality is used to view signals best viewed by qualifying them with other events.

Gate setup parameters are the same for all measurements – they do not change as you change measurements. Settings like these are called “Meas Global” and are unaffected by Meas Preset.

Note that Sweep Time autocoupling rules and annotation are changed by Gate being on.

Key Path	Sweep/Control
Scope	Meas Global
Readback	The state and method of Gate, as [Off, LO] or [On, Video]. Note that for measurements that only support gated LO, the method is nonetheless read back, but always as LO.
Initial S/W Revision	Prior to A.02.00

Gate On/Off

Turns the gate function on and off.

When the Gate Function is on, the selected Gate Method is used along with the gate settings and the signal at the gate source to control the sweep and video system with the gate signal. Not all measurements allow every type of Gate Methods.

When Gate is on, the annunciation in the measurement bar reflects that it is on and what method is used, as seen in the following "Gate: LO" annunciator graphic.

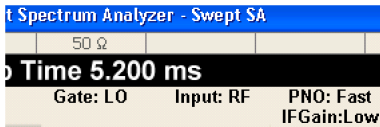

Key Path	Sweep/Control, Gate
Remote Command	[:SENSe] :SWEep:EGATe [:STATe] OFF ON 0 1 [:SENSe] :SWEep:EGATe [:STATe] ?
Example	SWE:EGAT ON SWE:EGAT?
Dependencies	<p>The function is unavailable (grayed out) and Off when:</p> <ul style="list-style-type: none"> • Gate Method is LO or Video and FFT Sweep Type is manually selected. • Gate Method is FFT and Swept Sweep Type is manually selected. • Marker Count is ON. <p>The following are unavailable whenever Gate is on:</p> <ul style="list-style-type: none"> • FFT under Sweep Type when Method=LO or Video or Swept under Sweep Type when Method=FFT • Marker Count <p>While Gate is on, the Auto Rules for Sweep Type are modified so that the choice agrees with the Gate Method: i.e., FFT for Method = FFT and Swept for Method = LO or Video.</p> <p>The Gate softkey and all SCPI under the [:SENSe]:SWEep:EGATe SCPI node are grayed out when Source Mode is Tracking with an external source. This is because the Gate circuitry is used to sync the external source. If the Tracking Source is turned on, the Gate is turned off.</p> <p>When in the ACP measurement:</p> <ul style="list-style-type: none"> • When Meas Method is RBW or FAST, this function is unavailable and the key is grayed out. • Whenever Gate is on, Meas Method, RBW or FAST is unavailable and keys for those are grayed out. • When Gate is on, Offset Res BW and Offset Video BW are ignored (if you set these values) and the measurement works as if all Offset Res BW and all Offset Video BW are coupled with the Res BW and the Video BW under the BW menu. When Gate is on, the Offset BW key in the Offset/Limit menu is grayed out.
Preset	Off LTETDD: On
State Saved	Saved in instrument state
Range	On Off
Backwards Compatibility SCPI	[:SENSe] :SWEep:TIME:GATE [:STATe] ESA compatibility
Backwards Compatibility Notes	In ESA, Trig Delay (On) and Gate (On) could not be active at the same time.. This dependency does not exist in PSA or in the X-Series.
Initial S/W Revision	Prior to A.02.00

Gate View On/Off

Turning on Gate View in the Swept SA measurement provides a single-window gate view display..

Turning on Gate View in other measurements shows the split-screen Gate View. In these measurements, when the Gate View is on, the regular view of the current measurement traces and results are reduced vertically to about 70% of the regular height. The Zero Span window, showing the positions of the Gate, is shown between the Measurement Bar and the reduced measurement window. By reducing the height of the measurement window, some of the annotation on the Data Display may not fit and is not shown.

Key Path	Sweep/Control, Gate
Remote Command	[:SENSe] :SWEep:EGATe:VIEW ON OFF 1 0 [:SENSe] :SWEep:EGATe:VIEW?
Example	SWE:EGAT:VIEW ON turns on the gate view.
Dependencies	In the Swept SA measurement: In Gate View, the regular Sweep Time key is grayed out . When pressed, the grayed out key puts up the informational message "Use Gate View Sweep Time in the Gate menu." In the other measurements: When you turn Gate View on, the lower window takes on the current state of the instrument. Upon leaving Gate View, the instrument takes on the state of the lower window. When you turn Gate View on, the upper window Sweep Time is set to the gate view sweep time.
Couplings	These couplings apply to the Swept SA measurement: <ul style="list-style-type: none"> • When Gate View is turned on, the instrument is set to Zero Span. • Gate View automatically turns off whenever a Span other than Zero is selected. • Gate View automatically turns off if you press the Last Span key while in Gate View, and the instrument returns to the Span it was in before entering Gate View (even if that is Zero Span). • When Gate View is turned on, the sweep time used is the gate view sweep time. This is set according to the rules in section "Gate View Setup" on page 2231 • When Gate View is turned off, Sweep Time is set to the normal Swept SA measurement sweep time. • If Gate View is on and Gate is off, then turning on Gate turns off Gate View.
Preset	OFF
State Saved	Saved in instrument state
Range	On Off
Initial S/W Revision	Prior to A.02.00

A sample of the Gate View screen in the Swept SA measurement is shown in the following graphic :

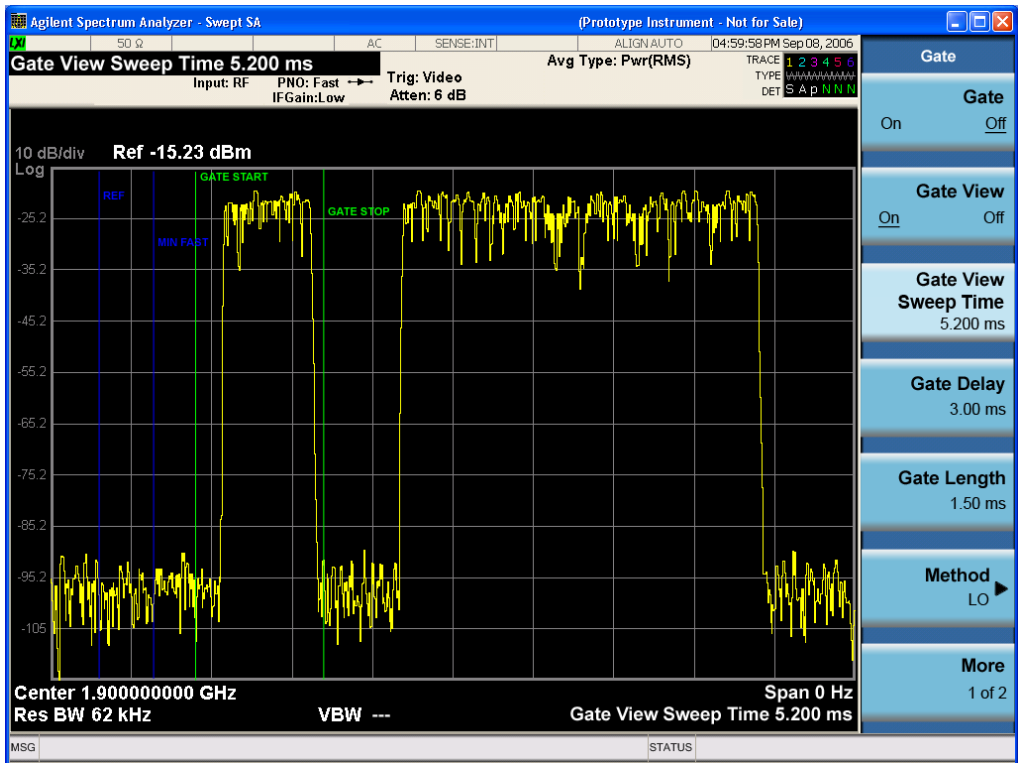

A sample of the Gate View screen in other measurements is shown in the following graphic. This example is for the ACP measurement:

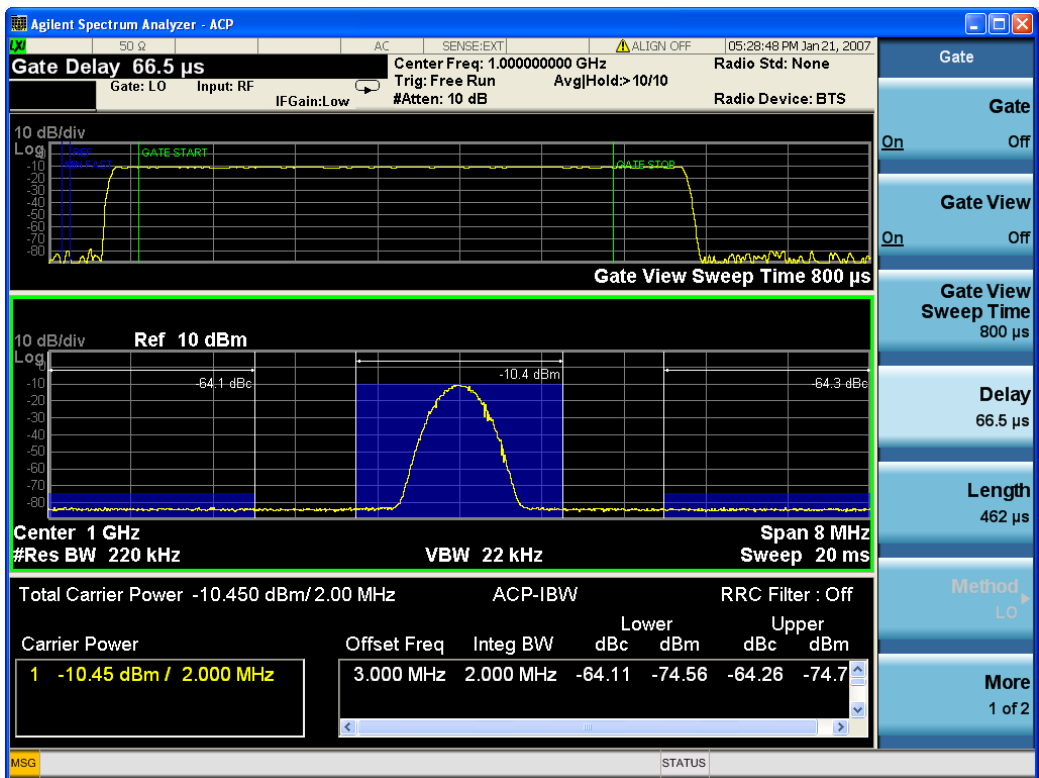

Turning Gate View off returns the analyzer to the Normal measurement view.

In the Swept SA, the normal measurement view is the single-window Swept SA view. When returning to this view, the Swept SA measurement returns to the Span it was in before entering **Gate View** (even if that is Zero Span).

The **Gate View** window is triggered from the Gate Source, with zero trigger delay. Also, when updating the **Gate View** window, the Gate itself must not operate. So it is internally shut off while the gate view window is being updated. For the Swept SA measurement, this means that the Gate is internally shut off whenever the gate view window is displayed. The measurement bar and softkeys continue to show the Trigger source for the main sweep window and give no indication that the Gate is shut off or that the Gate View window is triggered from the Gate Source.

When in **Gate View**, vertical lines are displayed in the Gate View window as follows:

- Green lines are displayed at the gate edges as follows: in Edge Gate, a line is shown for Delay and one for the end of the Gate period, defined by Length. In Level Gate a line is shown only for Delay. You can adjust the position of the green lines by adjusting the gate length and the gate delay. These lines update in the Gate View window as the active function changes, even if the window is not being updated. In Gated LO and Gated Video, these lines are positioned relative to the delay reference line (not relative to 0 time). In Gated FFT, their location is relative to the left edge of the screen.
- A blue line is displayed showing the delay reference, that is, the reference point for the Gate Delay within the Zero Span window. The blue line represents where (in time) the effective location of the gate start would be if the gate were programmed to zero delay.
-
- The second blue line is labeled "MIN FAST" as shown in the figure above because it represents the minimum Gate Delay for fast Gated LO operation. This line is only displayed in Gated LO. You cannot scroll (knob) or decrement (down key) the Gate Delay to less than that represented by the position of this line, it can only be set below this position manually, although once there it can be moved freely with the knob while below the line.
- A yellow line in the Gated Video case only, is displayed at Blength, where Blength is the display point (bucket) length for the swept trace, which is given by the sweep time for that trace divided by number of Points - 1. So it is referenced to 0 time, not to the delay reference. This line is labeled NEXT PT (it is not shown in the figure above because the figure above is for Gated LO).
- The yellow line represents the edge of a display point (bucket). Normally in Gated Video, the bucket length must be selected so that it exceeds the off time of the burst. There is another way to use the analyzer in Gated Video measurements, and that is to set the bucket width much shorter than the off time of the burst. Then use the Max Hold trace function to fill in "missing" buckets more slowly. This allows you to see some of the patterns of the Gated Video results earlier, though seeing a completely filled-in spectrum later.

Gate View Setup

Accesses a menu that enables you to setup parameters relevant to the Gate View

Key Path	Sweep/Control, Gate
Scope	Meas Global
Initial S/W Revision	A.10.00

Gate View Sweep Time

Controls the sweep time in the Gate View window. To provide an optimal view of the gate signal, the analyzer initializes Gate View Sweep Time based on the current settings of Gate Delay and Gate Length.

Key Path	Sweep/Control, Gate, Gate View Setup
Remote Command	[:SENSe] :SWEep:EGATe:TIME <time> [:SENSe] :SWEep:EGATe:TIME?
Example	SWE:EGAT:TIME 500 ms
Dependencies	Gate View Sweep Time is initialized: <ul style="list-style-type: none"> • On Preset (after initializing delay and length). • Every time the Gate Method is set/changed. <p>Additionally, in the Swept SA measurement, whenever you do a Preset, or leave Gate View, the analyzer remembers the Gate Delay and Gate Length settings. Then, when returning to Gate View, if the current Gate Delay and/or Gate Length do not match the remembered values Gate View Sweep Time is re-initialized.</p> <p>1. Compute the location of the "gate stop" line, which you know is at time $t = t_{min} + \text{GateDelay} + \text{GateLength}$.</p>
Preset	519.3 μ s WiMAX OFDMA: 5 ms GSM/EDGE: 1 ms
State Saved	Saved in instrument state
Max	6000 s
Initial S/W Revision	Prior to A.02.00

Gate View Start Time

Controls the time at the left edge of the Gate View.

Key Path	Sweep/Control, Gate, Gate View Setup
Remote Command	[:SENSe] :SWEep:EGATe:VIEW:START <time> [:SENSe] :SWEep:EGATe:VIEW:START?
Example	SWE:EGAT:VIEW:STAR 10ms
Notes	Units of time are required or no units; otherwise an invalid suffix error message will be generated. See error -131.
Preset	0 ms
State Saved	Saved in instrument state
Min	0
Max	500 ms
Initial S/W Revision	A.10.00

Gate Delay

Controls the length of time from the time the gate condition goes True until the gate is turned on.

Key Path	Sweep/Control, Gate
Remote Command	[:SENSe] :SWEep:EGATe:DELay <time> [:SENSe] :SWEep:EGATe:DELay?
Example	SWE:EGAT:DELay 500ms SWE:EGAT:DELay?
Notes	Units of time are required or no units; otherwise an invalid suffix error message will be generated.
Preset	57.7 us WiMAX OFDMA: 71 us GSM/EDGE: 600 us WLAN: 500 us
State Saved	Saved in instrument state
Min	0.0 us
Max	100 s
Backwards Compatibility SCPI	[:SENSe] :SWEep:TIME:GATE:DELay ESA compatibility
Initial S/W Revision	Prior to A.02.00

Gate Length

Controls the length of time that the gate is on after it opens.

Key Path	Sweep/Control, Gate
Remote Command	[:SENSe] :SWEep:EGATe:LENGth <time> [:SENSe] :SWEep:EGATe:LENGth?
Example	SWE:EGAT:LENG 1 SWE:EGAT:LENG?
Notes	Units of time are required or no units; otherwise an invalid suffix error message will be generated.
Dependencies	<p>Grayed out when Gate Method is set to FFT in which case the label changes to that shown below.</p> <div style="border: 1px solid gray; padding: 5px; display: inline-block;"> <p>Gate Length (=1.83/RBW) 2.8 ms</p> </div> <p style="margin-left: 20px;">vsd 39-1</p> <p>The key is also grayed out if Gate Control = Level.</p>
Preset	461.6 us

	WiMAX OFDMA: 50 us GSM/EDGE: 200 us WLAN: 1.54 ms
State Saved	Saved in instrument state
Min	100 ns
Max	5 s
Backwards Compatibility SCPI	[:SENSe]:SWEep:TIME:GATE:LENGth ESA compatibility
Initial S/W Revision	Prior to A.02.00

Gate Source

The menus under the **Gate Source** key are the same as those under the **Trigger key**, with the exception that neither **Free Run** nor **Video** are available as Gate Source selections. However, a different SCPI command is used to select the Gate Source (see table below) because you may independently set the Gate Source and the Trigger Source.

Any changes to the settings in the setup menus under each Gate Source selection key (for example: Trigger Level, Trigger Delay, etc.) also affect the corresponding settings under the Trigger menu keys. The SCPI commands used for these are the same for Trigger and Gate, since there is only one setting which affects both Gate and Trigger. Example: to set the Trigger Level for External 1 you use the command :TRIG:EXT1:LEV regardless of whether you are using External 1 as a Trigger Source or a Gate Source.

Key Path	Sweep/Control, Gate
Remote Command	[:SENSe]:SWEep:EGATe:SOURce EXTernal1 EXTernal2 LINE FRAME RFBurst [:SENSe]:SWEep:EGATe:SOURce?
Dependencies	In some models, there is no second External input. In these models, the External 2 key is blanked and the EXTernal2 parameter will generate a "Hardware missing; Not available for this model number" error.
Preset	EXTernal 1 GSM/EDGE, MSR: FRAME LTETDD: EXTernal 1When Direction is Downlink, FRAME when Direction is Uplink.
Backwards Compatibility Notes	In ESA, there is a single Gate input port. In PSA, the Gate Source may be taken from one of two specified input ports. In the X-Series, any Trigger Source can be a Gate Source.
Initial S/W Revision	Prior to A.02.00
Modified at S/W Revision	A.03.00, A.14.00

Line

Pressing this key, when it is not selected, selects the line signal as the trigger. A new sweep/measurement will start synchronized with the next cycle of the line voltage. Pressing this key, when it is already selected, access the line trigger setup menu.

Key Path	Trigger
Example	TRIG:SOUR LINE Swept SA measurement TRIG:<meas>:SOUR LINE Measurements other than Swept SA
Dependencies	Line trigger is not available when operating from a "dc power source", for example, when the instrument is powered from batteries.
State Saved	Saved in instrument state
Status Bits/OPC dependencies	The Status Operation Register bit 5 "Waiting for Trigger" is set at the same time as the Sweeping or Measuring bit is set. It is cleared when the trigger actually occurs (that is, after the trigger event occurs and all the applicable trigger criteria have been met). A corresponding pop-up message ("Waiting for trigger") is generated if no trigger signal appears after approximately 2 sec. This message goes away when a trigger signal appears.
Initial S/W Revision	Prior to A.02.00

Trig Slope

Controls the trigger polarity. It is set positive to trigger on a rising edge and negative to trigger on a falling edge.

Key Path	Trigger, Line
Remote Command	:TRIGger[:SEquence]:LINE:SLOPe POSitive NEGative :TRIGger[:SEquence]:LINE:SLOPe?
Example	TRIG:LINE:SLOP NEG
Preset	POSitive
State Saved	Saved in instrument state
Backwards Compatibility Notes	The legacy :TRIGger[:SEquence]:SLOPe command affects the slopes for the VID, LINE, EXT1, EXT2, and RFB triggers.
Initial S/W Revision	Prior to A.02.00

External 1

Pressing this key, when it is not selected, selects an external input signal as the trigger. A new sweep/measurement will start when the external trigger condition is met using the external 1 input connector on the rear panel.

Pressing this key, when it is already selected, accesses the external 1 trigger setup menu.

Key Path	Trigger
Example	TRIG:SOUR EXT1 Swept SA measurement TRIG:<meas>:SOUR EXT1 Measurements other than Swept SA
Dependencies	Grayed out if in use by Point Trigger in the Source Setup menu. Forced to Free Run if already selected and Point Trigger is set to External 1.
State Saved	Saved in instrument state
Status Bits/OPC dependencies	The Status Operation Register bit 5 "Waiting for Trigger" is set at the same time as the Sweeping or Measuring bit is set. It is cleared when the trigger actually occurs (that is, after the trigger event occurs and all the applicable trigger criteria have been met). A corresponding pop-up message ("Waiting for trigger") is generated if no trigger signal appears after approximately 2 sec. This message goes away when a trigger signal appears.
Initial S/W Revision	Prior to A.02.00

Trigger Level

Sets the value where the external 1 trigger input will trigger a new sweep/measurement.

Key Path	Trigger, External 1
Remote Command	:TRIGger[:SEquence]:EXTernal1:LEVel <level> :TRIGger[:SEquence]:EXTernal1:LEVel?
Example	TRIG:EXT1:LEV 0.4 V
Couplings	This same level is used for the Ext1 trigger source in the Trigger menu, for the Ext1 selection in the Periodic Timer sync source (in the Trigger menu and in the Gate Source menu), and also for the Ext1 selection in the Gate Source menu.
Preset	1.2 V
State Saved	Saved in instrument state
Min	-5 V
Max	5 V
Default Unit	V
Backwards Compatibility SCPI	:TRIGger[:SEquence]:EXTernal:LEVel For backward compatibility, the parameter EXTernal is mapped to EXTernal1
Backwards Compatibility SCPI	:TRIGger[:SEquence]:FRAME:EXTernal1:LEVel
Initial S/W Revision	Prior to A.02.00

Trig Slope

Controls the trigger polarity. It is set positive to trigger on a rising edge and negative to trigger on a falling edge.

Key Path	Trigger, External 1
Remote Command	:TRIGger[:SEquence]:EXTErnal1:SLOPe POSitive NEGative :TRIGger[:SEquence]:EXTErnal1:SLOPe?
Example	TRIG:EXT1:SLOP NEG
Couplings	This same slope is used in the Ext1 selection for the trigger source in the Trigger menu and for the period timer sync source (in the Trigger menu and in the Gate Source menu).
Preset	POSitive
State Saved	Saved in instrument state
Backwards Compatibility SCPI	:TRIGger[:SEquence]:EXTErnal:SLOPe For backward compatibility, the parameter EXTErnal is mapped to EXTErnal1
Backwards Compatibility SCPI	:TRIGger[:SEquence]:FRAMe:EXTErnal1:SLOPe
Backwards Compatibility Notes	The legacy :TRIGger[:SEquence]:SLOPe command affects the slopes for the VID, LINE, EXT1, EXT2, and RFB triggers.
Initial S/W Revision	Prior to A.02.00

Zero Span Delay Comp On/Off

In zero span, there is a natural delay in the signal path, which comes from the RBW filter. This is usually desirable, as it allows you to trigger on events and also see those events, because the signal is delayed from the trigger event. However, in some cases it is desirable to eliminate this delay, so that trigger events line up exactly with the zero time point in zero span. You can use the **Zero Span Delay Comp On/Off** feature to enable or disable zero span delay compensation.

Key Path	Trigger, External 1
Remote Command	:TRIGger[:SEquence]:EXTErnal1:DELAy:COMPensation OFF ON 0 1 :TRIGger[:SEquence]:EXTErnal1:DELAy:COMPensation?
Example	TRIG:EXT1:DEL:COMP ON
Dependencies	No effect except in zero-span, but not locked out in nonzero spans. Blanked in modes that do not support zero-span measurements. If the SCPI command is sent when the key is blanked, an error is returned: -221, "Settings conflict; Feature not supported for this measurement" In analyzers shipping N9060A, this feature requires N9060A-7FP.
Preset	OFF
State Saved	Saved in instrument state
Initial S/W Revision	A.11.00

External 2

Pressing this key, when it is not selected, selects an external input signal as the trigger. A new sweep/measurement will start when the external trigger condition is met using the external 2 input

connector. The external trigger 2 input connector is on the rear panel.

Pressing this key, when it is already selected, accesses the external 2 trigger setup menu.

Key Path	Trigger
Example	TRIG:SOUR EXT2 Swept SA measurement TRIG:<meas>:SOUR EXT2 Measurements other than Swept SA
Dependencies	In some models, there is no second External input. In these models, the External 2 key is blanked and the EXTernal2 parameter will generate a "Hardware missing; Not available for this model number" message. Grayed out if in use by Point Trigger in the Source Setup menu. Forced to Free Run if already selected and Point Trigger is set to External 2.
State Saved	Saved in instrument state
Status Bits/OPC dependencies	The Status Operation Register bit 5 "Waiting for Trigger" is set at the same time as the Sweeping or Measuring bit is set. It is cleared when the trigger actually occurs (that is, after the trigger event occurs and all the applicable trigger criteria have been met). A corresponding pop-up message ("Waiting for trigger") is generated if no trigger signal appears after approximately 2 sec. This message goes away when a trigger signal appears.
Initial S/W Revision	Prior to A.02.00
Modified at S/W Revision	A.03.00

Trigger Level

Sets the value where the external 2 trigger input will trigger a new sweep/measurement.

Key Path	Trigger, External 2
Remote Command	:TRIGger[:SEquence]:EXTernal2:LEVel :TRIGger[:SEquence]:EXTernal2:LEVel?
Example	TRIG:EXT2:LEV 1.1 V
Couplings	This same level is used for the Ext2 trigger source in the Trigger menu, for the Ext2 selection in the Periodic Timer sync source (in the Trigger menu and in the Gate Source menu), and also for the Ext2 selection in the Gate Source menu.
Preset	1.2 V
State Saved	Saved in instrument state
Min	-5 V
Max	5 V
Default Unit	V
Backwards Compatibility SCPI	:TRIGger[:SEquence]:FRAMe:EXTernal2:LEVel
Initial S/W Revision	Prior to A.02.00

Trig Slope

Controls the trigger polarity. It is set positive to trigger on a rising edge and negative to trigger on a falling edge.

Key Path	Trigger, External 2
Remote Command	:TRIGger[:SEquence]:EXternal2:SLOPe POSitive NEGative :TRIGger[:SEquence]:EXternal2:SLOPe?
Example	TRIG:EXT2:SLOP NEG
Couplings	This same slope is used in the Ext2 selection for the trigger source in the Trigger menu and for the period timer sync source (in the Trigger menu and in the Gate Source menu).
Preset	POSitive
State Saved	Saved in instrument state
Backwards Compatibility SCPI	:TRIGger[:SEquence]:FRAMe:EXternal2:SLOPe
Backwards Compatibility Notes	The legacy :TRIGger[:SEquence]:SLOPe command affects the slopes for the VID, LINE, EXT1, EXT2, and RFB triggers.
Initial S/W Revision	Prior to A.02.00

Zero Span Delay Comp On/Off

In zero span, there is a natural delay in the signal path, which comes from the RBW filter. This is usually desirable, as it allows you to trigger on events and also see those events, because the signal is delayed from the trigger event. However, in some cases it is desirable to eliminate this delay, so that trigger events line up exactly with the zero time point in zero span. You can use the **Zero Span Delay Comp On/Off** feature to enable or disable zero span delay compensation.

Key Path	Trigger, External 2
Remote Command	:TRIGger[:SEquence]:EXternal2:DELAy:COMPensation OFF ON 0 1 :TRIGger[:SEquence]:EXternal2:DELAy:COMPensation?
Example	TRIG:EXT2:DEL:COMP ON
Dependencies	No effect except in zero-span, but not locked out in nonzero spans. Blanked in modes that do not support zero-span measurements. If the SCPI command is sent when the key is blanked, an error is returned: -221, "Settings conflict; Feature not supported for this measurement" In analyzers shipping N9060A, this feature requires N9060A-7FP.
Preset	OFF
State Saved	Saved in instrument state
Initial S/W Revision	A.11.00

RF Burst

Pressing this key, when it is not selected, selects the RF Burst as the trigger. A new sweep/measurement will start when an RF burst envelope signal is identified from the signal at the RF Input connector. Pressing this key, when it is already selected, accesses the RF Burst trigger setup menu.

In some models, a variety of burst trigger circuitry is available, resulting in various available burst trigger bandwidths. The analyzer automatically chooses the appropriate trigger path based on the hardware configuration and other settings of the analyzer.

Key Path	Trigger
Example	TRIG:SOUR RFB Swept SA measurement TRIG:<meas>:SOUR RFB Measurements other than Swept SA
State Saved	Saved in instrument state
Status Bits/OPC dependencies	The Status Operation Register bit 5 "Waiting for Trigger" is set at the same time as the Sweeping or Measuring bit is set. It is cleared when the trigger actually occurs (that is, after the trigger event occurs and all the applicable trigger criteria have been met). A corresponding pop-up message ("Waiting for trigger") is generated if no trigger signal appears after approximately 2 sec. This message goes away when a trigger signal appears.
Backwards Compatibility Notes	The legacy command: :TRIGger[:SEquence]:RFBurst:FSElectivity[:STATe] OFF ON 0 1 is not supported in the X-Series, as the hardware to do Frequency Selective burst triggers does not exist in X-Series.
Initial S/W Revision	Prior to A.02.00
Modified at S/W Revision	A.04.00

Absolute Trigger Level

Sets the absolute trigger level for the RF burst envelope.

When using the External Mixing path, the Absolute Trigger Level is uncalibrated because the factory default was set to accommodate the expected IF levels for the RF path.

Key Path	Trigger, RF Burst
Scope	Meas Global
Remote Command	:TRIGger[:SEquence]:RFBurst:LEVel:ABSolute <ampl> :TRIGger[:SEquence]:RFBurst:LEVel:ABSolute?
Example	TRIG:RFB:LEV:ABS 10 dBm sets the trigger level of the RF burst envelope signal to the absolute level of 10 dBm
Notes	Sending this command does not switch the setting from relative to absolute; to switch it you need to send the :TRIGger[:SEquence]:RFBurst:LEVel:TYPE command, below. Amplitude Corrections are not taken into account by the Absolute Trigger Level. For example, if you have given yourself effective gain with an amplitude correction factor, the Absolute Trigger will not fire until you have set the trigger level that far below the displayed signal level, rather than simply to

	the displayed signal level. This is only true for Amplitude Corrections, not External Gain or Ref Level Offset functions. If mode is Bluetooth, the default value is -50 dBm.
Couplings	This same level is used for the RF Burst trigger source in the Trigger menu, for the RF Burst selection in the Periodic Timer sync source (in the Trigger menu and in the Gate Source menu), and also for the RF Burst selection in the Gate Source menu
Preset	-20 dBm
State Saved	Saved in instrument state
Min	-200 dBm
Max	100 dBm
Default Unit	depends on the current selected Y-Axis unit
Backwards Compatibility SCPI	:TRIGger[:SEquence]:FRAME:RFBurst:LEVel:ABSolute
Initial S/W Revision	Prior to A.02.00
Modified at S/W Revision	A.04.00

Key Path	Trigger, RF Burst
Remote Command	:TRIGger[:SEquence]:RFBurst:LEVel:TYPE ABSolute RELative :TRIGger[:SEquence]:RFBurst:LEVel:TYPE?
Example	TRIG:RFB:LEV:TYPE REL sets the trigger level type of the RF burst trigger to Relative.
Preset	ABSolute
State Saved	Saved in instrument state
Initial S/W Revision	Prior to A.02.00
Modified at S/W Revision	A.04.00

Relative Trigger Level

Sets the relative trigger level for the RF burst envelope.

In some models, the relative burst trigger function is implemented in hardware. In other models, without the advanced triggering hardware required, the relative burst trigger function is implemented in software in some measurements, and is unavailable in other measurements.

When implemented in software, the relative RF Burst trigger function is implemented as follows:

1. The measurement starts with the absolute RF Burst trigger setting. If it cannot get a trigger with that level, auto trigger fires and the acquisition starts anyway. After the acquisition, the measurement searches for the peak in the acquired waveform and saves it.

2. Now, in the next cycle of the measurement, the measurement determines a new absolute RF Burst level based on the peak value from the first measurement and the Relative RF Burst Trigger Level (always 0 or negative dB) set by the user. The following formula is used:
 3. absolute RF Burst level = peak level of the previous acquisition + relative RF Burst level
 4. If the new absolute RF Burst level differs from the previous by more than 0.5 dB, the new level is sent to the hardware; otherwise it is not updated (to avoid slowing down the acquisition)
- Steps 2 and 3 repeat for subsequent measurements.

Key Path	Trigger, RF Burst
Scope	Meas Global
Remote Command	:TRIGger[:SEQuence]:RFBurst:LEVel:RELative <rel_ampl> :TRIGger[:SEQuence]:RFBurst:LEVel:RELative?
Example	TRIG:RFB:LEV:REL -10 dB sets the trigger level of the RF burst envelope signal to the relative level of -10 dB
Notes	Sending this command does not switch the setting from absolute to relative; to switch it you need to send the :TRIGger[:SEQuence]:RFBurst:LEVel:TYPE command, above. The relative trigger level is not available in some measurements. In those measurements the RELative parameter, and the :TRIGger[:SEQuence]:RFBurst:LEVel:TYPE command (above), will generate an error if sent.
Dependencies	This key is grayed out and Absolute Trigger Level selected if the required hardware is not present in your analyzer and the current measurement does not support Relative triggering.
Preset	-6 dB GSM: -25 dB
State Saved	Saved in instrument state
Min	-45 dB
Max	0 dB
Default Unit	dB or dBc
Backwards Compatibility SCPI	:TRIGger[:SEQuence]:RFBurst:LEVel This legacy command is aliased to :TRIGger[:SEQuence]:RFBurst:LEVel:RELative because the PSA had ONLY relative burst triggering
Initial S/W Revision	Prior to A.02.00
Modified at S/W Revision	A.04.00

Trigger Slope

It is set positive to trigger on a rising edge and negative to trigger on a falling edge.

Key Path	Trigger, RF Burst
Remote Command	:TRIGger[:SEQuence]:RFBurst:SLOPe Positive NEGative :TRIGger[:SEQuence]:RFBurst:SLOPe?

Example	TRIG:RFB:SLOP NEG
Couplings	This same slope is used in the RF Burst selection for the trigger source in the Trigger menu and for the period timer sync source (in the Trigger menu and in the Gate Source menu).
Preset	POSitive
State Saved	Saved in instrument state
Backwards Compatibility SCPI	:TRIGger[:SEQuence]:FRAMe:RFBurst:SLOPe
Backwards Compatibility Notes	The legacy :TRIGger[:SEQuence]:SLOPe command affects the slopes for the VID, LINE, EXT1, EXT2, and RFB triggers.
Initial S/W Revision	Prior to A.02.00

Periodic Timer (Frame Trigger)

Pressing this key, when it is not selected, selects the internal periodic timer signal as the trigger. Triggering occurrences are set by the **Period** parameter, which is modified by the **Sync Source** and **Offset**. Pressing this key, when it is already selected, accesses the periodic timer trigger setup functions.

If you do not have a sync source selected (it is Off), then the internal timer will not be synchronized with any external timing events.

Key Path	Trigger
Example	TRIG:SOUR FRAM Swept SA measurement TRIG:<meas>:SOUR FRAM Measurements other than Swept SA
State Saved	Saved in instrument state
Readback	[Sync: <value of Sync Source>], for example, [Sync: External 1]
Status Bits/OPC dependencies	The Status Operation Register bit 5 "Waiting for Trigger" is set at the same time as the Sweeping or Measuring bit is set. It is cleared when the trigger actually occurs (that is, after the trigger event occurs and all the applicable trigger criteria have been met). A corresponding pop-up message ("Waiting for trigger") is generated if no trigger signal appears after approximately 2 sec. This message goes away when a trigger signal appears.
Initial S/W Revision	Prior to A.02.00

Periodic Timer Triggering:

This feature selects the internal periodic timer signal as the trigger. Trigger occurrences are set by the **Periodic Timer** parameter, which is modified by the **Sync Source** and **Offset**.

The figure below shows the action of the periodic timer trigger. Before reviewing the figure, we'll explain some uses for the periodic trigger.

A common application is measuring periodic burst RF signals for which a trigger signal is not easily available. For example, we might be measuring a TDMA radio which bursts every 20 ms. Let's assume that the 20 ms period is very consistent. Let's also assume that we do not have an external trigger source

available that is synchronized with the period, and that the signal-to-noise ratio of the signal is not high enough to provide a clean RF burst trigger at all of the analysis frequencies. For example, we might want to measure spurious transmissions at an offset from the carrier that is larger than the bandwidth of the RF burst trigger. In this application, we can set the Periodic Timer to a 20.00 ms period and adjust the offset from that timer to position our trigger just where we want it. If we find that the 20.00 ms is not exactly right, we can adjust the period slightly to minimize the drift between the period timer and the signal to be measured.

A second way to use this feature would be to use **Sync Source** temporarily, instead of **Offset**. In this case, we might tune to the signal in a narrow span and use the RF Burst trigger to synchronize the periodic timer. Then we would turn the sync source off so that it would not miss-trigger. Miss-triggering can occur when we are tuned so far away from the RF burst trigger that it is no longer reliable.

A third example would be to synchronize to a signal that has a reference time element of much longer period than the period of interest. In some CDMA applications, it is useful to look at signals with a short periodicity, by synchronizing that periodicity to the "even-second clock" edge that happens every two seconds. Thus, we could connect the even-second clock trigger to Ext1 and use then Ext1 as the sync source for the periodic timer.

The figure below illustrates this third example. The top trace represents the even-second clock. It causes the periodic timer to synchronize with the leading edge shown. The analyzer trigger occurs at a time delayed by the accumulated offset from the period trigger event. The periodic timer continues to run, and triggers continue to occur, with a periodicity determined by the analyzer time base. The timer output (labeled "late event") will drift away from its ideal time due to imperfect matching between the time base of the signal being measured and the time base of the analyzer, and also because of imperfect setting of the period parameter. But the synchronization is restored on the next even-second clock event. ("Accumulated offset" is described in the in the **Offset** function section.)

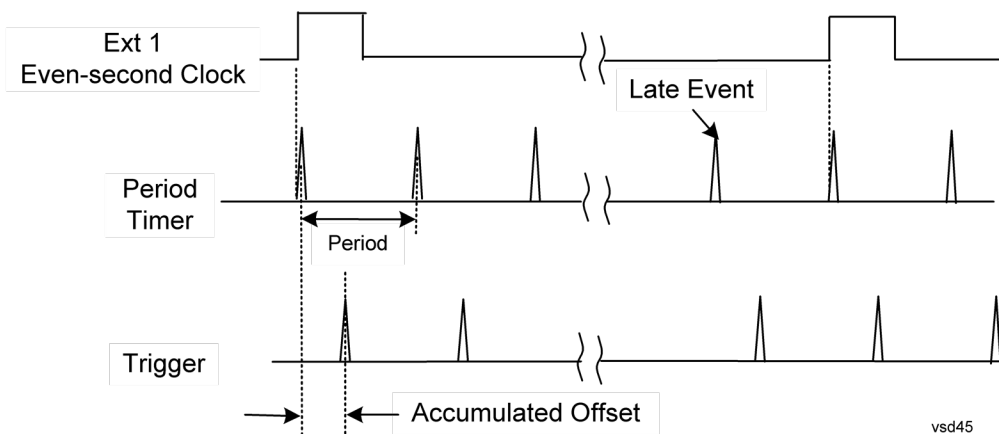

Period

Sets the period of the internal periodic timer clock. For digital communications signals, this is usually set to the frame period of your current input signal. In the case that sync source is not set to OFF, and the external sync source rate is changed for some reason, the periodic timer is synchronized at the every external synchronization pulse by resetting the internal state of the timer circuit.

Key Path	Trigger, Periodic Timer
Remote Command	:TRIGger[:SEquence]:FRAMe:PERiod <time>

	:TRIGger[:SEquence]:FRAMe:PERiod?
Example	TRIG:FRAM:PER 100 ms
Dependencies	The invalid data indicator turns on when the period is changed, until the next sweep/measurement completes.
Couplings	The same period is used in the Gate Source selection of the period timer.
Preset	20 ms GSM: 4.615383
State Saved	Saved in instrument state
Min	100.000 ns
Max	559.0000 ms
Default Unit	S
Initial S/W Revision	Prior to A.02.00

Offset

Adjusts the accumulated offset between the periodic timer events and the trigger event. Adjusting the accumulated offset is different than setting an offset, and requires explanation.

The periodic timer is usually not synchronized with any external events, so the timing of its output events has no absolute meaning. Since the timing relative to external events (RF signals) is important, you need to be able to adjust (offset) it. However, you have no direct way to see when the periodic timer events occur. All that you can see is the trigger timing. When you want to adjust the trigger timing, you will be changing the internal offset between the periodic timer events and the trigger event. Because the absolute value of that internal offset is unknown, we will just call that the accumulated offset. Whenever the Offset parameter is changed, you are changing that accumulated offset. You can reset the displayed offset using Reset Offset Display. Changing the display does not change the value of the accumulated offset, and you can still make additional changes to accumulated offset.

To avoid ambiguity, we define that an increase in the "offset" parameter, either from the knob or the SCPI adjust command, serves to delay the timing of the trigger event.

Key Path	Trigger, Periodic Timer
Remote Command	:TRIGger[:SEquence]:FRAMe:OFFSet <time> :TRIGger[:SEquence]:FRAMe:OFFSet?
Example	TRIG:FRAM:OFFS 1.2 ms
Notes	The front panel interface (for example, the knob), and this command, adjust the accumulated offset, which is shown on the active function display. However, the actual amount sent to the hardware each time the offset is updated is the delta value, that is, the current accumulated offset value minus the previous accumulated offset value. Note that the accumulated offset value is essentially arbitrary; it represents the accumulated offset from the last time the offset was zeroed (with the Reset Offset Display key). Note that this command does not change the period of the trigger waveform. Note also that Offset is used only when the sync source is set to OFF, otherwise delay is used, see section " Trig Delay " on page 476 .

	An increase in the "offset" parameter, either from the knob or the SCPI adjust command, serves to delay the timing of the trigger event.
Notes	When the SCPI command is sent the value shown on the key (and the Active Function, if this happens to be the active function) is updated with the new value. However, the actual amount sent to the hardware is the delta value, that is, the current accumulated offset value minus the previous accumulated offset value. The SCPI query simply returns the value currently showing on the key.
Dependencies	The invalid data indicator turns on when the offset is changed, until the next sweep/measurement completes.
Couplings	The same offset is used in the Gate Source selection of the period timer.
Preset	0 s
State Saved	Saved in instrument state
Min	-10.000 s
Max	10.000 s
Default Unit	S
Initial S/W Revision	Prior to A.02.00

Offset Adjust (Remote Command Only)

This remote command does not work at all like the related front panel keys. This command lets you advance the phase of the frame trigger by the amount you specify.

It does not change the period of the trigger waveform. If the command is sent multiple times, it advances the phase of the frame trigger an additional amount each time it is sent. Negative numbers are permitted.

Remote Command	:TRIGger[:SEquence]:FRAMe:ADJust <time>
Example	TRIG:FRAM:ADJ 1.2 ms
Notes	Note also that Offset is used only when the sync source is set to OFF, otherwise delay is used, see section " Trig Delay " on page 476 An increase in the "offset" parameter, either from the knob or the SCPI adjust command, serves to delay the timing of the trigger event.
Notes	The front panel interface (for example, the knob) and the :TRIG:FRAM:OFFS command adjust the accumulated offset, which is shown on the active function display. However, the actual amount sent to the hardware is the delta value, that is, the current offset value minus the previous offset value. When the SCPI command is sent the value shown on the key (and the Active Function, if this happens to be the active function) is updated by increasing it (or decreasing it if the value sent is negative) by the amount specified in the SCPI command. This is a "command only" SCPI command, with no query.
Dependencies	The invalid data indicator turns on when the offset is changed, until the next sweep/measurement completes.
Couplings	The same offset is used in the Gate Source selection of the period timer.
Preset	0 s

State Saved	Saved in instrument state
Min	-10.000 s
Max	10.000 s
Default Unit	S
Initial S/W Revision	Prior to A.02.00

Reset Offset Display

Resets the value of the periodic trigger offset display setting to 0.0 seconds. The current displayed trigger location may include an offset value defined with the **Offset** key. Pressing this key redefines the currently displayed trigger location as the new trigger point that is 0.0 s offset. The **Offset** key can then be used to add offset relative to this new timing.

Key Path	Trigger, Periodic Timer
Remote Command	:TRIGger[:SEquence]:FRAMe:OFFSet:DISPlay:RESet
Example	TRIG:FRAM:OFFS:DISP:RES
Initial S/W Revision	Prior to A.02.00

Sync Source

Selects a signal source for you to synchronize your periodic timer trigger to, otherwise you are triggering at some arbitrary location in the frame. Synchronization reduces the precision requirements on the setting of the period.

For convenience you may adjust the level and slope of the selected sync source in a conditional branch setup menu accessed from the Sync Source menu. Note that these settings match those in the **Trigger** and **Gate Source** menus; that is, each trigger source has only one value of level and slope, regardless of which menu it is accessed from.

Key Path	Trigger, Periodic Timer
Remote Command	:TRIGger[:SEquence]:FRAMe:SYNC EXTernal1 EXTernal2 RFBurst OFF :TRIGger[:SEquence]:FRAMe:SYNC?
Example	TRIG:FRAM:SYNC EXT2
Dependencies	In some models, there is no second External input. In these models, the External 2 key is blanked and the EXTernal2 parameter will generate a "Hardware missing; Not available for this model number" message.
Preset	Off GSM/EDGE, MSR,LTE,LTETDD: RFBurst
State Saved	Saved in instrument state
Readback	The current setting is read back to this key and it is also Readback to the previous Periodic Timer trigger key.

Backwards Compatibility SCPI	:TRIGger[:SEquence]:FRAMe:SYNC EXTernal
Initial S/W Revision	Prior to A.02.00
Modified at S/W Revision	A.03.00, A.14.00

Off

Turns off the sync source for your periodic trigger. With the sync source off, the timing will drift unless the signal source frequency is locked to the analyzer frequency reference.

Key Path	Trigger, Periodic Timer, Sync Source
Example	TRIG:FRAM:SYNC OFF
Readback	Off
Initial S/W Revision	Prior to A.02.00

External 1

Pressing this key, when it is not selected, selects an external input signal as the trigger. A new sweep/measurement will start when the external trigger condition is met using the external 1 input connector on the rear panel.

Pressing this key, when it is already selected, accesses the external 1 trigger setup menu.

Key Path	Trigger
Example	TRIG:SOUR EXT1 Swept SA measurement TRIG:<meas>:SOUR EXT1 Measurements other than Swept SA
Dependencies	Grayed out if in use by Point Trigger in the Source Setup menu. Forced to Free Run if already selected and Point Trigger is set to External 1.
State Saved	Saved in instrument state
Status Bits/OPC dependencies	The Status Operation Register bit 5 "Waiting for Trigger" is set at the same time as the Sweeping or Measuring bit is set. It is cleared when the trigger actually occurs (that is, after the trigger event occurs and all the applicable trigger criteria have been met). A corresponding pop-up message ("Waiting for trigger") is generated if no trigger signal appears after approximately 2 sec. This message goes away when a trigger signal appears.
Initial S/W Revision	Prior to A.02.00

Trigger Level

Sets the value where the external 1 trigger input will trigger a new sweep/measurement.

Key Path	Trigger, External 1
Remote Command	:TRIGger[:SEquence]:EXTernal1:LEVel <level> :TRIGger[:SEquence]:EXTernal1:LEVel?
Example	TRIG:EXT1:LEV 0.4 V
Couplings	This same level is used for the Ext1 trigger source in the Trigger menu, for the Ext1 selection in the Periodic Timer sync source (in the Trigger menu and in the Gate Source menu), and also for the Ext1 selection in the Gate Source menu.
Preset	1.2 V
State Saved	Saved in instrument state
Min	-5 V
Max	5 V
Default Unit	V
Backwards Compatibility SCPI	:TRIGger[:SEquence]:EXTernal:LEVel For backward compatibility, the parameter EXTernal is mapped to EXTernal1
Backwards Compatibility SCPI	:TRIGger[:SEquence]:FRAME:EXTernal1:LEVel
Initial S/W Revision	Prior to A.02.00

Trig Slope

Controls the trigger polarity. It is set positive to trigger on a rising edge and negative to trigger on a falling edge.

Key Path	Trigger, External 1
Remote Command	:TRIGger[:SEquence]:EXTernal1:SLOPe POSitive NEGative :TRIGger[:SEquence]:EXTernal1:SLOPe?
Example	TRIG:EXT1:SLOP NEG
Couplings	This same slope is used in the Ext1 selection for the trigger source in the Trigger menu and for the period timer sync source (in the Trigger menu and in the Gate Source menu).
Preset	POSitive
State Saved	Saved in instrument state
Backwards Compatibility SCPI	:TRIGger[:SEquence]:EXTernal:SLOPe For backward compatibility, the parameter EXTernal is mapped to EXTernal1
Backwards Compatibility SCPI	:TRIGger[:SEquence]:FRAME:EXTernal1:SLOPe
Backwards Compatibility Notes	The legacy :TRIGger[:SEquence]:SLOPe command affects the slopes for the VID, LINE, EXT1, EXT2, and RFB triggers.
Initial S/W Revision	Prior to A.02.00

External 2

Pressing this key, when it is not selected, selects an external input signal as the trigger. A new sweep/measurement will start when the external trigger condition is met using the external 2 input connector. The external trigger 2 input connector is on the rear panel.

Pressing this key, when it is already selected, accesses the external 2 trigger setup menu.

Key Path	Trigger
Example	TRIG:SOUR EXT2 Swept SA measurement TRIG:<meas>:SOUR EXT2 Measurements other than Swept SA
Dependencies	In some models, there is no second External input. In these models, the External 2 key is blanked and the EXTernal2 parameter will generate a "Hardware missing; Not available for this model number" message. Grayed out if in use by Point Trigger in the Source Setup menu. Forced to Free Run if already selected and Point Trigger is set to External 2.
State Saved	Saved in instrument state
Status Bits/OPC dependencies	The Status Operation Register bit 5 "Waiting for Trigger" is set at the same time as the Sweeping or Measuring bit is set. It is cleared when the trigger actually occurs (that is, after the trigger event occurs and all the applicable trigger criteria have been met). A corresponding pop-up message ("Waiting for trigger") is generated if no trigger signal appears after approximately 2 sec. This message goes away when a trigger signal appears.
Initial S/W Revision	Prior to A.02.00
Modified at S/W Revision	A.03.00

Trigger Level

Sets the value where the external 2 trigger input will trigger a new sweep/measurement.

Key Path	Trigger, External 2
Remote Command	:TRIGger[:SEquence]:EXTernal2:LEVel :TRIGger[:SEquence]:EXTernal2:LEVel?
Example	TRIG:EXT2:LEV 1.1 V
Couplings	This same level is used for the Ext2 trigger source in the Trigger menu, for the Ext2 selection in the Periodic Timer sync source (in the Trigger menu and in the Gate Source menu), and also for the Ext2 selection in the Gate Source menu.
Preset	1.2 V
State Saved	Saved in instrument state
Min	-5 V
Max	5 V
Default Unit	V
Backwards Compatibility SCPI	:TRIGger[:SEquence]:FRAMe:EXTernal2:LEVel

Initial S/W Revision	Prior to A.02.00
----------------------	------------------

Trig Slope

Controls the trigger polarity. It is set positive to trigger on a rising edge and negative to trigger on a falling edge.

Key Path	Trigger, External 2
Remote Command	:TRIGger[:SEquence]:EXTernal2:SLOPe POSitive NEGative :TRIGger[:SEquence]:EXTernal2:SLOPe?
Example	TRIG:EXT2:SLOP NEG
Couplings	This same slope is used in the Ext2 selection for the trigger source in the Trigger menu and for the period timer sync source (in the Trigger menu and in the Gate Source menu).
Preset	POSitive
State Saved	Saved in instrument state
Backwards Compatibility SCPI	:TRIGger[:SEquence]:FRAMe:EXTernal2:SLOPe
Backwards Compatibility Notes	The legacy :TRIGger[:SEquence]:SLOPe command affects the slopes for the VID, LINE, EXT1, EXT2, and RFB triggers.
Initial S/W Revision	Prior to A.02.00

RF Burst

Pressing this key, when it is not selected, selects the RF Burst as the trigger. A new sweep/measurement will start when an RF burst envelope signal is identified from the signal at the RF Input connector. Pressing this key, when it is already selected, accesses the RF Burst trigger setup menu.

In some models, a variety of burst trigger circuitry is available, resulting in various available burst trigger bandwidths. The analyzer automatically chooses the appropriate trigger path based on the hardware configuration and other settings of the analyzer.

Key Path	Trigger
Example	TRIG:SOUR RFB Swept SA measurement TRIG:< meas>:SOUR RFB Measurements other than Swept SA
State Saved	Saved in instrument state
Status Bits/OPC dependencies	The Status Operation Register bit 5 "Waiting for Trigger" is set at the same time as the Sweeping or Measuring bit is set. It is cleared when the trigger actually occurs (that is, after the trigger event occurs and all the applicable trigger criteria have been met). A corresponding pop-up message ("Waiting for trigger") is generated if no trigger signal appears after approximately 2 sec. This message goes away when a trigger signal appears.
Backwards Compatibility Notes	The legacy command:

	:TRIGger[:SEquence]:RFBurst:FSElectivity[:STATE] OFF ON 0 1 is not supported in the X-Series, as the hardware to do Frequency Selective burst triggers does not exist in X-Series.
Initial S/W Revision	Prior to A.02.00
Modified at S/W Revision	A.04.00

Absolute Trigger Level

Sets the absolute trigger level for the RF burst envelope.

When using the External Mixing path, the Absolute Trigger Level is uncalibrated because the factory default was set to accommodate the expected IF levels for the RF path.

Key Path	Trigger, RF Burst
Scope	Meas Global
Remote Command	:TRIGger[:SEquence]:RFBurst:LEVel:ABSolute <ampl> :TRIGger[:SEquence]:RFBurst:LEVel:ABSolute?
Example	TRIG:RFB:LEV:ABS 10 dBm sets the trigger level of the RF burst envelope signal to the absolute level of 10 dBm
Notes	Sending this command does not switch the setting from relative to absolute; to switch it you need to send the :TRIGger[:SEquence]:RFBurst:LEVel:TYPE command, below. Amplitude Corrections are not taken into account by the Absolute Trigger Level. For example, if you have given yourself effective gain with an amplitude correction factor, the Absolute Trigger will not fire until you have set the trigger level that far below the displayed signal level, rather than simply to the displayed signal level. This is only true for Amplitude Corrections, not External Gain or Ref Level Offset functions. If mode is Bluetooth, the default value is -50 dBm.
Couplings	This same level is used for the RF Burst trigger source in the Trigger menu, for the RF Burst selection in the Periodic Timer sync source (in the Trigger menu and in the Gate Source menu), and also for the RF Burst selection in the Gate Source menu
Preset	-20 dBm
State Saved	Saved in instrument state
Min	-200 dBm
Max	100 dBm
Default Unit	depends on the current selected Y-Axis unit
Backwards Compatibility SCPI	:TRIGger[:SEquence]:FRAME:RFBurst:LEVel:ABSolute
Initial S/W Revision	Prior to A.02.00
Modified at S/W Revision	A.04.00

Key Path	Trigger, RF Burst
Remote Command	:TRIGger[:SEquence]:RFBurst:LEVel:TYPE ABSolute RELative :TRIGger[:SEquence]:RFBurst:LEVel:TYPE?
Example	TRIG:RFB:LEV:TYPE REL sets the trigger level type of the RF burst trigger to Relative.
Preset	ABSolute
State Saved	Saved in instrument state
Initial S/W Revision	Prior to A.02.00
Modified at S/W Revision	A.04.00

Trigger Slope

It is set positive to trigger on a rising edge and negative to trigger on a falling edge.

Key Path	Trigger, RF Burst
Remote Command	:TRIGger[:SEquence]:RFBurst:SLOPe POSitive NEGative :TRIGger[:SEquence]:RFBurst:SLOPe?
Example	TRIG:RFB:SLOP NEG
Couplings	This same slope is used in the RF Burst selection for the trigger source in the Trigger menu and for the period timer sync source (in the Trigger menu and in the Gate Source menu).
Preset	POSitive
State Saved	Saved in instrument state
Backwards Compatibility SCPI	:TRIGger[:SEquence]:FRAME:RFBurst:SLOPe
Backwards Compatibility Notes	The legacy :TRIGger[:SEquence]:SLOPe command affects the slopes for the VID, LINE, EXT1, EXT2, and RFB triggers.
Initial S/W Revision	Prior to A.02.00

Sync Holdoff

Sync Holdoff specifies the duration that the sync source signal must be kept false before the transition to true to be recognized as the sync timing. The periodic timer phase is aligned when the sync source signal becomes true, after the Holdoff time is satisfied.

A holdoff of 2 ms will work with most WiMAX signals, but there may be cases where the burst off duration is less than 1 ms and this value will need to be changed.

Key Path	Trigger, Periodic Timer
Remote Command	:TRIGger[:SEquence]:FRAME:SYNC:HOLDoff <time> :TRIGger[:SEquence]:FRAME:SYNC:HOLDoff? :TRIGger[:SEquence]:FRAME:SYNC:HOLDoff:STATE OFF ON 0 1

	:TRIGger[:SEquence]:FRAMe:SYNC:HOLDoff:STATe?
Preset	On, 1.000 ms
State Saved	Saved in instrument state
Min	0 ms
Max	+500 ms
Default Unit	s
Initial S/W Revision	Prior to A.02.00

Aux IO Control (Remote Command Only)

Sets/Queries the value for all 8 data lines.

Key Path	SCPI only
Remote Command	OUTPut:AUX:IO <Value> OUTPut:AUX:IO?
Example	OUTPut:AUX:IO 31
Couplings	State of data 0 to data 7 under the AUX I/O Control panel (Input/Output menu) will change accordingly base on the AUX IO's value that key in.
Preset	31
Min	0
Max	255
Backwards Compatibility SCPI	OUTPut:UPORt <Value>
Initial S/W Revision	A.16.00

Control Edge/Level

Sets the method of controlling the gating function from the gating signal.

Edge

In Edge triggering, the gate opens (after the Delay) on the selected edge (for example, positive) of the gate signal and closes on the alternate edge (for example, negative).

Level

In Level triggering, the gate opens (after the Delay) when the gate signal has achieved a certain level and stays open as long as that level is maintained.

Key Path	Sweep/Control, Gate
Remote Command	[:SENSe]:SWEep:EGATe:CONTRol EDGE LEVel [:SENSe]:SWEep:EGATe:CONTRol?
Example	SWE:EGAT:CONT EDGE
Dependencies	If the Gate Method is FFT the Control key is grayed out and Edge is selected.

	If the Gate Source is TV, Frame or Line, the Control key is grayed out and Edge is selected.
Preset	EDGE
State Saved	Saved in instrument state
Backwards Compatibility SCPI	<code>[:SENSe]:SWEep:TIME:GATE:TYPE</code> ESA Compatibility
Initial S/W Revision	Prior to A.02.00

Gate Holdoff

Lets you increase or decrease the wait time after a gate event ends before the analyzer will respond to the next gate signal.

After any Gate event finishes, the analyzer must wait for the sweep system to settle before it can respond to another Gate signal. The analyzer calculates a "wait time," taking into account a number of factors, including RBW and Phase Noise Optimization settings. The goal is to achieve the same accuracy when gated as in ungated operation. The figure below illustrates this concept:

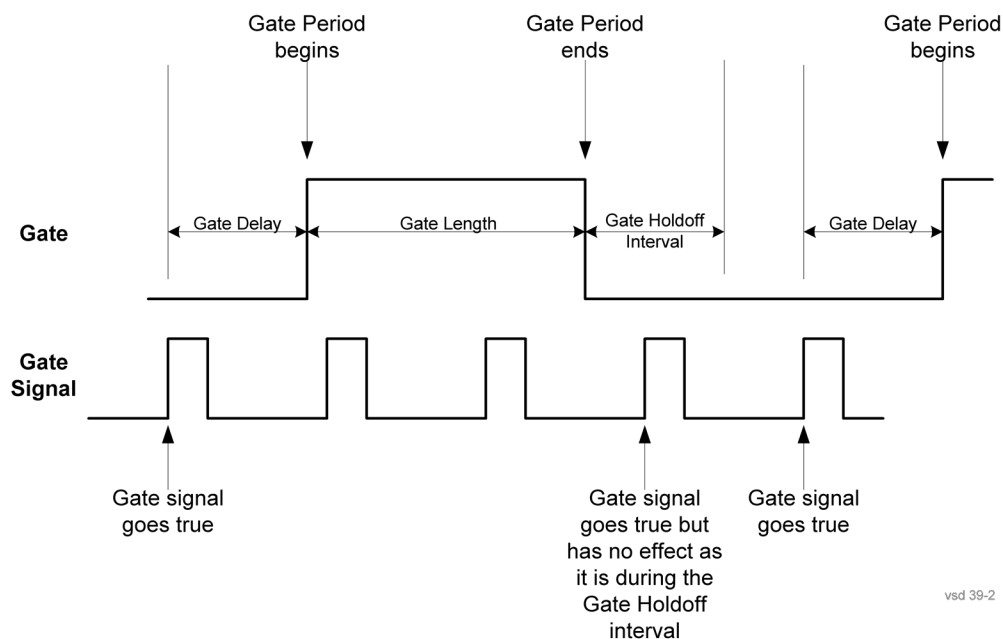

When Gate Holdoff is in Auto, the wait time calculated by the analyzer is used. When Gate Time is in Manual, the user may adjust the wait time, usually decreasing it in order to achieve greater speed, but at the risk of decreasing accuracy.

When the **Method** key is set to **Video** or **FFT**, the **Gate Holdoff** function has no effect.

In measurements that do not support Auto, the value shown when Auto is selected is “---” and the manually set holdoff is returned to a query.

Key Path	Sweep/Control, Gate
----------	----------------------------

Remote Command	[:SENSe]:SWEep:EGATe:HOLDoff <time> [:SENSe]:SWEep:EGATe:HOLDoff? [:SENSe]:SWEep:EGATe:HOLDoff:AUTO OFF ON 0 1 [:SENSe]:SWEep:EGATe:HOLDoff:AUTO?
Example	SWE:EGAT:HOLD 0.0002 SWE:EGAT:HOLD? SWE:EGAT:HOLD:AUTO ON SWE:EGAT:HOLD:AUTO?
Couplings	When Gate Holdoff is Auto , the Gate Holdoff key shows the value calculated by the analyzer for the wait time. Pressing the Gate Holdoff key while it is in Auto and not selected, causes the key to become selected and allows the user to adjust the value. If the value is adjusted, the setting changes to Man . Pressing the Gate Holdoff key, while it is in Auto and selected, does not change the value of Gate Holdoff , but causes the setting to change to Man . Now the user can adjust the value. Pressing the key while it is in Man and selected, cause the value to change back to Auto . Pressing the key while it is in Man and not selected, causes the key to become selected and allows the user to adjust the value. When Method is set to Video or FFT , the Gate Holdoff function has no effect.
Preset	Auto Auto/On
State Saved	Saved in instrument state
Min	1 μ sec
Max	1 sec
Initial S/W Revision	Prior to A.02.00

Gate Delay Compensation

This function allows you to select an RBW-dependent value by which to adjust the gate delay, to compensate for changes in the delay caused by RBW effects.

You can select between uncompensated operation and two types of compensation, **Delay Until RBW Settled** and **Compensate for RBW Group Delay**.

See "[More Information](#)" on page 1450

Key Path	Sweep/Control, Gate
Scope	Meas Global
Remote Command	[:SENSe]:SWEep:EGATe:DELaY:COMPensation:TYPE OFF SETTled GDELaY [:SENSe]:SWEep:EGATe:DELaY:COMPensation:TYPE?
Example	SWE:EGAT:DEL:COMP:TYPE SETT SWE:EGAT:DEL:COMP:TYPE?

Notes	<p>Although this function is Meas Global, there are some measurements that do not support this function. In those measurements the operation will be Uncompensated. Going into one of those measurements will not change the Meas Global selection; it will simply display the grayed-out menu key with “Uncompensated” showing as the selection. This is a non-forceful grayout, so the SCPI command is still accepted.</p> <p>If Gate Delay Compensation is not supported at all within a particular mode, the key is not displayed, and if the SCPI command is sent while in a measurement within that mode, an “Undefined Header” message is generated.</p> <p>Measurements that do not support this function include: Swept SA</p>
Preset	<p>TD-SCDMA mode: Compensate for RBW Group Delay All other modes: Delay Until RBW Settled</p>
State Saved	Saved in instrument state
Range	Uncompensated Delay Until RBW Settled Compensate for RBW Group Delay
Readback text	Uncompensated Settled Group Delay
Initial S/W Revision	Prior to A.02.00
Modified at S/W Revision	A.11.0

More Information

Selecting **Uncompensated** means that the actual gate delay is as you sets it.

Selecting **Delay Until RBW Settled** causes the gate delay to be increased above the user setting by an amount equal to $3.06/\text{RBW}$. This compensated delay causes the GATE START and GATE STOP lines on the display to move by the compensation amount, and the actual hardware gate delay to be increased by the same amount. All the other gate lines (for example, MIN FAST) are unaffected. If the RBW subsequently changes, the compensation is readjusted for the new RBW. The value shown on the **Gate Delay** key does NOT change.

Delay Until RBW Settled allows excellent measurements of gated signals, by allowing the IF to settle following any transient that affects the burst. Excellent measurements also require that the analysis region not extend into the region affected by the falling edge of the burst. Thus, excellent measurements can only be made over a width that declines with narrowing RBWs, which is achieved by decreasing the gate length below the user setting by an amount equal to $2.53/\text{RBW}$. Therefore, for general purpose compensation, you will still want to change the gate length with changes in RBW even if the gate delay is compensated. The compensated Gate Length is limited by the analyzer so that it will never go below 10% of the value shown on the Gate Length key, as otherwise the sweep times could get very long. Anytime the **Gate Length and RBW** values combine in such a way that this limiting takes place, a warning is displayed. For measurements which contain multiple sweeps with different RBW like SEM and SPUR, the smallest RBW is used for this limiting.

Selecting **Compensate for RBW Group Delay** causes the gate delay to be increased above the user setting by an amount equal to $1.81/\text{RBW}$. This compensated delay causes the GATE START, GATE STOP lines on the display to move by the compensation amount, and the actual hardware gate delay to be increased by the same amount. All the other gate lines (for example, MIN FAST) are unaffected. If the RBW

subsequently changes, the compensation is readjusted for the new RBW. The value shown on the **Gate Delay** key does NOT change. **Compensate for RBW Group Delay** also includes gate length compensation; the gate length itself is adjusted as necessary to attempt to compensate for delay effects imposed by the RBW.

Compensate for RBW Group Delay is similar to **Delay Until RBW Settled**, but compensates for the group delay of the RBW filter, rather than the filter settling time. As the RBW gets narrow, this can allow the settling tail of the RBW to affect the beginning part of the gated measurement, and allow the beginning of the RBW settling transient to affect the end of the gated measurement. These two effects are symmetric because the RBW response is symmetric. Because the gate length is not automatically compensated, some users might find this compensation to be more intuitive than compensation for RBW settling.

Min Fast Position Query (Remote Command Only)

This command queries the position of the MIN FAST line, relative to the delay reference (REF) line. See section "[Gate View On/Off](#)" on page 2228. If this query is sent while not in gate view, the MinFast calculation is performed based on the current values of the appropriate parameters and the result is returned. Knowing this value lets you set an optimal gate delay value for the current measurement setup.

Remote Command	<code>[:SENSe] :SWEep:EGATe:MINFast?</code>
Example	<code>SWE:EGAT:MIN?</code>
Initial S/W Revision	Prior to A.02.00

Gate Preset (Remote Command Only)

Presets the time-gated spectrum analysis capability.

This command sets gate parameter values to the ESA preset values, as follows:

Gate trigger type = edge

Gate polarity = positive

Gate delay = 1 us

Gate length = 1 us

Remote Command	<code>[:SENSe] :SWEep:TIME:GATE:PRESet</code> ESA Compatibility
Initial S/W Revision	Prior to A.02.00

Gate Level (Remote Command Only)

Sets the gate input transition point level for the external TRIGGER inputs on the front and rear panel. This is a legacy command for PSA compatibility. It is simply an alias to the equivalent trigger level command.

Remote Command	<code>[:SENSe] :SWEep:EGATe:EXTernal [1] 2 :LEVel <voltage></code> <code>[:SENSe] :SWEep:EGATe:EXTernal [1] 2 :LEVel?</code>
Notes	This command is simply an alias to

	:TRIGger[:SEQuence]:EXTernal[1]2:LEVel For details refer
Initial S/W Revision	Prior to A.02.00

Gate Polarity (Remote Command Only)

Sets the polarity for the gate signal. This setup is now done using the gate trigger's slope setting.

When Positive (Pos) is selected, a positive-going edge (Edge) or a high voltage (Level) will satisfy the gate condition, after the delay set with the Gate Delay key. When Negative (Neg) is selected, a negative-going edge (Edge) or a low voltage (Level) will satisfy the gate condition after the delay.

Remote Command	[:SENSe]:SWEep:EGATe:POLarity NEGative POSitive [:SENSe]:SWEep:EGATe:POLarity?
Example	SWE:EGAT:POL NEG SWE:EGAT:POL?
Preset	POSitive
State Saved	Saved in instrument state
Backwards Compatibility SCPI	[:SENSe]:SWEep:TIME:GATE:POLarity ESA compatibility
Initial S/W Revision	Prior to A.02.00

Remote Command	[:SENSe]:SWEep:TIME:GATE:LEVel HIGH LOW [:SENSe]:SWEep:TIME:GATE:LEVel? ESA compatibility
Preset	HIGH
Initial S/W Revision	Prior to A.02.00

System

See "System" on page 368

Trace/Detector

Accesses a menu of functions that enable you to control trace and detector for the current measurement.

Key Path	Front-panel key
Initial S/W Revision	Prior to A.02.00

Trace Type

Allows you to select the type of trace for the current measurement. The menu contains a 1-of-N selection of the trace type (Clear Write, Average, Max Hold, Min Hold).

Key Path	Trace/Detector
Mode	SA, WCDMA, C2K, WIMAX OFDMA, TD-SCDMA, 1xEVDO, DTMB (CTTB), DVB-T/H, ISDB-T, CMMB, LTE, LTE-TDD, Digital Cable TV, WLAN, MSR, LTEAFDD, LTEATDD
Remote Command	:TRACe:SEMask:TYPE WRITe AVERAge MAXHold MINHold :TRACe:SEMask:TYPE?
Example	TRAC:SEM:TYPE MINH TRAC:SEM:TYPE?
Notes	WRITe = Clear Write AVERAge = Average MAXHold = Maximum Hold MINHold = Minimum Hold
Couplings	When Detector setting is "Auto" ([[:SENSe]:SEMask:DETEctor:AUTO?]), Detector ([[:SENSe]:SEMask:DETEctor:[FUNCTion]?]) switches aligning with the switch of this parameter: "NORMal" with WRITe (Clear Write), "AVERAge" with AVERAge, "POSitive (peak)" with MAXHold, and "NEGative (peak)" with MINHold.
Preset	AVERAge
State Saved	Saved in instrument state.
Range	WRITe AVERAge MAXHold MINHold
Initial S/W Revision	Prior to A.02.00
Modified at S/W Revision	A.02.00, A.03.00

Chan Detector

Accesses a menu of functions that enable you to control the detectors for reference channel. The following choices are available:

- Auto– the detector selected depends on marker functions, trace functions, average type, and the trace averaging function.
- Normal–the detector determines the peak of the CW-like signals, and it yields alternating maximums and minimums of noise-like signals. This is also referred to as Rosenfell detection.

- Average—the detector determines the average of the signal within the sweep points. The averaging method depends upon the Average Type selection (voltage, power or log scales).
- Peak—the detector determines the maximum of the signal within the sweep points.
- Sample—the detector indicates the instantaneous level of the signal at the center of the sweep points represented by each display point.
- Negative Peak—the detector determines the minimum of the signal within the sweep points.

Key Path	Trace/Detector
Initial S/W Revision	Prior to A.02.00

Chan Detector Auto

Sets the detector to the default detection mode for the reference channel. This mode is dependent upon the current reference channel conditions.

Key Path	Trace/Detector
Mode	SA, WCDMA, C2K, WIMAX OFDMA, TD-SCDMA, 1xEVDO, DTMB (CTTB), DVB-T/H, ISDB-T, CMMB, LTE, LTE-TDD, Digital Cable TV, WLAN, MSR, LTEAFDD, LTEATDD
Remote Command	[:SENSe] :SEMAsk:DETEctor:CARRier:AUTO ON OFF 1 0 [:SENSe] :SEMAsk:DETEctor:CARRier:AUTO?
Example	SEM:DET:CARR:AUTO OFF SEM:DET:CARR:AUTO?
Notes	See Couplings in the Trace Type section. You must be in the mode that includes SEM measurement to use this command. Use :INSTrument:SElect to set the mode.
Preset	ON
State Saved	Saved in instrument state
Range	On Off
Initial S/W Revision	Prior to A.02.00
Modified at S/W Revision	A.02.00, A.03.00

Chan Detector Selection

Selects the detector mode for the reference channel.

Key Path	Trace/Detector
Mode	SA, WCDMA, C2K, WIMAX OFDMA, TD-SCDMA, 1xEVDO, DTMB (CTTB), DVB-T/H, ISDB-T, CMMB, LTE, LTE-TDD, Digital Cable TV, WLAN, MSR, LTEAFDD, LTEATDD
Remote Command	[:SENSe] :SEMAsk:DETEctor:CARRier[:FUNction] AVERAge NEGative NORMal POSitive SAMPlE [:SENSe] :SEMAsk:DETEctor:CARRier[:FUNction]?

Example	SEM:DET:CARR NEG SEM:DET:CARR?
Notes	When you manually select a detector (instead of selecting Auto), that detector is used regardless of other analyzer settings. Note: This detector setting affects the reference channel. There is not a per trace detector. You must be in the mode that includes SEM measurement to use this command. Use :INSTrument:SElect to set the mode.
Couplings	See Couplings in the Trace Type section.
Preset	AVERage
State Saved	Saved in instrument state.
Range	Normal Average Peak Sample Negative Peak
Initial S/W Revision	Prior to A.02.00
Modified at S/W Revision	A.02.00, A.03.00

Offset Detector

Accesses a menu of functions that enable you to control the detector for offsets. The following choices are available.

- Auto– the detector selected depends on marker functions, trace functions, average type, and the trace averaging function.
- Normal–the detector determines the peak of the CW-like signals, and it yields alternating maximums and minimums of noise-like signals. This is also referred to as Rosenfell detection.
- Average–the detector determines the average of the signal within the sweep points. The averaging method depends upon the Average Type selection (voltage, power or log scales).
- Peak–the detector determines the maximum of the signal within the sweep points.
- Sample–the detector indicates the instantaneous level of the signal at the center of the sweep points represented by each display point.
- Negative Peak–the detector determines the minimum of the signal within the sweep points.

Key Path	Trace/Detector
Initial S/W Revision	Prior to A.02.00

Offset Detector Auto

Sets the detector to the default detection mode for the offsets. This mode is dependent upon the current signal conditions of the offsets.

Key Path	Trace/Detector
Mode	SA, WCDMA, C2K, WIMAX OFDMA, TD-SCDMA, 1xEVDO, DTMB (CTTB), DVB-T/H, ISDB-T, CMMB,

	LTE, LTE-TDD, Digital Cable TV, WLAN, MSR, LTEAFDD, LTEATDD
Remote Command	[:SENSe] :SEMAsk:DETEctor:OFFSet:AUTO ON OFF 1 0 [:SENSe] :SEMAsk:DETEctor:OFFSet:AUTO?
Example	SEM:DET:OFFS:AUTO OFF SEM:DET:OFFS:AUTO?
Notes	See Couplings in the Trace Type section. You must be in the mode that includes SEM measurement to use this command. Use :INSTrument:SElect to set the mode.
Preset	ON
State Saved	Saved in instrument state.
Range	On Off
Initial S/W Revision	Prior to A.02.00
Modified at S/W Revision	A.02.00, A.03.00

Offset Detector Selection

Selects the detector mode for the offsets.

Key Path	Trace/Detector
Mode	SA, WCDMA, C2K, WIMAX OFDMA, TD-SCDMA, 1xEVDO, DTMB (CTTB), DVB-T/H, ISDB-T, CMMB, LTE, LTE-TDD, Digital Cable TV, WLAN, MSR, LTEAFDD, LTEATDD
Remote Command	[:SENSe] :SEMAsk:DETEctor:OFFSet[:FUNction] AVERAge NEGAtive NORMAl POSitive SAMPlE [:SENSe] :SEMAsk:DETEctor:OFFSet[:FUNction]?
Example	SEM:DET:OFFS AVER SEM:DET:OFFS?
Notes	When you manually select a detector (instead of selecting Auto), that detector is used regardless of other analyzer settings. Note: This detector setting has effects all offsets. There is not a per trace detector. You must be in the mode that includes SEM measurement to use this command. Use :INSTrument:SElect to set the mode.
Couplings	See Couplings in the Trace Type section.
Preset	POSitive
State Saved	Saved in instrument state.
Range	Normal Average Peak Sample Negative Peak
Initial S/W Revision	Prior to A.02.00
Modified at S/W Revision	A.02.00, A.03.00

Trigger

See ["Trigger" on page 444](#)

Free Run

See ["Free Run " on page 451](#)

Video

See ["Video \(IF Envelope\) " on page 452](#)

Trigger Level

See ["Trigger Level " on page 452](#)

Trig Slope

See ["Trig Slope " on page 453](#)

Trig Delay

See ["Trig Delay " on page 454](#)

Line

See ["Line " on page 2235](#)

Trig Slope

See ["Trig Slope " on page 2235](#)

Trig Delay

See ["Trig Delay " on page 456](#)

External 1

See ["External 1 " on page 2248](#)

Trigger Level

See ["Trigger Level " on page 2248](#)

Trig Slope

See ["Trig Slope " on page 2249](#)

Trig Delay

See ["Trig Delay " on page 459](#)

Zero Span Delay Comp

See ["Zero Span Delay Comp On/Off" on page 2237](#)

External 2

See ["External 2 "](#) on page 2250

Trigger Level

See ["Trigger Level "](#) on page 2250

Trig Slope

See ["Trig Slope "](#) on page 2251

Trig Delay

See ["Trig Delay "](#) on page 461

Zero Span Delay Comp

See ["Zero Span Delay Comp On/Off"](#) on page 2239

RF Burst

See ["RF Burst "](#) on page 2251

Absolute Trigger

See ["Absolute Trigger Level"](#) on page 2252

Relative Trigger

See ["Relative Trigger Level"](#) on page 2241

Trig Slope

See ["Trigger Slope "](#) on page 2253

Trig Delay

See ["Trig Delay "](#) on page 466

Periodic Timer

See ["Periodic Timer \(Frame Trigger\) "](#) on page 2243

Period

See ["Period "](#) on page 2244

Offset

See ["Offset "](#) on page 2245

Reset Offset Display

See ["Reset Offset Display "](#) on page 2247

Sync Source

See ["Sync Source "](#) on page 2247

Off

See ["Off "](#) on page 2248

External 1

See ["External 1 "](#) on page 2248

Trigger Level

See ["Trigger Level "](#) on page 2248

Trig Slope

See ["Trig Slope "](#) on page 2249

External 2

See ["External 2 "](#) on page 2250

Trigger Level

See ["Trigger Level "](#) on page 2250

Trig Slope

See ["Trig Slope "](#) on page 2251

RF Burst

See ["RF Burst "](#) on page 2251

Absolute Trigger

See ["Absolute Trigger Level"](#) on page 2252

Trig Slope

See ["Trigger Slope "](#) on page 2253

Trig Delay

See ["Trig Delay"](#) on page 476

Auto/Holdoff

See ["Auto/Holdoff "](#) on page 477

Auto Trig

See ["Auto Trig "](#) on page 477

Trig Holdoff

See ["Trig Holdoff "](#) on page 478

Holdoff Type

See "Holdoff Type" on page 478

User Preset

Accesses a menu that gives you the following three choices:

- **User Preset** – recalls a state previously saved using the Save User Preset function.
- **User Preset All Modes** – presets all of the modes in the analyzer
- **Save User Preset**– saves the current state for the current mode

Key Path	Front-panel key
Backwards Compatibility Notes	<p>User Preset is actually loading a state, and in legacy analyzers, it was possible to load a state without affecting the trace data, limit lines or correction data. Similarly it was possible to do a User Preset without affecting the trace data, limit lines or correction data.</p> <p>In the X-Series, “state” always includes all of this data; so whenever state is loaded, or User Preset is executed, all of the traces, limit lines and corrections are affected. Although this differs from previous behavior, it is desirable behavior, and should not cause adverse issues for users.</p> <p>On ESA and PSA, User Preset affected the entire instrument’s state. In the X-Series, User Preset only recalls the state for the active mode. There is a User Preset file for each mode. User Preset can never cause a mode switch as it can in legacy analyzers. If you want to recall all modes to their user preset file state, you will need to do a User Preset after mode switching into each mode.</p> <p>User Preset recalls mode state which can now include data like traces; whereas on ESA and PSA, User Preset did not affect data.</p>
Initial S/W Revision	Prior to A.02.00

User Preset

User Preset sets the state of the currently active mode back to the state that was previously saved for this mode using the Save User Preset menu key or the SCPI command, `SYST:PRES:USER:SAV`. It not only recalls the Mode Preset settings, but it also recalls all of the mode persistent settings, and the Input/Output system setting that existed at the time Save User Preset was executed.

If a Save User Preset has not been done at any time, User Preset recalls the default user preset file for the currently active mode. The default user preset files are created if, at power-on, a mode detects there is no user preset file. There will never be a scenario when there is no user preset file to restore. For each mode, the default user preset state is the same state that would be saved if a Save User Preset is performed in each mode right after doing a Restore Mode Default and after a Restore Input/Output Defaults.

The User Preset function does the following:

- Aborts the currently running measurement.
- Sets the mode State to the values defined by Save User Preset.
- Makes the saved measurement for the currently running mode the active measurement.
- Brings up the saved menu for the power-on mode.
- Clears the input and output buffers.
- Sets the Status Byte to 0.

Key Path	User Preset
Remote Command	:SYSTem:PRESet:USER
Example	:SYST:PRES:USER:SAVE:SYST:PRES:USER
Notes	:SYST:PRES:USER:SAVE is used to save the current state as the user preset state. Clears all pending OPC bits. The Status Byte is set to 0. Pressing the User Preset front-panel key while already in the User Preset menu will cause the User Preset to get executed
Couplings	A user preset will cause the currently running measurement to be aborted and cause the saved measurement to be active. Recalling a User Preset file has the same issues that recalling a Save State file has. Some settings may need to be limited and therefore re-coupled, since the capabilities of the mode may have changes when the User Preset file was last saved.
Initial S/W Revision	Prior to A.02.00

User Preset All Modes

Recalls all of the User Preset files for each mode, switches to the power-on mode, and activates the saved measurement from the power-on mode User Preset file.

NOTE

When the instrument is secured, all of the user preset files are converted back to their default user preset files.

The User Preset function does the following:

- Aborts the currently running measurement.
- Switches the Mode to the power-on mode.
- Restores the User Preset files for each mode.
- Makes the saved measurement for the power-on mode the active measurement.
- Brings up the saved menu for the power-on mode.
- Clears the input and output buffers.
- Sets the Status Byte to 0.

Key Path	User Preset
Remote Command	:SYSTem:PRESet:USER:ALL
Example	:SYST:PRES:USER:SAVE:SYST:PRES:USER:ALL
Notes	Clears all pending OPC bits. The Status Byte is set to 0. :SYST:PRES:USER:SAVE is used to save the current state as the user preset state.
Couplings	A user preset will cause the currently running measurement to be aborted, cause a mode switch to the power-on mode, and cause the saved measurement to be active in the power-on mode. Recalling a User Preset file has the same issues that recalling a Save State file has. Some settings may need to be limited and therefore re-coupled, since the capabilities of the mode may have changes when the User Preset file was last saved.

Initial S/W Revision	Prior to A.02.00
----------------------	------------------

Save User Preset

Saves the currently active mode and its State. You can recall this User Preset file by pressing the User Preset menu key or sending the SYST:PRES:USER remote command. This same state is also saved by the Save State function.

Key Path	User Preset
Remote Command	:SYSTem:PRESet:USER:SAVE
Example	:SYST:PRES:USER:SAVE
Notes	:SYST:PRES:SAVE creates the same file as if the user requested a *SAV or a MMEM:STOR:STAT, except User Preset Save does not allow the user to specify the filename or the location of the file.
Initial S/W Revision	Prior to A.02.00

View/Display

Accesses a menu of functions that enable you to control the instrument display.

The following keys select how the results are displayed:

- **Abs Pwr Freq**—displays the absolute power levels in dBm and the corresponding frequencies in the text window.
- **Rel Pwr Freq**—displays the relative power levels in dBc and the corresponding frequencies in the text window.
- **Integrated Power**—displays the absolute and relative power levels integrated throughout the bandwidths between the start and stop frequencies in the text window.
- **Carrier Info** —displays the carrier configuration information with measure powers. (Only available in MSR and LTE-Advanced FDD/TDD)

["View Selection by Name \(Remote Command Only\)" on page 1465](#)

["Views Selection by Number \(Remote Command only\)" on page 1465](#)

View Selection by Name (Remote Command Only)

Key Path	View/Display
Mode	SA, WCDMA, C2K, WIMAX OFDMA, TD-SCDMA, 1xEVDO, DTMB (CTTB), DVB-T/H, ISDB-T, CMMB, LTE, LTETDD, Digital Cable TV, WLAN, MSR, LTEAFDD, LTEATDD
Remote Command	:DISPlay:SEMask:VIEW[:SElect] APFReq RPFReq IPOWer CINformation :DISPlay:SEMask:VIEW[:SElect] ?
Example	DISP:SEM:VIEW IPOW DISP:SEM:VIEW?
Notes	You must be in the mode that includes SEM measurement to use this command. Use :INSTrument:SElect to set the mode.
Dependencies	In the SA mode, when "Radio Standard" is set to WLAN, IPOWer is not available and the key is grayed out. CINformation is available only in MSR and LTE-Advanced FDD/TDD mode, otherwise the key is blank.
Preset	SA, WCDMA, C2K, TD-SCDMA, 1xEVDO, DTMB (CTTB), DVB-T/H, ISDB-T, CMMB, LTE, LTETDD, Digital Cable TV, MSR, LTEAFDD, LTEATDD: APFReq WIMAX OFDMA, WLAN: RPFReq
State Saved	Saved in instrument state.
Range	Abs Pwr & Freq Rel Pwr & Freq Integrated Power Carrier Info
Initial S/W Revision	Prior to A.02.00
Modified at S/W Revision	A.02.00, A.03.00, A.10.00

Views Selection by Number (Remote Command only)

The following numerical selections determine how the results are displayed:

1. displays the absolute power levels in dBm and the corresponding frequencies in the text window.
2. displays the relative power levels in dBc and the corresponding frequencies in the text window.
3. displays the absolute and relative power levels integrated throughout the bandwidths between the start and stop frequencies in the text window.
4. displays the carrier info table. (Only available in MSR and LTE-Advanced FDD/TDD)

Mode	SA, WCDMA, C2K, WIMAX OFDMA, TD-SCDMA, 1xEVDO, DTMB (CTTB), DVB-T/H, ISDB-T, CMMB, LTE, LTETDD, Digital Cable TV, WLAN, MSR, LTEAFDD, LTEATDD
Remote Command	:DISPlay:SEMask:VIEW:NSElect <integer> :DISPlay:SEMask:VIEW:NSElect?
Example	DISP:SEM:VIEW:NSEL 2 DISP:SEM:VIEW:NSEL?
Notes	In the SA mode, when "Radio Standard" is set to WLAN, Option 3 is not available. Option 4 is available only in MSR and LTE-Advanced FDD/TDD mode. You must be in the mode that includes SEM measurement to use this command. Use :INSTrument:SElect to set the mode.
Preset	SA, WCDMA, C2K, TD-SCDMA, 1xEVDO, DTMB (CTTB), DVB-T/H, ISDB-T, CMMB, LTE, LTETDD, Digital Cable TV, MSR, LTEAFDD, LTEATDD: 1 WIMAX OFDMA, WLAN: 2
State Saved	Saved in instrument state.
Min	1
Max	MSR, LTEAFDD, LTEATDD: 4 Other modes: 3
Initial S/W Revision	Prior to A.02.00
Modified at S/W Revision	A.02.00, A.03.00, A.10.00

Key Path	Front-panel key
Initial S/W Revision	Prior to A.02.00

Display

The Display menu is common to most measurements, and is used for configuring items on the display. Some Display menu settings apply to all the measurements in a mode, and some only to the current measurement. Those under the **System Display Settings** key apply to all measurements in all modes.

Key Path	Display
Key Path	View/Display
Initial S/W Revision	Prior to A.02.00

Annotation

Turns on and off various parts of the display annotation. The annotation is divided up into four categories:

1. Meas Bar: This is the measurement bar at the top of the screen. It does not include the settings panel or the Active Function. Turning off the Meas Bar turns off the settings panel and the Active Function. When the Meas Bar is off, the graticule area expands to fill the area formerly occupied by the Meas Bar.
2. Screen Annotation: this is the annotation and annunciation around the graticule, including any annotation on lines (such as the display line, the threshold line, etc.) This does NOT include the marker number or the N dB result. When off, the graticule expands to fill the entire graticule area.
3. Trace annotation: these are the labels on the traces, showing their detector (or their math mode).
4. Active Function annotation: this is the active function display in the meas bar, and all of the active function values displayed on softkeys.

See the figure below. Each type of annotation can be turned on and off individually.

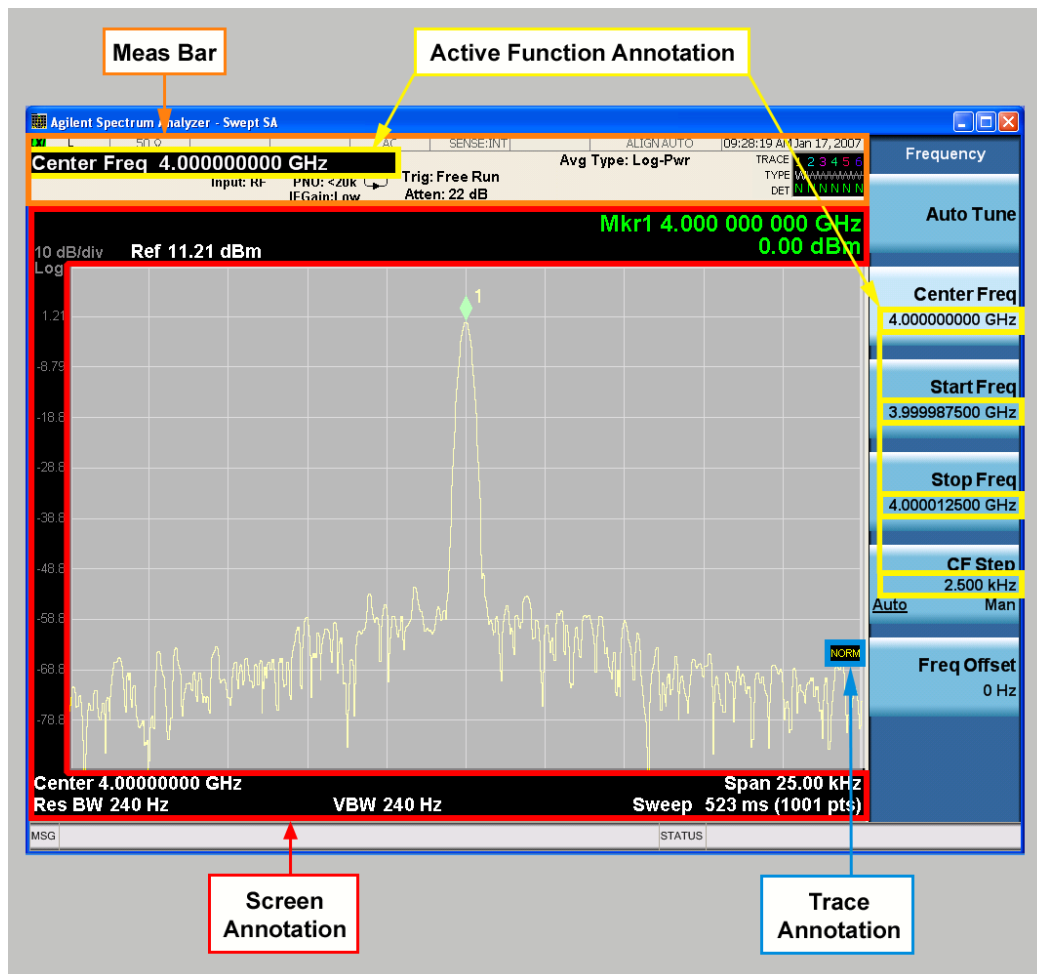

Key Path View/Display, Display

Initial S/W Revision Prior to A.02.00

Meas Bar On/Off

This function turns the Measurement Bar on and off, including the settings panel. When off, the graticule area expands to fill the area formerly occupied by the Measurement Bar.

Key Path	View/Display, Display, Annotation
Remote Command	:DISPlay:ANNotation:MBAR[:STATe] OFF ON 0 1 :DISPlay:ANNotation:MBAR[:STATe]?
Example	DISP:ANN:MBAR OFF
Dependencies	Grayed out and forced to OFF when System Display Settings, Annotation is set to Off.
Preset	On This should remain Off through a Preset when System DisplaySettings, Annotation is set to Off.
State Saved	Saved in instrument state.
Initial S/W Revision	Prior to A.02.00

Screen

This controls the display of the annunciation and annotation around the graticule, including any annotation on lines (such as the display line, the threshold line, etc.) and the y-axis annotation. This does NOT include marker annotation (or the N dB result). When off, the graticule expands to fill the entire graticule area, leaving only the 1.5% gap above the graticule as described in the Trace/Detector chapter.

Key Path	View/Display, Display, Annotation
Remote Command	:DISPlay:ANNotation:SCReen[:STATe] OFF ON 0 1 :DISPlay:ANNotation:SCReen[:STATe]?
Example	DISP:ANN:SCR OFF
Dependencies	Grayed-out and forced to OFF when System Display Settings, Annotation is set to Off.
Preset	On This should remain Off through a Preset when System DisplaySettings, Annotation is set to Off
State Saved	Saved in instrument state.
Initial S/W Revision	Prior to A.02.00

Active Function Values On/Off

Turns on and off the active function display in the Meas Bar, and all of the active function values displayed on the softkeys.

Note that all of the softkeys that have active functions have these numeric values blanked when this function is on. This is a security feature..

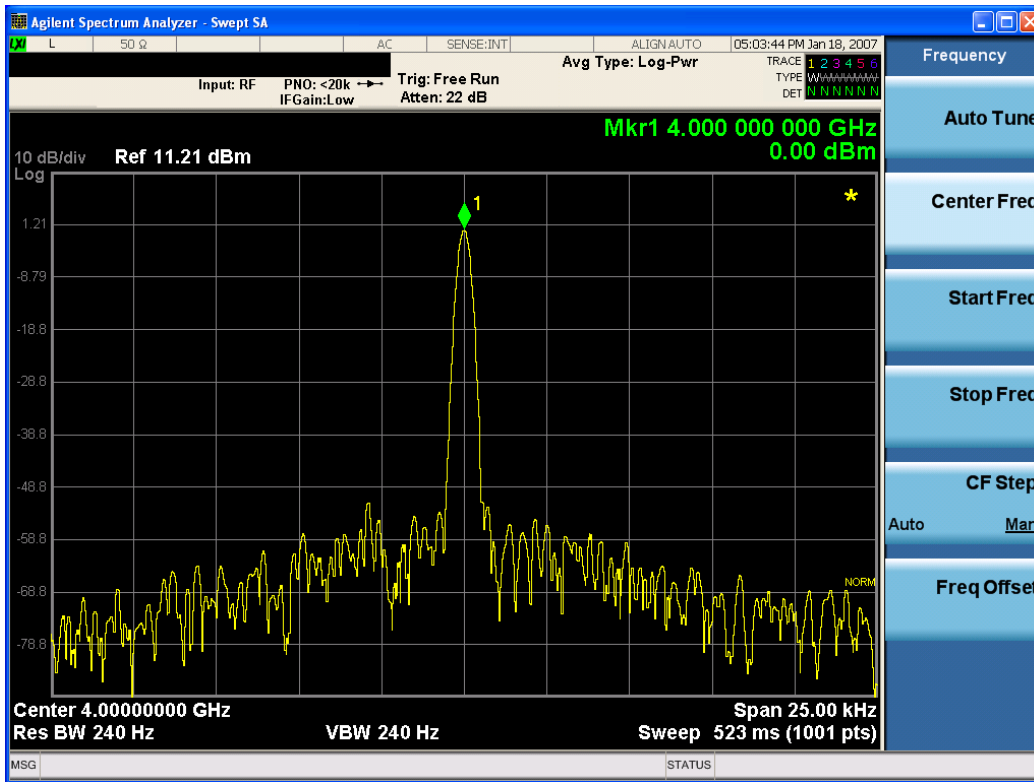

Key Path	View/Display, Display, Annotation
Remote Command	:DISPlay:ACTivefunc[:STATE] ON OFF 1 0 :DISPlay:ACTivefunc[:STATE]?
Example	DISP:ACT OFF
Dependencies	Grayed out and forced to OFF when System Display Settings, Annotation is set to Off.
Preset	On This should remain Off through a Preset when System DisplaySettings, Annotation is set to Off
State Saved	Saved in instrument state.
Initial S/W Revision	Prior to A.02.00

Title

Displays menu keys that enable you to change or clear a title on your display.

Key Path	View/Display, Display
Initial S/W Revision	Prior to A.02.00

Change Title

Writes a title into the "measurement name" field in the banner, for example, "Swept SA".

Press Change Title to enter a new title through the alpha editor. Press Enter or Return to complete the entry. Press ESC to cancel the entry and preserve your existing title.

The display title will replace the measurement name. It remains for this measurement until you press **Change Title** again, or you recall a state, or a Preset is performed. A title can also be cleared by pressing **Title**, **Clear Title**.

NOTE

Notice the inclusion of the <measurement> parameter in the command below. Because each measurement remembers the Display Title, the command must be qualified with the measurement name. For the Swept SA measurement this is not the case; no <measurement> parameter is used when changing the Display Title for the Swept SA measurement.

Key Path	View/Display, Display, Title
Mode	All
Remote Command	:DISPlay:<measurement>:ANNotation:TITLe:DATA <string> :DISPlay:<measurement>:ANNotation:TITLe:DATA?
Example	DISP:ANN:TITL:DATA "This Is My Title" This example is for the Swept SA measurement in the Spectrum Analyzer mode. The SANalyzer <measurement> name is not used. DISP:ACP:ANN:TITL:DATA "This Is My Title" This example is for Measurements other than Swept SA. Both set the title to: This Is My Title
Notes	Pressing this key cancels any active function. When a title is edited the previous title remains intact (it is not cleared) and the cursor goes at the end so that characters can be added or BKSP can be used to go back over previous characters.
Preset	No title (measurement name instead)
State Saved	Saved in instrument state.
Initial S/W Revision	Prior to A.02.00

Clear Title

Clears a title from the front-panel display. Once cleared, the title cannot be retrieved. After the title is cleared, the current Measurement Name replaces it in the title bar.

Key Path	View/Display, Display, Title
Example	The following commands clear the title and restore the measurement's original title: DISP:ANN:TITL:DATA "" This example is for the Swept SA measurement in the Spectrum Analyzer mode. The SANalyzer <measurement> name is not used. DISP:ACP:ANN:TITL:DATA "" This example is for ACP; in measurements other than Swept SA the measurement name is required.
Notes	Uses the :DISPlay:<measurement>:ANNotation:TITLe:DATA <string> command with an empty string (in the Swept SA, the <measurement> is omitted).

Preset	Performed on Preset.
Initial S/W Revision	Prior to A.02.00

Graticule

Pressing Graticule turns the display graticule On or Off. It also turns the graticule y-axis annotation on and off.

Key Path	View/Display, Display
Remote Command	:DISPlay:WINDow[1]:TRACe:GRATicule:GRID[:STATe] OFF ON 0 1 :DISPlay:WINDow[1]:TRACe:GRATicule:GRID[:STATe]?
Example	DISP:WIND:TRAC:GRAT:GRID OFF
Notes	The graticule is the set of horizontal and vertical lines that make up the grid/divisions for the x-axis and y-axis.
Preset	On
State Saved	Saved in instrument state
Initial S/W Revision	Prior to A.02.00

System Display Settings

These settings are "Mode Global" – they affect all modes and measurements and are reset only by **Restore Misc Defaults** or **Restore System Defaults** under System.

Key Path	View/Display, Display
Initial S/W Revision	Prior to A.02.00

Annotation Local Settings

This is a Mode Global override of the meas local annotation settings. When it is **All Off**, it forces **ScreenAnnotation, Meas Bar, Trace, and Active Function Values** settings to be **OFF** for all measurements in all modes. This provides the security based "annotation off" function of previous analyzers; hence it uses the legacy SCPI command.

When it is **All Off**, the **Screen, Meas Bar, Trace, and Active Function Values** keys under the **Display, Annotation** menu are grayed out and forced to **Off**. When **Local Settings** is selected, you are able to set the local annotation settings on a measurement by measurement basis.

Key Path	View/Display, Display, System Display Settings
Remote Command	:DISPlay:WINDow[1]:ANNotation[:ALL] OFF ON 0 1 :DISPlay:WINDow[1]:ANNotation[:ALL]?
Example	:DISP:WIND:ANN OFF

Preset	On (Set by Restore Misc Defaults)
State Saved	Not saved in instrument state.
Backwards Compatibility Notes	The WINDOW parameter and optional subopcode is included for backwards compatibility but ignored - all windows are equally affected.
Initial S/W Revision	Prior to A.02.00

Themes

Accesses a menu of functions that enable you to choose the theme to be used when saving the screen image.

The **Themes** option is the same as the **Themes** option under the **Display** and **Page Setup** dialogs. It allows you to choose between themes to be used when saving the screen image.

Key Path	Save, Screen Image
Remote Command	:MMEMory:STORe:SCReen:THEMe TDColor TDMonochrome FCOLor FMONochrome :MMEMory:STORe:SCReen:THEMe?
Example	:MMEM:STOR:SCR:THEM TDM
Preset	3D Color; Is not part of Preset, but is reset by Restore Misc Defaults or Restore System Defaults All and survives subsequent running of the modes.
Readback	3D Color 3D Mono Flat Color Flat Mono
Backwards Compatibility Notes	In ESA and PSA we offer the choice of "Reverse Bitmap" or "Reverse Metafile" when saving screen images. This is much like the "Flat Color" theme available in X-Series. Also, if you selected Reverse Bitmap AND a black & white screen image, that would be much like "Flat Monochrome". In other words, each of the X-Series themes has a similar screen image type in ESA/PSA. But they are not identical.
Initial S/W Revision	Prior to A.02.00

3D Color

Selects a standard color theme with each object filled, shaded and colored as designed.

Key Path	Save, Screen Image, Themes
Example	MMEM:STOR:SCR:THEM TDC
Readback	3D Color
Initial S/W Revision	Prior to A.02.00

3D Monochrome

Selects a format that is like 3D color but shades of gray are used instead of colors.

Key Path	Save, Screen Image, Themes
Example	MMEM:STOR:SCR:THEM TDM
Readback	3D Mono
Initial S/W Revision	Prior to A.02.00

Flat Color

Selects a format that is best when the screen is to be printed on an ink printer.

Key Path	Save, Screen Image, Themes
Example	MMEM:STOR:SCR:THEM FCOL
Readback	Flat Color
Initial S/W Revision	Prior to A.02.00

Flat Monochrome

Selects a format that is like Flat Color. But only black is used (no colors, not even gray), and no fill.

Key Path	Save, Screen Image, Themes
Example	MMEM:STOR:SCR:THEM FMON
Readback	Flat Mono
Initial S/W Revision	Prior to A.02.00

Backlight

Accesses the display backlight on/off keys. This setting may interact with settings under the Windows "Power" menu.

When the backlight is off, pressing ESC, TAB, SPACE, ENTER, UP, DOWN, LEFT, RIGHT, DEL, BKSP, CTRL, or ALT turns the backlight on without affecting the application. Pressing any other key will turn backlight on and could potentially perform the action as well.

Key Path	View/Display, Display, System Display Settings
Remote Command	:DISPlay:BACKlight ON OFF :DISPlay:BACKlight?
Preset	ON (Set by Restore Misc Defaults)
Initial S/W Revision	Prior to A.02.00

Backlight Intensity

An active function used to set the backlight intensity. It goes from 0 to 100 where 100 is full on and 0 is off. This value is independent of the values set under the Backlight on/off key.

Key Path	View/Display, Display, System Display Settings
Remote Command	:DISPlay:BACKlight:INTensity <integer> :DISPlay:BACKlight:INTensity?
Example	DISP:BACK:INT 50
Preset	100 (Set by Restore Misc Defaults)
Min	0
Max	100
Initial S/W Revision	Prior to A.02.00

Abs Pwr Freq

Sets the display to the Absolute Peak Power and Frequency view. The views differ depending on the setting of the measurement type (Meas Type) under the Measurement Setup menu.

"Abs Peak Pwr & Freq (Total Pwr Ref)" on page 1474

"Abs Peak Pwr & Freq (PSD Ref)" on page 1476

"Abs Peak Pwr & Freq (Spectrum Pk Ref)" on page 1478

Abs Peak Pwr & Freq (Total Pwr Ref)

This view consists of the following two windows:

"Trace Window" on page 1476

"Results Window " on page 1476

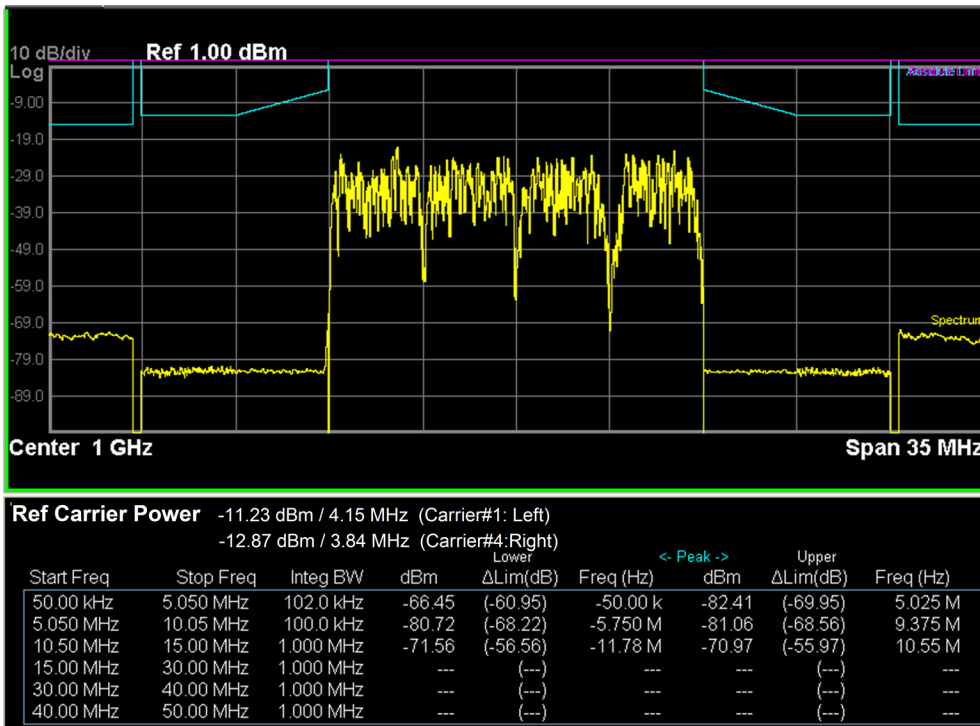
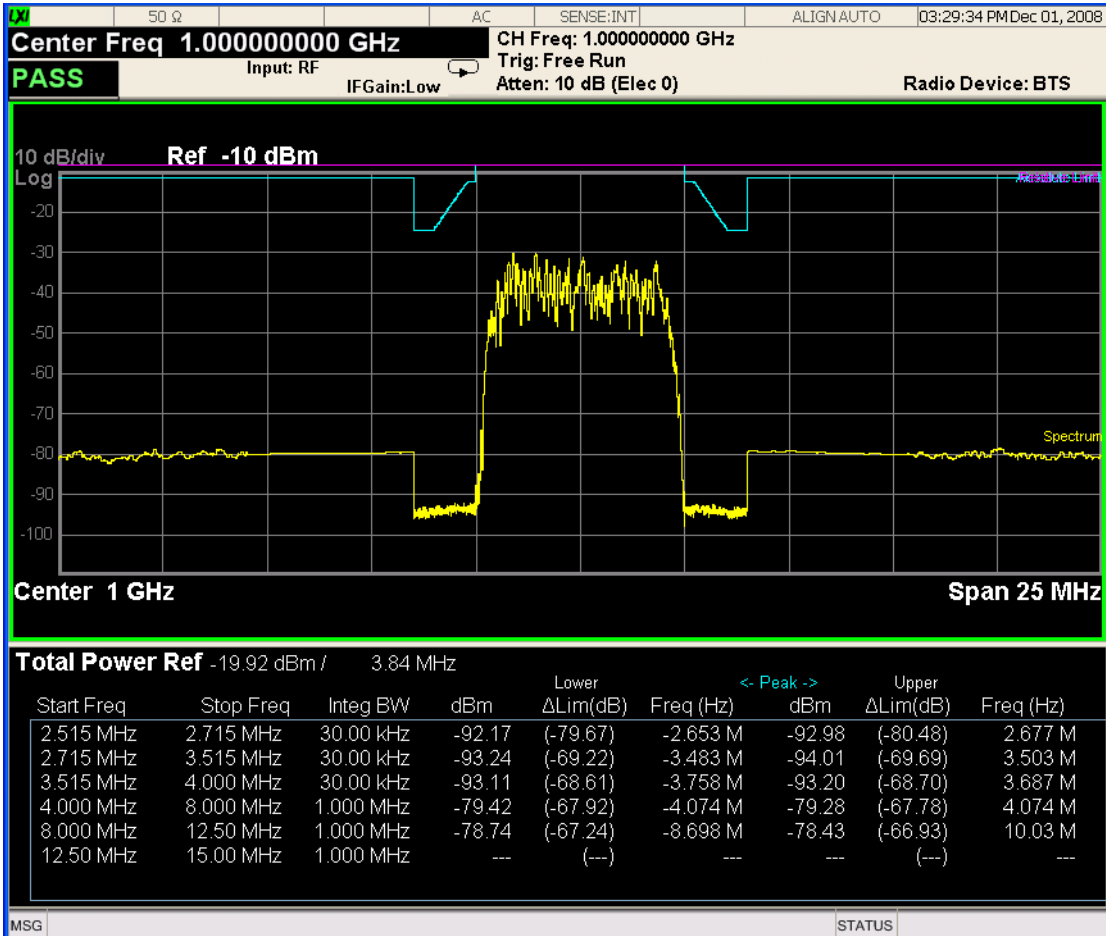

Trace Window

Corresponding Trace	yellow - Combined trace from carrier and each offset
---------------------	--

Results Window

Name	Corresponding Results
Total Pwr Ref	n=1 2nd element Absolute power at the reference area. Channel Integration Bandwidth
Start (Hz)	Start frequency for offset
Stop (Hz)	Stop frequency for offset
Meas BW (Hz)	Measurement bandwidth for offset
Lower Peak (dBm)	Absolute peak power on minimum margin point of the negative offset
Lower Δ lim (dB)	Minimum margin from limit line which is decided by Fail Mask setting on the negative offset
Lower Freq (Hz)	Frequency on minimum margin point of the negative offset
Upper Peak (dBm)	Absolute peak power on minimum margin point of the positive offset
Upper Δ lim (dB)	Minimum margin from limit line which is decided by Fail Mask setting on the positive offset
Upper Freq (Hz)	Frequency on minimum margin point of the positive offset

Abs Peak Pwr & Freq (PSD Ref)

This view consists of the following two windows:

["Trace Window" on page 1478](#)

["Results Window " on page 1478](#)

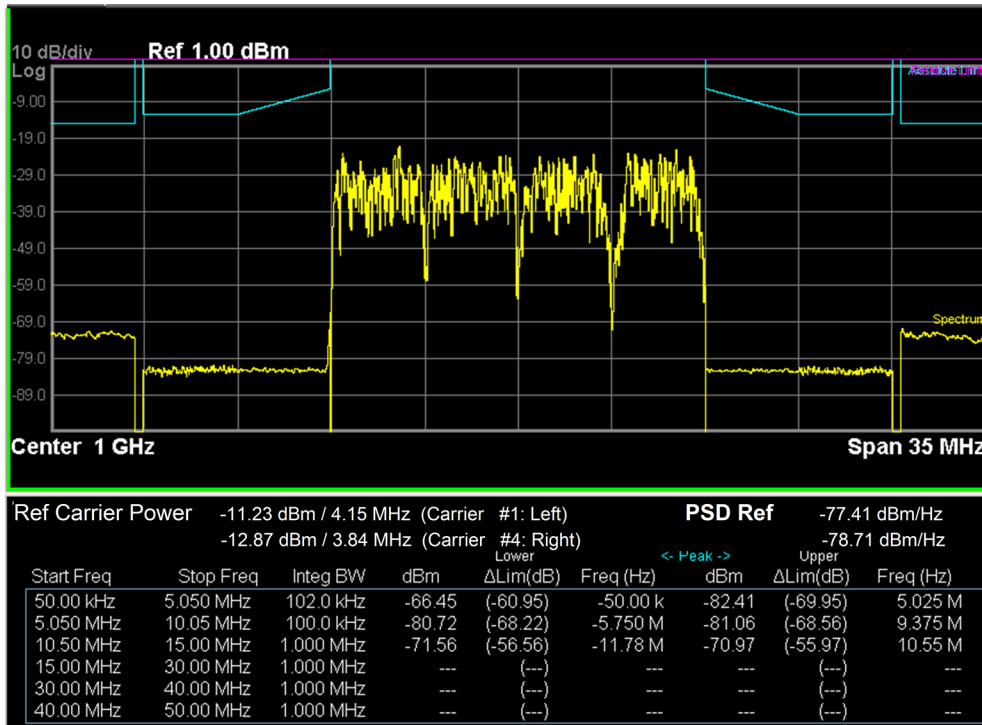
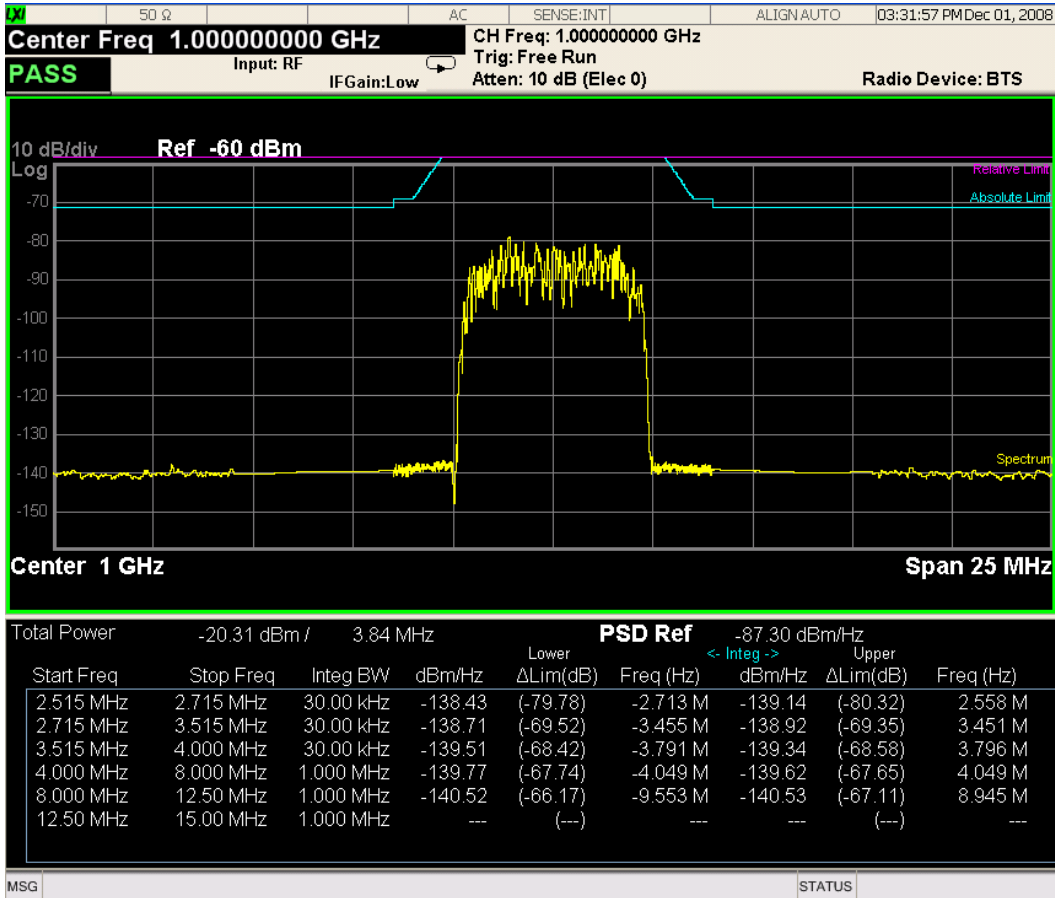

Trace Window

Corresponding Trace	yellow - Combined trace from carrier and each offset
---------------------	--

Results Window

Name	Corresponding Results
Total Pwr	n=1 2nd element Absolute power at the reference area. Channel Integration Bandwidth
PSD Ref	n=5 1st element Power spectral density reference at the reference area
Start (Hz)	Start frequency for offset
Stop (Hz)	Stop frequency for offset
Meas BW (Hz)	Measurement bandwidth for offset
Lower (dBm/Hz)	Absolute power spectrum density of the negative offset
Lower Δ lim (dB)	Minimum margin from limit line which is decided by Fail Mask setting on the negative offset
Lower Freq (Hz)	Frequency on minimum margin point of the negative offset
Upper (dBm/Hz)	Absolute power spectrum density of the positive offset
Upper Δ lim (dB)	Minimum margin from limit line which is decided by Fail Mask setting on the positive offset
Upper Freq (Hz)	Frequency on minimum margin point of the positive offset

Abs Peak Pwr & Freq (Spectrum Pk Ref)

This view consists of the following two windows:

["Trace Window" on page 1478](#)

["Results Window " on page 1478](#)

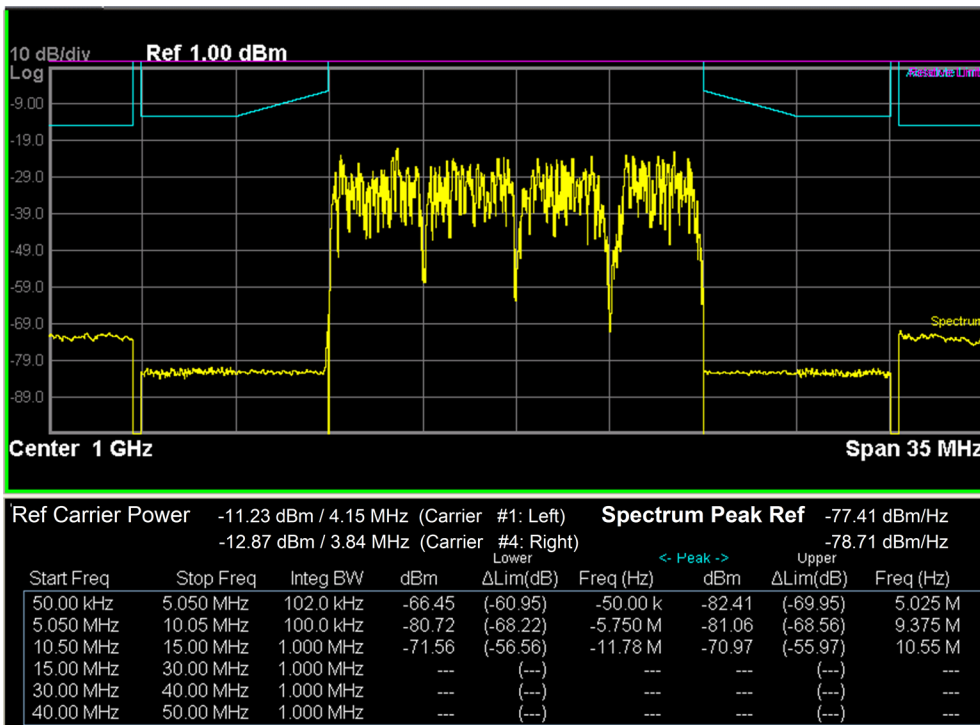
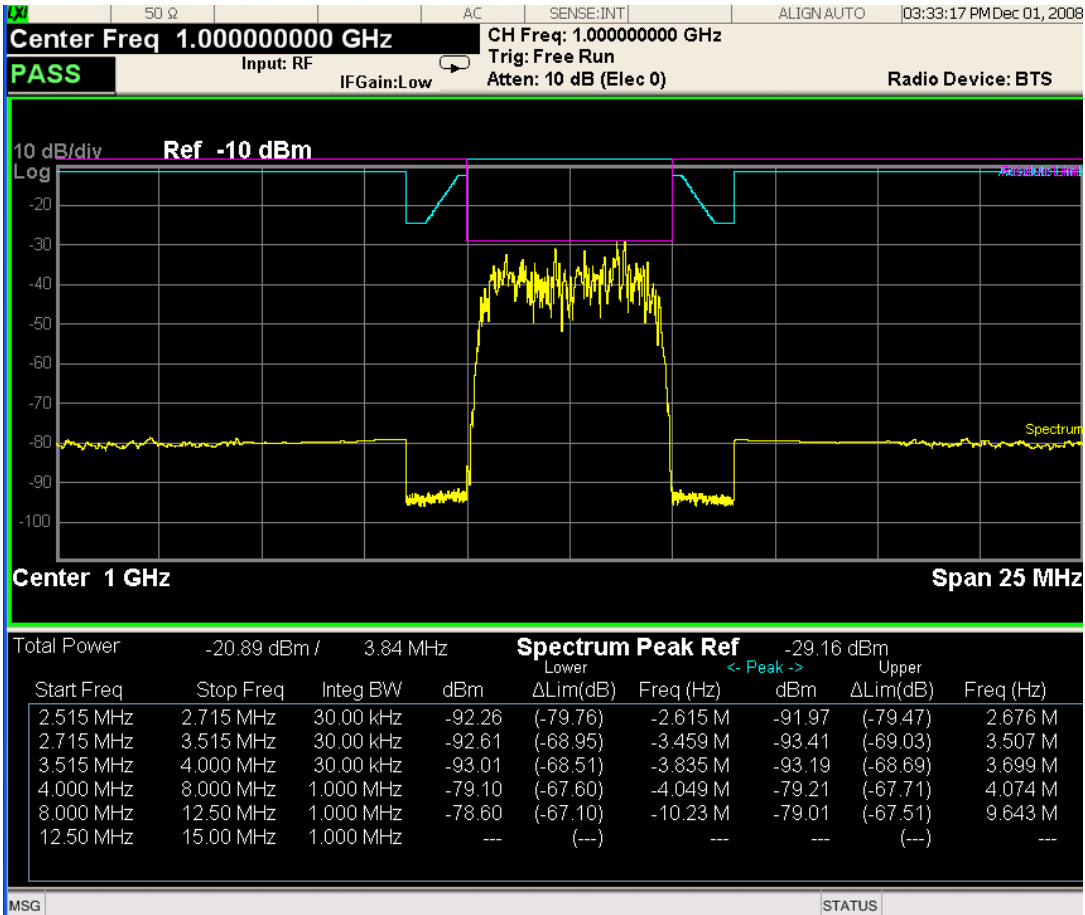

Trace Window

Corresponding Trace	yellow - Combined trace from carrier and each offset
---------------------	--

Results Window

Name	Corresponding Results
Total Pwr	Absolute power at the reference area. Channel Integration Bandwidth
Spectrum Peak Ref	n=5 1st element Spectrum peak power reference at the reference area
Start (Hz)	Start frequency for offset
Stop (Hz)	Stop frequency for offset
Meas BW (Hz)	Measurement bandwidth for offset
Lower(dBm)	Absolute peak power on minimum margin point of the negative offset
Lower Δ lim (dB)	Minimum margin from limit line which is decided by Fail Mask setting on the negative offset
Lower Freq (Hz)	Frequency on minimum margin point of the negative offset
Upper (dBm)	Absolute peak power on minimum margin point of the positive offset
Upper Δ lim (dB)	Minimum margin from limit line which is decided by Fail Mask setting on the positive offset
Upper Freq (Hz)	Frequency on minimum margin point of the positive offset

Key Path	View/Display
Initial S/W Revision	Prior to A.02.00

Rel Pwr Freq

Sets the display to the Relative Peak Power and Frequency view. The views differ depending on the setting of the measurement type (Meas Type) under the Measurement Setup menu.

"Rel Peak Pwr & Freq (Total Pwr Ref)" on page 1480

"Rel Peak Pwr & Freq (PSD Ref)" on page 1482

"Rel Peak Pwr & Freq (Spectrum Pk Ref)" on page 1483

Rel Peak Pwr & Freq (Total Pwr Ref)

This view consists of the following two windows:

"Trace Window" on page 1481

"Results Window" on page 1481

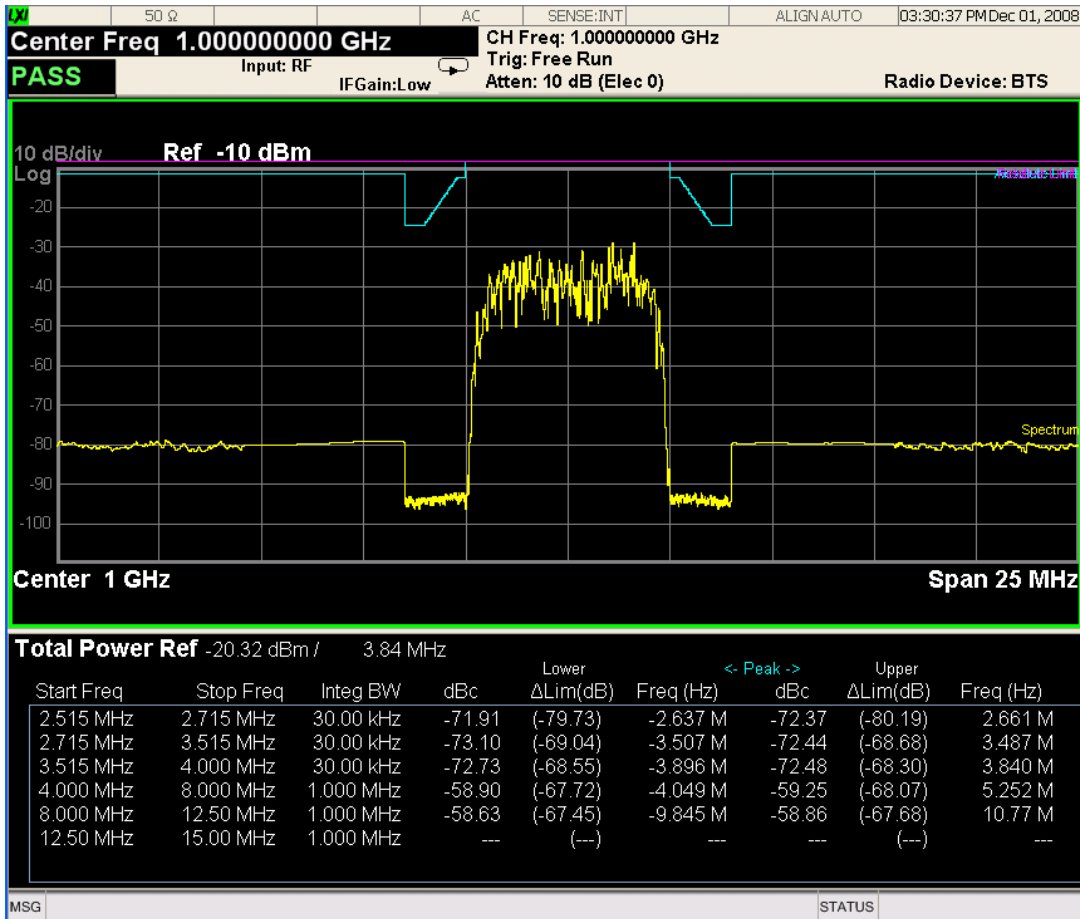

Trace Window

Corresponding Trace	yellow - Combined trace from carrier and each offset
---------------------	--

Results Window

Name	Corresponding Results
Total Pwr Ref	n=1 2nd element Absolute power at the reference area.
	Channel Integration Bandwidth
Start (Hz)	Start frequency for offset
Stop (Hz)	Stop frequency for offset
Meas BW (Hz)	Measurement bandwidth for offset
Lower Peak (dBc)	Relative peak power on minimum margin point of the negative offset
Lower ΔLim (dB)	Minimum margin from limit line which is decided by Fail Mask setting on the negative offset

Name	Corresponding Results
Lower Freq (Hz)	Frequency on minimum margin point of the negative offset
Upper Peak (dBc)	Relative peak power on minimum margin point of the positive offset
Upper ΔLim (dB)	Minimum margin from limit line which is decided by Fail Mask setting on the positive offset
Upper Freq (Hz)	Frequency on minimum margin point of the positive offset

Rel Peak Pwr & Freq (PSD Ref)

This view consists of the following two windows:

"Trace Window" on page 1482

"Results Window" on page 1483

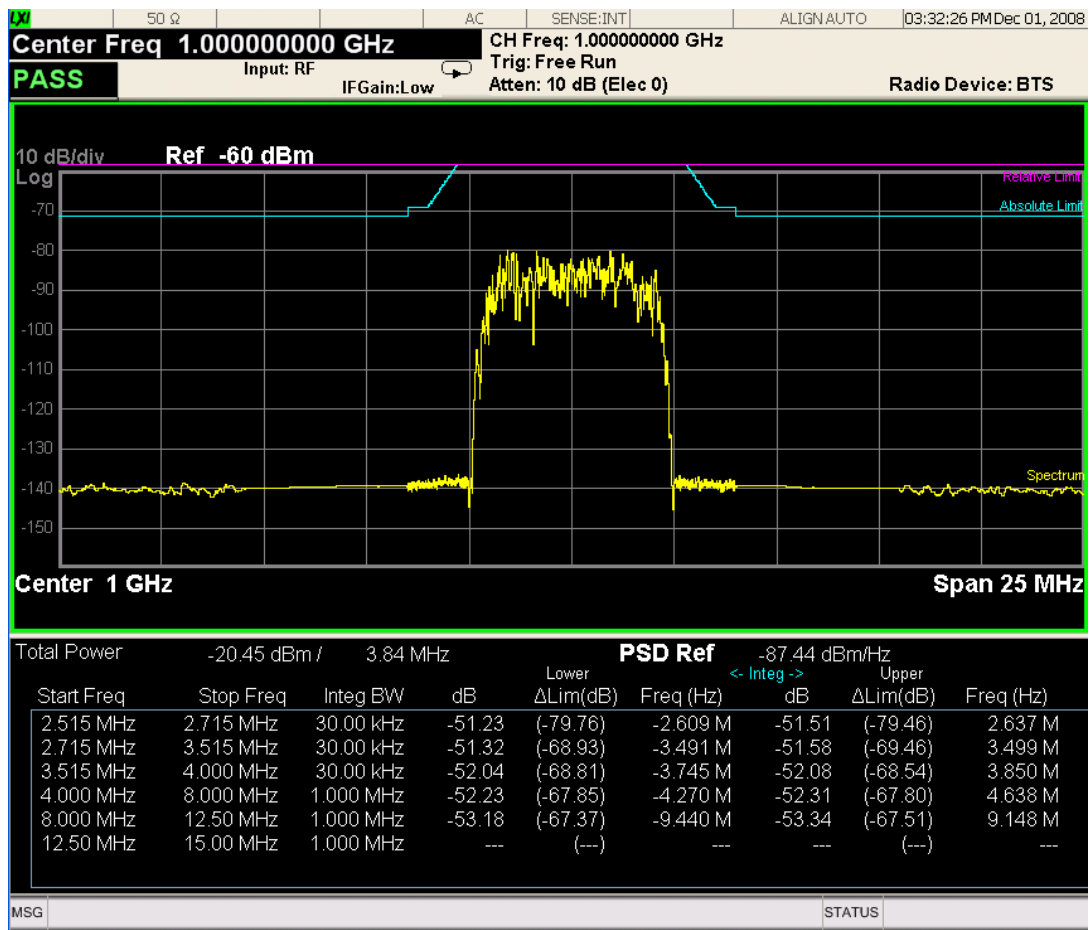

Trace Window

Corresponding Trace yellow - Combined trace from carrier and each offset

Results Window

Name	Corresponding Results
Total Pwr	n=1 2nd element Absolute power at the reference area.
	Channel Integration Bandwidth
PSD Ref	n=5 1st element Power spectral density reference at the reference area
Start (Hz)	Start frequency for offset
Stop (Hz)	Stop frequency for offset
Meas BW (Hz)	Measurement bandwidth for offset
Lower (dB)	Relative power spectrum density of the negative offset
Lower ΔLim (dB)	Minimum margin from limit line which is decided by Fail Mask setting on the negative offset
Lower Freq (Hz)	Frequency on minimum margin point of the negative offset
Upper (dB)	Relative power spectrum density of the positive offset
Upper ΔLim (dB)	Minimum margin from limit line which is decided by Fail Mask setting on the positive offset
Upper Freq (Hz)	Frequency on minimum margin point of the positive offset

Rel Peak Pwr & Freq (Spectrum Pk Ref)

This view consists of the following two windows:

"Trace Window" on page 1481

"Results Window" on page 1481

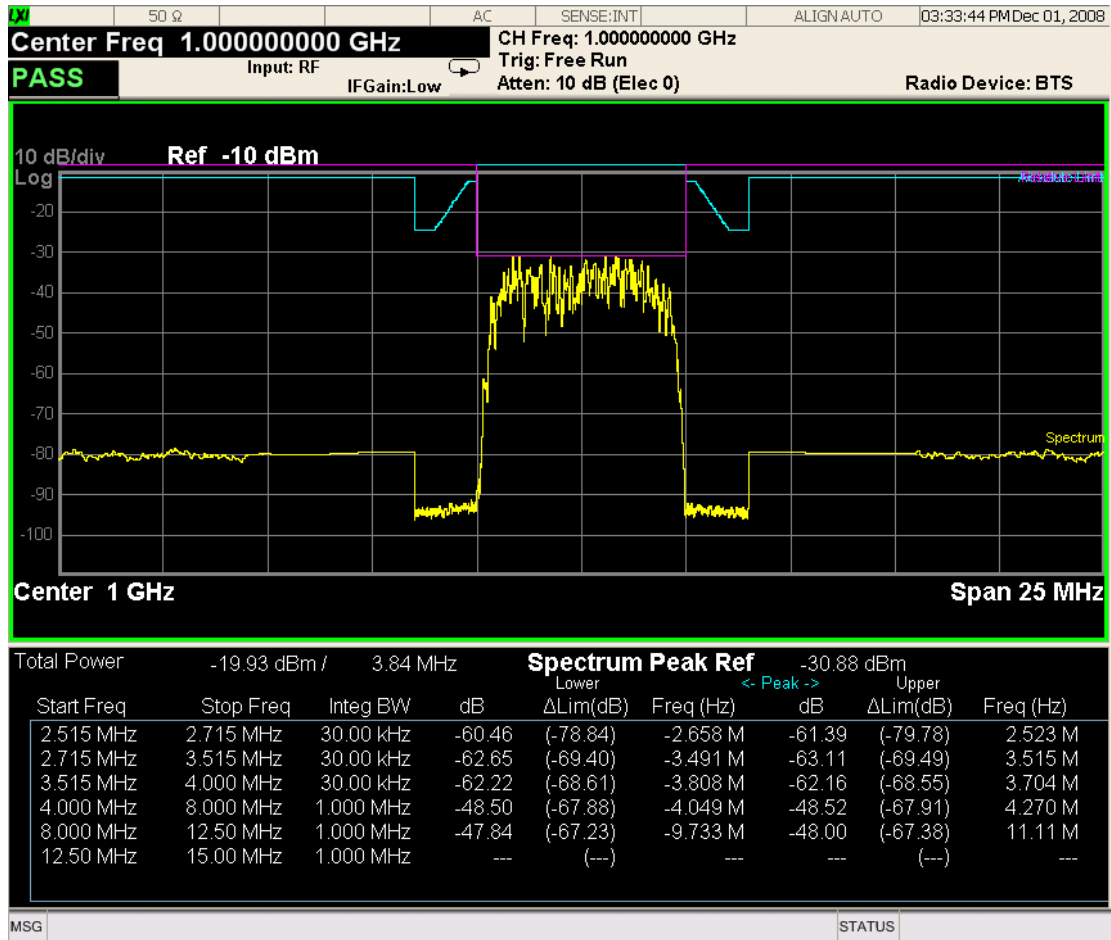

Trace Window

Corresponding Trace	yellow - Combined trace from carrier and each offset
---------------------	--

Results Window

Name	Corresponding Results
Total Pwr	Absolute power at the reference area.
	Channel Integration Bandwidth
Spectrum Peak Ref	n=5 1st element Spectrum peak power reference at the reference area
Start (Hz)	Start frequency for offset
Stop (Hz)	Stop frequency for offset
Meas BW (Hz)	Measurement bandwidth for offset
Lower Peak (dB)	Relative peak power on minimum margin point of the negative offset
Lower ΔLim (dB)	Minimum margin from limit line which is decided by Fail Mask setting

Name	Corresponding Results
	on the negative offset
Lower Freq (Hz)	Frequency on minimum margin point of the negative offset
Upper Peak (dB)	Relative peak power on minimum margin point of the positive offset
Upper ΔLim (dB)	Minimum margin from limit line which is decided by Fail Mask setting on the positive offset
Upper Freq (Hz)	Frequency on minimum margin point of the positive offset

Key Path	View/Display
Initial S/W Revision	Prior to A.02.00

Integrated Power

Sets the display to the Integrated Power view. The views differ depending on the setting of the measurement type (Meas Type) under the Measurement Setup menu.

"Integrated Power (Total Pwr Ref)" on page 1485

"Integrated Power (PSD Ref)" on page 1488

"Integrated Power (Spectrum Pk Ref)" on page 1490

Integrated Power (Total Pwr Ref)

"Trace Window" on page 1487

"Results Window" on page 1487

11 Spectrum Emission Mask Measurement
View/Display

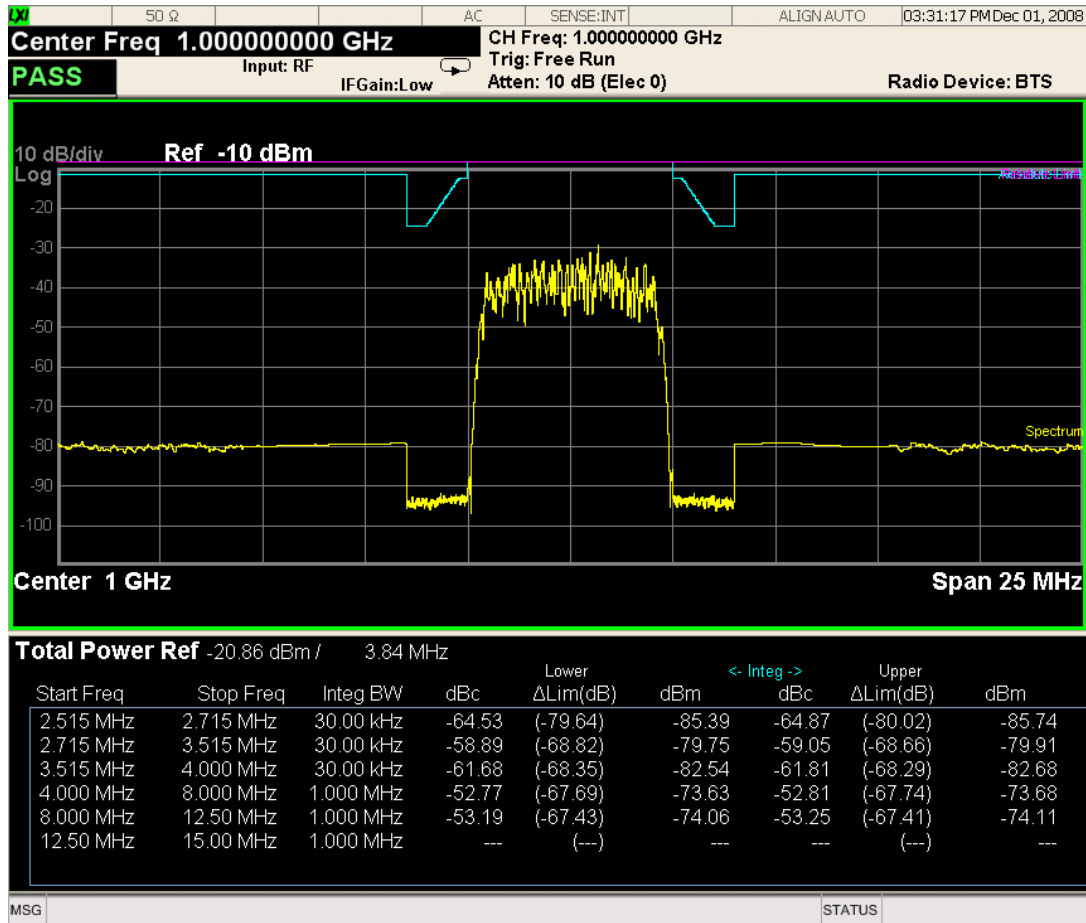

For WLAN 802.11ac (80 + 80 MHz), power readouts of both of the carriers are displayed in the lower result window.

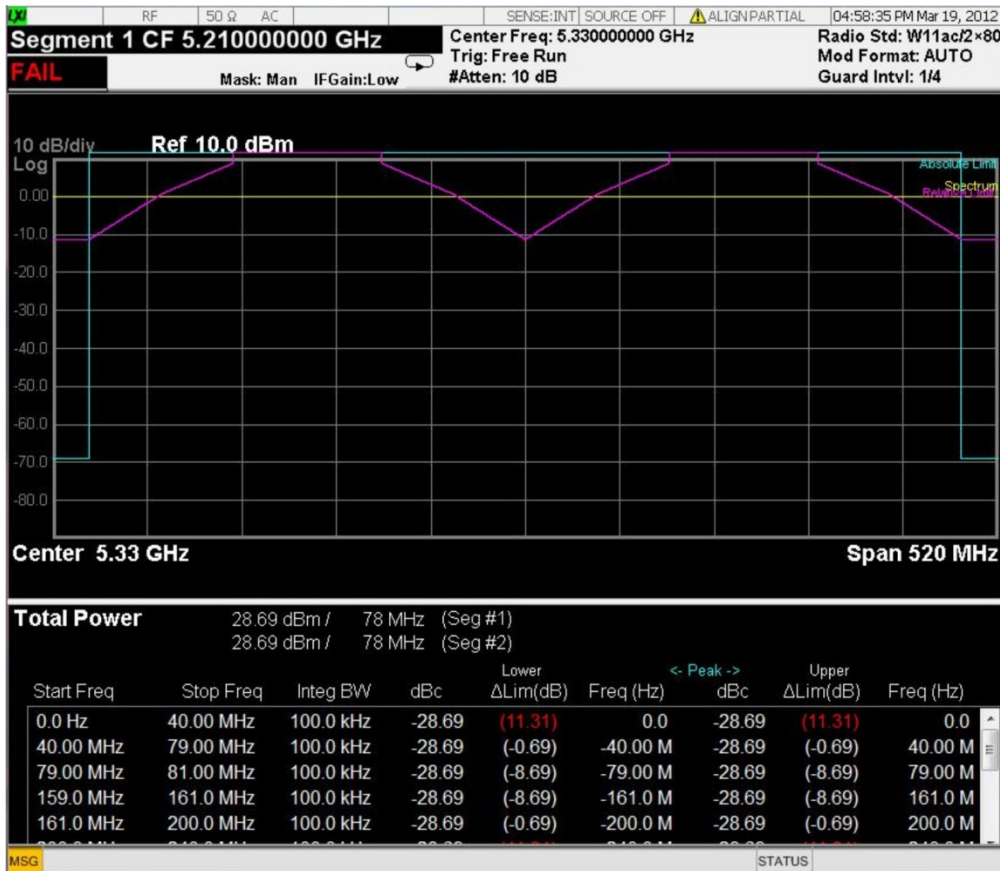

Trace Window

Corresponding Trace	yellow - Combined trace from carrier and each offset
---------------------	--

Results Window

Name	Corresponding Results
Total Pwr Ref	n=1 2nd element Absolute power at the reference area.
	Channel Integration Bandwidth
Start (Hz)	Start frequency for offset
Stop (Hz)	Stop frequency for offset
Meas BW (Hz)	Measurement bandwidth for offset
Lower Integ (dBc)	Relative integrated power on the negative offset
Lower ΔLim (dB)	Minimum margin from limit line which is decided by Fail Mask setting on the negative offset
Lower Integ (dBm)	Absolute integrated power on the negative offset

Name	Corresponding Results
Upper Integ (dBc)	Relative integrated power on the positive offset
Upper ΔLim (dB)	Minimum margin from limit line which is decided by Fail Mask setting on the positive offset
Upper Integ (dBm)	Absolute integrated power on the positive offset

Integrated Power (PSD Ref)

"Trace Window" on page 1489

"Results Window" on page 1489

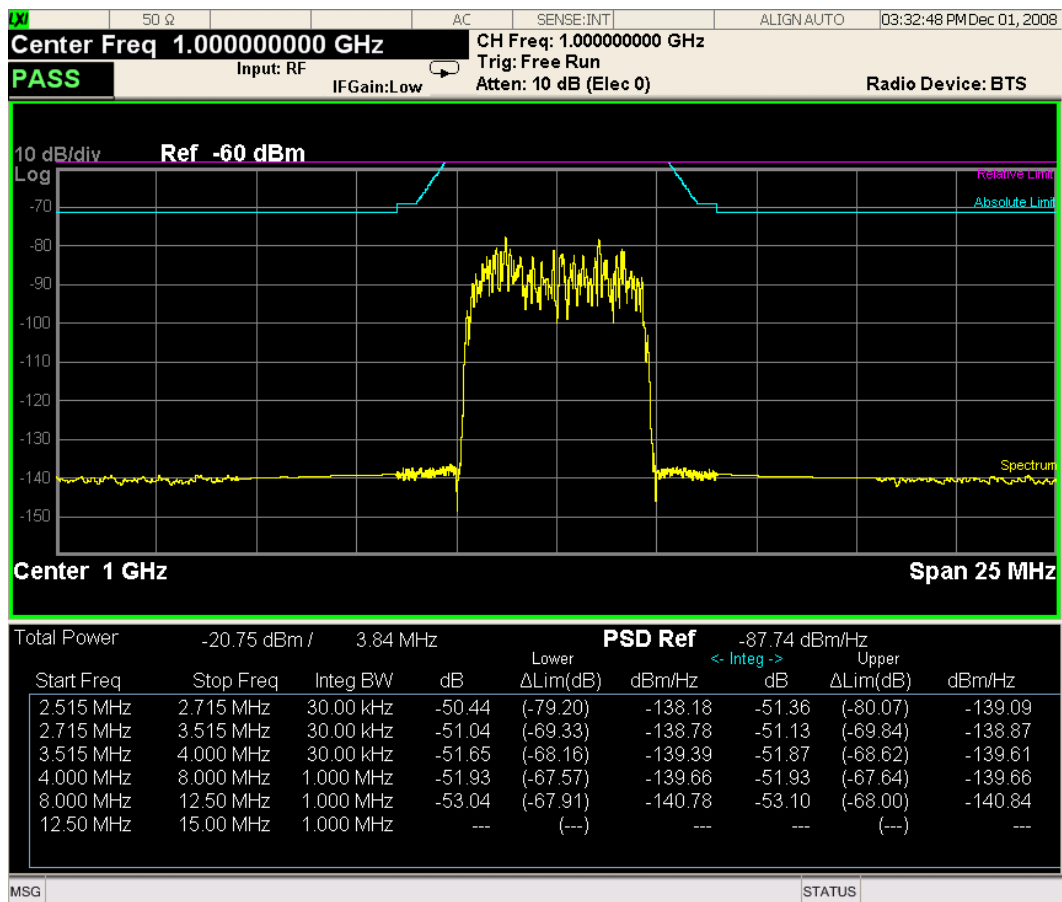

For WLAN 802.11ac (80 + 80 MHz), power readouts of both of the carriers are displayed in the lower result window.

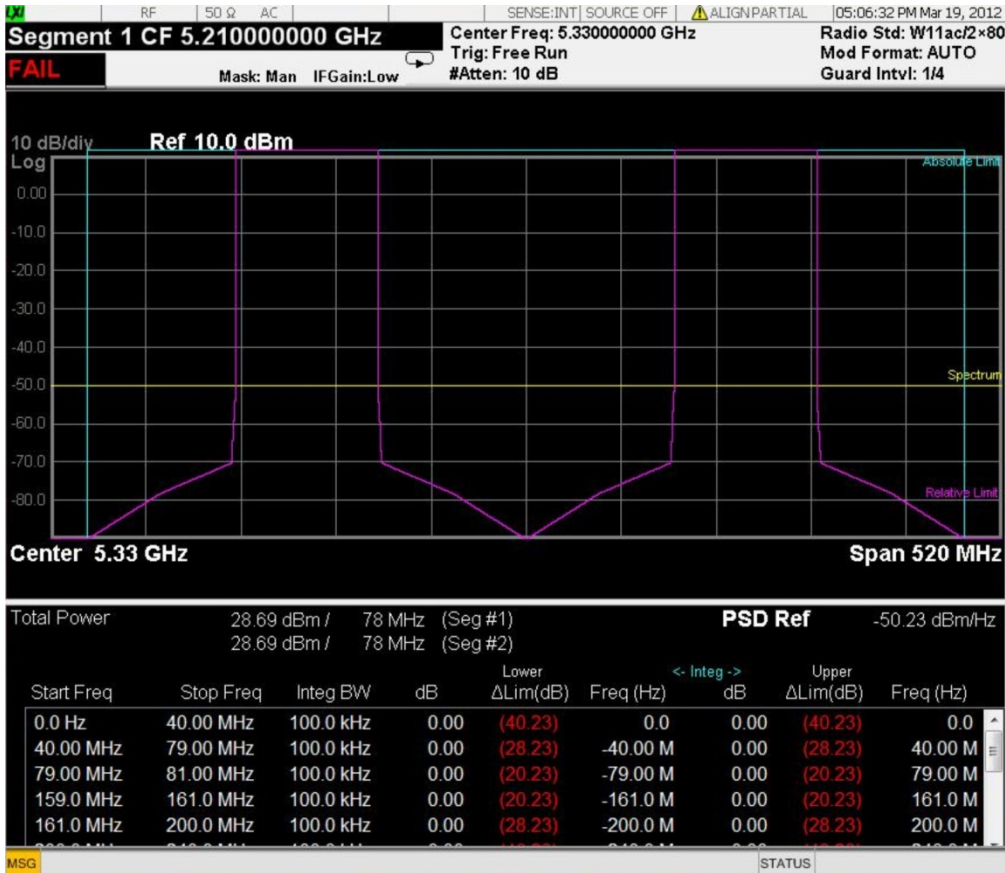

Trace Window

Corresponding Trace	yellow - Combined trace from carrier and each offset
---------------------	--

Results Window

Name	Corresponding Results
Total Pwr	n=1 2nd element Absolute power at the reference area.
PSD Ref	n=5 1st element Power spectral density reference at the reference area
Start (Hz)	Start frequency for offset
Stop (Hz)	Stop frequency for offset
Meas BW (Hz)	Measurement bandwidth for offset
Lower (dB)	Relative power spectrum density of the negative offset
Lower ΔLim (dB)	Minimum margin from limit line which is decided by Fail Mask setting on the negative offset

Name	Corresponding Results
Lower (dBm/Hz)	Absolute power spectrum density of the negative offset
Upper (dB)	Relative power spectrum density of the positive offset
Upper ΔLim (dB)	Minimum margin from limit line which is decided by Fail Mask setting on the positive offset
Upper (dBm/Hz)	Absolute power spectrum density of the negative offset

Integrated Power (Spectrum Pk Ref)

"Trace Window" on page 1487

"Results Window" on page 1487

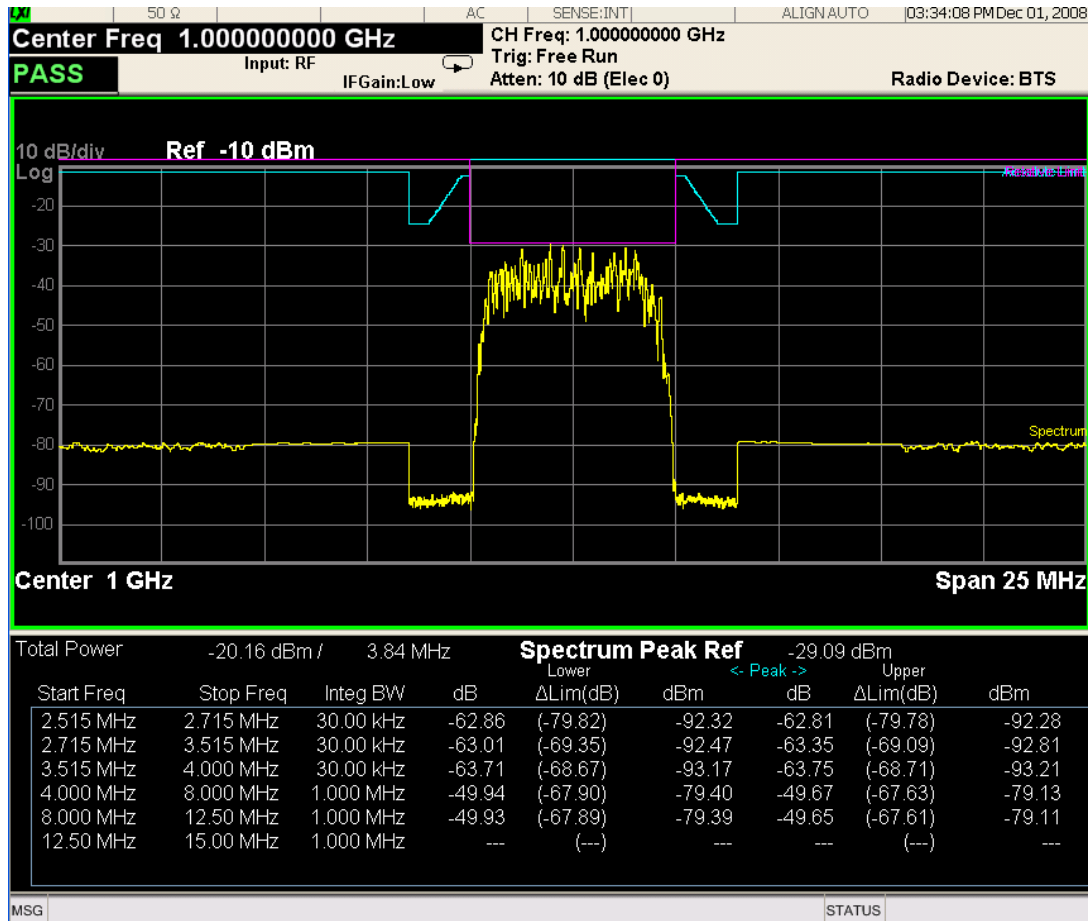

For WLAN 802.11ac (80 + 80 MHz), power readouts of both of the carriers are displayed in the lower result window.

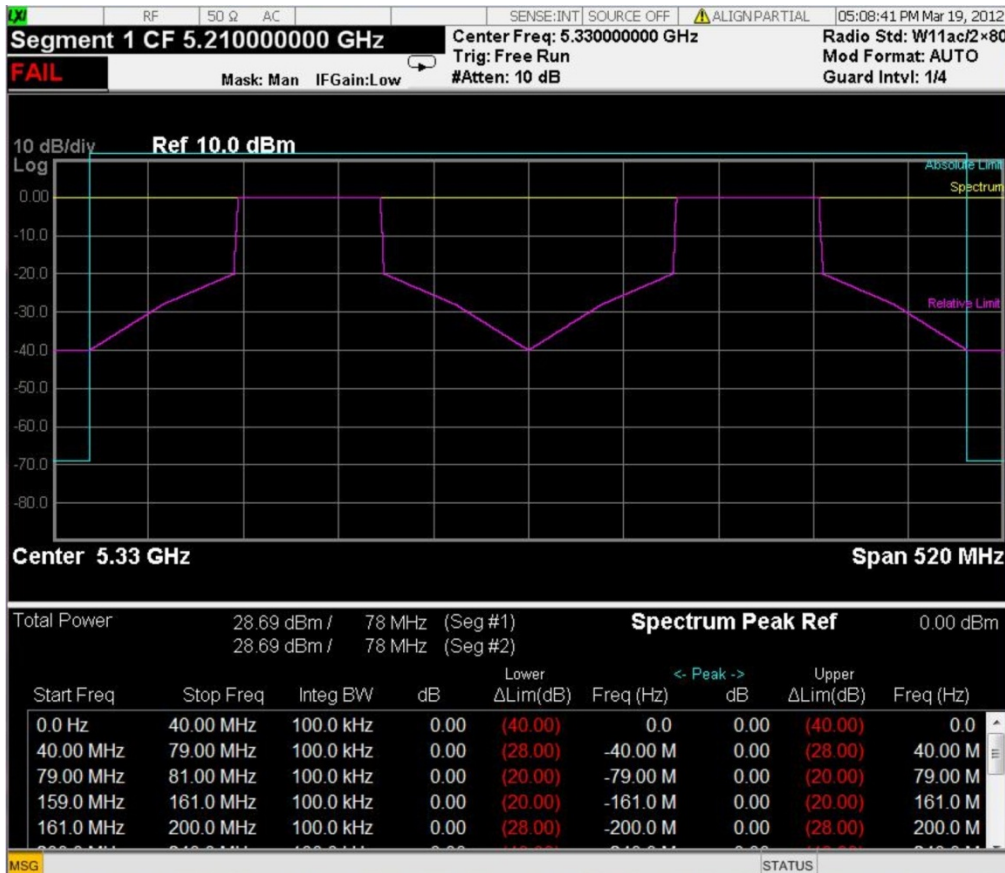

Trace Window

Corresponding Trace	yellow - Combined trace from carrier and each offset
---------------------	--

Results Window

Name	Corresponding Results
Total Pwr	Absolute power at the reference area.
	Channel Integration Bandwidth
Spectrum Peak Ref	n=5 1st element
	Peak power at the reference area
Start (Hz)	Start frequency for offset
Stop (Hz)	Stop frequency for offset
Meas BW (Hz)	Measurement bandwidth for offset
Lower Peak (dB)	Relative peak power on minimum margin point of the negative offset
Lower Δlim (dB)	Minimum margin from limit line which is decided by Fail Mask setting on the negative offset

Name	Corresponding Results
Lower Peak (dBm)	Absolute peak power on minimum margin point of the negative offset
Upper Peak (dB)	Relative peak power on minimum margin point of the positive offset
Upper Δlim (dB)	Minimum margin from limit line which is decided by Fail Mask setting on the positive offset
Upper Peak (dBm)	Absolute peak power on minimum margin point of the positive offset

Key Path	View/Display
Initial S/W Revision	Prior to A.02.00

Carrier Info (MSR and LTE-Advanced FDD/TDD Only)

Sets the display to the Carrier Info view. The lower window is the carrier info table in this view.

Carrier center frequency can be displayed in either offset or absolute frequency depending on Carrier Freq. The table can be scrolled by Carrier Result on Meas Setup menu or by Select Carrier on Config Carriers menu. The highlighted row changes as either Carrier Result or Select Carrier is changed. The highlighted row and these keys are not coupled.

LTE-Advanced FDD/TDD has the different carrier info table from that in MSR in this view, which displays with measured component carrier powers and its power spectral density in the order of component carrier index in one of the view windows.

Carrier Info Table View (Total Power)

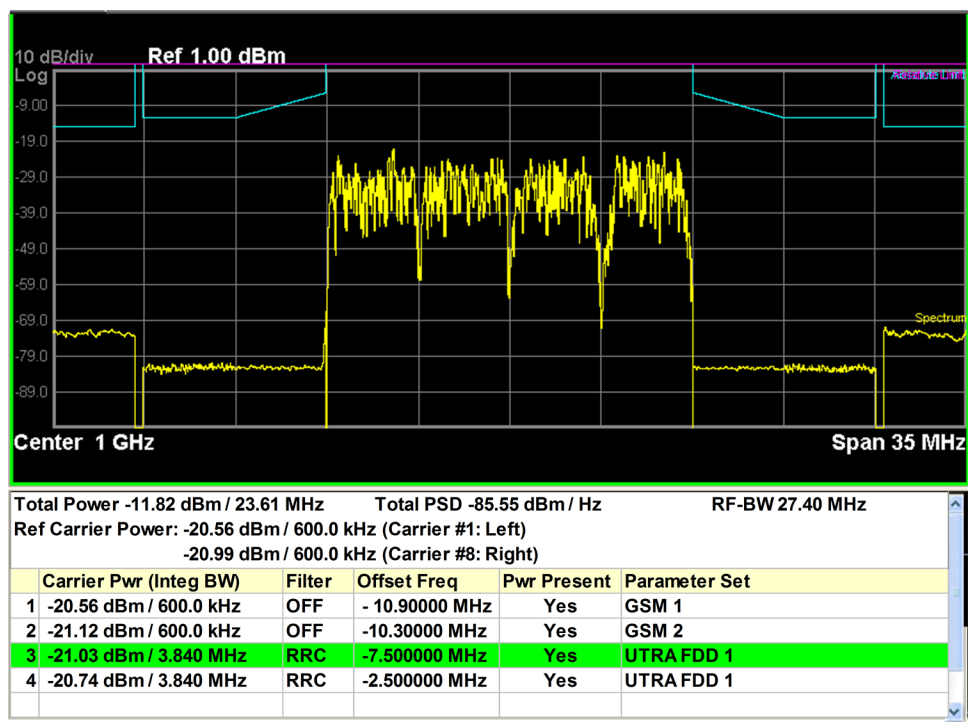

Carrier Info Table (PSD)

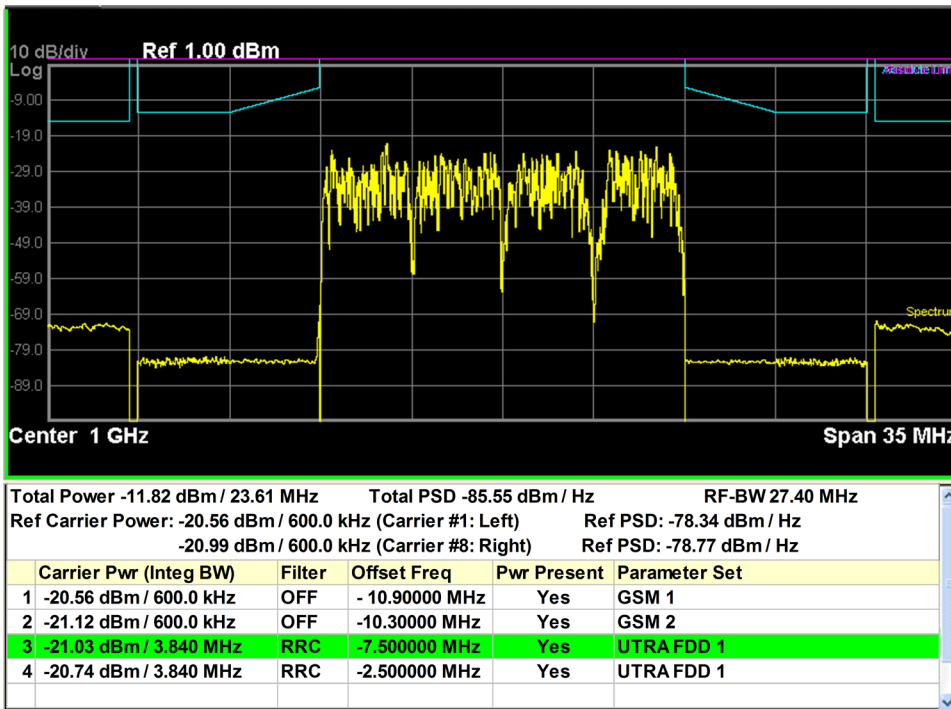

Carrier Info Table (Spectrum Pk)

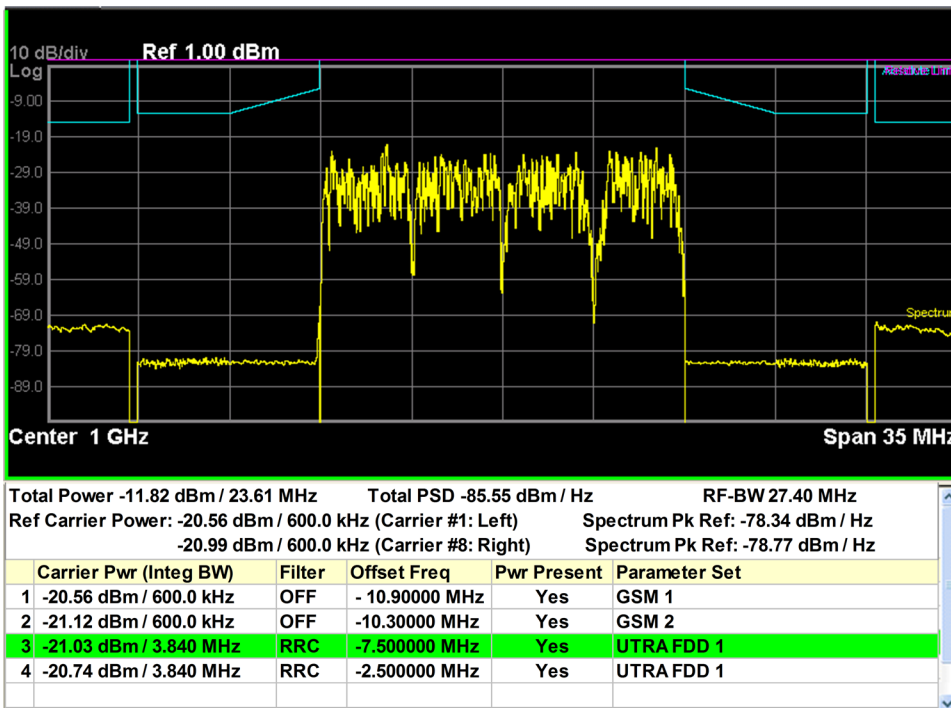

Key Path View/Display

Initial S/W Revision A.10.00

Carrier Freq (MSR and LTE-Advanced FDD/TDDOnly)

Sets the carrier frequency display type.

- Offset – The carrier center frequencies are displayed as offset from Carrier Ref Freq.
- Absolute – The carrier center frequencies are displayed as absolute frequency.

Key Path	View/Display, Carrier Info
Mode	MSR, LTEAFDD, LTEATDD
Remote Command	:DISPlay:SEMask:VIEW[1]:WINDow[1]:CINFormation:FREQuency OFFSet ABSolute :DISPlay:SEMask:VIEW[1]:WINDow[1]:CINFormation:FREQuency?
Example	DISP:SEM:VIEW:WIND:CINF:FREQ ABS DISP:SEM:VIEW:WIND:CINF:FREQ?
Preset	OFFSet
State Saved	Saved in instrument state
Range	Offset Absolute
Initial S/W Revision	A.10.00

Limit Lines

Toggles the limit lines display function for the spectrum emission mask measurements On and Off.

Key Path	View/Display
Mode	SA, WCDMA, C2K, WIMAX OFDMA, TD-SCDMA, 1xEVDO, DTMB (CTTB), DVB-T/H, ISDB-T, CMMB, LTE, LTE-TDD, Digital Cable TV, WLAN, MSR, LTEAFDD, LTEATDD
Remote Command	:CALCulate:SEMask:LLINe:STATe ON OFF 1 0 :CALCulate:SEMask:LLINe:STATe?
Example	CALC:SEM:LLIN:STAT OFF CALC:SEM:LLIN:STAT?
Notes	You must be in the mode that includes SEM measurement to use this command. Use :INSTrument:SElect to set the mode.
Preset	ON
State Saved	Saved in instrument state.
Range	On Off
Initial S/W Revision	Prior to A.02.00
Modified at S/W Revision	A.02.00, A.03.00

12 Spurious Emissions Measurement

The Spurious Emissions measurement identifies and determines the power level of spurious emissions in certain frequency bands. For measurement results and views, see ["View/Display" on page 1706](#).

This topic contains the following sections:

["Measurement Commands for Spurious Emissions" on page 1496](#)

["Remote Command Results for Spurious Emissions Measurement" on page 1497](#)

Measurement Commands for Spurious Emissions

The following commands can be used to retrieve the measurement results:

`:CONFigure:SPURious`

`:CONFigure:SPURious:NDEFault`

`:INITiate:SPURious`

`:FETCh:SPURious [n]?`

`:READ:SPURious [n]?`

`:MEASure:SPURious [n]?`

For more measurement related commands, see the SENSE subsystem, and the section "[Remote Measurement Functions](#)" on page 2381.

Remote Command Results for Spurious Emissions Measurement

The following table describes the results returned by the FETCh, MEASure, and READ queries listed above, according to the index value n. Note that the queries are not available when viewing the Range Table.

n	Return Value
1 (or not supplied)	Returns a variable-length (1+6*Spurs – up to 1201 entries) comma separated list containing detailed information in the following format: 1. Number of spurs in following list (Integer) 2.[Repeat the following for each spur] a.Spur # b.Range # Spur was located (Integer) c.Frequency of Spur (Hz, Float64) d.Amplitude of Spur (dBm, Float32) e.Absolute Limit (dBm, Float32) f.Pass or Fail (1 0, Boolean)
2 – 21	Returns a comma separated list of the trace data for the selected range (where range number = n – 1) using Detector 1. If selected range is not active SCPI_NAN is returned for each trace data element where SCPI_NAN = 9.91E37.
22	Returns the number of spurs found.
23 – 42	Returns a comma separated list of the trace data for the selected range (where range number = n – 22) using Detector 2. If selected range is not active or Detector 2 selection is off, SCPI_NAN is returned for each trace data element where SCPI_NAN = 9.91E37.

Key Path	Meas
Initial S/W Revision	Prior to A.02.00

AMPTD Y Scale

AMPTD Y Scale opens a menu of functions that enable you to modify the Amplitude parameters.

Key Path	Front-panel key
Initial S/W Revision	Prior to A.02.00

Ref Value

Sets the value for the absolute power reference. When Auto Scaling for the Y-axis is off, the measurement uses the current reference level settings. When Auto Scaling for the Y-axis is on, the analyzer will set the reference level such that the absolute limit will be positioned two divisions down from the top of the display.

Key Path	AMPTD Y Scale
Mode	SA, WCDMA, WIMAX OFDMA, TD-SCDMA,C2k, 1xEV-DO, DVB-T/H, LTE, LTETDD, WLAN, MSR, LTEAFDD, LTEATDD
Remote Command	:DISPlay:SPURious:VIEW[1]:WINDow[1]:TRACe:Y[:SCALe]:RLEVel < real> :DISPlay:SPURious:VIEW[1]:WINDow[1]:TRACe:Y[:SCALe]:RLEVel?
Example	DISP:SPUR:VIEW:WIND:TRAC:Y:RLEV -50 dBm DISP:SPUR:VIEW:WIND:TRAC:Y:RLEV?
Notes	You must be in the Spectrum Analysis mode, W-CDMA mode, cdma2000 mode, DVB-T/H mode, TD-SCDMA mode, LTE mode, LTETDD mode, WLAN mode, MSR, LTE-Advanced FDD/TDD mode or WiMAX mode to use this command. Use INSTRument:SElect to set the mode.
Couplings	When the Y Auto Scaling is off, the measurement uses the current reference level settings. When the Y Auto Scaling is on, the analyzer automatically sets the reference level such that the absolute limit is positioned two divisions down from the top of the display. This is the most useful setting when searching for spurs. The algorithm used for determining the ref level is Ref Level = Absolute Limit + (2 * Scale/Div). All other reference level settings are left as the current base instrument settings.
Preset	0.00 dBm
State Saved	Saved in instrument state.
Min	-250.0 dBm
Max	250.0 dBm
Initial S/W Revision	Prior to A.02.00
Modified at S/W Revision	A.03.00

Attenuation

This menu controls the attenuator functions and interactions between the attenuation system components.

There are two attenuator configurations in the X-Series. One is a dual attenuator configuration consisting of a mechanical attenuator and an optional electronic attenuator. The other configuration uses a single

attenuator with combined mechanical and electronic sections that controls all the attenuation functions. Different models in the X-Series come with different configurations.

See ["Dual Attenuator Configurations:" on page 1499](#)

See ["Single Attenuator Configuration:" on page 1500](#)

Most Attenuation settings are the same for all measurements – they do not change as you change measurements. Settings like these are called “Meas Global” and are unaffected by Meas Preset.

Key Path	AMPTD Y Scale
Scope	Meas Global
Dependencies	In measurements that support the I/Q inputs, this key is unavailable when I/Q is the selected input, and is replaced by the Range key in that case.
Readback Line	Contains a summary in [] brackets of the current total attenuation. See the descriptions of the , " (Mech) Atten " on page 2297, and " Enable Elec Atten " on page 2299 keys for more detail on the contributors to the total attenuation. Note that when "Pre-Adjust for Min Clip" is on, this value can change at the start of every measurement.
Initial S/W Revision	Prior to A.02.00
Modified at S/W Revision	A.03.00

Dual Attenuator Configurations:

Configuration 1: Mechanical attenuator + optional electronic attenuator

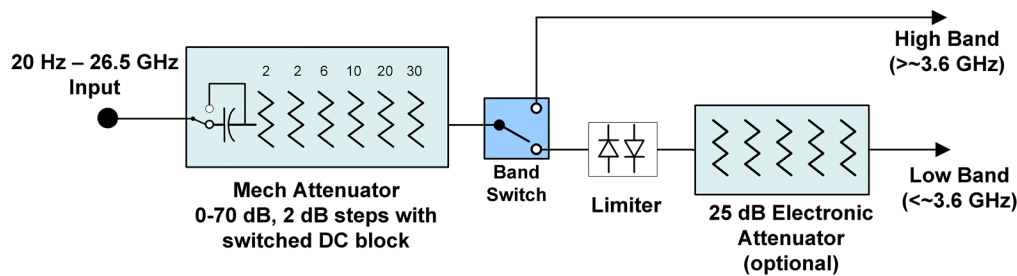

Configuration 2: Mechanical attenuator, no optional electronic attenuator

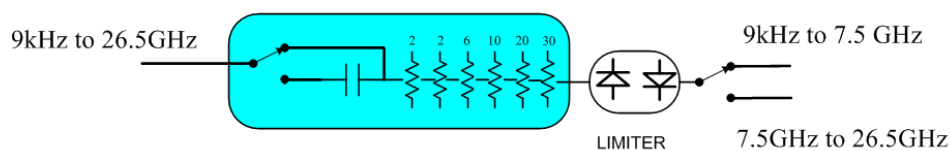

(note that Configuration 2 is not strictly speaking a dual-section attenuator, since there is no electronic section available. However, it behaves exactly like Configuration 1 without the Electronic Attenuator option EA3, therefore for the sake of this document it is grouped into the “Dual Attenuator” configuration)

Single Attenuator Configuration:

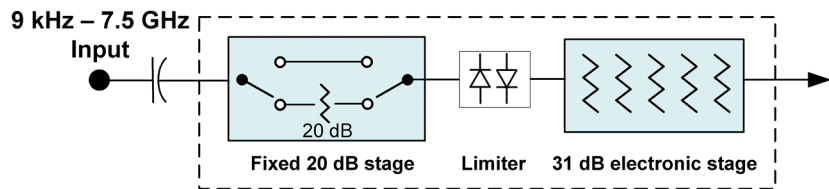

You can tell which attenuator configuration you have by pressing the Attenuation key, which (in most Modes) opens the Attenuation menu. If the first key in the Attenuation menu says **Mech Atten** you have the dual attenuator configuration. If the first key says **Atten** you have the single attenuator configuration.

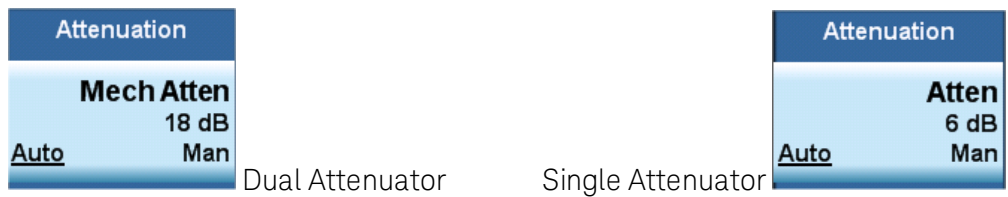

In the single attenuator configuration, you control the attenuation with a single control, as the fixed stage has only two states. In the dual attenuator configuration, both stages have significant range so you are given separate control of the mechanical and electronic attenuator stages.

When you have the dual attenuator configuration, you may still have only a single attenuator, because unless option EA3 (the Electronic Attenuator option) is available, and you purchase it, you will have only the mechanical attenuator.

(Mech) Atten

This key is labeled **Mech Atten** in dual attenuator models and **Atten** in single attenuator models. In the dual attenuator configuration, this key only affects the mechanical attenuator.

This key lets you modify the attenuation applied to the RF input signal path. This value is normally auto coupled to the Ref Level, the Internal Preamp Gain, any External Gain that is entered, and the Max Mixer Level, as described in the table below.

See "[Attenuator Configurations and Auto/Man](#)" on page 1502

Key Path	AMPTD Y Scale, Attenuation
Remote Command	<pre>[:SENSe] : POWer [:RF] : ATTenuation <rel_amp1> [:SENSe] : POWer [:RF] : ATTenuation? [:SENSe] : POWer [:RF] : ATTenuation : AUTO OFF ON 0 1 [:SENSe] : POWer [:RF] : ATTenuation : AUTO?</pre>
Example	<p>POW:ATT 20</p> <p>Dual attenuator configuration: sets the mechanical attenuator to 20 dB</p> <p>Single attenuator mode: sets the main attenuation to 20 dB (see below for definition of “main” attenuation).</p> <p>If the attenuator was in Auto, it sets it to Manual.</p>
Dependencies	Some measurements do not support the Auto setting of (Mech) Atten . In these measurements, the

Auto/Man selection is not available, and the Auto/Man line on the key disappears.

In dual attenuator configurations, when the electronic attenuator is enabled, the mechanical attenuator has no auto setting and the Auto/Man line on the key disappears. The state of Auto/Man is remembered and restored when the electronic attenuator is once again disabled. This is described in more detail in the ["Enable Elec Atten" on page 2299](#) key description.

See ["Attenuator Configurations and Auto/Man" on page 1502](#) for more information on the Auto/Man functionality of Attenuation.

Couplings

When **(Mech) Atten** is in Auto, it uses the following algorithm to determine a value:

If the USB Preamp is connected to USB, use 0 dB.

Otherwise, $Atten = ReferenceLevel + PreAmpGain + ExternalGain - RefLevelOffset - MaxMixerLevel + IF\ Gain$.

Limit this value to be between 6 dB and the Max value. No value below 6 dB can ever be chosen by Auto.

The resulting value is rounded up to the largest value possible given the attenuation step setting. That is, 50.01 dB would change to 60 dB (for a 10 dB attenuation step).

The "IF Gain" term in the equation above is either 0 dB or +10 dB, depending on the settings of FFT IF Gain, Swept IF Gain, max Ref Level and the Auto/Man setting of Mech Atten.

In External Mixing and BBIQ, where the Attenuator is not in the signal path, the Attenuator setting changes as described above when **(Mech) Atten** is in Auto, but no changes are made to the actual attenuator hardware setting until the input is changed back to the RF Input.

Preset The preset for Mech Attenuation is "Auto."
The Auto value of attenuation is:
CXA, EXA, MXA and PXA: 10 dB

State Saved Saved in instrument state

Min 0 dB
The attenuation set by this key cannot be decreased below 6 dB with the knob or step keys. To get to a value below 6 dB it has to be directly entered from the keypad or via SCPI. This protects from adjusting the attenuation to a dangerously small value which can put the instrument at risk of damage to input circuitry. However, if the current mechanical attenuation is below 6 dB it can be increased with the knob and step keys, but not decreased.

Max CXA N9000A-503/507: 50 dB
CXA N9000A-513/526: 70dB
EXA: 60 dB
MXA and PXA: 70 dB
In the single attenuator configuration, the total of ATT and EATT cannot exceed 50 dB, so if the EATT is set to 24 dB first, the main attenuation cannot be greater than 26 dB and will be reduced accordingly; if the main attenuator is set to 40 dB first, EATT cannot be greater than 10 dB.

Initial S/W Revision Prior to A.02.00

Modified at S/W Revision A.03.00

Attenuator Configurations and Auto/Man

As described in the Attenuation key description, there are two distinct attenuator configurations available in the X-Series, the single attenuator and dual attenuator configurations. In dual attenuator configurations, we have the mechanical attenuation and the electronic attenuation, and the current total attenuation is the sum of the electronic + mechanical attenuation. In single attenuator configurations, we refer to the attenuation set using the **(Mech) Atten** key (or POW:ATT SCPI) as the “main” attenuation; and the attenuation that is set by the SCPI command POW:EATT as the “soft” attenuation (the POW:EATT command is honored even in the single attenuator configuration, for compatibility purposes). Then the current total attenuation is the sum of the main + soft attenuation. See the **Elec Atten** key description for more on “soft” attenuation.

In the dual attenuator configuration, when the electronic attenuator is enabled, there is no Auto/Man functionality for the mechanical attenuator, and the third line of the key label (the Auto/Man line) disappears:

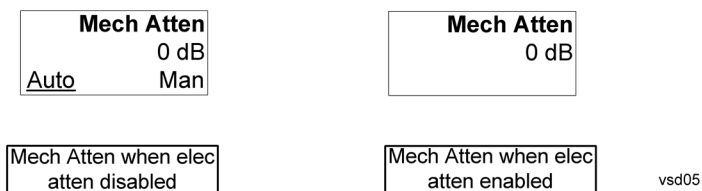

Enable Elec Atten

Enables the Electronic Attenuator.

The electronic attenuator offers finer steps than the mechanical attenuator, has no acoustical noise, is faster, and is less subject to wear. These advantages primarily aid in remote operation and are negligible for front panel use. See ["Using the Electronic Attenuator: Pros and Cons" on page 1504](#) for a detailed discussion of the pros and cons of using the electronic attenuator.

For the single attenuator configuration, for SCPI backwards compatibility, the “soft” attenuation feature replaces the dual attenuator configuration’s electronic attenuator. All the same couplings and limitations apply. See ["Attenuator Configurations and Auto/Man" on page 2299](#)

See ["More Information" on page 1503](#)

Key Path	AMPTD Y Scale, Attenuation
Remote Command	[:SENSe] :POWeR [:RF] :EATTenuation:STATe OFF ON 0 1 [:SENSe] :POWeR [:RF] :EATTenuation:STATe?
Example	POW:EATT:STAT ON
Dependencies	This key only appears in Dual Attenuator models with an Electronic Attenuator installed. It does not appear in models with the Single Attenuator configuration, as in the single attenuator configuration there is no “electronic attenuator” there is only a single integrated attenuator (which has both a mechanical and electronic stage). However, in the single attenuator configuration, EATT SCPI commands are accepted for compatibility with other X-series instruments and set a “soft” attenuation as described in "Attenuator Configurations and Auto/Man" on page 2299 . The electronic attenuator (and the “soft” attenuation function provided in single attenuator configurations) is unavailable above 3.6 GHz. Therefore, if the Stop Frequency of the analyzer is > 3.6 GHz then the Enable Elec Atten key will be OFF and grayed out.

	<p>If the Internal Preamp is on, meaning it is set to Low Band or Full, the electronic attenuator (and the “soft” attenuation function provided in single attenuator configurations) is unavailable. In this case the Enable Elec Atten key will be OFF and grayed out.</p> <p>If either of the above is true, if the SCPI command is sent, an error indicating that the electronic attenuator is unavailable will be sent.</p> <p>If the electronic/soft Attenuator is enabled, then the Stop Freq of the analyzer is limited to 3.6 GHz and the Internal Preamp is unavailable.</p> <p>The SCPI-only “soft” electronic attenuation for the single-attenuator configuration is not available in all measurements; in particular, it is not available in the Swept SA measurement.</p>
Couplings	Enabling and disabling the Electronic Attenuator affects the setting of the Mechanical Attenuator (in dual attenuator configurations). This is described in more detail below this table.
Preset	OFF for Swept SA measurement; ON for all other measurements that support the electronic attenuator
State Saved	Saved in instrument state
Initial S/W Revision	Prior to A.02.00
Modified at S/W Revision	A.03.00

More Information

Mechanical Attenuator Transition Rules

When the Electronic Attenuator is enabled, the Mechanical Attenuator transitions to a state that has no Auto function. Below are the rules for transitioning the Mechanical Attenuator. NOTE that the information below ONLY applies to the dual attenuator configurations, and ONLY when the Electronic Attenuator is installed:

When the Electronic Attenuation is enabled from a disabled state:

- The Mechanical Attenuator is initialized to 10 dB (this is its optimal performance setting). You can then set it as desired with SCPI, numeric keypad, step keys, or knob, and it behaves as it normally would in manual mode
- The Auto/Man state of (Mech) Atten is saved
- The Auto/Man line on the (Mech) Atten key disappears and the auto rules are disabled
- The Electronic Attenuator is set to 10 dB less than the previous value of the Mechanical Attenuator, within the limitation that it must stay within the range of 0 to 24 dB of attenuation.

Examples in the dual attenuator configuration:

- Mech Atten at 20 dB. Elec Atten enabled, Mech Atten set to 10 dB, and Elec Atten set to 10 dB. New total attenuation equals the value before Elec Atten enabled.
- Mech Atten at 0 dB. Elec Atten enabled, Mech Atten set to 10 dB, and Elec Atten set to 0 dB. New total attenuation does not equal the value before Elec Atten enabled.
- Mech Atten at 40 dB. Elec Atten enabled, Mech Atten set to 10 dB, and Elec Atten set to 24 dB. New total attenuation does not equal the value before Elec Atten enabled.

When the Electronic Attenuation is disabled from an enabled state:

- The Elec Atten key is grayed out
- The Auto/Man state of (Mech) Atten is restored
- If now in Auto, (Mech) Atten recouples
- If now in Man, (Mech) Atten is set to the value of total attenuation that existed before the Elec Atten was disabled. The resulting value is rounded up to the smallest value possible given the (Mech) Atten Step setting - (That is, 57 dB changes to 58 dB when (Mech) Atten Step is 2 dB.)

Using the Electronic Attenuator: Pros and Cons

The electronic attenuator offers finer steps than the mechanical attenuator, has no acoustical noise, is faster, and is less subject to wear.

The “finer steps” advantage of the electronic attenuator is beneficial in optimizing the alignment of the analyzer dynamic range to the signal power in the front panel as well as remote use. Thus, you can achieve improved relative signal measurement accuracy. Compared to a mechanical attenuator with 2 dB steps, the 1 dB resolution of the electronic attenuator only gives better resolution when the odd-decibel steps are used. Those odd-decibel steps are less accurately calibrated than the even-decibel steps, so one tradeoff for this superior relative accuracy is reduced absolute amplitude accuracy.

Another disadvantage of the electronic attenuator is that the spectrum analyzer loses its “Auto” setting, making operation less convenient.

Also, the relationship between the dynamic range specifications (TOI, SHI, compression and noise) and instrument performance are less well-known with the electrical attenuator. With the mechanical attenuator, TOI, SHI and compression threshold levels increase dB-for-dB with increasing attenuation, and the noise floor does as well. With the electronic attenuator, there is an excess attenuation of about 1 to 3 dB between 0 and 3.6 GHz, making the effective TOI, SHI, and so forth, less well known. Excess attenuation is the actual attenuation relative to stated attenuation. Excess attenuation is accounted for in the analyzer calibration

Elec Atten

Controls the Electronic Attenuator in dual attenuator configurations. This key does not appear in single attenuator configurations, as the control of both the mechanical and electronic stages of the single attenuator is integrated into the single **Atten** key.

Key Path	AMPTD Y Scale, Attenuation
Remote Command	<code>[:SENSe] :POWer [:RF] :EATTenuation <rel_ampl></code> <code>[:SENSe] :POWer [:RF] :EATTenuation?</code>
Notes	Electronic Attenuation's specification is defined only when Mechanical Attenuation is 6 dB.
Dependencies	This key only appears in Dual Attenuator models with an Electronic Attenuator installed. It does not appear in models with the Single Attenuator configuration, as in the single attenuator configuration there is no “electronic attenuator” there is only a single integrated attenuator (which has both a mechanical and electronic stage). However, in the single attenuator configuration, EATT SCPI commands are accepted for compatibility with other X-series instruments and set a “soft” attenuation as described in "Attenuator Configurations and Auto/Man" on page 2299 . The “soft” attenuation is treated as an addition to the “main” attenuation value set by the Atten softkey or the

	POW:ATT SCPI command and affects the total attenuation displayed on the Attenuation key and the Meas Bar. When Enable Elec Atten is off or grayed out, the Elec Atten key is grayed out.
Preset	0 dB
State Saved	Saved in instrument state
Min	0 dB
Max	Dual attenuator configuration: 24 dB Single attenuator configuration: the total of ATT and EATT cannot exceed 50 dB, so if the EATT is set to 24 dB first, the main attenuation cannot be greater than 26 dB and will be reduced accordingly; if the main attenuator is set to 40 dB first, EATT cannot be greater than 10 dB
Initial S/W Revision	Prior to A.02.00
Modified at S/W Revision	A.03.00

Adjust Atten for Min Clip

Sets the combination of mechanical and electronic attenuation and gain based on the current measured signal level so that clipping will be at a minimum.

This is an "immediate action" function, that is, it executes once, when the key is pressed.

This key is grayed out in measurements that do not support this functionality. The spectrum analyzer measurement, Swept SA, does not support this functionality.

Key Path	AMPTD Y Scale, Attenuation
Remote Command	<code>[:SENSe] :POWer [:RF] :RANGe:OPTimize IMMEDIATE</code>
Initial S/W Revision	Prior to A.02.00
Modified at S/W Revision	A.03.00

Pre-Adjust for Min Clip

If this function is on, it does the adjustment described under "[Adjust Atten for Min Clip](#)" on page 2302 each time a measurement restarts. Therefore, in Continuous measurement mode, it only executes before the first measurement.

In dual attenuator models, you can set **Elec+Mech Atten**, in which case both attenuators participate in the autoranging, or **Elec Atten Only**, in which case the mechanical attenuator does not participate in the autoranging. This latter case results in less wear on the mechanical attenuator and is usually faster.

This key is grayed out in measurements that do not support this functionality. The spectrum analyzer measurement, Swept SA, does not support this functionality.

Key Path	AMPTD Y Scale, Attenuation
Remote Command	<code>[:SENSe] :POWer [:RF] :RANGe:OPTimize:ATTenuation OFF ELECTRICAL COMBINED</code>

	<code>[:SENSe] :POWer [:RF] :RANGe:OPTimize:ATTenuation?</code>
Notes	The SCPI parameter ELECtrical sets this function to On in single attenuator models. The SCPI parameter COMBined is mapped to ELECtrical in single attenuator models; if you send COMBined, it sets the function to On and returns ELEC to a query.
Dependencies	This key only appears in Dual Attenuator models with an Electronic Attenuator installed. In instruments with Dual Attenuator model, when Enable Elec Atten is off or grayed out, the Pre-Adjust for Min Clip key is grayed out.
Preset	OFF for Swept SA measurement; ON for all other measurements that support Pre-Adjust for Min Clip
State Saved	Saved in instrument state
Range	Dual attenuator models: Off Elec Atten Only Mech + Elec Atten Single attenuator models: Off On
Initial S/W Revision	Prior to A.02.00
Modified at S/W Revision	A.03.00

Remote Command	<code>[:SENSe] :POWer [:RF] :RANGe:AUTO ON OFF 1 0</code> <code>[:SENSe] :POWer [:RF] :RANGe:AUTO?</code>
Notes	ON aliases to "Elec Atten Only" (:POW:RANG:OPT:ATT ELEC) OFF aliases to "Off" (:POW:RANG:OPT:ATT OFF) The query :POW:RANG:AUTO? returns true if :POW:RANG:OPT:ATT is not "Off"
Initial S/W Revision	Prior to A.02.00

Off

Turns **Pre-Adjust for Min Clip** off. This is the default setting.

This key is grayed out in measurements that do not support this functionality. The spectrum analyzer measurement, Swept SA, does not support this functionality.

Key Path	AMPTD Y Scale, Attenuation, Pre-Adjust for Min Clip
Example	:POW:RANGe:OPT:ATT OFF
Initial S/W Revision	Prior to A.02.00

Elec Atten Only

Selects only the electric attenuator to participate in auto ranging. This offers less wear on the mechanical attenuator and is usually faster.

This key is grayed out in measurements that do not support this functionality. The spectrum analyzer measurement, Swept SA, does not support this functionality.

Key Path	AMPTD Y Scale, Attenuation, Pre-Adjust for Min Clip
Example	:POW:RANGe:OPT:ATT ELEC
Initial S/W Revision	Prior to A.02.00

Mech + Elec Atten

In dual attenuator models, this selects both attenuators participate in the autoranging.

This key is grayed out in measurements that do not support this functionality. The spectrum analyzer measurement, Swept SA, does not support this functionality.

Key Path	AMPTD Y Scale, Attenuation, Pre-Adjust for Min Clip
Example	:POW:RANGe:OPT:ATT COMB
Initial S/W Revision	Prior to A.02.00

(Mech) Atten Step

This controls the step size used when making adjustments to the input attenuation.

This key is labeled **Mech Atten Step** in dual attenuator models and **Atten Step** in single attenuator models. In the dual attenuator configuration, this key only affects the step size of the mechanical attenuator.

Key Path	AMPTD Y Scale, Attenuation
Remote Command	[[:SENSe]:POWer[:RF]:ATTenuation:STEP[:INCRement] 10 dB 2 dB [:SENSe]:POWer[:RF]:ATTenuation:STEP[:INCRement]?
Example	POW:ATT:STEP 2
Notes	Note this feature works like a 1-N choice from the front panel, but it takes a specific value (in dB) when used remotely. The only valid values are 2 and 10.
Dependencies	Blanked in CXA and EXA if option FSA (2 dB steps) is not present. If blanked, attempts to set it via SCPI will yield an error.
Couplings	When the attenuation step size changes, the current mechanical attenuation value is adjusted (if necessary) to be quantized to the new step size. That is, if step is set to 10 dB, mech atten is increased if necessary so it is a multiple of 10 dB
Preset	PXA and MXA: 2 dB EXA and CXA: 10 dB (2 dB with option FSA)
State Saved	Saved in instrument state
Initial S/W Revision	Prior to A.02.00
Modified at S/W Revision	A.03.00

Adjust Atten (Remote Command only)

Allows you to select;

-Electric attenuator only

-Combination of Electric attenuator and Mechanical attenuator

when the SCPI command [:SENSe]:POWer[:RF]:RANGe:OPTimize IMMEDIATE is executed.

Remote Command	<code>[:SENSe]:POWer[:RF]:RANGe:OPTimize:TYPE EONLy COMBined</code> <code>[:SENSe]:POWer[:RF]:RANGe:OPTimize:TYPE?</code>
Example	<code>POW:RANG:OPT:TYPE EONL</code> <code>POW:RANG:OPT:TYPE?</code>
Preset	COMBined
State Saved	Saved in instrument state
Initial S/W Revision	A.16.00

Scale/Div

Sets the units per division of the vertical scale in the logarithmic display. However, since the Auto Scaling is defaulted to On, this value is automatically determined by the measurement result. When you set a value manually, Auto Scaling automatically changes to Off.

Key Path	AMPTD Y Scale
Mode	SA, WCDMA, C2K, WIMAX OFDMA, TD-SCDMA, DVB-T/H, LTE, LTE-TDD, WLAN, MSR, LTEAFDD, LTEATDD
Remote Command	<code>:DISPlay:SPURious:VIEW[1]:WINDow[1]:TRACe:Y[:SCALe]:PDIVision <rel_ ampl></code> <code>:DISPlay:SPURious:VIEW[1]:WINDow[1]:TRACe:Y[:SCALe]:PDIVision?</code>
Example	<code>DISP:SPUR:VIEW:WIND:TRAC:Y:PDIV 10 dB</code> <code>DISP:SPUR:VIEW:WIND:TRAC:Y:PDIV?</code>
Notes	You must be in the Spectrum Analysis mode, W-CDMA mode, cdma2000 mode, DVB-T/H mode, TD-SCDMA, LTE mode, LTE TDD mode, WLAN mode, MSR, LTE-Advanced FDD/TDD mode or WiMAX mode to use this command. Use INSTRUMENT:SElect to set the mode.
Couplings	When Auto Scaling is On, this value is automatically determined by the measurement result. When you set a value manually, Auto Scaling automatically changes to Off.
Preset	10.00 dB
State Saved	Saved in instrument state.
Range	0.10 dB to 20.00 dB
Min	0.10 dB
Max	20.00 dB
Initial S/W Revision	Prior to A.02.00
Modified at S/W Revision	A.03.00

Presel Center

When this key is pressed, the centering of the preselector filter is adjusted to optimize the amplitude accuracy at the frequency of the selected marker. If the selected marker is not on when Presel Center is pressed, the analyzer will turn on the selected marker, perform a peak search, and then perform centering on the marker's center frequency. If the selected marker is already on and between the start and stop frequencies of the analyzer, the analyzer performs the preselector calibration on that marker's frequency. If the selected marker is already on, but outside the frequency range between Start Freq and Stop Freq, the analyzer will first perform a peak search, and then perform centering on the marker's center frequency.

The value displayed on the **Presel Adjust** key will change to reflect the new preselector tuning (see **Presel Adjust**).

A number of considerations should be observed to ensure proper operation. See "[Proper Preselector Operation](#)" on page 1510.

Key Path	AMPTD Y Scale
Remote Command	[:SENSe] :POWer [:RF] :PCENter
Example	POW:PCEN
Notes	Note that the rules outlined above under the key description apply for the remote command as well as the key. The result of the command is dependent on marker position, and so forth. Any message shown by the key press is also shown in response to the remote command.
Dependencies	<ul style="list-style-type: none"> • Grayed out if the microwave preselector is off.) • If the selected marker's frequency is below Band 1, advisory message 0.5001 is generated and no action is taken. • Grayed out if entirely in Band 0. • Blank in models that do not include a preselector, such as option 503. If the SCPI is sent in these instruments, it is accepted without error, and the query always returns 0. • Grayed out in the Spectrogram View.
Couplings	The active marker position determines where the centering will be attempted. If the analyzer is in a measurement such as averaging when centering is initiated, the act of centering the preselector will restart averaging but the first average trace will not be taken until the centering is completed.
Status Bits/OPC dependencies	When centering the preselector, *OPC will not return true until the process is complete and a subsequent measurement has completed, nor will results be returned to a READ or MEASure command. The Measuring bit should remain set while this command is operating and should not go false until the subsequent sweep/measurement has completed.
Initial S/W Revision	Prior to A.02.00
Modified at S/W Revision	A.03.00

Proper Preselector Operation

A number of considerations should be observed to ensure proper operation:

1. If the selected marker is off, the analyzer will turn on a marker, perform a peak search, and adjust the preselector using the selected marker's frequency. It uses the "highest peak" peak search method unqualified by threshold or excursion, so that there is no chance of a 'no peak found' error. It continues with that peak, even if it is the peak of just noise. Therefore, for this operation to work properly, there should be a signal on screen in a preselected range for the peak search to find.
2. If the selected marker is already on, the analyzer will attempt the centering at that marker's frequency. There is no preselector for signals below about 3.6 GHz, therefore if the marker is on a signal below 3.6 GHz, no centering will be attempted and an advisory message generated
3. In some models, the preselector can be bypassed. If it is bypassed, no centering will be attempted in that range and a message will be generated.

Preselector Adjust

Allows you to manually adjust the preselector filter frequency to optimize its response to the signal of interest. This function is only available when "[Presel Center](#)" on page 2306 is available.

For general purpose signal analysis, using Presel Center is recommended. Centering the filter minimizes the impact of long-term preselector drift. Presel Adjust can be used instead to manually optimize the preselector. One application of manual optimization would be to peak the preselector response, which both optimizes the signal-to-noise ratio and minimizes amplitude variations due to small (short-term) preselector drifting.

Key Path	AMPTD Y Scale
Scope	Meas Global
Remote Command	[:SENSe] :POWer [:RF] :PADJust <freq> [:SENSe] :POWer [:RF] :PADJust?
Example	POW:PADJ 100KHz POW:PADJ?
Notes	The value on the key reads out to 0.1 MHz resolution.
Dependencies	<ul style="list-style-type: none"> • Grayed out if microwave preselector is off.) • Grayed out if entirely in Band 0. • Blank in models that do not include a preselector, such as option 503. If the SCPI is sent in these instruments, it is accepted without error, and the query always returns 0. • Grayed out in the Spectrogram View.
Preset	0 MHz
State Saved	The Presel Adjust value set by Presel Center , or by manually adjusting Presel Adjust , is not saved in instrument state, and does not survive a Preset or power cycle.
Min	-500 MHz
Max	500 MHz

Default Unit	Hz
Backwards Compatibility SCPI	[:SENSe] :POWer [:RF] :MW :PADJust [:SENSe] :POWer [:RF] :MMW :PADJust PSA had multiple preselectors, but the X-Series has only one. These commands simply alias to [:SENSe]:POWER[:RF]:PADJust
Initial S/W Revision	Prior to A.02.00
Modified at S/W Revision	A.03.00

Remote Command	[:SENSe] :POWer [:RF] :PADJust :PRESelector MWAVE MMWave EXTernal [:SENSe] :POWer [:RF] :PADJust :PRESelector?
Notes	PSA had multiple preselectors, and you could select which preselector to adjust. Since the X-Series has only one mm/uW preselector, the preselector selection softkey is no longer available. However, to provide backward compatibility, we accept the legacy remote commands. The command form has no effect, the query always returns MWAVE
Initial S/W Revision	Prior to A.02.00

μW Path Control

The **μW Path Control** functions include the **μW Preselector Bypass** (Option MPB) and **Low Noise Path** (Option LNP) controls in the High Band path circuits.

When the μW Preselector is bypassed, the user has better flatness, but will be subject to spurs from out of band interfering signals. When the Low Noise Path is enabled, the analyzer automatically switches around certain circuitry in the high frequency bands which can contribute to noise, when it is appropriate based on other analyzer settings.

For most applications, the preset state is Standard Path, which gives the best remote-control throughput, minimizes acoustic noise from switching and minimizes the risk of wear out in the hardware switches. For applications that utilize the wideband IF paths, the preset state is the μW Preselector Bypass path, if option MPB is present. This is because, when using a wideband IF such as the 140 MHz IF, the μW Preselector's bandwidth can be narrower than the available IF bandwidth, causing degraded amplitude flatness and phase linearity, so it is desirable to bypass the preselector in the default case.

Users may choose Low Noise Path Enable. It gives a lower noise floor, especially in the 21–26.5 GHz region, though without improving many measures of dynamic range, and without giving the best possible noise floor. The preamp, if purchased and used, gives better noise floor than does the Low Noise Path, however its compression threshold and third-order intercept are much poorer than that of the non-preamp Low Noise Path. There are some applications, typically for signals around –30 dBm, for which the third-order dynamic range of the standard path is good enough, but the noise floor is not low enough even with 0 dB input attenuation. When the third-order dynamic range of the preamp path is too little and the noise floor of the standard path is too high, the Low Noise Path can provide the best dynamic range.

Key Path	AMPTD Y Scale
Mode	SA, BASIC, PNOISE, VSA , LTE, LTETDD
Scope	Meas Global
Remote Command	[:SENSe] :POWer [:RF] :MW:PATH STD LNPath MPBypass FULL [:SENSe] :POWer [:RF] :MW:PATH?
Example	:POW:MW:PATH LNP Enables the Low Noise path
Notes	<p>If a Presel Center is performed, the analyzer will momentarily switch to the Standard Path, regardless of the setting of μW Path Control</p> <p>The DC Block will always be switched in when the low noise path is switched in, to protect succeeding circuitry from DC. Note that this does not mean “when the low noise path is enabled” but when, based on the Low Noise Path rules, the path is actually switched in. This can happen when the selection is Low Noise Path Enable . In the case where the DC Block is switched in the analyzer is now AC coupled. However, if the user has selected DC coupling, the UI will still behave as though it were DC coupled, including all annunciation, warnings, status bits, and responses to SCPI queries. This is because, based on other settings, the analyzer could switch out the low noise path at any time and hence go back to being DC coupled.</p> <p>Alignment switching ignores the settings in this menu, and restores them when finished.</p>
Dependencies	Unavailable in BBIQ and External Mixing
Preset	All modes other than IQ Analyzer mode and VXA: STD IQ Analyzer, VXA and WLAN mode: MPB option present and licensed: MPB MPB option not present and licensed: STD
State Saved	Save in instrument state
Readback	Value selected in the submenu
Initial S/W Revision	A.04.00
Modified at S/W Revision	A.10.00

Standard Path

This path gives the best remote-control throughput, minimizes acoustic noise from switching and minimizes the risk of wear in the hardware switches, particularly in remote test scenarios where both low band and high band setups will follow in rapid succession.

In this path, the bypass of the low band/high band switch and microwave preamp is never activated, which can cause some noise degradation but preserves the life of the bypass switch.

Key Path	AMPTD Y Scale, μW Path Control
Example	:POW:MW:PATH STD
Readback Text	Standard Path
Initial S/W Revision	A.04.00

Low Noise Path Enable

You may choose Low Noise Path Enable, which gives a lower noise floor under some circumstances, particularly when operating in the 21–26.5 GHz region. With the Low Noise Path enabled, the low band/high band switch and microwave preamp are bypassed whenever all of the following are true:

- The analyzer is not in the Low Band, meaning:
- the start frequency is above 3.5 GHz and
- the stop frequency is above 3.6 GHz.
- the internal preamp is not installed or (if installed) is set to **Off** or **Low Band**

Note that this means that, when any part of a sweep is done in Low Band, the Low Noise Path is not used, whether or not the **Low Noise Path Enable** is selected in the user interface. Also, if the preamp is turned on, the Low Noise Path is not used, whether or not the **Low Noise Path Enable** is selected in the user interface. The only time the Low Noise Path is used is when **Low Noise Path Enable** is selected, the sweep is completely in High Band (> 3.6 GHz) and no preamp is in use.

See "[More Information](#)" on page 1513

Key Path	AMPTD Y Scale, μW Path Control
Measurement	Swept SA
Example	:POW:MW:PATH LNP
Notes	For measurements that use IQ acquisition, the low noise path is used when the Center Frequency is in High Band (> 3.6 GHz) and no preamp is in use. In other words, the rules above are modified to use only the center frequency to qualify which path to switch in. This is not the case for FFT's in the Swept SA measurement; they use the same rules as swept measurements.
Dependencies	Key is blanked if current mode does not support it. Key is grayed out if mode supports it but current measurement does not support it. Unless Option LNP is present and licensed, key is blank and if SCPI command sent, error -241, "Hardware missing; Option not installed" is generated.
Readback Text	Low Noise Path Enable
Initial S/W Revision	A.04.00

More Information

The user should understand that the Low Noise Path, while giving improved DANL, has the disadvantage of decreased TOI performance and decreased gain compression performance relative to the standard path.

The user should also understand that the bypass switch is a mechanical switch and has finite life, so if the **Low Noise Path** is enabled, it is possible to cause frequent cycling of this switch by frequently changing analyzer settings such that the above conditions hold true only some of the time. A user making tests of this nature should consider opting for the **Standard Path**, which will never throw the bypass switch, at the expense of some degraded noise performance.

The low noise path is useful for situations where the signal level is so low that the analyzer performance is dominated by noise even with 0 dB attenuation, but still high enough that the preamp option would have excessive third-order intermodulation or compression. The preamp, if purchased and used, gives better noise floor than does the “Low Noise Path.” However, its compression threshold and third-order intercept are much poorer than that of the non-preamp path. There are some applications, typically for signals around -30 dBm, for which the third-order dynamic range of the standard path is good enough, but the noise floor is not low enough even with 0 dB input attenuation. When the third-order dynamic range of the preamp path is too little and the noise floor of the standard path is too high, the Low Noise Path can provide the best dynamic range

The graph below illustrates the concept. It shows, in red, the performance of an analyzer at different attenuation settings, both with the preamp on and off, in a measurement that is affected by both analyzer noise and analyzer TOI. The green shows the best available dynamic range, offset by 0.5 dB for clarity. The blue shows how the best available dynamic range improves for moderate signal levels with the low noise path switched in. In this illustration, the preamp improves the noise floor by 15 dB while degrading the third-order intercept by 30 dB, and the low noise path reduces loss by 8 dB. The attenuator step size is 2 dB.

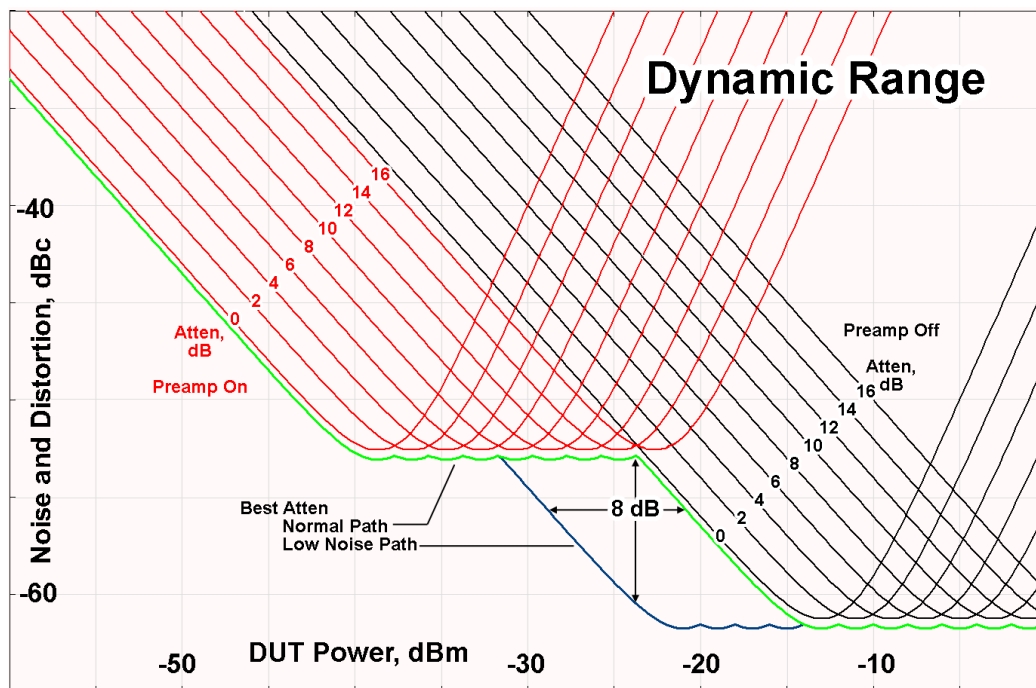

There are other times where selecting the low noise path improves performance, too. Compression-limited measurements such as finding the nulls in a pulsed-RF spectrum can profit from the low noise path in a way similar to the TOI-limited measurement illustrated. Accuracy can be improved when the low noise path allows the optimum attenuation to increase from a small amount like 0, 2 or 4 dB to a larger amount, giving better return loss at the analyzer input. Harmonic measurements, such as second and third harmonic levels, are much improved using the low noise path because of the superiority of that path for harmonic (though not intermodulation) distortion performance.

μW Preselector Bypass

This key toggles the preselector bypass switch for band 1 and higher. When the microwave preselector is on, the signal path is preselected. When the microwave preselector is off, the signal path is not preselected. The preselected path is the normal path for the analyzer.

The preselector is a tunable bandpass filter which prevents signals away from the frequency of interest from combining in the mixer to generate in-band spurious signals (images). The consequences of using a preselector filter are its limited bandwidth, the amplitude and phase ripple in its passband, and any amplitude and phase instability due to center frequency drift.

Option MPB or pre-selector bypass provides an unpreselected input mixer path for certain X-Series signal analyzers with frequency ranges above 3.6 GHz. This signal path allows a wider bandwidth and less amplitude variability, which is an advantage when doing modulation analysis and broadband signal analysis. The disadvantage is that, without the preselector, image signals will be displayed. Another disadvantage of bypassing the preselector is increased LO emission levels at the front panel input port.

Image responses are separated from the real signal by twice the 1st IF. For IF Paths of 10 MHz and 25 MHz, the 1st IF is 322.5 MHz, so the image response and the real signal will be separated by 645 MHz. The 1st IF will be different for other IF Path settings. When viewing a real signal and its corresponding image response in internal mixing, the image response will be to the left of the real signal.

Also, the image response and the real signal typically have the same amplitude and exhibit the same shape factor.

However, if Option FS1, Fast Sweep Capability, is enabled, the image response in the Swept SA measurement will appear lower in amplitude and have a much wider shape factor compared to the real signal.

Key Path	AMPTD Y Scale, μW Path Control
Example	:POW:MW:PATH MPB
Dependencies	Key is blanked if current mode does not support it. Key is grayed out if mode supports it but current measurement does not support it. Key is blank unless Option MPB is present and licensed. If SCPI command sent when MPB not present, error -241, "Hardware missing; Option not installed" is generated.
Readback Text	μW Preselector Bypass
Initial S/W Revision	A.04.00

Remote Command	[:SENSe] :POWer [:RF] :MW:PRESelector [:STATe] ON OFF 0 1 [:SENSe] :POWer [:RF] :MW:PRESelector [:STATe] ?
Example	:POW:MW:PRES OFF Bypasses the microwave preselector
Notes	The ON parameter sets the STD path (:POW:MW:PATH STD) The OFF parameter sets path MPB (:POW:MW:PATH MPB)
Preset	ON

Internal Preamp

Accesses a menu of keys that control the internal preamps. Turning on the preamp gives a better noise figure, but a poorer TOI to noise floor dynamic range. You can optimize this setting for your particular measurement.

The instrument takes the preamp gain into account as it sweeps. If you sweep outside of the range of the preamp the instrument will also account for that. The displayed result will always reflect the correct gain.

For some measurements, when the preamp is on and any part of the displayed frequency range is below the lowest frequency for which the preamp has specifications, a warning condition message appears in the status line. For example, for a preamp with a 9 kHz lowest specified frequency: "Preamp: Accy unspec'd below 9 kHz".

Key Path	AMPTD Y Scale
Scope	Meas Global
Remote Command	[:SENSe] :POWer [:RF] :GAIN [:STATe] OFF ON 0 1 [:SENSe] :POWer [:RF] :GAIN [:STATe] ?
Dependencies	Preamp is not available on all hardware platforms. If the preamp is not present or is unlicensed, the key is not shown. The preamp is not available when the electronic/soft attenuator is enabled.
Couplings	The act of connecting the U7227A USB Preamplifier to one of the analyzer's USB ports will cause the Internal Preamp to be switched on. When this happens an informational message will be generated: "Internal Preamp turned on for optimal operation with USB Preamp." Note that if the Internal Preamp was already on, there will be no change to the setting, but if it was Off it will be switched On, to Full Range. Note that this same action occurs when the SA mode is selected while the USB Preamp is connected to one of the analyzer's USB ports, if it is the first time that the SA mode has run since powerup, or if the last time the SA mode was running the USB Preamp was NOT connected. Subsequently disconnecting the USB Preamp from USB does not change the Internal Preamp setting nor restore the previous setting.
Preset	OFF
State Saved	Saved in instrument state
Initial S/W Revision	Prior to A.02.00
Modified at S/W Revision	A.14.00

Key Path	AMPTD Y Scale, Internal Preamp
Scope	Meas Global
Remote Command	[:SENSe] :POWer [:RF] :GAIN:BAND LOW FULL [:SENSe] :POWer [:RF] :GAIN:BAND?
Dependencies	Preamp is not available on all hardware platforms. If the preamp is not present or is unlicensed, the key is not shown. If a POW:GAIN:BAND FULL command is sent when a low band preamp is available, the preamp band

	parameter is to LOW instead of FULL, and an "Option not installed" message is generated.
Preset	LOW
State Saved	Saved in instrument state
Initial S/W Revision	Prior to A.02.00

Off

Turns the internal preamp off

Key Path	AMPTD Y Scale, Internal Preamp
Example	:POW:GAIN OFF
Readback	Off
Initial S/W Revision	Prior to A.02.00

Low Band

Sets the internal preamp to use only the low band.

The frequency range of the installed (optional) low-band preamp is displayed in square brackets on the **Low Band** key label.

Key Path	AMPTD Y Scale, Internal Preamp
Example	:POW:GAIN ON :POW:GAIN:BAND LOW
Readback	Low Band
Initial S/W Revision	Prior to A.02.00

Full Range

Sets the internal preamp to use its full range. The low band (0–3.6 GHz or 0–3GHz, depending on the model) is supplied by the low band preamp and the frequencies above low band are supplied by the high band preamp.

The frequency range of the installed (optional) preamp is displayed in square brackets on the **Full Range** key label. If the high band option is not installed the Full Range key does not appear.

Key Path	AMPTD Y Scale, Internal Preamp
Example	:POW:GAIN ON :POW:GAIN:BAND FULL
Readback	Full Range
Initial S/W Revision	Prior to A.02.00

Auto Scaling

Toggles the Auto Scaling function between On and Off.

Key Path	AMPTD Y Scale
Mode	SA, WCDMA, C2K, WIMAX OFDMA, TD-SCDMA, DVB-T/H, LTE, LTE-TDD, WLAN, MSR, LTEAFDD, LTEATDD
Remote Command	:DISPlay:SPURious:VIEW[1]:WINDow[1]:TRACe:Y[:SCALE]:COUple 0 1 OFF ON :DISPlay:SPURious:VIEW[1]:WINDow[1]:TRACe:Y[:SCALE]:COUple?
Example	DISP:SPUR:VIEW:WIND:TRAC:Y:COUP OFF DISP:SPUR:VIEW:WIND:TRAC:Y:COUP?
Couplings	When Auto Scaling is On and the Restart front-panel key is pressed, this function automatically determines the scale per division and reference values based on the measurement results. When you set a value to either Scale/Div or Ref Value manually, Auto Scaling automatically changes to Off. When the Y Auto Scaling is off, the measurement uses the current reference level settings. When the Y Auto Scaling is on, the analyzer automatically sets the reference level such that the absolute limit is positioned two divisions down from the top of the display. This is the most useful setting when searching for spurs. The algorithm used for determining the ref level is Ref Level = Absolute Limit + (2 * Scale/Div). All other reference level settings are left as the current base instrument settings.
Preset	1
State Saved	Saved in instrument state.
Range	On Off
Backwards Compatibility SCPI	[[:SENSe]:SPURious:POWer[:RF]:RANGe:AUTO
Initial S/W Revision	Prior to A.02.00
Modified at S/W Revision	A.03.00

Auto Couple

The Auto Couple feature provides a quick and convenient way to automatically couple multiple instrument settings. This helps ensure accurate measurements and optimum dynamic range. When the Auto Couple feature is activated, either from the front panel or remotely, all parameters of the current measurement that have an Auto/Manual mode are set to Auto mode and all measurement settings dependent on (or coupled to) the Auto/Man parameters are automatically adjusted for optimal performance.

However, the Auto Couple key actions are confined to the current measurement only. It does not affect other measurements in the mode, and it does not affect markers, marker functions, or trace or display attributes.

See "[More Information](#)" on page 1519

Key Path	Front-panel key
Remote Command	:COUPle ALL NONE
Example	:COUP ALL
Notes	:COUPle ALL puts all Auto/Man parameters in Auto mode (equivalent to pressing the Auto Couple key). :COUPLE NONE puts all Auto/Man parameters in manual mode. It decouples all the coupled instrument parameters and is not recommended for making measurements.
Initial S/W Revision	Prior to A.02.00

More Information

There are two types of functions that have Auto/Manual modes.

Auto/Man Active Function keys

An Auto/Man toggle key controls the binary state associated with an instrument parameter by toggling between **Auto** (where the parameter is automatically coupled to the other parameters it is dependent upon) and **Man** (where the parameter is controlled independent of the other parameters), as well as making the parameter the active function. The current mode is indicated on the softkey with either **Auto** or **Man** underlined as illustrated below.

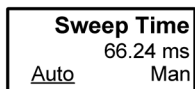

vsd07

Auto/Man 1-of-N keys

An Auto/Man 1-of-N key allows you to manually pick from a list of parameter values, or place the function in Auto, in which case the value is automatically selected (and indicated) as shown below. If in Auto, Auto is underlined on the calling key. If in manual operation, manual is indicated on the calling key. But the calling key does not actually toggle the function, it simply opens the menu.

12 Spurious Emissions Measurement
Auto Couple

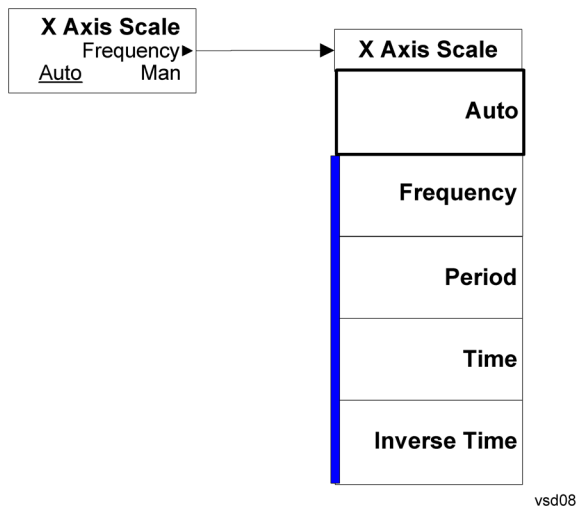

BW

BW is unavailable in the Spurious Emissions measurement. When pressed, this key displays a blank menu.

Key Path	Front-panel key
Initial S/W Revision	Prior to A.02.00

Cont (Continuous Measurement/Sweep)

Sets the analyzer for Continuous measurement operation. The single/continuous state is Meas Global so the setting will affect all measurements. If you are Paused, pressing **Cont** does a Resume.

Key Path	Front-panel key
Remote Command	:INITiate:CONTinuous OFF ON 0 1 :INITiate:CONTinuous?
Example	:INIT:CONT 0 puts analyzer in Single measurement operation. :INIT:CONT 1 puts analyzer in Continuous measurement operation
Preset	ON (Note that SYST:PRESet sets INIT:CONT to ON but *RST sets INIT:CONT to OFF)
State Saved	Saved in instrument state
Backwards Compatibility Notes	For Spectrum Analysis mode in ESA and PSA, there is no Cont hardkey, instead there is a Sweep Single/Cont key. In these analyzers, switching the Sweep Single/Cont key from Single to Cont restarts averages (displayed average count reset to 1), but does not restart Max Hold and Min Hold . The X-Series has Single and Cont keys in place of the SweepSingleCont key. In the X-Series, if in single measurement, the Cont key (and INIT:CONT ON) switches to continuous measurement, but never restarts a measurement and never resets a sweep.
Initial S/W Revision	Prior to A.02.00

In Swept SA Measurement (Spectrum Analysis Mode):

The analyzer takes repetitive sweeps, averages, measurements, etc., when in Continuous mode. When the average count reaches the Average/Hold Number the count stops incrementing, but the analyzer keeps sweeping. See the Trace/Detector section for the averaging formula used both before and after the Average/Hold Number is reached. The trigger condition must be met prior to each sweep. The type of trace processing for multiple sweeps, is set under the Trace/Detector key, with choices of **Trace Average**, **Max Hold**, or **Min Hold**.

In Other Measurements/Modes:

With **Avg/Hold Num** (in the **Meas Setup** menu) set to **Off** or set to **On** with a value of 1, a sweep is taken after the trigger condition is met; and the analyzer continues to take new sweeps after the current sweep has completed and the trigger condition is again met. However, with **Avg/Hold Num** set to On with a value >1, multiple sweeps (data acquisitions) are taken for the measurement. The trigger condition must be met prior to each sweep. The sweep is not stopped when the average count k equals the number N set for Avg/Hold Num is reached, but the number k stops incrementing. A measurement average usually applies to all traces, marker results, and numeric results. But sometimes it only applies to the numeric results.

If the analyzer is in Single measurement, pressing the **Cont** key does not change k and does not cause the sweep to be reset; the only action is to put the analyzer into Continuous measurement operation.

If it is already in continuous sweep:

the INIT:CONT 1 command has no effect

the INIT:CONT 0 command will place the analyzer in Single Sweep but will have no effect on the current sequence until $k = N$, at which point the current sequence will stop and the instrument will go to the idle state.

12 Spurious Emissions Measurement
File

File

See ["File" on page 362](#)

FREQ Channel

Accesses a menu of keys that allow you to control the Frequency and Channel parameters of the instrument.

Some features in the Frequency menu are the same for all measurements - they do not change as you change measurements. Settings like these are called "Meas Global" and are unaffected by Meas Preset. For example, the Center Freq setting is the same for all measurements - it does not change as you change measurements.

Key Path	Front Panel
Mode	MSR
Initial S/W Revision	A.10.00

Carrier Ref Freq

Sets carrier reference frequency. The center frequencies of carriers are defined as offset frequency from this value. This reference frequency is also the reference of carrier configuration preset.

Key Path	FREQ Channel
Mode	MSR
Measurement	all
Remote Command	<code>[:SENSe] :CARRier:REFeRence <freq></code> <code>[:SENSe] :CARRier:REFeRence?</code>
Example	CARR:REF 2GHz CARR:REF?
Preset	1GHz
State Saved	Saved in instrument state
Min	Depends on instrument minimum center frequency. Same as Center Freq
Max	Depends on instrument maximum center frequency. Same as Center Freq
Initial S/W Revision	A.10.00

Carrier Setup

Accesses the Carrier Setup menu.

Key Path	FREQ Channel
Initial S/W Revision	A.10.00

Carriers

Specifies how many carriers are used in MSR measurements. Base station RF bandwidth is determined from the carrier 1 to the carrier specified by this value whatever carriers' Present Pwr states are. Select Carrier can be select up to this value.

Key Path	FREQ Channel, Carrier Setup
Measurement	All
Remote Command	<code>[:SENSe]:CARRier:COUNt <integer></code> <code>[:SENSe]:CARRier:COUNt?</code>
Example	CARR:COUN 10 CARR:COUN?
Preset	1
State Saved	Saved in instrument state.
Min	1
Max	100
Initial S/W Revision	A.10.00

Configure Carriers

Accesses a menu of commonly used carrier configuration parameters.

Key Path	FREQ Channel, Carrier Setup
Initial S/W Revision	A.10.00

Select Carrier

Selects which carrier's configuration menu is displayed.

This key is also connected to the carrier info tables of some measurements. When the value is changed in a measurement which has carrier table view, the highlight in the table moves to Select Carrier. The highlight of the table and Select Carrier are not coupled.

Key Path	FREQ Channel, Carrier Setup, Configure Carriers
Preset	1
State Saved	No
Min	1
Max	Value of Carriers
Initial S/W Revision	A.10.00

Measure Carrier

Sets whether to measure this carrier or not.

Key Path	FREQ Channel, Carrier Setup, Configure Carriers
Remote Command	<code>[:SENSe] :CARRier<n> [:STATe] OFF ON 0 1</code> <code>[:SENSe] :CARRier<n> [:STATe] ?</code>
Example	CARR10 1 CARR10?
Notes	The command is used with a sub-op code <n> (default=1) to specify the carrier for configuration. The range of the sub-op code is determined by the number of carriers.
Preset	ON
State Saved	Saved in instrument state
Range	On Off
Initial S/W Revision	A.10.00

Carrier Offset

Sets the carrier center frequency as offset from Carrier Ref Frequency.

Key Path	FREQ Channel, Carrier Setup, Configure Carriers
Remote Command	<code>[:SENSe] :CARRier<n> :FREQuency:OFFSet <freq></code> <code>[:SENSe] :CARRier<n> :FREQuency:OFFSet ?</code>
Example	CARR10:FREQ:OFFS 10MHz CARR10:FREQ:OFFS?
Notes	The command is used with a sub-op code <n> (default=1) to specify the carrier for configuration. The range of the sub-op code is determined by the number of carriers.
Preset	0Hz
State Saved	Saved in instrument state
Min	-1GHz
Max	1GHz
Initial S/W Revision	A.10.00

Radio Format

Selects a format parameter set to set the radio format of the selected carrier.

NONE – No format is specified. Channel spacing, measurement BW and FOffset,RAT are values of defaults of LTE FDD 5MHz.

LTE FDD Parameter Set 1 – Selects LTE FDD parameter set 1. LTE FDD (E-UTRA FDD) is the radio format of the carrier.

LTE FDD Parameter Set 2 – Selects LTE FDD parameter set 2. LTE FDD (E-UTRA FDD) is the radio format of the carrier.

LTE FDD Parameter Set 3 – Selects LTE FDD parameter set 3. LTE FDD (E-UTRA FDD) is the radio format of the carrier.

W-CDMA Parameter Set 1 – Selects W-CDMA parameter set 1. W-CDMA (UTRA FDD) is the radio format of the carrier.

W-CDMA Parameter Set 2 – Selects W-CDMA parameter set 2. W-CDMA (UTRA FDD) is the radio format of the carrier.

W-CDMA Parameter Set 3 – Selects W-CDMA parameter set 3. W-CDMA (UTRA FDD) is the radio format of the carrier.

GSM/EDGE Parameter Set 1 – Selects GSM/EDGE parameter set 1. GSM/EDGE is the radio format of the carrier.

GSM/EDGE Parameter Set 2 – Selects GSM/EDGE parameter set 2. GSM/EDGE is the radio format of the carrier.

GSM/EDGE Parameter Set 3 – Selects GSM/EDGE parameter set 3. GSM/EDGE is the radio format of the carrier.

cdma2000 Parameter Set 1 – Selects cdma2000 parameter set 1. cdma2000 is the radio format of the carrier.

cdma2000 Parameter Set 2 – Selects cdma2000 parameter set 2. cdma2000 is the radio format of the carrier.

cdma2000 Parameter Set 3 – Selects cdma2000 parameter set 3. cdma2000 is the radio format of the carrier.

1xEV-DO Parameter Set 1 – Selects 1xEV-DO parameter set 1. 1xEV-DO is the radio format of the carrier.

1xEV-DO Parameter Set 2 – Selects 1xEV-DO parameter set 2. 1xEV-DO is the radio format of the carrier.

1xEV-DO Parameter Set 3 – Selects 1xEV-DO parameter set 3. 1xEV-DO is the radio format of the carrier.

LTE TDD Parameter Set 1 – Selects LTE TDD parameter set 1. LTE TDD (E-UTRA TDD) is the radio format of the carrier.

LTE TDD Parameter Set 2 – Selects LTE TDD parameter set 2. LTE TDD (E-UTRA TDD) is the radio format of the carrier.

LTE TDD Parameter Set 3 – Selects LTE TDD parameter set 3. LTE TDD (E-UTRA TDD) is the radio format of the carrier.

TD-SCDMA Parameter Set 1 – Selects TD-SCDMA parameter set 1. TD-SCDMA (UTRA-TDD LCR) is the radio format of the carrier.

TD-SCDMA Parameter Set 2 – Selects TD-SCDMA parameter set 2. TD-SCDMA (UTRA-TDD LCR) is the radio format of the carrier.

TD-SCDMA Parameter Set 3 – Selects TD-SCDMA parameter set 3. TD-SCDMA (UTRA-TDD LCR) is the radio format of the carrier.

Key Path	FREQ Channel, Carrier Setup, Configure Carriers
Remote Command	[:SENSE]:CARRier<n>:FORMat NONE LTEFdd1 LTEFdd2 LTEFdd3 WCDMa1 WCDMa2 WCDMa3 GSM1 GSM2 GSM3 CDMA1 CDMA2 CDMA3 EVDO1 EVDO2 EVDO3 LTETdd1 LTETdd2 LTETdd3 TDSCdma1 TDSCdma2 TDSCdma3 [:SENSE]:CARRier<n>:FORMat ?
Example	CARR10:FORM LTEF1 CARR10:FORM?
Notes	The command is used with a sub-op code <n> (default=1) to specify the carrier for configuration. The range of the sub-op code is determined by the number of carriers.
Dependencies	The following licenses are required for each key to be displayed. Without the licenses, corresponding enum values cannot be set even via the SCPI command. <ul style="list-style-type: none"> • LTE FDD - N9080A-1FP or W9080A-1FP • W-CDMA - N9073A-1FP or W9073A-1FP • GSM/EDGE - N9071A-2FP or W9071A-2FP • cdma2000 - N9072A-2FP or W9072A-2FP • 1xEV-DO - N9076A-1FP or W9076A-1FP • LTE TDD - N9082A-1FP or W9082A-1FP • TD-SCDMA - N9079A-1FP or W9079A-1FP
State Saved	Saved in instrument state
Range	None LTE FDD [Parameter Set 1] Parameter Set 1 ("LTE FDD 1") Parameter Set 2 ("LTE FDD 2") Parameter Set 3 ("LTE FDD 3") W-CDMA [Parameter Set 1] Parameter Set 1 ("W-CDMA 1") Parameter Set 2 ("W-CDMA 2") Parameter Set 3 ("W-CDMA 3") GSM/EDGE [Parameter Set 1] Parameter Set 1 ("GSM/EDGE 1") Parameter Set 2 ("GSM/EDGE 2") Parameter Set 3 ("GSM/EDGE 3") cdma2000 [Parameter Set 1] Parameter Set 1 ("cdma2000 1") Parameter Set 2 ("cdma2000 2") Parameter Set 3 ("cdma2000 3") 1xEV-DO [Parameter Set 1] Parameter Set 1 ("1xEV-DO 1") Parameter Set 2 ("1xEV-DO 2") Parameter Set 3 ("1xEV-DO 3")

	LTE TDD [Parameter Set 1] Parameter Set 1 ("LTE TDD 1") Parameter Set 2 ("LTE TDD 2") Parameter Set 3 ("LTE TDD 3") TD-SCDMA [Parameter Set 1] Parameter Set 1 ("TD-SCDMA 1") Parameter Set 2 ("TD-SCDMA 2") Parameter Set 3 ("TD-SCDMA 3")
Readback	The readback line on this key shows the currently selected Radio Format in square brackets.
Initial S/W Revision	A.10.00
Modified at S/W Revision	A.12.00, A.16.00

Carrier Allocation

Specifies the carrier frequency allocation. There are two types of allocation, contiguous and non-contiguous. Non-Contiguous frequency allocation is defined as an allocation where two sub-blocks are separated with a sub-block gap.

Contiguous – All the carriers belong to one block and no sub-block gap exists.

Non-Contiguous – Carriers are separated into two sub-blocks. Allocation Break Pt Carrier determines how sub-blocks are configured.

Key Path	FREQ Channel, Carrier Setup
Scope	Meas Global
Remote Command	[:SENSe]:CARRier:CONFig:ALLocation CONTiguous NCONtiguous [:SENSe]:CARRier:CONFig:ALLocation?
Example	CARR:CONF:ALL CONT CARR:CONF:ALL?
Preset	CONTiguous
State Saved	Saved in instrument state.
Range	Contiguous Non-Contiguous
Initial S/W Revision	A.13.00

Non-Contiguous

Opens a menu that enables you to set a non-contiguous parameter.

Key Path	FREQ Channel, Carrier Setup, Carrier Allocation
Initial S/W Revision	A.13.00

Allocation Break Pt Carrier

Specifies an allocation break point in non-contiguous carrier allocation. First sub-block starts from the lowest frequency carrier and stops at the allocation break point carrier. Next sub-block starts from the next upper frequency carrier and ends at the highest frequency carrier.

Two examples are shown below. In these examples carrier indices are not in the order of carrier frequency. In the first example, Allocation Break Pt Carrier is 2. It means that sub-block 1 ends at carrier 2 and sub-block 2 starts at carrier 5. Sub-block gap is located between carrier 2 and 5. In the second example, Allocation Break Pt Carrier is 3 and the sub-block gap comes between carrier 3 and 2.

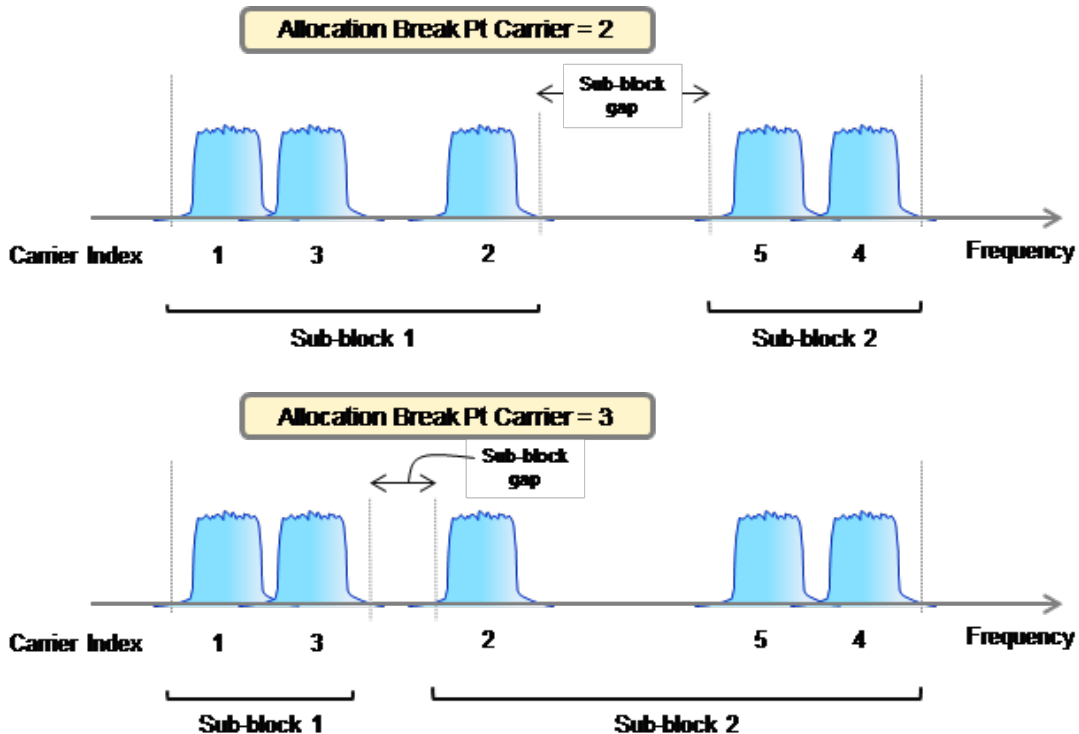

Key Path	FREQ Channel, Carrier Setup, Carrier Allocation, Non-Contiguous
Scope	Meas Global
Remote Command	<code>[[:SENSE]:CARRIER:CONFIG:ALLOCATION:NCONTIGUOUS:ABPOINT <integer></code> <code>[[:SENSE]:CARRIER:CONFIG:ALLOCATION:NCONTIGUOUS:ABPOINT?</code>
Example	<code>CARR:CONF:ALL:NCON:ABP 5</code> <code>CARR:CONF:ALL:NCON:ABP?</code>
Dependencies	The maximum value depends on the number of carriers.
Couplings	This value can change when you decrease the number of carriers.
Preset	1
State Saved	Saved in instrument state.
Min	1
Max	99
Initial S/W Revision	A.13.00

Carrier Conf Presets

Pressing this key pops up Conf Presets. Each parameter under this menu initiate carrier configuration preset when its value is changed.

Appropriate licenses are required to select carrier config enum. Required licenses are shown here. Note that N/W means N or W license, i.e. N/W9073A-1FP means either N9073A-1FP or W9073A-1FP is required.

TC1a (FDD): N/W9073A-1FP (W-CDMA)

TC2 (FDD): N/W9080A-1FP (LTE FDD)

TC3a (FDD): N/W9073A-1FP (W-CDMA) and N9080A-1FP (LTE FDD)

TC4a (FDD): N/W9071A-2FP (GSM/EDGE) and N/W9073A-1FP (W-CDMA)

TC4b (FDD): N/W9071A-2FP (GSM/EDGE) and N9080A-1FP (LTE FDD)

TC4c (FDD): N/W9071A-2FP (GSM/EDGE), N/W9073A-1FP (W-CDMA) and N9080A-1FP (LTE FDD)

TC4d (FDD): N/W9071A-2FP (GSM/EDGE) and N/W9073A-1FP (W-CDMA)

TC4e (FDD): N/W9071A-2FP (GSM/EDGE) and N9080A-1FP (LTE FDD)

TC4a (FDD) Two Carriers: N/W9071A-2FP (GSM/EDGE) and N/W9073A-1FP (W-CDMA)

TC4b (FDD) Two Carriers: N/W9071A-2FP (GSM/EDGE) and N9080A-1FP (LTE FDD)

TC4c (FDD) Two Carriers: N/W9071A-2FP (GSM/EDGE), N/W9073A-1FP (W-CDMA) and N9080A-1FP (LTE FDD)

NTC1a (FDD): N/W9073A-1FP (W-CDMA)

NTC2 (FDD): N/W9080A-1FP (LTE FDD)

NTC3a (FDD): N/W9073A-1FP (W-CDMA) and N9080A-1FP (LTE FDD)

NTC4a (FDD): N/W9071A-2FP (GSM/EDGE) and N/W9073A-1FP (W-CDMA)

NTC4b (FDD): N/W9071A-2FP (GSM/EDGE) and N9080A-1FP (LTE FDD)

NTC4c (FDD): N/W9071A-2FP (GSM/EDGE), N/W9073A-1FP (W-CDMA) and N9080A-1FP (LTE FDD)

LTE FDD: N/W9080A-1FP (LTE FDD)

W-CDMA: N/W9073A-1FP (W-CDMA)

GSM/EDGE: N/W9071A-2FP (GSM/EDGE)

cdma2000: N/W9072A-2FP (cdma2000)

1xEV-DO: N/W9076A-1FP (1xEV-DO)

Enum keys don't appear on the menu if required licenses are not installed.

Key Path	FREQ Channel, Carrier Setup
----------	-----------------------------

Remote Command	[:SENSe] :CARRier:CONFig?
Example	CARR:CONF TC1AFDD CARR:CONF?
Notes	The softkey for NONE is not available.
State Saved	Saved in instrument state
Initial S/W Revision	A.10.00
Modified at S/W Revision	A.12.00, A.13.00

MSR Test Config

Accesses the menu to select MSR Test Configurations.

Key Path	FREQ Channel, Carrier Setup
Initial S/W Revision	A.10.00

Carrier Conf Presets

Pressing this key pops up Conf Presets. Each parameter under this menu initiate carrier configuration preset when its value is changed.

Appropriate licenses are required to select carrier config enum. Required licenses are shown here. Note that N/W means N or W license, i.e. N/W9073A-1FP means either N9073A-1FP or W9073A-1FP is required.

TC1a (FDD): N/W9073A-1FP (W-CDMA)

TC2 (FDD): N/W9080A-1FP (LTE FDD)

TC3a (FDD): N/W9073A-1FP (W-CDMA) and N9080A-1FP (LTE FDD)

TC4a (FDD): N/W9071A-2FP (GSM/EDGE) and N/W9073A-1FP (W-CDMA)

TC4b (FDD): N/W9071A-2FP (GSM/EDGE) and N9080A-1FP (LTE FDD)

TC4c (FDD): N/W9071A-2FP (GSM/EDGE), N/W9073A-1FP (W-CDMA) and N9080A-1FP (LTE FDD)

TC4d (FDD): N/W9071A-2FP (GSM/EDGE) and N/W9073A-1FP (W-CDMA)

TC4e (FDD): N/W9071A-2FP (GSM/EDGE) and N9080A-1FP (LTE FDD)

TC4a (FDD) Two Carriers: N/W9071A-2FP (GSM/EDGE) and N/W9073A-1FP (W-CDMA)

TC4b (FDD) Two Carriers: N/W9071A-2FP (GSM/EDGE) and N9080A-1FP (LTE FDD)

TC4c (FDD) Two Carriers: N/W9071A-2FP (GSM/EDGE), N/W9073A-1FP (W-CDMA) and N9080A-1FP (LTE FDD)

NTC1a (FDD): N/W9073A-1FP (W-CDMA)

NTC2 (FDD): N/W9080A-1FP (LTE FDD)

NTC3a (FDD): N/W9073A-1FP (W-CDMA) and N9080A-1FP (LTE FDD)

NTC4a (FDD): N/W9071A-2FP (GSM/EDGE) and N/W9073A-1FP (W-CDMA)

NTC4b (FDD): N/W9071A-2FP (GSM/EDGE) and N9080A-1FP (LTE FDD)

NTC4c (FDD): N/W9071A-2FP (GSM/EDGE), N/W9073A-1FP (W-CDMA) and N9080A-1FP (LTE FDD)

LTE FDD: N/W9080A-1FP (LTE FDD)

W-CDMA: N/W9073A-1FP (W-CDMA)

GSM/EDGE: N/W9071A-2FP (GSM/EDGE)

cdma2000: N/W9072A-2FP (cdma2000)

1xEV-DO: N/W9076A-1FP (1xEV-DO)

Enum keys don't appear on the menu if required licenses are not installed.

Key Path	FREQ Channel, Carrier Setup
Remote Command	<code>[:SENSe] :CARRier:CONFig?</code>
Example	CARR:CONF TC1AFDD CARR:CONF?
Notes	The softkey for NONE is not available.
State Saved	Saved in instrument state
Initial S/W Revision	A.10.00
Modified at S/W Revision	A.12.00, A.13.00

Max W-CDMA Carriers (FDD)

Sets max W-CDMA carriers placed when the carrier configuration preset runs. When this value is changed, the carrier configuration preset is initiated.

Key Path	FREQ Channel, Carrier Setup, Carrier Conf Presets, MSR Test Config, TC1a (FDD)FREQ Channel, Carrier Setup, Carrier Conf Presets, MSR Test Config, TC3a (FDD)FREQ Channel, Carrier Setup, Carrier Conf Presets, MSR Test Config, TC4a (FDD)FREQ Channel, Carrier Setup, Carrier Conf Presets, MSR Test Config, TC4c (FDD)FREQ Channel, Carrier Setup, Carrier Conf Presets, Single RAT Config, W-CDMA
Remote Command	<code>[:SENSe] :CARRier:CONFig:WCDMa:CMAx <integer></code> <code>[:SENSe] :CARRier:CONFig:WCDMa:CMAx?</code>
Example	CARR:CONF:WCDM:CMAx 8 CARR:CONF:WCDM:CMAx?
Preset	100
State Saved	Saved in instrument state

Min	1
Max	100
Initial S/W Revision	A.10.00

Max LTE FDD Carriers

Sets max LTE FDD carriers placed when the carrier configuration preset runs. When this value is changed, the carrier configuration preset is initiated.

Key Path	FREQ Channel, Carrier Setup, Carrier Conf Presets, MSR Test Config, TC2 (FDD)FREQ Channel, Carrier Setup, Carrier Conf Presets, MSR Test Config, TC3a (FDD)FREQ Channel, Carrier Setup, Carrier Conf Presets, MSR Test Config, TC4b (FDD)FREQ Channel, Carrier Setup, Carrier Conf Presets, MSR Test Config, TC4c (FDD)FREQ Channel, Carrier Setup, Carrier Conf Presets, Single RAT Config, LTE FDD
Remote Command	<code>[:SENSe] :CARRier:CONFig:LTEFdd:CMAx <integer></code> <code>[:SENSe] :CARRier:CONFig:LTEFdd:CMAx?</code>
Example	CARR:CONF:LTEF:CMAx 8 CARR:CONF:LTEF:CMAx?
Preset	100
State Saved	Saved in instrument state
Min	1
Max	100
Initial S/W Revision	A.10.00

LTE FDD BW

Sets bandwidth of LTE FDD carriers placed when the carrier configuration preset runs. When this value is changed, the carrier configuration preset is initiated.

Key Path	FREQ Channel, Carrier Setup, Carrier Conf Presets, MSR Test Config, TC2 (FDD)FREQ Channel, Carrier Setup, Carrier Conf Presets, MSR Test Config, TC3a (FDD)FREQ Channel, Carrier Setup, Carrier Conf Presets, MSR Test Config, TC4b (FDD)FREQ Channel, Carrier Setup, Carrier Conf Presets, MSR Test Config, TC4c (FDD)FREQ Channel, Carrier Setup, Carrier Conf Presets, MSR Test Config, TC4d (FDD)FREQ Channel, Carrier Setup, Carrier Conf Presets, Single RAT Config, LTE FDD
Remote Command	<code>[:SENSe] :CARRier:CONFig:LTEFdd:BA NDwidth B1M4 B3M B5M B10M B15M B20M</code> <code>[:SENSe] :CARRier:CONFig:LTEFdd:BA NDwidth?</code>
Example	CARR:CONF:LTEF:BA ND B5M CARR:CONF:LTEF:BA ND?
Preset	B5M

State Saved	Saved in instrument state
Range	1.4MHz 3MHz 5MHz 10MHz 15MHz 20MHz
Readback	The currently selected LTE FDD BW
Initial S/W Revision	A.10.00

Narrowest LTE FDD BW

Sets narrowest bandwidth of LTE FDD carriers placed for TC2 when the carrier configuration preset runs. When this value is changed, the carrier configuration preset is initiated.

Key Path	FREQ Channel, Carrier Setup, Carrier Conf Presets, MSR Test Config, TC2 (FDD)
Remote Command	<code>[[:SENSe]:CARRier:CONFig:LTEFdd:BANDwidth:NARRowest B1M4 B3M B5M B10M B15M B20M</code> <code>[[:SENSe]:CARRier:CONFig:LTEFdd:BANDwidth:NARRowest?</code>
Example	CARR:CONF:LTEF:BAND:NARR B1M4 CARR:CONF:LTEF:BAND:NARR?
Preset	B1M4
State Saved	Saved in instrument state
Range	1.4MHz 3MHz 5MHz 10MHz 15MHz 20MHz
Readback	The currently selected Narrowest LTE FDD BW
Initial S/W Revision	A.10.00

Max GSM/EDGE Carriers

Sets max GSM/EDGE carriers placed when the carrier configuration preset runs. When this value is changed, the carrier configuration preset is initiated.

Key Path	FREQ Channel, Carrier Setup, Carrier Conf Presets, MSR Test Config, TC4a (FDD)FREQ Channel, Carrier Setup, Carrier Conf Presets, MSR Test Config, TC4b (FDD)FREQ Channel, Carrier Setup, Carrier Conf Presets, MSR Test Config, TC4c (FDD)FREQ Channel, Carrier Setup, Carrier Conf Presets, Single RAT Config, GSM/EDGE
Remote Command	<code>[[:SENSe]:CARRier:CONFig:GSM:CMAX <integer></code> <code>[[:SENSe]:CARRier:CONFig:GSM:CMAX?</code>
Example	CARR:CONF:GSM:CMAX 8 CARR:CONF:GSM:CMAX?
Preset	100
State Saved	Saved in instrument state
Min	1
Max	100
Initial S/W Revision	A.10.00

LTE FDD Location

Sets the location of LTE FDD carriers when carriers are configured as TC4c. This parameter is effective only for TC4c.

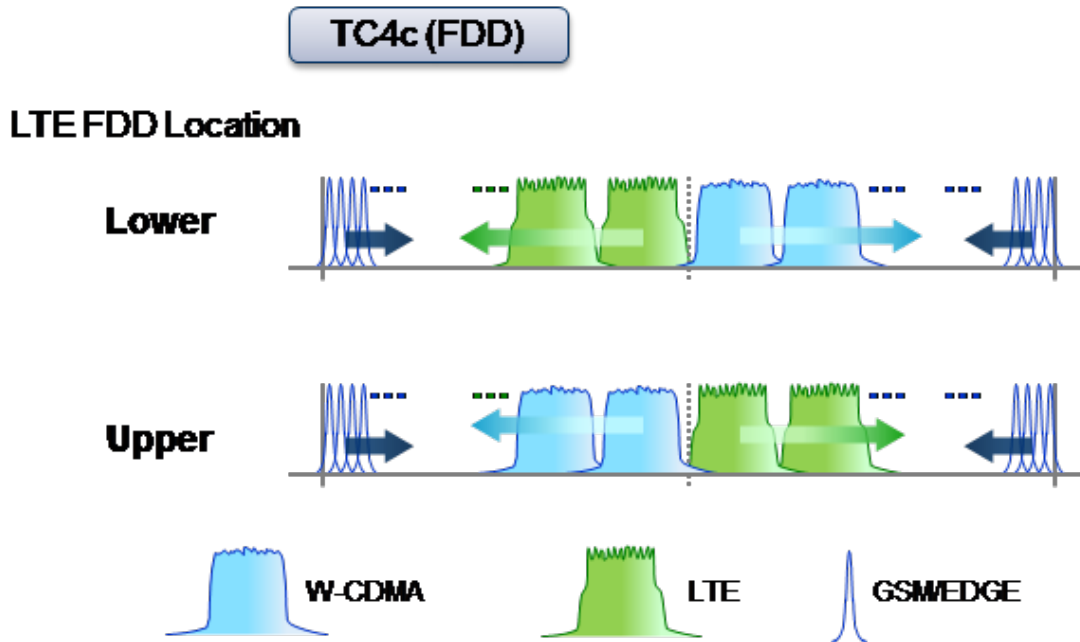

Key Path	FREQ Channel, Carrier Setup, Carrier Conf Presets, MSR Test Config, TC4c (FDD)
Remote Command	<code>[:SENSe] :CARRier:CONFig:LTEFdd:LOCation UPPer LOWer</code> <code>[:SENSe] :CARRier:CONFig:LTEFdd:LOCation?</code>
Example	<code>CARR:CONF:LTEF:LOC LOW</code> <code>CARR:CONF:LTEF:LOC?</code>
Notes	This setting is effective only for TC4c.
Preset	UPPer
State Saved	Saved in instrument state
Range	Lower (Lower than W-CDMA) Upper (Higher than W-CDMA)
Initial S/W Revision	A.11.00

MSR Non-Contig Test Config

Accesses the menu to select MSR Non-Contiguous Test Configurations.

Key Path	FREQ Channel, Carrier Setup
Initial S/W Revision	A.13.00

Carrier Conf Presets

Pressing this key pops up Conf Presets. Each parameter under this menu initiate carrier configuration preset when its value is changed.

Appropriate licenses are required to select carrier config enum. Required licenses are shown here. Note that N/W means N or W license, i.e. N/W9073A-1FP means either N9073A-1FP or W9073A-1FP is required.

TC1a (FDD): N/W9073A-1FP (W-CDMA)

TC2 (FDD): N/W9080A-1FP (LTE FDD)

TC3a (FDD): N/W9073A-1FP (W-CDMA) and N9080A-1FP (LTE FDD)

TC4a (FDD): N/W9071A-2FP (GSM/EDGE) and N/W9073A-1FP (W-CDMA)

TC4b (FDD): N/W9071A-2FP (GSM/EDGE) and N9080A-1FP (LTE FDD)

TC4c (FDD): N/W9071A-2FP (GSM/EDGE), N/W9073A-1FP (W-CDMA) and N9080A-1FP (LTE FDD)

TC4d (FDD): N/W9071A-2FP (GSM/EDGE) and N/W9073A-1FP (W-CDMA)

TC4e (FDD): N/W9071A-2FP (GSM/EDGE) and N9080A-1FP (LTE FDD)

TC4a (FDD) Two Carriers: N/W9071A-2FP (GSM/EDGE) and N/W9073A-1FP (W-CDMA)

TC4b (FDD) Two Carriers: N/W9071A-2FP (GSM/EDGE) and N9080A-1FP (LTE FDD)

TC4c (FDD) Two Carriers: N/W9071A-2FP (GSM/EDGE), N/W9073A-1FP (W-CDMA) and N9080A-1FP (LTE FDD)

NTC1a (FDD): N/W9073A-1FP (W-CDMA)

NTC2 (FDD): N/W9080A-1FP (LTE FDD)

NTC3a (FDD): N/W9073A-1FP (W-CDMA) and N9080A-1FP (LTE FDD)

NTC4a (FDD): N/W9071A-2FP (GSM/EDGE) and N/W9073A-1FP (W-CDMA)

NTC4b (FDD): N/W9071A-2FP (GSM/EDGE) and N9080A-1FP (LTE FDD)

NTC4c (FDD): N/W9071A-2FP (GSM/EDGE), N/W9073A-1FP (W-CDMA) and N9080A-1FP (LTE FDD)

LTE FDD: N/W9080A-1FP (LTE FDD)

W-CDMA: N/W9073A-1FP (W-CDMA)

GSM/EDGE: N/W9071A-2FP (GSM/EDGE)

cdma2000: N/W9072A-2FP (cdma2000)

1xEV-DO: N/W9076A-1FP (1xEV-DO)

Enum keys don't appear on the menu if required licenses are not installed.

Key Path	FREQ Channel, Carrier Setup
Remote Command	[:SENSe] :CARRier :CONFig?

Example	CARR:CONF TC1AFDD CARR:CONF?
Notes	The softkey for NONE is not available.
State Saved	Saved in instrument state
Initial S/W Revision	A.10.00
Modified at S/W Revision	A.12.00, A.13.00

LTE FDD BW

Sets bandwidth of LTE FDD carriers placed when the carrier configuration preset runs. When this value is changed, the carrier configuration preset is initiated.

Key Path	FREQ Channel, Carrier Setup, Carrier Conf Presets, MSR Test Config, TC2 (FDD)FREQ Channel, Carrier Setup, Carrier Conf Presets, MSR Test Config, TC3a (FDD)FREQ Channel, Carrier Setup, Carrier Conf Presets, MSR Test Config, TC4b (FDD)FREQ Channel, Carrier Setup, Carrier Conf Presets, MSR Test Config, TC4c (FDD)FREQ Channel, Carrier Setup, Carrier Conf Presets, MSR Test Config, TC4d (FDD)FREQ Channel, Carrier Setup, Carrier Conf Presets, Single RAT Config, LTE FDD
Remote Command	[:SENSe] :CARRier:CONFig:LTEFdd:BANDwidth B1M4 B3M B5M B10M B15M B20M [:SENSe] :CARRier:CONFig:LTEFdd:BANDwidth?
Example	CARR:CONF:LTEF:BAND B5M CARR:CONF:LTEF:BAND?
Preset	B5M
State Saved	Saved in instrument state
Range	1.4MHz 3MHz 5MHz 10MHz 15MHz 20MHz
Readback	The currently selected LTE FDD BW
Initial S/W Revision	A.10.00

NTC4 Carriers

Sets NTC4 carriers placed when the NTC4 carrier configuration preset runs. When this value is changed, the carrier configuration preset is initiated.

Key Path	FREQ Channel, Carrier Setup, Carrier Conf Presets, MSR Non-Contig Test Config, NTC4a (FDD)FREQ Channel, Carrier Setup, Carrier Conf Presets, MSR Non-Contig Test Config, NTC4b (FDD)FREQ Channel, Carrier Setup, Carrier Conf Presets, MSR Non-Contig Test Config, NTC4c(FDD)
Remote Command	[:SENSe] :CARRier:CONFig:NTC4:COUNT <integer> [:SENSe] :CARRier:CONFig:NTC4:COUNT?
Example	CARR:CONF:NTC4:COUN 6 CARR:CONF:NTC4:COUN?

Preset	6
State Saved	Saved in instrument state
Min	3
Max	6
Initial S/W Revision	A.13.00

Single RAT Config

Accesses the menu to select Single RAT Configurations.

Key Path	FREQ Channel, Carrier Setup
Initial S/W Revision	A.10.00

Carrier Conf Presets

Pressing this key pops up Conf Presets. Each parameter under this menu initiate carrier configuration preset when its value is changed.

Appropriate licenses are required to select carrier config enum. Required licenses are shown here. Note that N/W means N or W license, i.e. N/W9073A-1FP means either N9073A-1FP or W9073A-1FP is required.

TC1a (FDD): N/W9073A-1FP (W-CDMA)

TC2 (FDD): N/W9080A-1FP (LTE FDD)

TC3a (FDD): N/W9073A-1FP (W-CDMA) and N9080A-1FP (LTE FDD)

TC4a (FDD): N/W9071A-2FP (GSM/EDGE) and N/W9073A-1FP (W-CDMA)

TC4b (FDD): N/W9071A-2FP (GSM/EDGE) and N9080A-1FP (LTE FDD)

TC4c (FDD): N/W9071A-2FP (GSM/EDGE), N/W9073A-1FP (W-CDMA) and N9080A-1FP (LTE FDD)

TC4d (FDD): N/W9071A-2FP (GSM/EDGE) and N/W9073A-1FP (W-CDMA)

TC4e (FDD): N/W9071A-2FP (GSM/EDGE) and N9080A-1FP (LTE FDD)

TC4a (FDD) Two Carriers: N/W9071A-2FP (GSM/EDGE) and N/W9073A-1FP (W-CDMA)

TC4b (FDD) Two Carriers: N/W9071A-2FP (GSM/EDGE) and N9080A-1FP (LTE FDD)

TC4c (FDD) Two Carriers: N/W9071A-2FP (GSM/EDGE), N/W9073A-1FP (W-CDMA) and N9080A-1FP (LTE FDD)

NTC1a (FDD): N/W9073A-1FP (W-CDMA)

NTC2 (FDD): N/W9080A-1FP (LTE FDD)

NTC3a (FDD): N/W9073A-1FP (W-CDMA) and N9080A-1FP (LTE FDD)

NTC4a (FDD): N/W9071A-2FP (GSM/EDGE) and N/W9073A-1FP (W-CDMA)

NTC4b (FDD): N/W9071A–2FP (GSM/EDGE) and N9080A–1FP (LTE FDD)

NTC4c (FDD): N/W9071A–2FP (GSM/EDGE), N/W9073A–1FP (W-CDMA) and N9080A–1FP (LTE FDD)

LTE FDD: N/W9080A–1FP (LTE FDD)

W-CDMA: N/W9073A–1FP (W-CDMA)

GSM/EDGE: N/W9071A–2FP (GSM/EDGE)

cdma2000: N/W9072A–2FP (cdma2000)

1xEV-DO: N/W9076A–1FP (1xEV-DO)

Enum keys don't appear on the menu if required licenses are not installed.

Key Path	FREQ Channel, Carrier Setup
Remote Command	[:SENSe] :CARRier:CONFIg?
Example	CARR:CONF TC1AFDD CARR:CONF?
Notes	The softkey for NONE is not available.
State Saved	Saved in instrument state
Initial S/W Revision	A.10.00
Modified at S/W Revision	A.12.00, A.13.00

Max LTE FDD Carriers

Sets max LTE FDD carriers placed when the carrier configuration preset runs. When this value is changed, the carrier configuration preset is initiated.

Key Path	FREQ Channel, Carrier Setup, Carrier Conf Presets, MSR Test Config, TC2 (FDD)FREQ Channel, Carrier Setup, Carrier Conf Presets, MSR Test Config, TC3a (FDD)FREQ Channel, Carrier Setup, Carrier Conf Presets, MSR Test Config, TC4b (FDD)FREQ Channel, Carrier Setup, Carrier Conf Presets, MSR Test Config, TC4c (FDD)FREQ Channel, Carrier Setup, Carrier Conf Presets, Single RAT Config, LTE FDD
Remote Command	[:SENSe] :CARRier:CONFIg:LTEFdd:CMAx <integer> [:SENSe] :CARRier:CONFIg:LTEFdd:CMAx?
Example	CARR:CONF:LTEF:CMAx 8 CARR:CONF:LTEF:CMAx?
Preset	100
State Saved	Saved in instrument state
Min	1
Max	100
Initial S/W Revision	A.10.00

LTE FDD BW

Sets bandwidth of LTE FDD carriers placed when the carrier configuration preset runs. When this value is changed, the carrier configuration preset is initiated.

Key Path	FREQ Channel, Carrier Setup, Carrier Conf Presets, MSR Test Config, TC2 (FDD)FREQ Channel, Carrier Setup, Carrier Conf Presets, MSR Test Config, TC3a (FDD)FREQ Channel, Carrier Setup, Carrier Conf Presets, MSR Test Config, TC4b (FDD)FREQ Channel, Carrier Setup, Carrier Conf Presets, MSR Test Config, TC4c (FDD)FREQ Channel, Carrier Setup, Carrier Conf Presets, MSR Test Config, TC4d (FDD)FREQ Channel, Carrier Setup, Carrier Conf Presets, Single RAT Config, LTE FDD
Remote Command	[:SENSe] :CARRier:CONFig:LTEFdd:Bandwidth B1M4 B3M B5M B10M B15M B20M [:SENSe] :CARRier:CONFig:LTEFdd:Bandwidth?
Example	CARR:CONF:LTEF:Band B5M CARR:CONF:LTEF:Band?
Preset	B5M
State Saved	Saved in instrument state
Range	1.4MHz 3MHz 5MHz 10MHz 15MHz 20MHz
Readback	The currently selected LTE FDD BW
Initial S/W Revision	A.10.00

Max W-CDMA Carriers (FDD)

Sets max W-CDMA carriers placed when the carrier configuration preset runs. When this value is changed, the carrier configuration preset is initiated.

Key Path	FREQ Channel, Carrier Setup, Carrier Conf Presets, MSR Test Config, TC1a (FDD)FREQ Channel, Carrier Setup, Carrier Conf Presets, MSR Test Config, TC3a (FDD)FREQ Channel, Carrier Setup, Carrier Conf Presets, MSR Test Config, TC4a (FDD)FREQ Channel, Carrier Setup, Carrier Conf Presets, MSR Test Config, TC4c (FDD)FREQ Channel, Carrier Setup, Carrier Conf Presets, Single RAT Config, W-CDMA
Remote Command	[:SENSe] :CARRier:CONFig:WCDMa:CMAx <integer> [:SENSe] :CARRier:CONFig:WCDMa:CMAx?
Example	CARR:CONF:WCDM:CMAx 8 CARR:CONF:WCDM:CMAx?
Preset	100
State Saved	Saved in instrument state
Min	1
Max	100
Initial S/W Revision	A.10.00

Max GSM/EDGE Carriers

Sets max GSM/EDGE carriers placed when the carrier configuration preset runs. When this value is changed, the carrier configuration preset is initiated.

Key Path	FREQ Channel, Carrier Setup, Carrier Conf Presets, MSR Test Config, TC4a (FDD)FREQ Channel, Carrier Setup, Carrier Conf Presets, MSR Test Config, TC4b (FDD)FREQ Channel, Carrier Setup, Carrier Conf Presets, MSR Test Config, TC4c (FDD)FREQ Channel, Carrier Setup, Carrier Conf Presets, Single RAT Config, GSM/EDGE
Remote Command	<code>[:SENSe] :CARRier:CONFig:GSM:CMAX <integer></code> <code>[:SENSe] :CARRier:CONFig:GSM:CMAX?</code>
Example	CARR:CONF:GSM:CMAX 8 CARR:CONF:GSM:CMAX?
Preset	100
State Saved	Saved in instrument state
Min	1
Max	100
Initial S/W Revision	A.10.00

Max cdma2000 Carriers

Sets max cdma2000 carriers placed when the carrier configuration preset runs. When this value is changed, the carrier configuration preset is initiated.

Key Path	FREQ Channel, Carrier Setup, Carrier Conf Presets, Single RAT Config, cdma2000
Remote Command	<code>[:SENSe] :CARRier:CONFig:CDMA:CMAX <integer></code> <code>[:SENSe] :CARRier:CONFig:CDMA:CMAX?</code>
Example	CARR:CONF:CDMA:CMAX 8 CARR:CONF:CDMA:CMAX?
Preset	100
State Saved	Saved in instrument state
Min	1
Max	100
Initial S/W Revision	A.12.00

Max 1xEV-DO Carriers

Sets max 1xEV-DO carriers placed when the carrier configuration preset runs. When this value is changed, the carrier configuration preset is initiated.

Key Path	FREQ Channel, Carrier Setup, Carrier Conf Presets, Single RAT Config, 1xEV-DO
Remote Command	<code>[:SENSe] :CARRier:CONFig:EVDO:CMAX <integer></code>

	<code>[:SENSe] :CARRier:CONFig:EVDO:CMAx?</code>
Example	<code>CARR:CONF:EVDO:CMAx 8</code> <code>CARR:CONF:EVDO:CMAx?</code>
Preset	100
State Saved	Saved in instrument state
Min	1
Max	100
Initial S/W Revision	A.12.00

Max BS RF Bandwidth

Sets max BS RF bandwidth used when the carrier configuration preset runs. When this value is changed, the carrier configuration preset is initiated.

Key Path	FREQ Channel, Carrier Setup, Carrier Conf Presets
Remote Command	<code>[:SENSe] :CARRier:CONFig:RFBWidth <freq></code> <code>[:SENSe] :CARRier:CONFig:RFBWidth?</code>
Example	<code>CARR:CONF:RFBW 40MHz</code> <code>CARR:CONF:RFBW?</code>
Preset	40MHz
State Saved	Saved in instrument state
Min	600 kHz
Max	200 MHz
Initial S/W Revision	A.10.00

Channel Spacing Delta

Carriers are placed based on channel spacing assigned to the corresponding radio format, when they are configured by the carrier config preset. However, channel spacing can be adjusted using channel spacing delta parameters.

This key accesses the menu to set channel spacing delta of each radio format.

Key Path	FREQ Channel, Carrier Setup, Carrier Conf Presets
Initial S/W Revision	A.10.00

LTE FDD

Sets delta channel spacing for LTE FDD used when the carrier configuration preset runs. Channel spacing for LTE FDD is determined from this value and the default channel spacing defined in the standard, i.e. Channel spacing = (BWchan1 + BWchan2) * 0.5 + [the delta spacing]. Since this value is a difference from

the default spacing, this value can be negative to allow narrower channel spacing. When this value is changed, the carrier configuration preset is initiated.

Key Path	FREQ Channel, Carrier Setup, Carrier Conf Presets, Channel Spacing Delta
Remote Command	[:SENSE] :CARRier:CONFig:LTEFdd:SPACing:DELTA <freq> [:SENSE] :CARRier:CONFig:LTEFdd:SPACing:DELTA?
Example	CARR:CONF:LTEF:SPAC:DELT -200kHz CARR:CONF:LTEF:SPAC:DELT?
Preset	0Hz
State Saved	Saved in instrument state
Min	- 1.0 MHz
Max	10.0 MHz
Initial S/W Revision	A.10.00
Modified at S/W Revision	A.11.00

W-CDMA

Sets delta channel spacing for W-CDMA used when the carrier configuration preset runs. Channel spacing for W-CDMA is determined from this value and the default channel spacing defined in the standard, i.e. Channel spacing = 5.0 MHz + [the delta spacing]. Since this value is a difference from the default spacing, this value can be negative to allow narrower channel spacing. When this value is changed, the carrier configuration preset is initiated.

Key Path	FREQ Channel, Carrier Setup, Carrier Conf Presets, Channel Spacing Delta
Remote Command	[:SENSE] :CARRier:CONFig:WCDMa:SPACing:DELTA <freq> [:SENSE] :CARRier:CONFig:WCDMa:SPACing:DELTA?
Example	CARR:CONF:WCDM:SPAC:DELT 0 CARR:CONF:WCDM:SPAC:DELT?
Preset	0 Hz
State Saved	Saved in instrument state
Min	- 1.0 MHz
Max	10.0 MHz
Initial S/W Revision	A.10.00
Modified at S/W Revision	A.11.00

GSM/EDGE

Sets delta channel spacing for GSM/EDGE used when the carrier configuration preset runs. Channel spacing for GSM/EDGE is determined from this value and the default channel spacing defined in the standard, i.e. Channel spacing = 600 kHz + [the delta spacing]. Since this value is a difference from the default spacing, this value can be negative to allow narrower channel spacing. When this value is changed, the carrier configuration preset is initiated.

Key Path	FREQ Channel, Carrier Setup, Carrier Conf Presets, Channel Spacing Delta
Remote Command	[:SENSe] :CARRier:CONFig:GSM:SPACing:DELTA <freq> [:SENSe] :CARRier:CONFig:GSM:SPACing:DELTA?
Example	CARR:CONF:GSM:SPAC:DELT 0 CARR:CONF:GSM:SPAC:DELT?
Preset	0 Hz
State Saved	Saved in instrument state
Min	- 0.4 MHz
Max	10.0 MHz
Initial S/W Revision	A.10.00
Modified at S/W Revision	A.11.00

cdma2000

Sets delta channel spacing for cdma2000 used when the carrier configuration preset runs. Channel spacing for cdma2000 is determined from this value and the default channel spacing defined in the standard, i.e. Channel spacing = 1.25 MHz + [the delta spacing]. Since this value is a difference from the default spacing, this value can be negative to allow narrower channel spacing.

Key Path	FREQ Channel, Carrier Setup, Carrier Conf Presets, Channel Spacing Delta
Remote Command	[:SENSe] :CARRier:CONFig:CDMA:SPACing:DELTA <freq> [:SENSe] :CARRier:CONFig:CDMA:SPACing:DELTA?
Example	CARR:CONF:CDMA:SPAC:DELT 0 CARR:CONF:CDMA:SPAC:DELT?
Preset	0 Hz
State Saved	Saved in instrument state
Min	-1 MHz
Max	10 MHz
Initial S/W Revision	A.12.00

1xEV-DO

Sets delta channel spacing for 1xEV-DO used when the carrier configuration preset runs. Channel spacing for 1xEV-DO is determined from this value and the default channel spacing defined in the standard, i.e. Channel spacing = 1.25 MHz + [the delta spacing]. Since this value is a difference from the default spacing, this value can be negative to allow narrower channel spacing.

Key Path	FREQ Channel, Carrier Setup, Carrier Conf Presets, Channel Spacing Delta
Remote Command	[:SENSe] :CARRier:CONFig:EVDO:SPACing:DELTA <freq> [:SENSe] :CARRier:CONFig:EVDO:SPACing:DELTA?

Example	CARR:CONF:EVDO:SPAC:DELT 0 CARR:CONF:EVDO:SPAC:DELT?
Preset	0 Hz
State Saved	Saved in instrument state
Min	-1 MHz
Max	10 MHz
Initial S/W Revision	A.12.00

Apply to Meas Offset/Limits

This immediate action key sets the following measurement parameters.

- ACP: Offset and limit parameters under Offset/Limits.
- Spectrum Emission Mask: Offset and limit parameters under Offset/Limits.
- Spurious Emissions: Range frequency and limit parameters under Range Table.

These offset and limit values are determined by the carrier configuration parameters, Band Category and Assumed Adj Channels.

Each of these measurement has a local key, “Apply Carrier Config to ...”, which performs in the same way only for its parameters. So pressing this key is equivalent to pressing “Apply Carrier Config to ...” of all these measurements.

Key Path	FREQ Channel, Carrier Setup
Remote Command	[:SENSe] :MCONdition:IMMEDIATE
Example	MCON:IMM
Initial S/W Revision	A.11.00

RF Bandwidth (Remote Command Only)

Returns the RF bandwidth calculated from the outermost carriers and their Foffset_RAT.

Key Path	SCPI only
Mode	MSR
Remote Command	[:SENSe] :CARRier:RFBWidth?
Example	CARR:RFBW?
Preset	Calculated from preset values of carrier config parameters
State Saved	No
Initial S/W Revision	A.13.00

RF Bandwidth Center (Remote Command Only)

Returns the center frequency of RF bandwidth.

Key Path	SCPI only
Mode	MSR
Remote Command	[:SENSe] :CARRier:RFBWidth:CENTer?
Example	CARR:RFBW:CENT?
Preset	Calculated from preset values of carrier config parameters
State Saved	No
Initial S/W Revision	A.13.00

Sub-block Center (Remote Command Only)

Returns the center frequency of sub-block when Carrier Allocation is Non-Contiguous.

Key Path	SCPI only
Mode	MSR
Remote Command	[:SENSe] :CARRier:SBLOCK[1] 2 :CENTer?
Example	CARR:SBL:CENT?
Notes	When Carrier Allocation is Contiguous, 9.91 E+37 is returned.
Preset	Calculated from preset values of carrier config parameters
State Saved	No
Initial S/W Revision	A.13.00

Sub-block Bandwidth (Remote Command Only)

Returns the bandwidth of sub-block calculated from outermost carriers and corresponding Offset_RAT.

Key Path	SCPI only
Mode	MSR
Remote Command	[:SENSe] :CARRier:SBLOCK[1] 2 :BWIDth?
Example	CARR:SBL:BWID?
Notes	When Carrier Allocation is Contiguous, 9.91 E+37 is returned.
Preset	Calculated from preset values of carrier config parameters
State Saved	No
Initial S/W Revision	A.13.00

Sub-block Gap (Remote Command Only)

Returns the sub-block gap.

Key Path	SCPI only
Mode	MSR
Remote Command	[:SENSe] :CARRier :SBLock :GAP?
Example	CARR:SBL:GAP?
Notes	When Carrier Allocation is Contiguous, 9.91E+37 is returned.
Preset	Calculated from preset values of carrier config parameters
State Saved	No
Initial S/W Revision	A.13.00

12 Spurious Emissions Measurement
Input/Output

Input/Output

See "[Input/Output](#)" on page 190

Marker

Displays the menu keys that enable you to select, set up and control the markers for the current measurement.

Key Path	Front-panel key
Initial S/W Revision	Prior to A.02.00

Select Marker

Displays 12 markers available for selection.

Key Path	Marker
Initial S/W Revision	Prior to A.02.00

Marker Type

Sets the marker control mode to **Normal**, **Delta** and **Off**. Normal enables you to activate the selected marker to read the power level and time. Delta enables you to read the differences in the power levels and time scales between the selected marker and the next marker. Off enables you to turn off the selected marker.

All interactions and dependencies detailed under the key description are enforced when the remote command is sent.

Key Path	Marker
Mode	SA, WCDMA, C2K, WIMAX OFDMA, TD-SCDMA, 1xEV-DO, DVB-T/H, LTE, LTETDD, WLAN, MSR, LTEAFDD, LTEATDD
Remote Command	:CALCulate:SPURious:MARKer[1] 2 ... 12:MODE POSITION DELTA OFF :CALCulate:SPURious:MARKer[1] 2 ... 12:MODE?
Example	CALC:SPUR:MARK:MODE POS CALC:SPUR:MARK:MODE?
Notes	<p>If the selected marker is Off, pressing Marker sets it to Normal and places it at the center of the screen on the trace determined by the Marker Trace rules. At the same time, Marker X Axis Value appears on the Active Function area.</p> <p>Default Active Function: the active function for the selected marker's current control mode. If the current control mode is Off, there is no active function and the active function is turned off.</p> <p>Active Function Display: the marker X axis value entered in the active function area will display the marker value to its full entered precision.</p> <p>You must be in the cdma2000 mode, 1xEV-DO mode, TD-SCDMA mode, W-CDMA mode, DVB-T/H mode, GSM/EDGE mode, LTE mode, LTE TDD mode, WLAN mode, MSR, LTE-Advanced FDD/TDD mode or WiMAX mode to use this command. Use INSTRument:SElect to set the mode.</p>

Preset	=OFF
State Saved	Saved in instrument state.
Range	Normal Delta Off
Initial S/W Revision	Prior to A.02.00
Modified at S/W Revision	A.03.00

Properties

Accesses the Properties menu to set certain properties of the selected marker.

Key Path	Marker
Initial S/W Revision	Prior to A.02.00

Select Marker

Displays 12 markers available for selection.

Key Path	Marker
Initial S/W Revision	Prior to A.02.00

Relative To

Selects the marker the selected marker will be relative to (its reference marker).

Every marker has another marker to which it is relative. This marker is referred to as the "reference marker" for that marker. This attribute is set by the **Marker, Properties, Relative To** key. The marker must be a **Delta** marker to make this attribute relevant. If it is a **Delta** marker, the reference marker determines how the marker is controlled and how its value is displayed. A marker cannot be relative to itself.

Key Path	Marker, Properties
Mode	SA, WCDMA, C2K, WIMAX OFDMA, TD-SCDMA, 1xEV-DO, DVB-T/H, LTE, LTE-TDD, WLAN, MSR, LTE-FDD, LTE-TDD
Remote Command	:CALCulate:SPURious:MARKer[1] 2 ... 12:REFerence <integer> :CALCulate:SPURious:MARKer[1] 2 ... 12:REFerence?
Example	CALC:SPUR:MARK3:REF 5 CALC:SPUR:MARK:REF?
Notes	A marker cannot be relative to itself so that choice is grayed out, and if sent from SCPI generates error -221: "Settings conflict; marker cannot be relative to itself." When queried a single value will be returned (the specified marker numbers relative marker). You must be in the Spectrum Analysis mode, GSM mode, LTE mode, LTE TDD mode, WLAN mode, MSR, LTE-Advanced FDD/TDD mode or WiMAX mode or TD-SCDMA mode to use this command.

	Use INSTRument:SElect to set the mode.
Preset	2 3 4 5 6 7 8 9 10 11 12 1
State Saved	Saved in instrument state.
Min	1
Max	12
Initial S/W Revision	Prior to A.02.00
Modified at S/W Revision	A.03.00

Couple Markers

When this function is true, moving any marker causes an equal X Axis movement of every other marker which is not **Off**. By “equal X Axis movement” we mean that we preserve the difference between each marker’s X Axis value (in the fundamental x-axis units of the trace that marker is on) and the X Axis value of the marker being moved (in the same fundamental x-axis units).

Key Path	Marker
Mode	SA, WCDMA, C2K, WIMAX OFDMA, TD-SCDMA, 1xEV-DO, DVB-T/H, LTE, LTETDD, WLAN, MSR, LTEAFDD, LTEATDD
Remote Command	:CALCulate:SPURious:MARKer:COUPle[:STATe] ON OFF 1 0 :CALCulate:SPURious:MARKer:COUPle[:STATe]?
Example	CALC:SPUR:MARK:COUP ON CALC:SPUR:MARK:COUP?
Preset	OFF
State Saved	Saved in instrument state.
Range	On Off
Initial S/W Revision	Prior to A.02.00
Modified at S/W Revision	A.03.00

All Markers Off

Turns off all markers.

Key Path	Marker
Mode	SA, WCDMA, C2K, WIMAX OFDMA, TD-SCDMA, 1xEV-DO, DVB-T/H, LTE, LTETDD, WLAN, MSR, LTEAFDD, LTEATDD
Remote Command	:CALCulate:SPURious:MARKer:AOFF
Example	CALC:SPUR:MARK:AOFF
Initial S/W Revision	Prior to A.02.00
Modified at S/W Revision	A.03.00

Marker X Axis Value (Remote Command only)

Sets the Marker X Axis value in the current marker X Axis Scale unit. It has no effect if the control mode is **Off**, but is the SCPI equivalent of entering an X value if the control mode is **Normal** or **Delta**.

Mode	SA, WCDMA, C2K, WIMAX OFDMA, TD-SCDMA, DVB-T/H, LTE, LTE-TDD, WLAN, MSR, LTEAFDD, LTEATDD
Remote Command	:CALCulate:SPURious:MARKer[1] 2 ... 12:X <freq> :CALCulate:SPURious:MARKer[1] 2 ... 12:X?
Example	CALC:SPUR:MARK2:X 25 kHz CALC:SPUR:MARK3:X?
Notes	If no suffix is sent it will use the fundamental units for the current marker X Axis Scale. If a suffix is sent that does not match the current marker X Axis Scale unit, an error "Invalid suffix" will be generated. The query returns the absolute X Axis marker value if the control mode is Normal, or the offset from the reference marker if the control mode is Delta. The query is returned in the fundamental units for the current marker X Axis scale: Hz for Frequency and Inverse Time, seconds for Period and Time. If the marker is Off, the response is not a number.
Preset	1 GHz
State Saved	No
Min	-9.9E+37
Max	9.9E+37
Initial S/W Revision	Prior to A.02.00
Modified at S/W Revision	A.03.00

Marker X Axis Position (Remote Command only)

Sets the Marker X position in trace points. It has no effect if the control mode is **Off**, but is the SCPI equivalent of entering a value if the control mode is **Normal** or **Delta** - except in trace points rather than X Axis Scale units. The entered value is immediately translated into the current X Axis Scale units for setting the value of the marker.

Mode	SA, WCDMA, C2K, WIMAX OFDMA, TD-SCDMA, 1xEV-DO, DVB-T/H, LTE, LTE-TDD, WLAN, MSR, LTEAFDD, LTEATDD
Remote Command	:CALCulate:SPURious:MARKer[1] 2 ... 12:X:POSition <integer> :CALCulate:SPURious:MARKer[1] 2 ... 12:X:POSition?
Example	CALC:SPUR:MARK10:X:POS 300 CALC:SPUR:MARK10:X:POS?
Notes	The query returns the absolute X Axis marker value in trace points if the control mode is Normal , or the offset from the reference marker in trace points if the control mode is Delta . The value is returned as a real number, not an integer, corresponding to the translation from X Axis Scale units to trace points. If the marker is Off the response is not a number.
Preset	300

State Saved	No
Min	-9.9E+37
Max	9.9E+37
Initial S/W Revision	Prior to A.02.00
Modified at S/W Revision	A.03.00

Marker Y Axis Value (Remote Command only)

Returns the marker Y Axis value in the current marker Y Axis unit.

Mode	SA, WCDMA, C2K, WIMAX OFDMA, TD-SCDMA, 1xEV-DO, DVB-T/H, LTE, LTE-TDD, WLAN, MSR, LTEAFDD, LTEATDD
Remote Command	:CALCulate:SPURious:MARKer[1] 2 ... 12:Y?
Example	CALC:SPUR:MARK11:Y?
Notes	If no suffix is sent, it will use the current Y Axis unit. If a suffix is sent that does not have units of absolute amplitude, an error "Invalid suffix" will be generated.
Preset	Depends on Y axis range of selected Trace.
State Saved	No
Initial S/W Revision	Prior to A.02.00
Modified at S/W Revision	A.03.00

Marker Function

There are no 'Marker Functions' supported in Spurious Emissions so this front-panel key displays a blank menu when pressed.

Key Path	Front-panel key
Initial S/W Revision	Prior to A.02.00

Marker To

There is no 'Marker To' functionality supported in Spurious Emissions, so this front-panel key displays a blank menu when pressed.

Key Path	Front-panel key
Initial S/W Revision	Prior to A.02.00

Meas

The information in this section is common to all measurements. For key and remote command information for a specific measurement, refer to the section that describes the measurement of interest.

Measurements available under the Meas key are specific to the current Mode.

When viewing Help for measurements, note the following:

NOTE

Operation for some keys differs between measurements. The information displayed in Help pertains to the current measurement. To see how a key operates in a different measurement, exit Help (press the Cancel Esc key), select the measurement, then reenter Help (press the Help key) and press that key.

Key Path	Front-panel key
Initial S/W Revision	Prior to A.02.00

Remote Measurement Functions

This section contains the following topics:

["Measurement Group of Commands" on page 2382](#)

["Current Measurement Query \(Remote Command Only\)" on page 2384](#)

["Limit Test Current Results \(Remote Command Only\)" on page 2384](#)

["Data Query \(Remote Command Only\)" on page 2384](#)

["Calculate/Compress Trace Data Query \(Remote Command Only\)" on page 2385](#)

["Calculate Peaks of Trace Data \(Remote Command Only\)" on page 2390](#)

["Hardware-Accelerated Fast Power Measurement \(Remote Command Only\)" on page 2391](#)

["Format Data: Numeric Data \(Remote Command Only\)" on page 2405](#)

["Format Data: Byte Order \(Remote Command Only\)" on page 2406](#)

Initial S/W Revision	Prior to A.02.00
----------------------	------------------

Measurement Group of Commands

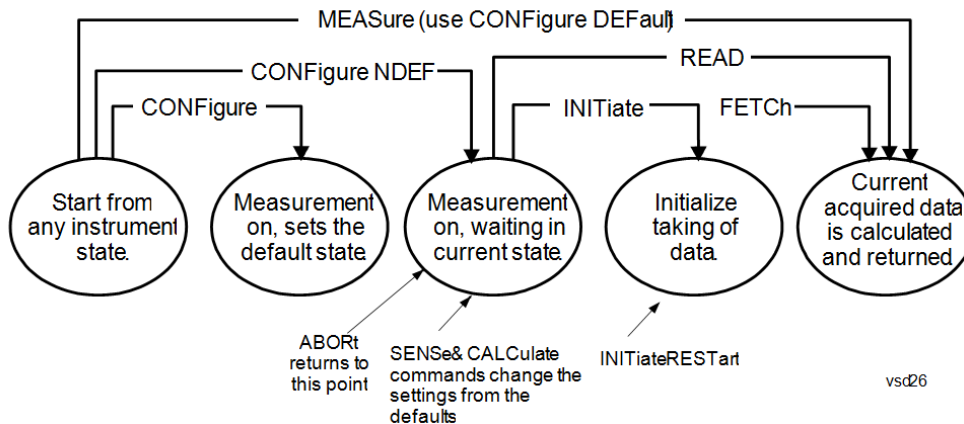

Measure Commands:

:MEASure:<measurement>[n]?

This is a fast single-command way to make a measurement using the factory default instrument settings. These are the settings and units that conform to the Mode Setup settings (e.g. radio standard) that you have currently selected.

- Stops the current measurement (if any) and sets up the instrument for the specified measurement using the factory defaults
- Initiates the data acquisition for the measurement
- Blocks other SCPI communication, waiting until the measurement is complete before returning results.
- If the function does averaging, it is turned on and the number of averages is set to 10.
- After the data is valid it returns the scalar results, or the trace data, for the specified measurement. The type of data returned may be defined by an [n] value that is sent with the command.
- The scalar measurement results will be returned if the optional [n] value is not included, or is set to 1. If the [n] value is set to a value other than 1, the selected trace data results will be returned. See each command for details of what types of scalar results or trace data results are available.
- ASCII is the default format for the data output. (Older versions of Spectrum Analysis and Phase Noise mode measurements only use ASCII.) The binary data formats should be used for handling large blocks of data since they are smaller and faster than the ASCII format. Refer to the FORMat:DATA command for more information.

If you need to change some of the measurement parameters from the factory default settings you can set up the measurement with the CONFIgure command. Use the commands in the SENSe:<measurement> and CALCulate:<measurement> subsystems to change the settings. Then you can use the READ? command to initiate the measurement and query the results.

If you need to repeatedly make a given measurement with settings other than the factory defaults, you can use the commands in the SENSe:<measurement> and CALCulate:<measurement> subsystems to set up the measurement. Then use the READ? command to initiate the measurement and query results.

Measurement settings persist if you initiate a different measurement and then return to a previous one. Use READ:<measurement>? if you want to use those persistent settings. If you want to go back to the default settings, use MEASure:<measurement>?.

Configure Commands:

:CONFIgure:<measurement>

This command stops the current measurement (if any) and sets up the instrument for the specified measurement using

the factory default instrument settings. It does not initiate the taking of measurement data unless INIT:CONTinuous is ON. If you change any measurement settings after using the CONFigure command, the READ command can be used to initiate a measurement without changing the settings back to their defaults.

In the Swept SA measurement in Spectrum Analyzer mode the CONFigure command also turns the averaging function on and sets the number of averages to 10 for all measurements.

:CONFigure: <measurement>: NDEFault stops the current measurement and changes to the specified measurement. It does not change the settings to the defaults. It does not initiate the taking of measurement data unless INIT:CONTinuous is ON.

The CONFigure? query returns the current measurement name.

The CONFigure:CATalog? query returns a quoted string of all licensed measurement names in the current mode. For example, "SAN, CHP, OBW, ACP, PST, TXP, SPUR, SEM, LIST".

Fetch Commands:

:FETCh:<measurement>[n]?

This command puts selected data from the most recent measurement into the output buffer. Use FETCh if you have already made a good measurement and you want to return several types of data (different [n] values, for example, both scalars and trace data) from a single measurement. FETCh saves you the time of re-making the measurement. You can only FETCh results from the measurement that is currently active, it will not change to a different measurement. An error message is reported if a measurement other than the current one is specified.

If you need to get new measurement data, use the READ command, which is equivalent to an INITiate followed by a FETCh.

The scalar measurement results will be returned if the optional [n] value is not included, or is set to 1. If the [n] value is set to a value other than 1, the selected trace data results will be returned. See each command for details of what types of scalar results or trace data results are available. The binary data formats should be used for handling large blocks of data since they are smaller and transfer faster than the ASCII format. (FORMat:DATA)

FETCh may be used to return results other than those specified with the original READ or MEASure command that you sent.

INITiate Commands:

:INITiate:<measurement>

This command is not available for measurements in all the instrument modes:

- Initiates a trigger cycle for the specified measurement, but does not output any data. You must then use the FETCh<meas> command to return data. If a measurement other than the current one is specified, the instrument will switch to that measurement and then initiate it.
 - For example, suppose you have previously initiated the ACP measurement, but now you are running the channel power measurement. If you send INIT:ACP? it will change from channel power to ACP and will initiate an ACP measurement.
 - Does not change any of the measurement settings. For example, if you have previously started the ACP measurement and you send INIT:ACP? it will initiate a new ACP measurement using the same instrument settings as the last time ACP was run.
 - If your selected measurement is currently active (in the idle state) it triggers the measurement, assuming the trigger conditions are met. Then it completes one trigger cycle. Depending upon the measurement and the number of averages, there may be multiple data acquisitions, with multiple trigger events, for one full trigger cycle. It also holds off additional commands on GPIB until the acquisition is complete.
-

READ Commands:

:READ:<measurement>[n]?

- Does not preset the measurement to the factory default settings. For example, if you have previously initiated the ACP
-

measurement and you send READ:ACP? it will initiate a new measurement using the same instrument settings.

- Initiates the measurement and puts valid data into the output buffer. If a measurement other than the current one is specified, the instrument will switch to that measurement before it initiates the measurement and returns results.
 - For example, suppose you have previously initiated the ACP measurement, but now you are running the channel power measurement. Then you send READ:ACP? It will change from channel power back to ACP and, using the previous ACP settings, will initiate the measurement and return results.
 - Blocks other SCPI communication, waiting until the measurement is complete before returning the results
 - If the optional [n] value is not included, or is set to 1, the scalar measurement results will be returned. If the [n] value is set to a value other than 1, the selected trace data results will be returned. See each command for details of what types of scalar results or trace data results are available. The binary data formats should be used when handling large blocks of data since they are smaller and faster than the ASCII format. (FORMat:DATA)
-

Initial S/W Revision	Prior to A.02.00
----------------------	------------------

Current Measurement Query (Remote Command Only)

This command returns the name of the measurement that is currently running.

Remote Command	:CONFigure?
-----------------------	-------------

Example	CONF?
----------------	-------

Initial S/W Revision	Prior to A.02.00
----------------------	------------------

Limit Test Current Results (Remote Command Only)

Queries the status of the current measurement limit testing. It returns a 0 if the measured results pass when compared with the current limits. It returns a 1 if the measured results fail any limit tests.

Remote Command	:CALCulate:CLIMits:FAIL?
-----------------------	--------------------------

Example	CALC:CLIM:FAIL? queries the current measurement to see if it fails the defined limits. Returns a 0 or 1: 0 it passes, 1 it fails.
----------------	--

Initial S/W Revision	Prior to A.02.00
----------------------	------------------

Data Query (Remote Command Only)

Returns the designated measurement data for the currently selected measurement and subopcode.

n = any valid subopcode for the current measurement. See the measurement command results table for your current measurement, for information about what data is returned for the subopcodes.

This command uses the data setting specified by the FORMat:BORDER and FORMat:DATA commands and can return real or ASCII data. (See the format command descriptions under Input/Output in the Analyzer Setup section.)

Remote Command	:CALCulate:DATA[n]?
Notes	The return trace depends on the measurement. In CALCulate:<meas>:DATA[n], n is any valid subopcode for the current measurement. It returns the same data as the FETCH:<measurement>? query where <measurement> is the current measurement.
Initial S/W Revision	Prior to A.02.00

Calculate/Compress Trace Data Query (Remote Command Only)

Returns compressed data for the currently selected measurement and sub-opcode [n].

n = any valid sub-opcode for that measurement. See the MEASure:<measurement>? command description of your specific measurement for information on the data that can be returned.

The data is returned in the current Y Axis Unit of the analyzer. The command is used with a sub-opcode <n> (default=1) to specify the trace. With trace queries, it is best if the analyzer is not sweeping during the query. Therefore, it is generally advisable to be in Single Sweep, or Update=Off.

This command is used to compress or decimate a long trace to extract and return only the desired data. A typical example would be to acquire N frames of GSM data and return the mean power of the first burst in each frame. The command can also be used to identify the best curve fit for the data.

Remote Command	:CALCulate:DATA<n>:COMPRESS? BLOCK CFIT MAXimum MINimum MEAN DMEan RMS RMSCubed SAMPLE SDEViation PPHase [,<soffset> [,<length>[,<roffset>[,<rlimit>]]]]
Example	To query the mean power of a set of GSM bursts: Supply a signal that is a set of GSM bursts. Select the IQ Waveform measurement (in IQ Analyzer Mode). Set the sweep time to acquire at least one burst. Set the triggers such that acquisition happens at a known position relative to a burst. Then query the mean burst levels using, CALC:DATA2:COMP? MEAN, 24e-6, 526e-6 (These parameter values correspond to GSM signals, where 526e-6 is the length of the burst in the slot and you just want 1 burst.)
Notes	The command supports 5 parameters. Note that the last 4 (<soffset>, <length>, <roffset>, <rlimit>) are optional. But these optional parameters must be entered in the specified order. For example, if you want to specify <length>, then you must also specify <soffset>. See details below for a definition of each of these parameters. This command uses the data in the format specified by FORMat:DATA, returning either binary or ASCII data.
Initial S/W Revision	Prior to A.02.00

- BLOCK or block data - returns all the data points from the region of the trace data that you specify. For example, it could be used to return the data points of an input signal over several timeslots, excluding the portions of the trace data that you do not want. (This is x,y pairs for trace data and I,Q pairs for complex data.)

- CFIT or curve fit - applies curve fitting routines to the data. <soffset> and <length> are required to define the data that you want. <roffset> is an optional parameter for the desired order of the curve equation. The query will return the following values: the x-offset (in seconds) and the curve coefficients ((order + 1) values).

MIN, MAX, MEAN, DME, RMS, RMSC, SAMP, SDEV and PPH return one data value for each specified region (or <length>) of trace data, for as many regions as possible until you run out of trace data (using <roffset> to specify regions). Or they return the number of regions you specify (using <rlimit>) ignoring any data beyond that.

- MINimum - returns the minimum data point (y value) for the specified region(s) of trace data. For I/Q trace data, the minimum magnitude of the I/Q pairs is returned.
- MAXimum - returns the maximum data point (y value) for the specified region(s) of trace data. For I/Q trace data, the maximum magnitude of the I/Q pairs is returned.
- MEAN - returns a single value that is the arithmetic mean of the data point values (in dB/ dBm) for the specified region(s) of trace data. For I/Q trace data, the mean of the magnitudes of the I/Q pairs is returned. See the following equations.

-

NOTE

If the original trace data is in dB, this function returns the arithmetic mean of those log values, not log of the mean power which is a more useful value. The mean of the log is the better measurement technique when measuring CW signals in the presence of noise. The mean of the power, expressed in dB, is useful in power measurements such as Channel Power. To achieve the mean of the power, use the RMS option.

Equation 1

Mean Value of Data Points for Specified Region(s)

$$\text{MEAN} = \frac{1}{n} \sum_{X_i \in \text{region}(s)} X_i$$

where X_i is a data point value, and n is the number of data points in the specified region(s).

Equation 2

Mean Value of I/Q Data Pairs for Specified Region(s)

$$\text{MEAN} = \frac{1}{n} \sum_{X_i \in \text{region}(s)} |X_i|$$

where $|X_i|$ is the magnitude of an I/Q pair, and n is the number of I/Q pairs in the specified region(s).

- DMEan - returns a single value that is the mean power (in dB/ dBm) of the data point values for the specified region(s) of trace data. See the following equation:

Equation 3

DMEan Value of Data Points for Specified Region(s)

$$\text{DME} = 10 \times \log_{10} \left(\frac{1}{n} \sum_{X_i \in \text{region}(s)} 10^{\frac{X_i}{10}} \right)$$

- RMS - returns a single value that is the average power on a root-mean-squared voltage scale (arithmetic rms) of the data point values for the specified region(s) of trace data. See the following equation.

NOTE For I/Q trace data, the rms of the magnitudes of the I/Q pairs is returned. See the following equation. This function is very useful for I/Q trace data. However, if the original trace data is in dB, this function returns the rms of the log values which is not usually needed.

Equation 4

RMS Value of Data Points for Specified Region(s)

$$\text{RMS} = \sqrt{\frac{1}{n} \sum_{X_i \in \text{region}(s)} X_i^2}$$

where X_i is a data point value, and n is the number of data points in the specified region(s).

Equation 5

RMS Value of I/Q Data Pairs for Specified Region(s)

$$\text{RMS} = \sqrt{\frac{1}{n} \sum_{X_i \in \text{region}(s)} X_i X_i^*}$$

where X_i is the complex value representation of an I/Q pair, X_i^* its conjugate complex number, and n is the number of I/Q pairs in the specified region(s).

Once you have the rms value for a region of trace data (linear or I/Q), you may want to calculate the mean power. You must convert this rms value (peak volts) to power in dBm:

$$10 \times \log[10 \times (\text{rms value})^2]$$

- SAMPLe - returns the first data value (x,y pair) for the specified region(s) of trace data. For I/Q trace data, the first I/Q pair is returned.
- SDEViation - returns a single value that is the arithmetic standard deviation for the data point values for the specified region(s) of trace data. See the following equation.
- For I/Q trace data, the standard deviation of the magnitudes of the I/Q pairs is returned. See the following equation.

Equation 6

Standard Deviation of Data Point Values for Specified Region(s)

$$\text{SDEV} = \sqrt{\frac{1}{n} \sum_{X_i \in \text{region}(s)} (X_i - \bar{X})^2}$$

where X_i is a data point value, \bar{X} is the arithmetic mean of the data point values for the specified region (s), and n is the number of data points in the specified region(s).

$$\text{SDEV} = \sqrt{\frac{1}{n} \sum_{X_i \in \text{region}(s)} (|X_i| - \bar{X})^2}$$

where $|X_i|$ is the magnitude of an I/Q pair, \bar{X} is the mean of the magnitudes for the specified region(s), and n is the number of data points in the specified region(s).

- PPHase - returns the x,y pairs of both rms power (dBm) and arithmetic mean phase (radian) for every specified region and frequency offset (Hz). The number of pairs is defined by the specified number of regions. This parameter can be used for I/Q vector (n=0) in Waveform (time domain) measurement and all parameters are specified by data point in PPHase.

The rms power of the specified region may be expressed as:

$$\text{Power} = 10 \times \log [10 \times (\text{RMS I/Q value})] + 10.$$

The RMS I/Q value (peak volts) is:

$$\sqrt{\frac{1}{n} \sum_{X_i \in \text{region}} X_i X_i^*}$$

where X_i is the complex value representation of an I/Q pair, X_i^* its conjugate complex number, and n is the number of I/Q pairs in the specified region.

The arithmetic mean phase of the specified region may be expressed as:

$$\frac{1}{n} \sum_{Y_i \in \text{region}} Y_i$$

where Y_i is the unwrapped phase of I/Q pair with applying frequency correction and n is the number of I/Q pairs in the specified region.

The frequency correction is made by the frequency offset calculated by the arithmetic mean of every specified region's frequency offset. Each frequency offset is calculated by the least square method against the unwrapped phase of I/Q pair.

Sample Trace Data - Constant Envelope

(See below for explanation of variables.)

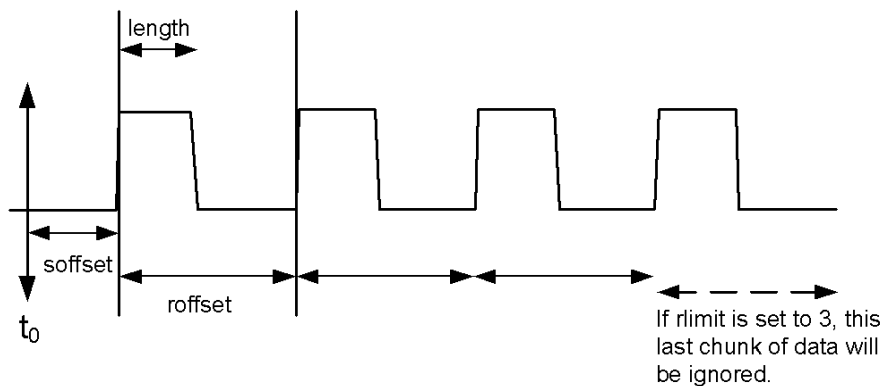

Sample Trace Data - Not Constant Envelope

(See below for explanation of variables.)

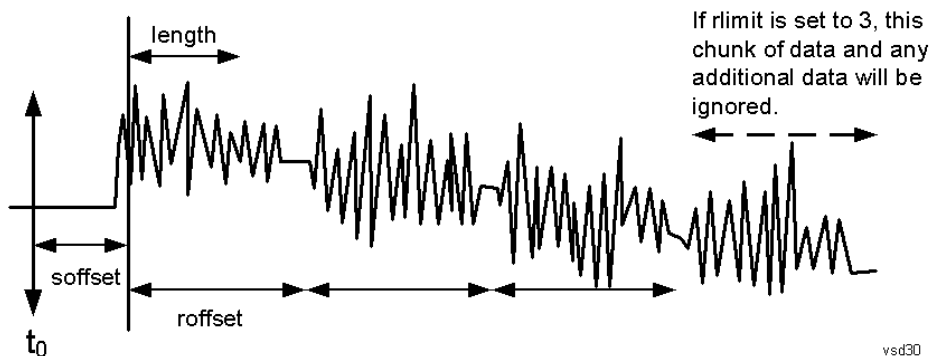

<soffset> - start offset is an optional real number. (It is in seconds for time-domain traces, and is a dimensionless index 0 to Npoints - 1, for frequency-domain traces). It specifies the amount of data at the beginning of the trace that will be ignored before the decimation process starts. It is the time or frequency change from the start of the trace to the point where you want to start using the data. The default value is zero.

<length> - is an optional real number. (It is in seconds for time-domain traces, and is a dimensionless index 0 to Npoints - 1, for frequency-domain traces). It defines how much data will be compressed into one value. This parameter has a default value equal to the current trace length.

<roffset> - repeat offset is an optional real number. (It is in seconds for time-domain traces, and is a dimensionless index 0 to Npoints - 1, for frequency-domain traces). It defines the beginning of the next field of trace elements to be compressed. This is relative to the beginning of the previous field. This parameter has a default value equal to the <length> variable. Note that this parameter is used for a completely different purpose when curve fitting (see CFIT above).

<rlimit> - repeat limit is an optional integer. It specifies the number of data items that you want returned. It will ignore any additional items beyond that number. You can use the Start offset and the Repeat limit to pick out exactly what part of the data you want to use. The default value is all the data.

Calculate Peaks of Trace Data (Remote Command Only)

Returns a list of all the peaks for the currently selected measurement and sub-opcode [n]. The peaks must meet the requirements of the peak threshold and excursion values.

n = any valid sub-opcode for the current measurement. See the MEASure:<measurement> command description of your specific measurement for information on the data that can be returned.

The command can only be used with specific sub-opcodes with measurement results that are trace data. Both real and complex traces can be searched, but complex traces are converted to magnitude in dBm. In many measurements the sub-opcode n=0, is the raw trace data which cannot be searched for peaks. And Sub-opcode n=1, is often calculated results values which also cannot be searched for peaks.

This command uses the data setting specified by the FORMat:BORDER and FORMat:DATA commands and can return real or ASCII data. If the format is set to INT,32, it returns REAL,32 data.

The command has four types of parameters:

- Threshold (in dBm)
- Excursion (in dB)
- Sorting order (amplitude, frequency, time)
- Optional in some measurements: Display line use (all, > display line, < display line)

Remote Command	<p>For Swept SA measurement:</p> <pre>:CALCulate:DATA[1] 2 ... 6:PEAKs? <threshold>,<excursion>[,AMPLitude FREQuency TIME[,ALL GTDLLine LTDLine]]</pre> <p>For most other measurements:</p> <pre>:CALCulate:DATA[1] 2 ... 6:PEAKs? <threshold>,<excursion>[,AMPLitude FREQuency TIME]</pre>
Example	<p>Example for Swept SA measurement in Spectrum Analyzer Mode:</p> <p>CALC:DATA4:PEAK? -40, 10, FREQ, GTDL This will identify the peaks of trace 4 that are above -40 dBm, with excursions of at least 10 dB. The peaks are returned in order of increasing frequency, starting with the lowest frequency. Only the peaks that are above the display line are returned.</p> <p>Query Results 1:</p> <p>With FORMat:DATA REAL, 32 selected, it returns a list of floating-point numbers. The first value in the list is the number of peak points that are in the following list. A peak point consists of two values: a peak amplitude followed by its corresponding frequency (or time).</p> <p>If no peaks are found the peak list will consist of only the number of peaks, (0).</p>
Notes	<p><n> - is the trace that will be used</p> <p><threshold> - is the level below which trace data peaks are ignored. Note that the threshold value is required and is always used as a peak criterion. To effectively disable the threshold criterion for this command, provide a substantially low threshold value such as -200 dBm. Also note that the threshold value used in this command is independent of and has no effect on the threshold value stored under the Peak Criteria menu.</p> <p><excursion> - is the minimum amplitude variation (rise and fall) required for a signal to be identified as peak. Note that the excursion value is required and is always used as a peak criterion. To effectively disable the excursion criterion for this command, provide the minimum value of 0.0 dB. Also note that the excursion value used in this command is independent of and has no effect on the</p>

excursion value stored under the Peak Criteria menu.

Values must be provided for threshold and excursion. The sorting and display line parameters are optional (defaults are AMPLitude and ALL).

Note that there is always a Y-axis value for the display line, regardless of whether the display line state is on or off. It is the current Y-axis value of the display line which is used by this command to determine whether a peak should be reported

Sorting order:

AMPLitude - lists the peaks in order of descending amplitude, with the highest peak first (default if optional parameter not sent)

FREQuency - lists the peaks in order of occurrence, left to right across the x-axis.

TIME - lists the peaks in order of occurrence, left to right across the x-axis.

Peaks vs. Display Line:

ALL - lists all of the peaks found (default if optional parameter not sent).

GTDLine (greater than display line) - lists all of the peaks found above the display line.

LTDLine (less than display line) - lists all of the peaks found below the display line.

Initial S/W Revision	Prior to A.02.00
----------------------	------------------

Hardware-Accelerated Fast Power Measurement (Remote Command Only)

The Fast Power option (FP2) enables very fast channel power measurements for instruments with the prerequisite hardware (DP2 and/or B40). It accomplishes this by performing real-time overlapped FFTs at the hardware layer, using software for basic post-processing before returning the result to the user. The upshot of this approach is improved throughput for user applications that require many sequential power measurements.

The analysis bandwidth of FP2 is limited by the licenses in the instrument, but its maximum overall analysis bandwidth per acquisition is 40 MHz.

FP2 is remote-only, which means the instrument does not switch to any particular mode or measurement. FP2 commands can be sent while another application is in use on the front panel.

Each Fast Power measurement can be predefined using an array index, and up to 1,000 measurements can be stored. In the following documentation, instances of [1,2,...,999] can be substituted with a particular measurement index, e.g. CALC:FPOW:POW1?, CALC:FPOW:POW2?, CALC:FPOW:POW134?. In this way, power measurements can be defined one time in a batch, and then executed multiple times without having to redefine them, similar to “list mode” on other measurements.

In addition to basic channel power measurements, there are a number of other measurement “functions” for each channel, including peak power, peak frequency, and power spectral density. See the Function parameter for more information.

Reset Fast Power Measurement (Remote Command Only)

Resets the measurement configuration to the defaults.

Mode	All
Remote Command	:CALCulate:FPOWer:POWer [1, 2, ..., 999] :RESet
Example	:CALC:FPOW:POW1:RES

Notes	Option FP2 is required.
Initial S/W Revision	A.14.00

Define Fast Power Measurement (Remote Command Only)

Fast Power acquisitions are configured using the DEFine command. This command accepts a comma-delimited string of configuration parameters and their appropriate values, which are all specified in the subsection below.

Mode	All
Remote Command	:CALCulate:FPOWer:POWer[1,2,...,999]:DEFine "configuration string"
Example	:CALC:FPOW:POW1:DEF "CenterFrequency=2e9, AcquisitionTime=0.005"
Notes	See below for a list of measurement variables that can be defined in the configuration string.
Initial S/W Revision	A.14.00

Acquisition Time

Example	CALC:FPOW:POW1:DEF "AcquisitionTime=0.002"
Notes	The acquisition time parameter sets the time in which the entire spectrum is measured. An increase in the acquisition time yields an improvement in measurement repeatability.
Preset	0.001 s
Range	0 s to 1 s
Default Unit	Time (s)
Initial S/W Revision	A.14.00

Center Frequency

Example	CALC:FPOW:POW1:DEF "CenterFrequency=2e9"
Notes	The center frequency parameter sets the frequency in which the measurement is centered around. The OffsetFrequency parameter is calculated relative to the center frequency.
Preset	1 GHz
Range	0 Hz to maximum instrument frequency
Default Unit	Frequency (Hz)
Initial S/W Revision	A.14.00

DC Coupled

Example	CALC:FPOW:POW1:DEF "DCCoupled=True"
Notes	The DC coupled parameter allows the user to specify whether the DC blocking capacitor is utilized. Set parameter to true when measuring frequencies below 10 MHz.
Preset	False
Range	True (DC Coupled) or False (AC Coupled)
Default Unit	Boolean
Initial S/W Revision	A.14.00

DetectorType

Example	CALC:FPOW:POW1:DEF "DetectorType=Peak"
Notes	Option FP2 is required. The detector type parameter allows the user to choose whether a RMS average or peak value is used during the measurement.
Preset	RmsAverage
Range	RmsAverage, Peak
Initial S/W Revision	A.14.00

Do Noise Correction

Example	CALC:FPOW:POW1:DEF "DoNoiseCorrection=True"
Notes	When noise correction is enabled, the linear noise power contributed by the analyzer is subtracted from all measurements. This effectively lowers the noise floor of the analyzer. When noise correction is enabled, the first measurement for a given set of input parameters will take extra time. This is because the analyzer takes an extra acquisition with the RF input disconnected from the analyzer's front end to measure the noise of just the analyzer. The measured noise floor is stored in a cache so the noise acquisition will occur only once for the same state settings. In other words, if noise correction was turned on and the analyzer made an acquisition at frequency A, then frequency B, and back again to frequency A, the hidden initial noise floor acquisition would only occur for the first acquisition at frequency A and the cached noise floor would be used the second time frequency A was measured.
Preset	False
Range	True (enable noise correction) or False (disable noise correction)
Default Unit	Boolean
Initial S/W Revision	A.14.00

Do Spur Suppression

Example	CALC:FPOW:POW1:DEF "DoSpurSuppression=True"
Notes	<p>When measuring very low level signals, or when large out-of-band inputs are input into the analyzer, sometimes unwanted spurs and residuals can appear in the measured spectrum. Spur suppression is a method to help minimize the levels of these internally generated spurs and residuals.</p> <p>When spur suppression is enabled, the analyzer will automatically take two acquisitions using two different internal analog LO frequencies. The FFT spectrums from both acquisitions are combined by taking the minimum power between both traces on a per FFT bin basis. External signals will have the same amplitude for both traces and therefore will return the expected amplitudes. However, low level spurs and residuals generated internally to the analyzer tend to move to different FFT bins depending on the internal analog LO frequency used, and therefore tend to be suppressed using this spur suppression method.</p> <p>Because two acquisitions, rather than a single acquisition, are made when spur suppression is enabled, the measurement time will always be slower when spur suppression is enabled.</p>
Preset	False
Range	True (enable spur suppression) or False (disable spur suppression)
Default Unit	Boolean
Initial S/W Revision	A.14.00

Electronic Attenuator Bypass

Example	CALC:FPOW:POW1:DEF "ElecAttBypass =False"
Notes	The electronic attenuation bypass parameter allows the user to either utilize or bypass the electronic attenuator. The electronic attenuator is only available for frequencies up to 3.6 GHz. Set parameter to true when using frequencies above 3.6 GHz and set the parameter to false when using the preamp.
Preset	True
Range	True (bypass electronic attenuator) or False (use electronic attenuator)
Default Unit	Boolean
Initial S/W Revision	A.14.00

Electronic Attenuation

Example	CALC:FPOW:POW1:DEF "ElecAttenuation=10"
Notes	<p>Option EA3 is required.</p> <p>The electronic attenuation value parameter sets the amount of electrical attenuation from 0 to 24 dB (1 dB steps).</p> <p>Set "ElecAttBypass=False" to make sure the electronic attenuator path is enabled.</p>
Preset	0 dB
Range	0 - 24 dB (1 dB steps)

Default Unit	dB
Initial S/W Revision	A.14.00

IF Gain

Example	CALC:FPOW:POW1:DEF "IFGain=10"
Notes	The IF gain parameter allows the user to specify the gain at the IF stage anywhere from -6 to 16 dB (1 dB steps). This is an advanced feature, and for most cases this should remain at its default value of 0 dB.
Preset	0 dB
Range	-6 - 16 dB (1 dB steps)
Default Unit	dB
Initial S/W Revision	A.14.00

IF Type

Example	CALC:FPOW:POW1:DEF "IFType=B25M"
Notes	The IF type parameter allows the user to select between different IF paths. For example, if the signal is less than 25 MHz wide, then the user can select the B25M path to take advantage of additional filtering on this analog IF path.
Preset	B40M
Range	B10M, B25M, B40M
Initial S/W Revision	A.14.00

Include Power Spectrum

Example	CALC:FPOW:POW1:DEF "IncludePowerSpectrum=True"
Notes	The power spectrum parameter allows the user to read data on the entire spectrum for diagnostic purposes. It is not recommended for production use. See CALC:FPOW:POW[n]:READ2? for details on the binary format of the response.
Preset	False
Range	True (return both channel power and full power spectrum) or False (returns only channel power)
Default Unit	Boolean
Initial S/W Revision	A.14.00

Mechanical Attenuation

Example	CALC:FPOW:POW1:DEF "MechAttenuation=10"
Notes	The mechanical attenuation value parameter sets the amount of mechanical attenuation anywhere from 0 to 70 dB (2 dB steps).
Preset	0 dB
Range	0 – 70 dB (2 dB steps)
Default Unit	dB
Initial S/W Revision	A.14.00

Preamp Mode

Example	CALC:FPOW:POW1:DEF "PreAmpMode=Low"
Notes	The license for the appropriate preamp is required. The preamp mode parameter specifies whether the preamps are being utilized. Low allows any preamps up to 3.6 GHz, and Full allows all licensed preamps. Set "ElecAttBypass=True" in order to utilize any preamps.
Preset	Off
Range	Off, Low, Full
Initial S/W Revision	A.14.00

Resolution Bandwidth Mode

Example	CALC:FPOW:POW1:DEF "PreAmpMode=Low"
Notes	The resolution bandwidth mode parameter allows the user to choose whether the RBW filter is automatically or manually set. The BestSpeed value minimizes measurement time, while the Narrowest value minimizes RBW size (minimum of two FFT bins per RBW). To manually specify an RBW, set this parameter to Explicit, and set the ResolutionBW parameter to the desired value.
Preset	BestSpeed
Range	BestSpeed, Narrowest, Explicit
Initial S/W Revision	A.14.00

Resolution Bandwidth

Example	CALC:FPOW:POW1:DEF "ResolutionBW=25e3"
Notes	The resolution bandwidth parameter sets the 3-dB bandwidth of the RBW filter. The ResolutionBWMode parameter must be set to Explicit in order to manually set the RBW.

Preset	0 Hz
Default Unit	Hz
Initial S/W Revision	A.14.00

Trigger Delay

Example	CALC:FPOW:POW1:DEF "TriggerDelay=0.025"
Notes	The trigger delay parameter sets the time after an external trigger is detected until the measurement is performed.
Preset	0 s
Range	0 - 1 s
Default Unit	Seconds
Initial S/W Revision	A.14.00

Trigger Level

Example	CALC:FPOW:POW1:DEF "TriggerLevel=2"
Notes	The trigger level parameter sets the voltage value at which an external trigger is detected.
Preset	1.2 V
Range	-5 to 5 V
Default Unit	Volts
Initial S/W Revision	A.14.00

Trigger Slope

Example	CALC:FPOW:POW1:DEF "TriggerSlope=Negative"
Notes	The trigger slope parameter indicates the direction of the edge trigger voltage for detection.
Preset	Positive
Range	Positive, Negative
Initial S/W Revision	A.14.00

Trigger Source

Example	CALC:FPOW:POW1:DEF "TriggerSource=Ext1"
Notes	The trigger source parameter allows the user to choose between measurement's triggering freely or controlled by an external input. Ext1 and Ext2 correspond to Trigger 1 In and Trigger 2 In, respectively.
Preset	Free
Range	Free, Ext1, Ext2
Initial S/W Revision	A.14.00

Trigger Timeout

Example	CALC:FPOW:POW1:DEF "TriggerTimeout=0.1"
Notes	The trigger timeout parameter sets the time in which the analyzer will wait for a trigger before automatically performing the measurement.
Preset	1 s
Range	0 – 1 s
Default Unit	Seconds
Initial S/W Revision	A.14.00

Signal Input

Example	CALC:FPOW:POW1:DEF "SignalInput=Fp50MHzCW"
Notes	The signal input parameter allows the user to select between using the main RF input or the internal analyzer reference CW signal of 50 MHz.
Preset	FpMainRf
Range	FpMainRf, Fp50MHzCW
Initial S/W Revision	A.14.00

Use Preselector

Example	CALC:FPOW:POW1:DEF "UsePreSelector=True"
Notes	The preselector parameter allows the user to either utilize or bypass the front end tunable filter at frequencies above 3.6 GHz. For frequencies below 3.6 GHz, the preselector is automatically bypassed, so you do not need to set this parameter to False in those cases.
Preset	False
Range	True (use preselector above 3.6 GHz), or False (preselector bypassed)

Default Unit	Boolean
Initial S/W Revision	A.14.00

Channel Bandwidth Array

Example	CALC:FPOW:POW1:DEF "Bandwidth=[3.84e6, 5e6, 3.84e6]"
Notes	The bandwidth parameter array defines the bandwidth of each channel that will be measured. All array parameters should have the same number of elements. Alternatively, if all the elements are the same value, a single number with no square brackets can be used to define the parameter.
Preset	[1e6]
Range	0 to 40 MHz
Default Unit	Hz
Initial S/W Revision	A.14.00

Channel Filter Type Array

Example	CALC:FPOW:POW1:DEF "FilterType=[RRC, IBW, RRC]"
Notes	The filter type parameter allows the user to choose between an integration bandwidth (IBW) filter or a root-raised-cosine (RRC) filter. The integration bandwidth filter weighs all frequencies within the bandwidth equally. The root-raised-cosine filter has an associated shape parameter, defined by the FilterAlpha parameter. All array parameters should have the same number of elements. Alternatively, if all the elements are the same value, a single value with no square brackets can be used to define the parameter.
Preset	[IBW]
Range	IBW, RRC
Initial S/W Revision	A.14.00

Channel Filter Alpha Array

Example	CALC:FPOW:POW1:DEF "FilterAlpha=[0.5, 0.0, 0.5]"
Notes	The filter alpha parameter allows the user to adjust the alpha value associated with the root-raised-cosine (RRC) filter type. Set FilterType to RRC in order to utilize this parameter. All array parameters should have the same number of elements. Alternatively, if all the elements are the same value, a single number with no square brackets can be used to define the parameter.
Preset	[0.22]
Range	0.0 - 1.0

Initial S/W Revision	A.14.00
-------------------------	---------

Channel Measurement Function Array

Example	CALC:FPOW:POW1:DEF "Function=[BandPower, PeakPower, BandPower]"
Notes	<p>This parameter array defines what measurement is being made for each individually-specified channel:</p> <p>BandPower: Total power within the specified bandwidth of the channel (dBm)</p> <p>BandDensity: Total power density within the specified bandwidth of the channel (dBm/Hz)</p> <p>PeakPower: The peak power value within the specified bandwidth of the channel (dBm)</p> <p>PeakFrequency: The frequency which corresponds to the peak power value within the specified bandwidth of the channel. This frequency is relative to the center frequency (Hz)</p> <p>XdBBandwidth: The half power (-3.01 dB) bandwidth of the highest amplitude signal that resides within the channel (Hz), dB is configurable using XdBBandwidth parameter</p> <p>OccupiedBandwidth: The bandwidth at which 99% of the total power resides within the channel (Hz), percentage configurable using OccupiedBandwidthPercent parameter</p> <p>All array parameters should have the same number of elements. Alternatively, if all the elements are the same value, a single value with no square brackets can be used to define the parameter.</p>
Preset	[BandPower]
Range	BandPower, BandDensity, PeakPower, PeakFrequency, XdBBandwidth, OccupiedBandwidth
Initial S/W Revision	A.14.00

Channel Offset Frequency Array

Example	CALC:FPOW:POW1:DEF "OffsetFrequency=[-5e6, 0, 5e6]"
Notes	<p>The offset frequency parameter array defines the difference between the center frequency to the center frequency of each channel.</p> <p>All array parameters should have the same number of elements.</p>
Preset	[0]
Range	0 to 20 MHz
Default Unit	Hz
Initial S/W Revision	A.14.00

Channel Occupied Bandwidth Percent Array

Example	CALC:FPOW:POW1:DEF "OccupiedBandwidthPercent =[0.95, 0.95, 0.95]"
Notes	This parameter only applies for channels whose Function is set to OccupiedBandwidth. The occupied

	bandwidth percent parameter specifies the percent of total power in these channels. The valid range for this parameter is 0.0 to 1.0, where 1.0 represents 100%. The default for this parameter is 0.99, which will return the bandwidth that contains 99% of the total channel power.
Preset	[0.99]
Range	0 - 1.0
Initial S/W Revision	A.14.00

Channel x-dB Bandwidth Array

Example	CALC:FPOW:POW1:DEF " XdBBandwidth =[-6.02, -3.01, -1.0]"
Notes	This parameter only applies for channels whose Function is set to XdBBandwidth. The X dB bandwidth parameter is used to specify the power relative to the peak channel power over which the bandwidth is calculated. The parameter value must be a negative number.
Preset	[-3.01]
Range	-200 to 0 dB
Default Unit	dB
Initial S/W Revision	A.14.00

Define Fast Power Measurement Query (Remote Command Only)

The DEFine? command is used to retrieve a list of all defined parameters in an ASCII string format

```

M All
o
d
e
-----
R :CALCulate:FPOWer:POWer[1,2,...,999]:DEFine?
e
m
o
t
e
C
o
m
m
a
n
d
-----
E :CALC:FPOW:POW1:DEF?

```

x
a
m
p
l
e

N This command query is used to retrieve a list of all defined parameters in an ASCII format.

O The following is an example of the returned results:

S "DCCoupled=False,ElecAttBypass=True,ElecAttenuation=0,IFGain=0,MechAttenuation=0,PreAmpMode=Off,PreSelectorOffset=0,UsePreSelector=False,ExternalReferenceFrequency=1000000,FrequencyReferenceSource=AutoExternalFrequencyReference,IFType=B40M,LOMode=SLW,SignalInput=FpMainRf,AcquisitionTime=0.001,CenterFrequency=100000000,ResolutionBW=0,ResolutionBWMode=BestSpeed,DetectorType=RmsAverage,Bandwidth=[1000000],OffsetFrequency=[0],Function=[BandPower],FilterType=[IBW],FilterAlpha=[0.22],OccupiedBandwidthPercent=[0.99],XdBBandwidth=[-3.01],DoNoiseCorrection=False,DoSpurSuppression=False,MeasurementMethod=HardwareFFT,IncludePowerSpectrum=False,TriggerDelay=0,TriggerLevel=1.2,TriggerSlope=Positive,TriggerSource=Free,TriggerTimeout=1"

I A.14.00

n
i
t
i
a
l

S
/
W

R
e
v
i
s
i
o
n

Configure Fast Power Measurement (Remote Command Only)

The configure command begins hardware setup and returns immediately, with no acquisition made. This can be used in parallel with other hardware operations to effectively hide the hardware setup time.

Mode	All
Remote Command	:CALCulate:FPOWER:POWER[1,2,...,999]:CONFigure
Example	:CALC:FPOW:POW1:CONF
Notes	Option FP2 is required.
Initial S/W Revision	A.14.00

Initiate Fast Power Measurement (Remote Command Only)

The INITiate command begins an acquisition and returns immediately. The results of the measurement can be retrieved using FETCh.

Mode	All
Remote Command	:CALCulate:FPOWER:POWER[1,2,...,999]:INITiate
Example	:CALC:FPOW:POW1:INIT
Notes	Option FP2 is required.
Initial S/W Revision	A.14.00

Fetch Fast Power Measurement (Remote Command Only)

The FETCh command query is used to retrieve the results of an acquisition initiated by the INIT command. The returned results are in ASCII string format. The string begins and ends with quotation marks.

Mode	All
Remote Command	:CALCulate:FPOWER:POWER[1,2,...,999]:FETCh?
Example	:CALC:FPOW:POW1:FETC?
Notes	Option FP2 is required. Returns m comma-separated ASCII values, where m corresponds to the number of bandwidths defined. 1. Declared function return in the 1st specified channel 2. Declared function return in the 2nd specified channel ... m. Declared function return in the last specified channel The INIT and FETC? command sequence performs the same functionality of a single CALC:FPOW:POW[n]? query. Units of the returned values are dependent on the Function parameter for each channel.
Initial S/W Revision	A.14.00

Execute Fast Power Measurement (Remote Command Only)

This command query is used as shorthand for an INIT command immediately followed by a FETC? command. The returned results are in ASCII string format. The string begins and ends with quotation marks.

Mode	All
Remote Command	:CALCulate:FPOWER:POWER[1,2,...,999]?
Example	:CALC:FPOW:POW1?

Notes	Option FP2 is required. See notes for Fast Power Fetch for return format.
Initial S/W Revision	A.14.00

Binary Read Fast Power Measurement (Remote Command Only)

This command query is used as shorthand for an INIT command immediately followed by a FETC? command. The returned results are in a binary format.

Mode	All
Remote Command	:CALCulate:FPOWER:POWER[1,2,...,999]:READ? :CALCulate:FPOWER:POWER[1,2,...,999]:READ1?
Example	:CALC:FPOW:POW1:READ? :CALC:FPOW:POW1:READ1?
Notes	Option FP2 is required. Returns m 4 byte floating point binary values (Little-Endian), where m corresponds to the number of bandwidths defined.
Initial S/W Revision	A.14.00

Diagnostic Binary Read Fast Power Measurement (Remote Command Only)

This command query is used as shorthand for an INIT command immediately followed by a FETC? command. The returned results are in a binary format. This command is used primarily for diagnostic purposes to test for ADC overloads and to visibly inspect the spectrum.

Mode	All
Remote Command	:CALCulate:FPOWER:POWER[1,2,...,999]:READ2?
Example	:CALC:FPOW:POW1:READ2?
Notes	Option FP2 is required. Note: Spectrum data is only returned if the IncludePowerSpectrum parameter is set to True. If IncludePowerSpectrum is False, the number of spectrum points will be zero (0). Units of the returned values are dependent on the Function parameter per channel (e.g. dBm for BandPower, Hz for PeakFrequency). Returns binary data (Little-Endian) that contains information on m amount of channels, along with ADC over range and full spectrum data. The following is the binary format of the response. Bandwidth Return Value 1. Number of channels specified, m [4 byte int] 2. Declared function result for the 1st specified channel [4 byte float]

	3. Declared function result for the 2nd specified channel [4 byte float]
	...
	(m + 1). Declared function result for the last (mth) specified channel [4 byte float]
	ADC Over Range
	1. ADC over-range occurred (1: true, 0: false) [2 byte short]
	Spectrum Data
	1. Number of points in the spectrum data, k [4 byte int]
	2. Start frequency of spectrum data (Hz) [8 byte double]
	3. Step frequency of spectrum data (Hz) [8 byte double]
	4. FFT bin at 1st point (dBm) [4 byte float]
	5. FFT bin at 2nd point (dBm) [4 byte float]
	...
	(k + 3). FFT bin at last (kth) point (dBm) [4 byte float]

Initial S/W Revision	A.14.00
-------------------------	---------

Format Data: Numeric Data (Remote Command Only)

This command specifies the format of the trace data input and output. It specifies the formats used for trace data during data transfer across any remote port. It affects only the data format for setting and querying trace data for the :TRACe[:DATA], TRACe[:DATA]?, :CALCulate:DATA[n]? and FETCh:SANalyzer [n]? commands and queries.

Remote Command	:FORMat [:TRACe] [:DATA] ASCii INTeger, 32 REAL, 32 REAL, 64 :FORMat [:TRACe] [:DATA] ?
Notes	The query response is: ASCii: ASC,8 REAL,32: REAL,32 REAL,64: REAL,64 INTeger,32: INT,32 When the numeric data format is REAL or ASCii, data is output in the current Y Axis unit. When the data format is INTeger, data is output in units of m dBm (.001 dBm). The INT,32 format returns binary 32-bit integer values in internal units (m dBm), in a definite length block.
Dependencies	Sending a data format spec with an invalid number (for example, INT,48) generates no error. The analyzer simply uses the default (8 for ASCii, 32 for INTeger, 32 for REAL). Sending data to the analyzer which does not conform to the current FORMat specified, results in an error. Sending ASCII data when a definite block is expected generates message -161 "Invalid Block Data" and sending a definite block when ASCII data is expected generates message -121 "Invalid Character in Number".
Preset	ASCii
Backwards Compatibility	Note that the INT,32 format is only applicable to the command, TRACe:DATA. This preserves

Notes	backwards compatibility for the Swept SA measurement. For all other commands/queries which honor FORMat:DATA, if INT,32 is sent the analyzer will behave as though it were set to REAL,32.
Initial S/W Revision	Prior to A.02.00

The specs for each output type follow:

ASCIi - Amplitude values are in ASCII, in the current Y Axis Unit, one ASCII character per digit, values separated by commas, each value in the form:

SX.YYYYYEsZZ

Where:

S = sign (+ or -)

X = one digit to left of decimal point

Y = 5 digits to right of decimal point

E = E, exponent header

s = sign of exponent (+ or -)

ZZ = two digit exponent

REAL,32 - Binary 32-bit real values in the current Y Axis Unit, in a definite length block.

REAL,64 - Binary 64-bit real values in the current Y Axis Unit, in a definite length block.

Format Data: Byte Order (Remote Command Only)

This command selects the binary data byte order for data transfer and other queries. It controls whether binary data is transferred in normal or swapped mode. This command affects only the byte order for setting and querying trace data for the :TRACe[:DATA], TRACe[:DATA]? , :CALCulate:DATA[n]? and FETCh:SANalyzer[n]? commands and queries.

By definition any command that says it uses FORMat:DATA uses any format supported by FORMat:DATA.

The NORMAl order is a byte sequence that begins with the most significant byte (MSB) first, and ends with the least significant byte (LSB) last in the sequence: 1|2|3|4. SWAPped order is when the byte sequence begins with the LSB first, and ends with the MSB last in the sequence: 4|3|2|1.

Remote Command	:FORMat:BORDER NORMAl SWAPped :FORMat:BORDER?
Preset	NORMAl
Initial S/W Revision	Prior to A.02.00

Meas Setup

Displays the measurement setup menu for the currently selected measurement.

Key Path	Front-panel key
Initial S/W Revision	Prior to A.02.00

Avg/Hold Num

Specifies the number of measurement averages used to calculate the measurement result. The average is displayed at the end of each sweep.

Average State allows you to turn averaging on or off.

Key Path	Meas Setup
Mode	SA, WCDMA, C2K, WIMAX OFDMA, CDMA1xEVDO, TD-SCDMA, DVB-T/H, LTE, LTETDD, WLAN, MSR, LTEAFDD, LTEATDD
Remote Command	[:SENSe]:SPURious:AVERage:COUNT <integer> [:SENSe]:SPURious:AVERage:COUNT? [:SENSe]:SPURious:AVERage[:STATe] ON OFF 1 0 [:SENSe]:SPURious:AVERage[:STATe]?
Example	SPUR:AVER:COUN 2500 SPUR:AVER:COUN? SPUR:AVER ON SPUR:AVER?
Notes	You must be in the Spectrum Analysis mode, W-CDMA mode, cdma2000 mode, DVB-T/H mode, TD-SCDMA mode, LTE mode, LTE TDD mode, WLAN mode, MSR, LTE-Advanced FDD/TDD mode or WiMAX mode to use this command. Use INSTRument:SElect to set the mode.
Preset	10 OFF
State Saved	Saved in instrument state.
Min	1
Max	10000
Initial S/W Revision	Prior to A.02.00
Modified at S/W Revision	A.03.00

Avg Mode

Enables you to set the averaging mode.

- When set to Exponential (Exp) the measurement averaging continues using the specified number of averages to compute each averaged value. The average will be displayed at the end of each sweep.

- When set to Repeat, the measurement resets the average counter each time the specified number of averages is reached.

Key Path	Meas Setup
Mode	SA, WCDMA, WIMAX OFDMA, TD-SCDMA, DVB-T/H, LTE, LTETDD, WLAN, MSR, LTEAFDD, LTEATDD
Remote Command	[:SENSe] :SPURious :AVERage :TCONtrol EXPonential REPEAT [:SENSe] :SPURious :AVERage :TCONtrol ?
Example	SPUR: AVER: TCON REP SPUR: AVER: TCON ?
Notes	You must be in the cdma2000 mode, TD-SCDMA mode, W-CDMA mode, DVB-T/H mode, GSM/EDGE mode, LTE mode, LTE TDD mode, WLAN mode, MSR, LTE-Advanced FDD/TDD mode or WiMAX mode to use this command. Use INSTRUMENT: SElect to set the mode.
Preset	EXPonential
State Saved	Saved in instrument state.
Range	Exp Repeat
Initial S/W Revision	Prior to A.02.00
Modified at S/W Revision	A.03.00

Range Table

Enables you to set range parameters.

To change a parameter, select the appropriate menu softkey and enter the value using the numeric keypad or the knob. The analyzer settings will be updated with the new parameter values.

When the current view is the Range Table view, the selected range is highlighted and displayed in the Range Table automatically. With the normal window arrangement, up to five ranges are displayed. In the zoom mode, all 20 ranges can be displayed.

In the Range Table window, there are three tables corresponding to each page of the Range Table menu. When the Range Table key is pressed, the table of the first menu page is displayed.

The Displayed table is changed by changing the Range Table menu page. It can also be changed by a remote command. When the Range Table is changed by the command, the menu page changes accordingly if the Range Table menu is displayed.

Key Path	Meas Setup
Initial S/W Revision	Prior to A.02.00

Range

Changing the range updates the values on the other menu keys so that they reflect the settings for the selected range. If Range is turned on, it will be used as part of the measurement. If it is off, it will be excluded. A range is made up of the next fifteen parameters. This parameter can send up to 20 values. The

	Abs Stop Freq.
Preset	ABSolute, ABSolute
State Saved	Saved in instrument state.
Range	Abs Offset
Initial S/W Revision	A.11.00

Abs Start Freq (Only for MSR and LTE-Advanced FDD/TDD)

Sets the start frequency of the analyzer. This parameter can send up to 20 values. The location where the start frequency occurs in the list sent to the measurement corresponds to the range the value is associated with.

This parameter is coupled with either Offset Start Freq or Offset Stop Freq. The coupling equations are shown in ["Frequency Type \(Only for MSR\)" on page 1587](#).

Missing values are not permitted; that is, if you want to change values 2 and 6 you must send all values up to 6. Subsequent values will remain as they were. The query for this parameter always returns 20 values.

Key Path	Meas Setup, Range Table, Freq Range
Mode	MSR, LTEATDD, LTEAFDD
Remote Command	[:SENSE] :SPURious [:RANGE] [:LIST] :FREQuency:STARt <freq>, <freq>, <freq>, <freq>, <freq>, <freq>, <freq>, <freq>, <freq>, <freq>, <freq>, <freq>, <freq>, <freq>, <freq>, <freq>, <freq>, <freq>, <freq>, <freq> [:SENSE] :SPURious [:RANGE] [:LIST] :FREQuency:STARt?
Example	SPUR:FREQ:STAR 9 kHz, 150 kHz, 30 MHz, 1GHz, 1.5 GHz, 1.5 GHz, 1.5 GHz, 1.5 GHz, 1.5 GHz, 1.5 GHz, 1.5 GHz, 1.5 GHz, 1.5 GHz, 1.5 GHz, 1.5 GHz, 1.5 GHz, 1.5 GHz, 1.5 GHz, 1.5 GHz, 1.5 GHz SPUR:FREQ:STAR?
Notes	You must be in the MSR, LTE-Advanced FDD/TDD mode to use this command. Use INSTRument:SElect to set the mode.
Preset	MSR, LTEAFDD: 9 kHz, 150 kHz, 30 MHz, 1 GHz, 1.92GHz, 1.98 GHz, 2.18 GHz, 1.5 GHz, 1.5 GHz, 1.5 GHz, 1.5 GHz, 1.5 GHz, 1.5 GHz, 1.5 GHz, 1.5 GHz, 1.5 GHz, 1.5 GHz, 1.5 GHz, 1.5 GHz, 1.5 GHz, 1.5 GHz LTEATDD: 9 kHz, 150 kHz, 30 MHz, 1 GHz, 1.90GHz, 2.01 GHz, 2.025 GHz, 1.5 GHz, 1.5 GHz, 1.5 GHz, 1.5 GHz, 1.5 GHz, 1.5 GHz, 1.5 GHz, 1.5 GHz, 1.5 GHz, 1.5 GHz, 1.5 GHz, 1.5 GHz, 1.5 GHz, 1.5 GHz
State Saved	Saved in instrument state.
Min	-80 MHz
Max	Hardware Dependent: Option 503: 3699999990 Option 508: 8499999990 Option 513: 13799999990 Option 526: 26999999990

Initial S/W Revision	Prior to A.02.00
Modified at S/W Revision	A.03.00, A.10.00

Abs Stop Freq(Only for MSR and LTE-Advanced FDD/TDD)

Sets the stop frequency of the analyzer. This parameter can send up to 20 values. The location in the list sent corresponds to the range the value is associated with.

This parameter is coupled with either Offset Start Freq or Offset Stop Freq. The coupling equations are shown in "[Frequency Type \(Only for MSR\)](#)" on page 1587.

The location of where the stop frequency occurs in the list sent to the measurement corresponds to the range the value is associated with.

Missing values are not permitted; that is, if you want to change values 2 and 6 you must send all values up to 6. Subsequent values will remain as they were. The query for this parameter always returns 20 values.

Key Path	Meas Setup, Range Table, Freq Range
Mode	MSR, LTEAFDD, LTATDD
Remote Command	[:SENSe]:SPURious[:RANGe][:LIST]:FREQuency:STOP <freq>, <freq>, <freq>, <freq>, <freq>, <freq>, <freq>, <freq>, <freq>, <freq>, <freq>, <freq>, <freq>, <freq>, <freq>, <freq>, <freq>, <freq>, <freq>, <freq> [:SENSe]:SPURious[:RANGe][:LIST]:FREQuency:STOP?
Example	SPUR:FREQ:STOP 150kHz, 30MHz, 1GHz, 2.1GHz, 2.1GHz, 2.1774GHz, 2.18GHz, 12.75GHz, 2.5GHz, 2.5GHz, 2.5GHz, 2.5GHz, 2.5GHz, 2.5GHz, 2.5GHz, 2.5GHz, 2.5GHz, 2.5GHz, 2.5GHz, 2.5GHz SPUR:FREQ:STOP?
Notes	You must be in the MSR, LTE-Advanced FDD/TDD mode to use this command. Use INSTRument:SElect to set the mode.
Preset	MSR, LTEAFDD:150kHz, 30MHz, 1GHz, 1.92GHz, 1.98GHz, 2.1GHz, 12.75GHz, 2.5GHz, 2.5GHz, 2.5GHz, 2.5GHz, 2.5GHz, 2.5GHz, 2.5GHz, 2.5GHz, 2.5GHz, 2.5GHz, 2.5GHz, 2.5GHz, 2.5GHz LTEATDD:150kHz, 30MHz, 1GHz, 1.90GHz, 2.01GHz, 2.025GHz, 12.75GHz, 2.5GHz, 2.5GHz, 2.5GHz, 2.5GHz, 2.5GHz, 2.5GHz, 2.5GHz, 2.5GHz, 2.5GHz, 2.5GHz, 2.5GHz, 2.5GHz, 2.5GHz
State Saved	Saved in instrument state.
Min	-79999990
Max	Hardware Dependent: Option 503: 3.7 GHz Option 508: 8.5 GHz Option 513: 13.8 GHz Option 526: 27.0 GHz
Initial S/W Revision	Prior to A.02.00
Modified at S/W Revision	A.03.00
Modified at S/W Revision	A.03.00

Offset Start Freq (Only for MSR)

Sets the range frequency as offset from one of the operating band edges. This parameter can send up to 20 values. The location where the start frequency occurs in the list sent to the measurement corresponds to the range the value is associated with. Missing values are not permitted; that is, if you want to change values 2 and 6 you must send all values up to 6. Subsequent values will remain as they were. The query for this parameter always returns 20 values.

This parameter is coupled with either Abs Start Freq or Abs Stop Freq using the coupling equations shown in ["Frequency Type \(Only for MSR\)" on page 1587](#).

This value is clipped to keep Abs Start/Stop Freq within the available frequency range. This clipping needs to work even when OB Start Freq, OB Stop Freq or Offset Side is changed.

Key Path	Meas Setup, Range Table, Freq Range
Mode	MSR
Remote Command	[:SENSe] :SPURious [:RANGe] [:LIST] :OFFSet:FREQuency:STARt <freq>, <freq>, <freq>, <freq>, <freq>, <freq>, <freq>, <freq>, <freq>, <freq>, <freq>, <freq>, <freq>, <freq>, <freq>, <freq>, <freq>, <freq>, <freq>, <freq> [:SENSe] :SPURious [:RANGe] [:LIST] :OFFSet:FREQuency:STARt?
Example	SPUR:OFFS:FREQ:STAR 9 kHz, 150 kHz, 30 MHz, 1GHz, 1.5 GHz, 1.5 GHz, 1.5 GHz, 1.5 GHz, 1.5 GHz, 1.5 GHz, 1.5 GHz, 1.5 GHz, 1.5 GHz, 1.5 GHz, 1.5 GHz, 1.5 GHz, 1.5 GHz, 1.5 GHz, 1.5 GHz, 1.5 GHz SPUR:OFFS:FREQ:STAR?
Notes	You must be in the MSR mode to use this command. Use INSTRument:SElect to set the mode.
Preset	10 MHz, 20 MHz, 30 MHz, 30 MHz, 30 MHz, 30 MHz, 30 MHz, 30 MHz, 30 MHz, 30 MHz, 30 MHz, 30 MHz, 30 MHz, 30 MHz, 30 MHz, 30 MHz, 30 MHz, 30 MHz, 30 MHz, 30 MHz
State Saved	Saved in instrument state.
Min	-80 MHz
Max	SA Max Freq - 10Hz (Hardware Dependent)
Initial S/W Revision	A.11.00

Offset Stop Freq(Only for MSR)

Sets the range frequency as offset from one of operating band edges. This parameter can send up to 20 values. The location in the list sent corresponds to the range the value is associated with.

The location of where the stop frequency occurs in the list sent to the measurement corresponds to the range the value is associated with.

Missing values are not permitted. If you want to change values 2 and 6 you must send all values up to 6. Subsequent values will remain as they were. The query for this parameter always returns 20 values.

This parameter is coupled with either Abs Start Freq or Abs Stop Freq using the coupling equations shown in ["Frequency Type \(Only for MSR\)" on page 1587](#).

This value is clipped to keep Abs Start/Stop Freq inside the available frequency range. This clipping needs to work even when OB Start Freq, OB Stop Freq or Offset Side is changed.

Key Path	Meas Setup, Range Table, Freq Range
Mode	MSR
Remote Command	<code>[:SENSe]:SPURious[:RANGe][:LIST]:OFFSet:FREQuency:STOP <freq>, <freq>, <freq>, <freq>, <freq>, <freq>, <freq>, <freq>, <freq>, <freq>, <freq></code> <code>[:SENSe]:SPURious[:RANGe][:LIST]:OFFSet:FREQuency:STOP?</code>
Example	SPUR:OFFS:FREQ:STOP 150kHz, 30MHz, 1GHz, 2.1GHz, 2.1GHz, 2.1774GHz, 2.18GHz, 12.75GHz, 2.5GHz, 2.5GHz, 2.5GHz, 2.5GHz, 2.5GHz, 2.5GHz, 2.5GHz, 2.5GHz, 2.5GHz, 2.5GHz, 2.5GHz SPUR:OFFS:FREQ:STOP?
Notes	You must be in the MSR mode to use this command. Use INSTRUMENT:SElect to set the mode.
Preset	20 MHz, 30 MHz, 30 MHz, 30 MHz, 30 MHz, 30 MHz, 30 MHz, 30 MHz, 30 MHz, 30 MHz, 30 MHz, 30 MHz, 30 MHz, 30 MHz, 30 MHz, 30 MHz, 30 MHz, 30 MHz, 30 MHz
State Saved	Saved in instrument state.
Min	-79999990
Max	SA Max Frequency (Hardware Dependent)
Initial S/W Revision	A.11.00

Offset Side (Only for MSR)

Sets the offset side to either Negative or Positive. This parameter indicates which side of the operation band the specified range is on. It also determines which coupling equations defined in Frequency Type section are used to couple the absolute frequencies and the offset frequencies. This setting is effective only when Freq Type is Offset.

Key Path	Meas Setup, Range Table, Freq Range,
Mode	MSR
Remote Command	<code>[:SENSe]:SPURious[:RANGe][:LIST]:OFFSet:SIDE NEGative POSitive, NEGative POSitive, NEGative POSitive, NEGative POSitive, NEGative POSitive, NEGative POSitive, NEGative POSitive, NEGative POSitive, NEGative POSitive, NEGative POSitive, NEGative POSitive, NEGative POSitive, NEGative POSitive, NEGative POSitive, NEGative POSitive, NEGative POSitive</code> <code>[:SENSe]:SPURious[:RANGe][:LIST]:OFFSet:SIDE?</code>
Example	SPUR:OFFS:SIDE NEG, NEG, POS, POS SPUR:OFFS:SIDE?
Notes	You must be in the MSR mode. Use INSTRUMENT:SElect to set the mode.
Preset	NEG, NEG, POS, POS, POS, POS, POS, POS, POS, POS, POS, POS, POS, POS, POS, POS, POS, POS
State Saved	Saved in instrument state.
Range	Negative (From Op. Band Start Edge) Positive (From Op. Band Stop Edge)
Initial S/W Revision	A.11.00

Res BW

Sets the resolution bandwidth of the analyzer. This parameter can send up to 20 values.

The location of where the resolution bandwidth occurs in the list sent to the measurement corresponds to the range the value is associated with.

Missing values are not permitted. In other words, if you want to change values 2 and 6 you must send all values up to 6. Subsequent values will remain as they were. The query for this parameter always returns 20 values.

Key Path	Meas Setup, Range Table
Mode	SA, WCDMA, C2K, WIMAX OFDMA, TD-SCDMA, 1xEV-DO, DVB-T/H, LTE, LTETDD, WLAN, MSR, LTEAFDD, LTEATDD
Remote Command	<pre>[:SENSe] :SPURious [:RANGe] [:LIST] :BANDwidth [:RESolution] <freq>, <freq>, <freq>, <freq>, <freq>, <freq>, <freq>, <freq>, <freq>, <freq>, <freq>, <freq>, <freq>, <freq>, <freq>, <freq>, <freq>, <freq>, <freq>, <freq> [:SENSe] :SPURious [:RANGe] [:LIST] :BANDwidth [:RESolution] ? [:SENSe] :SPURious [:RANGe] [:LIST] :BANDwidth [:RESolution] :AUTO OFF ON 0 1, OFF ON 0 1 [:SENSe] :SPURious [:RANGe] [:LIST] :BANDwidth [:RESolution] :AUTO?</pre>
Example	<pre>SPUR:BAND 1kHz, 10kHz, 100kHz, 1MHz, 1MHz, 1MHz, 1MHz, 3MHz, 3MHz, 3MHz, 3MHz, 3MHz, 3MHz, 3MHz, 3MHz, 3MHz, 3MHz, 3MHz, 3MHz, 3MHz, 3MHz SPUR:BAND? SPUR:BWID:AUTO ON, ON, ON, OFF, OFF, OFF, OFF, OFF, ON, ON, ON, ON, OFF, OFF, OFF, OFF, OFF, OFF, ON, ON SPUR:BWID:AUTO?</pre>
Notes	You must be in cdma2000 mode, TD-SCDMA mode, W-CDMA mode, DVB-T/H, GSM/EDGE mode, LTE mode, LTE TDD mode, WLAN mode, MSR, LTE-Advanced FDD/TDD mode or WiMAX mode to use this command. Use INSTRument:SElect to set the mode.
Preset	<pre>SA, WIMAX OFDMA:1.2MHz, 0.51MHz, 0.1MHz, 0.1MHz, 4MHz, 3MHz, 3MHz, 3MHz, 3MHz, 3MHz, 3MHz, 3MHz, 3MHz, 3MHz, 3MHz, 3MHz, 3MHz, 3MHz, 3MHz WCDMA:1kHz, 10kHz, 100kHz, 1MHz, 1MHz, 1MHz, 1MHz, 1MHz, 3MHz, 3MHz, 3MHz, 3MHz, 3MHz, 3MHz, 3MHz, 3MHz, 3MHz, 3MHz, 3MHz C2k, 1xEV-DO: 1kHz, 10kHz, 100kHz, 1MHz, 1MHz, 1MHz, 1MHz, 3MHz, 3MHz, 3MHz, 3MHz, 3MHz, 3MHz, 3MHz, 3MHz, 3MHz, 3MHz, 3MHz, 3MHz TD-SCDMA: 1kHz, 10kHz, 100kHz, 1MHz, 3MHz, 3MHz, 3MHz, 3MHz, 3MHz, 3MHz, 3MHz, 3MHz, 3MHz, 3MHz, 3MHz, 3MHz, 3MHz, 3MHz DVB-T/H: 100kHz, 3.9kHz, 100kHz, 3.9kHz, 100kHz, 100kHz, 3MHz, 3MHz, 3MHz, 3MHz, 3MHz, 3MHz, 3MHz, 3MHz, 3MHz, 3MHz, 3MHz, 3MHz, 3MHz LTE, MSR, LTEAFDD: 1kHz, 10kHz, 100kHz, 1MHz, 100kHz, 1MHz, 1MHz, 3MHz, 3MHz, 3MHz, 3MHz, 3MHz, 3MHz, 3MHz, 3MHz, 3MHz, 3MHz, 3MHz, 3MHz, 3MHz</pre>

	<pre><ampl>, <ampl>, <ampl>, <ampl>, <ampl>, <ampl>, <ampl>, <ampl>, <ampl>, <ampl>, <ampl> :CALCulate:SPURious[:RANGe][:LIST]:LIMit:ABSolute[:UPPer]:DATA[:START]?</pre>
Example	<pre>CALC:SPUR:LIM:ABS:DATA 0, 0, 0, 0, 0, 0, 0, 0, 0, 0, 0, 0, 0, 0, 0, 0, 0, 0, 0, 0 CALC:SPUR:LIM:ABS:DATA?</pre>
Preset	<pre>SA, WIMAX OFDMA: -5.00000000E+001, -5.00000000E+001, -5.00000000E+001, - 5.00000000E+001, -5.00000000E+001, -5.00000000E+001, -5.00000000E+001, - 5.00000000E+001, -5.00000000E+001, -5.00000000E+001, -5.00000000E+001, - 5.00000000E+001, -5.00000000E+001, -5.00000000E+001, -5.00000000E+001, - 5.00000000E+001, -5.00000000E+001, -5.00000000E+001, -5.00000000E+001, - 5.00000000E+001 WCDMA: -36dBm, -36dBm, -36dBm, -30dBm, -25dBm, -15dBm, -25dBm, -30dBm, -50dBm, - 50dBm, -50dBm, -50dBm, -50dBm, -50dBm, -50dBm, -50dBm, -50dBm, -50dBm, - 50dBm C2K, 1xEV-DO: -13 dBm, -13dBm, -13 dBm, -13 dBm, -50 dBm, -50 dBm, -50 dBm, -50 dBm, -50 dBm, -50 dBm, -50 dBm, -50 dBm, -50 dBm, -50 dBm, -50 dBm, -50 dBm, -50 dBm, -50 dBm, -50 dBm, -50 dBm TD-SCDMA: -13 dBm, -13dBm, -13 dBm, -13 dBm, -50 dBm, -50 dBm, -50 dBm, -50 dBm, -50 dBm, -50 dBm, -50 dBm, -50 dBm, -50 dBm, -50 dBm, -50 dBm, -50 dBm, -50 dBm, -50 dBm, -50 dBm DVB-T/H: -36dBm, -82dBm, -36dBm, -76dBm, -36dBm, -30dBm, -50dBm, -50dBm, -50dBm, -50dBm, - 50dBm, -50dBm, -50dBm, -50dBm, -50dBm, -50dBm, -50dBm, -50dBm, -50dBm, -50dBm LTE, MSR, LTEAFDD: -36dBm, -36dBm, -36dBm, -30dBm, -96dBm, -30dBm, -30dBm, -50dBm, -50dBm, -50dBm, -50dBm, -50dBm, -50dBm, -50dBm, -50dBm, -50dBm, -50dBm, -50dBm, - 50dBm, -50dBm LTETDD, LTEATDD: -36dBm, -36dBm, -36dBm, -30dBm, -96dBm, -30dBm, -30dBm, -50dBm, - 50dBm, -50dBm, -50dBm, -50dBm, -50dBm, -50dBm, -50dBm, -50dBm, -50dBm, -50dBm, - 50dBm, -50dBm WLAN: -36dBm, -36dBm, -36dBm, -30dBm, -50dBm, -50dBm, -50dBm, -50dBm, -50dBm, -50dBm, - 50dBm, -50dBm, -50dBm, -50dBm, -50dBm, -50dBm, -50dBm, -50dBm, -50dBm, -50dBm</pre>
State Saved	Saved in instrument state.
Min	-200 dBm
Max	50.0 dBm
Initial S/W Revision	Prior to A.02.00
Modified at S/W Revision	A.03.00

Abs Stop Limit

Abs Stop Limit is used to determine the limit above which spurs will report a failing. If Abs Stop Limit Mode is set to Auto, this is coupled to Abs Start Limit to make a flat limit line. If set to Man, Abs Start Limit and

Abs Stop Limit can take different values to make a sloped limit line.

Abs Stop Limit Mode, when set to Couple, couples Abs Start Limit and Abs Stop Limit to make a flat limit line. If set to Man, Abs Start and Abs Stop can take different values to make a sloped limit line.

This parameter can send up to 20 values. The location in the list sent corresponds to the range of the associated value. Missing values are not permitted; that is, if you want to change values 2 and 6 you must send all values up to 6. Subsequent values will remain as they were. The query for this parameter always returns 20 values.

Key Path	Meas Setup, Range Table
Mode	SA, WCDMA, C2K, WIMAX OFDMA, TD-SCDMA, 1xEV-DO, DVB-T/H, LTE, LTEFDD, WLAN, MSR, LTEAFDD, LTEATDD
Remote Command	<pre>:CALCulate:SPURious[:RANGE][:LIST]:LIMit:ABSolute[:UPPer]:DATA:STOP <ampl>, <ampl>, <ampl>, <ampl>, <ampl>, <ampl>, <ampl>, <ampl>, <ampl>, <ampl>, <ampl>, <ampl>, <ampl>, <ampl>, <ampl>, <ampl>, <ampl>, <ampl>, <ampl>, <ampl>, <ampl>, <ampl> :CALCulate:SPURious[:RANGE][:LIST]:LIMit:ABSolute[:UPPer]:DATA:STOP? :CALCulate:SPURious[:RANGE][:LIST]:LIMit:ABSolute [:UPPer]:DATA:STOP:AUTO OFF ON 0 1, OFF ON 0 1 :CALCulate:SPURious[:RANGE][:LIST]:LIMit:ABSolute [:UPPer]:DATA:STOP:AUTO?</pre>
Example	<pre>CALC:SPUR:LIM:ABS:DATA:STOP -25, -25, -25, -25, -25, -25, -25, -25, -25, -25, -25, -25, - 25, -25, -25, -25, -25, -25, -25, -25 CALC:SPUR:LIM:ABS:DATA:STOP? CALC:SPUR:LIM:ABS:DATA:STOP:AUTO ON, ON, ON, ON, ON, ON, ON, ON, ON, ON, ON, ON, ON, ON, ON, ON, ON, ON, ON, ON CALC:SPUR:LIM:ABS:DATA:STOP:AUTO?</pre>
Preset	<pre>SA, WIMAX OFDMA: -5.00000000E+001, -5.00000000E+001, -5.00000000E+001, - 5.00000000E+001, -5.00000000E+001, -5.00000000E+001, -5.00000000E+001, - 5.00000000E+001, -5.00000000E+001, -5.00000000E+001, -5.00000000E+001, - 5.00000000E+001, -5.00000000E+001, -5.00000000E+001, -5.00000000E+001, - 5.00000000E+001, -5.00000000E+001, -5.00000000E+001, -5.00000000E+001, - 5.00000000E+001 WCDMA: -36dBm, -36dBm, -36dBm, -30dBm, -25dBm, -15dBm, -25dBm, -30dBm, -50dBm, - 50dBm, -50dBm, -50dBm, -50dBm, -50dBm, -50dBm, -50dBm, -50dBm, -50dBm, -50dBm, - 50dBm C2K, 1xEV-DO: -13 dBm, -13dBm, -13 dBm, -13 dBm, -50 dBm, -50 dBm, -50 dBm, -50 dBm, -50 dBm, -50 dBm, -50 dBm, -50 dBm, -50 dBm, -50 dBm, -50 dBm, -50 dBm, -50 dBm, -50 dBm, -50 dBm, -50 dBm TD-SCDMA: -13 dBm, -13dBm, -13 dBm, -13 dBm, -50 dBm, -50 dBm, -50 dBm, -50 dBm, -50 dBm, -50 dBm, -50 dBm, -50 dBm, -50 dBm, -50 dBm, -50 dBm, -50 dBm, -50 dBm, -50 dBm, -50 dBm, -50 dBm</pre>

	<p>-50 dBm</p> <p>DVB-T/H: -36dBm, -82dBm, -36dBm, -76dBm, -36dBm, -30dBm, -50dBm, -50dBm, -50dBm, -50dBm, -50dBm, -50dBm, -50dBm, -50dBm, -50dBm, -50dBm, -50dBm, -50dBm, -50dBm, -50dBm, -50dBm</p> <p>LTE, MSR, LTEAFDD: -36dBm, -36dBm, -36dBm, -30dBm, -96dBm, -30dBm, -30dBm, -50dBm, -50dBm, -50dBm, -50dBm, -50dBm, -50dBm, -50dBm, -50dBm, -50dBm, -50dBm, -50dBm, -50dBm, -50dBm, -50dBm</p> <p>LTETDD, LTEATDD: -36dBm, -36dBm, -36dBm, -52dBm, -52dBm, -30dBm, -30dBm, -50dBm, -50dBm, -50dBm, -50dBm, -50dBm, -50dBm, -50dBm, -50dBm, -50dBm, -50dBm, -50dBm, -50dBm, -50dBm, -50dBm</p> <p>WLAN: -36dBm, -36dBm, -36dBm, -30dBm, -50dBm, -50dBm, -50dBm, -50dBm, -50dBm, -50dBm, -50dBm, -50dBm, -50dBm, -50dBm, -50dBm, -50dBm, -50dBm, -50dBm, -50dBm, -50dBm, -50dBm</p> <p>ON, ON, ON, ON, ON, ON, ON, ON, ON, ON, ON, ON, ON, ON, ON, ON, ON, ON, ON, ON</p>
State Saved	Saved in instrument state.
Min	-200 dBm
Max	50.0 dBm
Initial S/W Revision	Prior to A.02.00
Modified at S/W Revision	A.03.00

Peak Excursion

Sets the minimum amplitude variation of signals that can be identified as peaks. If a value of 6 dB is selected, peaks that rise and fall more than 6 dB above the peak threshold value are identified.

This parameter can send up to 20 values. The location in the list sent corresponds to the range of the associated value. Missing values are not permitted. If you want to change values 2 and 6 you must send all values up to 6. Subsequent values will remain as they were. The query for this parameter always returns 20 values.

Key Path	Meas Setup, Range Table
Mode	SA, WCDMA, C2K, WIMAX OFDMA, TD-SCDMA, 1xEV-DO, DVB-T/H, LTE, LTETDD, WLAN, MSR, LTEAFDD, LTEATDD
Remote Command	<pre>[:SENSE] : SPURious [:RANGe] [:LIST] : PEAK : EXCursion <rel_ampl>, <rel_ampl>, <rel_ampl>, <rel_ampl>, <rel_ampl>, <rel_ampl>, <rel_ampl>, <rel_ampl>, <rel_ampl>, <rel_ampl>, <rel_ampl>, <rel_ampl>, <rel_ampl>, <rel_ampl>, <rel_ampl>, <rel_ampl>, <rel_ampl>, <rel_ampl>, <rel_ampl>, <rel_ampl></pre> <pre>[:SENSE] : SPURious [:RANGe] [:LIST] : PEAK : EXCursion?</pre>
Example	<pre>SPUR:PEAK:EXC 20, 20</pre> <pre>SPUR:PEAK:EXC?</pre>
Preset	<pre>+6.00000000E+000, +6.00000000E+000, +6.00000000E+000, +6.00000000E+000, +6.00000000E+000, +6.00000000E+000, +6.00000000E+000, +6.00000000E+000, +6.00000000E+000, +6.00000000E+000, +6.00000000E+000, +6.00000000E+000, +6.00000000E+000, +6.00000000E+000, +6.00000000E+000, +6.00000000E+000, +6.00000000E+000, +6.00000000E+000, +6.00000000E+000, +6.00000000E+000</pre>

	+6.00000000E+000, +6.00000000E+000, +6.00000000E+000, +6.00000000E+000
State Saved	Saved in instrument state.
Min	0.0 dB
Max	100.0 dB
Initial S/W Revision	Prior to A.02.00
Modified at S/W Revision	A.03.00

Pk Threshold

Sets the minimum amplitude of signals that can be identified as peaks. For example, if a value of -90 dBm is selected, only peaks that rise and fall more than the peak excursion value which are above -90 dBm are identified.

This parameter can send up to 20 values. The location in the list sent corresponds to the range of the associated value. Missing values are not permitted. If you want to change values 2 and 6 you must send all values up to 6. Subsequent values will remain as they were. The query for this parameter always returns 20 values.

Key Path	Meas Setup, Range Table
Mode	SA, WCDMA, C2K, WIMAX OFDMA, TD-SCDMA, 1xEV-DO, DVB-T/H, LTE, LTETDD, WLAN, MSR, LTEAFDD, LTEATDD
Remote Command	[[:SENSe]:SPURious[:RANGe][:LIST]:PEAK:THReshold <real>, <real>, <real>, <real>, <real>, <real>, <real>, <real>, <real>, <real>, <real>, <real>, <real>, <real>, <real>, <real>, <real>, <real>, <real>, <real> [[:SENSe]:SPURious[:RANGe][:LIST]:PEAK:THReshold?
Example	SPUR:PEAK:THR 0,0,0 SPUR:PEAK:THR?
Preset	-9.00000000E+001, -9.00000000E+001, -9.00000000E+001, -9.00000000E+001, -9.00000000E+001, -9.00000000E+001, -9.00000000E+001, -9.00000000E+001, -9.00000000E+001, -9.00000000E+001, -9.00000000E+001, -9.00000000E+001, -9.00000000E+001, -9.00000000E+001, -9.00000000E+001, -9.00000000E+001, -9.00000000E+001, -9.00000000E+001, -9.00000000E+001, -9.00000000E+001
State Saved	Saved in instrument state.
Min	-200
Max	0
Initial S/W Revision	Prior to A.02.00
Modified at S/W Revision	A.03.00, A.07.00

Attenuation

Defines attenuation value for each range.

- When Auto state is ON, attenuation value under AMPTD Y Scale is used.

- When Auto state is OFF, this value is used as mechanical attenuation value without electric attenuation.

Key Path	Meas Setup, Range Table
Mode	SA, WCDMA, C2K, WIMAX OFDMA, TD-SCDMA, 1xEV-DO, DVB-T/H, LTE, LTETDD, WLAN, MSR, LTEAFDD, LTEATDD
Remote Command	<pre>[:SENSe]:SPURious[:RANGe][:LIST]:ATTenuation <rel_ampl>, <rel_ampl>, <rel_ampl>, <rel_ampl>, <rel_ampl>, <rel_ampl>, <rel_ampl>, <rel_ampl>, <rel_ampl>, <rel_ampl>, <rel_ampl>, <rel_ampl>, <rel_ampl>, <rel_ampl>, <rel_ampl>, <rel_ampl>, <rel_ampl>, <rel_ampl>, <rel_ampl>, <rel_ampl> [:SENSe]:SPURious[:RANGe][:LIST]:ATTenuation? [:SENSe]:SPURious[:RANGe][:LIST]:ATTenuation:AUTO OFF ON 0 1, OFF [:SENSe]:SPURious[:RANGe][:LIST]:ATTenuation:AUTO?</pre>
Example	<pre>SPUR:ATT 10dB, 10dB, 10dB, 10dB, 10dB, 10dB, 10dB, 10dB, 10dB, 10dB, 10dB, 10dB, 10dB, 10dB, 10dB, 10dB, 10dB, 10dB, 10dB, 10dB SPUR:ATT? SPUR:ATT:AUTO 0, 0, 0, 0, 0, 0, 0, 0, 0, 0, 0, 0, 0, 0, 0, 0, 0, 0, 0, 0 SPUR:ATT:AUTO?</pre>
Notes	You must be in cdma2000 mode, 1xEV-DO mode, TD-SCDMA mode, W-CDMA mode, DVB-T/H, SA mode, LTE mode, LTE TDD mode, WLAN mode, MSR, LTE-Advanced FDD/TDD or WiMAX mode to use this command. Use INSTRUMENT:SElect to set the mode.
Couplings	“---“ is displayed as value when Auto state is ON, to indicate attenuation value under AMPTD Y Scale is being used.
Preset	<pre>10dB, 10dB ON, ON, ON, ON, ON, ON, ON, ON, ON, ON, ON, ON, ON, ON, ON, ON, ON, ON, ON, ON</pre>
State Saved	Saved in instrument state.
Min	0 dB
Max	70 dB
Initial S/W Revision	Prior to A.02.00
Modified at S/W Revision	A.03.00

Detector 1

Sets the detector to be used by the trace for spur detection and limit line testing.

Key Path	Meas Setup, Range Table
Mode	SA, WCDMA, C2K, WIMAX OFDMA, TD-SCDMA, 1xEV-DO, DVB-T/H, LTE, LTETDD, WLAN, MSR, LTEAFDD, LTEATDD

Remote Command	[:SENSe]:SPURious[:RANGe][:LIST]:DETEctor[1][:FUNction] AVERage NEGative NORMal POSitive SAMPlE RMS, AVERage NEGative NORMal POSitive SAMPlE RMS, AVERage NEGative NORMal POSitive SAMPlE RMS, AVERage NEGative NORMal POSitive SAMPlE RMS, AVERage NEGative NORMal POSitive SAMPlE RMS, AVERage NEGative NORMal POSitive SAMPlE RMS, AVERage NEGative NORMal POSitive SAMPlE RMS, AVERage NEGative NORMal POSitive SAMPlE RMS, AVERage NEGative NORMal POSitive SAMPlE RMS, AVERage NEGative NORMal POSitive SAMPlE RMS, AVERage NEGative NORMal POSitive SAMPlE RMS, AVERage NEGative NORMal POSitive SAMPlE RMS, AVERage NEGative NORMal POSitive SAMPlE RMS, AVERage NEGative NORMal POSitive SAMPlE RMS, AVERage NEGative NORMal POSitive SAMPlE RMS, AVERage NEGative NORMal POSitive SAMPlE RMS, AVERage NEGative NORMal POSitive SAMPlE RMS, AVERage NEGative NORMal POSitive SAMPlE RMS, AVERage NEGative NORMal POSitive SAMPlE RMS, AVERage NEGative NORMal POSitive SAMPlE RMS
	[:SENSe]:SPURious[:RANGe][:LIST]:DETEctor[1][:FUNction]?
Example	SPUR:DET NORM, SPUR:DET?
Notes	For backward compatibility, "NORMal" is available as a SCPI command parameter. However this is treated the same as "RMS" internally, so the query never returns "NORMal" as its results.
Preset	POS, POS, POS, POS, POS, POS, POS, POS, POS, POS, POS, POS, POS, POS, POS, POS, POS, POS
State Saved	Saved in instrument state.
Range	Normal Average Peak Sample Negative Peak
Initial S/W Revision	Prior to A.02.00
Modified at S/W Revision	A.03.00

Detector 2

Sets the detector to be used by the trace for display purposes only.

Key Path	Meas Setup, Range Table
Mode	SA, WCDMA, C2K, WIMAX OFDMA, TD-SCDMA, 1xEV-DO, DVB-T/H, LTE, LTETDD, WLAN, MSR, LTEAFDD, LTEATDD
Remote Command	[:SENSe]:SPURious[:RANGe][:LIST]:DETEctor2[:FUNction] OFF AVERage NEGative NORMal POSitive SAMPlE RMS, OFF AVERage NEGative NORMal POSitive SAMPlE RMS, OFF AVERage NEGative NORMal POSitive SAMPlE RMS, OFF AVERage NEGative NORMal POSitive SAMPlE RMS, OFF AVERage NEGative NORMal POSitive SAMPlE RMS, OFF AVERage NEGative NORMal POSitive SAMPlE RMS, OFF AVERage NEGative NORMal POSitive SAMPlE RMS, OFF AVERage NEGative NORMal POSitive SAMPlE RMS, OFF AVERage NEGative NORMal POSitive SAMPlE RMS, OFF AVERage NEGative NORMal POSitive SAMPlE RMS, OFF AVERage NEGative NORMal POSitive

	SAMPlE RMS, OFF AVERAge NEGAtive NORMAl POSItive SAMPlE RMS, OFF AVERAge NEGAtive NORMAl POSItive SAMPlE RMS, OFF AVERAge NEGAtive NORMAl POSItive SAMPlE RMS, OFF AVERAge NEGAtive NORMAl POSItive SAMPlE RMS, OFF AVERAge NEGAtive NORMAl POSItive SAMPlE RMS, OFF AVERAge NEGAtive NORMAl POSItive SAMPlE RMS, OFF AVERAge NEGAtive NORMAl POSItive SAMPlE RMS, OFF AVERAge NEGAtive NORMAl POSItive SAMPlE RMS, OFF AVERAge NEGAtive NORMAl POSItive SAMPlE RMS [:SENSe]:SPURious[:RANGe][:LIST]:DETEctor2[:FUNction]?
Example	SPUR:DET2 AVER, AVER, AVER, AVER, AVER, AVER, AVER, AVER, AVER, AVER, AVER, AVER, AVER, AVER, AVER, AVER, AVER, AVER, AVER, AVER SPUR:DET2?
Notes	For backward compatibility, "NORMAl" is available as a SCPI command parameter. However this is treated same as "RMS" internally, so the query never returns "NORMAl" as its results.
Preset	OFF, OFF, OFF, OFF, OFF, OFF, OFF, OFF, OFF, OFF, OFF, OFF, OFF, OFF, OFF, OFF, OFF, OFF, OFF
State Saved	Saved in instrument state.
Range	Off Normal Average Peak Sample Negative Peak
Initial S/W Revision	Prior to A.02.00
Modified at S/W Revision	A.03.00

Sweep Time

Sets the sweep time mode of the analyzer. This can be Auto, where the analyzer determines the optimum setting, or Manual, where you determine the setting.

This parameter can send up to 20 values. The location in the list sent corresponds to the range of the associated value. Missing values are not permitted. If you want to change values 2 and 6 you must send all values up to 6. Subsequent values will remain as they were. The query for this parameter always returns 20 values.

Key Path	Meas Setup, Range Table
Mode	SA, WCDMA, C2K, WIMAX OFDMA, TD-SCDMA, 1xEV-DO, DVB-T/H, LTE, LTETDD, WLAN, MSR, LTEAFDD, LTEATDD
Remote Command	[:SENSe]:SPURious[:RANGe][:LIST]:SWEep:TIME <time>, <time>, <time>, <time>, <time>, <time>, <time>, <time>, <time>, <time>, <time>, <time>, <time>, <time>, <time>, <time>, <time>, <time>, <time>, <time> [:SENSe]:SPURious[:RANGe][:LIST]:SWEep:TIME? [:SENSe]:SPURious[:RANGe][:LIST]:SWEep:TIME:AUTO OFF ON 0 1, OFF ON 0 1, OFF ON 0 1, OFF ON 0 1, OFF ON 0 1, OFF ON 0 1, OFF ON 0 1, OFF ON 0 1, OFF ON 0 1, OFF ON 0 1, OFF ON 0 1, OFF ON 0 1, OFF ON 0 1, OFF ON 0 1, OFF ON 0 1, OFF ON 0 1, OFF ON 0 1, OFF ON 0 1, OFF ON 0 1, OFF ON 0 1 [:SENSe]:SPURious[:RANGe][:LIST]:SWEep:TIME:AUTO?
Example	SPUR:SWE:TIME 10, 10, 10, 10, 10, 10, 10, 10, 10, 10, 10, 10, 10, 10, 10, 10, 10, 10

Example	SPUR:SWE:POIN 1001,1001,1001 SPUR:SWE:POIN? SPUR:SWE:POIN:AUTO ON,ON,ON SPUR:SWE:POIN:AUTO?
Preset	SA, WIMAX OFDMA, DVB-T/H, WLAN: +601, +601, +601, +601, +601, +601, +601, +601, +601, +601, +601, +601, +601, +601, +601 WCDMA: 601, 2985, 9700, 1100, 601, 601, 601, 10570, 601, 601, 601, 601, 601, 601, 601, 601 C2K: 601, 601, 9970, 11750, , 601, 601, 601, 601, 601, 601, 601, 601, 601, 601, 601, 601, 601 CDMA1xEVDO: 601, 601, 9970, 11750, 601, 601, 601, 10570, 601, 601, 601, 601, 601, 601, 601 TD-SCDMA: 601, 5970, 19400, 20001, 601, 601, 601, 601, 601, 601, 601, 601, 601, 601, 601, 601 LTE, LTETDD, MSR, LTEAFDD, LTEATDD : Automatically calculated. WLAN: Automatically calculated. OFF, OFF, OFF, OFF, OFF, OFF, OFF, OFF, OFF, OFF, OFF, OFF, OFF, OFF, OFF, OFF, OFF, OFF, OFF LTE, LTETDD, WLAN, MSR, LTEAFDD, LTEATDD: ON, ON, ON, ON, ON, ON, ON, ON, ON, ON, ON, ON, ON, ON, ON, ON, ON, ON, ON
State Saved	Saved in instrument state.
Min	101
Max	20001
Initial S/W Revision	Prior to A.02.00
Modified at S/W Revision	A.03.00

IF Gain

Sets the IF Gain function to Auto, On (the extra 10 dB) or Off. These settings affect sensitivity and IF overloads. A switched IF amplifier with approximately 10 dB of gain is available. This amplifier takes full advantage of the RF dynamic range of the analyzer. When it can be turned on without an overload, the dynamic range is always better with the amplifier on than off.

Key Path	Meas Setup, Range Table
Dependencies	The IF Gain keys (FFT IF Gain and Swept IF Gain) have no effect when the U7227A USB Preamplifier is connected. This is not annotated or reflected on any softkey; there are no keys grayed out nor any SCPI locked out. The analyzer simply behaves as though both FFT IF Gain and Swept IF Gain are set to Low regardless of the setting on the keys.
Initial S/W Revision	Prior to A.02.00

IF Gain Auto

Activates the rules for auto IF Gain.

Meas Type

Selects either Examine or Full measurement type. This parameter is coupled to the average mode. Therefore, if the examine measurement type is selected, the measurement sets the average mode to exponential. If the full measurement type is selected, the measurement sets the average mode to repeat. The behavior of each measurement type is described in the table below. When averaging is on, trace averaging is used as each active range is measured. Averaging is not used at any other time.

Type	Single	Continuous			
No Spurs Found	Spurs Found	No Spurs Found	Spurs Found		
Examine	All active ranges are measured. On completion the measurement is set to the idle state and the 'No Spurs' happening is displayed.	All active ranges are measured and the spurs found reported. On completion the measurement is set to the idle state and the trace containing the worst spur restored. The spur menu key is enabled. A marker is also added which is set to the frequency of the worst spur.	All active ranges are measured. On completion the SA remains set to last range checked with an active trace and the 'No Spurs' happening is displayed.	All active ranges are measured and the spurs found reported. On completion the SA is set to the range containing the worst spur found and continually sweeps this range. Note that the trace is continually updated but the metrics results aren't updated until restart to keep the initial results as references. Use marker readouts to refer the latest results. The spur menu key is enabled. A marker is also added which is set to the frequency of the worst spur.	
Full	All active ranges are measured. On completion measurement is set to idle state and the 'No Spurs' happening is displayed.	All active ranges are measured and spurs found reported. On completion the measurement is set to the idle state, displaying the trace of the last active range.	Measurement continually cycles through all active ranges.	All active ranges are measured and spurs found reported. On each cycle of the active ranges the spurs found are reset. This ensures any remote queries retrieve the trace data that matches the currently displayed results.	

Key Path	Meas Setup
Mode	SA, WCDMA, C2K, WIMAX OFDMA, TD-SCDMA, 1xEV-DO, DVB-T/H, LTE, LTEFDD, LTEATDD
Remote Command	[:SENSe] :SPURious:TYPE EXAMine FULL [:SENSe] :SPURious:TYPE?
Example	SPUR:TYPE FULL SPUR:TYPE?
Preset	EXAMine
State Saved	Saved in instrument state.
Range	Examine Full

Initial S/W Revision	Prior to A.02.00
Modified at S/W Revision	A.03.00

Spur

Displays any spurs found. It is only enabled when the measurement type is set to examine and will turn on upon completion of a measurement. Once the Spur menu key has been enabled, you can view any spur. The measurement sets the analyzer to the range in which the currently selected spur was found. The range settings only changes if the spur selected is in a range which is different from the current range settings. A marker is used to identify the currently selected spur on the trace.

Key Path	Meas Setup
Mode	SA, WCDMA, C2K, WIMAX OFDMA, CDMA1xEVDO, TD-SCDMA, DVB-T/H, LTE, LTETDD, WLAN, MSR, LTEAFDD, LTEATDD
Remote Command	<code>[:SENSe] :SPURious:SPUR <integer></code> <code>[:SENSe] :SPURious:SPUR?</code>
Example	SPUR:SPUR 55 SPUR:SPUR?
Preset	1
State Saved	No
Min	1
Max	200
Initial S/W Revision	Prior to A.02.00
Modified at S/W Revision	A.03.00

Spurious Report Mode

Selects the spurious report mode.

- Select Limit Line Test (LIMTest) to report only spurs above the limit line. Any spurs reported will cause the measurement to fail. See Abs Start Limit for more information.
- Select All Spurs (ALL) to report all spurs detected by Peak Threshold and Peak Excursion.
- Select Minimum Margin (MMARgin) to report only the spur with the minimum margin from the limit line. For the spur above the limit, its margin is defined as the negative margin. If there are more than one spurs above the limit, only one spur with the largest negative margin is reported.

Key Path	Meas Setup
Mode	SA, WCDMA, C2K, WIMAX OFDMA, TD-SCDMA, 1xEV-DO, DVB-T/H, LTE, LTETDD, WLAN, MSR, LTEAFDD, LTEATDD
Remote Command	<code>[:SENSe] :SPURious:REPT:MODE ALL LIMTest MMARgin</code> <code>[:SENSe] :SPURious:REPT:MODE?</code>

Example	SPUR:REPT:MODE LIMIT SPUR:REPT:MODE?
Dependencies	MMARgin is available only when option N9060A-7FP is installed.
Preset	ALL
State Saved	Saved in instrument state.
Range	All Spurs Limit Test Minimum Margin
Initial S/W Revision	Prior to A.02.00
Modified at S/W Revision	A.03.00, A.11.00

Apply Carrier Config to Range Table (Only for MSR and LTE-Advanced FDD/TDD)

Sets offset and limit parameters under Range Table. The range frequency and limit values are determined by the carrier configuration parameters and Band Category.

Key Path	Meas Setup
Mode	MSR, LTAfDD, LTATDD
Remote Command	[:SENSe] :SPURious :MCONdition :IMMediate
Example	SPUR:MCON:IMM
Initial S/W Revision	A.11.00

Meas Preset

Restores all measurement parameters to their default values.

Key Path	Meas Setup
Mode	SA, WCDMA, C2K, WIMAX OFDMA, TD-SCDMA, 1xEV-DO, DVB-T/H, LTE, LTETDD, WLAN, MSR, LTAfDD, LTeATDD
Remote Command	:CONFigure:SPURious
Example	CONF:SPUR
Initial S/W Revision	Prior to A.02.00
Modified at S/W Revision	A.03.00

Fast Spurious Meas (Remote Command only)

This command is provided as the backward compatibility SCPI command of the Fast Spurious Measurement. Since this command is another representation of Spurious Report Mode, this command is coupled with the command.

When set to ON, only spurs above the limit line are reported. This is the same as Spurious Report Mode "LIMTest".

When set to OFF, all detected spurs are reported. This is the same as Spurious Report Mode “ALL.”

Mode	SA, WCDMA, C2K, WIMAX OFDMA, TD-SCDMA, 1xEV-DO, DVB-T/H, WLAN, MSR, LTEAFDD, LTEATDD
Remote Command	[:SENSe] :SPURious:FSMeas ON OFF 1 0 [:SENSe] :SPURious:FSMeas?
Example	SPUR:FSM ON SPUR:FSM?
Couplings	If SPUR:REPT:MODE is ALL, this parameter is OFF. If SPUR:REPT:MODE is LIMTest, this parameter is ON.
Preset	OFF
State Saved	Saved in instrument state.
Initial S/W Revision	A.04.00

12 Spurious Emissions Measurement
Mode

Mode

See "[Mode](#)" on page 276

Mode Preset

Returns the active mode to a known state.

Mode Preset does the following for the currently active mode:

- Aborts the currently running measurement.
- Brings up the default menu for the mode, with no active function.
- Sets measurement Global settings to their preset values for the active mode only.
- Activates the default measurement.
- Brings up the default menu for the mode.
- Clears the input and output buffers.
- Sets Status Byte to 0.

Mode Preset does not:

- Cause a mode switch
- Affect mode persistent settings
- Affect system settings
- See "[How-To Preset](#)" on page 1612 for more information.

Key Path	Front-panel key
Remote Command	:SYSTem:PRESet
Example	:SYST:PRES
Notes	*RST is preferred over :SYST:PRES for remote operation. *RST does a Mode Preset, as done by the :SYST:PRES command, and it sets the measurement mode to Single measurement rather than Continuous for optimal remote control throughput. Clears all pending OPC bits. The Status Byte is set to 0.
Couplings	A Mode Preset aborts the currently running measurement, activates the default measurement, and gets the mode to a consistent state with all of the default couplings set.
Backwards Compatibility Notes	In the X-Series, the legacy "Factory Preset" has been replaced with Mode Preset, which only presets the currently active mode, not the entire instrument. In the X-Series, the way to preset the entire instrument is by using System, Restore System Defaults All, which behaves essentially the same way as restore System Defaults does on ESA and PSA. There is also no "Preset Type" as there is on the PSA. There is a green Mode Preset front-panel key that does a Mode Preset and a white-with-green-letters User Preset front-panel key that does a User Preset. The old PRESet:TYPE command is ignored (without generating an error), and SYST:PRES without a parameter does a Mode Preset, which should cover most backward code compatibility issues. The settings and correction data under the Input/Output front-panel key (examples: Input Z Corr, Ext Amp Gain, etc.) are no longer part of any Mode, so they will not be preset by a Mode Preset. They are preset using Restore Input/Output Defaults, Restore System Defaults All. Note that because User Preset does a Recall State, and all of these settings are saved in State, they ARE recalled when using

	User Preset.
Initial S/W Revision	Prior to A.02.00

How-To Preset

The table below shows all possible presets, their corresponding SCPI commands and front-panel access (key paths). Instrument settings depend on the current measurement context. Some settings are local to the current measurement, some are global (common) across all the measurements in the current mode, and some are global to all the available modes. In a similar way, restoring the settings to their preset state can be done within the different contexts.

Auto Couple - is a measurement local key. It sets all Auto/Man parameter couplings in the measurement to Auto. Any Auto/Man selection that is local to other measurements in the mode will not be affected.

Meas Preset - is a measurement local key. Meas Preset resets all the variables local to the current measurement except the persistent ones.

Mode Preset - resets all the current mode's measurement local and measurement global variables except the persistent ones.

Restore Mode Defaults - resets ALL the Mode variables (and all the Meas global and Meas local variables), including the persistent ones.

Type Of Preset	SCPI Command	Front Panel Access
Auto Couple	:COUPle ALL	Auto Couple front-panel key
Meas Preset	:CONFigure:<Measurement>	Meas Setup Menu
Mode Preset	:SYSTem:PRESet	Mode Preset (green key)
Restore Mode Defaults	:INSTrument:DEFault	Mode Setup Menu
Restore All Mode Defaults	:SYSTem:DEFault MODes	System Menu; Restore System Default Menu
*RST	*RST	not possible (Mode Preset with Single)
Restore Input/Output Defaults	:SYSTem:DEFault INPUt	System Menu; Restore System Default Menu
Restore Power On Defaults	:SYSTem:DEFault PON	System Menu; Restore System Default Menu
Restore Alignment Defaults	:SYSTem:DEFault ALIGN	System Menu; Restore System Default Menu
Restore Miscellaneous Defaults	:SYSTem:DEFault MISC	System Menu; Restore System Default Menu
Restore All System Defaults	:SYSTem:DEFault [ALL] :SYSTem:PRESet:PERsistent	System Menu; Restore System Default Menu
User Preset	:SYSTem:PRESet:USER	User Preset Menu
User Preset All Modes	:SYSTem:PRESet:USER:ALL	User Preset Menu

Power On Mode Preset	:SYSTem:PON:TYPE MODE	System Menu
Power On User Preset	:SYSTem:PON:TYPE USER	System Menu
Power On Last State	:SYSTem:PON:TYPE LAST	System Menu

Preset Type (Remote Command Only)

As stated in the Backward Compatibility section, to be compatible with ESA/PSA the PRESet:TYPE command will be implemented as a no-op.

Mode	All
Remote Command	:SYSTem:PRESet:TYPE FACTory MODE USER :SYSTem:PRESet:TYPE?
Example	:SYST:PRESet:TYPE FACT
Notes	This command is supported for backward compatibility only. It is a no-op which does not change the behavior of any preset operation.
Preset	This is unaffected by Preset but is set to Mode on a “Restore System Defaults->All”
State Saved	No
Initial S/W Revision	Prior to A.02.00

Mode Setup

See "[Mode Setup](#)" on page 306

Peak Search

Performs a peak search and opens the Peak Search menu. The Peak Search functions allow you to define specific search criteria to determine which signals can be considered peaks, excluding unwanted signals from the search.

Places the selected marker on the trace point with the maximum y-axis value for that marker's trace.

Key Path	Front-panel key
Mode	SA, WCDMA, C2K, WIMAX OFDMA, 1xEV-DO, DVB-T/H, LTE, LTETDD, WLAN, MSR, LTEAFDD, LTEATDD
Remote Command	:CALCulate:SPURious:MARKer[1] 2 ... 12:MAXimum
Example	CALC:SPUR:MARK2:MAX
Initial S/W Revision	Prior to A.02.00
Modified at S/W Revision	A.03.00

Next Peak

Moves the selected marker to the peak that has the next highest amplitude less than the current marker value.

Key Path	Peak Search
Mode	SA, WCDMA, C2K, WIMAX OFDMA, TD-SCDMA, 1xEV-DO, DVB-T/H, LTE, LTETDD, WLAN, MSR, LTEAFDD, LTEATDD
Remote Command	:CALCulate:SPURious:MARKer[1] 2 ... 12:MAXimum:NEXT
Example	CALC:SPUR:MARK2:MAX:NEXT
Initial S/W Revision	Prior to A.02.00
Modified at S/W Revision	A.03.00

Next Pk Right

Moves the selected marker to the nearest peak to the right of the current marker which meets all enabled peak criteria.

Key Path	Peak Search
Mode	SA, WCDMA, C2K, WIMAX OFDMA, TD-SCDMA, 1xEV-DO, DVB-T/H, LTE, LTETDD, WLAN
Remote Command	:CALCulate:SPURious:MARKer[1] 2 ... 12:MAXimum:RIGHT
Example	CALC:SPUR:MARK2:MAX:RIGH
Initial S/W Revision	Prior to A.02.00
Modified at S/W Revision	A.03.00

Next Pk Left

Moves the selected marker to the nearest peak to the left of the current marker which meets all enabled peak criteria.

Key Path	Peak Search
Mode	SA, WCDMA, C2K, WIMAX OFDMA, TD-SCDMA, 1xEV-DO, DVB-T/H, LTE, LTETDD, WLAN, MSR, LTEAFDD, LTEATDD
Remote Command	:CALCulate:SPURious:MARKer[1 2 ... 12:MAXimum:LEFT
Example	CALC:SPUR:MARK2:MAX:LEFT
Initial S/W Revision	Prior to A.02.00
Modified at S/W Revision	A.03.00

Marker Delta

Performs the same function as the Delta 1-of-N selection key in the Marker menu. This sets the control mode for the selected marker to Delta mode. See the Marker section for the complete description of this function. The key is duplicated here in the Peak Search Menu to allow you to conveniently perform a peak search and change the control of the Marker mode to Delta without having to access two separate menus.

Key Path	Peak Search
Initial S/W Revision	Prior to A.02.00

Pk-Pk Search

Finds and displays the amplitude and frequency (or time, if in zero span) differences between the highest and lowest y-axis value.

Key Path	Peak Search
Mode	SA, WCDMA, C2K, WIMAX OFDMA, TD-SCDMA, 1xEV-DO, DVB-T/H, LTE, LTETDD, WLAN, MSR, LTEAFDD, LTEATDD
Remote Command	:CALCulate:SPURious:MARKer[1 2 ... 12:PTPeak
Example	CALC:SPUR:MARK:PTP
Notes	Turns on the Marker Δ
Dependencies	This key is not available (key is grayed-out) when Coupled Markers is on.
Initial S/W Revision	Prior to A.02.00
Modified at S/W Revision	A.03.00

Min Search

Moves the selected marker to the minimum y-axis value on the current trace.

Key Path	Peak Search
Mode	SA, WCDMA, C2K, WIMAX OFDMA, TD-SCDMA, 1xEV-DO, DVB-T/H, LTE, LTETDD, WLAN, MSR, LTEAFDD, LTEATDD
Remote Command	:CALCulate:SPURious:MARKer[1] 2 ... 12:MINimum
Example	CALC:SPUR:MARK:MIN
Initial S/W Revision	Prior to A.02.00
Modified at S/W Revision	A.03.00

12 Spurious Emissions Measurement
Print

Print

See "[Print](#) " on page 367

Quick Save

The Quick Save front-panel key repeats the most recent save that was performed from the Save menu, with the following exceptions:

- Register saves are not remembered as Saves for the purpose of the Quick Save function
- If the current measurement does not support the last non-register save that was performed, an informational message is generated, “File type not supported for this measurement”

Quick Save repeats the last type of qualified save (that is, a save qualified by the above criteria) in the last save directory by creating a unique filename using the Auto File Naming algorithm described below.

If Quick Save is pressed after startup and before any qualified Save has been performed, the Quick Save function performs a Screen Image save using the current settings for Screen Image saves (current theme, current directory), which then becomes the “last save” for the purpose of subsequent Quick Saves.

The Auto File Naming feature automatically generates a file name for use when saving a file. The filename consists of a prefix and suffix separated by a dot, as is standard for the Windows® file system. A default prefix exists for each of the available file types:

Type	Default Prefix	Menu
State	State_	(Save/Recall)
Trace + State	State_	(Save/Recall)
Screen	Screen_	(Save/Recall)
Amplitude Corrections	Ampcor_	(Import/Export)
Traces	Trace_	(Import/Export)
Limit Lines	LLine_	(Import/Export)
Measurement Result	MeasR_	(Import/Export)
Capture Buffer	CapBuf_	(Import/Export)

A four digit number is appended to the prefix to create a unique file name. The numbering sequence starts at 0000 within each Mode for each file type and updates incrementally to 9999, then wraps to 0000 again. It remembers where it was through a Mode Preset and when leaving and returning to the Mode. It is reset by Restore Misc Defaults and Restore System Defaults and subsequent running of the instrument application. So, for example, the first auto file name generated for State files is State_0000.state. The next is State_0001, and so forth.

One of the key features of Auto File Name is that we guarantee that the Auto File Name will never conflict with an existing file. The algorithm looks for the next available number. If it gets to 9999, then it looks for holes. If it find no holes, that is no more numbers are available, it gives an error.

For example, if when we get to State_0010.state there is already a State_0010.state file in the current directory, it advances the counter to State_0011.state to ensure that no conflict will exist (and then it verifies that State_0011.state also does not exist in the current directory and advances again if it does, and so forth).

If you enter a file name for a given file type, then the prefix becomes the filename you entered instead of the default prefix, followed by an underscore. The last four letters (the suffix) are the 4-digit number.

For example, if you save a measurement results file as “fred.csv”, then the next auto file name chosen for a measurement results save will be fred_0000.csv.

NOTE Although 0000 is used in the example above, the number that is used is actually the current number in the Meas Results sequence, that is, the number that would have been used if you had not entered your own file name.

NOTE If the filename you entered ends with _dddd, where d=any number, making it look just like an auto file name, then the next auto file name picks up where you left off with the suffix being dddd + 1.

Key Path	Front-panel key
Notes	No remote command for this key specifically.
Initial S/W Revision	Prior to A.02.00

Recall

In the MSR mode, two types of recall functions are available under the Data menu: Parameter Sets and Masks. Masks enables setting of a preset limit mask for Power Suite-based measurements, and currently it is available for the SEM, ACP and SPUR measurements in the MSR mode.

Key Path	Front Panel
Mode	MSR
Initial S/W Revision	A.10.00

State

The **Recall State** menu lets you choose a register or file from which to recall the state.

The content of a state file includes all of the settings and data required to return the analyzer as closely as possible to the Mode it was in, with the exact settings that were in place, when the save occurred. The Mode settings in each state file include the settings that are affected by Mode Preset, as well as the additional settings affected by Restore Mode Defaults; all of the Mode's settings. In addition, all of the settings of the **Input/Output** system are included, even though they are outside of the Mode's state, because they are needed to restore the complete setup. Persistent System settings (for example, GPIB address) are not affected by either a Mode Preset or Restore Mode Defaults, nor are they included in a saved State file.

Since each state file is only for one Mode, the settings for other Modes are unaffected when it is loaded. **Recall State** will cause a mode switch if the state being recalled is not from the current active mode.

After the recall completes, the message "File <filename> recalled" or "Recalled State Register <register number>" is displayed.

For rapid recalls, the State menu lists 16 registers that you can choose from to recall. Pressing a Register key initiates the recall. You can also select a file from which to recall.

The default path for all State Files is:

My Documents\<<mode name>\state

where <mode name> is the parameter used to select the mode with the INST:SEL command (for example, SA for the Spectrum Analyzer).

See "[More Information](#)" on page 1622.

Key Path	Recall
Mode	All
Remote Command	:MMEMory:LOAD:STATe <filename>
Example	:MMEM:LOAD:STAT "myState.state" This recalls the file myState.state on the default path
Example	MMEM:LOAD:STAT "MyStateFile.state" This loads the state file data (on the default file directory path) into the instrument state.

Notes	<p>When you pick a file to recall, the analyzer first verifies that the file is recallable in the current instrument by checking the software version and model number of the instrument. If everything matches, a full recall proceeds by aborting the currently running measurement, clearing any pending operations, and then loading the State from the saved state file. You can open state files from any mode, so recalling a State file switches to the mode that was active when the save occurred. After switching to the mode of the saved state file, mode settings and data (if any for the mode) are loaded with values from the saved file. The saved measurement of the mode becomes the newly active measurement and the data relevant to the measurement (if there is any) is recalled.</p> <ul style="list-style-type: none"> • If there is a mismatch between file version or model number or instrument version or model number, the recall function tries to recall as much as possible and returns a warning message. It may limit settings that differ based on model number, licensing or version number. <p>After recalling the state, the Recall State function does the following:</p> <ul style="list-style-type: none"> • Makes the saved measurement for the mode the active measurement. • Clears the input and output buffers. • Status Byte is set to 0. • Executes a *CLS <p>If the file specified is empty an error is generated. If the specified file does not exist, another error is generated. If there is a mismatch between the file and the proper file type, an error is generated. If there is a mismatch between file version or model number or instrument version or model number, a warning is displayed. Then it returns to the State menu and File Open dialog goes away.</p> <p>After the Recall, the analyzer exits the Recall menu and returns to the previous menu.</p>
Backwards Compatibility SCPI	<pre>:MMEMory:LOAD:STATe 1,<filename></pre> <p>For backwards compatibility, the above syntax is supported. The "1" is simply ignored.</p>
Initial S/W Revision	Prior to A.02.00

More Information

In measurements that support saving Traces, for example, Swept SA, the Trace data is saved along with the State in the State file. When recalling the State, the Trace data is recalled as well. Traces are recalled exactly as they were stored, including the writing mode and update and display modes. If a Trace was updating and visible when the State was saved, it will come back updating and visible, and its data will be rewritten right away. When you use State to save and recall traces, any trace whose data must be preserved should be placed in View or Blank mode before saving.

The following table describes the Trace Save and Recall possibilities:

You want to recall state and one trace's data, leaving other traces unaffected.	Save Trace+State from 1 trace. Make sure that no other traces are updating (they should all be in View or Blank mode) when the save is performed.	On Recall, specify the trace you want to load the one trace's data into. This trace will load in View. All other traces' data will be unaffected, although their trace mode will be as it was when the state save was performed.
You want to recall all traces	Save Trace+State from ALL traces.	On Recall, all traces will come back in View (or Blank if they were in Blank or Background when

		saved)
You want all traces to load exactly as they were when saved.	Save State	On recall, all traces' mode and data will be exactly as they were when saved. Any traces that were updating will have their data immediately overwritten.

From File...

When you press “From File”, the analyzer brings up a Windows dialog and a menu entitled “File Open.” This menu allows you to navigate to the various fields in the Windows dialog without using a keyboard or mouse. The **Tab** and **Arrow** keys can also be used for dialog navigation.

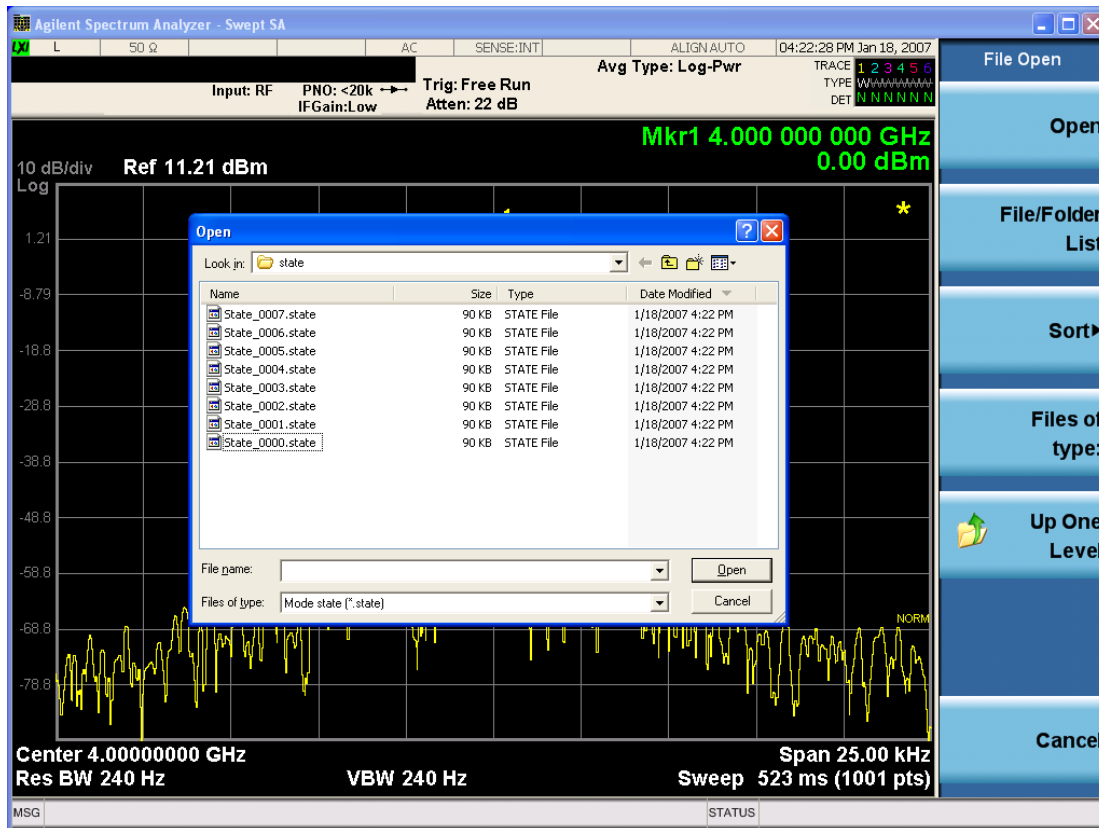

Listed below are the functions of the various fields in the dialog, and the corresponding softkeys:

Open

Performs the recall of the specified file. While the recall is being performed, the floppy icon appears briefly in the Meas bar.

File/Folder List

Enables you to navigate to the center of the dialog that contains the list of files and folders. Once here you can get information about the file and use the tab keys to navigate to the other fields in the dialog, such as Look In.

Look In

The **Look In** field shows the path from which the file will be recalled and allows you to change the path using the up and down arrow keys to navigate to other paths; the Enter key to open a directory; and the Backspace key to go back one directory. The **Look In field** first uses the last path from the Save As dialog **Save In:** path for that same file type. There is no softkey for directly navigating to the Look In field, but you can use the left tab to get here from the File/Folder List.

User specified paths are remembered when you leave and return to a Mode and are reset back to the default using **Restore Mode Defaults**.

Sort

Accesses a menu that enables you to sort the files within the File Open dialog. Only one sorting type can be selected at a time and the sorting happens immediately. The sorting types are **By Date, By Name, By extension, and By Size**.

Files of Type

This field shows the file suffix for the type of file you have selected to recall. For example, if you navigated here while recalling State, "Mode state (*.state)" is in the field. If you navigated here while recalling Trace, ""Mode state (*.trace)" is in the field. If you navigated here while importing a trace data file, "Trace Data (*.csv)" is in the field. For some file types, there is more than one choice in the dropdown menu, which you can select by using the up and down arrow keys and Enter.

Up One Level

This key corresponds to the icon of a folder with the up arrow that is in the tool bar of the dialog. When pressed, it causes the file and folder list to navigate up one level in the directory structure. The Backspace key does the same thing.

Cancel

This key corresponds to the **Cancel** selection in the dialog. It causes the current **Open** request to be cancelled. The ESC key does the same thing.

Key Path	Recall, State
Notes	Brings up the Open dialog for recalling a State Save Type
Initial S/W Revision	Prior to A.02.00

Edit Register Names

You may enter a custom name on any of the Register keys, to help you remember what you are using that state to save. To do this, press the **Edit Register Names** key, choose the register whose name you wish to edit, and then enter the desired label using the Alpha Editor or an external PC keyboard.

The maximum number of characters that can be added is 30. In most cases, 30 characters will fit on two lines of the key.

For more information and the SCPI command, see Edit Register Names under the **Save, State** function.

Key Path	Recall, State
Mode	All
Dependencies	N9060A-7FP or N9060B-2FP license required to edit the register names. When the feature is not licensed, sending the SCPI command generates an error, -221,"Settings conflict;Option not available"
Initial S/W Revision	A.11.00

Register 1 thru Register 16

Selecting any one of these register keys causes the State of the mode from the specified Register to be recalled. Each of the register keys annotates whether it is empty or at what date and time it was last modified. In addition, you can use the **Edit Register Names** key under **Save, State** to enter custom names for each register.

Registers are shared by all modes, so recalling from any one of the registers will cause a mode switch to the mode that was active when the save to the Register occurred.

Although these 16 registers are the only registers available from the front panel, there are 128 state registers available in the instrument. Registers 17–128 are only available from the SCPI interface, using the *RCL command.

After the recall completes, the message "Register <register number> recalled" appears in the message bar. If you are in the Spectrum Analyzer Mode, and you are recalling a register that was saved in the Spectrum Analyzer Mode, then after the recall, you will still be in the Recall Register menu. If the Recall causes you to switch modes, then after the Recall, you will be in the Frequency menu.

If a requested register is empty an error is generated.

Key Path	Recall, State
Example	*RCL 1
Range	1-16 from front panel, 1-128 from SCPI
Readback	Date and time with seconds resolution are displayed on the key OR A custom name of up to 30 characters entered using the Save, State,Edit Register Names key OR “(empty)” if no prior save operation has been performed to this register.
Initial S/W Revision	Prior to A.02.00
Modified at S/W Revision	Prior to A.11.00

Register 1 thru Register 16

Selecting any one of these register keys causes the State of the mode from the specified Register to be recalled. Each of the register keys annotates whether it is empty or at what date and time it was last

modified. In addition, you can use the **Edit Register Names** key under **Save, State** to enter custom names for each register.

Registers are shared by all modes, so recalling from any one of the registers will cause a mode switch to the mode that was active when the save to the Register occurred.

Although these 16 registers are the only registers available from the front panel, there are 128 state registers available in the instrument. Registers 17–128 are only available from the SCPI interface, using the *RCL command.

After the recall completes, the message "Register <register number> recalled" appears in the message bar. If you are in the Spectrum Analyzer Mode, and you are recalling a register that was saved in the Spectrum Analyzer Mode, then after the recall, you will still be in the Recall Register menu. If the Recall causes you to switch modes, then after the Recall, you will be in the Frequency menu.

If a requested register is empty an error is generated.

Key Path	Recall, State
Example	*RCL 1
Range	1–16 from front panel, 1–128 from SCPI
Readback	Date and time with seconds resolution are displayed on the key OR A custom name of up to 30 characters entered using the Save, State, Edit Register Names key OR “(empty)” if no prior save operation has been performed to this register.
Initial S/W Revision	Prior to A.02.00
Modified at S/W Revision	Prior to A.11.00

Data (Import)

Importing a data file loads data that was previously saved from the current measurement or from other measurements and/or modes that produce compatible data files. The Import Menu only contains Data Types that are supported by the current measurement.

Since the commonly exported data files are in .csv format, the data can be edited by the user prior to importing. This allows you to export a data file, manipulate the data in Excel (the most common PC Application for manipulating .csv files) and then import it.

Importing Data loads measurement data from the specified file into the specified or default destination, depending on the data type selected. Selecting an Import Data menu key will not actually cause the importing to occur, since the analyzer still needs to know from where to get the data. Pressing the Open key in this menu brings up the Open dialog and Open menu that provides you with the options from where to recall the data. Once a filename has been selected or entered in the Open menu, the recall occurs as soon as the Open button is pressed.

Key Path	Recall
Mode	All

Notes	The menu is built from whatever data types are available for the mode. Some keys will be missing completely, so the key locations in the sub-menu will vary. No SCPI command directly controls the Data Type that this key controls. The Data Type is included in the MMEM:LOAD commands.
Dependencies	If a file type is not used by a certain measurement, it is grayed out for that measurement. The key for a file type will not show at all if there are no measurements in the Mode that support it.
Preset	Is not affected by Preset or shutdown, but is reset during Restore Mode Defaults
Readback	The data type that is currently selected
Initial S/W Revision	Prior to A.02.00

Parameter Set

Enables you to import format parameter set data to specified format parameter sets. Selecting this key displays a menu that enables you to select the destination parameter set. After making this selection, depress Open... and use the file dialog to select the file you wish to recall.

Supported import file formats are dependent on radio formats.

LTE FDD: Format Parameter Set Files (*.fps), LTE FDD app state files (*.state), 89601 VSA Setup Files (*.set, *.setx) and Signal Studio Setup Files (*.scp)

W-CDMA:Format Parameter Set Files (*.fps) and W-CDMA app state files (*.state)

GSM/EDGE:Format Parameter Set Files (*.fps) and GSM/EDGE app state files (*.state)

cdma2000:Format Parameter Set Files (*.fps) and cdma2000 app state files (*.state)

1xEV-DO:Format Parameter Set Files (*.fps) and 1xEV-DO app state files (*.state)

LTE TDD: Format Parameter Set Files (*.fps), LTE TDD app state files (*.state), 89601 VSA Setup Files (*.set, *.setx) and Signal Studio Setup Files (*.scp)

TD-SCDMA:Format Parameter Set Files (*.fps) and TD-SCDMA app state files (*.state)

Format Parameter Set Files

Extention: fps

Basic file type of format parameter set. This file contains a format parameter set exported using Parameter Set under Recall, Data (Export). It is imported if the radio format of the file matches the destination radio format. If not, an error message, -230 "Data corrupt or stale", is issued with the specified file name.

App State Files

Extention: state

The state file of each mode can be imported to the corresponding parameter set. If the mode name in the state file matches the selected destination format, the state file data are imported. If not, an error message, -230 "Data corrupt or stale", is issued with the specified file name.

The parameters to be imported are ones referred in a particular measurement of each mode. The relevant measurements are listed below.

LTE FDD: Modulation Analysis

W-CDMA: Mod Accuracy

GSM/EDGE: EDGE EVM

cdma2000: Mod Accuracy

1xEV-DO: Mod Accuracy

LTE TDD: Modulation Analysis

TD-SCDMA: Mod Accuracy

Note that Integ BW and Measurement Noise BW parameters of ACP, SEM and CHP are not imported.

89601 VSA Setup Files

Extention: set, setx

The 89600 Vector Signal Analyzer Setup file created using the 89600 Vector Signal Analyzer Option BHD (LTE FDD)/Option BHE (LTE TDD) can be imported as LTE FDD/LTE TDD parameter set. If the setup file is not loaded successfully, an error message, -230 "Data corrupt or stale", is issued with the specified file name.

Signal Studio Setup Files

Extention: scp

The Keysight Signal Studio setup file created using Signal Studio (N7624B/N7625B) can be imported as LTE FDD/LTE TDD parameter set. Supported carrier types are listed in the table below:

<i>Signal Studio</i>	<i>Carrier Type</i>
N7624B Signal Studio for 3GPP LTE	Advanced LTE FDD Downlink (2009-03)
	Advanced LTE FDD Downlink (2009-12)
	Advanced LTE FDD Downlink (2010-06)
	Advanced LTE FDD Uplink (2009-12)
	Advanced LTE FDD Uplink (2010-06)
	Basic LTE FDD Downlink (2009-03)
	Basic LTE FDD Downlink (2009-12)
	Basic LTE FDD Downlink (2010-06)
	Basic LTE FDD Uplink (2009-03)
	Basic LTE FDD Uplink (2009-12)
	Basic LTE FDD Uplink (2010-06)
N7625B Signal Studio for 3GPP LTE TDD	Advanced LTE TDD (2009-03)
	Advanced LTE TDD (2009-12)
	Basic LTE TDD (2009-03)
	Basic LTE TDD (2009-12)
	Basic LTE TDD R9
Advanced LTE TDD R9	

 Basic LTE TDD R9 PRACH

If the setup file is not loaded successfully, an error message, –230 “Data corrupt or stale”, is issued with the specified file name.

Default path of this import type is “My Documents\MSR\data\params” folder. Note that “My Documents” is an alias to a directory and its location depends on which user is logged in. If the file path is specified without root folder, the import file is determined with the default path. For example if “folder1\paramData.prms” is specified, “My Documents\MSR\data\params\folder1\paramData.prms” is imported.

File Dialog Filter

Since supported import file formats differ between radio formats, file filters available in the open file dialog vary depending on the selected radio format. This table below defines file name filters available for each format.

<i>Radio Format</i>	<i>File Name Filters</i>
LTE FDD	All Supported Format Parameter Setup Files (*.fps; *.state; *.set; *.setx; *.scp) Format Parameter Setup Files (*.fps) State Files (*.state) 89601 VSA Setup Files (*.set; *.setx) Signal Studio Setup Files (*.scp)
W-CDMA	All Supported Format Parameter Setup Files (*.fps; *.state) Format Parameter Setup Files (*.fps) W-CDMA State Files (*.state)
GSM/EDGE	All Supported Format Parameter Setup Files (*.fps; *.state) Format Parameter Setup Files (*.fps) State Files (*.state)
cdma2000	All Supported Format Parameter Set Files (*.fps; *.state) Format Parameter Set Files (*.fps) State Files (*.state)
1xEV-DO	All Supported Format Parameter Set Files (*.fps; *.state) Format Parameter Set Files (*.fps) State Files (*.state)
LTE TDD	All Supported Format Parameter Setup Files (*.fps; *.state; *.set; *.setx; *.scp) Format Parameter Setup Files (*.fps) State Files (*.state) 89601 VSA Setup Files (*.set; *.setx) Signal Studio Setup Files (*.scp)
TD-SCDMA	All Supported Format Parameter Set Files (*.fps; *.state) Format Parameter Set Files (*.fps) State Files (*.state)

Key Path	Recall, Data
Mode	MSR
Remote Command	MMEMory:LOAD:PSET LTEFdd1 LTEFdd2 LTEFdd3 WCDMa1 WCDMa2 WCDMa3 GSM1 GSM2 GSM3 CDMA1 CDMA2 CDMA3 EVDO1 EVDO2 EVDO3 LTETdd1 LTETdd2 LTETdd3 TDSCdma1 TDSCdma2 TDSCdma3, <string>
Example	MMEM:LOAD:PSET LTEF1,"LTE FDD.set"
Notes	The first enum selects the destination format parameter set to which the file data are imported.
Initial S/W Revision	A.10.00
Modified at S/W Revision	A.12.00, A.16.00

Masks

This key enables you to recall a preset mask file which contains Offset and Limit settings. Parameters except them will not be overwritten. You cannot change or create preset mask files since they are binary files. This key is valid for the Spectrum Emission Mask, ACP and Spurious Emissions measurements.

Default path: "My Documents\MSR\data\masks"

Note that **"My Documents"** is an alias to a directory and its location depends on which user is logged in. At XSA start up, all of the limit mask files in the current user's "My Documents\MSR\data\masks" directory are overwritten.

File type: Binary

Filename: The filename follows the rule below with the words connected using underscores.

<Measurement>_<Condition>.mask

Where

<Measurement> Measurement the limit mask file is applied to: SEM, ACP or SPUR

<Condition> Condition. It depends on the measurement.

File extension: .mask

File Dialog Filter: Preset Mask Files (*.mask)

Selecting OPEN... under the Import Data menu opens the above directory enabling you to select a mask file.

Details of the masks are provided in a PDF file in the default folder of masks.

Key Path	Recall, Data
Mode	MSR
Remote Command	MMEMory:LOAD:MASK <string>
Example	MMEM:LOAD:MASK "ACP_BS\ACP_BS_3MHz_pairE-UTRA_CatA.mask"

Notes	Parameters related to Limit and Offset are overwritten by the contents of the preset mask file.
Initial S/W Revision	A.10.00

Open...

When you press “Open”, the analyzer brings up a Windows dialog and a menu entitled “**File Open.**” This menu allows you to navigate to the various fields in the Windows dialog without using a keyboard or mouse. The **Tab** and **Arrow** keys can also be used for dialog navigation.

See "[From File...](#)" on page 2454 in **Recall, State**, for a full description of this dialog and menu.

Key Path	Recall, Data
Notes	The key location is mode-dependent and will vary. Brings up Open dialog for recalling a <mode specific> Save Type
Initial S/W Revision	Prior to A.02.00

Restart

The Restart function restarts the current sweep, or measurement, or set of averaged/held sweeps or measurements. If you are Paused, pressing Restart does a Resume.

The Restart function is accessed in several ways:

- Pressing the Restart key
- Sending the remote command INIT:IMMEDIATE
- Sending the remote command INIT:RESTART

See "[More Information](#)" on page 1632

Key Path	Front-panel key
Remote Command	:INITiate[:IMMEDIATE] :INITiate:RESTART
Example	:INIT:IMM :INIT:REST
Notes	:INITiate:RESTART and :INITiate:IMMEDIATE perform exactly the same function.
Couplings	Resets average/hold count k. For the first sweep overwrites all active (update=on) traces with new current data. For application modes, it resets other parameters as required by the measurement.
Status Bits/OPC dependencies	This is an Overlapped command. The STATus:OPERation register bits 0 through 8 are cleared. The STATus:QUESTionable register bit 9 (INTEgrity sum) is cleared. The SWEEPING bit is set. The MEASURING bit is set.
Backwards Compatibility Notes	For Spectrum Analysis mode in ESA and PSA, the Restart hardkey and the INITiate:RESTART command restart trace averages (displayed average count reset to 1) for a trace in Clear Write , but did not restart Max Hold and Min Hold . In the X-Series, the Restart hardkey and the INITiate:RESTART command restart not only Trace Average , but MaxHold and MinHold traces as well. For wireless comms modes in ESA and PSA, the Restart hardkey and the INITiate:RESTART command restart every measurement, which includes all traces and numeric results. There is no change to this operation.
Initial S/W Revision	Prior to A.02.00

More Information

The **Restart** function first aborts the current sweep/measurement as quickly as possible. It then resets the sweep and trigger systems, sets up the measurement and initiates a new data measurement sequence with a new data acquisition (sweep) taken once the trigger condition is met.

If the analyzer is in the process of aligning when **Restart** is executed, the alignment finishes before the restart function is performed.

Even when set for Single operation, multiple sweeps may be taken when Restart is pressed (for example, when averaging/holding is on). Thus when we say that **Restart** "restarts a measurement," we may mean:

- It restarts the current sweep
- It restarts the current measurement
- It restarts the current set of sweeps if any trace is in Trace Average, Max Hold or Min Hold
- It restarts the current set of measurements if Averaging, or Max Hold, or Min Hold is on for the measurement
- depending on the current settings.

With **Average/Hold Number** (in **Meas Setup** menu) set to 1, or Averaging off, or no trace in Trace Average or Hold, a single sweep is equivalent to a single measurement. A single sweep is taken after the trigger condition is met; and the analyzer stops sweeping once that sweep has completed. However, with **Average/Hold Number** >1 and at least one trace set to **Trace Average**, **Max Hold**, or **Min Hold (SA Measurement)** or **Averaging on (most other measurements)**, multiple sweeps/data acquisitions are taken for a single measurement. The trigger condition must be met prior to each sweep. The sweep is stopped when the average count k equals the number N set for **Average/Hold Number**. A measurement average usually applies to all traces, marker results, and numeric results; but sometimes it only applies to the numeric results.

Once the full set of sweeps has been taken, the analyzer will go to idle state. To take one more sweep without resetting the average count, increment the average count by 1, by pressing the step up key while **Average/Hold Number** is the active function, or sending the remote command `CALC:AVER:TCON UP`.

Save

In the MSR mode, two types of save functions are available under the Data menu: Parameter Sets and Meas Results.

Key Path	Front Panel
Mode	MSR
Initial S/W Revision	Prior to A.10.00
Modified at S/W Revision	A.10.00

State

The Save State menu lets you choose a register or file for saving the state.

The content of a state file includes all of the settings and data required to return the analyzer as closely as possible to the Mode it was in, with the exact settings which were in place, when the save occurred. The Mode settings in each state file include the settings that are affected by Mode Preset, as well as the additional settings affected by Restore Mode Defaults; all of the Mode's settings. In addition, all of the settings of the **Input/Output** system are included, even though they are outside of the Mode's state, because they are needed to restore the complete setup. Persistent **System** settings (for example, Verbose SCPI) are not affected by either Mode Preset or Restore Mode Defaults, nor are they included in a saved State file.

After the save completes, the message "File <filename> saved" or "State Register <register number> saved" is displayed.

For rapid saving, the State menu lists 16 registers to save to. Pressing a Register key initiates the save. You can also select a file to save to.

The default path for all State Files is:

My Documents\<<mode name>\state

where <mode name> is the parameter used to select the mode with the INST:SEL command (for example, SA for the Spectrum Analyzer).

Key Path	Save
Mode	All
Remote Command	:MMEMory:STORe:STATe <filename>
Example	MMEM:STOR:STATe "MyStateFile.state" This stores the current instrument state data in the file MyStateFile.state in the default directory.
Notes	Both single and double quotes are supported for any filename parameter over remote. After saving to a register, that register's menu key is updated with the date the time, unless a custom label has been entered for that key. After saving to a register, you remain in the Save State menu, so that you can see the Register key update. After saving to a file, the analyzer automatically returns to the previous menu and any Save As dialog goes away.

Backwards Compatibility SCPI	:MMEMory:STORe:STATe 1,<filename> For backwards compatibility, the above syntax is supported. The "1" is simply ignored. The command is sequential.
Initial S/W Revision	Prior to A.02.00

To File . . .

When you press “To File”, the analyzer brings up a Windows dialog and a menu entitled “**Save As.**” This menu allows you to navigate to the various fields in the Windows dialog without using a keyboard or mouse. The **Tab** and **Arrow** keys can also be used for dialog navigation.

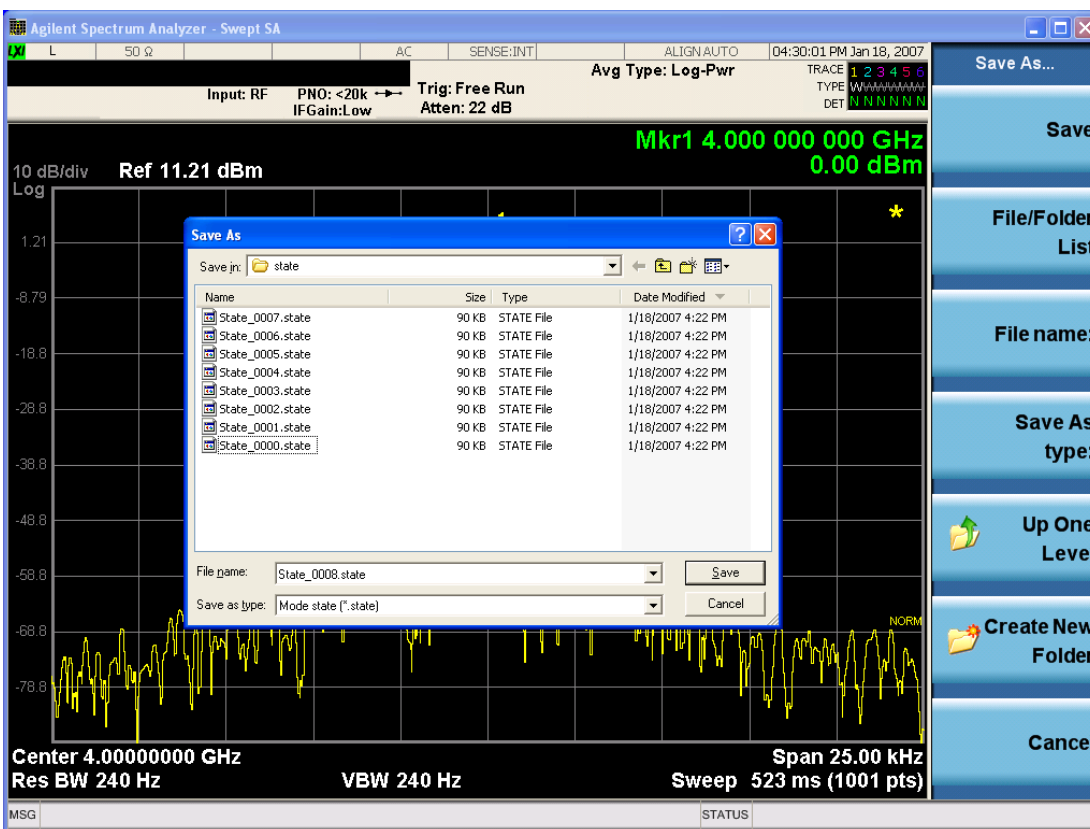

The Listed below

are the functions of the various fields in the dialog, and the corresponding softkeys:

Save

Performs the save to the specified file of the selected type. If the file already exists, a dialog will appear that allows you to replace the existing file by selecting **OK**, or you can **Cancel** the request. If you select **OK**, the file will be overwritten. Using the C: drive is strongly discouraged, since it runs the risk of being overwritten during an instrument software upgrade.

While the save is being performed, the floppy icon appears briefly in the Meas bar.

File/Folder List

Enables you to navigate to the center of the dialog that contains the list of files and folders. Once here you can get information about the file and use the tab keys to navigate to the other fields in the dialog, such as Save In.

Save In

The Save In field shows the path to which the file will be saved and allows you to change the path using the up and down arrow keys to navigate to other paths; the Enter key to open a directory; and the Backspace key to go back one directory. The **Save In field** defaults to the default path for this type of file and remembers the last path you used to save this type of file. There is no softkey for directly navigating to the Save In field but you can use left tab to get here from the File/Folder List.

User specified paths are remembered when you leave and return to a Mode and are reset back to the default using **Restore Mode Defaults**.

File Name

The **File Name** field is initially loaded with an automatically generated filename specific to the appropriate Save Type. The automatically generated filename is guaranteed not to conflict with any filename currently in the directory. You may replace or modify this filename using the File Name key. See the "[Quick Save](#)" on [page 2428](#) documentation for more on the automatic file naming algorithm.

When you press the **File Name** key the analyzer displays the Alpha Editor. Use the knob to choose the letter to add and the front-panel Enter key to add the letter to the file name. The BK character moves you back and the FW character moves you forward in the filename. The Select key on the front panel generates a space character. When you are done entering the filename press the **Done** softkey. This returns back to the **File Open** dialog and menu, but does not cause the save to occur.

Save As Type

This field shows the file suffix for the type of file you have selected to save. For example, if you navigated here while saving State, "Mode state (*.state)" is in the field. If you navigated here from saving Trace, ""Mode state (*.trace)" is in the field. If you navigated here while exporting a trace data file, "Trace Data (*.csv)" is in the field. For some file types, there is more than one choice in the dropdown, which you can select by using the up and down arrow keys and Enter.

Up One Level

This key corresponds to the icon of a folder with the up arrow that is in the tool bar of the dialog. When pressed, it causes the file and folder list to navigate up one level in the directory structure. The Backspace key does the same thing.

Create New Folder

This key corresponds to the icon of a folder with the "*" that is in the tool bar of the dialog. When pressed, a new folder is created in the current directory with the name **New Folder** and you can enter a new folder name using the Alpha Editor.

Cancel

This key corresponds to the **Cancel** selection in the dialog. It causes the current **Save As** request to be cancelled. The ESC key does the same thing.

Key Path	Save, State
----------	--------------------

Mode	All
Notes	Brings up Save As dialog for saving a State Save Type
Initial S/W Revision	Prior to A.02.00

Edit Register Names

You may enter a custom name on any of the Register keys, to help you remember what you are using that state to save. To do this, press the **Edit Register Names** key, choose the register whose name you wish to edit, and then enter the desired label using the Alpha Editor or an external PC keyboard.

The maximum number of characters that can be added is 30. In most cases, 30 characters will fit on two lines of the key.

See ["More Information" on page 1637](#)

Key Path	Save, State
Mode	All
Remote Command	:MMEMory:REGister:STATe:LABel <reg number>,"label" :MMEMory:REGister:STATe:LABel? <reg number>
Example	:MMEM:REG:STAT:LAB 1,"my label"
Notes	<reg number> is an integer from 1 to 16. If the SCPI specifies an invalid register number an error message is generated, -222,"Data out of range;Invalid register label number" "label" is a string from 0 to 30 characters in length. If a label exceeds 30 characters, an error message is generated, -150,"String data error;Label clipped to 30 characters" "label" of length 0 erases the custom label and restores the default (time and date) label. E.g.: :MMEM:REG:STAT:LAB 1,""
Dependencies	N9060A-7FP or N9060B-2FP license required to edit the register names. When the feature is not licensed, sending this command generates an error, -221,"Settings conflict;Option not available"
Preset	The names are unaffected by Preset or power cycle but are set to the default label (time and date) on a "Restore System Defaults->Misc"
Initial S/W Revision	A.11.00

More Information

When you edit one of the register names, the time and date field will be replaced by the custom name.

If you delete all the characters in the custom name, it restores the default (time and date).

The register names are stored within the state files, but they are not part of the instrument state; that is, once you have edited a register name, loading a new state will not change that register name. Another consequence of this is that the names will be persistent through a power cycle. Also, if a named state file is transferred to another analyzer, it will bring its custom name along with it.

If you try to edit the name of an empty register, the analyzer will first save the state to have a file to put the name in. If you load a named state file into an analyzer with older firmware it will ignore the metadata.

The *SAV and *RCL commands will not be affected by the custom register names, nor will the MMEM commands.

Register 1 thru Register 16

Selecting any one of these register menu keys causes the State of the currently active mode to be saved to the specified Register. The registers are provided for rapid saving and recalling, since you do not need to specify a filename or navigate to a file. Each of the register menu keys annotates whether it is empty or at what date and time it was last modified. In addition, you can use the **Edit Register Names** key to enter custom names for each register.

Although these 16 registers are the only registers available from the front panel, there are 128 state registers available in the instrument. Registers 17–128 are only available from the SCPI interface, using the *SAV command.

There is one set of 128 state registers in the instrument, not one set for each Mode. When a state is saved, the Mode it was saved from is saved with it; then when it is recalled, the instrument switches to that Mode.

After the save completes, the corresponding register menu key annotation is updated with the date and time and the message "Register <register number> saved" is displayed.

Key Path	Save, State
Mode	All
Example	*SAV 1
Range	1–16 from front panel, 1–128 from SCPI
Readback	Date and time with seconds resolution are displayed on the key OR A custom name of up to 30 characters entered using the Edit Register Names key OR “(empty)” if no prior save operation has been performed to this register.
Initial S/W Revision	Prior to A.02.00
Modified at S/W Revision	A.11.00

Register 1 thru Register 16

Selecting any one of these register menu keys causes the State of the currently active mode to be saved to the specified Register. The registers are provided for rapid saving and recalling, since you do not need to specify a filename or navigate to a file. Each of the register menu keys annotates whether it is empty or at what date and time it was last modified. In addition, you can use the **Edit Register Names** key to enter custom names for each register.

Although these 16 registers are the only registers available from the front panel, there are 128 state registers available in the instrument. Registers 17–128 are only available from the SCPI interface, using the *SAV command.

There is one set of 128 state registers in the instrument, not one set for each Mode. When a state is saved, the Mode it was saved from is saved with it; then when it is recalled, the instrument switches to that Mode.

After the save completes, the corresponding register menu key annotation is updated with the date and time and the message "Register <register number> saved" is displayed.

Key Path	Save, State
Mode	All
Example	*SAV 1
Range	1-16 from front panel, 1-128 from SCPI
Readback	Date and time with seconds resolution are displayed on the key OR A custom name of up to 30 characters entered using the Edit Register Names key OR “(empty)” if no prior save operation has been performed to this register.
Initial S/W Revision	Prior to A.02.00
Modified at S/W Revision	A.11.00

Mass Storage Catalog (Remote Command Only)

Key path	SCPI Only
Remote Command	:MMEMory:CATalog? [<directory_name>]
Notes	The string must be a valid logical path. Queries disk usage information (drive capacity, free space available) and obtains a list of files and directories in a specified directory in the following format: <numeric_value>,<numeric_value>,{<file_entry>} It returns two numeric parameters and as many strings as there are files and directories. The first parameter indicates the total amount of storage currently used in bytes. The second parameter indicates the total amount of storage available, also in bytes. The <file_entry> is a string. Each <file_entry> indicates the name, type, and size of one file in the directory list: <file_name>,<file_type>,<file_size> As the windows file system has an extension that indicates file type, <file_type> is always empty. <file_size> provides the size of the file in bytes. For directories, <file_entry> is surrounded by square brackets and both <file_type> and <file_size> are empty
Initial S/W Revision	Prior to A.02.00

Mass Storage Change Directory (Remote Command Only)

Key path	SCPI Only
Remote Command	:MMEMory:CDIRectory [<directory_name>] :MMEMory:CDIRectory?
Notes	The string must be a valid logical path. Changes the default directory for a mass memory file system. The <directory_name> parameter is a string. If no parameter is specified, the directory is set to the *RST value.

	At *RST, this value is set to the default user data storage area, that is defined as System.Environment.SpecialFolder.Personal. Query returns full path of the default directory.
Initial S/W Revision	Prior to A.02.00

Mass Storage Copy (Remote Command Only)

Key path	SCPI Only
Remote Command	:MMEMory:COpy <string>,<string>[,<string>,<string>]
Notes	<p>The string must be a valid logical path.</p> <p>Copies an existing file to a new file or an existing directory to a new directory.</p> <p>Two forms of parameters are allowed. The first form has two parameters. In this form, the first parameter specifies the source, and the second parameter specifies the destination.</p> <p>The second form has four parameters. In this form, the first and third parameters specify the source. The second and fourth parameters specify the directories. The first pair of parameters specifies the source. The second pair specifies the destination. An error is generated if the source doesn't exist or the destination file already exists.</p> <p>This command will generate an "access denied" error if the destination is a restricted folder (e.g., C:\Windows) and the current user does not have Power User or Administrator privileges.</p>

Mass Storage Device Copy (Remote Command Only)

This command transfers data to/from a file and a peripheral device.

Key path	SCPI Only
Remote Command	:MMEMory:COpy:DEvice <source_string>,<dest_string>
Notes	<p>The strings must be a valid logical path or a valid device keyword. If the dest_string is a device keyword, the data is copied from the source file to the device. If the source_string is a device keyword, the data is copied to the source file from the device.</p> <p>Valid device keywords are:</p> <p>SNS (smart noise source)</p> <p>An error is generated if the file or device is not found.</p>

Mass Storage Delete (Remote Command Only)

Key path	SCPI Only
Remote Command	:MMEMory:DElete <file_name>[,<directory_name>]
Notes	<p>The string must be a valid logical path.</p> <p>Removes a file from the specified directory. The <file_name> parameter specifies the file name to be removed. This command will generate an "access denied" error if the file is in a restricted folder (e.g.,</p>

C:\Windows) and the current user does not have Power User or Administrator privileges.

Initial S/W Revision Prior to A.02.00

Mass Storage Data (Remote Command Only)

Creates a file containing the specified data OR queries the data from an existing file.

Key path	SCPI Only
Remote Command	:MMEMory:DATA <file_name>, <data> :MMEMory:DATA? <file_name>
Notes	The string must be a valid logical path. The command form is MMEMory:DATA <file_name>,<data>. It loads <data> into the file <file_name>. <data> is in 488.2 block format. <file_name> is string data. The query form is MMEMory:DATA? <file_name> with the response being the associated <data> in block format.
Initial S/W Revision	Prior to A.02.00

Mass Storage Make Directory (Remote Command Only)

Key path	SCPI Only
Remote Command	:MMEMory:MDIRectory <directory_name>
Notes	The string must be a valid logical path. Creates a new directory. The <directory_name> parameter specifies the name to be created. This command will generate an “access denied” error if the new directory would be in a restricted folder (e.g., C:\Windows) and the current user does not have Power User or Administrator privileges.
Initial S/W Revision	Prior to A.02.00

Mass Storage Move (Remote Command Only)

Key path	SCPI Only
Remote Command	:MMEMory:MOVE <string>,<string> [,<string>,<string>]
Notes	The string must be a valid logical path. Moves an existing file to a new file or an existing directory to a new directory. Two forms of parameters are allowed. The first form has two parameters. In this form, the first parameter specifies the source, and the second parameter specifies the destination. The second form has four parameters. In this form, the first and third parameters specify the source. The second and fourth parameters specify the directories. The first pair of parameters specifies the source. The second pair specifies the destination. An error is generated if the source doesn't exist or the destination file already exists.

	This command will generate an “access denied” error if the destination is a restricted folder (e.g., C:\Windows) and the current user does not have Power User or Administrator privileges.
Initial S/W Revision	Prior to A.02.00

Mass Storage Remove Directory (Remote Command Only)

Key path	SCPI Only
Remote Command	<code>:MMEMory:RDIRectory <directory_name></code>
Notes	The string must be a valid logical path. Removes a directory. The <directory_name> parameter specifies the directory name to be removed. All files and directories under the specified directory shall also be removed. This command will generate an “access denied” error if the folder is a restricted folder (e.g., C:\Windows) or is in a restricted folder and the current user does not have Power User or Administrator privileges.
Initial S/W Revision	Prior to A.02.00

Mass Storage Determine Removable Media (Remote Command Only)

This command is used to determine if any removable media devices are connected to the instrument. Primarily, these are USB memory devices plugged-in to the front panel or rear panel USB ports. On instruments with PC6 or PC7 CPU’s, one SD card slot is available for removable media. The instrument’s primary disk drive is not a removable media device.

Key Path	SCPI Only
Remote Command	<code>:MMEMory:RMEDIA:LIST?</code>
Notes	The return value will be a string containing a list of partition identifiers which are removable media devices. Each identifier will be separated by a comma. If no removable media is present, an empty string will be returned. Examples: One removable device present will result in a return string of “F:”. Two removable devices present will result in a return string of “F:,G:”. No removable devices present will result in a return string of “”.
Initial S/W Revision	x.15.00

Mass Storage Determine Removable Media Label (Remote Command Only)

This command is used to set or query a removable media device’s label.

Key Path	SCPI Only
----------	------------------

Remote Command	:MMEMory:RMEDia:LABel <partition>,<string> :MMEMory:RMEDia:LABel? <partition>
Example	MMEM:RMED:LAB "F:","My Device"
Notes	If the <partition> specified does not exist or is not a removable media device the error -252,"Missing Media" will be generated. Setting the removable media label requires Administrative privileges. If the currently logged in user does not have appropriate privileges the error "-221.9900,Settings conflict;Administrator privileges required" is generated.
Initial S/W Revision	x.15.00

Mass Storage Determine Removable Media Write-protect status (Remote Command Only)

This command is used to query a removable media device's write-protect status.

Key Path	SCPI Only
Remote Command	:MMEMory:RMEDia:WPRotect? <partition>
Example	MMEM:RMED:WPR? "F:"
Notes	The return value is 1 if the device is write-protected, and 0 if the device is write-enabled. If the <partition> specified does not exist or is not a removable media device the error -252,"Missing Media" will be generated.
Preset	The return value will be depending on SD card installed.
Initial S/W Revision	x.15.00

Mass Storage Determine Removable Media size (Remote Command Only)

This command is used to query a removable media device's total memory size (not available memory size).

Key Path	SCPI Only
Remote Command	:MMEMory:RMEDia:SIZE? <partition>
Example	MMEM:RMED:SIZE? "F:"
Notes	The return value is integer value in GBytes. Any device which is less than 1 GB will return 0 GB. If the <partition> specified does not exist or is not a removable media device the error -252,"Missing Media" will be generated.
Initial S/W Revision	x.15.00

Trace (+State)

The **Save Trace (+State)** menu lets you choose a register or file specifying where to save the Trace+State state file.

A saved state contains all of the settings and data required to return the analyzer as closely as possible to the exact setup it had when the save occurred. This includes the Input/Output settings, even though they are outside of the Mode's state, because they are needed to restore the complete setup. A Trace+State file also includes trace data from one trace or all traces, which will load in View mode when the Trace+State file is recalled.

After the save completes, the message "File <filename> saved" or "Trace Register <register number> saved" is displayed.

For rapid saves, the Trace (+State) menu lists 5 registers to save to. Pressing a Register key initiates the save. You can also select a file to save to.

The default path for all State Files including .trace files is:

My Documents\<mode name>\state

where <mode name> is the parameter used to select the mode with the INST:SEL command (for example, Basic for the IQAnalyzer).

This key is grayed out for measurements that do not support trace saves. It is blanked for modes that do not support trace saves. Saving **Trace** is identical to saving State except a .trace extension is used on the file instead of .state, and internal flags are set in the file indicating which trace was saved. You may select to save one trace or ALL traces.

Key Path	Save
Mode	SA
Remote Command	:MMEMory:STORe:TRACe TRACE1 TRACE2 TRACE3 TRACE4 TRACE5 TRACE6 ALL,<filename> :MMEMory:STORe:TRACe:REGister TRACE1 TRACE2 TRACE3 TRACE4 TRACE5 TRACE6 ALL,<integer>
Example	:MMEM:STOR:TRAC TRACE1, "myState.trace" saves the file myState.trace on the default path and flags it as a "single trace" file with Trace 1 as the single trace (even though all of the traces are in fact stored). :MMEM:STOR:TRAC ALL, "myState.trace" saves the file myState.trace on the default path and flags it as an "all traces" file :MMEM:STOR:TRAC:REG TRACE1, 2 stores trace 1 data in trace register 2
Notes	This command actually performs a save state, which in the Swept SA measurement includes the trace data. However it flags it (in the file) as a "save trace" file of the specified trace (or all traces). Some modes and measurements do not have available all 6 traces. The Phase Noise mode command, for example, is: MMEMory:STORe:TRACe TRACE1 TRACE2 TRACE3 ALL,<filename> Some modes and measurements have more than 6 traces available. The Realtime SA mode command, for example, is: MMEMory:STORe:TRACe TRACE1 TRACE2 TRACE3 TRACE4 TRACE5 TRACE6 TRACE7 TRACE8 TRACE9 TRACE10 TRACE11 TRACE12 ALL,<filename> The range for the register parameter is 1-5 When you initiate a save, if the file already exists, a dialog will appear that allows you to replace the existing file by selecting OK or you can Cancel the request. If you select OK, the file will be overwritten. Using the C: drive is strongly discouraged, since it runs the risk of being overwritten during an instrument software upgrade. Both single and double quotes are supported for any filename parameter over remote.

After saving to a register, that register's menu key is updated with the date and time of the save.
After saving to a register, you remain in the **Save Trace** menu, so that you can see the Register key update. After saving to a file, the analyzer automatically returns to the previous menu and any Save As dialog goes away.

Initial S/W Revision	Prior to A.02.00
----------------------	------------------

From Trace

Accesses a menu that enables you to select the trace to be saved. Once a trace is selected, the key returns to the Save Trace menu and the selected trace number is annotated on the key. The default is the currently selected trace, selected in this menu or in the Trace/Det, Export Data, Import Data or Recall Trace menus, except if you have chosen All then it remains chosen until you specifically change it to a single trace. To save the Trace you must select the **Save As** key in the Save Trace menu.

When you select a trace, it makes that trace the current trace, so it displays on top of all of the other traces.

Key Path	Save, Trace + State
Mode	SA
Initial S/W Revision	Prior to A.02.00

From File...

When you press "From File", the analyzer brings up a Windows dialog and a menu entitled "**File Open.**" This menu allows you to navigate to the various fields in the Windows dialog without using a keyboard or mouse. The **Tab** and **Arrow** keys can also be used for dialog navigation.

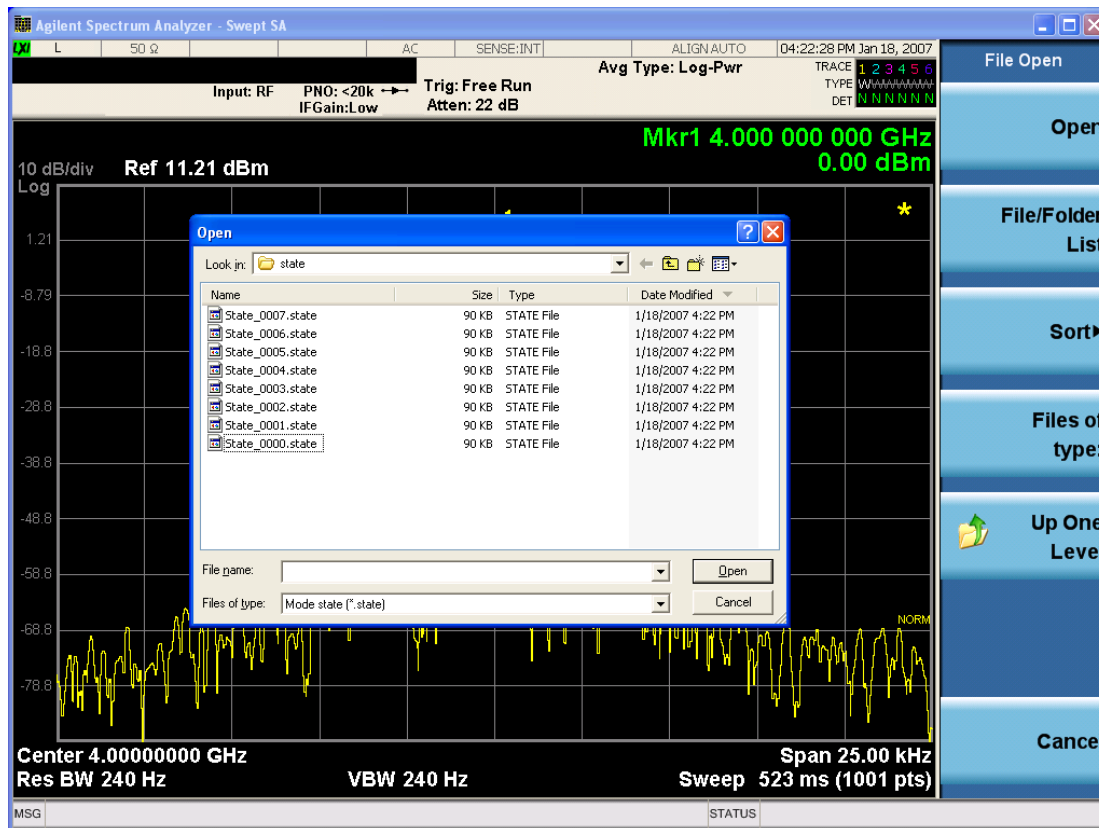

Listed below are the functions of the various fields in the dialog, and the corresponding softkeys:

Open

Performs the recall of the specified file. While the recall is being performed, the floppy icon appears briefly in the Meas bar.

File/Folder List

Enables you to navigate to the center of the dialog that contains the list of files and folders. Once here you can get information about the file and use the tab keys to navigate to the other fields in the dialog, such as Look In.

Look In

The **Look In** field shows the path from which the file will be recalled and allows you to change the path using the up and down arrow keys to navigate to other paths; the Enter key to open a directory; and the Backspace key to go back one directory. The **Look In field** first uses the last path from the Save As dialog **Save In:** path for that same file type. There is no softkey for directly navigating to the Look In field, but you can use the left tab to get here from the File/Folder List.

User specified paths are remembered when you leave and return to a Mode and are reset back to the default using **Restore Mode Defaults**.

Sort

Accesses a menu that enables you to sort the files within the File Open dialog. Only one sorting type can be selected at a time and the sorting happens immediately. The sorting types are **By Date**, **By Name**, **By extension**, and **By Size**.

Files of Type

This field shows the file suffix for the type of file you have selected to recall. For example, if you navigated here while recalling State, "Mode state (*.state)" is in the field. If you navigated here while recalling Trace, ""Mode state (*.trace)" is in the field. If you navigated here while importing a trace data file, "Trace Data (*.csv)" is in the field. For some file types, there is more than one choice in the dropdown menu, which you can select by using the up and down arrow keys and Enter.

Up One Level

This key corresponds to the icon of a folder with the up arrow that is in the tool bar of the dialog. When pressed, it causes the file and folder list to navigate up one level in the directory structure. The Backspace key does the same thing.

Cancel

This key corresponds to the **Cancel** selection in the dialog. It causes the current **Open** request to be cancelled. The ESC key does the same thing.

Key Path	Recall, State
Notes	Brings up the Open dialog for recalling a State Save Type
Initial S/W Revision	Prior to A.02.00

Register 1 thru Register 16

Selecting any one of these register menu keys causes the State of the currently active mode to be saved to the specified Register. The registers are provided for rapid saving and recalling, since you do not need to specify a filename or navigate to a file. Each of the register menu keys annotates whether it is empty or at what date and time it was last modified. In addition, you can use the **Edit Register Names** key to enter custom names for each register.

Although these 16 registers are the only registers available from the front panel, there are 128 state registers available in the instrument. Registers 17–128 are only available from the SCPI interface, using the *SAV command.

There is one set of 128 state registers in the instrument, not one set for each Mode. When a state is saved, the Mode it was saved from is saved with it; then when it is recalled, the instrument switches to that Mode.

After the save completes, the corresponding register menu key annotation is updated with the date and time and the message "Register <register number> saved" is displayed.

Key Path	Save, State
Mode	All
Example	*SAV 1
Range	1–16 from front panel, 1–128 from SCPI

Readback	Date and time with seconds resolution are displayed on the key OR A custom name of up to 30 characters entered using the Edit Register Names key OR "(empty)" if no prior save operation has been performed to this register.
Initial S/W Revision	Prior to A.02.00
Modified at S/W Revision	A.11.00

Data (Export)

Exporting a data file stores data from the current measurement to mass storage files. The Export Menu only contains data types that are supported by the current measurement.

Since the commonly exported data files are in .csv format, the data can be edited by you prior to importing. This allows you to export a data file, manipulate the data in Excel (the most common PC Application for manipulating .csv files) and then import it.

Selecting an Export Data menu key will not actually cause the exporting to occur, since the analyzer still needs to know where you wish to save the data. Pressing the Save As key in this menu brings up the Save As dialog and Save As menu that allows you to specify the destination file and directory. Once a filename has been selected or entered in the Open menu, the export will occur as soon as the Save key is pressed.

Key Path	Save
Mode	All
Notes	The menu is built from whatever data types are available for the mode. So the key locations in the sub menu will vary. No SCPI command directly controls the Data Type that this key controls. The Data Type is included in the MMEM:STORe commands.
Dependencies	If a file type is not used by a certain measurement, that type is grayed out for that measurement. The key for a file type will not show at all if there are no measurements in the Mode that support it.
Preset	Is not affected by a Preset or shutdown, but is reset during Restore Mode Defaults
Readback	The data type that is currently selected
Initial S/W Revision	Prior to A.02.00

Parameter Set

Enables you to export format parameter set data to files. Selecting this key displays a menu that enables you to select the data source. After making this selection, depress Save As... and use the file dialog to enter the file name to save. You can import the exported file by selecting Parameter Set under Recall, Data.

Default path:

Default path of this import type is “My Documents\MSR\data\params” folder. Note that “My Documents” is an alias to a directory and its location depends on which user is logged in. If the file path is specified without root folder, the export file is determined with the default path. For example if “folder1\paramData.prms” is specified, “My Documents\MSR\data\params\folder1\paramData.fps” is exported.

File Extension: fps

Default Prefix: ParamSet_

File Dialog Filter: Format Parameter Set Files (*.fps)

Key Path	Save, Data
Mode	MSR
Remote Command	MMEMOry:STORe:PSET LTEFdd1 LTEFdd2 LTEFdd3 WCDma1 WCDma2 WCDma3 GSM1 GSM2 GSM3 CDMA1 CDMA2 CDMA3 EVDO1 EVDO2 EVDO3 LTETdd1 LTETdd2 LTETdd3 TDSCdma1 TDSCdma2 TDSCdma3,<string>
Example	MMEM:STOR:PSET WCDM1,"WCDMA.fps"
Notes	The first enum selects the source format parameter set from which the file data are exported.
Initial S/W Revision	A.10.00
Modified at S/W Revision	A.12.00, A.16.00

Measurement Results

Pressing this key selects Meas Results as the data type to be exported.

The Meas Results file contains measurement result sets, plus information describing the current state of the analyzer, as detailed in "[Meas Results File Definition](#)" on page 1650 and "[Meas Results File Example](#)" on page 1652 below.

Key Path	Save, Data
Remote Command	:MMEMOry:STORe:RESults <string>
Example	:MMEM:STOR:RES "MeasR_0000.csv"
Notes	If the save is initiated via SCPI and the file already exists, the file will be overwritten. The SCPI command exports Spurious Emissions measurement results to the file specified as the parameter in the current path. The default path is My Documents\<current mode>\data\SPUR\results. Using the C: drive is strongly discouraged, since it runs the risk of being overwritten during an instrument software upgrade. The SCPI parameter is a quoted string that specifies the filename. Both single and double quotes are supported for any filename parameter over SCPI.
Dependencies	The current active measurement must be the Spurious Emissions measurement to use this command.
Status Bits/OPC dependencies	Sequential – waits for the previous measurement to complete
Initial S/W Revision	Prior to A.02.00

Meas Results File Definition

The content of a Meas Results File is defined in this section.

The first lines in the file consist of identification and instrument configuration details, as follows.

- File ID string, which is “MeasResult”
- Measurement ID following Mode ID, which is “SA:SPUR” for example.
- Firmware rev and model number
- Option string
- Abs Start Limit
- Abs Stop Limit
- Abs Stop Limit Mode
- Auto Scaling
- Auto Sweep Time Rules
- Automatic Trigger Time
- Automatic Trigger Time State
- Average Mode
- Average Number
- Average State
- Detector 1
- Detector 2
- Electrical Atten
- Electrical Atten State
- External Array Trigger Delay
- External Array Trigger Delay State
- External Array Trigger Level
- External Array Trigger Slope
- Filter Type
- IF Gain Auto
- IF Gain State
- Internal Preamp
- Internal Preamp Band

- Line Trigger Delay
- Line Trigger Delay State
- Line Trigger Slope
- Meas Type
- Mechanical Atten
- MechanicalAttenStepEnum
- Peak Excursn
- Periodic Timer Period
- Periodic Timer Sync Source
- Periodic Timer Trigger Delay
- Periodic Timer Trigger Delay State
- Pk Threshold
- Points
- Points Mode
- Range State
- Ref Value
- Res BW
- Res BW Mode
- RFBurst Trigger Delay
- RFBurst Trigger Delay State
- RFBurst Trigger Level Abs
- RFBurst Trigger Level Rel
- RFBurst Trigger Level Type
- RFBurst Trigger Slope
- Scale/Div
- Spurious Report Mode
- SpurRangeStartFrequencyArray
- SpurRangeStopFrequencyArray
- Sweep Time
- Sweep Time Mode
- Trigger Holdoff

- Trigger Holdoff State
- TriggerSource
- Video BW
- Video BW Mode

The data above is followed in the file by a line containing “MeasResult1” to “MeasResult42”. This line forms a header for each set of measurement results, which appear in subsequent lines. Each line of Measurement Results consists of 42 comma-separated values, from the MeasResult1 value to the MeasResult42 value.

The MeasResult1 set in the file corresponds to the data returned by MEAS/READ/FETCH:SPURious1; the MeasResult2 set corresponds to the data returned by MEAS/READ/FETCH:SPURious2, and so on.

The exported file is in CSV format, with a .csv extension.

Meas Results File Example

When imported into Excel, a typical Meas Results file appears as shown in the example below.

NOTE: The following table omits the columns for MeasResult11 to MeasResult42, due to lack of space.

MeasResult	1	2	3	4	5	6	7	8	9	10
SA:SPUR										
A.10.53	N903 0A									
526 ALV ATP B1X B1Y B25 B40 BBA CR3 CRP DCF DDA DP2 DRD EA3 EDP EMC EP1 ERC ESC ESP EXM FSA LFE LNP MAT MPB NFE NUL P26 PFR PNC RTL RTS S40 SB1 SEC SM1 TVT YAS YAV	1									
Abs Start Limit	-50	-50	-50	-50	-50	-50	-50	-50	-50	-50
Abs Stop Limit	-50	-50	-50	-50	-50	-50	-50	-50	-50	-50
Abs Stop Limit Mode	TRUE	TRUE	TRUE	TRUE	TRUE	TRUE	TRUE	TRUE	TRUE	TRUE
Auto Scaling	TRUE									
Auto Sweep Time Rules	Norm									
Automatic Trigger Time	0.1									

Automatic Trigger Time State	FALSE									
Average Mode	Exponential									
Average Number	10									
Average State	FALSE									
Detector 1	Peak	Peak	Peak	Peak	Peak	Peak	Peak	Peak	Peak	Peak
Detector 2	Off	Off	Off	Off	Off	Off	Off	Off	Off	Off
Electrical Atten	0									
Electrical Atten State	FALSE									
External Array Trigger Delay	1.00 E-06	1.00 E-06								
External Array Trigger Delay State	FALSE	FALSE								
External Array Trigger Level	1.2	1.2								
External Array Trigger Slope	Positive	Positive								
Filter Type	Gaussian	Gaussian	Gaussian	Gaussian	Gaussian	Gaussian	Gaussian	Gaussian	Gaussian	Gaussian
IF Gain Auto	FALSE	FALSE	FALSE	FALSE	FALSE	FALSE	FALSE	FALSE	FALSE	FALSE
IF Gain State	FALSE	FALSE	FALSE	FALSE	FALSE	FALSE	FALSE	FALSE	FALSE	FALSE
Internal Preamp	FALSE									
Internal Preamp Band	Low									
Line Trigger Delay	1.00 E-06									
Line Trigger Delay State	FALSE									
Line Trigger Slope	Positive									
Meas Type	Examine									
Mechanical Atten	10									
MechanicalAtten StepEnum	S2dB									
Peak Excursn	6	6	6	6	6	6	6	6	6	6
Periodic Timer Period	0.02									

Periodic Timer Sync Source	None									
Periodic Timer Trigger Delay	1.00 E-06									
Periodic Timer Trigger Delay State	FALSE									
Pk Threshold	-90	-90	-90	-90	-90	-90	-90	-90	-90	-90
Points	601	601	601	601	601	601	601	601	601	601
Points Mode	FALSE	FALSE	FALSE	FALSE	FALSE	FALSE	FALSE	FALSE	FALSE	FALSE
Range State	TRUE	TRUE	TRUE	TRUE	TRUE	FALSE	FALSE	FALSE	FALSE	FALSE
Ref Value	0									
Res BW	1200000	510000	100000	100000	400000	300000	300000	300000	300000	300000
Res BW Mode	FALSE	FALSE	FALSE	FALSE	FALSE	TRUE	TRUE	TRUE	TRUE	TRUE
RFBurst Trigger Delay	1.00 E-06									
RFBurst Trigger Delay State	FALSE									
RFBurst Trigger Level Abs	-20									
RFBurst Trigger Level Rel	-6									
RFBurst Trigger Level Type	Absolute									
RFBurst Trigger Slope	Positive									
Scale/Div	10									
Spurious Report Mode	All									
SpurRangeStartFrequencyArray	1.92E+09	1.89E+09	2.1E+09	2.18E+09	8E+08	1.5E+09	1.5E+09	1.5E+09	1.5E+09	1.5E+09
SpurRangeStopFrequencyArray	1.98E+09	1.92E+09	2.1E+09	2.18E+09	1E+09	2.5E+09	2.5E+09	2.5E+09	2.5E+09	2.5E+09
Sweep Time	0.001	0.001	0.0012	0.00396	0.001	0.001	0.001	0.001	0.001	0.001
Sweep Time Mode	TRUE	TRUE	TRUE	TRUE	TRUE	TRUE	TRUE	TRUE	TRUE	TRUE
Trigger Holdoff	0.1									
Trigger Holdoff State	FALSE									

TriggerSource	Free									
Video BW	1200 00	5100 0	1000 0	1000 0	3900 00	3000 00	3000 00	3000 00	30000 0	30000 0
Video BW Mode	TRUE	TRUE	TRUE	TRUE	TRUE	TRUE	TRUE	TRUE	TRUE	TRUE
MeasResult1	Meas Result 2	Meas Result 3	Meas Result 4	Meas Result 5	Meas Result 6	Meas Result 7	Meas Result 8	Meas Result 9	MeasR esult1 0	MeasR esult1 1
19	- 80.27 209	- 80.87 862	- 90.94 577	- 89.27 086	- 76.77 856	- 9.91E +37	- 9.91E +37	- 9.91E +37	- 9.91E+ 37	- 9.91E+ 37
1	- 78.28 497	- 80.93 996	- 91.00 485	- 90.56 063	- 76.33 968					

Save As . . .

When you press “Save As”, the analyzer brings up a Windows dialog and a menu entitled “**Save As.**” This menu allows you to navigate to the various fields in the Windows dialog without using a keyboard or mouse. The **Tab** and **Arrow** keys can also be used for dialog navigation.

See "[To File . . .](#)" on page 2444 in **Save, State** for a full description of this dialog and menu.

The default path for saving files is:

For all of the Trace Data Files:

My Documents\<<mode name>\data\traces

For all of the Limit Data Files:

My Documents\<<mode name>\data\limits

For all of the Measurement Results Data Files:

My Documents\<<mode name>\data\<<measurement name>\results

For all of the Capture Buffer Data Files:

My Documents\<<mode name>\data\captureBuffer

Key Path	Save, Data
Mode	All
Notes	The key location is mode-dependent and will vary. Brings up the Save As dialog for saving a <mode specific> Save Type. The save is performed immediately and does not wait until the measurement is complete.
Initial S/W Revision	Prior to A.02.00

Screen Image

Pressing Screen Image accesses a menu of functions that enable you to specify a format and location for the saved screen image. It brings up a menu that allows you to specify the color scheme of the Screen Image (Themes) or navigate to the Save As dialog to perform the actual save.

Screen Image files contain an exact representation of the analyzer display. They cannot be loaded back onto the analyzer, but they can be loaded into your PC for use in many popular applications.

The image to be saved is actually captured when the **Save** front panel key is pressed, and kept in temporary storage to be used if you ask for a Screen Image save. When the Screen Image key is pressed, a "thumbnail" of the captured image is displayed, as shown below:

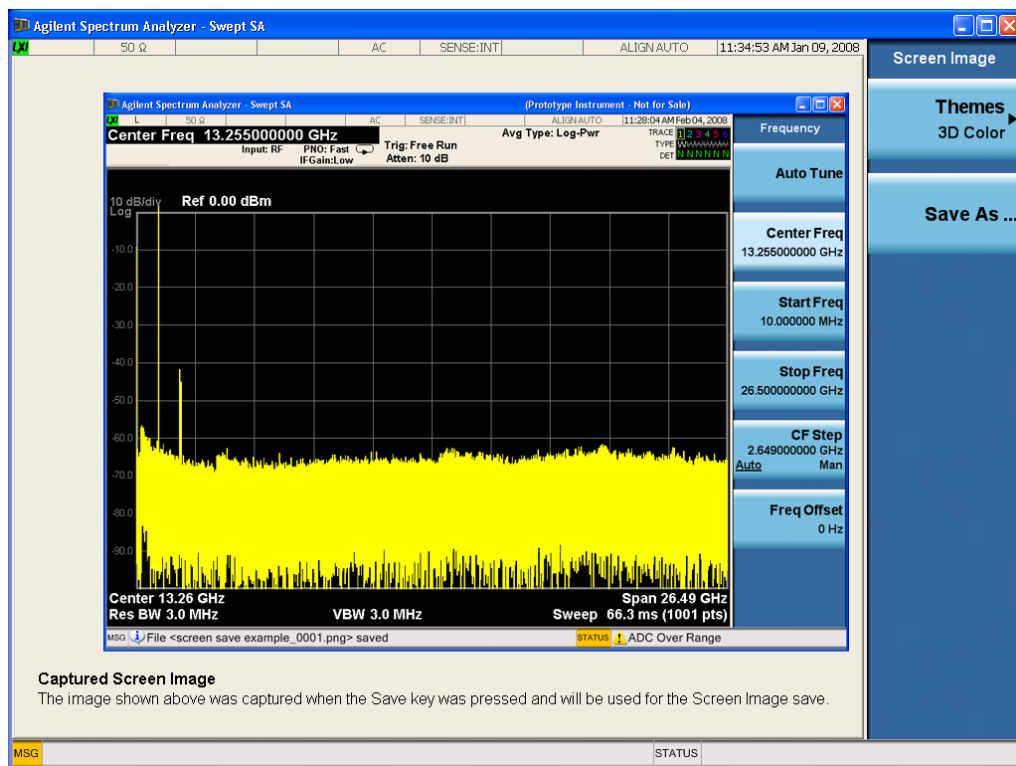

When you continue on into the **Save As** menu and complete the Screen Image save, the image depicted in the thumbnail is the one that gets saved, showing the menus that were on the screen before going into the **Save** menus. The save is performed immediately and does not wait until the measurement is complete.

After you have completed the save, the **Quick Save** front-panel key lets you quickly repeat the last save performed, using an auto-named file, with the current screen data.

NOTE

For versions previous to A.01.55, if you initiate a screen image save by navigating through the Save menus, the image that is saved will contain the Save menu softkeys, not the menus and the active function that were on the screen when you first pressed the Save front panel key.

Key Path	Save
Mode	All

Remote Command	:MMEMory:STORe:SCReen <filename>
Example	:MMEM:STOR:SCR "myScreen.png" This stores the current screen image in the file MyScreenFile.png in the default directory.
Initial S/W Revision	Prior to A.02.00

Themes

Accesses a menu of functions that enable you to choose the theme to be used when saving the screen image.

The **Themes** option is the same as the **Themes** option under the **Display** and **Page Setup** dialogs. It allows you to choose between themes to be used when saving the screen image.

Key Path	Save, Screen Image
Remote Command	:MMEMory:STORe:SCReen:THEMe TDColor TDMonochrome FCOLor FMONochrome :MMEMory:STORe:SCReen:THEMe?
Example	:MMEM:STOR:SCR:THEM TDM
Preset	3D Color; Is not part of Preset, but is reset by Restore Misc Defaults or Restore System Defaults All and survives subsequent running of the modes.
Readback	3D Color 3D Mono Flat Color Flat Mono
Backwards Compatibility Notes	In ESA and PSA we offer the choice of "Reverse Bitmap" or "Reverse Metafile" when saving screen images. This is much like the "Flat Color" theme available in X-Series. Also, if you selected Reverse Bitmap AND a black & white screen image, that would be much like "Flat Monochrome". In other words, each of the X-Series themes has a similar screen image type in ESA/PSA. But they are not identical.
Initial S/W Revision	Prior to A.02.00

3D Color

Selects a standard color theme with each object filled, shaded and colored as designed.

Key Path	Save, Screen Image, Themes
Example	MMEM:STOR:SCR:THEM TDC
Readback	3D Color
Initial S/W Revision	Prior to A.02.00

3D Monochrome

Selects a format that is like 3D color but shades of gray are used instead of colors.

Key Path	Save, Screen Image, Themes
Example	MMEM:STOR:SCR:THEM TDM
Readback	3D Mono
Initial S/W Revision	Prior to A.02.00

Flat Color

Selects a format that is best when the screen is to be printed on an ink printer.

Key Path	Save, Screen Image, Themes
Example	MMEM:STOR:SCR:THEM FCOL
Readback	Flat Color
Initial S/W Revision	Prior to A.02.00

Flat Monochrome

Selects a format that is like Flat Color. But only black is used (no colors, not even gray), and no fill.

Key Path	Save, Screen Image, Themes
Example	MMEM:STOR:SCR:THEM FMON
Readback	Flat Mono
Initial S/W Revision	Prior to A.02.00

Save As...

When you press "Save As", the analyzer brings up a Windows dialog and a menu entitled "**Save As.**" This menu allows you to navigate to the various fields in the Windows dialog without using a keyboard or mouse. The **Tab** and **Arrow** keys can also be used for dialog navigation.

See "[To File . . .](#)" on page 2444 in **Save, State** for a full description of this dialog and menu.

The default path for Screen Images is

My Documents\`<mode name>`\screen.

where `<mode name>` is the parameter used to select the mode with the INST:SEL command (for example, SA for the Spectrum Analyzer).

Key Path	Save, Screen Image
Notes	Brings up Save As dialog for saving a Screen Image Save Type
Initial S/W Revision	Prior to A.02.00

Single (Single Measurement/Sweep)

Sets the analyzer for Single measurement operation. The single/continuous state is Meas Global, so the setting will affect all the measurements. If you are Paused, pressing **Single** does a Resume.

See "[More Information](#)" on page 1659

Key Path	Front-panel key
Example	:INIT:CONT OFF
Notes	See Cont key description.
Backwards Compatibility Notes	<p>For Spectrum Analysis mode in ESA and PSA, the Single hardkey and the INITiate:IMM switched from continuous measurement to single measurement and restarted sweeps and averages (displayed average count reset to 1), but did not restart Max Hold and Min Hold. In the X-Series, the Single hardkey and the INITiate:IMM command initiate a sweep/ measurement/ average sequence/hold sequence including MaxHold and MinHold.</p> <p>For Spectrum Analysis mode in ESA and PSA, the Single hardkey restarted the sweep regardless of whether or not you were in an active sweep or sweep sequence. In the X-Series, Restart does this but Single only restarts the sweep or sweep sequence if you are in the idle state.</p> <p>INIT[:IMM] in ESA & PSA Spectrum Analysis Mode does an implied ABORt. In some other PSA Modes, INIT[:IMM] is ignored if not in the idle state. . The X-Series follows the ESA/PSA SA Mode model, which may cause some Modes to have compatibility problems.</p>
Initial S/W Revision	Prior to A.02.00

More Information

See "[Restart](#)" on page 2441 for details on the INIT:IMMEDIATE (Restart) function.

If you are already in single sweep, the INIT:CONT OFF command has no effect.

If you are already in Single Sweep, then pressing the **Single** key in the middle of a sweep does not restart the sweep or sequence. Similarly, pressing the **Single** key does not restart the sweep or sequence if the sweep is not in the idle state (for example, if you are taking a very slow sweep, or the analyzer is waiting for a trigger). Instead, it results in a message. "Already in Single, press Restart to initiate a new sweep or sequence". Even though pressing the **Single** key in the middle of a sweep does not restart the sweep, sending INIT:IMMEDIATE does reset it.

To take one more sweep without resetting the average count, increment the average count by 1, by pressing the step up key while **Average/Hold Number** is the active function, or sending the remote command CALC:AVER:TCON UP.

Source

There is no Source control functionality for this measurement. When this key is pressed, the screen either displays a blank menu, or the previously-selected menu remains unchanged.

Key Path	Front-panel key
----------	-----------------

Span X Scale

Span X Scale is unavailable in the Spurious Emissions measurement. When pressed, this key displays a blank menu.

Key Path	Front-panel key
Initial S/W Revision	Prior to A.02.00

Sweep/Control

Accesses the Sweep/Control menu keys used to set up and control the sweep time and source.

Key Path	Front-panel key
Initial S/W Revision	Prior to A.02.00

Sweep Setup

Sets the sweep functions that control the sweep state and time.

Key Path	Sweep/Control
Initial S/W Revision	Prior to A.02.00

Auto Sweep Time Rules

Switches the analyzer between normal and accuracy sweep states. Setting **Auto Sweep Time** to **Accy** will result in slower sweep times, usually about three times as long, but better amplitude accuracy for CW signals. The instrument amplitude accuracy specifications only apply when **Auto Sweep Time** is set to **Accy**.

Additional amplitude errors which occur when **Auto Sweep Time** is set to **Norm** are usually well under 0.1 dB, though this is not guaranteed. Because of the faster sweep times and still low errors, **Norm** is the preferred setting of **Auto Sweep Time**. **Auto Sweep Time** is set to **Norm** on a **Preset** or **Auto Couple**. This means that in the Preset or Auto Coupled state, instrument amplitude accuracy specifications do not apply.

Key Path	Sweep/Control, Sweep Setup
Mode	SA, WCDMA, C2K, WIMAX OFDMA, TD-SCDMA, 1xEV-DO, DVB-T/H, LTE, LTE-TDD, WLAN, MSR, LTEAFDD, LTEATDD
Remote Command	[:SENSe] :SPURious :SWEep :TIME :AUTO :RULEs NORMal ACCuracy [:SENSe] :SPURious :SWEep :TIME :AUTO :RULEs ?
Example	SPUR:SWE:TIME:AUTO:RUL ACC SPUR:SWE:TIME:AUTO:RUL ?
Notes	In Zero Span, this key is irrelevant and inaccessible (because the whole Sweep Setup menu is grayed out), however, Sweep Setup settings can be changed remotely with no error indication.
Preset	NORMal
State Saved	Saved in instrument state.
Range	Norm Accy
Initial S/W Revision	Prior to A.02.00
Modified at S/W Revision	A.03.00

Sweep Type

Sets the sweep type of the spurious measurement to either Auto or Swept. When in Auto, the selections of swept type of ranges are governed by the Best Speed Sweep Type Rule, and FFT analysis might be chosen for some ranges if it speeds up the measurement.

Key Path	Sweep/Control, Sweep Setup
Mode	SA, WCDMA, C2K, WIMAX OFDMA, TD-SCDMA, 1xEV-DO, DVB-T/H, LTE, LTETDD, WLAN, MSR, LTEAFDD, LTEATDD
Remote Command	[:SENSe] :SPURious [:RANGe] :ALL :SWEep :TYPE :AUTO OFF ON 0 1 [:SENSe] :SPURious [:RANGe] :ALL :SWEep :TYPE :AUTO ?
Example	SPUR:ALL:SWE:TYPE:AUTO 1 SPUR:ALL:SWE:TYPE:AUTO ?
Dependencies	This parameter is available only when option N9060A-7FP is installed.
Preset	ON
State Saved	Saved in instrument state.
Range	Auto Swept
Initial S/W Revision	A.11.00

Pause

Pauses a measurement after the current data acquisition is complete.

When paused, the label on the key changes to **Resume**. Pressing **Resume** resumes the measurement at the point it was at when paused.

See "[Pause/Resume](#)" on page 2468 for more information.

Key Path	Sweep/Control
Initial S/W Revision	Prior to A.02.00

Gate

Accesses a menu that enables you to control the gating function. The Gate functionality is used to view signals best viewed by qualifying them with other events.

Gate setup parameters are the same for all measurements – they do not change as you change measurements. Settings like these are called “Meas Global” and are unaffected by Meas Preset.

Note that Sweep Time autocoupling rules and annotation are changed by Gate being on.

Key Path	Sweep/Control
Scope	Meas Global
Readback	

The state and method of Gate, as [Off, LO] or [On, Video]. Note that for measurements that only support gated LO, the method is nonetheless read back, but always as LO.

Initial S/W Revision Prior to A.02.00

Gate On/Off

Turns the gate function on and off.

When the Gate Function is on, the selected Gate Method is used along with the gate settings and the signal at the gate source to control the sweep and video system with the gate signal. Not all measurements allow every type of Gate Methods.

When Gate is on, the annunciation in the measurement bar reflects that it is on and what method is used, as seen in the following "Gate: LO" annunciator graphic.

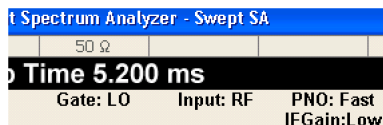

Key Path	Sweep/Control, Gate
Remote Command	[:SENSE] :SWEep:EGATe [:STATe] OFF ON 0 1 [:SENSE] :SWEep:EGATe [:STATe] ?
Example	SWE:EGAT ON SWE:EGAT?

Dependencies

The function is unavailable (grayed out) and Off when:

- Gate Method is LO or Video and FFT Sweep Type is manually selected.
- Gate Method is FFT and Swept Sweep Type is manually selected.
- Marker Count is ON.

The following are unavailable whenever Gate is on:

- FFT under Sweep Type when Method=LO or Video or Swept under Sweep Type when Method=FFT
- **Marker Count**

While Gate is on, the Auto Rules for Sweep Type are modified so that the choice agrees with the Gate Method: i.e., FFT for Method = FFT and Swept for Method = LO or Video.

The Gate softkey and all SCPI under the [:SENSE]:SWEep:EGATe SCPI node are grayed out when Source Mode is Tracking with an external source. This is because the Gate circuitry is used to sync the external source. If the Tracking Source is turned on, the Gate is turned off.

When in the ACP measurement:

- When Meas Method is RBW or FAST, this function is unavailable and the key is grayed out.
- Whenever Gate is on, Meas Method, RBW or FAST is unavailable and keys for those are grayed out.
- When Gate is on, Offset Res BW and Offset Video BW are ignored (if you set these values) and the

	measurement works as if all Offset Res BW and all Offset Video BW are coupled with the Res BW and the Video BW under the BW menu. When Gate is on, the Offset BW key in the Offset/Limit menu is grayed out.
Preset	Off LTETDD: On
State Saved	Saved in instrument state
Range	On Off
Backwards Compatibility SCPI	[:SENSe]:SWEep:TIME:GATE[:STATE] ESA compatibility
Backwards Compatibility Notes	In ESA, Trig Delay (On) and Gate (On) could not be active at the same time.. This dependency does not exist in PSA or in the X-Series.
Initial S/W Revision	Prior to A.02.00

Gate View On/Off

Turning on Gate View in the Swept SA measurement provides a single-window gate view display..

Turning on Gate View in other measurements shows the split-screen Gate View. In these measurements, when the Gate View is on, the regular view of the current measurement traces and results are reduced vertically to about 70% of the regular height. The Zero Span window, showing the positions of the Gate, is shown between the Measurement Bar and the reduced measurement window. By reducing the height of the measurement window, some of the annotation on the Data Display may not fit and is not shown.

Key Path	Sweep/Control, Gate
Remote Command	[:SENSe]:SWEep:EGATe:VIEW ON OFF 1 0 [:SENSe]:SWEep:EGATe:VIEW?
Example	SWE:EGAT:VIEW ON turns on the gate view.
Dependencies	In the Swept SA measurement: In Gate View, the regular Sweep Time key is grayed out . When pressed, the grayed out key puts up the informational message "Use Gate View Sweep Time in the Gate menu." In the other measurements: When you turn Gate View on, the lower window takes on the current state of the instrument. Upon leaving Gate View, the instrument takes on the state of the lower window. When you turn Gate View on, the upper window Sweep Time is set to the gate view sweep time.
Couplings	These couplings apply to the Swept SA measurement: <ul style="list-style-type: none"> • When Gate View is turned on, the instrument is set to Zero Span. • Gate View automatically turns off whenever a Span other than Zero is selected. • Gate View automatically turns off if you press the Last Span key while in Gate View, and the instrument returns to the Span it was in before entering Gate View (even if that is Zero Span). • When Gate View is turned on, the sweep time used is the gate view sweep time. This is set according to the rules in section "Gate View Setup " on page 2231 • When Gate View is turned off, Sweep Time is set to the normal Swept SA measurement sweep time.

- If Gate View is on and Gate is off, then turning on Gate turns off Gate View.

Preset	OFF
State Saved	Saved in instrument state
Range	On Off
Initial S/W Revision	Prior to A.02.00

A sample of the Gate View screen in the Swept SA measurement is shown in the following graphic :

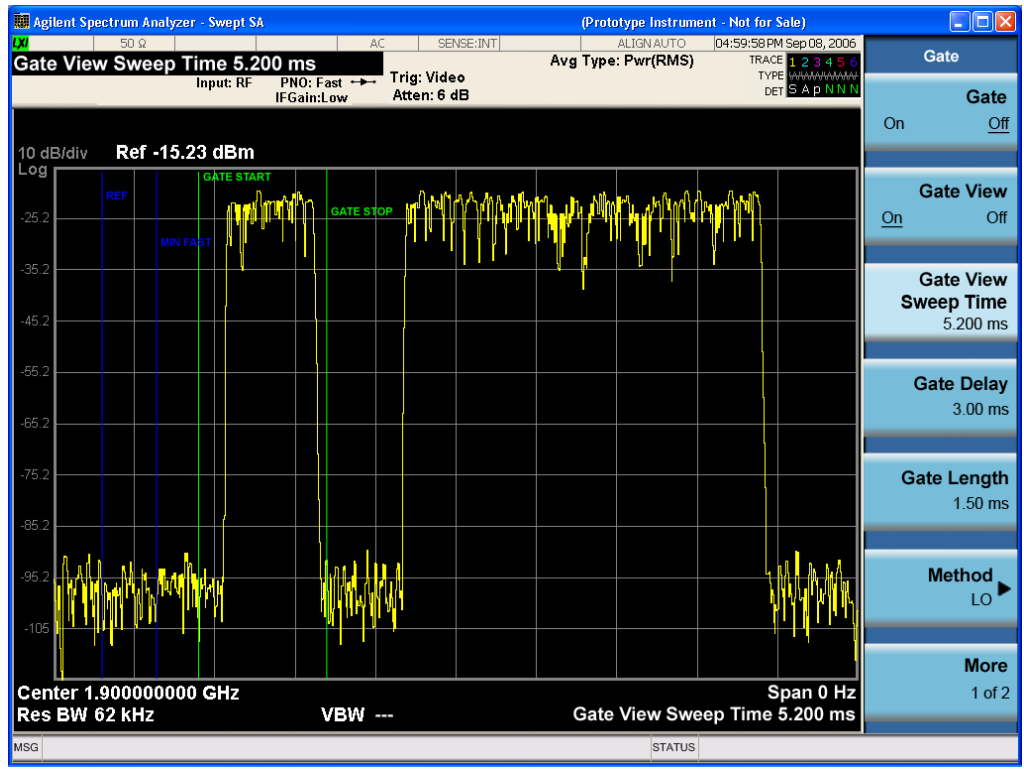

A sample of the Gate View screen in other measurements is shown in the following graphic . This example is for the ACP measurement:

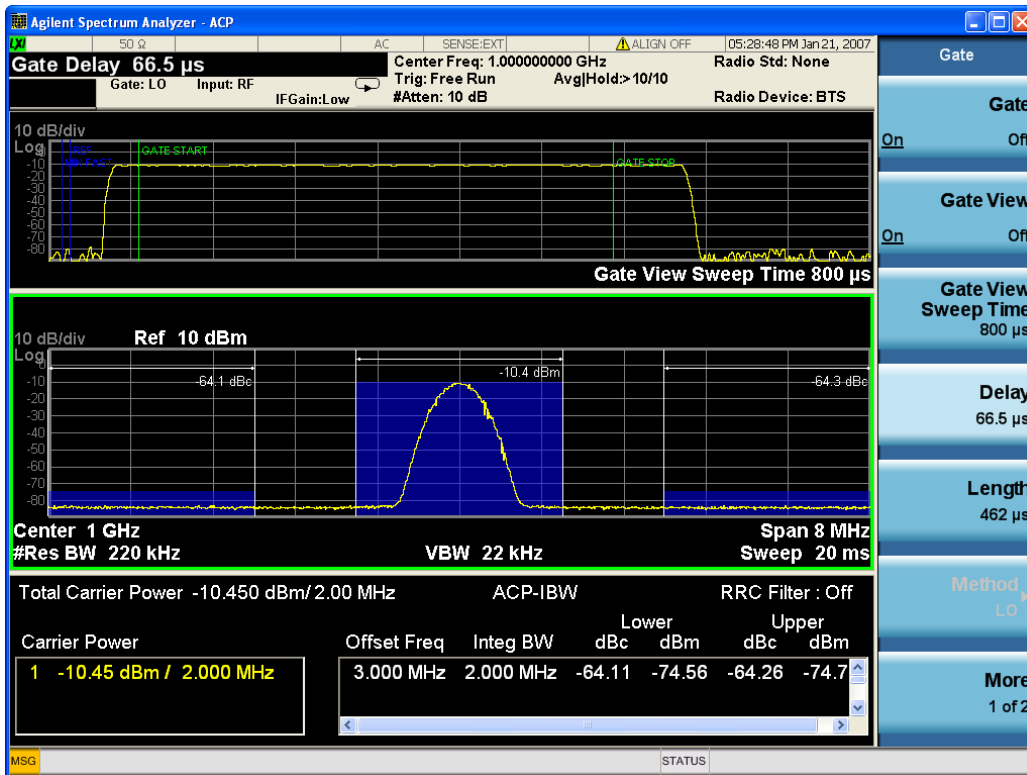

Turning Gate View off returns the analyzer to the Normal measurement view.

In the Swept SA, the normal measurement view is the single-window Swept SA view. When returning to this view, the Swept SA measurement returns to the Span it was in before entering **Gate View** (even if that is Zero Span).

The **Gate View** window is triggered from the Gate Source, with zero trigger delay. Also, when updating the **Gate View** window, the Gate itself must not operate. So it is internally shut off while the gate view window is being updated. For the Swept SA measurement, this means that the Gate is internally shut off whenever the gate view window is displayed. The measurement bar and softkeys continue to show the Trigger source for the main sweep window and give no indication that the Gate is shut off or that the Gate View window is triggered from the Gate Source.

When in **Gate View**, vertical lines are displayed in the Gate View window as follows:

- Green lines are displayed at the gate edges as follows: in Edge Gate, a line is shown for Delay and one for the end of the Gate period, defined by Length. In Level Gate a line is shown only for Delay. You can adjust the position of the green lines by adjusting the gate length and the gate delay. These lines update in the Gate View window as the active function changes, even if the window is not being updated. In Gated LO and Gated Video, these lines are positioned relative to the delay reference line (not relative to 0 time). In Gated FFT, their location is relative to the left edge of the screen.
- A blue line is displayed showing the delay reference, that is, the reference point for the Gate Delay within the Zero Span window. The blue line represents where (in time) the effective location of the gate start would be if the gate were programmed to zero delay.
-

- The second blue line is labeled "MIN FAST" as shown in the figure above because it represents the minimum Gate Delay for fast Gated LO operation. This line is only displayed in Gated LO. You cannot scroll (knob) or decrement (down key) the Gate Delay to less than that represented by the position of this line, it can only be set below this position manually, although once there it can be moved freely with the knob while below the line.
- A yellow line in the Gated Video case only, is displayed at Blength, where Blength is the display point (bucket) length for the swept trace, which is given by the sweep time for that trace divided by number of Points – 1. So it is referenced to 0 time, not to the delay reference. This line is labeled NEXT PT (it is not shown in the figure above because the figure above is for Gated LO).
- The yellow line represents the edge of a display point (bucket). Normally in Gated Video, the bucket length must be selected so that it exceeds the off time of the burst. There is another way to use the analyzer in Gated Video measurements, and that is to set the bucket width much shorter than the off time of the burst. Then use the Max Hold trace function to fill in "missing" buckets more slowly. This allows you to see some of the patterns of the Gated Video results earlier, though seeing a completely filled-in spectrum later.

Gate View Setup

Accesses a menu that enables you to setup parameters relevant to the Gate View

Key Path	Sweep/Control, Gate
Scope	Meas Global
Initial S/W Revision	A.10.00

Gate View Sweep Time

Controls the sweep time in the Gate View window. To provide an optimal view of the gate signal, the analyzer initializes Gate View Sweep Time based on the current settings of Gate Delay and Gate Length.

Key Path	Sweep/Control, Gate, Gate View Setup
Remote Command	[:SENSe] :SWEep:EGATe:TIME <time> [:SENSe] :SWEep:EGATe:TIME?
Example	SWE:EGAT:TIME 500 ms
Dependencies	Gate View Sweep Time is initialized: <ul style="list-style-type: none"> • On Preset (after initializing delay and length). • Every time the Gate Method is set/changed. <p>Additionally, in the Swept SA measurement, whenever you do a Preset, or leave Gate View, the analyzer remembers the Gate Delay and Gate Length settings. Then, when returning to Gate View, if the current Gate Delay and/or Gate Length do not match the remembered values Gate View Sweep Time is re-initialized.</p> <ol style="list-style-type: none"> 1. Compute the location of the "gate stop" line, which you know is at time $t = t_{min} + GateDelay + GateLength$.
Preset	519.3 μ s

	WiMAX OFDMA: 5 ms GSM/EDGE: 1 ms
State Saved	Saved in instrument state
Max	6000 s
Initial S/W Revision	Prior to A.02.00

Gate View Start Time

Controls the time at the left edge of the Gate View.

Key Path	Sweep/Control, Gate, Gate View Setup
Remote Command	[:SENSe] :SWEep:EGATe:VIEW:STARt <time> [:SENSe] :SWEep:EGATe:VIEW:STARt?
Example	SWE:EGAT:VIEW:STAR 10ms
Notes	Units of time are required or no units; otherwise an invalid suffix error message will be generated. See error -131.
Preset	0 ms
State Saved	Saved in instrument state
Min	0
Max	500 ms
Initial S/W Revision	A.10.00

Gate Delay

Controls the length of time from the time the gate condition goes True until the gate is turned on.

Key Path	Sweep/Control, Gate
Remote Command	[:SENSe] :SWEep:EGATe:DELay <time> [:SENSe] :SWEep:EGATe:DELay?
Example	SWE:EGAT:DELay 500ms SWE:EGAT:DELay?
Notes	Units of time are required or no units; otherwise an invalid suffix error message will be generated.
Preset	57.7 us WiMAX OFDMA: 71 us GSM/EDGE: 600 us WLAN: 500 us
State Saved	Saved in instrument state
Min	0.0 us

Max	100 s
Backwards Compatibility SCPI	[:SENSe]:SWEep:TIME:GATE:DELay ESA compatibility
Initial S/W Revision	Prior to A.02.00

Gate Length

Controls the length of time that the gate is on after it opens.

Key Path	Sweep/Control, Gate
Remote Command	[:SENSe]:SWEep:EGATe:LENGth <time> [:SENSe]:SWEep:EGATe:LENGth?
Example	SWE:EGAT:LENG 1 SWE:EGAT:LENG?
Notes	Units of time are required or no units; otherwise an invalid suffix error message will be generated.

Dependencies

Grayed out when Gate Method is set to FFT in which case the label changes to that shown below.

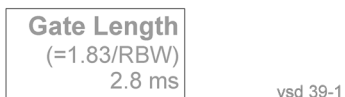

The key is also grayed out if Gate Control = Level.

Preset	461.6 us WiMAX OFDMA: 50 us GSM/EDGE: 200 us WLAN: 1.54 ms
State Saved	Saved in instrument state
Min	100 ns
Max	5 s
Backwards Compatibility SCPI	[:SENSe]:SWEep:TIME:GATE:LENGth ESA compatibility
Initial S/W Revision	Prior to A.02.00

Gate Source

The menus under the **Gate Source** key are the same as those under the **Trigger key**, with the exception that neither **Free Run** nor **Video** are available as Gate Source selections. However, a different SCPI command is used to select the Gate Source (see table below) because you may independently set the Gate Source and the Trigger Source.

Any changes to the settings in the setup menus under each Gate Source selection key (for example: Trigger Level, Trigger Delay, etc.) also affect the corresponding settings under the Trigger menu keys. The SCPI commands used for these are the same for Trigger and Gate, since there is only one setting which affects both Gate and Trigger. Example: to set the Trigger Level for External 1 you use the command :TRIG:EXT1:LEV regardless of whether you are using External 1 as a Trigger Source or a Gate Source.

Key Path	Sweep/Control, Gate
Remote Command	[:SENSe] :SWEep:EGATe:SOURce EXTernal1 EXTernal2 LINE FRAME RFBurst [:SENSe] :SWEep:EGATe:SOURce?
Dependencies	In some models, there is no second External input. In these models, the External 2 key is blanked and the EXTernal2 parameter will generate a "Hardware missing; Not available for this model number" error.
Preset	EXTernal 1 GSM/EDGE, MSR: FRAME LTETDD: EXTernal 1When Direction is Downlink, FRAME when Direction is Uplink.
Backwards Compatibility Notes	In ESA, there is a single Gate input port. In PSA, the Gate Source may be taken from one of two specified input ports. In the X-Series, any Trigger Source can be a Gate Source.
Initial S/W Revision	Prior to A.02.00
Modified at S/W Revision	A.03.00, A.14.00

Line

Pressing this key, when it is not selected, selects the line signal as the trigger. A new sweep/measurement will start synchronized with the next cycle of the line voltage. Pressing this key, when it is already selected, access the line trigger setup menu.

Key Path	Trigger
Example	TRIG:SOUR LINE Swept SA measurement TRIG:<meas>:SOUR LINE Measurements other than Swept SA
Dependencies	Line trigger is not available when operating from a "dc power source", for example, when the instrument is powered from batteries.
State Saved	Saved in instrument state
Status Bits/OPC dependencies	The Status Operation Register bit 5 "Waiting for Trigger" is set at the same time as the Sweeping or Measuring bit is set. It is cleared when the trigger actually occurs (that is, after the trigger event occurs and all the applicable trigger criteria have been met). A corresponding pop-up message ("Waiting for trigger") is generated if no trigger signal appears after approximately 2 sec. This message goes away when a trigger signal appears.
Initial S/W Revision	Prior to A.02.00

Trig Slope

Controls the trigger polarity. It is set positive to trigger on a rising edge and negative to trigger on a falling edge.

Key Path	Trigger, Line
Remote Command	:TRIGger[:SEquence]:LINE:SLOPe POSitive NEGative :TRIGger[:SEquence]:LINE:SLOPe?
Example	TRIG:LINE:SLOP NEG
Preset	POSitive
State Saved	Saved in instrument state
Backwards Compatibility Notes	The legacy :TRIGger[:SEquence]:SLOPe command affects the slopes for the VID, LINE, EXT1, EXT2, and RFB triggers.
Initial S/W Revision	Prior to A.02.00

External 1

Pressing this key, when it is not selected, selects an external input signal as the trigger. A new sweep/measurement will start when the external trigger condition is met using the external 1 input connector on the rear panel.

Pressing this key, when it is already selected, accesses the external 1 trigger setup menu.

Key Path	Trigger
Example	TRIG:SOUR EXT1 Swept SA measurement TRIG:<meas>:SOUR EXT1 Measurements other than Swept SA
Dependencies	Grayed out if in use by Point Trigger in the Source Setup menu. Forced to Free Run if already selected and Point Trigger is set to External 1.
State Saved	Saved in instrument state
Status Bits/OPC dependencies	The Status Operation Register bit 5 "Waiting for Trigger" is set at the same time as the Sweeping or Measuring bit is set. It is cleared when the trigger actually occurs (that is, after the trigger event occurs and all the applicable trigger criteria have been met). A corresponding pop-up message ("Waiting for trigger") is generated if no trigger signal appears after approximately 2 sec. This message goes away when a trigger signal appears.
Initial S/W Revision	Prior to A.02.00

Trigger Level

Sets the value where the external 1 trigger input will trigger a new sweep/measurement.

Key Path	Trigger, External 1
Remote Command	:TRIGger[:SEquence]:EXTernal1:LEVel <level>

	:TRIGger[:SEquence]:EXTernal1:LEVel?
Example	TRIG:EXT1:LEV 0.4 V
Couplings	This same level is used for the Ext1 trigger source in the Trigger menu, for the Ext1 selection in the Periodic Timer sync source (in the Trigger menu and in the Gate Source menu), and also for the Ext1 selection in the Gate Source menu.
Preset	1.2 V
State Saved	Saved in instrument state
Min	-5 V
Max	5 V
Default Unit	V
Backwards Compatibility SCPI	:TRIGger[:SEquence]:EXTernal:LEVel For backward compatibility, the parameter EXTernal is mapped to EXTernal1
Backwards Compatibility SCPI	:TRIGger[:SEquence]:FRAMe:EXTernal1:LEVel
Initial S/W Revision	Prior to A.02.00

Trig Slope

Controls the trigger polarity. It is set positive to trigger on a rising edge and negative to trigger on a falling edge.

Key Path	Trigger, External 1
Remote Command	:TRIGger[:SEquence]:EXTernal1:SLOPe POSitive NEGative :TRIGger[:SEquence]:EXTernal1:SLOPe?
Example	TRIG:EXT1:SLOP NEG
Couplings	This same slope is used in the Ext1 selection for the trigger source in the Trigger menu and for the period timer sync source (in the Trigger menu and in the Gate Source menu).
Preset	POSitive
State Saved	Saved in instrument state
Backwards Compatibility SCPI	:TRIGger[:SEquence]:EXTernal:SLOPe For backward compatibility, the parameter EXTernal is mapped to EXTernal1
Backwards Compatibility SCPI	:TRIGger[:SEquence]:FRAMe:EXTernal1:SLOPe
Backwards Compatibility Notes	The legacy :TRIGger[:SEquence]:SLOPe command affects the slopes for the VID, LINE, EXT1, EXT2, and RFB triggers.
Initial S/W Revision	Prior to A.02.00

Zero Span Delay Comp On/Off

In zero span, there is a natural delay in the signal path, which comes from the RBW filter. This is usually desirable, as it allows you to trigger on events and also see those events, because the signal is delayed from the trigger event. However, in some cases it is desirable to eliminate this delay, so that trigger events line up exactly with the zero time point in zero span. You can use the **Zero Span Delay Comp On/Off** feature to enable or disable zero span delay compensation.

Key Path	Trigger, External 1
Remote Command	:TRIGger[:SEquence]:EXTernal1:DELay:COMPensation OFF ON 0 1 :TRIGger[:SEquence]:EXTernal1:DELay:COMPensation?
Example	TRIG:EXT1:DEL:COMP ON
Dependencies	No effect except in zero-span, but not locked out in nonzero spans. Blanked in modes that do not support zero-span measurements. If the SCPI command is sent when the key is blanked, an error is returned: -221, "Settings conflict; Feature not supported for this measurement" In analyzers shipping N9060A, this feature requires N9060A-7FP.
Preset	OFF
State Saved	Saved in instrument state
Initial S/W Revision	A.11.00

External 2

Pressing this key, when it is not selected, selects an external input signal as the trigger. A new sweep/measurement will start when the external trigger condition is met using the external 2 input connector. The external trigger 2 input connector is on the rear panel.

Pressing this key, when it is already selected, accesses the external 2 trigger setup menu.

Key Path	Trigger
Example	TRIG:SOUR EXT2 Swept SA measurement TRIG:<meas>:SOUR EXT2 Measurements other than Swept SA
Dependencies	In some models, there is no second External input. In these models, the External 2 key is blanked and the EXTernal2 parameter will generate a "Hardware missing; Not available for this model number" message. Grayed out if in use by Point Trigger in the Source Setup menu. Forced to Free Run if already selected and Point Trigger is set to External 2.
State Saved	Saved in instrument state
Status Bits/OPC dependencies	The Status Operation Register bit 5 "Waiting for Trigger" is set at the same time as the Sweeping or Measuring bit is set. It is cleared when the trigger actually occurs (that is, after the trigger event occurs and all the applicable trigger criteria have been met). A corresponding pop-up message ("Waiting for trigger") is generated if no trigger signal appears after approximately 2 sec. This message goes away when a trigger signal appears.

Initial S/W Revision	Prior to A.02.00
Modified at S/W Revision	A.03.00

Trigger Level

Sets the value where the external 2 trigger input will trigger a new sweep/measurement.

Key Path	Trigger, External 2
Remote Command	:TRIGger[:SEquence]:EXTernal2:LEVel :TRIGger[:SEquence]:EXTernal2:LEVel?
Example	TRIG:EXT2:LEV 1.1 V
Couplings	This same level is used for the Ext2 trigger source in the Trigger menu, for the Ext2 selection in the Periodic Timer sync source (in the Trigger menu and in the Gate Source menu), and also for the Ext2 selection in the Gate Source menu.
Preset	1.2 V
State Saved	Saved in instrument state
Min	-5 V
Max	5 V
Default Unit	V
Backwards Compatibility SCPI	:TRIGger[:SEquence]:FRAMe:EXTernal2:LEVel
Initial S/W Revision	Prior to A.02.00

Trig Slope

Controls the trigger polarity. It is set positive to trigger on a rising edge and negative to trigger on a falling edge.

Key Path	Trigger, External 2
Remote Command	:TRIGger[:SEquence]:EXTernal2:SLOPe POSitive NEGative :TRIGger[:SEquence]:EXTernal2:SLOPe?
Example	TRIG:EXT2:SLOP NEG
Couplings	This same slope is used in the Ext2 selection for the trigger source in the Trigger menu and for the period timer sync source (in the Trigger menu and in the Gate Source menu).
Preset	POSitive
State Saved	Saved in instrument state
Backwards Compatibility SCPI	:TRIGger[:SEquence]:FRAMe:EXTernal2:SLOPe
Backwards Compatibility Notes	The legacy :TRIGger[:SEquence]:SLOPe command affects the slopes for the VID, LINE, EXT1, EXT2, and RFB triggers.
Initial S/W Revision	Prior to A.02.00

Zero Span Delay Comp On/Off

In zero span, there is a natural delay in the signal path, which comes from the RBW filter. This is usually desirable, as it allows you to trigger on events and also see those events, because the signal is delayed from the trigger event. However, in some cases it is desirable to eliminate this delay, so that trigger events line up exactly with the zero time point in zero span. You can use the **Zero Span Delay Comp On/Off** feature to enable or disable zero span delay compensation.

Key Path	Trigger, External 2
Remote Command	:TRIGger[:SEquence]:EXTernal2:DElay:COMPensation OFF ON 0 1 :TRIGger[:SEquence]:EXTernal2:DElay:COMPensation?
Example	TRIG:EXT2:DEL:COMP ON
Dependencies	No effect except in zero-span, but not locked out in nonzero spans. Blanked in modes that do not support zero-span measurements. If the SCPI command is sent when the key is blanked, an error is returned: -221, "Settings conflict; Feature not supported for this measurement" In analyzers shipping N9060A, this feature requires N9060A-7FP.
Preset	OFF
State Saved	Saved in instrument state
Initial S/W Revision	A.11.00

RF Burst

Pressing this key, when it is not selected, selects the RF Burst as the trigger. A new sweep/measurement will start when an RF burst envelope signal is identified from the signal at the RF Input connector. Pressing this key, when it is already selected, accesses the RF Burst trigger setup menu.

In some models, a variety of burst trigger circuitry is available, resulting in various available burst trigger bandwidths. The analyzer automatically chooses the appropriate trigger path based on the hardware configuration and other settings of the analyzer.

Key Path	Trigger
Example	TRIG:SOUR RFB Swept SA measurement TRIG:<meas>:SOUR RFB Measurements other than Swept SA
State Saved	Saved in instrument state
Status Bits/OPC dependencies	The Status Operation Register bit 5 "Waiting for Trigger" is set at the same time as the Sweeping or Measuring bit is set. It is cleared when the trigger actually occurs (that is, after the trigger event occurs and all the applicable trigger criteria have been met). A corresponding pop-up message ("Waiting for trigger") is generated if no trigger signal appears after approximately 2 sec. This message goes away when a trigger signal appears.
Backwards Compatibility Notes	The legacy command: :TRIGger[:SEquence]:RFBurst:FSElectivity[:STATe] OFF ON 0 1

	is not supported in the X-Series, as the hardware to do Frequency Selective burst triggers does not exist in X-Series.
Initial S/W Revision	Prior to A.02.00
Modified at S/W Revision	A.04.00

Absolute Trigger Level

Sets the absolute trigger level for the RF burst envelope.

When using the External Mixing path, the Absolute Trigger Level is uncalibrated because the factory default was set to accommodate the expected IF levels for the RF path.

Key Path	Trigger, RF Burst
Scope	Meas Global
Remote Command	:TRIGger[:SEquence]:RFBurst:LEVel:ABSolute <ampl> :TRIGger[:SEquence]:RFBurst:LEVel:ABSolute?
Example	TRIG:RFB:LEV:ABS 10 dBm sets the trigger level of the RF burst envelope signal to the absolute level of 10 dBm
Notes	Sending this command does not switch the setting from relative to absolute; to switch it you need to send the :TRIGger[:SEquence]:RFBurst:LEVel:TYPE command, below. Amplitude Corrections are not taken into account by the Absolute Trigger Level. For example, if you have given yourself effective gain with an amplitude correction factor, the Absolute Trigger will not fire until you have set the trigger level that far below the displayed signal level, rather than simply to the displayed signal level. This is only true for Amplitude Corrections, not External Gain or Ref Level Offset functions. If mode is Bluetooth, the default value is -50 dBm.
Couplings	This same level is used for the RF Burst trigger source in the Trigger menu, for the RF Burst selection in the Periodic Timer sync source (in the Trigger menu and in the Gate Source menu), and also for the RF Burst selection in the Gate Source menu
Preset	-20 dBm
State Saved	Saved in instrument state
Min	-200 dBm
Max	100 dBm
Default Unit	depends on the current selected Y-Axis unit
Backwards Compatibility SCPI	:TRIGger[:SEquence]:FRAMe:RFBurst:LEVel:ABSolute
Initial S/W Revision	Prior to A.02.00
Modified at S/W Revision	A.04.00

Key Path	Trigger, RF Burst
Remote Command	:TRIGger[:SEquence]:RFBurst:LEVel:TYPE ABSolute RELative

	:TRIGger[:SEquence]:RFBurst:LEVel:TYPE?
Example	TRIG:RFB:LEV:TYPE REL sets the trigger level type of the RF burst trigger to Relative.
Preset	ABSolute
State Saved	Saved in instrument state
Initial S/W Revision	Prior to A.02.00
Modified at S/W Revision	A.04.00

Relative Trigger Level

Sets the relative trigger level for the RF burst envelope.

In some models, the relative burst trigger function is implemented in hardware. In other models, without the advanced triggering hardware required, the relative burst trigger function is implemented in software in some measurements, and is unavailable in other measurements.

When implemented in software, the relative RF Burst trigger function is implemented as follows:

1. The measurement starts with the absolute RF Burst trigger setting. If it cannot get a trigger with that level, auto trigger fires and the acquisition starts anyway. After the acquisition, the measurement searches for the peak in the acquired waveform and saves it.
2. Now, in the next cycle of the measurement, the measurement determines a new absolute RF Burst level based on the peak value from the first measurement and the Relative RF Burst Trigger Level (always 0 or negative dB) set by the user. The following formula is used:
3. absolute RF Burst level = peak level of the previous acquisition + relative RF Burst level
4. If the new absolute RF Burst level differs from the previous by more than 0.5 dB, the new level is sent to the hardware; otherwise it is not updated (to avoid slowing down the acquisition)

Steps 2 and 3 repeat for subsequent measurements.

Key Path	Trigger, RF Burst
Scope	Meas Global
Remote Command	:TRIGger[:SEquence]:RFBurst:LEVel:RELative <rel_ampl> :TRIGger[:SEquence]:RFBurst:LEVel:RELative?
Example	TRIG:RFB:LEV:REL -10 dB sets the trigger level of the RF burst envelope signal to the relative level of -10 dB
Notes	Sending this command does not switch the setting from absolute to relative; to switch it you need to send the :TRIGger[:SEquence]:RFBurst:LEVel:TYPE command, above. The relative trigger level is not available in some measurements. In those measurements the RELative parameter, and the :TRIGger[:SEquence]:RFBurst:LEVel:TYPE command (above), will generate an error if sent.
Dependencies	This key is grayed out and Absolute Trigger Level selected if the required hardware is not present in your analyzer and the current measurement does not support Relative triggering.

Preset	-6 dB GSM: -25 dB
State Saved	Saved in instrument state
Min	-45 dB
Max	0 dB
Default Unit	dB or dBc
Backwards Compatibility SCPI	:TRIGger[:SEquence]:RFBurst:LEVel
	This legacy command is aliased to :TRIGger[:SEquence]:RFBurst:LEVel:RELative because the PSA had ONLY relative burst triggering
Initial S/W Revision	Prior to A.02.00
Modified at S/W Revision	A.04.00

Trigger Slope

It is set positive to trigger on a rising edge and negative to trigger on a falling edge.

Key Path	Trigger, RF Burst
Remote Command	:TRIGger[:SEquence]:RFBurst:SLOPe POSitive NEGative :TRIGger[:SEquence]:RFBurst:SLOPe?
Example	TRIG:RFB:SLOP NEG
Couplings	This same slope is used in the RF Burst selection for the trigger source in the Trigger menu and for the period timer sync source (in the Trigger menu and in the Gate Source menu).
Preset	POSitive
State Saved	Saved in instrument state
Backwards Compatibility SCPI	:TRIGger[:SEquence]:FRAME:RFBurst:SLOPe
Backwards Compatibility Notes	The legacy :TRIGger[:SEquence]:SLOPe command affects the slopes for the VID, LINE, EXT1, EXT2, and RFB triggers.
Initial S/W Revision	Prior to A.02.00

Periodic Timer (Frame Trigger)

Pressing this key, when it is not selected, selects the internal periodic timer signal as the trigger. Triggering occurrences are set by the **Period** parameter, which is modified by the **Sync Source** and **Offset**. Pressing this key, when it is already selected, accesses the periodic timer trigger setup functions.

If you do not have a sync source selected (it is Off), then the internal timer will not be synchronized with any external timing events.

Key Path	Trigger
Example	TRIG:SOUR FRAM Swept SA measurement

	TRIG:<meas>:SOUR FRAM Measurements other than Swept SA
State Saved	Saved in instrument state
Readback	[Sync: <value of Sync Source>], for example, [Sync: External 1]
Status Bits/OPC dependencies	The Status Operation Register bit 5 "Waiting for Trigger" is set at the same time as the Sweeping or Measuring bit is set. It is cleared when the trigger actually occurs (that is, after the trigger event occurs and all the applicable trigger criteria have been met). A corresponding pop-up message ("Waiting for trigger") is generated if no trigger signal appears after approximately 2 sec. This message goes away when a trigger signal appears.
Initial S/W Revision	Prior to A.02.00

Periodic Timer Triggering:

This feature selects the internal periodic timer signal as the trigger. Trigger occurrences are set by the **Periodic Timer** parameter, which is modified by the **Sync Source** and **Offset**.

The figure below shows the action of the periodic timer trigger. Before reviewing the figure, we'll explain some uses for the periodic trigger.

A common application is measuring periodic burst RF signals for which a trigger signal is not easily available. For example, we might be measuring a TDMA radio which bursts every 20 ms. Let's assume that the 20 ms period is very consistent. Let's also assume that we do not have an external trigger source available that is synchronized with the period, and that the signal-to-noise ratio of the signal is not high enough to provide a clean RF burst trigger at all of the analysis frequencies. For example, we might want to measure spurious transmissions at an offset from the carrier that is larger than the bandwidth of the RF burst trigger. In this application, we can set the Periodic Timer to a 20.00 ms period and adjust the offset from that timer to position our trigger just where we want it. If we find that the 20.00 ms is not exactly right, we can adjust the period slightly to minimize the drift between the period timer and the signal to be measured.

A second way to use this feature would be to use **Sync Source** temporarily, instead of **Offset**. In this case, we might tune to the signal in a narrow span and use the RF Burst trigger to synchronize the periodic timer. Then we would turn the sync source off so that it would not miss-trigger. Miss-triggering can occur when we are tuned so far away from the RF burst trigger that it is no longer reliable.

A third example would be to synchronize to a signal that has a reference time element of much longer period than the period of interest. In some CDMA applications, it is useful to look at signals with a short periodicity, by synchronizing that periodicity to the "even-second clock" edge that happens every two seconds. Thus, we could connect the even-second clock trigger to Ext1 and use then Ext1 as the sync source for the periodic timer.

The figure below illustrates this third example. The top trace represents the even-second clock. It causes the periodic timer to synchronize with the leading edge shown. The analyzer trigger occurs at a time delayed by the accumulated offset from the period trigger event. The periodic timer continues to run, and triggers continue to occur, with a periodicity determined by the analyzer time base. The timer output (labeled "late event") will drift away from its ideal time due to imperfect matching between the time base of the signal being measured and the time base of the analyzer, and also because of imperfect setting of the

period parameter. But the synchronization is restored on the next even-second clock event. ("Accumulated offset" is described in the in the **Offset** function section.)

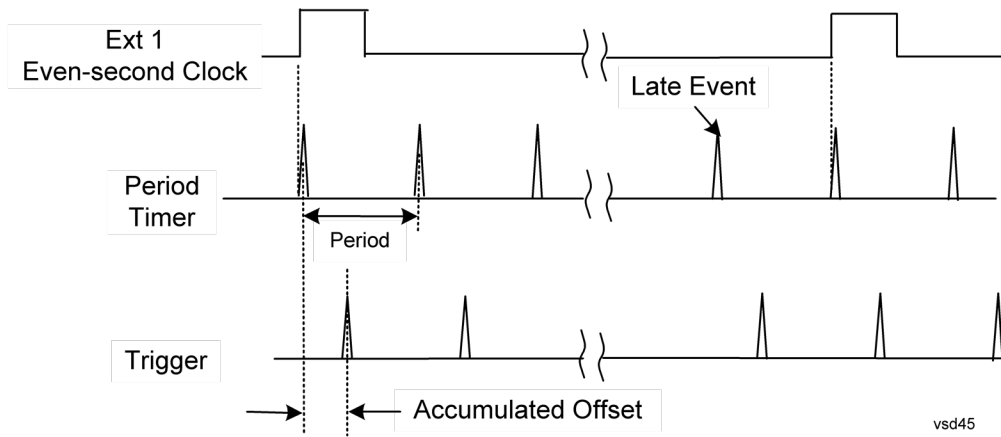

Period

Sets the period of the internal periodic timer clock. For digital communications signals, this is usually set to the frame period of your current input signal. In the case that sync source is not set to OFF, and the external sync source rate is changed for some reason, the periodic timer is synchronized at the every external synchronization pulse by resetting the internal state of the timer circuit.

Key Path	Trigger, Periodic Timer
Remote Command	:TRIGger[:SEquence]:FRAMe:PERiod <time> :TRIGger[:SEquence]:FRAMe:PERiod?
Example	TRIG:FRAM:PER 100 ms
Dependencies	The invalid data indicator turns on when the period is changed, until the next sweep/measurement completes.
Couplings	The same period is used in the Gate Source selection of the period timer.
Preset	20 ms GSM: 4.615383
State Saved	Saved in instrument state
Min	100.000 ns
Max	559.0000 ms
Default Unit	S
Initial S/W Revision	Prior to A.02.00

Offset

Adjusts the accumulated offset between the periodic timer events and the trigger event. Adjusting the accumulated offset is different than setting an offset, and requires explanation.

The periodic timer is usually not synchronized with any external events, so the timing of its output events has no absolute meaning. Since the timing relative to external events (RF signals) is important, you need to

be able to adjust (offset) it. However, you have no direct way to see when the periodic timer events occur. All that you can see is the trigger timing. When you want to adjust the trigger timing, you will be changing the internal offset between the periodic timer events and the trigger event. Because the absolute value of that internal offset is unknown, we will just call that the accumulated offset. Whenever the Offset parameter is changed, you are changing that accumulated offset. You can reset the displayed offset using Reset Offset Display. Changing the display does not change the value of the accumulated offset, and you can still make additional changes to accumulated offset.

To avoid ambiguity, we define that an increase in the "offset" parameter, either from the knob or the SCPI adjust command, serves to delay the timing of the trigger event.

Key Path	Trigger, Periodic Timer
Remote Command	:TRIGger[:SEquence]:FRAMe:OFFSet <time> :TRIGger[:SEquence]:FRAMe:OFFSet?
Example	TRIG:FRAM:OFFS 1.2 ms
Notes	<p>The front panel interface (for example, the knob), and this command, adjust the accumulated offset, which is shown on the active function display. However, the actual amount sent to the hardware each time the offset is updated is the delta value, that is, the current accumulated offset value minus the previous accumulated offset value. Note that the accumulated offset value is essentially arbitrary; it represents the accumulated offset from the last time the offset was zeroed (with the Reset Offset Display key).</p> <p>Note that this command does not change the period of the trigger waveform. Note also that Offset is used only when the sync source is set to OFF, otherwise delay is used, see section "Trig Delay" on page 476.</p> <p>An increase in the "offset" parameter, either from the knob or the SCPI adjust command, serves to delay the timing of the trigger event.</p>
Notes	<p>When the SCPI command is sent the value shown on the key (and the Active Function, if this happens to be the active function) is updated with the new value. However, the actual amount sent to the hardware is the delta value, that is, the current accumulated offset value minus the previous accumulated offset value.</p> <p>The SCPI query simply returns the value currently showing on the key.</p>
Dependencies	The invalid data indicator turns on when the offset is changed, until the next sweep/measurement completes.
Couplings	The same offset is used in the Gate Source selection of the period timer.
Preset	0 s
State Saved	Saved in instrument state
Min	-10.000 s
Max	10.000 s
Default Unit	S
Initial S/W Revision	Prior to A.02.00

Offset Adjust (Remote Command Only)

This remote command does not work at all like the related front panel keys. This command lets you advance the phase of the frame trigger by the amount you specify.

It does not change the period of the trigger waveform. If the command is sent multiple times, it advances the phase of the frame trigger an additional amount each time it is sent. Negative numbers are permitted.

Remote Command	:TRIGger[:SEquence]:FRAMe:ADJust <time>
Example	TRIG:FRAM:ADJ 1.2 ms
Notes	Note also that Offset is used only when the sync source is set to OFF, otherwise delay is used, see section "Trig Delay" on page 476 An increase in the "offset" parameter, either from the knob or the SCPI adjust command, serves to delay the timing of the trigger event.
Notes	The front panel interface (for example, the knob) and the :TRIG:FRAM:OFFS command adjust the accumulated offset, which is shown on the active function display. However, the actual amount sent to the hardware is the delta value, that is, the current offset value minus the previous offset value. When the SCPI command is sent the value shown on the key (and the Active Function, if this happens to be the active function) is updated by increasing it (or decreasing it if the value sent is negative) by the amount specified in the SCPI command. This is a "command only" SCPI command, with no query.
Dependencies	The invalid data indicator turns on when the offset is changed, until the next sweep/measurement completes.
Couplings	The same offset is used in the Gate Source selection of the period timer.
Preset	0 s
State Saved	Saved in instrument state
Min	-10.000 s
Max	10.000 s
Default Unit	S
Initial S/W Revision	Prior to A.02.00

Reset Offset Display

Resets the value of the periodic trigger offset display setting to 0.0 seconds. The current displayed trigger location may include an offset value defined with the **Offset** key. Pressing this key redefines the currently displayed trigger location as the new trigger point that is 0.0 s offset. The **Offset** key can then be used to add offset relative to this new timing.

Key Path	Trigger, Periodic Timer
Remote Command	:TRIGger[:SEquence]:FRAMe:OFFSet:DISPlay:RESet
Example	TRIG:FRAM:OFFS:DISP:RES
Initial S/W Revision	Prior to A.02.00

Sync Source

Selects a signal source for you to synchronize your periodic timer trigger to, otherwise you are triggering at some arbitrary location in the frame. Synchronization reduces the precision requirements on the setting of the period.

For convenience you may adjust the level and slope of the selected sync source in a conditional branch setup menu accessed from the Sync Source menu. Note that these settings match those in the **Trigger** and **Gate Source** menus; that is, each trigger source has only one value of level and slope, regardless of which menu it is accessed from.

Key Path	Trigger, Periodic Timer
Remote Command	:TRIGger[:SEquence]:FRAMe:SYNC EXTernal1 EXTernal2 RFBurst OFF :TRIGger[:SEquence]:FRAMe:SYNC?
Example	TRIG:FRAM:SYNC EXT2
Dependencies	In some models, there is no second External input. In these models, the External 2 key is blanked and the EXTERNAL2 parameter will generate a "Hardware missing; Not available for this model number" message.
Preset	Off GSM/EDGE, MSR,LTE,LTETDD: RFBurst
State Saved	Saved in instrument state
Readback	The current setting is read back to this key and it is also Readback to the previous Periodic Timer trigger key.
Backwards Compatibility SCPI	:TRIGger[:SEquence]:FRAMe:SYNC EXTernal For backward compatibility, the parameter EXTernal is mapped to EXTernal1
Initial S/W Revision	Prior to A.02.00
Modified at S/W Revision	A.03.00, A.14.00

Off

Turns off the sync source for your periodic trigger. With the sync source off, the timing will drift unless the signal source frequency is locked to the analyzer frequency reference.

Key Path	Trigger, Periodic Timer, Sync Source
Example	TRIG:FRAM:SYNC OFF
Readback	Off
Initial S/W Revision	Prior to A.02.00

External 1

Pressing this key, when it is not selected, selects an external input signal as the trigger. A new sweep/measurement will start when the external trigger condition is met using the external 1 input connector on the rear panel.

Pressing this key, when it is already selected, accesses the external 1 trigger setup menu.

Key Path	Trigger
Example	TRIG:SOUR EXT1 Swept SA measurement

	TRIG:<meas>:SOUR EXT1 Measurements other than Swept SA
Dependencies	Grayed out if in use by Point Trigger in the Source Setup menu. Forced to Free Run if already selected and Point Trigger is set to External 1.
State Saved	Saved in instrument state
Status Bits/OPC dependencies	The Status Operation Register bit 5 "Waiting for Trigger" is set at the same time as the Sweeping or Measuring bit is set. It is cleared when the trigger actually occurs (that is, after the trigger event occurs and all the applicable trigger criteria have been met). A corresponding pop-up message ("Waiting for trigger") is generated if no trigger signal appears after approximately 2 sec. This message goes away when a trigger signal appears.
Initial S/W Revision	Prior to A.02.00

Trigger Level

Sets the value where the external 1 trigger input will trigger a new sweep/measurement.

Key Path	Trigger, External 1
Remote Command	:TRIGger[:SEquence]:EXTernal1:LEVel <level> :TRIGger[:SEquence]:EXTernal1:LEVel?
Example	TRIG:EXT1:LEV 0.4 V
Couplings	This same level is used for the Ext1 trigger source in the Trigger menu, for the Ext1 selection in the Periodic Timer sync source (in the Trigger menu and in the Gate Source menu), and also for the Ext1 selection in the Gate Source menu.
Preset	1.2 V
State Saved	Saved in instrument state
Min	-5 V
Max	5 V
Default Unit	V
Backwards Compatibility SCPI	:TRIGger[:SEquence]:EXTernal:LEVel For backward compatibility, the parameter EXTernal is mapped to EXTernal1
Backwards Compatibility SCPI	:TRIGger[:SEquence]:FRAMe:EXTernal1:LEVel
Initial S/W Revision	Prior to A.02.00

Trig Slope

Controls the trigger polarity. It is set positive to trigger on a rising edge and negative to trigger on a falling edge.

Key Path	Trigger, External 1
Remote Command	:TRIGger[:SEquence]:EXTernal1:SLOPe POSitive NEGative

	:TRIGger[:SEquence]:EXTernal1:SLOPe?
Example	TRIG:EXT1:SLOP NEG
Couplings	This same slope is used in the Ext1 selection for the trigger source in the Trigger menu and for the period timer sync source (in the Trigger menu and in the Gate Source menu).
Preset	POSitive
State Saved	Saved in instrument state
Backwards Compatibility SCPI	:TRIGger[:SEquence]:EXTernal:SLOPe For backward compatibility, the parameter EXTernal is mapped to EXTernal1
Backwards Compatibility SCPI	:TRIGger[:SEquence]:FRAMe:EXTernal1:SLOPe
Backwards Compatibility Notes	The legacy :TRIGger[:SEquence]:SLOPe command affects the slopes for the VID, LINE, EXT1, EXT2, and RFB triggers.
Initial S/W Revision	Prior to A.02.00

External 2

Pressing this key, when it is not selected, selects an external input signal as the trigger. A new sweep/measurement will start when the external trigger condition is met using the external 2 input connector. The external trigger 2 input connector is on the rear panel.

Pressing this key, when it is already selected, accesses the external 2 trigger setup menu.

Key Path	Trigger
Example	TRIG:SOUR EXT2 Swept SA measurement TRIG:<meas>:SOUR EXT2 Measurements other than Swept SA
Dependencies	In some models, there is no second External input. In these models, the External 2 key is blanked and the EXTernal2 parameter will generate a "Hardware missing; Not available for this model number" message. Grayed out if in use by Point Trigger in the Source Setup menu. Forced to Free Run if already selected and Point Trigger is set to External 2.
State Saved	Saved in instrument state
Status Bits/OPC dependencies	The Status Operation Register bit 5 "Waiting for Trigger" is set at the same time as the Sweeping or Measuring bit is set. It is cleared when the trigger actually occurs (that is, after the trigger event occurs and all the applicable trigger criteria have been met). A corresponding pop-up message ("Waiting for trigger") is generated if no trigger signal appears after approximately 2 sec. This message goes away when a trigger signal appears.
Initial S/W Revision	Prior to A.02.00
Modified at S/W Revision	A.03.00

Trigger Level

Sets the value where the external 2 trigger input will trigger a new sweep/measurement.

Key Path	Trigger, External 2
Remote Command	:TRIGger[:SEquence]:EXTernal2:LEVel :TRIGger[:SEquence]:EXTernal2:LEVel?
Example	TRIG:EXT2:LEV 1.1 V
Couplings	This same level is used for the Ext2 trigger source in the Trigger menu, for the Ext2 selection in the Periodic Timer sync source (in the Trigger menu and in the Gate Source menu), and also for the Ext2 selection in the Gate Source menu.
Preset	1.2 V
State Saved	Saved in instrument state
Min	-5 V
Max	5 V
Default Unit	V
Backwards Compatibility SCPI	:TRIGger[:SEquence]:FRAMe:EXTernal2:LEVel
Initial S/W Revision	Prior to A.02.00

Trig Slope

Controls the trigger polarity. It is set positive to trigger on a rising edge and negative to trigger on a falling edge.

Key Path	Trigger, External 2
Remote Command	:TRIGger[:SEquence]:EXTernal2:SLOPe POSitive NEGative :TRIGger[:SEquence]:EXTernal2:SLOPe?
Example	TRIG:EXT2:SLOP NEG
Couplings	This same slope is used in the Ext2 selection for the trigger source in the Trigger menu and for the period timer sync source (in the Trigger menu and in the Gate Source menu).
Preset	POSitive
State Saved	Saved in instrument state
Backwards Compatibility SCPI	:TRIGger[:SEquence]:FRAMe:EXTernal2:SLOPe
Backwards Compatibility Notes	The legacy :TRIGger[:SEquence]:SLOPe command affects the slopes for the VID, LINE, EXT1, EXT2, and RFB triggers.
Initial S/W Revision	Prior to A.02.00

RF Burst

Pressing this key, when it is not selected, selects the RF Burst as the trigger. A new sweep/measurement will start when an RF burst envelope signal is identified from the signal at the RF Input connector. Pressing this key, when it is already selected, accesses the RF Burst trigger setup menu.

In some models, a variety of burst trigger circuitry is available, resulting in various available burst trigger bandwidths. The analyzer automatically chooses the appropriate trigger path based on the hardware configuration and other settings of the analyzer.

Key Path	Trigger
Example	TRIG:SOUR RFB Swept SA measurement TRIG:<meas>:SOUR RFB Measurements other than Swept SA
State Saved	Saved in instrument state
Status Bits/OPC dependencies	The Status Operation Register bit 5 "Waiting for Trigger" is set at the same time as the Sweeping or Measuring bit is set. It is cleared when the trigger actually occurs (that is, after the trigger event occurs and all the applicable trigger criteria have been met). A corresponding pop-up message ("Waiting for trigger") is generated if no trigger signal appears after approximately 2 sec. This message goes away when a trigger signal appears.
Backwards Compatibility Notes	The legacy command: :TRIGger[:SEQuence]:RFBurst:FSElectivity[:STATe] OFF ON 0 1 is not supported in the X-Series, as the hardware to do Frequency Selective burst triggers does not exist in X-Series.
Initial S/W Revision	Prior to A.02.00
Modified at S/W Revision	A.04.00

Absolute Trigger Level

Sets the absolute trigger level for the RF burst envelope.

When using the External Mixing path, the Absolute Trigger Level is uncalibrated because the factory default was set to accommodate the expected IF levels for the RF path.

Key Path	Trigger, RF Burst
Scope	Meas Global
Remote Command	:TRIGger[:SEQuence]:RFBurst:LEVel:ABSolute <ampl> :TRIGger[:SEQuence]:RFBurst:LEVel:ABSolute?
Example	TRIG:RFB:LEV:ABS 10 dBm sets the trigger level of the RF burst envelope signal to the absolute level of 10 dBm
Notes	Sending this command does not switch the setting from relative to absolute; to switch it you need to send the :TRIGger[:SEQuence]:RFBurst:LEVel:TYPE command, below. Amplitude Corrections are not taken into account by the Absolute Trigger Level. For example, if you have given yourself effective gain with an amplitude correction factor, the Absolute Trigger will not fire until you have set the trigger level that far below the displayed signal level, rather than simply to the displayed signal level. This is only true for Amplitude Corrections, not External Gain or Ref Level Offset functions. If mode is Bluetooth, the default value is -50 dBm.
Couplings	This same level is used for the RF Burst trigger source in the Trigger menu, for the RF Burst selection in the Periodic Timer sync source (in the Trigger menu and in the Gate Source menu), and also for the

	RF Burst selection in the Gate Source menu
Preset	-20 dBm
State Saved	Saved in instrument state
Min	-200 dBm
Max	100 dBm
Default Unit	depends on the current selected Y-Axis unit
Backwards Compatibility SCPI	:TRIGger[:SEquence]:FRAMe:RFBurst:LEVel:ABSolute
Initial S/W Revision	Prior to A.02.00
Modified at S/W Revision	A.04.00

Key Path	Trigger, RF Burst
Remote Command	:TRIGger[:SEquence]:RFBurst:LEVel:TYPE ABSolute RELative :TRIGger[:SEquence]:RFBurst:LEVel:TYPE?
Example	TRIG:RFB:LEV:TYPE REL sets the trigger level type of the RF burst trigger to Relative.
Preset	ABSolute
State Saved	Saved in instrument state
Initial S/W Revision	Prior to A.02.00
Modified at S/W Revision	A.04.00

Trigger Slope

It is set positive to trigger on a rising edge and negative to trigger on a falling edge.

Key Path	Trigger, RF Burst
Remote Command	:TRIGger[:SEquence]:RFBurst:SLOPe POSitive NEGative :TRIGger[:SEquence]:RFBurst:SLOPe?
Example	TRIG:RFB:SLOP NEG
Couplings	This same slope is used in the RF Burst selection for the trigger source in the Trigger menu and for the period timer sync source (in the Trigger menu and in the Gate Source menu).
Preset	POSitive
State Saved	Saved in instrument state
Backwards Compatibility SCPI	:TRIGger[:SEquence]:FRAMe:RFBurst:SLOPe
Backwards Compatibility Notes	The legacy :TRIGger[:SEquence]:SLOPe command affects the slopes for the VID, LINE, EXT1, EXT2, and RFB triggers.
Initial S/W Revision	Prior to A.02.00

Sync Holdoff

Sync Holdoff specifies the duration that the sync source signal must be kept false before the transition to true to be recognized as the sync timing. The periodic timer phase is aligned when the sync source signal becomes true, after the Holdoff time is satisfied.

A holdoff of 2 ms will work with most WiMAX signals, but there may be cases where the burst off duration is less than 1 ms and this value will need to be changed.

Key Path	Trigger, Periodic Timer
Remote Command	:TRIGger[:SEquence]:FRAMe:SYNC:HOLDoff <time> :TRIGger[:SEquence]:FRAMe:SYNC:HOLDoff? :TRIGger[:SEquence]:FRAMe:SYNC:HOLDoff:STATe OFF ON 0 1 :TRIGger[:SEquence]:FRAMe:SYNC:HOLDoff:STATe?
Preset	On, 1.000 ms
State Saved	Saved in instrument state
Min	0 ms
Max	+500 ms
Default Unit	s
Initial S/W Revision	Prior to A.02.00

Aux IO Control (Remote Command Only)

Sets/Queries the value for all 8 data lines.

Key Path	SCPI only
Remote Command	OUTPut:AUX:IO <Value> OUTPut:AUX:IO?
Example	OUTPut:AUX:IO 31
Couplings	State of data 0 to data 7 under the AUX I/O Control panel (Input/Output menu) will change accordingly base on the AUX IO's value that key in.
Preset	31
Min	0
Max	255
Backwards Compatibility SCPI	OUTPut:UPORt <Value>
Initial S/W Revision	A.16.00

Control Edge/Level

Sets the method of controlling the gating function from the gating signal.

Edge

In Edge triggering, the gate opens (after the Delay) on the selected edge (for example, positive) of the gate signal and closes on the alternate edge (for example, negative).

Level

In Level triggering, the gate opens (after the Delay) when the gate signal has achieved a certain level and stays open as long as that level is maintained.

Key Path	Sweep/Control, Gate
Remote Command	[:SENSe] :SWEep:EGATe:CONTRol EDGE LEVEl [:SENSe] :SWEep:EGATe:CONTRol?
Example	SWE:EGAT:CONT EDGE
Dependencies	If the Gate Method is FFT the Control key is grayed out and Edge is selected. If the Gate Source is TV, Frame or Line, the Control key is grayed out and Edge is selected.
Preset	EDGE
State Saved	Saved in instrument state
Backwards Compatibility SCPI	[:SENSe] :SWEep:TIME:GATE:TYPE ESA Compatibility
Initial S/W Revision	Prior to A.02.00

Gate Holdoff

Lets you increase or decrease the wait time after a gate event ends before the analyzer will respond to the next gate signal.

After any Gate event finishes, the analyzer must wait for the sweep system to settle before it can respond to another Gate signal. The analyzer calculates a "wait time," taking into account a number of factors, including RBW and Phase Noise Optimization settings. The goal is to achieve the same accuracy when gated as in ungated operation. The figure below illustrates this concept:

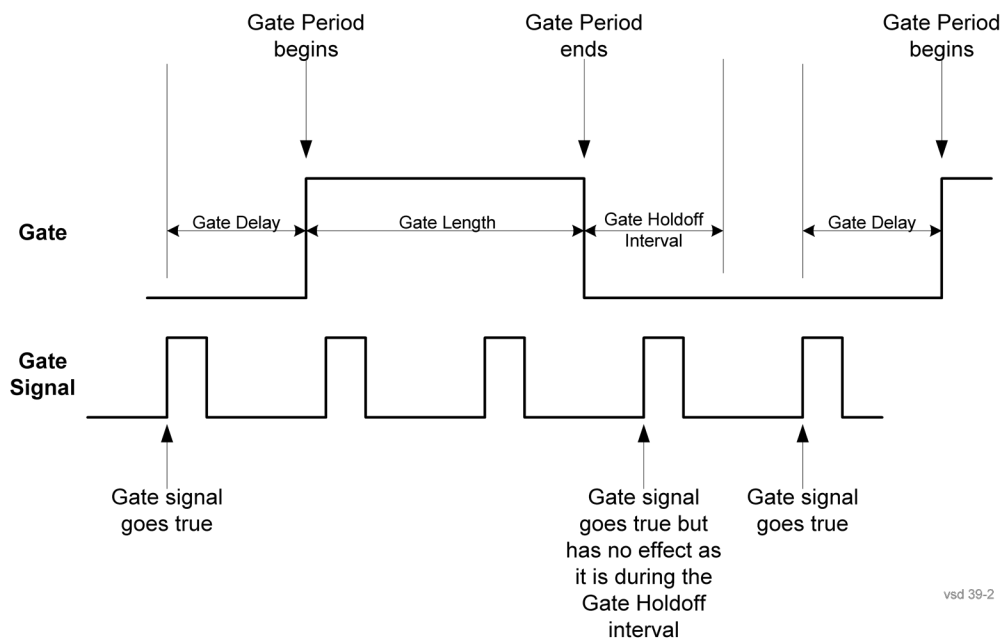

vsd 39-2

When Gate Holdoff is in Auto, the wait time calculated by the analyzer is used. When Gate Time is in Manual, the user may adjust the wait time, usually decreasing it in order to achieve greater speed, but at the risk of decreasing accuracy.

When the **Method** key is set to **Video** or **FFT**, the **Gate Holdoff** function has no effect.

In measurements that do not support Auto, the value shown when Auto is selected is “---“ and the manually set holdoff is returned to a query.

Key Path	Sweep/Control, Gate
Remote Command	[:SENSe]:SWEep:EGATe:HOLDoff <time> [:SENSe]:SWEep:EGATe:HOLDoff? [:SENSe]:SWEep:EGATe:HOLDoff:AUTO OFF ON 0 1 [:SENSe]:SWEep:EGATe:HOLDoff:AUTO?
Example	SWE:EGAT:HOLD 0.0002 SWE:EGAT:HOLD? SWE:EGAT:HOLD:AUTO ON SWE:EGAT:HOLD:AUTO?
Couplings	When Gate Holdoff is Auto , the Gate Holdoff key shows the value calculated by the analyzer for the wait time. Pressing the Gate Holdoff key while it is in Auto and not selected, causes the key to become selected and allows the user to adjust the value. If the value is adjusted, the setting changes to Man . Pressing the Gate Holdoff key, while it is in Auto and selected, does not change the value of Gate Holdoff , but causes the setting to change to Man . Now the user can adjust the value. Pressing the key while it is in Man and selected, cause the value to change back to Auto . Pressing the key while it is in Man and not selected, causes the key to become selected and allows the user to adjust the value. When Method is set to Video or FFT , the Gate Holdoff function has no effect.
Preset	Auto Auto/On
State Saved	Saved in instrument state
Min	1 μsec
Max	1 sec
Initial S/W Revision	Prior to A.02.00

Gate Delay Compensation

This function allows you to select an RBW-dependent value by which to adjust the gate delay, to compensate for changes in the delay caused by RBW effects.

You can select between uncompensated operation and two types of compensation, **Delay Until RBW Settled** and **Compensate for RBW Group Delay**.

See ["More Information" on page 1693](#)

Key Path	Sweep/Control, Gate
Scope	Meas Global
Remote Command	[:SENSe] :SWEep:EGATe:DELaY:COMPensation:TYPE OFF SETTled GDELaY [:SENSe] :SWEep:EGATe:DELaY:COMPensation:TYPE?
Example	SWE:EGAT:DEL:COMP:TYPE SETT SWE:EGAT:DEL:COMP:TYPE?
Notes	<p>Although this function is Meas Global, there are some measurements that do not support this function. In those measurements the operation will be Uncompensated. Going into one of those measurements will not change the Meas Global selection; it will simply display the grayed-out menu key with “Uncompensated” showing as the selection. This is a non-forceful grayout, so the SCPI command is still accepted.</p> <p>If Gate Delay Compensation is not supported at all within a particular mode, the key is not displayed, and if the SCPI command is sent while in a measurement within that mode, an “Undefined Header” message is generated.</p> <p>Measurements that do not support this function include: Swept SA</p>
Preset	TD-SCDMA mode: Compensate for RBW Group Delay All other modes: Delay Until RBW Settled
State Saved	Saved in instrument state
Range	Uncompensated Delay Until RBW Settled Compensate for RBW Group Delay
Readback text	Uncompensated Settled Group Delay
Initial S/W Revision	Prior to A.02.00
Modified at S/W Revision	A.11.0

More Information

Selecting **Uncompensated** means that the actual gate delay is as you sets it.

Selecting **Delay Until RBW Settled** causes the gate delay to be increased above the user setting by an amount equal to $3.06/\text{RBW}$. This compensated delay causes the GATE START and GATE STOP lines on the display to move by the compensation amount, and the actual hardware gate delay to be increased by the same amount. All the other gate lines (for example, MIN FAST) are unaffected. If the RBW subsequently changes, the compensation is readjusted for the new RBW. The value shown on the **Gate Delay** key does NOT change.

Delay Until RBW Settled allows excellent measurements of gated signals, by allowing the IF to settle following any transient that affects the burst. Excellent measurements also require that the analysis region not extend into the region affected by the falling edge of the burst. Thus, excellent measurements can only be made over a width that declines with narrowing RBWs, which is achieved by decreasing the gate length below the user setting by an amount equal to $2.53/\text{RBW}$. Therefore, for general purpose compensation, you will still want to change the gate length with changes in RBW even if the gate delay is compensated. The compensated Gate Length is limited by the analyzer so that it will never go below 10% of the value shown on the Gate Length key, as otherwise the sweep times could get very long. Anytime

the **Gate Length and RBW** values combine in such a way that this limiting takes place, a warning is displayed. For measurements which contain multiple sweeps with different RBW like SEM and SPUR, the smallest RBW is used for this limiting.

Selecting **Compensate for RBW Group Delay** causes the gate delay to be increased above the user setting by an amount equal to $1.81/\text{RBW}$. This compensated delay causes the GATE START, GATE STOP lines on the display to move by the compensation amount, and the actual hardware gate delay to be increased by the same amount. All the other gate lines (for example, MIN FAST) are unaffected. If the RBW subsequently changes, the compensation is readjusted for the new RBW. The value shown on the **Gate Delay** key does NOT change. **Compensate for RBW Group Delay** also includes gate length compensation; the gate length itself is adjusted as necessary to attempt to compensate for delay effects imposed by the RBW.

Compensate for RBW Group Delay is similar to **Delay Until RBW Settled**, but compensates for the group delay of the RBW filter, rather than the filter settling time. As the RBW gets narrow, this can allow the settling tail of the RBW to affect the beginning part of the gated measurement, and allow the beginning of the RBW settling transient to affect the end of the gated measurement. These two effects are symmetric because the RBW response is symmetric. Because the gate length is not automatically compensated, some users might find this compensation to be more intuitive than compensation for RBW settling.

Min Fast Position Query (Remote Command Only)

This command queries the position of the MIN FAST line, relative to the delay reference (REF) line. See section "[Gate View On/Off](#)" on page 2228. If this query is sent while not in gate view, the MinFast calculation is performed based on the current values of the appropriate parameters and the result is returned. Knowing this value lets you set an optimal gate delay value for the current measurement setup.

Remote Command	<code>[:SENSe] :SWEep:EGATe:MINFast?</code>
Example	<code>SWE:EGAT:MIN?</code>
Initial S/W Revision	Prior to A.02.00

Gate Preset (Remote Command Only)

Presets the time-gated spectrum analysis capability.

This command sets gate parameter values to the ESA preset values, as follows:

Gate trigger type = edge

Gate polarity = positive

Gate delay = 1 us

Gate length = 1 us

Remote Command	<code>[:SENSe];SWEep:TIME:GATE:PRESet</code> ESA Compatibility
Initial S/W Revision	Prior to A.02.00

Gate Level (Remote Command Only)

Sets the gate input transition point level for the external TRIGGER inputs on the front and rear panel. This is a legacy command for PSA compatibility. It is simply an alias to the equivalent trigger level command.

Remote Command	<code>[:SENSe] :SWEep:EGATe:EXTeRnal [1] 2:LEVel <voltage></code> <code>[:SENSe] :SWEep:EGATe:EXTeRnal [1] 2:LEVel?</code>
Notes	This command is simply an alias to <code>:TRIGger[:SEQuence]:EXTeRnal[1]2:LEVel</code> For details refer
Initial S/W Revision	Prior to A.02.00

Gate Polarity (Remote Command Only)

Sets the polarity for the gate signal. This setup is now done using the gate trigger's slope setting.

When Positive (Pos) is selected, a positive-going edge (Edge) or a high voltage (Level) will satisfy the gate condition, after the delay set with the Gate Delay key. When Negative (Neg) is selected, a negative-going edge (Edge) or a low voltage (Level) will satisfy the gate condition after the delay.

Remote Command	<code>[:SENSe] :SWEep:EGATe:POLarity NEGative POSitive</code> <code>[:SENSe] :SWEep:EGATe:POLarity?</code>
Example	<code>SWE:EGAT:POL NEG</code> <code>SWE:EGAT:POL?</code>
Preset	POSitive
State Saved	Saved in instrument state
Backwards Compatibility SCPI	<code>[:SENSe] :SWEep:TIME:GATE:POLarity</code> ESA compatibility
Initial S/W Revision	Prior to A.02.00

Remote Command	<code>[:SENSe] :SWEep:TIME:GATE:LEVel HIGH LOW</code> <code>[:SENSe] :SWEep:TIME:GATE:LEVel?</code> ESA compatibility
Preset	HIGH
Initial S/W Revision	Prior to A.02.00

Gate

Accesses a menu that enables you to control the gating function.

The Gate functionality is used to view signals best viewed by qualifying them with other events. See "[Gate](#)" on page 2227 for more details.

12 Spurious Emissions Measurement
Sweep/Control

Key Path	Sweep/Control
Initial S/W Revision	A.03.00

System

See "System" on page 368

Trace/Detector

Trace/Detector is unavailable in the Spurious Emissions measurement. When pressed, this key displays a blank menu.

Key Path	Front-panel key
Initial S/W Revision	Prior to A.02.00

Trigger

See ["Trigger" on page 444](#)

Free Run

See ["Free Run " on page 451](#)

Video

See ["Video \(IF Envelope\) " on page 452](#)

Trigger Level

See ["Trigger Level " on page 452](#)

Trig Slope

See ["Trig Slope " on page 453](#)

Trig Delay

See ["Trig Delay " on page 454](#)

Line

See ["Line " on page 2235](#)

Trig Slope

See ["Trig Slope " on page 2235](#)

Trig Delay

See ["Trig Delay " on page 456](#)

External 1

See ["External 1 " on page 2248](#)

Trigger Level

See ["Trigger Level " on page 2248](#)

Trig Slope

See ["Trig Slope " on page 2249](#)

Trig Delay

See ["Trig Delay " on page 459](#)

Zero Span Delay Comp

See ["Zero Span Delay Comp On/Off" on page 2237](#)

External 2

See ["External 2 "](#) on page 2250

Trigger Level

See ["Trigger Level "](#) on page 2250

Trig Slope

See ["Trig Slope "](#) on page 2251

Trig Delay

See ["Trig Delay "](#) on page 461

Zero Span Delay Comp

See ["Zero Span Delay Comp On/Off"](#) on page 2239

RF Burst

See ["RF Burst "](#) on page 2251

Absolute Trigger

See ["Absolute Trigger Level"](#) on page 2252

Relative Trigger

See ["Relative Trigger Level"](#) on page 2241

Trig Slope

See ["Trigger Slope "](#) on page 2253

Trig Delay

See ["Trig Delay "](#) on page 466

Periodic Timer

See ["Periodic Timer \(Frame Trigger\) "](#) on page 2243

Period

See ["Period "](#) on page 2244

Offset

See ["Offset "](#) on page 2245

Reset Offset Display

See ["Reset Offset Display "](#) on page 2247

Sync Source

See "Sync Source " on page 2247

Off

See "Off " on page 2248

External 1

See "External 1 " on page 2248

Trigger Level

See "Trigger Level " on page 2248

Trig Slope

See "Trig Slope " on page 2249

External 2

See "External 2 " on page 2250

Trigger Level

See "Trigger Level " on page 2250

Trig Slope

See "Trig Slope " on page 2251

RF Burst

See "RF Burst " on page 2251

Absolute Trigger

See "Absolute Trigger Level" on page 2252

Trig Slope

See "Trigger Slope " on page 2253

Trig Delay

See "Trig Delay" on page 476

Auto/Holdoff

See "Auto/Holdoff " on page 477

Auto Trig

See "Auto Trig " on page 477

Trig Holdoff

See "Trig Holdoff " on page 478

12 Spurious Emissions Measurement
Trigger

Holdoff Type

See "[Holdoff Type](#)" on page 478

User Preset

Accesses a menu that gives you the following three choices:

- **User Preset** – recalls a state previously saved using the Save User Preset function.
- **User Preset All Modes** – presets all of the modes in the analyzer
- **Save User Preset**– saves the current state for the current mode

Key Path	Front-panel key
Backwards Compatibility Notes	<p>User Preset is actually loading a state, and in legacy analyzers, it was possible to load a state without affecting the trace data, limit lines or correction data. Similarly it was possible to do a User Preset without affecting the trace data, limit lines or correction data.</p> <p>In the X-Series, “state” always includes all of this data; so whenever state is loaded, or User Preset is executed, all of the traces, limit lines and corrections are affected. Although this differs from previous behavior, it is desirable behavior, and should not cause adverse issues for users.</p> <p>On ESA and PSA, User Preset affected the entire instrument’s state. In the X-Series, User Preset only recalls the state for the active mode. There is a User Preset file for each mode. User Preset can never cause a mode switch as it can in legacy analyzers. If you want to recall all modes to their user preset file state, you will need to do a User Preset after mode switching into each mode.</p> <p>User Preset recalls mode state which can now include data like traces; whereas on ESA and PSA, User Preset did not affect data.</p>
Initial S/W Revision	Prior to A.02.00

User Preset

User Preset sets the state of the currently active mode back to the state that was previously saved for this mode using the Save User Preset menu key or the SCPI command, `SYST:PRES:USER:SAV`. It not only recalls the Mode Preset settings, but it also recalls all of the mode persistent settings, and the Input/Output system setting that existed at the time Save User Preset was executed.

If a Save User Preset has not been done at any time, User Preset recalls the default user preset file for the currently active mode. The default user preset files are created if, at power-on, a mode detects there is no user preset file. There will never be a scenario when there is no user preset file to restore. For each mode, the default user preset state is the same state that would be saved if a Save User Preset is performed in each mode right after doing a Restore Mode Default and after a Restore Input/Output Defaults.

The User Preset function does the following:

- Aborts the currently running measurement.
- Sets the mode State to the values defined by Save User Preset.
- Makes the saved measurement for the currently running mode the active measurement.
- Brings up the saved menu for the power-on mode.
- Clears the input and output buffers.
- Sets the Status Byte to 0.

Key Path	User Preset
Remote Command	:SYSTem:PRESet:USER
Example	:SYST:PRES:USER:SAVE:SYST:PRES:USER
Notes	:SYST:PRES:USER:SAVE is used to save the current state as the user preset state. Clears all pending OPC bits. The Status Byte is set to 0. Pressing the User Preset front-panel key while already in the User Preset menu will cause the User Preset to get executed
Couplings	A user preset will cause the currently running measurement to be aborted and cause the saved measurement to be active. Recalling a User Preset file has the same issues that recalling a Save State file has. Some settings may need to be limited and therefore re-coupled, since the capabilities of the mode may have changes when the User Preset file was last saved.
Initial S/W Revision	Prior to A.02.00

User Preset All Modes

Recalls all of the User Preset files for each mode, switches to the power-on mode, and activates the saved measurement from the power-on mode User Preset file.

NOTE

When the instrument is secured, all of the user preset files are converted back to their default user preset files.

The User Preset function does the following:

- Aborts the currently running measurement.
- Switches the Mode to the power-on mode.
- Restores the User Preset files for each mode.
- Makes the saved measurement for the power-on mode the active measurement.
- Brings up the saved menu for the power-on mode.
- Clears the input and output buffers.
- Sets the Status Byte to 0.

Key Path	User Preset
Remote Command	:SYSTem:PRESet:USER:ALL
Example	:SYST:PRES:USER:SAVE:SYST:PRES:USER:ALL
Notes	Clears all pending OPC bits. The Status Byte is set to 0. :SYST:PRES:USER:SAVE is used to save the current state as the user preset state.
Couplings	A user preset will cause the currently running measurement to be aborted, cause a mode switch to the power-on mode, and cause the saved measurement to be active in the power-on mode. Recalling a User Preset file has the same issues that recalling a Save State file has. Some settings may need to be limited and therefore re-coupled, since the capabilities of the mode may have changes when the User Preset file was last saved.

Initial S/W Revision	Prior to A.02.00
----------------------	------------------

Save User Preset

Saves the currently active mode and its State. You can recall this User Preset file by pressing the User Preset menu key or sending the SYST:PRES:USER remote command. This same state is also saved by the Save State function.

Key Path	User Preset
Remote Command	:SYSTem:PRESet:USER:SAVE
Example	:SYST:PRES:USER:SAVE
Notes	:SYST:PRES:SAVE creates the same file as if the user requested a *SAV or a MMEM:STOR:STAT, except User Preset Save does not allow the user to specify the filename or the location of the file.
Initial S/W Revision	Prior to A.02.00

View/Display

Accesses a menu that includes keys that enables you to control the instrument display.

For details of available views, see [View Selection](#).

For details of remote commands associated with views, see [Range Table Selection \(SCPI only command\)](#).

Key Path	Front-panel key
Initial S/W Revision	Prior to A.02.00

Display

The Display menu is common to most measurements, and is used for configuring items on the display. Some Display menu settings apply to all the measurements in a mode, and some only to the current measurement. Those under the **System Display Settings** key apply to all measurements in all modes.

Key Path	Display
Key Path	View/Display
Initial S/W Revision	Prior to A.02.00

Annotation

Turns on and off various parts of the display annotation. The annotation is divided up into four categories:

1. Meas Bar: This is the measurement bar at the top of the screen. It does not include the settings panel or the Active Function. Turning off the Meas Bar turns off the settings panel and the Active Function. When the Meas Bar is off, the graticule area expands to fill the area formerly occupied by the Meas Bar.
2. Screen Annotation: this is the annotation and annunciation around the graticule, including any annotation on lines (such as the display line, the threshold line, etc.) This does NOT include the marker number or the N dB result. When off, the graticule expands to fill the entire graticule area.
3. Trace annotation: these are the labels on the traces, showing their detector (or their math mode).
4. Active Function annotation: this is the active function display in the meas bar, and all of the active function values displayed on softkeys.

See the figure below. Each type of annotation can be turned on and off individually.

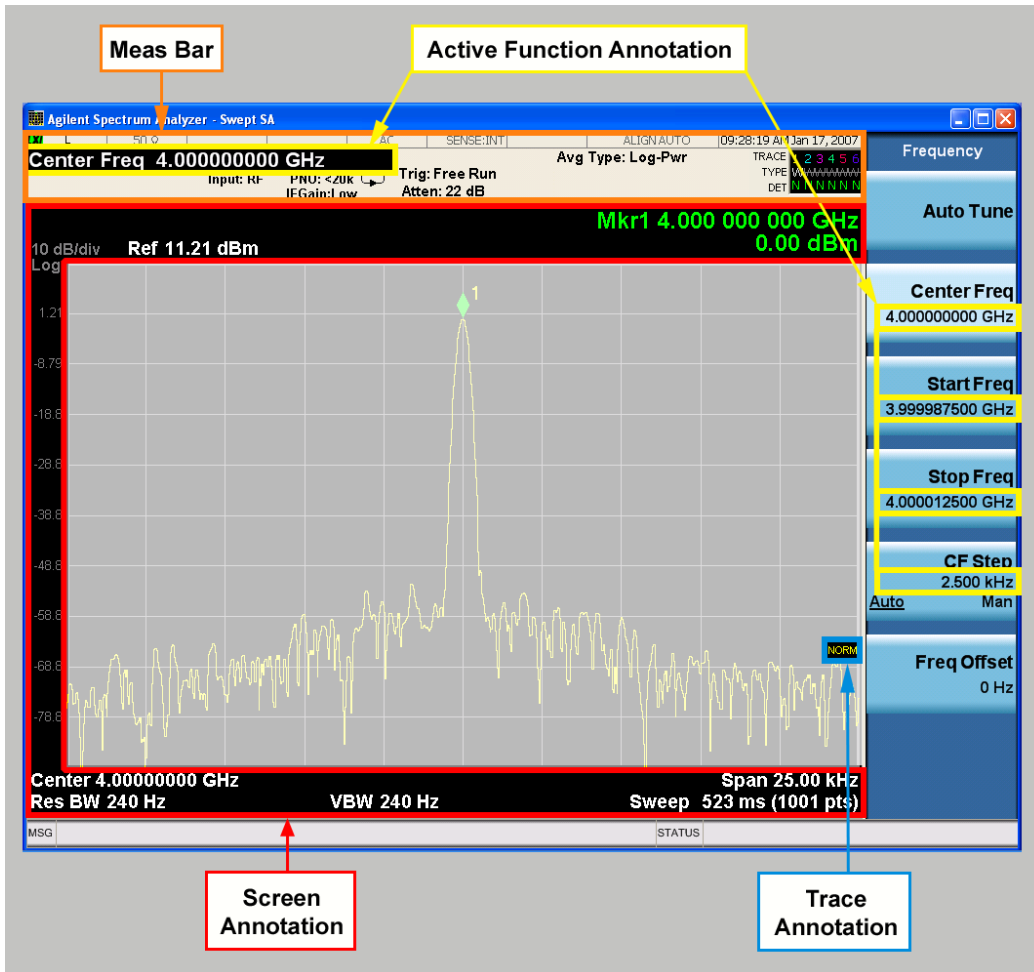

Key Path	View/Display, Display
Initial S/W Revision	Prior to A.02.00

Meas Bar On/Off

This function turns the Measurement Bar on and off, including the settings panel. When off, the graticule area expands to fill the area formerly occupied by the Measurement Bar.

Key Path	View/Display, Display, Annotation
Remote Command	:DISPlay:ANNotation:MBAR[:STATE] OFF ON 0 1 :DISPlay:ANNotation:MBAR[:STATE]?
Example	DISP:ANN:MBAR OFF
Dependencies	Grayed out and forced to OFF when System Display Settings, Annotation is set to Off.
Preset	On This should remain Off through a Preset when System DisplaySettings, Annotation is set to Off.

State Saved	Saved in instrument state.
Initial S/W Revision	Prior to A.02.00

Screen

This controls the display of the annunciation and annotation around the graticule, including any annotation on lines (such as the display line, the threshold line, etc.) and the y-axis annotation. This does NOT include marker annotation (or the N dB result). When off, the graticule expands to fill the entire graticule area, leaving only the 1.5% gap above the graticule as described in the Trace/Detector chapter.

Key Path	View/Display, Display, Annotation
Remote Command	:DISPlay:ANNotation:SCReen[:STATe] OFF ON 0 1 :DISPlay:ANNotation:SCReen[:STATe]?
Example	DISP:ANN:SCR OFF
Dependencies	Grayed-out and forced to OFF when System Display Settings, Annotation is set to Off.
Preset	On This should remain Off through a Preset when System DisplaySettings, Annotation is set to Off
State Saved	Saved in instrument state.
Initial S/W Revision	Prior to A.02.00

Active Function Values On/Off

Turns on and off the active function display in the Meas Bar, and all of the active function values displayed on the softkeys.

Note that all of the softkeys that have active functions have these numeric values blanked when this function is on. This is a security feature..

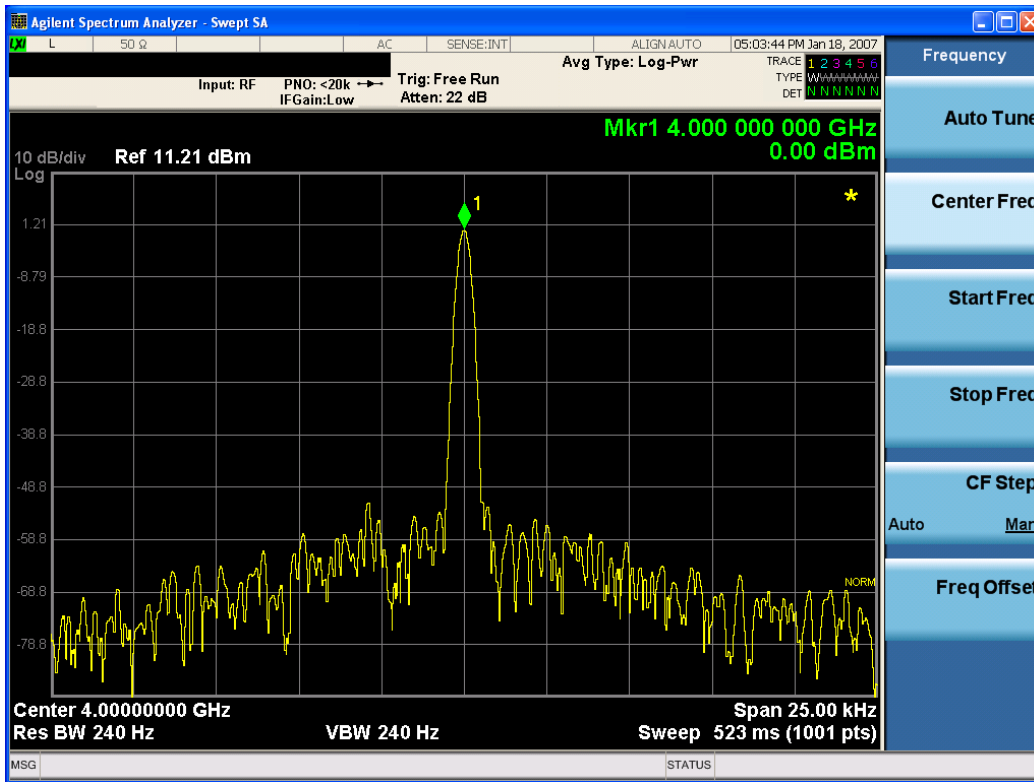

Key Path	View/Display, Display, Annotation
Remote Command	:DISPlay:ACTivefunc[:STATE] ON OFF 1 0 :DISPlay:ACTivefunc[:STATE]?
Example	DISP:ACT OFF
Dependencies	Grayed out and forced to OFF when System Display Settings, Annotation is set to Off.
Preset	On This should remain Off through a Preset when System DisplaySettings, Annotation is set to Off
State Saved	Saved in instrument state.
Initial S/W Revision	Prior to A.02.00

Title

Displays menu keys that enable you to change or clear a title on your display.

Key Path	View/Display, Display
Initial S/W Revision	Prior to A.02.00

Change Title

Writes a title into the "measurement name" field in the banner, for example, "Swept SA".

Press Change Title to enter a new title through the alpha editor. Press Enter or Return to complete the entry. Press ESC to cancel the entry and preserve your existing title.

The display title will replace the measurement name. It remains for this measurement until you press **Change Title** again, or you recall a state, or a Preset is performed. A title can also be cleared by pressing **Title**, **Clear Title**.

NOTE

Notice the inclusion of the <measurement> parameter in the command below. Because each measurement remembers the Display Title, the command must be qualified with the measurement name. For the Swept SA measurement this is not the case; no <measurement> parameter is used when changing the Display Title for the Swept SA measurement.

Key Path	View/Display, Display, Title
Mode	All
Remote Command	:DISPlay:<measurement>:ANNotation:TITLe:DATA <string> :DISPlay:<measurement>:ANNotation:TITLe:DATA?
Example	DISP:ANN:TITL:DATA "This Is My Title" This example is for the Swept SA measurement in the Spectrum Analyzer mode. The SANalyzer <measurement> name is not used. DISP:ACP:ANN:TITL:DATA "This Is My Title" This example is for Measurements other than Swept SA. Both set the title to: This Is My Title
Notes	Pressing this key cancels any active function. When a title is edited the previous title remains intact (it is not cleared) and the cursor goes at the end so that characters can be added or BKSP can be used to go back over previous characters.
Preset	No title (measurement name instead)
State Saved	Saved in instrument state.
Initial S/W Revision	Prior to A.02.00

Clear Title

Clears a title from the front-panel display. Once cleared, the title cannot be retrieved. After the title is cleared, the current Measurement Name replaces it in the title bar.

Key Path	View/Display, Display, Title
Example	The following commands clear the title and restore the measurement's original title: DISP:ANN:TITL:DATA "" This example is for the Swept SA measurement in the Spectrum Analyzer mode. The SANalyzer <measurement> name is not used. DISP:ACP:ANN:TITL:DATA "" This example is for ACP; in measurements other than Swept SA the measurement name is required.
Notes	Uses the :DISPlay:<measurement>:ANNotation:TITLe:DATA <string> command with an empty string (in the Swept SA, the <measurement> is omitted).

Preset	Performed on Preset.
Initial S/W Revision	Prior to A.02.00

Graticule

Pressing Graticule turns the display graticule On or Off. It also turns the graticule y-axis annotation on and off.

Key Path	View/Display, Display
Remote Command	:DISPlay:WINDow[1]:TRACe:GRATicule:GRID[:STATe] OFF ON 0 1 :DISPlay:WINDow[1]:TRACe:GRATicule:GRID[:STATe]?
Example	DISP:WIND:TRAC:GRAT:GRID OFF
Notes	The graticule is the set of horizontal and vertical lines that make up the grid/divisions for the x-axis and y-axis.
Preset	On
State Saved	Saved in instrument state
Initial S/W Revision	Prior to A.02.00

System Display Settings

These settings are "Mode Global" – they affect all modes and measurements and are reset only by **Restore Misc Defaults** or **Restore System Defaults** under System.

Key Path	View/Display, Display
Initial S/W Revision	Prior to A.02.00

Annotation Local Settings

This is a Mode Global override of the meas local annotation settings. When it is **All Off**, it forces **ScreenAnnotation, Meas Bar, Trace, and Active Function Values** settings to be **OFF** for all measurements in all modes. This provides the security based "annotation off" function of previous analyzers; hence it uses the legacy SCPI command.

When it is **All Off**, the **Screen, Meas Bar, Trace, and Active Function Values** keys under the **Display, Annotation** menu are grayed out and forced to **Off**. When **Local Settings** is selected, you are able to set the local annotation settings on a measurement by measurement basis.

Key Path	View/Display, Display, System Display Settings
Remote Command	:DISPlay:WINDow[1]:ANNOtation[:ALL] OFF ON 0 1 :DISPlay:WINDow[1]:ANNOtation[:ALL]?
Example	:DISP:WIND:ANN OFF

Preset	On (Set by Restore Misc Defaults)
State Saved	Not saved in instrument state.
Backwards Compatibility Notes	The WINDOW parameter and optional subopcode is included for backwards compatibility but ignored - all windows are equally affected.
Initial S/W Revision	Prior to A.02.00

Themes

Accesses a menu of functions that enable you to choose the theme to be used when saving the screen image.

The **Themes** option is the same as the **Themes** option under the **Display** and **Page Setup** dialogs. It allows you to choose between themes to be used when saving the screen image.

Key Path	Save, Screen Image
Remote Command	:MMEMory:STORe:SCReen:THEMe TDColor TDMonochrome FCOLor FMONochrome :MMEMory:STORe:SCReen:THEMe?
Example	:MMEM:STOR:SCR:THEM TDM
Preset	3D Color; Is not part of Preset, but is reset by Restore Misc Defaults or Restore System Defaults All and survives subsequent running of the modes.
Readback	3D Color 3D Mono Flat Color Flat Mono
Backwards Compatibility Notes	In ESA and PSA we offer the choice of "Reverse Bitmap" or "Reverse Metafile" when saving screen images. This is much like the "Flat Color" theme available in X-Series. Also, if you selected Reverse Bitmap AND a black & white screen image, that would be much like "Flat Monochrome". In other words, each of the X-Series themes has a similar screen image type in ESA/PSA. But they are not identical.
Initial S/W Revision	Prior to A.02.00

3D Color

Selects a standard color theme with each object filled, shaded and colored as designed.

Key Path	Save, Screen Image, Themes
Example	MMEM:STOR:SCR:THEM TDC
Readback	3D Color
Initial S/W Revision	Prior to A.02.00

3D Monochrome

Selects a format that is like 3D color but shades of gray are used instead of colors.

Key Path	Save, Screen Image, Themes
Example	MMEM:STOR:SCR:THEM TDM
Readback	3D Mono
Initial S/W Revision	Prior to A.02.00

Flat Color

Selects a format that is best when the screen is to be printed on an ink printer.

Key Path	Save, Screen Image, Themes
Example	MMEM:STOR:SCR:THEM FCOL
Readback	Flat Color
Initial S/W Revision	Prior to A.02.00

Flat Monochrome

Selects a format that is like Flat Color. But only black is used (no colors, not even gray), and no fill.

Key Path	Save, Screen Image, Themes
Example	MMEM:STOR:SCR:THEM FMON
Readback	Flat Mono
Initial S/W Revision	Prior to A.02.00

Backlight

Accesses the display backlight on/off keys. This setting may interact with settings under the Windows "Power" menu.

When the backlight is off, pressing ESC, TAB, SPACE, ENTER, UP, DOWN, LEFT, RIGHT, DEL, BKSP, CTRL, or ALT turns the backlight on without affecting the application. Pressing any other key will turn backlight on and could potentially perform the action as well.

Key Path	View/Display, Display, System Display Settings
Remote Command	:DISPlay:BACKlight ON OFF :DISPlay:BACKlight?
Preset	ON (Set by Restore Misc Defaults)
Initial S/W Revision	Prior to A.02.00

Backlight Intensity

An active function used to set the backlight intensity. It goes from 0 to 100 where 100 is full on and 0 is off. This value is independent of the values set under the Backlight on/off key.

Key Path	View/Display, Display, System Display Settings
Remote Command	:DISPlay:BACKlight:INTensity <integer> :DISPlay:BACKlight:INTensity?
Example	DISP:BACK:INT 50
Preset	100 (Set by Restore Misc Defaults)
Min	0
Max	100
Initial S/W Revision	Prior to A.02.00

View Selection

Selects the desired view. The following views are available:

- **"Graph + Metrics" on page 1715** – The lower window displays a list of spurs detected in a measurement cycle. The upper window displays a trace of the range that contains the currently selected spur.
- **"Range Table" on page 1716** – The lower window displays settings of ranges. The upper window displays a trace of the currently selected range.
- **"All Ranges" on page 1718** – The lower window displays a list of spurs detected in a measurement cycle. The upper window displays a merged trace of all the ranges.

Key Path	View/Display
Mode	SA, WCDMA, C2K, 1xEV-DO, WIMAX OFDMA, TD-SCDMA, DVB-T/H, LTE, LTE-TDD, MSR, LTE-FDD, LTE-TDD
Remote Command	:DISPlay:SPURious:VIEW[:SElect] RESult RANGE ALL :DISPlay:SPURious:VIEW[:SElect]?
Example	DISP:SPUR:VIEW RANG DISP:SPUR:VIEW?
Notes	You must be in cdma2000 mode, TD-SCDMA mode, W-CDMA mode, DVB-T/H mode, GSM/EDGE mode, LTE mode, LTE TDD mode, LTE-Advanced FDD/TDD mode, MSR or WiMAX mode to use this command. Use INSTRument:SElect to set the mode.
Preset	RESult
State Saved	No
Range	Graph + Metrics Range Table All Ranges
Initial S/W Revision	A.10.00
Modified at S/W Revision	A.11.00

Graph + Metrics

Select Graph + Metrics to view measurement results.

- The lower window displays a list of spurs detected in a measurement cycle. The currently selected spur, which is highlighted, can be changed by the Spur softkey in the Meas Setup menu.
- The upper window displays a trace of the range that contains the currently selected spur.

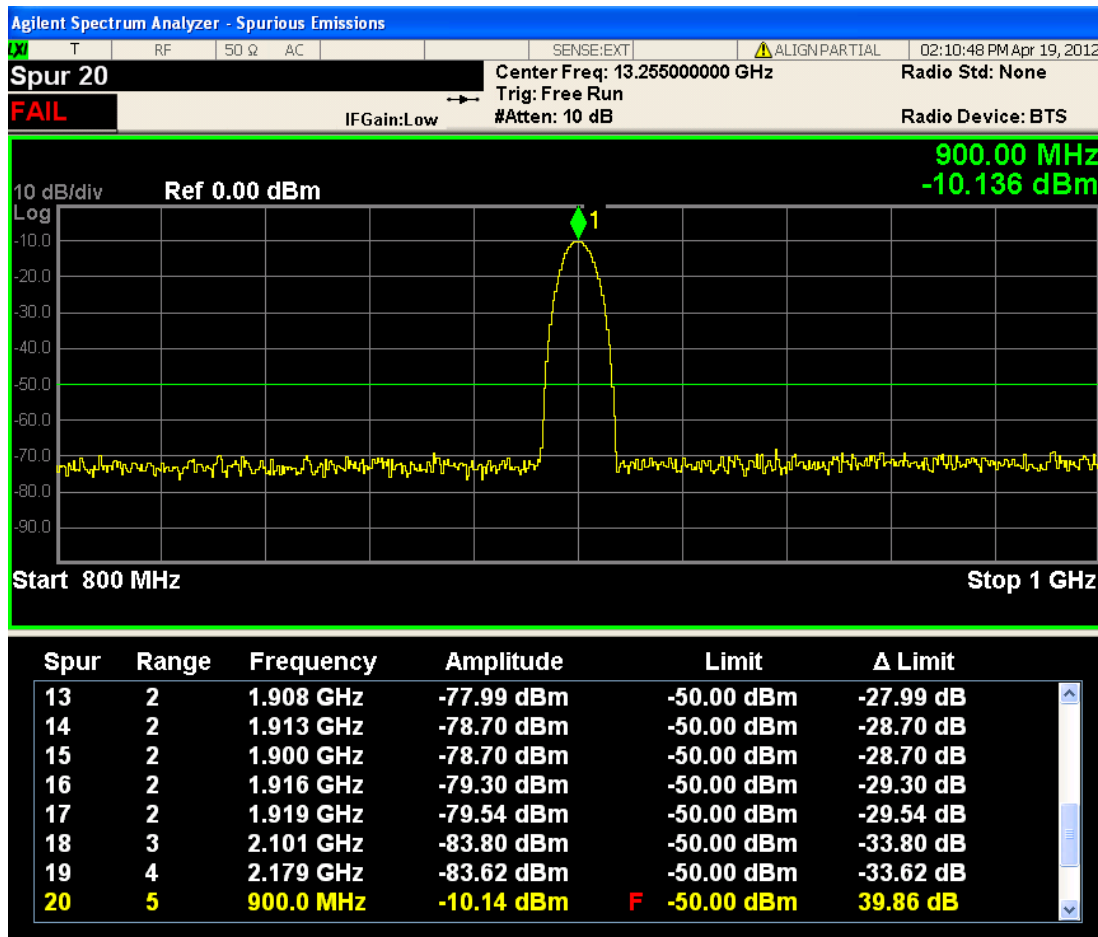

Result	Units	Min	Max
Spur	N/A	0	200
Range	N/A	1	20
Frequency	Hz	Analyzer Min	Analyzer Max
Amplitude	dBm	-150	50
Limit	dBm	-150	50

The spurs listed are within the current value of the Marker Peak Excursion setting of the absolute limit. All of the spurs listed passed. Any spur that has failed the absolute limit will have an 'F' beside it.

Range Table

Select Range Table to view range settings.

- The upper window displays a trace of the range specified by the Range key under Range Table in Meas Setup.
- The lower window displays the range setting.

All enabled range may not be displayed with the normal window arrangement. Even in that case, the instrument always displays the highlighted line in the table. When you zoom the lower window, all 20 ranges can be displayed.

When the range state is OFF, “---” appears, to indicate the range is inactive.

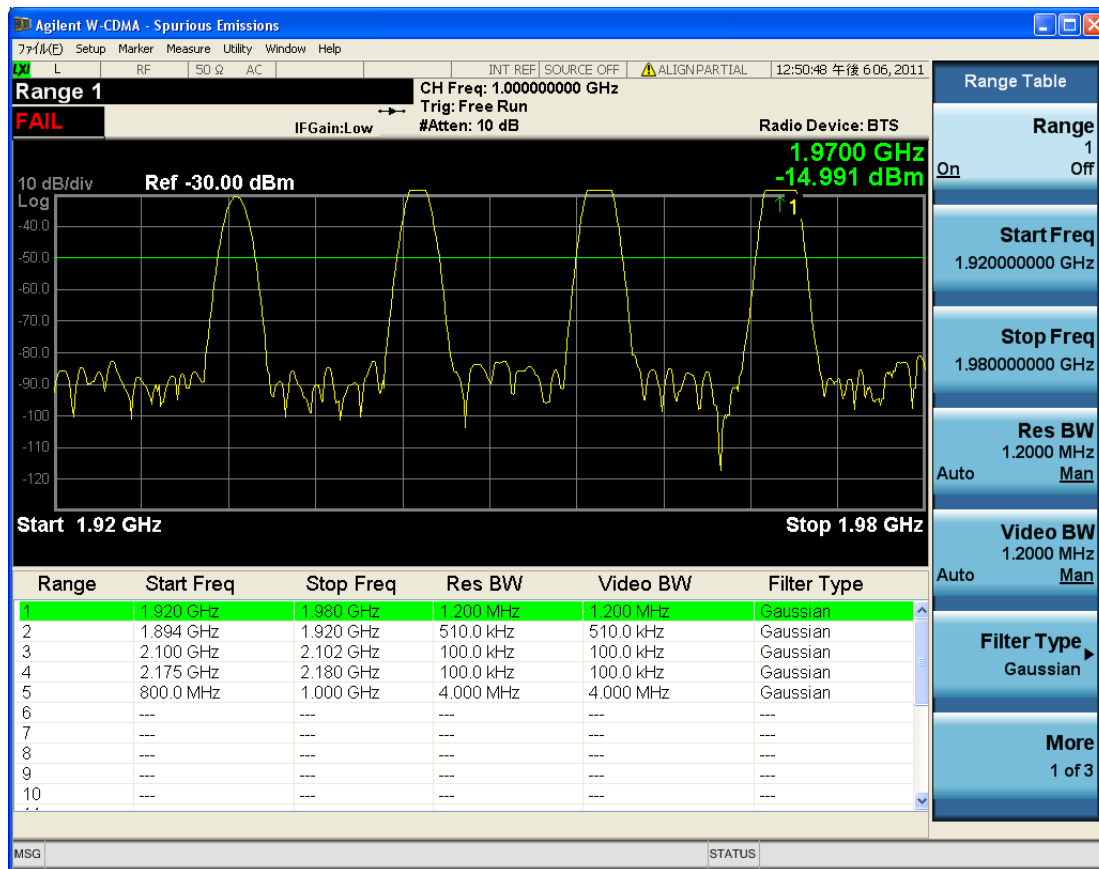

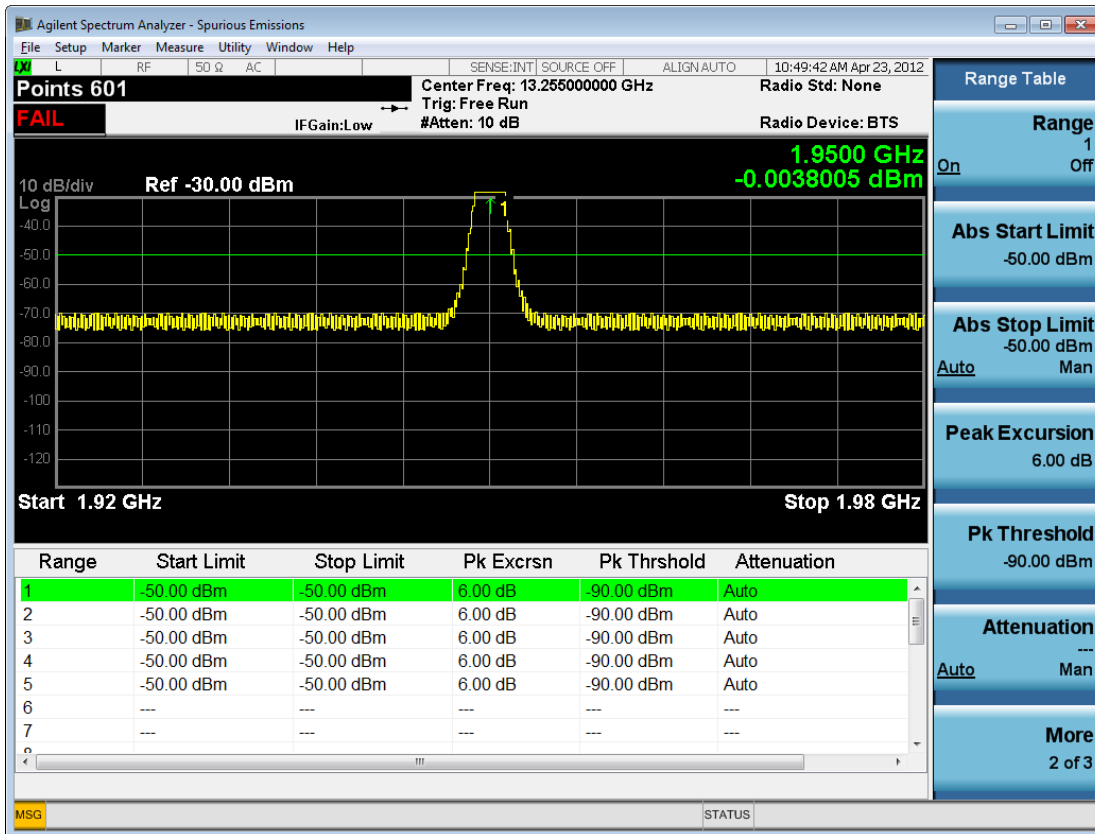

12 Spurious Emissions Measurement View/Display

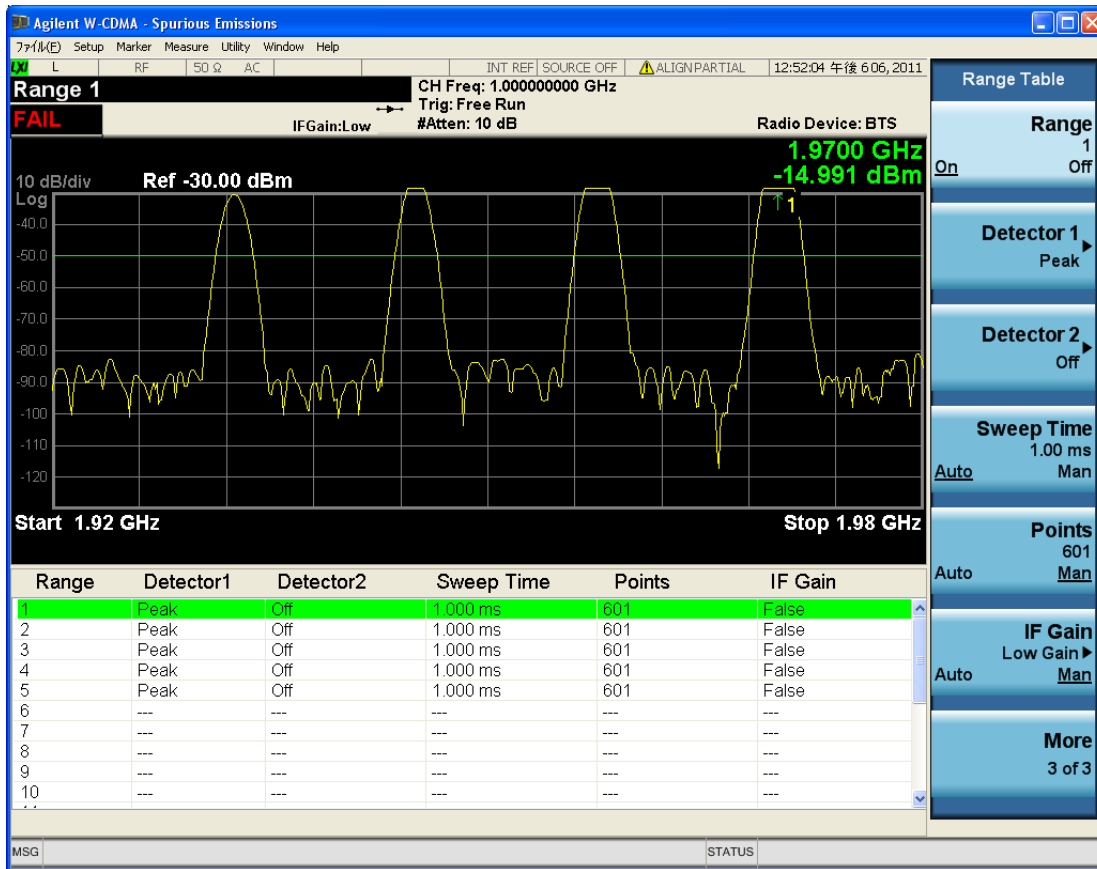

All Ranges

Select All Ranges to view measurement results for all the ranges.

- The upper window displays a merged trace of all the ranges.
- The lower window displays a list of spurs detected in a measurement cycle. The currently selected spur, which is highlighted, can be changed by the Spur softkey in the Meas Setup menu.

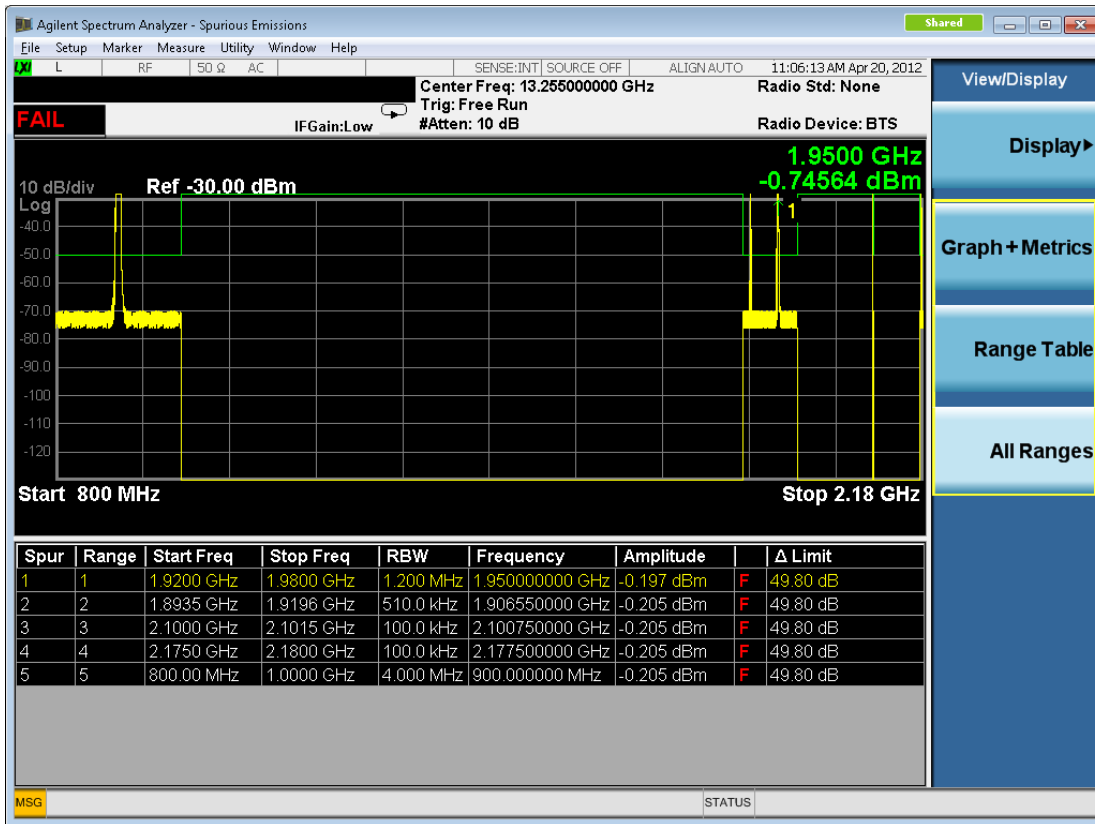

Range Table Selection (SCPI only command)

Switches contents of Range Table. There are three tables in the Range Table window, corresponding to each page of the Range Table menu. If the Range Table menu is displayed, this command changes the page of the Range Table menu too. Pressing the Range Table softkey always changes the current Range Table to 1.

Key Path	SCPI only
Mode	SA, WCDMA, C2K, 1xEV-DO, WiMAX OFDMA, TD-SCDMA, DVB-T/H, LTE, LTE-TDD, WLAN, MSR, LTE-FDD, LTE-TDD
Remote Command	:DISPlay:SPURious:VIEW:RANGe:TABLE <integer> :DISPlay:SPURious:VIEW:RANGe:TABLE?
Example	DISP:SPUR:VIEW:RANG:TABL 2 DISP:SPUR:VIEW:RANG:TABL?
Notes	You must be in cdma2000 mode, TD-SCDMA mode, W-CDMA mode, DVB-T/H mode, GSM/EDGE mode, LTE mode, LTE TDD mode, WLAN mode, LTE-Advanced FDD/TDD mode, MSR or WiMAX mode to use this command. Use INSTRument:SElect to set the mode.
Preset	1
State Saved	No
Min	1
Max	3
Initial S/W Revision	A.10.00

13 Conformance EVM

"Description" on page 1722

"Measurement Commands" on page 1723

"Remote Command SCPI Results" on page 1724

Description

All available measurement parameters of each radio format are configurable in the Format Parameter List at the mode level. Most parameter items are the same as those used in the original measurements or its mode, but some parameters are newly added to this mode/measurement. See [Format Parameter List in Mode Setup](#) section for details.

Averaging function is available for each radio format individually.

Auto Attenuation function is available in this measurement. See the MSR mode for details.

This measurement does not have the limit judge function.

Measurement results of a specified carrier are displayed in the tabular form. See the section [Result Metrics Carrier Index](#) for details. Remote results depend on the Result Selection setting for each format. Therefore, the user can get only the results they want without being annoyed by those they do not want. See ["Remote Command SCPI Results" on page 1724](#) section for details. The concept is the same as the LTE FDD Conformance EVM.

This measurement has the following results.

- GSM/EDGE (EDGE EVM)
- W-CDMA (Mod Accuracy)
- LTE FDD (Conformance EVM)
- cdma2000 (Mod Accuracy)
- 1xEV-DO (Mod Accuracy)
- LTE TDD (Conformance EVM)
- TD-SCDMA (Mod Accuracy)

Measurement Commands

Once you have configured the measurement parameters, you can use these commands to initiate the measurement and retrieve the measurement results.

:CONFigure:CEVM

:CONFigure:CEVM:NDEFault

:INITiate:CEVM

:FETCh:CEVM[n]?

:READ:CEVM[n]?

:MEASure:CEVM[n]?

Remote Command SCPI Results

For queries listed in "[Measurement Commands](#)" on page 1723 section, the results returned depend on the value of n, as follows.

N	Results Returned
Not specified or n=1	<p>Returns measurement results of all carriers set with Carrier Configuration in Mode Setup. The total result length is variable.</p> <p>The contents of each carrier vary depending on the radio format and result values enable/disable setting. These results are corresponding exactly to the items shown on the display.</p> <p>The Remote Command SCPI results of n = 2 (for example, "FETCh:CEVM2?") show the point where each carrier result starts.</p> <p>All the return values are floating points.</p> <p>LTEDownlink Results</p> <p>The result contents are customizable. See "LTE FDD Downlink Result Output Selection (SCPI only)" on page 1827 section for details. If no result is available, NaN (9.91E+37) is returned.</p> <ol style="list-style-type: none"> 1. EVM (%) 2. EVM Symbol Time Adjust <ol style="list-style-type: none"> 1: Window Start 2: Window End 3: Center 4: Custom 3. EVM Pk (%) 4. EVM Pk Index 5. EVM Peak Sub Car Index 6. Data EVM (%) – Not available when Detection is Manual and no User is added. 7. 3GPP-defined QPSK EVM (%) 8. 3GPP-defined 16QAM EVM (%) 9. 3GPP-defined 64QAM EVM (%) 10. RS EVM (%) 11. RS Tx. Power (dBm) 12. OFDM Symbol Tx. Power (dBm) 13. Frequency Error (Hz) 14. Sync Correlation (%) 15. Sync Type <ol style="list-style-type: none"> 1: P-SS 20: Ant Port 0 RS 21: Ant Port 1 RS 22: Ant Port 2 RS 23: Ant Port 3 RS 16. Common Tracking Error (%) 17. Symbol Clock Error (ppm) 18. Time Offset (s)

N	Results Returned
	19. Offset (dB)
	20. IQ Gain Imbalance (dB)
	21. IQ Quad Error (deg)
	22. IQ Timing Skew (s)
	23. CP Length Mode
	1: Normal
	2: Extended
	24. Cell ID
	25. Cell ID Group/Sector
	Integer part: Cell ID Group, After the decimal point: Cell ID Sector
	26. RS-OS/PRS
	1: 3GPP
	4: Custom
	27. Reference Signal Rx Power (dBm)
	28. Reference Signal Rx Quality (dB)
	29. Received Signal Strength Indicator (dBm)
	30. Channel Power (dBm)
	W-CDMA Results for BTS
	The result contents are customizable. See " W-CDMA Result Output Selection for BTS (SCPI only) " on page 1829 section for details. If no result is available, NaN (9.91E+37) is returned.
	#. Result Name (average mode) <explanations>, where average mode is one of:
	Average : Averaged value in average cycle
	Peak Hold : Detected Peak/Maximum value in average cycle
	Latest : Value at last average cycle
	1. RMS EVM (Average)
	the EVM over the entire measurement area (in percent).
	2. Peak EVM (Peak Hold)
	the peak EVM in the measurement area (in percent).
	3. Magnitude error (Average)
	the average magnitude error over the entire measurement area (in percent).
	4. Phase error (Average)
	the average phase error over the entire measurement area (in degree).
	5. I/Q origin offset (Average)
	the I and Q error (magnitude squared) offset from the origin (in dB).
	6. Frequency error (Average)
	the frequency error in the measured signal (in Hz).
	7. Rho (Average)
	8. Peak Code Domain Error (Peak Hold)
	the Peak Code Domain Error relative to the mean power (in dB).
	9. Peak Code Domain Error Channel Number (Peak Hold)

N	Results Returned
	the channel number in which the peak code domain error is detected.
	10. Number of active channels (Average)
	11. Time offset (Average)
	the pilot phase timing from the acquisition trigger point (in chips).
	12. CPICH power over a slot (Average)
	the CPICH power over a measurement slot (in dB).
	13. Total power over a slot (Average)
	the total RF power over a measurement slot (in dBm)
	14. First Slot Number (Latest)
	the first slot in Capture Interval. When the averaging is On, returns the value at the last cycle of averaging.
	15. Detected Scrambling Code (Latest)
	Returns a detected scramble code. The value returned is 0~511.
	Available only when Radio Device is set to BTS and P-Scramble Code is set to Autodetect. Otherwise NaN is returned.
	16. Average 64QAM RCDE (Average): See Note1 below.
	the 64QAM RCDE over entire measurement area in the BTS mode.
	17. Peak 64QAM RCDE (Peak Hold): See Note1 below.
	the peak 64QAM RCDE in the measurement area in the BTS mode.
	18. Peak Slot RMS EVM (Peak Hold)
	Worst Slot RMS EVM in captured data (in percent).
	19. Average IQ Gain Imbalance (dB)
	20. Peak IQ Gain Imbalance (dB)
	21. Average IQ Quad Error (deg)
	22. Peak IQ Quad Error (deg)
	Note1:64QAM RCDE is a floating point number (in dB) of the Relative Code Domain Error averaged over 64QAM channels in slot.
	GSM/EDGE Results
	The result contents are customizable. See "GSM/EDGE Result Output Selection (SCPI only)" on page 1830 for details. If no result is available, NaN (9.91E+37) is returned.
	1. RMS 95th %tile EVM
	the EVM over 95% of the entire measurement area (in percent).
	2. Average RMS EVM
	the EVM over the entire measurement area (in percent).
	3. Maximum RMS EVM
	the highest EVM over the entire measurement area (in percent).
	4. Average Peak EVM
	the average of the peak EVMs (in percent). Take the peak EVMs from each burst and average them together.
	5. Maximum Peak EVM
	the maximum peak EVM (in percent). Take the peak EVMs from each burst and identify the highest peak.
	6. Symbol position of the peak EVM

N	Results Returned
	the symbol position where the peak EVM error is detected.
	7. Average RMS Magnitude Error the average RMS magnitude error over the entire measurement area (in percent).
	8. Maximum RMS Magnitude Error the maximum RMS magnitude error over the entire measurement area (in percent).
	9. Average RMS Phase Error the average RMS phase error over the entire measurement area (in degree).
	10. Maximum RMS Phase Error the maximum RMS phase error over the entire measurement area (in degree).
	11. Average Frequency Error the frequency error in the measured signal (in Hz).
	12. Maximum Frequency Error the highest frequency error in the measured signal (in Hz).
	13. Average I/Q Origin Offset the I and Q error (magnitude squared) offset from the origin (in dB).
	14. Amplitude Droop Error the amplitude droop measured across the 142 symbol burst (in dB).
	15. Trigger to T0 the time interval between the trigger point to T0 (in sec). T0 means the transition time from symbol 13 to symbol 14 of the midamble training sequence for each time slot.
	16. Timing Offset of AM/PM path the averaged time interval between Amplitude Modulation path and Phase Modulation path (in sec). When GMSK is measured, this timing offset value is 0, which will be included in the average calculation.
	17. Detected TSC the detected TSC. The returned value is 0~7 (Burst Type: Normal), 10 (Burst Type: Sync), 20 (Burst Type: Access) if TSC is detected. If TSC is not detected, the returned value is NaN (9.91E+37). If Amptd or NONE is selected for Sync Type, the returned value is NaN (9.91E+37). In multi slot condition, the returned value is the detected TSC of the specified slot (Time Slot ON) or the first evaluated slot (Time Slot OFF). The returned value in AQPSK is more than or equal to 100100. The first three digits represent TSC of VAMOS subchannel A. The second three digits represent VAMOS subchannel B. TSCs of TSC set 1 and TSC set 2 correspond to 100 to 107 and 200 to 207 respectively. Thus the returned value is ([TSC num of VAMOS subchannel A] * 1000 + [TSC num of VAMOS subchannel B]). For example, if measured AQPSK signal has TSC 3 of set1 on VAMOS subchannel A and TSC 5 of TSC set2 on VAMOS B, returned value is 103205. The returned value is 200 ~ 207, ([TSC num] + 200), if one of set2 TSCs is detected. When the averaging is On, returns the value at the last cycle of averaging.
	18. Detected Mod Scheme the detected modulation scheme. 0: GMSK 1: NB 8PSK 2: NB 16QAM

N	Results Returned
	<p>3: NB 32QAM</p> <p>10: NB AQPSK</p> <p>11: HB QPSK</p> <p>12: HB 16QAM</p> <p>13: HB 32QAM</p> <p>When the averaging is On, returns the value at the last cycle of averaging.</p> <p>Note that values except for GMSK and NB 8PSK return only when N9071A-3FP is installed.</p> <p>19. Maximum I/Q origin offset</p> <p>the amplitude droop measured across the 142 symbol burst (in dB).</p> <p>the I and Q error (magnitude squared) offset from the origin (in dB). If averaging is ON, this is the max hold number of the individual IQ Offset.</p> <p>20. Average Absolute Peak Phase Error</p> <p>the average of the absolute peak phase errors (in percent). Take the peak phase error from each burst and average them together.</p> <p>21. Maximum Absolute Peak Phase Error</p> <p>the maximum absolute peak phase error (in percent). Take the peak phase errors from each burst and identify the highest peak.</p> <p>cdma2000 Results</p> <p>The result contents are customizable. See "cdma2000 Result Output Selection (SCPI only)" on page 1831 section for details. If no result is available, NaN (9.91E+37) is returned.</p> <p>#. Result Name (average mode) <explanations>, where average mode is one of:</p> <p>Average : Averaged value in average cycle</p> <p>Peak Hold : Detected Peak/Maximum value in average cycle</p> <p>Latest : Value at last average cycle</p> <p>1. RMS EVM (Average)</p> <p>the EVM over the entire measurement area (in percent).</p> <p>2. Peak EVM (Peak Hold)</p> <p>the peak EVM in the measurement area (in percent).</p> <p>3. Magnitude error (Average)</p> <p>the average magnitude error over the entire measurement area (in percent).</p> <p>4. Phase error (Average)</p> <p>the average phase error over the entire measurement area (in degree).</p> <p>5. I/Q origin offset (Average)</p> <p>the I and Q error (magnitude squared) offset from the origin (in dB).</p> <p>6. Frequency error (Average)</p> <p>the frequency error in the measured signal (in Hz).</p> <p>7. Rho (Average)</p> <p>8. Peak Code Domain Error (Peak Hold)</p> <p>the Peak Code Domain Error relative to the mean power (in dB).</p> <p>9. Peak Code Domain Error Channel Number (Peak Hold)</p>

N	Results Returned
	<p>the channel number in which the peak code domain error is detected.</p> <p>10. Number of active channels. (Latest)</p> <p>11. Time offset (Average)</p> <p>floating point number (in micro seconds) of the pilot phase timing from the acquisition trigger point.</p> <p>1xEV-DO Results for BTS</p> <p>The result contents are customizable. See "1xEV-DO Result Output Selection for BTS (SCPI only)" on page 1832 section for details. If no result is available, NaN (9.91E+37) is returned.</p> <p>#. Result Name (average mode) <explanations>, where average mode is one of:</p> <ul style="list-style-type: none"> Average : Averaged value in average cycle Peak Hold : Detected Peak/Maximum value in average cycle Latest : Value at last average cycle <p>1. RMS EVM (Pilot Channel) (Average)</p> <p>the EVM over the entire measurement area (in percent).</p> <p>2. Peak EVM (Pilot Channel) (Peak Hold)</p> <p>the peak EVM in the measurement area (in percent).</p> <p>3. Magnitude error (Pilot Channel) (Average)</p> <p>the average magnitude error over the entire measurement area (in percent).</p> <p>4. Phase error (Pilot Channel) (Average)</p> <p>the average phase error over the entire measurement area (in degree).</p> <p>5. I/Q origin offset (Pilot Channel) (Average)</p> <p>the I and Q error (magnitude squared) offset from the origin (in dB).</p> <p>6. Frequency error (Pilot Channel) (Peak Hold)</p> <p>the frequency error in the measured signal (in Hz).</p> <p>7. Rho (Pilot Channel) (Average)</p> <p>8. Number of active channels (Pilot Channel) (Latest)</p> <p>9. Pilot offset (Average)</p> <p>the time from the trigger to the PN offset in micro seconds</p> <p>10. RMS EVM (MAC Channel) (Average)</p> <p>the EVM over the entire measurement area (in percent).</p> <p>11. Peak EVM (MAC Channel) (Peak Hold)</p> <p>the peak EVM in the measurement area (in percent).</p> <p>12. Magnitude error (MAC Channel) (Average)</p> <p>the average magnitude error over the entire measurement area (in percent).</p> <p>13. Phase error (MAC Channel) (Average)</p> <p>the average phase error over the entire measurement area (in degree).</p> <p>14. I/Q origin offset (MAC Channel) (Average)</p> <p>the I and Q error (magnitude squared) offset from the origin (in dB).</p> <p>15. Frequency error (MAC Channel) (Peak Hold)</p> <p>the frequency error in the measured signal (in Hz).</p> <p>16. Rho (MAC Channel) (Average)</p>

N	Results Returned
	17. Number of active channels (MAC Channel) (Latest)
	18. Pilot offset (Average)
	the time from the trigger to the PN offset in micro seconds.
	19. RMS EVM (Data Channel) (Average)
	the EVM over the entire measurement area (in percent).
	20. Peak EVM (Data Channel) (Peak Hold)
	the peak EVM in the measurement area (in percent).
	21. Magnitude error (Data Channel) (Average)
	the average magnitude error over the entire measurement area (in percent).
	22. Phase error (Data Channel) (Average)
	the average phase error over the entire measurement area (in degree).
	23. I/Q origin offset (Data Channel) (Average)
	the I and Q error (magnitude squared) offset from the origin (in dB).
	24. Frequency error (Data Channel) (Peak Hold)
	the frequency error in the measured signal (in Hz).
	25. Rho (Data Channel) (Average)
	26. Number of active channels (Data Channel) (Latest)
	27. Pilot offset (Average)
	the time from the trigger to the PN offset in micro seconds.
	28. RMS EVM (Preamble) (Average)
	the EVM over the entire measurement area (in percent).
	29. Peak EVM (Preamble) (Peak Hold)
	the peak EVM in the measurement area (in percent).
	30. Magnitude error (Preamble) (Average)
	the average magnitude error over the entire measurement area (in percent).
	31. Phase error (Preamble) (Average)
	the average phase error over the entire measurement area (in degree).
	32. I/Q origin offset (Preamble) (Average)
	the I and Q error (magnitude squared) offset from the origin (in dB).
	33. Frequency error (Preamble) (Peak Hold)
	the frequency error in the measured signal (in Hz).
	34. Rho (Preamble) (Average)
	35. Number of active channels (Preamble) (Latest)
	36. Pilot offset (Average)
	the time from the trigger to the PN offset in micro seconds.
	Rho Overall-1 and Rho Overall-2 specified in 3GPP2 C.S0032-0 v.2.0 Recommended Minimum
	Performance Standard for cdma2000 High Rate Data Packet Access Network, 11.4.2 Waveform Quality
	Measurement Equipment section.
	37. RMS EVM (Overall-1) (Average) – a floating point number (in percent) of EVM over the entire
	measurement area.

N	Results Returned
	38. Peak EVM error (Overall-1) (Peak Hold) – a floating point number (in percent) of peak EVM in the measurement area.
	39. Magnitude error (Overall-1) (Average) – a floating point number (in percent) of average magnitude error over the entire measurement area.
	40. Phase error (Overall-1) (Average) – a floating point number (in degree) of average phase error over the entire measurement area.
	41. I/Q origin offset (Overall-1) (Average) – a floating point number (in dB) of the I and Q error (magnitude squared) offset from the origin.
	42. Frequency error (Overall-1) (Peak Hold) – a floating point number (in Hz) of the frequency error in the measured signal.
	43. Rho (Overall-1) (Average) – a floating point number of Rho.
	44. RMS EVM (Overall-2) (Average) – a floating point number (in percent) of EVM over the entire measurement area.
	45. Peak EVM error (Overall-2) (Peak Hold) – a floating point number (in percent) of peak EVM in the measurement area.
	46. Magnitude error (Overall-2) (Average) – a floating point number (in percent) of average magnitude error over the entire measurement area.
	47. Phase error (Overall-2) (Average) – a floating point number (in degree) of average phase error over the entire measurement area.
	48. I/Q origin offset (Overall-2) (Average) – a floating point number (in dB) of the I and Q error (magnitude squared) offset from the origin.
	49. Frequency error (Overall-2) (Peak Hold) – a floating point number (in Hz) of the frequency error in the measured signal.
	50. Rho (Overall-2) (Average) – a floating point number of Rho.
	51. Number of active channels in Pilot (Latest)
	52. Number of active channels in Mac (Latest)
	53. Number of active channels in Data (Latest)
	54. Preamble length (Latest) - a floating point number (in chips)
	55. MAC index (Latest)
	56. Max MAC inactive channel power (Average) – a floating point number (in dB) of Maximum MAC inactive channel power.
	57. Max Data active channel power (Average) – a floating point number (in dB) of Maximum Data active channel power
	58. Min Data active channel power (Average) – a floating point number (in dB) of Minimum Data active channel power
	59. First slot number (Latest)– a integer number of absolute slot number of a slot which is specified by Meas Offset 0 (CALCulate:RADio:FORMat:EVDO[1]]2 3[:BTS]:SWEp:OFFSet)
	LTE TDD Downlink Results
	The result contents are customizable. See " LTE TDD Downlink Result Output Selection (SCPI only) " on page 1834 section for details. If no result is available, NaN (9.91E+37) is returned.
	1. EVM (%)
	2. EVM Symbol Time Adjust
	1: Window Start

N	Results Returned
	2: Window End
	3: Center
	4: Custom
	3. EVM Pk (%)
	4. EVM Pk Index
	5. EVM Peak Sub Car Index
	6. Data EVM (%) – Not available when Detection is Manual and no User is added.
	7. 3GPP-defined QPSK EVM (%)
	8. 3GPP-defined 16QAM EVM (%)
	9. 3GPP-defined 64QAM EVM (%)
	10. RS EVM (%)
	11. RS Tx. Power (dBm)
	12. OFDM Symbol Tx. Power (dBm)
	13. Frequency Error (Hz)
	14. Sync Correlation (%)
	15. Sync Type
	1: P-SS
	20: Ant Port 0 RS
	21: Ant Port 1 RS
	22: Ant Port 2 RS
	23: Ant Port 3 RS
	16. Common Tracking Error (%)
	17. Symbol Clock Error (ppm)
	18. Time Offset (s)
	19. Offset (dB)
	20. IQ Gain Imbalance (dB)
	21. IQ Quad Error (deg)
	22. IQ Timing Skew (s)
	23. CP Length Mode
	1: Normal
	2: Extended
	24. Cell ID
	25. Cell ID Group/Sector
	Integer part: Cell ID Group, After the decimal point: Cell ID Sector
	26. RS-OS/PRS
	1: 3GPP
	4: Custom
	27. Reference Signal Rx Power (dBm)
	28. Reference Signal Rx Quality (dB)
	29. Received Signal Strength Indicator (dBm)

N	Results Returned
	<p>30. Channel Power (dBm)</p> <p>TD-SCDMA Results</p> <p>The result contents are customizable. See "TD-SCDMA Result Output Selection (SCPI only)" on page 1836 section for details. If no result is available, NaN (9.91E+37) is returned.</p> <p>#. Result Name (average mode) <explanations>, where average mode is one of:</p> <ul style="list-style-type: none"> Average : Averaged value in average cycle Peak Hold : Detected Peak/Maximum value in average cycle Latest : Value at last average cycle <p>1. Rho (Average) (float) [NA] Averaged composite Rho (in average cycle) in the selected timeslot and sub-frame.</p> <p>2. Rho (Peak Hold) (float) [NA] Peak/Maximum composite Rho (in average cycle) in the selected timeslot and sub-frame.</p> <p>3. RMS EVM (Average) (float) [% rms] Averaged composite RMS EVM (in average cycle) in the selected timeslot and sub-frame.</p> <p>4. RMS EVM (Peak Hold) (float) [% rms] Peak/Maximum composite RMS EVM (in average cycle) in the selected timeslot and sub-frame.</p> <p>5. Peak EVM (Average) (float) [% pk] Averaged composite peak EVM (in average cycle) in the selected timeslot and sub-frame.</p> <p>6. Peak EVM (Peak Hold) (float) [% pk] Peak/Maximum composite peak EVM (in average cycle) in the selected timeslot and sub-frame.</p> <p>7. RMS Magnitude Error (Average) (float) [% rms] Averaged composite RMS magnitude error (in average cycle) in the selected timeslot and sub-frame.</p> <p>8. RMS Magnitude Error (Peak Hold) (float) [% rms] Peak/Maximum composite RMS magnitude error (in average cycle) in the selected timeslot and sub-frame.</p> <p>9. Peak Magnitude Error (Average) (float) [% pk] Averaged composite peak magnitude error in the selected timeslot and sub-frame.</p> <p>10. Peak Magnitude Error (Peak Hold) (float) [% pk] Peak/Maximum composite peak magnitude error in the selected timeslot and sub-frame.</p> <p>11. RMS Phase Error (Average) (float) [° rms] Averaged composite RMS phase error (in average cycle) in the selected timeslot and sub-frame.</p> <p>12. RMS Phase Error (Peak Hold) (float) [° rms] Peak/Maximum composite RMS phase error (in average cycle) in the selected timeslot and sub-frame.</p> <p>13. Peak Phase Error (Average) (float) [° pk] Averaged composite peak phase error (in average cycle) in the selected timeslot and sub-frame.</p> <p>14. Peak Phase Error (Peak Hold) (float) [° pk] Peak/Maximum composite peak phase error (in average cycle) in the selected timeslot and sub-frame.</p> <p>15. Peak CDE (Average) (float) [dB] Averaged Peak code domain error of all code channels (in average cycle), including active code channels and inactive code channels. When DwPTS or UpPTS is selected, NaN will be returned.</p>

N	Results Returned
16.	<p>Peak CDE (Peak Hold) (float) [dB]</p> <p>Peak/Maximum Peak code domain error of all code channels (in average cycle), including active code channels and inactive code channels.</p> <p>When DwPTS or UpPTS is selected, NaN will be returned.</p>
17.	<p>Peak Active CDE (Average) (float) [dB]</p> <p>Averaged Peak Code Domain Error of active code channels (in average cycle).</p> <p>If no active channel is detected, NaN will be returned.</p> <p>When DwPTS or UpPTS is selected, NaN will be returned.</p>
18.	<p>Peak Active CDE (Peak Hold) (float) [dB]</p> <p>Peak/Maximum Peak Code Domain Error of active code channels (in average cycle).</p> <p>If no active channel is detected, NaN will be returned.</p> <p>When DwPTS or UpPTS is selected, NaN will be returned.</p>
19.	<p>Frequency Error (Average) (float) [Hz]</p> <p>Averaged composite frequency error (in average cycle) in the selected timeslot and sub-frame.</p>
20.	<p>Frequency Error (Peak Hold) (float) [Hz]</p> <p>Peak/Maximum composite frequency error (in average cycle) in the selected timeslot and sub-frame.</p>
21.	<p>IQ Offset (Average) (float) [dB]</p> <p>Averaged composite IQ offset (in average cycle) in the selected timeslot and sub-frame.</p>
22.	<p>IQ Offset (Peak Hold) (float) [dB]</p> <p>Peak/Maximum composite IQ offset (in average cycle) in the selected timeslot and sub-frame.</p>
23.	<p>Quad Error (Average) (float) [°]</p> <p>Averaged composite Quad Error (in average cycle) in the selected timeslot and sub-frame.</p>
24.	<p>Quad Error (Peak Hold) (float) [°]</p> <p>Peak/Maximum composite Quad Error (in average cycle) in the selected timeslot and sub-frame.</p>
25.	<p>Gain Imbalance (Average) (float) [dB]</p> <p>Averaged composite gain imbalance (in average cycle) in the selected timeslot and sub-frame.</p>
26.	<p>Gain Imbalance (Peak Hold) (float) [dB]</p> <p>Peak/Maximum composite gain imbalance (in average cycle) in the selected timeslot and sub-frame.</p>
27.	<p>Time Offset (Average) (float) [chips]</p> <p>Averaged composite timing error (in average cycle) in chips, relative to the timing reference (DwPTS/UpPTS/Trig)</p>
28.	<p>Time Offset (Peak Hold) (float) [chips]</p> <p>Peak/Maximum composite timing error (in average cycle) in chips, relative to the timing reference (DwPTS/UpPTS/Trig)</p>
29.	<p>Position of Peak CDE – Code Length (Peak Hold) (float) [NA]</p> <p>Code channel number of Peak/Maximum Peak CDE (in average cycle) is SX(Y). X is the OVFSF code length (1,2,4,8,16), Y is the OVFSF code index (0, ... X-1). OVFSF code length X is returned.</p> <p>When DwPTS or UpPTS is selected, NaN will be returned.</p>
30.	<p>Position of Peak CDE – Code Index (Peak Hold) (float) [NA]</p> <p>Code channel number of Peak/Maximum Peak CDE (in average cycle) is SX(Y). X is the OVFSF code length (1,2,4,8,16), Y is the OVFSF code index (0, ... X-1). OVFSF Code index Y is returned.</p>

N	Results Returned																		
	<p>When DwPTS or UpPTS is selected, NaN will be returned.</p> <p>31. Position of Peak Active CDE – Code Length (Peak Hold) (float) [NA] Code channel number of Peak/Maximum Peak Active CDE (in average cycle) is SX(Y). X is the OVFSF length (1,2,4,8,16), Y is the OVFSF code index (0, ..., X-1). OVFSF code length X is returned. If no active channel is detected, NaN will be returned.</p> <p>When DwPTS or UpPTS is selected, NaN will be returned.</p> <p>32. Position of Peak Active CDE – Code Index (Peak Hold) (float) [NA] Code channel number of Peak/Maximum Peak Active CDE (in average cycle) is SX(Y). X is the OVFSF code length (1,2,4,8,16), Y is the OVFSF code index (0, ..., X-1). OVFSF code index Y is returned. If no active channel is detected, NaN will be returned.</p> <p>When DwPTS or UpPTS is selected, NaN will be returned.</p> <p>33. Number of Active Channels (float) [NA] Number of active channels in the selected timeslot and sub-frame.</p> <p>34. Total Data Power (float) [dBm] The total data part power of the selected timeslot and sub-frame.</p>																		
2	<p>Carrier Results Location Pointer</p> <p>Returns results location pointer of each carrier for Remote Command SCPI Results, n = 1. The total result length is variable. The returned contents vary depending on the carrier configuration. Returns the following scalar results:</p> <ol style="list-style-type: none"> 1. Index where measurement result of the 1st carrier starts. 2. Index where measurement result of the 2nd carrier starts. 3. Index where measurement result of the 3rd carrier starts. 4. Index where measurement result of the 4th carrier starts. <p>...</p> <p>nCarr. Index where measurement results of last carrier starts.</p> <p>Where nCarr is the number of carriers to be measured.</p>																		
3	<p>Error Information of each Carrier</p> <p>Returns total error information of each carrier. The values are bitwise OR operated on the Error Information as follows:</p> <table border="1" data-bbox="370 1476 1446 1738"> <tr> <td>No Error</td> <td>0</td> <td>0x00000000</td> </tr> <tr> <td>Parameter Setting Conflict</td> <td>1</td> <td>0x00000001</td> </tr> <tr> <td>ADC OverRange</td> <td>2</td> <td>0x00000010</td> </tr> <tr> <td>Sync Error</td> <td>4</td> <td>0x00000100</td> </tr> <tr> <td>Demod Error</td> <td>8</td> <td>0x00001000</td> </tr> <tr> <td>Burst Not Found</td> <td>16</td> <td>0x00010000</td> </tr> </table> <p>For example, if ADC Over Range and Sync Error occurred, the value is 6. The total result length is variable. The returned contents vary depending on the carrier configuration. Returns the following scalar results:</p>	No Error	0	0x00000000	Parameter Setting Conflict	1	0x00000001	ADC OverRange	2	0x00000010	Sync Error	4	0x00000100	Demod Error	8	0x00001000	Burst Not Found	16	0x00010000
No Error	0	0x00000000																	
Parameter Setting Conflict	1	0x00000001																	
ADC OverRange	2	0x00000010																	
Sync Error	4	0x00000100																	
Demod Error	8	0x00001000																	
Burst Not Found	16	0x00010000																	

N	Results Returned
	1.Total Error Information of 1 st carrier. 2.Total Error Information of 2nd carrier. 3.Total Error Information of the 3rd carrier. 4.Total Error Information of the 4th carrier. ... nCarr. Total Error Information of the last carrier. Where nCarr is the number of carriers to be measured.

WCDMA Specific Remote Command SCPI Results

The following are WCDMA specific Remote Command SCPI Results.

- WCDMA Slot RMS EVM Query (SCPI Only)
- WCDMA Slot Frequency Error Query (SCPI Only)

WCDMA Slot RMS EVM Query (SCPI Only)

Returns a series of floating point numbers (in percent) that represent each slot RMS EVM trace of Capture Interval. Total length of trace is equivalent to Capture Interval in slot. If no result is available, NaN (9.91E+37) is returned.

Remote Command	:CALCulate:CEVM:WCDMa:RMSevm? <integer>
Example	<p>For example, when Carrier Index is 1 and Capture Length is 15 slots, the query command :CALC:CEVM:WCDMA:RMS? 1 returns the trace as follows:</p> <p>1.810794942E+00, 1.834260512E+00, 1.834396193E+00, 1.833849078E+00, 1.851578366E+00, 1.844391360E+00, 1.864154369E+00, 1.839423499E+00, 1.834623128E+00, 1.883643539E+00, 1.867448722E+00, 1.827889353E+00, 1.825238749E+00, 1.825094071E+00, 1.816015947E+00</p> <p>Recommended sequence of SCPI commands is as follows.</p> <p>INIT:CONT OFF READ:CEVM? CALC:CEVM:WCDMA:RMS? 1</p>
Notes	<p>Parameter <integer> is any valid Carrier Index for WCDMA. This command does not assure measurement completion to return the result. Therefore it is recommended to run measurement as single mode and to assure measurement completion by *opc? or READ:CEVM? as shown in SCPI Example.</p>
Initial S/W Revision	A.11.00

WCDMA Slot Frequency Error Query (SCPI Only)

Returns a series of floating point numbers (in percent) that represent each slot Frequency Error trace of Capture Interval. Total length of trace is equivalent to Capture Interval in slot. If no result is available, NaN (9.91E+37) is returned.

Remote Command	:CALCulate:CEVM:WCDMa:FERRor? <integer>
Example	<p>For example, when Carrier Index is 1 and Capture Length is 15 slots, the query command :CALC:CEVM:WCDMA:FERR? 1 returns the trace as follows:</p> <p>-9.447783951E+00, -8.887693935E+00, -9.550971994E+00, -9.306154642E+00, -8.928877240E+00, -8.494433812E+00, -9.228602710E+00, -9.268674496E+00, -8.975340803E+00, -9.054861328E+00, -9.481389199E+00, -9.254381500E+00, -8.706714019E+00, -9.349441184E+00, -8.656034862E+00</p> <p>Recommended sequence of SCPI commands is as follows.</p> <p>INIT:CONT OFF</p> <p>READ:CEVM?</p> <p>CALC:CEVM:WCDMA:FERR? 1</p>
Notes	Parameter <integer> is any valid Carrier Index for WCDMA. This command does not assure measurement completion to return the result. Therefore it is recommended to run measurement as single mode and to assure measurement completion by *opc? or READ:CEVM? as shown in SCPI Example.
Initial S/W Revision	A.11.00

Key Path	Front-panel key
Initial S/W Revision	A.10.00
Modified at S/W Revision	A.11.00, A.13.00, A.14.50

AMPTD (Amplitude) Y Scale

See AMPTD Y Scale, Amptd/Y Scale for details.

Key Path	Front-panel key
Initial S/W Revision	A.10.00

Attenuation

This menu controls the attenuator functions and interactions between the attenuation system components.

There are two attenuator configurations in the X-Series. One is a dual attenuator configuration consisting of a mechanical attenuator and an optional electronic attenuator. The other configuration uses a single attenuator with combined mechanical and electronic sections that controls all the attenuation functions. Different models in the X-Series come with different configurations.

See ["Dual Attenuator Configurations:" on page 1740](#)

See ["Single Attenuator Configuration:" on page 1741](#)

Most Attenuation settings are the same for all measurements – they do not change as you change measurements. Settings like these are called “Meas Global” and are unaffected by Meas Preset.

Key Path	AMPTD Y Scale
Scope	Meas Global
Dependencies	In measurements that support the I/Q inputs, this key is unavailable when I/Q is the selected input, and is replaced by the Range key in that case.
Readback Line	Contains a summary in [] brackets of the current total attenuation. See the descriptions of the , " (Mech) Atten " on page 2297, and " Enable Elec Atten " on page 2299 keys for more detail on the contributors to the total attenuation. Note that when "Pre-Adjust for Min Clip" is on, this value can change at the start of every measurement.
Initial S/W Revision	Prior to A.02.00
Modified at S/W Revision	A.03.00

Dual Attenuator Configurations:

Configuration 1: Mechanical attenuator + optional electronic attenuator

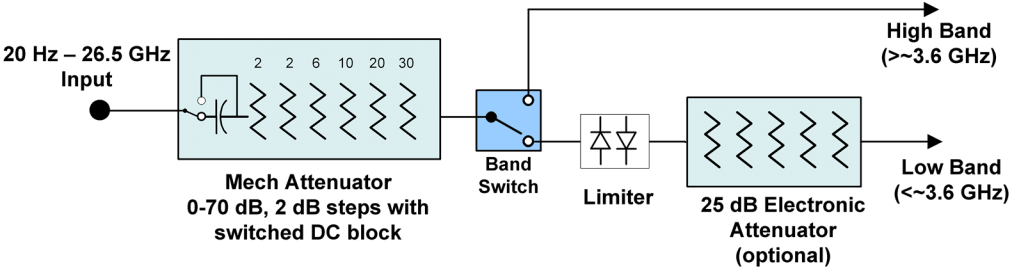

Configuration 2: Mechanical attenuator, no optional electronic attenuator

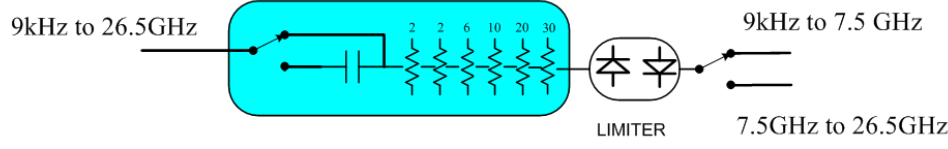

(note that Configuration 2 is not strictly speaking a dual-section attenuator, since there is no electronic section available. However, it behaves exactly like Configuration 1 without the Electronic Attenuator option EA3, therefore for the sake of this document it is grouped into the “Dual Attenuator” configuration)

Single Attenuator Configuration:

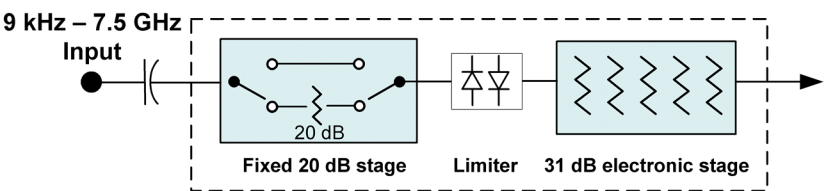

You can tell which attenuator configuration you have by pressing the Attenuation key, which (in most Modes) opens the Attenuation menu. If the first key in the Attenuation menu says **Mech Atten** you have the dual attenuator configuration. If the first key says **Atten** you have the single attenuator configuration.

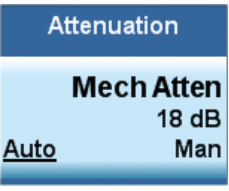

Dual Attenuator

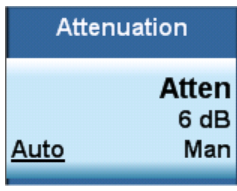

Single Attenuator

In the single attenuator configuration, you control the attenuation with a single control, as the fixed stage has only two states. In the dual attenuator configuration, both stages have significant range so you are given separate control of the mechanical and electronic attenuator stages.

When you have the dual attenuator configuration, you may still have only a single attenuator, because unless option EA3 (the Electronic Attenuator option) is available, and you purchase it, you will have only the mechanical attenuator.

(Mech) Atten

This key is labeled **Mech Atten** in dual attenuator models and **Atten** in single attenuator models. In the dual attenuator configuration, this key only affects the mechanical attenuator.

This key lets you modify the attenuation applied to the RF input signal path. This value is normally auto coupled to the Ref Level, the Internal Preamp Gain, any External Gain that is entered, and the Max Mixer Level, as described in the table below.

See "[Attenuator Configurations and Auto/Man](#)" on page 1743

Key Path	AMPTD Y Scale, Attenuation
Remote Command	<pre>[:SENSe] :POWer [:RF] :ATTenuation <rel_ampl> [:SENSe] :POWer [:RF] :ATTenuation? [:SENSe] :POWer [:RF] :ATTenuation:AUTO OFF ON 0 1 [:SENSe] :POWer [:RF] :ATTenuation:AUTO?</pre>
Example	<p>POW:ATT 20</p> <p>Dual attenuator configuration: sets the mechanical attenuator to 20 dB</p> <p>Single attenuator mode: sets the main attenuation to 20 dB (see below for definition of “main” attenuation).</p> <p>If the attenuator was in Auto, it sets it to Manual.</p>
Dependencies	<p>Some measurements do not support the Auto setting of (Mech) Atten. In these measurements, the Auto/Man selection is not available, and the Auto/Man line on the key disappears.</p> <p>In dual attenuator configurations, when the electronic attenuator is enabled, the mechanical attenuator has no auto setting and the Auto/Man line on the key disappears. The state of Auto/Man is remembered and restored when the electronic attenuator is once again disabled. This is described in more detail in the "Enable Elec Atten" on page 2299 key description.</p> <p>See "Attenuator Configurations and Auto/Man" on page 1743 for more information on the Auto/Man functionality of Attenuation.</p>
Couplings	<p>When (Mech) Atten is in Auto, it uses the following algorithm to determine a value:</p> <p>If the USB Preamp is connected to USB, use 0 dB.</p> <p>Otherwise, $Atten = ReferenceLevel + PreAmpGain + ExternalGain - RefLevelOffset - MaxMixerLevel + IF\ Gain$.</p> <p>Limit this value to be between 6 dB and the Max value. No value below 6 dB can ever be chosen by Auto.</p> <p>The resulting value is rounded up to the largest value possible given the attenuation step setting. That is, 50.01 dB would change to 60 dB (for a 10 dB attenuation step).</p> <p>The “IF Gain” term in the equation above is either 0 dB or +10 dB, depending on the settings of FFT IF Gain, Swept IF Gain, max Ref Level and the Auto/Man setting of Mech Atten.</p> <p>In External Mixing and BBIQ, where the Attenuator is not in the signal path, the Attenuator setting changes as described above when (Mech) Atten is in Auto, but no changes are made to the actual attenuator hardware setting until the input is changed back to the RF Input.</p>
Preset	<p>The preset for Mech Attenuation is “Auto.”</p> <p>The Auto value of attenuation is:</p> <p>CXA, EXA, MXA and PXA: 10 dB</p>

State Saved	Saved in instrument state
Min	0 dB The attenuation set by this key cannot be decreased below 6 dB with the knob or step keys. To get to a value below 6 dB it has to be directly entered from the keypad or via SCPI. This protects from adjusting the attenuation to a dangerously small value which can put the instrument at risk of damage to input circuitry. However, if the current mechanical attenuation is below 6 dB it can be increased with the knob and step keys, but not decreased.
Max	CXA N9000A-503/507: 50 dB CXA N9000A-513/526: 70dB EXA: 60 dB MXA and PXA: 70 dB In the single attenuator configuration, the total of ATT and EATT cannot exceed 50 dB, so if the EATT is set to 24 dB first, the main attenuation cannot be greater than 26 dB and will be reduced accordingly; if the main attenuator is set to 40 dB first, EATT cannot be greater than 10 dB.
Initial S/W Revision	Prior to A.02.00
Modified at S/W Revision	A.03.00

Attenuator Configurations and Auto/Man

As described in the Attenuation key description, there are two distinct attenuator configurations available in the X-Series, the single attenuator and dual attenuator configurations. In dual attenuator configurations, we have the mechanical attenuation and the electronic attenuation, and the current total attenuation is the sum of the electronic + mechanical attenuation. In single attenuator configurations, we refer to the attenuation set using the **(Mech) Atten** key (or POW:ATT SCPI) as the “main” attenuation; and the attenuation that is set by the SCPI command POW:EATT as the “soft” attenuation (the POW:EATT command is honored even in the single attenuator configuration, for compatibility purposes). Then the current total attenuation is the sum of the main + soft attenuation. See the **Elec Atten** key description for more on “soft” attenuation.

In the dual attenuator configuration, when the electronic attenuator is enabled, there is no Auto/Man functionality for the mechanical attenuator, and the third line of the key label (the Auto/Man line) disappears:

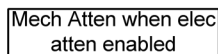
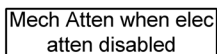
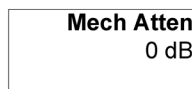
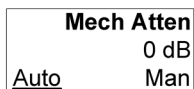

vsd05

Enable Elec Atten

Enables the Electronic Attenuator.

The electronic attenuator offers finer steps than the mechanical attenuator, has no acoustical noise, is faster, and is less subject to wear. These advantages primarily aid in remote operation and are negligible

for front panel use. See ["Using the Electronic Attenuator: Pros and Cons" on page 1745](#) for a detailed discussion of the pros and cons of using the electronic attenuator.

For the single attenuator configuration, for SCPI backwards compatibility, the “soft” attenuation feature replaces the dual attenuator configuration’s electronic attenuator. All the same couplings and limitations apply. See ["Attenuator Configurations and Auto/Man" on page 2299](#)

See ["More Information" on page 1744](#)

Key Path	AMPTD Y Scale, Attenuation
Remote Command	[:SENSe] :POWer [:RF] :EATTenuation :STATe OFF ON 0 1 [:SENSe] :POWer [:RF] :EATTenuation :STATe ?
Example	POW:EATT:STAT ON
Dependencies	<p>This key only appears in Dual Attenuator models with an Electronic Attenuator installed. It does not appear in models with the Single Attenuator configuration, as in the single attenuator configuration there is no “electronic attenuator” there is only a single integrated attenuator (which has both a mechanical and electronic stage). However, in the single attenuator configuration, EATT SCPI commands are accepted for compatibility with other X-series instruments and set a “soft” attenuation as described in "Attenuator Configurations and Auto/Man" on page 2299.</p> <p>The electronic attenuator (and the “soft” attenuation function provided in single attenuator configurations) is unavailable above 3.6 GHz. Therefore, if the Stop Frequency of the analyzer is > 3.6 GHz then the Enable Elec Atten key will be OFF and grayed out.</p> <p>If the Internal Preamp is on, meaning it is set to Low Band or Full, the electronic attenuator (and the “soft” attenuation function provided in single attenuator configurations) is unavailable. In this case the Enable Elec Atten key will be OFF and grayed out.</p> <p>If either of the above is true, if the SCPI command is sent, an error indicating that the electronic attenuator is unavailable will be sent.</p> <p>If the electronic/soft Attenuator is enabled, then the Stop Freq of the analyzer is limited to 3.6 GHz and the Internal Preamp is unavailable.</p> <p>The SCPI-only “soft” electronic attenuation for the single-attenuator configuration is not available in all measurements; in particular, it is not available in the Swept SA measurement.</p>
Couplings	Enabling and disabling the Electronic Attenuator affects the setting of the Mechanical Attenuator (in dual attenuator configurations). This is described in more detail below this table.
Preset	OFF for Swept SA measurement; ON for all other measurements that support the electronic attenuator
State Saved	Saved in instrument state
Initial S/W Revision	Prior to A.02.00
Modified at S/W Revision	A.03.00

More Information

Mechanical Attenuator Transition Rules

When the Electronic Attenuator is enabled, the Mechanical Attenuator transitions to a state that has no Auto function. Below are the rules for transitioning the Mechanical Attenuator. NOTE that the information

below ONLY applies to the dual attenuator configurations, and ONLY when the Electronic Attenuator is installed:

When the Electronic Attenuation is enabled from a disabled state:

- The Mechanical Attenuator is initialized to 10 dB (this is its optimal performance setting). You can then set it as desired with SCPI, numeric keypad, step keys, or knob, and it behaves as it normally would in manual mode
- The Auto/Man state of (Mech) Atten is saved
- The Auto/Man line on the (Mech) Atten key disappears and the auto rules are disabled
- The Electronic Attenuator is set to 10 dB less than the previous value of the Mechanical Attenuator, within the limitation that it must stay within the range of 0 to 24 dB of attenuation.

Examples in the dual attenuator configuration:

- Mech Atten at 20 dB. Elec Atten enabled, Mech Atten set to 10 dB, and Elec Atten set to 10 dB. New total attenuation equals the value before Elec Atten enabled.
- Mech Atten at 0 dB. Elec Atten enabled, Mech Atten set to 10 dB, and Elec Atten set to 0 dB. New total attenuation does not equal the value before Elec Atten enabled.
- Mech Atten at 40 dB. Elec Atten enabled, Mech Atten set to 10 dB, and Elec Atten set to 24 dB. New total attenuation does not equal the value before Elec Atten enabled.

When the Electronic Attenuation is disabled from an enabled state:

- The Elec Atten key is grayed out
- The Auto/Man state of (Mech) Atten is restored
- If now in Auto, (Mech) Atten recouples
- If now in Man, (Mech) Atten is set to the value of total attenuation that existed before the Elec Atten was disabled. The resulting value is rounded up to the smallest value possible given the (Mech) Atten Step setting - (That is, 57 dB changes to 58 dB when (Mech) Atten Step is 2 dB.)

Using the Electronic Attenuator: Pros and Cons

The electronic attenuator offers finer steps than the mechanical attenuator, has no acoustical noise, is faster, and is less subject to wear.

The “finer steps” advantage of the electronic attenuator is beneficial in optimizing the alignment of the analyzer dynamic range to the signal power in the front panel as well as remote use. Thus, you can achieve improved relative signal measurement accuracy. Compared to a mechanical attenuator with 2 dB steps, the 1 dB resolution of the electronic attenuator only gives better resolution when the odd-decibel steps are used. Those odd-decibel steps are less accurately calibrated than the even-decibel steps, so one tradeoff for this superior relative accuracy is reduced absolute amplitude accuracy.

Another disadvantage of the electronic attenuator is that the spectrum analyzer loses its “Auto” setting, making operation less convenient.

Also, the relationship between the dynamic range specifications (TOI, SHI, compression and noise) and instrument performance are less well-known with the electrical attenuator. With the mechanical

attenuator, TOI, SHI and compression threshold levels increase dB-for-dB with increasing attenuation, and the noise floor does as well. With the electronic attenuator, there is an excess attenuation of about 1 to 3 dB between 0 and 3.6 GHz, making the effective TOI, SHI, and so forth, less well known. Excess attenuation is the actual attenuation relative to stated attenuation. Excess attenuation is accounted for in the analyzer calibration

Elec Atten

Controls the Electronic Attenuator in dual attenuator configurations. This key does not appear in single attenuator configurations, as the control of both the mechanical and electronic stages of the single attenuator is integrated into the single **Atten** key.

Key Path	AMPTD Y Scale, Attenuation
Remote Command	<code>[:SENSe] :POWer [:RF] :EATTenuation <rel_ampl></code> <code>[:SENSe] :POWer [:RF] :EATTenuation?</code>
Notes	Electronic Attenuation's specification is defined only when Mechanical Attenuation is 6 dB.
Dependencies	This key only appears in Dual Attenuator models with an Electronic Attenuator installed. It does not appear in models with the Single Attenuator configuration, as in the single attenuator configuration there is no "electronic attenuator" there is only a single integrated attenuator (which has both a mechanical and electronic stage). However, in the single attenuator configuration, EATT SCPI commands are accepted for compatibility with other X-series instruments and set a "soft" attenuation as described in " Attenuator Configurations and Auto/Man " on page 2299. The "soft" attenuation is treated as an addition to the "main" attenuation value set by the Atten softkey or the POW:ATT SCPI command and affects the total attenuation displayed on the Attenuation key and the Meas Bar. When Enable Elec Atten is off or grayed out, the Elec Atten key is grayed out.
Preset	0 dB
State Saved	Saved in instrument state
Min	0 dB
Max	Dual attenuator configuration: 24 dB Single attenuator configuration: the total of ATT and EATT cannot exceed 50 dB, so if the EATT is set to 24 dB first, the main attenuation cannot be greater than 26 dB and will be reduced accordingly; if the main attenuator is set to 40 dB first, EATT cannot be greater than 10 dB
Initial S/W Revision	Prior to A.02.00
Modified at S/W Revision	A.03.00

Adjust Atten for Min Clip

Sets the combination of mechanical and electronic attenuation and gain based on the current measured signal level so that clipping will be at a minimum.

This is an "immediate action" function, that is, it executes once, when the key is pressed.

This key is grayed out in measurements that do not support this functionality. The spectrum analyzer measurement, Swept SA, does not support this functionality.

Key Path	AMPTD Y Scale, Attenuation
Remote Command	<code>[:SENSe] :POWer [:RF] :RANGe:OPTimize IMMEDIATE</code>
Initial S/W Revision	Prior to A.02.00
Modified at S/W Revision	A.03.00

Pre-Adjust for Min Clip

If this function is on, it does the adjustment described under "[Adjust Atten for Min Clip](#)" on page 2302 each time a measurement restarts. Therefore, in Continuous measurement mode, it only executes before the first measurement.

In dual attenuator models, you can set **Elec+Mech Atten**, in which case both attenuators participate in the autoranging, or **Elec Atten Only**, in which case the mechanical attenuator does not participate in the autoranging. This latter case results in less wear on the mechanical attenuator and is usually faster.

This key is grayed out in measurements that do not support this functionality. The spectrum analyzer measurement, Swept SA, does not support this functionality.

Key Path	AMPTD Y Scale, Attenuation
Remote Command	<code>[:SENSe] :POWer [:RF] :RANGe:OPTimize:ATTenuation OFF ELECTrical COMBined</code> <code>[:SENSe] :POWer [:RF] :RANGe:OPTimize:ATTenuation?</code>
Notes	The SCPI parameter ELECTrical sets this function to On in single attenuator models. The SCPI parameter COMBined is mapped to ELECTrical in single attenuator models; if you send COMBined, it sets the function to On and returns ELEC to a query.
Dependencies	This key only appears in Dual Attenuator models with an Electronic Attenuator installed. In instruments with Dual Attenuator model, when Enable Elec Atten is off or grayed out, the Pre-Adjust for Min Clip key is grayed out.
Preset	OFF for Swept SA measurement; ON for all other measurements that support Pre-Adjust for Min Clip
State Saved	Saved in instrument state
Range	Dual attenuator models: Off Elec Atten Only Mech + Elec Atten Single attenuator models: Off On
Initial S/W Revision	Prior to A.02.00
Modified at S/W Revision	A.03.00

Remote Command	<code>[:SENSe] :POWer [:RF] :RANGe:AUTO ON OFF 1 0</code> <code>[:SENSe] :POWer [:RF] :RANGe:AUTO?</code>
Notes	ON aliases to "Elec Atten Only" (:POW:RANG:OPT:ATT ELEC)

	OFF aliases to "Off" (:POW:RANG:OPT:ATT OFF) The query :POW:RANG:AUTO? returns true if :POW:RANG:OPT:ATT is not "Off"
Initial S/W Revision	Prior to A.02.00

Off

Turns **Pre-Adjust for Min Clip** off. This is the default setting.

This key is grayed out in measurements that do not support this functionality. The spectrum analyzer measurement, Swept SA, does not support this functionality.

Key Path	AMPTD Y Scale, Attenuation, Pre-Adjust for Min Clip
Example	:POW:RANGe:OPT:ATT OFF
Initial S/W Revision	Prior to A.02.00

Elec Atten Only

Selects only the electric attenuator to participate in auto ranging. This offers less wear on the mechanical attenuator and is usually faster.

This key is grayed out in measurements that do not support this functionality. The spectrum analyzer measurement, Swept SA, does not support this functionality.

Key Path	AMPTD Y Scale, Attenuation, Pre-Adjust for Min Clip
Example	:POW:RANGe:OPT:ATT ELEC
Initial S/W Revision	Prior to A.02.00

Mech + Elec Atten

In dual attenuator models, this selects both attenuators participate in the autoranging.

This key is grayed out in measurements that do not support this functionality. The spectrum analyzer measurement, Swept SA, does not support this functionality.

Key Path	AMPTD Y Scale, Attenuation, Pre-Adjust for Min Clip
Example	:POW:RANGe:OPT:ATT COMB
Initial S/W Revision	Prior to A.02.00

(Mech) Atten Step

This controls the step size used when making adjustments to the input attenuation.

This key is labeled **Mech Atten Step** in dual attenuator models and **Atten Step** in single attenuator models. In the dual attenuator configuration, this key only affects the step size of the mechanical attenuator.

Key Path	AMPTD Y Scale, Attenuation
Remote Command	<code>[:SENSe] :POWer [:RF] :ATTenuation :STEP [:INCRement] 10 dB 2 dB</code> <code>[:SENSe] :POWer [:RF] :ATTenuation :STEP [:INCRement] ?</code>
Example	POW:ATT:STEP 2
Notes	Note this feature works like a 1-N choice from the front panel, but it takes a specific value (in dB) when used remotely. The only valid values are 2 and 10.
Dependencies	Blanked in CXA and EXA if option FSA (2 dB steps) is not present. If blanked, attempts to set it via SCPI will yield an error.
Couplings	When the attenuation step size changes, the current mechanical attenuation value is adjusted (if necessary) to be quantized to the new step size. That is, if step is set to 10 dB, mech atten is increased if necessary so it is a multiple of 10 dB
Preset	PXA and MXA: 2 dB EXA and CXA: 10 dB (2 dB with option FSA)
State Saved	Saved in instrument state
Initial S/W Revision	Prior to A.02.00
Modified at S/W Revision	A.03.00

Adjust Atten (Remote Command only)

Allows you to select;

-Electric attenuator only

-Combination of Electric attenuator and Mechanical attenuator

when the SCPI command `[:SENSe] :POWer [:RF] :RANGe :OPTimize IMMEDIATE` is executed.

Remote Command	<code>[:SENSe] :POWer [:RF] :RANGe :OPTimize :TYPE EONLY COMBined</code> <code>[:SENSe] :POWer [:RF] :RANGe :OPTimize :TYPE ?</code>
Example	POW:RANG:OPT:TYPE EONL POW:RANG:OPT:TYPE?
Preset	COMBined
State Saved	Saved in instrument state
Initial S/W Revision	A.16.00

Presel Center

When this key is pressed, the centering of the preselector filter is adjusted to optimize the amplitude accuracy at the frequency of the selected marker. If the selected marker is not on when Presel Center is

pressed, the analyzer will turn on the selected marker, perform a peak search, and then perform centering on the marker's center frequency. If the selected marker is already on and between the start and stop frequencies of the analyzer, the analyzer performs the preselector calibration on that marker's frequency. If the selected marker is already on, but outside the frequency range between Start Freq and Stop Freq, the analyzer will first perform a peak search, and then perform centering on the marker's center frequency.

The value displayed on the **Presel Adjust** key will change to reflect the new preselector tuning (see **Presel Adjust**).

A number of considerations should be observed to ensure proper operation. See "[Proper Preselector Operation](#)" on page 1750.

Key Path	AMPTD Y Scale
Remote Command	<code>[:SENSe] :POWer [:RF] :PCENter</code>
Example	POW:PCEN
Notes	Note that the rules outlined above under the key description apply for the remote command as well as the key. The result of the command is dependent on marker position, and so forth. Any message shown by the key press is also shown in response to the remote command.
Dependencies	<ul style="list-style-type: none"> • Grayed out if the microwave preselector is off.) • If the selected marker's frequency is below Band 1, advisory message 0.5001 is generated and no action is taken. • Grayed out if entirely in Band 0. • Blank in models that do not include a preselector, such as option 503. If the SCPI is sent in these instruments, it is accepted without error, and the query always returns 0. • Grayed out in the Spectrogram View.
Couplings	<p>The active marker position determines where the centering will be attempted.</p> <p>If the analyzer is in a measurement such as averaging when centering is initiated, the act of centering the preselector will restart averaging but the first average trace will not be taken until the centering is completed.</p>
Status Bits/OPC dependencies	<p>When centering the preselector, *OPC will not return true until the process is complete and a subsequent measurement has completed, nor will results be returned to a READ or MEASure command.</p> <p>The Measuring bit should remain set while this command is operating and should not go false until the subsequent sweep/measurement has completed.</p>
Initial S/W Revision	Prior to A.02.00
Modified at S/W Revision	A.03.00

Proper Preselector Operation

A number of considerations should be observed to ensure proper operation:

1. If the selected marker is off, the analyzer will turn on a marker, perform a peak search, and adjust the preselector using the selected marker's frequency. It uses the "highest peak" peak search method unqualified by threshold or excursion, so that there is no chance of a 'no peak found' error. It continues

with that peak, even if it is the peak of just noise. Therefore, for this operation to work properly, there should be a signal on screen in a preselected range for the peak search to find.

2. If the selected marker is already on, the analyzer will attempt the centering at that marker's frequency. There is no preselector for signals below about 3.6 GHz, therefore if the marker is on a signal below 3.6 GHz, no centering will be attempted and an advisory message generated
3. In some models, the preselector can be bypassed. If it is bypassed, no centering will be attempted in that range and a message will be generated.

Preselector Adjust

Allows you to manually adjust the preselector filter frequency to optimize its response to the signal of interest. This function is only available when **"Presel Center"** on page 2306 is available.

For general purpose signal analysis, using Presel Center is recommended. Centering the filter minimizes the impact of long-term preselector drift. Presel Adjust can be used instead to manually optimize the preselector. One application of manual optimization would be to peak the preselector response, which both optimizes the signal-to-noise ratio and minimizes amplitude variations due to small (short-term) preselector drifting.

Key Path	AMPTD Y Scale
Scope	Meas Global
Remote Command	<code>[:SENSe] :POWer [:RF] :PADJust <freq></code> <code>[:SENSe] :POWer [:RF] :PADJust?</code>
Example	POW:PADJ 100KHz POW:PADJ?
Notes	The value on the key reads out to 0.1 MHz resolution.
Dependencies	<ul style="list-style-type: none"> • Grayed out if microwave preselector is off.) • Grayed out if entirely in Band 0. • Blank in models that do not include a preselector, such as option 503. If the SCPI is sent in these instruments, it is accepted without error, and the query always returns 0. • Grayed out in the Spectrogram View.
Preset	0 MHz
State Saved	The Presel Adjust value set by Presel Center , or by manually adjusting Presel Adjust , is not saved in instrument state, and does not survive a Preset or power cycle.
Min	-500 MHz
Max	500 MHz
Default Unit	Hz
Backwards Compatibility SCPI	<code>[:SENSe] :POWer [:RF] :MW :PADJust</code> <code>[:SENSe] :POWer [:RF] :MMW :PADJust</code> PSA had multiple preselectors, but the X-Series has only one. These commands simply alias to <code>[:SENSe] :POWer [:RF] :PADJust</code>

Initial S/W Revision	Prior to A.02.00
Modified at S/W Revision	A.03.00

Remote Command	<code>[:SENSe] :POWer [:RF] :PADJust :PRESelector MWAVE MMWave EXTernal</code> <code>[:SENSe] :POWer [:RF] :PADJust :PRESelector?</code>
Notes	PSA had multiple preselectors, and you could select which preselector to adjust. Since the X-Series has only one mm/uW preselector, the preselector selection softkey is no longer available. However, to provide backward compatibility, we accept the legacy remote commands. The command form has no effect, the query always returns MWAVE

Initial S/W Revision	Prior to A.02.00
----------------------	------------------

μW Path Control

The **μW Path Control** functions include the **μW Preselector Bypass** (Option MPB) and **Low Noise Path** (Option LNP) controls in the High Band path circuits.

When the μW Preselector is bypassed, the user has better flatness, but will be subject to spurs from out of band interfering signals. When the Low Noise Path is enabled, the analyzer automatically switches around certain circuitry in the high frequency bands which can contribute to noise, when it is appropriate based on other analyzer settings.

For most applications, the preset state is Standard Path, which gives the best remote-control throughput, minimizes acoustic noise from switching and minimizes the risk of wear out in the hardware switches. For applications that utilize the wideband IF paths, the preset state is the μW Preselector Bypass path, if option MPB is present. This is because, when using a wideband IF such as the 140 MHz IF, the μW Preselector's bandwidth can be narrower than the available IF bandwidth, causing degraded amplitude flatness and phase linearity, so it is desirable to bypass the preselector in the default case.

Users may choose Low Noise Path Enable. It gives a lower noise floor, especially in the 21–26.5 GHz region, though without improving many measures of dynamic range, and without giving the best possible noise floor. The preamp, if purchased and used, gives better noise floor than does the Low Noise Path, however its compression threshold and third-order intercept are much poorer than that of the non-preamp Low Noise Path. There are some applications, typically for signals around –30 dBm, for which the third-order dynamic range of the standard path is good enough, but the noise floor is not low enough even with 0 dB input attenuation. When the third-order dynamic range of the preamp path is too little and the noise floor of the standard path is too high, the Low Noise Path can provide the best dynamic range.

Key Path	AMPTD Y Scale
Mode	SA, BASIC, PNOISE, VSA, LTE, LTETDD
Scope	Meas Global
Remote Command	<code>[:SENSe] :POWer [:RF] :MW :PATH STD LNPath MPBypass FULL</code> <code>[:SENSe] :POWer [:RF] :MW :PATH?</code>

Example	:POW:MW:PATH LNP Enables the Low Noise path
Notes	<p>If a Presel Center is performed, the analyzer will momentarily switch to the Standard Path, regardless of the setting of μW Path Control</p> <p>The DC Block will always be switched in when the low noise path is switched in, to protect succeeding circuitry from DC. Note that this does not mean “when the low noise path is enabled” but when, based on the Low Noise Path rules, the path is actually switched in. This can happen when the selection is Low Noise Path Enable . In the case where the DC Block is switched in the analyzer is now AC coupled. However, if the user has selected DC coupling, the UI will still behave as though it were DC coupled, including all annunciation, warnings, status bits, and responses to SCPI queries. This is because, based on other settings, the analyzer could switch out the low noise path at any time and hence go back to being DC coupled.</p> <p>Alignment switching ignores the settings in this menu, and restores them when finished.</p>
Dependencies	Unavailable in BBIQ and External Mixing
Preset	<p>All modes other than IQ Analyzer mode and VXA: STD</p> <p>IQ Analyzer, VXA and WLAN mode:</p> <p>MPB option present and licensed: MPB</p> <p>MPB option not present and licensed: STD</p>
State Saved	Save in instrument state
Readback	Value selected in the submenu
Initial S/W Revision	A.04.00
Modified at S/W Revision	A.10.00

Standard Path

This path gives the best remote-control throughput, minimizes acoustic noise from switching and minimizes the risk of wear in the hardware switches, particularly in remote test scenarios where both low band and high band setups will follow in rapid succession.

In this path, the bypass of the low band/high band switch and microwave preamp is never activated, which can cause some noise degradation but preserves the life of the bypass switch.

Key Path	AMPTD Y Scale, μW Path Control
Example	:POW:MW:PATH STD
Readback Text	Standard Path
Initial S/W Revision	A.04.00

Low Noise Path Enable

You may choose Low Noise Path Enable, which gives a lower noise floor under some circumstances, particularly when operating in the 21–26.5 GHz region. With the Low Noise Path enabled, the low band/high band switch and microwave preamp are bypassed whenever all of the following are true:

- The analyzer is not in the Low Band, meaning:

- the start frequency is above 3.5 GHz and
- the stop frequency is above 3.6 GHz.
- the internal preamp is not installed or (if installed) is set to **Off** or **Low Band**

Note that this means that, when any part of a sweep is done in Low Band, the Low Noise Path is not used, whether or not the **Low Noise Path Enable** is selected in the user interface. Also, if the preamp is turned on, the Low Noise Path is not used, whether or not the **Low Noise Path Enable** is selected in the user interface. The only time the Low Noise Path is used is when **Low Noise Path Enable** is selected, the sweep is completely in High Band (> 3.6 GHz) and no preamp is in use.

See "[More Information](#)" on page 1754

Key Path	AMPTD Y Scale, μ W Path Control
Measurement	Swept SA
Example	:POW:MW:PATH LNP
Notes	<p>For measurements that use IQ acquisition, the low noise path is used when the Center Frequency is in High Band (> 3.6 GHz) and no preamp is in use.</p> <p>In other words, the rules above are modified to use only the center frequency to qualify which path to switch in.</p> <p>This is not the case for FFT's in the Swept SA measurement; they use the same rules as swept measurements.</p>
Dependencies	<p>Key is blanked if current mode does not support it.</p> <p>Key is grayed out if mode supports it but current measurement does not support it.</p> <p>Unless Option LNP is present and licensed, key is blank and if SCPI command sent, error -241, "Hardware missing; Option not installed" is generated.</p>
Readback Text	Low Noise Path Enable
Initial S/W Revision	A.04.00

More Information

The user should understand that the Low Noise Path, while giving improved DANL, has the disadvantage of decreased TOI performance and decreased gain compression performance relative to the standard path.

The user should also understand that the bypass switch is a mechanical switch and has finite life, so if the **Low Noise Path** is enabled, it is possible to cause frequent cycling of this switch by frequently changing analyzer settings such that the above conditions hold true only some of the time. A user making tests of this nature should consider opting for the **Standard Path**, which will never throw the bypass switch, at the expense of some degraded noise performance.

The low noise path is useful for situations where the signal level is so low that the analyzer performance is dominated by noise even with 0 dB attenuation, but still high enough that the preamp option would have excessive third-order intermodulation or compression. The preamp, if purchased and used, gives better noise floor than does the "Low Noise Path." However, its compression threshold and third-order intercept are much poorer than that of the non-preamp path. There are some applications, typically for signals around -30 dBm, for which the third-order dynamic range of the standard path is good enough, but the noise floor is not low enough even with 0 dB input attenuation. When the third-order dynamic range of the

preamp path is too little and the noise floor of the standard path is too high, the Low Noise Path can provide the best dynamic range

The graph below illustrates the concept. It shows, in red, the performance of an analyzer at different attenuation settings, both with the preamp on and off, in a measurement that is affected by both analyzer noise and analyzer TOI. The green shows the best available dynamic range, offset by 0.5 dB for clarity. The blue shows how the best available dynamic range improves for moderate signal levels with the low noise path switched in. In this illustration, the preamp improves the noise floor by 15 dB while degrading the third-order intercept by 30 dB, and the low noise path reduces loss by 8 dB. The attenuator step size is 2 dB.

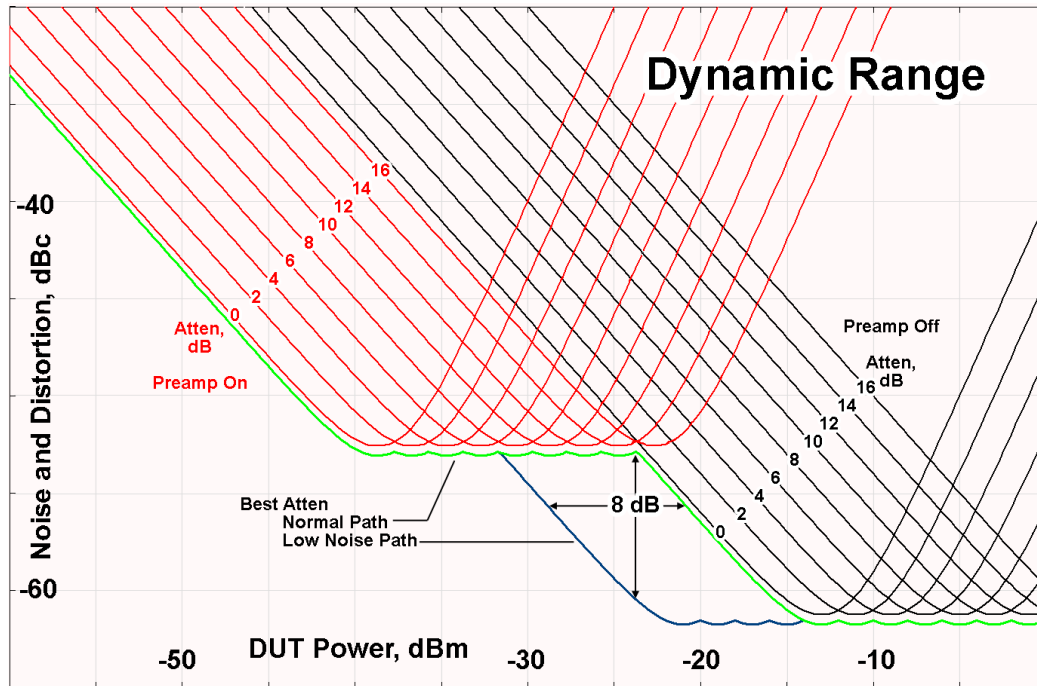

There are other times where selecting the low noise path improves performance, too. Compression-limited measurements such as finding the nulls in a pulsed-RF spectrum can profit from the low noise path in a way similar to the TOI-limited measurement illustrated. Accuracy can be improved when the low noise path allows the optimum attenuation to increase from a small amount like 0, 2 or 4 dB to a larger amount, giving better return loss at the analyzer input. Harmonic measurements, such as second and third harmonic levels, are much improved using the low noise path because of the superiority of that path for harmonic (though not intermodulation) distortion performance.

μW Preselector Bypass

This key toggles the preselector bypass switch for band 1 and higher. When the microwave preselector is on, the signal path is preselected. When the microwave preselector is off, the signal path is not preselected. The preselected path is the normal path for the analyzer.

The preselector is a tunable bandpass filter which prevents signals away from the frequency of interest from combining in the mixer to generate in-band spurious signals (images). The consequences of using a preselector filter are its limited bandwidth, the amplitude and phase ripple in its passband, and any amplitude and phase instability due to center frequency drift.

Option MPB or pre-selector bypass provides an unpreselected input mixer path for certain X-Series signal analyzers with frequency ranges above 3.6 GHz. This signal path allows a wider bandwidth and less amplitude variability, which is an advantage when doing modulation analysis and broadband signal analysis. The disadvantage is that, without the preselector, image signals will be displayed. Another disadvantage of bypassing the preselector is increased LO emission levels at the front panel input port.

Image responses are separated from the real signal by twice the 1st IF. For IF Paths of 10 MHz and 25 MHz, the 1st IF is 322.5 MHz, so the image response and the real signal will be separated by 645 MHz. The 1st IF will be different for other IF Path settings. When viewing a real signal and its corresponding image response in internal mixing, the image response will be to the left of the real signal.

Also, the image response and the real signal typically have the same amplitude and exhibit the same shape factor.

However, if Option FS1, Fast Sweep Capability, is enabled, the image response in the Swept SA measurement will appear lower in amplitude and have a much wider shape factor compared to the real signal.

Key Path	AMPTD Y Scale, μW Path Control
Example	:POW:MW:PATH MPB
Dependencies	Key is blanked if current mode does not support it. Key is grayed out if mode supports it but current measurement does not support it. Key is blank unless Option MPB is present and licensed. If SCPI command sent when MPB not present, error -241, "Hardware missing; Option not installed" is generated.
Readback Text	μ W Preselector Bypass
Initial S/W Revision	A.04.00

Remote Command	[:SENSE] :POWER [:RF] :MW:PRESelector [:STATE] ON OFF 0 1 [:SENSE] :POWER [:RF] :MW:PRESelector [:STATE] ?
Example	:POW:MW:PRES OFF Bypasses the microwave preselector
Notes	The ON parameter sets the STD path (:POW:MW:PATH STD) The OFF parameter sets path MPB (:POW:MW:PATH MPB)
Preset	ON

Internal Preamp

Accesses a menu of keys that control the internal preamps. Turning on the preamp gives a better noise figure, but a poorer TOI to noise floor dynamic range. You can optimize this setting for your particular measurement.

The instrument takes the preamp gain into account as it sweeps. If you sweep outside of the range of the preamp the instrument will also account for that. The displayed result will always reflect the correct gain.

For some measurements, when the preamp is on and any part of the displayed frequency range is below the lowest frequency for which the preamp has specifications, a warning condition message appears in the status line. For example, for a preamp with a 9 kHz lowest specified frequency: "Preamp: Accy unspc'd below 9 kHz".

Key Path	AMPTD Y Scale
Scope	Meas Global
Remote Command	[:SENSe] :POWer [:RF] :GAIN [:STATe] OFF ON 0 1 [:SENSe] :POWer [:RF] :GAIN [:STATe] ?
Dependencies	Preamp is not available on all hardware platforms. If the preamp is not present or is unlicensed, the key is not shown. The preamp is not available when the electronic/soft attenuator is enabled.
Couplings	The act of connecting the U7227A USB Preamplifier to one of the analyzer's USB ports will cause the Internal Preamp to be switched on. When this happens an informational message will be generated: "Internal Preamp turned on for optimal operation with USB Preamp." Note that if the Internal Preamp was already on, there will be no change to the setting, but if it was Off it will be switched On, to Full Range. Note that this same action occurs when the SA mode is selected while the USB Preamp is connected to one of the analyzer's USB ports, if it is the first time that the SA mode has run since powerup, or if the last time the SA mode was running the USB Preamp was NOT connected. Subsequently disconnecting the USB Preamp from USB does not change the Internal Preamp setting nor restore the previous setting.
Preset	OFF
State Saved	Saved in instrument state
Initial S/W Revision	Prior to A.02.00
Modified at S/W Revision	A.14.00

Key Path	AMPTD Y Scale, Internal Preamp
Scope	Meas Global
Remote Command	[:SENSe] :POWer [:RF] :GAIN :BAND LOW FULL [:SENSe] :POWer [:RF] :GAIN :BAND ?
Dependencies	Preamp is not available on all hardware platforms. If the preamp is not present or is unlicensed, the key is not shown. If a POW:GAIN:BAND FULL command is sent when a low band preamp is available, the preamp band parameter is to LOW instead of FULL, and an "Option not installed" message is generated.
Preset	LOW
State Saved	Saved in instrument state
Initial S/W Revision	Prior to A.02.00

Off

Turns the internal preamp off

Key Path	AMPTD Y Scale, Internal Preamp
Example	:POW:GAIN OFF
Readback	Off
Initial S/W Revision	Prior to A.02.00

Low Band

Sets the internal preamp to use only the low band.

The frequency range of the installed (optional) low-band preamp is displayed in square brackets on the **Low Band** key label.

Key Path	AMPTD Y Scale, Internal Preamp
Example	:POW:GAIN ON :POW:GAIN:BAND LOW
Readback	Low Band
Initial S/W Revision	Prior to A.02.00

Full Range

Sets the internal preamp to use its full range. The low band (0–3.6 GHz or 0–3GHz, depending on the model) is supplied by the low band preamp and the frequencies above low band are supplied by the high band preamp.

The frequency range of the installed (optional) preamp is displayed in square brackets on the **Full Range** key label. If the high band option is not installed the Full Range key does not appear.

Key Path	AMPTD Y Scale, Internal Preamp
Example	:POW:GAIN ON :POW:GAIN:BAND FULL
Readback	Full Range
Initial S/W Revision	Prior to A.02.00

Attenuation

See AMPTD Y Scale, "[Attenuation](#)" on page 2295 for details.

Auto Couple

The Auto Couple feature provides a quick and convenient way to automatically couple multiple instrument settings. This helps ensure accurate measurements and optimum dynamic range. When the Auto Couple feature is activated, either from the front panel or remotely, all parameters of the current measurement that have an Auto/Manual mode are set to Auto mode and all measurement settings dependent on (or coupled to) the Auto/Man parameters are automatically adjusted for optimal performance.

However, the Auto Couple key actions are confined to the current measurement only. It does not affect other measurements in the mode, and it does not affect markers, marker functions, or trace or display attributes.

See ["More Information" on page 1759](#)

Key Path	Front-panel key
Remote Command	:COUPle ALL NONE
Example	:COUP ALL
Notes	:COUPle ALL puts all Auto/Man parameters in Auto mode (equivalent to pressing the Auto Couple key). :COUPLE NONE puts all Auto/Man parameters in manual mode. It decouples all the coupled instrument parameters and is not recommended for making measurements.
Initial S/W Revision	Prior to A.02.00

More Information

There are two types of functions that have Auto/Manual modes.

Auto/Man Active Function keys

An Auto/Man toggle key controls the binary state associated with an instrument parameter by toggling between **Auto** (where the parameter is automatically coupled to the other parameters it is dependent upon) and **Man** (where the parameter is controlled independent of the other parameters), as well as making the parameter the active function. The current mode is indicated on the softkey with either **Auto** or **Man** underlined as illustrated below.

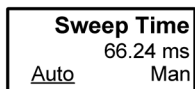

vsd07

Auto/Man 1-of-N keys

An Auto/Man 1-of-N key allows you to manually pick from a list of parameter values, or place the function in Auto, in which case the value is automatically selected (and indicated) as shown below. If in Auto, Auto is underlined on the calling key. If in manual operation, manual is indicated on the calling key. But the calling key does not actually toggle the function, it simply opens the menu.

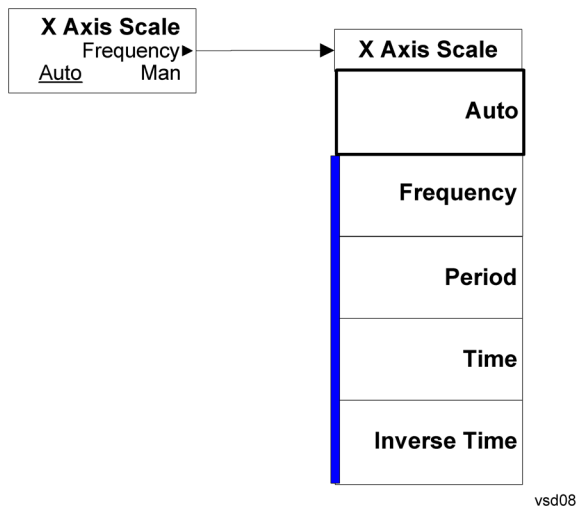

BW

There is no BW functionality in this measurement. When pressed, blank menu appears.

Key Path	Front-panel key
Initial S/W Revision	A.10.00

Cont (Continuous Measurement/Sweep)

Sets the analyzer for Continuous measurement operation. The single/continuous state is Meas Global so the setting will affect all measurements. If you are Paused, pressing **Cont** does a Resume.

Key Path	Front-panel key
Remote Command	:INITiate:CONTinuous OFF ON 0 1 :INITiate:CONTinuous?
Example	:INIT:CONT 0 puts analyzer in Single measurement operation. :INIT:CONT 1 puts analyzer in Continuous measurement operation
Preset	ON (Note that SYST:PRESet sets INIT:CONT to ON but *RST sets INIT:CONT to OFF)
State Saved	Saved in instrument state
Backwards Compatibility Notes	For Spectrum Analysis mode in ESA and PSA, there is no Cont hardkey, instead there is a Sweep Single/Cont key. In these analyzers, switching the Sweep Single/Cont key from Single to Cont restarts averages (displayed average count reset to 1), but does not restart Max Hold and Min Hold . The X-Series has Single and Cont keys in place of the SweepSingleCont key. In the X-Series, if in single measurement, the Cont key (and INIT:CONT ON) switches to continuous measurement, but never restarts a measurement and never resets a sweep.
Initial S/W Revision	Prior to A.02.00

In Swept SA Measurement (Spectrum Analysis Mode):

The analyzer takes repetitive sweeps, averages, measurements, etc., when in Continuous mode. When the average count reaches the Average/Hold Number the count stops incrementing, but the analyzer keeps sweeping. See the Trace/Detector section for the averaging formula used both before and after the Average/Hold Number is reached. The trigger condition must be met prior to each sweep. The type of trace processing for multiple sweeps, is set under the Trace/Detector key, with choices of **Trace Average**, **Max Hold**, or **Min Hold**.

In Other Measurements/Modes:

With **Avg/Hold Num** (in the **Meas Setup** menu) set to **Off** or set to **On** with a value of 1, a sweep is taken after the trigger condition is met; and the analyzer continues to take new sweeps after the current sweep has completed and the trigger condition is again met. However, with **Avg/Hold Num** set to On with a value >1, multiple sweeps (data acquisitions) are taken for the measurement. The trigger condition must be met prior to each sweep. The sweep is not stopped when the average count k equals the number N set for Avg/Hold Num is reached, but the number k stops incrementing. A measurement average usually applies to all traces, marker results, and numeric results. But sometimes it only applies to the numeric results.

If the analyzer is in Single measurement, pressing the **Cont** key does not change k and does not cause the sweep to be reset; the only action is to put the analyzer into Continuous measurement operation.

If it is already in continuous sweep:

the INIT:CONT 1 command has no effect

the INIT:CONT 0 command will place the analyzer in Single Sweep but will have no effect on the current sequence until $k = N$, at which point the current sequence will stop and the instrument will go to the idle state.

13 Conformance EVM
File

File

See "File" on page 362

FREQ Channel

Accesses a menu of keys that allow you to control the Frequency and Channel parameters of the instrument.

Some features in the Frequency menu are the same for all measurements - they do not change as you change measurements. Settings like these are called "Meas Global" and are unaffected by Meas Preset. For example, the Center Freq setting is the same for all measurements - it does not change as you change measurements.

Key Path	Front Panel
Mode	MSR
Initial S/W Revision	A.10.00

Carrier Ref Freq

Sets carrier reference frequency. The center frequencies of carriers are defined as offset frequency from this value. This reference frequency is also the reference of carrier configuration preset.

Key Path	FREQ Channel
Mode	MSR
Measurement	all
Remote Command	<code>[:SENSe] :CARRier:REFerence <freq></code> <code>[:SENSe] :CARRier:REFerence?</code>
Example	CARR:REF 2GHz CARR:REF?
Preset	1GHz
State Saved	Saved in instrument state
Min	Depends on instrument minimum center frequency. Same as Center Freq
Max	Depends on instrument maximum center frequency. Same as Center Freq
Initial S/W Revision	A.10.00

Carrier Setup

Accesses the Carrier Setup menu.

Key Path	FREQ Channel
Initial S/W Revision	A.10.00

Carriers

Specifies how many carriers are used in MSR measurements. Base station RF bandwidth is determined from the carrier 1 to the carrier specified by this value whatever carriers' Present Pwr states are. Select Carrier can be select up to this value.

Key Path	FREQ Channel, Carrier Setup
Measurement	All
Remote Command	<code>[:SENSe]:CARRier:COUNt <integer></code> <code>[:SENSe]:CARRier:COUNt?</code>
Example	CARR:COUN 10 CARR:COUN?
Preset	1
State Saved	Saved in instrument state.
Min	1
Max	100
Initial S/W Revision	A.10.00

Configure Carriers

Accesses a menu of commonly used carrier configuration parameters.

Key Path	FREQ Channel, Carrier Setup
Initial S/W Revision	A.10.00

Select Carrier

Selects which carrier's configuration menu is displayed.

This key is also connected to the carrier info tables of some measurements. When the value is changed in a measurement which has carrier table view, the highlight in the table moves to Select Carrier. The highlight of the table and Select Carrier are not coupled.

Key Path	FREQ Channel, Carrier Setup, Configure Carriers
Preset	1
State Saved	No
Min	1
Max	Value of Carriers
Initial S/W Revision	A.10.00

Measure Carrier

Sets whether to measure this carrier or not.

Key Path	FREQ Channel, Carrier Setup, Configure Carriers
Remote Command	<code>[:SENSe] :CARRier<n> [:STATe] OFF ON 0 1</code> <code>[:SENSe] :CARRier<n> [:STATe] ?</code>
Example	CARR10 1 CARR10?
Notes	The command is used with a sub-op code <n> (default=1) to specify the carrier for configuration. The range of the sub-op code is determined by the number of carriers.
Preset	ON
State Saved	Saved in instrument state
Range	On Off
Initial S/W Revision	A.10.00

Carrier Offset

Sets the carrier center frequency as offset from Carrier Ref Frequency.

Key Path	FREQ Channel, Carrier Setup, Configure Carriers
Remote Command	<code>[:SENSe] :CARRier<n> :FREQuency:OFFSet <freq></code> <code>[:SENSe] :CARRier<n> :FREQuency:OFFSet ?</code>
Example	CARR10:FREQ:OFFS 10MHz CARR10:FREQ:OFFS?
Notes	The command is used with a sub-op code <n> (default=1) to specify the carrier for configuration. The range of the sub-op code is determined by the number of carriers.
Preset	0Hz
State Saved	Saved in instrument state
Min	-1GHz
Max	1GHz
Initial S/W Revision	A.10.00

Radio Format

Selects a format parameter set to set the radio format of the selected carrier.

NONE – No format is specified. Channel spacing, measurement BW and FOffset,RAT are values of defaults of LTE FDD 5MHz.

LTE FDD Parameter Set 1 – Selects LTE FDD parameter set 1. LTE FDD (E-UTRA FDD) is the radio format of the carrier.

LTE FDD Parameter Set 2 – Selects LTE FDD parameter set 2. LTE FDD (E-UTRA FDD) is the radio format of the carrier.

LTE FDD Parameter Set 3 – Selects LTE FDD parameter set 3. LTE FDD (E-UTRA FDD) is the radio format of the carrier.

W-CDMA Parameter Set 1 – Selects W-CDMA parameter set 1. W-CDMA (UTRA FDD) is the radio format of the carrier.

W-CDMA Parameter Set 2 – Selects W-CDMA parameter set 2. W-CDMA (UTRA FDD) is the radio format of the carrier.

W-CDMA Parameter Set 3 – Selects W-CDMA parameter set 3. W-CDMA (UTRA FDD) is the radio format of the carrier.

GSM/EDGE Parameter Set 1 – Selects GSM/EDGE parameter set 1. GSM/EDGE is the radio format of the carrier.

GSM/EDGE Parameter Set 2 – Selects GSM/EDGE parameter set 2. GSM/EDGE is the radio format of the carrier.

GSM/EDGE Parameter Set 3 – Selects GSM/EDGE parameter set 3. GSM/EDGE is the radio format of the carrier.

cdma2000 Parameter Set 1 – Selects cdma2000 parameter set 1. cdma2000 is the radio format of the carrier.

cdma2000 Parameter Set 2 – Selects cdma2000 parameter set 2. cdma2000 is the radio format of the carrier.

cdma2000 Parameter Set 3 – Selects cdma2000 parameter set 3. cdma2000 is the radio format of the carrier.

1xEV-DO Parameter Set 1 – Selects 1xEV-DO parameter set 1. 1xEV-DO is the radio format of the carrier.

1xEV-DO Parameter Set 2 – Selects 1xEV-DO parameter set 2. 1xEV-DO is the radio format of the carrier.

1xEV-DO Parameter Set 3 – Selects 1xEV-DO parameter set 3. 1xEV-DO is the radio format of the carrier.

LTE TDD Parameter Set 1 – Selects LTE TDD parameter set 1. LTE TDD (E-UTRA TDD) is the radio format of the carrier.

LTE TDD Parameter Set 2 – Selects LTE TDD parameter set 2. LTE TDD (E-UTRA TDD) is the radio format of the carrier.

LTE TDD Parameter Set 3 – Selects LTE TDD parameter set 3. LTE TDD (E-UTRA TDD) is the radio format of the carrier.

TD-SCDMA Parameter Set 1 – Selects TD-SCDMA parameter set 1. TD-SCDMA (UTRA-TDD LCR) is the radio format of the carrier.

TD-SCDMA Parameter Set 2 – Selects TD-SCDMA parameter set 2. TD-SCDMA (UTRA-TDD LCR) is the radio format of the carrier.

TD-SCDMA Parameter Set 3 – Selects TD-SCDMA parameter set 3. TD-SCDMA (UTRA-TDD LCR) is the radio format of the carrier.

Key Path	FREQ Channel, Carrier Setup, Configure Carriers
Remote Command	[:SENSe]:CARRier<n>:FORMat NONE LTEFdd1 LTEFdd2 LTEFdd3 WCDMa1 WCDMa2 WCDMa3 GSM1 GSM2 GSM3 CDMA1 CDMA2 CDMA3 EVDO1 EVDO2 EVDO3 LTETdd1 LTETdd2 LTETdd3 TDSCdma1 TDSCdma2 TDSCdma3 [:SENSe]:CARRier<n>:FORMat ?
Example	CARR10:FORM LTEF1 CARR10:FORM?
Notes	The command is used with a sub-op code <n> (default=1) to specify the carrier for configuration. The range of the sub-op code is determined by the number of carriers.
Dependencies	The following licenses are required for each key to be displayed. Without the licenses, corresponding enum values cannot be set even via the SCPI command. <ul style="list-style-type: none"> • LTE FDD - N9080A-1FP or W9080A-1FP • W-CDMA - N9073A-1FP or W9073A-1FP • GSM/EDGE - N9071A-2FP or W9071A-2FP • cdma2000 - N9072A-2FP or W9072A-2FP • 1xEV-DO - N9076A-1FP or W9076A-1FP • LTE TDD - N9082A-1FP or W9082A-1FP • TD-SCDMA - N9079A-1FP or W9079A-1FP
State Saved	Saved in instrument state
Range	None LTE FDD [Parameter Set 1] Parameter Set 1 ("LTE FDD 1") Parameter Set 2 ("LTE FDD 2") Parameter Set 3 ("LTE FDD 3") W-CDMA [Parameter Set 1] Parameter Set 1 ("W-CDMA 1") Parameter Set 2 ("W-CDMA 2") Parameter Set 3 ("W-CDMA 3") GSM/EDGE [Parameter Set 1] Parameter Set 1 ("GSM/EDGE 1") Parameter Set 2 ("GSM/EDGE 2") Parameter Set 3 ("GSM/EDGE 3") cdma2000 [Parameter Set 1] Parameter Set 1 ("cdma2000 1") Parameter Set 2 ("cdma2000 2") Parameter Set 3 ("cdma2000 3") 1xEV-DO [Parameter Set 1] Parameter Set 1 ("1xEV-DO 1") Parameter Set 2 ("1xEV-DO 2") Parameter Set 3 ("1xEV-DO 3")

	LTE TDD [Parameter Set 1] Parameter Set 1 ("LTE TDD 1") Parameter Set 2 ("LTE TDD 2") Parameter Set 3 ("LTE TDD 3") TD-SCDMA [Parameter Set 1] Parameter Set 1 ("TD-SCDMA 1") Parameter Set 2 ("TD-SCDMA 2") Parameter Set 3 ("TD-SCDMA 3")
Readback	The readback line on this key shows the currently selected Radio Format in square brackets.
Initial S/W Revision	A.10.00
Modified at S/W Revision	A.12.00, A.16.00

Carrier Allocation

Specifies the carrier frequency allocation. There are two types of allocation, contiguous and non-contiguous. Non-Contiguous frequency allocation is defined as an allocation where two sub-blocks are separated with a sub-block gap.

Contiguous – All the carriers belong to one block and no sub-block gap exists.

Non-Contiguous – Carriers are separated into two sub-blocks. Allocation Break Pt Carrier determines how sub-blocks are configured.

Key Path	FREQ Channel, Carrier Setup
Scope	Meas Global
Remote Command	[:SENSe]:CARRier:CONFig:ALLocation CONTiguous NCONtiguous [:SENSe]:CARRier:CONFig:ALLocation?
Example	CARR:CONF:ALL CONT CARR:CONF:ALL?
Preset	CONTiguous
State Saved	Saved in instrument state.
Range	Contiguous Non-Contiguous
Initial S/W Revision	A.13.00

Non-Contiguous

Opens a menu that enables you to set a non-contiguous parameter.

Key Path	FREQ Channel, Carrier Setup, Carrier Allocation
Initial S/W Revision	A.13.00

Allocation Break Pt Carrier

Specifies an allocation break point in non-contiguous carrier allocation. First sub-block starts from the lowest frequency carrier and stops at the allocation break point carrier. Next sub-block starts from the next upper frequency carrier and ends at the highest frequency carrier.

Two examples are shown below. In these examples carrier indices are not in the order of carrier frequency. In the first example, Allocation Break Pt Carrier is 2. It means that sub-block 1 ends at carrier 2 and sub-block 2 starts at carrier 5. Sub-block gap is located between carrier 2 and 5. In the second example, Allocation Break Pt Carrier is 3 and the sub-block gap comes between carrier 3 and 2.

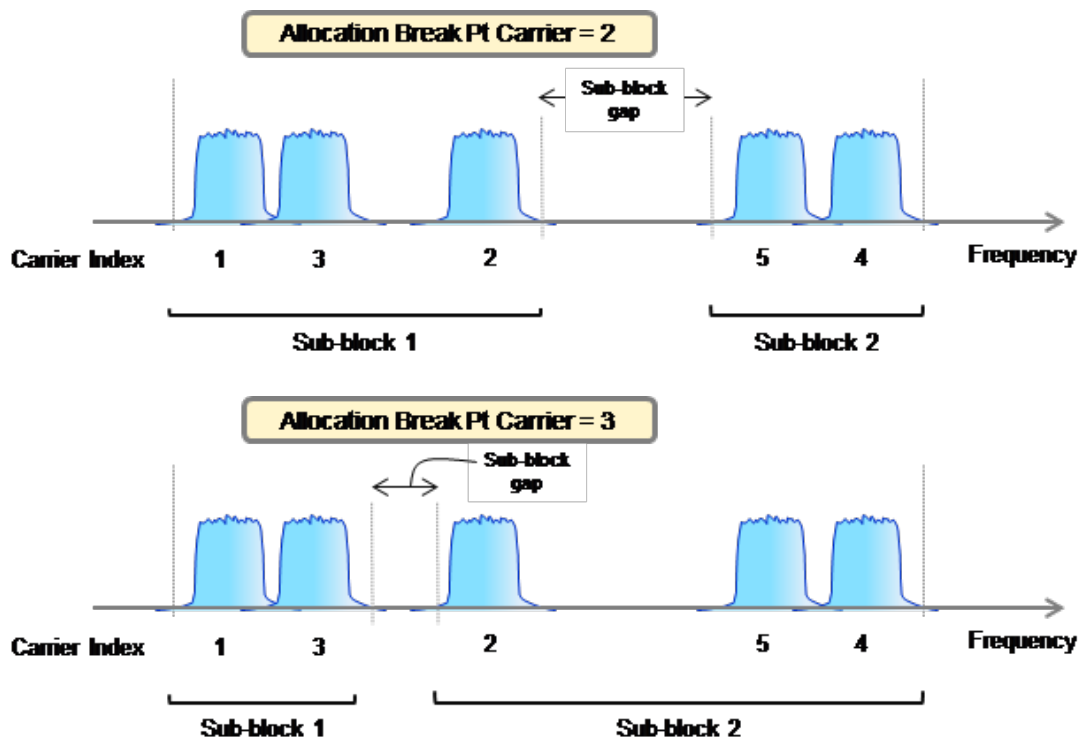

Key Path	FREQ Channel, Carrier Setup, Carrier Allocation, Non-Contiguous
Scope	Meas Global
Remote Command	<code>[[:SENSE]:CARRIER:CONFIG:ALLOCATION:NCONTIGUOUS:ABPOINT <integer></code> <code>[[:SENSE]:CARRIER:CONFIG:ALLOCATION:NCONTIGUOUS:ABPOINT?</code>
Example	<code>CARR:CONF:ALL:NCON:ABP 5</code> <code>CARR:CONF:ALL:NCON:ABP?</code>
Dependencies	The maximum value depends on the number of carriers.
Couplings	This value can change when you decrease the number of carriers.
Preset	1
State Saved	Saved in instrument state.
Min	1
Max	99
Initial S/W Revision	A.13.00

Carrier Conf Presets

Pressing this key pops up Conf Presets. Each parameter under this menu initiate carrier configuration preset when its value is changed.

Appropriate licenses are required to select carrier config enum. Required licenses are shown here. Note that N/W means N or W license, i.e. N/W9073A-1FP means either N9073A-1FP or W9073A-1FP is required.

TC1a (FDD): N/W9073A-1FP (W-CDMA)

TC2 (FDD): N/W9080A-1FP (LTE FDD)

TC3a (FDD): N/W9073A-1FP (W-CDMA) and N9080A-1FP (LTE FDD)

TC4a (FDD): N/W9071A-2FP (GSM/EDGE) and N/W9073A-1FP (W-CDMA)

TC4b (FDD): N/W9071A-2FP (GSM/EDGE) and N9080A-1FP (LTE FDD)

TC4c (FDD): N/W9071A-2FP (GSM/EDGE), N/W9073A-1FP (W-CDMA) and N9080A-1FP (LTE FDD)

TC4d (FDD): N/W9071A-2FP (GSM/EDGE) and N/W9073A-1FP (W-CDMA)

TC4e (FDD): N/W9071A-2FP (GSM/EDGE) and N9080A-1FP (LTE FDD)

TC4a (FDD) Two Carriers: N/W9071A-2FP (GSM/EDGE) and N/W9073A-1FP (W-CDMA)

TC4b (FDD) Two Carriers: N/W9071A-2FP (GSM/EDGE) and N9080A-1FP (LTE FDD)

TC4c (FDD) Two Carriers: N/W9071A-2FP (GSM/EDGE), N/W9073A-1FP (W-CDMA) and N9080A-1FP (LTE FDD)

NTC1a (FDD): N/W9073A-1FP (W-CDMA)

NTC2 (FDD): N/W9080A-1FP (LTE FDD)

NTC3a (FDD): N/W9073A-1FP (W-CDMA) and N9080A-1FP (LTE FDD)

NTC4a (FDD): N/W9071A-2FP (GSM/EDGE) and N/W9073A-1FP (W-CDMA)

NTC4b (FDD): N/W9071A-2FP (GSM/EDGE) and N9080A-1FP (LTE FDD)

NTC4c (FDD): N/W9071A-2FP (GSM/EDGE), N/W9073A-1FP (W-CDMA) and N9080A-1FP (LTE FDD)

LTE FDD: N/W9080A-1FP (LTE FDD)

W-CDMA: N/W9073A-1FP (W-CDMA)

GSM/EDGE: N/W9071A-2FP (GSM/EDGE)

cdma2000: N/W9072A-2FP (cdma2000)

1xEV-DO: N/W9076A-1FP (1xEV-DO)

Enum keys don't appear on the menu if required licenses are not installed.

Key Path	FREQ Channel, Carrier Setup
----------	-----------------------------

Remote Command	
	[:SENSe] :CARRier:CONFig?
Example	CARR:CONF TC1AFDD CARR:CONF?
Notes	The softkey for NONE is not available.
State Saved	Saved in instrument state
Initial S/W Revision	A.10.00
Modified at S/W Revision	A.12.00, A.13.00

MSR Test Config

Accesses the menu to select MSR Test Configurations.

Key Path	FREQ Channel, Carrier Setup
Initial S/W Revision	A.10.00

Carrier Conf Presets

Pressing this key pops up Conf Presets. Each parameter under this menu initiate carrier configuration preset when its value is changed.

Appropriate licenses are required to select carrier config enum. Required licenses are shown here. Note that N/W means N or W license, i.e. N/W9073A-1FP means either N9073A-1FP or W9073A-1FP is required.

TC1a (FDD): N/W9073A-1FP (W-CDMA)

TC2 (FDD): N/W9080A-1FP (LTE FDD)

TC3a (FDD): N/W9073A-1FP (W-CDMA) and N9080A-1FP (LTE FDD)

TC4a (FDD): N/W9071A-2FP (GSM/EDGE) and N/W9073A-1FP (W-CDMA)

TC4b (FDD): N/W9071A-2FP (GSM/EDGE) and N9080A-1FP (LTE FDD)

TC4c (FDD): N/W9071A-2FP (GSM/EDGE), N/W9073A-1FP (W-CDMA) and N9080A-1FP (LTE FDD)

TC4d (FDD): N/W9071A-2FP (GSM/EDGE) and N/W9073A-1FP (W-CDMA)

TC4e (FDD): N/W9071A-2FP (GSM/EDGE) and N9080A-1FP (LTE FDD)

TC4a (FDD) Two Carriers: N/W9071A-2FP (GSM/EDGE) and N/W9073A-1FP (W-CDMA)

TC4b (FDD) Two Carriers: N/W9071A-2FP (GSM/EDGE) and N9080A-1FP (LTE FDD)

TC4c (FDD) Two Carriers: N/W9071A-2FP (GSM/EDGE), N/W9073A-1FP (W-CDMA) and N9080A-1FP (LTE FDD)

NTC1a (FDD): N/W9073A-1FP (W-CDMA)

NTC2 (FDD): N/W9080A–1FP (LTE FDD)

NTC3a (FDD): N/W9073A–1FP (W-CDMA) and N9080A–1FP (LTE FDD)

NTC4a (FDD): N/W9071A–2FP (GSM/EDGE) and N/W9073A–1FP (W-CDMA)

NTC4b (FDD): N/W9071A–2FP (GSM/EDGE) and N9080A–1FP (LTE FDD)

NTC4c (FDD): N/W9071A–2FP (GSM/EDGE), N/W9073A–1FP (W-CDMA) and N9080A–1FP (LTE FDD)

LTE FDD: N/W9080A–1FP (LTE FDD)

W-CDMA: N/W9073A–1FP (W-CDMA)

GSM/EDGE: N/W9071A–2FP (GSM/EDGE)

cdma2000: N/W9072A–2FP (cdma2000)

1xEV-DO: N/W9076A–1FP (1xEV-DO)

Enum keys don't appear on the menu if required licenses are not installed.

Key Path	FREQ Channel, Carrier Setup
Remote Command	<code>[:SENSe] :CARRier:CONFig?</code>
Example	CARR:CONF TC1AFDD CARR:CONF?
Notes	The softkey for NONE is not available.
State Saved	Saved in instrument state
Initial S/W Revision	A.10.00
Modified at S/W Revision	A.12.00, A.13.00

Max W-CDMA Carriers (FDD)

Sets max W-CDMA carriers placed when the carrier configuration preset runs. When this value is changed, the carrier configuration preset is initiated.

Key Path	FREQ Channel, Carrier Setup, Carrier Conf Presets, MSR Test Config, TC1a (FDD)FREQ Channel, Carrier Setup, Carrier Conf Presets, MSR Test Config, TC3a (FDD)FREQ Channel, Carrier Setup, Carrier Conf Presets, MSR Test Config, TC4a (FDD)FREQ Channel, Carrier Setup, Carrier Conf Presets, MSR Test Config, TC4c (FDD)FREQ Channel, Carrier Setup, Carrier Conf Presets, Single RAT Config, W-CDMA
Remote Command	<code>[:SENSe] :CARRier:CONFig:WCDMa:CMAx <integer></code> <code>[:SENSe] :CARRier:CONFig:WCDMa:CMAx?</code>
Example	CARR:CONF:WCDM:CMAx 8 CARR:CONF:WCDM:CMAx?
Preset	100
State Saved	Saved in instrument state

Min	1
Max	100
Initial S/W Revision	A.10.00

Max LTE FDD Carriers

Sets max LTE FDD carriers placed when the carrier configuration preset runs. When this value is changed, the carrier configuration preset is initiated.

Key Path	FREQ Channel, Carrier Setup, Carrier Conf Presets, MSR Test Config, TC2 (FDD)FREQ Channel, Carrier Setup, Carrier Conf Presets, MSR Test Config, TC3a (FDD)FREQ Channel, Carrier Setup, Carrier Conf Presets, MSR Test Config, TC4b (FDD)FREQ Channel, Carrier Setup, Carrier Conf Presets, MSR Test Config, TC4c (FDD)FREQ Channel, Carrier Setup, Carrier Conf Presets, Single RAT Config, LTE FDD
Remote Command	[:SENSe] :CARRier:CONFig:LTEFdd:CMAx <integer> [:SENSe] :CARRier:CONFig:LTEFdd:CMAx?
Example	CARR:CONF:LTEF:CMAx 8 CARR:CONF:LTEF:CMAx?
Preset	100
State Saved	Saved in instrument state
Min	1
Max	100
Initial S/W Revision	A.10.00

LTE FDD BW

Sets bandwidth of LTE FDD carriers placed when the carrier configuration preset runs. When this value is changed, the carrier configuration preset is initiated.

Key Path	FREQ Channel, Carrier Setup, Carrier Conf Presets, MSR Test Config, TC2 (FDD)FREQ Channel, Carrier Setup, Carrier Conf Presets, MSR Test Config, TC3a (FDD)FREQ Channel, Carrier Setup, Carrier Conf Presets, MSR Test Config, TC4b (FDD)FREQ Channel, Carrier Setup, Carrier Conf Presets, MSR Test Config, TC4c (FDD)FREQ Channel, Carrier Setup, Carrier Conf Presets, MSR Test Config, TC4d (FDD)FREQ Channel, Carrier Setup, Carrier Conf Presets, Single RAT Config, LTE FDD
Remote Command	[:SENSe] :CARRier:CONFig:LTEFdd:BANDwidth B1M4 B3M B5M B10M B15M B20M [:SENSe] :CARRier:CONFig:LTEFdd:BANDwidth?
Example	CARR:CONF:LTEF:BAND B5M CARR:CONF:LTEF:BAND?
Preset	B5M

State Saved	Saved in instrument state
Range	1.4MHz 3MHz 5MHz 10MHz 15MHz 20MHz
Readback	The currently selected LTE FDD BW
Initial S/W Revision	A.10.00

Narrowest LTE FDD BW

Sets narrowest bandwidth of LTE FDD carriers placed for TC2 when the carrier configuration preset runs. When this value is changed, the carrier configuration preset is initiated.

Key Path	FREQ Channel, Carrier Setup, Carrier Conf Presets, MSR Test Config, TC2 (FDD)
Remote Command	[[:SENSe]:CARRier:CONFig:LTEFdd:BANDwidth:NARRowest B1M4 B3M B5M B10M B15M B20M [:SENSe]:CARRier:CONFig:LTEFdd:BANDwidth:NARRowest?
Example	CARR:CONF:LTEF:BAND:NARR B1M4 CARR:CONF:LTEF:BAND:NARR?
Preset	B1M4
State Saved	Saved in instrument state
Range	1.4MHz 3MHz 5MHz 10MHz 15MHz 20MHz
Readback	The currently selected Narrowest LTE FDD BW
Initial S/W Revision	A.10.00

Max GSM/EDGE Carriers

Sets max GSM/EDGE carriers placed when the carrier configuration preset runs. When this value is changed, the carrier configuration preset is initiated.

Key Path	FREQ Channel, Carrier Setup, Carrier Conf Presets, MSR Test Config, TC4a (FDD)FREQ Channel, Carrier Setup, Carrier Conf Presets, MSR Test Config, TC4b (FDD)FREQ Channel, Carrier Setup, Carrier Conf Presets, MSR Test Config, TC4c (FDD)FREQ Channel, Carrier Setup, Carrier Conf Presets, Single RAT Config, GSM/EDGE
Remote Command	[[:SENSe]:CARRier:CONFig:GSM:CMAx <integer> [:SENSe]:CARRier:CONFig:GSM:CMAx?
Example	CARR:CONF:GSM:CMAx 8 CARR:CONF:GSM:CMAx?
Preset	100
State Saved	Saved in instrument state
Min	1
Max	100
Initial S/W Revision	A.10.00

LTE FDD Location

Sets the location of LTE FDD carriers when carriers are configured as TC4c. This parameter is effective only for TC4c.

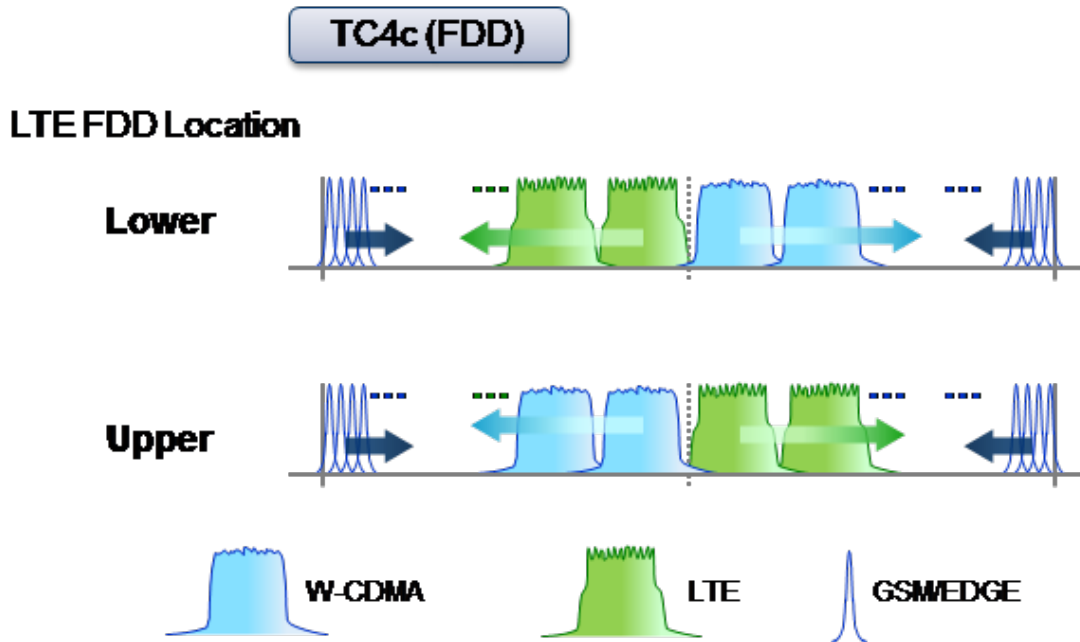

Key Path	FREQ Channel, Carrier Setup, Carrier Conf Presets, MSR Test Config, TC4c (FDD)
Remote Command	[:SENSe] :CARRier:CONFig:LTEFdd:LOCation UPPER LOWer [:SENSe] :CARRier:CONFig:LTEFdd:LOCation?
Example	CARR:CONF:LTEF:LOC LOW CARR:CONF:LTEF:LOC?
Notes	This setting is effective only for TC4c.
Preset	UPPer
State Saved	Saved in instrument state
Range	Lower (Lower than W-CDMA) Upper (Higher than W-CDMA)
Initial S/W Revision	A.11.00

MSR Non-Contig Test Config

Accesses the menu to select MSR Non-Contiguous Test Configurations.

Key Path	FREQ Channel, Carrier Setup
Initial S/W Revision	A.13.00

Carrier Conf Presets

Pressing this key pops up Conf Presets. Each parameter under this menu initiate carrier configuration preset when its value is changed.

Appropriate licenses are required to select carrier config enum. Required licenses are shown here. Note that N/W means N or W license, i.e. N/W9073A-1FP means either N9073A-1FP or W9073A-1FP is required.

TC1a (FDD): N/W9073A-1FP (W-CDMA)

TC2 (FDD): N/W9080A-1FP (LTE FDD)

TC3a (FDD): N/W9073A-1FP (W-CDMA) and N9080A-1FP (LTE FDD)

TC4a (FDD): N/W9071A-2FP (GSM/EDGE) and N/W9073A-1FP (W-CDMA)

TC4b (FDD): N/W9071A-2FP (GSM/EDGE) and N9080A-1FP (LTE FDD)

TC4c (FDD): N/W9071A-2FP (GSM/EDGE), N/W9073A-1FP (W-CDMA) and N9080A-1FP (LTE FDD)

TC4d (FDD): N/W9071A-2FP (GSM/EDGE) and N/W9073A-1FP (W-CDMA)

TC4e (FDD): N/W9071A-2FP (GSM/EDGE) and N9080A-1FP (LTE FDD)

TC4a (FDD) Two Carriers: N/W9071A-2FP (GSM/EDGE) and N/W9073A-1FP (W-CDMA)

TC4b (FDD) Two Carriers: N/W9071A-2FP (GSM/EDGE) and N9080A-1FP (LTE FDD)

TC4c (FDD) Two Carriers: N/W9071A-2FP (GSM/EDGE), N/W9073A-1FP (W-CDMA) and N9080A-1FP (LTE FDD)

NTC1a (FDD): N/W9073A-1FP (W-CDMA)

NTC2 (FDD): N/W9080A-1FP (LTE FDD)

NTC3a (FDD): N/W9073A-1FP (W-CDMA) and N9080A-1FP (LTE FDD)

NTC4a (FDD): N/W9071A-2FP (GSM/EDGE) and N/W9073A-1FP (W-CDMA)

NTC4b (FDD): N/W9071A-2FP (GSM/EDGE) and N9080A-1FP (LTE FDD)

NTC4c (FDD): N/W9071A-2FP (GSM/EDGE), N/W9073A-1FP (W-CDMA) and N9080A-1FP (LTE FDD)

LTE FDD: N/W9080A-1FP (LTE FDD)

W-CDMA: N/W9073A-1FP (W-CDMA)

GSM/EDGE: N/W9071A-2FP (GSM/EDGE)

cdma2000: N/W9072A-2FP (cdma2000)

1xEV-DO: N/W9076A-1FP (1xEV-DO)

Enum keys don't appear on the menu if required licenses are not installed.

Key Path	FREQ Channel, Carrier Setup
-----------------	------------------------------------

Remote Command

[:SENSe] :CARRier :CONFig?

Example	CARR:CONF TC1AFDD CARR:CONF?
Notes	The softkey for NONE is not available.
State Saved	Saved in instrument state
Initial S/W Revision	A.10.00
Modified at S/W Revision	A.12.00, A.13.00

LTE FDD BW

Sets bandwidth of LTE FDD carriers placed when the carrier configuration preset runs. When this value is changed, the carrier configuration preset is initiated.

Key Path	FREQ Channel, Carrier Setup, Carrier Conf Presets, MSR Test Config, TC2 (FDD)FREQ Channel, Carrier Setup, Carrier Conf Presets, MSR Test Config, TC3a (FDD)FREQ Channel, Carrier Setup, Carrier Conf Presets, MSR Test Config, TC4b (FDD)FREQ Channel, Carrier Setup, Carrier Conf Presets, MSR Test Config, TC4c (FDD)FREQ Channel, Carrier Setup, Carrier Conf Presets, MSR Test Config, TC4d (FDD)FREQ Channel, Carrier Setup, Carrier Conf Presets, Single RAT Config, LTE FDD
Remote Command	[:SENSe] :CARRier:CONFig:LTEFdd:BANDwidth B1M4 B3M B5M B10M B15M B20M [:SENSe] :CARRier:CONFig:LTEFdd:BANDwidth?
Example	CARR:CONF:LTEF:BAND B5M CARR:CONF:LTEF:BAND?
Preset	B5M
State Saved	Saved in instrument state
Range	1.4MHz 3MHz 5MHz 10MHz 15MHz 20MHz
Readback	The currently selected LTE FDD BW
Initial S/W Revision	A.10.00

NTC4 Carriers

Sets NTC4 carriers placed when the NTC4 carrier configuration preset runs. When this value is changed, the carrier configuration preset is initiated.

Key Path	FREQ Channel, Carrier Setup, Carrier Conf Presets, MSR Non-Contig Test Config, NTC4a (FDD)FREQ Channel, Carrier Setup, Carrier Conf Presets, MSR Non-Contig Test Config, NTC4b (FDD)FREQ Channel, Carrier Setup, Carrier Conf Presets, MSR Non-Contig Test Config, NTC4c(FDD)
Remote Command	[:SENSe] :CARRier:CONFig:NTC4:COUNT <integer> [:SENSe] :CARRier:CONFig:NTC4:COUNT?
Example	CARR:CONF:NTC4:COUN 6 CARR:CONF:NTC4:COUN?

Preset	6
State Saved	Saved in instrument state
Min	3
Max	6
Initial S/W Revision	A.13.00

Single RAT Config

Accesses the menu to select Single RAT Configurations.

Key Path	FREQ Channel, Carrier Setup
Initial S/W Revision	A.10.00

Carrier Conf Presets

Pressing this key pops up Conf Presets. Each parameter under this menu initiate carrier configuration preset when its value is changed.

Appropriate licenses are required to select carrier config enum. Required licenses are shown here. Note that N/W means N or W license, i.e. N/W9073A-1FP means either N9073A-1FP or W9073A-1FP is required.

TC1a (FDD): N/W9073A-1FP (W-CDMA)

TC2 (FDD): N/W9080A-1FP (LTE FDD)

TC3a (FDD): N/W9073A-1FP (W-CDMA) and N9080A-1FP (LTE FDD)

TC4a (FDD): N/W9071A-2FP (GSM/EDGE) and N/W9073A-1FP (W-CDMA)

TC4b (FDD): N/W9071A-2FP (GSM/EDGE) and N9080A-1FP (LTE FDD)

TC4c (FDD): N/W9071A-2FP (GSM/EDGE), N/W9073A-1FP (W-CDMA) and N9080A-1FP (LTE FDD)

TC4d (FDD): N/W9071A-2FP (GSM/EDGE) and N/W9073A-1FP (W-CDMA)

TC4e (FDD): N/W9071A-2FP (GSM/EDGE) and N9080A-1FP (LTE FDD)

TC4a (FDD) Two Carriers: N/W9071A-2FP (GSM/EDGE) and N/W9073A-1FP (W-CDMA)

TC4b (FDD) Two Carriers: N/W9071A-2FP (GSM/EDGE) and N9080A-1FP (LTE FDD)

TC4c (FDD) Two Carriers: N/W9071A-2FP (GSM/EDGE), N/W9073A-1FP (W-CDMA) and N9080A-1FP (LTE FDD)

NTC1a (FDD): N/W9073A-1FP (W-CDMA)

NTC2 (FDD): N/W9080A-1FP (LTE FDD)

NTC3a (FDD): N/W9073A-1FP (W-CDMA) and N9080A-1FP (LTE FDD)

NTC4a (FDD): N/W9071A-2FP (GSM/EDGE) and N/W9073A-1FP (W-CDMA)

NTC4b (FDD): N/W9071A–2FP (GSM/EDGE) and N9080A–1FP (LTE FDD)

NTC4c (FDD): N/W9071A–2FP (GSM/EDGE), N/W9073A–1FP (W-CDMA) and N9080A–1FP (LTE FDD)

LTE FDD: N/W9080A–1FP (LTE FDD)

W-CDMA: N/W9073A–1FP (W-CDMA)

GSM/EDGE: N/W9071A–2FP (GSM/EDGE)

cdma2000: N/W9072A–2FP (cdma2000)

1xEV-DO: N/W9076A–1FP (1xEV-DO)

Enum keys don't appear on the menu if required licenses are not installed.

Key Path	FREQ Channel, Carrier Setup
Remote Command	[:SENSe] :CARRier:CONFig?
Example	CARR:CONF TC1AFDD CARR:CONF?
Notes	The softkey for NONE is not available.
State Saved	Saved in instrument state
Initial S/W Revision	A.10.00
Modified at S/W Revision	A.12.00, A.13.00

Max LTE FDD Carriers

Sets max LTE FDD carriers placed when the carrier configuration preset runs. When this value is changed, the carrier configuration preset is initiated.

Key Path	FREQ Channel, Carrier Setup, Carrier Conf Presets, MSR Test Config, TC2 (FDD)FREQ Channel, Carrier Setup, Carrier Conf Presets, MSR Test Config, TC3a (FDD)FREQ Channel, Carrier Setup, Carrier Conf Presets, MSR Test Config, TC4b (FDD)FREQ Channel, Carrier Setup, Carrier Conf Presets, MSR Test Config, TC4c (FDD)FREQ Channel, Carrier Setup, Carrier Conf Presets, Single RAT Config, LTE FDD
Remote Command	[:SENSe] :CARRier:CONFig:LTEFdd:CMAx <integer> [:SENSe] :CARRier:CONFig:LTEFdd:CMAx?
Example	CARR:CONF:LTEF:CMAx 8 CARR:CONF:LTEF:CMAx?
Preset	100
State Saved	Saved in instrument state
Min	1
Max	100
Initial S/W Revision	A.10.00

LTE FDD BW

Sets bandwidth of LTE FDD carriers placed when the carrier configuration preset runs. When this value is changed, the carrier configuration preset is initiated.

Key Path	FREQ Channel, Carrier Setup, Carrier Conf Presets, MSR Test Config, TC2 (FDD)FREQ Channel, Carrier Setup, Carrier Conf Presets, MSR Test Config, TC3a (FDD)FREQ Channel, Carrier Setup, Carrier Conf Presets, MSR Test Config, TC4b (FDD)FREQ Channel, Carrier Setup, Carrier Conf Presets, MSR Test Config, TC4c (FDD)FREQ Channel, Carrier Setup, Carrier Conf Presets, MSR Test Config, TC4d (FDD)FREQ Channel, Carrier Setup, Carrier Conf Presets, Single RAT Config, LTE FDD
Remote Command	[:SENSe] :CARRier :CONFig :LTEFdd :BANDwidth B1M4 B3M B5M B10M B15M B20M [:SENSe] :CARRier :CONFig :LTEFdd :BANDwidth ?
Example	CARR:CONF:LTEF:BAND B5M CARR:CONF:LTEF:BAND?
Preset	B5M
State Saved	Saved in instrument state
Range	1.4MHz 3MHz 5MHz 10MHz 15MHz 20MHz
Readback	The currently selected LTE FDD BW
Initial S/W Revision	A.10.00

Max W-CDMA Carriers (FDD)

Sets max W-CDMA carriers placed when the carrier configuration preset runs. When this value is changed, the carrier configuration preset is initiated.

Key Path	FREQ Channel, Carrier Setup, Carrier Conf Presets, MSR Test Config, TC1a (FDD)FREQ Channel, Carrier Setup, Carrier Conf Presets, MSR Test Config, TC3a (FDD)FREQ Channel, Carrier Setup, Carrier Conf Presets, MSR Test Config, TC4a (FDD)FREQ Channel, Carrier Setup, Carrier Conf Presets, MSR Test Config, TC4c (FDD)FREQ Channel, Carrier Setup, Carrier Conf Presets, Single RAT Config, W-CDMA
Remote Command	[:SENSe] :CARRier :CONFig :WCDMa :CMAX <integer> [:SENSe] :CARRier :CONFig :WCDMa :CMAX ?
Example	CARR:CONF:WCDM:CMAX 8 CARR:CONF:WCDM:CMAX?
Preset	100
State Saved	Saved in instrument state
Min	1
Max	100
Initial S/W Revision	A.10.00

Max GSM/EDGE Carriers

Sets max GSM/EDGE carriers placed when the carrier configuration preset runs. When this value is changed, the carrier configuration preset is initiated.

Key Path	FREQ Channel, Carrier Setup, Carrier Conf Presets, MSR Test Config, TC4a (FDD)FREQ Channel, Carrier Setup, Carrier Conf Presets, MSR Test Config, TC4b (FDD)FREQ Channel, Carrier Setup, Carrier Conf Presets, MSR Test Config, TC4c (FDD)FREQ Channel, Carrier Setup, Carrier Conf Presets, Single RAT Config, GSM/EDGE
Remote Command	<code>[:SENSe] :CARRier:CONFig:GSM:CMAX <integer></code> <code>[:SENSe] :CARRier:CONFig:GSM:CMAX?</code>
Example	CARR:CONF:GSM:CMAX 8 CARR:CONF:GSM:CMAX?
Preset	100
State Saved	Saved in instrument state
Min	1
Max	100
Initial S/W Revision	A.10.00

Max cdma2000 Carriers

Sets max cdma2000 carriers placed when the carrier configuration preset runs. When this value is changed, the carrier configuration preset is initiated.

Key Path	FREQ Channel, Carrier Setup, Carrier Conf Presets, Single RAT Config, cdma2000
Remote Command	<code>[:SENSe] :CARRier:CONFig:CDMA:CMAX <integer></code> <code>[:SENSe] :CARRier:CONFig:CDMA:CMAX?</code>
Example	CARR:CONF:CDMA:CMAX 8 CARR:CONF:CDMA:CMAX?
Preset	100
State Saved	Saved in instrument state
Min	1
Max	100
Initial S/W Revision	A.12.00

Max 1xEV-DO Carriers

Sets max 1xEV-DO carriers placed when the carrier configuration preset runs. When this value is changed, the carrier configuration preset is initiated.

Key Path	FREQ Channel, Carrier Setup, Carrier Conf Presets, Single RAT Config, 1xEV-DO
Remote Command	<code>[:SENSe] :CARRier:CONFig:EVDO:CMAX <integer></code>

	<code>[:SENSe] :CARRier:CONFig:EVDO:CMAx?</code>
Example	<code>CARR:CONF:EVDO:CMAx 8</code> <code>CARR:CONF:EVDO:CMAx?</code>
Preset	100
State Saved	Saved in instrument state
Min	1
Max	100
Initial S/W Revision	A.12.00

Max BS RF Bandwidth

Sets max BS RF bandwidth used when the carrier configuration preset runs. When this value is changed, the carrier configuration preset is initiated.

Key Path	FREQ Channel, Carrier Setup, Carrier Conf Presets
Remote Command	<code>[:SENSe] :CARRier:CONFig:RFBWidth <freq></code> <code>[:SENSe] :CARRier:CONFig:RFBWidth?</code>
Example	<code>CARR:CONF:RFBW 40MHz</code> <code>CARR:CONF:RFBW?</code>
Preset	40MHz
State Saved	Saved in instrument state
Min	600 kHz
Max	200 MHz
Initial S/W Revision	A.10.00

Channel Spacing Delta

Carriers are placed based on channel spacing assigned to the corresponding radio format, when they are configured by the carrier config preset. However, channel spacing can be adjusted using channel spacing delta parameters.

This key accesses the menu to set channel spacing delta of each radio format.

Key Path	FREQ Channel, Carrier Setup, Carrier Conf Presets
Initial S/W Revision	A.10.00

LTE FDD

Sets delta channel spacing for LTE FDD used when the carrier configuration preset runs. Channel spacing for LTE FDD is determined from this value and the default channel spacing defined in the standard, i.e. Channel spacing = (BWchan1 + BWchan2) * 0.5 + [the delta spacing]. Since this value is a difference from

the default spacing, this value can be negative to allow narrower channel spacing. When this value is changed, the carrier configuration preset is initiated.

Key Path	FREQ Channel, Carrier Setup, Carrier Conf Presets, Channel Spacing Delta
Remote Command	[:SENSE] :CARRier:CONFig:LTEFdd:SPACing:DELTA <freq> [:SENSE] :CARRier:CONFig:LTEFdd:SPACing:DELTA?
Example	CARR:CONF:LTEF:SPAC:DELTA -200kHz CARR:CONF:LTEF:SPAC:DELTA?
Preset	0Hz
State Saved	Saved in instrument state
Min	- 1.0 MHz
Max	10.0 MHz
Initial S/W Revision	A.10.00
Modified at S/W Revision	A.11.00

W-CDMA

Sets delta channel spacing for W-CDMA used when the carrier configuration preset runs. Channel spacing for W-CDMA is determined from this value and the default channel spacing defined in the standard, i.e. Channel spacing = 5.0 MHz + [the delta spacing]. Since this value is a difference from the default spacing, this value can be negative to allow narrower channel spacing. When this value is changed, the carrier configuration preset is initiated.

Key Path	FREQ Channel, Carrier Setup, Carrier Conf Presets, Channel Spacing Delta
Remote Command	[:SENSE] :CARRier:CONFig:WCDMa:SPACing:DELTA <freq> [:SENSE] :CARRier:CONFig:WCDMa:SPACing:DELTA?
Example	CARR:CONF:WCDM:SPAC:DELTA 0 CARR:CONF:WCDM:SPAC:DELTA?
Preset	0 Hz
State Saved	Saved in instrument state
Min	- 1.0 MHz
Max	10.0 MHz
Initial S/W Revision	A.10.00
Modified at S/W Revision	A.11.00

GSM/EDGE

Sets delta channel spacing for GSM/EDGE used when the carrier configuration preset runs. Channel spacing for GSM/EDGE is determined from this value and the default channel spacing defined in the standard, i.e. Channel spacing = 600 kHz + [the delta spacing]. Since this value is a difference from the default spacing, this value can be negative to allow narrower channel spacing. When this value is changed, the carrier configuration preset is initiated.

Key Path	FREQ Channel, Carrier Setup, Carrier Conf Presets, Channel Spacing Delta
Remote Command	<code>[:SENSe] :CARRier :CONFig :GSM :SPACing :DELTA <freq></code> <code>[:SENSe] :CARRier :CONFig :GSM :SPACing :DELTA?</code>
Example	CARR:CONF:GSM:SPAC:DELT 0 CARR:CONF:GSM:SPAC:DELT?
Preset	0 Hz
State Saved	Saved in instrument state
Min	- 0.4 MHz
Max	10.0 MHz
Initial S/W Revision	A.10.00
Modified at S/W Revision	A.11.00

cdma2000

Sets delta channel spacing for cdma2000 used when the carrier configuration preset runs. Channel spacing for cdma2000 is determined from this value and the default channel spacing defined in the standard, i.e. Channel spacing = 1.25 MHz + [the delta spacing]. Since this value is a difference from the default spacing, this value can be negative to allow narrower channel spacing.

Key Path	FREQ Channel, Carrier Setup, Carrier Conf Presets, Channel Spacing Delta
Remote Command	<code>[:SENSe] :CARRier :CONFig :CDMA :SPACing :DELTA <freq></code> <code>[:SENSe] :CARRier :CONFig :CDMA :SPACing :DELTA?</code>
Example	CARR:CONF:CDMA:SPAC:DELT 0 CARR:CONF:CDMA:SPAC:DELT?
Preset	0 Hz
State Saved	Saved in instrument state
Min	-1 MHz
Max	10 MHz
Initial S/W Revision	A.12.00

1xEV-DO

Sets delta channel spacing for 1xEV-DO used when the carrier configuration preset runs. Channel spacing for 1xEV-DO is determined from this value and the default channel spacing defined in the standard, i.e. Channel spacing = 1.25 MHz + [the delta spacing]. Since this value is a difference from the default spacing, this value can be negative to allow narrower channel spacing.

Key Path	FREQ Channel, Carrier Setup, Carrier Conf Presets, Channel Spacing Delta
Remote Command	<code>[:SENSe] :CARRier :CONFig :EVDO :SPACing :DELTA <freq></code> <code>[:SENSe] :CARRier :CONFig :EVDO :SPACing :DELTA?</code>

Example	CARR:CONF:EVDO:SPAC:DELT 0 CARR:CONF:EVDO:SPAC:DELT?
Preset	0 Hz
State Saved	Saved in instrument state
Min	-1 MHz
Max	10 MHz
Initial S/W Revision	A.12.00

Apply to Meas Offset/Limits

This immediate action key sets the following measurement parameters.

- ACP: Offset and limit parameters under Offset/Limits.
- Spectrum Emission Mask: Offset and limit parameters under Offset/Limits.
- Spurious Emissions: Range frequency and limit parameters under Range Table.

These offset and limit values are determined by the carrier configuration parameters, Band Category and Assumed Adj Channels.

Each of these measurement has a local key, “Apply Carrier Config to ...”, which performs in the same way only for its parameters. So pressing this key is equivalent to pressing “Apply Carrier Config to ...” of all these measurements.

Key Path	FREQ Channel, Carrier Setup
Remote Command	[:SENSe] :MCONdition:IMMEDIATE
Example	MCON:IMM
Initial S/W Revision	A.11.00

RF Bandwidth (Remote Command Only)

Returns the RF bandwidth calculated from the outermost carriers and their Foffset_RAT.

Key Path	SCPI only
Mode	MSR
Remote Command	[:SENSe] :CARRier:RFBWidth?
Example	CARR:RFBW?
Preset	Calculated from preset values of carrier config parameters
State Saved	No
Initial S/W Revision	A.13.00

RF Bandwidth Center (Remote Command Only)

Returns the center frequency of RF bandwidth.

Key Path	SCPI only
Mode	MSR
Remote Command	[:SENSe] :CARRier :RFBWidth :CENTer ?
Example	CARR:RFBW:CENT?
Preset	Calculated from preset values of carrier config parameters
State Saved	No
Initial S/W Revision	A.13.00

Sub-block Center (Remote Command Only)

Returns the center frequency of sub-block when Carrier Allocation is Non-Contiguous.

Key Path	SCPI only
Mode	MSR
Remote Command	[:SENSe] :CARRier :SBLock [1] 2 :CENTer ?
Example	CARR:SBL:CENT?
Notes	When Carrier Allocation is Contiguous, 9.91 E+37 is returned.
Preset	Calculated from preset values of carrier config parameters
State Saved	No
Initial S/W Revision	A.13.00

Sub-block Bandwidth (Remote Command Only)

Returns the bandwidth of sub-block calculated from outermost carriers and corresponding Offset_RAT.

Key Path	SCPI only
Mode	MSR
Remote Command	[:SENSe] :CARRier :SBLock [1] 2 :BWIDth ?
Example	CARR:SBL:BWID?
Notes	When Carrier Allocation is Contiguous, 9.91 E+37 is returned.
Preset	Calculated from preset values of carrier config parameters
State Saved	No
Initial S/W Revision	A.13.00

Sub-block Gap (Remote Command Only)

Returns the sub-block gap.

Key Path	SCPI only
Mode	MSR
Remote Command	[:SENSe] :CARRier :SBLock :GAP?
Example	CARR:SBL:GAP?
Notes	When Carrier Allocation is Contiguous, 9.91E+37 is returned.
Preset	Calculated from preset values of carrier config parameters
State Saved	No
Initial S/W Revision	A.13.00

13 Conformance EVM
Input/Output

Input/Output

See ["Input/Output" on page 190](#)

Marker

There is no Marker functionality in this measurement. When pressed, blank menu appears.

Key Path	Front-panel key
Initial S/W Revision	A.10.00

Marker > (Marker To)

There is no Marker To functionality in this measurement. When pressed, blank menu appears.

Key Path	Front-panel key
Initial S/W Revision	A.10.00

Marker Fctn (Function)

There is no Marker Function functionality in this measurement. When pressed, blank menu appears.

Key Path	Front-panel key
Initial S/W Revision	A.10.00

Meas

The information in this section is common to all measurements. For key and remote command information for a specific measurement, refer to the section that describes the measurement of interest.

Measurements available under the Meas key are specific to the current Mode.

When viewing Help for measurements, note the following:

NOTE

Operation for some keys differs between measurements. The information displayed in Help pertains to the current measurement. To see how a key operates in a different measurement, exit Help (press the Cancel Esc key), select the measurement, then reenter Help (press the Help key) and press that key.

Key Path	Front-panel key
Initial S/W Revision	Prior to A.02.00

Remote Measurement Functions

This section contains the following topics:

["Measurement Group of Commands" on page 2382](#)

["Current Measurement Query \(Remote Command Only\)" on page 2384](#)

["Limit Test Current Results \(Remote Command Only\)" on page 2384](#)

["Data Query \(Remote Command Only\)" on page 2384](#)

["Calculate/Compress Trace Data Query \(Remote Command Only\)" on page 2385](#)

["Calculate Peaks of Trace Data \(Remote Command Only\)" on page 2390](#)

["Hardware-Accelerated Fast Power Measurement \(Remote Command Only\)" on page 2391](#)

["Format Data: Numeric Data \(Remote Command Only\)" on page 2405](#)

["Format Data: Byte Order \(Remote Command Only\)" on page 2406](#)

Initial S/W Revision	Prior to A.02.00
----------------------	------------------

Measurement Group of Commands

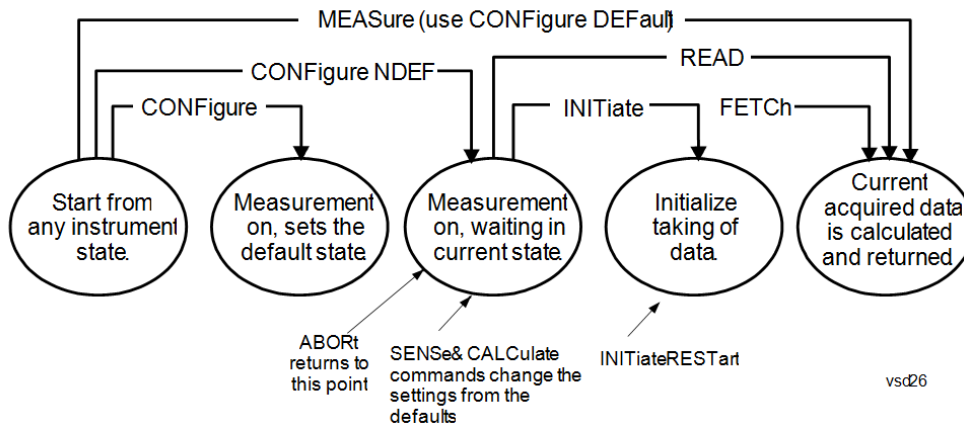

Measure Commands:

:MEASure:<measurement>[n]?

This is a fast single-command way to make a measurement using the factory default instrument settings. These are the settings and units that conform to the Mode Setup settings (e.g. radio standard) that you have currently selected.

- Stops the current measurement (if any) and sets up the instrument for the specified measurement using the factory defaults
- Initiates the data acquisition for the measurement
- Blocks other SCPI communication, waiting until the measurement is complete before returning results.
- If the function does averaging, it is turned on and the number of averages is set to 10.
- After the data is valid it returns the scalar results, or the trace data, for the specified measurement. The type of data returned may be defined by an [n] value that is sent with the command.
- The scalar measurement results will be returned if the optional [n] value is not included, or is set to 1. If the [n] value is set to a value other than 1, the selected trace data results will be returned. See each command for details of what types of scalar results or trace data results are available.
- ASCII is the default format for the data output. (Older versions of Spectrum Analysis and Phase Noise mode measurements only use ASCII.) The binary data formats should be used for handling large blocks of data since they are smaller and faster than the ASCII format. Refer to the FORMat:DATA command for more information.

If you need to change some of the measurement parameters from the factory default settings you can set up the measurement with the CONFigure command. Use the commands in the SENSe:<measurement> and CALCulate:<measurement> subsystems to change the settings. Then you can use the READ? command to initiate the measurement and query the results.

If you need to repeatedly make a given measurement with settings other than the factory defaults, you can use the commands in the SENSe:<measurement> and CALCulate:<measurement> subsystems to set up the measurement. Then use the READ? command to initiate the measurement and query results.

Measurement settings persist if you initiate a different measurement and then return to a previous one. Use READ:<measurement>? if you want to use those persistent settings. If you want to go back to the default settings, use MEASure:<measurement>?.

Configure Commands:

:CONFigure:<measurement>

This command stops the current measurement (if any) and sets up the instrument for the specified measurement using

the factory default instrument settings. It does not initiate the taking of measurement data unless INIT:CONTinuous is ON. If you change any measurement settings after using the CONFigure command, the READ command can be used to initiate a measurement without changing the settings back to their defaults.

In the Swept SA measurement in Spectrum Analyzer mode the CONFigure command also turns the averaging function on and sets the number of averages to 10 for all measurements.

:CONFigure: <measurement>: NDEFault stops the current measurement and changes to the specified measurement. It does not change the settings to the defaults. It does not initiate the taking of measurement data unless INIT:CONTinuous is ON.

The CONFigure? query returns the current measurement name.

The CONFigure:CATalog? query returns a quoted string of all licensed measurement names in the current mode. For example, "SAN, CHP, OBW, ACP, PST, TXP, SPUR, SEM, LIST".

Fetch Commands:

:FETCh:<measurement>[n]?

This command puts selected data from the most recent measurement into the output buffer. Use FETCh if you have already made a good measurement and you want to return several types of data (different [n] values, for example, both scalars and trace data) from a single measurement. FETCh saves you the time of re-making the measurement. You can only FETCh results from the measurement that is currently active, it will not change to a different measurement. An error message is reported if a measurement other than the current one is specified.

If you need to get new measurement data, use the READ command, which is equivalent to an INITiate followed by a FETCh.

The scalar measurement results will be returned if the optional [n] value is not included, or is set to 1. If the [n] value is set to a value other than 1, the selected trace data results will be returned. See each command for details of what types of scalar results or trace data results are available. The binary data formats should be used for handling large blocks of data since they are smaller and transfer faster than the ASCII format. (FORMat:DATA)

FETCh may be used to return results other than those specified with the original READ or MEASure command that you sent.

INITiate Commands:

:INITiate:<measurement>

This command is not available for measurements in all the instrument modes:

- Initiates a trigger cycle for the specified measurement, but does not output any data. You must then use the FETCh<meas> command to return data. If a measurement other than the current one is specified, the instrument will switch to that measurement and then initiate it.
 - For example, suppose you have previously initiated the ACP measurement, but now you are running the channel power measurement. If you send INIT:ACP? it will change from channel power to ACP and will initiate an ACP measurement.
 - Does not change any of the measurement settings. For example, if you have previously started the ACP measurement and you send INIT:ACP? it will initiate a new ACP measurement using the same instrument settings as the last time ACP was run.
 - If your selected measurement is currently active (in the idle state) it triggers the measurement, assuming the trigger conditions are met. Then it completes one trigger cycle. Depending upon the measurement and the number of averages, there may be multiple data acquisitions, with multiple trigger events, for one full trigger cycle. It also holds off additional commands on GPIB until the acquisition is complete.
-

READ Commands:

:READ:<measurement>[n]?

- Does not preset the measurement to the factory default settings. For example, if you have previously initiated the ACP
-

measurement and you send READ:ACP? it will initiate a new measurement using the same instrument settings.

- Initiates the measurement and puts valid data into the output buffer. If a measurement other than the current one is specified, the instrument will switch to that measurement before it initiates the measurement and returns results.
 - For example, suppose you have previously initiated the ACP measurement, but now you are running the channel power measurement. Then you send READ:ACP? It will change from channel power back to ACP and, using the previous ACP settings, will initiate the measurement and return results.
 - Blocks other SCPI communication, waiting until the measurement is complete before returning the results
 - If the optional [n] value is not included, or is set to 1, the scalar measurement results will be returned. If the [n] value is set to a value other than 1, the selected trace data results will be returned. See each command for details of what types of scalar results or trace data results are available. The binary data formats should be used when handling large blocks of data since they are smaller and faster than the ASCII format. (FORMat:DATA)
-

Initial S/W Revision	Prior to A.02.00
----------------------	------------------

Current Measurement Query (Remote Command Only)

This command returns the name of the measurement that is currently running.

Remote Command	:CONFigure?
-----------------------	-------------

Example	CONF?
----------------	-------

Initial S/W Revision	Prior to A.02.00
----------------------	------------------

Limit Test Current Results (Remote Command Only)

Queries the status of the current measurement limit testing. It returns a 0 if the measured results pass when compared with the current limits. It returns a 1 if the measured results fail any limit tests.

Remote Command	:CALCulate:CLIMits:FAIL?
-----------------------	--------------------------

Example	CALC:CLIM:FAIL? queries the current measurement to see if it fails the defined limits. Returns a 0 or 1: 0 it passes, 1 it fails.
----------------	--

Initial S/W Revision	Prior to A.02.00
----------------------	------------------

Data Query (Remote Command Only)

Returns the designated measurement data for the currently selected measurement and subopcode.

n = any valid subopcode for the current measurement. See the measurement command results table for your current measurement, for information about what data is returned for the subopcodes.

This command uses the data setting specified by the FORMat:BORDER and FORMat:DATA commands and can return real or ASCII data. (See the format command descriptions under Input/Output in the Analyzer Setup section.)

Remote Command	:CALCulate:DATA[n]?
Notes	The return trace depends on the measurement. In CALCulate:<meas>:DATA[n], n is any valid subopcode for the current measurement. It returns the same data as the FETCH:<measurement>? query where <measurement> is the current measurement.
Initial S/W Revision	Prior to A.02.00

Calculate/Compress Trace Data Query (Remote Command Only)

Returns compressed data for the currently selected measurement and sub-opcode [n].

n = any valid sub-opcode for that measurement. See the MEASure:<measurement>? command description of your specific measurement for information on the data that can be returned.

The data is returned in the current Y Axis Unit of the analyzer. The command is used with a sub-opcode <n> (default=1) to specify the trace. With trace queries, it is best if the analyzer is not sweeping during the query. Therefore, it is generally advisable to be in Single Sweep, or Update=Off.

This command is used to compress or decimate a long trace to extract and return only the desired data. A typical example would be to acquire N frames of GSM data and return the mean power of the first burst in each frame. The command can also be used to identify the best curve fit for the data.

Remote Command	:CALCulate:DATA<n>:COMPRESS? BLOCK CFIT MAXimum MINimum MEAN DMEan RMS RMSCubed SAMPLE SDEViation PPHase [,<soffset> [,<length>[,<roffset>[,<rlimit>]]]]
Example	To query the mean power of a set of GSM bursts: Supply a signal that is a set of GSM bursts. Select the IQ Waveform measurement (in IQ Analyzer Mode). Set the sweep time to acquire at least one burst. Set the triggers such that acquisition happens at a known position relative to a burst. Then query the mean burst levels using, CALC:DATA2:COMP? MEAN, 24e-6, 526e-6 (These parameter values correspond to GSM signals, where 526e-6 is the length of the burst in the slot and you just want 1 burst.)
Notes	The command supports 5 parameters. Note that the last 4 (<soffset>, <length>, <roffset>, <rlimit>) are optional. But these optional parameters must be entered in the specified order. For example, if you want to specify <length>, then you must also specify <soffset>. See details below for a definition of each of these parameters. This command uses the data in the format specified by FORMat:DATA, returning either binary or ASCII data.
Initial S/W Revision	Prior to A.02.00

- BLOCK or block data - returns all the data points from the region of the trace data that you specify. For example, it could be used to return the data points of an input signal over several timeslots, excluding the portions of the trace data that you do not want. (This is x,y pairs for trace data and I,Q pairs for complex data.)

- CFIT or curve fit - applies curve fitting routines to the data. <soffset> and <length> are required to define the data that you want. <roffset> is an optional parameter for the desired order of the curve equation. The query will return the following values: the x-offset (in seconds) and the curve coefficients ((order + 1) values).

MIN, MAX, MEAN, DME, RMS, RMSC, SAMP, SDEV and PPH return one data value for each specified region (or <length>) of trace data, for as many regions as possible until you run out of trace data (using <roffset> to specify regions). Or they return the number of regions you specify (using <rlimit>) ignoring any data beyond that.

- MINimum - returns the minimum data point (y value) for the specified region(s) of trace data. For I/Q trace data, the minimum magnitude of the I/Q pairs is returned.
- MAXimum - returns the maximum data point (y value) for the specified region(s) of trace data. For I/Q trace data, the maximum magnitude of the I/Q pairs is returned.
- MEAN - returns a single value that is the arithmetic mean of the data point values (in dB/ dBm) for the specified region(s) of trace data. For I/Q trace data, the mean of the magnitudes of the I/Q pairs is returned. See the following equations.

-

NOTE

If the original trace data is in dB, this function returns the arithmetic mean of those log values, not log of the mean power which is a more useful value. The mean of the log is the better measurement technique when measuring CW signals in the presence of noise. The mean of the power, expressed in dB, is useful in power measurements such as Channel Power. To achieve the mean of the power, use the RMS option.

Equation 1

Mean Value of Data Points for Specified Region(s)

$$\text{MEAN} = \frac{1}{n} \sum_{X_i \in \text{region}(s)} X_i$$

where X_i is a data point value, and n is the number of data points in the specified region(s).

Equation 2

Mean Value of I/Q Data Pairs for Specified Region(s)

$$\text{MEAN} = \frac{1}{n} \sum_{X_i \in \text{region}(s)} |X_i|$$

where $|X_i|$ is the magnitude of an I/Q pair, and n is the number of I/Q pairs in the specified region(s).

- DMEan - returns a single value that is the mean power (in dB/ dBm) of the data point values for the specified region(s) of trace data. See the following equation:

Equation 3

DMEan Value of Data Points for Specified Region(s)

$$\text{DME} = 10 \times \log_{10} \left(\frac{1}{n} \sum_{X_i \in \text{region}(s)} 10^{\frac{X_i}{10}} \right)$$

- RMS - returns a single value that is the average power on a root-mean-squared voltage scale (arithmetic rms) of the data point values for the specified region(s) of trace data. See the following equation.

NOTE For I/Q trace data, the rms of the magnitudes of the I/Q pairs is returned. See the following equation. This function is very useful for I/Q trace data. However, if the original trace data is in dB, this function returns the rms of the log values which is not usually needed.

Equation 4

RMS Value of Data Points for Specified Region(s)

$$\text{RMS} = \sqrt{\frac{1}{n} \sum_{X_i \in \text{region}(s)} X_i^2}$$

where X_i is a data point value, and n is the number of data points in the specified region(s).

Equation 5

RMS Value of I/Q Data Pairs for Specified Region(s)

$$\text{RMS} = \sqrt{\frac{1}{n} \sum_{X_i \in \text{region}(s)} X_i X_i^*}$$

where X_i is the complex value representation of an I/Q pair, X_i^* its conjugate complex number, and n is the number of I/Q pairs in the specified region(s).

Once you have the rms value for a region of trace data (linear or I/Q), you may want to calculate the mean power. You must convert this rms value (peak volts) to power in dBm:

$$10 \times \log[10 \times (\text{rms value})^2]$$

- SAMPlE - returns the first data value (x,y pair) for the specified region(s) of trace data. For I/Q trace data, the first I/Q pair is returned.
- SDEVIation - returns a single value that is the arithmetic standard deviation for the data point values for the specified region(s) of trace data. See the following equation.
- For I/Q trace data, the standard deviation of the magnitudes of the I/Q pairs is returned. See the following equation.

Equation 6

Standard Deviation of Data Point Values for Specified Region(s)

$$\text{SDEV} = \sqrt{\frac{1}{n} \sum_{X_i \in \text{region}(s)} (X_i - \bar{X})^2}$$

where X_i is a data point value, \bar{X} is the arithmetic mean of the data point values for the specified region (s), and n is the number of data points in the specified region(s).

$$\text{SDEV} = \sqrt{\frac{1}{n} \sum_{X_i \in \text{region}(s)} (|X_i| - \bar{X})^2}$$

where $|X_i|$ is the magnitude of an I/Q pair, \bar{X} is the mean of the magnitudes for the specified region(s), and n is the number of data points in the specified region(s).

- PPHase - returns the x,y pairs of both rms power (dBm) and arithmetic mean phase (radian) for every specified region and frequency offset (Hz). The number of pairs is defined by the specified number of regions. This parameter can be used for I/Q vector (n=0) in Waveform (time domain) measurement and all parameters are specified by data point in PPHase.

The rms power of the specified region may be expressed as:

$$\text{Power} = 10 \times \log [10 \times (\text{RMS I/Q value})] + 10.$$

The RMS I/Q value (peak volts) is:

$$\sqrt{\frac{1}{n} \sum_{X_i \in \text{region}} X_i X_i^*}$$

where X_i is the complex value representation of an I/Q pair, X_i^* its conjugate complex number, and n is the number of I/Q pairs in the specified region.

The arithmetic mean phase of the specified region may be expressed as:

$$\frac{1}{n} \sum_{Y_i \in \text{region}} Y_i$$

where Y_i is the unwrapped phase of I/Q pair with applying frequency correction and n is the number of I/Q pairs in the specified region.

The frequency correction is made by the frequency offset calculated by the arithmetic mean of every specified region's frequency offset. Each frequency offset is calculated by the least square method against the unwrapped phase of I/Q pair.

Sample Trace Data - Constant Envelope

(See below for explanation of variables.)

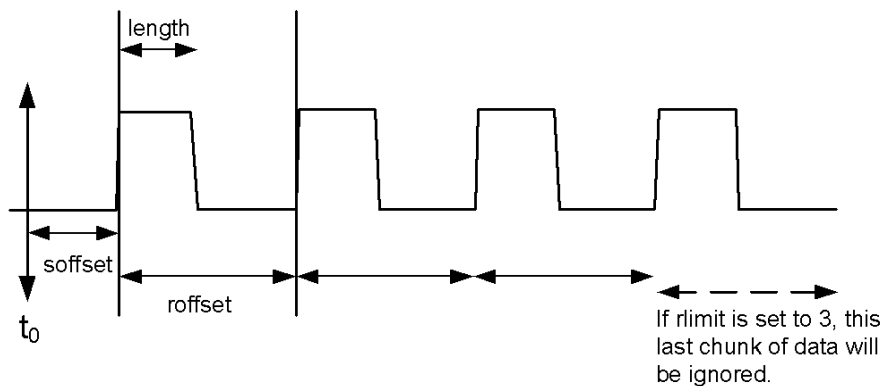

Sample Trace Data - Not Constant Envelope

(See below for explanation of variables.)

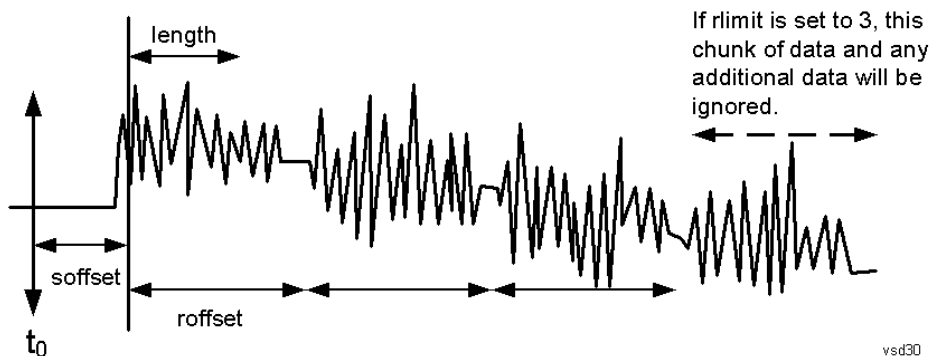

<soffset> - start offset is an optional real number. (It is in seconds for time-domain traces, and is a dimensionless index 0 to Npoints - 1, for frequency-domain traces). It specifies the amount of data at the beginning of the trace that will be ignored before the decimation process starts. It is the time or frequency change from the start of the trace to the point where you want to start using the data. The default value is zero.

<length> - is an optional real number. (It is in seconds for time-domain traces, and is a dimensionless index 0 to Npoints - 1, for frequency-domain traces). It defines how much data will be compressed into one value. This parameter has a default value equal to the current trace length.

<roffset> - repeat offset is an optional real number. (It is in seconds for time-domain traces, and is a dimensionless index 0 to Npoints - 1, for frequency-domain traces). It defines the beginning of the next field of trace elements to be compressed. This is relative to the beginning of the previous field. This parameter has a default value equal to the <length> variable. Note that this parameter is used for a completely different purpose when curve fitting (see CFIT above).

<rlimit> - repeat limit is an optional integer. It specifies the number of data items that you want returned. It will ignore any additional items beyond that number. You can use the Start offset and the Repeat limit to pick out exactly what part of the data you want to use. The default value is all the data.

Calculate Peaks of Trace Data (Remote Command Only)

Returns a list of all the peaks for the currently selected measurement and sub-opcode [n]. The peaks must meet the requirements of the peak threshold and excursion values.

n = any valid sub-opcode for the current measurement. See the MEASure:<measurement> command description of your specific measurement for information on the data that can be returned.

The command can only be used with specific sub-opcodes with measurement results that are trace data. Both real and complex traces can be searched, but complex traces are converted to magnitude in dBm. In many measurements the sub-opcode n=0, is the raw trace data which cannot be searched for peaks. And Sub-opcode n=1, is often calculated results values which also cannot be searched for peaks.

This command uses the data setting specified by the FORMat:BORDER and FORMat:DATA commands and can return real or ASCII data. If the format is set to INT,32, it returns REAL,32 data.

The command has four types of parameters:

- Threshold (in dBm)
- Excursion (in dB)
- Sorting order (amplitude, frequency, time)
- Optional in some measurements: Display line use (all, > display line, < display line)

Remote Command	<p>For Swept SA measurement:</p> <pre>:CALCulate:DATA[1] 2 ... 6:PEAKs? <threshold>,<excursion>[,AMPLitude FREQuency TIME[,ALL GTDLLine LTDLine]]</pre> <p>For most other measurements:</p> <pre>:CALCulate:DATA[1] 2 ... 6:PEAKs? <threshold>,<excursion>[,AMPLitude FREQuency TIME]</pre>
-----------------------	---

Example	<p>Example for Swept SA measurement in Spectrum Analyzer Mode:</p> <p>CALC:DATA4:PEAK? -40, 10, FREQ, GTDL This will identify the peaks of trace 4 that are above -40 dBm, with excursions of at least 10 dB. The peaks are returned in order of increasing frequency, starting with the lowest frequency. Only the peaks that are above the display line are returned.</p> <p>Query Results 1:</p> <p>With FORMat:DATA REAL, 32 selected, it returns a list of floating-point numbers. The first value in the list is the number of peak points that are in the following list. A peak point consists of two values: a peak amplitude followed by its corresponding frequency (or time).</p> <p>If no peaks are found the peak list will consist of only the number of peaks, (0).</p>
----------------	---

Notes	<p><n> - is the trace that will be used</p> <p><threshold> - is the level below which trace data peaks are ignored. Note that the threshold value is required and is always used as a peak criterion. To effectively disable the threshold criterion for this command, provide a substantially low threshold value such as -200 dBm. Also note that the threshold value used in this command is independent of and has no effect on the threshold value stored under the Peak Criteria menu.</p> <p><excursion> - is the minimum amplitude variation (rise and fall) required for a signal to be identified as peak. Note that the excursion value is required and is always used as a peak criterion. To effectively disable the excursion criterion for this command, provide the minimum value of 0.0 dB. Also note that the excursion value used in this command is independent of and has no effect on the</p>
--------------	---

excursion value stored under the Peak Criteria menu.

Values must be provided for threshold and excursion. The sorting and display line parameters are optional (defaults are AMPLitude and ALL).

Note that there is always a Y-axis value for the display line, regardless of whether the display line state is on or off. It is the current Y-axis value of the display line which is used by this command to determine whether a peak should be reported
Sorting order:

AMPLitude - lists the peaks in order of descending amplitude, with the highest peak first (default if optional parameter not sent)

FREQuency - lists the peaks in order of occurrence, left to right across the x-axis.

TIME - lists the peaks in order of occurrence, left to right across the x-axis.

Peaks vs. Display Line:

ALL - lists all of the peaks found (default if optional parameter not sent).

GTDLine (greater than display line) - lists all of the peaks found above the display line.

LTDLine (less than display line) - lists all of the peaks found below the display line.

Initial S/W Revision	Prior to A.02.00
----------------------	------------------

Hardware-Accelerated Fast Power Measurement (Remote Command Only)

The Fast Power option (FP2) enables very fast channel power measurements for instruments with the prerequisite hardware (DP2 and/or B40). It accomplishes this by performing real-time overlapped FFTs at the hardware layer, using software for basic post-processing before returning the result to the user. The upshot of this approach is improved throughput for user applications that require many sequential power measurements.

The analysis bandwidth of FP2 is limited by the licenses in the instrument, but its maximum overall analysis bandwidth per acquisition is 40 MHz.

FP2 is remote-only, which means the instrument does not switch to any particular mode or measurement. FP2 commands can be sent while another application is in use on the front panel.

Each Fast Power measurement can be predefined using an array index, and up to 1,000 measurements can be stored. In the following documentation, instances of [1,2,...,999] can be substituted with a particular measurement index, e.g. CALC:FPOW:POW1?, CALC:FPOW:POW2?, CALC:FPOW:POW134?. In this way, power measurements can be defined one time in a batch, and then executed multiple times without having to redefine them, similar to “list mode” on other measurements.

In addition to basic channel power measurements, there are a number of other measurement “functions” for each channel, including peak power, peak frequency, and power spectral density. See the Function parameter for more information.

Reset Fast Power Measurement (Remote Command Only)

Resets the measurement configuration to the defaults.

Mode	All
Remote Command	:CALCulate:FPOWer:POWer [1, 2, ..., 999] :RESet
Example	:CALC:FPOW:POW1:RES

Notes	Option FP2 is required.
Initial S/W Revision	A.14.00

Define Fast Power Measurement (Remote Command Only)

Fast Power acquisitions are configured using the DEFine command. This command accepts a comma-delimited string of configuration parameters and their appropriate values, which are all specified in the subsection below.

Mode	All
Remote Command	:CALCulate:FPOWer:POWer[1,2,...,999]:DEFine "configuration string"
Example	:CALC:FPOW:POW1:DEF "CenterFrequency=2e9, AcquisitionTime=0.005"
Notes	See below for a list of measurement variables that can be defined in the configuration string.
Initial S/W Revision	A.14.00

Acquisition Time

Example	CALC:FPOW:POW1:DEF "AcquisitionTime=0.002"
Notes	The acquisition time parameter sets the time in which the entire spectrum is measured. An increase in the acquisition time yields an improvement in measurement repeatability.
Preset	0.001 s
Range	0 s to 1 s
Default Unit	Time (s)
Initial S/W Revision	A.14.00

Center Frequency

Example	CALC:FPOW:POW1:DEF "CenterFrequency=2e9"
Notes	The center frequency parameter sets the frequency in which the measurement is centered around. The OffsetFrequency parameter is calculated relative to the center frequency.
Preset	1 GHz
Range	0 Hz to maximum instrument frequency
Default Unit	Frequency (Hz)
Initial S/W Revision	A.14.00

DC Coupled

Example	CALC:FPOW:POW1:DEF "DCCoupled=True"
Notes	The DC coupled parameter allows the user to specify whether the DC blocking capacitor is utilized. Set parameter to true when measuring frequencies below 10 MHz.
Preset	False
Range	True (DC Coupled) or False (AC Coupled)
Default Unit	Boolean
Initial S/W Revision	A.14.00

DetectorType

Example	CALC:FPOW:POW1:DEF "DetectorType=Peak"
Notes	Option FP2 is required. The detector type parameter allows the user to choose whether a RMS average or peak value is used during the measurement.
Preset	RmsAverage
Range	RmsAverage, Peak
Initial S/W Revision	A.14.00

Do Noise Correction

Example	CALC:FPOW:POW1:DEF "DoNoiseCorrection=True"
Notes	When noise correction is enabled, the linear noise power contributed by the analyzer is subtracted from all measurements. This effectively lowers the noise floor of the analyzer. When noise correction is enabled, the first measurement for a given set of input parameters will take extra time. This is because the analyzer takes an extra acquisition with the RF input disconnected from the analyzer's front end to measure the noise of just the analyzer. The measured noise floor is stored in a cache so the noise acquisition will occur only once for the same state settings. In other words, if noise correction was turned on and the analyzer made an acquisition at frequency A, then frequency B, and back again to frequency A, the hidden initial noise floor acquisition would only occur for the first acquisition at frequency A and the cached noise floor would be used the second time frequency A was measured.
Preset	False
Range	True (enable noise correction) or False (disable noise correction)
Default Unit	Boolean
Initial S/W Revision	A.14.00

Do Spur Suppression

Example	CALC:FPOW:POW1:DEF "DoSpurSuppression=True"
Notes	<p>When measuring very low level signals, or when large out-of-band inputs are input into the analyzer, sometimes unwanted spurs and residuals can appear in the measured spectrum. Spur suppression is a method to help minimize the levels of these internally generated spurs and residuals.</p> <p>When spur suppression is enabled, the analyzer will automatically take two acquisitions using two different internal analog LO frequencies. The FFT spectrums from both acquisitions are combined by taking the minimum power between both traces on a per FFT bin basis. External signals will have the same amplitude for both traces and therefore will return the expected amplitudes. However, low level spurs and residuals generated internally to the analyzer tend to move to different FFT bins depending on the internal analog LO frequency used, and therefore tend to be suppressed using this spur suppression method.</p> <p>Because two acquisitions, rather than a single acquisition, are made when spur suppression is enabled, the measurement time will always be slower when spur suppression is enabled.</p>
Preset	False
Range	True (enable spur suppression) or False (disable spur suppression)
Default Unit	Boolean
Initial S/W Revision	A.14.00

Electronic Attenuator Bypass

Example	CALC:FPOW:POW1:DEF "ElecAttBypass =False"
Notes	The electronic attenuation bypass parameter allows the user to either utilize or bypass the electronic attenuator. The electronic attenuator is only available for frequencies up to 3.6 GHz. Set parameter to true when using frequencies above 3.6 GHz and set the parameter to false when using the preamp.
Preset	True
Range	True (bypass electronic attenuator) or False (use electronic attenuator)
Default Unit	Boolean
Initial S/W Revision	A.14.00

Electronic Attenuation

Example	CALC:FPOW:POW1:DEF "ElecAttenuation=10"
Notes	<p>Option EA3 is required.</p> <p>The electronic attenuation value parameter sets the amount of electrical attenuation from 0 to 24 dB (1 dB steps).</p> <p>Set "ElecAttBypass=False" to make sure the electronic attenuator path is enabled.</p>
Preset	0 dB
Range	0 - 24 dB (1 dB steps)

Default Unit	dB
Initial S/W Revision	A.14.00

IF Gain

Example	CALC:FPOW:POW1:DEF "IFGain=10"
Notes	The IF gain parameter allows the user to specify the gain at the IF stage anywhere from -6 to 16 dB (1 dB steps). This is an advanced feature, and for most cases this should remain at its default value of 0 dB.
Preset	0 dB
Range	-6 - 16 dB (1 dB steps)
Default Unit	dB
Initial S/W Revision	A.14.00

IF Type

Example	CALC:FPOW:POW1:DEF "IFType=B25M"
Notes	The IF type parameter allows the user to select between different IF paths. For example, if the signal is less than 25 MHz wide, then the user can select the B25M path to take advantage of additional filtering on this analog IF path.
Preset	B40M
Range	B10M, B25M, B40M
Initial S/W Revision	A.14.00

Include Power Spectrum

Example	CALC:FPOW:POW1:DEF "IncludePowerSpectrum=True"
Notes	The power spectrum parameter allows the user to read data on the entire spectrum for diagnostic purposes. It is not recommended for production use. See CALC:FPOW:POW[n]:READ2? for details on the binary format of the response.
Preset	False
Range	True (return both channel power and full power spectrum) or False (returns only channel power)
Default Unit	Boolean
Initial S/W Revision	A.14.00

Mechanical Attenuation

Example	CALC:FPOW:POW1:DEF "MechAttenuation=10"
Notes	The mechanical attenuation value parameter sets the amount of mechanical attenuation anywhere from 0 to 70 dB (2 dB steps).
Preset	0 dB
Range	0 – 70 dB (2 dB steps)
Default Unit	dB
Initial S/W Revision	A.14.00

Preamp Mode

Example	CALC:FPOW:POW1:DEF "PreAmpMode=Low"
Notes	The license for the appropriate preamp is required. The preamp mode parameter specifies whether the preamps are being utilized. Low allows any preamps up to 3.6 GHz, and Full allows all licensed preamps. Set "ElecAttBypass=True" in order to utilize any preamps.
Preset	Off
Range	Off, Low, Full
Initial S/W Revision	A.14.00

Resolution Bandwidth Mode

Example	CALC:FPOW:POW1:DEF "PreAmpMode=Low"
Notes	The resolution bandwidth mode parameter allows the user to choose whether the RBW filter is automatically or manually set. The BestSpeed value minimizes measurement time, while the Narrowest value minimizes RBW size (minimum of two FFT bins per RBW). To manually specify an RBW, set this parameter to Explicit, and set the ResolutionBW parameter to the desired value.
Preset	BestSpeed
Range	BestSpeed, Narrowest, Explicit
Initial S/W Revision	A.14.00

Resolution Bandwidth

Example	CALC:FPOW:POW1:DEF "ResolutionBW=25e3"
Notes	The resolution bandwidth parameter sets the 3-dB bandwidth of the RBW filter. The ResolutionBWMode parameter must be set to Explicit in order to manually set the RBW.

Preset	0 Hz
Default Unit	Hz
Initial S/W Revision	A.14.00

Trigger Delay

Example	CALC:FPOW:POW1:DEF "TriggerDelay=0.025"
Notes	The trigger delay parameter sets the time after an external trigger is detected until the measurement is performed.
Preset	0 s
Range	0 - 1 s
Default Unit	Seconds
Initial S/W Revision	A.14.00

Trigger Level

Example	CALC:FPOW:POW1:DEF "TriggerLevel=2"
Notes	The trigger level parameter sets the voltage value at which an external trigger is detected.
Preset	1.2 V
Range	-5 to 5 V
Default Unit	Volts
Initial S/W Revision	A.14.00

Trigger Slope

Example	CALC:FPOW:POW1:DEF "TriggerSlope=Negative"
Notes	The trigger slope parameter indicates the direction of the edge trigger voltage for detection.
Preset	Positive
Range	Positive, Negative
Initial S/W Revision	A.14.00

Trigger Source

Example	CALC:FPOW:POW1:DEF "TriggerSource=Ext1"
Notes	The trigger source parameter allows the user to choose between measurement's triggering freely or controlled by an external input. Ext1 and Ext2 correspond to Trigger 1 In and Trigger 2 In, respectively.
Preset	Free
Range	Free, Ext1, Ext2
Initial S/W Revision	A.14.00

Trigger Timeout

Example	CALC:FPOW:POW1:DEF "TriggerTimeout=0.1"
Notes	The trigger timeout parameter sets the time in which the analyzer will wait for a trigger before automatically performing the measurement.
Preset	1 s
Range	0 – 1 s
Default Unit	Seconds
Initial S/W Revision	A.14.00

Signal Input

Example	CALC:FPOW:POW1:DEF "SignalInput=Fp50MHzCW"
Notes	The signal input parameter allows the user to select between using the main RF input or the internal analyzer reference CW signal of 50 MHz.
Preset	FpMainRf
Range	FpMainRf, Fp50MHzCW
Initial S/W Revision	A.14.00

Use Preselector

Example	CALC:FPOW:POW1:DEF "UsePreSelector=True"
Notes	The preselector parameter allows the user to either utilize or bypass the front end tunable filter at frequencies above 3.6 GHz. For frequencies below 3.6 GHz, the preselector is automatically bypassed, so you do not need to set this parameter to False in those cases.
Preset	False
Range	True (use preselector above 3.6 GHz), or False (preselector bypassed)

Default Unit	Boolean
Initial S/W Revision	A.14.00

Channel Bandwidth Array

Example	CALC:FPOW:POW1:DEF "Bandwidth=[3.84e6, 5e6, 3.84e6]"
Notes	The bandwidth parameter array defines the bandwidth of each channel that will be measured. All array parameters should have the same number of elements. Alternatively, if all the elements are the same value, a single number with no square brackets can be used to define the parameter.
Preset	[1e6]
Range	0 to 40 MHz
Default Unit	Hz
Initial S/W Revision	A.14.00

Channel Filter Type Array

Example	CALC:FPOW:POW1:DEF "FilterType=[RRC, IBW, RRC]"
Notes	The filter type parameter allows the user to choose between an integration bandwidth (IBW) filter or a root-raised-cosine (RRC) filter. The integration bandwidth filter weighs all frequencies within the bandwidth equally. The root-raised-cosine filter has an associated shape parameter, defined by the FilterAlpha parameter. All array parameters should have the same number of elements. Alternatively, if all the elements are the same value, a single value with no square brackets can be used to define the parameter.
Preset	[IBW]
Range	IBW, RRC
Initial S/W Revision	A.14.00

Channel Filter Alpha Array

Example	CALC:FPOW:POW1:DEF "FilterAlpha=[0.5, 0.0, 0.5]"
Notes	The filter alpha parameter allows the user to adjust the alpha value associated with the root-raised-cosine (RRC) filter type. Set FilterType to RRC in order to utilize this parameter. All array parameters should have the same number of elements. Alternatively, if all the elements are the same value, a single number with no square brackets can be used to define the parameter.
Preset	[0.22]
Range	0.0 - 1.0

Initial S/W Revision	A.14.00
-------------------------	---------

Channel Measurement Function Array

Example	CALC:FPOW:POW1:DEF "Function=[BandPower, PeakPower, BandPower]"
Notes	<p>This parameter array defines what measurement is being made for each individually-specified channel:</p> <p>BandPower: Total power within the specified bandwidth of the channel (dBm)</p> <p>BandDensity: Total power density within the specified bandwidth of the channel (dBm/Hz)</p> <p>PeakPower: The peak power value within the specified bandwidth of the channel (dBm)</p> <p>PeakFrequency: The frequency which corresponds to the peak power value within the specified bandwidth of the channel. This frequency is relative to the center frequency (Hz)</p> <p>XdBBandwidth: The half power (-3.01 dB) bandwidth of the highest amplitude signal that resides within the channel (Hz), dB is configurable using XdBBandwidth parameter</p> <p>OccupiedBandwidth: The bandwidth at which 99% of the total power resides within the channel (Hz), percentage configurable using OccupiedBandwidthPercent parameter</p> <p>All array parameters should have the same number of elements. Alternatively, if all the elements are the same value, a single value with no square brackets can be used to define the parameter.</p>
Preset	[BandPower]
Range	BandPower, BandDensity, PeakPower, PeakFrequency, XdBBandwidth, OccupiedBandwidth
Initial S/W Revision	A.14.00

Channel Offset Frequency Array

Example	CALC:FPOW:POW1:DEF "OffsetFrequency=[-5e6, 0, 5e6]"
Notes	<p>The offset frequency parameter array defines the difference between the center frequency to the center frequency of each channel.</p> <p>All array parameters should have the same number of elements.</p>
Preset	[0]
Range	0 to 20 MHz
Default Unit	Hz
Initial S/W Revision	A.14.00

Channel Occupied Bandwidth Percent Array

Example	CALC:FPOW:POW1:DEF "OccupiedBandwidthPercent =[0.95, 0.95, 0.95]"
Notes	This parameter only applies for channels whose Function is set to OccupiedBandwidth. The occupied

	bandwidth percent parameter specifies the percent of total power in these channels. The valid range for this parameter is 0.0 to 1.0, where 1.0 represents 100%. The default for this parameter is 0.99, which will return the bandwidth that contains 99% of the total channel power.
Preset	[0.99]
Range	0 - 1.0
Initial S/W Revision	A.14.00

Channel x-dB Bandwidth Array

Example	CALC:FPOW:POW1:DEF " XdBBandwidth =[-6.02, -3.01, -1.0]"
Notes	This parameter only applies for channels whose Function is set to XdBBandwidth. The X dB bandwidth parameter is used to specify the power relative to the peak channel power over which the bandwidth is calculated. The parameter value must be a negative number.
Preset	[-3.01]
Range	-200 to 0 dB
Default Unit	dB
Initial S/W Revision	A.14.00

Define Fast Power Measurement Query (Remote Command Only)

The DEFine? command is used to retrieve a list of all defined parameters in an ASCII string format

```

M All
o
d
e
-----
R :CALCulate:FPOWer:POWer[1,2,...,999]:DEFine?
e
m
o
t
e
C
o
m
m
a
n
d
-----
E :CALC:FPOW:POW1:DEF?

```

x
a
m
p
l
e

N This command query is used to retrieve a list of all defined parameters in an ASCII format.

O The following is an example of the returned results:

S "DCCoupled=False,ElecAttBypass=True,ElecAttenuation=0,IFGain=0,MechAttenuation=0,PreAmpMode=Off,PreSelectorOffset=0,UsePreSelector=False,ExternalReferenceFrequency=1000000,FrequencyReferenceSource=AutoExternalFrequencyReference,IFType=B40M,LOMode=SLW,SignalInput=FpMainRf,AcquisitionTime=0.001,CenterFrequency=100000000,ResolutionBW=0,ResolutionBWMode=BestSpeed,DetectorType=RmsAverage,Bandwidth=[1000000],OffsetFrequency=[0],Function=[BandPower],FilterType=[IBW],FilterAlpha=[0.22],OccupiedBandwidthPercent=[0.99],XdBBandwidth=[-3.01],DoNoiseCorrection=False,DoSpurSuppression=False,MeasurementMethod=HardwareFFT,IncludePowerSpectrum=False,TriggerDelay=0,TriggerLevel=1.2,TriggerSlope=Positive,TriggerSource=Free,TriggerTimeout=1"

I A.14.00

n
i
t
i
a
l

S
/
W

R
e
v
i
s
i
o
n

Configure Fast Power Measurement (Remote Command Only)

The configure command begins hardware setup and returns immediately, with no acquisition made. This can be used in parallel with other hardware operations to effectively hide the hardware setup time.

Mode	All
Remote Command	:CALCulate:FPOWER:POWER[1,2,...,999]:CONFigure
Example	:CALC:FPOW:POW1:CONF
Notes	Option FP2 is required.
Initial S/W Revision	A.14.00

Initiate Fast Power Measurement (Remote Command Only)

The INITiate command begins an acquisition and returns immediately. The results of the measurement can be retrieved using FETCh.

Mode	All
Remote Command	:CALCulate:FPOWer:POWer [1, 2, ..., 999] :INITiate
Example	:CALC:FPOW:POW1:INIT
Notes	Option FP2 is required.
Initial S/W Revision	A.14.00

Fetch Fast Power Measurement (Remote Command Only)

The FETCh command query is used to retrieve the results of an acquisition initiated by the INIT command. The returned results are in ASCII string format. The string begins and ends with quotation marks.

Mode	All
Remote Command	:CALCulate:FPOWer:POWer [1, 2, ..., 999] :FETCh?
Example	:CALC:FPOW:POW1:FETC?
Notes	Option FP2 is required. Returns m comma-separated ASCII values, where m corresponds to the number of bandwidths defined. 1. Declared function return in the 1st specified channel 2. Declared function return in the 2nd specified channel ... m. Declared function return in the last specified channel The INIT and FETC? command sequence performs the same functionality of a single CALC:FPOW:POW[n]? query. Units of the returned values are dependent on the Function parameter for each channel.
Initial S/W Revision	A.14.00

Execute Fast Power Measurement (Remote Command Only)

This command query is used as shorthand for an INIT command immediately followed by a FETC? command. The returned results are in ASCII string format. The string begins and ends with quotation marks.

Mode	All
Remote Command	:CALCulate:FPOWer:POWer [1, 2, ..., 999] ?
Example	:CALC:FPOW:POW1?

Notes	Option FP2 is required. See notes for Fast Power Fetch for return format.
Initial S/W Revision	A.14.00

Binary Read Fast Power Measurement (Remote Command Only)

This command query is used as shorthand for an INIT command immediately followed by a FETC? command. The returned results are in a binary format.

Mode	All
Remote Command	:CALCulate:FPOWER:POWER[1,2,...,999]:READ? :CALCulate:FPOWER:POWER[1,2,...,999]:READ1?
Example	:CALC:FPOW:POW1:READ? :CALC:FPOW:POW1:READ1?
Notes	Option FP2 is required. Returns m 4 byte floating point binary values (Little-Endian), where m corresponds to the number of bandwidths defined.
Initial S/W Revision	A.14.00

Diagnostic Binary Read Fast Power Measurement (Remote Command Only)

This command query is used as shorthand for an INIT command immediately followed by a FETC? command. The returned results are in a binary format. This command is used primarily for diagnostic purposes to test for ADC overloads and to visibly inspect the spectrum.

Mode	All
Remote Command	:CALCulate:FPOWER:POWER[1,2,...,999]:READ2?
Example	:CALC:FPOW:POW1:READ2?
Notes	Option FP2 is required. Note: Spectrum data is only returned if the IncludePowerSpectrum parameter is set to True. If IncludePowerSpectrum is False, the number of spectrum points will be zero (0). Units of the returned values are dependent on the Function parameter per channel (e.g. dBm for BandPower, Hz for PeakFrequency). Returns binary data (Little-Endian) that contains information on m amount of channels, along with ADC over range and full spectrum data. The following is the binary format of the response. Bandwidth Return Value 1. Number of channels specified, m [4 byte int] 2. Declared function result for the 1st specified channel [4 byte float]

	3. Declared function result for the 2nd specified channel [4 byte float]
	...
	(m + 1). Declared function result for the last (mth) specified channel [4 byte float]
	ADC Over Range
	1. ADC over-range occurred (1: true, 0: false) [2 byte short]
	Spectrum Data
	1. Number of points in the spectrum data, k [4 byte int]
	2. Start frequency of spectrum data (Hz) [8 byte double]
	3. Step frequency of spectrum data (Hz) [8 byte double]
	4. FFT bin at 1st point (dBm) [4 byte float]
	5. FFT bin at 2nd point (dBm) [4 byte float]
	...
	(k + 3). FFT bin at last (kth) point (dBm) [4 byte float]

Initial S/W Revision	A.14.00
-------------------------	---------

Format Data: Numeric Data (Remote Command Only)

This command specifies the format of the trace data input and output. It specifies the formats used for trace data during data transfer across any remote port. It affects only the data format for setting and querying trace data for the :TRACe[:DATA], TRACe[:DATA]?, :CALCulate:DATA[n]? and FETCh:SANalyzer [n]? commands and queries.

Remote Command	:FORMat [:TRACe] [:DATA] ASCii INTeger, 32 REAL, 32 REAL, 64 :FORMat [:TRACe] [:DATA] ?
Notes	The query response is: ASCii: ASC,8 REAL,32: REAL,32 REAL,64: REAL,64 INTeger,32: INT,32 When the numeric data format is REAL or ASCii, data is output in the current Y Axis unit. When the data format is INTeger, data is output in units of m dBm (.001 dBm). The INT,32 format returns binary 32-bit integer values in internal units (m dBm), in a definite length block.
Dependencies	Sending a data format spec with an invalid number (for example, INT,48) generates no error. The analyzer simply uses the default (8 for ASCii, 32 for INTeger, 32 for REAL). Sending data to the analyzer which does not conform to the current FORMat specified, results in an error. Sending ASCII data when a definite block is expected generates message -161 "Invalid Block Data" and sending a definite block when ASCII data is expected generates message -121 "Invalid Character in Number".
Preset	ASCii
Backwards Compatibility	Note that the INT,32 format is only applicable to the command, TRACe:DATA. This preserves

Notes	backwards compatibility for the Swept SA measurement. For all other commands/queries which honor FORMat:DATA, if INT,32 is sent the analyzer will behave as though it were set to REAL,32.
Initial S/W Revision	Prior to A.02.00

The specs for each output type follow:

ASCIi - Amplitude values are in ASCII, in the current Y Axis Unit, one ASCII character per digit, values separated by commas, each value in the form:

SX.YYYYYEsZZ

Where:

S = sign (+ or -)

X = one digit to left of decimal point

Y = 5 digits to right of decimal point

E = E, exponent header

s = sign of exponent (+ or -)

ZZ = two digit exponent

REAL,32 - Binary 32-bit real values in the current Y Axis Unit, in a definite length block.

REAL,64 - Binary 64-bit real values in the current Y Axis Unit, in a definite length block.

Format Data: Byte Order (Remote Command Only)

This command selects the binary data byte order for data transfer and other queries. It controls whether binary data is transferred in normal or swapped mode. This command affects only the byte order for setting and querying trace data for the :TRACe[:DATA], TRACe[:DATA]? , :CALCulate:DATA[n]? and FETCh:SANalyzer[n]? commands and queries.

By definition any command that says it uses FORMat:DATA uses any format supported by FORMat:DATA.

The NORMal order is a byte sequence that begins with the most significant byte (MSB) first, and ends with the least significant byte (LSB) last in the sequence: 1|2|3|4. SWAPped order is when the byte sequence begins with the LSB first, and ends with the MSB last in the sequence: 4|3|2|1.

Remote Command	:FORMat:BORDER NORMal SWAPped :FORMat:BORDER?
Preset	NORMal
Initial S/W Revision	Prior to A.02.00

Meas (Measure) Setup

In the Meas Setup menu, the average setup functionality is available and average related parameters can be set for each radio format. The Average Mode is not available in this measurement since it is always the Repeat.

All other measurement parameters can be modified using SCPI, or via the Format Parameter List. See Format Parameter List in the MSR mode. Parameters required for each radio format are listed in the section **Format Parameter List in Mode Setup**. Behavior of each parameter (default value, range etc) is the same as the original measurement.

Key Path	Front-panel key
Initial S/W Revision	A.10.00

Meas (Measure) Setup

In the Meas Setup menu, the average setup functionality is available and average related parameters can be set for each radio format. The Average Mode is not available in this measurement since it is always the Repeat.

All other measurement parameters can be modified using SCPI, or via the Format Parameter List. See Format Parameter List in the MSR mode. Parameters required for each radio format are listed in the section **Format Parameter List in Mode Setup**. Behavior of each parameter (default value, range etc) is the same as the original measurement.

Key Path	Front-panel key
Initial S/W Revision	A.10.00

LTE FDD Average/Hold Number

Sets the number of data acquisitions that will be averaged for the LTE FDD format carrier.

Key Path	Meas Setup, LTE FDD
Mode	MSR
Remote Command	[:SENSe]:CEVM:LTEFdd:AVERage:COUNT <integer> [:SENSe]:CEVM:LTEFdd:AVERage:COUNT? [:SENSe]:CEVM:LTEFdd:AVERage[:STATe] OFF ON 0 1 [:SENSe]:CEVM:LTEFdd:AVERage[:STATe]?
Example	CEVM:LTEF:AVER:COUN 3 CEVM:LTEF:AVER:COUN? CEVM:LTEF:AVER ON CEVM:LTEF:AVER?
Notes	You must be in the MSR mode to use this command. Use INSTRument:SElect to set the mode.

Preset	10 OFF
State Saved	Saved in instrument state.
Min	1
Max	10000
Initial S/W Revision	A.10.00

Meas (Measure) Setup

In the Meas Setup menu, the average setup functionality is available and average related parameters can be set for each radio format. The Average Mode is not available in this measurement since it is always the Repeat.

All other measurement parameters can be modified using SCPI, or via the Format Parameter List. See Format Parameter List in the MSR mode. Parameters required for each radio format are listed in the section **Format Parameter List in Mode Setup**. Behavior of each parameter (default value, range etc) is the same as the original measurement.

Key Path	Front-panel key
Initial S/W Revision	A.10.00

W-CDMA Average/Hold Number

Sets the number of data acquisitions that will be averaged for the W-CDMA format carrier.

Key Path	Meas Setup, W-CDMA
Mode	MSR
Remote Command	[:SENSe]:CEVM:WCDMa:AVERage:COUNt <integer> [:SENSe]:CEVM:WCDMa:AVERage:COUNt? [:SENSe]:CEVM:WCDMa:AVERage[:STATe] OFF ON 0 1 [:SENSe]:CEVM:WCDMa:AVERage[:STATe]?
Example	CEVM:WCDM:AVER:COUN 3 CEVM:WCDM:AVER:COUN? CEVM:WCDM:AVER ON CEVM:WCDM:AVER?
Notes	You must be in the MSR mode to use this command. Use INSTRument:SElect to set the mode.
Preset	10 OFF
State Saved	Saved in instrument state.
Min	1

Max	10000
Initial S/W Revision	A.10.00

Meas (Measure) Setup

In the Meas Setup menu, the average setup functionality is available and average related parameters can be set for each radio format. The Average Mode is not available in this measurement since it is always the Repeat.

All other measurement parameters can be modified using SCPI, or via the Format Parameter List. See Format Parameter List in the MSR mode. Parameters required for each radio format are listed in the section **Format Parameter List in Mode Setup**. Behavior of each parameter (default value, range etc) is the same as the original measurement.

Key Path	Front-panel key
Initial S/W Revision	A.10.00

GSM/EDGE Average/Hold Number

Sets the number of data acquisitions that will be averaged for the GSM/EDGE format carrier.

Key Path	Meas Setup, GSM/EDGE
Mode	MSR
Remote Command	[:SENSe]:CEVM:GSM:AVERage:COUNT <integer> [:SENSe]:CEVM:GSM:AVERage:COUNT? [:SENSe]:CEVM:GSM:AVERage[:STATe] OFF ON 0 1 [:SENSe]:CEVM:GSM:AVERage[:STATe]?
Example	CEVM:GSM:AVER:COUN 3 CEVM:GSM:AVER:COUN? CEVM:GSM:AVER ON CEVM:GSM:AVER?
Notes	You must be in the MSR mode to use this command. Use INSTRument:SElect to set the mode.
Preset	10 OFF
State Saved	Saved in instrument state.
Min	1
Max	10000
Initial S/W Revision	A.10.00

Meas (Measure) Setup

In the Meas Setup menu, the average setup functionality is available and average related parameters can be set for each radio format. The Average Mode is not available in this measurement since it is always the Repeat.

All other measurement parameters can be modified using SCPI, or via the Format Parameter List. See Format Parameter List in the MSR mode. Parameters required for each radio format are listed in the section **Format Parameter List in Mode Setup**. Behavior of each parameter (default value, range etc) is the same as the original measurement.

Key Path	Front-panel key
Initial S/W Revision	A.10.00

cdma2000 Average/Hold Number

Sets the number of data acquisitions that will be averaged for the cdma2000 format carrier.

Key Path	Meas Setup, cdma2000
Mode	MSR
Remote Command	[:SENSe]:CEVM:CDMA:AVERAge:COUNT <integer> [:SENSe]:CEVM:CDMA:AVERAge:COUNT? [:SENSe]:CEVM:CDMA:AVERAge[:STATe] OFF ON 0 1 [:SENSe]:CEVM:CDMA:AVERAge[:STATe]?
Example	CEVM:CDMA:AVER:COUN 3 CEVM:CDMA:AVER:COUN? CEVM:CDMA:AVER ON CEVM:CDMA:AVER?
Notes	You must be in the MSR mode to use this command. Use INSTRument:SElect to set the mode.
Preset	10 OFF
State Saved	Saved in instrument state.
Min	1
Max	10000
Initial S/W Revision	A.12.00

Meas (Measure) Setup

In the Meas Setup menu, the average setup functionality is available and average related parameters can be set for each radio format. The Average Mode is not available in this measurement since it is always the Repeat.

All other measurement parameters can be modified using SCPI, or via the Format Parameter List. See Format Parameter List in the MSR mode. Parameters required for each radio format are listed in the section **Format Parameter List in Mode Setup**. Behavior of each parameter (default value, range etc) is the same as the original measurement.

Key Path	Front-panel key
Initial S/W Revision	A.10.00

1xEV-DO Average/Hold Number

Sets the number of data acquisitions that will be averaged for the 1xEV-DO format carrier.

Key Path	Meas Setup, 1xEV-DO
Mode	MSR
Remote Command	[:SENSe]:CEVM:EVDO:AVERAge:COUNT <integer> [:SENSe]:CEVM:EVDO:AVERAge:COUNT? [:SENSe]:CEVM:EVDO:AVERAge[:STATe] OFF ON 0 1 [:SENSe]:CEVM:EVDO:AVERAge[:STATe]?
Example	CEVM:EVDO:AVER:COUN 3 CEVM:EVDO:AVER:COUN? CEVM:EVDO:AVER ON CEVM:EVDO:AVER?
Notes	You must be in the MSR mode to use this command. Use INSTRument:SElect to set the mode.
Preset	10 OFF
State Saved	Saved in instrument state.
Min	1
Max	10000
Initial S/W Revision	A.12.00

Meas (Measure) Setup

In the Meas Setup menu, the average setup functionality is available and average related parameters can be set for each radio format. The Average Mode is not available in this measurement since it is always the Repeat.

All other measurement parameters can be modified using SCPI, or via the Format Parameter List. See Format Parameter List in the MSR mode. Parameters required for each radio format are listed in the section **Format Parameter List in Mode Setup**. Behavior of each parameter (default value, range etc) is the same as the original measurement.

Key Path	Front-panel key
Initial S/W Revision	A.10.00

LTE TDD Average/Hold Number

Sets the number of data acquisitions that will be averaged for the LTE TDD format carrier.

Key Path	Meas Setup, LTE TDD
Mode	MSR
Remote Command	[:SENSe] :CEVM:LTETdd:AVERage:COUNT <integer> [:SENSe] :CEVM:LTETdd:AVERage:COUNT? [:SENSe] :CEVM:LTETdd:AVERage[:STATe] OFF ON 0 1 [:SENSe] :CEVM:LTETdd:AVERage[:STATe] ?
Example	CEVM:LTET:AVER:COUN 3 CEVM:LTET:AVER:COUN? CEVM:LTET:AVER ON CEVM:LTET:AVER?
Notes	You must be in the MSR mode to use this command. Use INSTRument:SElect to set the mode.
Preset	10 OFF
State Saved	Saved in instrument state.
Min	1
Max	10000
Initial S/W Revision	A.14.50

Meas (Measure) Setup

In the Meas Setup menu, the average setup functionality is available and average related parameters can be set for each radio format. The Average Mode is not available in this measurement since it is always the Repeat.

All other measurement parameters can be modified using SCPI, or via the Format Parameter List. See Format Parameter List in the MSR mode. Parameters required for each radio format are listed in the section **Format Parameter List in Mode Setup**. Behavior of each parameter (default value, range etc) is the same as the original measurement.

Key Path	Front-panel key
Initial S/W Revision	A.10.00

TD-SCDMA Average/Hold Number

Sets the number of data acquisitions that will be averaged for the TD-SCDMA format carrier.

Key Path	Meas Setup, TD-SCDMA
Mode	MSR
Remote Command	[:SENSe] :CEVM:TDSCdma:AVERage:COUNT <integer> [:SENSe] :CEVM:TDSCdma:AVERage:COUNT? [:SENSe] :CEVM:TDSCdma:AVERage [:STATe] OFF ON 0 1 [:SENSe] :CEVM:TDSCdma:AVERage [:STATe] ?
Example	CEVM:TDSC:AVER:COUN 3 CEVM:TDSC:AVER:COUN? CEVM:TDSC:AVER ON CEVM:TDSC:AVER?
Notes	You must be in the MSR mode to use this command. Use INSTRument:SElect to set the mode.
Preset	10 OFF
State Saved	Saved in instrument state.
Min	1
Max	10000
Initial S/W Revision	A.14.50

Spectrum

This function determines if the spectrum of the incoming data is mirrored or not. The actual mirroring is accomplished by conjugating the complex time data.

Key Path	Meas Setup
Mode	MSR
Remote Command	[:SENSe] :CEVM:SPECTrum NORMal INVert [:SENSe] :CEVM:SPECTrum?
Example	CEVM:SPEC INV CEVM:SPEC?
Preset	NORM
State Saved	Saved in instrument state.
Range	Normal Invert
Initial S/W Revision	A.10.00

Meas Preset

Restores all the measurement parameters to their default values.

Key Path	Meas Setup
Mode	BASIC, PNOISE, WCDMA, C2K, GSM, WIMAXOFDMA, TDSCDMA, 1XEVD0, DVB, DTMB, ISDBT, CMMB, LTE, LTETDD, DCATV, WLAN, MSR,LTEATDD, LTEAFDD
Remote Command	:CONFigure:WAVeform
Example	CONF:WAV
Notes	Restore default values of all parameters. You must be in a mode that includes the Waveform measurement to use this command. Use INSTRument:SElect to set the mode.
Initial S/W Revision	Prior to A.02.00
Modified at S/W Revision	A.03.00

LTE FDD Downlink Result Output Selection (SCPI only)

Sets the composition of the LTE FDD Downlink results. Disabled items (=off) are neither shown nor contained in the remote results.

IndexResult

1. EVM
2. EVM Symbol Time Adjust
3. EVM Pk
4. EVM Pk Index
5. EVM Peak Sub Car Index
6. Data EVM
7. 3GPP-defined QPSK EVM
8. 3GPP-defined 16QAM EVM
9. 3GPP-defined 64QAM EVM
10. RS EVM
11. RS Tx. Power
12. OFDM Symbol Tx. Power
13. Frequency Error
14. Sync Correlation
15. Sync Type
16. Common Tracking Error
17. Symbol Clock Error
18. Time Offset

LTE FDD Uplink Set All Results (SCPI Only)

This action command can set all of the “LTE FDD Uplink Result Output Selection” to 0 or 1 at once. It works whenever the command is sent, regardless of the current result status.

Mode	MSR
Remote Command	<code>[:SENSe] :CEVM:LTEFdd:ULINK:RESult:ALL ON OFF 0 1</code>
Example	<code>CEVM:LTEF:ULIN:RES:ALL 0</code>
State Saved	No
Initial S/W Revision	A.14.00

W-CDMA Result Output Selection for BTS (SCPI only)

Sets the composition of the W-CDMA results in BTS mode. Disabled items (=off) are neither shown nor contained in the remote results.

IndexResult

1. RMS EVM
2. Peak EVM
3. Magnitude error
4. Phase error
5. I/Q origin offset
6. Frequency error
7. Rho
8. Peak Code Domain Error
9. Peak Code Domain Error Channel Number
10. Number of active channels
11. Time offset
12. CPICH power over a slot
13. Total power over a slot
14. First Slot Number
15. Detected Scrambling Code
16. Average 64QAM RCDE
17. Peak 64QAM RCDE
18. Peak Slot RMS EVM
19. Average IQ Gain Imbalance

20. Peak IQ Gain Imbalance

21. Average IQ Quad Error

22. Peak IQ Quad Error

Mode	MSR
Remote Command	[[:SENSE]:CEVM:WCDMA:RESult[:BTS] ON OFF 0 1, ... [:SENSE]:CEVM:WCDMA:RESult[:BTS]?
Example	CEVM:WCDM:RES 1, 1, 1, 1, 1, 1, 1, 1, 1, 1, 1, 1, 1, 1, 1, 1, 1, 1, 1, 1 CEVM:WCDM:RES?
Notes	Refer to the above list to see the mapping of the index and result parameter.
Preset	1, 1, 1, 1, 1, 1, 1, 1, 1, 1, 1, 1, 1, 1, 1, 1, 1, 1, 1, 1
Preset	1, 1, 1, 1, 1, 1, 1, 1, 1, 1, 1, 1, 1, 1, 1, 1, 1, 1, 1, 1
State Saved	Saved in instrument state.
Initial S/W Revision	A.10.00
Modified at S/W Revision	A.11.00, A.13.00

GSM/EDGE Result Output Selection (SCPI only)

Sets the composition of the GSM/EDGE results. Disabled items (=off) are neither shown nor contained in the remote results.

IndexResult

1. RMS 95th %tile EVM
2. Average RMS EVM
3. Maximum RMS EVM
4. Average Peak EVM
5. Maximum Peak EVM
6. Symbol position of the peak EVM
7. Average RMS Magnitude Error
8. Maximum RMS Magnitude Error
9. Average RMS Phase Error
10. Maximum RMS Phase Error
11. Average Frequency error
12. Maximum Frequency error
13. Average I/Q origin offset
14. Amplitude Droop Error

15. Trigger to T0
16. Timing Offset of AM/PM path
17. Detected TSC
18. Detected Mod Scheme
19. Maximum I/Q origin offset
20. Average Absolute Peak Phase
21. Maximum Absolute Peak Phase error

Mode	MSR
Remote Command	[:SENSe] :CEVM:GSM:RESult ON OFF 0 1, ... [:SENSe] :CEVM:GSM:RESult?
Example	CEVM:GSM:RES 1, 1, 0, 0, 1, 1, 1, 0, 1, 1, 1, 1, 1, 0, 0, 0, 0, 0, 1 CEVM:GSM:RES?
Notes	Refer to the above table to see the mapping of the index and result parameter.
Preset	1, 1, 1, 1, 1, 1, 1, 1, 1, 1, 1, 1, 1, 1, 1, 1, 1, 1
State Saved	Saved in instrument state.
Initial S/W Revision	A.10.00

cdma2000 Result Output Selection (SCPI only)

Sets the composition of the cdma2000 results. Disabled items (=off) are neither shown nor contained in the remote results.

IndexResult

1. RMS EVM
2. Peak EVM
3. Magnitude error
4. Phase error
5. I/Q origin offset
6. Frequency error
7. Rho
8. Peak Code Domain Error
9. Peak Code Domain Error Channel Number
10. Number of active channels
11. Time offset

Mode	MSR
Remote Command	[:SENSe] :CEVM:CDMA:RESult ON OFF 0 1, ... [:SENSe] :CEVM:CDMA:RESult?
Example	CEVM:CDMA:RES 1, 1, 1, 1, 1, 1, 1, 1, 1, 1, 1, 1, 1, 1, 0, 0 CEVM:CDMA:RES?
Notes	Refer to the above table to see the mapping of the index and result parameter.
Preset	1,1,1,1,1,1,1,1,1,1
State Saved	Saved in instrument state.
Initial S/W Revision	A.12.00

1xEV-DO Result Output Selection for BTS (SCPI only)

Sets the composition of the 1xEV-DO results in the BTS mode. Disabled items (=off) are neither shown nor contained in the remote results.

IndexResult

1. RMS EVM (Pilot Channel)
2. Peak EVM (Pilot Channel)
3. Magnitude error (Pilot Channel)
4. Phase error (Pilot Channel)
5. I/Q origin offset (Pilot Channel)
6. Frequency error (Pilot Channel)
7. Rho (Pilot Channel)
8. Number of active channels (Pilot Channel)
9. Pilot offset
10. RMS EVM (MAC Channel)
11. Peak EVM (MAC Channel)
12. Magnitude error (MAC Channel)
13. Phase error (MAC Channel)
14. I/Q origin offset (MAC Channel)
15. Frequency error (MAC Channel)
16. Rho (MAC Channel)
17. Number of active channels (MAC Channel)
18. Pilot offset

19. RMS EVM (Data Channel)
20. Peak EVM (Data Channel)
21. Magnitude error (Data Channel)
22. Phase error (Data Channel)
23. I/Q origin offset (Data Channel)
24. Frequency error (Data Channel)
25. Rho (Data Channel)
26. Number of active channels (Data Channel)
27. Pilot offset
28. RMS EVM (Preamble)
29. Peak EVM (Preamble)
30. Magnitude error (Preamble)
31. Phase error (Preamble)
32. I/Q origin offset (Preamble)
33. Frequency error (Preamble)
34. Rho (Preamble)
35. Number of active channels (Preamble)
36. Pilot offset
37. RMS EVM (Overall-1)
38. Peak EVM error (Overall-1)
39. Magnitude error (Overall-1)
40. Phase error (Overall-1)
41. I/Q origin offset (Overall-1)
42. Frequency error (Overall-1)
43. Rho (Overall-1)
44. RMS EVM (Overall-2)
45. Peak EVM error (Overall-2)
46. Magnitude error (Overall-2)
47. Phase error (Overall-2)
48. I/Q origin offset (Overall-2)
49. Frequency error (Overall-2)

TD-SCDMA Result Output Selection (SCPI only)

Sets the composition of the TD-SCDMA results. Disabled items (=off) are neither shown nor contained in the remote results.

Index Result

1. Rho (Average)
2. Rho (Peak Hold)
3. RMS EVM (Average)
4. RMS EVM (Peak Hold)
5. Peak EVM (Average)
6. Peak EVM (Peak Hold)
7. RMS Magnitude Error (Average)
8. RMS Magnitude Error (Peak Hold)
9. Peak Magnitude Error (Average)
10. Peak Magnitude Error (Peak Hold)
11. RMS Phase Error (Average)
12. RMS Phase Error (Peak Hold)
13. Peak Phase Error (Average)
14. Peak Phase Error (Peak Hold)
15. Peak CDE (Average)
16. Peak CDE (Peak Hold)
17. Peak Active CDE (Average)
18. Peak Active CDE (Peak Hold)
19. Frequency Error (Average)
20. Frequency Error (Peak Hold)
21. IQ Offset (Average)
22. IQ Offset (Peak Hold)
23. Quad Error (Average)
24. Quad Error (Peak Hold)
25. Gain Imbalance (Average)
26. Gain Imbalance (Peak Hold)
27. Time Offset (Average)

13 Conformance EVM
Mode

Mode

See "[Mode](#)" on page 276

Mode Preset

Returns the active mode to a known state.

Mode Preset does the following for the currently active mode:

- Aborts the currently running measurement.
- Brings up the default menu for the mode, with no active function.
- Sets measurement Global settings to their preset values for the active mode only.
- Activates the default measurement.
- Brings up the default menu for the mode.
- Clears the input and output buffers.
- Sets Status Byte to 0.

Mode Preset does not:

- Cause a mode switch
- Affect mode persistent settings
- Affect system settings
- See "[How-To Preset](#)" on page 1840 for more information.

Key Path	Front-panel key
Remote Command	:SYSTem:PRESet
Example	:SYST:PRES
Notes	*RST is preferred over :SYST:PRES for remote operation. *RST does a Mode Preset, as done by the :SYST:PRES command, and it sets the measurement mode to Single measurement rather than Continuous for optimal remote control throughput. Clears all pending OPC bits. The Status Byte is set to 0.
Couplings	A Mode Preset aborts the currently running measurement, activates the default measurement, and gets the mode to a consistent state with all of the default couplings set.
Backwards Compatibility Notes	In the X-Series, the legacy "Factory Preset" has been replaced with Mode Preset, which only presets the currently active mode, not the entire instrument. In the X-Series, the way to preset the entire instrument is by using System, Restore System Defaults All, which behaves essentially the same way as restore System Defaults does on ESA and PSA. There is also no "Preset Type" as there is on the PSA. There is a green Mode Preset front-panel key that does a Mode Preset and a white-with-green-letters User Preset front-panel key that does a User Preset. The old PRESet:TYPE command is ignored (without generating an error), and SYST:PRES without a parameter does a Mode Preset, which should cover most backward code compatibility issues. The settings and correction data under the Input/Output front-panel key (examples: Input Z Corr, Ext Amp Gain, etc.) are no longer part of any Mode, so they will not be preset by a Mode Preset. They are preset using Restore Input/Output Defaults, Restore System Defaults All. Note that because User Preset does a Recall State, and all of these settings are saved in State, they ARE recalled when using

	User Preset.
Initial S/W Revision	Prior to A.02.00

How-To Preset

The table below shows all possible presets, their corresponding SCPI commands and front-panel access (key paths). Instrument settings depend on the current measurement context. Some settings are local to the current measurement, some are global (common) across all the measurements in the current mode, and some are global to all the available modes. In a similar way, restoring the settings to their preset state can be done within the different contexts.

Auto Couple - is a measurement local key. It sets all Auto/Man parameter couplings in the measurement to Auto. Any Auto/Man selection that is local to other measurements in the mode will not be affected.

Meas Preset - is a measurement local key. Meas Preset resets all the variables local to the current measurement except the persistent ones.

Mode Preset - resets all the current mode's measurement local and measurement global variables except the persistent ones.

Restore Mode Defaults - resets ALL the Mode variables (and all the Meas global and Meas local variables), including the persistent ones.

Type Of Preset	SCPI Command	Front Panel Access
Auto Couple	:COUPle ALL	Auto Couple front-panel key
Meas Preset	:CONFigure:<Measurement>	Meas Setup Menu
Mode Preset	:SYSTem:PRESet	Mode Preset (green key)
Restore Mode Defaults	:INSTrument:DEFault	Mode Setup Menu
Restore All Mode Defaults	:SYSTem:DEFault MODes	System Menu; Restore System Default Menu
*RST	*RST	not possible (Mode Preset with Single)
Restore Input/Output Defaults	:SYSTem:DEFault INPUt	System Menu; Restore System Default Menu
Restore Power On Defaults	:SYSTem:DEFault PON	System Menu; Restore System Default Menu
Restore Alignment Defaults	:SYSTem:DEFault ALIGN	System Menu; Restore System Default Menu
Restore Miscellaneous Defaults	:SYSTem:DEFault MISC	System Menu; Restore System Default Menu
Restore All System Defaults	:SYSTem:DEFault [ALL] :SYSTem:PRESet:PERsistent	System Menu; Restore System Default Menu
User Preset	:SYSTem:PRESet:USER	User Preset Menu
User Preset All Modes	:SYSTem:PRESet:USER:ALL	User Preset Menu

Power On Mode Preset	:SYSTEM:PON:TYPE MODE	System Menu
Power On User Preset	:SYSTEM:PON:TYPE USER	System Menu
Power On Last State	:SYSTEM:PON:TYPE LAST	System Menu

Mode Setup

See "[Mode Setup](#)" on page 306

Peak Search

There is no Peak Search functionality in this measurement. When pressed, blank menu appears.

Key Path	Front-panel key
Initial S/W Revision	A.10.00

13 Conformance EVM
Print

Print

See "[Print](#) " on page 367

Quick Save

The Quick Save front-panel key repeats the most recent save that was performed from the Save menu, with the following exceptions:

- Register saves are not remembered as Saves for the purpose of the Quick Save function
- If the current measurement does not support the last non-register save that was performed, an informational message is generated, “File type not supported for this measurement”

Quick Save repeats the last type of qualified save (that is, a save qualified by the above criteria) in the last save directory by creating a unique filename using the Auto File Naming algorithm described below.

If Quick Save is pressed after startup and before any qualified Save has been performed, the Quick Save function performs a Screen Image save using the current settings for Screen Image saves (current theme, current directory), which then becomes the “last save” for the purpose of subsequent Quick Saves.

The Auto File Naming feature automatically generates a file name for use when saving a file. The filename consists of a prefix and suffix separated by a dot, as is standard for the Windows® file system. A default prefix exists for each of the available file types:

Type	Default Prefix	Menu
State	State_	(Save/Recall)
Trace + State	State_	(Save/Recall)
Screen	Screen_	(Save/Recall)
Amplitude Corrections	Ampcor_	(Import/Export)
Traces	Trace_	(Import/Export)
Limit Lines	LLine_	(Import/Export)
Measurement Result	MeasR_	(Import/Export)
Capture Buffer	CapBuf_	(Import/Export)

A four digit number is appended to the prefix to create a unique file name. The numbering sequence starts at 0000 within each Mode for each file type and updates incrementally to 9999, then wraps to 0000 again. It remembers where it was through a Mode Preset and when leaving and returning to the Mode. It is reset by Restore Misc Defaults and Restore System Defaults and subsequent running of the instrument application. So, for example, the first auto file name generated for State files is State_0000.state. The next is State_0001, and so forth.

One of the key features of Auto File Name is that we guarantee that the Auto File Name will never conflict with an existing file. The algorithm looks for the next available number. If it gets to 9999, then it looks for holes. If it find no holes, that is no more numbers are available, it gives an error.

For example, if when we get to State_0010.state there is already a State_0010.state file in the current directory, it advances the counter to State_0011.state to ensure that no conflict will exist (and then it verifies that State_0011.state also does not exist in the current directory and advances again if it does, and so forth).

If you enter a file name for a given file type, then the prefix becomes the filename you entered instead of the default prefix, followed by an underscore. The last four letters (the suffix) are the 4-digit number.

For example, if you save a measurement results file as “fred.csv”, then the next auto file name chosen for a measurement results save will be fred_0000.csv.

NOTE

Although 0000 is used in the example above, the number that is used is actually the current number in the Meas Results sequence, that is, the number that would have been used if you had not entered your own file name.

NOTE

If the filename you entered ends with _dddd, where d=any number, making it look just like an auto file name, then the next auto file name picks up where you left off with the suffix being dddd + 1.

Key Path	Front-panel key
Notes	No remote command for this key specifically.
Initial S/W Revision	Prior to A.02.00

Recall

In the MSR mode, two types of recall functions are available under the Data menu: Parameter Sets and Masks. Masks enables setting of a preset limit mask for Power Suite-based measurements, and currently it is available for the SEM, ACP and SPUR measurements in the MSR mode.

Key Path	Front Panel
Mode	MSR
Initial S/W Revision	A.10.00

State

The **Recall State** menu lets you choose a register or file from which to recall the state.

The content of a state file includes all of the settings and data required to return the analyzer as closely as possible to the Mode it was in, with the exact settings that were in place, when the save occurred. The Mode settings in each state file include the settings that are affected by Mode Preset, as well as the additional settings affected by Restore Mode Defaults; all of the Mode's settings. In addition, all of the settings of the **Input/Output** system are included, even though they are outside of the Mode's state, because they are needed to restore the complete setup. Persistent System settings (for example, GPIB address) are not affected by either a Mode Preset or Restore Mode Defaults, nor are they included in a saved State file.

Since each state file is only for one Mode, the settings for other Modes are unaffected when it is loaded. **Recall State** will cause a mode switch if the state being recalled is not from the current active mode.

After the recall completes, the message "File <filename> recalled" or "Recalled State Register <register number>" is displayed.

For rapid recalls, the State menu lists 16 registers that you can choose from to recall. Pressing a Register key initiates the recall. You can also select a file from which to recall.

The default path for all State Files is:

My Documents\<<mode name>\state

where <mode name> is the parameter used to select the mode with the INST:SEL command (for example, SA for the Spectrum Analyzer).

See ["More Information" on page 1848](#).

Key Path	Recall
Mode	All
Remote Command	:MMEMory:LOAD:STATe <filename>
Example	:MMEM:LOAD:STAT "myState.state" This recalls the file myState.state on the default path
Example	MMEM:LOAD:STAT "MyStateFile.state" This loads the state file data (on the default file directory path) into the instrument state.

Notes	<p>When you pick a file to recall, the analyzer first verifies that the file is recallable in the current instrument by checking the software version and model number of the instrument. If everything matches, a full recall proceeds by aborting the currently running measurement, clearing any pending operations, and then loading the State from the saved state file. You can open state files from any mode, so recalling a State file switches to the mode that was active when the save occurred. After switching to the mode of the saved state file, mode settings and data (if any for the mode) are loaded with values from the saved file. The saved measurement of the mode becomes the newly active measurement and the data relevant to the measurement (if there is any) is recalled.</p> <ul style="list-style-type: none"> • If there is a mismatch between file version or model number or instrument version or model number, the recall function tries to recall as much as possible and returns a warning message. It may limit settings that differ based on model number, licensing or version number. <p>After recalling the state, the Recall State function does the following:</p> <ul style="list-style-type: none"> • Makes the saved measurement for the mode the active measurement. • Clears the input and output buffers. • Status Byte is set to 0. • Executes a *CLS <p>If the file specified is empty an error is generated. If the specified file does not exist, another error is generated. If there is a mismatch between the file and the proper file type, an error is generated. If there is a mismatch between file version or model number or instrument version or model number, a warning is displayed. Then it returns to the State menu and File Open dialog goes away.</p> <p>After the Recall, the analyzer exits the Recall menu and returns to the previous menu.</p>
Backwards Compatibility SCPI	<pre>:MMEMory:LOAD:STATe 1,<filename></pre> <p>For backwards compatibility, the above syntax is supported. The "1" is simply ignored.</p>
Initial S/W Revision	Prior to A.02.00

More Information

In measurements that support saving Traces, for example, Swept SA, the Trace data is saved along with the State in the State file. When recalling the State, the Trace data is recalled as well. Traces are recalled exactly as they were stored, including the writing mode and update and display modes. If a Trace was updating and visible when the State was saved, it will come back updating and visible, and its data will be rewritten right away. When you use State to save and recall traces, any trace whose data must be preserved should be placed in View or Blank mode before saving.

The following table describes the Trace Save and Recall possibilities:

You want to recall state and one trace's data, leaving other traces unaffected.	Save Trace+State from 1 trace. Make sure that no other traces are updating (they should all be in View or Blank mode) when the save is performed.	On Recall, specify the trace you want to load the one trace's data into. This trace will load in View. All other traces' data will be unaffected, although their trace mode will be as it was when the state save was performed.
You want to recall all traces	Save Trace+State from ALL traces.	On Recall, all traces will come back in View (or Blank if they were in Blank or Background when

		saved)
You want all traces to load exactly as they were when saved.	Save State	On recall, all traces' mode and data will be exactly as they were when saved. Any traces that were updating will have their data immediately overwritten.

From File...

When you press “From File”, the analyzer brings up a Windows dialog and a menu entitled “File Open.” This menu allows you to navigate to the various fields in the Windows dialog without using a keyboard or mouse. The **Tab** and **Arrow** keys can also be used for dialog navigation.

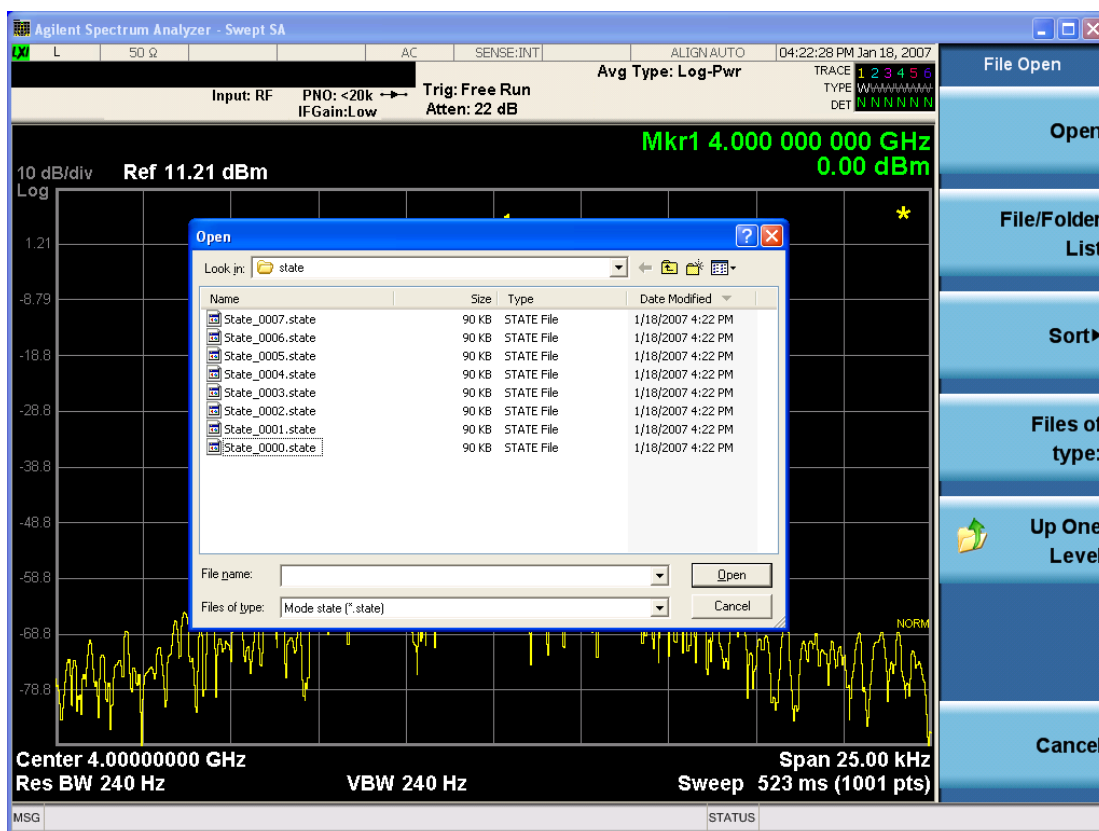

Listed below are the functions of the various fields in the dialog, and the corresponding softkeys:

Open

Performs the recall of the specified file. While the recall is being performed, the floppy icon appears briefly in the Meas bar.

File/Folder List

Enables you to navigate to the center of the dialog that contains the list of files and folders. Once here you can get information about the file and use the tab keys to navigate to the other fields in the dialog, such as Look In.

Look In

The **Look In** field shows the path from which the file will be recalled and allows you to change the path using the up and down arrow keys to navigate to other paths; the Enter key to open a directory; and the Backspace key to go back one directory. The **Look In field** first uses the last path from the Save As dialog **Save In:** path for that same file type. There is no softkey for directly navigating to the Look In field, but you can use the left tab to get here from the File/Folder List.

User specified paths are remembered when you leave and return to a Mode and are reset back to the default using **Restore Mode Defaults**.

Sort

Accesses a menu that enables you to sort the files within the File Open dialog. Only one sorting type can be selected at a time and the sorting happens immediately. The sorting types are **By Date, By Name, By extension, and By Size**.

Files of Type

This field shows the file suffix for the type of file you have selected to recall. For example, if you navigated here while recalling State, "Mode state (*.state)" is in the field. If you navigated here while recalling Trace, ""Mode state (*.trace)" is in the field. If you navigated here while importing a trace data file, "Trace Data (*.csv)" is in the field. For some file types, there is more than one choice in the dropdown menu, which you can select by using the up and down arrow keys and Enter.

Up One Level

This key corresponds to the icon of a folder with the up arrow that is in the tool bar of the dialog. When pressed, it causes the file and folder list to navigate up one level in the directory structure. The Backspace key does the same thing.

Cancel

This key corresponds to the **Cancel** selection in the dialog. It causes the current **Open** request to be cancelled. The ESC key does the same thing.

Key Path	Recall, State
Notes	Brings up the Open dialog for recalling a State Save Type
Initial S/W Revision	Prior to A.02.00

Edit Register Names

You may enter a custom name on any of the Register keys, to help you remember what you are using that state to save. To do this, press the **Edit Register Names** key, choose the register whose name you wish to edit, and then enter the desired label using the Alpha Editor or an external PC keyboard.

The maximum number of characters that can be added is 30. In most cases, 30 characters will fit on two lines of the key.

For more information and the SCPI command, see Edit Register Names under the **Save, State** function.

Key Path	Recall, State
Mode	All
Dependencies	N9060A-7FP or N9060B-2FP license required to edit the register names. When the feature is not licensed, sending the SCPI command generates an error, -221,"Settings conflict;Option not available"
Initial S/W Revision	A.11.00

Register 1 thru Register 16

Selecting any one of these register keys causes the State of the mode from the specified Register to be recalled. Each of the register keys annotates whether it is empty or at what date and time it was last modified. In addition, you can use the **Edit Register Names** key under **Save, State** to enter custom names for each register.

Registers are shared by all modes, so recalling from any one of the registers will cause a mode switch to the mode that was active when the save to the Register occurred.

Although these 16 registers are the only registers available from the front panel, there are 128 state registers available in the instrument. Registers 17–128 are only available from the SCPI interface, using the *RCL command.

After the recall completes, the message "Register <register number> recalled" appears in the message bar. If you are in the Spectrum Analyzer Mode, and you are recalling a register that was saved in the Spectrum Analyzer Mode, then after the recall, you will still be in the Recall Register menu. If the Recall causes you to switch modes, then after the Recall, you will be in the Frequency menu.

If a requested register is empty an error is generated.

Key Path	Recall, State
Example	*RCL 1
Range	1-16 from front panel, 1-128 from SCPI
Readback	Date and time with seconds resolution are displayed on the key OR A custom name of up to 30 characters entered using the Save, State,Edit Register Names key OR “(empty)” if no prior save operation has been performed to this register.
Initial S/W Revision	Prior to A.02.00
Modified at S/W Revision	Prior to A.11.00

Register 1 thru Register 16

Selecting any one of these register keys causes the State of the mode from the specified Register to be recalled. Each of the register keys annotates whether it is empty or at what date and time it was last

modified. In addition, you can use the **Edit Register Names** key under **Save, State** to enter custom names for each register.

Registers are shared by all modes, so recalling from any one of the registers will cause a mode switch to the mode that was active when the save to the Register occurred.

Although these 16 registers are the only registers available from the front panel, there are 128 state registers available in the instrument. Registers 17–128 are only available from the SCPI interface, using the *RCL command.

After the recall completes, the message "Register <register number> recalled" appears in the message bar. If you are in the Spectrum Analyzer Mode, and you are recalling a register that was saved in the Spectrum Analyzer Mode, then after the recall, you will still be in the Recall Register menu. If the Recall causes you to switch modes, then after the Recall, you will be in the Frequency menu.

If a requested register is empty an error is generated.

Key Path	Recall, State
Example	*RCL 1
Range	1–16 from front panel, 1–128 from SCPI
Readback	Date and time with seconds resolution are displayed on the key OR A custom name of up to 30 characters entered using the Save, State, Edit Register Names key OR “(empty)” if no prior save operation has been performed to this register.
Initial S/W Revision	Prior to A.02.00
Modified at S/W Revision	Prior to A.11.00

Data (Import)

Importing a data file loads data that was previously saved from the current measurement or from other measurements and/or modes that produce compatible data files. The Import Menu only contains Data Types that are supported by the current measurement.

Since the commonly exported data files are in .csv format, the data can be edited by the user prior to importing. This allows you to export a data file, manipulate the data in Excel (the most common PC Application for manipulating .csv files) and then import it.

Importing Data loads measurement data from the specified file into the specified or default destination, depending on the data type selected. Selecting an Import Data menu key will not actually cause the importing to occur, since the analyzer still needs to know from where to get the data. Pressing the Open key in this menu brings up the Open dialog and Open menu that provides you with the options from where to recall the data. Once a filename has been selected or entered in the Open menu, the recall occurs as soon as the Open button is pressed.

Key Path	Recall
Mode	All

Notes	The menu is built from whatever data types are available for the mode. Some keys will be missing completely, so the key locations in the sub-menu will vary. No SCPI command directly controls the Data Type that this key controls. The Data Type is included in the MMEM:LOAD commands.
Dependencies	If a file type is not used by a certain measurement, it is grayed out for that measurement. The key for a file type will not show at all if there are no measurements in the Mode that support it.
Preset	Is not affected by Preset or shutdown, but is reset during Restore Mode Defaults
Readback	The data type that is currently selected
Initial S/W Revision	Prior to A.02.00

Parameter Set

Enables you to import format parameter set data to specified format parameter sets. Selecting this key displays a menu that enables you to select the destination parameter set. After making this selection, depress Open... and use the file dialog to select the file you wish to recall.

Supported import file formats are dependent on radio formats.

LTE FDD: Format Parameter Set Files (*.fps), LTE FDD app state files (*.state), 89601 VSA Setup Files (*.set, *.setx) and Signal Studio Setup Files (*.scp)

W-CDMA:Format Parameter Set Files (*.fps) and W-CDMA app state files (*.state)

GSM/EDGE:Format Parameter Set Files (*.fps) and GSM/EDGE app state files (*.state)

cdma2000:Format Parameter Set Files (*.fps) and cdma2000 app state files (*.state)

1xEV-DO:Format Parameter Set Files (*.fps) and 1xEV-DO app state files (*.state)

LTE TDD: Format Parameter Set Files (*.fps), LTE TDD app state files (*.state), 89601 VSA Setup Files (*.set, *.setx) and Signal Studio Setup Files (*.scp)

TD-SCDMA:Format Parameter Set Files (*.fps) and TD-SCDMA app state files (*.state)

Format Parameter Set Files

Extention: fps

Basic file type of format parameter set. This file contains a format parameter set exported using Parameter Set under Recall, Data (Export). It is imported if the radio format of the file matches the destination radio format. If not, an error message, -230 "Data corrupt or stale", is issued with the specified file name.

App State Files

Extention: state

The state file of each mode can be imported to the corresponding parameter set. If the mode name in the state file matches the selected destination format, the state file data are imported. If not, an error message, -230 "Data corrupt or stale", is issued with the specified file name.

The parameters to be imported are ones referred in a particular measurement of each mode. The relevant measurements are listed below.

LTE FDD: Modulation Analysis

W-CDMA: Mod Accuracy

GSM/EDGE: EDGE EVM

cdma2000: Mod Accuracy

1xEV-DO: Mod Accuracy

LTE TDD: Modulation Analysis

TD-SCDMA: Mod Accuracy

Note that Integ BW and Measurement Noise BW parameters of ACP, SEM and CHP are not imported.

89601 VSA Setup Files

Extention: set, setx

The 89600 Vector Signal Analyzer Setup file created using the 89600 Vector Signal Analyzer Option BHD (LTE FDD)/Option BHE (LTE TDD) can be imported as LTE FDD/LTE TDD parameter set. If the setup file is not loaded successfully, an error message, -230 "Data corrupt or stale", is issued with the specified file name.

Signal Studio Setup Files

Extention: scp

The Keysight Signal Studio setup file created using Signal Studio (N7624B/N7625B) can be imported as LTE FDD/LTE TDD parameter set. Supported carrier types are listed in the table below:

<i>Signal Studio</i>	<i>Carrier Type</i>
N7624B Signal Studio for 3GPP LTE	Advanced LTE FDD Downlink (2009-03)
	Advanced LTE FDD Downlink (2009-12)
	Advanced LTE FDD Downlink (2010-06)
	Advanced LTE FDD Uplink (2009-12)
	Advanced LTE FDD Uplink (2010-06)
	Basic LTE FDD Downlink (2009-03)
	Basic LTE FDD Downlink (2009-12)
	Basic LTE FDD Downlink (2010-06)
	Basic LTE FDD Uplink (2009-03)
	Basic LTE FDD Uplink (2009-12)
	Basic LTE FDD Uplink (2010-06)
N7625B Signal Studio for 3GPP LTE TDD	Advanced LTE TDD (2009-03)
	Advanced LTE TDD (2009-12)
	Basic LTE TDD (2009-03)
	Basic LTE TDD (2009-12)
	Basic LTE TDD R9
Advanced LTE TDD R9	

 Basic LTE TDD R9 PRACH

If the setup file is not loaded successfully, an error message, –230 “Data corrupt or stale”, is issued with the specified file name.

Default path of this import type is “My Documents\MSR\data\params” folder. Note that “**My Documents**” is an alias to a directory and its location depends on which user is logged in. If the file path is specified without root folder, the import file is determined with the default path. For example if “folder1\paramData.prms” is specified, “My Documents\MSR\data\params\folder1\paramData.prms” is imported.

File Dialog Filter

Since supported import file formats differ between radio formats, file filters available in the open file dialog vary depending on the selected radio format. This table below defines file name filters available for each format.

<i>Radio Format</i>	<i>File Name Filters</i>
LTE FDD	All Supported Format Parameter Setup Files (*.fps; *.state; *.set; *.setx; *.scp) Format Parameter Setup Files (*.fps) State Files (*.state) 89601 VSA Setup Files (*.set; *.setx) Signal Studio Setup Files (*.scp)
W-CDMA	All Supported Format Parameter Setup Files (*.fps; *.state) Format Parameter Setup Files (*.fps) W-CDMA State Files (*.state)
GSM/EDGE	All Supported Format Parameter Setup Files (*.fps; *.state) Format Parameter Setup Files (*.fps) State Files (*.state)
cdma2000	All Supported Format Parameter Set Files (*.fps; *.state) Format Parameter Set Files (*.fps) State Files (*.state)
1xEV-DO	All Supported Format Parameter Set Files (*.fps; *.state) Format Parameter Set Files (*.fps) State Files (*.state)
LTE TDD	All Supported Format Parameter Setup Files (*.fps; *.state; *.set; *.setx; *.scp) Format Parameter Setup Files (*.fps) State Files (*.state) 89601 VSA Setup Files (*.set; *.setx) Signal Studio Setup Files (*.scp)
TD-SCDMA	All Supported Format Parameter Set Files (*.fps; *.state) Format Parameter Set Files (*.fps) State Files (*.state)

Key Path	Recall, Data
Mode	MSR
Remote Command	MMEMory:LOAD:PSET LTEFdd1 LTEFdd2 LTEFdd3 WCDMa1 WCDMa2 WCDMa3 GSM1 GSM2 GSM3 CDMA1 CDMA2 CDMA3 EVDO1 EVDO2 EVDO3 LTETdd1 LTETdd2 LTETdd3 TDSCdma1 TDSCdma2 TDSCdma3, <string>
Example	MMEM:LOAD:PSET LTEF1,"LTE FDD.set"
Notes	The first enum selects the destination format parameter set to which the file data are imported.
Initial S/W Revision	A.10.00
Modified at S/W Revision	A.12.00, A.16.00

Masks

This key enables you to recall a preset mask file which contains Offset and Limit settings. Parameters except them will not be overwritten. You cannot change or create preset mask files since they are binary files. This key is valid for the Spectrum Emission Mask, ACP and Spurious Emissions measurements.

Default path: "My Documents\MSR\data.masks"

Note that "**My Documents**" is an alias to a directory and its location depends on which user is logged in. At XSA start up, all of the limit mask files in the current user's "My Documents\MSR\data.masks" directory are overwritten.

File type: Binary

Filename: The filename follows the rule below with the words connected using underscores.

<Measurement>_<Condition>.mask

Where

<Measurement> Measurement the limit mask file is applied to: SEM, ACP or SPUR

<Condition> Condition. It depends on the measurement.

File extension: .mask

File Dialog Filter: Preset Mask Files (*.mask)

Selecting OPEN... under the Import Data menu opens the above directory enabling you to select a mask file.

Details of the masks are provided in a PDF file in the default folder of masks.

Key Path	Recall, Data
Mode	MSR
Remote Command	MMEMory:LOAD:MASK <string>
Example	MMEM:LOAD:MASK "ACP_BS\ACP_BS_3MHz_pairE-UTRA_CatA.mask"

Notes	Parameters related to Limit and Offset are overwritten by the contents of the preset mask file.
Initial S/W Revision	A.10.00

Open...

When you press “Open”, the analyzer brings up a Windows dialog and a menu entitled “**File Open.**” This menu allows you to navigate to the various fields in the Windows dialog without using a keyboard or mouse. The **Tab** and **Arrow** keys can also be used for dialog navigation.

See "[From File...](#)" on page 2454 in **Recall, State**, for a full description of this dialog and menu.

Key Path	Recall, Data
Notes	The key location is mode-dependent and will vary. Brings up Open dialog for recalling a <mode specific> Save Type
Initial S/W Revision	Prior to A.02.00

Restart

The Restart function restarts the current sweep, or measurement, or set of averaged/held sweeps or measurements. If you are Paused, pressing Restart does a Resume.

The Restart function is accessed in several ways:

- Pressing the Restart key
- Sending the remote command INIT:IMMEDIATE
- Sending the remote command INIT:RESTART

See "[More Information](#)" on page 1858

Key Path	Front-panel key
Remote Command	:INITiate[:IMMEDIATE] :INITiate:RESTART
Example	:INIT:IMM :INIT:REST
Notes	:INITiate:RESTART and :INITiate:IMMEDIATE perform exactly the same function.
Couplings	Resets average/hold count k. For the first sweep overwrites all active (update=on) traces with new current data. For application modes, it resets other parameters as required by the measurement.
Status Bits/OPC dependencies	This is an Overlapped command. The STATus:OPERation register bits 0 through 8 are cleared. The STATus:QUESTionable register bit 9 (INTEgrity sum) is cleared. The SWEEPING bit is set. The MEASURING bit is set.
Backwards Compatibility Notes	For Spectrum Analysis mode in ESA and PSA, the Restart hardkey and the INITiate:RESTART command restart trace averages (displayed average count reset to 1) for a trace in Clear Write , but did not restart Max Hold and Min Hold . In the X-Series, the Restart hardkey and the INITiate:RESTART command restart not only Trace Average , but MaxHold and MinHold traces as well. For wireless comms modes in ESA and PSA, the Restart hardkey and the INITiate:RESTART command restart every measurement, which includes all traces and numeric results. There is no change to this operation.
Initial S/W Revision	Prior to A.02.00

More Information

The **Restart** function first aborts the current sweep/measurement as quickly as possible. It then resets the sweep and trigger systems, sets up the measurement and initiates a new data measurement sequence with a new data acquisition (sweep) taken once the trigger condition is met.

If the analyzer is in the process of aligning when **Restart** is executed, the alignment finishes before the restart function is performed.

Even when set for Single operation, multiple sweeps may be taken when Restart is pressed (for example, when averaging/holding is on). Thus when we say that **Restart** "restarts a measurement," we may mean:

- It restarts the current sweep
- It restarts the current measurement
- It restarts the current set of sweeps if any trace is in Trace Average, Max Hold or Min Hold
- It restarts the current set of measurements if Averaging, or Max Hold, or Min Hold is on for the measurement
- depending on the current settings.

With **Average/Hold Number** (in **Meas Setup** menu) set to 1, or Averaging off, or no trace in Trace Average or Hold, a single sweep is equivalent to a single measurement. A single sweep is taken after the trigger condition is met; and the analyzer stops sweeping once that sweep has completed. However, with **Average/Hold Number** >1 and at least one trace set to **Trace Average**, **Max Hold**, or **Min Hold (SA Measurement)** or **Averaging on (most other measurements)**, multiple sweeps/data acquisitions are taken for a single measurement. The trigger condition must be met prior to each sweep. The sweep is stopped when the average count k equals the number N set for **Average/Hold Number**. A measurement average usually applies to all traces, marker results, and numeric results; but sometimes it only applies to the numeric results.

Once the full set of sweeps has been taken, the analyzer will go to idle state. To take one more sweep without resetting the average count, increment the average count by 1, by pressing the step up key while **Average/Hold Number** is the active function, or sending the remote command `CALC:AVER:TCON UP`.

Save

In the MSR mode, two types of save functions are available under the Data menu: Parameter Sets and Meas Results.

Key Path	Front Panel
Mode	MSR
Initial S/W Revision	Prior to A.10.00
Modified at S/W Revision	A.10.00

State

The Save State menu lets you choose a register or file for saving the state.

The content of a state file includes all of the settings and data required to return the analyzer as closely as possible to the Mode it was in, with the exact settings which were in place, when the save occurred. The Mode settings in each state file include the settings that are affected by Mode Preset, as well as the additional settings affected by Restore Mode Defaults; all of the Mode's settings. In addition, all of the settings of the **Input/Output** system are included, even though they are outside of the Mode's state, because they are needed to restore the complete setup. Persistent **System** settings (for example, Verbose SCPI) are not affected by either Mode Preset or Restore Mode Defaults, nor are they included in a saved State file.

After the save completes, the message "File <filename> saved" or "State Register <register number> saved" is displayed.

For rapid saving, the State menu lists 16 registers to save to. Pressing a Register key initiates the save. You can also select a file to save to.

The default path for all State Files is:

My Documents\<<mode name>\state

where <mode name> is the parameter used to select the mode with the INST:SEL command (for example, SA for the Spectrum Analyzer).

Key Path	Save
Mode	All
Remote Command	:MMEMory:STORe:STATe <filename>
Example	MMEM:STOR:STATe "MyStateFile.state" This stores the current instrument state data in the file MyStateFile.state in the default directory.
Notes	Both single and double quotes are supported for any filename parameter over remote. After saving to a register, that register's menu key is updated with the date the time, unless a custom label has been entered for that key. After saving to a register, you remain in the Save State menu, so that you can see the Register key update. After saving to a file, the analyzer automatically returns to the previous menu and any Save As dialog goes away.

Backwards Compatibility SCPI	:MMEMory:STORe:STATe 1,<filename> For backwards compatibility, the above syntax is supported. The "1" is simply ignored. The command is sequential.
Initial S/W Revision	Prior to A.02.00

To File . . .

When you press “To File”, the analyzer brings up a Windows dialog and a menu entitled “**Save As.**” This menu allows you to navigate to the various fields in the Windows dialog without using a keyboard or mouse. The **Tab** and **Arrow** keys can also be used for dialog navigation.

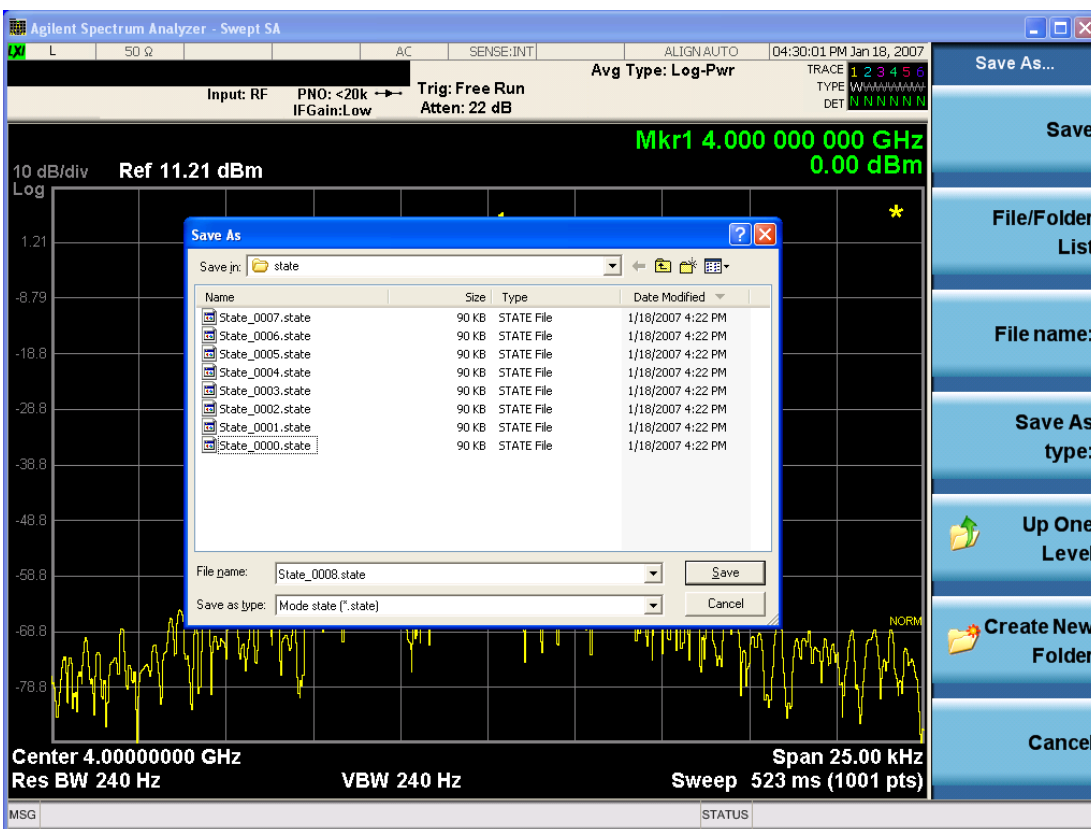

The Listed below

are the functions of the various fields in the dialog, and the corresponding softkeys:

Save

Performs the save to the specified file of the selected type. If the file already exists, a dialog will appear that allows you to replace the existing file by selecting **OK**, or you can **Cancel** the request. If you select **OK**, the file will be overwritten. Using the C: drive is strongly discouraged, since it runs the risk of being overwritten during an instrument software upgrade.

While the save is being performed, the floppy icon appears briefly in the Meas bar.

File/Folder List

Enables you to navigate to the center of the dialog that contains the list of files and folders. Once here you can get information about the file and use the tab keys to navigate to the other fields in the dialog, such as Save In.

Save In

The Save In field shows the path to which the file will be saved and allows you to change the path using the up and down arrow keys to navigate to other paths; the Enter key to open a directory; and the Backspace key to go back one directory. The **Save In field** defaults to the default path for this type of file and remembers the last path you used to save this type of file. There is no softkey for directly navigating to the Save In field but you can use left tab to get here from the File/Folder List.

User specified paths are remembered when you leave and return to a Mode and are reset back to the default using **Restore Mode Defaults**.

File Name

The **File Name** field is initially loaded with an automatically generated filename specific to the appropriate Save Type. The automatically generated filename is guaranteed not to conflict with any filename currently in the directory. You may replace or modify this filename using the File Name key. See the "[Quick Save](#)" on [page 2428](#) documentation for more on the automatic file naming algorithm.

When you press the **File Name** key the analyzer displays the Alpha Editor. Use the knob to choose the letter to add and the front-panel Enter key to add the letter to the file name. The BK character moves you back and the FW character moves you forward in the filename. The Select key on the front panel generates a space character. When you are done entering the filename press the **Done** softkey. This returns back to the **File Open** dialog and menu, but does not cause the save to occur.

Save As Type

This field shows the file suffix for the type of file you have selected to save. For example, if you navigated here while saving State, "Mode state (*.state)" is in the field. If you navigated here from saving Trace, ""Mode state (*.trace)" is in the field. If you navigated here while exporting a trace data file, "Trace Data (*.csv)" is in the field. For some file types, there is more than one choice in the dropdown, which you can select by using the up and down arrow keys and Enter.

Up One Level

This key corresponds to the icon of a folder with the up arrow that is in the tool bar of the dialog. When pressed, it causes the file and folder list to navigate up one level in the directory structure. The Backspace key does the same thing.

Create New Folder

This key corresponds to the icon of a folder with the "*" that is in the tool bar of the dialog. When pressed, a new folder is created in the current directory with the name **New Folder** and you can enter a new folder name using the Alpha Editor.

Cancel

This key corresponds to the **Cancel** selection in the dialog. It causes the current **Save As** request to be cancelled. The ESC key does the same thing.

Key Path	Save, State
----------	--------------------

Mode	All
Notes	Brings up Save As dialog for saving a State Save Type
Initial S/W Revision	Prior to A.02.00

Edit Register Names

You may enter a custom name on any of the Register keys, to help you remember what you are using that state to save. To do this, press the **Edit Register Names** key, choose the register whose name you wish to edit, and then enter the desired label using the Alpha Editor or an external PC keyboard.

The maximum number of characters that can be added is 30. In most cases, 30 characters will fit on two lines of the key.

See "[More Information](#)" on page 1863

Key Path	Save, State
Mode	All
Remote Command	:MMEMory:REGister:STATe:LABel <reg number>,"label" :MMEMory:REGister:STATe:LABel? <reg number>
Example	:MMEM:REG:STAT:LAB 1,"my label"
Notes	<reg number> is an integer from 1 to 16. If the SCPI specifies an invalid register number an error message is generated, -222,"Data out of range;Invalid register label number" "label" is a string from 0 to 30 characters in length. If a label exceeds 30 characters, an error message is generated, -150,"String data error;Label clipped to 30 characters" "label" of length 0 erases the custom label and restores the default (time and date) label. E.g.: :MMEM:REG:STAT:LAB 1,""
Dependencies	N9060A-7FP or N9060B-2FP license required to edit the register names. When the feature is not licensed, sending this command generates an error, -221,"Settings conflict;Option not available"
Preset	The names are unaffected by Preset or power cycle but are set to the default label (time and date) on a "Restore System Defaults->Misc"
Initial S/W Revision	A.11.00

More Information

When you edit one of the register names, the time and date field will be replaced by the custom name.

If you delete all the characters in the custom name, it restores the default (time and date).

The register names are stored within the state files, but they are not part of the instrument state; that is, once you have edited a register name, loading a new state will not change that register name. Another consequence of this is that the names will be persistent through a power cycle. Also, if a named state file is transferred to another analyzer, it will bring its custom name along with it.

If you try to edit the name of an empty register, the analyzer will first save the state to have a file to put the name in. If you load a named state file into an analyzer with older firmware it will ignore the metadata.

The *SAV and *RCL commands will not be affected by the custom register names, nor will the MMEM commands.

Register 1 thru Register 16

Selecting any one of these register menu keys causes the State of the currently active mode to be saved to the specified Register. The registers are provided for rapid saving and recalling, since you do not need to specify a filename or navigate to a file. Each of the register menu keys annotates whether it is empty or at what date and time it was last modified. In addition, you can use the **Edit Register Names** key to enter custom names for each register.

Although these 16 registers are the only registers available from the front panel, there are 128 state registers available in the instrument. Registers 17–128 are only available from the SCPI interface, using the *SAV command.

There is one set of 128 state registers in the instrument, not one set for each Mode. When a state is saved, the Mode it was saved from is saved with it; then when it is recalled, the instrument switches to that Mode.

After the save completes, the corresponding register menu key annotation is updated with the date and time and the message "Register <register number> saved" is displayed.

Key Path	Save, State
Mode	All
Example	*SAV 1
Range	1–16 from front panel, 1–128 from SCPI
Readback	Date and time with seconds resolution are displayed on the key OR A custom name of up to 30 characters entered using the Edit Register Names key OR “(empty)” if no prior save operation has been performed to this register.
Initial S/W Revision	Prior to A.02.00
Modified at S/W Revision	A.11.00

Register 1 thru Register 16

Selecting any one of these register menu keys causes the State of the currently active mode to be saved to the specified Register. The registers are provided for rapid saving and recalling, since you do not need to specify a filename or navigate to a file. Each of the register menu keys annotates whether it is empty or at what date and time it was last modified. In addition, you can use the **Edit Register Names** key to enter custom names for each register.

Although these 16 registers are the only registers available from the front panel, there are 128 state registers available in the instrument. Registers 17–128 are only available from the SCPI interface, using the *SAV command.

There is one set of 128 state registers in the instrument, not one set for each Mode. When a state is saved, the Mode it was saved from is saved with it; then when it is recalled, the instrument switches to that Mode.

After the save completes, the corresponding register menu key annotation is updated with the date and time and the message "Register <register number> saved" is displayed.

Key Path	Save, State
Mode	All
Example	*SAV 1
Range	1-16 from front panel, 1-128 from SCPI
Readback	Date and time with seconds resolution are displayed on the key OR A custom name of up to 30 characters entered using the Edit Register Names key OR “(empty)” if no prior save operation has been performed to this register.
Initial S/W Revision	Prior to A.02.00
Modified at S/W Revision	A.11.00

Mass Storage Catalog (Remote Command Only)

Key path	SCPI Only
Remote Command	:MMEMory:CATalog? [<directory_name>]
Notes	The string must be a valid logical path. Queries disk usage information (drive capacity, free space available) and obtains a list of files and directories in a specified directory in the following format: <numeric_value>,<numeric_value>,{<file_entry>} It returns two numeric parameters and as many strings as there are files and directories. The first parameter indicates the total amount of storage currently used in bytes. The second parameter indicates the total amount of storage available, also in bytes. The <file_entry> is a string. Each <file_entry> indicates the name, type, and size of one file in the directory list: <file_name>,<file_type>,<file_size> As the windows file system has an extension that indicates file type, <file_type> is always empty. <file_size> provides the size of the file in bytes. For directories, <file_entry> is surrounded by square brackets and both <file_type> and <file_size> are empty
Initial S/W Revision	Prior to A.02.00

Mass Storage Change Directory (Remote Command Only)

Key path	SCPI Only
Remote Command	:MMEMory:CDIRectory [<directory_name>] :MMEMory:CDIRectory?
Notes	The string must be a valid logical path. Changes the default directory for a mass memory file system. The <directory_name> parameter is a string. If no parameter is specified, the directory is set to the *RST value.

	At *RST, this value is set to the default user data storage area, that is defined as System.Environment.SpecialFolder.Personal. Query returns full path of the default directory.
Initial S/W Revision	Prior to A.02.00

Mass Storage Copy (Remote Command Only)

Key path	SCPI Only
Remote Command	:MMEMory:COpy <string>,<string>[,<string>,<string>]
Notes	<p>The string must be a valid logical path.</p> <p>Copies an existing file to a new file or an existing directory to a new directory.</p> <p>Two forms of parameters are allowed. The first form has two parameters. In this form, the first parameter specifies the source, and the second parameter specifies the destination.</p> <p>The second form has four parameters. In this form, the first and third parameters specify the source. The second and fourth parameters specify the directories. The first pair of parameters specifies the source. The second pair specifies the destination. An error is generated if the source doesn't exist or the destination file already exists.</p> <p>This command will generate an "access denied" error if the destination is a restricted folder (e.g., C:\Windows) and the current user does not have Power User or Administrator privileges.</p>

Mass Storage Device Copy (Remote Command Only)

This command transfers data to/from a file and a peripheral device.

Key path	SCPI Only
Remote Command	:MMEMory:COpy:DEvice <source_string>,<dest_string>
Notes	<p>The strings must be a valid logical path or a valid device keyword. If the dest_string is a device keyword, the data is copied from the source file to the device. If the source_string is a device keyword, the data is copied to the source file from the device.</p> <p>Valid device keywords are:</p> <p>SNS (smart noise source)</p> <p>An error is generated if the file or device is not found.</p>

Mass Storage Delete (Remote Command Only)

Key path	SCPI Only
Remote Command	:MMEMory:DElete <file_name>[,<directory_name>]
Notes	<p>The string must be a valid logical path.</p> <p>Removes a file from the specified directory. The <file_name> parameter specifies the file name to be removed. This command will generate an "access denied" error if the file is in a restricted folder (e.g.,</p>

C:\Windows) and the current user does not have Power User or Administrator privileges.

Initial S/W Revision Prior to A.02.00

Mass Storage Data (Remote Command Only)

Creates a file containing the specified data OR queries the data from an existing file.

Key path	SCPI Only
Remote Command	:MMEMory:DATA <file_name>, <data> :MMEMory:DATA? <file_name>
Notes	The string must be a valid logical path. The command form is MMEMory:DATA <file_name>,<data>. It loads <data> into the file <file_name>. <data> is in 488.2 block format. <file_name> is string data. The query form is MMEMory:DATA? <file_name> with the response being the associated <data> in block format.
Initial S/W Revision	Prior to A.02.00

Mass Storage Make Directory (Remote Command Only)

Key path	SCPI Only
Remote Command	:MMEMory:MDIRectory <directory_name>
Notes	The string must be a valid logical path. Creates a new directory. The <directory_name> parameter specifies the name to be created. This command will generate an “access denied” error if the new directory would be in a restricted folder (e.g., C:\Windows) and the current user does not have Power User or Administrator privileges.
Initial S/W Revision	Prior to A.02.00

Mass Storage Move (Remote Command Only)

Key path	SCPI Only
Remote Command	:MMEMory:MOVE <string>,<string> [,<string>,<string>]
Notes	The string must be a valid logical path. Moves an existing file to a new file or an existing directory to a new directory. Two forms of parameters are allowed. The first form has two parameters. In this form, the first parameter specifies the source, and the second parameter specifies the destination. The second form has four parameters. In this form, the first and third parameters specify the source. The second and fourth parameters specify the directories. The first pair of parameters specifies the source. The second pair specifies the destination. An error is generated if the source doesn't exist or the destination file already exists.

	This command will generate an “access denied” error if the destination is a restricted folder (e.g., C:\Windows) and the current user does not have Power User or Administrator privileges.
Initial S/W Revision	Prior to A.02.00

Mass Storage Remove Directory (Remote Command Only)

Key path	SCPI Only
Remote Command	:MMEMory:RDIRectory <directory_name>
Notes	The string must be a valid logical path. Removes a directory. The <directory_name> parameter specifies the directory name to be removed. All files and directories under the specified directory shall also be removed. This command will generate an “access denied” error if the folder is a restricted folder (e.g., C:\Windows) or is in a restricted folder and the current user does not have Power User or Administrator privileges.
Initial S/W Revision	Prior to A.02.00

Mass Storage Determine Removable Media (Remote Command Only)

This command is used to determine if any removable media devices are connected to the instrument. Primarily, these are USB memory devices plugged-in to the front panel or rear panel USB ports. On instruments with PC6 or PC7 CPU’s, one SD card slot is available for removable media. The instrument’s primary disk drive is not a removable media device.

Key Path	SCPI Only
Remote Command	:MMEMory:RMEDIA:LIST?
Notes	The return value will be a string containing a list of partition identifiers which are removable media devices. Each identifier will be separated by a comma. If no removable media is present, an empty string will be returned. Examples: One removable device present will result in a return string of “F:”. Two removable devices present will result in a return string of “F:,G:”. No removable devices present will result in a return string of “”.
Initial S/W Revision	x.15.00

Mass Storage Determine Removable Media Label (Remote Command Only)

This command is used to set or query a removable media device’s label.

Key Path	SCPI Only
----------	------------------

Remote Command	:MMEMory:RMEDia:LABel <partition>,<string> :MMEMory:RMEDia:LABel? <partition>
Example	MMEM:RMED:LAB "F:","My Device"
Notes	If the <partition> specified does not exist or is not a removable media device the error -252,"Missing Media" will be generated. Setting the removable media label requires Administrative privileges. If the currently logged in user does not have appropriate privileges the error "-221.9900,Settings conflict;Administrator privileges required" is generated.
Initial S/W Revision	x.15.00

Mass Storage Determine Removable Media Write-protect status (Remote Command Only)

This command is used to query a removable media device's write-protect status.

Key Path	SCPI Only
Remote Command	:MMEMory:RMEDia:WPRotect? <partition>
Example	MMEM:RMED:WPR? "F:"
Notes	The return value is 1 if the device is write-protected, and 0 if the device is write-enabled. If the <partition> specified does not exist or is not a removable media device the error -252,"Missing Media" will be generated.
Preset	The return value will be depending on SD card installed.
Initial S/W Revision	x.15.00

Mass Storage Determine Removable Media size (Remote Command Only)

This command is used to query a removable media device's total memory size (not available memory size).

Key Path	SCPI Only
Remote Command	:MMEMory:RMEDia:SIZE? <partition>
Example	MMEM:RMED:SIZE? "F:"
Notes	The return value is integer value in GBytes. Any device which is less than 1 GB will return 0 GB. If the <partition> specified does not exist or is not a removable media device the error -252,"Missing Media" will be generated.
Initial S/W Revision	x.15.00

Trace (+State)

The **Save Trace (+State)** menu lets you choose a register or file specifying where to save the Trace+State state file.

A saved state contains all of the settings and data required to return the analyzer as closely as possible to the exact setup it had when the save occurred. This includes the Input/Output settings, even though they are outside of the Mode's state, because they are needed to restore the complete setup. A Trace+State file also includes trace data from one trace or all traces, which will load in View mode when the Trace+State file is recalled.

After the save completes, the message "File <filename> saved" or "Trace Register <register number> saved" is displayed.

For rapid saves, the Trace (+State) menu lists 5 registers to save to. Pressing a Register key initiates the save. You can also select a file to save to.

The default path for all State Files including .trace files is:

My Documents\<mode name>\state

where <mode name> is the parameter used to select the mode with the INST:SEL command (for example, Basic for the IQAnalyzer).

This key is grayed out for measurements that do not support trace saves. It is blanked for modes that do not support trace saves. Saving **Trace** is identical to saving State except a .trace extension is used on the file instead of .state, and internal flags are set in the file indicating which trace was saved. You may select to save one trace or ALL traces.

Key Path	Save
Mode	SA
Remote Command	:MMEMory:STORe:TRACe TRACE1 TRACE2 TRACE3 TRACE4 TRACE5 TRACE6 ALL,<filename> :MMEMory:STORe:TRACe:REGister TRACE1 TRACE2 TRACE3 TRACE4 TRACE5 TRACE6 ALL,<integer>
Example	:MMEM:STOR:TRAC TRACE1, "myState.trace" saves the file myState.trace on the default path and flags it as a "single trace" file with Trace 1 as the single trace (even though all of the traces are in fact stored). :MMEM:STOR:TRAC ALL, "myState.trace" saves the file myState.trace on the default path and flags it as an "all traces" file :MMEM:STOR:TRAC:REG TRACE1, 2 stores trace 1 data in trace register 2
Notes	This command actually performs a save state, which in the Swept SA measurement includes the trace data. However it flags it (in the file) as a "save trace" file of the specified trace (or all traces). Some modes and measurements do not have available all 6 traces. The Phase Noise mode command, for example, is: MMEMory:STORe:TRACe TRACE1 TRACE2 TRACE3 ALL,<filename> Some modes and measurements have more than 6 traces available. The Realtime SA mode command, for example, is: MMEMory:STORe:TRACe TRACE1 TRACE2 TRACE3 TRACE4 TRACE5 TRACE6 TRACE7 TRACE8 TRACE9 TRACE10 TRACE11 TRACE12 ALL,<filename> The range for the register parameter is 1-5 When you initiate a save, if the file already exists, a dialog will appear that allows you to replace the existing file by selecting OK or you can Cancel the request. If you select OK, the file will be overwritten. Using the C: drive is strongly discouraged, since it runs the risk of being overwritten during an instrument software upgrade. Both single and double quotes are supported for any filename parameter over remote.

After saving to a register, that register's menu key is updated with the date and time of the save.
After saving to a register, you remain in the **Save Trace** menu, so that you can see the Register key update. After saving to a file, the analyzer automatically returns to the previous menu and any Save As dialog goes away.

Initial S/W Revision	Prior to A.02.00
----------------------	------------------

From Trace

Accesses a menu that enables you to select the trace to be saved. Once a trace is selected, the key returns to the Save Trace menu and the selected trace number is annotated on the key. The default is the currently selected trace, selected in this menu or in the Trace/Det, Export Data, Import Data or Recall Trace menus, except if you have chosen All then it remains chosen until you specifically change it to a single trace. To save the Trace you must select the **Save As** key in the Save Trace menu.

When you select a trace, it makes that trace the current trace, so it displays on top of all of the other traces.

Key Path	Save, Trace + State
Mode	SA
Initial S/W Revision	Prior to A.02.00

From File...

When you press "From File", the analyzer brings up a Windows dialog and a menu entitled "**File Open.**" This menu allows you to navigate to the various fields in the Windows dialog without using a keyboard or mouse. The **Tab** and **Arrow** keys can also be used for dialog navigation.

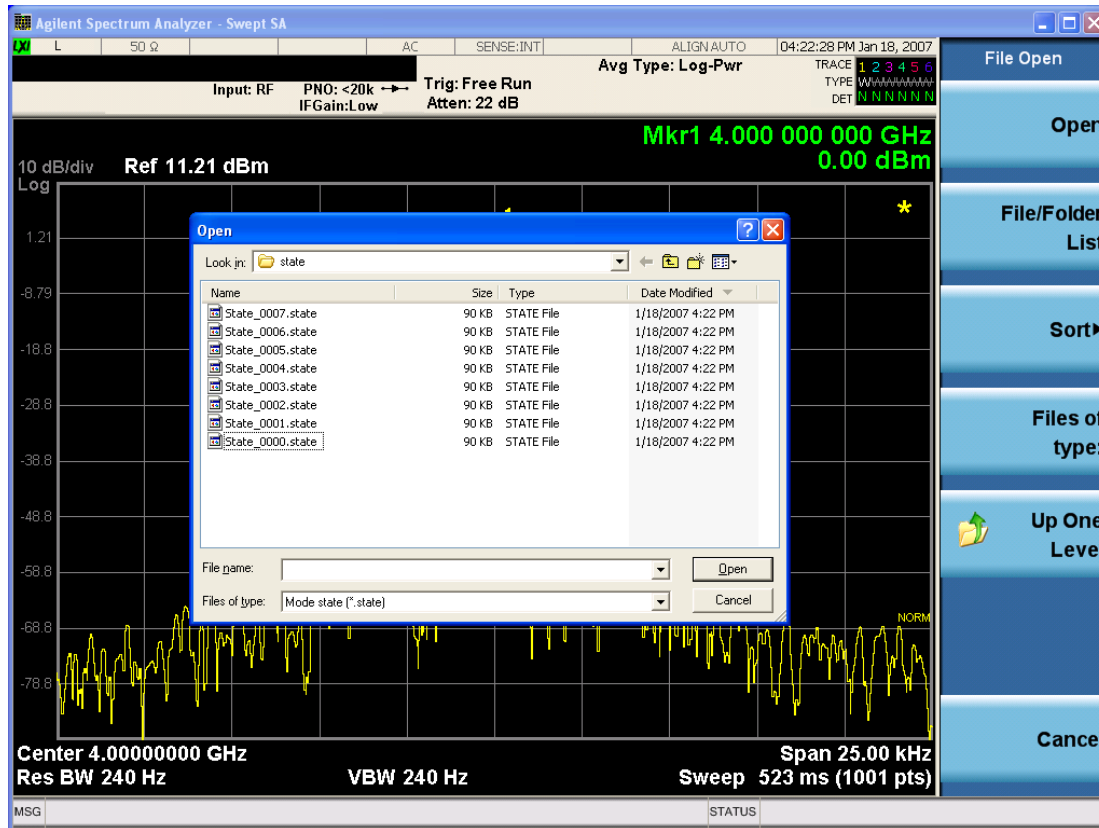

Listed below are the functions of the various fields in the dialog, and the corresponding softkeys:

Open

Performs the recall of the specified file. While the recall is being performed, the floppy icon appears briefly in the Meas bar.

File/Folder List

Enables you to navigate to the center of the dialog that contains the list of files and folders. Once here you can get information about the file and use the tab keys to navigate to the other fields in the dialog, such as Look In.

Look In

The **Look In** field shows the path from which the file will be recalled and allows you to change the path using the up and down arrow keys to navigate to other paths; the Enter key to open a directory; and the Backspace key to go back one directory. The **Look In field** first uses the last path from the Save As dialog **Save In:** path for that same file type. There is no softkey for directly navigating to the Look In field, but you can use the left tab to get here from the File/Folder List.

User specified paths are remembered when you leave and return to a Mode and are reset back to the default using **Restore Mode Defaults**.

Sort

Accesses a menu that enables you to sort the files within the File Open dialog. Only one sorting type can be selected at a time and the sorting happens immediately. The sorting types are **By Date**, **By Name**, **By extension**, and **By Size**.

Files of Type

This field shows the file suffix for the type of file you have selected to recall. For example, if you navigated here while recalling State, "Mode state (*.state)" is in the field. If you navigated here while recalling Trace, ""Mode state (*.trace)" is in the field. If you navigated here while importing a trace data file, "Trace Data (*.csv)" is in the field. For some file types, there is more than one choice in the dropdown menu, which you can select by using the up and down arrow keys and Enter.

Up One Level

This key corresponds to the icon of a folder with the up arrow that is in the tool bar of the dialog. When pressed, it causes the file and folder list to navigate up one level in the directory structure. The Backspace key does the same thing.

Cancel

This key corresponds to the **Cancel** selection in the dialog. It causes the current **Open** request to be cancelled. The ESC key does the same thing.

Key Path	Recall, State
Notes	Brings up the Open dialog for recalling a State Save Type
Initial S/W Revision	Prior to A.02.00

Register 1 thru Register 16

Selecting any one of these register menu keys causes the State of the currently active mode to be saved to the specified Register. The registers are provided for rapid saving and recalling, since you do not need to specify a filename or navigate to a file. Each of the register menu keys annotates whether it is empty or at what date and time it was last modified. In addition, you can use the **Edit Register Names** key to enter custom names for each register.

Although these 16 registers are the only registers available from the front panel, there are 128 state registers available in the instrument. Registers 17–128 are only available from the SCPI interface, using the *SAV command.

There is one set of 128 state registers in the instrument, not one set for each Mode. When a state is saved, the Mode it was saved from is saved with it; then when it is recalled, the instrument switches to that Mode.

After the save completes, the corresponding register menu key annotation is updated with the date and time and the message "Register <register number> saved" is displayed.

Key Path	Save, State
Mode	All
Example	*SAV 1
Range	1–16 from front panel, 1–128 from SCPI

Readback	Date and time with seconds resolution are displayed on the key OR A custom name of up to 30 characters entered using the Edit Register Names key OR “(empty)” if no prior save operation has been performed to this register.
Initial S/W Revision	Prior to A.02.00
Modified at S/W Revision	A.11.00

Data (Export)

Exporting a data file stores data from the current measurement to mass storage files. The Export Menu only contains data types that are supported by the current measurement.

Since the commonly exported data files are in .csv format, the data can be edited by you prior to importing. This allows you to export a data file, manipulate the data in Excel (the most common PC Application for manipulating .csv files) and then import it.

Selecting an Export Data menu key will not actually cause the exporting to occur, since the analyzer still needs to know where you wish to save the data. Pressing the Save As key in this menu brings up the Save As dialog and Save As menu that allows you to specify the destination file and directory. Once a filename has been selected or entered in the Open menu, the export will occur as soon as the Save key is pressed.

Key Path	Save
Mode	All
Notes	The menu is built from whatever data types are available for the mode. So the key locations in the sub menu will vary. No SCPI command directly controls the Data Type that this key controls. The Data Type is included in the MMEM:STORe commands.
Dependencies	If a file type is not used by a certain measurement, that type is grayed out for that measurement. The key for a file type will not show at all if there are no measurements in the Mode that support it.
Preset	Is not affected by a Preset or shutdown, but is reset during Restore Mode Defaults
Readback	The data type that is currently selected
Initial S/W Revision	Prior to A.02.00

Parameter Set

Enables you to export format parameter set data to files. Selecting this key displays a menu that enables you to select the data source. After making this selection, depress Save As... and use the file dialog to enter the file name to save. You can import the exported file by selecting Parameter Set under Recall, Data.

Default path:

Default path of this import type is “My Documents\MSR\data\params” folder. Note that “**My Documents**” is an alias to a directory and its location depends on which user is logged in. If the file path is specified without root folder, the export file is determined with the default path. For example if “folder1\paramData.prms” is specified, “My Documents\MSR\data\params\folder1\paramData.fps” is exported.

File Extension: fps

Default Prefix: ParamSet_

File Dialog Filter: Format Parameter Set Files (*.fps)

Key Path	Save, Data
Mode	MSR
Remote Command	MMEMoRY:STORe:PSET LTEFdd1 LTEFdd2 LTEFdd3 WCDMa1 WCDMa2 WCDMa3 GSM1 GSM2 GSM3 CDMA1 CDMA2 CDMA3 EVDO1 EVDO2 EVDO3 LTETdd1 LTETdd2 LTETdd3 TDSCdma1 TDSCdma2 TDSCdma3,<string>
Example	MME:STOR:PSET WCDM1,"WCDMA.fps"
Notes	The first enum selects the source format parameter set from which the file data are exported.
Initial S/W Revision	A.10.00
Modified at S/W Revision	A.12.00, A.16.00

Meas Results

Different types of results are available for each particular measurement. The results that are available are documented under the individual measurements. These measurement results are the same as the results that are returned when using the MEASure:<measurement> command (usually for sub-opcode 1).

Measurement results may not be available for all measurements.

Key Path	Save, Data
Mode	MSR
Example	MME:STOR:RES "MyResultsFile.xml" This stores the measurement results data in the file MyResultsFile.xml in the default directory.
Notes	The key will not show if the measurements in the Mode do not support it.
Initial S/W Revision	A.10.00

Save As . . .

When you press “Save As”, the analyzer brings up a Windows dialog and a menu entitled “**Save As.**” This menu allows you to navigate to the various fields in the Windows dialog without using a keyboard or mouse. The **Tab** and **Arrow** keys can also be used for dialog navigation.

See "[To File . . .](#)" on page 2444 in **Save, State** for a full description of this dialog and menu.

The default path for saving files is:

For all of the Trace Data Files:

My Documents\<<mode name>\data\traces

For all of the Limit Data Files:

My Documents\<<mode name>\data\limits

For all of the Measurement Results Data Files:

My Documents\<<mode name>\data\<<measurement name>\results

For all of the Capture Buffer Data Files:

My Documents\<<mode name>\data\captureBuffer

Key Path	Save, Data
Mode	All
Notes	The key location is mode-dependent and will vary. Brings up the Save As dialog for saving a <mode specific> Save Type. The save is performed immediately and does not wait until the measurement is complete.
Initial S/W Revision	Prior to A.02.00

Screen Image

Pressing Screen Image accesses a menu of functions that enable you to specify a format and location for the saved screen image. It brings up a menu that allows you to specify the color scheme of the Screen Image (Themes) or navigate to the Save As dialog to perform the actual save.

Screen Image files contain an exact representation of the analyzer display. They cannot be loaded back onto the analyzer, but they can be loaded into your PC for use in many popular applications.

The image to be saved is actually captured when the **Save** front panel key is pressed, and kept in temporary storage to be used if you ask for a Screen Image save. When the Screen Image key is pressed, a "thumbnail" of the captured image is displayed, as shown below:

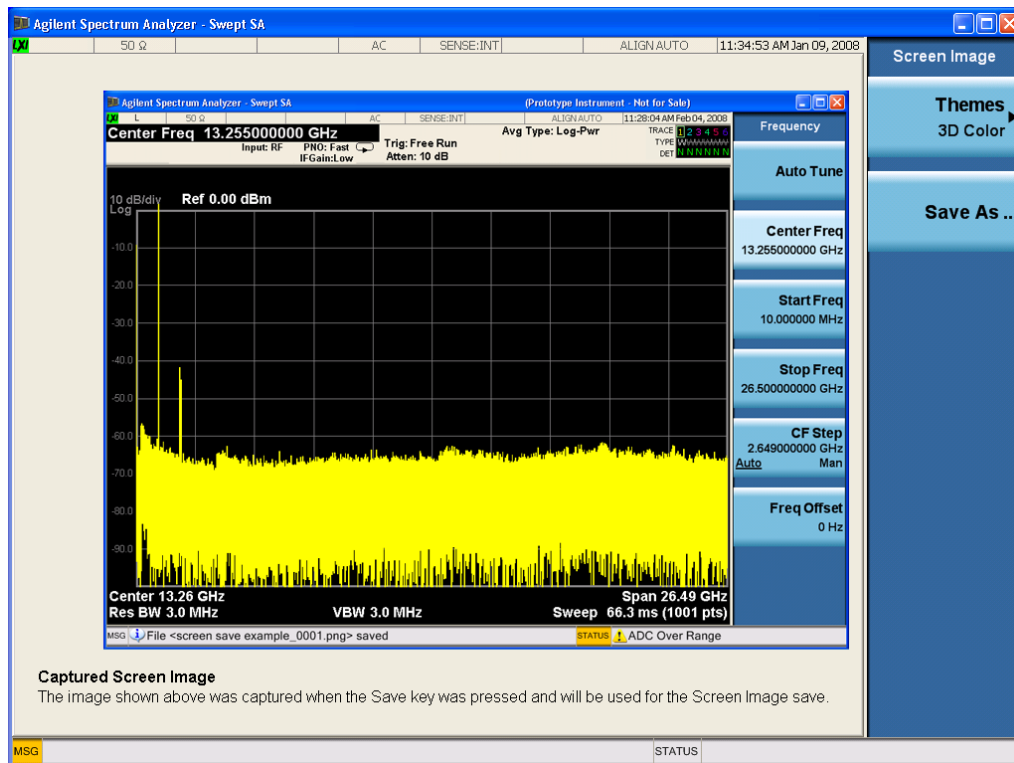

When you continue on into the **Save As** menu and complete the Screen Image save, the image depicted in the thumbnail is the one that gets saved, showing the menus that were on the screen before going into the **Save** menus. The save is performed immediately and does not wait until the measurement is complete.

After you have completed the save, the **Quick Save** front-panel key lets you quickly repeat the last save performed, using an auto-named file, with the current screen data.

NOTE

For versions previous to A.01.55, if you initiate a screen image save by navigating through the **Save** menus, the image that is saved will contain the **Save** menu softkeys, not the menus and the active function that were on the screen when you first pressed the **Save** front panel key.

Key Path	Save
Mode	All
Remote Command	:MMEMory:STORe:SCReem <filename>
Example	:MMEM:STOR:SCR "myScreen.png" This stores the current screen image in the file MyScreenFile.png in the default directory.
Initial S/W Revision	Prior to A.02.00

Themes

Accesses a menu of functions that enable you to choose the theme to be used when saving the screen image.

The **Themes** option is the same as the **Themes** option under the **Display** and **Page Setup** dialogs. It allows you to choose between themes to be used when saving the screen image.

Key Path	Save, Screen Image
Remote Command	:MMEMory:STORe:SCReen:THEMe TDColor TDMonochrome FCOLor FMONochrome :MMEMory:STORe:SCReen:THEMe?
Example	:MMEM:STOR:SCR:THEM TDM
Preset	3D Color; Is not part of Preset, but is reset by Restore Misc Defaults or Restore System Defaults All and survives subsequent running of the modes.
Readback	3D Color 3D Mono Flat Color Flat Mono
Backwards Compatibility Notes	In ESA and PSA we offer the choice of "Reverse Bitmap" or "Reverse Metafile" when saving screen images. This is much like the "Flat Color" theme available in X-Series. Also, if you selected Reverse Bitmap AND a black & white screen image, that would be much like "Flat Monochrome". In other words, each of the X-Series themes has a similar screen image type in ESA/PSA. But they are not identical.
Initial S/W Revision	Prior to A.02.00

3D Color

Selects a standard color theme with each object filled, shaded and colored as designed.

Key Path	Save, Screen Image, Themes
Example	MMEM:STOR:SCR:THEM TDC
Readback	3D Color
Initial S/W Revision	Prior to A.02.00

3D Monochrome

Selects a format that is like 3D color but shades of gray are used instead of colors.

Key Path	Save, Screen Image, Themes
Example	MMEM:STOR:SCR:THEM TDM
Readback	3D Mono
Initial S/W Revision	Prior to A.02.00

Flat Color

Selects a format that is best when the screen is to be printed on an ink printer.

Key Path	Save, Screen Image, Themes
-----------------	-----------------------------------

Example	MMEM:STOR:SCR:THEM FCOL
Readback	Flat Color
Initial S/W Revision	Prior to A.02.00

Flat Monochrome

Selects a format that is like Flat Color. But only black is used (no colors, not even gray), and no fill.

Key Path	Save, Screen Image, Themes
Example	MMEM:STOR:SCR:THEM FMON
Readback	Flat Mono
Initial S/W Revision	Prior to A.02.00

Save As...

When you press "Save As", the analyzer brings up a Windows dialog and a menu entitled "**Save As.**" This menu allows you to navigate to the various fields in the Windows dialog without using a keyboard or mouse. The **Tab** and **Arrow** keys can also be used for dialog navigation.

See "[To File . . .](#)" on page 2444 in **Save, State** for a full description of this dialog and menu.

The default path for Screen Images is

My Documents\`<mode name>`\screen.

where `<mode name>` is the parameter used to select the mode with the INST:SEL command (for example, SA for the Spectrum Analyzer).

Key Path	Save, Screen Image
Notes	Brings up Save As dialog for saving a Screen Image Save Type
Initial S/W Revision	Prior to A.02.00

Single (Single Measurement/Sweep)

Sets the analyzer for Single measurement operation. The single/continuous state is Meas Global, so the setting will affect all the measurements. If you are Paused, pressing **Single** does a Resume.

See "[More Information](#)" on page 1880

Key Path	Front-panel key
Example	:INIT:CONT OFF
Notes	See Cont key description.
Backwards Compatibility Notes	<p>For Spectrum Analysis mode in ESA and PSA, the Single hardkey and the INITiate:IMM switched from continuous measurement to single measurement and restarted sweeps and averages (displayed average count reset to 1), but did not restart Max Hold and Min Hold. In the X-Series, the Single hardkey and the INITiate:IMM command initiate a sweep/ measurement/ average sequence/hold sequence including MaxHold and MinHold.</p> <p>For Spectrum Analysis mode in ESA and PSA, the Single hardkey restarted the sweep regardless of whether or not you were in an active sweep or sweep sequence. In the X-Series, Restart does this but Single only restarts the sweep or sweep sequence if you are in the idle state.</p> <p>INIT[:IMM] in ESA & PSA Spectrum Analysis Mode does an implied ABORT. In some other PSA Modes, INIT[:IMM] is ignored if not in the idle state. . The X-Series follows the ESA/PSA SA Mode model, which may cause some Modes to have compatibility problems.</p>
Initial S/W Revision	Prior to A.02.00

More Information

See "[Restart](#)" on page 2441 for details on the INIT:IMMEDIATE (Restart) function.

If you are already in single sweep, the INIT:CONT OFF command has no effect.

If you are already in Single Sweep, then pressing the **Single** key in the middle of a sweep does not restart the sweep or sequence. Similarly, pressing the **Single** key does not restart the sweep or sequence if the sweep is not in the idle state (for example, if you are taking a very slow sweep, or the analyzer is waiting for a trigger). Instead, it results in a message. "Already in Single, press Restart to initiate a new sweep or sequence". Even though pressing the **Single** key in the middle of a sweep does not restart the sweep, sending INIT:IMMEDIATE does reset it.

To take one more sweep without resetting the average count, increment the average count by 1, by pressing the step up key while **Average/Hold Number** is the active function, or sending the remote command CALC:AVER:TCON UP.

Source

There is no Source functionality in this measurement. When pressed, blank menu appears.

Key Path	Front-panel key
Initial S/W Revision	A.10.00

SPAN X Scale

There is no SPAN X Scale functionality in this measurement. When pressed, blank menu appears.

Key Path	Front-panel key
Initial S/W Revision	A.10.00

Sweep/Control

There is no Sweep/Control functionality in this measurement. When pressed, blank menu appears.

Key Path	Front-panel key
Initial S/W Revision	A.10.00

13 Conformance EVM
System

System

See "[System](#)" on page 368

Trace/Detector

There is no Trace/Detector functionality in this measurement. When pressed, blank menu appears.

Key Path	Front-panel key
Initial S/W Revision	A.10.00

Trigger

See ["Trigger" on page 444](#)

Free Run

See ["Free Run " on page 451](#)

Video

See ["Video \(IF Envelope\) " on page 452](#)

Trigger Level

See ["Trigger Level " on page 452](#)

Trig Slope

See ["Trig Slope " on page 453](#)

Trig Delay

See ["Trig Delay " on page 454](#)

Line

See ["Line " on page 2235](#)

Trig Slope

See ["Trig Slope " on page 2235](#)

Trig Delay

See ["Trig Delay " on page 456](#)

External 1

See ["External 1 " on page 2248](#)

Trigger Level

See ["Trigger Level " on page 2248](#)

Trig Slope

See ["Trig Slope " on page 2249](#)

Trig Delay

See ["Trig Delay " on page 459](#)

Zero Span Delay Comp

See ["Zero Span Delay Comp On/Off" on page 2237](#)

External 2

See ["External 2 "](#) on page 2250

Trigger Level

See ["Trigger Level "](#) on page 2250

Trig Slope

See ["Trig Slope "](#) on page 2251

Trig Delay

See ["Trig Delay "](#) on page 461

Zero Span Delay Comp

See ["Zero Span Delay Comp On/Off"](#) on page 2239

RF Burst

See ["RF Burst "](#) on page 2251

Absolute Trigger

See ["Absolute Trigger Level"](#) on page 2252

Relative Trigger

See ["Relative Trigger Level"](#) on page 2241

Trig Slope

See ["Trigger Slope "](#) on page 2253

Trig Delay

See ["Trig Delay "](#) on page 466

Periodic Timer

See ["Periodic Timer \(Frame Trigger\) "](#) on page 2243

Period

See ["Period "](#) on page 2244

Offset

See ["Offset "](#) on page 2245

Offset Adjust (Remote Command Only)

See ["Offset Adjust \(Remote Command Only\)"](#) on page 2246

Reset Offset Display

See ["Reset Offset Display "](#) on page 2247

Sync Source

See ["Sync Source "](#) on page 2247

Off

See ["Off "](#) on page 2248

External 1

See ["External 1 "](#) on page 2248

Trigger Level

See ["Trigger Level "](#) on page 2248

Trig Slope

See ["Trig Slope "](#) on page 2249

External 2

See ["External 2 "](#) on page 2250

Trigger Level

See ["Trigger Level "](#) on page 2250

Trig Slope

See ["Trig Slope "](#) on page 2251

RF Burst

See ["RF Burst "](#) on page 2251

Absolute Trigger

See ["Absolute Trigger Level"](#) on page 2252

Trig Slope

See ["Trigger Slope "](#) on page 2253

Trig Delay

See ["Trig Delay"](#) on page 476

Auto/Holdoff

See ["Auto/Holdoff "](#) on page 477

Auto Trig

See ["Auto Trig "](#) on page 477

Trig Holdoff

See "Trig Holdoff " on page 478

Holdoff Type

See "Holdoff Type" on page 478

User Preset

Accesses a menu that gives you the following three choices:

- **User Preset** – recalls a state previously saved using the Save User Preset function.
- **User Preset All Modes** – presets all of the modes in the analyzer
- **Save User Preset**– saves the current state for the current mode

Key Path	Front-panel key
Backwards Compatibility Notes	<p>User Preset is actually loading a state, and in legacy analyzers, it was possible to load a state without affecting the trace data, limit lines or correction data. Similarly it was possible to do a User Preset without affecting the trace data, limit lines or correction data.</p> <p>In the X-Series, “state” always includes all of this data; so whenever state is loaded, or User Preset is executed, all of the traces, limit lines and corrections are affected. Although this differs from previous behavior, it is desirable behavior, and should not cause adverse issues for users.</p> <p>On ESA and PSA, User Preset affected the entire instrument’s state. In the X-Series, User Preset only recalls the state for the active mode. There is a User Preset file for each mode. User Preset can never cause a mode switch as it can in legacy analyzers. If you want to recall all modes to their user preset file state, you will need to do a User Preset after mode switching into each mode.</p> <p>User Preset recalls mode state which can now include data like traces; whereas on ESA and PSA, User Preset did not affect data.</p>
Initial S/W Revision	Prior to A.02.00

User Preset

User Preset sets the state of the currently active mode back to the state that was previously saved for this mode using the Save User Preset menu key or the SCPI command, `SYST:PRES:USER:SAV`. It not only recalls the Mode Preset settings, but it also recalls all of the mode persistent settings, and the Input/Output system setting that existed at the time Save User Preset was executed.

If a Save User Preset has not been done at any time, User Preset recalls the default user preset file for the currently active mode. The default user preset files are created if, at power-on, a mode detects there is no user preset file. There will never be a scenario when there is no user preset file to restore. For each mode, the default user preset state is the same state that would be saved if a Save User Preset is performed in each mode right after doing a Restore Mode Default and after a Restore Input/Output Defaults.

The User Preset function does the following:

- Aborts the currently running measurement.
- Sets the mode State to the values defined by Save User Preset.
- Makes the saved measurement for the currently running mode the active measurement.
- Brings up the saved menu for the power-on mode.
- Clears the input and output buffers.
- Sets the Status Byte to 0.

Key Path	User Preset
Remote Command	:SYSTem:PRESet:USER
Example	:SYST:PRES:USER:SAVE:SYST:PRES:USER
Notes	:SYST:PRES:USER:SAVE is used to save the current state as the user preset state. Clears all pending OPC bits. The Status Byte is set to 0. Pressing the User Preset front-panel key while already in the User Preset menu will cause the User Preset to get executed
Couplings	A user preset will cause the currently running measurement to be aborted and cause the saved measurement to be active. Recalling a User Preset file has the same issues that recalling a Save State file has. Some settings may need to be limited and therefore re-coupled, since the capabilities of the mode may have changes when the User Preset file was last saved.
Initial S/W Revision	Prior to A.02.00

User Preset All Modes

Recalls all of the User Preset files for each mode, switches to the power-on mode, and activates the saved measurement from the power-on mode User Preset file.

NOTE

When the instrument is secured, all of the user preset files are converted back to their default user preset files.

The User Preset function does the following:

- Aborts the currently running measurement.
- Switches the Mode to the power-on mode.
- Restores the User Preset files for each mode.
- Makes the saved measurement for the power-on mode the active measurement.
- Brings up the saved menu for the power-on mode.
- Clears the input and output buffers.
- Sets the Status Byte to 0.

Key Path	User Preset
Remote Command	:SYSTem:PRESet:USER:ALL
Example	:SYST:PRES:USER:SAVE:SYST:PRES:USER:ALL
Notes	Clears all pending OPC bits. The Status Byte is set to 0. :SYST:PRES:USER:SAVE is used to save the current state as the user preset state.
Couplings	A user preset will cause the currently running measurement to be aborted, cause a mode switch to the power-on mode, and cause the saved measurement to be active in the power-on mode. Recalling a User Preset file has the same issues that recalling a Save State file has. Some settings may need to be limited and therefore re-coupled, since the capabilities of the mode may have changes when the User Preset file was last saved.

Initial S/W Revision	Prior to A.02.00
----------------------	------------------

Save User Preset

Saves the currently active mode and its State. You can recall this User Preset file by pressing the User Preset menu key or sending the SYST:PRES:USER remote command. This same state is also saved by the Save State function.

Key Path	User Preset
Remote Command	:SYSTem:PRESet:USER:SAVE
Example	:SYST:PRES:USER:SAVE
Notes	:SYST:PRES:SAVE creates the same file as if the user requested a *SAV or a MMEM:STOR:STAT, except User Preset Save does not allow the user to specify the filename or the location of the file.
Initial S/W Revision	Prior to A.02.00

View/Display

The View/Display key opens up the Display Menu for the current measurement.

Key Path	Front-panel key
Initial S/W Revision	A.10.00

Display

The Display menu is common to most measurements, and is used for configuring items on the display. Some Display menu settings apply to all the measurements in a mode, and some only to the current measurement. Those under the **System Display Settings** key apply to all measurements in all modes.

Key Path	Display
Key Path	View/Display
Initial S/W Revision	Prior to A.02.00

Annotation

Turns on and off various parts of the display annotation. The annotation is divided up into four categories:

1. Meas Bar: This is the measurement bar at the top of the screen. It does not include the settings panel or the Active Function. Turning off the Meas Bar turns off the settings panel and the Active Function. When the Meas Bar is off, the graticule area expands to fill the area formerly occupied by the Meas Bar.
2. Screen Annotation: this is the annotation and annunciation around the graticule, including any annotation on lines (such as the display line, the threshold line, etc.) This does NOT include the marker number or the N dB result. When off, the graticule expands to fill the entire graticule area.
3. Trace annotation: these are the labels on the traces, showing their detector (or their math mode).
4. Active Function annotation: this is the active function display in the meas bar, and all of the active function values displayed on softkeys.

See the figure below. Each type of annotation can be turned on and off individually.

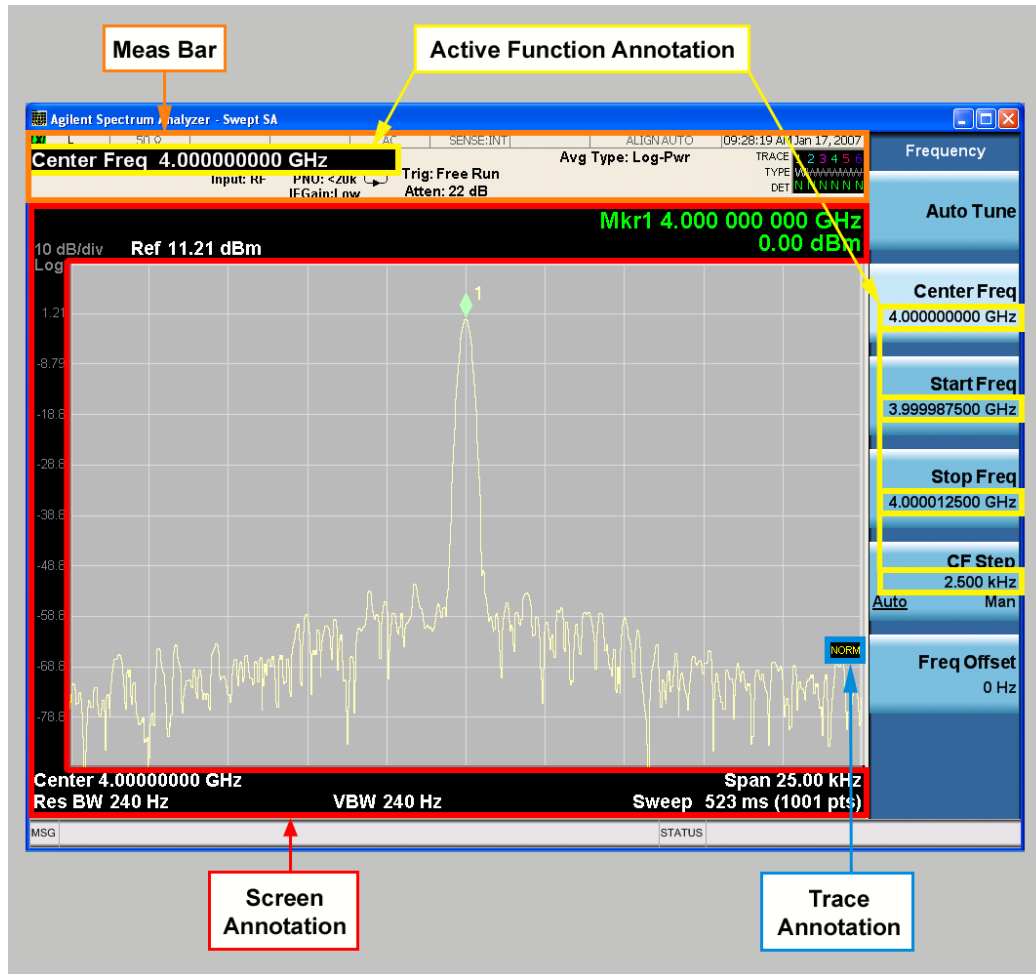

Key Path	View/Display, Display
Initial S/W Revision	Prior to A.02.00

Meas Bar On/Off

This function turns the Measurement Bar on and off, including the settings panel. When off, the graticule area expands to fill the area formerly occupied by the Measurement Bar.

Key Path	View/Display, Display, Annotation
Remote Command	:DISPlay:ANNOtation:MBAR[:STATe] OFF ON 0 1 :DISPlay:ANNOtation:MBAR[:STATe]?
Example	DISP:ANN:MBAR OFF
Dependencies	Grayed out and forced to OFF when System Display Settings, Annotation is set to Off.
Preset	On This should remain Off through a Preset when System DisplaySettings, Annotation is set to Off.

State Saved	Saved in instrument state.
Initial S/W Revision	Prior to A.02.00

Screen

This controls the display of the annunciation and annotation around the graticule, including any annotation on lines (such as the display line, the threshold line, etc.) and the y-axis annotation. This does NOT include marker annotation (or the N dB result). When off, the graticule expands to fill the entire graticule area, leaving only the 1.5% gap above the graticule as described in the Trace/Detector chapter.

Key Path	View/Display, Display, Annotation
Remote Command	:DISPlay:ANNotation:SCReen[:STATe] OFF ON 0 1 :DISPlay:ANNotation:SCReen[:STATe]?
Example	DISP:ANN:SCR OFF
Dependencies	Grayed-out and forced to OFF when System Display Settings, Annotation is set to Off.
Preset	On This should remain Off through a Preset when System DisplaySettings, Annotation is set to Off
State Saved	Saved in instrument state.
Initial S/W Revision	Prior to A.02.00

Active Function Values On/Off

Turns on and off the active function display in the Meas Bar, and all of the active function values displayed on the softkeys.

Note that all of the softkeys that have active functions have these numeric values blanked when this function is on. This is a security feature..

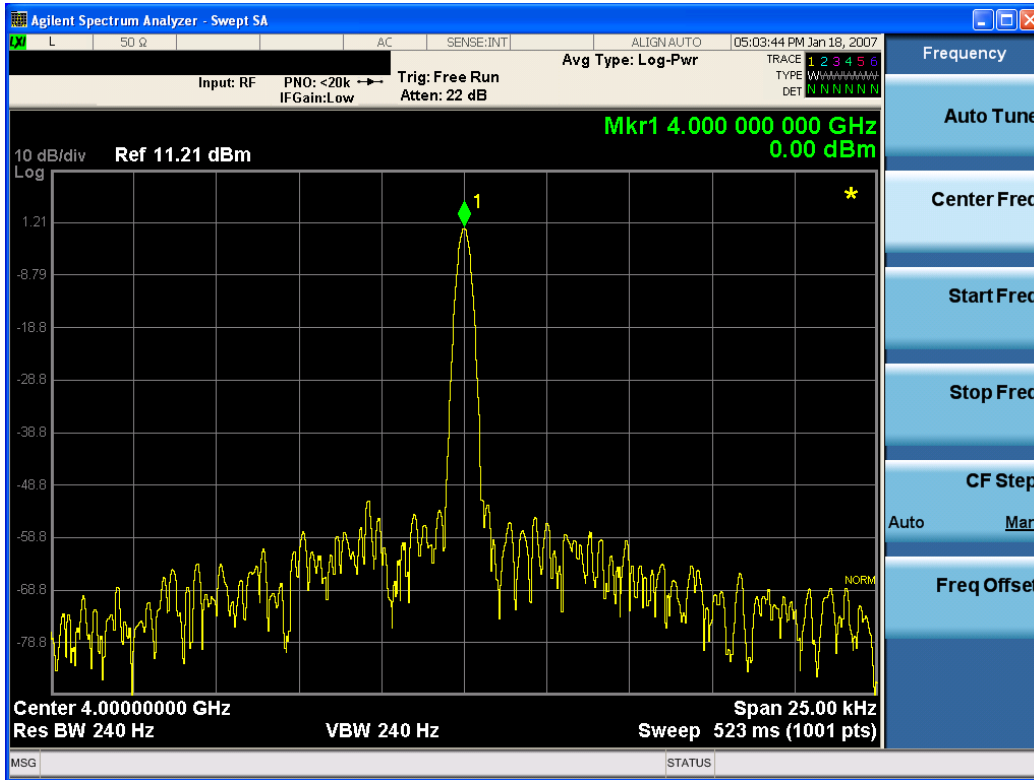

Key Path	View/Display, Display, Annotation
Remote Command	:DISPlay:ACTivefunc[:STATE] ON OFF 1 0 :DISPlay:ACTivefunc[:STATE] ?
Example	DISP:ACT OFF
Dependencies	Grayed out and forced to OFF when System Display Settings, Annotation is set to Off.
Preset	On This should remain Off through a Preset when System DisplaySettings, Annotation is set to Off
State Saved	Saved in instrument state.
Initial S/W Revision	Prior to A.02.00

Title

Displays menu keys that enable you to change or clear a title on your display.

Key Path	View/Display, Display
Initial S/W Revision	Prior to A.02.00

Change Title

Writes a title into the "measurement name" field in the banner, for example, "Swept SA".

Press Change Title to enter a new title through the alpha editor. Press Enter or Return to complete the entry. Press ESC to cancel the entry and preserve your existing title.

The display title will replace the measurement name. It remains for this measurement until you press **Change Title** again, or you recall a state, or a Preset is performed. A title can also be cleared by pressing **Title, Clear Title**.

NOTE

Notice the inclusion of the <measurement> parameter in the command below. Because each measurement remembers the Display Title, the command must be qualified with the measurement name. For the Swept SA measurement this is not the case; no <measurement> parameter is used when changing the Display Title for the Swept SA measurement.

Key Path	View/Display, Display, Title
Mode	All
Remote Command	:DISPlay:<measurement>:ANNotation:TITLe:DATA <string> :DISPlay:<measurement>:ANNotation:TITLe:DATA?
Example	DISP:ANN:TITL:DATA "This Is My Title" This example is for the Swept SA measurement in the Spectrum Analyzer mode. The SANalyzer <measurement> name is not used. DISP:ACP:ANN:TITL:DATA "This Is My Title" This example is for Measurements other than Swept SA. Both set the title to: This Is My Title
Notes	Pressing this key cancels any active function. When a title is edited the previous title remains intact (it is not cleared) and the cursor goes at the end so that characters can be added or BKSP can be used to go back over previous characters.
Preset	No title (measurement name instead)
State Saved	Saved in instrument state.
Initial S/W Revision	Prior to A.02.00

Clear Title

Clears a title from the front-panel display. Once cleared, the title cannot be retrieved. After the title is cleared, the current Measurement Name replaces it in the title bar.

Key Path	View/Display, Display, Title
Example	The following commands clear the title and restore the measurement's original title: DISP:ANN:TITL:DATA "" This example is for the Swept SA measurement in the Spectrum Analyzer mode. The SANalyzer <measurement> name is not used. DISP:ACP:ANN:TITL:DATA "" This example is for ACP; in measurements other than Swept SA the measurement name is required.
Notes	Uses the :DISPlay:<measurement>:ANNotation:TITLe:DATA <string> command with an empty string (in the Swept SA, the <measurement> is omitted).

Preset	Performed on Preset.
Initial S/W Revision	Prior to A.02.00

Graticule

Pressing Graticule turns the display graticule On or Off. It also turns the graticule y-axis annotation on and off.

Key Path	View/Display, Display
Remote Command	:DISPlay:WINDow[1]:TRACe:GRATicule:GRID[:STATe] OFF ON 0 1 :DISPlay:WINDow[1]:TRACe:GRATicule:GRID[:STATe]?
Example	DISP:WIND:TRAC:GRAT:GRID OFF
Notes	The graticule is the set of horizontal and vertical lines that make up the grid/divisions for the x-axis and y-axis.
Preset	On
State Saved	Saved in instrument state
Initial S/W Revision	Prior to A.02.00

System Display Settings

These settings are "Mode Global" – they affect all modes and measurements and are reset only by **Restore Misc Defaults** or **Restore System Defaults** under System.

Key Path	View/Display, Display
Initial S/W Revision	Prior to A.02.00

Annotation Local Settings

This is a Mode Global override of the meas local annotation settings. When it is **All Off**, it forces **ScreenAnnotation, Meas Bar, Trace, and Active Function Values** settings to be **OFF** for all measurements in all modes. This provides the security based "annotation off" function of previous analyzers; hence it uses the legacy SCPI command.

When it is **All Off**, the **Screen, Meas Bar, Trace, and Active Function Values** keys under the **Display, Annotation** menu are grayed out and forced to **Off**. When **Local Settings** is selected, you are able to set the local annotation settings on a measurement by measurement basis.

Key Path	View/Display, Display, System Display Settings
Remote Command	:DISPlay:WINDow[1]:ANNotation[:ALL] OFF ON 0 1 :DISPlay:WINDow[1]:ANNotation[:ALL]?
Example	:DISP:WIND:ANN OFF

Preset	On (Set by Restore Misc Defaults)
State Saved	Not saved in instrument state.
Backwards Compatibility Notes	The WINDow parameter and optional subopcode is included for backwards compatibility but ignored – all windows are equally affected.
Initial S/W Revision	Prior to A.02.00

Themes

Accesses a menu of functions that enable you to choose the theme to be used when saving the screen image.

The **Themes** option is the same as the **Themes** option under the **Display** and **Page Setup** dialogs. It allows you to choose between themes to be used when saving the screen image.

Key Path	Save, Screen Image
Remote Command	:MMEMory:STORe:SCReen:THEMe TDColor TDMonochrome FCOlor FMONochrome :MMEMory:STORe:SCReen:THEMe?
Example	:MMEM:STOR:SCR:THEM TDM
Preset	3D Color; Is not part of Preset, but is reset by Restore Misc Defaults or Restore System Defaults All and survives subsequent running of the modes.
Readback	3D Color 3D Mono Flat Color Flat Mono
Backwards Compatibility Notes	In ESA and PSA we offer the choice of "Reverse Bitmap" or "Reverse Metafile" when saving screen images. This is much like the "Flat Color" theme available in X-Series. Also, if you selected Reverse Bitmap AND a black & white screen image, that would be much like "Flat Monochrome". In other words, each of the X-Series themes has a similar screen image type in ESA/PSA. But they are not identical.
Initial S/W Revision	Prior to A.02.00

3D Color

Selects a standard color theme with each object filled, shaded and colored as designed.

Key Path	Save, Screen Image, Themes
Example	MMEM:STOR:SCR:THEM TDC
Readback	3D Color
Initial S/W Revision	Prior to A.02.00

3D Monochrome

Selects a format that is like 3D color but shades of gray are used instead of colors.

Key Path	Save, Screen Image, Themes
Example	MMEM:STOR:SCR:THEM TDM
Readback	3D Mono
Initial S/W Revision	Prior to A.02.00

Flat Color

Selects a format that is best when the screen is to be printed on an ink printer.

Key Path	Save, Screen Image, Themes
Example	MMEM:STOR:SCR:THEM FCOL
Readback	Flat Color
Initial S/W Revision	Prior to A.02.00

Flat Monochrome

Selects a format that is like Flat Color. But only black is used (no colors, not even gray), and no fill.

Key Path	Save, Screen Image, Themes
Example	MMEM:STOR:SCR:THEM FMON
Readback	Flat Mono
Initial S/W Revision	Prior to A.02.00

Backlight

Accesses the display backlight on/off keys. This setting may interact with settings under the Windows "Power" menu.

When the backlight is off, pressing ESC, TAB, SPACE, ENTER, UP, DOWN, LEFT, RIGHT, DEL, BKSP, CTRL, or ALT turns the backlight on without affecting the application. Pressing any other key will turn backlight on and could potentially perform the action as well.

Key Path	View/Display, Display, System Display Settings
Remote Command	:DISPlay:BACKlight ON OFF :DISPlay:BACKlight?
Preset	ON (Set by Restore Misc Defaults)
Initial S/W Revision	Prior to A.02.00

Backlight Intensity

An active function used to set the backlight intensity. It goes from 0 to 100 where 100 is full on and 0 is off. This value is independent of the values set under the Backlight on/off key.

Key Path	View/Display, Display, System Display Settings
Remote Command	:DISPlay:BACKlight:INTensity <integer> :DISPlay:BACKlight:INTensity?
Example	DISP:BACK:INT 50
Preset	100 (Set by Restore Misc Defaults)
Min	0
Max	100
Initial S/W Revision	Prior to A.02.00

Result Metrics Carrier Index

Specifies the carrier index which includes the results you want to display.

Key Path	View/Display
Mode	MSR
Remote Command	:DISPlay:CEVM:VIEW:RMCindex <integer> :DISPlay:CEVM:VIEW:RMCindex?
Example	DISP:CEVM:VIEW:RMC 3 DISP:CEVM:VIEW:RMC?
Preset	1
State Saved	Saved in instrument state.
Min	1
Max	100
Initial S/W Revision	A.10.00

14 Power Stat CCDF Measurement

Many of the digitally modulated signals now look noise-like in the time and frequency domain. This means that statistical measurements of the signals can be a useful characterization. The Power Complementary Cumulative Distribution Function (CCDF) curves characterize the higher level power statistics of a digitally modulated signal. The curves can be useful in determining design parameters for digital communications systems.

For more details, see ["Power Stat CCDF Measurement Description" on page 1907](#).

For measurement results and views, see ["View/Display" on page 2067](#).

This topic contains the following sections:

["Measurement Commands for Power Stat CCDF" on page 1904](#)

["Remote Command Results for Power Stat CCDF" on page 1905](#)

["Power Stat CCDF Measurement Description" on page 1907](#)

Measurement Commands for Power Stat CCDF

The following commands and queries can be used to retrieve the measurement results:

`:CONFigure:PSStatistic`

`:CONFigure:PSStatistic:NDEFault`

`:INITiate:PSStatistic`

`:FETCh:PSStatistic[n]?`

`:READ:PSStatistic[n]?`

`:MEASure:PSStatistic[n]?`

For more measurement related commands, see the SENSE subsystem, and the section "[Remote Measurement Functions](#)" on page 2381.

Remote Command Results for Power Stat CCDF

The following table describes the results returned by the FETCh, MEASure, and READ queries listed above, according to the index value n.

n	Results Returned
0	Returns unprocessed I/Q trace data, as a series of trace point values, in volts. The I values are listed first in each pair, using the 0 through even-indexed values. The Q values are the odd-indexed values,
not specified or 1	Returns 10 scalar results: <ol style="list-style-type: none"> 1. Average input power (in dBm) 2. Probability at the average input power level (in %) 3. Power level that has 10% of the power 4. Power level that has 1% of the power 5. Power level that has 0.1% of the power 6. Power level that has 0.01% of the power 7. Power level that has 0.001% of the power 8. Power level that has 0.0001% of the power 9. Peak power (in dB) 10.Count
2	Returns a series of 5001 floating point numbers (in percent) that represent the current measured power stat trace. This is the probability at particular power levels (average power), in the following order: <ol style="list-style-type: none"> 1. Probability at 0.0 dB power 2. Probability at 0.01 dB power 3. Probability at 0.02 dB power ... 5000. Probability at 49.9 dB power 5001. Probability at 50.0 dB power
3	Returns a series of 5001 floating point numbers (in percent) that represent the Gaussian trace. This is the probability at particular power levels (average power), in the following order: <ol style="list-style-type: none"> 1. Probability at 0.0 dB power 2. Probability at 0.01 dB power 3. Probability at 0.02 dB power ... 5000. Probability at 49.9 dB power 5001. Probability at 50.0 dB power
4	Returns a series of 5001 floating point numbers (in percent) that represent the user-definable reference trace. This is the probability at particular power levels (average power), in the following order: <ol style="list-style-type: none"> 1. Probability at 0.0 dB power 2. Probability at 0.01 dB power 3. Probability at 0.02 dB power ... 5000. Probability at 49.9 dB power 5001. Probability at 50.0 dB power

Power Stat CCDF Measurement Description

The power statistics CCDF measurement can be affected by many factors. For example, modulation filtering, modulation format, combining the multiple signals at different frequencies, number of active codes, and correlation between symbols on different codes with spread spectrum systems will all affect measurement results. These factors are all related to modulation and signal parameters. External factors such as signal compression and expansion by nonlinear components, group delay distortion from filtering, and power control within the observation interval also affect the measurement.

The power measured in power statistics CCDF curves is actually instantaneous envelope power defined by the equation:

$$P = (I^2 + Q^2) / Z_0$$

where I & Q are the quadrature voltage components of the waveform, and Z_0 is the characteristic impedance.

A CCDF curve is defined by how much time the waveform spends at or above a given power level. The percent of time the signal spends at or above the level defines the probability for that particular power level. For capturing a lower probability down to 0.0001%, this measurement is made in the single mode by pressing Single. To make the power statistics CCDF measurement, the instrument uses digital signal processing (DSP) to sample the input signal in the channel bandwidth. The Gaussian distribution line as the band-limited Gaussian noise CCDF reference line, the user-definable reference trace, and the currently measured trace can be displayed on a semi-log graph. If the currently measured trace is above the user reference trace, it means that the higher peak power levels against the average power are included in the input signal.

Key Path	Meas
Initial S/W Revision	Prior to A.02.00

AMPTD Y Scale

Accesses a menu of functions that enable you to set the vertical scale parameters. The parameter values are measurement independent except all Attenuation values, and the Internal Preamp selection, which are the same across all measurements.

Key Path	Front-panel key
Initial S/W Revision	Prior to A.02.00

Attenuation

This menu controls the attenuator functions and interactions between the attenuation system components.

There are two attenuator configurations in the X-Series. One is a dual attenuator configuration consisting of a mechanical attenuator and an optional electronic attenuator. The other configuration uses a single attenuator with combined mechanical and electronic sections that controls all the attenuation functions. Different models in the X-Series come with different configurations.

See ["Dual Attenuator Configurations:" on page 1908](#)

See ["Single Attenuator Configuration:" on page 1909](#)

Most Attenuation settings are the same for all measurements – they do not change as you change measurements. Settings like these are called “Meas Global” and are unaffected by Meas Preset.

Key Path	AMPTD Y Scale
Scope	Meas Global
Dependencies	In measurements that support the I/Q inputs, this key is unavailable when I/Q is the selected input, and is replaced by the Range key in that case.
Readback Line	Contains a summary in [] brackets of the current total attenuation. See the descriptions of the , " (Mech) Atten " on page 2297, and " Enable Elec Atten " on page 2299 keys for more detail on the contributors to the total attenuation. Note that when "Pre-Adjust for Min Clip" is on, this value can change at the start of every measurement.
Initial S/W Revision	Prior to A.02.00
Modified at S/W Revision	A.03.00

Dual Attenuator Configurations:

Configuration 1: Mechanical attenuator + optional electronic attenuator

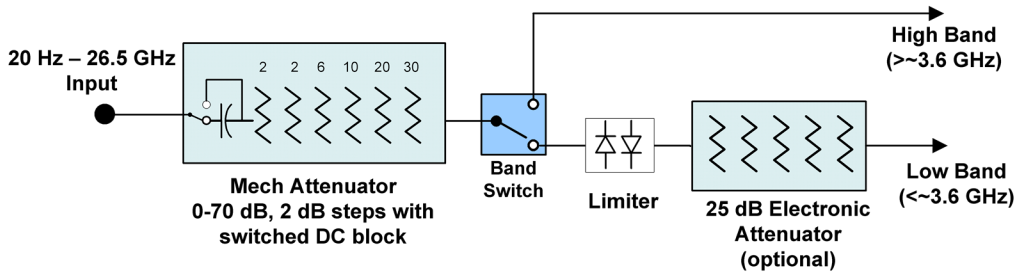

Configuration 2: Mechanical attenuator, no optional electronic attenuator

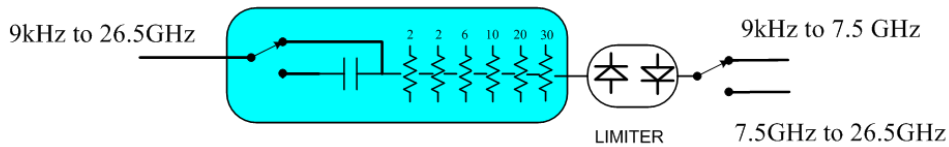

(note that Configuration 2 is not strictly speaking a dual-section attenuator, since there is no electronic section available. However, it behaves exactly like Configuration 1 without the Electronic Attenuator option EA3, therefore for the sake of this document it is grouped into the “Dual Attenuator” configuration)

Single Attenuator Configuration:

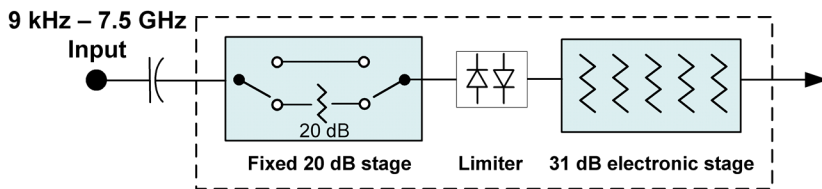

You can tell which attenuator configuration you have by pressing the Attenuation key, which (in most Modes) opens the Attenuation menu. If the first key in the Attenuation menu says **Mech Atten** you have the dual attenuator configuration. If the first key says **Atten** you have the single attenuator configuration.

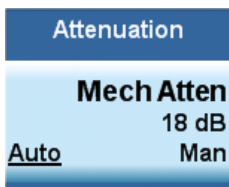

Dual Attenuator

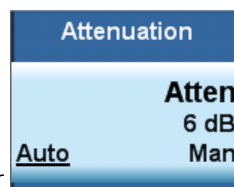

Single Attenuator

In the single attenuator configuration, you control the attenuation with a single control, as the fixed stage has only two states. In the dual attenuator configuration, both stages have significant range so you are given separate control of the mechanical and electronic attenuator stages.

When you have the dual attenuator configuration, you may still have only a single attenuator, because unless option EA3 (the Electronic Attenuator option) is available, and you purchase it, you will have only the mechanical attenuator.

(Mech) Atten

This key is labeled **Mech Atten** in dual attenuator models and **Atten** in single attenuator models. In the dual attenuator configuration, this key only affects the mechanical attenuator.

This key lets you modify the attenuation applied to the RF input signal path. This value is normally auto coupled to the Ref Level, the Internal Preamp Gain, any External Gain that is entered, and the Max Mixer Level, as described in the table below.

See "[Attenuator Configurations and Auto/Man](#)" on page 1911

Key Path	AMPTD Y Scale, Attenuation
Remote Command	<pre>[:SENSe] :POWer [:RF] :ATTenuation <rel_ampl> [:SENSe] :POWer [:RF] :ATTenuation? [:SENSe] :POWer [:RF] :ATTenuation:AUTO OFF ON 0 1 [:SENSe] :POWer [:RF] :ATTenuation:AUTO?</pre>
Example	<p>POW:ATT 20</p> <p>Dual attenuator configuration: sets the mechanical attenuator to 20 dB</p> <p>Single attenuator mode: sets the main attenuation to 20 dB (see below for definition of “main” attenuation).</p> <p>If the attenuator was in Auto, it sets it to Manual.</p>
Dependencies	<p>Some measurements do not support the Auto setting of (Mech) Atten. In these measurements, the Auto/Man selection is not available, and the Auto/Man line on the key disappears.</p> <p>In dual attenuator configurations, when the electronic attenuator is enabled, the mechanical attenuator has no auto setting and the Auto/Man line on the key disappears. The state of Auto/Man is remembered and restored when the electronic attenuator is once again disabled. This is described in more detail in the "Enable Elec Atten" on page 2299 key description.</p> <p>See "Attenuator Configurations and Auto/Man" on page 1911 for more information on the Auto/Man functionality of Attenuation.</p>
Couplings	<p>When (Mech) Atten is in Auto, it uses the following algorithm to determine a value:</p> <p>If the USB Preamp is connected to USB, use 0 dB.</p> <p>Otherwise, $Atten = ReferenceLevel + PreAmpGain + ExternalGain - RefLevelOffset - MaxMixerLevel + IF\ Gain$.</p> <p>Limit this value to be between 6 dB and the Max value. No value below 6 dB can ever be chosen by Auto.</p> <p>The resulting value is rounded up to the largest value possible given the attenuation step setting. That is, 50.01 dB would change to 60 dB (for a 10 dB attenuation step).</p> <p>The “IF Gain” term in the equation above is either 0 dB or +10 dB, depending on the settings of FFT IF Gain, Swept IF Gain, max Ref Level and the Auto/Man setting of Mech Atten.</p> <p>In External Mixing and BBIQ, where the Attenuator is not in the signal path, the Attenuator setting changes as described above when (Mech) Atten is in Auto, but no changes are made to the actual attenuator hardware setting until the input is changed back to the RF Input.</p>
Preset	<p>The preset for Mech Attenuation is “Auto.”</p> <p>The Auto value of attenuation is:</p> <p>CXA, EXA, MXA and PXA: 10 dB</p>

State Saved	Saved in instrument state
Min	0 dB The attenuation set by this key cannot be decreased below 6 dB with the knob or step keys. To get to a value below 6 dB it has to be directly entered from the keypad or via SCPI. This protects from adjusting the attenuation to a dangerously small value which can put the instrument at risk of damage to input circuitry. However, if the current mechanical attenuation is below 6 dB it can be increased with the knob and step keys, but not decreased.
Max	CXA N9000A-503/507: 50 dB CXA N9000A-513/526: 70dB EXA: 60 dB MXA and PXA: 70 dB In the single attenuator configuration, the total of ATT and EATT cannot exceed 50 dB, so if the EATT is set to 24 dB first, the main attenuation cannot be greater than 26 dB and will be reduced accordingly; if the main attenuator is set to 40 dB first, EATT cannot be greater than 10 dB.
Initial S/W Revision	Prior to A.02.00
Modified at S/W Revision	A.03.00

Attenuator Configurations and Auto/Man

As described in the Attenuation key description, there are two distinct attenuator configurations available in the X-Series, the single attenuator and dual attenuator configurations. In dual attenuator configurations, we have the mechanical attenuation and the electronic attenuation, and the current total attenuation is the sum of the electronic + mechanical attenuation. In single attenuator configurations, we refer to the attenuation set using the **(Mech) Atten** key (or POW:ATT SCPI) as the “main” attenuation; and the attenuation that is set by the SCPI command POW:EATT as the “soft” attenuation (the POW:EATT command is honored even in the single attenuator configuration, for compatibility purposes). Then the current total attenuation is the sum of the main + soft attenuation. See the **Elec Atten** key description for more on “soft” attenuation.

In the dual attenuator configuration, when the electronic attenuator is enabled, there is no Auto/Man functionality for the mechanical attenuator, and the third line of the key label (the Auto/Man line) disappears:

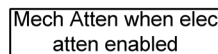
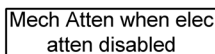
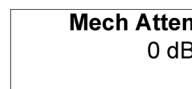
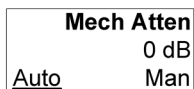

vsd05

Enable Elec Atten

Enables the Electronic Attenuator.

The electronic attenuator offers finer steps than the mechanical attenuator, has no acoustical noise, is faster, and is less subject to wear. These advantages primarily aid in remote operation and are negligible

for front panel use. See ["Using the Electronic Attenuator: Pros and Cons" on page 1913](#) for a detailed discussion of the pros and cons of using the electronic attenuator.

For the single attenuator configuration, for SCPI backwards compatibility, the “soft” attenuation feature replaces the dual attenuator configuration’s electronic attenuator. All the same couplings and limitations apply. See ["Attenuator Configurations and Auto/Man" on page 2299](#)

See ["More Information" on page 1912](#)

Key Path	AMPTD Y Scale, Attenuation
Remote Command	[:SENSe] :POWer [:RF] :EATTenuation:STATe OFF ON 0 1 [:SENSe] :POWer [:RF] :EATTenuation:STATe?
Example	POW:EATT:STAT ON
Dependencies	<p>This key only appears in Dual Attenuator models with an Electronic Attenuator installed. It does not appear in models with the Single Attenuator configuration, as in the single attenuator configuration there is no “electronic attenuator” there is only a single integrated attenuator (which has both a mechanical and electronic stage). However, in the single attenuator configuration, EATT SCPI commands are accepted for compatibility with other X-series instruments and set a “soft” attenuation as described in "Attenuator Configurations and Auto/Man" on page 2299.</p> <p>The electronic attenuator (and the “soft” attenuation function provided in single attenuator configurations) is unavailable above 3.6 GHz. Therefore, if the Stop Frequency of the analyzer is > 3.6 GHz then the Enable Elec Atten key will be OFF and grayed out.</p> <p>If the Internal Preamp is on, meaning it is set to Low Band or Full, the electronic attenuator (and the “soft” attenuation function provided in single attenuator configurations) is unavailable. In this case the Enable Elec Atten key will be OFF and grayed out.</p> <p>If either of the above is true, if the SCPI command is sent, an error indicating that the electronic attenuator is unavailable will be sent.</p> <p>If the electronic/soft Attenuator is enabled, then the Stop Freq of the analyzer is limited to 3.6 GHz and the Internal Preamp is unavailable.</p> <p>The SCPI-only “soft” electronic attenuation for the single-attenuator configuration is not available in all measurements; in particular, it is not available in the Swept SA measurement.</p>
Couplings	Enabling and disabling the Electronic Attenuator affects the setting of the Mechanical Attenuator (in dual attenuator configurations). This is described in more detail below this table.
Preset	OFF for Swept SA measurement; ON for all other measurements that support the electronic attenuator
State Saved	Saved in instrument state
Initial S/W Revision	Prior to A.02.00
Modified at S/W Revision	A.03.00

More Information

Mechanical Attenuator Transition Rules

When the Electronic Attenuator is enabled, the Mechanical Attenuator transitions to a state that has no Auto function. Below are the rules for transitioning the Mechanical Attenuator. NOTE that the information

below ONLY applies to the dual attenuator configurations, and ONLY when the Electronic Attenuator is installed:

When the Electronic Attenuation is enabled from a disabled state:

- The Mechanical Attenuator is initialized to 10 dB (this is its optimal performance setting). You can then set it as desired with SCPI, numeric keypad, step keys, or knob, and it behaves as it normally would in manual mode
- The Auto/Man state of (Mech) Atten is saved
- The Auto/Man line on the (Mech) Atten key disappears and the auto rules are disabled
- The Electronic Attenuator is set to 10 dB less than the previous value of the Mechanical Attenuator, within the limitation that it must stay within the range of 0 to 24 dB of attenuation.

Examples in the dual attenuator configuration:

- Mech Atten at 20 dB. Elec Atten enabled, Mech Atten set to 10 dB, and Elec Atten set to 10 dB. New total attenuation equals the value before Elec Atten enabled.
- Mech Atten at 0 dB. Elec Atten enabled, Mech Atten set to 10 dB, and Elec Atten set to 0 dB. New total attenuation does not equal the value before Elec Atten enabled.
- Mech Atten at 40 dB. Elec Atten enabled, Mech Atten set to 10 dB, and Elec Atten set to 24 dB. New total attenuation does not equal the value before Elec Atten enabled.

When the Electronic Attenuation is disabled from an enabled state:

- The Elec Atten key is grayed out
- The Auto/Man state of (Mech) Atten is restored
- If now in Auto, (Mech) Atten recouples
- If now in Man, (Mech) Atten is set to the value of total attenuation that existed before the Elec Atten was disabled. The resulting value is rounded up to the smallest value possible given the (Mech) Atten Step setting - (That is, 57 dB changes to 58 dB when (Mech) Atten Step is 2 dB.)

Using the Electronic Attenuator: Pros and Cons

The electronic attenuator offers finer steps than the mechanical attenuator, has no acoustical noise, is faster, and is less subject to wear.

The “finer steps” advantage of the electronic attenuator is beneficial in optimizing the alignment of the analyzer dynamic range to the signal power in the front panel as well as remote use. Thus, you can achieve improved relative signal measurement accuracy. Compared to a mechanical attenuator with 2 dB steps, the 1 dB resolution of the electronic attenuator only gives better resolution when the odd-decibel steps are used. Those odd-decibel steps are less accurately calibrated than the even-decibel steps, so one tradeoff for this superior relative accuracy is reduced absolute amplitude accuracy.

Another disadvantage of the electronic attenuator is that the spectrum analyzer loses its “Auto” setting, making operation less convenient.

Also, the relationship between the dynamic range specifications (TOI, SHI, compression and noise) and instrument performance are less well-known with the electrical attenuator. With the mechanical

attenuator, TOI, SHI and compression threshold levels increase dB-for-dB with increasing attenuation, and the noise floor does as well. With the electronic attenuator, there is an excess attenuation of about 1 to 3 dB between 0 and 3.6 GHz, making the effective TOI, SHI, and so forth, less well known. Excess attenuation is the actual attenuation relative to stated attenuation. Excess attenuation is accounted for in the analyzer calibration

Elec Atten

Controls the Electronic Attenuator in dual attenuator configurations. This key does not appear in single attenuator configurations, as the control of both the mechanical and electronic stages of the single attenuator is integrated into the single **Atten** key.

Key Path	AMPTD Y Scale, Attenuation
Remote Command	<code>[:SENSe] :POWer [:RF] :EATTenuation <rel_ampl></code> <code>[:SENSe] :POWer [:RF] :EATTenuation?</code>
Notes	Electronic Attenuation's specification is defined only when Mechanical Attenuation is 6 dB.
Dependencies	This key only appears in Dual Attenuator models with an Electronic Attenuator installed. It does not appear in models with the Single Attenuator configuration, as in the single attenuator configuration there is no "electronic attenuator" there is only a single integrated attenuator (which has both a mechanical and electronic stage). However, in the single attenuator configuration, EATT SCPI commands are accepted for compatibility with other X-series instruments and set a "soft" attenuation as described in "Attenuator Configurations and Auto/Man" on page 2299 . The "soft" attenuation is treated as an addition to the "main" attenuation value set by the Atten softkey or the POW:ATT SCPI command and affects the total attenuation displayed on the Attenuation key and the Meas Bar. When Enable Elec Atten is off or grayed out, the Elec Atten key is grayed out.
Preset	0 dB
State Saved	Saved in instrument state
Min	0 dB
Max	Dual attenuator configuration: 24 dB Single attenuator configuration: the total of ATT and EATT cannot exceed 50 dB, so if the EATT is set to 24 dB first, the main attenuation cannot be greater than 26 dB and will be reduced accordingly; if the main attenuator is set to 40 dB first, EATT cannot be greater than 10 dB
Initial S/W Revision	Prior to A.02.00
Modified at S/W Revision	A.03.00

Adjust Atten for Min Clip

Sets the combination of mechanical and electronic attenuation and gain based on the current measured signal level so that clipping will be at a minimum.

This is an "immediate action" function, that is, it executes once, when the key is pressed.

This key is grayed out in measurements that do not support this functionality. The spectrum analyzer measurement, Swept SA, does not support this functionality.

Key Path	AMPTD Y Scale, Attenuation
Remote Command	<code>[:SENSe] :POWer [:RF] :RANGe:OPTimize IMMEDIATE</code>
Initial S/W Revision	Prior to A.02.00
Modified at S/W Revision	A.03.00

Pre-Adjust for Min Clip

If this function is on, it does the adjustment described under "[Adjust Atten for Min Clip](#)" on page 2302 each time a measurement restarts. Therefore, in Continuous measurement mode, it only executes before the first measurement.

In dual attenuator models, you can set **Elec+Mech Atten**, in which case both attenuators participate in the autoranging, or **Elec Atten Only**, in which case the mechanical attenuator does not participate in the autoranging. This latter case results in less wear on the mechanical attenuator and is usually faster.

This key is grayed out in measurements that do not support this functionality. The spectrum analyzer measurement, Swept SA, does not support this functionality.

Key Path	AMPTD Y Scale, Attenuation
Remote Command	<code>[:SENSe] :POWer [:RF] :RANGe:OPTimize:ATTenuation OFF ELECTrical COMBined</code> <code>[:SENSe] :POWer [:RF] :RANGe:OPTimize:ATTenuation?</code>
Notes	The SCPI parameter ELECTrical sets this function to On in single attenuator models. The SCPI parameter COMBined is mapped to ELECTrical in single attenuator models; if you send COMBined, it sets the function to On and returns ELEC to a query.
Dependencies	This key only appears in Dual Attenuator models with an Electronic Attenuator installed. In instruments with Dual Attenuator model, when Enable Elec Atten is off or grayed out, the Pre-Adjust for Min Clip key is grayed out.
Preset	OFF for Swept SA measurement; ON for all other measurements that support Pre-Adjust for Min Clip
State Saved	Saved in instrument state
Range	Dual attenuator models: Off Elec Atten Only Mech + Elec Atten Single attenuator models: Off On
Initial S/W Revision	Prior to A.02.00
Modified at S/W Revision	A.03.00

Remote Command	<code>[:SENSe] :POWer [:RF] :RANGe:AUTO ON OFF 1 0</code> <code>[:SENSe] :POWer [:RF] :RANGe:AUTO?</code>
Notes	ON aliases to "Elec Atten Only" (:POW:RANG:OPT:ATT ELEC)

	OFF aliases to "Off" (:POW:RANG:OPT:ATT OFF) The query :POW:RANG:AUTO? returns true if :POW:RANG:OPT:ATT is not "Off"
Initial S/W Revision	Prior to A.02.00

Off

Turns **Pre-Adjust for Min Clip** off. This is the default setting.

This key is grayed out in measurements that do not support this functionality. The spectrum analyzer measurement, Swept SA, does not support this functionality.

Key Path	AMPTD Y Scale, Attenuation, Pre-Adjust for Min Clip
Example	:POW:RANGe:OPT:ATT OFF
Initial S/W Revision	Prior to A.02.00

Elec Atten Only

Selects only the electric attenuator to participate in auto ranging. This offers less wear on the mechanical attenuator and is usually faster.

This key is grayed out in measurements that do not support this functionality. The spectrum analyzer measurement, Swept SA, does not support this functionality.

Key Path	AMPTD Y Scale, Attenuation, Pre-Adjust for Min Clip
Example	:POW:RANGe:OPT:ATT ELEC
Initial S/W Revision	Prior to A.02.00

Mech + Elec Atten

In dual attenuator models, this selects both attenuators participate in the autoranging.

This key is grayed out in measurements that do not support this functionality. The spectrum analyzer measurement, Swept SA, does not support this functionality.

Key Path	AMPTD Y Scale, Attenuation, Pre-Adjust for Min Clip
Example	:POW:RANGe:OPT:ATT COMB
Initial S/W Revision	Prior to A.02.00

(Mech) Atten Step

This controls the step size used when making adjustments to the input attenuation.

This key is labeled **Mech Atten Step** in dual attenuator models and **Atten Step** in single attenuator models. In the dual attenuator configuration, this key only affects the step size of the mechanical attenuator.

Key Path	AMPTD Y Scale, Attenuation
Remote Command	<code>[:SENSe] :POWer [:RF] :ATTenuation :STEP [:INCRement] 10 dB 2 dB</code> <code>[:SENSe] :POWer [:RF] :ATTenuation :STEP [:INCRement] ?</code>
Example	POW:ATT:STEP 2
Notes	Note this feature works like a 1-N choice from the front panel, but it takes a specific value (in dB) when used remotely. The only valid values are 2 and 10.
Dependencies	Blanked in CXA and EXA if option FSA (2 dB steps) is not present. If blanked, attempts to set it via SCPI will yield an error.
Couplings	When the attenuation step size changes, the current mechanical attenuation value is adjusted (if necessary) to be quantized to the new step size. That is, if step is set to 10 dB, mech atten is increased if necessary so it is a multiple of 10 dB
Preset	PXA and MXA: 2 dB EXA and CXA: 10 dB (2 dB with option FSA)
State Saved	Saved in instrument state
Initial S/W Revision	Prior to A.02.00
Modified at S/W Revision	A.03.00

Adjust Atten (Remote Command only)

Allows you to select;

-Electric attenuator only

-Combination of Electric attenuator and Mechanical attenuator

when the SCPI command `[:SENSe] :POWer [:RF] :RANGe :OPTimize IMMEDIATE` is executed.

Remote Command	<code>[:SENSe] :POWer [:RF] :RANGe :OPTimize :TYPE EONLY COMBined</code> <code>[:SENSe] :POWer [:RF] :RANGe :OPTimize :TYPE ?</code>
Example	POW:RANG:OPT:TYPE EONL POW:RANG:OPT:TYPE?
Preset	COMBined
State Saved	Saved in instrument state
Initial S/W Revision	A.16.00

Presel Center

When this key is pressed, the centering of the preselector filter is adjusted to optimize the amplitude accuracy at the frequency of the selected marker. If the selected marker is not on when Presel Center is

pressed, the analyzer will turn on the selected marker, perform a peak search, and then perform centering on the marker's center frequency. If the selected marker is already on and between the start and stop frequencies of the analyzer, the analyzer performs the preselector calibration on that marker's frequency. If the selected marker is already on, but outside the frequency range between Start Freq and Stop Freq, the analyzer will first perform a peak search, and then perform centering on the marker's center frequency.

The value displayed on the **Presel Adjust** key will change to reflect the new preselector tuning (see **Presel Adjust**).

A number of considerations should be observed to ensure proper operation. See "[Proper Preselector Operation](#)" on page 1918.

Key Path	AMPTD Y Scale
Remote Command	<code>[:SENSe] :POWer [:RF] :PCENter</code>
Example	POW:PCEN
Notes	Note that the rules outlined above under the key description apply for the remote command as well as the key. The result of the command is dependent on marker position, and so forth. Any message shown by the key press is also shown in response to the remote command.
Dependencies	<ul style="list-style-type: none"> • Grayed out if the microwave preselector is off.) • If the selected marker's frequency is below Band 1, advisory message 0.5001 is generated and no action is taken. • Grayed out if entirely in Band 0. • Blank in models that do not include a preselector, such as option 503. If the SCPI is sent in these instruments, it is accepted without error, and the query always returns 0. • Grayed out in the Spectrogram View.
Couplings	<p>The active marker position determines where the centering will be attempted.</p> <p>If the analyzer is in a measurement such as averaging when centering is initiated, the act of centering the preselector will restart averaging but the first average trace will not be taken until the centering is completed.</p>
Status Bits/OPC dependencies	<p>When centering the preselector, *OPC will not return true until the process is complete and a subsequent measurement has completed, nor will results be returned to a READ or MEASure command.</p> <p>The Measuring bit should remain set while this command is operating and should not go false until the subsequent sweep/measurement has completed.</p>
Initial S/W Revision	Prior to A.02.00
Modified at S/W Revision	A.03.00

Proper Preselector Operation

A number of considerations should be observed to ensure proper operation:

1. If the selected marker is off, the analyzer will turn on a marker, perform a peak search, and adjust the preselector using the selected marker's frequency. It uses the "highest peak" peak search method unqualified by threshold or excursion, so that there is no chance of a 'no peak found' error. It continues

with that peak, even if it is the peak of just noise. Therefore, for this operation to work properly, there should be a signal on screen in a preselected range for the peak search to find.

2. If the selected marker is already on, the analyzer will attempt the centering at that marker's frequency. There is no preselector for signals below about 3.6 GHz, therefore if the marker is on a signal below 3.6 GHz, no centering will be attempted and an advisory message generated
3. In some models, the preselector can be bypassed. If it is bypassed, no centering will be attempted in that range and a message will be generated.

Preselector Adjust

Allows you to manually adjust the preselector filter frequency to optimize its response to the signal of interest. This function is only available when **"Presel Center"** on page 2306 is available.

For general purpose signal analysis, using Presel Center is recommended. Centering the filter minimizes the impact of long-term preselector drift. Presel Adjust can be used instead to manually optimize the preselector. One application of manual optimization would be to peak the preselector response, which both optimizes the signal-to-noise ratio and minimizes amplitude variations due to small (short-term) preselector drifting.

Key Path	AMPTD Y Scale
Scope	Meas Global
Remote Command	<code>[:SENSe] :POWer [:RF] :PADJust <freq></code> <code>[:SENSe] :POWer [:RF] :PADJust?</code>
Example	POW:PADJ 100KHz POW:PADJ?
Notes	The value on the key reads out to 0.1 MHz resolution.
Dependencies	<ul style="list-style-type: none"> • Grayed out if microwave preselector is off.) • Grayed out if entirely in Band 0. • Blank in models that do not include a preselector, such as option 503. If the SCPI is sent in these instruments, it is accepted without error, and the query always returns 0. • Grayed out in the Spectrogram View.
Preset	0 MHz
State Saved	The Presel Adjust value set by Presel Center , or by manually adjusting Presel Adjust , is not saved in instrument state, and does not survive a Preset or power cycle.
Min	-500 MHz
Max	500 MHz
Default Unit	Hz
Backwards Compatibility SCPI	<code>[:SENSe] :POWer [:RF] :MW :PADJust</code> <code>[:SENSe] :POWer [:RF] :MMW :PADJust</code> PSA had multiple preselectors, but the X-Series has only one. These commands simply alias to <code>[:SENSe] :POWer [:RF] :PADJust</code>

Initial S/W Revision	Prior to A.02.00
Modified at S/W Revision	A.03.00

Remote Command	<code>[:SENSe] :POWer [:RF] :PADJust :PRESelector MWAVE MMWave EXTernal</code> <code>[:SENSe] :POWer [:RF] :PADJust :PRESelector?</code>
Notes	PSA had multiple preselectors, and you could select which preselector to adjust. Since the X-Series has only one mm/uW preselector, the preselector selection softkey is no longer available. However, to provide backward compatibility, we accept the legacy remote commands. The command form has no effect, the query always returns MWAVE

Initial S/W Revision	Prior to A.02.00
----------------------	------------------

μW Path Control

The **μW Path Control** functions include the **μW Preselector Bypass** (Option MPB) and **Low Noise Path** (Option LNP) controls in the High Band path circuits.

When the μW Preselector is bypassed, the user has better flatness, but will be subject to spurs from out of band interfering signals. When the Low Noise Path is enabled, the analyzer automatically switches around certain circuitry in the high frequency bands which can contribute to noise, when it is appropriate based on other analyzer settings.

For most applications, the preset state is Standard Path, which gives the best remote-control throughput, minimizes acoustic noise from switching and minimizes the risk of wear out in the hardware switches. For applications that utilize the wideband IF paths, the preset state is the μW Preselector Bypass path, if option MPB is present. This is because, when using a wideband IF such as the 140 MHz IF, the μW Preselector's bandwidth can be narrower than the available IF bandwidth, causing degraded amplitude flatness and phase linearity, so it is desirable to bypass the preselector in the default case.

Users may choose Low Noise Path Enable. It gives a lower noise floor, especially in the 21–26.5 GHz region, though without improving many measures of dynamic range, and without giving the best possible noise floor. The preamp, if purchased and used, gives better noise floor than does the Low Noise Path, however its compression threshold and third-order intercept are much poorer than that of the non-preamp Low Noise Path. There are some applications, typically for signals around –30 dBm, for which the third-order dynamic range of the standard path is good enough, but the noise floor is not low enough even with 0 dB input attenuation. When the third-order dynamic range of the preamp path is too little and the noise floor of the standard path is too high, the Low Noise Path can provide the best dynamic range.

Key Path	AMPTD Y Scale
Mode	SA, BASIC, PNOISE, VSA, LTE, LTETDD
Scope	Meas Global
Remote Command	<code>[:SENSe] :POWer [:RF] :MW :PATH STD LNPath MPBypass FULL</code> <code>[:SENSe] :POWer [:RF] :MW :PATH?</code>

Example	:POW:MW:PATH LNP Enables the Low Noise path
Notes	<p>If a Presel Center is performed, the analyzer will momentarily switch to the Standard Path, regardless of the setting of μW Path Control</p> <p>The DC Block will always be switched in when the low noise path is switched in, to protect succeeding circuitry from DC. Note that this does not mean “when the low noise path is enabled” but when, based on the Low Noise Path rules, the path is actually switched in. This can happen when the selection is Low Noise Path Enable . In the case where the DC Block is switched in the analyzer is now AC coupled. However, if the user has selected DC coupling, the UI will still behave as though it were DC coupled, including all annunciation, warnings, status bits, and responses to SCPI queries. This is because, based on other settings, the analyzer could switch out the low noise path at any time and hence go back to being DC coupled.</p> <p>Alignment switching ignores the settings in this menu, and restores them when finished.</p>
Dependencies	Unavailable in BBIQ and External Mixing
Preset	<p>All modes other than IQ Analyzer mode and VXA: STD</p> <p>IQ Analyzer, VXA and WLAN mode:</p> <p>MPB option present and licensed: MPB</p> <p>MPB option not present and licensed: STD</p>
State Saved	Save in instrument state
Readback	Value selected in the submenu
Initial S/W Revision	A.04.00
Modified at S/W Revision	A.10.00

Standard Path

This path gives the best remote-control throughput, minimizes acoustic noise from switching and minimizes the risk of wear in the hardware switches, particularly in remote test scenarios where both low band and high band setups will follow in rapid succession.

In this path, the bypass of the low band/high band switch and microwave preamp is never activated, which can cause some noise degradation but preserves the life of the bypass switch.

Key Path	AMPTD Y Scale, μW Path Control
Example	:POW:MW:PATH STD
Readback Text	Standard Path
Initial S/W Revision	A.04.00

Low Noise Path Enable

You may choose Low Noise Path Enable, which gives a lower noise floor under some circumstances, particularly when operating in the 21–26.5 GHz region. With the Low Noise Path enabled, the low band/high band switch and microwave preamp are bypassed whenever all of the following are true:

- The analyzer is not in the Low Band, meaning:

- the start frequency is above 3.5 GHz and
- the stop frequency is above 3.6 GHz.
- the internal preamp is not installed or (if installed) is set to **Off** or **Low Band**

Note that this means that, when any part of a sweep is done in Low Band, the Low Noise Path is not used, whether or not the **Low Noise Path Enable** is selected in the user interface. Also, if the preamp is turned on, the Low Noise Path is not used, whether or not the **Low Noise Path Enable** is selected in the user interface. The only time the Low Noise Path is used is when **Low Noise Path Enable** is selected, the sweep is completely in High Band (> 3.6 GHz) and no preamp is in use.

See "[More Information](#)" on page 1922

Key Path	AMPTD Y Scale, μ W Path Control
Measurement	Swept SA
Example	:POW:MW:PATH LNP
Notes	<p>For measurements that use IQ acquisition, the low noise path is used when the Center Frequency is in High Band (> 3.6 GHz) and no preamp is in use.</p> <p>In other words, the rules above are modified to use only the center frequency to qualify which path to switch in.</p> <p>This is not the case for FFT's in the Swept SA measurement; they use the same rules as swept measurements.</p>
Dependencies	<p>Key is blanked if current mode does not support it.</p> <p>Key is grayed out if mode supports it but current measurement does not support it.</p> <p>Unless Option LNP is present and licensed, key is blank and if SCPI command sent, error -241, "Hardware missing; Option not installed" is generated.</p>
Readback Text	Low Noise Path Enable
Initial S/W Revision	A.04.00

More Information

The user should understand that the Low Noise Path, while giving improved DANL, has the disadvantage of decreased TOI performance and decreased gain compression performance relative to the standard path.

The user should also understand that the bypass switch is a mechanical switch and has finite life, so if the **Low Noise Path** is enabled, it is possible to cause frequent cycling of this switch by frequently changing analyzer settings such that the above conditions hold true only some of the time. A user making tests of this nature should consider opting for the **Standard Path**, which will never throw the bypass switch, at the expense of some degraded noise performance.

The low noise path is useful for situations where the signal level is so low that the analyzer performance is dominated by noise even with 0 dB attenuation, but still high enough that the preamp option would have excessive third-order intermodulation or compression. The preamp, if purchased and used, gives better noise floor than does the "Low Noise Path." However, its compression threshold and third-order intercept are much poorer than that of the non-preamp path. There are some applications, typically for signals around -30 dBm, for which the third-order dynamic range of the standard path is good enough, but the noise floor is not low enough even with 0 dB input attenuation. When the third-order dynamic range of the

preamp path is too little and the noise floor of the standard path is too high, the Low Noise Path can provide the best dynamic range

The graph below illustrates the concept. It shows, in red, the performance of an analyzer at different attenuation settings, both with the preamp on and off, in a measurement that is affected by both analyzer noise and analyzer TOI. The green shows the best available dynamic range, offset by 0.5 dB for clarity. The blue shows how the best available dynamic range improves for moderate signal levels with the low noise path switched in. In this illustration, the preamp improves the noise floor by 15 dB while degrading the third-order intercept by 30 dB, and the low noise path reduces loss by 8 dB. The attenuator step size is 2 dB.

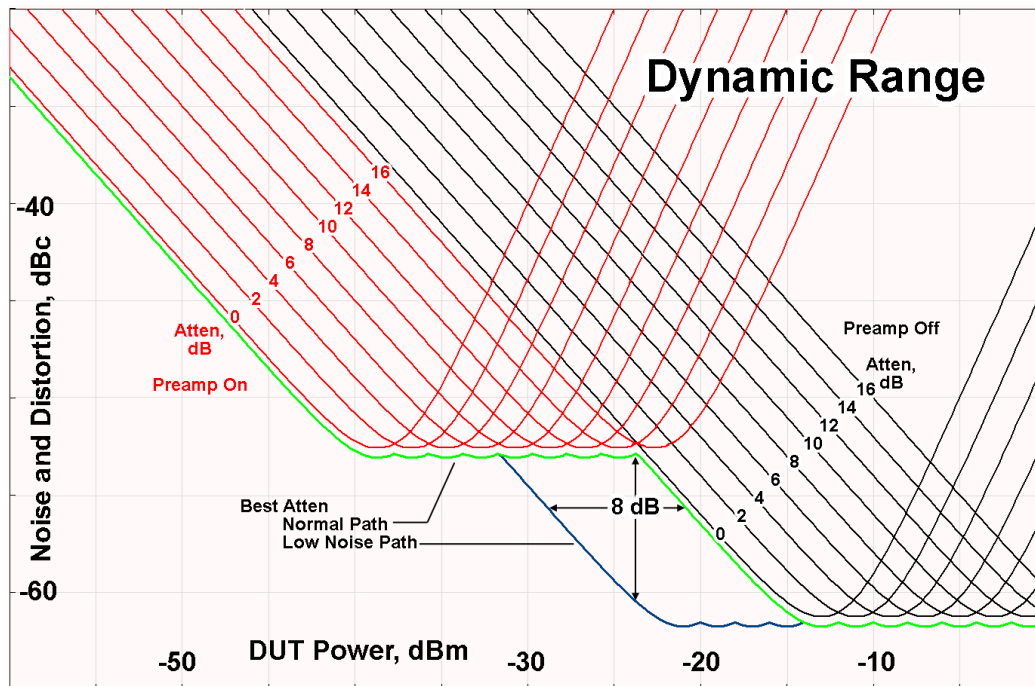

There are other times where selecting the low noise path improves performance, too. Compression-limited measurements such as finding the nulls in a pulsed-RF spectrum can profit from the low noise path in a way similar to the TOI-limited measurement illustrated. Accuracy can be improved when the low noise path allows the optimum attenuation to increase from a small amount like 0, 2 or 4 dB to a larger amount, giving better return loss at the analyzer input. Harmonic measurements, such as second and third harmonic levels, are much improved using the low noise path because of the superiority of that path for harmonic (though not intermodulation) distortion performance.

μW Preselector Bypass

This key toggles the preselector bypass switch for band 1 and higher. When the microwave preselector is on, the signal path is preselected. When the microwave preselector is off, the signal path is not preselected. The preselected path is the normal path for the analyzer.

The preselector is a tunable bandpass filter which prevents signals away from the frequency of interest from combining in the mixer to generate in-band spurious signals (images). The consequences of using a preselector filter are its limited bandwidth, the amplitude and phase ripple in its passband, and any amplitude and phase instability due to center frequency drift.

Option MPB or pre-selector bypass provides an unpreselected input mixer path for certain X-Series signal analyzers with frequency ranges above 3.6 GHz. This signal path allows a wider bandwidth and less amplitude variability, which is an advantage when doing modulation analysis and broadband signal analysis. The disadvantage is that, without the preselector, image signals will be displayed. Another disadvantage of bypassing the preselector is increased LO emission levels at the front panel input port.

Image responses are separated from the real signal by twice the 1st IF. For IF Paths of 10 MHz and 25 MHz, the 1st IF is 322.5 MHz, so the image response and the real signal will be separated by 645 MHz. The 1st IF will be different for other IF Path settings. When viewing a real signal and its corresponding image response in internal mixing, the image response will be to the left of the real signal.

Also, the image response and the real signal typically have the same amplitude and exhibit the same shape factor.

However, if Option FS1, Fast Sweep Capability, is enabled, the image response in the Swept SA measurement will appear lower in amplitude and have a much wider shape factor compared to the real signal.

Key Path	AMPTD Y Scale, μW Path Control
Example	:POW:MW:PATH MPB
Dependencies	Key is blanked if current mode does not support it. Key is grayed out if mode supports it but current measurement does not support it. Key is blank unless Option MPB is present and licensed. If SCPI command sent when MPB not present, error -241, "Hardware missing; Option not installed" is generated.
Readback Text	μ W Preselector Bypass
Initial S/W Revision	A.04.00

Remote Command	[:SENSE] :POWER [:RF] :MW:PRESelector [:STATe] ON OFF 0 1 [:SENSE] :POWER [:RF] :MW:PRESelector [:STATe] ?
Example	:POW:MW:PRES OFF Bypasses the microwave preselector
Notes	The ON parameter sets the STD path (:POW:MW:PATH STD) The OFF parameter sets path MPB (:POW:MW:PATH MPB)
Preset	ON

Internal Preamp

Accesses a menu of keys that control the internal preamps. Turning on the preamp gives a better noise figure, but a poorer TOI to noise floor dynamic range. You can optimize this setting for your particular measurement.

The instrument takes the preamp gain into account as it sweeps. If you sweep outside of the range of the preamp the instrument will also account for that. The displayed result will always reflect the correct gain.

For some measurements, when the preamp is on and any part of the displayed frequency range is below the lowest frequency for which the preamp has specifications, a warning condition message appears in the status line. For example, for a preamp with a 9 kHz lowest specified frequency: "Preamp: Accy unspec'd below 9 kHz".

Key Path	AMPTD Y Scale
Scope	Meas Global
Remote Command	[:SENSe] :POWer [:RF] :GAIN [:STATe] OFF ON 0 1 [:SENSe] :POWer [:RF] :GAIN [:STATe] ?
Dependencies	Preamp is not available on all hardware platforms. If the preamp is not present or is unlicensed, the key is not shown. The preamp is not available when the electronic/soft attenuator is enabled.
Couplings	The act of connecting the U7227A USB Preamplifier to one of the analyzer's USB ports will cause the Internal Preamp to be switched on. When this happens an informational message will be generated: "Internal Preamp turned on for optimal operation with USB Preamp." Note that if the Internal Preamp was already on, there will be no change to the setting, but if it was Off it will be switched On, to Full Range. Note that this same action occurs when the SA mode is selected while the USB Preamp is connected to one of the analyzer's USB ports, if it is the first time that the SA mode has run since powerup, or if the last time the SA mode was running the USB Preamp was NOT connected. Subsequently disconnecting the USB Preamp from USB does not change the Internal Preamp setting nor restore the previous setting.
Preset	OFF
State Saved	Saved in instrument state
Initial S/W Revision	Prior to A.02.00
Modified at S/W Revision	A.14.00

Key Path	AMPTD Y Scale, Internal Preamp
Scope	Meas Global
Remote Command	[:SENSe] :POWer [:RF] :GAIN :BAND LOW FULL [:SENSe] :POWer [:RF] :GAIN :BAND ?
Dependencies	Preamp is not available on all hardware platforms. If the preamp is not present or is unlicensed, the key is not shown. If a POW:GAIN:BAND FULL command is sent when a low band preamp is available, the preamp band parameter is to LOW instead of FULL, and an "Option not installed" message is generated.
Preset	LOW
State Saved	Saved in instrument state
Initial S/W Revision	Prior to A.02.00

Off

Turns the internal preamp off

Key Path	AMPTD Y Scale, Internal Preamp
Example	:POW:GAIN OFF
Readback	Off
Initial S/W Revision	Prior to A.02.00

Low Band

Sets the internal preamp to use only the low band.

The frequency range of the installed (optional) low-band preamp is displayed in square brackets on the **Low Band** key label.

Key Path	AMPTD Y Scale, Internal Preamp
Example	:POW:GAIN ON :POW:GAIN:BAND LOW
Readback	Low Band
Initial S/W Revision	Prior to A.02.00

Full Range

Sets the internal preamp to use its full range. The low band (0–3.6 GHz or 0–3GHz, depending on the model) is supplied by the low band preamp and the frequencies above low band are supplied by the high band preamp.

The frequency range of the installed (optional) preamp is displayed in square brackets on the **Full Range** key label. If the high band option is not installed the Full Range key does not appear.

Key Path	AMPTD Y Scale, Internal Preamp
Example	:POW:GAIN ON :POW:GAIN:BAND FULL
Readback	Full Range
Initial S/W Revision	Prior to A.02.00

Range

This key is only available when I/Q is the selected input. It replaces the Attenuation key in that case.

Each input channel (I and Q) has four internal gain ranges. The maximum allowed voltage in each gain range is slightly more than the nominal value, so the break point between ranges is a couple of millivolts higher than the nominal (setting a peak voltage of 0.502 mV will still map to the 0.5 V Peak range).

Gain Setting	Volts RMS	Volts Peak	Volts Peak - Peak	dBm (50Ω)	Break Point
0 dB	0.7071	1.0	2.0	10	n/a
6 dB	0.3536	0.5	1.0	4	0.502 V Peak
12 dB	0.1768	0.25	0.5	-2	0.252 V Peak
18 dB	0.0884	0.125	0.25	-8	0.127 V Peak

Key Path	AMPTD Y Scale
Notes	Visible only when the selected input is I/Q.
State Saved	No
Readback Text	When Range is Auto, "[Auto]" When Range is Man and I & Q are the same, "[<range value>]" When Range is Man and I & Q are different: "I: <I range value> Q: <Q range value>]" See I Range and Q Range for the <range value> enumeration definition.
Initial S/W Revision	Prior to A.02.00

Range Auto/Man

The Auto setting for Range causes the range to be set based on the Y Scale settings. When Range is "Auto", the I & Q Range are set based on the top of the Y Scale when the Y scale is in dB units (for example, power), or to the max(abs(top), abs(bottom)) when the Y scale reference is not at the top of the screen.

Not all measurements support Range Auto/Man. If Auto is not supported in the current measurement, this key is grayed out and shows "Man" and MAN is returned to a SCPI query, but this does NOT change the Auto/Man setting for Range. When you go to a measurement that supports Auto, it goes back to Auto if it was previously in Auto mode.

Key Path	AMPTD Y Scale, Range
Scope	Meas Global
Remote Command	[:SENSe] :VOLTage :IQ :RANGe :AUTO OFF ON 0 1 [:SENSe] :VOLTage :IQ :RANGe :AUTO ?
Example	Put the I Range and Q Range in manual. VOLT:IQ:RANG:AUTO OFF
Dependencies	If Auto is not supported, sending the SCPI command will generate an error.
Couplings	When in Auto, both I Range and Q Range are set to the same value, computed as follows: Maximum absolute value is computed for the Y Scale. The top and bottom of the graph are computed based on Ref Value, Scale/Div, and Ref Position. Formula: YMax = max(abs(top), abs(bottom)). The I Range and Q Range are then set to YMax.
Preset	ON

State Saved	Saved in instrument state
Range	Auto Man
Initial S/W Revision	Prior to A.02.00

Remote Command	<code>[:SENSe] :POWer :IQ :RANGe :AUTO OFF ON 0 1</code> <code>[:SENSe] :POWer :IQ :RANGe :AUTO ?</code>
-----------------------	---

Example	Put the I Range and Q Range in manual. <code>POW:IQ:RANG:AUTO OFF</code>
----------------	---

Notes	The <code>POW:IQ:RANG:AUTO</code> is an alternate form of the <code>VOLT:IQ:RANG:AUTO</code> command. This is to maintain consistency with I Range and Q Range, which support both the <code>POWer</code> and <code>VOLTage</code> forms of the command.
-------	--

Preset	ON
Range	Auto Man
Initial S/W Revision	Prior to A.02.00

I Range

This is the internal gain range for the I channel when Input Path is I Only or I and I/Q, and it is used for both the I and Q channels when the Input Path is I+jQ. See "[I/Q Gain Ranges](#)" on page 2321.

Key Path	AMPTD Y Scale, Range
Remote Command	<code>[:SENSe] :VOLTage :IQ [: I] :RANGe [:UPPer] <voltage></code> <code>[:SENSe] :VOLTage :IQ [: I] :RANGe [:UPPer] ?</code>
Example	Set the I Range to 0.5 V Peak <code>VOLT:IQ:RANG 0.5 V</code>
Notes	The numeric entries are mapped to the smallest gain range whose break point is greater than or equal to the value, or 1 V Peak if the value is greater than 1 V.
Couplings	When Q Same as I is On, the I Range value will be copied to the Q Range. Changing the value will also set Range = Man.
Preset	1 V Peak
State Saved	Saved in instrument state
Range	1 V Peak 0.5 V Peak 0.25 V Peak 0.125 V Peak
Min	0.125 V
Max	1 V
Initial S/W Revision	Prior to A.02.00

Remote Command	<code>[:SENSe] :POWer :IQ [: I] :RANGe [:UPPer] <ampl></code>
-----------------------	---

[:SENSe] :POWer :IQ [:I] :RANGe [:UPPer] ?

Example

Set the I Range to 0.5 V Peak when Reference Z is 50Ω, and to 1.0 V Peak when Reference Z is 75Ω.

POW:IQ:RANG 4 dBm

Notes

The POWER form of the command is provided for convenience. It maps to the same underlying gain range parameter as the VOLTage form of the command.

The Reference Z (not the I channel Input Z) is used to convert the power to peak voltage, which is then used to set the I Range as with the VOLTage form of the command. The power values of the 4 range states (1V Peak, 0.5V Peak, 0.25V Peak, and 0.125V Peak) will vary with Reference Z. Here are some examples:

50Ω: 10, 4, -2, -8

75Ω: 8.2, 2.2, -3.8, -9.8

600Ω: -0.8, -6.8, -12.8, -18.9

Preset

10.0 dBm

Range

-20 dBm to 10 dBm

Min

-20 dBm

Max

10 dBm

Initial S/W Revision

Prior to A.02.00

1 V Peak

Set the channel gain state to 1 Volt Peak.

Key Path	AMPTD Y Scale, I Range Q Range
Initial S/W Revision	Prior to A.02.00

0.5 V Peak

Set the channel gain state to 0.5 Volt Peak.

Key Path	AMPTD Y Scale, I Range Q Range
Initial S/W Revision	Prior to A.02.00

0.25 V Peak

Set the channel gain state to 0.25 Volt Peak.

Key Path	AMPTD Y Scale, I Range Q Range
Initial S/W Revision	Prior to A.02.00

0.125 V Peak

Set the channel gain state to 0.125 Volt Peak.

Key Path	AMPTD Y Scale, I Range Q Range
Initial S/W Revision	Prior to A.02.00

Q Range Value

This is the internal gain range for the Q channel. See "[I/Q Gain Ranges](#)" on page 2321. The Q Range only applies to Input Path Q Only and Ind I/Q. For input I+jQ the I Range determines both I and Q channel range settings.

Key Path	AMPTD Y Scale, Range
Remote Command	<code>[:SENSe] :VOLTage:IQ:Q:RANGe [:UPPer] <voltage></code> <code>[:SENSe] :VOLTage:IQ:Q:RANGe [:UPPer] ?</code>
Example	Set the Q Range to 0.5 V Peak <code>VOLT:IQ:Q:RANG 0.5 V</code>
Notes	The numeric entries are mapped to the smallest gain range whose break point is greater than or equal to the value, or 1 V Peak if the value is greater than 1 V. The Q Range is only used for Input Path Q Only and Ind I/Q. For input I+jQ the I Range determines both I and Q channel range settings.
Couplings	When Q Same as I is On, the I Range value will be copied to the Q Range and the range value keys are disabled. Changing the value will also set Range = Man.
Preset	1 V Peak
State Saved	Saved in instrument state
Range	1 V Peak 0.5 V Peak 0.25 V Peak 0.125 V Peak
Min	0.125 V
Max	1 V
Initial S/W Revision	Prior to A.02.00

Remote Command	<code>[:SENSe] :POWer:IQ:Q:RANGe [:UPPer] <amp;pl></code> <code>[:SENSe] :POWer:IQ:Q:RANGe [:UPPer] ?</code>
Example	Will set the Q Range to 0.5 V Peak when Reference Z is 50Ω, and to 1.0 V Peak when Reference Z is 75Ω. <code>POW:IQ:Q:RANG 4 dBm</code>
Notes	The POWER form of the command is provided for convenience. It maps to the same underlying gain range parameter as the VOLTage form of the command. The Reference Z (not the Q channel Input Z) is used to convert the power to peak voltage, which is then used to set the Q Range as with the VOLTage form of the command. The power values of the 4

range states (1V Peak, 0.5V Peak, 0.25V Peak, and 0.125V Peak) will vary with Reference Z. Here are some examples:

50Ω: 10, 4, -2, -8
75Ω: 8.2, 2.2, -3.8, -9.8
600Ω: -0.8, -6.8, -12.8, -18.9

Preset	10.0 dBm
Range	-20 dBm to 10 dBm
Min	-20 dBm
Max	10 dBm
Initial S/W Revision	Prior to A.02.00

Q Same as I

Many, but not all, usages require the I and Q channels to have an identical setup. To simplify channel setup, the Q Same as I will cause the Q channel range to be mirrored from the I channel. That way you only need to set up one channel (the I channel). The I channel values are copied to the Q channel, so at the time Q Same as I is Off, the I and Q channel setups will be identical.

Key Path	AMPTD Y Scale, Range, Q Range
Remote Command	[:SENSe] :VOLTage P OWer : IQ :MIRRored OFF ON 0 1 [:SENSe] :VOLTage P OWer : IQ :MIRRored?
Example	Turn off the mirroring of I Range to Q Range. VOLT:IQ:MIRR OFF POW:IQ:MIRR OFF
Couplings	When On, the I Range value is mirrored (copied) to the Q Range.
Preset	On
State Saved	Saved in instrument state.
Range	On Off
Readback Text	"Q Same as I" when On, otherwise none.
Initial S/W Revision	Prior to A.02.00

1 V Peak

Set the channel gain state to 1 Volt Peak.

Key Path	AMPTD Y Scale, I Range Q Range
Initial S/W Revision	Prior to A.02.00

0.5 V Peak

Set the channel gain state to 0.5 Volt Peak.

Key Path	AMPTD Y Scale, I Range Q Range
Initial S/W Revision	Prior to A.02.00

0.25 V Peak

Set the channel gain state to 0.25 Volt Peak.

Key Path	AMPTD Y Scale, I Range Q Range
Initial S/W Revision	Prior to A.02.00

0.125 V Peak

Set the channel gain state to 0.125 Volt Peak.

Key Path	AMPTD Y Scale, I Range Q Range
Initial S/W Revision	Prior to A.02.00

I/Q Gain Ranges

See the following sections:

["1 V Peak" on page 2321](#)

["0.5 V Peak" on page 2322](#)

["0.25 V Peak" on page 2322](#)

["0.125 V Peak" on page 2322](#)

1 V Peak

Set the channel gain state to 1 Volt Peak.

Key Path	AMPTD Y Scale, I Range Q Range
Initial S/W Revision	Prior to A.02.00

0.5 V Peak

Set the channel gain state to 0.5 Volt Peak.

Key Path	AMPTD Y Scale, I Range Q Range
Initial S/W Revision	Prior to A.02.00

0.25 V Peak

Set the channel gain state to 0.25 Volt Peak.

Key Path	AMPTD Y Scale, I Range Q Range
Initial S/W Revision	Prior to A.02.00

0.125 V Peak

Set the channel gain state to 0.125 Volt Peak.

Key Path	AMPTD Y Scale, I Range Q Range
Initial S/W Revision	Prior to A.02.00

Presel Center

When this key is pressed, the centering of the preselector filter is adjusted to optimize the amplitude accuracy at the frequency of the selected marker.

See AMPTD Y Scale, "[Presel Center](#)" on page 2306 for more information.

This is only available when the selected input is RF.

Key Path	AMPTD Y Scale
Initial S/W Revision	Prior to A.02.00

Presel Adjust

Allows you to manually adjust the preselector filter frequency to optimize its response to the signal of interest. This function is only available when **Presel Center** is available.

See AMPTD Y Scale, "[Preselector Adjust](#)" on page 2307 for more information.

This is only available when the selected input is RF.

Key Path	AMPTD Y Scale
Initial S/W Revision	Prior to A.02.00

Y Axis Unit

Allows you to change the vertical (Y) axis amplitude unit.

See Y Axis Unit under AMPTD Y Scale for more information.

Key Path	AMPTD Y Scale
Initial S/W Revision	A.04.00

Reference Level Offset

Adds an offset value to the displayed reference level. The reference level is the absolute amplitude represented by the top graticule line on the display.

See Reference Level Offset under AMPTD Y Scale for more information.

Key Path	AMPTD Y Scale
Initial S/W Revision	A.04.00

μ W Path Control

The μ W Path Control functions include the μ W Preselector Bypass (Option MPB) and Low Noise Path (Option LNP) controls in the High Band path circuits.

See " [\$\mu\$ W Path Control](#)" on page 2308 under AMPTD Y Scale for more information.

Key Path	AMPTD Y Scale
Initial S/W Revision	A.04.00

Auto Couple

The Auto Couple feature provides a quick and convenient way to automatically couple multiple instrument settings. This helps ensure accurate measurements and optimum dynamic range. When the Auto Couple feature is activated, either from the front panel or remotely, all parameters of the current measurement that have an Auto/Manual mode are set to Auto mode and all measurement settings dependent on (or coupled to) the Auto/Man parameters are automatically adjusted for optimal performance.

However, the Auto Couple key actions are confined to the current measurement only. It does not affect other measurements in the mode, and it does not affect markers, marker functions, or trace or display attributes.

See "[More Information](#)" on page 1935

Key Path	Front-panel key
Remote Command	:COUPle ALL NONE
Example	:COUP ALL
Notes	:COUPle ALL puts all Auto/Man parameters in Auto mode (equivalent to pressing the Auto Couple key). :COUPLE NONE puts all Auto/Man parameters in manual mode. It decouples all the coupled instrument parameters and is not recommended for making measurements.
Initial S/W Revision	Prior to A.02.00

More Information

There are two types of functions that have Auto/Manual modes.

Auto/Man Active Function keys

An Auto/Man toggle key controls the binary state associated with an instrument parameter by toggling between **Auto** (where the parameter is automatically coupled to the other parameters it is dependent upon) and **Man** (where the parameter is controlled independent of the other parameters), as well as making the parameter the active function. The current mode is indicated on the softkey with either **Auto** or **Man** underlined as illustrated below.

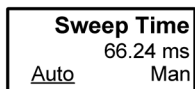

vsd07

Auto/Man 1-of-N keys

An Auto/Man 1-of-N key allows you to manually pick from a list of parameter values, or place the function in Auto, in which case the value is automatically selected (and indicated) as shown below. If in Auto, Auto is underlined on the calling key. If in manual operation, manual is indicated on the calling key. But the calling key does not actually toggle the function, it simply opens the menu.

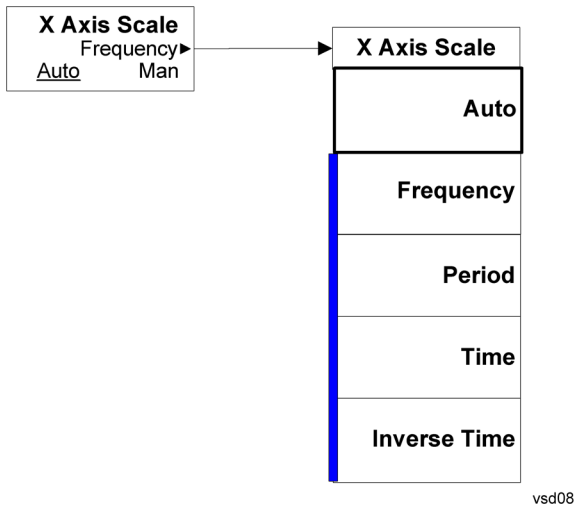

BW

Opens the BW menu, which contains keys to control the information bandwidth functions of the instrument.

Key Path	Front-panel key
Initial S/W Revision	Prior to A.02.00

Info BW

Allows you to enter a frequency value to set the channel bandwidth that will be used for data acquisition.

Key Path	BW
Mode	SA, WCDMA, C2K, WIMAXOFDMA, TD-SCDMA, 1xEV-DO, DVB-T/H, DTMB (CTTB), ISDB-T, CMMB, LTE, LTETDD, Digital Cable TV, WLAN, MSR, LTEATDD, LTEAFDD
Remote Command	<code>[:SENSe] :PStatistic :BANDwidth <freq></code> <code>[:SENSe] :PStatistic :BANDwidth?</code>
Example	PST:BAND 8 MHz PST:BAND?
Couplings	WiMAX OFDMA: The default value depends on the Radio Standard selection..
Preset	SA, WCDM: 5 MHz C2K:1.5 MHz 1xEV-DO:1.3 MHz WiMAX OFDMA: Hardware Dependent No Option = 10 MHz WB (25 MHz or wider) = 25 MHz TD-SCDMA: 1.3 MHz DVB-T/H, DTMB (CTTB): 8 MHz ISDB-T: 6 MHz CMMB: 8 MHz LTE, LTETDD, LTEATDD, LTEAFDD: 6 MHz Digital Cable TV: 8MHz WLAN: Hardware Dependent No option = 10 MHz Option B25 = 25 MHz Option B40: if Radio Std is 802.11a/b/g/n(20MHz) = 25 MHz if Radio Std is 802.11n(40MHz) = 40 MHz if Radio Std is 802.11ac(20MHz) = 25 MHz if Radio Std is 802.11ac(40MHz) = 40 MHz Option B1X: if Radio Std is 802.11ac(80MHz) = 80 MHz

	Option B1Y: if Radio Std is 802.11ac(160MHz) = 160 MHz MSR: same as max value
State Saved	Saved in instrument state.
Min	10.0 kHz
Max	Hardware Dependent: RF Input: No Option = 10 MHz WB (25MHz or wider) = Hardware Option Limit I/Q Input (for I+jQ): No Option = 20 MHz Option B25 = 50 MHz
Backwards Compatibility SCPI	<code>[:SENSe] :PStatistic:BWIDth</code>
Initial S/W Revision	Prior to A.02.00
Modified at S/W Revision	A.02.00, A.03.00, A.06.00

Cont (Continuous Measurement/Sweep)

Sets the analyzer for Continuous measurement operation. The single/continuous state is Meas Global so the setting will affect all measurements. If you are Paused, pressing **Cont** does a Resume.

Key Path	Front-panel key
Remote Command	:INITiate:CONTinuous OFF ON 0 1 :INITiate:CONTinuous?
Example	:INIT:CONT 0 puts analyzer in Single measurement operation. :INIT:CONT 1 puts analyzer in Continuous measurement operation
Preset	ON (Note that SYST:PRESet sets INIT:CONT to ON but *RST sets INIT:CONT to OFF)
State Saved	Saved in instrument state
Backwards Compatibility Notes	For Spectrum Analysis mode in ESA and PSA, there is no Cont hardkey, instead there is a Sweep Single/Cont key. In these analyzers, switching the Sweep Single/Cont key from Single to Cont restarts averages (displayed average count reset to 1), but does not restart Max Hold and Min Hold . The X-Series has Single and Cont keys in place of the SweepSingleCont key. In the X-Series, if in single measurement, the Cont key (and INIT:CONT ON) switches to continuous measurement, but never restarts a measurement and never resets a sweep.
Initial S/W Revision	Prior to A.02.00

In Swept SA Measurement (Spectrum Analysis Mode):

The analyzer takes repetitive sweeps, averages, measurements, etc., when in Continuous mode. When the average count reaches the Average/Hold Number the count stops incrementing, but the analyzer keeps sweeping. See the Trace/Detector section for the averaging formula used both before and after the Average/Hold Number is reached. The trigger condition must be met prior to each sweep. The type of trace processing for multiple sweeps, is set under the Trace/Detector key, with choices of **Trace Average**, **Max Hold**, or **Min Hold**.

In Other Measurements/Modes:

With **Avg/Hold Num** (in the **Meas Setup** menu) set to **Off** or set to **On** with a value of 1, a sweep is taken after the trigger condition is met; and the analyzer continues to take new sweeps after the current sweep has completed and the trigger condition is again met. However, with **Avg/Hold Num** set to On with a value >1, multiple sweeps (data acquisitions) are taken for the measurement. The trigger condition must be met prior to each sweep. The sweep is not stopped when the average count k equals the number N set for Avg/Hold Num is reached, but the number k stops incrementing. A measurement average usually applies to all traces, marker results, and numeric results. But sometimes it only applies to the numeric results.

If the analyzer is in Single measurement, pressing the **Cont** key does not change k and does not cause the sweep to be reset; the only action is to put the analyzer into Continuous measurement operation.

If it is already in continuous sweep:

the INIT:CONT 1 command has no effect

14 Power Stat CCDF Measurement
Cont (Continuous Measurement/Sweep)

the INIT:CONT 0 command will place the analyzer in Single Sweep but will have no effect on the current sequence until $k = N$, at which point the current sequence will stop and the instrument will go to the idle state.

File

See "File" on page 362

FREQ Channel

Accesses a menu of keys that allow you to control the Frequency and Channel parameters of the instrument.

Some features in the Frequency menu are the same for all measurements - they do not change as you change measurements. Settings like these are called "Meas Global" and are unaffected by Meas Preset. For example, the Center Freq setting is the same for all measurements - it does not change as you change measurements.

Key Path	Front Panel
Mode	MSR
Initial S/W Revision	A.10.00

Center Freq

Sets center frequency used in Monitor Spectrum, IQ Waveform and Power Stat CCDF. Center Freq, Center Freq Offset and Carrier Ref Freq are coupled with this equation, Center Freq = Carrier Ref Freq + Center Freq Offset. When Center Freq is changed, Center Freq Offset is updated and Carrier Ref Freq is not.

When auto, Center Freq Offset remains the same value. Thus Center Freq changes the same amount of Carrier Ref Freq change when Carrier Ref Freq is changed. The auto state changes to manual when either Center Freq is changed.

Key Path	FREQ Channel
Mode	MSR
Measurement	Monitor Spectrum, IQ Waveform, Power Stat CCDF
Remote Command	[:SENSe]:FREQuency:CENTer <freq> [:SENSe]:FREQuency:CENTer? [:SENSe]:FREQuency:CENTer:AUTO ON OFF 1 0 [:SENSe]:FREQuency:CENTer:AUTO?
Example	FREQ:CENT 1.0GHz FREQ:CENT? FREQ:CENT:AUTO OFF FREQ:CENT:AUTO?
Preset	Automatically calculated ON
State Saved	Saved in instrument state
Min	Depends on instrument minimum frequency.
Max	Depends on instrument maximum frequency.
Initial S/W Revision	A.10.00

Center Freq Offset

Sets Center Freq Offset which is coupled with center frequency used in Monitor Spectrum, IQ Waveform and Power Stat CCDF as the offset from Carrier Ref Freq. Center Freq, Center Freq Offset and Carrier Ref Freq are coupled with this equation, Center Freq = Carrier Ref Freq + Center Freq Offset. When Center Freq Offset is changed, Center Freq is updated and Carrier Ref Freq is not.

Key Path	FREQ Channel
Mode	MSR
Measurement	Monitor Spectrum, IQ Waveform, Power Stat CCDF
Remote Command	<code>[:SENSe] :FREQuency:CENTer:OFFSet <freq></code> <code>[:SENSe] :FREQuency:CENTer:OFFSet?</code>
Example	FREQ:CENT:OFFS 100kHz FREQ:CENT:OFFS?
Notes	Center Freq State is changed to man when Center Freq Offset is changed.
Preset	0 GHz
State Saved	Saved in instrument state
Min	Minimum of Center Frequency - Carrier Ref Frequency
Max	Maximum of Center Frequency - Carrier Ref Frequency
Initial S/W Revision	A.10.00

Carrier Ref Freq

Sets carrier reference frequency. The center frequencies of carriers are defined as offset frequency from this value. This reference frequency is also the reference of carrier configuration preset.

Key Path	FREQ Channel
Mode	MSR
Measurement	all
Remote Command	<code>[:SENSe] :CARRier:REFerence <freq></code> <code>[:SENSe] :CARRier:REFerence?</code>
Example	CARR:REF 2GHz CARR:REF?
Preset	1GHz
State Saved	Saved in instrument state
Min	Depends on instrument minimum center frequency. Same as Center Freq
Max	Depends on instrument maximum center frequency. Same as Center Freq
Initial S/W Revision	A.10.00

Carrier Setup

Accesses the Carrier Setup menu.

Key Path	FREQ Channel
Initial S/W Revision	A.10.00

Carriers

Specifies how many carriers are used in MSR measurements. Base station RF bandwidth is determined from the carrier 1 to the carrier specified by this value whatever carriers' Present Pwr states are. Select Carrier can be select up to this value.

Key Path	FREQ Channel, Carrier Setup
Measurement	All
Remote Command	<code>[:SENSe] :CARRier :COUNt <integer></code> <code>[:SENSe] :CARRier :COUNt?</code>
Example	CARR:COUN 10 CARR:COUN?
Preset	1
State Saved	Saved in instrument state.
Min	1
Max	100
Initial S/W Revision	A.10.00

Configure Carriers

Accesses a menu of commonly used carrier configuration parameters.

Key Path	FREQ Channel, Carrier Setup
Initial S/W Revision	A.10.00

Select Carrier

Selects which carrier's configuration menu is displayed.

This key is also connected to the carrier info tables of some measurements. When the value is changed in a measurement which has carrier table view, the highlight in the table moves to Select Carrier. The highlight of the table and Select Carrier are not coupled.

Key Path	FREQ Channel, Carrier Setup, Configure Carriers
Preset	1

State Saved	No
Min	1
Max	Value of Carriers
Initial S/W Revision	A.10.00

Measure Carrier

Sets whether to measure this carrier or not.

Key Path	FREQ Channel, Carrier Setup, Configure Carriers
Remote Command	<code>[:SENSe] :CARRier<n> [:STATe] OFF ON 0 1</code> <code>[:SENSe] :CARRier<n> [:STATe] ?</code>
Example	CARR10 1 CARR10?
Notes	The command is used with a sub-op code <n> (default=1) to specify the carrier for configuration. The range of the sub-op code is determined by the number of carriers.
Preset	ON
State Saved	Saved in instrument state
Range	On Off
Initial S/W Revision	A.10.00

Carrier Offset

Sets the carrier center frequency as offset from Carrier Ref Frequency.

Key Path	FREQ Channel, Carrier Setup, Configure Carriers
Remote Command	<code>[:SENSe] :CARRier<n> :FREQuency:OFFSet <freq></code> <code>[:SENSe] :CARRier<n> :FREQuency:OFFSet?</code>
Example	CARR10:FREQ:OFFS 10MHz CARR10:FREQ:OFFS?
Notes	The command is used with a sub-op code <n> (default=1) to specify the carrier for configuration. The range of the sub-op code is determined by the number of carriers.
Preset	0Hz
State Saved	Saved in instrument state
Min	-1GHz
Max	1GHz
Initial S/W Revision	A.10.00

Radio Format

Selects a format parameter set to set the radio format of the selected carrier.

NONE – No format is specified. Channel spacing, measurement BW and FOffset,RAT are values of defaults of LTE FDD 5MHz.

LTE FDD Parameter Set 1 – Selects LTE FDD parameter set 1. LTE FDD (E-UTRA FDD) is the radio format of the carrier.

LTE FDD Parameter Set 2 – Selects LTE FDD parameter set 2. LTE FDD (E-UTRA FDD) is the radio format of the carrier.

LTE FDD Parameter Set 3 – Selects LTE FDD parameter set 3. LTE FDD (E-UTRA FDD) is the radio format of the carrier.

W-CDMA Parameter Set 1 – Selects W-CDMA parameter set 1. W-CDMA (UTRA FDD) is the radio format of the carrier.

W-CDMA Parameter Set 2 – Selects W-CDMA parameter set 2. W-CDMA (UTRA FDD) is the radio format of the carrier.

W-CDMA Parameter Set 3 – Selects W-CDMA parameter set 3. W-CDMA (UTRA FDD) is the radio format of the carrier.

GSM/EDGE Parameter Set 1 – Selects GSM/EDGE parameter set 1. GSM/EDGE is the radio format of the carrier.

GSM/EDGE Parameter Set 2 – Selects GSM/EDGE parameter set 2. GSM/EDGE is the radio format of the carrier.

GSM/EDGE Parameter Set 3 – Selects GSM/EDGE parameter set 3. GSM/EDGE is the radio format of the carrier.

cdma2000 Parameter Set 1 – Selects cdma2000 parameter set 1. cdma2000 is the radio format of the carrier.

cdma2000 Parameter Set 2 – Selects cdma2000 parameter set 2. cdma2000 is the radio format of the carrier.

cdma2000 Parameter Set 3 – Selects cdma2000 parameter set 3. cdma2000 is the radio format of the carrier.

1xEV-DO Parameter Set 1 – Selects 1xEV-DO parameter set 1. 1xEV-DO is the radio format of the carrier.

1xEV-DO Parameter Set 2 – Selects 1xEV-DO parameter set 2. 1xEV-DO is the radio format of the carrier.

1xEV-DO Parameter Set 3 – Selects 1xEV-DO parameter set 3. 1xEV-DO is the radio format of the carrier.

LTE TDD Parameter Set 1 – Selects LTE TDD parameter set 1. LTE TDD (E-UTRA TDD) is the radio format of the carrier.

LTE TDD Parameter Set 2 – Selects LTE TDD parameter set 2. LTE TDD (E-UTRA TDD) is the radio format of the carrier.

LTE TDD Parameter Set 3 – Selects LTE TDD parameter set 3. LTE TDD (E-UTRA TDD) is the radio format of the carrier.

TD-SCDMA Parameter Set 1 – Selects TD-SCDMA parameter set 1. TD-SCDMA (UTRA-TDD LCR) is the radio format of the carrier.

TD-SCDMA Parameter Set 2 – Selects TD-SCDMA parameter set 2. TD-SCDMA (UTRA-TDD LCR) is the radio format of the carrier.

TD-SCDMA Parameter Set 3 – Selects TD-SCDMA parameter set 3. TD-SCDMA (UTRA-TDD LCR) is the radio format of the carrier.

Key Path	FREQ Channel, Carrier Setup, Configure Carriers
Remote Command	[:SENSe]:CARRier<n>:FORMat NONE LTEFdd1 LTEFdd2 LTEFdd3 WCDMa1 WCDMa2 WCDMa3 GSM1 GSM2 GSM3 CDMA1 CDMA2 CDMA3 EVDO1 EVDO2 EVDO3 LTETdd1 LTETdd2 LTETdd3 TDSCdma1 TDSCdma2 TDSCdma3 [:SENSe]:CARRier<n>:FORMat ?
Example	CARR10:FORM LTEF1 CARR10:FORM?
Notes	The command is used with a sub-op code <n> (default=1) to specify the carrier for configuration. The range of the sub-op code is determined by the number of carriers.
Dependencies	The following licenses are required for each key to be displayed. Without the licenses, corresponding enum values cannot be set even via the SCPI command. <ul style="list-style-type: none"> • LTE FDD - N9080A-1FP or W9080A-1FP • W-CDMA - N9073A-1FP or W9073A-1FP • GSM/EDGE - N9071A-2FP or W9071A-2FP • cdma2000 - N9072A-2FP or W9072A-2FP • 1xEV-DO - N9076A-1FP or W9076A-1FP • LTE TDD - N9082A-1FP or W9082A-1FP • TD-SCDMA - N9079A-1FP or W9079A-1FP
State Saved	Saved in instrument state
Range	None LTE FDD [Parameter Set 1] Parameter Set 1 ("LTE FDD 1") Parameter Set 2 ("LTE FDD 2") Parameter Set 3 ("LTE FDD 3") W-CDMA [Parameter Set 1] Parameter Set 1 ("W-CDMA 1") Parameter Set 2 ("W-CDMA 2") Parameter Set 3 ("W-CDMA 3") GSM/EDGE [Parameter Set 1] Parameter Set 1 ("GSM/EDGE 1") Parameter Set 2 ("GSM/EDGE 2") Parameter Set 3 ("GSM/EDGE 3") cdma2000 [Parameter Set 1] Parameter Set 1 ("cdma2000 1")

	Parameter Set 2 ("cdma2000 2") Parameter Set 3 ("cdma2000 3") 1xEV-DO [Parameter Set 1] Parameter Set 1 ("1xEV-DO 1") Parameter Set 2 ("1xEV-DO 2") Parameter Set 3 ("1xEV-DO 3") LTE TDD [Parameter Set 1] Parameter Set 1 ("LTE TDD 1") Parameter Set 2 ("LTE TDD 2") Parameter Set 3 ("LTE TDD 3") TD-SCDMA [Parameter Set 1] Parameter Set 1 ("TD-SCDMA 1") Parameter Set 2 ("TD-SCDMA 2") Parameter Set 3 ("TD-SCDMA 3")
Readback	The readback line on this key shows the currently selected Radio Format in square brackets.
Initial S/W Revision	A.10.00
Modified at S/W Revision	A.12.00, A.16.00

Carrier Allocation

Specifies the carrier frequency allocation. There are two types of allocation, contiguous and non-contiguous. Non-Contiguous frequency allocation is defined as an allocation where two sub-blocks are separated with a sub-block gap.

Contiguous – All the carriers belong to one block and no sub-block gap exists.

Non-Contiguous – Carriers are separated into two sub-blocks. Allocation Break Pt Carrier determines how sub-blocks are configured.

Key Path	FREQ Channel, Carrier Setup
Scope	Meas Global
Remote Command	[:SENSe] :CARRier :CONFig :ALLocation CONTiguous NCONtiguous [:SENSe] :CARRier :CONFig :ALLocation?
Example	CARR:CONF:ALL CONT CARR:CONF:ALL?
Preset	CONTiguous
State Saved	Saved in instrument state.
Range	Contiguous Non-Contiguous
Initial S/W Revision	A.13.00

Non-Contiguous

Opens a menu that enables you to set a non-contiguous parameter.

Key Path	FREQ Channel, Carrier Setup, Carrier Allocation
Initial S/W Revision	A.13.00

Allocation Break Pt Carrier

Specifies an allocation break point in non-contiguous carrier allocation. First sub-block starts from the lowest frequency carrier and stops at the allocation break point carrier. Next sub-block starts from the next upper frequency carrier and ends at the highest frequency carrier.

Two examples are shown below. In these examples carrier indices are not in the order of carrier frequency. In the first example, Allocation Break Pt Carrier is 2. It means that sub-block 1 ends at carrier 2 and sub-block 2 starts at carrier 5. Sub-block gap is located between carrier 2 and 5. In the second example, Allocation Break Pt Carrier is 3 and the sub-block gap comes between carrier 3 and 2.

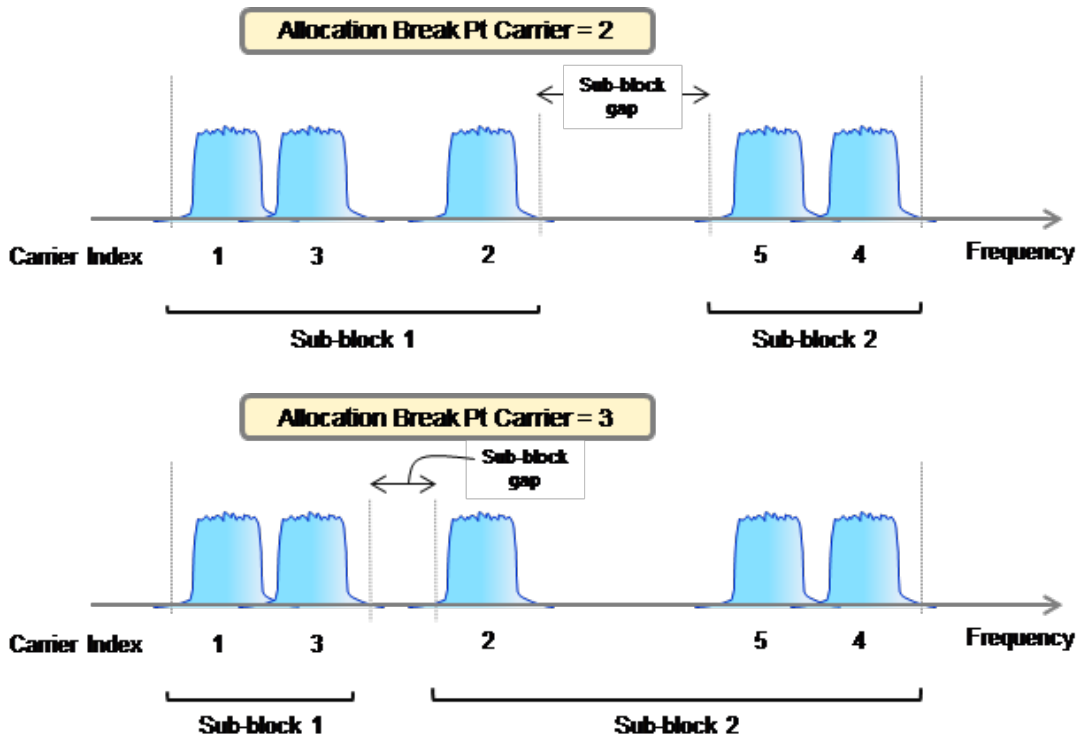

Key Path	FREQ Channel, Carrier Setup, Carrier Allocation, Non-Contiguous
Scope	Meas Global
Remote Command	<code>[:SENSe] :CARRier:CONFig:ALLocation:NCONtiguous:ABPoint <integer></code> <code>[:SENSe] :CARRier:CONFig:ALLocation:NCONtiguous:ABPoint?</code>
Example	<code>CARR:CONF:ALL:NCON:ABP 5</code> <code>CARR:CONF:ALL:NCON:ABP?</code>

Dependencies	The maximum value depends on the number of carriers.
Couplings	This value can change when you decrease the number of carriers.
Preset	1
State Saved	Saved in instrument state.
Min	1
Max	99
Initial S/W Revision	A.13.00

Carrier Conf Presets

Pressing this key pops up Conf Presets. Each parameter under this menu initiate carrier configuration preset when its value is changed.

Appropriate licenses are required to select carrier config enum. Required licenses are shown here. Note that N/W means N or W license, i.e. N/W9073A-1FP means either N9073A-1FP or W9073A-1FP is required.

TC1a (FDD): N/W9073A-1FP (W-CDMA)

TC2 (FDD): N/W9080A-1FP (LTE FDD)

TC3a (FDD): N/W9073A-1FP (W-CDMA) and N9080A-1FP (LTE FDD)

TC4a (FDD): N/W9071A-2FP (GSM/EDGE) and N/W9073A-1FP (W-CDMA)

TC4b (FDD): N/W9071A-2FP (GSM/EDGE) and N9080A-1FP (LTE FDD)

TC4c (FDD): N/W9071A-2FP (GSM/EDGE), N/W9073A-1FP (W-CDMA) and N9080A-1FP (LTE FDD)

TC4d (FDD): N/W9071A-2FP (GSM/EDGE) and N/W9073A-1FP (W-CDMA)

TC4e (FDD): N/W9071A-2FP (GSM/EDGE) and N9080A-1FP (LTE FDD)

TC4a (FDD) Two Carriers: N/W9071A-2FP (GSM/EDGE) and N/W9073A-1FP (W-CDMA)

TC4b (FDD) Two Carriers: N/W9071A-2FP (GSM/EDGE) and N9080A-1FP (LTE FDD)

TC4c (FDD) Two Carriers: N/W9071A-2FP (GSM/EDGE), N/W9073A-1FP (W-CDMA) and N9080A-1FP (LTE FDD)

NTC1a (FDD): N/W9073A-1FP (W-CDMA)

NTC2 (FDD): N/W9080A-1FP (LTE FDD)

NTC3a (FDD): N/W9073A-1FP (W-CDMA) and N9080A-1FP (LTE FDD)

NTC4a (FDD): N/W9071A-2FP (GSM/EDGE) and N/W9073A-1FP (W-CDMA)

NTC4b (FDD): N/W9071A-2FP (GSM/EDGE) and N9080A-1FP (LTE FDD)

NTC4c (FDD): N/W9071A-2FP (GSM/EDGE), N/W9073A-1FP (W-CDMA) and N9080A-1FP (LTE FDD)

LTE FDD: N/W9080A-1FP (LTE FDD)

W-CDMA: N/W9073A-1FP (W-CDMA)

GSM/EDGE: N/W9071A-2FP (GSM/EDGE)

cdma2000: N/W9072A-2FP (cdma2000)

1xEV-DO: N/W9076A-1FP (1xEV-DO)

Enum keys don't appear on the menu if required licenses are not installed.

Key Path	FREQ Channel, Carrier Setup
Remote Command	[:SENSe] :CARRier:CONFIg?
Example	CARR:CONF TC1AFDD CARR:CONF?
Notes	The softkey for NONE is not available.
State Saved	Saved in instrument state
Initial S/W Revision	A.10.00
Modified at S/W Revision	A.12.00, A.13.00

MSR Test Config

Accesses the menu to select MSR Test Configurations.

Key Path	FREQ Channel, Carrier Setup
Initial S/W Revision	A.10.00

Carrier Conf Presets

Pressing this key pops up Conf Presets. Each parameter under this menu initiate carrier configuration preset when its value is changed.

Appropriate licenses are required to select carrier config enum. Required licenses are shown here. Note that N/W means N or W license, i.e. N/W9073A-1FP means either N9073A-1FP or W9073A-1FP is required.

TC1a (FDD): N/W9073A-1FP (W-CDMA)

TC2 (FDD): N/W9080A-1FP (LTE FDD)

TC3a (FDD): N/W9073A-1FP (W-CDMA) and N9080A-1FP (LTE FDD)

TC4a (FDD): N/W9071A-2FP (GSM/EDGE) and N/W9073A-1FP (W-CDMA)

TC4b (FDD): N/W9071A-2FP (GSM/EDGE) and N9080A-1FP (LTE FDD)

TC4c (FDD): N/W9071A-2FP (GSM/EDGE), N/W9073A-1FP (W-CDMA) and N9080A-1FP (LTE FDD)

TC4d (FDD): N/W9071A-2FP (GSM/EDGE) and N/W9073A-1FP (W-CDMA)

TC4e (FDD): N/W9071A-2FP (GSM/EDGE) and N9080A-1FP (LTE FDD)

TC4a (FDD) Two Carriers: N/W9071A–2FP (GSM/EDGE) and N/W9073A–1FP (W-CDMA)

TC4b (FDD) Two Carriers: N/W9071A–2FP (GSM/EDGE) and N9080A–1FP (LTE FDD)

TC4c (FDD) Two Carriers: N/W9071A–2FP (GSM/EDGE), N/W9073A–1FP (W-CDMA) and N9080A–1FP (LTE FDD)

NTC1a (FDD): N/W9073A–1FP (W-CDMA)

NTC2 (FDD): N/W9080A–1FP (LTE FDD)

NTC3a (FDD): N/W9073A–1FP (W-CDMA) and N9080A–1FP (LTE FDD)

NTC4a (FDD): N/W9071A–2FP (GSM/EDGE) and N/W9073A–1FP (W-CDMA)

NTC4b (FDD): N/W9071A–2FP (GSM/EDGE) and N9080A–1FP (LTE FDD)

NTC4c (FDD): N/W9071A–2FP (GSM/EDGE), N/W9073A–1FP (W-CDMA) and N9080A–1FP (LTE FDD)

LTE FDD: N/W9080A–1FP (LTE FDD)

W-CDMA: N/W9073A–1FP (W-CDMA)

GSM/EDGE: N/W9071A–2FP (GSM/EDGE)

cdma2000: N/W9072A–2FP (cdma2000)

1xEV-DO: N/W9076A–1FP (1xEV-DO)

Enum keys don't appear on the menu if required licenses are not installed.

Key Path	FREQ Channel, Carrier Setup
Remote Command	<code>[:SENSe] :CARRier:CONFig?</code>
Example	CARR:CONF TC1AFDD CARR:CONF?
Notes	The softkey for NONE is not available.
State Saved	Saved in instrument state
Initial S/W Revision	A.10.00
Modified at S/W Revision	A.12.00, A.13.00

Max W-CDMA Carriers (FDD)

Sets max W-CDMA carriers placed when the carrier configuration preset runs. When this value is changed, the carrier configuration preset is initiated.

Key Path	FREQ Channel, Carrier Setup, Carrier Conf Presets, MSR Test Config, TC1a (FDD)FREQ Channel, Carrier Setup, Carrier Conf Presets, MSR Test Config, TC3a (FDD)FREQ Channel, Carrier Setup, Carrier Conf Presets, MSR Test Config, TC4a (FDD)FREQ Channel, Carrier Setup, Carrier Conf Presets, MSR Test Config, TC4c (FDD)FREQ Channel, Carrier Setup, Carrier Conf Presets, Single RAT Config, W-CDMA
-----------------	---

Remote Command	<code>[:SENSe] :CARRier:CONFig:WCDMa:CMAX <integer></code> <code>[:SENSe] :CARRier:CONFig:WCDMa:CMAX?</code>
Example	CARR:CONF:WCDM:CMAX 8 CARR:CONF:WCDM:CMAX?
Preset	100
State Saved	Saved in instrument state
Min	1
Max	100
Initial S/W Revision	A.10.00

Max LTE FDD Carriers

Sets max LTE FDD carriers placed when the carrier configuration preset runs. When this value is changed, the carrier configuration preset is initiated.

Key Path	FREQ Channel, Carrier Setup, Carrier Conf Presets, MSR Test Config, TC2 (FDD)FREQ Channel, Carrier Setup, Carrier Conf Presets, MSR Test Config, TC3a (FDD)FREQ Channel, Carrier Setup, Carrier Conf Presets, MSR Test Config, TC4b (FDD)FREQ Channel, Carrier Setup, Carrier Conf Presets, MSR Test Config, TC4c (FDD)FREQ Channel, Carrier Setup, Carrier Conf Presets, Single RAT Config, LTE FDD
Remote Command	<code>[:SENSe] :CARRier:CONFig:LTEFdd:CMAX <integer></code> <code>[:SENSe] :CARRier:CONFig:LTEFdd:CMAX?</code>
Example	CARR:CONF:LTEF:CMAX 8 CARR:CONF:LTEF:CMAX?
Preset	100
State Saved	Saved in instrument state
Min	1
Max	100
Initial S/W Revision	A.10.00

LTE FDD BW

Sets bandwidth of LTE FDD carriers placed when the carrier configuration preset runs. When this value is changed, the carrier configuration preset is initiated.

Key Path	FREQ Channel, Carrier Setup, Carrier Conf Presets, MSR Test Config, TC2 (FDD)FREQ Channel, Carrier Setup, Carrier Conf Presets, MSR Test Config, TC3a (FDD)FREQ Channel, Carrier Setup, Carrier Conf Presets, MSR Test Config, TC4b (FDD)FREQ Channel, Carrier Setup, Carrier Conf Presets, MSR Test Config, TC4c (FDD)FREQ Channel, Carrier Setup, Carrier Conf Presets, MSR Test Config, TC4d (FDD)FREQ Channel, Carrier Setup, Carrier Conf Presets, Single RAT Config, LTE FDD
Remote Command	<code>[:SENSe] :CARRier:CONFig:LTEFdd:BANDwidth B1M4 B3M B5M B10M B15M</code>

	B20M [:SENSe]:CARRier:CONFig:LTEFdd:BANDwidth?
Example	CARR:CONF:LTEF:BAND B5M CARR:CONF:LTEF:BAND?
Preset	B5M
State Saved	Saved in instrument state
Range	1.4MHz 3MHz 5MHz 10MHz 15MHz 20MHz
Readback	The currently selected LTE FDD BW
Initial S/W Revision	A.10.00

Narrowest LTE FDD BW

Sets narrowest bandwidth of LTE FDD carriers placed for TC2 when the carrier configuration preset runs. When this value is changed, the carrier configuration preset is initiated.

Key Path	FREQ Channel, Carrier Setup, Carrier Conf Presets, MSR Test Config, TC2 (FDD)
Remote Command	[:SENSe]:CARRier:CONFig:LTEFdd:BANDwidth:NARRowest B1M4 B3M B5M B10M B15M B20M [:SENSe]:CARRier:CONFig:LTEFdd:BANDwidth:NARRowest?
Example	CARR:CONF:LTEF:BAND:NARR B1M4 CARR:CONF:LTEF:BAND:NARR?
Preset	B1M4
State Saved	Saved in instrument state
Range	1.4MHz 3MHz 5MHz 10MHz 15MHz 20MHz
Readback	The currently selected Narrowest LTE FDD BW
Initial S/W Revision	A.10.00

Max GSM/EDGE Carriers

Sets max GSM/EDGE carriers placed when the carrier configuration preset runs. When this value is changed, the carrier configuration preset is initiated.

Key Path	FREQ Channel, Carrier Setup, Carrier Conf Presets, MSR Test Config, TC4a (FDD)FREQ Channel, Carrier Setup, Carrier Conf Presets, MSR Test Config, TC4b (FDD)FREQ Channel, Carrier Setup, Carrier Conf Presets, MSR Test Config, TC4c (FDD)FREQ Channel, Carrier Setup, Carrier Conf Presets, Single RAT Config, GSM/EDGE
Remote Command	[:SENSe]:CARRier:CONFig:GSM:CMAX <integer> [:SENSe]:CARRier:CONFig:GSM:CMAX?
Example	CARR:CONF:GSM:CMAX 8 CARR:CONF:GSM:CMAX?

Preset	100
State Saved	Saved in instrument state
Min	1
Max	100
Initial S/W Revision	A.10.00

LTE FDD Location

Sets the location of LTE FDD carriers when carriers are configured as TC4c. This parameter is effective only for TC4c.

TC4c (FDD)

LTE FDD Location

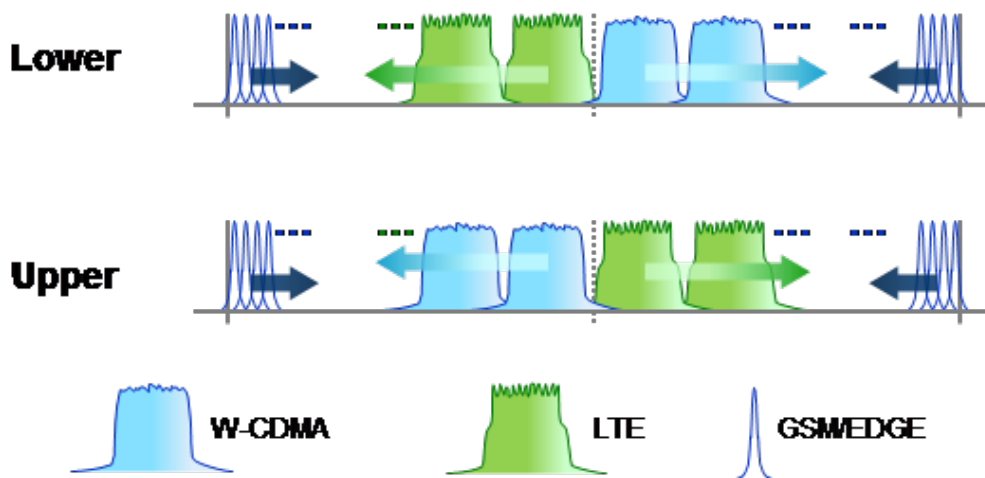

Key Path	FREQ Channel, Carrier Setup, Carrier Conf Presets, MSR Test Config, TC4c (FDD)
Remote Command	[[:SENSE]:CARRIER:CONFIG:LTEFdd:LOCATION UPPER LOWER [:SENSE]:CARRIER:CONFIG:LTEFdd:LOCATION?
Example	CARR:CONF:LTEF:LOC LOW CARR:CONF:LTEF:LOC?
Notes	This setting is effective only for TC4c.
Preset	UPPER
State Saved	Saved in instrument state
Range	Lower (Lower than W-CDMA) Upper (Higher than W-CDMA)
Initial S/W Revision	A.11.00

MSR Non-Contig Test Config

Accesses the menu to select MSR Non-Contiguous Test Configurations.

Key Path	FREQ Channel, Carrier Setup
Initial S/W Revision	A.13.00

Carrier Conf Presets

Pressing this key pops up Conf Presets. Each parameter under this menu initiate carrier configuration preset when its value is changed.

Appropriate licenses are required to select carrier config enum. Required licenses are shown here. Note that N/W means N or W license, i.e. N/W9073A-1FP means either N9073A-1FP or W9073A-1FP is required.

TC1a (FDD): N/W9073A-1FP (W-CDMA)

TC2 (FDD): N/W9080A-1FP (LTE FDD)

TC3a (FDD): N/W9073A-1FP (W-CDMA) and N9080A-1FP (LTE FDD)

TC4a (FDD): N/W9071A-2FP (GSM/EDGE) and N/W9073A-1FP (W-CDMA)

TC4b (FDD): N/W9071A-2FP (GSM/EDGE) and N9080A-1FP (LTE FDD)

TC4c (FDD): N/W9071A-2FP (GSM/EDGE), N/W9073A-1FP (W-CDMA) and N9080A-1FP (LTE FDD)

TC4d (FDD): N/W9071A-2FP (GSM/EDGE) and N/W9073A-1FP (W-CDMA)

TC4e (FDD): N/W9071A-2FP (GSM/EDGE) and N9080A-1FP (LTE FDD)

TC4a (FDD) Two Carriers: N/W9071A-2FP (GSM/EDGE) and N/W9073A-1FP (W-CDMA)

TC4b (FDD) Two Carriers: N/W9071A-2FP (GSM/EDGE) and N9080A-1FP (LTE FDD)

TC4c (FDD) Two Carriers: N/W9071A-2FP (GSM/EDGE), N/W9073A-1FP (W-CDMA) and N9080A-1FP (LTE FDD)

NTC1a (FDD): N/W9073A-1FP (W-CDMA)

NTC2 (FDD): N/W9080A-1FP (LTE FDD)

NTC3a (FDD): N/W9073A-1FP (W-CDMA) and N9080A-1FP (LTE FDD)

NTC4a (FDD): N/W9071A-2FP (GSM/EDGE) and N/W9073A-1FP (W-CDMA)

NTC4b (FDD): N/W9071A-2FP (GSM/EDGE) and N9080A-1FP (LTE FDD)

NTC4c (FDD): N/W9071A-2FP (GSM/EDGE), N/W9073A-1FP (W-CDMA) and N9080A-1FP (LTE FDD)

LTE FDD: N/W9080A-1FP (LTE FDD)

W-CDMA: N/W9073A-1FP (W-CDMA)

GSM/EDGE: N/W9071A-2FP (GSM/EDGE)

cdma2000: N/W9072A-2FP (cdma2000)

1xEV-DO: N/W9076A-1FP (1xEV-DO)

Enum keys don't appear on the menu if required licenses are not installed.

Key Path	FREQ Channel, Carrier Setup
Remote Command	<code>[:SENSe] :CARRier:CONFig?</code>
Example	CARR:CONF TC1AFDD CARR:CONF?
Notes	The softkey for NONE is not available.
State Saved	Saved in instrument state
Initial S/W Revision	A.10.00
Modified at S/W Revision	A.12.00, A.13.00

LTE FDD BW

Sets bandwidth of LTE FDD carriers placed when the carrier configuration preset runs. When this value is changed, the carrier configuration preset is initiated.

Key Path	FREQ Channel, Carrier Setup, Carrier Conf Presets, MSR Test Config, TC2 (FDD)FREQ Channel, Carrier Setup, Carrier Conf Presets, MSR Test Config, TC3a (FDD)FREQ Channel, Carrier Setup, Carrier Conf Presets, MSR Test Config, TC4b (FDD)FREQ Channel, Carrier Setup, Carrier Conf Presets, MSR Test Config, TC4c (FDD)FREQ Channel, Carrier Setup, Carrier Conf Presets, MSR Test Config, TC4d (FDD)FREQ Channel, Carrier Setup, Carrier Conf Presets, Single RAT Config, LTE FDD
Remote Command	<code>[:SENSe] :CARRier:CONFig:LTEFdd:BA NDwidth B1M4 B3M B5M B10M B15M B20M</code> <code>[:SENSe] :CARRier:CONFig:LTEFdd:BA NDwidth?</code>
Example	CARR:CONF:LTEF:BA ND B5M CARR:CONF:LTEF:BA ND?
Preset	B5M
State Saved	Saved in instrument state
Range	1.4MHz 3MHz 5MHz 10MHz 15MHz 20MHz
Readback	The currently selected LTE FDD BW
Initial S/W Revision	A.10.00

NTC4 Carriers

Sets NTC4 carriers placed when the NTC4 carrier configuration preset runs. When this value is changed, the carrier configuration preset is initiated.

Key Path	FREQ Channel, Carrier Setup, Carrier Conf Presets, MSR Non-Contig Test Config, NTC4a (FDD)FREQ Channel, Carrier Setup, Carrier Conf Presets, MSR Non-Contig Test Config, NTC4b (FDD)FREQ Channel, Carrier Setup, Carrier Conf Presets, MSR Non-Contig Test Config, NTC4c(FDD)
-----------------	--

Remote Command	<code>[:SENSe] :CARRier:CONFig:NTC4:COUNT <integer></code> <code>[:SENSe] :CARRier:CONFig:NTC4:COUNT?</code>
Example	<code>CARR:CONF:NTC4:COUN 6</code> <code>CARR:CONF:NTC4:COUN?</code>
Preset	6
State Saved	Saved in instrument state
Min	3
Max	6
Initial S/W Revision	A.13.00

Single RAT Config

Accesses the menu to select Single RAT Configurations.

Key Path	FREQ Channel, Carrier Setup
Initial S/W Revision	A.10.00

Carrier Conf Presets

Pressing this key pops up Conf Presets. Each parameter under this menu initiate carrier configuration preset when its value is changed.

Appropriate licenses are required to select carrier config enum. Required licenses are shown here. Note that N/W means N or W license, i.e. N/W9073A-1FP means either N9073A-1FP or W9073A-1FP is required.

TC1a (FDD): N/W9073A-1FP (W-CDMA)

TC2 (FDD): N/W9080A-1FP (LTE FDD)

TC3a (FDD): N/W9073A-1FP (W-CDMA) and N9080A-1FP (LTE FDD)

TC4a (FDD): N/W9071A-2FP (GSM/EDGE) and N/W9073A-1FP (W-CDMA)

TC4b (FDD): N/W9071A-2FP (GSM/EDGE) and N9080A-1FP (LTE FDD)

TC4c (FDD): N/W9071A-2FP (GSM/EDGE), N/W9073A-1FP (W-CDMA) and N9080A-1FP (LTE FDD)

TC4d (FDD): N/W9071A-2FP (GSM/EDGE) and N/W9073A-1FP (W-CDMA)

TC4e (FDD): N/W9071A-2FP (GSM/EDGE) and N9080A-1FP (LTE FDD)

TC4a (FDD) Two Carriers: N/W9071A-2FP (GSM/EDGE) and N/W9073A-1FP (W-CDMA)

TC4b (FDD) Two Carriers: N/W9071A-2FP (GSM/EDGE) and N9080A-1FP (LTE FDD)

TC4c (FDD) Two Carriers: N/W9071A-2FP (GSM/EDGE), N/W9073A-1FP (W-CDMA) and N9080A-1FP (LTE FDD)

NTC1a (FDD): N/W9073A-1FP (W-CDMA)

NTC2 (FDD): N/W9080A-1FP (LTE FDD)

NTC3a (FDD): N/W9073A-1FP (W-CDMA) and N9080A-1FP (LTE FDD)

NTC4a (FDD): N/W9071A-2FP (GSM/EDGE) and N/W9073A-1FP (W-CDMA)

NTC4b (FDD): N/W9071A-2FP (GSM/EDGE) and N9080A-1FP (LTE FDD)

NTC4c (FDD): N/W9071A-2FP (GSM/EDGE), N/W9073A-1FP (W-CDMA) and N9080A-1FP (LTE FDD)

LTE FDD: N/W9080A-1FP (LTE FDD)

W-CDMA: N/W9073A-1FP (W-CDMA)

GSM/EDGE: N/W9071A-2FP (GSM/EDGE)

cdma2000: N/W9072A-2FP (cdma2000)

1xEV-DO: N/W9076A-1FP (1xEV-DO)

Enum keys don't appear on the menu if required licenses are not installed.

Key Path	FREQ Channel, Carrier Setup
Remote Command	[:SENSe] :CARRier:CONFig?
Example	CARR:CONF TC1AFDD CARR:CONF?
Notes	The softkey for NONE is not available.
State Saved	Saved in instrument state
Initial S/W Revision	A.10.00
Modified at S/W Revision	A.12.00, A.13.00

Max LTE FDD Carriers

Sets max LTE FDD carriers placed when the carrier configuration preset runs. When this value is changed, the carrier configuration preset is initiated.

Key Path	FREQ Channel, Carrier Setup, Carrier Conf Presets, MSR Test Config, TC2 (FDD)FREQ Channel, Carrier Setup, Carrier Conf Presets, MSR Test Config, TC3a (FDD)FREQ Channel, Carrier Setup, Carrier Conf Presets, MSR Test Config, TC4b (FDD)FREQ Channel, Carrier Setup, Carrier Conf Presets, MSR Test Config, TC4c (FDD)FREQ Channel, Carrier Setup, Carrier Conf Presets, Single RAT Config, LTE FDD
Remote Command	[:SENSe] :CARRier:CONFig:LTEFdd:CMAx <integer> [:SENSe] :CARRier:CONFig:LTEFdd:CMAx?
Example	CARR:CONF:LTEF:CMAx 8 CARR:CONF:LTEF:CMAx?
Preset	100
State Saved	Saved in instrument state

Min	1
Max	100
Initial S/W Revision	A.10.00

LTE FDD BW

Sets bandwidth of LTE FDD carriers placed when the carrier configuration preset runs. When this value is changed, the carrier configuration preset is initiated.

Key Path	FREQ Channel, Carrier Setup, Carrier Conf Presets, MSR Test Config, TC2 (FDD)FREQ Channel, Carrier Setup, Carrier Conf Presets, MSR Test Config, TC3a (FDD)FREQ Channel, Carrier Setup, Carrier Conf Presets, MSR Test Config, TC4b (FDD)FREQ Channel, Carrier Setup, Carrier Conf Presets, MSR Test Config, TC4c (FDD)FREQ Channel, Carrier Setup, Carrier Conf Presets, MSR Test Config, TC4d (FDD)FREQ Channel, Carrier Setup, Carrier Conf Presets, Single RAT Config, LTE FDD
Remote Command	[:SENSe] :CARRier:CONFig:LTEFdd:BAWdwidth B1M4 B3M B5M B10M B15M B20M [:SENSe] :CARRier:CONFig:LTEFdd:BAWdwidth?
Example	CARR:CONF:LTEF:BAW B5M CARR:CONF:LTEF:BAW?
Preset	B5M
State Saved	Saved in instrument state
Range	1.4MHz 3MHz 5MHz 10MHz 15MHz 20MHz
Readback	The currently selected LTE FDD BW
Initial S/W Revision	A.10.00

Max W-CDMA Carriers (FDD)

Sets max W-CDMA carriers placed when the carrier configuration preset runs. When this value is changed, the carrier configuration preset is initiated.

Key Path	FREQ Channel, Carrier Setup, Carrier Conf Presets, MSR Test Config, TC1a (FDD)FREQ Channel, Carrier Setup, Carrier Conf Presets, MSR Test Config, TC3a (FDD)FREQ Channel, Carrier Setup, Carrier Conf Presets, MSR Test Config, TC4a (FDD)FREQ Channel, Carrier Setup, Carrier Conf Presets, MSR Test Config, TC4c (FDD)FREQ Channel, Carrier Setup, Carrier Conf Presets, Single RAT Config, W-CDMA
Remote Command	[:SENSe] :CARRier:CONFig:WCDMa:CMAX <integer> [:SENSe] :CARRier:CONFig:WCDMa:CMAX?
Example	CARR:CONF:WCDM:CMAX 8 CARR:CONF:WCDM:CMAX?
Preset	100

State Saved	Saved in instrument state
Min	1
Max	100
Initial S/W Revision	A.10.00

Max GSM/EDGE Carriers

Sets max GSM/EDGE carriers placed when the carrier configuration preset runs. When this value is changed, the carrier configuration preset is initiated.

Key Path	FREQ Channel, Carrier Setup, Carrier Conf Presets, MSR Test Config, TC4a (FDD)FREQ Channel, Carrier Setup, Carrier Conf Presets, MSR Test Config, TC4b (FDD)FREQ Channel, Carrier Setup, Carrier Conf Presets, MSR Test Config, TC4c (FDD)FREQ Channel, Carrier Setup, Carrier Conf Presets, Single RAT Config, GSM/EDGE
Remote Command	[:SENSe] :CARRier:CONFig:GSM:CMAX <integer> [:SENSe] :CARRier:CONFig:GSM:CMAX?
Example	CARR:CONF:GSM:CMAX 8 CARR:CONF:GSM:CMAX?
Preset	100
State Saved	Saved in instrument state
Min	1
Max	100
Initial S/W Revision	A.10.00

Max cdma2000 Carriers

Sets max cdma2000 carriers placed when the carrier configuration preset runs. When this value is changed, the carrier configuration preset is initiated.

Key Path	FREQ Channel, Carrier Setup, Carrier Conf Presets, Single RAT Config, cdma2000
Remote Command	[:SENSe] :CARRier:CONFig:CDMA:CMAX <integer> [:SENSe] :CARRier:CONFig:CDMA:CMAX?
Example	CARR:CONF:CDMA:CMAX 8 CARR:CONF:CDMA:CMAX?
Preset	100
State Saved	Saved in instrument state
Min	1
Max	100
Initial S/W Revision	A.12.00

Max 1xEV-DO Carriers

Sets max 1xEV-DO carriers placed when the carrier configuration preset runs. When this value is changed, the carrier configuration preset is initiated.

Key Path	FREQ Channel, Carrier Setup, Carrier Conf Presets, Single RAT Config, 1xEV-DO
Remote Command	<code>[[:SENSe]:CARRier:CONFig:EVDO:CMAx <integer></code> <code>[[:SENSe]:CARRier:CONFig:EVDO:CMAx?</code>
Example	<code>CARR:CONF:EVDO:CMAx 8</code> <code>CARR:CONF:EVDO:CMAx?</code>
Preset	100
State Saved	Saved in instrument state
Min	1
Max	100
Initial S/W Revision	A.12.00

Max BS RF Bandwidth

Sets max BS RF bandwidth used when the carrier configuration preset runs. When this value is changed, the carrier configuration preset is initiated.

Key Path	FREQ Channel, Carrier Setup, Carrier Conf Presets
Remote Command	<code>[[:SENSe]:CARRier:CONFig:RFBWidth <freq></code> <code>[[:SENSe]:CARRier:CONFig:RFBWidth?</code>
Example	<code>CARR:CONF:RFBW 40MHz</code> <code>CARR:CONF:RFBW?</code>
Preset	40MHz
State Saved	Saved in instrument state
Min	600 kHz
Max	200 MHz
Initial S/W Revision	A.10.00

Channel Spacing Delta

Carriers are placed based on channel spacing assigned to the corresponding radio format, when they are configured by the carrier config preset. However, channel spacing can be adjusted using channel spacing delta parameters.

This key accesses the menu to set channel spacing delta of each radio format.

Key Path	FREQ Channel, Carrier Setup, Carrier Conf Presets
Initial S/W Revision	A.10.00

LTE FDD

Sets delta channel spacing for LTE FDD used when the carrier configuration preset runs. Channel spacing for LTE FDD is determined from this value and the default channel spacing defined in the standard, i.e. Channel spacing = (BWchan1 + BWchan2) * 0.5 + [the delta spacing]. Since this value is a difference from the default spacing, this value can be negative to allow narrower channel spacing. When this value is changed, the carrier configuration preset is initiated.

Key Path	FREQ Channel, Carrier Setup, Carrier Conf Presets, Channel Spacing Delta
Remote Command	[:SENSe] :CARRier:CONFig:LTEFdd:SPACing:DELTA <freq> [:SENSe] :CARRier:CONFig:LTEFdd:SPACing:DELTA?
Example	CARR:CONF:LTEF:SPAC:DELTA -200kHz CARR:CONF:LTEF:SPAC:DELTA?
Preset	0Hz
State Saved	Saved in instrument state
Min	- 1.0 MHz
Max	10.0 MHz
Initial S/W Revision	A.10.00
Modified at S/W Revision	A.11.00

W-CDMA

Sets delta channel spacing for W-CDMA used when the carrier configuration preset runs. Channel spacing for W-CDMA is determined from this value and the default channel spacing defined in the standard, i.e. Channel spacing = 5.0 MHz + [the delta spacing]. Since this value is a difference from the default spacing, this value can be negative to allow narrower channel spacing. When this value is changed, the carrier configuration preset is initiated.

Key Path	FREQ Channel, Carrier Setup, Carrier Conf Presets, Channel Spacing Delta
Remote Command	[:SENSe] :CARRier:CONFig:WCDMa:SPACing:DELTA <freq> [:SENSe] :CARRier:CONFig:WCDMa:SPACing:DELTA?
Example	CARR:CONF:WCDM:SPAC:DELTA 0 CARR:CONF:WCDM:SPAC:DELTA?
Preset	0 Hz
State Saved	Saved in instrument state
Min	- 1.0 MHz
Max	10.0 MHz
Initial S/W Revision	A.10.00
Modified at S/W Revision	A.11.00

GSM/EDGE

Sets delta channel spacing for GSM/EDGE used when the carrier configuration preset runs. Channel spacing for GSM/EDGE is determined from this value and the default channel spacing defined in the standard, i.e. Channel spacing = 600 kHz + [the delta spacing]. Since this value is a difference from the default spacing, this value can be negative to allow narrower channel spacing. When this value is changed, the carrier configuration preset is initiated.

Key Path	FREQ Channel, Carrier Setup, Carrier Conf Presets, Channel Spacing Delta
Remote Command	[:SENSe]:CARRier:CONFig:GSM:SPACing:DELTa <freq> [:SENSe]:CARRier:CONFig:GSM:SPACing:DELTa?
Example	CARR:CONF:GSM:SPAC:DELT 0 CARR:CONF:GSM:SPAC:DELT?
Preset	0 Hz
State Saved	Saved in instrument state
Min	- 0.4 MHz
Max	10.0 MHz
Initial S/W Revision	A.10.00
Modified at S/W Revision	A.11.00

cdma2000

Sets delta channel spacing for cdma2000 used when the carrier configuration preset runs. Channel spacing for cdma2000 is determined from this value and the default channel spacing defined in the standard, i.e. Channel spacing = 1.25 MHz + [the delta spacing]. Since this value is a difference from the default spacing, this value can be negative to allow narrower channel spacing.

Key Path	FREQ Channel, Carrier Setup, Carrier Conf Presets, Channel Spacing Delta
Remote Command	[:SENSe]:CARRier:CONFig:CDMA:SPACing:DELTa <freq> [:SENSe]:CARRier:CONFig:CDMA:SPACing:DELTa?
Example	CARR:CONF:CDMA:SPAC:DELT 0 CARR:CONF:CDMA:SPAC:DELT?
Preset	0 Hz
State Saved	Saved in instrument state
Min	-1 MHz
Max	10 MHz
Initial S/W Revision	A.12.00

1xEV-DO

Sets delta channel spacing for 1xEV-DO used when the carrier configuration preset runs. Channel spacing for 1xEV-DO is determined from this value and the default channel spacing defined in the standard, i.e.

Channel spacing = 1.25 MHz + [the delta spacing]. Since this value is a difference from the default spacing, this value can be negative to allow narrower channel spacing.

Key Path	FREQ Channel, Carrier Setup, Carrier Conf Presets, Channel Spacing Delta
Remote Command	<code>[:SENSe] :CARRier :CONFig :EVDO :SPACing :DELTA <freq></code> <code>[:SENSe] :CARRier :CONFig :EVDO :SPACing :DELTA?</code>
Example	<code>CARR:CONF:EVDO:SPAC:DELT 0</code> <code>CARR:CONF:EVDO:SPAC:DELT?</code>
Preset	0 Hz
State Saved	Saved in instrument state
Min	-1 MHz
Max	10 MHz
Initial S/W Revision	A.12.00

Apply to Meas Offset/Limits

This immediate action key sets the following measurement parameters.

- ACP: Offset and limit parameters under Offset/Limits.
- Spectrum Emission Mask: Offset and limit parameters under Offset/Limits.
- Spurious Emissions: Range frequency and limit parameters under Range Table.

These offset and limit values are determined by the carrier configuration parameters, Band Category and Assumed Adj Channels.

Each of these measurement has a local key, “Apply Carrier Config to ...”, which performs in the same way only for its parameters. So pressing this key is equivalent to pressing “Apply Carrier Config to ...” of all these measurements.

Key Path	FREQ Channel, Carrier Setup
Remote Command	<code>[:SENSe] :MCONdition :IMMediate</code>
Example	<code>MCON:IMM</code>
Initial S/W Revision	A.11.00

RF Bandwidth (Remote Command Only)

Returns the RF bandwidth calculated from the outermost carriers and their Foffset_RAT.

Key Path	SCPI only
Mode	MSR
Remote Command	<code>[:SENSe] :CARRier :RFBWidth?</code>
Example	<code>CARR:RFBW?</code>

Preset	Calculated from preset values of carrier config parameters
State Saved	No
Initial S/W Revision	A.13.00

RF Bandwidth Center (Remote Command Only)

Returns the center frequency of RF bandwidth.

Key Path	SCPI only
Mode	MSR
Remote Command	<code>[:SENSe] :CARRier:RFBWidth:CENTer?</code>
Example	CARR:RFBW:CENT?
Preset	Calculated from preset values of carrier config parameters
State Saved	No
Initial S/W Revision	A.13.00

Sub-block Center (Remote Command Only)

Returns the center frequency of sub-block when Carrier Allocation is Non-Contiguous.

Key Path	SCPI only
Mode	MSR
Remote Command	<code>[:SENSe] :CARRier:SBLock [1] 2 :CENTer?</code>
Example	CARR:SBL:CENT?
Notes	When Carrier Allocation is Contiguous, 9.91E+37 is returned.
Preset	Calculated from preset values of carrier config parameters
State Saved	No
Initial S/W Revision	A.13.00

Sub-block Bandwidth (Remote Command Only)

Returns the bandwidth of sub-block calculated from outermost carriers and corresponding Foffset_RAT.

Key Path	SCPI only
Mode	MSR
Remote Command	<code>[:SENSe] :CARRier:SBLock [1] 2 :BWIDth?</code>
Example	CARR:SBL:BWID?
Notes	When Carrier Allocation is Contiguous, 9.91E+37 is returned.

Preset	Calculated from preset values of carrier config parameters
State Saved	No
Initial S/W Revision	A.13.00

Sub-block Gap (Remote Command Only)

Returns the sub-block gap.

Key Path	SCPI only
Mode	MSR
Remote Command	[:SENSe] :CARRier :SBLock :GAP?
Example	CARR:SBL:GAP?
Notes	When Carrier Allocation is Contiguous, 9.91E+37 is returned.
Preset	Calculated from preset values of carrier config parameters
State Saved	No
Initial S/W Revision	A.13.00

14 Power Stat CCDF Measurement
Input/Output

Input/Output

See ["Input/Output" on page 190](#)

Marker

Accesses a menu that enables you to select, set up and control the markers for the current measurement.

Key Path	Front-panel key
Initial S/W Revision	Prior to A.02.00

Select Marker

Accesses a menu that allows you to select one of 12 markers for control and function

Key Path	Marker
Initial S/W Revision	Prior to A.02.00

Marker Type

Sets the marker control mode to **Normal**, **Delta**, **Fixed** or **Off**.

If the selected marker is **Off**, pressing **Marker** sets it to **Normal** and places it at the center of the screen on the trace determined by the Marker Trace rules. At the same time, Marker X Axis Value appears on the Active Function area.

The Active function for the selected marker's current control mode is the default active function. If the current control mode is **Off**, there is no active function and the active function is turned off. The active function display is the marker X axis value entered in the active function area, which displays the marker value to its full entered precision.

All interactions and dependencies detailed under the key description are enforced when the remote command is sent.

Key Path	Marker
Mode	SA, WCDMA, C2K, WiMAX OFDMA, TD-SCDMA, 1xEV-DO, DVB-T/H, DTMB (CTTB), ISDB-T, CMMB, LTE, LTE-TDD, Digital Cable TV, WLAN, MSR, LTE-TDD, LTE-FDD
Remote Command	:CALCulate:PStatistic:MARKer[1] 2 ... 12:MODE POSition DELTA OFF :CALCulate:PStatistic:MARKer[1] 2 ... 12:MODE?
Example	CALC:PST:MARK:MODE POS CALC:PST:MARK:MODE?
Notes	If the selected marker is Off, pressing Marker sets it to Normal and places it at the center of the screen on the trace determined by the Marker Trace rules. At the same time, Marker X Axis Value appears on the Active Function area. Default Active Function: the active function for the selected marker's current control mode. If the current control mode is Off, there is no active function and the active function is turned off. Active Function Display: the marker X axis value entered in the active function area displays the marker value to its full entered precision.

Preset	OFF
State Saved	Saved in instrument state.
Range	Normal Delta Off
Initial S/W Revision	Prior to A.02.00
Modified at S/W Revision	A.02.00, A.03.00

Properties

Accesses the marker properties menu.

Key Path	Marker
Initial S/W Revision	Prior to A.02.00

Select Marker

Accesses a menu that allows you to select one of 12 markers for control and function

Key Path	Marker
Initial S/W Revision	Prior to A.02.00

Relative To

Sets the reference marker that the selected marker will be relative to.

Key Path	Marker, Properties
Mode	SA, WCDMA, C2K, WIMAXOFDMA, TD-SCDMA, 1xEV-DO, DVB-T/H, DTMB (CTTB), ISDB-T, CMMB, LTE, LTETDD, Digital Cable TV, WLAN, MSR, LTEATDD, LTEAFDD
Remote Command	:CALCulate:PStatistic:MARKer[1] 2 ... 12:REFerence <integer> :CALCulate:PStatistic:MARKer[1] 2 ... 12:REFerence?
Example	CALC:PST:MARK:REF 3 CALC:PST:MARK:REF?
Notes	A marker cannot be relative to itself so that choice is grayed out, and if sent from SCPI generates error -221: "Settings conflict; marker cannot be relative to itself." When queried a single value will be returned (the specified marker numbers relative marker).
Preset	2 3 4 5 6 7 8 9 10 11 12 1
State Saved	Saved in instrument state.
Min	1
Max	12
Initial S/W Revision	Prior to A.02.00
Modified at S/W Revision	A.02.00, A.03.00

Marker Trace

Assigns the specified marker to the designated trace. The trace choices are:

- Measured
- Gaussian
- Reference

Key Path	Marker
Mode	SA, WCDMA, C2K, WIMAXOFDMA, TD-SCDMA, 1xEV-DO, DVB-T/H, DTMB (CTTB), ISDB-T, CMMB, LTE, LTE-TDD, Digital Cable TV, WLAN, MSR, LTE-TDD, LTE-FDD
Remote Command	:CALCulate:PStatistic:MARKer[1] 2 ... 12:TRACe MEASured GAUSSian REFerence :CALCulate:PStatistic:MARKer[1] 2 ... 12:TRACe?
Example	CALC:PST:MARK3:TRAC MEAS CALC:PST:MARK:TRACE?
Preset	MEASured
State Saved	Saved in instrument state.
Range	Measured Gaussian Reference
Initial S/W Revision	Prior to A.02.00
Modified at S/W Revision	A.02.00, A.03.00

Couple Markers

When this function is on, moving any marker causes an equal X axis movement of every other marker that is not off. By “equal X axis movement” we mean that we preserve the difference between each marker’s X axis value (in the fundamental x-axis units of the trace that marker is on) and the X axis value of the marker being moved (in the same fundamental x-axis units).

Key Path	Marker
Initial S/W Revision	Prior to A.02.00

All Markers Off

Turns off all markers.

Key Path	Marker, More
Mode	SA, WCDMA, C2K, WIMAXOFDMA, TD-SCDMA, 1xEV-DO, DVB-T/H, DTMB (CTTB), ISDB-T, CMMB, LTE, LTE-TDD, Digital Cable TV, WLAN, MSR, LTE-TDD, LTE-FDD
Remote Command	:CALCulate:PStatistic:MARKer:AOFF

Example	CALC:PST:MARK:AOFF
Initial S/W Revision	Prior to A.02.00
Modified at S/W Revision	A.02.00, A.03.00

Marker X Axis Value (Remote Command Only)

Sets the marker X Axis value in the current marker X Axis Scale unit. This function has no effect if the control mode is **Off**, but is the remote command equivalent of entering an X value if the control mode is **Normal** or **Delta**.

Mode	SA, WCDMA, C2K, WIMAXOFDMA, TD-SCDMA, 1xEV-DO, DVB-T/H, DTMB (CTTB), ISDB-T, CMMB, LTE, LTE-TDD, Digital Cable TV, WLAN, MSR, LTE-TDD, LTEAFDD
Remote Command	:CALCulate:PStatistic:MARKer[1] 2 ... 12:X <rel_amp> :CALCulate:PStatistic:MARKer[1] 2 ... 12:X?
Example	CALC:PST:MARK3:X 0 CALC:PST:MARK3:X?
Notes	If no suffix is sent, it will use the fundamental units for the current marker X Axis Scale. If a suffix is sent that does not match the current marker X Axis Scale unit, an error "Invalid suffix" will be generated. If the specified marker is Fixed and a Marker Function is on, error -221 "Settings conflict; cannot adjust Fixed marker while Marker Function is on" is generated. The query returns the marker's absolute X Axis value if the control mode is Normal , or the offset from the marker's reference marker if the control mode is Delta . The query is returned in the fundamental units for the current marker X Axis scale: Hz for Frequency and Inverse Time , seconds for Period and Time . If the marker is Off the response is not a number.
Preset	After a preset, all Markers are turned OFF, so Marker X Axis Value query will return a not a number (NAN).
State Saved	No
Min	-9.9E+37
Max	9.9E+37
Initial S/W Revision	Prior to A.02.00
Modified at S/W Revision	A.02.00, A.03.00

Marker Y Axis Value (Remote Command Only)

Queries the marker Y Axis value in the current marker Y Axis unit.

Mode	SA, WCDMA, C2K, WIMAXOFDMA, TD-SCDMA, 1xEV-DO, DVB-T/H, DTMB (CTTB), ISDB-T, CMMB, LTE, LTE-TDD, Digital Cable TV, WLAN, MSR, LTE-TDD, LTEAFDD
Remote Command	:CALCulate:PStatistic:MARKer[1] 2 ... 12:Y?
Example	CALC:PST:MARK11:Y?
Notes	The query returns the marker Y-axis result, if the control mode is Normal , or Delta . If the marker is

	Off the response is not a number.
Preset	0
State Saved	No
Backwards Compatibility SCPI	:CALCulate:PSStatistic:MARKer[1] 2 ... 12:FUNCTION:RESult?
Initial S/W Revision	Prior to A.02.00
Modified at S/W Revision	A.02.00, A.03.00

Marker Function

There are no 'Marker Functions' supported in Power Stat CCDF measurement. The front-panel key displays a blank menu when pressed.

Key Path	Front-panel key
Initial S/W Revision	Prior to A.02.00

Marker To

There is no 'Marker To' functionality supported in Power Stat CCDF measurement. The front-panel key displays a blank menu when pressed.

Key Path	Front-panel key
Initial S/W Revision	Prior to A.02.00

Meas

The information in this section is common to all measurements. For key and remote command information for a specific measurement, refer to the section that describes the measurement of interest.

Measurements available under the Meas key are specific to the current Mode.

When viewing Help for measurements, note the following:

NOTE

Operation for some keys differs between measurements. The information displayed in Help pertains to the current measurement. To see how a key operates in a different measurement, exit Help (press the Cancel Esc key), select the measurement, then reenter Help (press the Help key) and press that key.

Key Path	Front-panel key
Initial S/W Revision	Prior to A.02.00

Remote Measurement Functions

This section contains the following topics:

["Measurement Group of Commands" on page 2382](#)

["Current Measurement Query \(Remote Command Only\) " on page 2384](#)

["Limit Test Current Results \(Remote Command Only\)" on page 2384](#)

["Data Query \(Remote Command Only\)" on page 2384](#)

["Calculate/Compress Trace Data Query \(Remote Command Only\)" on page 2385](#)

["Calculate Peaks of Trace Data \(Remote Command Only\)" on page 2390](#)

["Hardware-Accelerated Fast Power Measurement \(Remote Command Only\) " on page 2391](#)

["Format Data: Numeric Data \(Remote Command Only\)" on page 2405](#)

["Format Data: Byte Order \(Remote Command Only\)" on page 2406](#)

Initial S/W Revision	Prior to A.02.00
----------------------	------------------

Measurement Group of Commands

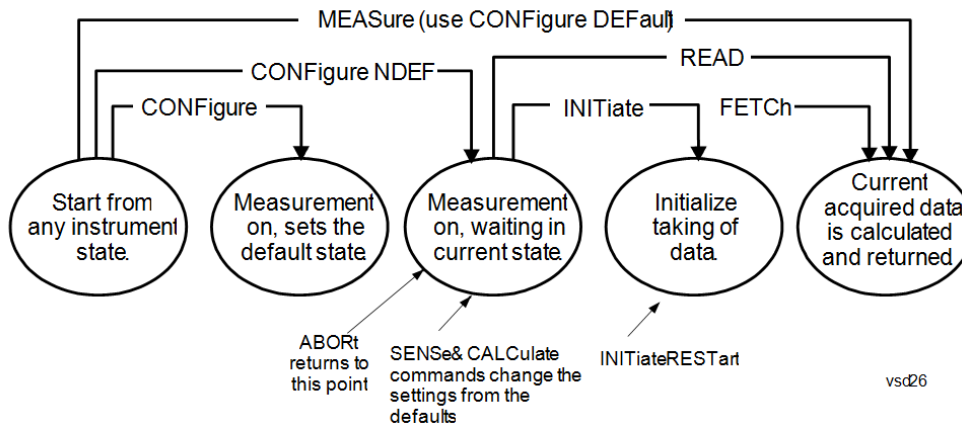

Measure Commands:

:MEASure:<measurement>[n]?

This is a fast single-command way to make a measurement using the factory default instrument settings. These are the settings and units that conform to the Mode Setup settings (e.g. radio standard) that you have currently selected.

- Stops the current measurement (if any) and sets up the instrument for the specified measurement using the factory defaults
- Initiates the data acquisition for the measurement
- Blocks other SCPI communication, waiting until the measurement is complete before returning results.
- If the function does averaging, it is turned on and the number of averages is set to 10.
- After the data is valid it returns the scalar results, or the trace data, for the specified measurement. The type of data returned may be defined by an [n] value that is sent with the command.
- The scalar measurement results will be returned if the optional [n] value is not included, or is set to 1. If the [n] value is set to a value other than 1, the selected trace data results will be returned. See each command for details of what types of scalar results or trace data results are available.
- ASCII is the default format for the data output. (Older versions of Spectrum Analysis and Phase Noise mode measurements only use ASCII.) The binary data formats should be used for handling large blocks of data since they are smaller and faster than the ASCII format. Refer to the FORMat:DATA command for more information.

If you need to change some of the measurement parameters from the factory default settings you can set up the measurement with the CONFIgure command. Use the commands in the SENSe:<measurement> and CALCulate:<measurement> subsystems to change the settings. Then you can use the READ? command to initiate the measurement and query the results.

If you need to repeatedly make a given measurement with settings other than the factory defaults, you can use the commands in the SENSe:<measurement> and CALCulate:<measurement> subsystems to set up the measurement. Then use the READ? command to initiate the measurement and query results.

Measurement settings persist if you initiate a different measurement and then return to a previous one. Use READ:<measurement>? if you want to use those persistent settings. If you want to go back to the default settings, use MEASure:<measurement>?.

Configure Commands:

:CONFIgure:<measurement>

This command stops the current measurement (if any) and sets up the instrument for the specified measurement using

the factory default instrument settings. It does not initiate the taking of measurement data unless INIT:CONTinuous is ON. If you change any measurement settings after using the CONFigure command, the READ command can be used to initiate a measurement without changing the settings back to their defaults.

In the Swept SA measurement in Spectrum Analyzer mode the CONFigure command also turns the averaging function on and sets the number of averages to 10 for all measurements.

:CONFigure: <measurement>: NDEFault stops the current measurement and changes to the specified measurement. It does not change the settings to the defaults. It does not initiate the taking of measurement data unless INIT:CONTinuous is ON.

The CONFigure? query returns the current measurement name.

The CONFigure:CATalog? query returns a quoted string of all licensed measurement names in the current mode. For example, "SAN, CHP, OBW, ACP, PST, TXP, SPUR, SEM, LIST".

Fetch Commands:

:FETCh:<measurement>[n]?

This command puts selected data from the most recent measurement into the output buffer. Use FETCh if you have already made a good measurement and you want to return several types of data (different [n] values, for example, both scalars and trace data) from a single measurement. FETCh saves you the time of re-making the measurement. You can only FETCh results from the measurement that is currently active, it will not change to a different measurement. An error message is reported if a measurement other than the current one is specified.

If you need to get new measurement data, use the READ command, which is equivalent to an INITiate followed by a FETCh.

The scalar measurement results will be returned if the optional [n] value is not included, or is set to 1. If the [n] value is set to a value other than 1, the selected trace data results will be returned. See each command for details of what types of scalar results or trace data results are available. The binary data formats should be used for handling large blocks of data since they are smaller and transfer faster than the ASCII format. (FORMat:DATA)

FETCh may be used to return results other than those specified with the original READ or MEASure command that you sent.

INITiate Commands:

:INITiate:<measurement>

This command is not available for measurements in all the instrument modes:

- Initiates a trigger cycle for the specified measurement, but does not output any data. You must then use the FETCh<meas> command to return data. If a measurement other than the current one is specified, the instrument will switch to that measurement and then initiate it.
 - For example, suppose you have previously initiated the ACP measurement, but now you are running the channel power measurement. If you send INIT:ACP? it will change from channel power to ACP and will initiate an ACP measurement.
 - Does not change any of the measurement settings. For example, if you have previously started the ACP measurement and you send INIT:ACP? it will initiate a new ACP measurement using the same instrument settings as the last time ACP was run.
 - If your selected measurement is currently active (in the idle state) it triggers the measurement, assuming the trigger conditions are met. Then it completes one trigger cycle. Depending upon the measurement and the number of averages, there may be multiple data acquisitions, with multiple trigger events, for one full trigger cycle. It also holds off additional commands on GPIB until the acquisition is complete.
-

READ Commands:

:READ:<measurement>[n]?

- Does not preset the measurement to the factory default settings. For example, if you have previously initiated the ACP
-

measurement and you send READ:ACP? it will initiate a new measurement using the same instrument settings.

- Initiates the measurement and puts valid data into the output buffer. If a measurement other than the current one is specified, the instrument will switch to that measurement before it initiates the measurement and returns results.
 - For example, suppose you have previously initiated the ACP measurement, but now you are running the channel power measurement. Then you send READ:ACP? It will change from channel power back to ACP and, using the previous ACP settings, will initiate the measurement and return results.
 - Blocks other SCPI communication, waiting until the measurement is complete before returning the results
 - If the optional [n] value is not included, or is set to 1, the scalar measurement results will be returned. If the [n] value is set to a value other than 1, the selected trace data results will be returned. See each command for details of what types of scalar results or trace data results are available. The binary data formats should be used when handling large blocks of data since they are smaller and faster than the ASCII format. (FORMat:DATA)
-

Initial S/W Revision	Prior to A.02.00
----------------------	------------------

Current Measurement Query (Remote Command Only)

This command returns the name of the measurement that is currently running.

Remote Command	:CONFigure?
-----------------------	-------------

Example	CONF?
----------------	-------

Initial S/W Revision	Prior to A.02.00
----------------------	------------------

Limit Test Current Results (Remote Command Only)

Queries the status of the current measurement limit testing. It returns a 0 if the measured results pass when compared with the current limits. It returns a 1 if the measured results fail any limit tests.

Remote Command	:CALCulate:CLIMits:FAIL?
-----------------------	--------------------------

Example	CALC:CLIM:FAIL? queries the current measurement to see if it fails the defined limits. Returns a 0 or 1: 0 it passes, 1 it fails.
----------------	--

Initial S/W Revision	Prior to A.02.00
----------------------	------------------

Data Query (Remote Command Only)

Returns the designated measurement data for the currently selected measurement and subopcode.

n = any valid subopcode for the current measurement. See the measurement command results table for your current measurement, for information about what data is returned for the subopcodes.

This command uses the data setting specified by the FORMat:BORDER and FORMat:DATA commands and can return real or ASCII data. (See the format command descriptions under Input/Output in the Analyzer Setup section.)

Remote Command	:CALCulate:DATA[n]?
Notes	The return trace depends on the measurement. In CALCulate:<meas>:DATA[n], n is any valid subopcode for the current measurement. It returns the same data as the FETCH:<measurement>? query where <measurement> is the current measurement.
Initial S/W Revision	Prior to A.02.00

Calculate/Compress Trace Data Query (Remote Command Only)

Returns compressed data for the currently selected measurement and sub-opcode [n].

n = any valid sub-opcode for that measurement. See the MEASure:<measurement>? command description of your specific measurement for information on the data that can be returned.

The data is returned in the current Y Axis Unit of the analyzer. The command is used with a sub-opcode <n> (default=1) to specify the trace. With trace queries, it is best if the analyzer is not sweeping during the query. Therefore, it is generally advisable to be in Single Sweep, or Update=Off.

This command is used to compress or decimate a long trace to extract and return only the desired data. A typical example would be to acquire N frames of GSM data and return the mean power of the first burst in each frame. The command can also be used to identify the best curve fit for the data.

Remote Command	:CALCulate:DATA<n>:COMPRESS? BLOCK CFIT MAXimum MINimum MEAN DMEan RMS RMSCubed SAMPLE SDEViation PPHase [,<soffset> [,<length>[,<roffset>[,<rlimit>]]]]
Example	To query the mean power of a set of GSM bursts: Supply a signal that is a set of GSM bursts. Select the IQ Waveform measurement (in IQ Analyzer Mode). Set the sweep time to acquire at least one burst. Set the triggers such that acquisition happens at a known position relative to a burst. Then query the mean burst levels using, CALC:DATA2:COMP? MEAN, 24e-6, 526e-6 (These parameter values correspond to GSM signals, where 526e-6 is the length of the burst in the slot and you just want 1 burst.)
Notes	The command supports 5 parameters. Note that the last 4 (<soffset>, <length>, <roffset>, <rlimit>) are optional. But these optional parameters must be entered in the specified order. For example, if you want to specify <length>, then you must also specify <soffset>. See details below for a definition of each of these parameters. This command uses the data in the format specified by FORMat:DATA, returning either binary or ASCII data.
Initial S/W Revision	Prior to A.02.00

- BLOCK or block data - returns all the data points from the region of the trace data that you specify. For example, it could be used to return the data points of an input signal over several timeslots, excluding the portions of the trace data that you do not want. (This is x,y pairs for trace data and I,Q pairs for complex data.)

- CFIT or curve fit - applies curve fitting routines to the data. <soffset> and <length> are required to define the data that you want. <roffset> is an optional parameter for the desired order of the curve equation. The query will return the following values: the x-offset (in seconds) and the curve coefficients ((order + 1) values).

MIN, MAX, MEAN, DME, RMS, RMSC, SAMP, SDEV and PPH return one data value for each specified region (or <length>) of trace data, for as many regions as possible until you run out of trace data (using <roffset> to specify regions). Or they return the number of regions you specify (using <rlimit>) ignoring any data beyond that.

- MINimum - returns the minimum data point (y value) for the specified region(s) of trace data. For I/Q trace data, the minimum magnitude of the I/Q pairs is returned.
- MAXimum - returns the maximum data point (y value) for the specified region(s) of trace data. For I/Q trace data, the maximum magnitude of the I/Q pairs is returned.
- MEAN - returns a single value that is the arithmetic mean of the data point values (in dB/ dBm) for the specified region(s) of trace data. For I/Q trace data, the mean of the magnitudes of the I/Q pairs is returned. See the following equations.

-

NOTE

If the original trace data is in dB, this function returns the arithmetic mean of those log values, not log of the mean power which is a more useful value. The mean of the log is the better measurement technique when measuring CW signals in the presence of noise. The mean of the power, expressed in dB, is useful in power measurements such as Channel Power. To achieve the mean of the power, use the RMS option.

Equation 1

Mean Value of Data Points for Specified Region(s)

$$\text{MEAN} = \frac{1}{n} \sum_{X_i \in \text{region}(s)} X_i$$

where X_i is a data point value, and n is the number of data points in the specified region(s).

Equation 2

Mean Value of I/Q Data Pairs for Specified Region(s)

$$\text{MEAN} = \frac{1}{n} \sum_{X_i \in \text{region}(s)} |X_i|$$

where $|X_i|$ is the magnitude of an I/Q pair, and n is the number of I/Q pairs in the specified region(s).

- DMEan - returns a single value that is the mean power (in dB/ dBm) of the data point values for the specified region(s) of trace data. See the following equation:

Equation 3

DMEan Value of Data Points for Specified Region(s)

$$\text{DME} = 10 \times \log_{10} \left(\frac{1}{n} \sum_{X_i \in \text{region}(s)} 10^{\frac{X_i}{10}} \right)$$

- RMS - returns a single value that is the average power on a root-mean-squared voltage scale (arithmetic rms) of the data point values for the specified region(s) of trace data. See the following equation.

NOTE For I/Q trace data, the rms of the magnitudes of the I/Q pairs is returned. See the following equation. This function is very useful for I/Q trace data. However, if the original trace data is in dB, this function returns the rms of the log values which is not usually needed.

Equation 4

RMS Value of Data Points for Specified Region(s)

$$\text{RMS} = \sqrt{\frac{1}{n} \sum_{X_i \in \text{region}(s)} X_i^2}$$

where X_i is a data point value, and n is the number of data points in the specified region(s).

Equation 5

RMS Value of I/Q Data Pairs for Specified Region(s)

$$\text{RMS} = \sqrt{\frac{1}{n} \sum_{X_i \in \text{region}(s)} X_i X_i^*}$$

where X_i is the complex value representation of an I/Q pair, X_i^* its conjugate complex number, and n is the number of I/Q pairs in the specified region(s).

Once you have the rms value for a region of trace data (linear or I/Q), you may want to calculate the mean power. You must convert this rms value (peak volts) to power in dBm:

$$10 \times \log[10 \times (\text{rms value})^2]$$

- SAMPlE - returns the first data value (x,y pair) for the specified region(s) of trace data. For I/Q trace data, the first I/Q pair is returned.
- SDEVIation - returns a single value that is the arithmetic standard deviation for the data point values for the specified region(s) of trace data. See the following equation.
- For I/Q trace data, the standard deviation of the magnitudes of the I/Q pairs is returned. See the following equation.

Equation 6

Standard Deviation of Data Point Values for Specified Region(s)

$$\text{SDEV} = \sqrt{\frac{1}{n} \sum_{X_i \in \text{region}(s)} (X_i - \bar{X})^2}$$

where X_i is a data point value, \bar{X} is the arithmetic mean of the data point values for the specified region (s), and n is the number of data points in the specified region(s).

$$\text{SDEV} = \sqrt{\frac{1}{n} \sum_{X_i \in \text{region}(s)} (|X_i| - \bar{X})^2}$$

where $|X_i|$ is the magnitude of an I/Q pair, \bar{X} is the mean of the magnitudes for the specified region(s), and n is the number of data points in the specified region(s).

- PPHase - returns the x,y pairs of both rms power (dBm) and arithmetic mean phase (radian) for every specified region and frequency offset (Hz). The number of pairs is defined by the specified number of regions. This parameter can be used for I/Q vector (n=0) in Waveform (time domain) measurement and all parameters are specified by data point in PPHase.

The rms power of the specified region may be expressed as:

$$\text{Power} = 10 \times \log [10 \times (\text{RMS I/Q value})] + 10.$$

The RMS I/Q value (peak volts) is:

$$\sqrt{\frac{1}{n} \sum_{X_i \in \text{region}} X_i X_i^*}$$

where X_i is the complex value representation of an I/Q pair, X_i^* its conjugate complex number, and n is the number of I/Q pairs in the specified region.

The arithmetic mean phase of the specified region may be expressed as:

$$\frac{1}{n} \sum_{Y_i \in \text{region}} Y_i$$

where Y_i is the unwrapped phase of I/Q pair with applying frequency correction and n is the number of I/Q pairs in the specified region.

The frequency correction is made by the frequency offset calculated by the arithmetic mean of every specified region's frequency offset. Each frequency offset is calculated by the least square method against the unwrapped phase of I/Q pair.

Sample Trace Data - Constant Envelope

(See below for explanation of variables.)

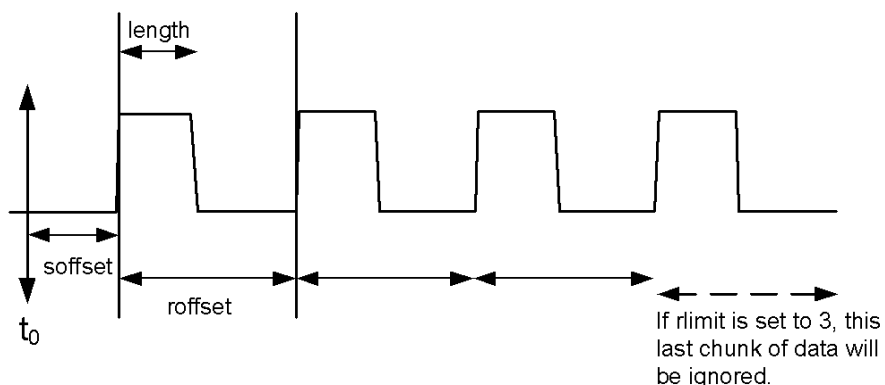

Sample Trace Data - Not Constant Envelope

(See below for explanation of variables.)

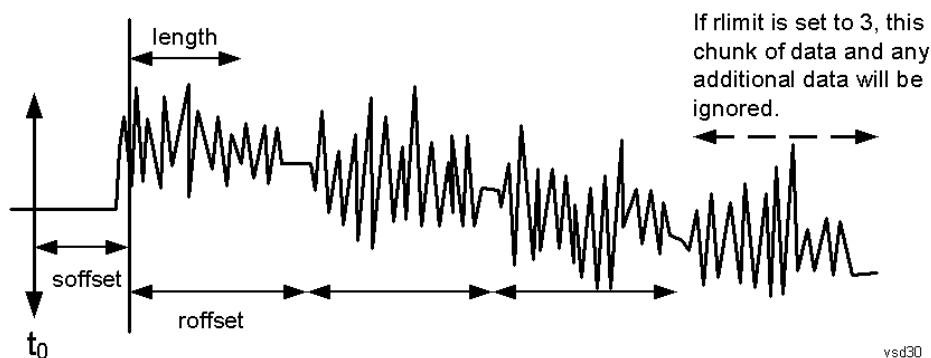

<soffset> - start offset is an optional real number. (It is in seconds for time-domain traces, and is a dimensionless index 0 to Npoints - 1, for frequency-domain traces). It specifies the amount of data at the beginning of the trace that will be ignored before the decimation process starts. It is the time or frequency change from the start of the trace to the point where you want to start using the data. The default value is zero.

<length> - is an optional real number. (It is in seconds for time-domain traces, and is a dimensionless index 0 to Npoints - 1, for frequency-domain traces). It defines how much data will be compressed into one value. This parameter has a default value equal to the current trace length.

<roffset> - repeat offset is an optional real number. (It is in seconds for time-domain traces, and is a dimensionless index 0 to Npoints - 1, for frequency-domain traces). It defines the beginning of the next field of trace elements to be compressed. This is relative to the beginning of the previous field. This parameter has a default value equal to the <length> variable. Note that this parameter is used for a completely different purpose when curve fitting (see CFIT above).

<rlimit> - repeat limit is an optional integer. It specifies the number of data items that you want returned. It will ignore any additional items beyond that number. You can use the Start offset and the Repeat limit to pick out exactly what part of the data you want to use. The default value is all the data.

Calculate Peaks of Trace Data (Remote Command Only)

Returns a list of all the peaks for the currently selected measurement and sub-opcode [n]. The peaks must meet the requirements of the peak threshold and excursion values.

n = any valid sub-opcode for the current measurement. See the MEASure:<measurement> command description of your specific measurement for information on the data that can be returned.

The command can only be used with specific sub-opcodes with measurement results that are trace data. Both real and complex traces can be searched, but complex traces are converted to magnitude in dBm. In many measurements the sub-opcode n=0, is the raw trace data which cannot be searched for peaks. And Sub-opcode n=1, is often calculated results values which also cannot be searched for peaks.

This command uses the data setting specified by the FORMat:BORDER and FORMat:DATA commands and can return real or ASCII data. If the format is set to INT,32, it returns REAL,32 data.

The command has four types of parameters:

- Threshold (in dBm)
- Excursion (in dB)
- Sorting order (amplitude, frequency, time)
- Optional in some measurements: Display line use (all, > display line, < display line)

Remote Command	<p>For Swept SA measurement:</p> <pre>:CALCulate:DATA[1] 2 ... 6:PEAKs? <threshold>,<excursion>[,AMPLitude FREQuency TIME[,ALL GTDLLine LTDLine]]</pre> <p>For most other measurements:</p> <pre>:CALCulate:DATA[1] 2 ... 6:PEAKs? <threshold>,<excursion>[,AMPLitude FREQuency TIME]</pre>
Example	<p>Example for Swept SA measurement in Spectrum Analyzer Mode:</p> <p>CALC:DATA4:PEAK? -40, 10, FREQ, GTDL This will identify the peaks of trace 4 that are above -40 dBm, with excursions of at least 10 dB. The peaks are returned in order of increasing frequency, starting with the lowest frequency. Only the peaks that are above the display line are returned.</p> <p>Query Results 1:</p> <p>With FORMat:DATA REAL, 32 selected, it returns a list of floating-point numbers. The first value in the list is the number of peak points that are in the following list. A peak point consists of two values: a peak amplitude followed by its corresponding frequency (or time).</p> <p>If no peaks are found the peak list will consist of only the number of peaks, (0).</p>
Notes	<p><n> - is the trace that will be used</p> <p><threshold> - is the level below which trace data peaks are ignored. Note that the threshold value is required and is always used as a peak criterion. To effectively disable the threshold criterion for this command, provide a substantially low threshold value such as -200 dBm. Also note that the threshold value used in this command is independent of and has no effect on the threshold value stored under the Peak Criteria menu.</p> <p><excursion> - is the minimum amplitude variation (rise and fall) required for a signal to be identified as peak. Note that the excursion value is required and is always used as a peak criterion. To effectively disable the excursion criterion for this command, provide the minimum value of 0.0 dB. Also note that the excursion value used in this command is independent of and has no effect on the</p>

excursion value stored under the Peak Criteria menu.

Values must be provided for threshold and excursion. The sorting and display line parameters are optional (defaults are AMPLitude and ALL).

Note that there is always a Y-axis value for the display line, regardless of whether the display line state is on or off. It is the current Y-axis value of the display line which is used by this command to determine whether a peak should be reported

Sorting order:

AMPLitude - lists the peaks in order of descending amplitude, with the highest peak first (default if optional parameter not sent)

FREQuency - lists the peaks in order of occurrence, left to right across the x-axis.

TIME - lists the peaks in order of occurrence, left to right across the x-axis.

Peaks vs. Display Line:

ALL - lists all of the peaks found (default if optional parameter not sent).

GTDLine (greater than display line) - lists all of the peaks found above the display line.

LTDLine (less than display line) - lists all of the peaks found below the display line.

Initial S/W Revision	Prior to A.02.00
----------------------	------------------

Hardware-Accelerated Fast Power Measurement (Remote Command Only)

The Fast Power option (FP2) enables very fast channel power measurements for instruments with the prerequisite hardware (DP2 and/or B40). It accomplishes this by performing real-time overlapped FFTs at the hardware layer, using software for basic post-processing before returning the result to the user. The upshot of this approach is improved throughput for user applications that require many sequential power measurements.

The analysis bandwidth of FP2 is limited by the licenses in the instrument, but its maximum overall analysis bandwidth per acquisition is 40 MHz.

FP2 is remote-only, which means the instrument does not switch to any particular mode or measurement. FP2 commands can be sent while another application is in use on the front panel.

Each Fast Power measurement can be predefined using an array index, and up to 1,000 measurements can be stored. In the following documentation, instances of [1,2,...,999] can be substituted with a particular measurement index, e.g. CALC:FPOW:POW1?, CALC:FPOW:POW2?, CALC:FPOW:POW134?. In this way, power measurements can be defined one time in a batch, and then executed multiple times without having to redefine them, similar to “list mode” on other measurements.

In addition to basic channel power measurements, there are a number of other measurement “functions” for each channel, including peak power, peak frequency, and power spectral density. See the Function parameter for more information.

Reset Fast Power Measurement (Remote Command Only)

Resets the measurement configuration to the defaults.

Mode	All
Remote Command	:CALCulate:FPOWer:POWer [1, 2, ..., 999] :RESet
Example	:CALC:FPOW:POW1:RES

Notes	Option FP2 is required.
Initial S/W Revision	A.14.00

Define Fast Power Measurement (Remote Command Only)

Fast Power acquisitions are configured using the DEFine command. This command accepts a comma-delimited string of configuration parameters and their appropriate values, which are all specified in the subsection below.

Mode	All
Remote Command	:CALCulate:FPOWer:POWer[1,2,...,999]:DEFine "configuration string"
Example	:CALC:FPOW:POW1:DEF "CenterFrequency=2e9, AcquisitionTime=0.005"
Notes	See below for a list of measurement variables that can be defined in the configuration string.
Initial S/W Revision	A.14.00

Acquisition Time

Example	CALC:FPOW:POW1:DEF "AcquisitionTime=0.002"
Notes	The acquisition time parameter sets the time in which the entire spectrum is measured. An increase in the acquisition time yields an improvement in measurement repeatability.
Preset	0.001 s
Range	0 s to 1 s
Default Unit	Time (s)
Initial S/W Revision	A.14.00

Center Frequency

Example	CALC:FPOW:POW1:DEF "CenterFrequency=2e9"
Notes	The center frequency parameter sets the frequency in which the measurement is centered around. The OffsetFrequency parameter is calculated relative to the center frequency.
Preset	1 GHz
Range	0 Hz to maximum instrument frequency
Default Unit	Frequency (Hz)
Initial S/W Revision	A.14.00

DC Coupled

Example	CALC:FPOW:POW1:DEF "DCCoupled=True"
Notes	The DC coupled parameter allows the user to specify whether the DC blocking capacitor is utilized. Set parameter to true when measuring frequencies below 10 MHz.
Preset	False
Range	True (DC Coupled) or False (AC Coupled)
Default Unit	Boolean
Initial S/W Revision	A.14.00

DetectorType

Example	CALC:FPOW:POW1:DEF "DetectorType=Peak"
Notes	Option FP2 is required. The detector type parameter allows the user to choose whether a RMS average or peak value is used during the measurement.
Preset	RmsAverage
Range	RmsAverage, Peak
Initial S/W Revision	A.14.00

Do Noise Correction

Example	CALC:FPOW:POW1:DEF "DoNoiseCorrection=True"
Notes	When noise correction is enabled, the linear noise power contributed by the analyzer is subtracted from all measurements. This effectively lowers the noise floor of the analyzer. When noise correction is enabled, the first measurement for a given set of input parameters will take extra time. This is because the analyzer takes an extra acquisition with the RF input disconnected from the analyzer's front end to measure the noise of just the analyzer. The measured noise floor is stored in a cache so the noise acquisition will occur only once for the same state settings. In other words, if noise correction was turned on and the analyzer made an acquisition at frequency A, then frequency B, and back again to frequency A, the hidden initial noise floor acquisition would only occur for the first acquisition at frequency A and the cached noise floor would be used the second time frequency A was measured.
Preset	False
Range	True (enable noise correction) or False (disable noise correction)
Default Unit	Boolean
Initial S/W Revision	A.14.00

Do Spur Suppression

Example	CALC:FPOW:POW1:DEF "DoSpurSuppression=True"
Notes	<p>When measuring very low level signals, or when large out-of-band inputs are input into the analyzer, sometimes unwanted spurs and residuals can appear in the measured spectrum. Spur suppression is a method to help minimize the levels of these internally generated spurs and residuals.</p> <p>When spur suppression is enabled, the analyzer will automatically take two acquisitions using two different internal analog LO frequencies. The FFT spectrums from both acquisitions are combined by taking the minimum power between both traces on a per FFT bin basis. External signals will have the same amplitude for both traces and therefore will return the expected amplitudes. However, low level spurs and residuals generated internally to the analyzer tend to move to different FFT bins depending on the internal analog LO frequency used, and therefore tend to be suppressed using this spur suppression method.</p> <p>Because two acquisitions, rather than a single acquisition, are made when spur suppression is enabled, the measurement time will always be slower when spur suppression is enabled.</p>
Preset	False
Range	True (enable spur suppression) or False (disable spur suppression)
Default Unit	Boolean
Initial S/W Revision	A.14.00

Electronic Attenuator Bypass

Example	CALC:FPOW:POW1:DEF "ElecAttBypass =False"
Notes	The electronic attenuation bypass parameter allows the user to either utilize or bypass the electronic attenuator. The electronic attenuator is only available for frequencies up to 3.6 GHz. Set parameter to true when using frequencies above 3.6 GHz and set the parameter to false when using the preamp.
Preset	True
Range	True (bypass electronic attenuator) or False (use electronic attenuator)
Default Unit	Boolean
Initial S/W Revision	A.14.00

Electronic Attenuation

Example	CALC:FPOW:POW1:DEF "ElecAttenuation=10"
Notes	<p>Option EA3 is required.</p> <p>The electronic attenuation value parameter sets the amount of electrical attenuation from 0 to 24 dB (1 dB steps).</p> <p>Set "ElecAttBypass=False" to make sure the electronic attenuator path is enabled.</p>
Preset	0 dB
Range	0 - 24 dB (1 dB steps)

Default Unit	dB
Initial S/W Revision	A.14.00

IF Gain

Example	CALC:FPOW:POW1:DEF "IFGain=10"
Notes	The IF gain parameter allows the user to specify the gain at the IF stage anywhere from -6 to 16 dB (1 dB steps). This is an advanced feature, and for most cases this should remain at its default value of 0 dB.
Preset	0 dB
Range	-6 - 16 dB (1 dB steps)
Default Unit	dB
Initial S/W Revision	A.14.00

IF Type

Example	CALC:FPOW:POW1:DEF "IFType=B25M"
Notes	The IF type parameter allows the user to select between different IF paths. For example, if the signal is less than 25 MHz wide, then the user can select the B25M path to take advantage of additional filtering on this analog IF path.
Preset	B40M
Range	B10M, B25M, B40M
Initial S/W Revision	A.14.00

Include Power Spectrum

Example	CALC:FPOW:POW1:DEF "IncludePowerSpectrum=True"
Notes	The power spectrum parameter allows the user to read data on the entire spectrum for diagnostic purposes. It is not recommended for production use. See CALC:FPOW:POW[n]:READ2? for details on the binary format of the response.
Preset	False
Range	True (return both channel power and full power spectrum) or False (returns only channel power)
Default Unit	Boolean
Initial S/W Revision	A.14.00

Mechanical Attenuation

Example	CALC:FPOW:POW1:DEF "MechAttenuation=10"
Notes	The mechanical attenuation value parameter sets the amount of mechanical attenuation anywhere from 0 to 70 dB (2 dB steps).
Preset	0 dB
Range	0 – 70 dB (2 dB steps)
Default Unit	dB
Initial S/W Revision	A.14.00

Preamp Mode

Example	CALC:FPOW:POW1:DEF "PreAmpMode=Low"
Notes	The license for the appropriate preamp is required. The preamp mode parameter specifies whether the preamps are being utilized. Low allows any preamps up to 3.6 GHz, and Full allows all licensed preamps. Set "ElecAttBypass=True" in order to utilize any preamps.
Preset	Off
Range	Off, Low, Full
Initial S/W Revision	A.14.00

Resolution Bandwidth Mode

Example	CALC:FPOW:POW1:DEF "PreAmpMode=Low"
Notes	The resolution bandwidth mode parameter allows the user to choose whether the RBW filter is automatically or manually set. The BestSpeed value minimizes measurement time, while the Narrowest value minimizes RBW size (minimum of two FFT bins per RBW). To manually specify an RBW, set this parameter to Explicit, and set the ResolutionBW parameter to the desired value.
Preset	BestSpeed
Range	BestSpeed, Narrowest, Explicit
Initial S/W Revision	A.14.00

Resolution Bandwidth

Example	CALC:FPOW:POW1:DEF "ResolutionBW=25e3"
Notes	The resolution bandwidth parameter sets the 3-dB bandwidth of the RBW filter. The ResolutionBWMode parameter must be set to Explicit in order to manually set the RBW.

Preset	0 Hz
Default Unit	Hz
Initial S/W Revision	A.14.00

Trigger Delay

Example	CALC:FPOW:POW1:DEF "TriggerDelay=0.025"
Notes	The trigger delay parameter sets the time after an external trigger is detected until the measurement is performed.
Preset	0 s
Range	0 - 1 s
Default Unit	Seconds
Initial S/W Revision	A.14.00

Trigger Level

Example	CALC:FPOW:POW1:DEF "TriggerLevel=2"
Notes	The trigger level parameter sets the voltage value at which an external trigger is detected.
Preset	1.2 V
Range	-5 to 5 V
Default Unit	Volts
Initial S/W Revision	A.14.00

Trigger Slope

Example	CALC:FPOW:POW1:DEF "TriggerSlope=Negative"
Notes	The trigger slope parameter indicates the direction of the edge trigger voltage for detection.
Preset	Positive
Range	Positive, Negative
Initial S/W Revision	A.14.00

Trigger Source

Example	CALC:FPOW:POW1:DEF "TriggerSource=Ext1"
Notes	The trigger source parameter allows the user to choose between measurement's triggering freely or controlled by an external input. Ext1 and Ext2 correspond to Trigger 1 In and Trigger 2 In, respectively.
Preset	Free
Range	Free, Ext1, Ext2
Initial S/W Revision	A.14.00

Trigger Timeout

Example	CALC:FPOW:POW1:DEF "TriggerTimeout=0.1"
Notes	The trigger timeout parameter sets the time in which the analyzer will wait for a trigger before automatically performing the measurement.
Preset	1 s
Range	0 – 1 s
Default Unit	Seconds
Initial S/W Revision	A.14.00

Signal Input

Example	CALC:FPOW:POW1:DEF "SignalInput=Fp50MHzCW"
Notes	The signal input parameter allows the user to select between using the main RF input or the internal analyzer reference CW signal of 50 MHz.
Preset	FpMainRf
Range	FpMainRf, Fp50MHzCW
Initial S/W Revision	A.14.00

Use Preselector

Example	CALC:FPOW:POW1:DEF "UsePreSelector=True"
Notes	The preselector parameter allows the user to either utilize or bypass the front end tunable filter at frequencies above 3.6 GHz. For frequencies below 3.6 GHz, the preselector is automatically bypassed, so you do not need to set this parameter to False in those cases.
Preset	False
Range	True (use preselector above 3.6 GHz), or False (preselector bypassed)

Default Unit	Boolean
Initial S/W Revision	A.14.00

Channel Bandwidth Array

Example	CALC:FPOW:POW1:DEF "Bandwidth=[3.84e6, 5e6, 3.84e6]"
Notes	The bandwidth parameter array defines the bandwidth of each channel that will be measured. All array parameters should have the same number of elements. Alternatively, if all the elements are the same value, a single number with no square brackets can be used to define the parameter.
Preset	[1e6]
Range	0 to 40 MHz
Default Unit	Hz
Initial S/W Revision	A.14.00

Channel Filter Type Array

Example	CALC:FPOW:POW1:DEF "FilterType=[RRC, IBW, RRC]"
Notes	The filter type parameter allows the user to choose between an integration bandwidth (IBW) filter or a root-raised-cosine (RRC) filter. The integration bandwidth filter weighs all frequencies within the bandwidth equally. The root-raised-cosine filter has an associated shape parameter, defined by the FilterAlpha parameter. All array parameters should have the same number of elements. Alternatively, if all the elements are the same value, a single value with no square brackets can be used to define the parameter.
Preset	[IBW]
Range	IBW, RRC
Initial S/W Revision	A.14.00

Channel Filter Alpha Array

Example	CALC:FPOW:POW1:DEF "FilterAlpha=[0.5, 0.0, 0.5]"
Notes	The filter alpha parameter allows the user to adjust the alpha value associated with the root-raised-cosine (RRC) filter type. Set FilterType to RRC in order to utilize this parameter. All array parameters should have the same number of elements. Alternatively, if all the elements are the same value, a single number with no square brackets can be used to define the parameter.
Preset	[0.22]
Range	0.0 - 1.0

Initial S/W Revision	A.14.00
-------------------------	---------

Channel Measurement Function Array

Example	CALC:FPOW:POW1:DEF "Function=[BandPower, PeakPower, BandPower]"
Notes	<p>This parameter array defines what measurement is being made for each individually-specified channel:</p> <p>BandPower: Total power within the specified bandwidth of the channel (dBm)</p> <p>BandDensity: Total power density within the specified bandwidth of the channel (dBm/Hz)</p> <p>PeakPower: The peak power value within the specified bandwidth of the channel (dBm)</p> <p>PeakFrequency: The frequency which corresponds to the peak power value within the specified bandwidth of the channel. This frequency is relative to the center frequency (Hz)</p> <p>XdBBandwidth: The half power (-3.01 dB) bandwidth of the highest amplitude signal that resides within the channel (Hz), dB is configurable using XdBBandwidth parameter</p> <p>OccupiedBandwidth: The bandwidth at which 99% of the total power resides within the channel (Hz), percentage configurable using OccupiedBandwidthPercent parameter</p> <p>All array parameters should have the same number of elements. Alternatively, if all the elements are the same value, a single value with no square brackets can be used to define the parameter.</p>
Preset	[BandPower]
Range	BandPower, BandDensity, PeakPower, PeakFrequency, XdBBandwidth, OccupiedBandwidth
Initial S/W Revision	A.14.00

Channel Offset Frequency Array

Example	CALC:FPOW:POW1:DEF "OffsetFrequency=[-5e6, 0, 5e6]"
Notes	<p>The offset frequency parameter array defines the difference between the center frequency to the center frequency of each channel.</p> <p>All array parameters should have the same number of elements.</p>
Preset	[0]
Range	0 to 20 MHz
Default Unit	Hz
Initial S/W Revision	A.14.00

Channel Occupied Bandwidth Percent Array

Example	CALC:FPOW:POW1:DEF "OccupiedBandwidthPercent =[0.95, 0.95, 0.95]"
Notes	This parameter only applies for channels whose Function is set to OccupiedBandwidth. The occupied

	bandwidth percent parameter specifies the percent of total power in these channels. The valid range for this parameter is 0.0 to 1.0, where 1.0 represents 100%. The default for this parameter is 0.99, which will return the bandwidth that contains 99% of the total channel power.
Preset	[0.99]
Range	0 - 1.0
Initial S/W Revision	A.14.00

Channel x-dB Bandwidth Array

Example	CALC:FPOW:POW1:DEF " XdBBandwidth =[-6.02, -3.01, -1.0]"
Notes	This parameter only applies for channels whose Function is set to XdBBandwidth. The X dB bandwidth parameter is used to specify the power relative to the peak channel power over which the bandwidth is calculated. The parameter value must be a negative number.
Preset	[-3.01]
Range	-200 to 0 dB
Default Unit	dB
Initial S/W Revision	A.14.00

Define Fast Power Measurement Query (Remote Command Only)

The DEFine? command is used to retrieve a list of all defined parameters in an ASCII string format

```

M All
o
d
e
-----
R :CALCulate:FPOWer:POWer[1,2,...,999]:DEFine?
e
m
o
t
e
C
o
m
m
a
n
d
-----
E :CALC:FPOW:POW1:DEF?

```

x
a
m
p
l
e

N This command query is used to retrieve a list of all defined parameters in an ASCII format.

O The following is an example of the returned results:

S "DCCoupled=False,ElecAttBypass=True,ElecAttenuation=0,IFGain=0,MechAttenuation=0,PreAmpMode=Off,PreSelectorOffset=0,UsePreSelector=False,ExternalReferenceFrequency=1000000,FrequencyReferenceSource=AutoExternalFrequencyReference,IFType=B40M,LOMode=SLW,SignalInput=FpMainRf,AcquisitionTime=0.001,CenterFrequency=100000000,ResolutionBW=0,ResolutionBWMode=BestSpeed,DetectorType=RmsAverage,Bandwidth=[1000000],OffsetFrequency=[0],Function=[BandPower],FilterType=[IBW],FilterAlpha=[0.22],OccupiedBandwidthPercent=[0.99],XdBBandwidth=[-3.01],DoNoiseCorrection=False,DoSpurSuppression=False,MeasurementMethod=HardwareFFT,IncludePowerSpectrum=False,TriggerDelay=0,TriggerLevel=1.2,TriggerSlope=Positive,TriggerSource=Free,TriggerTimeout=1"

I A.14.00

n
i
t
i
a
l

S
/
W

R
e
v
i
s
i
o
n

Configure Fast Power Measurement (Remote Command Only)

The configure command begins hardware setup and returns immediately, with no acquisition made. This can be used in parallel with other hardware operations to effectively hide the hardware setup time.

Mode	All
Remote Command	:CALCulate:FPOWER:POWER[1,2,...,999]:CONFigure
Example	:CALC:FPOW:POW1:CONF
Notes	Option FP2 is required.
Initial S/W Revision	A.14.00

Initiate Fast Power Measurement (Remote Command Only)

The INITiate command begins an acquisition and returns immediately. The results of the measurement can be retrieved using FETCh.

Mode	All
Remote Command	:CALCulate:FPOWer:POWer [1, 2, ..., 999] :INITiate
Example	:CALC:FPOW:POW1:INIT
Notes	Option FP2 is required.
Initial S/W Revision	A.14.00

Fetch Fast Power Measurement (Remote Command Only)

The FETCh command query is used to retrieve the results of an acquisition initiated by the INIT command. The returned results are in ASCII string format. The string begins and ends with quotation marks.

Mode	All
Remote Command	:CALCulate:FPOWer:POWer [1, 2, ..., 999] :FETCh?
Example	:CALC:FPOW:POW1:FETC?
Notes	Option FP2 is required. Returns m comma-separated ASCII values, where m corresponds to the number of bandwidths defined. 1. Declared function return in the 1st specified channel 2. Declared function return in the 2nd specified channel ... m. Declared function return in the last specified channel The INIT and FETC? command sequence performs the same functionality of a single CALC:FPOW:POW[n]? query. Units of the returned values are dependent on the Function parameter for each channel.
Initial S/W Revision	A.14.00

Execute Fast Power Measurement (Remote Command Only)

This command query is used as shorthand for an INIT command immediately followed by a FETC? command. The returned results are in ASCII string format. The string begins and ends with quotation marks.

Mode	All
Remote Command	:CALCulate:FPOWer:POWer [1, 2, ..., 999] ?
Example	:CALC:FPOW:POW1?

Notes	Option FP2 is required. See notes for Fast Power Fetch for return format.
Initial S/W Revision	A.14.00

Binary Read Fast Power Measurement (Remote Command Only)

This command query is used as shorthand for an INIT command immediately followed by a FETC? command. The returned results are in a binary format.

Mode	All
Remote Command	:CALCulate:FPOWER:POWER[1,2,...,999]:READ? :CALCulate:FPOWER:POWER[1,2,...,999]:READ1?
Example	:CALC:FPOW:POW1:READ? :CALC:FPOW:POW1:READ1?
Notes	Option FP2 is required. Returns m 4 byte floating point binary values (Little-Endian), where m corresponds to the number of bandwidths defined.
Initial S/W Revision	A.14.00

Diagnostic Binary Read Fast Power Measurement (Remote Command Only)

This command query is used as shorthand for an INIT command immediately followed by a FETC? command. The returned results are in a binary format. This command is used primarily for diagnostic purposes to test for ADC overloads and to visibly inspect the spectrum.

Mode	All
Remote Command	:CALCulate:FPOWER:POWER[1,2,...,999]:READ2?
Example	:CALC:FPOW:POW1:READ2?
Notes	Option FP2 is required. Note: Spectrum data is only returned if the IncludePowerSpectrum parameter is set to True. If IncludePowerSpectrum is False, the number of spectrum points will be zero (0). Units of the returned values are dependent on the Function parameter per channel (e.g. dBm for BandPower, Hz for PeakFrequency). Returns binary data (Little-Endian) that contains information on m amount of channels, along with ADC over range and full spectrum data. The following is the binary format of the response. Bandwidth Return Value 1. Number of channels specified, m [4 byte int] 2. Declared function result for the 1st specified channel [4 byte float]

	3. Declared function result for the 2nd specified channel [4 byte float]
	...
	(m + 1). Declared function result for the last (mth) specified channel [4 byte float]
	ADC Over Range
	1. ADC over-range occurred (1: true, 0: false) [2 byte short]
	Spectrum Data
	1. Number of points in the spectrum data, k [4 byte int]
	2. Start frequency of spectrum data (Hz) [8 byte double]
	3. Step frequency of spectrum data (Hz) [8 byte double]
	4. FFT bin at 1st point (dBm) [4 byte float]
	5. FFT bin at 2nd point (dBm) [4 byte float]
	...
	(k + 3). FFT bin at last (kth) point (dBm) [4 byte float]

Initial S/W Revision	A.14.00
-------------------------	---------

Format Data: Numeric Data (Remote Command Only)

This command specifies the format of the trace data input and output. It specifies the formats used for trace data during data transfer across any remote port. It affects only the data format for setting and querying trace data for the :TRACe[:DATA], TRACe[:DATA]?, :CALCulate:DATA[n]? and FETCh:SANalyzer [n]? commands and queries.

Remote Command	:FORMat [:TRACe] [:DATA] ASCii INTeger, 32 REAL, 32 REAL, 64 :FORMat [:TRACe] [:DATA] ?
Notes	The query response is: ASCii: ASC,8 REAL,32: REAL,32 REAL,64: REAL,64 INTeger,32: INT,32 When the numeric data format is REAL or ASCii, data is output in the current Y Axis unit. When the data format is INTeger, data is output in units of m dBm (.001 dBm). The INT,32 format returns binary 32-bit integer values in internal units (m dBm), in a definite length block.
Dependencies	Sending a data format spec with an invalid number (for example, INT,48) generates no error. The analyzer simply uses the default (8 for ASCii, 32 for INTeger, 32 for REAL). Sending data to the analyzer which does not conform to the current FORMat specified, results in an error. Sending ASCII data when a definite block is expected generates message -161 "Invalid Block Data" and sending a definite block when ASCII data is expected generates message -121 "Invalid Character in Number".
Preset	ASCii
Backwards Compatibility	Note that the INT,32 format is only applicable to the command, TRACe:DATA. This preserves

Notes	backwards compatibility for the Swept SA measurement. For all other commands/queries which honor FORMat:DATA, if INT,32 is sent the analyzer will behave as though it were set to REAL,32.
Initial S/W Revision	Prior to A.02.00

The specs for each output type follow:

ASCIi - Amplitude values are in ASCII, in the current Y Axis Unit, one ASCII character per digit, values separated by commas, each value in the form:

SX.YYYYYEsZZ

Where:

S = sign (+ or -)

X = one digit to left of decimal point

Y = 5 digits to right of decimal point

E = E, exponent header

s = sign of exponent (+ or -)

ZZ = two digit exponent

REAL,32 - Binary 32-bit real values in the current Y Axis Unit, in a definite length block.

REAL,64 - Binary 64-bit real values in the current Y Axis Unit, in a definite length block.

Format Data: Byte Order (Remote Command Only)

This command selects the binary data byte order for data transfer and other queries. It controls whether binary data is transferred in normal or swapped mode. This command affects only the byte order for setting and querying trace data for the :TRACe[:DATA], TRACe[:DATA]? , :CALCulate:DATA[n]? and FETCh:SANalyzer[n]? commands and queries.

By definition any command that says it uses FORMat:DATA uses any format supported by FORMat:DATA.

The NORMAl order is a byte sequence that begins with the most significant byte (MSB) first, and ends with the least significant byte (LSB) last in the sequence: 1|2|3|4. SWAPped order is when the byte sequence begins with the LSB first, and ends with the MSB last in the sequence: 4|3|2|1.

Remote Command	:FORMat:BORDER NORMAl SWAPped :FORMat:BORDER?
Preset	NORMAl
Initial S/W Revision	Prior to A.02.00

Meas Setup

Accesses the functions that allow you to change the settings for your measurement requirements.

Key Path	Front-panel key
Initial S/W Revision	Prior to A.02.00

Counts

Sets the accumulated number of sampling points for data acquisition. The range is 1.000 kpt (k point) to 2.00000 Gpt (G point) with 1 kpt resolution. Counts couples to Meas Cycles. When the value for counts is changed, the Meas Cycles value will be $(\text{Counts} / \text{SamplingFrequency} * \text{MeasInterval})$.

Key Path	Meas Setup
Mode	SA, WCDMA, C2K, WIMAXOFDMA, TD-SCDMA, 1xEV-DO, DVB-T/H, DTMB (CTTB), ISDB-T, CMMB, LTE, LTE-TDD, Digital Cable TV, WLAN, MSR, LTE-TDD, LTEAFDD
Remote Command	<code>[[:SENSE]:PStatistic:COUNTs <integer></code> <code>[[:SENSE]:PStatistic:COUNTs?</code>
Example	PST:COUN 5001 PST:COUN?
Couplings	This value is coupled to Meas Cycles. When Counts is changed, the MeasCycles value will be $(\text{Counts} / \text{SamplingFrequency} * \text{MeasInterval})$. TD-SCDMA: When Counts is changed, the MeasCycles value will be $(\text{Counts} / (\text{Sampling Frequency} * \text{Time duration of measured time slots} / 5 \text{ msec}))$, Time duration of measured time slots is determined by Analysis Time Slot and Measure Interval.
Preset	10000000
State Saved	Saved in instrument state.
Min	1000
Max	2000000000
Default Unit	Kpt
Initial S/W Revision	Prior to A.02.00
Modified at S/W Revision	A.02.00, A.03.00

Meas Cycles

Set the number of measurement cycles to calculate power statistic data. This number couples to Counts. The Counts value is $(\text{MeasCycles} * \text{Sampling Frequency} * \text{MeasInterval})$.

When the counts value cannot be divided by $(\text{Sampling Frequency} * \text{MeasInterval})$, this value is displayed as a decimal fraction.

Key Path	Meas Setup
----------	------------

Mode	SA, WCDMA, C2K, WiMAX OFDMA, TD-SCDMA, 1xEV-DO, DVB-T/H, DTMB (CTTB), ISDB-T, CMMB, LTE, LTE-TDD, Digital Cable TV, WLAN, MSR, LTE-TDD, LTE-FDD
Remote Command	[:SENSe] :PStatistic:SWEep:CYCLes <integer> [:SENSe] :PStatistic:SWEep:CYCLes?
Example	PST:SWE:CYCL 1001 PST:SWE:CYCL?
Notes	.
Couplings	The Counts value will be (MeasCycles * Sampling Frequency * MeasInterval). TD-SCDMA: The Counts value will be (MeasCycles * Sampling Frequency * Time duration of measured time slots / 5 msec), Time duration of measured time slots is determined by Analysis Time Slot and Measure Interval.
Preset	Depends on the sampling frequency.
Min	1
Max	Depends on the sampling frequency.
Initial S/W Revision	Prior to A.02.00
Modified at S/W Revision	A.02.00, A.03.00

Meas Interval (Not 1xEVDO)

Sets the number of data points to be used as the measurement interval. This value couples to Counts. The Counts value is (MeasCycles * Sampling Frequency * MeasInterval).

Key Path	Meas Setup
Mode	SA, WCDMA, C2K, WiMAX OFDMA, TD-SCDMA, DVB-T/H, DTMB (CTTB), ISDB-T, CMMB, LTE, LTE-TDD, Digital Cable TV, WLAN, MSR, LTE-TDD, LTE-FDD
Remote Command	[:SENSe] :PStatistic:SWEep:TIME <time> [:SENSe] :PStatistic:SWEep:TIME?
Example	PST:SWE:TIME 2 ms PST:SWE:TIME?
Couplings	The Counts value will be (MeasCycles * Sampling Frequency * MeasInterval). WiMAX OFDMA: The default value depends on Radio Device status. TD-SCDMA: The Counts value will be (MeasCycles * Sampling Frequency * Time duration of measured time slots / 5 msec), Time duration of measured time slots is determined by Analysis Time Slot and Measure Interval. When TriggerSource is RFBurst, this button is grayed.
Preset	Others: 1.0 ms TD-SCDMA: 1 slot LTE-TDD, LTE-TDD: 500 us
Min	Others: 50.0 us TD-SCDMA: 1 slot

Max	Others: 10.0 ms TD-SCDMA: 9 slot
Initial S/W Revision	Prior to A.02.00
Modified at S/W Revision	A.02.00, A.03.00

IF Gain

Sets the IF Gain function to Auto, Low Gain or High Gain. These settings affect sensitivity and IF overloads. This only applies to the RF input. It does not apply to baseband I/Q input.

Key Path	Meas Setup
Dependencies	The IF Gain keys (FFT IF Gain and Swept IF Gain) have no effect when the U7227A USB Preamplifier is connected. This is not annotated or reflected on any softkey; there are no keys grayed out nor any SCPI locked out. The analyzer simply behaves as though both FFT IF Gain and Swept IF Gain are set to Low regardless of the setting on the keys.
Initial S/W Revision	Prior to A.02.00

IF Gain Auto

Activates the Auto Rules for IF Gain When Auto is active, the IF Gain is set to High Gain under any of the following conditions:

- the input attenuator is set to 0 dB
- the preamp is turned On
- the Max Mixer Level is –20 dBm or lower

For other settings, Auto sets IF Gain to Off.

Key Path	Meas Setup, IF Gain
Mode	SA, WCDMA, C2K, WiMAX OFDMA, TD-SCDMA, 1xEV-DO, DVB-T/H, DTMB (CTTB), ISDB-T, CMMB, LTE, LTE-TDD, Digital Cable TV, WLAN, MSR, LTE-TDD, LTEAFDD
Remote Command	<code>[[:SENSE]:PSTatistic:IF:GAIN:AUTO[:STATE] ON OFF 1 0</code> <code>[[:SENSE]:PSTatistic:IF:GAIN:AUTO[:STATE]?</code>
Example	PST:IF:GAIN:AUTO ON PST:IF:GAIN:AUTO?
Notes	IF Gain only applies to the RF input. It does not apply to baseband I/Q input.
Couplings	When either the auto attenuation is active (for example, with electrical attenuator), or the optimize mechanical attenuator range is requested, the IF Gain setting is changed using the following rule. The Auto selection sets IF Gain On under any of the following conditions: <ul style="list-style-type: none"> • the input attenuator is set to 0 dB • the preamp is turned on,

	<ul style="list-style-type: none"> the Max Mixer Level is -20 dBm or lower. For other settings, Auto sets IF Gain to Off.
Preset	OFF
State Saved	Saved in instrument state.
Range	Auto Man
Initial S/W Revision	Prior to A.02.00
Modified at S/W Revision	A.02.00, A.03.00

IF Gain State

Selects the range of IF gain. On sets the high gain option, which allows for better noise level measurements and Off sets low gain when measuring large signals.

Key Path	Meas Setup, IF Gain
Mode	SA, WCDMA, C2K, WIMAXOFDMA, TD-SCDMA, 1xEV-DO, DVB-T/H, DTMB (CTTB), ISDB-T, CMMB, LTE, LTE-TDD, Digital Cable TV, WLAN, MSR, LTE-TDD, LTEAFDD
Remote Command	<code>[[:SENSE]:PStatistic:IF:GAIN[:STATE] ON OFF 1 0</code> <code>[[:SENSE]:PStatistic:IF:GAIN[:STATE]?</code>
Example	PST:IF:GAIN ON PST:IF:GAIN?
Notes	IF Gain only applies to the RF input. It does not apply to baseband I/Q input. where ON = high gain OFF = low gain
Preset	OFF
State Saved	Saved in instrument state.
Range	Low Gain (Best for Large Signals) High Gain (Best Noise Level)
Readback Text	Low Gain High Gain
Initial S/W Revision	Prior to A.02.00
Modified at S/W Revision	A.02.00, A.03.00

Meas Preset

Restores all measurement settings to their default values.

Key Path	Meas Setup
Mode	SA, WCDMA, C2K, WIMAXOFDMA, TD-SCDMA, 1xEV-DO, DVB-T/H, DTMB (CTTB), ISDB-T, CMMB, LTE, LTE-TDD, Digital Cable TV, WLAN, MSR, LTE-TDD, LTEAFDD
Remote Command	<code>:CONFigure:PStatistic</code>
Example	CONF:PST

Notes	You must be in the Spectrum Analysis mode, W-CDMA mode, cdma2000 mode, TD-SCDMA mode, DVB-T/H mode, DTMB (CTTB) mode, SDB-T mode, CMMB mode, Digital Cable TV mode or WIMAXOFDMA mode to use this command. Use :INSTRument:SElect to set the mode.
Couplings	Selecting Meas Preset will restore all measurement parameters to their default values.
Initial S/W Revision	Prior to A.02.00
Modified at S/W Revision	A.02.00, A.03.00

Mode

See "Mode" on page 276

Mode Preset

Returns the active mode to a known state.

Mode Preset does the following for the currently active mode:

- Aborts the currently running measurement.
- Brings up the default menu for the mode, with no active function.
- Sets measurement Global settings to their preset values for the active mode only.
- Activates the default measurement.
- Brings up the default menu for the mode.
- Clears the input and output buffers.
- Sets Status Byte to 0.

Mode Preset does not:

- Cause a mode switch
- Affect mode persistent settings
- Affect system settings
- See "[How-To Preset](#)" on page 2009 for more information.

Key Path	Front-panel key
Remote Command	:SYSTem:PRESet
Example	:SYST:PRES
Notes	*RST is preferred over :SYST: PRES for remote operation. *RST does a Mode Preset, as done by the :SYST:PRES command, and it sets the measurement mode to Single measurement rather than Continuous for optimal remote control throughput. Clears all pending OPC bits. The Status Byte is set to 0.
Couplings	A Mode Preset aborts the currently running measurement, activates the default measurement, and gets the mode to a consistent state with all of the default couplings set.
Backwards Compatibility Notes	In the X-Series, the legacy "Factory Preset" has been replaced with Mode Preset, which only presets the currently active mode, not the entire instrument. In the X-Series, the way to preset the entire instrument is by using System, Restore System Defaults All, which behaves essentially the same way as restore System Defaults does on ESA and PSA. There is also no "Preset Type" as there is on the PSA. There is a green Mode Preset front-panel key that does a Mode Preset and a white-with-green-letters User Preset front-panel key that does a User Preset. The old PRESet:TYPE command is ignored (without generating an error), and SYST:PRES without a parameter does a Mode Preset, which should cover most backward code compatibility issues. The settings and correction data under the Input/Output front-panel key (examples: Input Z Corr, Ext Amp Gain, etc.) are no longer part of any Mode, so they will not be preset by a Mode Preset. They are preset using Restore Input/Output Defaults, Restore System Defaults All. Note that because User Preset does a Recall State, and all of these settings are saved in State, they ARE recalled when using

	User Preset.
Initial S/W Revision	Prior to A.02.00

How-To Preset

The table below shows all possible presets, their corresponding SCPI commands and front-panel access (key paths). Instrument settings depend on the current measurement context. Some settings are local to the current measurement, some are global (common) across all the measurements in the current mode, and some are global to all the available modes. In a similar way, restoring the settings to their preset state can be done within the different contexts.

Auto Couple - is a measurement local key. It sets all Auto/Man parameter couplings in the measurement to Auto. Any Auto/Man selection that is local to other measurements in the mode will not be affected.

Meas Preset - is a measurement local key. Meas Preset resets all the variables local to the current measurement except the persistent ones.

Mode Preset - resets all the current mode's measurement local and measurement global variables except the persistent ones.

Restore Mode Defaults - resets ALL the Mode variables (and all the Meas global and Meas local variables), including the persistent ones.

Type Of Preset	SCPI Command	Front Panel Access
Auto Couple	:COUPlE ALL	Auto Couple front-panel key
Meas Preset	:CONFIgure:<Measurement>	Meas Setup Menu
Mode Preset	:SYSTem:PRESet	Mode Preset (green key)
Restore Mode Defaults	:INSTrument:DEFault	Mode Setup Menu
Restore All Mode Defaults	:SYSTem:DEFault MODEs	System Menu; Restore System Default Menu
*RST	*RST	not possible (Mode Preset with Single)
Restore Input/Output Defaults	:SYSTem:DEFault INPut	System Menu; Restore System Default Menu
Restore Power On Defaults	:SYSTem:DEFault PON	System Menu; Restore System Default Menu
Restore Alignment Defaults	:SYSTem:DEFault ALIGn	System Menu; Restore System Default Menu
Restore Miscellaneous Defaults	:SYSTem:DEFault MISC	System Menu; Restore System Default Menu
Restore All System Defaults	:SYSTem:DEFault [ALL] :SYSTem:PRESet:PERSistent	System Menu; Restore System Default Menu
User Preset	:SYSTem:PRESet:USER	User Preset Menu
User Preset All Modes	:SYSTem:PRESet:USER:ALL	User Preset Menu

Power On Mode Preset	:SYSTem:PON:TYPE MODE	System Menu
Power On User Preset	:SYSTem:PON:TYPE USER	System Menu
Power On Last State	:SYSTem:PON:TYPE LAST	System Menu

Preset Type (Remote Command Only)

As stated in the Backward Compatibility section, to be compatible with ESA/PSA the PRESet:TYPE command will be implemented as a no-op.

Mode	All
Remote Command	:SYSTem:PRESet:TYPE FACTory MODE USER :SYSTem:PRESet:TYPE?
Example	:SYST:PRESet:TYPE FACT
Notes	This command is supported for backward compatibility only. It is a no-op which does not change the behavior of any preset operation.
Preset	This is unaffected by Preset but is set to Mode on a "Restore System Defaults->All"
State Saved	No
Initial S/W Revision	Prior to A.02.00

Mode Setup

See ["Mode Setup" on page 306](#)

Peak Search

There is no 'Peak Search' functionality supported in Power Stat CCDF measurement. The front-panel key displays a blank menu when pressed.

Key Path	Front-panel key
Initial S/W Revision	Prior to A.02.00

Print

See "Print " on page 367

Quick Save

The Quick Save front-panel key repeats the most recent save that was performed from the Save menu, with the following exceptions:

- Register saves are not remembered as Saves for the purpose of the Quick Save function
- If the current measurement does not support the last non-register save that was performed, an informational message is generated, “File type not supported for this measurement”

Quick Save repeats the last type of qualified save (that is, a save qualified by the above criteria) in the last save directory by creating a unique filename using the Auto File Naming algorithm described below.

If Quick Save is pressed after startup and before any qualified Save has been performed, the Quick Save function performs a Screen Image save using the current settings for Screen Image saves (current theme, current directory), which then becomes the “last save” for the purpose of subsequent Quick Saves.

The Auto File Naming feature automatically generates a file name for use when saving a file. The filename consists of a prefix and suffix separated by a dot, as is standard for the Windows® file system. A default prefix exists for each of the available file types:

Type	Default Prefix	Menu
State	State_	(Save/Recall)
Trace + State	State_	(Save/Recall)
Screen	Screen_	(Save/Recall)
Amplitude Corrections	Ampcor_	(Import/Export)
Traces	Trace_	(Import/Export)
Limit Lines	LLine_	(Import/Export)
Measurement Result	MeasR_	(Import/Export)
Capture Buffer	CapBuf_	(Import/Export)

A four digit number is appended to the prefix to create a unique file name. The numbering sequence starts at 0000 within each Mode for each file type and updates incrementally to 9999, then wraps to 0000 again. It remembers where it was through a Mode Preset and when leaving and returning to the Mode. It is reset by Restore Misc Defaults and Restore System Defaults and subsequent running of the instrument application. So, for example, the first auto file name generated for State files is State_0000.state. The next is State_0001, and so forth.

One of the key features of Auto File Name is that we guarantee that the Auto File Name will never conflict with an existing file. The algorithm looks for the next available number. If it gets to 9999, then it looks for holes. If it find no holes, that is no more numbers are available, it gives an error.

For example, if when we get to State_0010.state there is already a State_0010.state file in the current directory, it advances the counter to State_0011.state to ensure that no conflict will exist (and then it verifies that State_0011.state also does not exist in the current directory and advances again if it does, and so forth).

If you enter a file name for a given file type, then the prefix becomes the filename you entered instead of the default prefix, followed by an underscore. The last four letters (the suffix) are the 4-digit number.

For example, if you save a measurement results file as “fred.csv”, then the next auto file name chosen for a measurement results save will be fred_0000.csv.

NOTE Although 0000 is used in the example above, the number that is used is actually the current number in the Meas Results sequence, that is, the number that would have been used if you had not entered your own file name.

NOTE If the filename you entered ends with _dddd, where d=any number, making it look just like an auto file name, then the next auto file name picks up where you left off with the suffix being dddd + 1.

Key Path	Front-panel key
Notes	No remote command for this key specifically.
Initial S/W Revision	Prior to A.02.00

Recall

In the MSR mode, two types of recall functions are available under the Data menu: Parameter Sets and Masks. Masks enables setting of a preset limit mask for Power Suite-based measurements, and currently it is available for the SEM, ACP and SPUR measurements in the MSR mode.

Key Path	Front Panel
Mode	MSR
Initial S/W Revision	A.10.00

State

The **Recall State** menu lets you choose a register or file from which to recall the state.

The content of a state file includes all of the settings and data required to return the analyzer as closely as possible to the Mode it was in, with the exact settings that were in place, when the save occurred. The Mode settings in each state file include the settings that are affected by Mode Preset, as well as the additional settings affected by Restore Mode Defaults; all of the Mode's settings. In addition, all of the settings of the **Input/Output** system are included, even though they are outside of the Mode's state, because they are needed to restore the complete setup. Persistent System settings (for example, GPIB address) are not affected by either a Mode Preset or Restore Mode Defaults, nor are they included in a saved State file.

Since each state file is only for one Mode, the settings for other Modes are unaffected when it is loaded. **Recall State** will cause a mode switch if the state being recalled is not from the current active mode.

After the recall completes, the message "File <filename> recalled" or "Recalled State Register <register number>" is displayed.

For rapid recalls, the State menu lists 16 registers that you can choose from to recall. Pressing a Register key initiates the recall. You can also select a file from which to recall.

The default path for all State Files is:

My Documents\<mode name>\state

where <mode name> is the parameter used to select the mode with the INST:SEL command (for example, SA for the Spectrum Analyzer).

See "[More Information](#)" on page 2017.

Key Path	Recall
Mode	All
Remote Command	:MMEMory:LOAD:STATe <filename>
Example	:MMEM:LOAD:STAT "myState.state" This recalls the file myState.state on the default path
Example	MMEM:LOAD:STAT "MyStateFile.state" This loads the state file data (on the default file directory path) into the instrument state.

Notes	<p>When you pick a file to recall, the analyzer first verifies that the file is recallable in the current instrument by checking the software version and model number of the instrument. If everything matches, a full recall proceeds by aborting the currently running measurement, clearing any pending operations, and then loading the State from the saved state file. You can open state files from any mode, so recalling a State file switches to the mode that was active when the save occurred. After switching to the mode of the saved state file, mode settings and data (if any for the mode) are loaded with values from the saved file. The saved measurement of the mode becomes the newly active measurement and the data relevant to the measurement (if there is any) is recalled.</p> <ul style="list-style-type: none"> • If there is a mismatch between file version or model number or instrument version or model number, the recall function tries to recall as much as possible and returns a warning message. It may limit settings that differ based on model number, licensing or version number. <p>After recalling the state, the Recall State function does the following:</p> <ul style="list-style-type: none"> • Makes the saved measurement for the mode the active measurement. • Clears the input and output buffers. • Status Byte is set to 0. • Executes a *CLS <p>If the file specified is empty an error is generated. If the specified file does not exist, another error is generated. If there is a mismatch between the file and the proper file type, an error is generated. If there is a mismatch between file version or model number or instrument version or model number, a warning is displayed. Then it returns to the State menu and File Open dialog goes away.</p> <p>After the Recall, the analyzer exits the Recall menu and returns to the previous menu.</p>
Backwards Compatibility SCPI	<p>:MMEMory:LOAD:STATe 1,<filename></p> <p>For backwards compatibility, the above syntax is supported. The "1" is simply ignored.</p>
Initial S/W Revision	Prior to A.02.00

More Information

In measurements that support saving Traces, for example, Swept SA, the Trace data is saved along with the State in the State file. When recalling the State, the Trace data is recalled as well. Traces are recalled exactly as they were stored, including the writing mode and update and display modes. If a Trace was updating and visible when the State was saved, it will come back updating and visible, and its data will be rewritten right away. When you use State to save and recall traces, any trace whose data must be preserved should be placed in View or Blank mode before saving.

The following table describes the Trace Save and Recall possibilities:

You want to recall state and one trace's data, leaving other traces unaffected.	Save Trace+State from 1 trace. Make sure that no other traces are updating (they should all be in View or Blank mode) when the save is performed.	On Recall, specify the trace you want to load the one trace's data into. This trace will load in View. All other traces' data will be unaffected, although their trace mode will be as it was when the state save was performed.
You want to recall all traces	Save Trace+State from ALL traces.	On Recall, all traces will come back in View (or Blank if they were in Blank or Background when

saved)

You want all traces to load exactly as they were when saved.

Save State

On recall, all traces' mode and data will be exactly as they were when saved. Any traces that were updating will have their data immediately overwritten.

From File...

When you press “From File”, the analyzer brings up a Windows dialog and a menu entitled “File Open.” This menu allows you to navigate to the various fields in the Windows dialog without using a keyboard or mouse. The **Tab** and **Arrow** keys can also be used for dialog navigation.

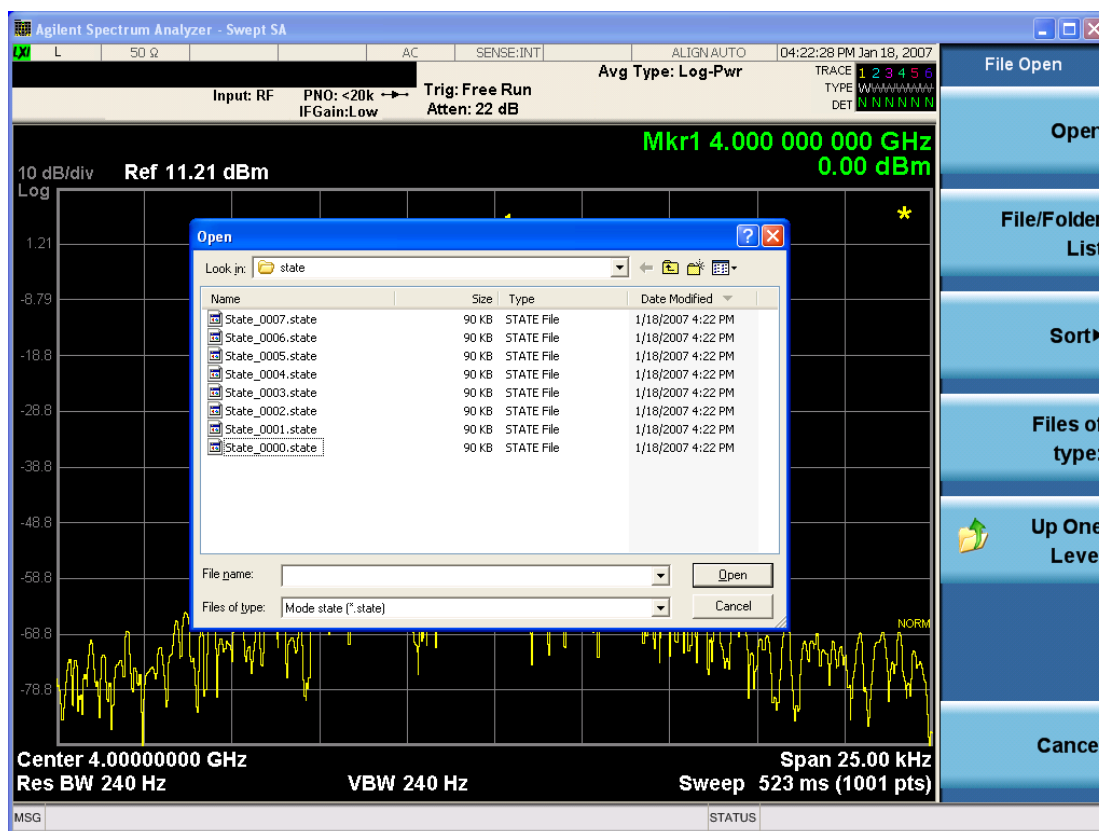

Listed below are the functions of the various fields in the dialog, and the corresponding softkeys:

Open

Performs the recall of the specified file. While the recall is being performed, the floppy icon appears briefly in the Meas bar.

File/Folder List

Enables you to navigate to the center of the dialog that contains the list of files and folders. Once here you can get information about the file and use the tab keys to navigate to the other fields in the dialog, such as Look In.

Look In

The **Look In** field shows the path from which the file will be recalled and allows you to change the path using the up and down arrow keys to navigate to other paths; the Enter key to open a directory; and the Backspace key to go back one directory. The **Look In field** first uses the last path from the Save As dialog **Save In:** path for that same file type. There is no softkey for directly navigating to the Look In field, but you can use the left tab to get here from the File/Folder List.

User specified paths are remembered when you leave and return to a Mode and are reset back to the default using **Restore Mode Defaults**.

Sort

Accesses a menu that enables you to sort the files within the File Open dialog. Only one sorting type can be selected at a time and the sorting happens immediately. The sorting types are **By Date, By Name, By extension, and By Size**.

Files of Type

This field shows the file suffix for the type of file you have selected to recall. For example, if you navigated here while recalling State, "Mode state (*.state)" is in the field. If you navigated here while recalling Trace, ""Mode state (*.trace)" is in the field. If you navigated here while importing a trace data file, "Trace Data (*.csv)" is in the field. For some file types, there is more than one choice in the dropdown menu, which you can select by using the up and down arrow keys and Enter.

Up One Level

This key corresponds to the icon of a folder with the up arrow that is in the tool bar of the dialog. When pressed, it causes the file and folder list to navigate up one level in the directory structure. The Backspace key does the same thing.

Cancel

This key corresponds to the **Cancel** selection in the dialog. It causes the current **Open** request to be cancelled. The ESC key does the same thing.

Key Path	Recall, State
Notes	Brings up the Open dialog for recalling a State Save Type
Initial S/W Revision	Prior to A.02.00

Edit Register Names

You may enter a custom name on any of the Register keys, to help you remember what you are using that state to save. To do this, press the **Edit Register Names** key, choose the register whose name you wish to edit, and then enter the desired label using the Alpha Editor or an external PC keyboard.

The maximum number of characters that can be added is 30. In most cases, 30 characters will fit on two lines of the key.

For more information and the SCPI command, see Edit Register Names under the **Save, State** function.

Key Path	Recall, State
Mode	All
Dependencies	N9060A-7FP or N9060B-2FP license required to edit the register names. When the feature is not licensed, sending the SCPI command generates an error, -221, "Settings conflict;Option not available"
Initial S/W Revision	A.11.00

Register 1 thru Register 16

Selecting any one of these register keys causes the State of the mode from the specified Register to be recalled. Each of the register keys annotates whether it is empty or at what date and time it was last modified. In addition, you can use the **Edit Register Names** key under **Save, State** to enter custom names for each register.

Registers are shared by all modes, so recalling from any one of the registers will cause a mode switch to the mode that was active when the save to the Register occurred.

Although these 16 registers are the only registers available from the front panel, there are 128 state registers available in the instrument. Registers 17–128 are only available from the SCPI interface, using the *RCL command.

After the recall completes, the message "Register <register number> recalled" appears in the message bar. If you are in the Spectrum Analyzer Mode, and you are recalling a register that was saved in the Spectrum Analyzer Mode, then after the recall, you will still be in the Recall Register menu. If the Recall causes you to switch modes, then after the Recall, you will be in the Frequency menu.

If a requested register is empty an error is generated.

Key Path	Recall, State
Example	*RCL 1
Range	1–16 from front panel, 1–128 from SCPI
Readback	Date and time with seconds resolution are displayed on the key OR A custom name of up to 30 characters entered using the Save, State,Edit Register Names key OR “(empty)” if no prior save operation has been performed to this register.
Initial S/W Revision	Prior to A.02.00
Modified at S/W Revision	Prior to A.11.00

Register 1 thru Register 16

Selecting any one of these register keys causes the State of the mode from the specified Register to be recalled. Each of the register keys annotates whether it is empty or at what date and time it was last

modified. In addition, you can use the **Edit Register Names** key under **Save, State** to enter custom names for each register.

Registers are shared by all modes, so recalling from any one of the registers will cause a mode switch to the mode that was active when the save to the Register occurred.

Although these 16 registers are the only registers available from the front panel, there are 128 state registers available in the instrument. Registers 17–128 are only available from the SCPI interface, using the *RCL command.

After the recall completes, the message "Register <register number> recalled" appears in the message bar. If you are in the Spectrum Analyzer Mode, and you are recalling a register that was saved in the Spectrum Analyzer Mode, then after the recall, you will still be in the Recall Register menu. If the Recall causes you to switch modes, then after the Recall, you will be in the Frequency menu.

If a requested register is empty an error is generated.

Key Path	Recall, State
Example	*RCL 1
Range	1–16 from front panel, 1–128 from SCPI
Readback	Date and time with seconds resolution are displayed on the key OR A custom name of up to 30 characters entered using the Save, State,Edit Register Names key OR “(empty)” if no prior save operation has been performed to this register.
Initial S/W Revision	Prior to A.02.00
Modified at S/W Revision	Prior to A.11.00

Data (Import)

Importing a data file loads data that was previously saved from the current measurement or from other measurements and/or modes that produce compatible data files. The Import Menu only contains Data Types that are supported by the current measurement.

Since the commonly exported data files are in .csv format, the data can be edited by the user prior to importing. This allows you to export a data file, manipulate the data in Excel (the most common PC Application for manipulating .csv files) and then import it.

Importing Data loads measurement data from the specified file into the specified or default destination, depending on the data type selected. Selecting an Import Data menu key will not actually cause the importing to occur, since the analyzer still needs to know from where to get the data. Pressing the Open key in this menu brings up the Open dialog and Open menu that provides you with the options from where to recall the data. Once a filename has been selected or entered in the Open menu, the recall occurs as soon as the Open button is pressed.

Key Path	Recall
Mode	All

Notes	The menu is built from whatever data types are available for the mode. Some keys will be missing completely, so the key locations in the sub-menu will vary. No SCPI command directly controls the Data Type that this key controls. The Data Type is included in the MMEM:LOAD commands.
Dependencies	If a file type is not used by a certain measurement, it is grayed out for that measurement. The key for a file type will not show at all if there are no measurements in the Mode that support it.
Preset	Is not affected by Preset or shutdown, but is reset during Restore Mode Defaults
Readback	The data type that is currently selected
Initial S/W Revision	Prior to A.02.00

Parameter Set

Enables you to import format parameter set data to specified format parameter sets. Selecting this key displays a menu that enables you to select the destination parameter set. After making this selection, depress Open... and use the file dialog to select the file you wish to recall.

Supported import file formats are dependent on radio formats.

LTE FDD: Format Parameter Set Files (*.fps), LTE FDD app state files (*.state), 89601 VSA Setup Files (*.set, *.setx) and Signal Studio Setup Files (*.scp)

W-CDMA:Format Parameter Set Files (*.fps) and W-CDMA app state files (*.state)

GSM/EDGE:Format Parameter Set Files (*.fps) and GSM/EDGE app state files (*.state)

cdma2000:Format Parameter Set Files (*.fps) and cdma2000 app state files (*.state)

1xEV-DO:Format Parameter Set Files (*.fps) and 1xEV-DO app state files (*.state)

LTE TDD: Format Parameter Set Files (*.fps), LTE TDD app state files (*.state), 89601 VSA Setup Files (*.set, *.setx) and Signal Studio Setup Files (*.scp)

TD-SCDMA:Format Parameter Set Files (*.fps) and TD-SCDMA app state files (*.state)

Format Parameter Set Files

Extention: fps

Basic file type of format parameter set. This file contains a format parameter set exported using Parameter Set under Recall, Data (Export). It is imported if the radio format of the file matches the destination radio format. If not, an error message, -230 "Data corrupt or stale", is issued with the specified file name.

App State Files

Extention: state

The state file of each mode can be imported to the corresponding parameter set. If the mode name in the state file matches the selected destination format, the state file data are imported. If not, an error message, -230 "Data corrupt or stale", is issued with the specified file name.

The parameters to be imported are ones referred in a particular measurement of each mode. The relevant measurements are listed below.

LTE FDD: Modulation Analysis

W-CDMA: Mod Accuracy

GSM/EDGE: EDGE EVM

cdma2000: Mod Accuracy

1xEV-DO: Mod Accuracy

LTE TDD: Modulation Analysis

TD-SCDMA: Mod Accuracy

Note that Integ BW and Measurement Noise BW parameters of ACP, SEM and CHP are not imported.

89601 VSA Setup Files

Extention: set, setx

The 89600 Vector Signal Analyzer Setup file created using the 89600 Vector Signal Analyzer Option BHD (LTE FDD)/Option BHE (LTE TDD) can be imported as LTE FDD/LTE TDD parameter set. If the setup file is not loaded successfully, an error message, -230 “Data corrupt or stale”, is issued with the specified file name.

Signal Studio Setup Files

Extention: scp

The Keysight Signal Studio setup file created using Signal Studio (N7624B/N7625B) can be imported as LTE FDD/LTE TDD parameter set. Supported carrier types are listed in the table below:

<i>Signal Studio</i>	<i>Carrier Type</i>
N7624B Signal Studio for 3GPP LTE	Advanced LTE FDD Downlink (2009-03)
	Advanced LTE FDD Downlink (2009-12)
	Advanced LTE FDD Downlink (2010-06)
	Advanced LTE FDD Uplink (2009-12)
	Advanced LTE FDD Uplink (2010-06)
	Basic LTE FDD Downlink (2009-03)
	Basic LTE FDD Downlink (2009-12)
	Basic LTE FDD Downlink (2010-06)
	Basic LTE FDD Uplink (2009-03)
	Basic LTE FDD Uplink (2009-12)
	Basic LTE FDD Uplink (2010-06)
N7625B Signal Studio for 3GPP LTE TDD	Advanced LTE TDD (2009-03)
	Advanced LTE TDD (2009-12)
	Basic LTE TDD (2009-03)
	Basic LTE TDD (2009-12)
	Basic LTE TDD R9
	Advanced LTE TDD R9

Basic LTE TDD R9 PRACH

If the setup file is not loaded successfully, an error message, -230 “Data corrupt or stale”, is issued with the specified file name.

Default path of this import type is “My Documents\MSR\data\params” folder. Note that “**My Documents**” is an alias to a directory and its location depends on which user is logged in. If the file path is specified without root folder, the import file is determined with the default path. For example if “folder1\paramData.prms” is specified, “My Documents\MSR\data\params\folder1\paramData.prms” is imported.

File Dialog Filter

Since supported import file formats differ between radio formats, file filters available in the open file dialog vary depending on the selected radio format. This table below defines file name filters available for each format.

<i>Radio Format</i>	<i>File Name Filters</i>
LTE FDD	All Supported Format Parameter Setup Files (*.fps; *.state; *.set; *.setx; *.scp) Format Parameter Setup Files (*.fps) State Files (*.state) 89601 VSA Setup Files (*.set; *.setx) Signal Studio Setup Files (*.scp)
W-CDMA	All Supported Format Parameter Setup Files (*.fps; *.state) Format Parameter Setup Files (*.fps) W-CDMA State Files (*.state)
GSM/EDGE	All Supported Format Parameter Setup Files (*.fps; *.state) Format Parameter Setup Files (*.fps) State Files (*.state)
cdma2000	All Supported Format Parameter Set Files (*.fps; *.state) Format Parameter Set Files (*.fps) State Files (*.state)
1xEV-DO	All Supported Format Parameter Set Files (*.fps; *.state) Format Parameter Set Files (*.fps) State Files (*.state)
LTE TDD	All Supported Format Parameter Setup Files (*.fps; *.state; *.set; *.setx; *.scp) Format Parameter Setup Files (*.fps) State Files (*.state) 89601 VSA Setup Files (*.set; *.setx) Signal Studio Setup Files (*.scp)
TD-SCDMA	All Supported Format Parameter Set Files (*.fps; *.state) Format Parameter Set Files (*.fps) State Files (*.state)

Key Path	Recall, Data
Mode	MSR
Remote Command	MMEMoRY:LOAD:PSET LTEFdd1 LTEFdd2 LTEFdd3 WCDMa1 WCDMa2 WCDMa3 GSM1 GSM2 GSM3 CDMA1 CDMA2 CDMA3 EVDO1 EVDO2 EVDO3 LTETdd1 LTETdd2 LTETdd3 TDSCdma1 TDSCdma2 TDSCdma3, <string>
Example	MMEM:LOAD:PSET LTEF1,"LTE FDD.set"
Notes	The first enum selects the destination format parameter set to which the file data are imported.
Initial S/W Revision	A.10.00
Modified at S/W Revision	A.12.00, A.16.00

Masks

This key enables you to recall a preset mask file which contains Offset and Limit settings. Parameters except them will not be overwritten. You cannot change or create preset mask files since they are binary files. This key is valid for the Spectrum Emission Mask, ACP and Spurious Emissions measurements.

Default path: "My Documents\MSR\data\masks"

Note that "My Documents" is an alias to a directory and its location depends on which user is logged in. At XSA start up, all of the limit mask files in the current user's "My Documents\MSR\data\masks" directory are overwritten.

File type: Binary

Filename: The filename follows the rule below with the words connected using underscores.

<Measurement>_<Condition>.mask

Where

<Measurement> Measurement the limit mask file is applied to: SEM, ACP or SPUR

<Condition> Condition. It depends on the measurement.

File extension: .mask

File Dialog Filter: Preset Mask Files (*.mask)

Selecting OPEN... under the Import Data menu opens the above directory enabling you to select a mask file.

Details of the masks are provided in a PDF file in the default folder of masks.

Key Path	Recall, Data
Mode	MSR
Remote Command	MMEMoRY:LOAD:MASK <string>
Example	MMEM:LOAD:MASK "ACP_BS\ACP_BS_3MHz_pairE-UTRA_CatA.mask"

Notes	Parameters related to Limit and Offset are overwritten by the contents of the preset mask file.
Initial S/W Revision	A.10.00

Open...

When you press “Open”, the analyzer brings up a Windows dialog and a menu entitled “**File Open.**” This menu allows you to navigate to the various fields in the Windows dialog without using a keyboard or mouse. The **Tab** and **Arrow** keys can also be used for dialog navigation.

See "[From File...](#)" on page 2454 in **Recall, State**, for a full description of this dialog and menu.

Key Path	Recall, Data
Notes	The key location is mode-dependent and will vary. Brings up Open dialog for recalling a <mode specific> Save Type
Initial S/W Revision	Prior to A.02.00

Restart

The Restart function restarts the current sweep, or measurement, or set of averaged/held sweeps or measurements. If you are Paused, pressing Restart does a Resume.

The Restart function is accessed in several ways:

- Pressing the Restart key
- Sending the remote command INIT:IMMEDIATE
- Sending the remote command INIT:RESTART

See "[More Information](#)" on page 2027

Key Path	Front-panel key
Remote Command	:INITiate[:IMMEDIATE] :INITiate:RESTART
Example	:INIT:IMM :INIT:REST
Notes	:INITiate:RESTART and :INITiate:IMMEDIATE perform exactly the same function.
Couplings	Resets average/hold count k. For the first sweep overwrites all active (update=on) traces with new current data. For application modes, it resets other parameters as required by the measurement.
Status Bits/OPC dependencies	This is an Overlapped command. The STATUS:OPERation register bits 0 through 8 are cleared. The STATUS:QUESTIONable register bit 9 (INTEgrity sum) is cleared. The SWEEPING bit is set. The MEASURING bit is set.
Backwards Compatibility Notes	For Spectrum Analysis mode in ESA and PSA, the Restart hardkey and the INITiate:RESTART command restart trace averages (displayed average count reset to 1) for a trace in Clear Write , but did not restart Max Hold and Min Hold . In the X-Series, the Restart hardkey and the INITiate:RESTART command restart not only Trace Average , but MaxHold and MinHold traces as well. For wireless comms modes in ESA and PSA, the Restart hardkey and the INITiate:RESTART command restart every measurement, which includes all traces and numeric results. There is no change to this operation.
Initial S/W Revision	Prior to A.02.00

More Information

The **Restart** function first aborts the current sweep/measurement as quickly as possible. It then resets the sweep and trigger systems, sets up the measurement and initiates a new data measurement sequence with a new data acquisition (sweep) taken once the trigger condition is met.

If the analyzer is in the process of aligning when **Restart** is executed, the alignment finishes before the restart function is performed.

Even when set for Single operation, multiple sweeps may be taken when Restart is pressed (for example, when averaging/holding is on). Thus when we say that **Restart** "restarts a measurement," we may mean:

- It restarts the current sweep
- It restarts the current measurement
- It restarts the current set of sweeps if any trace is in Trace Average, Max Hold or Min Hold
- It restarts the current set of measurements if Averaging, or Max Hold, or Min Hold is on for the measurement
- depending on the current settings.

With **Average/Hold Number** (in **Meas Setup** menu) set to 1, or Averaging off, or no trace in Trace Average or Hold, a single sweep is equivalent to a single measurement. A single sweep is taken after the trigger condition is met; and the analyzer stops sweeping once that sweep has completed. However, with **Average/Hold Number** > 1 and at least one trace set to **Trace Average, Max Hold, or Min Hold (SA Measurement)** or **Averaging on (most other measurements)**, multiple sweeps/data acquisitions are taken for a single measurement. The trigger condition must be met prior to each sweep. The sweep is stopped when the average count k equals the number N set for **Average/Hold Number**. A measurement average usually applies to all traces, marker results, and numeric results; but sometimes it only applies to the numeric results.

Once the full set of sweeps has been taken, the analyzer will go to idle state. To take one more sweep without resetting the average count, increment the average count by 1, by pressing the step up key while **Average/Hold Number** is the active function, or sending the remote command **CALC: AVER: TCON UP**.

Save

In the MSR mode, two types of save functions are available under the Data menu: Parameter Sets and Meas Results.

Key Path	Front Panel
Mode	MSR
Initial S/W Revision	Prior to A.10.00
Modified at S/W Revision	A.10.00

State

The Save State menu lets you choose a register or file for saving the state.

The content of a state file includes all of the settings and data required to return the analyzer as closely as possible to the Mode it was in, with the exact settings which were in place, when the save occurred. The Mode settings in each state file include the settings that are affected by Mode Preset, as well as the additional settings affected by Restore Mode Defaults; all of the Mode's settings. In addition, all of the settings of the **Input/Output** system are included, even though they are outside of the Mode's state, because they are needed to restore the complete setup. Persistent **System** settings (for example, Verbose SCPI) are not affected by either Mode Preset or Restore Mode Defaults, nor are they included in a saved State file.

After the save completes, the message "File <filename> saved" or "State Register <register number> saved" is displayed.

For rapid saving, the State menu lists 16 registers to save to. Pressing a Register key initiates the save. You can also select a file to save to.

The default path for all State Files is:

My Documents\<<mode name>\state

where <mode name> is the parameter used to select the mode with the INST:SEL command (for example, SA for the Spectrum Analyzer).

Key Path	Save
Mode	All
Remote Command	:MMEMory:STORe:STATe <filename>
Example	MMEM:STOR:STATe "MyStateFile.state" This stores the current instrument state data in the file MyStateFile.state in the default directory.
Notes	Both single and double quotes are supported for any filename parameter over remote. After saving to a register, that register's menu key is updated with the date the time, unless a custom label has been entered for that key. After saving to a register, you remain in the Save State menu, so that you can see the Register key update. After saving to a file, the analyzer automatically returns to the previous menu and any Save As dialog goes away.

Backwards Compatibility SCPI	:MMEMory:STORE:STATE 1,<filename> For backwards compatibility, the above syntax is supported. The "1" is simply ignored. The command is sequential.
Initial S/W Revision	Prior to A.02.00

To File . . .

When you press “To File”, the analyzer brings up a Windows dialog and a menu entitled “Save As.” This menu allows you to navigate to the various fields in the Windows dialog without using a keyboard or mouse. The **Tab** and **Arrow** keys can also be used for dialog navigation.

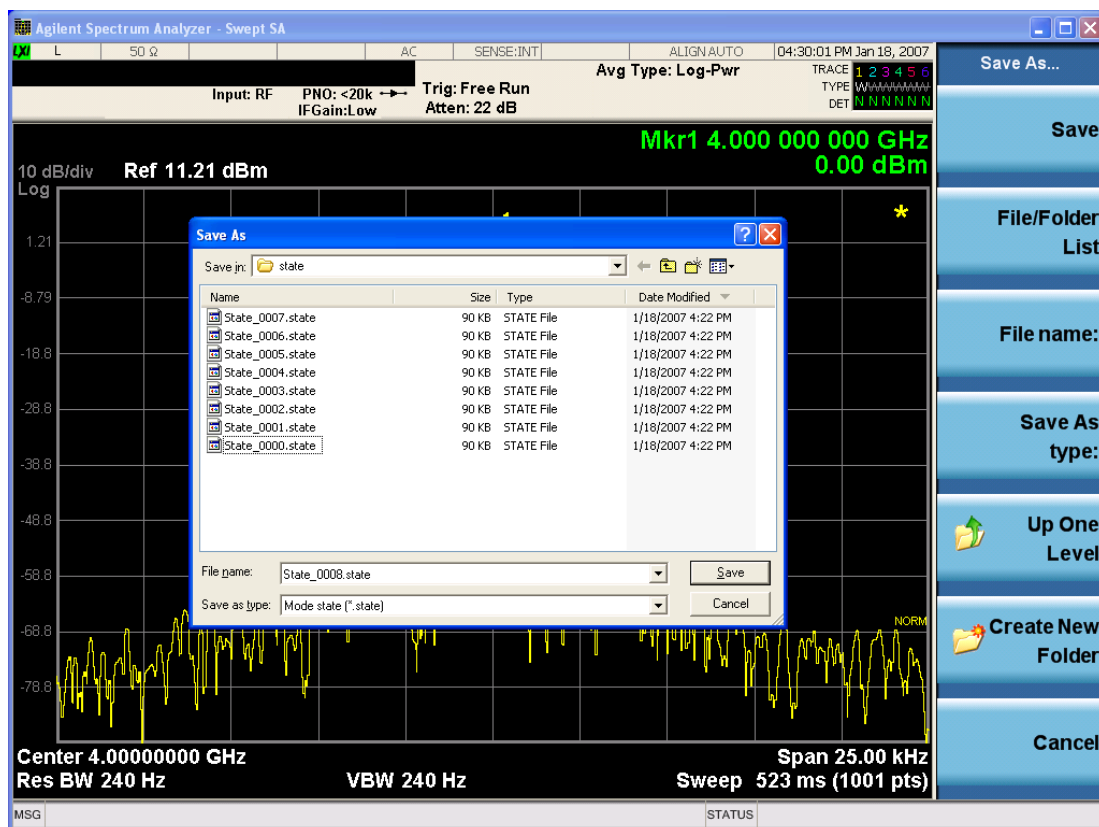

The Listed below

are the functions of the various fields in the dialog, and the corresponding softkeys:

Save

Performs the save to the specified file of the selected type. If the file already exists, a dialog will appear that allows you to replace the existing file by selecting **OK**, or you can Cancel the request. If you select OK, the file will be overwritten. Using the C: drive is strongly discouraged, since it runs the risk of being overwritten during an instrument software upgrade.

While the save is being performed, the floppy icon appears briefly in the Meas bar.

File/Folder List

Enables you to navigate to the center of the dialog that contains the list of files and folders. Once here you can get information about the file and use the tab keys to navigate to the other fields in the dialog, such as Save In.

Save In

The Save In field shows the path to which the file will be saved and allows you to change the path using the up and down arrow keys to navigate to other paths; the Enter key to open a directory; and the Backspace key to go back one directory. The **Save In field** defaults to the default path for this type of file and remembers the last path you used to save this type of file. There is no softkey for directly navigating to the Save In field but you can use left tab to get here from the File/Folder List.

User specified paths are remembered when you leave and return to a Mode and are reset back to the default using **Restore Mode Defaults**.

File Name

The **File Name** field is initially loaded with an automatically generated filename specific to the appropriate Save Type. The automatically generated filename is guaranteed not to conflict with any filename currently in the directory. You may replace or modify this filename using the File Name key. See the "[Quick Save](#)" on [page 2428](#) documentation for more on the automatic file naming algorithm.

When you press the **File Name** key the analyzer displays the Alpha Editor. Use the knob to choose the letter to add and the front-panel Enter key to add the letter to the file name. The BK character moves you back and the FW character moves you forward in the filename. The Select key on the front panel generates a space character. When you are done entering the filename press the **Done** softkey. This returns back to the **File Open** dialog and menu, but does not cause the save to occur.

Save As Type

This field shows the file suffix for the type of file you have selected to save. For example, if you navigated here while saving State, "Mode state (*.state)" is in the field. If you navigated here from saving Trace, ""Mode state (*.trace)" is in the field. If you navigated here while exporting a trace data file, "Trace Data (*.csv)" is in the field. For some file types, there is more than one choice in the dropdown, which you can select by using the up and down arrow keys and Enter.

Up One Level

This key corresponds to the icon of a folder with the up arrow that is in the tool bar of the dialog. When pressed, it causes the file and folder list to navigate up one level in the directory structure. The Backspace key does the same thing.

Create New Folder

This key corresponds to the icon of a folder with the "*" that is in the tool bar of the dialog. When pressed, a new folder is created in the current directory with the name **New Folder** and you can enter a new folder name using the Alpha Editor.

Cancel

This key corresponds to the **Cancel** selection in the dialog. It causes the current **Save As** request to be cancelled. The ESC key does the same thing.

Key Path	Save, State
----------	-------------

Mode	All
Notes	Brings up Save As dialog for saving a State Save Type
Initial S/W Revision	Prior to A.02.00

Edit Register Names

You may enter a custom name on any of the Register keys, to help you remember what you are using that state to save. To do this, press the **Edit Register Names** key, choose the register whose name you wish to edit, and then enter the desired label using the Alpha Editor or an external PC keyboard.

The maximum number of characters that can be added is 30. In most cases, 30 characters will fit on two lines of the key.

See ["More Information" on page 2032](#)

Key Path	Save, State
Mode	All
Remote Command	:MMEMory:REGister:STATe:LABel <reg number>,"label" :MMEMory:REGister:STATe:LABel? <reg number>
Example	:MMEM:REG:STAT:LAB 1,"my label"
Notes	<reg number> is an integer from 1 to 16. If the SCPI specifies an invalid register number an error message is generated, -222,"Data out of range;Invalid register label number" "label" is a string from 0 to 30 characters in length. If a label exceeds 30 characters, an error message is generated, -150,"String data error;Label clipped to 30 characters" "label" of length 0 erases the custom label and restores the default (time and date) label. E.g.: :MMEM:REG:STAT:LAB 1,""
Dependencies	N9060A-7FP or N9060B-2FP license required to edit the register names. When the feature is not licensed, sending this command generates an error, -221,"Settings conflict;Option not available"
Preset	The names are unaffected by Preset or power cycle but are set to the default label (time and date) on a "Restore System Defaults->Misc"
Initial S/W Revision	A.11.00

More Information

When you edit one of the register names, the time and date field will be replaced by the custom name.

If you delete all the characters in the custom name, it restores the default (time and date).

The register names are stored within the state files, but they are not part of the instrument state; that is, once you have edited a register name, loading a new state will not change that register name. Another consequence of this is that the names will be persistent through a power cycle. Also, if a named state file is transferred to another analyzer, it will bring its custom name along with it.

If you try to edit the name of an empty register, the analyzer will first save the state to have a file to put the name in. If you load a named state file into an analyzer with older firmware it will ignore the metadata.

The *SAV and *RCL commands will not be affected by the custom register names, nor will the MMEM commands.

Register 1 thru Register 16

Selecting any one of these register menu keys causes the State of the currently active mode to be saved to the specified Register. The registers are provided for rapid saving and recalling, since you do not need to specify a filename or navigate to a file. Each of the register menu keys annotates whether it is empty or at what date and time it was last modified. In addition, you can use the **Edit Register Names** key to enter custom names for each register.

Although these 16 registers are the only registers available from the front panel, there are 128 state registers available in the instrument. Registers 17–128 are only available from the SCPI interface, using the *SAV command.

There is one set of 128 state registers in the instrument, not one set for each Mode. When a state is saved, the Mode it was saved from is saved with it; then when it is recalled, the instrument switches to that Mode.

After the save completes, the corresponding register menu key annotation is updated with the date and time and the message "Register <register number> saved" is displayed.

Key Path	Save, State
Mode	All
Example	*SAV 1
Range	1–16 from front panel, 1–128 from SCPI
Readback	Date and time with seconds resolution are displayed on the key OR A custom name of up to 30 characters entered using the Edit Register Names key OR “(empty)” if no prior save operation has been performed to this register.
Initial S/W Revision	Prior to A.02.00
Modified at S/W Revision	A.11.00

Register 1 thru Register 16

Selecting any one of these register menu keys causes the State of the currently active mode to be saved to the specified Register. The registers are provided for rapid saving and recalling, since you do not need to specify a filename or navigate to a file. Each of the register menu keys annotates whether it is empty or at what date and time it was last modified. In addition, you can use the **Edit Register Names** key to enter custom names for each register.

Although these 16 registers are the only registers available from the front panel, there are 128 state registers available in the instrument. Registers 17–128 are only available from the SCPI interface, using the *SAV command.

There is one set of 128 state registers in the instrument, not one set for each Mode. When a state is saved, the Mode it was saved from is saved with it; then when it is recalled, the instrument switches to that Mode.

After the save completes, the corresponding register menu key annotation is updated with the date and time and the message "Register <register number> saved" is displayed.

Key Path	Save, State
Mode	All
Example	*SAV 1
Range	1-16 from front panel, 1-128 from SCPI
Readback	Date and time with seconds resolution are displayed on the key OR A custom name of up to 30 characters entered using the Edit Register Names key OR “(empty)” if no prior save operation has been performed to this register.
Initial S/W Revision	Prior to A.02.00
Modified at S/W Revision	A.11.00

Mass Storage Catalog (Remote Command Only)

Key path	SCPI Only
Remote Command	:MMEMory:CATalog? [<directory_name>]
Notes	The string must be a valid logical path. Queries disk usage information (drive capacity, free space available) and obtains a list of files and directories in a specified directory in the following format: <numeric_value>,<numeric_value>,{<file_entry>} It returns two numeric parameters and as many strings as there are files and directories. The first parameter indicates the total amount of storage currently used in bytes. The second parameter indicates the total amount of storage available, also in bytes. The <file_entry> is a string. Each <file_entry> indicates the name, type, and size of one file in the directory list: <file_name>,<file_type>,<file_size> As the windows file system has an extension that indicates file type, <file_type> is always empty. <file_size> provides the size of the file in bytes. For directories, <file_entry> is surrounded by square brackets and both <file_type> and <file_size> are empty
Initial S/W Revision	Prior to A.02.00

Mass Storage Change Directory (Remote Command Only)

Key path	SCPI Only
Remote Command	:MMEMory:CDIRectory [<directory_name>] :MMEMory:CDIRectory?
Notes	The string must be a valid logical path. Changes the default directory for a mass memory file system. The <directory_name> parameter is a string. If no parameter is specified, the directory is set to the *RST value.

	At *RST, this value is set to the default user data storage area, that is defined as System.Environment.SpecialFolder.Personal. Query returns full path of the default directory.
Initial S/W Revision	Prior to A.02.00

Mass Storage Copy (Remote Command Only)

Key path	SCPI Only
Remote Command	:MMEMory:COpy <string>,<string>[,<string>,<string>]
Notes	<p>The string must be a valid logical path.</p> <p>Copies an existing file to a new file or an existing directory to a new directory.</p> <p>Two forms of parameters are allowed. The first form has two parameters. In this form, the first parameter specifies the source, and the second parameter specifies the destination.</p> <p>The second form has four parameters. In this form, the first and third parameters specify the source. The second and fourth parameters specify the directories. The first pair of parameters specifies the source. The second pair specifies the destination. An error is generated if the source doesn't exist or the destination file already exists.</p> <p>This command will generate an "access denied" error if the destination is a restricted folder (e.g., C:\Windows) and the current user does not have Power User or Administrator privileges.</p>

Mass Storage Device Copy (Remote Command Only)

This command transfers data to/from a file and a peripheral device.

Key path	SCPI Only
Remote Command	:MMEMory:COpy:DEvice <source_string>,<dest_string>
Notes	<p>The strings must be a valid logical path or a valid device keyword. If the dest_string is a device keyword, the data is copied from the source file to the device. If the source_string is a device keyword, the data is copied to the source file from the device.</p> <p>Valid device keywords are: SNS (smart noise source)</p> <p>An error is generated if the file or device is not found.</p>

Mass Storage Delete (Remote Command Only)

Key path	SCPI Only
Remote Command	:MMEMory:DElete <file_name>[,<directory_name>]
Notes	<p>The string must be a valid logical path.</p> <p>Removes a file from the specified directory. The <file_name> parameter specifies the file name to be removed. This command will generate an "access denied" error if the file is in a restricted folder (e.g.,</p>

	C:\Windows) and the current user does not have Power User or Administrator privileges.
Initial S/W Revision	Prior to A.02.00

Mass Storage Data (Remote Command Only)

Creates a file containing the specified data OR queries the data from an existing file.

Key path	SCPI Only
Remote Command	:MMEMory:DATA <file_name>, <data> :MMEMory:DATA? <file_name>
Notes	The string must be a valid logical path. The command form is MMEMory:DATA <file_name>,<data>. It loads <data> into the file <file_name>. <data> is in 488.2 block format. <file_name> is string data. The query form is MMEMory:DATA? <file_name> with the response being the associated <data> in block format.
Initial S/W Revision	Prior to A.02.00

Mass Storage Make Directory (Remote Command Only)

Key path	SCPI Only
Remote Command	:MMEMory:MDIRectory <directory_name>
Notes	The string must be a valid logical path. Creates a new directory. The <directory_name> parameter specifies the name to be created. This command will generate an “access denied” error if the new directory would be in a restricted folder (e.g., C:\Windows) and the current user does not have Power User or Administrator privileges.
Initial S/W Revision	Prior to A.02.00

Mass Storage Move (Remote Command Only)

Key path	SCPI Only
Remote Command	:MMEMory:MOVE <string>,<string>[,<string>,<string>]
Notes	The string must be a valid logical path. Moves an existing file to a new file or an existing directory to a new directory. Two forms of parameters are allowed. The first form has two parameters. In this form, the first parameter specifies the source, and the second parameter specifies the destination. The second form has four parameters. In this form, the first and third parameters specify the source. The second and fourth parameters specify the directories. The first pair of parameters specifies the source. The second pair specifies the destination. An error is generated if the source doesn't exist or the destination file already exists.

This command will generate an “access denied” error if the destination is a restricted folder (e.g., C:\Windows) and the current user does not have Power User or Administrator privileges.

Initial S/W Revision Prior to A.02.00

Mass Storage Remove Directory (Remote Command Only)

Key path **SCPI Only**

Remote Command :MMEMory:RDIrectory <directory_name>

Notes The string must be a valid logical path.

Removes a directory. The <directory_name> parameter specifies the directory name to be removed. All files and directories under the specified directory shall also be removed.

This command will generate an “access denied” error if the folder is a restricted folder (e.g., C:\Windows) or is in a restricted folder and the current user does not have Power User or Administrator privileges.

Initial S/W Revision Prior to A.02.00

Mass Storage Determine Removable Media (Remote Command Only)

This command is used to determine if any removable media devices are connected to the instrument. Primarily, these are USB memory devices plugged-in to the front panel or rear panel USB ports. On instruments with PC6 or PC7 CPU's, one SD card slot is available for removable media. The instrument's primary disk drive is not a removable media device.

Key Path **SCPI Only**

Remote Command :MMEMory:RMEDia:LIST?

Notes The return value will be a string containing a list of partition identifiers which are removable media devices. Each identifier will be separated by a comma. If no removable media is present, an empty string will be returned.

Examples:

One removable device present will result in a return string of “F:”.

Two removable devices present will result in a return string of “F:,G:”.

No removable devices present will result in a return string of “”.

Initial S/W Revision x.15.00

Mass Storage Determine Removable Media Label (Remote Command Only)

This command is used to set or query a removable media device's label.

Key Path **SCPI Only**

Remote Command	:MMEMory:RMEDia:LABel <partition>,<string> :MMEMory:RMEDia:LABel? <partition>
Example	MMEM:RMED:LAB "F:","My Device"
Notes	If the <partition> specified does not exist or is not a removable media device the error -252,"Missing Media" will be generated. Setting the removable media label requires Administrative privileges. If the currently logged in user does not have appropriate privileges the error "-221.9900,Settings conflict;Administrator privileges required" is generated.
Initial S/W Revision	x.15.00

Mass Storage Determine Removable Media Write-protect status (Remote Command Only)

This command is used to query a removable media device's write-protect status.

Key Path	SCPI Only
Remote Command	:MMEMory:RMEDia:WPRotect? <partition>
Example	MMEM:RMED:WPR? "F:"
Notes	The return value is 1 if the device is write-protected, and 0 if the device is write-enabled. If the <partition> specified does not exist or is not a removable media device the error -252,"Missing Media" will be generated.
Preset	The return value will be depending on SD card installed.
Initial S/W Revision	x.15.00

Mass Storage Determine Removable Media size (Remote Command Only)

This command is used to query a removable media device's total memory size (not available memory size).

Key Path	SCPI Only
Remote Command	:MMEMory:RMEDia:SIZE? <partition>
Example	MMEM:RMED:SIZE? "F:"
Notes	The return value is integer value in GBytes. Any device which is less than 1 GB will return 0 GB. If the <partition> specified does not exist or is not a removable media device the error -252,"Missing Media" will be generated.
Initial S/W Revision	x.15.00

Trace (+State)

The **Save Trace (+State)** menu lets you choose a register or file specifying where to save the Trace+State state file.

A saved state contains all of the settings and data required to return the analyzer as closely as possible to the exact setup it had when the save occurred. This includes the Input/Output settings, even though they are outside of the Mode's state, because they are needed to restore the complete setup. A Trace+State file also includes trace data from one trace or all traces, which will load in View mode when the Trace+State file is recalled.

After the save completes, the message "File <filename> saved" or "Trace Register <register number> saved" is displayed.

For rapid saves, the Trace (+State) menu lists 5 registers to save to. Pressing a Register key initiates the save. You can also select a file to save to.

The default path for all State Files including .trace files is:

My Documents\<mode name>\state

where <mode name> is the parameter used to select the mode with the INST:SEL command (for example, Basic for the IQAnalyzer).

This key is grayed out for measurements that do not support trace saves. It is blanked for modes that do not support trace saves. Saving **Trace** is identical to saving State except a .trace extension is used on the file instead of .state, and internal flags are set in the file indicating which trace was saved. You may select to save one trace or ALL traces.

Key Path	Save
Mode	SA
Remote Command	:MMEMory:STORe:TRACe TRACE1 TRACE2 TRACE3 TRACE4 TRACE5 TRACE6 ALL,<filename> :MMEMory:STORe:TRACe:REGister TRACE1 TRACE2 TRACE3 TRACE4 TRACE5 TRACE6 ALL,<integer>
Example	:MMEM:STOR:TRAC TRACE1, "myState.trace" saves the file myState.trace on the default path and flags it as a "single trace" file with Trace 1 as the single trace (even though all of the traces are in fact stored). :MMEM:STOR:TRAC ALL, "myState.trace" saves the file myState.trace on the default path and flags it as an "all traces" file :MMEM:STOR:TRAC:REG TRACE1, 2 stores trace 1 data in trace register 2
Notes	This command actually performs a save state, which in the Swept SA measurement includes the trace data. However it flags it (in the file) as a "save trace" file of the specified trace (or all traces). Some modes and measurements do not have available all 6 traces. The Phase Noise mode command, for example, is: MMEMory:STORe:TRACe TRACE1 TRACE2 TRACE3 ALL,<filename> Some modes and measurements have more than 6 traces available. The Realtime SA mode command, for example, is: MMEMory:STORe:TRACe TRACE1 TRACE2 TRACE3 TRACE4 TRACE5 TRACE6 TRACE7 TRACE8 TRACE9 TRACE10 TRACE11 TRACE12 ALL,<filename> The range for the register parameter is 1-5 When you initiate a save, if the file already exists, a dialog will appear that allows you to replace the existing file by selecting OK or you can Cancel the request. If you select OK, the file will be overwritten. Using the C: drive is strongly discouraged, since it runs the risk of being overwritten during an instrument software upgrade. Both single and double quotes are supported for any filename parameter over remote.

After saving to a register, that register's menu key is updated with the date and time of the save.
After saving to a register, you remain in the **Save Trace** menu, so that you can see the Register key update. After saving to a file, the analyzer automatically returns to the previous menu and any Save As dialog goes away.

Initial S/W Revision	Prior to A.02.00
----------------------	------------------

From Trace

Accesses a menu that enables you to select the trace to be saved. Once a trace is selected, the key returns to the Save Trace menu and the selected trace number is annotated on the key. The default is the currently selected trace, selected in this menu or in the Trace/Det, Export Data, Import Data or Recall Trace menus, except if you have chosen All then it remains chosen until you specifically change it to a single trace. To save the Trace you must select the **Save As** key in the Save Trace menu.

When you select a trace, it makes that trace the current trace, so it displays on top of all of the other traces.

Key Path	Save, Trace + State
Mode	SA
Initial S/W Revision	Prior to A.02.00

From File...

When you press "From File", the analyzer brings up a Windows dialog and a menu entitled "**File Open.**" This menu allows you to navigate to the various fields in the Windows dialog without using a keyboard or mouse. The **Tab** and **Arrow** keys can also be used for dialog navigation.

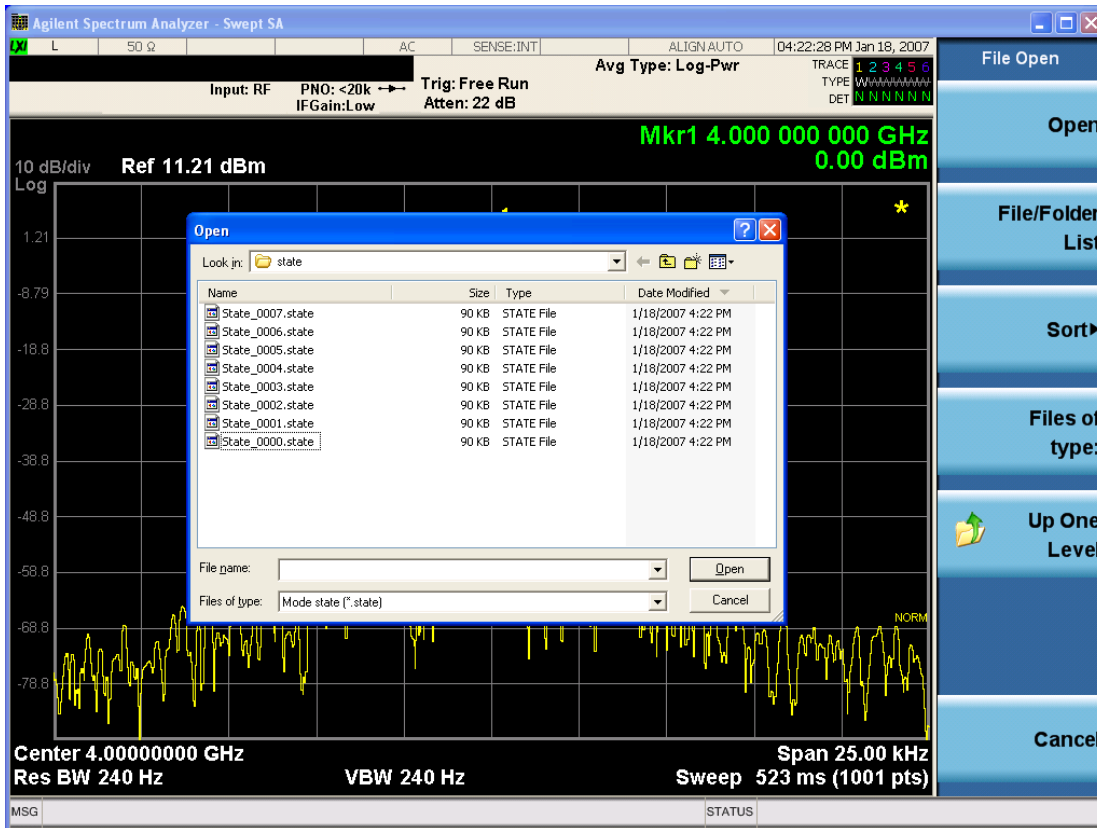

Listed below are the functions of the various fields in the dialog, and the corresponding softkeys:

Open

Performs the recall of the specified file. While the recall is being performed, the floppy icon appears briefly in the Meas bar.

File/Folder List

Enables you to navigate to the center of the dialog that contains the list of files and folders. Once here you can get information about the file and use the tab keys to navigate to the other fields in the dialog, such as Look In.

Look In

The **Look In** field shows the path from which the file will be recalled and allows you to change the path using the up and down arrow keys to navigate to other paths; the Enter key to open a directory; and the Backspace key to go back one directory. The **Look In field** first uses the last path from the Save As dialog **Save In:** path for that same file type. There is no softkey for directly navigating to the Look In field, but you can use the left tab to get here from the File/Folder List.

User specified paths are remembered when you leave and return to a Mode and are reset back to the default using **Restore Mode Defaults**.

Sort

Accesses a menu that enables you to sort the files within the File Open dialog. Only one sorting type can be selected at a time and the sorting happens immediately. The sorting types are **By Date**, **By Name**, **By extension**, and **By Size**.

Files of Type

This field shows the file suffix for the type of file you have selected to recall. For example, if you navigated here while recalling State, "Mode state (*.state)" is in the field. If you navigated here while recalling Trace, ""Mode state (*.trace)" is in the field. If you navigated here while importing a trace data file, "Trace Data (*.csv)" is in the field. For some file types, there is more than one choice in the dropdown menu, which you can select by using the up and down arrow keys and Enter.

Up One Level

This key corresponds to the icon of a folder with the up arrow that is in the tool bar of the dialog. When pressed, it causes the file and folder list to navigate up one level in the directory structure. The Backspace key does the same thing.

Cancel

This key corresponds to the **Cancel** selection in the dialog. It causes the current **Open** request to be cancelled. The ESC key does the same thing.

Key Path	Recall, State
Notes	Brings up the Open dialog for recalling a State Save Type
Initial S/W Revision	Prior to A.02.00

Register 1 thru Register 16

Selecting any one of these register menu keys causes the State of the currently active mode to be saved to the specified Register. The registers are provided for rapid saving and recalling, since you do not need to specify a filename or navigate to a file. Each of the register menu keys annotates whether it is empty or at what date and time it was last modified. In addition, you can use the **Edit Register Names** key to enter custom names for each register.

Although these 16 registers are the only registers available from the front panel, there are 128 state registers available in the instrument. Registers 17–128 are only available from the SCPI interface, using the *SAV command.

There is one set of 128 state registers in the instrument, not one set for each Mode. When a state is saved, the Mode it was saved from is saved with it; then when it is recalled, the instrument switches to that Mode.

After the save completes, the corresponding register menu key annotation is updated with the date and time and the message "Register <register number> saved" is displayed.

Key Path	Save, State
Mode	All
Example	*SAV 1
Range	1–16 from front panel, 1–128 from SCPI

Readback	Date and time with seconds resolution are displayed on the key OR A custom name of up to 30 characters entered using the Edit Register Names key OR “(empty)” if no prior save operation has been performed to this register.
Initial S/W Revision	Prior to A.02.00
Modified at S/W Revision	A.11.00

Data (Export)

Exporting a data file stores data from the current measurement to mass storage files. The Export Menu only contains data types that are supported by the current measurement.

Since the commonly exported data files are in .csv format, the data can be edited by you prior to importing. This allows you to export a data file, manipulate the data in Excel (the most common PC Application for manipulating .csv files) and then import it.

Selecting an Export Data menu key will not actually cause the exporting to occur, since the analyzer still needs to know where you wish to save the data. Pressing the Save As key in this menu brings up the Save As dialog and Save As menu that allows you to specify the destination file and directory. Once a filename has been selected or entered in the Open menu, the export will occur as soon as the Save key is pressed.

Key Path	Save
Mode	All
Notes	The menu is built from whatever data types are available for the mode. So the key locations in the sub menu will vary. No SCPI command directly controls the Data Type that this key controls. The Data Type is included in the MMEM:STORe commands.
Dependencies	If a file type is not used by a certain measurement, that type is grayed out for that measurement. The key for a file type will not show at all if there are no measurements in the Mode that support it.
Preset	Is not affected by a Preset or shutdown, but is reset during Restore Mode Defaults
Readback	The data type that is currently selected
Initial S/W Revision	Prior to A.02.00

Parameter Set

Enables you to export format parameter set data to files. Selecting this key displays a menu that enables you to select the data source. After making this selection, depress Save As... and use the file dialog to enter the file name to save. You can import the exported file by selecting Parameter Set under Recall, Data.

Default path:

Default path of this import type is “My Documents\MSR\data\params” folder. Note that “My Documents” is an alias to a directory and its location depends on which user is logged in. If the file path is specified without root folder, the export file is determined with the default path. For example if “folder1\paramData.prms” is specified, “My Documents\MSR\data\params\folder1\paramData.fps” is exported.

File Extension: fps

Default Prefix: ParamSet_

File Dialog Filter: Format Parameter Set Files (*.fps)

Key Path	Save, Data
Mode	MSR
Remote Command	MMEMory:STORe:PSET LTEFdd1 LTEFdd2 LTEFdd3 WCDMa1 WCDMa2 WCDMa3 GSM1 GSM2 GSM3 CDMA1 CDMA2 CDMA3 EVDO1 EVDO2 EVDO3 LTETdd1 LTETdd2 LTETdd3 TDSCdma1 TDSCdma2 TDSCdma3,<string>
Example	MMEM:STOR:PSET WCDM1,"WCDMA.fps"
Notes	The first enum selects the source format parameter set from which the file data are exported.
Initial S/W Revision	A.10.00
Modified at S/W Revision	A.12.00, A.16.00

Measurement Results

Pressing this key selects Meas Results as the data type to be exported.

The Meas Results file contains measurement result sets, plus information describing the current state of the analyzer, as detailed in ["Meas Results File Definition" on page 2045](#) and ["Meas Results File Example" on page 2046](#) below.

Key Path	Save, Data
Remote Command	:MMEMory:STORe:RESults <string>
Example	:MMEM:STOR:RES "MeasR_0000.csv"
Notes	If the save is initiated via SCPI and the file already exists, the file will be overwritten. The SCPI command exports Power Stat CCDF measurement results to the file specified as the parameter in the current path. The default path is My Documents\<current mode>\data\PST\results. Using the C: drive is strongly discouraged, since it runs the risk of being overwritten during an instrument software upgrade. The SCPI parameter is a quoted string that specifies the filename. Both single and double quotes are supported for any filename parameter over SCPI.
Dependencies	The current active measurement must be the Power Stat CCDF measurement to use this command.
Status Bits/OPC dependencies	Sequential – waits for the previous measurement to complete
Initial S/W Revision	Prior to A.02.00

Meas Results File Definition

The content of a Meas Results File is defined in this section.

The first lines in the file consist of identification and instrument configuration details, as follows.

- File ID string, which is “MeasResult”
- Measurement ID following Mode ID, which is “SA:PST” for example.
- Firmware rev and model number
- Option string
- Automatic Trigger Time
- Automatic Trigger Time State
- CcdfCurrentCounts
- Center Frequency
- Center Frequency Step
- Center Frequency Step State
- Counts
- Electrical Atten
- Electrical Atten State
- External Array Trigger Delay
- External Array Trigger Delay State
- External Array Trigger Level
- External Array Trigger Slope
- Gaussian Line
- IF Gain Auto
- IF Gain State
- Info BW
- Internal Preamp
- Internal Preamp Band
- Line Trigger Delay
- Line Trigger Delay State
- Line Trigger Slope
- Meas Cycles
- MeasInterval

- Mechanical Atten
- MechanicalAttenStepEnum
- Periodic Timer Period
- Periodic Timer Sync Source
- Periodic Timer Trigger Delay
- Periodic Timer Trigger Delay State
- Preselector Adjust
- Ref Trace
- RFBurst Trigger Delay
- RFBurst Trigger Delay State
- RFBurst Trigger Level Abs
- RFBurst Trigger Level Rel
- RFBurst Trigger Level Type
- RFBurst Trigger Slope
- Scale/Div
- Trigger Holdoff
- Trigger Holdoff State
- TriggerSource

The data above is followed in the file by a line containing “MeasResult1” to “MeasResult4”. This line forms a header for each set of measurement results, which appear in subsequent lines. Each line of Measurement Results consists of 4 comma-separated values, from the MeasResult1 value to the MeasResult4 value.

The MeasResult1 set in the file corresponds to the data returned by MEAS|READ|FETCh:PStatistic1; the MeasResult2 set corresponds to the data returned by MEAS|READ|FETCh:PStatistic2, and so on.

The exported file is in CSV format, with a .csv extension.

Meas Results File Example

When imported into Microsoft Excel, a typical Meas Results CSV file appears as shown in the example below.

MeasResult	
SA:PST	
A.10.53	N9030A
526 ALV ATP B1X B1Y B25 B40 BBA CR3 CRP DCF DDA DP2 DRD EA3 EDP EMC EP1	1

ERC ESC ESP EXM FSA LFE LNP MAT MPB NFE NUL P26 PFR PNC RTL RTS S40 SB1 SEC SM1 TVT YAS YAV			
Automatic Trigger Time	0.1		
Automatic Trigger Time State	FALSE		
CcdfCurrentCounts	6087500		
Center Frequency	1.33E+10		
Center Frequency Step	5000000		
Center Frequency Step State	TRUE		
Counts	10000000		
Electrical Atten	0		
Electrical Atten State	FALSE		
External Array Trigger Delay	1.00E-06	1.00E-06	
External Array Trigger Delay State	FALSE	FALSE	
External Array Trigger Level	1.2	1.2	
External Array Trigger Slope	Positive	Positive	
Gaussian Line	TRUE		
IF Gain AUto	FALSE		
IF Gain State	FALSE		
Info BW	5000000		
Internal Preamp	FALSE		
Internal Preamp Band	Low		
Line Trigger Delay	1.00E-06		
Line Trigger Delay State	FALSE		
Line Trigger Slope	Positive		
Meas Cycles	1600		
MeasInterval	0.001		
Mechanical Atten	10		
MechanicalAttenStepEnum	S2dB		
Periodic Timer Period	0.02		
Periodic Timer Sync Source	None		
Periodic Timer Trigger Delay	1.00E-06		
Periodic Timer Trigger Delay State	FALSE		
Preselector Adjust	0		

Ref Trace	FALSE		
RFBurst Trigger Delay	1.00E-06		
RFBurst Trigger Delay State	FALSE		
RFBurst Trigger Level Abs	-20		
RFBurst Trigger Level Rel	-6		
RFBurst Trigger Level Type	Absolute		
RFBurst Trigger Slope	Positive		
Scale/Div	2		
Trigger Holdoff	0.1		
Trigger Holdoff State	FALSE		
TriggerSource	Free		
MeasResult1	MeasResult2	MeasResult3	MeasResult4
-73.0651058869747	36.9712197125257	36.7879441171442	
36.9712197125257	36.8850431211499	36.7032368203129	

Save As . . .

When you press “Save As”, the analyzer brings up a Windows dialog and a menu entitled “**Save As.**” This menu allows you to navigate to the various fields in the Windows dialog without using a keyboard or mouse. The **Tab** and **Arrow** keys can also be used for dialog navigation.

See "[To File . . .](#)" on page 2444 in **Save, State** for a full description of this dialog and menu.

The default path for saving files is:

For all of the Trace Data Files:

My Documents\<<mode name>\data\traces

For all of the Limit Data Files:

My Documents\<<mode name>\data\limits

For all of the Measurement Results Data Files:

My Documents\<<mode name>\data\<<measurement name>\results

For all of the Capture Buffer Data Files:

My Documents\<<mode name>\data\captureBuffer

Key Path	Save, Data
Mode	All
Notes	The key location is mode-dependent and will vary. Brings up the Save As dialog for saving a <mode specific> Save Type. The save is performed immediately and does not wait until the measurement is complete.
Initial S/W Revision	Prior to A.02.00

Screen Image

Pressing Screen Image accesses a menu of functions that enable you to specify a format and location for the saved screen image. It brings up a menu that allows you to specify the color scheme of the Screen Image (Themes) or navigate to the Save As dialog to perform the actual save.

Screen Image files contain an exact representation of the analyzer display. They cannot be loaded back onto the analyzer, but they can be loaded into your PC for use in many popular applications.

The image to be saved is actually captured when the **Save** front panel key is pressed, and kept in temporary storage to be used if you ask for a Screen Image save. When the Screen Image key is pressed, a "thumbnail" of the captured image is displayed, as shown below:

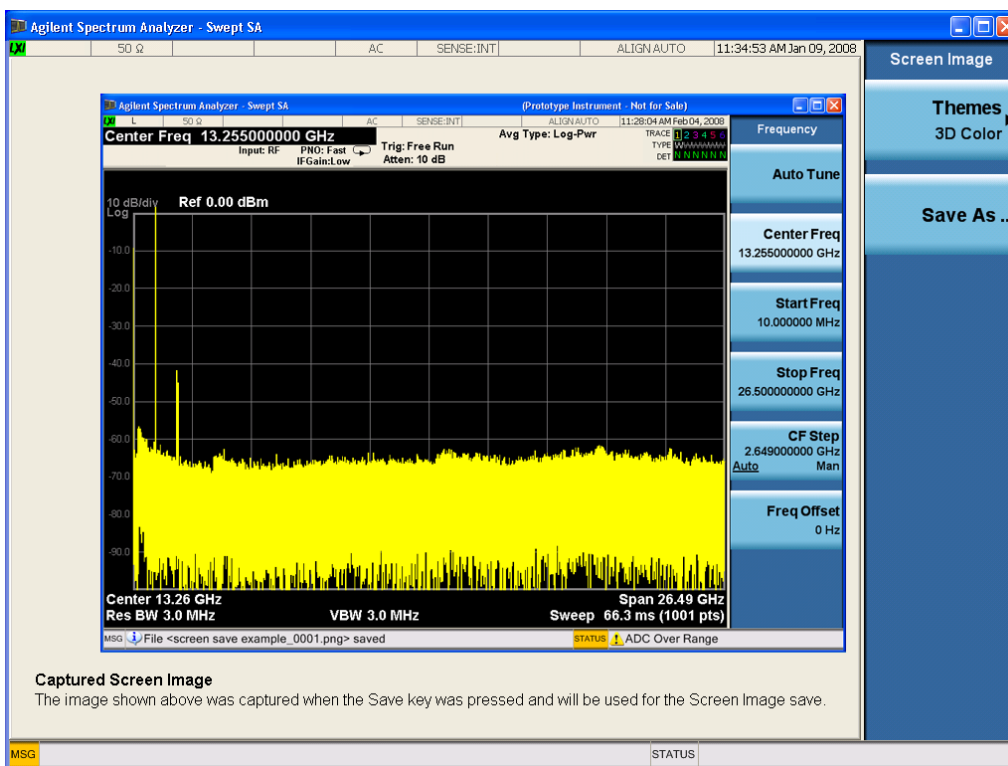

When you continue on into the **Save As** menu and complete the Screen Image save, the image depicted in the thumbnail is the one that gets saved, showing the menus that were on the screen before going into the **Save** menus. The save is performed immediately and does not wait until the measurement is complete.

After you have completed the save, the **Quick Save** front-panel key lets you quickly repeat the last save performed, using an auto-named file, with the current screen data.

NOTE

For versions previous to A.01.55, if you initiate a screen image save by navigating through the Save menus, the image that is saved will contain the Save menu softkeys, not the menus and the active function that were on the screen when you first pressed the Save front panel key.

Key Path **Save**

Mode	All
Remote Command	:MMEMory:STORe:SCReen <filename>
Example	:MMEM:STOR:SCR "myScreen.png" This stores the current screen image in the file MyScreenFile.png in the default directory.
Initial S/W Revision	Prior to A.02.00

Themes

Accesses a menu of functions that enable you to choose the theme to be used when saving the screen image.

The **Themes** option is the same as the **Themes** option under the **Display** and **Page Setup** dialogs. It allows you to choose between themes to be used when saving the screen image.

Key Path	Save, Screen Image
Remote Command	:MMEMory:STORe:SCReen:THEMe TDColor TDMonochrome FCOLOR FMONochrome :MMEMory:STORe:SCReen:THEMe?
Example	:MMEM:STOR:SCR:THEM TDM
Preset	3D Color; Is not part of Preset, but is reset by Restore Misc Defaults or Restore System Defaults All and survives subsequent running of the modes.
Readback	3D Color 3D Mono Flat Color Flat Mono
Backwards Compatibility Notes	In ESA and PSA we offer the choice of "Reverse Bitmap" or "Reverse Metafile" when saving screen images. This is much like the "Flat Color" theme available in X-Series. Also, if you selected Reverse Bitmap AND a black & white screen image, that would be much like "Flat Monochrome". In other words, each of the X-Series themes has a similar screen image type in ESA/PSA. But they are not identical.
Initial S/W Revision	Prior to A.02.00

3D Color

Selects a standard color theme with each object filled, shaded and colored as designed.

Key Path	Save, Screen Image, Themes
Example	MMEM:STOR:SCR:THEM TDC
Readback	3D Color
Initial S/W Revision	Prior to A.02.00

3D Monochrome

Selects a format that is like 3D color but shades of gray are used instead of colors.

Key Path	Save, Screen Image, Themes
Example	MMEM:STOR:SCR:THEM TDM
Readback	3D Mono
Initial S/W Revision	Prior to A.02.00

Flat Color

Selects a format that is best when the screen is to be printed on an ink printer.

Key Path	Save, Screen Image, Themes
Example	MMEM:STOR:SCR:THEM FCOL
Readback	Flat Color
Initial S/W Revision	Prior to A.02.00

Flat Monochrome

Selects a format that is like Flat Color. But only black is used (no colors, not even gray), and no fill.

Key Path	Save, Screen Image, Themes
Example	MMEM:STOR:SCR:THEM FMON
Readback	Flat Mono
Initial S/W Revision	Prior to A.02.00

Save As...

When you press "Save As", the analyzer brings up a Windows dialog and a menu entitled "**Save As.**" This menu allows you to navigate to the various fields in the Windows dialog without using a keyboard or mouse. The **Tab** and **Arrow** keys can also be used for dialog navigation.

See "[To File . . .](#)" on page 2444 in **Save, State** for a full description of this dialog and menu.

The default path for Screen Images is

My Documents\`<mode name>`\screen.

where `<mode name>` is the parameter used to select the mode with the INST:SEL command (for example, SA for the Spectrum Analyzer).

Key Path	Save, Screen Image
Notes	Brings up Save As dialog for saving a Screen Image Save Type
Initial S/W Revision	Prior to A.02.00

Single (Single Measurement/Sweep)

Sets the analyzer for Single measurement operation. The single/continuous state is Meas Global, so the setting will affect all the measurements. If you are Paused, pressing **Single** does a Resume.

See "[More Information](#)" on page 2052

Key Path	Front-panel key
Example	:INIT:CONT OFF
Notes	See Cont key description.
Backwards Compatibility Notes	<p>For Spectrum Analysis mode in ESA and PSA, the Single hardkey and the INITiate:IMM switched from continuous measurement to single measurement and restarted sweeps and averages (displayed average count reset to 1), but did not restart Max Hold and Min Hold. In the X-Series, the Single hardkey and the INITiate:IMM command initiate a sweep/ measurement/ average sequence/hold sequence including MaxHold and MinHold.</p> <p>For Spectrum Analysis mode in ESA and PSA, the Single hardkey restarted the sweep regardless of whether or not you were in an active sweep or sweep sequence. In the X-Series, Restart does this but Single only restarts the sweep or sweep sequence if you are in the idle state.</p> <p>INIT[:IMM] in ESA & PSA Spectrum Analysis Mode does an implied ABORT. In some other PSA Modes, INIT[:IMM] is ignored if not in the idle state. . The X-Series follows the ESA/PSA SA Mode model, which may cause some Modes to have compatibility problems.</p>
Initial S/W Revision	Prior to A.02.00

More Information

See "[Restart](#)" on page 2441 for details on the INIT:IMMEDIATE (Restart) function.

If you are already in single sweep, the INIT:CONT OFF command has no effect.

If you are already in Single Sweep, then pressing the **Single** key in the middle of a sweep does not restart the sweep or sequence. Similarly, pressing the **Single** key does not restart the sweep or sequence if the sweep is not in the idle state (for example, if you are taking a very slow sweep, or the analyzer is waiting for a trigger). Instead, it results in a message. "Already in Single, press Restart to initiate a new sweep or sequence". Even though pressing the **Single** key in the middle of a sweep does not restart the sweep, sending INIT:IMMEDIATE does reset it.

To take one more sweep without resetting the average count, increment the average count by 1, by pressing the step up key while **Average/Hold Number** is the active function, or sending the remote command CALC:AVER:TCON UP.

Source

There is no Source control functionality for this measurement. When this key is pressed, the screen either displays a blank menu, or the previously-selected menu remains unchanged.

Key Path	Front-panel key
----------	-----------------

Span X Scale

The SPAN X Scale key accesses the menu to set the desired horizontal scale.

Key Path	Front-panel key
Initial S/W Revision	Prior to A.02.00

Scale/Div

Enables you to enter a time value to change the horizontal scale.

Key Path	Span X Scale
Mode	SA, WCDMA, C2K, WIMAXOFDMA, TD-SCDMA, 1xEV-DO, DVB-T/H, DTMB (CTTB), ISDB-T, CMMB, LTE, LTEFDD, Digital Cable TV, WLAN, MSR,, LTEATDD, LTEAFDD
Remote Command	:DISPlay:PSTatistic:VIEW[1]:WINDow2:TRACe:X[:SCALe]:PDIVision <rel_ ampl> :DISPlay:PSTatistic:VIEW[1]:WINDow2:TRACe:X[:SCALe]:PDIVision?
Example	DISP:PST:VIEW:WIND2:TRAC:X:PDIV 10 DISP:PST:VIEW:WIND2:TRAC:X:PDIV?
Notes	CCDF measurement has the trace display only at Window 2.
Couplings	See Notes
Preset	2.00
State Saved	Saved in instrument state.
Min	0.1
Max	20
Backwards Compatibility SCPI	:DISPlay:PSTatistic:XScale
Initial S/W Revision	Prior to A.02.00
Modified at S/W Revision	A.02.00, A.03.00

Sweep/Control

Enables you to pause the power statistics CCDF measurement after the current data acquisition is complete. When Paused, the label on the menu key changes to **Resume**. Press **Resume** to resume the measurement where it was when it was paused.

Key Path	Front-panel key
Initial S/W Revision	Prior to A.02.00

Pause/Resume

Pauses a measurement after the current data acquisition is complete. When Paused, the label on the key changes to **Resume**. Press **Resume** to resume the measurement where it was when it was paused. See ["Pause/Resume" on page 2468](#) for details.

Key Path	Sweep/Control
Initial S/W Revision	Prior to A.02.00

14 Power Stat CCDF Measurement
System

System

See "[System](#)" on page 368

Trace/Detector

Accesses a menu of functions that enable you to control the storage and manipulation of the reference trace, as well as controls the display of the trace data.

Key Path	Front-panel key
Initial S/W Revision	Prior to A.02.00

Store Ref Trace

Copies the currently measured curve as the user-definable reference trace. The captured data remains until the other mode is chosen. Pressing this key also refreshes the reference trace.

No query command is available.

Key Path	Trace/Detector
Mode	SA, WCDMA, C2K, WIMAXOFDMA, TD-SCDMA, 1xEV-DO, DVB-T/H, DTMB (CTTB), ISDB-T, CMMB, LTE, LTE-TDD, Digital Cable TV, WLAN, MSR, LTE-TDD, LTEAFDD
Remote Command	:CALCulate:PSTatistic:STORe:REFerence
Example	CALC:PST:STOR:REF
Backwards Compatibility SCPI	[[:SENSe]:PSTatistic:SRTRace
Initial S/W Revision	Prior to A.02.00
Modified at S/W Revision	A.02.00, A.03.00

Ref Trace

Toggles the reference trace display between On and Off.

Key Path	Trace/Detector
Mode	SA, WCDMA, C2K, WIMAXOFDMA, TD-SCDMA, 1xEV-DO, DVB-T/H, DTMB (CTTB), ISDB-T, CMMB, LTE, LTE-TDD, Digital Cable TV, WLAN, MSR, LTE-TDD, LTEAFDD
Remote Command	:DISPlay:PSTatistic:RTRace[:STATe] OFF ON 0 1 :DISPlay:PSTatistic:RTRace[:STATe]?
Example	DISP:PST:RTR OFF DISP:PST:RTR?
Preset	OFF
State Saved	Saved in instrument state.
Range	On Off
Backwards Compatibility SCPI	[[:SENSe]:PSTatistic:RTRace[:STATe]

Initial S/W Revision	Prior to A.02.00
Modified at S/W Revision	A.02.00, A.03.00, A.04.00

Gaussian Line

Toggles the Gaussian trace display between On and Off.

Key Path	Trace/Detector
Mode	SA, WCDMA, C2K, WIMAXOFDMA, TD-SCDMA, 1xEV-DO, DVB-T/H, DTMB (CTTB), ISDB-T, CMMB, LTE, LTE-TDD, Digital Cable TV, WLAN, MSR, LTE-TDD, LTE-FDD
Remote Command	:DISPlay:PStAtistic:GAUSSian[:STATe] OFF ON 0 1 :DISPlay:PStAtistic:GAUSSian[:STATe]?
Example	DISP:PST:GAUS OFF DISP:PST:GAUS?
Preset	ON
State Saved	Saved in instrument state.
Range	On Off
Backwards Compatibility SCPI	[:SENSe]:PStAtistic:GAUSSian[:STATe]
Initial S/W Revision	Prior to A.02.00
Modified at S/W Revision	A.02.00, A.03.00, A.04.00

Trigger

See ["Trigger" on page 444](#)

Free Run

See ["Free Run " on page 451](#)

Video

See ["Video \(IF Envelope\) " on page 452](#)

Trigger Level

See ["Trigger Level " on page 452](#)

Trig Slope

See ["Trig Slope " on page 453](#)

Trig Delay

See ["Trig Delay " on page 454](#)

Line

See ["Line " on page 2235](#)

Trig Slope

See ["Trig Slope " on page 2235](#)

Trig Delay

See ["Trig Delay " on page 456](#)

External 1

See ["External 1 " on page 2248](#)

Trigger Level

See ["Trigger Level " on page 2248](#)

Trig Slope

See ["Trig Slope " on page 2249](#)

Trig Delay

See ["Trig Delay " on page 459](#)

Zero Span Delay Comp

See ["Zero Span Delay Comp On/Off" on page 2237](#)

External 2

See ["External 2 "](#) on page 2250

Trigger Level

See ["Trigger Level "](#) on page 2250

Trig Slope

See ["Trig Slope "](#) on page 2251

Trig Delay

See ["Trig Delay "](#) on page 461

Zero Span Delay Comp

See ["Zero Span Delay Comp On/Off"](#) on page 2239

RF Burst

See ["RF Burst "](#) on page 2251

Absolute Trigger

See ["Absolute Trigger Level"](#) on page 2252

Relative Trigger

See ["Relative Trigger Level"](#) on page 2241

Trig Slope

See ["Trigger Slope "](#) on page 2253

Trig Delay

See ["Trig Delay "](#) on page 466

Periodic Timer

See ["Periodic Timer \(Frame Trigger\) "](#) on page 2243

Period

See ["Period "](#) on page 2244

Offset

See ["Offset "](#) on page 2245

Offset Adjust (Remote Command Only)

See ["Offset Adjust \(Remote Command Only\)"](#) on page 2246

Reset Offset Display

See ["Reset Offset Display "](#) on page 2247

Sync Source

See ["Sync Source "](#) on page 2247

Off

See ["Off "](#) on page 2248

External 1

See ["External 1 "](#) on page 2248

Trigger Level

See ["Trigger Level "](#) on page 2248

Trig Slope

See ["Trig Slope "](#) on page 2249

External 2

See ["External 2 "](#) on page 2250

Trigger Level

See ["Trigger Level "](#) on page 2250

Trig Slope

See ["Trig Slope "](#) on page 2251

RF Burst

See ["RF Burst "](#) on page 2251

Absolute Trigger

See ["Absolute Trigger Level"](#) on page 2252

Trig Slope

See ["Trigger Slope "](#) on page 2253

Trig Delay

See ["Trig Delay"](#) on page 476

Auto/Holdoff

See ["Auto/Holdoff "](#) on page 477

Auto Trig

See ["Auto Trig "](#) on page 477

Trig Holdoff

See ["Trig Holdoff"](#) on page 478

Holdoff Type

See ["Holdoff Type"](#) on page 478

Baseband I/Q

See [___](#) on page X

I/Q Mag

See [___](#) on page X

Trigger Level

See [___](#) on page X

Trig Slope

See [___](#) on page X

Trig Delay

See [___](#) on page X

I

See [___](#) on page X

Trigger Level

See [___](#) on page X

Trig Slope

See [___](#) on page X

Trig Delay

See [___](#) on page X

Q

See [___](#) on page X

Trigger Level

See [___](#) on page X

Trig Slope

See [___](#) on page X

Trig Delay

See [___](#) on page X

Input I

See ___ on page X

Trigger Level

See ___ on page X

Trig Slope

See ___ on page X

Trig Delay

See ___ on page X

Input Q

See ___ on page X

Trigger Level

See ___ on page X

Trig Slope

See ___ on page X

Trig Delay

See ___ on page X

Aux Channel Center Freq

See ___ on page X

Trigger Level

See ___ on page X

Trig Slope

See ___ on page X

Trig Delay

See ___ on page X

Trigger Center Freq

See ___ on page X

Trigger BW

See ___ on page X

User Preset

Accesses a menu that gives you the following three choices:

- **User Preset** – recalls a state previously saved using the Save User Preset function.
- **User Preset All Modes** – presets all of the modes in the analyzer
- **Save User Preset**– saves the current state for the current mode

Key Path	Front-panel key
Backwards Compatibility Notes	<p>User Preset is actually loading a state, and in legacy analyzers, it was possible to load a state without affecting the trace data, limit lines or correction data. Similarly it was possible to do a User Preset without affecting the trace data, limit lines or correction data.</p> <p>In the X-Series, “state” always includes all of this data; so whenever state is loaded, or User Preset is executed, all of the traces, limit lines and corrections are affected. Although this differs from previous behavior, it is desirable behavior, and should not cause adverse issues for users.</p> <p>On ESA and PSA, User Preset affected the entire instrument’s state. In the X-Series, User Preset only recalls the state for the active mode. There is a User Preset file for each mode. User Preset can never cause a mode switch as it can in legacy analyzers. If you want to recall all modes to their user preset file state, you will need to do a User Preset after mode switching into each mode.</p> <p>User Preset recalls mode state which can now include data like traces; whereas on ESA and PSA, User Preset did not affect data.</p>
Initial S/W Revision	Prior to A.02.00

User Preset

User Preset sets the state of the currently active mode back to the state that was previously saved for this mode using the Save User Preset menu key or the SCPI command, `SYST:PRES:USER:SAV`. It not only recalls the Mode Preset settings, but it also recalls all of the mode persistent settings, and the Input/Output system setting that existed at the time Save User Preset was executed.

If a Save User Preset has not been done at any time, User Preset recalls the default user preset file for the currently active mode. The default user preset files are created if, at power-on, a mode detects there is no user preset file. There will never be a scenario when there is no user preset file to restore. For each mode, the default user preset state is the same state that would be saved if a Save User Preset is performed in each mode right after doing a Restore Mode Default and after a Restore Input/Output Defaults.

The User Preset function does the following:

- Aborts the currently running measurement.
- Sets the mode State to the values defined by Save User Preset.
- Makes the saved measurement for the currently running mode the active measurement.
- Brings up the saved menu for the power-on mode.
- Clears the input and output buffers.
- Sets the Status Byte to 0.

Key Path	User Preset
Remote Command	:SYSTem:PRESet:USER
Example	:SYST:PRES:USER:SAVE:SYST:PRES:USER
Notes	:SYST:PRES:USER:SAVE is used to save the current state as the user preset state. Clears all pending OPC bits. The Status Byte is set to 0. Pressing the User Preset front-panel key while already in the User Preset menu will cause the User Preset to get executed
Couplings	A user preset will cause the currently running measurement to be aborted and cause the saved measurement to be active. Recalling a User Preset file has the same issues that recalling a Save State file has. Some settings may need to be limited and therefore re-coupled, since the capabilities of the mode may have changes when the User Preset file was last saved.
Initial S/W Revision	Prior to A.02.00

User Preset All Modes

Recalls all of the User Preset files for each mode, switches to the power-on mode, and activates the saved measurement from the power-on mode User Preset file.

NOTE

When the instrument is secured, all of the user preset files are converted back to their default user preset files.

The User Preset function does the following:

- Aborts the currently running measurement.
- Switches the Mode to the power-on mode.
- Restores the User Preset files for each mode.
- Makes the saved measurement for the power-on mode the active measurement.
- Brings up the saved menu for the power-on mode.
- Clears the input and output buffers.
- Sets the Status Byte to 0.

Key Path	User Preset
Remote Command	:SYSTem:PRESet:USER:ALL
Example	:SYST:PRES:USER:SAVE:SYST:PRES:USER:ALL
Notes	Clears all pending OPC bits. The Status Byte is set to 0. :SYST:PRES:USER:SAVE is used to save the current state as the user preset state.
Couplings	A user preset will cause the currently running measurement to be aborted, cause a mode switch to the power-on mode, and cause the saved measurement to be active in the power-on mode. Recalling a User Preset file has the same issues that recalling a Save State file has. Some settings may need to be limited and therefore re-coupled, since the capabilities of the mode may have changes when the User Preset file was last saved.

Initial S/W Revision	Prior to A.02.00
----------------------	------------------

Save User Preset

Saves the currently active mode and its State. You can recall this User Preset file by pressing the User Preset menu key or sending the SYST:PRES:USER remote command. This same state is also saved by the Save State function.

Key Path	User Preset
Remote Command	:SYSTem:PRESet:USER:SAVE
Example	:SYST:PRES:USER:SAVE
Notes	:SYST:PRES:SAVE creates the same file as if the user requested a *SAV or a MMEM:STOR:STAT, except User Preset Save does not allow the user to specify the filename or the location of the file.
Initial S/W Revision	Prior to A.02.00

View/Display

Accesses a menu of functions that enable you to control the instrument display as well as turn the bar graph On and Off.

The Power Stat CCDF measurement provides a single view. This is common for both Uplink (MS) and Downlink (BTS). The view consists of the following windows:

"Metrics window" on page 2069

"Graph window" on page 2070

"Wave window (TD-SCDMA and LTE TDD only)" on page 2070

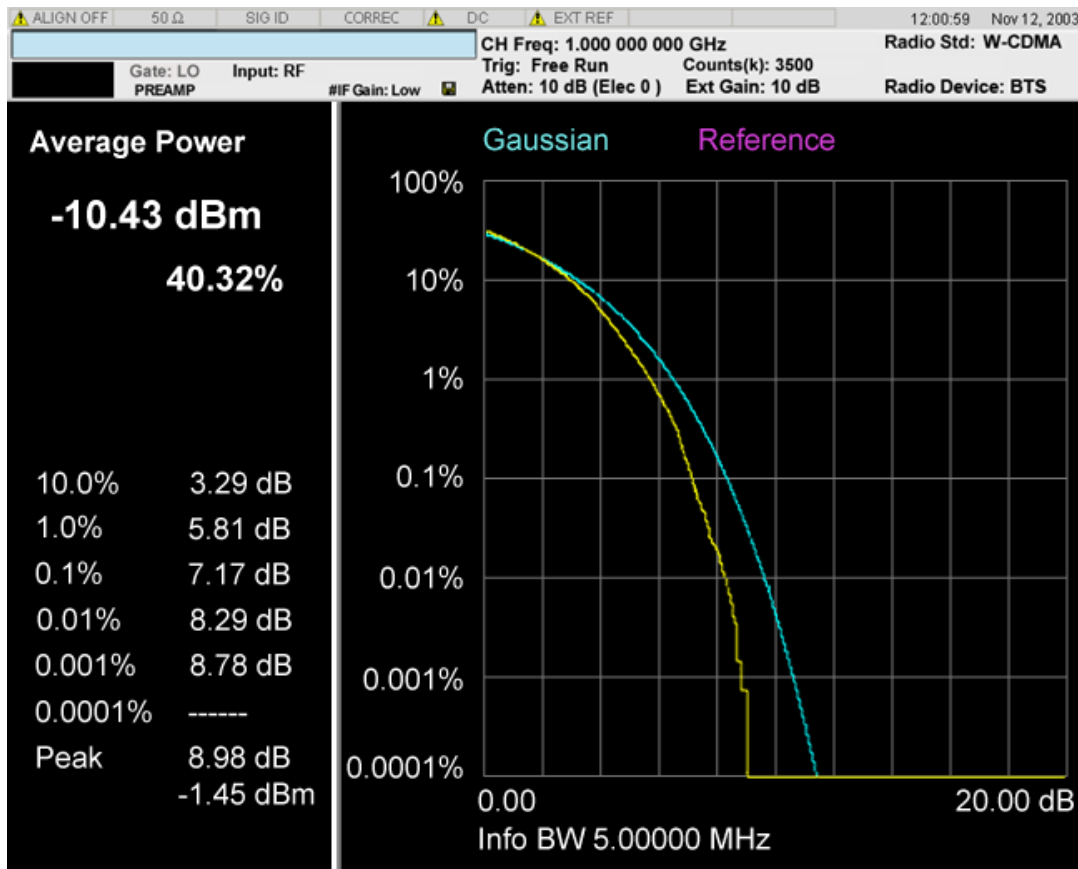

Above: View for Power Stat CCDF Measurement.

14 Power Stat CCDF Measurement
View/Display

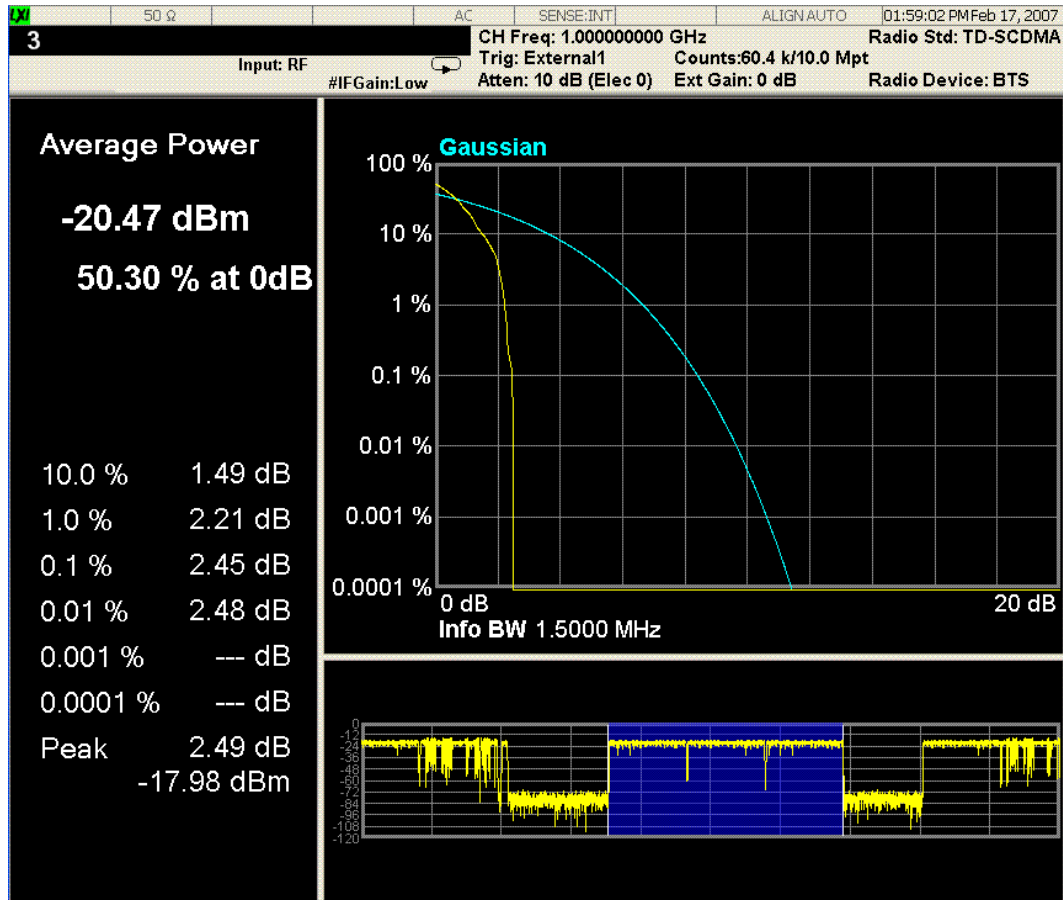

Above: Slot View for Power Stat CCDF Measurement in TD-SCDMA mode.

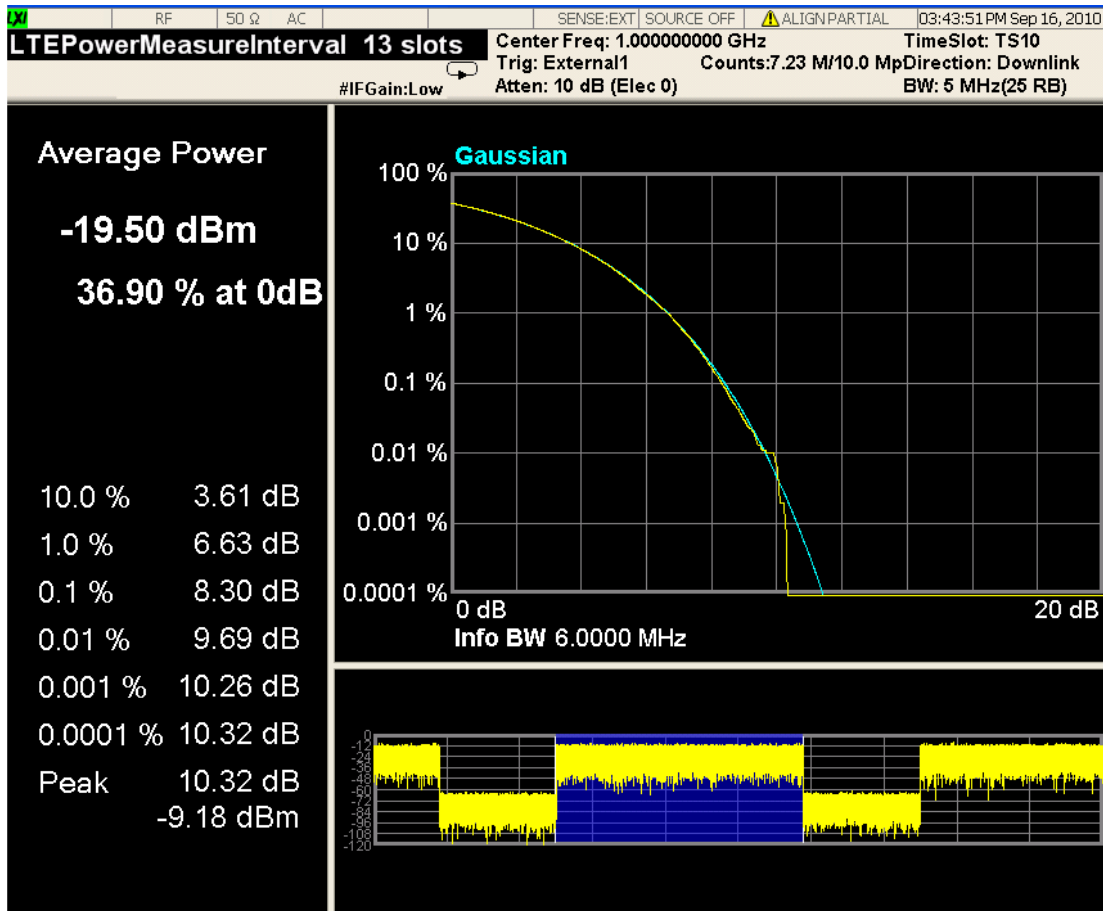

Above: View for Power Stat CCDF Measurement in LTE TDD mode.

Metrics window

Name	Corresponding Results	Explanation
Average Power [dBm]	n=1 1st Average input power	99.99 dBm
Average Power [%]	n=1 2nd Probability at the average input power level	99.99 %
10.0% [dB]	n=1 3rd Power level that has 10% of the power	99.99 dB
1.0% [dB]	n=1 4th Power level that has 1% of the power	99.99 dB
0.1% [dB]	n=1 5th Power level that has 0.1% of the power	99.99 dB
0.01% [dB]	n=1 6th Power level that has 0.01% of the power	99.99 dB
0.001% [dB]	n=1 7th	99.99 dB

Name	Corresponding Results	Explanation
	Power level that has 0.001% of the power	
0.0001% [dB]	n=1 8th	99.99 dB
	Power level that has 0.0001% of the power	
Peak [dB]	n=1 9th Peak power	99.99 dB
Peak[dBm]	This is not available from SCPI using remote commands.	99.99 dBm

Graph window

Marker Operation	Yes
Corresponding Trace	<p>Yellow: Series of 5001 floating the current measured power stat trace. (n=2) Initially all markers refer this trace.</p> <p>Light Blue: Series of 5001 floating point numbers (in percent) that represent the Gaussian trace. (n=3)</p> <p>Violet: series of 5001 floating point numbers (in percent) that represent the user-definable reference trace. (n=4)</p> <p>The Gaussian and Reference trace/line can be removed using the functions under the Trace/Detector key</p>

Wave window (TD-SCDMA and LTE TDD only)

This window is only available under TD-SCDMA mode and LTE TDD mode, and by default this window is closed, it can be turned on or off by using the softkey "Slot View". For more details, refer to the section [Slot View](#).

Marker Operation	No
Corresponding Trace	<p>Yellow: For TD-SCDMA, Waveform of entire TD-SCDMA frame. If measurement range specified by Analysis Time Slot and Measured Time Slot is out of the first frame, the display range extends to two TD-SCDMA frames. For LTETDD, Waveform of 2 continuous LTE type2 frames.</p> <p>Blue: Indicates current measurement range</p>

Key Path	Front-panel key
Initial S/W Revision	Prior to A.02.00

Display

The Display menu is common to most measurements, and is used for configuring items on the display. Some Display menu settings apply to all the measurements in a mode, and some only to the current measurement. Those under the **System Display Settings** key apply to all measurements in all modes.

Key Path	Display
Key Path	View/Display
Initial S/W Revision	Prior to A.02.00

Annotation

Turns on and off various parts of the display annotation. The annotation is divided up into four categories:

1. Meas Bar: This is the measurement bar at the top of the screen. It does not include the settings panel or the Active Function. Turning off the Meas Bar turns off the settings panel and the Active Function. When the Meas Bar is off, the graticule area expands to fill the area formerly occupied by the Meas Bar.
2. Screen Annotation: this is the annotation and annunciation around the graticule, including any annotation on lines (such as the display line, the threshold line, etc.) This does NOT include the marker number or the N dB result. When off, the graticule expands to fill the entire graticule area.
3. Trace annotation: these are the labels on the traces, showing their detector (or their math mode).
4. Active Function annotation: this is the active function display in the meas bar, and all of the active function values displayed on softkeys.

See the figure below. Each type of annotation can be turned on and off individually.

14 Power Stat CCDF Measurement
View/Display

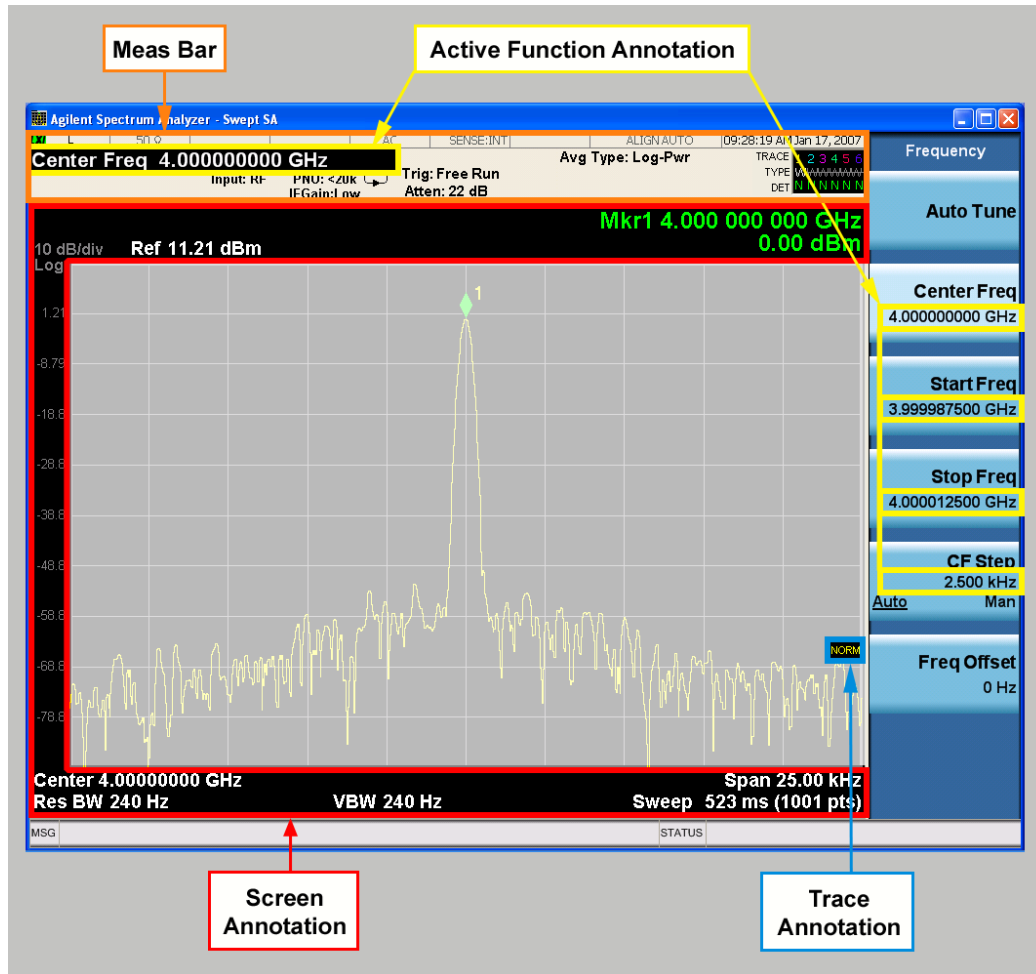

Key Path	View/Display, Display
Initial S/W Revision	Prior to A.02.00

Meas Bar On/Off

This function turns the Measurement Bar on and off, including the settings panel. When off, the graticule area expands to fill the area formerly occupied by the Measurement Bar.

Key Path	View/Display, Display, Annotation
Remote Command	:DISPlay:ANNOtation:MBAR[:STATe] OFF ON 0 1 :DISPlay:ANNOtation:MBAR[:STATe]?
Example	DISP:ANN:MBAR OFF
Dependencies	Grayed out and forced to OFF when System Display Settings, Annotation is set to Off.
Preset	On This should remain Off through a Preset when System DisplaySettings, Annotation is set to Off.

State Saved	Saved in instrument state.
Initial S/W Revision	Prior to A.02.00

Screen

This controls the display of the annunciation and annotation around the graticule, including any annotation on lines (such as the display line, the threshold line, etc.) and the y-axis annotation. This does NOT include marker annotation (or the N dB result). When off, the graticule expands to fill the entire graticule area, leaving only the 1.5% gap above the graticule as described in the Trace/Detector chapter.

Key Path	View/Display, Display, Annotation
Remote Command	:DISPlay:ANNotation:SCReen[:STATe] OFF ON 0 1 :DISPlay:ANNotation:SCReen[:STATe]?
Example	DISP:ANN:SCR OFF
Dependencies	Grayed-out and forced to OFF when System Display Settings, Annotation is set to Off.
Preset	On This should remain Off through a Preset when System DisplaySettings, Annotation is set to Off
State Saved	Saved in instrument state.
Initial S/W Revision	Prior to A.02.00

Active Function Values On/Off

Turns on and off the active function display in the Meas Bar, and all of the active function values displayed on the softkeys.

Note that all of the softkeys that have active functions have these numeric values blanked when this function is on. This is a security feature..

14 Power Stat CCDF Measurement
View/Display

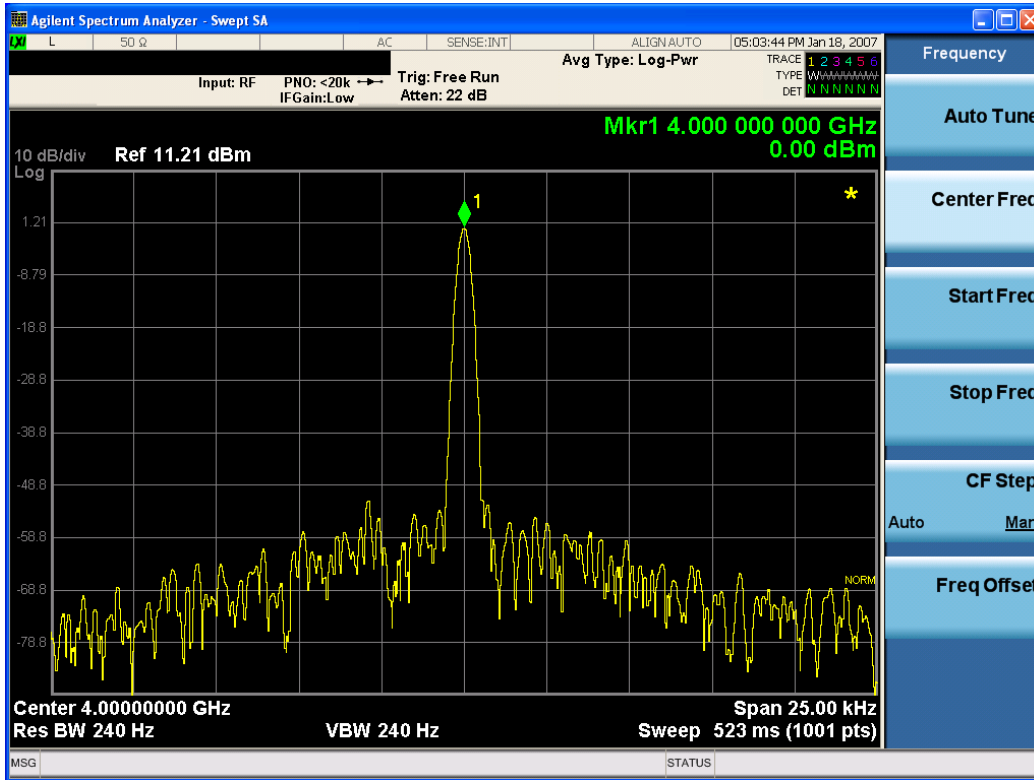

Key Path	View/Display, Display, Annotation
Remote Command	:DISPlay:ACTivefunc[:STATE] ON OFF 1 0 :DISPlay:ACTivefunc[:STATE] ?
Example	DISP:ACT OFF
Dependencies	Grayed out and forced to OFF when System Display Settings, Annotation is set to Off.
Preset	On This should remain Off through a Preset when System DisplaySettings, Annotation is set to Off
State Saved	Saved in instrument state.
Initial S/W Revision	Prior to A.02.00

Title

Displays menu keys that enable you to change or clear a title on your display.

Key Path	View/Display, Display
Initial S/W Revision	Prior to A.02.00

Change Title

Writes a title into the "measurement name" field in the banner, for example, "Swept SA".

Press Change Title to enter a new title through the alpha editor. Press Enter or Return to complete the entry. Press ESC to cancel the entry and preserve your existing title.

The display title will replace the measurement name. It remains for this measurement until you press **Change Title** again, or you recall a state, or a Preset is performed. A title can also be cleared by pressing **Title, Clear Title**.

NOTE

Notice the inclusion of the <measurement> parameter in the command below. Because each measurement remembers the Display Title, the command must be qualified with the measurement name. For the Swept SA measurement this is not the case; no <measurement> parameter is used when changing the Display Title for the Swept SA measurement.

Key Path	View/Display, Display, Title
Mode	All
Remote Command	:DISPlay:<measurement>:ANNotation:TITLe:DATA <string> :DISPlay:<measurement>:ANNotation:TITLe:DATA?
Example	DISP:ANN:TITL:DATA "This Is My Title" This example is for the Swept SA measurement in the Spectrum Analyzer mode. The SANalyzer <measurement> name is not used. DISP:ACP:ANN:TITL:DATA "This Is My Title" This example is for Measurements other than Swept SA. Both set the title to: This Is My Title
Notes	Pressing this key cancels any active function. When a title is edited the previous title remains intact (it is not cleared) and the cursor goes at the end so that characters can be added or BKSP can be used to go back over previous characters.
Preset	No title (measurement name instead)
State Saved	Saved in instrument state.
Initial S/W Revision	Prior to A.02.00

Clear Title

Clears a title from the front-panel display. Once cleared, the title cannot be retrieved. After the title is cleared, the current Measurement Name replaces it in the title bar.

Key Path	View/Display, Display, Title
Example	The following commands clear the title and restore the measurement's original title: DISP:ANN:TITL:DATA "" This example is for the Swept SA measurement in the Spectrum Analyzer mode. The SANalyzer <measurement> name is not used. DISP:ACP:ANN:TITL:DATA "" This example is for ACP; in measurements other than Swept SA the measurement name is required.
Notes	Uses the :DISPlay:<measurement>:ANNotation:TITLe:DATA <string> command with an empty string (in the Swept SA, the <measurement> is omitted).

Preset	Performed on Preset.
Initial S/W Revision	Prior to A.02.00

Graticule

Pressing Graticule turns the display graticule On or Off. It also turns the graticule y-axis annotation on and off.

Key Path	View/Display, Display
Remote Command	:DISPlay:WINDow[1]:TRACe:GRATicule:GRID[:STATe] OFF ON 0 1 :DISPlay:WINDow[1]:TRACe:GRATicule:GRID[:STATe]?
Example	DISP:WIND:TRAC:GRAT:GRID OFF
Notes	The graticule is the set of horizontal and vertical lines that make up the grid/divisions for the x-axis and y-axis.
Preset	On
State Saved	Saved in instrument state
Initial S/W Revision	Prior to A.02.00

System Display Settings

These settings are "Mode Global" – they affect all modes and measurements and are reset only by **Restore Misc Defaults** or **Restore System Defaults** under System.

Key Path	View/Display, Display
Initial S/W Revision	Prior to A.02.00

Annotation Local Settings

This is a Mode Global override of the meas local annotation settings. When it is **All Off**, it forces **ScreenAnnotation, Meas Bar, Trace, and Active Function Values** settings to be **OFF** for all measurements in all modes. This provides the security based "annotation off" function of previous analyzers; hence it uses the legacy SCPI command.

When it is **All Off**, the **Screen, Meas Bar, Trace, and Active Function Values** keys under the **Display, Annotation** menu are grayed out and forced to **Off**. When **Local Settings** is selected, you are able to set the local annotation settings on a measurement by measurement basis.

Key Path	View/Display, Display, System Display Settings
Remote Command	:DISPlay:WINDow[1]:ANNotation[:ALL] OFF ON 0 1 :DISPlay:WINDow[1]:ANNotation[:ALL]?
Example	:DISP:WIND:ANN OFF

Preset	On (Set by Restore Misc Defaults)
State Saved	Not saved in instrument state.
Backwards Compatibility Notes	The WINDow parameter and optional subopcode is included for backwards compatibility but ignored – all windows are equally affected.
Initial S/W Revision	Prior to A.02.00

Themes

Accesses a menu of functions that enable you to choose the theme to be used when saving the screen image.

The **Themes** option is the same as the **Themes** option under the **Display** and **Page Setup** dialogs. It allows you to choose between themes to be used when saving the screen image.

Key Path	Save, Screen Image
Remote Command	:MMEMory:STORe:SCReen:THEMe TDColor TDMonochrome FCOlor FMONochrome :MMEMory:STORe:SCReen:THEMe?
Example	:MMEM:STOR:SCR:THEM TDM
Preset	3D Color; Is not part of Preset, but is reset by Restore Misc Defaults or Restore System Defaults All and survives subsequent running of the modes.
Readback	3D Color 3D Mono Flat Color Flat Mono
Backwards Compatibility Notes	In ESA and PSA we offer the choice of "Reverse Bitmap" or "Reverse Metafile" when saving screen images. This is much like the "Flat Color" theme available in X-Series. Also, if you selected Reverse Bitmap AND a black & white screen image, that would be much like "Flat Monochrome". In other words, each of the X-Series themes has a similar screen image type in ESA/PSA. But they are not identical.
Initial S/W Revision	Prior to A.02.00

3D Color

Selects a standard color theme with each object filled, shaded and colored as designed.

Key Path	Save, Screen Image, Themes
Example	MMEM:STOR:SCR:THEM TDC
Readback	3D Color
Initial S/W Revision	Prior to A.02.00

3D Monochrome

Selects a format that is like 3D color but shades of gray are used instead of colors.

Key Path	Save, Screen Image, Themes
Example	MMEM:STOR:SCR:THEM TDM
Readback	3D Mono
Initial S/W Revision	Prior to A.02.00

Flat Color

Selects a format that is best when the screen is to be printed on an ink printer.

Key Path	Save, Screen Image, Themes
Example	MMEM:STOR:SCR:THEM FCOL
Readback	Flat Color
Initial S/W Revision	Prior to A.02.00

Flat Monochrome

Selects a format that is like Flat Color. But only black is used (no colors, not even gray), and no fill.

Key Path	Save, Screen Image, Themes
Example	MMEM:STOR:SCR:THEM FMON
Readback	Flat Mono
Initial S/W Revision	Prior to A.02.00

Backlight

Accesses the display backlight on/off keys. This setting may interact with settings under the Windows "Power" menu.

When the backlight is off, pressing ESC, TAB, SPACE, ENTER, UP, DOWN, LEFT, RIGHT, DEL, BKSP, CTRL, or ALT turns the backlight on without affecting the application. Pressing any other key will turn backlight on and could potentially perform the action as well.

Key Path	View/Display, Display, System Display Settings
Remote Command	:DISPlay:BACKlight ON OFF :DISPlay:BACKlight?
Preset	ON (Set by Restore Misc Defaults)
Initial S/W Revision	Prior to A.02.00

Backlight Intensity

An active function used to set the backlight intensity. It goes from 0 to 100 where 100 is full on and 0 is off. This value is independent of the values set under the Backlight on/off key.

Key Path	View/Display, Display, System Display Settings
Remote Command	:DISPlay:BACKlight:INTensity <integer> :DISPlay:BACKlight:INTensity?
Example	DISP:BACK:INT 50
Preset	100 (Set by Restore Misc Defaults)
Min	0
Max	100
Initial S/W Revision	Prior to A.02.00

15 Monitor Spectrum Measurement

The monitor spectrum measurement is used as a quick, convenient means of looking at the entire spectrum. While the look and feel are similar to the Spectrum Analyzer mode, the functionality is greatly reduced for easy operation. The main purpose of the measurement is to show the spectrum. The default span should cover an appropriate frequency range of the application.

For measurement results and views, see ["View/Display" on page 2274](#).

This topic contains the following sections:

["Measurement Commands for Monitor Spectrum" on page 2082](#)

["Remote Command Results for Monitor Spectrum Measurement" on page 2083](#)

Measurement Commands for Monitor Spectrum

The following commands can be used to retrieve the measurement results:

`:CONFigure:MONitor`

`:CONFigure:MONitor:NDEFault`

`:INITiate:MONitor`

`:FETCh:MONitor[n]?`

`:READ:MONitor[n]?`

`:MEASure:MONitor[n]?`

For more measurement related commands, see the SENSE subsystem, and the section "[Remote Measurement Functions](#)" on page 2381.

Remote Command Results for Monitor Spectrum Measurement

The following table describes the results returned by the queries listed above, according to the index value n.

n	Results Returned
1 (or not specified)	Returns trace1 data with comma separated floating numbers
2	Returns trace2 data with comma separated floating numbers
3	Returns trace3 data with comma separated floating numbers

Key Path	Meas
Initial S/W Revision	Prior to A.02.00

AMPTD Y Scale

Accesses a menu of functions that enable you to set the vertical scale parameters. These functions control how data on the vertical (Y) axis is displayed and control instrument settings that affect the vertical axis.

Key Path	Front-panel key
Initial S/W Revision	Prior to A.02.00

Ref Value

Sets the absolute power reference value. However, since Auto Scaling defaults to On, this value is automatically determined by the measurement result. When you set a value manually, Auto Scaling automatically changes to Off.

Key Path	AMPTD Y Scale
Mode	All except SA and BASIC
Remote Command	:DISPlay:MONitor:VIEW[1]:WINDow[1]:TRACe:Y[:SCALe]:RLEVel <real> :DISPlay:MONitor:VIEW[1]:WINDow[1]:TRACe:Y[:SCALe]:RLEVel?
Example	DISP:MON:VIEW:WIND:TRAC:Y:RLEV 2.0 DISP:MON:VIEW:WIND:TRAC:Y:RLEV?
Couplings	When the Auto Scaling is On, this value is automatically determined by the measurement result. When you set a value manually, Auto Scaling automatically changes to Off.
Preset	10.00 dBm
State Saved	Saved in instrument state.
Min	-250.00 dBm
Max	250.00 dBm
Initial S/W Revision	Prior to A.02.00

Attenuation

This menu controls the attenuator functions and interactions between the attenuation system components.

There are two attenuator configurations in the X-Series. One is a dual attenuator configuration consisting of a mechanical attenuator and an optional electronic attenuator. The other configuration uses a single attenuator with combined mechanical and electronic sections that controls all the attenuation functions. Different models in the X-Series come with different configurations.

See ["Dual Attenuator Configurations:" on page 2085](#)

See ["Single Attenuator Configuration:" on page 2085](#)

Most Attenuation settings are the same for all measurements – they do not change as you change measurements. Settings like these are called “Meas Global” and are unaffected by Meas Preset.

Key Path	AMPTD Y Scale
Scope	Meas Global
Dependencies	In measurements that support the I/Q inputs, this key is unavailable when I/Q is the selected input, and is replaced by the Range key in that case.
Readback Line	Contains a summary in [] brackets of the current total attenuation. See the descriptions of the , " (Mech) Atten " on page 2297, and " Enable Elec Atten " on page 2299 keys for more detail on the contributors to the total attenuation. Note that when "Pre-Adjust for Min Clip" is on, this value can change at the start of every measurement.
Initial S/W Revision	Prior to A.02.00
Modified at S/W Revision	A.03.00

Dual Attenuator Configurations:

Configuration 1: Mechanical attenuator + optional electronic attenuator

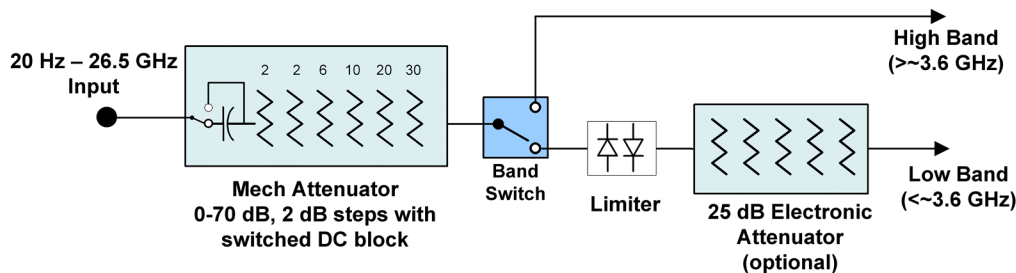

Configuration 2: Mechanical attenuator, no optional electronic attenuator

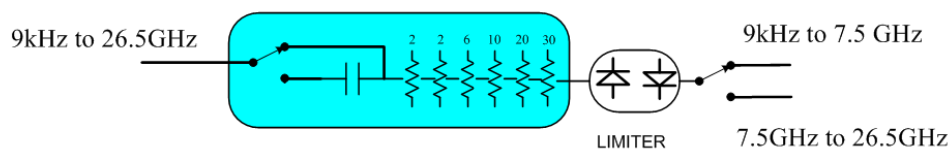

(note that Configuration 2 is not strictly speaking a dual-section attenuator, since there is no electronic section available. However, it behaves exactly like Configuration 1 without the Electronic Attenuator option EA3, therefore for the sake of this document it is grouped into the "Dual Attenuator" configuration)

Single Attenuator Configuration:

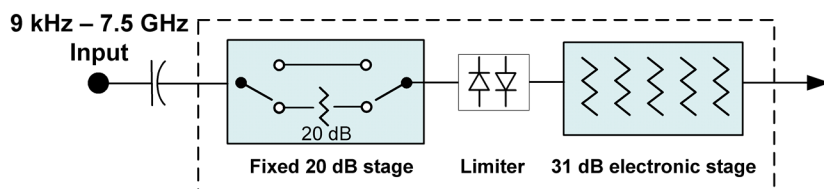

You can tell which attenuator configuration you have by pressing the Attenuation key, which (in most Modes) opens the Attenuation menu. If the first key in the Attenuation menu says **Mech Atten** you have the dual attenuator configuration. If the first key says **Atten** you have the single attenuator configuration.

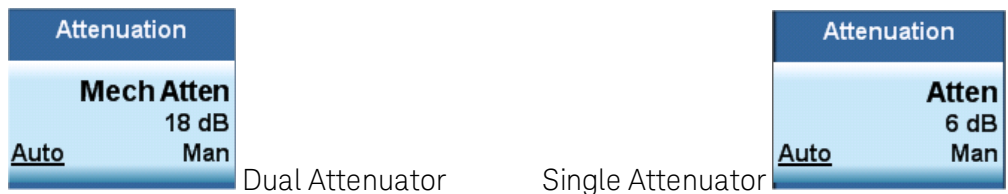

In the single attenuator configuration, you control the attenuation with a single control, as the fixed stage has only two states. In the dual attenuator configuration, both stages have significant range so you are given separate control of the mechanical and electronic attenuator stages.

When you have the dual attenuator configuration, you may still have only a single attenuator, because unless option EA3 (the Electronic Attenuator option) is available, and you purchase it, you will have only the mechanical attenuator.

(Mech) Atten

This key is labeled **Mech Atten** in dual attenuator models and **Atten** in single attenuator models. In the dual attenuator configuration, this key only affects the mechanical attenuator.

This key lets you modify the attenuation applied to the RF input signal path. This value is normally auto coupled to the Ref Level, the Internal Preamp Gain, any External Gain that is entered, and the Max Mixer Level, as described in the table below.

See "[Attenuator Configurations and Auto/Man](#)" on page 2087

Key Path	AMPTD Y Scale, Attenuation
Remote Command	<pre>[:SENSe] : POWer [:RF] : ATTenuation <rel_ampl> [:SENSe] : POWer [:RF] : ATTenuation? [:SENSe] : POWer [:RF] : ATTenuation : AUTO OFF ON 0 1 [:SENSe] : POWer [:RF] : ATTenuation : AUTO?</pre>
Example	<p>POW:ATT 20</p> <p>Dual attenuator configuration: sets the mechanical attenuator to 20 dB</p> <p>Single attenuator mode: sets the main attenuation to 20 dB (see below for definition of "main" attenuation).</p> <p>If the attenuator was in Auto, it sets it to Manual.</p>
Dependencies	<p>Some measurements do not support the Auto setting of (Mech) Atten. In these measurements, the Auto/Man selection is not available, and the Auto/Man line on the key disappears.</p> <p>In dual attenuator configurations, when the electronic attenuator is enabled, the mechanical attenuator has no auto setting and the Auto/Man line on the key disappears. The state of Auto/Man is remembered and restored when the electronic attenuator is once again disabled. This is described in more detail in the "Enable Elec Atten" on page 2299 key description.</p> <p>See "Attenuator Configurations and Auto/Man" on page 2087 for more information on the Auto/Man functionality of Attenuation.</p>
Couplings	

	<p>When (Mech) Atten is in Auto, it uses the following algorithm to determine a value: If the USB Preamp is connected to USB, use 0 dB. Otherwise, $Atten = ReferenceLevel + PreAmpGain + ExternalGain - RefLevelOffset - MaxMixerLevel + IF\ Gain$. Limit this value to be between 6 dB and the Max value. No value below 6 dB can ever be chosen by Auto. The resulting value is rounded up to the largest value possible given the attenuation step setting. That is, 50.01 dB would change to 60 dB (for a 10 dB attenuation step). The "IF Gain" term in the equation above is either 0 dB or +10 dB, depending on the settings of FFT IF Gain, Swept IF Gain, max Ref Level and the Auto/Man setting of Mech Atten. In External Mixing and BBIQ, where the Attenuator is not in the signal path, the Attenuator setting changes as described above when (Mech) Atten is in Auto, but no changes are made to the actual attenuator hardware setting until the input is changed back to the RF Input.</p>
Preset	<p>The preset for Mech Attenuation is "Auto." The Auto value of attenuation is: CXA, EXA, MXA and PXA: 10 dB</p>
State Saved	Saved in instrument state
Min	<p>0 dB The attenuation set by this key cannot be decreased below 6 dB with the knob or step keys. To get to a value below 6 dB it has to be directly entered from the keypad or via SCPI. This protects from adjusting the attenuation to a dangerously small value which can put the instrument at risk of damage to input circuitry. However, if the current mechanical attenuation is below 6 dB it can be increased with the knob and step keys, but not decreased.</p>
Max	<p>CXA N9000A-503/507: 50 dB CXA N9000A-513/526: 70dB EXA: 60 dB MXA and PXA: 70 dB In the single attenuator configuration, the total of ATT and EATT cannot exceed 50 dB, so if the EATT is set to 24 dB first, the main attenuation cannot be greater than 26 dB and will be reduced accordingly; if the main attenuator is set to 40 dB first, EATT cannot be greater than 10 dB.</p>
Initial S/W Revision	Prior to A.02.00
Modified at S/W Revision	A.03.00

Attenuator Configurations and Auto/Man

As described in the Attenuation key description, there are two distinct attenuator configurations available in the X-Series, the single attenuator and dual attenuator configurations. In dual attenuator configurations, we have the mechanical attenuation and the electronic attenuation, and the current total attenuation is the sum of the electronic + mechanical attenuation. In single attenuator configurations, we refer to the attenuation set using the **(Mech) Atten** key (or POW:ATT SCPI) as the "main" attenuation; and the attenuation that is set by the SCPI command POW:EATT as the "soft" attenuation (the POW:EATT command is honored even in the single attenuator configuration, for compatibility purposes). Then the

current total attenuation is the sum of the main + soft attenuation. See the **Elec Atten** key description for more on “soft” attenuation.

In the dual attenuator configuration, when the electronic attenuator is enabled, there is no Auto/Man functionality for the mechanical attenuator, and the third line of the key label (the Auto/Man line) disappears:

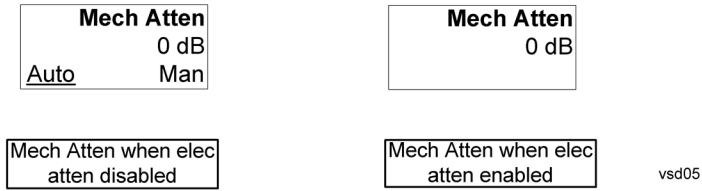

Enable Elec Atten

Enables the Electronic Attenuator.

The electronic attenuator offers finer steps than the mechanical attenuator, has no acoustical noise, is faster, and is less subject to wear. These advantages primarily aid in remote operation and are negligible for front panel use. See ["Using the Electronic Attenuator: Pros and Cons" on page 2090](#) for a detailed discussion of the pros and cons of using the electronic attenuator.

For the single attenuator configuration, for SCPI backwards compatibility, the “soft” attenuation feature replaces the dual attenuator configuration’s electronic attenuator. All the same couplings and limitations apply. See ["Attenuator Configurations and Auto/Man" on page 2299](#)

See ["More Information" on page 2089](#)

Key Path	AMPTD Y Scale, Attenuation
Remote Command	<code>[:SENSe] :POWer [:RF] :EATTenuation :STATe OFF ON 0 1</code> <code>[:SENSe] :POWer [:RF] :EATTenuation :STATe ?</code>
Example	POW:EATT:STAT ON
Dependencies	<p>This key only appears in Dual Attenuator models with an Electronic Attenuator installed. It does not appear in models with the Single Attenuator configuration, as in the single attenuator configuration there is no “electronic attenuator” there is only a single integrated attenuator (which has both a mechanical and electronic stage). However, in the single attenuator configuration, EATT SCPI commands are accepted for compatibility with other X-series instruments and set a “soft” attenuation as described in "Attenuator Configurations and Auto/Man" on page 2299.</p> <p>The electronic attenuator (and the “soft” attenuation function provided in single attenuator configurations) is unavailable above 3.6 GHz. Therefore, if the Stop Frequency of the analyzer is > 3.6 GHz then the Enable Elec Atten key will be OFF and grayed out.</p> <p>If the Internal Preamp is on, meaning it is set to Low Band or Full, the electronic attenuator (and the “soft” attenuation function provided in single attenuator configurations) is unavailable. In this case the Enable Elec Atten key will be OFF and grayed out.</p> <p>If either of the above is true, if the SCPI command is sent, an error indicating that the electronic attenuator is unavailable will be sent.</p> <p>If the electronic/soft Attenuator is enabled, then the Stop Freq of the analyzer is limited to 3.6 GHz and the Internal Preamp is unavailable.</p> <p>The SCPI-only “soft” electronic attenuation for the single-attenuator configuration is not available in</p>

	all measurements; in particular, it is not available in the Swept SA measurement.
Couplings	Enabling and disabling the Electronic Attenuator affects the setting of the Mechanical Attenuator (in dual attenuator configurations). This is described in more detail below this table.
Preset	OFF for Swept SA measurement; ON for all other measurements that support the electronic attenuator
State Saved	Saved in instrument state
Initial S/W Revision	Prior to A.02.00
Modified at S/W Revision	A.03.00

More Information

Mechanical Attenuator Transition Rules

When the Electronic Attenuator is enabled, the Mechanical Attenuator transitions to a state that has no Auto function. Below are the rules for transitioning the Mechanical Attenuator. NOTE that the information below ONLY applies to the dual attenuator configurations, and ONLY when the Electronic Attenuator is installed:

When the Electronic Attenuation is enabled from a disabled state:

- The Mechanical Attenuator is initialized to 10 dB (this is its optimal performance setting). You can then set it as desired with SCPI, numeric keypad, step keys, or knob, and it behaves as it normally would in manual mode
- The Auto/Man state of (Mech) Atten is saved
- The Auto/Man line on the (Mech) Atten key disappears and the auto rules are disabled
- The Electronic Attenuator is set to 10 dB less than the previous value of the Mechanical Attenuator, within the limitation that it must stay within the range of 0 to 24 dB of attenuation.

Examples in the dual attenuator configuration:

- Mech Atten at 20 dB. Elec Atten enabled, Mech Atten set to 10 dB, and Elec Atten set to 10 dB. New total attenuation equals the value before Elec Atten enabled.
- Mech Atten at 0 dB. Elec Atten enabled, Mech Atten set to 10 dB, and Elec Atten set to 0 dB. New total attenuation does not equal the value before Elec Atten enabled.
- Mech Atten at 40 dB. Elec Atten enabled, Mech Atten set to 10 dB, and Elec Atten set to 24 dB. New total attenuation does not equal the value before Elec Atten enabled.

When the Electronic Attenuation is disabled from an enabled state:

- The Elec Atten key is grayed out
- The Auto/Man state of (Mech) Atten is restored
- If now in Auto, (Mech) Atten recouples

- If now in Man, (Mech) Atten is set to the value of total attenuation that existed before the Elec Atten was disabled. The resulting value is rounded up to the smallest value possible given the (Mech) Atten Step setting - (That is, 57 dB changes to 58 dB when (Mech) Atten Step is 2 dB.)

Using the Electronic Attenuator: Pros and Cons

The electronic attenuator offers finer steps than the mechanical attenuator, has no acoustical noise, is faster, and is less subject to wear.

The “finer steps” advantage of the electronic attenuator is beneficial in optimizing the alignment of the analyzer dynamic range to the signal power in the front panel as well as remote use. Thus, you can achieve improved relative signal measurement accuracy. Compared to a mechanical attenuator with 2 dB steps, the 1 dB resolution of the electronic attenuator only gives better resolution when the odd-decibel steps are used. Those odd-decibel steps are less accurately calibrated than the even-decibel steps, so one tradeoff for this superior relative accuracy is reduced absolute amplitude accuracy.

Another disadvantage of the electronic attenuator is that the spectrum analyzer loses its “Auto” setting, making operation less convenient.

Also, the relationship between the dynamic range specifications (TOI, SHI, compression and noise) and instrument performance are less well-known with the electrical attenuator. With the mechanical attenuator, TOI, SHI and compression threshold levels increase dB-for-dB with increasing attenuation, and the noise floor does as well. With the electronic attenuator, there is an excess attenuation of about 1 to 3 dB between 0 and 3.6 GHz, making the effective TOI, SHI, and so forth, less well known. Excess attenuation is the actual attenuation relative to stated attenuation. Excess attenuation is accounted for in the analyzer calibration

Elec Atten

Controls the Electronic Attenuator in dual attenuator configurations. This key does not appear in single attenuator configurations, as the control of both the mechanical and electronic stages of the single attenuator is integrated into the single **Atten** key.

Key Path	AMPTD Y Scale, Attenuation
Remote Command	<code>[:SENSE] : POWer [:RF] : EATTenuation <rel_amp1></code> <code>[:SENSE] : POWer [:RF] : EATTenuation?</code>
Notes	Electronic Attenuation’s specification is defined only when Mechanical Attenuation is 6 dB.
Dependencies	This key only appears in Dual Attenuator models with an Electronic Attenuator installed. It does not appear in models with the Single Attenuator configuration, as in the single attenuator configuration there is no “electronic attenuator” there is only a single integrated attenuator (which has both a mechanical and electronic stage). However, in the single attenuator configuration, EATT SCPI commands are accepted for compatibility with other X-series instruments and set a “soft” attenuation as described in "Attenuator Configurations and Auto/Man" on page 2299 . The “soft” attenuation is treated as an addition to the “main” attenuation value set by the Atten softkey or the POW:ATT SCPI command and affects the total attenuation displayed on the Attenuation key and the Meas Bar. When Enable Elec Atten is off or grayed out, the Elec Atten key is grayed out.
Preset	0 dB
State Saved	Saved in instrument state
Min	0 dB

Max	Dual attenuator configuration: 24 dB Single attenuator configuration: the total of ATT and EATT cannot exceed 50 dB, so if the EATT is set to 24 dB first, the main attenuation cannot be greater than 26 dB and will be reduced accordingly; if the main attenuator is set to 40 dB first, EATT cannot be greater than 10 dB
Initial S/W Revision	Prior to A.02.00
Modified at S/W Revision	A.03.00

Adjust Atten for Min Clip

Sets the combination of mechanical and electronic attenuation and gain based on the current measured signal level so that clipping will be at a minimum.

This is an "immediate action" function, that is, it executes once, when the key is pressed.

This key is grayed out in measurements that do not support this functionality. The spectrum analyzer measurement, Swept SA, does not support this functionality.

Key Path	AMPTD Y Scale, Attenuation
Remote Command	<code>[:SENSe] :POWer [:RF] :RANGe:OPTimize IMMEDIATE</code>
Initial S/W Revision	Prior to A.02.00
Modified at S/W Revision	A.03.00

Pre-Adjust for Min Clip

If this function is on, it does the adjustment described under "[Adjust Atten for Min Clip](#)" on page 2302 each time a measurement restarts. Therefore, in Continuous measurement mode, it only executes before the first measurement.

In dual attenuator models, you can set **Elec+Mech Atten**, in which case both attenuators participate in the autoranging, or **Elec Atten Only**, in which case the mechanical attenuator does not participate in the autoranging. This latter case results in less wear on the mechanical attenuator and is usually faster.

This key is grayed out in measurements that do not support this functionality. The spectrum analyzer measurement, Swept SA, does not support this functionality.

Key Path	AMPTD Y Scale, Attenuation
Remote Command	<code>[:SENSe] :POWer [:RF] :RANGe:OPTimize:ATTenuation OFF ELECTrical COMBined</code> <code>[:SENSe] :POWer [:RF] :RANGe:OPTimize:ATTenuation?</code>
Notes	The SCPI parameter ELECTrical sets this function to On in single attenuator models. The SCPI parameter COMBined is mapped to ELECTrical in single attenuator models; if you send COMBined, it sets the function to On and returns ELEC to a query.
Dependencies	This key only appears in Dual Attenuator models with an Electronic Attenuator installed. In instruments with Dual Attenuator model, when Enable Elec Atten is off or grayed out, the Pre-Adjust for Min Clip key is grayed out.

Preset	OFF for Swept SA measurement; ON for all other measurements that support Pre-Adjust for Min Clip
State Saved	Saved in instrument state
Range	Dual attenuator models: Off Elec Atten Only Mech + Elec Atten Single attenuator models: Off On
Initial S/W Revision	Prior to A.02.00
Modified at S/W Revision	A.03.00

Remote Command	<code>[:SENSe] :POWer [:RF] :RANGe:AUTO ON OFF 1 0</code> <code>[:SENSe] :POWer [:RF] :RANGe:AUTO?</code>
Notes	ON aliases to "Elec Atten Only" (:POW:RANG:OPT:ATT ELEC) OFF aliases to "Off" (:POW:RANG:OPT:ATT OFF) The query :POW:RANG:AUTO? returns true if :POW:RANG:OPT:ATT is not "Off"
Initial S/W Revision	Prior to A.02.00

Off

Turns **Pre-Adjust for Min Clip** off. This is the default setting.

This key is grayed out in measurements that do not support this functionality. The spectrum analyzer measurement, Swept SA, does not support this functionality.

Key Path	AMPTD Y Scale, Attenuation, Pre-Adjust for Min Clip
Example	:POW:RANGe:OPT:ATT OFF
Initial S/W Revision	Prior to A.02.00

Elec Atten Only

Selects only the electric attenuator to participate in auto ranging. This offers less wear on the mechanical attenuator and is usually faster.

This key is grayed out in measurements that do not support this functionality. The spectrum analyzer measurement, Swept SA, does not support this functionality.

Key Path	AMPTD Y Scale, Attenuation, Pre-Adjust for Min Clip
Example	:POW:RANGe:OPT:ATT ELEC
Initial S/W Revision	Prior to A.02.00

Mech + Elec Atten

In dual attenuator models, this selects both attenuators participate in the autoranging.

This key is grayed out in measurements that do not support this functionality. The spectrum analyzer measurement, Swept SA, does not support this functionality.

Key Path	AMPTD Y Scale, Attenuation, Pre-Adjust for Min Clip
Example	:POW:RANGe:OPT:ATT COMB
Initial S/W Revision	Prior to A.02.00

(Mech) Atten Step

This controls the step size used when making adjustments to the input attenuation.

This key is labeled **Mech Atten Step** in dual attenuator models and **Atten Step** in single attenuator models. In the dual attenuator configuration, this key only affects the step size of the mechanical attenuator.

Key Path	AMPTD Y Scale, Attenuation
Remote Command	[:SENSe] :POWer [:RF] :ATTenuation :STEP [:INCRement] 10 dB 2 dB [:SENSe] :POWer [:RF] :ATTenuation :STEP [:INCRement] ?
Example	POW:ATT:STEP 2
Notes	Note this feature works like a 1-N choice from the front panel, but it takes a specific value (in dB) when used remotely. The only valid values are 2 and 10.
Dependencies	Blanked in CXA and EXA if option FSA (2 dB steps) is not present. If blanked, attempts to set it via SCPI will yield an error.
Couplings	When the attenuation step size changes, the current mechanical attenuation value is adjusted (if necessary) to be quantized to the new step size. That is, if step is set to 10 dB, mech atten is increased if necessary so it is a multiple of 10 dB
Preset	PXA and MXA: 2 dB EXA and CXA: 10 dB (2 dB with option FSA)
State Saved	Saved in instrument state
Initial S/W Revision	Prior to A.02.00
Modified at S/W Revision	A.03.00

Adjust Atten (Remote Command only)

Allows you to select;

-Electric attenuator only

-Combination of Electric attenuator and Mechanical attenuator

when the SCPI command [:SENSe] :POWer [:RF] :RANGe :OPTimize IMMEDIATE is executed.

Remote Command	<code>[:SENSe] :POWer [:RF] :RANGe:OPTimize:TYPE EONLy COMBined</code> <code>[:SENSe] :POWer [:RF] :RANGe:OPTimize:TYPE?</code>
Example	<code>POW:RANG:OPT:TYPE EONL</code> <code>POW:RANG:OPT:TYPE?</code>
Preset	COMBined
State Saved	Saved in instrument state
Initial S/W Revision	A.16.00

Scale/Div

Sets the logarithmic units per vertical graticule division on the display. However, since the Auto Scaling defaults to On, this value is automatically determined by the measurement result. When you set a value manually, Auto Scaling automatically changes to Off.

Key Path	AMPTD Y Scale
Mode	All except SA and BASIC
Remote Command	<code>:DISPlay:MONitor:VIEW[1]:WINDow[1]:TRACe:Y[:SCALe]:PDIVision <rel_amp1></code> <code>:DISPlay:MONitor:VIEW[1]:WINDow[1]:TRACe:Y[:SCALe]:PDIVision?</code>
Example	<code>DISP:MON:VIEW:WIND:TRAC:Y:PDIV 5.0 dB</code> <code>DISP:MON:VIEW:WIND:TRAC:Y:PDIV?</code>
Couplings	When the Auto Scaling is On, this value is automatically determined by the measurement result. When you set a value manually, Auto Scaling automatically changes to Off.
Preset	10.00 dB
State Saved	Saved in instrument state.
Min	0.10 dB
Max	20.00 dB
Initial S/W Revision	Prior to A.02.00

Presel Center

When this key is pressed, the centering of the preselector filter is adjusted to optimize the amplitude accuracy at the frequency of the selected marker. If the selected marker is not on when Presel Center is pressed, the analyzer will turn on the selected marker, perform a peak search, and then perform centering on the marker's center frequency. If the selected marker is already on and between the start and stop frequencies of the analyzer, the analyzer performs the preselector calibration on that marker's frequency. If the selected marker is already on, but outside the frequency range between Start Freq and Stop Freq, the analyzer will first perform a peak search, and then perform centering on the marker's center frequency.

The value displayed on the **Presel Adjust** key will change to reflect the new preselector tuning (see **Presel Adjust**).

A number of considerations should be observed to ensure proper operation. See "[Proper Preselector Operation](#)" on page 2095.

Key Path	AMPTD Y Scale
Remote Command	[:SENSe] :POWer [:RF] :PCENter
Example	POW:PCEN
Notes	Note that the rules outlined above under the key description apply for the remote command as well as the key. The result of the command is dependent on marker position, and so forth. Any message shown by the key press is also shown in response to the remote command.
Dependencies	<ul style="list-style-type: none"> • Grayed out if the microwave preselector is off.) • If the selected marker's frequency is below Band 1, advisory message 0.5001 is generated and no action is taken. • Grayed out if entirely in Band 0. • Blank in models that do not include a preselector, such as option 503. If the SCPI is sent in these instruments, it is accepted without error, and the query always returns 0. • Grayed out in the Spectrogram View.
Couplings	<p>The active marker position determines where the centering will be attempted.</p> <p>If the analyzer is in a measurement such as averaging when centering is initiated, the act of centering the preselector will restart averaging but the first average trace will not be taken until the centering is completed.</p>
Status Bits/OPC dependencies	<p>When centering the preselector, *OPC will not return true until the process is complete and a subsequent measurement has completed, nor will results be returned to a READ or MEASure command.</p> <p>The Measuring bit should remain set while this command is operating and should not go false until the subsequent sweep/measurement has completed.</p>
Initial S/W Revision	Prior to A.02.00
Modified at S/W Revision	A.03.00

Proper Preselector Operation

A number of considerations should be observed to ensure proper operation:

1. If the selected marker is off, the analyzer will turn on a marker, perform a peak search, and adjust the preselector using the selected marker's frequency. It uses the "highest peak" peak search method unqualified by threshold or excursion, so that there is no chance of a 'no peak found' error. It continues with that peak, even if it is the peak of just noise. Therefore, for this operation to work properly, there should be a signal on screen in a preselected range for the peak search to find.
2. If the selected marker is already on, the analyzer will attempt the centering at that marker's frequency. There is no preselector for signals below about 3.6 GHz, therefore if the marker is on a signal below 3.6 GHz, no centering will be attempted and an advisory message generated
3. In some models, the preselector can be bypassed. If it is bypassed, no centering will be attempted in that range and a message will be generated.

Preselector Adjust

Allows you to manually adjust the preselector filter frequency to optimize its response to the signal of interest. This function is only available when "Presel Center" on page 2306 is available.

For general purpose signal analysis, using Presel Center is recommended. Centering the filter minimizes the impact of long-term preselector drift. Presel Adjust can be used instead to manually optimize the preselector. One application of manual optimization would be to peak the preselector response, which both optimizes the signal-to-noise ratio and minimizes amplitude variations due to small (short-term) preselector drifting.

Key Path	AMPTD Y Scale
Scope	Meas Global
Remote Command	<code>[:SENSe] :POWer [:RF] :PADJust <freq></code> <code>[:SENSe] :POWer [:RF] :PADJust?</code>
Example	POW:PADJ 100KHz POW:PADJ?
Notes	The value on the key reads out to 0.1 MHz resolution.
Dependencies	<ul style="list-style-type: none"> • Grayed out if microwave preselector is off.) • Grayed out if entirely in Band 0. • Blank in models that do not include a preselector, such as option 503. If the SCPI is sent in these instruments, it is accepted without error, and the query always returns 0. • Grayed out in the Spectrogram View.
Preset	0 MHz
State Saved	The Presel Adjust value set by Presel Center , or by manually adjusting Presel Adjust , is not saved in instrument state, and does not survive a Preset or power cycle.
Min	-500 MHz
Max	500 MHz
Default Unit	Hz
Backwards Compatibility SCPI	<code>[:SENSe] :POWer [:RF] :MW :PADJust</code> <code>[:SENSe] :POWer [:RF] :MMW :PADJust</code> PSA had multiple preselectors, but the X-Series has only one. These commands simply alias to <code>[:SENSe] :POWer [:RF] :PADJust</code>
Initial S/W Revision	Prior to A.02.00
Modified at S/W Revision	A.03.00

Remote Command	<code>[:SENSe] :POWer [:RF] :PADJust :PRESelector MWAVE MMWave EXTErnal</code> <code>[:SENSe] :POWer [:RF] :PADJust :PRESelector?</code>
Notes	PSA had multiple preselectors, and you could select which preselector to adjust. Since the X-Series has only one mm/uW preselector, the preselector selection softkey is no longer available. However,

to provide backward compatibility, we accept the legacy remote commands.
The command form has no effect, the query always returns MWAVE

Initial S/W Revision Prior to A.02.00

μW Path Control

The **μW Path Control** functions include the **μW Preselector Bypass** (Option MPB) and **Low Noise Path** (Option LNP) controls in the High Band path circuits.

When the μW Preselector is bypassed, the user has better flatness, but will be subject to spurs from out of band interfering signals. When the Low Noise Path is enabled, the analyzer automatically switches around certain circuitry in the high frequency bands which can contribute to noise, when it is appropriate based on other analyzer settings.

For most applications, the preset state is Standard Path, which gives the best remote-control throughput, minimizes acoustic noise from switching and minimizes the risk of wear out in the hardware switches. For applications that utilize the wideband IF paths, the preset state is the μW Preselector Bypass path, if option MPB is present. This is because, when using a wideband IF such as the 140 MHz IF, the μW Preselector's bandwidth can be narrower than the available IF bandwidth, causing degraded amplitude flatness and phase linearity, so it is desirable to bypass the preselector in the default case.

Users may choose Low Noise Path Enable. It gives a lower noise floor, especially in the 21–26.5 GHz region, though without improving many measures of dynamic range, and without giving the best possible noise floor. The preamp, if purchased and used, gives better noise floor than does the Low Noise Path, however its compression threshold and third-order intercept are much poorer than that of the non-preamp Low Noise Path. There are some applications, typically for signals around –30 dBm, for which the third-order dynamic range of the standard path is good enough, but the noise floor is not low enough even with 0 dB input attenuation. When the third-order dynamic range of the preamp path is too little and the noise floor of the standard path is too high, the Low Noise Path can provide the best dynamic range.

Key Path	AMPTD Y Scale
Mode	SA, BASIC, PNOISE, VSA , LTE, LTETDD
Scope	Meas Global
Remote Command	[:SENSe] :POWer [:RF] :MW:PATH STD LNPath MPBypass FULL [:SENSe] :POWer [:RF] :MW:PATH?
Example	:POW:MW:PATH LNP Enables the Low Noise path
Notes	If a Presel Center is performed, the analyzer will momentarily switch to the Standard Path, regardless of the setting of μW Path Control The DC Block will always be switched in when the low noise path is switched in, to protect succeeding circuitry from DC. Note that this does not mean “when the low noise path is enabled” but when, based on the Low Noise Path rules, the path is actually switched in. This can happen when the selection is Low Noise Path Enable . In the case where the DC Block is switched in the analyzer is now AC coupled. However, if the user has selected DC coupling, the UI will still behave as though it were DC coupled, including all annunciation, warnings, status bits, and responses to SCPI queries. This is because, based on other settings, the analyzer could switch out the low noise path at any time

	and hence go back to being DC coupled. Alignment switching ignores the settings in this menu, and restores them when finished.
Dependencies	Unavailable in BBIQ and External Mixing
Preset	All modes other than IQ Analyzer mode and VXA: STD IQ Analyzer, VXA and WLAN mode: MPB option present and licensed: MPB MPB option not present and licensed: STD
State Saved	Save in instrument state
Readback	Value selected in the submenu
Initial S/W Revision	A.04.00
Modified at S/W Revision	A.10.00

Standard Path

This path gives the best remote-control throughput, minimizes acoustic noise from switching and minimizes the risk of wear in the hardware switches, particularly in remote test scenarios where both low band and high band setups will follow in rapid succession.

In this path, the bypass of the low band/high band switch and microwave preamp is never activated, which can cause some noise degradation but preserves the life of the bypass switch.

Key Path	AMPTD Y Scale, μW Path Control
Example	:POW:MW:PATH STD
Readback Text	Standard Path
Initial S/W Revision	A.04.00

Low Noise Path Enable

You may choose Low Noise Path Enable, which gives a lower noise floor under some circumstances, particularly when operating in the 21–26.5 GHz region. With the Low Noise Path enabled, the low band/high band switch and microwave preamp are bypassed whenever all of the following are true:

- The analyzer is not in the Low Band, meaning:
- the start frequency is above 3.5 GHz and
- the stop frequency is above 3.6 GHz.
- the internal preamp is not installed or (if installed) is set to **Off** or **Low Band**

Note that this means that, when any part of a sweep is done in Low Band, the Low Noise Path is not used, whether or not the **Low Noise Path Enable** is selected in the user interface. Also, if the preamp is turned on, the Low Noise Path is not used, whether or not the **Low Noise Path Enable** is selected in the user interface. The only time the Low Noise Path is used is when **Low Noise Path Enable** is selected, the sweep is completely in High Band (> 3.6 GHz) and no preamp is in use.

See "[More Information](#)" on page 2099

Key Path	AMPTD Y Scale, μW Path Control
Measurement	Swept SA
Example	:POW:MW:PATH LNP
Notes	<p>For measurements that use IQ acquisition, the low noise path is used when the Center Frequency is in High Band (> 3.6 GHz) and no preamp is in use.</p> <p>In other words, the rules above are modified to use only the center frequency to qualify which path to switch in.</p> <p>This is not the case for FFT's in the Swept SA measurement; they use the same rules as swept measurements.</p>
Dependencies	<p>Key is blanked if current mode does not support it.</p> <p>Key is grayed out if mode supports it but current measurement does not support it.</p> <p>Unless Option LNP is present and licensed, key is blank and if SCPI command sent, error -241, "Hardware missing; Option not installed" is generated.</p>
Readback Text	Low Noise Path Enable
Initial S/W Revision	A.04.00

More Information

The user should understand that the Low Noise Path, while giving improved DANL, has the disadvantage of decreased TOI performance and decreased gain compression performance relative to the standard path.

The user should also understand that the bypass switch is a mechanical switch and has finite life, so if the **Low Noise Path** is enabled, it is possible to cause frequent cycling of this switch by frequently changing analyzer settings such that the above conditions hold true only some of the time. A user making tests of this nature should consider opting for the **Standard Path**, which will never throw the bypass switch, at the expense of some degraded noise performance.

The low noise path is useful for situations where the signal level is so low that the analyzer performance is dominated by noise even with 0 dB attenuation, but still high enough that the preamp option would have excessive third-order intermodulation or compression. The preamp, if purchased and used, gives better noise floor than does the "Low Noise Path." However, its compression threshold and third-order intercept are much poorer than that of the non-preamp path. There are some applications, typically for signals around -30 dBm, for which the third-order dynamic range of the standard path is good enough, but the noise floor is not low enough even with 0 dB input attenuation. When the third-order dynamic range of the preamp path is too little and the noise floor of the standard path is too high, the Low Noise Path can provide the best dynamic range

The graph below illustrates the concept. It shows, in red, the performance of an analyzer at different attenuation settings, both with the preamp on and off, in a measurement that is affected by both analyzer noise and analyzer TOI. The green shows the best available dynamic range, offset by 0.5 dB for clarity. The blue shows how the best available dynamic range improves for moderate signal levels with the low noise path switched in. In this illustration, the preamp improves the noise floor by 15 dB while degrading the third-order intercept by 30 dB, and the low noise path reduces loss by 8 dB. The attenuator step size is 2 dB.

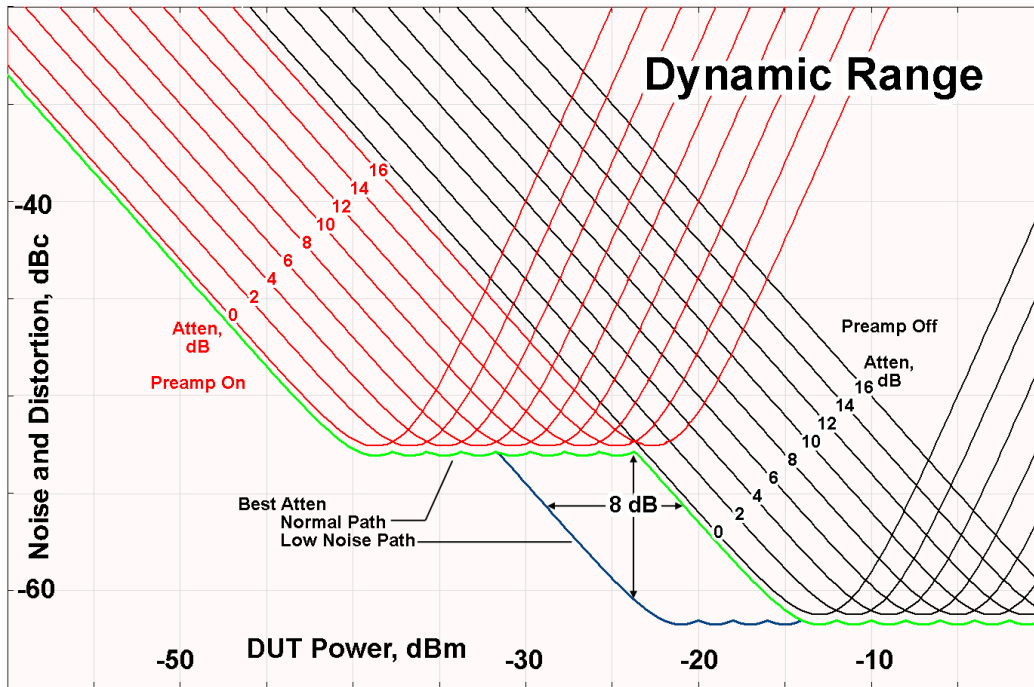

There are other times where selecting the low noise path improves performance, too. Compression-limited measurements such as finding the nulls in a pulsed-RF spectrum can profit from the low noise path in a way similar to the TOI-limited measurement illustrated. Accuracy can be improved when the low noise path allows the optimum attenuation to increase from a small amount like 0, 2 or 4 dB to a larger amount, giving better return loss at the analyzer input. Harmonic measurements, such as second and third harmonic levels, are much improved using the low noise path because of the superiority of that path for harmonic (though not intermodulation) distortion performance.

μW Preselector Bypass

This key toggles the preselector bypass switch for band 1 and higher. When the microwave preselector is on, the signal path is preselected. When the microwave preselector is off, the signal path is not preselected. The preselected path is the normal path for the analyzer.

The preselector is a tunable bandpass filter which prevents signals away from the frequency of interest from combining in the mixer to generate in-band spurious signals (images). The consequences of using a preselector filter are its limited bandwidth, the amplitude and phase ripple in its passband, and any amplitude and phase instability due to center frequency drift.

Option MPB or pre-selector bypass provides an unpreselected input mixer path for certain X-Series signal analyzers with frequency ranges above 3.6 GHz. This signal path allows a wider bandwidth and less amplitude variability, which is an advantage when doing modulation analysis and broadband signal analysis. The disadvantage is that, without the preselector, image signals will be displayed. Another disadvantage of bypassing the preselector is increased LO emission levels at the front panel input port.

Image responses are separated from the real signal by twice the 1st IF. For IF Paths of 10 MHz and 25 MHz, the 1st IF is 322.5 MHz, so the image response and the real signal will be separated by 645 MHz. The 1st IF will be different for other IF Path settings. When viewing a real signal and its corresponding image response in internal mixing, the image response will be to the left of the real signal.

Also, the image response and the real signal typically have the same amplitude and exhibit the same shape factor.

However, if Option FS1, Fast Sweep Capability, is enabled, the image response in the Swept SA measurement will appear lower in amplitude and have a much wider shape factor compared to the real signal.

Key Path	AMPTD Y Scale, μW Path Control
Example	:POW:MW:PATH MPB
Dependencies	Key is blanked if current mode does not support it. Key is grayed out if mode supports it but current measurement does not support it. Key is blank unless Option MPB is present and licensed. If SCPI command sent when MPB not present, error -241, "Hardware missing; Option not installed" is generated.
Readback Text	μ W Preselector Bypass
Initial S/W Revision	A.04.00

Remote Command	[:SENSe] :POWer [:RF] :MW :PRESelector [:STATe] ON OFF 0 1 [:SENSe] :POWer [:RF] :MW :PRESelector [:STATe] ?
Example	:POW:MW:PRES OFF Bypasses the microwave preselector
Notes	The ON parameter sets the STD path (:POW:MW:PATH STD) The OFF parameter sets path MPB (:POW:MW:PATH MPB)
Preset	ON

Internal Preamp

Accesses a menu of keys that control the internal preamps. Turning on the preamp gives a better noise figure, but a poorer TOI to noise floor dynamic range. You can optimize this setting for your particular measurement.

The instrument takes the preamp gain into account as it sweeps. If you sweep outside of the range of the preamp the instrument will also account for that. The displayed result will always reflect the correct gain.

For some measurements, when the preamp is on and any part of the displayed frequency range is below the lowest frequency for which the preamp has specifications, a warning condition message appears in the status line. For example, for a preamp with a 9 kHz lowest specified frequency: "Preamp: Accy unspc'd below 9 kHz".

Key Path	AMPTD Y Scale
Scope	Meas Global
Remote Command	[:SENSe] :POWer [:RF] :GAIN [:STATe] OFF ON 0 1 [:SENSe] :POWer [:RF] :GAIN [:STATe] ?
Dependencies	Preamp is not available on all hardware platforms. If the preamp is not present or is unlicensed, the

	key is not shown. The preamp is not available when the electronic/soft attenuator is enabled.
--	--

Couplings	The act of connecting the U7227A USB Preamplifier to one of the analyzer's USB ports will cause the Internal Preamp to be switched on. When this happens an informational message will be generated: "Internal Preamp turned on for optimal operation with USB Preamp." Note that if the Internal Preamp was already on, there will be no change to the setting, but if it was Off it will be switched On, to Full Range. Note that this same action occurs when the SA mode is selected while the USB Preamp is connected to one of the analyzer's USB ports, if it is the first time that the SA mode has run since powerup, or if the last time the SA mode was running the USB Preamp was NOT connected. Subsequently disconnecting the USB Preamp from USB does not change the Internal Preamp setting nor restore the previous setting.
Preset	OFF
State Saved	Saved in instrument state
Initial S/W Revision	Prior to A.02.00
Modified at S/W Revision	A.14.00

Key Path	AMPTD Y Scale, Internal Preamp
Scope	Meas Global
Remote Command	[:SENSe] : POWer [:RF] : GAIN : BAND LOW FULL [:SENSe] : POWer [:RF] : GAIN : BAND ?
Dependencies	Preamp is not available on all hardware platforms. If the preamp is not present or is unlicensed, the key is not shown. If a POW:GAIN:BAND FULL command is sent when a low band preamp is available, the preamp band parameter is to LOW instead of FULL, and an "Option not installed" message is generated.
Preset	LOW
State Saved	Saved in instrument state
Initial S/W Revision	Prior to A.02.00

Off

Turns the internal preamp off

Key Path	AMPTD Y Scale, Internal Preamp
Example	:POW:GAIN OFF
Readback	Off
Initial S/W Revision	Prior to A.02.00

Low Band

Sets the internal preamp to use only the low band.

The frequency range of the installed (optional) low-band preamp is displayed in square brackets on the **Low Band** key label.

Key Path	AMPTD Y Scale, Internal Preamp
Example	:POW:GAIN ON :POW:GAIN:BAND LOW
Readback	Low Band
Initial S/W Revision	Prior to A.02.00

Full Range

Sets the internal preamp to use its full range. The low band (0–3.6 GHz or 0–3GHz, depending on the model) is supplied by the low band preamp and the frequencies above low band are supplied by the high band preamp.

The frequency range of the installed (optional) preamp is displayed in square brackets on the **Full Range** key label. If the high band option is not installed the Full Range key does not appear.

Key Path	AMPTD Y Scale, Internal Preamp
Example	:POW:GAIN ON :POW:GAIN:BAND FULL
Readback	Full Range
Initial S/W Revision	Prior to A.02.00

Ref Position

Positions the reference level at the top, center or bottom of the Y Scale display. Changing the reference position does not change the reference level value.

Key Path	AMPTD Y Scale
Mode	All except SA and BASIC
Remote Command	:DISPlay:MONitor:VIEW[1]:WINDow[1]:TRACe:Y[:SCALe]:RPOSition TOP CENTer BOTTom :DISPlay:MONitor:VIEW[1]:WINDow[1]:TRACe:Y[:SCALe]:RPOSition?
Example	DISP:MON:VIEW:WIND:TRAC:Y:RPOS CENT DISP:MON:VIEW:WIND:TRAC:Y:RPOS?
Preset	TOP
State Saved	Saved in instrument state.
Range	Top Ctr Bot
Initial S/W Revision	Prior to A.02.00

Auto Scaling

Toggles the Auto Scaling function between On and Off.

Key Path	AMPTD Y Scale
Mode	All except SA and BASIC
Remote Command	:DISPlay:MONitor:VIEW[1]:WINDow[1]:TRACe:Y[:SCALe]:COUPle 0 1 OFF ON :DISPlay:MONitor:VIEW[1]:WINDow[1]:TRACe:Y[:SCALe]:COUPle?
Example	DISP:MON:VIEW:WIND:TRAC:Y:COUP ON DISP:MON:VIEW:WIND:TRAC:Y:COUP?
Couplings	When Auto Scaling is On, and the Restart front-panel key is pressed, this function automatically determines the scale per division and reference values based on the measurement results. When you set a value to either Scale/Div or Ref Value manually, Auto Scaling automatically changes to Off.
Preset	ON
State Saved	Saved in instrument state.
Range	On Off
Initial S/W Revision	Prior to A.02.00

Auto Couple

The Auto Couple feature provides a quick and convenient way to automatically couple multiple instrument settings. This helps ensure accurate measurements and optimum dynamic range. When the Auto Couple feature is activated, either from the front panel or remotely, all parameters of the current measurement that have an Auto/Manual mode are set to Auto mode and all measurement settings dependent on (or coupled to) the Auto/Man parameters are automatically adjusted for optimal performance.

However, the Auto Couple key actions are confined to the current measurement only. It does not affect other measurements in the mode, and it does not affect markers, marker functions, or trace or display attributes.

See "[More Information](#)" on page 2105

Key Path	Front-panel key
Remote Command	:COUPle ALL NONE
Example	:COUP ALL
Notes	:COUPle ALL puts all Auto/Man parameters in Auto mode (equivalent to pressing the Auto Couple key). :COUPLE NONE puts all Auto/Man parameters in manual mode. It decouples all the coupled instrument parameters and is not recommended for making measurements.
Initial S/W Revision	Prior to A.02.00

More Information

There are two types of functions that have Auto/Manual modes.

Auto/Man Active Function keys

An Auto/Man toggle key controls the binary state associated with an instrument parameter by toggling between **Auto** (where the parameter is automatically coupled to the other parameters it is dependent upon) and **Man** (where the parameter is controlled independent of the other parameters), as well as making the parameter the active function. The current mode is indicated on the softkey with either **Auto** or **Man** underlined as illustrated below.

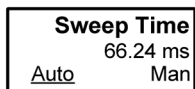

vsd07

Auto/Man 1-of-N keys

An Auto/Man 1-of-N key allows you to manually pick from a list of parameter values, or place the function in Auto, in which case the value is automatically selected (and indicated) as shown below. If in Auto, Auto is underlined on the calling key. If in manual operation, manual is indicated on the calling key. But the calling key does not actually toggle the function, it simply opens the menu.

15 Monitor Spectrum Measurement
Auto Couple

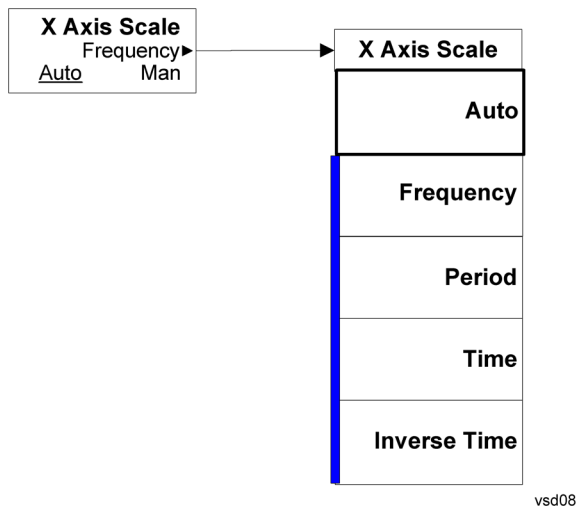

BW

Accesses a menu that enables you to specify the resolution bandwidth functions that control the bandwidth and filter selection.

Key Path	Front-panel key
Initial S/W Revision	Prior to A.02.00

Res BW

Sets the resolution bandwidth for the current measurement. If an unavailable bandwidth is entered with the numeric keypad, the closest available bandwidth is selected.

Key Path	BW
Mode	All except SA and BASIC
Remote Command	[:SENSe]:MONitor:BANDwidth[:RESolution] <freq> [:SENSe]:MONitor:BANDwidth[:RESolution]? [:SENSe]:MONitor:BANDwidth[:RESolution]:AUTO OFF ON 0 1 [:SENSe]:MONitor:BANDwidth[:RESolution]:AUTO?
Example	MON:BAND 2.4 MHz MON:BAND? MON:BAND:AUTO ON MON:BAND:AUTO?
Preset	WCDMA: Automatically calculated WIMAX OFDMA: 100kHz C2K: Automatically calculated BLUETOOTH: Automatically calculated PN: Automatically calculated GSM/EDGE: Automatically calculated TD-SCDMA: Automatically calculated 1xEVDO: 30kHz DVB-T/H: 3.9kHz DTMB (CTTB): 3.9kHz ISDB-T: 3.9kHz CMMB: 3.9kHz LTE: 100 kHz LTETDD: 100 kHz Digital Cable TV: 3.9kHz WLAN: 100 kHz MSR: Automatically calculated LTEAFDD, LTEATDD: 100kHz

	WCDMA: ON
	WIMAX: OFF
	C2K: ON
	BLUETOOTH: ON
	PN: ON
	GSM/EDGE: ON
	TD-SCDMA: ON
	1xEVDO: ON
	DVB-T/H: OFF
	DTMB (CTTB): OFF
	ISDB-T: OFF
	CMMB: OFF
	LTE:OFF
	LTETDD: OFF
	Digital Cable TV: OFF
	WLAN: OFF
	MSR: ON
	LTEAFDD, LTEATDD: OFF
State Saved	Saved in instrument state.
Min	1.0 Hz
Max	8.0 MHz
Backwards Compatibility SCPI	<code>[[:SENSE]:MONitor:BWIDth[:RESolution]</code>
Initial S/W Revision	Prior to A.02.00
Modified at S/W Revision	A.02.00
Modified at S/W Revision	A.03.00

Video BW

Changes the analyzer post-detection filter.

Key Path	BW
Mode	All except SA and BASIC
Remote Command	<code>[[:SENSE]:MONitor:BANDwidth:VIDeo <bandwidth></code> <code>[[:SENSE]:MONitor:BANDwidth:VIDeo?</code> <code>[[:SENSE]:MONitor:BANDwidth:VIDeo:AUTO ON OFF 1 0</code> <code>[[:SENSE]:MONitor:BANDwidth:VIDeo:AUTO?</code>
Example	MON:BAND:VID 10 MHz MON:BAND:VID? MON:BAND:VID:AUTO OFF

	MON:BAND:VID:AUTO?
Preset	WCDMA: Automatically calculated WIMAX OFDMA: 1MHz C2K: Automatically calculated BLUETOOTH: Automatically calculated PN: Automatically calculated GSM/EDGE: Automatically calculated TD-SCDMA: Automatically calculated 1xEVDO: 300kHz DVB-T/H: 39kHz DTMB (CTTB): 39kHz ISDB-T: 39kHz CMMB: 39kHz LTE: 1 MHz LTETDD: 1 MHz Digital Cable TV: 39kHz WLAN: 1 MHz MSR: Automatically calculated LTEAFDD, LTEATDD:1 MHz WCDMA: ON WIMAX: OFF C2K: ON BLUETOOTH: ON PN: ON GSM/EDGE: ON TD-SCDMA: ON 1xEVDO: ON DVB-T/H: OFF DTMB (CTTB): OFF ISDB-T: OFF CMMB: OFF LTE:OFF LTETDD:OFF Digital Cable TV: OFF WLAN: OFF MSR: ON LTEAFDD, LTEATDD: OFF
State Saved	Saved in instrument state.
Min	1 Hz
Max	50 MHz

Backwards Compatibility SCPI	<code>[:SENSe] :MONitor :BWIDth :VIDeo</code>
Initial S/W Revision	Prior to A.02.00
Modified at S/W Revision	A.02.00
Modified at S/W Revision	A.03.00

VBW:3dB RBW

Selects the ratio between the video bandwidth and the equivalent 3 dB resolution bandwidth to be used for setting the VBW when VBW is in Auto.

Key Path	BW
Mode	All except SA and BASIC
Remote Command	<code>[:SENSe] :MONitor :BANDwidth :VIDeo :RATio <real></code> <code>[:SENSe] :MONitor :BANDwidth :VIDeo :RATio?</code> <code>[:SENSe] :MONitor :BANDwidth :VIDeo :RATio :AUTO OFF ON 0 1</code> <code>[:SENSe] :MONitor :BANDwidth :VIDeo :RATio :AUTO?</code>
Example	MON:BAND:VID:RAT 2 MON:BAND:VID:RAT? MON:BAND:VID:RAT:AUTO 0 MON:BAND:VID:RAT:AUTO?
Preset	1 ON
State Saved	Saved in instrument state.
Min	0.00001
Max	3000000
Backwards Compatibility SCPI	<code>[:SENSe] :MONitor :BWIDth :VIDeo :RATio</code>
Initial S/W Revision	Prior to A.02.00

Span:3dB RBW

Selects the ratio between span and resolution bandwidth.

The default setting is Auto with a Span:3 dB RBW ratio of 106:1. You can manually change this ratio by pressing the key, entering a new value, and pressing **Enter**.

Key Path	BW
Mode	All except SA and BASIC
Remote Command	<code>[:SENSe] :MONitor :FREQuency :SPAN :BANDwidth [:RESolution] :RATio <integer></code>

```
[:SENSe]:MONitor:FREQuency:SPAN:BANDwidth[:RESolution]:RATio?
[:SENSe]:MONitor:FREQuency:SPAN:BANDwidth[:RESolution]:RATio:AUTO OFF |
ON | 0 | 1
[:SENSe]:MONitor:FREQuency:SPAN:BANDwidth[:RESolution]:RATio:AUTO?
```

Example

```
MON:FREQ:SPAN:BAND:RAT 200
MON:FREQ:SPAN:BAND:RAT?
MON:FREQ:SPAN:BAND:RAT:AUTO ON
MON:FREQ:SPAN:BAND:RAT:AUTO?
```

Preset 106
ON

State Saved Saved in instrument state.

Min 2

Max 10000

Backwards Compatibility SCPI [:SENSe]:MONitor:FREQuency:SPAN:BWIDth[:RESolution]:RATio

Initial S/W Revision Prior to A.02.00

Modified at S/W Revision A.04.00

Cont (Continuous Measurement/Sweep)

Sets the analyzer for Continuous measurement operation. The single/continuous state is Meas Global so the setting will affect all measurements. If you are Paused, pressing **Cont** does a Resume.

Key Path	Front-panel key
Remote Command	:INITiate:CONTinuous OFF ON 0 1 :INITiate:CONTinuous?
Example	:INIT:CONT 0 puts analyzer in Single measurement operation. :INIT:CONT 1 puts analyzer in Continuous measurement operation
Preset	ON (Note that SYST:PRESet sets INIT:CONT to ON but *RST sets INIT:CONT to OFF)
State Saved	Saved in instrument state
Backwards Compatibility Notes	For Spectrum Analysis mode in ESA and PSA, there is no Cont hardkey, instead there is a Sweep Single/Cont key. In these analyzers, switching the Sweep Single/Cont key from Single to Cont restarts averages (displayed average count reset to 1), but does not restart Max Hold and Min Hold . The X-Series has Single and Cont keys in place of the SweepSingleCont key. In the X-Series, if in single measurement, the Cont key (and INIT:CONT ON) switches to continuous measurement, but never restarts a measurement and never resets a sweep.
Initial S/W Revision	Prior to A.02.00

In Swept SA Measurement (Spectrum Analysis Mode):

The analyzer takes repetitive sweeps, averages, measurements, etc., when in Continuous mode. When the average count reaches the Average/Hold Number the count stops incrementing, but the analyzer keeps sweeping. See the Trace/Detector section for the averaging formula used both before and after the Average/Hold Number is reached. The trigger condition must be met prior to each sweep. The type of trace processing for multiple sweeps, is set under the Trace/Detector key, with choices of **Trace Average**, **Max Hold**, or **Min Hold**.

In Other Measurements/Modes:

With **Avg/Hold Num** (in the **Meas Setup** menu) set to **Off** or set to **On** with a value of 1, a sweep is taken after the trigger condition is met; and the analyzer continues to take new sweeps after the current sweep has completed and the trigger condition is again met. However, with **Avg/Hold Num** set to On with a value >1, multiple sweeps (data acquisitions) are taken for the measurement. The trigger condition must be met prior to each sweep. The sweep is not stopped when the average count k equals the number N set for Avg/Hold Num is reached, but the number k stops incrementing. A measurement average usually applies to all traces, marker results, and numeric results. But sometimes it only applies to the numeric results.

If the analyzer is in Single measurement, pressing the **Cont** key does not change k and does not cause the sweep to be reset; the only action is to put the analyzer into Continuous measurement operation.

If it is already in continuous sweep:

the INIT:CONT 1 command has no effect

the INIT:CONT 0 command will place the analyzer in Single Sweep but will have no effect on the current sequence until $k = N$, at which point the current sequence will stop and the instrument will go to the idle state.

15 Monitor Spectrum Measurement
File

File

See "File" on page 362

FREQ Channel

Accesses a menu of keys that allow you to control the Frequency and Channel parameters of the instrument.

Some features in the Frequency menu are the same for all measurements - they do not change as you change measurements. Settings like these are called "Meas Global" and are unaffected by Meas Preset. For example, the Center Freq setting is the same for all measurements - it does not change as you change measurements.

Key Path	Front Panel
Mode	MSR
Initial S/W Revision	A.10.00

Center Freq

Sets center frequency used in Monitor Spectrum, IQ Waveform and Power Stat CCDF. Center Freq, Center Freq Offset and Carrier Ref Freq are coupled with this equation, $\text{Center Freq} = \text{Carrier Ref Freq} + \text{Center Freq Offset}$. When Center Freq is changed, Center Freq Offset is updated and Carrier Ref Freq is not.

When auto, Center Freq Offset remains the same value. Thus Center Freq changes the same amount of Carrier Ref Freq change when Carrier Ref Freq is changed. The auto state changes to manual when either Center Freq is changed.

Key Path	FREQ Channel
Mode	MSR
Measurement	Monitor Spectrum, IQ Waveform, Power Stat CCDF
Remote Command	<pre>[:SENSe] :FREQuency:CENTer <freq> [:SENSe] :FREQuency:CENTer? [:SENSe] :FREQuency:CENTer:AUTO ON OFF 1 0 [:SENSe] :FREQuency:CENTer:AUTO?</pre>
Example	<pre>FREQ:CENT 1.0GHz FREQ:CENT? FREQ:CENT:AUTO OFF FREQ:CENT:AUTO?</pre>
Preset	Automatically calculated ON
State Saved	Saved in instrument state
Min	Depends on instrument minimum frequency.
Max	Depends on instrument maximum frequency.
Initial S/W Revision	A.10.00

Center Freq Offset

Sets Center Freq Offset which is coupled with center frequency used in Monitor Spectrum, IQ Waveform and Power Stat CCDF as the offset from Carrier Ref Freq. Center Freq, Center Freq Offset and Carrier Ref Freq are coupled with this equation, Center Freq = Carrier Ref Freq + Center Freq Offset. When Center Freq Offset is changed, Center Freq is updated and Carrier Ref Freq is not.

Key Path	FREQ Channel
Mode	MSR
Measurement	Monitor Spectrum, IQ Waveform, Power Stat CCDF
Remote Command	<code>[:SENSe] :FREQuency:CENTer:OFFSet <freq></code> <code>[:SENSe] :FREQuency:CENTer:OFFSet?</code>
Example	FREQ:CENT:OFFS 100kHz FREQ:CENT:OFFS?
Notes	Center Freq State is changed to man when Center Freq Offset is changed.
Preset	0 GHz
State Saved	Saved in instrument state
Min	Minimum of Center Frequency - Carrier Ref Frequency
Max	Maximum of Center Frequency - Carrier Ref Frequency
Initial S/W Revision	A.10.00

Carrier Ref Freq

Sets carrier reference frequency. The center frequencies of carriers are defined as offset frequency from this value. This reference frequency is also the reference of carrier configuration preset.

Key Path	FREQ Channel
Mode	MSR
Measurement	all
Remote Command	<code>[:SENSe] :CARRier:REFerence <freq></code> <code>[:SENSe] :CARRier:REFerence?</code>
Example	CARR:REF 2GHz CARR:REF?
Preset	1GHz
State Saved	Saved in instrument state
Min	Depends on instrument minimum center frequency. Same as Center Freq
Max	Depends on instrument maximum center frequency. Same as Center Freq
Initial S/W Revision	A.10.00

Carrier Setup

Accesses the Carrier Setup menu.

Key Path	FREQ Channel
Initial S/W Revision	A.10.00

Carriers

Specifies how many carriers are used in MSR measurements. Base station RF bandwidth is determined from the carrier 1 to the carrier specified by this value whatever carriers' Present Pwr states are. Select Carrier can be select up to this value.

Key Path	FREQ Channel, Carrier Setup
Measurement	All
Remote Command	<code>[:SENSe] :CARRier:COUNT <integer></code> <code>[:SENSe] :CARRier:COUNT?</code>
Example	CARR:COUN 10 CARR:COUN?
Preset	1
State Saved	Saved in instrument state.
Min	1
Max	100
Initial S/W Revision	A.10.00

Configure Carriers

Accesses a menu of commonly used carrier configuration parameters.

Key Path	FREQ Channel, Carrier Setup
Initial S/W Revision	A.10.00

Select Carrier

Selects which carrier's configuration menu is displayed.

This key is also connected to the carrier info tables of some measurements. When the value is changed in a measurement which has carrier table view, the highlight in the table moves to Select Carrier. The highlight of the table and Select Carrier are not coupled.

Key Path	FREQ Channel, Carrier Setup, Configure Carriers
Preset	1

State Saved	No
Min	1
Max	Value of Carriers
Initial S/W Revision	A.10.00

Measure Carrier

Sets whether to measure this carrier or not.

Key Path	FREQ Channel, Carrier Setup, Configure Carriers
Remote Command	[:SENSe] :CARRier<n> [:STATe] OFF ON 0 1 [:SENSe] :CARRier<n> [:STATe] ?
Example	CARR10 1 CARR10?
Notes	The command is used with a sub-op code <n> (default=1) to specify the carrier for configuration. The range of the sub-op code is determined by the number of carriers.
Preset	ON
State Saved	Saved in instrument state
Range	On Off
Initial S/W Revision	A.10.00

Carrier Offset

Sets the carrier center frequency as offset from Carrier Ref Frequency.

Key Path	FREQ Channel, Carrier Setup, Configure Carriers
Remote Command	[:SENSe] :CARRier<n> :FREQuency:OFFSet <freq> [:SENSe] :CARRier<n> :FREQuency:OFFSet ?
Example	CARR10:FREQ:OFFS 10MHz CARR10:FREQ:OFFS?
Notes	The command is used with a sub-op code <n> (default=1) to specify the carrier for configuration. The range of the sub-op code is determined by the number of carriers.
Preset	0Hz
State Saved	Saved in instrument state
Min	-1GHz
Max	1GHz
Initial S/W Revision	A.10.00

Radio Format

Selects a format parameter set to set the radio format of the selected carrier.

NONE – No format is specified. Channel spacing, measurement BW and FOffset, RAT are values of defaults of LTE FDD 5MHz.

LTE FDD Parameter Set 1 – Selects LTE FDD parameter set 1. LTE FDD (E-UTRA FDD) is the radio format of the carrier.

LTE FDD Parameter Set 2 – Selects LTE FDD parameter set 2. LTE FDD (E-UTRA FDD) is the radio format of the carrier.

LTE FDD Parameter Set 3 – Selects LTE FDD parameter set 3. LTE FDD (E-UTRA FDD) is the radio format of the carrier.

W-CDMA Parameter Set 1 – Selects W-CDMA parameter set 1. W-CDMA (UTRA FDD) is the radio format of the carrier.

W-CDMA Parameter Set 2 – Selects W-CDMA parameter set 2. W-CDMA (UTRA FDD) is the radio format of the carrier.

W-CDMA Parameter Set 3 – Selects W-CDMA parameter set 3. W-CDMA (UTRA FDD) is the radio format of the carrier.

GSM/EDGE Parameter Set 1 – Selects GSM/EDGE parameter set 1. GSM/EDGE is the radio format of the carrier.

GSM/EDGE Parameter Set 2 – Selects GSM/EDGE parameter set 2. GSM/EDGE is the radio format of the carrier.

GSM/EDGE Parameter Set 3 – Selects GSM/EDGE parameter set 3. GSM/EDGE is the radio format of the carrier.

cdma2000 Parameter Set 1 – Selects cdma2000 parameter set 1. cdma2000 is the radio format of the carrier.

cdma2000 Parameter Set 2 – Selects cdma2000 parameter set 2. cdma2000 is the radio format of the carrier.

cdma2000 Parameter Set 3 – Selects cdma2000 parameter set 3. cdma2000 is the radio format of the carrier.

1xEV-DO Parameter Set 1 – Selects 1xEV-DO parameter set 1. 1xEV-DO is the radio format of the carrier.

1xEV-DO Parameter Set 2 – Selects 1xEV-DO parameter set 2. 1xEV-DO is the radio format of the carrier.

1xEV-DO Parameter Set 3 – Selects 1xEV-DO parameter set 3. 1xEV-DO is the radio format of the carrier.

LTE TDD Parameter Set 1 – Selects LTE TDD parameter set 1. LTE TDD (E-UTRA TDD) is the radio format of the carrier.

LTE TDD Parameter Set 2 – Selects LTE TDD parameter set 2. LTE TDD (E-UTRA TDD) is the radio format of the carrier.

LTE TDD Parameter Set 3 – Selects LTE TDD parameter set 3. LTE TDD (E-UTRA TDD) is the radio format of the carrier.

TD-SCDMA Parameter Set 1 – Selects TD-SCDMA parameter set 1. TD-SCDMA (UTRA-TDD LCR) is the radio format of the carrier.

TD-SCDMA Parameter Set 2 – Selects TD-SCDMA parameter set 2. TD-SCDMA (UTRA-TDD LCR) is the radio format of the carrier.

TD-SCDMA Parameter Set 3 – Selects TD-SCDMA parameter set 3. TD-SCDMA (UTRA-TDD LCR) is the radio format of the carrier.

Key Path	FREQ Channel, Carrier Setup, Configure Carriers
Remote Command	[:SENSe]:CARRier<n>:FORMat NONE LTEFdd1 LTEFdd2 LTEFdd3 WCDMa1 WCDMa2 WCDMa3 GSM1 GSM2 GSM3 CDMA1 CDMA2 CDMA3 EVDO1 EVDO2 EVDO3 LTEFdd1 LTEFdd2 LTEFdd3 TDSCdma1 TDSCdma2 TDSCdma3 [:SENSe]:CARRier<n>:FORMat ?
Example	CARR10:FORM LTEF1 CARR10:FORM?
Notes	The command is used with a sub-op code <n> (default=1) to specify the carrier for configuration. The range of the sub-op code is determined by the number of carriers.
Dependencies	The following licenses are required for each key to be displayed. Without the licenses, corresponding enum values cannot be set even via the SCPI command. <ul style="list-style-type: none"> • LTE FDD - N9080A-1FP or W9080A-1FP • W-CDMA - N9073A-1FP or W9073A-1FP • GSM/EDGE - N9071A-2FP or W9071A-2FP • cdma2000 - N9072A-2FP or W9072A-2FP • 1xEV-DO - N9076A-1FP or W9076A-1FP • LTE TDD - N9082A-1FP or W9082A-1FP • TD-SCDMA - N9079A-1FP or W9079A-1FP
State Saved	Saved in instrument state
Range	None LTE FDD [Parameter Set 1] Parameter Set 1 ("LTE FDD 1") Parameter Set 2 ("LTE FDD 2") Parameter Set 3 ("LTE FDD 3") W-CDMA [Parameter Set 1] Parameter Set 1 ("W-CDMA 1") Parameter Set 2 ("W-CDMA 2") Parameter Set 3 ("W-CDMA 3") GSM/EDGE [Parameter Set 1] Parameter Set 1 ("GSM/EDGE 1") Parameter Set 2 ("GSM/EDGE 2") Parameter Set 3 ("GSM/EDGE 3") cdma2000 [Parameter Set 1] Parameter Set 1 ("cdma2000 1")

	Parameter Set 2 ("cdma2000 2") Parameter Set 3 ("cdma2000 3") 1xEV-DO [Parameter Set 1] Parameter Set 1 ("1xEV-DO 1") Parameter Set 2 ("1xEV-DO 2") Parameter Set 3 ("1xEV-DO 3") LTE TDD [Parameter Set 1] Parameter Set 1 ("LTE TDD 1") Parameter Set 2 ("LTE TDD 2") Parameter Set 3 ("LTE TDD 3") TD-SCDMA [Parameter Set 1] Parameter Set 1 ("TD-SCDMA 1") Parameter Set 2 ("TD-SCDMA 2") Parameter Set 3 ("TD-SCDMA 3")
Readback	The readback line on this key shows the currently selected Radio Format in square brackets.
Initial S/W Revision	A.10.00
Modified at S/W Revision	A.12.00, A.16.00

Carrier Allocation

Specifies the carrier frequency allocation. There are two types of allocation, contiguous and non-contiguous. Non-Contiguous frequency allocation is defined as an allocation where two sub-blocks are separated with a sub-block gap.

Contiguous – All the carriers belong to one block and no sub-block gap exists.

Non-Contiguous – Carriers are separated into two sub-blocks. Allocation Break Pt Carrier determines how sub-blocks are configured.

Key Path	FREQ Channel, Carrier Setup
Scope	Meas Global
Remote Command	[:SENSe]:CARRier:CONFig:ALLocation CONTiguous NCONtiguous [:SENSe]:CARRier:CONFig:ALLocation?
Example	CARR:CONF:ALL CONT CARR:CONF:ALL?
Preset	CONtiguous
State Saved	Saved in instrument state.
Range	Contiguous Non-Contiguous
Initial S/W Revision	A.13.00

Non-Contiguous

Opens a menu that enables you to set a non-contiguous parameter.

Key Path	FREQ Channel, Carrier Setup, Carrier Allocation
Initial S/W Revision	A.13.00

Allocation Break Pt Carrier

Specifies an allocation break point in non-contiguous carrier allocation. First sub-block starts from the lowest frequency carrier and stops at the allocation break point carrier. Next sub-block starts from the next upper frequency carrier and ends at the highest frequency carrier.

Two examples are shown below. In these examples carrier indices are not in the order of carrier frequency. In the first example, Allocation Break Pt Carrier is 2. It means that sub-block 1 ends at carrier 2 and sub-block 2 starts at carrier 5. Sub-block gap is located between carrier 2 and 5. In the second example, Allocation Break Pt Carrier is 3 and the sub-block gap comes between carrier 3 and 2.

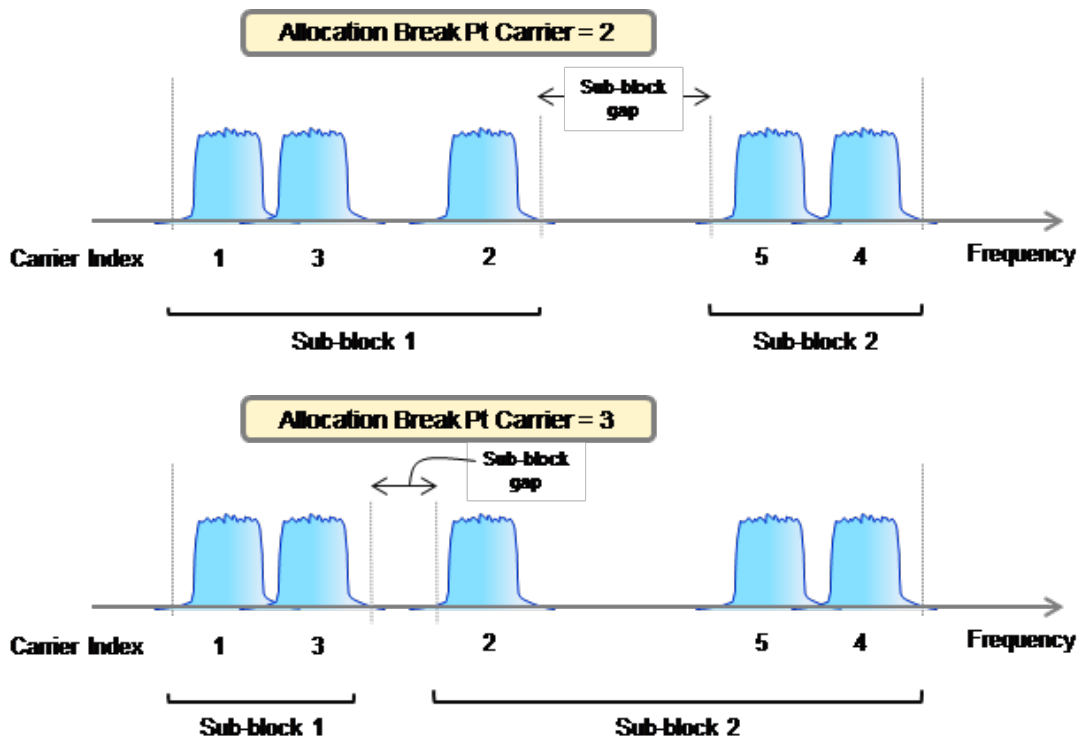

Key Path	FREQ Channel, Carrier Setup, Carrier Allocation, Non-Contiguous
Scope	Meas Global
Remote Command	[[:SENSe]:CARRier:CONFig:ALLocation:NCONtiguous:ABPoint <integer> [[:SENSe]:CARRier:CONFig:ALLocation:NCONtiguous:ABPoint?
Example	CARR:CONF:ALL:NCON:ABP 5 CARR:CONF:ALL:NCON:ABP?

Dependencies	The maximum value depends on the number of carriers.
Couplings	This value can change when you decrease the number of carriers.
Preset	1
State Saved	Saved in instrument state.
Min	1
Max	99
Initial S/W Revision	A.13.00

Carrier Conf Presets

Pressing this key pops up Conf Presets. Each parameter under this menu initiate carrier configuration preset when its value is changed.

Appropriate licenses are required to select carrier config enum. Required licenses are shown here. Note that N/W means N or W license, i.e. N/W9073A-1FP means either N9073A-1FP or W9073A-1FP is required.

TC1a (FDD): N/W9073A-1FP (W-CDMA)

TC2 (FDD): N/W9080A-1FP (LTE FDD)

TC3a (FDD): N/W9073A-1FP (W-CDMA) and N9080A-1FP (LTE FDD)

TC4a (FDD): N/W9071A-2FP (GSM/EDGE) and N/W9073A-1FP (W-CDMA)

TC4b (FDD): N/W9071A-2FP (GSM/EDGE) and N9080A-1FP (LTE FDD)

TC4c (FDD): N/W9071A-2FP (GSM/EDGE), N/W9073A-1FP (W-CDMA) and N9080A-1FP (LTE FDD)

TC4d (FDD): N/W9071A-2FP (GSM/EDGE) and N/W9073A-1FP (W-CDMA)

TC4e (FDD): N/W9071A-2FP (GSM/EDGE) and N9080A-1FP (LTE FDD)

TC4a (FDD) Two Carriers: N/W9071A-2FP (GSM/EDGE) and N/W9073A-1FP (W-CDMA)

TC4b (FDD) Two Carriers: N/W9071A-2FP (GSM/EDGE) and N9080A-1FP (LTE FDD)

TC4c (FDD) Two Carriers: N/W9071A-2FP (GSM/EDGE), N/W9073A-1FP (W-CDMA) and N9080A-1FP (LTE FDD)

NTC1a (FDD): N/W9073A-1FP (W-CDMA)

NTC2 (FDD): N/W9080A-1FP (LTE FDD)

NTC3a (FDD): N/W9073A-1FP (W-CDMA) and N9080A-1FP (LTE FDD)

NTC4a (FDD): N/W9071A-2FP (GSM/EDGE) and N/W9073A-1FP (W-CDMA)

NTC4b (FDD): N/W9071A-2FP (GSM/EDGE) and N9080A-1FP (LTE FDD)

NTC4c (FDD): N/W9071A-2FP (GSM/EDGE), N/W9073A-1FP (W-CDMA) and N9080A-1FP (LTE FDD)

LTE FDD: N/W9080A-1FP (LTE FDD)

W-CDMA: N/W9073A-1FP (W-CDMA)

GSM/EDGE: N/W9071A-2FP (GSM/EDGE)

cdma2000: N/W9072A-2FP (cdma2000)

1xEV-DO: N/W9076A-1FP (1xEV-DO)

Enum keys don't appear on the menu if required licenses are not installed.

Key Path	FREQ Channel, Carrier Setup
Remote Command	[:SENSe] :CARRier:CONFig?
Example	CARR:CONF TC1AFDD CARR:CONF?
Notes	The softkey for NONE is not available.
State Saved	Saved in instrument state
Initial S/W Revision	A.10.00
Modified at S/W Revision	A.12.00, A.13.00

MSR Test Config

Accesses the menu to select MSR Test Configurations.

Key Path	FREQ Channel, Carrier Setup
Initial S/W Revision	A.10.00

Carrier Conf Presets

Pressing this key pops up Conf Presets. Each parameter under this menu initiate carrier configuration preset when its value is changed.

Appropriate licenses are required to select carrier config enum. Required licenses are shown here. Note that N/W means N or W license, i.e. N/W9073A-1FP means either N9073A-1FP or W9073A-1FP is required.

TC1a (FDD): N/W9073A-1FP (W-CDMA)

TC2 (FDD): N/W9080A-1FP (LTE FDD)

TC3a (FDD): N/W9073A-1FP (W-CDMA) and N9080A-1FP (LTE FDD)

TC4a (FDD): N/W9071A-2FP (GSM/EDGE) and N/W9073A-1FP (W-CDMA)

TC4b (FDD): N/W9071A-2FP (GSM/EDGE) and N9080A-1FP (LTE FDD)

TC4c (FDD): N/W9071A-2FP (GSM/EDGE), N/W9073A-1FP (W-CDMA) and N9080A-1FP (LTE FDD)

TC4d (FDD): N/W9071A-2FP (GSM/EDGE) and N/W9073A-1FP (W-CDMA)

TC4e (FDD): N/W9071A-2FP (GSM/EDGE) and N9080A-1FP (LTE FDD)

TC4a (FDD) Two Carriers: N/W9071A–2FP (GSM/EDGE) and N/W9073A–1FP (W-CDMA)

TC4b (FDD) Two Carriers: N/W9071A–2FP (GSM/EDGE) and N9080A–1FP (LTE FDD)

TC4c (FDD) Two Carriers: N/W9071A–2FP (GSM/EDGE), N/W9073A–1FP (W-CDMA) and N9080A–1FP (LTE FDD)

NTC1a (FDD): N/W9073A–1FP (W-CDMA)

NTC2 (FDD): N/W9080A–1FP (LTE FDD)

NTC3a (FDD): N/W9073A–1FP (W-CDMA) and N9080A–1FP (LTE FDD)

NTC4a (FDD): N/W9071A–2FP (GSM/EDGE) and N/W9073A–1FP (W-CDMA)

NTC4b (FDD): N/W9071A–2FP (GSM/EDGE) and N9080A–1FP (LTE FDD)

NTC4c (FDD): N/W9071A–2FP (GSM/EDGE), N/W9073A–1FP (W-CDMA) and N9080A–1FP (LTE FDD)

LTE FDD: N/W9080A–1FP (LTE FDD)

W-CDMA: N/W9073A–1FP (W-CDMA)

GSM/EDGE: N/W9071A–2FP (GSM/EDGE)

cdma2000: N/W9072A–2FP (cdma2000)

1xEV-DO: N/W9076A–1FP (1xEV-DO)

Enum keys don't appear on the menu if required licenses are not installed.

Key Path	FREQ Channel, Carrier Setup
Remote Command	[:SENSe] :CARRier:CONFig?
Example	CARR:CONF TC1AFDD CARR:CONF?
Notes	The softkey for NONE is not available.
State Saved	Saved in instrument state
Initial S/W Revision	A.10.00
Modified at S/W Revision	A.12.00, A.13.00

Max W-CDMA Carriers (FDD)

Sets max W-CDMA carriers placed when the carrier configuration preset runs. When this value is changed, the carrier configuration preset is initiated.

Key Path	FREQ Channel, Carrier Setup, Carrier Conf Presets, MSR Test Config, TC1a (FDD)FREQ Channel, Carrier Setup, Carrier Conf Presets, MSR Test Config, TC3a (FDD)FREQ Channel, Carrier Setup, Carrier Conf Presets, MSR Test Config, TC4a (FDD)FREQ Channel, Carrier Setup, Carrier Conf Presets, MSR Test Config, TC4c (FDD)FREQ Channel, Carrier Setup, Carrier Conf Presets, Single RAT Config, W-CDMA
----------	--

Remote Command	<code>[:SENSe] :CARRier:CONFig:WCDMa:CMAX <integer></code> <code>[:SENSe] :CARRier:CONFig:WCDMa:CMAX?</code>
Example	<code>CARR:CONF:WCDM:CMAX 8</code> <code>CARR:CONF:WCDM:CMAX?</code>
Preset	100
State Saved	Saved in instrument state
Min	1
Max	100
Initial S/W Revision	A.10.00

Max LTE FDD Carriers

Sets max LTE FDD carriers placed when the carrier configuration preset runs. When this value is changed, the carrier configuration preset is initiated.

Key Path	FREQ Channel, Carrier Setup, Carrier Conf Presets, MSR Test Config, TC2 (FDD)FREQ Channel, Carrier Setup, Carrier Conf Presets, MSR Test Config, TC3a (FDD)FREQ Channel, Carrier Setup, Carrier Conf Presets, MSR Test Config, TC4b (FDD)FREQ Channel, Carrier Setup, Carrier Conf Presets, MSR Test Config, TC4c (FDD)FREQ Channel, Carrier Setup, Carrier Conf Presets, Single RAT Config, LTE FDD
Remote Command	<code>[:SENSe] :CARRier:CONFig:LTEFdd:CMAX <integer></code> <code>[:SENSe] :CARRier:CONFig:LTEFdd:CMAX?</code>
Example	<code>CARR:CONF:LTEF:CMAX 8</code> <code>CARR:CONF:LTEF:CMAX?</code>
Preset	100
State Saved	Saved in instrument state
Min	1
Max	100
Initial S/W Revision	A.10.00

LTE FDD BW

Sets bandwidth of LTE FDD carriers placed when the carrier configuration preset runs. When this value is changed, the carrier configuration preset is initiated.

Key Path	FREQ Channel, Carrier Setup, Carrier Conf Presets, MSR Test Config, TC2 (FDD)FREQ Channel, Carrier Setup, Carrier Conf Presets, MSR Test Config, TC3a (FDD)FREQ Channel, Carrier Setup, Carrier Conf Presets, MSR Test Config, TC4b (FDD)FREQ Channel, Carrier Setup, Carrier Conf Presets, MSR Test Config, TC4c (FDD)FREQ Channel, Carrier Setup, Carrier Conf Presets, MSR Test Config, TC4d (FDD)FREQ Channel, Carrier Setup, Carrier Conf Presets, Single RAT Config, LTE FDD
Remote Command	<code>[:SENSe] :CARRier:CONFig:LTEFdd:BANDwidth B1M4 B3M B5M B10M B15M</code>

	B20M [:SENSe]:CARRier:CONFig:LTEFdd:BANDwidth?
Example	CARR:CONF:LTEF:BAND B5M CARR:CONF:LTEF:BAND?
Preset	B5M
State Saved	Saved in instrument state
Range	1.4MHz 3MHz 5MHz 10MHz 15MHz 20MHz
Readback	The currently selected LTE FDD BW
Initial S/W Revision	A.10.00

Narrowest LTE FDD BW

Sets narrowest bandwidth of LTE FDD carriers placed for TC2 when the carrier configuration preset runs. When this value is changed, the carrier configuration preset is initiated.

Key Path	FREQ Channel, Carrier Setup, Carrier Conf Presets, MSR Test Config, TC2 (FDD)
Remote Command	[:SENSe]:CARRier:CONFig:LTEFdd:BANDwidth:NARRowest B1M4 B3M B5M B10M B15M B20M [:SENSe]:CARRier:CONFig:LTEFdd:BANDwidth:NARRowest?
Example	CARR:CONF:LTEF:BAND:NARR B1M4 CARR:CONF:LTEF:BAND:NARR?
Preset	B1M4
State Saved	Saved in instrument state
Range	1.4MHz 3MHz 5MHz 10MHz 15MHz 20MHz
Readback	The currently selected Narrowest LTE FDD BW
Initial S/W Revision	A.10.00

Max GSM/EDGE Carriers

Sets max GSM/EDGE carriers placed when the carrier configuration preset runs. When this value is changed, the carrier configuration preset is initiated.

Key Path	FREQ Channel, Carrier Setup, Carrier Conf Presets, MSR Test Config, TC4a (FDD)FREQ Channel, Carrier Setup, Carrier Conf Presets, MSR Test Config, TC4b (FDD)FREQ Channel, Carrier Setup, Carrier Conf Presets, MSR Test Config, TC4c (FDD)FREQ Channel, Carrier Setup, Carrier Conf Presets, Single RAT Config, GSM/EDGE
Remote Command	[:SENSe]:CARRier:CONFig:GSM:CMAX <integer> [:SENSe]:CARRier:CONFig:GSM:CMAX?
Example	CARR:CONF:GSM:CMAX 8 CARR:CONF:GSM:CMAX?

Preset	100
State Saved	Saved in instrument state
Min	1
Max	100
Initial S/W Revision	A.10.00

LTE FDD Location

Sets the location of LTE FDD carriers when carriers are configured as TC4c. This parameter is effective only for TC4c.

TC4c (FDD)

LTE FDD Location

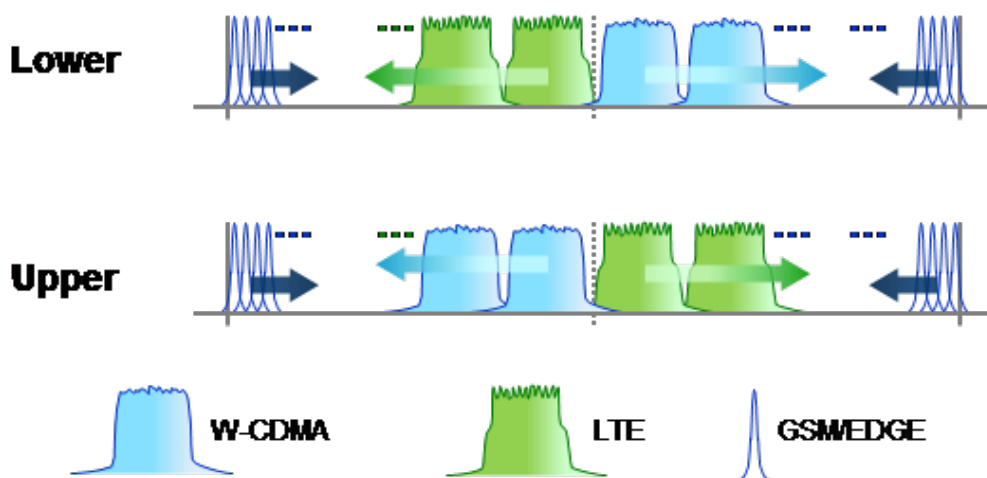

Key Path	FREQ Channel, Carrier Setup, Carrier Conf Presets, MSR Test Config, TC4c (FDD)
Remote Command	[[:SENSE]:CARRIER:CONFIG:LTEFdd:LOCATION UPPER LOWER [:SENSE]:CARRIER:CONFIG:LTEFdd:LOCATION?
Example	CARR:CONF:LTEF:LOC LOW CARR:CONF:LTEF:LOC?
Notes	This setting is effective only for TC4c.
Preset	UPPER
State Saved	Saved in instrument state
Range	Lower (Lower than W-CDMA) Upper (Higher than W-CDMA)
Initial S/W Revision	A.11.00

MSR Non-Contig Test Config

Accesses the menu to select MSR Non-Contiguous Test Configurations.

Key Path	FREQ Channel, Carrier Setup
Initial S/W Revision	A.13.00

Carrier Conf Presets

Pressing this key pops up Conf Presets. Each parameter under this menu initiate carrier configuration preset when its value is changed.

Appropriate licenses are required to select carrier config enum. Required licenses are shown here. Note that N/W means N or W license, i.e. N/W9073A-1FP means either N9073A-1FP or W9073A-1FP is required.

TC1a (FDD): N/W9073A-1FP (W-CDMA)

TC2 (FDD): N/W9080A-1FP (LTE FDD)

TC3a (FDD): N/W9073A-1FP (W-CDMA) and N9080A-1FP (LTE FDD)

TC4a (FDD): N/W9071A-2FP (GSM/EDGE) and N/W9073A-1FP (W-CDMA)

TC4b (FDD): N/W9071A-2FP (GSM/EDGE) and N9080A-1FP (LTE FDD)

TC4c (FDD): N/W9071A-2FP (GSM/EDGE), N/W9073A-1FP (W-CDMA) and N9080A-1FP (LTE FDD)

TC4d (FDD): N/W9071A-2FP (GSM/EDGE) and N/W9073A-1FP (W-CDMA)

TC4e (FDD): N/W9071A-2FP (GSM/EDGE) and N9080A-1FP (LTE FDD)

TC4a (FDD) Two Carriers: N/W9071A-2FP (GSM/EDGE) and N/W9073A-1FP (W-CDMA)

TC4b (FDD) Two Carriers: N/W9071A-2FP (GSM/EDGE) and N9080A-1FP (LTE FDD)

TC4c (FDD) Two Carriers: N/W9071A-2FP (GSM/EDGE), N/W9073A-1FP (W-CDMA) and N9080A-1FP (LTE FDD)

NTC1a (FDD): N/W9073A-1FP (W-CDMA)

NTC2 (FDD): N/W9080A-1FP (LTE FDD)

NTC3a (FDD): N/W9073A-1FP (W-CDMA) and N9080A-1FP (LTE FDD)

NTC4a (FDD): N/W9071A-2FP (GSM/EDGE) and N/W9073A-1FP (W-CDMA)

NTC4b (FDD): N/W9071A-2FP (GSM/EDGE) and N9080A-1FP (LTE FDD)

NTC4c (FDD): N/W9071A-2FP (GSM/EDGE), N/W9073A-1FP (W-CDMA) and N9080A-1FP (LTE FDD)

LTE FDD: N/W9080A-1FP (LTE FDD)

W-CDMA: N/W9073A-1FP (W-CDMA)

GSM/EDGE: N/W9071A-2FP (GSM/EDGE)

cdma2000: N/W9072A-2FP (cdma2000)

1xEV-DO: N/W9076A-1FP (1xEV-DO)

Enum keys don't appear on the menu if required licenses are not installed.

Key Path	FREQ Channel, Carrier Setup
Remote Command	<code>[:SENSe] :CARRier:CONFig?</code>
Example	CARR:CONF TC1AFDD CARR:CONF?
Notes	The softkey for NONE is not available.
State Saved	Saved in instrument state
Initial S/W Revision	A.10.00
Modified at S/W Revision	A.12.00, A.13.00

LTE FDD BW

Sets bandwidth of LTE FDD carriers placed when the carrier configuration preset runs. When this value is changed, the carrier configuration preset is initiated.

Key Path	FREQ Channel, Carrier Setup, Carrier Conf Presets, MSR Test Config, TC2 (FDD)FREQ Channel, Carrier Setup, Carrier Conf Presets, MSR Test Config, TC3a (FDD)FREQ Channel, Carrier Setup, Carrier Conf Presets, MSR Test Config, TC4b (FDD)FREQ Channel, Carrier Setup, Carrier Conf Presets, MSR Test Config, TC4c (FDD)FREQ Channel, Carrier Setup, Carrier Conf Presets, MSR Test Config, TC4d (FDD)FREQ Channel, Carrier Setup, Carrier Conf Presets, Single RAT Config, LTE FDD
Remote Command	<code>[:SENSe] :CARRier:CONFig:LTEFdd:Bandwidth B1M4 B3M B5M B10M B15M B20M</code> <code>[:SENSe] :CARRier:CONFig:LTEFdd:Bandwidth?</code>
Example	CARR:CONF:LTEF:BAND B5M CARR:CONF:LTEF:BAND?
Preset	B5M
State Saved	Saved in instrument state
Range	1.4MHz 3MHz 5MHz 10MHz 15MHz 20MHz
Readback	The currently selected LTE FDD BW
Initial S/W Revision	A.10.00

NTC4 Carriers

Sets NTC4 carriers placed when the NTC4 carrier configuration preset runs. When this value is changed, the carrier configuration preset is initiated.

Key Path	FREQ Channel, Carrier Setup, Carrier Conf Presets, MSR Non-Contig Test Config, NTC4a (FDD)FREQ Channel, Carrier Setup, Carrier Conf Presets, MSR Non-Contig Test Config, NTC4b (FDD)FREQ Channel, Carrier Setup, Carrier Conf Presets, MSR Non-Contig Test Config, NTC4c(FDD)
-----------------	--

Remote Command	[:SENSe] :CARRier:CONFIg:NTC4:COUNt <integer> [:SENSe] :CARRier:CONFIg:NTC4:COUNt?
Example	CARR:CONF:NTC4:COUN 6 CARR:CONF:NTC4:COUN?
Preset	6
State Saved	Saved in instrument state
Min	3
Max	6
Initial S/W Revision	A.13.00

Single RAT Config

Accesses the menu to select Single RAT Configurations.

Key Path	FREQ Channel, Carrier Setup
Initial S/W Revision	A.10.00

Carrier Conf Presets

Pressing this key pops up Conf Presets. Each parameter under this menu initiate carrier configuration preset when its value is changed.

Appropriate licenses are required to select carrier config enum. Required licenses are shown here. Note that N/W means N or W license, i.e. N/W9073A-1FP means either N9073A-1FP or W9073A-1FP is required.

TC1a (FDD): N/W9073A-1FP (W-CDMA)

TC2 (FDD): N/W9080A-1FP (LTE FDD)

TC3a (FDD): N/W9073A-1FP (W-CDMA) and N9080A-1FP (LTE FDD)

TC4a (FDD): N/W9071A-2FP (GSM/EDGE) and N/W9073A-1FP (W-CDMA)

TC4b (FDD): N/W9071A-2FP (GSM/EDGE) and N9080A-1FP (LTE FDD)

TC4c (FDD): N/W9071A-2FP (GSM/EDGE), N/W9073A-1FP (W-CDMA) and N9080A-1FP (LTE FDD)

TC4d (FDD): N/W9071A-2FP (GSM/EDGE) and N/W9073A-1FP (W-CDMA)

TC4e (FDD): N/W9071A-2FP (GSM/EDGE) and N9080A-1FP (LTE FDD)

TC4a (FDD) Two Carriers: N/W9071A-2FP (GSM/EDGE) and N/W9073A-1FP (W-CDMA)

TC4b (FDD) Two Carriers: N/W9071A-2FP (GSM/EDGE) and N9080A-1FP (LTE FDD)

TC4c (FDD) Two Carriers: N/W9071A-2FP (GSM/EDGE), N/W9073A-1FP (W-CDMA) and N9080A-1FP (LTE FDD)

NTC1a (FDD): N/W9073A-1FP (W-CDMA)

NTC2 (FDD): N/W9080A-1FP (LTE FDD)

NTC3a (FDD): N/W9073A-1FP (W-CDMA) and N9080A-1FP (LTE FDD)

NTC4a (FDD): N/W9071A-2FP (GSM/EDGE) and N/W9073A-1FP (W-CDMA)

NTC4b (FDD): N/W9071A-2FP (GSM/EDGE) and N9080A-1FP (LTE FDD)

NTC4c (FDD): N/W9071A-2FP (GSM/EDGE), N/W9073A-1FP (W-CDMA) and N9080A-1FP (LTE FDD)

LTE FDD: N/W9080A-1FP (LTE FDD)

W-CDMA: N/W9073A-1FP (W-CDMA)

GSM/EDGE: N/W9071A-2FP (GSM/EDGE)

cdma2000: N/W9072A-2FP (cdma2000)

1xEV-DO: N/W9076A-1FP (1xEV-DO)

Enum keys don't appear on the menu if required licenses are not installed.

Key Path	FREQ Channel, Carrier Setup
Remote Command	<code>[:SENSe] :CARRier:CONFig?</code>
Example	CARR:CONF TC1AFDD CARR:CONF?
Notes	The softkey for NONE is not available.
State Saved	Saved in instrument state
Initial S/W Revision	A.10.00
Modified at S/W Revision	A.12.00, A.13.00

Max LTE FDD Carriers

Sets max LTE FDD carriers placed when the carrier configuration preset runs. When this value is changed, the carrier configuration preset is initiated.

Key Path	FREQ Channel, Carrier Setup, Carrier Conf Presets, MSR Test Config, TC2 (FDD)FREQ Channel, Carrier Setup, Carrier Conf Presets, MSR Test Config, TC3a (FDD)FREQ Channel, Carrier Setup, Carrier Conf Presets, MSR Test Config, TC4b (FDD)FREQ Channel, Carrier Setup, Carrier Conf Presets, MSR Test Config, TC4c (FDD)FREQ Channel, Carrier Setup, Carrier Conf Presets, Single RAT Config, LTE FDD
Remote Command	<code>[:SENSe] :CARRier:CONFig:LTEFdd:CMAx <integer></code> <code>[:SENSe] :CARRier:CONFig:LTEFdd:CMAx?</code>
Example	CARR:CONF:LTEF:CMAx 8 CARR:CONF:LTEF:CMAx?
Preset	100
State Saved	Saved in instrument state

Min	1
Max	100
Initial S/W Revision	A.10.00

LTE FDD BW

Sets bandwidth of LTE FDD carriers placed when the carrier configuration preset runs. When this value is changed, the carrier configuration preset is initiated.

Key Path	FREQ Channel, Carrier Setup, Carrier Conf Presets, MSR Test Config, TC2 (FDD)FREQ Channel, Carrier Setup, Carrier Conf Presets, MSR Test Config, TC3a (FDD)FREQ Channel, Carrier Setup, Carrier Conf Presets, MSR Test Config, TC4b (FDD)FREQ Channel, Carrier Setup, Carrier Conf Presets, MSR Test Config, TC4c (FDD)FREQ Channel, Carrier Setup, Carrier Conf Presets, MSR Test Config, TC4d (FDD)FREQ Channel, Carrier Setup, Carrier Conf Presets, Single RAT Config, LTE FDD
Remote Command	<code>[:SENSe] :CARRier:CONFig:LTEFdd:BANDwidth B1M4 B3M B5M B10M B15M B20M</code> <code>[:SENSe] :CARRier:CONFig:LTEFdd:BANDwidth?</code>
Example	CARR:CONF:LTEF:BAND B5M CARR:CONF:LTEF:BAND?
Preset	B5M
State Saved	Saved in instrument state
Range	1.4MHz 3MHz 5MHz 10MHz 15MHz 20MHz
Readback	The currently selected LTE FDD BW
Initial S/W Revision	A.10.00

Max W-CDMA Carriers (FDD)

Sets max W-CDMA carriers placed when the carrier configuration preset runs. When this value is changed, the carrier configuration preset is initiated.

Key Path	FREQ Channel, Carrier Setup, Carrier Conf Presets, MSR Test Config, TC1a (FDD)FREQ Channel, Carrier Setup, Carrier Conf Presets, MSR Test Config, TC3a (FDD)FREQ Channel, Carrier Setup, Carrier Conf Presets, MSR Test Config, TC4a (FDD)FREQ Channel, Carrier Setup, Carrier Conf Presets, MSR Test Config, TC4c (FDD)FREQ Channel, Carrier Setup, Carrier Conf Presets, Single RAT Config, W-CDMA
Remote Command	<code>[:SENSe] :CARRier:CONFig:WCDMa:CMAx <integer></code> <code>[:SENSe] :CARRier:CONFig:WCDMa:CMAx?</code>
Example	CARR:CONF:WCDM:CMAx 8 CARR:CONF:WCDM:CMAx?
Preset	100

State Saved	Saved in instrument state
Min	1
Max	100
Initial S/W Revision	A.10.00

Max GSM/EDGE Carriers

Sets max GSM/EDGE carriers placed when the carrier configuration preset runs. When this value is changed, the carrier configuration preset is initiated.

Key Path	FREQ Channel, Carrier Setup, Carrier Conf Presets, MSR Test Config, TC4a (FDD)FREQ Channel, Carrier Setup, Carrier Conf Presets, MSR Test Config, TC4b (FDD)FREQ Channel, Carrier Setup, Carrier Conf Presets, MSR Test Config, TC4c (FDD)FREQ Channel, Carrier Setup, Carrier Conf Presets, Single RAT Config, GSM/EDGE
Remote Command	<code>[:SENSe] :CARRier:CONFig:GSM:CMAx <integer></code> <code>[:SENSe] :CARRier:CONFig:GSM:CMAx?</code>
Example	CARR:CONF:GSM:CMAx 8 CARR:CONF:GSM:CMAx?
Preset	100
State Saved	Saved in instrument state
Min	1
Max	100
Initial S/W Revision	A.10.00

Max cdma2000 Carriers

Sets max cdma2000 carriers placed when the carrier configuration preset runs. When this value is changed, the carrier configuration preset is initiated.

Key Path	FREQ Channel, Carrier Setup, Carrier Conf Presets, Single RAT Config, cdma2000
Remote Command	<code>[:SENSe] :CARRier:CONFig:CDMA:CMAx <integer></code> <code>[:SENSe] :CARRier:CONFig:CDMA:CMAx?</code>
Example	CARR:CONF:CDMA:CMAx 8 CARR:CONF:CDMA:CMAx?
Preset	100
State Saved	Saved in instrument state
Min	1
Max	100
Initial S/W Revision	A.12.00

Max 1xEV-DO Carriers

Sets max 1xEV-DO carriers placed when the carrier configuration preset runs. When this value is changed, the carrier configuration preset is initiated.

Key Path	FREQ Channel, Carrier Setup, Carrier Conf Presets, Single RAT Config, 1xEV-DO
Remote Command	[:SENSe] :CARRier:CONFig:EVDO:CMAx <integer> [:SENSe] :CARRier:CONFig:EVDO:CMAx?
Example	CARR:CONF:EVDO:CMAx 8 CARR:CONF:EVDO:CMAx?
Preset	100
State Saved	Saved in instrument state
Min	1
Max	100
Initial S/W Revision	A.12.00

Max BS RF Bandwidth

Sets max BS RF bandwidth used when the carrier configuration preset runs. When this value is changed, the carrier configuration preset is initiated.

Key Path	FREQ Channel, Carrier Setup, Carrier Conf Presets
Remote Command	[:SENSe] :CARRier:CONFig:RFBWidth <freq> [:SENSe] :CARRier:CONFig:RFBWidth?
Example	CARR:CONF:RFBW 40MHz CARR:CONF:RFBW?
Preset	40MHz
State Saved	Saved in instrument state
Min	600 kHz
Max	200 MHz
Initial S/W Revision	A.10.00

Channel Spacing Delta

Carriers are placed based on channel spacing assigned to the corresponding radio format, when they are configured by the carrier config preset. However, channel spacing can be adjusted using channel spacing delta parameters.

This key accesses the menu to set channel spacing delta of each radio format.

Key Path	FREQ Channel, Carrier Setup, Carrier Conf Presets
Initial S/W Revision	A.10.00

LTE FDD

Sets delta channel spacing for LTE FDD used when the carrier configuration preset runs. Channel spacing for LTE FDD is determined from this value and the default channel spacing defined in the standard, i.e. Channel spacing = (BWchan1 + BWchan2) * 0.5 + [the delta spacing]. Since this value is a difference from the default spacing, this value can be negative to allow narrower channel spacing. When this value is changed, the carrier configuration preset is initiated.

Key Path	FREQ Channel, Carrier Setup, Carrier Conf Presets, Channel Spacing Delta
Remote Command	[:SENSe] :CARRier:CONFig:LTEFdd:SPACing:DELTA <freq> [:SENSe] :CARRier:CONFig:LTEFdd:SPACing:DELTA?
Example	CARR:CONF:LTEF:SPAC:DELT -200kHz CARR:CONF:LTEF:SPAC:DELT?
Preset	0Hz
State Saved	Saved in instrument state
Min	- 1.0 MHz
Max	10.0 MHz
Initial S/W Revision	A.10.00
Modified at S/W Revision	A.11.00

W-CDMA

Sets delta channel spacing for W-CDMA used when the carrier configuration preset runs. Channel spacing for W-CDMA is determined from this value and the default channel spacing defined in the standard, i.e. Channel spacing = 5.0 MHz + [the delta spacing]. Since this value is a difference from the default spacing, this value can be negative to allow narrower channel spacing. When this value is changed, the carrier configuration preset is initiated.

Key Path	FREQ Channel, Carrier Setup, Carrier Conf Presets, Channel Spacing Delta
Remote Command	[:SENSe] :CARRier:CONFig:WCDma:SPACing:DELTA <freq> [:SENSe] :CARRier:CONFig:WCDma:SPACing:DELTA?
Example	CARR:CONF:WCDM:SPAC:DELT 0 CARR:CONF:WCDM:SPAC:DELT?
Preset	0 Hz
State Saved	Saved in instrument state
Min	- 1.0 MHz
Max	10.0 MHz
Initial S/W Revision	A.10.00
Modified at S/W Revision	A.11.00

GSM/EDGE

Sets delta channel spacing for GSM/EDGE used when the carrier configuration preset runs. Channel spacing for GSM/EDGE is determined from this value and the default channel spacing defined in the standard, i.e. Channel spacing = 600 kHz + [the delta spacing]. Since this value is a difference from the default spacing, this value can be negative to allow narrower channel spacing. When this value is changed, the carrier configuration preset is initiated.

Key Path	FREQ Channel, Carrier Setup, Carrier Conf Presets, Channel Spacing Delta
Remote Command	<code>[:SENSe] :CARRier:CONFig:GSM:SPACing:DELTA <freq></code> <code>[:SENSe] :CARRier:CONFig:GSM:SPACing:DELTA?</code>
Example	<code>CARR:CONF:GSM:SPAC:DELT 0</code> <code>CARR:CONF:GSM:SPAC:DELT?</code>
Preset	0 Hz
State Saved	Saved in instrument state
Min	- 0.4 MHz
Max	10.0 MHz
Initial S/W Revision	A.10.00
Modified at S/W Revision	A.11.00

cdma2000

Sets delta channel spacing for cdma2000 used when the carrier configuration preset runs. Channel spacing for cdma2000 is determined from this value and the default channel spacing defined in the standard, i.e. Channel spacing = 1.25 MHz + [the delta spacing]. Since this value is a difference from the default spacing, this value can be negative to allow narrower channel spacing.

Key Path	FREQ Channel, Carrier Setup, Carrier Conf Presets, Channel Spacing Delta
Remote Command	<code>[:SENSe] :CARRier:CONFig:CDMA:SPACing:DELTA <freq></code> <code>[:SENSe] :CARRier:CONFig:CDMA:SPACing:DELTA?</code>
Example	<code>CARR:CONF:CDMA:SPAC:DELT 0</code> <code>CARR:CONF:CDMA:SPAC:DELT?</code>
Preset	0 Hz
State Saved	Saved in instrument state
Min	-1 MHz
Max	10 MHz
Initial S/W Revision	A.12.00

1xEV-DO

Sets delta channel spacing for 1xEV-DO used when the carrier configuration preset runs. Channel spacing for 1xEV-DO is determined from this value and the default channel spacing defined in the standard, i.e.

Channel spacing = 1.25 MHz + [the delta spacing]. Since this value is a difference from the default spacing, this value can be negative to allow narrower channel spacing.

Key Path	FREQ Channel, Carrier Setup, Carrier Conf Presets, Channel Spacing Delta
Remote Command	[:SENSe] :CARRier:CONFig:EVDO:SPACing:DELTa <freq> [:SENSe] :CARRier:CONFig:EVDO:SPACing:DELTa?
Example	CARR:CONF:EVDO:SPAC:DELT 0 CARR:CONF:EVDO:SPAC:DELT?
Preset	0 Hz
State Saved	Saved in instrument state
Min	-1 MHz
Max	10 MHz
Initial S/W Revision	A.12.00

Apply to Meas Offset/Limits

This immediate action key sets the following measurement parameters.

- ACP: Offset and limit parameters under Offset/Limits.
- Spectrum Emission Mask: Offset and limit parameters under Offset/Limits.
- Spurious Emissions: Range frequency and limit parameters under Range Table.

These offset and limit values are determined by the carrier configuration parameters, Band Category and Assumed Adj Channels.

Each of these measurement has a local key, “Apply Carrier Config to ...”, which performs in the same way only for its parameters. So pressing this key is equivalent to pressing “Apply Carrier Config to ...” of all these measurements.

Key Path	FREQ Channel, Carrier Setup
Remote Command	[:SENSe] :MCONdition:IMMediate
Example	MCON:IMM
Initial S/W Revision	A.11.00

RF Bandwidth (Remote Command Only)

Returns the RF bandwidth calculated from the outermost carriers and their Foffset_RAT.

Key Path	SCPI only
Mode	MSR
Remote Command	[:SENSe] :CARRier:RFBWidth?
Example	CARR:RFBW?

Preset	Calculated from preset values of carrier config parameters
State Saved	No
Initial S/W Revision	A.13.00

RF Bandwidth Center (Remote Command Only)

Returns the center frequency of RF bandwidth.

Key Path	SCPI only
Mode	MSR
Remote Command	[:SENSE] :CARRier:RFBWidth:CENTer?
Example	CARR:RFBW:CENT?
Preset	Calculated from preset values of carrier config parameters
State Saved	No
Initial S/W Revision	A.13.00

Sub-block Center (Remote Command Only)

Returns the center frequency of sub-block when Carrier Allocation is Non-Contiguous.

Key Path	SCPI only
Mode	MSR
Remote Command	[:SENSE] :CARRier:SBLock[1] 2:CENTer?
Example	CARR:SBL:CENT?
Notes	When Carrier Allocation is Contiguous, 9.91E+37 is returned.
Preset	Calculated from preset values of carrier config parameters
State Saved	No
Initial S/W Revision	A.13.00

Sub-block Bandwidth (Remote Command Only)

Returns the bandwidth of sub-block calculated from outermost carriers and corresponding Foffset_RAT.

Key Path	SCPI only
Mode	MSR
Remote Command	[:SENSE] :CARRier:SBLock[1] 2:BWIDth?
Example	CARR:SBL:BWID?
Notes	When Carrier Allocation is Contiguous, 9.91E+37 is returned.

Preset	Calculated from preset values of carrier config parameters
State Saved	No
Initial S/W Revision	A.13.00

Sub-block Gap (Remote Command Only)

Returns the sub-block gap.

Key Path	SCPI only
Mode	MSR
Remote Command	<code>[:SENSe] :CARRier :SBLock :GAP?</code>
Example	CARR:SBL:GAP?
Notes	When Carrier Allocation is Contiguous, 9.91 E+37 is returned.
Preset	Calculated from preset values of carrier config parameters
State Saved	No
Initial S/W Revision	A.13.00

Input/Output

See "Input/Output" on page 190

Marker

Accesses a menu that enables you to select, set up and control the markers for the current measurement. For remote-only commands associated with Marker functionality, see:

- "Marker X Axis Value (Remote Command only)" on page 2145
- "Marker X Axis Position (Remote Command only)" on page 2145
- "Marker Y Axis Value (Remote Command only)" on page 2146

Key Path	Front-panel key
Initial S/W Revision	Prior to A.02.00

Select Marker

Displays 12 markers available for selection.

Key Path	Marker
Initial S/W Revision	Prior to A.02.00

Marker Type

Sets the marker control mode to **Normal**, **Delta** or **Off**. If the selected marker is **Off**, pressing **Marker** sets it to **Normal** and places a single marker at the center of the display. At the same time, **Marker X Axis Value** appears on the Active Function area.

Key Path	Marker
Mode	All except SA and BASIC
Remote Command	:CALCulate:MONitor:MARKer[1] 2 ... 12:MODE POSITION DELTA OFF :CALCulate:MONitor:MARKer[1] 2 ... 12:MODE?
Example	CALC:MON:MARK:MODE POS CALC:MON:MARK:MODE?
Notes	If the selected marker is Off, pressing Marker sets it to Normal and places it at the center of the screen on the trace determined by the Marker Trace rules. At the same time, Marker X Axis Value appears on the Active Function area. Default Active Function: the active function for the selected marker's current control mode. If the current control mode is Off, there is no active function and the active function is turned off. Active Function Display: the marker X axis value entered in the active function area displays the marker value to its full entered precision.
Preset	OFF
State Saved	Saved in instrument state.
Range	Normal Delta Off
Initial S/W Revision	Prior to A.02.00

Properties

Accesses a menu that enables you to select the active marker, the reference marker and the trace for the current measurement.

Key Path	Marker
Initial S/W Revision	Prior to A.02.00

Select Marker

Displays 12 markers available for selection.

Key Path	Marker
Initial S/W Revision	Prior to A.02.00

Relative To

Selects the desired marker. The selected marker is relative to its reference marker.

Key Path	Marker, Properties
Mode	All except SA and BASIC
Remote Command	:CALCulate:MONitor:MARKer[1] 2 ... 12:REFerence <integer> :CALCulate:MONitor:MARKer[1] 2 ... 12:REFerence?
Example	CALC:MON:MARK2:REF 1 CALC:MON:MARK2:REF?
Notes	A marker cannot be relative to itself so that choice is grayed out, and if sent from SCPI generates error -221: "Settings conflict; marker cannot be relative to itself." When queried a single value is returned (the specified marker number's relative marker).
Preset	2 3 4 5 6 7 8 9 10 11 12 1
State Saved	Saved in instrument state.
Min	1
Max	12
Initial S/W Revision	Prior to A.02.00

Marker Trace

Assigns the specified marker to the designated trace.

Key Path	Marker, Properties
Mode	All except SA and BASIC

Remote Command	:CALCulate:MONitor:MARKer[1] 2 ... 12:TRACe <integer> :CALCulate:MONitor:MARKer[1] 2 ... 12:TRACe?
Example	CALC:MON:MARK:TRAC 1 CALC:MON:MARK:TRAC?
Preset	1
State Saved	Saved in instrument state.
Min	1
Max	3
Initial S/W Revision	Prior to A.02.00

Couple Markers

When this function is true, moving any marker causes an equal X Axis movement of every other marker that is not **Off**. By “equal X Axis movement” we mean that we preserve the difference between each marker’s X Axis value (in the fundamental x–axis units of the trace that marker is on) and the X Axis value of the marker being moved (in the same fundamental x–axis units).

Key Path	Marker
Mode	All except SA and BASIC
Remote Command	:CALCulate:MONitor:MARKer:COUPle[:STATe] ON OFF 1 0 :CALCulate:MONitor:MARKer:COUPle[:STATe]?
Example	CALC:MON:MARK:COUP ON CALC:MON:MARK:COUP?
Preset	OFF
State Saved	Saved in instrument state.
Range	On Off
Initial S/W Revision	Prior to A.02.00

All Markers Off

Turns off all markers on the current measurement.

Key Path	Marker
Mode	All except SA and BASIC
Remote Command	:CALCulate:MONitor:MARKer:AOff
Example	CALC:MON:MARK:AOff
Initial S/W Revision	Prior to A.02.00

Marker X Axis Value (Remote Command only)

Sets the marker X Axis value in the current marker X Axis Scale unit. It has no effect if the control mode is **Off**, but is the SCPI equivalent of entering an X value if the control mode is **Normal** or **Delta**.

Mode	All except SA and BASIC
Remote Command	:CALCulate:MONitor:MARKer[1] 2 ... 12:X <freq> :CALCulate:MONitor:MARKer[1] 2 ... 12:X?
Example	CALC:MON:MARK3:X 0 CALC:MON:MARK3:X?
Notes	If no suffix is sent, uses the fundamental units for the current marker X Axis Scale. If a suffix is sent that does not match the current marker X Axis Scale unit, an error "Invalid suffix" is generated. The query returns the marker's absolute X Axis value if the control mode is Normal , or the offset from the marker's reference marker if the control mode is Delta . The query is returned in the fundamental units for the current marker X Axis scale: Hz for Frequency and Inverse Time , seconds for Period and Time . If the marker is Off the response is not a number.
Preset	After a preset, all markers are turned OFF, so Marker X Axis Value query returns a not a number (NAN).
State Saved	No
Min	-9.9E+37
Max	9.9E+37
Initial S/W Revision	Prior to A.02.00

Marker X Axis Position (Remote Command only)

Sets the marker X position in trace points. It has no effect if the control mode is **Off**, but is the SCPI equivalent of entering a value if the control mode is **Normal** or **Delta** – except in trace points rather than X Axis Scale units. The entered value is immediately translated into the current X Axis Scale units for setting the value of the marker.

Mode	All except SA and BASIC
Remote Command	:CALCulate:MONitor:MARKer[1] 2 ... 12:X:POSition <real> :CALCulate:MONitor:MARKer[1] 2 ... 12:X:POSition?
Example	CALC:MON:MARK:X:POS 0 CALC:MON:MARK:X:POS?
Notes	The query returns the marker's absolute X Axis value in trace points if the control mode is Normal , or the offset from the marker's reference marker in trace points if the control mode is Delta . The value is returned as a real number, not an integer, corresponding to the translation from X Axis Scale units to trace points. If the marker is Off the response is not a number.
Preset	After a preset, all markers are turned OFF, so Marker X Axis Value query returns a not a number (NAN).
State Saved	No
Min	-9.9E+37

Max	9.9E+37
Initial S/W Revision	Prior to A.02.00

Marker Y Axis Value (Remote Command only)

Returns the marker Y Axis value in the current marker.

Mode	All except SA and BASIC
Remote Command	:CALCulate:MONitor:MARKer[1] 2 ... 12:Y?
Example	CALC:MON:MARK11:Y?
Preset	Result dependent on markers setup and signal source
Backwards Compatibility SCPI	:CALCulate:MONitor:MARKer[1] 2 ... 12:FUNCTion:RESult?
Initial S/W Revision	Prior to A.02.00

Marker Function

Accesses special marker functions such as marker noise, and power in a specified bandwidth or time interval.

Key Path	Front-panel key
Initial S/W Revision	Prior to A.02.00

Select Marker

Displays 12 markers available for selection.

Key Path	Marker
Initial S/W Revision	Prior to A.02.00

Marker Function Type

Sets the marker control function type to one of the following:

NOISe	Marker Noise
BPOWer	Band/Interval Power
BDENsity	Band Interval Density
OFF	Marker Function Off

Key Path	Marker Function
Mode	All except SA and BASIC
Remote Command	:CALCulate:MONitor:MARKer[1] 2 ... 12:FUNCtion NOISe BPOWer BDENsity OFF :CALCulate:MONitor:MARKer[1] 2 ... 12:FUNCtion?
Example	CALC:MON:MARK:FUNC NOISCALC:MON:MARK:FUNC?
Preset	OFF
State Saved	Saved in instrument state.
Range	Marker Noise Band/Interval Power Band Interval Density Marker Function Off
Initial S/W Revision	Prior to A.02.00

Band Adjust

Accesses a menu that enables you to set the frequency span width and the left and right edge, or time values, for the band or interval of the selected marker.

Key Path	Marker Function
Initial S/W Revision	Prior to A.02.00

Band/Interval Span for Frequency Domain

Sets the width of the frequency span for the selected marker.

Key Path	Marker Function
Mode	All except SA and BASIC
Remote Command	:CALCulate:MONitor:MARKer[1] 2 ... 12:FUNction:BAND:SPAN <freq> :CALCulate:MONitor:MARKer[1] 2 ... 12:FUNction:BAND:SPAN?
Example	CALC:MON:MARK12:FUNC:BAND:SPAN 20 MHz CALC:MON:MARK12:FUNC:BAND:SPAN?
Couplings	Changing the Band/Interval Span necessarily changes the Band/Interval Left and Band/Interval Right values.
Preset	Depends on X axis range of selected Trace.
State Saved	Saved in instrument state.
Min	-9.9E+37
Max	9.9E+37
Initial S/W Revision	Prior to A.02.00

Band/Interval Left for Frequency Domain

Sets the left edge frequency or time value for the band of the selected marker.

Key Path	Marker Function
Mode	All except SA and BASIC
Remote Command	:CALCulate:MONitor:MARKer[1] 2 ... 12:FUNction:BAND:LEFT <freq> :CALCulate:MONitor:MARKer[1] 2 ... 12:FUNction:BAND:LEFT?
Example	CALC:MON:MARK12:FUNC:BAND:LEFT 20 GHz CALC:MON:MARK12:FUNC:BAND:LEFT?
Couplings	Changing the Band/Interval Left necessarily changes the Band/Interval Span value.
Preset	Depends on X axis range of selected Trace.
State Saved	Saved in instrument state.
Min	-9.9E+37
Max	9.9E+37
Initial S/W Revision	Prior to A.02.00

Band/Interval Right for Frequency Domain

Sets the right edge frequency or time value for the band of the selected marker.

Key Path	Marker Function
Mode	All except SA and BASIC
Remote Command	:CALCulate:MONitor:MARKer[1] 2 ... 12:FUNCtion:BAND:RIGHT <freq> :CALCulate:MONitor:MARKer[1] 2 ... 12:FUNCtion:BAND:RIGHT?
Example	CALC:MON:MARK12:FUNC:BAND:RIGH 20 GHz CALC:MON:MARK12:FUNC:BAND:RIGH?
Couplings	Changing the Band/Interval Right necessarily changes the Band/Interval Span value.
Preset	Depends on X axis range of selected Trace.
State Saved	Saved in instrument state.
Min	-9.9E+37
Max	9.9E+37
Initial S/W Revision	Prior to A.02.00

Marker To

There is no 'Marker To' functionality supported in Monitor Spectrum. The front-panel key displays a blank menu when pressed.

Key Path	Front-panel key
Initial S/W Revision	Prior to A.02.00

Meas

The information in this section is common to all measurements. For key and remote command information for a specific measurement, refer to the section that describes the measurement of interest.

Measurements available under the Meas key are specific to the current Mode.

When viewing Help for measurements, note the following:

NOTE

Operation for some keys differs between measurements. The information displayed in Help pertains to the current measurement. To see how a key operates in a different measurement, exit Help (press the Cancel Esc key), select the measurement, then reenter Help (press the Help key) and press that key.

Key Path	Front-panel key
Initial S/W Revision	Prior to A.02.00

Remote Measurement Functions

This section contains the following topics:

"Measurement Group of Commands" on page 2382

"Current Measurement Query (Remote Command Only)" on page 2384

"Limit Test Current Results (Remote Command Only)" on page 2384

"Data Query (Remote Command Only)" on page 2384

"Calculate/Compress Trace Data Query (Remote Command Only)" on page 2385

"Calculate Peaks of Trace Data (Remote Command Only)" on page 2390

"Hardware-Accelerated Fast Power Measurement (Remote Command Only)" on page 2391

"Format Data: Numeric Data (Remote Command Only)" on page 2405

"Format Data: Byte Order (Remote Command Only)" on page 2406

Initial S/W Revision	Prior to A.02.00
----------------------	------------------

Measurement Group of Commands

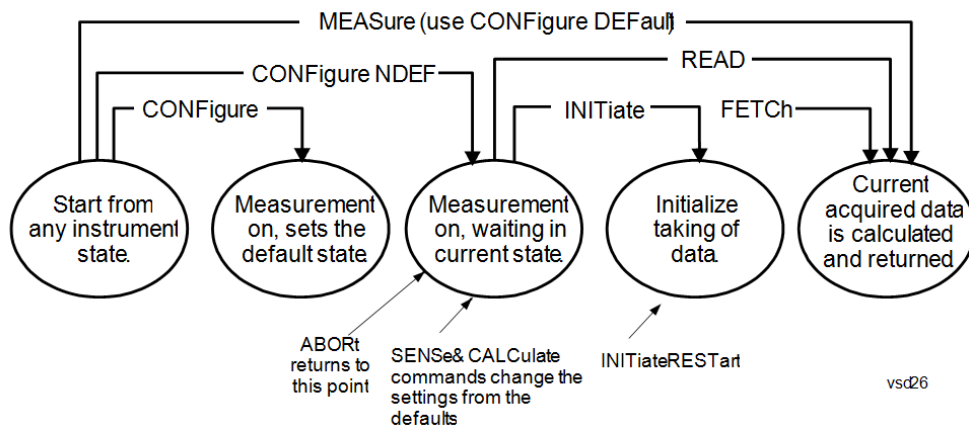

Measure Commands:

:MEASure:<measurement>[n]?

This is a fast single-command way to make a measurement using the factory default instrument settings. These are the settings and units that conform to the Mode Setup settings (e.g. radio standard) that you have currently selected.

- Stops the current measurement (if any) and sets up the instrument for the specified measurement using the factory defaults
- Initiates the data acquisition for the measurement
- Blocks other SCPI communication, waiting until the measurement is complete before returning results.
- If the function does averaging, it is turned on and the number of averages is set to 10.
- After the data is valid it returns the scalar results, or the trace data, for the specified measurement. The type of data returned may be defined by an [n] value that is sent with the command.
- The scalar measurement results will be returned if the optional [n] value is not included, or is set to 1. If the [n] value is set to a value other than 1, the selected trace data results will be returned. See each command for details of what types of scalar results or trace data results are available.
- ASCII is the default format for the data output. (Older versions of Spectrum Analysis and Phase Noise mode measurements only use ASCII.) The binary data formats should be used for handling large blocks of data since they are smaller and faster than the ASCII format. Refer to the FORMat:DATA command for more information.

If you need to change some of the measurement parameters from the factory default settings you can set up the measurement with the CONFigure command. Use the commands in the SENSE:<measurement> and CALCulate:<measurement> subsystems to change the settings. Then you can use the READ? command to initiate the measurement and query the results.

If you need to repeatedly make a given measurement with settings other than the factory defaults, you can use the commands in the SENSE:<measurement> and CALCulate:<measurement> subsystems to set up the measurement. Then use the READ? command to initiate the measurement and query results.

Measurement settings persist if you initiate a different measurement and then return to a previous one. Use READ:<measurement>? if you want to use those persistent settings. If you want to go back to the default settings, use MEASure:<measurement>?.

Configure Commands:

:CONFigure:<measurement>

This command stops the current measurement (if any) and sets up the instrument for the specified measurement using

the factory default instrument settings. It does not initiate the taking of measurement data unless INIT:CONTInuous is ON. If you change any measurement settings after using the CONFigure command, the READ command can be used to initiate a measurement without changing the settings back to their defaults.

In the Swept SA measurement in Spectrum Analyzer mode the CONFigure command also turns the averaging function on and sets the number of averages to 10 for all measurements.

:CONFigure: <measurement>: NDEFault stops the current measurement and changes to the specified measurement. It does not change the settings to the defaults. It does not initiate the taking of measurement data unless INIT:CONTInuous is ON.

The CONFigure? query returns the current measurement name.

The CONFigure:CATalog? query returns a quoted string of all licensed measurement names in the current mode. For example, "SAN, CHP, OBW, ACP, PST, TXP, SPUR, SEM, LIST".

Fetch Commands:

:FETCh:<measurement>[n]?

This command puts selected data from the most recent measurement into the output buffer. Use FETCh if you have already made a good measurement and you want to return several types of data (different [n] values, for example, both scalars and trace data) from a single measurement. FETCh saves you the time of re-making the measurement. You can only FETCh results from the measurement that is currently active, it will not change to a different measurement. An error message is reported if a measurement other than the current one is specified.

If you need to get new measurement data, use the READ command, which is equivalent to an INITiate followed by a FETCh.

The scalar measurement results will be returned if the optional [n] value is not included, or is set to 1. If the [n] value is set to a value other than 1, the selected trace data results will be returned. See each command for details of what types of scalar results or trace data results are available. The binary data formats should be used for handling large blocks of data since they are smaller and transfer faster than the ASCII format. (FORMat:DATA)

FETCh may be used to return results other than those specified with the original READ or MEASure command that you sent.

INITiate Commands:

:INITiate:<measurement>

This command is not available for measurements in all the instrument modes:

- Initiates a trigger cycle for the specified measurement, but does not output any data. You must then use the FETCh<meas> command to return data. If a measurement other than the current one is specified, the instrument will switch to that measurement and then initiate it.
- For example, suppose you have previously initiated the ACP measurement, but now you are running the channel power measurement. If you send INIT:ACP? it will change from channel power to ACP and will initiate an ACP measurement.
- Does not change any of the measurement settings. For example, if you have previously started the ACP measurement and you send INIT:ACP? it will initiate a new ACP measurement using the same instrument settings as the last time ACP was run.
- If your selected measurement is currently active (in the idle state) it triggers the measurement, assuming the trigger conditions are met. Then it completes one trigger cycle. Depending upon the measurement and the number of averages, there may be multiple data acquisitions, with multiple trigger events, for one full trigger cycle. It also holds off additional commands on GPIB until the acquisition is complete.

READ Commands:

:READ:<measurement>[n]?

- Does not preset the measurement to the factory default settings. For example, if you have previously initiated the ACP
-

measurement and you send READ:ACP? it will initiate a new measurement using the same instrument settings.

- Initiates the measurement and puts valid data into the output buffer. If a measurement other than the current one is specified, the instrument will switch to that measurement before it initiates the measurement and returns results.
 - For example, suppose you have previously initiated the ACP measurement, but now you are running the channel power measurement. Then you send READ:ACP? It will change from channel power back to ACP and, using the previous ACP settings, will initiate the measurement and return results.
 - Blocks other SCPI communication, waiting until the measurement is complete before returning the results
 - If the optional [n] value is not included, or is set to 1, the scalar measurement results will be returned. If the [n] value is set to a value other than 1, the selected trace data results will be returned. See each command for details of what types of scalar results or trace data results are available. The binary data formats should be used when handling large blocks of data since they are smaller and faster than the ASCII format. (FORMat:DATA)
-

Initial S/W Revision	Prior to A.02.00
----------------------	------------------

Current Measurement Query (Remote Command Only)

This command returns the name of the measurement that is currently running.

Remote Command	:CONFigure?
-----------------------	-------------

Example	CONF?
----------------	-------

Initial S/W Revision	Prior to A.02.00
----------------------	------------------

Limit Test Current Results (Remote Command Only)

Queries the status of the current measurement limit testing. It returns a 0 if the measured results pass when compared with the current limits. It returns a 1 if the measured results fail any limit tests.

Remote Command	:CALCulate:CLIMits:FAIL?
-----------------------	--------------------------

Example	CALC:CLIM:FAIL? queries the current measurement to see if it fails the defined limits. Returns a 0 or 1: 0 it passes, 1 it fails.
----------------	--

Initial S/W Revision	Prior to A.02.00
----------------------	------------------

Data Query (Remote Command Only)

Returns the designated measurement data for the currently selected measurement and subopcode.

n = any valid subopcode for the current measurement. See the measurement command results table for your current measurement, for information about what data is returned for the subopcodes.

This command uses the data setting specified by the FORMat:BORDER and FORMat:DATA commands and can return real or ASCII data. (See the format command descriptions under Input/Output in the Analyzer Setup section.)

Remote Command	:CALCulate:DATA[n]?
Notes	The return trace depends on the measurement. In CALCulate:<meas>:DATA[n], n is any valid subopcode for the current measurement. It returns the same data as the FETCH:<measurement>? query where <measurement> is the current measurement.
Initial S/W Revision	Prior to A.02.00

Calculate/Compress Trace Data Query (Remote Command Only)

Returns compressed data for the currently selected measurement and sub-opcode [n].

n = any valid sub-opcode for that measurement. See the MEASure:<measurement>? command description of your specific measurement for information on the data that can be returned.

The data is returned in the current Y Axis Unit of the analyzer. The command is used with a sub-opcode <n> (default=1) to specify the trace. With trace queries, it is best if the analyzer is not sweeping during the query. Therefore, it is generally advisable to be in Single Sweep, or Update=Off.

This command is used to compress or decimate a long trace to extract and return only the desired data. A typical example would be to acquire N frames of GSM data and return the mean power of the first burst in each frame. The command can also be used to identify the best curve fit for the data.

Remote Command	:CALCulate:DATA<n>:COMPRESS? BLOCK CFIT MAXimum MINimum MEAN DMEan RMS RMSCubed SAMPLE SDEVIation PPHase [,<soffset> [,<length>[,<roffset>[,<rlimit>]]]]
Example	To query the mean power of a set of GSM bursts: Supply a signal that is a set of GSM bursts. Select the IQ Waveform measurement (in IQ Analyzer Mode). Set the sweep time to acquire at least one burst. Set the triggers such that acquisition happens at a known position relative to a burst. Then query the mean burst levels using, CALC:DATA2:COMP? MEAN, 24e-6, 526e-6 (These parameter values correspond to GSM signals, where 526e-6 is the length of the burst in the slot and you just want 1 burst.)
Notes	The command supports 5 parameters. Note that the last 4 (<soffset>, <length>, <roffset>, <rlimit>) are optional. But these optional parameters must be entered in the specified order. For example, if you want to specify <length>, then you must also specify <soffset>. See details below for a definition of each of these parameters. This command uses the data in the format specified by FORMat:DATA, returning either binary or ASCII data.
Initial S/W Revision	Prior to A.02.00

- BLOCK or block data - returns all the data points from the region of the trace data that you specify. For example, it could be used to return the data points of an input signal over several timeslots, excluding the portions of the trace data that you do not want. (This is x,y pairs for trace data and I,Q pairs for complex data.)

- CFIT or curve fit - applies curve fitting routines to the data. <soffset> and <length> are required to define the data that you want. <roffset> is an optional parameter for the desired order of the curve equation. The query will return the following values: the x-offset (in seconds) and the curve coefficients ((order + 1) values).

MIN, MAX, MEAN, DME, RMS, RMSC, SAMP, SDEV and PPH return one data value for each specified region (or <length>) of trace data, for as many regions as possible until you run out of trace data (using <roffset> to specify regions). Or they return the number of regions you specify (using <rlimit>) ignoring any data beyond that.

- MINimum - returns the minimum data point (y value) for the specified region(s) of trace data. For I/Q trace data, the minimum magnitude of the I/Q pairs is returned.
- MAXimum - returns the maximum data point (y value) for the specified region(s) of trace data. For I/Q trace data, the maximum magnitude of the I/Q pairs is returned.
- MEAN - returns a single value that is the arithmetic mean of the data point values (in dB/ dBm) for the specified region(s) of trace data. For I/Q trace data, the mean of the magnitudes of the I/Q pairs is returned. See the following equations.

•

NOTE

If the original trace data is in dB, this function returns the arithmetic mean of those log values, not log of the mean power which is a more useful value. The mean of the log is the better measurement technique when measuring CW signals in the presence of noise. The mean of the power, expressed in dB, is useful in power measurements such as Channel Power. To achieve the mean of the power, use the RMS option.

Equation 1

Mean Value of Data Points for Specified Region(s)

$$MEAN = \frac{1}{n} \sum_{X_i \in \text{region}(s)} X_i$$

where X_i is a data point value, and n is the number of data points in the specified region(s).

Equation 2

Mean Value of I/Q Data Pairs for Specified Region(s)

$$MEAN = \frac{1}{n} \sum_{X_i \in \text{region}(s)} |X_i|$$

where $|X_i|$ is the magnitude of an I/Q pair, and n is the number of I/Q pairs in the specified region(s).

- DMEan - returns a single value that is the mean power (in dB/ dBm) of the data point values for the specified region(s) of trace data. See the following equation:

Equation 3

DMEan Value of Data Points for Specified Region(s)

$$\text{DME} = 10 \times \log_{10} \left(\frac{1}{n} \sum_{X_i \in \text{region}(s)} 10^{\frac{X_i}{10}} \right)$$

- RMS - returns a single value that is the average power on a root-mean-squared voltage scale (arithmetic rms) of the data point values for the specified region(s) of trace data. See the following equation.

NOTE For I/Q trace data, the rms of the magnitudes of the I/Q pairs is returned. See the following equation. This function is very useful for I/Q trace data. However, if the original trace data is in dB, this function returns the rms of the log values which is not usually needed.

Equation 4

RMS Value of Data Points for Specified Region(s)

$$\text{RMS} = \sqrt{\frac{1}{n} \sum_{X_i \in \text{region}(s)} X_i^2}$$

where X_i is a data point value, and n is the number of data points in the specified region(s).

Equation 5

RMS Value of I/Q Data Pairs for Specified Region(s)

$$\text{RMS} = \sqrt{\frac{1}{n} \sum_{X_i \in \text{region}(s)} X_i X_i^*}$$

where X_i is the complex value representation of an I/Q pair, X_i^* its conjugate complex number, and n is the number of I/Q pairs in the specified region(s).

Once you have the rms value for a region of trace data (linear or I/Q), you may want to calculate the mean power. You must convert this rms value (peak volts) to power in dBm:

$$10 \times \log[10 \times (\text{rms value})^2]$$

- SAMPlE - returns the first data value (x,y pair) for the specified region(s) of trace data. For I/Q trace data, the first I/Q pair is returned.
- SDEVIation - returns a single value that is the arithmetic standard deviation for the data point values for the specified region(s) of trace data. See the following equation.
- For I/Q trace data, the standard deviation of the magnitudes of the I/Q pairs is returned. See the following equation.

Equation 6

Standard Deviation of Data Point Values for Specified Region(s)

$$\text{SDEV} = \sqrt{\frac{1}{n} \sum_{X_i \in \text{region}(s)} (X_i - \bar{X})^2}$$

where X_i is a data point value, \bar{X} is the arithmetic mean of the data point values for the specified region (s), and n is the number of data points in the specified region(s).

$$\text{SDEV} = \sqrt{\frac{1}{n} \sum_{X_i \in \text{region}(s)} (|X_i| - \bar{X})^2}$$

where $|X_i|$ is the magnitude of an I/Q pair, \bar{X} is the mean of the magnitudes for the specified region(s), and n is the number of data points in the specified region(s).

- PPHase - returns the x,y pairs of both rms power (dBm) and arithmetic mean phase (radian) for every specified region and frequency offset (Hz). The number of pairs is defined by the specified number of regions. This parameter can be used for I/Q vector ($n=0$) in Waveform (time domain) measurement and all parameters are specified by data point in PPHase.

The rms power of the specified region may be expressed as:

$$\text{Power} = 10 \times \log [10 \times (\text{RMS I/Q value})] + 10.$$

The RMS I/Q value (peak volts) is:

$$\sqrt{\frac{1}{n} \sum_{X_i \in \text{region}} X_i X_i^*}$$

where X_i is the complex value representation of an I/Q pair, X_i^* its conjugate complex number, and n is the number of I/Q pairs in the specified region.

The arithmetic mean phase of the specified region may be expressed as:

$$\frac{1}{n} \sum_{Y_i \in \text{region}} Y_i$$

where Y_i is the unwrapped phase of I/Q pair with applying frequency correction and n is the number of I/Q pairs in the specified region.

The frequency correction is made by the frequency offset calculated by the arithmetic mean of every specified region's frequency offset. Each frequency offset is calculated by the least square method against the unwrapped phase of I/Q pair.

Sample Trace Data - Constant Envelope

(See below for explanation of variables.)

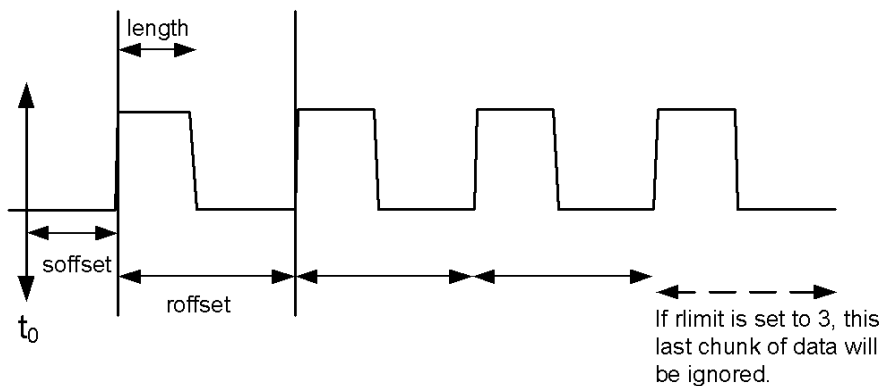

Sample Trace Data - Not Constant Envelope

(See below for explanation of variables.)

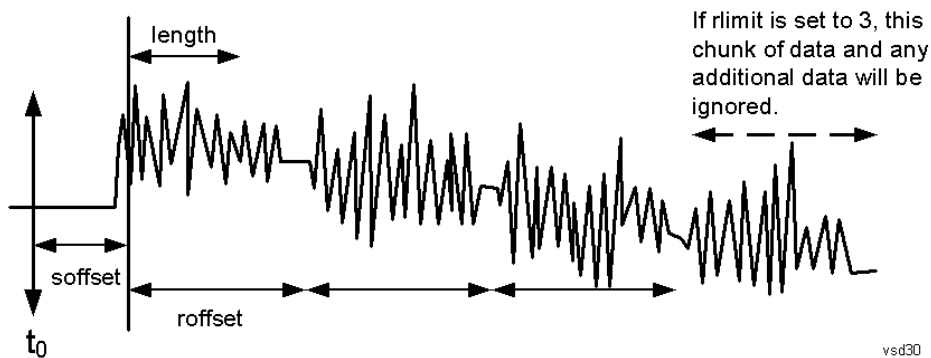

<soffset> - start offset is an optional real number. (It is in seconds for time-domain traces, and is a dimensionless index 0 to Npoints - 1, for frequency-domain traces). It specifies the amount of data at the beginning of the trace that will be ignored before the decimation process starts. It is the time or frequency change from the start of the trace to the point where you want to start using the data. The default value is zero.

<length> - is an optional real number. (It is in seconds for time-domain traces, and is a dimensionless index 0 to Npoints - 1, for frequency-domain traces). It defines how much data will be compressed into one value. This parameter has a default value equal to the current trace length.

<roffset> - repeat offset is an optional real number. (It is in seconds for time-domain traces, and is a dimensionless index 0 to Npoints - 1, for frequency-domain traces). It defines the beginning of the next field of trace elements to be compressed. This is relative to the beginning of the previous field. This parameter has a default value equal to the <length> variable. Note that this parameter is used for a completely different purpose when curve fitting (see CFIT above).

<rlimit> - repeat limit is an optional integer. It specifies the number of data items that you want returned. It will ignore any additional items beyond that number. You can use the Start offset and the Repeat limit to pick out exactly what part of the data you want to use. The default value is all the data.

Calculate Peaks of Trace Data (Remote Command Only)

Returns a list of all the peaks for the currently selected measurement and sub-opcode [n]. The peaks must meet the requirements of the peak threshold and excursion values.

n = any valid sub-opcode for the current measurement. See the MEASure:<measurement> command description of your specific measurement for information on the data that can be returned.

The command can only be used with specific sub-opcodes with measurement results that are trace data. Both real and complex traces can be searched, but complex traces are converted to magnitude in dBm. In many measurements the sub-opcode n=0, is the raw trace data which cannot be searched for peaks. And Sub-opcode n=1, is often calculated results values which also cannot be searched for peaks.

This command uses the data setting specified by the FORMat:BORDER and FORMat:DATA commands and can return real or ASCII data. If the format is set to INT,32, it returns REAL,32 data.

The command has four types of parameters:

- Threshold (in dBm)
- Excursion (in dB)
- Sorting order (amplitude, frequency, time)
- Optional in some measurements: Display line use (all, > display line, < display line)

Remote Command	<p>For Swept SA measurement:</p> <pre>:CALCulate:DATA[1] 2 ... 6:PEAKs? <threshold>,<excursion>[,AMPLitude FREQuency TIME[,ALL GTDLine LTDLine]]</pre> <p>For most other measurements:</p> <pre>:CALCulate:DATA[1] 2 ... 6:PEAKs? <threshold>,<excursion>[,AMPLitude FREQuency TIME]</pre>
-----------------------	--

Example	<p>Example for Swept SA measurement in Spectrum Analyzer Mode:</p> <p>CALC:DATA4:PEAK? -40, 10, FREQ, GTDL This will identify the peaks of trace 4 that are above -40 dBm, with excursions of at least 10 dB. The peaks are returned in order of increasing frequency, starting with the lowest frequency. Only the peaks that are above the display line are returned.</p> <p>Query Results 1:</p> <p>With FORMat:DATA REAL, 32 selected, it returns a list of floating-point numbers. The first value in the list is the number of peak points that are in the following list. A peak point consists of two values: a peak amplitude followed by its corresponding frequency (or time).</p> <p>If no peaks are found the peak list will consist of only the number of peaks, (0).</p>
----------------	---

Notes	<p><n> - is the trace that will be used</p> <p><threshold> - is the level below which trace data peaks are ignored. Note that the threshold value is required and is always used as a peak criterion. To effectively disable the threshold criterion for this command, provide a substantially low threshold value such as -200 dBm. Also note that the threshold value used in this command is independent of and has no effect on the threshold value stored under the Peak Criteria menu.</p> <p><excursion> - is the minimum amplitude variation (rise and fall) required for a signal to be identified as peak. Note that the excursion value is required and is always used as a peak criterion. To effectively disable the excursion criterion for this command, provide the minimum value of 0.0 dB. Also note that the excursion value used in this command is independent of and has no effect on the</p>
--------------	---

excursion value stored under the Peak Criteria menu.

Values must be provided for threshold and excursion. The sorting and display line parameters are optional (defaults are AMPLitude and ALL).

Note that there is always a Y-axis value for the display line, regardless of whether the display line state is on or off. It is the current Y-axis value of the display line which is used by this command to determine whether a peak should be reported

Sorting order:

AMPLitude - lists the peaks in order of descending amplitude, with the highest peak first (default if optional parameter not sent)

FREQuency - lists the peaks in order of occurrence, left to right across the x-axis.

TIME - lists the peaks in order of occurrence, left to right across the x-axis.

Peaks vs. Display Line:

ALL - lists all of the peaks found (default if optional parameter not sent).

GTDLine (greater than display line) - lists all of the peaks found above the display line.

LTDLine (less than display line) - lists all of the peaks found below the display line.

Initial S/W Revision	Prior to A.02.00
----------------------	------------------

Hardware-Accelerated Fast Power Measurement (Remote Command Only)

The Fast Power option (FP2) enables very fast channel power measurements for instruments with the prerequisite hardware (DP2 and/or B40). It accomplishes this by performing real-time overlapped FFTs at the hardware layer, using software for basic post-processing before returning the result to the user. The upshot of this approach is improved throughput for user applications that require many sequential power measurements.

The analysis bandwidth of FP2 is limited by the licenses in the instrument, but its maximum overall analysis bandwidth per acquisition is 40 MHz.

FP2 is remote-only, which means the instrument does not switch to any particular mode or measurement. FP2 commands can be sent while another application is in use on the front panel.

Each Fast Power measurement can be predefined using an array index, and up to 1,000 measurements can be stored. In the following documentation, instances of [1,2,...,999] can be substituted with a particular measurement index, e.g. CALC:FPOW:POW1?, CALC:FPOW:POW2?, CALC:FPOW:POW134?. In this way, power measurements can be defined one time in a batch, and then executed multiple times without having to redefine them, similar to “list mode” on other measurements.

In addition to basic channel power measurements, there are a number of other measurement “functions” for each channel, including peak power, peak frequency, and power spectral density. See the Function parameter for more information.

Reset Fast Power Measurement (Remote Command Only)

Resets the measurement configuration to the defaults.

Mode	All
Remote Command	:CALCulate:FPOWer:POWer [1, 2, ..., 999] :RESet
Example	:CALC:FPOW:POW1:RES

Notes	Option FP2 is required.
Initial S/W Revision	A.14.00

Define Fast Power Measurement (Remote Command Only)

Fast Power acquisitions are configured using the DEFine command. This command accepts a comma-delimited string of configuration parameters and their appropriate values, which are all specified in the subsection below.

Mode	All
Remote Command	:CALCulate:FPOWer:POWer[1,2,...,999]:DEFine "configuration string"
Example	:CALC:FPOW:POW1:DEF "CenterFrequency=2e9, AcquisitionTime=0.005"
Notes	See below for a list of measurement variables that can be defined in the configuration string.
Initial S/W Revision	A.14.00

Acquisition Time

Example	CALC:FPOW:POW1:DEF "AcquisitionTime=0.002"
Notes	The acquisition time parameter sets the time in which the entire spectrum is measured. An increase in the acquisition time yields an improvement in measurement repeatability.
Preset	0.001 s
Range	0 s to 1 s
Default Unit	Time (s)
Initial S/W Revision	A.14.00

Center Frequency

Example	CALC:FPOW:POW1:DEF "CenterFrequency=2e9"
Notes	The center frequency parameter sets the frequency in which the measurement is centered around. The OffsetFrequency parameter is calculated relative to the center frequency.
Preset	1 GHz
Range	0 Hz to maximum instrument frequency
Default Unit	Frequency (Hz)
Initial S/W Revision	A.14.00

DC Coupled

Example	CALC:FPOW:POW1:DEF "DCCoupled=True"
Notes	The DC coupled parameter allows the user to specify whether the DC blocking capacitor is utilized. Set parameter to true when measuring frequencies below 10 MHz.
Preset	False
Range	True (DC Coupled) or False (AC Coupled)
Default Unit	Boolean
Initial S/W Revision	A.14.00

DetectorType

Example	CALC:FPOW:POW1:DEF "DetectorType=Peak"
Notes	Option FP2 is required. The detector type parameter allows the user to choose whether a RMS average or peak value is used during the measurement.
Preset	RmsAverage
Range	RmsAverage, Peak
Initial S/W Revision	A.14.00

Do Noise Correction

Example	CALC:FPOW:POW1:DEF "DoNoiseCorrection=True"
Notes	When noise correction is enabled, the linear noise power contributed by the analyzer is subtracted from all measurements. This effectively lowers the noise floor of the analyzer. When noise correction is enabled, the first measurement for a given set of input parameters will take extra time. This is because the analyzer takes an extra acquisition with the RF input disconnected from the analyzer's front end to measure the noise of just the analyzer. The measured noise floor is stored in a cache so the noise acquisition will occur only once for the same state settings. In other words, if noise correction was turned on and the analyzer made an acquisition at frequency A, then frequency B, and back again to frequency A, the hidden initial noise floor acquisition would only occur for the first acquisition at frequency A and the cached noise floor would be used the second time frequency A was measured.
Preset	False
Range	True (enable noise correction) or False (disable noise correction)
Default Unit	Boolean
Initial S/W Revision	A.14.00

Do Spur Suppression

Example	CALC:FPOW:POW1:DEF "DoSpurSuppression=True"
Notes	<p>When measuring very low level signals, or when large out-of-band inputs are input into the analyzer, sometimes unwanted spurs and residuals can appear in the measured spectrum. Spur suppression is a method to help minimize the levels of these internally generated spurs and residuals.</p> <p>When spur suppression is enabled, the analyzer will automatically take two acquisitions using two different internal analog LO frequencies. The FFT spectrums from both acquisitions are combined by taking the minimum power between both traces on a per FFT bin basis. External signals will have the same amplitude for both traces and therefore will return the expected amplitudes. However, low level spurs and residuals generated internally to the analyzer tend to move to different FFT bins depending on the internal analog LO frequency used, and therefore tend to be suppressed using this spur suppression method.</p> <p>Because two acquisitions, rather than a single acquisition, are made when spur suppression is enabled, the measurement time will always be slower when spur suppression is enabled.</p>
Preset	False
Range	True (enable spur suppression) or False (disable spur suppression)
Default Unit	Boolean
Initial S/W Revision	A.14.00

Electronic Attenuator Bypass

Example	CALC:FPOW:POW1:DEF "ElecAttBypass =False"
Notes	The electronic attenuation bypass parameter allows the user to either utilize or bypass the electronic attenuator. The electronic attenuator is only available for frequencies up to 3.6 GHz. Set parameter to true when using frequencies above 3.6 GHz and set the parameter to false when using the preamp.
Preset	True
Range	True (bypass electronic attenuator) or False (use electronic attenuator)
Default Unit	Boolean
Initial S/W Revision	A.14.00

Electronic Attenuation

Example	CALC:FPOW:POW1:DEF "ElecAttenuation=10"
Notes	<p>Option EA3 is required.</p> <p>The electronic attenuation value parameter sets the amount of electrical attenuation from 0 to 24 dB (1 dB steps).</p> <p>Set "ElecAttBypass=False" to make sure the electronic attenuator path is enabled.</p>
Preset	0 dB
Range	0 – 24 dB (1 dB steps)

Default Unit	dB
Initial S/W Revision	A.14.00

IF Gain

Example	CALC:FPOW:POW1:DEF "IFGain=10"
Notes	The IF gain parameter allows the user to specify the gain at the IF stage anywhere from -6 to 16 dB (1 dB steps). This is an advanced feature, and for most cases this should remain at its default value of 0 dB.
Preset	0 dB
Range	-6 - 16 dB (1 dB steps)
Default Unit	dB
Initial S/W Revision	A.14.00

IF Type

Example	CALC:FPOW:POW1:DEF "IFType=B25M"
Notes	The IF type parameter allows the user to select between different IF paths. For example, if the signal is less than 25 MHz wide, then the user can select the B25M path to take advantage of additional filtering on this analog IF path.
Preset	B40M
Range	B10M, B25M, B40M
Initial S/W Revision	A.14.00

Include Power Spectrum

Example	CALC:FPOW:POW1:DEF "IncludePowerSpectrum=True"
Notes	The power spectrum parameter allows the user to read data on the entire spectrum for diagnostic purposes. It is not recommended for production use. See CALC:FPOW:POW[n]:READ2? for details on the binary format of the response.
Preset	False
Range	True (return both channel power and full power spectrum) or False (returns only channel power)
Default Unit	Boolean
Initial S/W Revision	A.14.00

Mechanical Attenuation

Example	CALC:FPOW:POW1:DEF "MechAttenuation=10"
Notes	The mechanical attenuation value parameter sets the amount of mechanical attenuation anywhere from 0 to 70 dB (2 dB steps).
Preset	0 dB
Range	0 – 70 dB (2 dB steps)
Default Unit	dB
Initial S/W Revision	A.14.00

Preamp Mode

Example	CALC:FPOW:POW1:DEF "PreAmpMode=Low"
Notes	The license for the appropriate preamp is required. The preamp mode parameter specifies whether the preamps are being utilized. Low allows any preamps up to 3.6 GHz, and Full allows all licensed preamps. Set "ElecAttBypass=True" in order to utilize any preamps.
Preset	Off
Range	Off, Low, Full
Initial S/W Revision	A.14.00

Resolution Bandwidth Mode

Example	CALC:FPOW:POW1:DEF "PreAmpMode=Low"
Notes	The resolution bandwidth mode parameter allows the user to choose whether the RBW filter is automatically or manually set. The BestSpeed value minimizes measurement time, while the Narrowest value minimizes RBW size (minimum of two FFT bins per RBW). To manually specify an RBW, set this parameter to Explicit, and set the ResolutionBW parameter to the desired value.
Preset	BestSpeed
Range	BestSpeed, Narrowest, Explicit
Initial S/W Revision	A.14.00

Resolution Bandwidth

Example	CALC:FPOW:POW1:DEF "ResolutionBW=25e3"
Notes	The resolution bandwidth parameter sets the 3-dB bandwidth of the RBW filter. The ResolutionBWMode parameter must be set to Explicit in order to manually set the RBW.

Preset	0 Hz
Default Unit	Hz
Initial S/W Revision	A.14.00

Trigger Delay

Example	CALC:FPOW:POW1:DEF "TriggerDelay=0.025"
Notes	The trigger delay parameter sets the time after an external trigger is detected until the measurement is performed.
Preset	0 s
Range	0 – 1 s
Default Unit	Seconds
Initial S/W Revision	A.14.00

Trigger Level

Example	CALC:FPOW:POW1:DEF "TriggerLevel=2"
Notes	The trigger level parameter sets the voltage value at which an external trigger is detected.
Preset	1.2 V
Range	-5 to 5 V
Default Unit	Volts
Initial S/W Revision	A.14.00

Trigger Slope

Example	CALC:FPOW:POW1:DEF "TriggerSlope=Negative"
Notes	The trigger slope parameter indicates the direction of the edge trigger voltage for detection.
Preset	Positive
Range	Positive, Negative
Initial S/W Revision	A.14.00

Trigger Source

Example	CALC:FPOW:POW1:DEF "TriggerSource=Ext1"
Notes	The trigger source parameter allows the user to choose between measurement's triggering freely or controlled by an external input. Ext1 and Ext2 correspond to Trigger 1 In and Trigger 2 In, respectively.
Preset	Free
Range	Free, Ext1, Ext2
Initial S/W Revision	A.14.00

Trigger Timeout

Example	CALC:FPOW:POW1:DEF "TriggerTimeout=0.1"
Notes	The trigger timeout parameter sets the time in which the analyzer will wait for a trigger before automatically performing the measurement.
Preset	1 s
Range	0 - 1 s
Default Unit	Seconds
Initial S/W Revision	A.14.00

Signal Input

Example	CALC:FPOW:POW1:DEF "SignalInput=Fp50MHzCW"
Notes	The signal input parameter allows the user to select between using the main RF input or the internal analyzer reference CW signal of 50 MHz.
Preset	FpMainRf
Range	FpMainRf, Fp50MHzCW
Initial S/W Revision	A.14.00

Use Preselector

Example	CALC:FPOW:POW1:DEF "UsePreSelector=True"
Notes	The preselector parameter allows the user to either utilize or bypass the front end tunable filter at frequencies above 3.6 GHz. For frequencies below 3.6 GHz, the preselector is automatically bypassed, so you do not need to set this parameter to False in those cases.
Preset	False
Range	True (use preselector above 3.6 GHz), or False (preselector bypassed)

Default Unit	Boolean
Initial S/W Revision	A.14.00

Channel Bandwidth Array

Example	CALC:FPOW:POW1:DEF "Bandwidth=[3.84e6, 5e6, 3.84e6]"
Notes	The bandwidth parameter array defines the bandwidth of each channel that will be measured. All array parameters should have the same number of elements. Alternatively, if all the elements are the same value, a single number with no square brackets can be used to define the parameter.
Preset	[1 e6]
Range	0 to 40 MHz
Default Unit	Hz
Initial S/W Revision	A.14.00

Channel Filter Type Array

Example	CALC:FPOW:POW1:DEF "FilterType=[RRC, IBW, RRC]"
Notes	The filter type parameter allows the user to choose between an integration bandwidth (IBW) filter or a root-raised-cosine (RRC) filter. The integration bandwidth filter weighs all frequencies within the bandwidth equally. The root-raised-cosine filter has an associated shape parameter, defined by the FilterAlpha parameter. All array parameters should have the same number of elements. Alternatively, if all the elements are the same value, a single value with no square brackets can be used to define the parameter.
Preset	[IBW]
Range	IBW, RRC
Initial S/W Revision	A.14.00

Channel Filter Alpha Array

Example	CALC:FPOW:POW1:DEF "FilterAlpha=[0.5, 0.0, 0.5]"
Notes	The filter alpha parameter allows the user to adjust the alpha value associated with the root-raised-cosine (RRC) filter type. Set FilterType to RRC in order to utilize this parameter. All array parameters should have the same number of elements. Alternatively, if all the elements are the same value, a single number with no square brackets can be used to define the parameter.
Preset	[0.22]
Range	0.0 - 1.0

Initial S/W Revision	A.14.00
-------------------------	---------

Channel Measurement Function Array

Example	CALC:FPOW:POW1:DEF "Function=[BandPower, PeakPower, BandPower]"
Notes	<p>This parameter array defines what measurement is being made for each individually-specified channel:</p> <p>BandPower: Total power within the specified bandwidth of the channel (dBm)</p> <p>BandDensity: Total power density within the specified bandwidth of the channel (dBm/Hz)</p> <p>PeakPower: The peak power value within the specified bandwidth of the channel (dBm)</p> <p>PeakFrequency: The frequency which corresponds to the peak power value within the specified bandwidth of the channel. This frequency is relative to the center frequency (Hz)</p> <p>XdBBandwidth: The half power (-3.01 dB) bandwidth of the highest amplitude signal that resides within the channel (Hz), dB is configurable using XdBBandwidth parameter</p> <p>OccupiedBandwidth: The bandwidth at which 99% of the total power resides within the channel (Hz), percentage configurable using OccupiedBandwidthPercent parameter</p> <p>All array parameters should have the same number of elements. Alternatively, if all the elements are the same value, a single value with no square brackets can be used to define the parameter.</p>
Preset	[BandPower]
Range	BandPower, BandDensity, PeakPower, PeakFrequency, XdBBandwidth, OccupiedBandwidth
Initial S/W Revision	A.14.00

Channel Offset Frequency Array

Example	CALC:FPOW:POW1:DEF "OffsetFrequency=[-5e6, 0, 5e6]"
Notes	<p>The offset frequency parameter array defines the difference between the center frequency to the center frequency of each channel.</p> <p>All array parameters should have the same number of elements.</p>
Preset	[0]
Range	0 to 20 MHz
Default Unit	Hz
Initial S/W Revision	A.14.00

Channel Occupied Bandwidth Percent Array

Example	CALC:FPOW:POW1:DEF "OccupiedBandwidthPercent =[0.95, 0.95, 0.95]"
Notes	This parameter only applies for channels whose Function is set to OccupiedBandwidth. The occupied

bandwidth percent parameter specifies the percent of total power in these channels. The valid range for this parameter is 0.0 to 1.0, where 1.0 represents 100%. The default for this parameter is 0.99, which will return the bandwidth that contains 99% of the total channel power.

Preset	[0.99]
Range	0 - 1.0
Initial S/W Revision	A.14.00

Channel x-dB Bandwidth Array

Example	CALC:FPOW:POW1:DEF " XdBBandwidth =[-6.02, -3.01, -1.0]"
Notes	This parameter only applies for channels whose Function is set to XdBBandwidth. The X dB bandwidth parameter is used to specify the power relative to the peak channel power over which the bandwidth is calculated. The parameter value must be a negative number.
Preset	[-3.01]
Range	-200 to 0 dB
Default Unit	dB
Initial S/W Revision	A.14.00

Define Fast Power Measurement Query (Remote Command Only)

The DEFine? command is used to retrieve a list of all defined parameters in an ASCII string format

```

M All
o
d
e
R :CALCulate:FPOWER:POWER[1,2,...,999]:DEFine?
e
m
o
t
e
C
o
m
m
a
n
d
E :CALC:FPOW:POW1:DEF?

```

x
a
m
p
l
e

N This command query is used to retrieve a list of all defined parameters in an ASCII format.
o The following is an example of the returned results:
t "DCCoupled=False,ElecAttBypass=True,ElecAttenuation=0,IFGain=0,MechAttenuation=0,PreAmpMode=Off,PreSelectorOffset
e =0,UsePreSelector=False,ExternalReferenceFrequency=10000000,FrequencyReferenceSource=AutoExternalFrequencyRefer
s ence,IFType=B40M,LOMode=SLW,SignalInput=FpMainRf,AcquisitionTime=0.001,CenterFrequency=1000000000,Resolution
BW=0,ResolutionBWMode=BestSpeed,DetectorType=RmsAverage,Bandwidth=[1000000],OffsetFrequency=[0],Function=
[BandPower],FilterType=[IBW],FilterAlpha=[0.22],OccupiedBandwidthPercent=[0.99],XdBBandwidth=[-
3.01],DoNoiseCorrection=False,DoSpurSuppression=False,MeasurementMethod=HardwareFFT,IncludePowerSpectrum=False,
e,TriggerDelay=0,TriggerLevel=1.2,TriggerSlope=Positive,TriggerSource=Free,TriggerTimeout=1 "

I A.14.00
n
i
t
i
a
l

S
/
W

R
e
v
i
s
i
o
n

Configure Fast Power Measurement (Remote Command Only)

The configure command begins hardware setup and returns immediately, with no acquisition made. This can be used in parallel with other hardware operations to effectively hide the hardware setup time.

Mode	All
Remote Command	:CALCulate:FPOWer:POWer[1,2,...,999]:CONFigure
Example	:CALC:FPOW:POW1:CONF
Notes	Option FP2 is required.
Initial S/W Revision	A.14.00

Initiate Fast Power Measurement (Remote Command Only)

The INITiate command begins an acquisition and returns immediately. The results of the measurement can be retrieved using FETCh.

Mode	All
Remote Command	:CALCulate:FPOWER:POWER[1,2,...,999]:INITiate
Example	:CALC:FPOW:POW1:INIT
Notes	Option FP2 is required.
Initial S/W Revision	A.14.00

Fetch Fast Power Measurement (Remote Command Only)

The FETCh command query is used to retrieve the results of an acquisition initiated by the INIT command. The returned results are in ASCII string format. The string begins and ends with quotation marks.

Mode	All
Remote Command	:CALCulate:FPOWER:POWER[1,2,...,999]:FETCh?
Example	:CALC:FPOW:POW1:FETC?
Notes	Option FP2 is required. Returns m comma-separated ASCII values, where m corresponds to the number of bandwidths defined. 1. Declared function return in the 1st specified channel 2. Declared function return in the 2nd specified channel ... m. Declared function return in the last specified channel The INIT and FETC? command sequence performs the same functionality of a single CALC:FPOW:POW[n]? query. Units of the returned values are dependent on the Function parameter for each channel.
Initial S/W Revision	A.14.00

Execute Fast Power Measurement (Remote Command Only)

This command query is used as shorthand for an INIT command immediately followed by a FETC? command. The returned results are in ASCII string format. The string begins and ends with quotation marks.

Mode	All
Remote Command	:CALCulate:FPOWER:POWER[1,2,...,999]?
Example	:CALC:FPOW:POW1?

Notes	Option FP2 is required. See notes for Fast Power Fetch for return format.
Initial S/W Revision	A.14.00

Binary Read Fast Power Measurement (Remote Command Only)

This command query is used as shorthand for an INIT command immediately followed by a FETC? command. The returned results are in a binary format.

Mode	All
Remote Command	:CALCulate:FPOWER:POWER[1,2,...,999]:READ? :CALCulate:FPOWER:POWER[1,2,...,999]:READ1?
Example	:CALC:FPOW:POW1:READ? :CALC:FPOW:POW1:READ1?
Notes	Option FP2 is required. Returns m 4 byte floating point binary values (Little-Endian), where m corresponds to the number of bandwidths defined.
Initial S/W Revision	A.14.00

Diagnostic Binary Read Fast Power Measurement (Remote Command Only)

This command query is used as shorthand for an INIT command immediately followed by a FETC? command. The returned results are in a binary format. This command is used primarily for diagnostic purposes to test for ADC overloads and to visibly inspect the spectrum.

Mode	All
Remote Command	:CALCulate:FPOWER:POWER[1,2,...,999]:READ2?
Example	:CALC:FPOW:POW1:READ2?
Notes	Option FP2 is required. Note: Spectrum data is only returned if the IncludePowerSpectrum parameter is set to True. If IncludePowerSpectrum is False, the number of spectrum points will be zero (0). Units of the returned values are dependent on the Function parameter per channel (e.g. dBm for BandPower, Hz for PeakFrequency). Returns binary data (Little-Endian) that contains information on m amount of channels, along with ADC over range and full spectrum data. The following is the binary format of the response. Bandwidth Return Value 1. Number of channels specified, m [4 byte int] 2. Declared function result for the 1st specified channel [4 byte float]

	3. Declared function result for the 2nd specified channel [4 byte float]
	...
	(m + 1). Declared function result for the last (mth) specified channel [4 byte float]
	ADC Over Range
	1. ADC over-range occurred (1: true, 0: false) [2 byte short]
	Spectrum Data
	1. Number of points in the spectrum data, k [4 byte int]
	2. Start frequency of spectrum data (Hz) [8 byte double]
	3. Step frequency of spectrum data (Hz) [8 byte double]
	4. FFT bin at 1st point (dBm) [4 byte float]
	5. FFT bin at 2nd point (dBm) [4 byte float]
	...
	(k + 3). FFT bin at last (kth) point (dBm) [4 byte float]

Initial S/W Revision	A.14.00
-------------------------	---------

Format Data: Numeric Data (Remote Command Only)

This command specifies the format of the trace data input and output. It specifies the formats used for trace data during data transfer across any remote port. It affects only the data format for setting and querying trace data for the :TRACe[:DATA], TRACe[:DATA]?, :CALCulate:DATA[n]? and FETCh:SANalyzer [n]? commands and queries.

Remote Command	:FORMat[:TRACe][:DATA] ASCii INTEger,32 REAL,32 REAL,64 :FORMat[:TRACe][:DATA]?
Notes	The query response is: ASCii: ASC,8 REAL,32: REAL,32 REAL,64: REAL,64 INTEger,32: INT,32 When the numeric data format is REAL or ASCii, data is output in the current Y Axis unit. When the data format is INTEger, data is output in units of m dBm (.001 dBm). The INT,32 format returns binary 32-bit integer values in internal units (m dBm), in a definite length block.
Dependencies	Sending a data format spec with an invalid number (for example, INT,48) generates no error. The analyzer simply uses the default (8 for ASCii, 32 for INTEger, 32 for REAL). Sending data to the analyzer which does not conform to the current FORMat specified, results in an error. Sending ASCII data when a definite block is expected generates message -161 "Invalid Block Data" and sending a definite block when ASCII data is expected generates message -121 "Invalid Character in Number".
Preset	ASCii
Backwards Compatibility	Note that the INT,32 format is only applicable to the command, TRACe:DATA. This preserves

Notes	backwards compatibility for the Swept SA measurement. For all other commands/queries which honor FORMat:DATA, if INT,32 is sent the analyzer will behave as though it were set to REAL,32.
Initial S/W Revision	Prior to A.02.00

The specs for each output type follow:

ASCIi - Amplitude values are in ASCII, in the current Y Axis Unit, one ASCII character per digit, values separated by commas, each value in the form:

SX.YYYYYEsZZ

Where:

S = sign (+ or -)

X = one digit to left of decimal point

Y = 5 digits to right of decimal point

E = E, exponent header

s = sign of exponent (+ or -)

ZZ = two digit exponent

REAL,32 - Binary 32-bit real values in the current Y Axis Unit, in a definite length block.

REAL,64 - Binary 64-bit real values in the current Y Axis Unit, in a definite length block.

Format Data: Byte Order (Remote Command Only)

This command selects the binary data byte order for data transfer and other queries. It controls whether binary data is transferred in normal or swapped mode. This command affects only the byte order for setting and querying trace data for the :TRACe[:DATA], TRACe[:DATA]? , :CALCulate:DATA[n]? and FETCh:SANalyzer[n]? commands and queries.

By definition any command that says it uses FORMat:DATA uses any format supported by FORMat:DATA.

The NORMal order is a byte sequence that begins with the most significant byte (MSB) first, and ends with the least significant byte (LSB) last in the sequence: 1|2|3|4. SWAPped order is when the byte sequence begins with the LSB first, and ends with the MSB last in the sequence: 4|3|2|1.

Remote Command	:FORMat:BORDer NORMal SWAPped :FORMat:BORDer?
Preset	NORMal
Initial S/W Revision	Prior to A.02.00

Meas Setup

Displays the setup menu for the current measurement. The measurement setup parameters include the number of measurement averages used to calculate the measurement result and the averaging mode. The setup menu also includes the option to reset the measurement settings to their factory defaults.

Key Path	Front-panel key
Initial S/W Revision	Prior to A.02.00

Avg/Hold Num

Specifies the number of measurement averages used when calculating the measurement result. The average is displayed at the end of each sweep.

After the specified number of average counts, the averaging mode (terminal control) setting determines the averaging action.

Key Path	Meas Setup
Mode	All except SA and BASIC
Remote Command	[:SENSe]:MONitor:AVERage:COUNT <integer> [:SENSe]:MONitor:AVERage:COUNT? [:SENSe]:MONitor:AVERage[:STATe] OFF ON 0 1 [:SENSe]:MONitor:AVERage[:STATe]?
Example	MON:AVER:COUN 25 MON:AVER:COUN? MON:AVER ON MON:AVER?
Preset	10 OFF
State Saved	Saved in instrument state.
Min	1
Max	1000
Initial S/W Revision	Prior to A.02.00

Avg Mode

Toggles the average mode between exponential (Exp) and Repeat.

- **Exp**– continues measurement averaging, using the specified number of averages to compute each averaged value. The average is displayed at the end of each sweep.
- **Repeat**– causes the measurement to reset the average counter each time the specified number of averages is reached.

Key Path	Meas Setup
Mode	All except SA and BASIC
Remote Command	[:SENSe] :MONitor :AVERage :TCONtrol EXPonential REPEAT [:SENSe] :MONitor :AVERage :TCONtrol ?
Example	MON:AVER:TCON EXP MON:AVER:TCON?
Preset	EXPonential
State Saved	Saved in instrument state.
Range	ExpRepeat
Initial S/W Revision	Prior to A.02.00

Meas Preset

Restores all the measurement parameters to their default values.

Key Path	Meas Setup
Mode	All except SA and BASIC
Remote Command	:CONFigure:MONitor
Example	CONF:MON
Initial S/W Revision	Prior to A.02.00

Mode

See "Mode" on page 276

Mode Preset

Returns the active mode to a known state.

Mode Preset does the following for the currently active mode:

- Aborts the currently running measurement.
- Brings up the default menu for the mode, with no active function.
- Sets measurement Global settings to their preset values for the active mode only.
- Activates the default measurement.
- Brings up the default menu for the mode.
- Clears the input and output buffers.
- Sets Status Byte to 0.

Mode Preset does not:

- Cause a mode switch
- Affect mode persistent settings
- Affect system settings
- See "[How-To Preset](#)" on page 2181 for more information.

Key Path	Front-panel key
Remote Command	:SYSTem:PRESet
Example	:SYST:PRES
Notes	*RST is preferred over :SYST : PRES for remote operation. *RST does a Mode Preset, as done by the :SYST:PRES command, and it sets the measurement mode to Single measurement rather than Continuous for optimal remote control throughput. Clears all pending OPC bits. The Status Byte is set to 0.
Couplings	A Mode Preset aborts the currently running measurement, activates the default measurement, and gets the mode to a consistent state with all of the default couplings set.
Backwards Compatibility Notes	In the X-Series, the legacy "Factory Preset" has been replaced with Mode Preset, which only presets the currently active mode, not the entire instrument. In the X-Series, the way to preset the entire instrument is by using System, Restore System Defaults All, which behaves essentially the same way as restore System Defaults does on ESA and PSA. There is also no "Preset Type" as there is on the PSA. There is a green Mode Preset front-panel key that does a Mode Preset and a white-with-green-letters User Preset front-panel key that does a User Preset. The old PRESet:TYPE command is ignored (without generating an error), and SYST:PRES without a parameter does a Mode Preset, which should cover most backward code compatibility issues. The settings and correction data under the Input/Output front-panel key (examples: Input Z Corr, Ext Amp Gain, etc.) are no longer part of any Mode, so they will not be preset by a Mode Preset. They are preset using Restore Input/Output Defaults, Restore System Defaults All. Note that because User Preset does a Recall State, and all of these settings are saved in State, they ARE recalled when using

	User Preset.
Initial S/W Revision	Prior to A.02.00

How-To Preset

The table below shows all possible presets, their corresponding SCPI commands and front-panel access (key paths). Instrument settings depend on the current measurement context. Some settings are local to the current measurement, some are global (common) across all the measurements in the current mode, and some are global to all the available modes. In a similar way, restoring the settings to their preset state can be done within the different contexts.

Auto Couple - is a measurement local key. It sets all Auto/Man parameter couplings in the measurement to Auto. Any Auto/Man selection that is local to other measurements in the mode will not be affected.

Meas Preset - is a measurement local key. Meas Preset resets all the variables local to the current measurement except the persistent ones.

Mode Preset - resets all the current mode's measurement local and measurement global variables except the persistent ones.

Restore Mode Defaults - resets ALL the Mode variables (and all the Meas global and Meas local variables), including the persistent ones.

Type Of Preset	SCPI Command	Front Panel Access
Auto Couple	:COUPlE ALL	Auto Couple front-panel key
Meas Preset	:CONFIgure:<Measurement>	Meas Setup Menu
Mode Preset	:SYSTem:PRESet	Mode Preset (green key)
Restore Mode Defaults	:INSTrument:DEFault	Mode Setup Menu
Restore All Mode Defaults	:SYSTem:DEFault MODEs	System Menu; Restore System Default Menu
*RST	*RST	not possible (Mode Preset with Single)
Restore Input/Output Defaults	:SYSTem:DEFault INPut	System Menu; Restore System Default Menu
Restore Power On Defaults	:SYSTem:DEFault PON	System Menu; Restore System Default Menu
Restore Alignment Defaults	:SYSTem:DEFault ALIGn	System Menu; Restore System Default Menu
Restore Miscellaneous Defaults	:SYSTem:DEFault MISC	System Menu; Restore System Default Menu
Restore All System Defaults	:SYSTem:DEFault [ALL] :SYSTem:PRESet:PERsistent	System Menu; Restore System Default Menu
User Preset	:SYSTem:PRESet:USER	User Preset Menu
User Preset All Modes	:SYSTem:PRESet:USER:ALL	User Preset Menu

Power On Mode Preset	:SYSTem:PON:TYPE MODE	System Menu
Power On User Preset	:SYSTem:PON:TYPE USER	System Menu
Power On Last State	:SYSTem:PON:TYPE LAST	System Menu

Preset Type (Remote Command Only)

As stated in the Backward Compatibility section, to be compatible with ESA/PSA the PRESet:TYPE command will be implemented as a no-op.

Mode	All
Remote Command	:SYSTem:PRESet:TYPE FACTory MODE USER :SYSTem:PRESet:TYPE?
Example	:SYST:PRESet:TYPE FACT
Notes	This command is supported for backward compatibility only. It is a no-op which does not change the behavior of any preset operation.
Preset	This is unaffected by Preset but is set to Mode on a "Restore System Defaults->All"
State Saved	No
Initial S/W Revision	Prior to A.02.00

Mode Setup

See ["Mode Setup" on page 306](#)

Peak Search

Places the selected marker on the trace point with the maximum y-axis value for that marker's trace. Pressing **Peak Search** with the selected marker off causes the selected marker to be set to **Normal**, then a peak search is immediately performed.

Key Path	Front-panel key
Mode	All except SA and BASIC
Remote Command	:CALCulate:MONitor:MARKer[1] 2 ... 12:MAXimum
Example	CALC:MON:MARK2:MAX
Initial S/W Revision	Prior to A.02.00

Print

See "Print " on page 367

Quick Save

The Quick Save front-panel key repeats the most recent save that was performed from the Save menu, with the following exceptions:

- Register saves are not remembered as Saves for the purpose of the Quick Save function
- If the current measurement does not support the last non-register save that was performed, an informational message is generated, “File type not supported for this measurement”

Quick Save repeats the last type of qualified save (that is, a save qualified by the above criteria) in the last save directory by creating a unique filename using the Auto File Naming algorithm described below.

If Quick Save is pressed after startup and before any qualified Save has been performed, the Quick Save function performs a Screen Image save using the current settings for Screen Image saves (current theme, current directory), which then becomes the “last save” for the purpose of subsequent Quick Saves.

The Auto File Naming feature automatically generates a file name for use when saving a file. The filename consists of a prefix and suffix separated by a dot, as is standard for the Windows® file system. A default prefix exists for each of the available file types:

Type	Default Prefix	Menu
State	State_	(Save/Recall)
Trace + State	State_	(Save/Recall)
Screen	Screen_	(Save/Recall)
Amplitude Corrections	Ampcor_	(Import/Export)
Traces	Trace_	(Import/Export)
Limit Lines	LLine_	(Import/Export)
Measurement Result	MeasR_	(Import/Export)
Capture Buffer	CapBuf_	(Import/Export)

A four digit number is appended to the prefix to create a unique file name. The numbering sequence starts at 0000 within each Mode for each file type and updates incrementally to 9999, then wraps to 0000 again. It remembers where it was through a Mode Preset and when leaving and returning to the Mode. It is reset by Restore Misc Defaults and Restore System Defaults and subsequent running of the instrument application. So, for example, the first auto file name generated for State files is State_0000.state. The next is State_0001, and so forth.

One of the key features of Auto File Name is that we guarantee that the Auto File Name will never conflict with an existing file. The algorithm looks for the next available number. If it gets to 9999, then it looks for holes. If it find no holes, that is no more numbers are available, it gives an error.

For example, if when we get to State_0010.state there is already a State_0010.state file in the current directory, it advances the counter to State_0011.state to ensure that no conflict will exist (and then it verifies that State_0011.state also does not exist in the current directory and advances again if it does, and so forth).

If you enter a file name for a given file type, then the prefix becomes the filename you entered instead of the default prefix, followed by an underscore. The last four letters (the suffix) are the 4-digit number.

For example, if you save a measurement results file as “fred.csv”, then the next auto file name chosen for a measurement results save will be fred_0000.csv.

NOTE Although 0000 is used in the example above, the number that is used is actually the current number in the Meas Results sequence, that is, the number that would have been used if you had not entered your own file name.

NOTE If the filename you entered ends with _dddd, where d=any number, making it look just like an auto file name, then the next auto file name picks up where you left off with the suffix being dddd + 1.

Key Path	Front-panel key
Notes	No remote command for this key specifically.
Initial S/W Revision	Prior to A.02.00

Recall

In the MSR mode, two types of recall functions are available under the Data menu: Parameter Sets and Masks. Masks enables setting of a preset limit mask for Power Suite-based measurements, and currently it is available for the SEM, ACP and SPUR measurements in the MSR mode.

Key Path	Front Panel
Mode	MSR
Initial S/W Revision	A.10.00

State

The **Recall State** menu lets you choose a register or file from which to recall the state.

The content of a state file includes all of the settings and data required to return the analyzer as closely as possible to the Mode it was in, with the exact settings that were in place, when the save occurred. The Mode settings in each state file include the settings that are affected by Mode Preset, as well as the additional settings affected by Restore Mode Defaults; all of the Mode's settings. In addition, all of the settings of the **Input/Output** system are included, even though they are outside of the Mode's state, because they are needed to restore the complete setup. Persistent System settings (for example, GPIB address) are not affected by either a Mode Preset or Restore Mode Defaults, nor are they included in a saved State file.

Since each state file is only for one Mode, the settings for other Modes are unaffected when it is loaded. **Recall State** will cause a mode switch if the state being recalled is not from the current active mode.

After the recall completes, the message "File <filename> recalled" or "Recalled State Register <register number>" is displayed.

For rapid recalls, the State menu lists 16 registers that you can choose from to recall. Pressing a Register key initiates the recall. You can also select a file from which to recall.

The default path for all State Files is:

My Documents\<mode name>\state

where <mode name> is the parameter used to select the mode with the INST:SEL command (for example, SA for the Spectrum Analyzer).

See "[More Information](#)" on page 2189.

Key Path	Recall
Mode	All
Remote Command	:MMEMory:LOAD:STATe <filename>
Example	:MMEM:LOAD:STAT "myState.state" This recalls the file myState.state on the default path
Example	MMEM:LOAD:STAT "MyStateFile.state" This loads the state file data (on the default file directory path) into the instrument state.

Notes	<p>When you pick a file to recall, the analyzer first verifies that the file is recallable in the current instrument by checking the software version and model number of the instrument. If everything matches, a full recall proceeds by aborting the currently running measurement, clearing any pending operations, and then loading the State from the saved state file. You can open state files from any mode, so recalling a State file switches to the mode that was active when the save occurred. After switching to the mode of the saved state file, mode settings and data (if any for the mode) are loaded with values from the saved file. The saved measurement of the mode becomes the newly active measurement and the data relevant to the measurement (if there is any) is recalled.</p> <ul style="list-style-type: none"> • If there is a mismatch between file version or model number or instrument version or model number, the recall function tries to recall as much as possible and returns a warning message. It may limit settings that differ based on model number, licensing or version number. <p>After recalling the state, the Recall State function does the following:</p> <ul style="list-style-type: none"> • Makes the saved measurement for the mode the active measurement. • Clears the input and output buffers. • Status Byte is set to 0. • Executes a *CLS <p>If the file specified is empty an error is generated. If the specified file does not exist, another error is generated. If there is a mismatch between the file and the proper file type, an error is generated. If there is a mismatch between file version or model number or instrument version or model number, a warning is displayed. Then it returns to the State menu and File Open dialog goes away.</p> <p>After the Recall, the analyzer exits the Recall menu and returns to the previous menu.</p>
Backwards Compatibility SCPI	<pre>:MMEMory:LOAD:STATe 1,<filename></pre> <p>For backwards compatibility, the above syntax is supported. The "1" is simply ignored.</p>
Initial S/W Revision	Prior to A.02.00

More Information

In measurements that support saving Traces, for example, Swept SA, the Trace data is saved along with the State in the State file. When recalling the State, the Trace data is recalled as well. Traces are recalled exactly as they were stored, including the writing mode and update and display modes. If a Trace was updating and visible when the State was saved, it will come back updating and visible, and its data will be rewritten right away. When you use State to save and recall traces, any trace whose data must be preserved should be placed in View or Blank mode before saving.

The following table describes the Trace Save and Recall possibilities:

You want to recall state and one trace's data, leaving other traces unaffected.	Save Trace+State from 1 trace. Make sure that no other traces are updating (they should all be in View or Blank mode) when the save is performed.	On Recall, specify the trace you want to load the one trace's data into. This trace will load in View. All other traces' data will be unaffected, although their trace mode will be as it was when the state save was performed.
You want to recall all traces	Save Trace+State from ALL traces.	On Recall, all traces will come back in View (or Blank if they were in Blank or Background when

		saved)
You want all traces to load exactly as they were when saved.	Save State	On recall, all traces' mode and data will be exactly as they were when saved. Any traces that were updating will have their data immediately overwritten.

From File...

When you press “From File”, the analyzer brings up a Windows dialog and a menu entitled “File Open.” This menu allows you to navigate to the various fields in the Windows dialog without using a keyboard or mouse. The **Tab** and **Arrow** keys can also be used for dialog navigation.

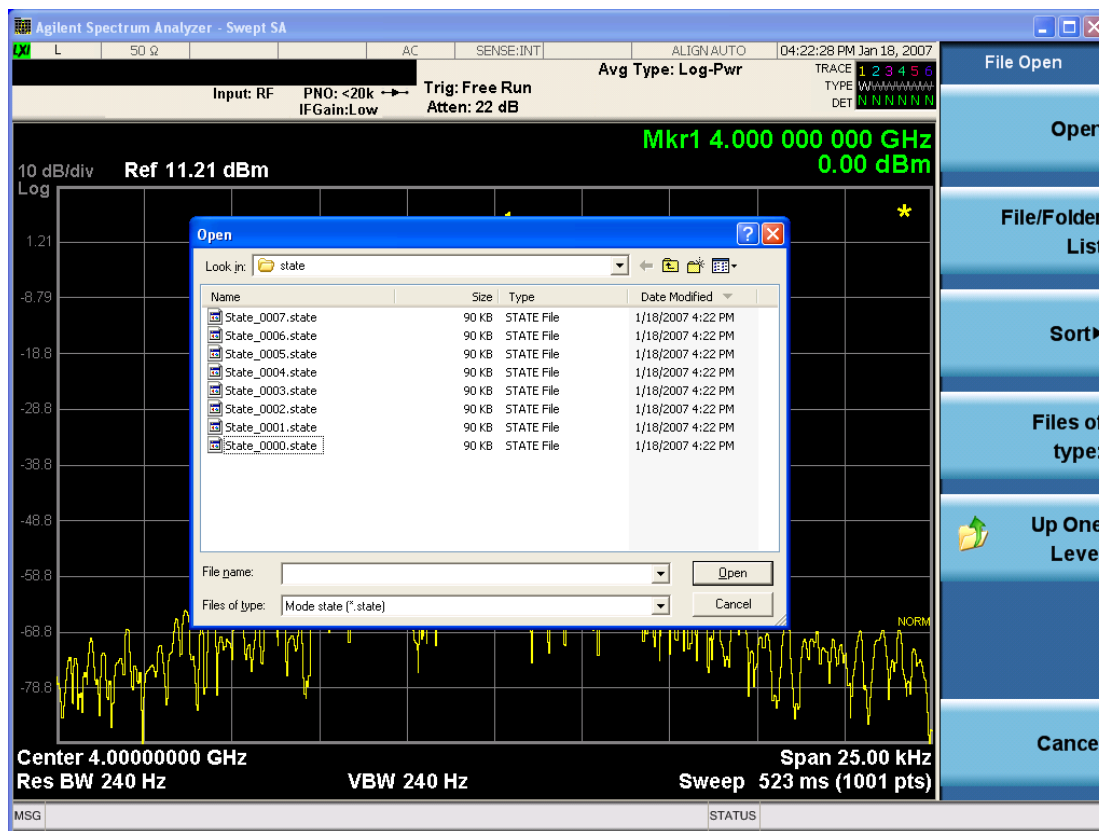

Listed below are the functions of the various fields in the dialog, and the corresponding softkeys:

Open

Performs the recall of the specified file. While the recall is being performed, the floppy icon appears briefly in the Meas bar.

File/Folder List

Enables you to navigate to the center of the dialog that contains the list of files and folders. Once here you can get information about the file and use the tab keys to navigate to the other fields in the dialog, such as Look In.

Look In

The **Look In** field shows the path from which the file will be recalled and allows you to change the path using the up and down arrow keys to navigate to other paths; the Enter key to open a directory; and the Backspace key to go back one directory. The **Look In field** first uses the last path from the Save As dialog **Save In:** path for that same file type. There is no softkey for directly navigating to the Look In field, but you can use the left tab to get here from the File/Folder List.

User specified paths are remembered when you leave and return to a Mode and are reset back to the default using **Restore Mode Defaults**.

Sort

Accesses a menu that enables you to sort the files within the File Open dialog. Only one sorting type can be selected at a time and the sorting happens immediately. The sorting types are **By Date, By Name, By extension, and By Size**.

Files of Type

This field shows the file suffix for the type of file you have selected to recall. For example, if you navigated here while recalling State, "Mode state (*.state)" is in the field. If you navigated here while recalling Trace, ""Mode state (*.trace)" is in the field. If you navigated here while importing a trace data file, "Trace Data (*.csv)" is in the field. For some file types, there is more than one choice in the dropdown menu, which you can select by using the up and down arrow keys and Enter.

Up One Level

This key corresponds to the icon of a folder with the up arrow that is in the tool bar of the dialog. When pressed, it causes the file and folder list to navigate up one level in the directory structure. The Backspace key does the same thing.

Cancel

This key corresponds to the **Cancel** selection in the dialog. It causes the current **Open** request to be cancelled. The ESC key does the same thing.

Key Path	Recall, State
Notes	Brings up the Open dialog for recalling a State Save Type
Initial S/W Revision	Prior to A.02.00

Edit Register Names

You may enter a custom name on any of the Register keys, to help you remember what you are using that state to save. To do this, press the **Edit Register Names** key, choose the register whose name you wish to edit, and then enter the desired label using the Alpha Editor or an external PC keyboard.

The maximum number of characters that can be added is 30. In most cases, 30 characters will fit on two lines of the key.

For more information and the SCPI command, see Edit Register Names under the **Save, State** function.

Key Path	Recall, State
Mode	All
Dependencies	N9060A-7FP or N9060B-2FP license required to edit the register names. When the feature is not licensed, sending the SCPI command generates an error, -221, "Settings conflict;Option not available"
Initial S/W Revision	A.11.00

Register 1 thru Register 16

Selecting any one of these register keys causes the State of the mode from the specified Register to be recalled. Each of the register keys annotates whether it is empty or at what date and time it was last modified. In addition, you can use the **Edit Register Names** key under **Save, State** to enter custom names for each register.

Registers are shared by all modes, so recalling from any one of the registers will cause a mode switch to the mode that was active when the save to the Register occurred.

Although these 16 registers are the only registers available from the front panel, there are 128 state registers available in the instrument. Registers 17-128 are only available from the SCPI interface, using the *RCL command.

After the recall completes, the message "Register <register number> recalled" appears in the message bar. If you are in the Spectrum Analyzer Mode, and you are recalling a register that was saved in the Spectrum Analyzer Mode, then after the recall, you will still be in the Recall Register menu. If the Recall causes you to switch modes, then after the Recall, you will be in the Frequency menu.

If a requested register is empty an error is generated.

Key Path	Recall, State
Example	*RCL 1
Range	1-16 from front panel, 1-128 from SCPI
Readback	Date and time with seconds resolution are displayed on the key OR A custom name of up to 30 characters entered using the Save, State,Edit Register Names key OR "(empty)" if no prior save operation has been performed to this register.
Initial S/W Revision	Prior to A.02.00
Modified at S/W Revision	Prior to A.11.00

Register 1 thru Register 16

Selecting any one of these register keys causes the State of the mode from the specified Register to be recalled. Each of the register keys annotates whether it is empty or at what date and time it was last

modified. In addition, you can use the **Edit Register Names** key under **Save, State** to enter custom names for each register.

Registers are shared by all modes, so recalling from any one of the registers will cause a mode switch to the mode that was active when the save to the Register occurred.

Although these 16 registers are the only registers available from the front panel, there are 128 state registers available in the instrument. Registers 17–128 are only available from the SCPI interface, using the *RCL command.

After the recall completes, the message "Register <register number> recalled" appears in the message bar. If you are in the Spectrum Analyzer Mode, and you are recalling a register that was saved in the Spectrum Analyzer Mode, then after the recall, you will still be in the Recall Register menu. If the Recall causes you to switch modes, then after the Recall, you will be in the Frequency menu.

If a requested register is empty an error is generated.

Key Path	Recall, State
Example	*RCL 1
Range	1–16 from front panel, 1–128 from SCPI
Readback	Date and time with seconds resolution are displayed on the key OR A custom name of up to 30 characters entered using the Save, State,Edit Register Names key OR “(empty)” if no prior save operation has been performed to this register.
Initial S/W Revision	Prior to A.02.00
Modified at S/W Revision	Prior to A.11.00

Data (Import)

Importing a data file loads data that was previously saved from the current measurement or from other measurements and/or modes that produce compatible data files. The Import Menu only contains Data Types that are supported by the current measurement.

Since the commonly exported data files are in .csv format, the data can be edited by the user prior to importing. This allows you to export a data file, manipulate the data in Excel (the most common PC Application for manipulating .csv files) and then import it.

Importing Data loads measurement data from the specified file into the specified or default destination, depending on the data type selected. Selecting an Import Data menu key will not actually cause the importing to occur, since the analyzer still needs to know from where to get the data. Pressing the Open key in this menu brings up the Open dialog and Open menu that provides you with the options from where to recall the data. Once a filename has been selected or entered in the Open menu, the recall occurs as soon as the Open button is pressed.

Key Path	Recall
Mode	All

Notes	The menu is built from whatever data types are available for the mode. Some keys will be missing completely, so the key locations in the sub-menu will vary. No SCPI command directly controls the Data Type that this key controls. The Data Type is included in the MMEM:LOAD commands.
Dependencies	If a file type is not used by a certain measurement, it is grayed out for that measurement. The key for a file type will not show at all if there are no measurements in the Mode that support it.
Preset	Is not affected by Preset or shutdown, but is reset during Restore Mode Defaults
Readback	The data type that is currently selected
Initial S/W Revision	Prior to A.02.00

Parameter Set

Enables you to import format parameter set data to specified format parameter sets. Selecting this key displays a menu that enables you to select the destination parameter set. After making this selection, depress Open... and use the file dialog to select the file you wish to recall.

Supported import file formats are dependent on radio formats.

LTE FDD: Format Parameter Set Files (*.fps), LTE FDD app state files (*.state), 89601 VSA Setup Files (*.set, *.setx) and Signal Studio Setup Files (*.scp)

W-CDMA:Format Parameter Set Files (*.fps) and W-CDMA app state files (*.state)

GSM/EDGE:Format Parameter Set Files (*.fps) and GSM/EDGE app state files (*.state)

cdma2000:Format Parameter Set Files (*.fps) and cdma2000 app state files (*.state)

1xEV-DO:Format Parameter Set Files (*.fps) and 1xEV-DO app state files (*.state)

LTE TDD: Format Parameter Set Files (*.fps), LTE TDD app state files (*.state), 89601 VSA Setup Files (*.set, *.setx) and Signal Studio Setup Files (*.scp)

TD-SCDMA:Format Parameter Set Files (*.fps) and TD-SCDMA app state files (*.state)

Format Parameter Set Files

Extention: fps

Basic file type of format parameter set. This file contains a format parameter set exported using Parameter Set under Recall, Data (Export). It is imported if the radio format of the file matches the destination radio format. If not, an error message, -230 "Data corrupt or stale", is issued with the specified file name.

App State Files

Extention: state

The state file of each mode can be imported to the corresponding parameter set. If the mode name in the state file matches the selected destination format, the state file data are imported. If not, an error message, -230 "Data corrupt or stale", is issued with the specified file name.

The parameters to be imported are ones referred in a particular measurement of each mode. The relevant measurements are listed below.

LTE FDD: Modulation Analysis

W-CDMA: Mod Accuracy

GSM/EDGE: EDGE EVM

cdma2000: Mod Accuracy

1xEV-DO: Mod Accuracy

LTE TDD: Modulation Analysis

TD-SCDMA: Mod Accuracy

Note that Integ BW and Measurement Noise BW parameters of ACP, SEM and CHP are not imported.

89601 VSA Setup Files

Extention: set, setx

The 89600 Vector Signal Analyzer Setup file created using the 89600 Vector Signal Analyzer Option BHD (LTE FDD)/Option BHE (LTE TDD) can be imported as LTE FDD/LTE TDD parameter set. If the setup file is not loaded successfully, an error message, -230 “Data corrupt or stale”, is issued with the specified file name.

Signal Studio Setup Files

Extention: scp

The Keysight Signal Studio setup file created using Signal Studio (N7624B/N7625B) can be imported as LTE FDD/LTE TDD parameter set. Supported carrier types are listed in the table below:

<i>Signal Studio</i>	<i>Carrier Type</i>
N7624B Signal Studio for 3GPP LTE	Advanced LTE FDD Downlink (2009-03)
	Advanced LTE FDD Downlink (2009-12)
	Advanced LTE FDD Downlink (2010-06)
	Advanced LTE FDD Uplink (2009-12)
	Advanced LTE FDD Uplink (2010-06)
	Basic LTE FDD Downlink (2009-03)
	Basic LTE FDD Downlink (2009-12)
	Basic LTE FDD Downlink (2010-06)
	Basic LTE FDD Uplink (2009-03)
	Basic LTE FDD Uplink (2009-12)
	Basic LTE FDD Uplink (2010-06)
N7625B Signal Studio for 3GPP LTE TDD	Advanced LTE TDD (2009-03)
	Advanced LTE TDD (2009-12)
	Basic LTE TDD (2009-03)
	Basic LTE TDD (2009-12)
	Basic LTE TDD R9
	Advanced LTE TDD R9

Basic LTE TDD R9 PRACH

If the setup file is not loaded successfully, an error message, -230 “Data corrupt or stale”, is issued with the specified file name.

Default path of this import type is “My Documents\MSR\data\params” folder. Note that “**My Documents**” is an alias to a directory and its location depends on which user is logged in. If the file path is specified without root folder, the import file is determined with the default path. For example if “folder1\paramData.prms” is specified, “My Documents\MSR\data\params\folder1\paramData.prms” is imported.

File Dialog Filter

Since supported import file formats differ between radio formats, file filters available in the open file dialog vary depending on the selected radio format. This table below defines file name filters available for each format.

<i>Radio Format</i>	<i>File Name Filters</i>
LTE FDD	All Supported Format Parameter Setup Files (*.fps; *.state; *.set; *.setx; *.scp) Format Parameter Setup Files (*.fps) State Files (*.state) 89601 VSA Setup Files (*.set; *.setx) Signal Studio Setup Files (*.scp)
W-CDMA	All Supported Format Parameter Setup Files (*.fps; *.state) Format Parameter Setup Files (*.fps) W-CDMA State Files (*.state)
GSM/EDGE	All Supported Format Parameter Setup Files (*.fps; *.state) Format Parameter Setup Files (*.fps) State Files (*.state)
cdma2000	All Supported Format Parameter Set Files (*.fps; *.state) Format Parameter Set Files (*.fps) State Files (*.state)
1xEV-DO	All Supported Format Parameter Set Files (*.fps; *.state) Format Parameter Set Files (*.fps) State Files (*.state)
LTE TDD	All Supported Format Parameter Setup Files (*.fps; *.state; *.set; *.setx; *.scp) Format Parameter Setup Files (*.fps) State Files (*.state) 89601 VSA Setup Files (*.set; *.setx) Signal Studio Setup Files (*.scp)
TD-SCDMA	All Supported Format Parameter Set Files (*.fps; *.state) Format Parameter Set Files (*.fps) State Files (*.state)

Key Path	Recall, Data
Mode	MSR
Remote Command	MMEMoRY:LOAD:PSET LTEFdd1 LTEFdd2 LTEFdd3 WCDMa1 WCDMa2 WCDMa3 GSM1 GSM2 GSM3 CDMA1 CDMA2 CDMA3 EVDO1 EVDO2 EVDO3 LTETdd1 LTETdd2 LTETdd3 TDSCdma1 TDSCdma2 TDSCdma3, <string>
Example	MMEM:LOAD:PSET LTEF1,"LTE FDD.set"
Notes	The first enum selects the destination format parameter set to which the file data are imported.
Initial S/W Revision	A.10.00
Modified at S/W Revision	A.12.00, A.16.00

Masks

This key enables you to recall a preset mask file which contains Offset and Limit settings. Parameters except them will not be overwritten. You cannot change or create preset mask files since they are binary files. This key is valid for the Spectrum Emission Mask, ACP and Spurious Emissions measurements.

Default path: "My Documents\MSR\data\masks"

Note that "My Documents" is an alias to a directory and its location depends on which user is logged in. At XSA start up, all of the limit mask files in the current user's "My Documents\MSR\data\masks" directory are overwritten.

File type: Binary

Filename: The filename follows the rule below with the words connected using underscores.

<Measurement>_<Condition>.mask

Where

<Measurement> Measurement the limit mask file is applied to: SEM, ACP or SPUR

<Condition> Condition. It depends on the measurement.

File extension: .mask

File Dialog Filter: Preset Mask Files (*.mask)

Selecting OPEN... under the Import Data menu opens the above directory enabling you to select a mask file.

Details of the masks are provided in a PDF file in the default folder of masks.

Key Path	Recall, Data
Mode	MSR
Remote Command	MMEMoRY:LOAD:MASK <string>
Example	MMEM:LOAD:MASK "ACP_BS\ACP_BS_3MHz_pairE-UTRA_CatA.mask"

Notes	Parameters related to Limit and Offset are overwritten by the contents of the preset mask file.
Initial S/W Revision	A.10.00

Open...

When you press “Open”, the analyzer brings up a Windows dialog and a menu entitled “**File Open.**” This menu allows you to navigate to the various fields in the Windows dialog without using a keyboard or mouse. The **Tab** and **Arrow** keys can also be used for dialog navigation.

See "[From File...](#)" on page 2454 in **Recall, State**, for a full description of this dialog and menu.

Key Path	Recall, Data
Notes	The key location is mode-dependent and will vary. Brings up Open dialog for recalling a <mode specific> Save Type
Initial S/W Revision	Prior to A.02.00

Restart

The Restart function restarts the current sweep, or measurement, or set of averaged/held sweeps or measurements. If you are Paused, pressing Restart does a Resume.

The Restart function is accessed in several ways:

- Pressing the Restart key
- Sending the remote command INIT:IMMEDIATE
- Sending the remote command INIT:RESTART

See "[More Information](#)" on page 2199

Key Path	Front-panel key
Remote Command	:INITiate[:IMMEDIATE] :INITiate:RESTART
Example	:INIT:IMM :INIT:REST
Notes	:INITiate:RESTART and :INITiate:IMMEDIATE perform exactly the same function.
Couplings	Resets average/hold count k. For the first sweep overwrites all active (update=on) traces with new current data. For application modes, it resets other parameters as required by the measurement.
Status Bits/OPC dependencies	This is an Overlapped command. The STATUS:OPERation register bits 0 through 8 are cleared. The STATUS:QUESTIONable register bit 9 (INTEgrity sum) is cleared. The SWEEPING bit is set. The MEASURING bit is set.
Backwards Compatibility Notes	For Spectrum Analysis mode in ESA and PSA, the Restart hardkey and the INITiate:RESTART command restart trace averages (displayed average count reset to 1) for a trace in Clear Write , but did not restart Max Hold and Min Hold . In the X-Series, the Restart hardkey and the INITiate:RESTART command restart not only Trace Average , but MaxHold and MinHold traces as well. For wireless comms modes in ESA and PSA, the Restart hardkey and the INITiate:RESTART command restart every measurement, which includes all traces and numeric results. There is no change to this operation.
Initial S/W Revision	Prior to A.02.00

More Information

The **Restart** function first aborts the current sweep/measurement as quickly as possible. It then resets the sweep and trigger systems, sets up the measurement and initiates a new data measurement sequence with a new data acquisition (sweep) taken once the trigger condition is met.

If the analyzer is in the process of aligning when **Restart** is executed, the alignment finishes before the restart function is performed.

Even when set for Single operation, multiple sweeps may be taken when Restart is pressed (for example, when averaging/holding is on). Thus when we say that **Restart** "restarts a measurement," we may mean:

- It restarts the current sweep
- It restarts the current measurement
- It restarts the current set of sweeps if any trace is in Trace Average, Max Hold or Min Hold
- It restarts the current set of measurements if Averaging, or Max Hold, or Min Hold is on for the measurement
- depending on the current settings.

With **Average/Hold Number** (in **Meas Setup** menu) set to 1, or Averaging off, or no trace in Trace Average or Hold, a single sweep is equivalent to a single measurement. A single sweep is taken after the trigger condition is met; and the analyzer stops sweeping once that sweep has completed. However, with **Average/Hold Number** > 1 and at least one trace set to **Trace Average, Max Hold, or Min Hold (SA Measurement)** or **Averaging on (most other measurements)**, multiple sweeps/data acquisitions are taken for a single measurement. The trigger condition must be met prior to each sweep. The sweep is stopped when the average count k equals the number N set for **Average/Hold Number**. A measurement average usually applies to all traces, marker results, and numeric results; but sometimes it only applies to the numeric results.

Once the full set of sweeps has been taken, the analyzer will go to idle state. To take one more sweep without resetting the average count, increment the average count by 1, by pressing the step up key while **Average/Hold Number** is the active function, or sending the remote command **CALC: AVER: TCON UP**.

Save

In the MSR mode, two types of save functions are available under the Data menu: Parameter Sets and Meas Results.

Key Path	Front Panel
Mode	MSR
Initial S/W Revision	Prior to A.10.00
Modified at S/W Revision	A.10.00

State

The Save State menu lets you choose a register or file for saving the state.

The content of a state file includes all of the settings and data required to return the analyzer as closely as possible to the Mode it was in, with the exact settings which were in place, when the save occurred. The Mode settings in each state file include the settings that are affected by Mode Preset, as well as the additional settings affected by Restore Mode Defaults; all of the Mode's settings. In addition, all of the settings of the **Input/Output** system are included, even though they are outside of the Mode's state, because they are needed to restore the complete setup. Persistent **System** settings (for example, Verbose SCPI) are not affected by either Mode Preset or Restore Mode Defaults, nor are they included in a saved State file.

After the save completes, the message "File <filename> saved" or "State Register <register number> saved" is displayed.

For rapid saving, the State menu lists 16 registers to save to. Pressing a Register key initiates the save. You can also select a file to save to.

The default path for all State Files is:

My Documents\<<mode name>\state

where <mode name> is the parameter used to select the mode with the INST:SEL command (for example, SA for the Spectrum Analyzer).

Key Path	Save
Mode	All
Remote Command	:MMEMory:STORe:STATe <filename>
Example	MMEM:STOR:STATe "MyStateFile.state" This stores the current instrument state data in the file MyStateFile.state in the default directory.
Notes	Both single and double quotes are supported for any filename parameter over remote. After saving to a register, that register's menu key is updated with the date the time, unless a custom label has been entered for that key. After saving to a register, you remain in the Save State menu, so that you can see the Register key update. After saving to a file, the analyzer automatically returns to the previous menu and any Save As dialog goes away.

Backwards Compatibility SCPI	:MMEMory:STORE:STATe 1,<filename> For backwards compatibility, the above syntax is supported. The "1" is simply ignored. The command is sequential.
Initial S/W Revision	Prior to A.02.00

To File . . .

When you press “To File”, the analyzer brings up a Windows dialog and a menu entitled “Save As.” This menu allows you to navigate to the various fields in the Windows dialog without using a keyboard or mouse. The **Tab** and **Arrow** keys can also be used for dialog navigation.

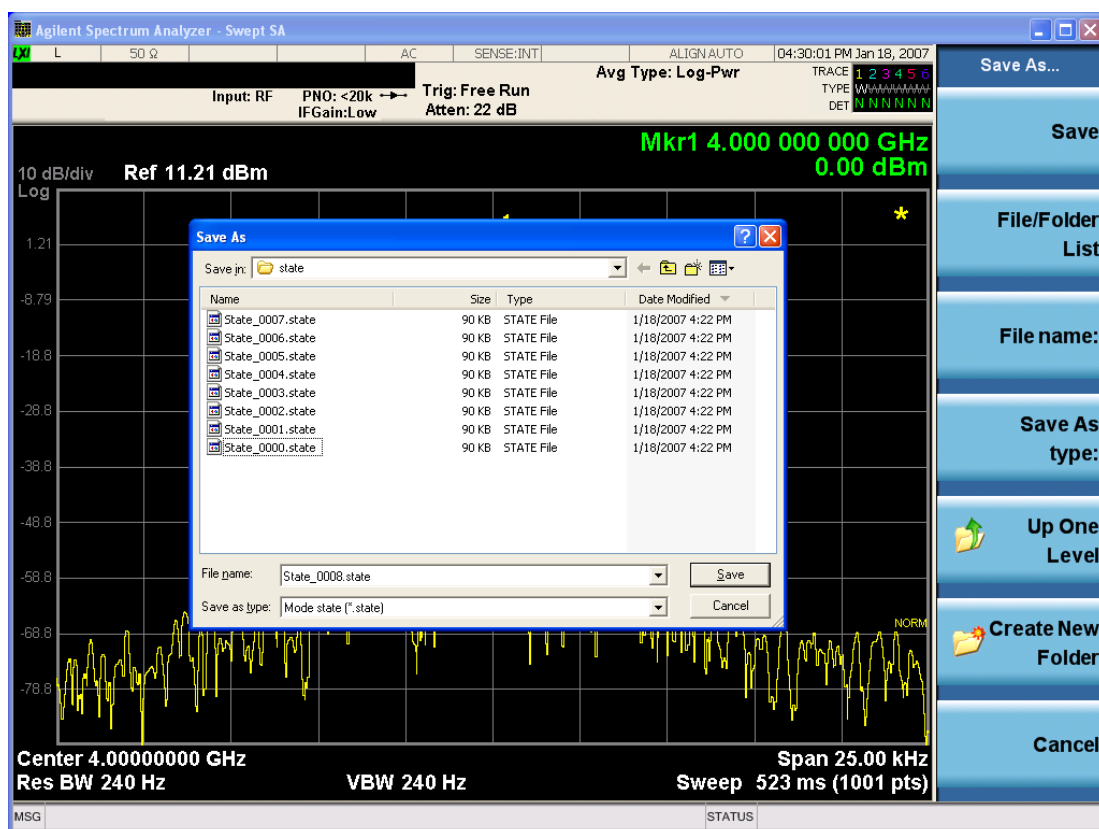

The Listed below

are the functions of the various fields in the dialog, and the corresponding softkeys:

Save

Performs the save to the specified file of the selected type. If the file already exists, a dialog will appear that allows you to replace the existing file by selecting **OK**, or you can Cancel the request. If you select OK, the file will be overwritten. Using the C: drive is strongly discouraged, since it runs the risk of being overwritten during an instrument software upgrade.

While the save is being performed, the floppy icon appears briefly in the Meas bar.

File/Folder List

Enables you to navigate to the center of the dialog that contains the list of files and folders. Once here you can get information about the file and use the tab keys to navigate to the other fields in the dialog, such as Save In.

Save In

The Save In field shows the path to which the file will be saved and allows you to change the path using the up and down arrow keys to navigate to other paths; the Enter key to open a directory; and the Backspace key to go back one directory. The **Save In field** defaults to the default path for this type of file and remembers the last path you used to save this type of file. There is no softkey for directly navigating to the Save In field but you can use left tab to get here from the File/Folder List.

User specified paths are remembered when you leave and return to a Mode and are reset back to the default using **Restore Mode Defaults**.

File Name

The **File Name** field is initially loaded with an automatically generated filename specific to the appropriate Save Type. The automatically generated filename is guaranteed not to conflict with any filename currently in the directory. You may replace or modify this filename using the File Name key. See the "[Quick Save](#)" on [page 2428](#) documentation for more on the automatic file naming algorithm.

When you press the **File Name** key the analyzer displays the Alpha Editor. Use the knob to choose the letter to add and the front-panel Enter key to add the letter to the file name. The BK character moves you back and the FW character moves you forward in the filename. The Select key on the front panel generates a space character. When you are done entering the filename press the **Done** softkey. This returns back to the **File Open** dialog and menu, but does not cause the save to occur.

Save As Type

This field shows the file suffix for the type of file you have selected to save. For example, if you navigated here while saving State, "Mode state (*.state)" is in the field. If you navigated here from saving Trace, ""Mode state (*.trace)" is in the field. If you navigated here while exporting a trace data file, "Trace Data (*.csv)" is in the field. For some file types, there is more than one choice in the dropdown, which you can select by using the up and down arrow keys and Enter.

Up One Level

This key corresponds to the icon of a folder with the up arrow that is in the tool bar of the dialog. When pressed, it causes the file and folder list to navigate up one level in the directory structure. The Backspace key does the same thing.

Create New Folder

This key corresponds to the icon of a folder with the "*" that is in the tool bar of the dialog. When pressed, a new folder is created in the current directory with the name **New Folder** and you can enter a new folder name using the Alpha Editor.

Cancel

This key corresponds to the **Cancel** selection in the dialog. It causes the current **Save As** request to be cancelled. The ESC key does the same thing.

Key Path	Save, State
----------	-------------

Mode	All
Notes	Brings up Save As dialog for saving a State Save Type
Initial S/W Revision	Prior to A.02.00

Edit Register Names

You may enter a custom name on any of the Register keys, to help you remember what you are using that state to save. To do this, press the **Edit Register Names** key, choose the register whose name you wish to edit, and then enter the desired label using the Alpha Editor or an external PC keyboard.

The maximum number of characters that can be added is 30. In most cases, 30 characters will fit on two lines of the key.

See ["More Information" on page 2204](#)

Key Path	Save, State
Mode	All
Remote Command	:MMEMory:REGister:STATe:LABel <reg number>,"label" :MMEMory:REGister:STATe:LABel? <reg number>
Example	:MMEM:REG:STAT:LAB 1,"my label"
Notes	<reg number> is an integer from 1 to 16. If the SCPI specifies an invalid register number an error message is generated, -222,"Data out of range;Invalid register label number" "label" is a string from 0 to 30 characters in length. If a label exceeds 30 characters, an error message is generated, -150,"String data error;Label clipped to 30 characters" "label" of length 0 erases the custom label and restores the default (time and date) label. E.g.: :MMEM:REG:STAT:LAB 1,""
Dependencies	N9060A-7FP or N9060B-2FP license required to edit the register names. When the feature is not licensed, sending this command generates an error, -221,"Settings conflict;Option not available"
Preset	The names are unaffected by Preset or power cycle but are set to the default label (time and date) on a "Restore System Defaults->Misc"
Initial S/W Revision	A.11.00

More Information

When you edit one of the register names, the time and date field will be replaced by the custom name.

If you delete all the characters in the custom name, it restores the default (time and date).

The register names are stored within the state files, but they are not part of the instrument state; that is, once you have edited a register name, loading a new state will not change that register name. Another consequence of this is that the names will be persistent through a power cycle. Also, if a named state file is transferred to another analyzer, it will bring its custom name along with it.

If you try to edit the name of an empty register, the analyzer will first save the state to have a file to put the name in. If you load a named state file into an analyzer with older firmware it will ignore the metadata.

The *SAV and *RCL commands will not be affected by the custom register names, nor will the MMEM commands.

Register 1 thru Register 16

Selecting any one of these register menu keys causes the State of the currently active mode to be saved to the specified Register. The registers are provided for rapid saving and recalling, since you do not need to specify a filename or navigate to a file. Each of the register menu keys annotates whether it is empty or at what date and time it was last modified. In addition, you can use the **Edit Register Names** key to enter custom names for each register.

Although these 16 registers are the only registers available from the front panel, there are 128 state registers available in the instrument. Registers 17–128 are only available from the SCPI interface, using the *SAV command.

There is one set of 128 state registers in the instrument, not one set for each Mode. When a state is saved, the Mode it was saved from is saved with it; then when it is recalled, the instrument switches to that Mode.

After the save completes, the corresponding register menu key annotation is updated with the date and time and the message "Register <register number> saved" is displayed.

Key Path	Save, State
Mode	All
Example	*SAV 1
Range	1–16 from front panel, 1–128 from SCPI
Readback	Date and time with seconds resolution are displayed on the key OR A custom name of up to 30 characters entered using the Edit Register Names key OR “(empty)” if no prior save operation has been performed to this register.
Initial S/W Revision	Prior to A.02.00
Modified at S/W Revision	A.11.00

Register 1 thru Register 16

Selecting any one of these register menu keys causes the State of the currently active mode to be saved to the specified Register. The registers are provided for rapid saving and recalling, since you do not need to specify a filename or navigate to a file. Each of the register menu keys annotates whether it is empty or at what date and time it was last modified. In addition, you can use the **Edit Register Names** key to enter custom names for each register.

Although these 16 registers are the only registers available from the front panel, there are 128 state registers available in the instrument. Registers 17–128 are only available from the SCPI interface, using the *SAV command.

There is one set of 128 state registers in the instrument, not one set for each Mode. When a state is saved, the Mode it was saved from is saved with it; then when it is recalled, the instrument switches to that Mode.

After the save completes, the corresponding register menu key annotation is updated with the date and time and the message "Register <register number> saved" is displayed.

Key Path	Save, State
Mode	All
Example	*SAV 1
Range	1-16 from front panel, 1-128 from SCPI
Readback	Date and time with seconds resolution are displayed on the key OR A custom name of up to 30 characters entered using the Edit Register Names key OR “(empty)” if no prior save operation has been performed to this register.
Initial S/W Revision	Prior to A.02.00
Modified at S/W Revision	A.11.00

Mass Storage Catalog (Remote Command Only)

Key path	SCPI Only
Remote Command	:MMEMory:CATalog? [<directory_name>]
Notes	The string must be a valid logical path. Queries disk usage information (drive capacity, free space available) and obtains a list of files and directories in a specified directory in the following format: <numeric_value>,<numeric_value>,{<file_entry>} It returns two numeric parameters and as many strings as there are files and directories. The first parameter indicates the total amount of storage currently used in bytes. The second parameter indicates the total amount of storage available, also in bytes. The <file_entry> is a string. Each <file_entry> indicates the name, type, and size of one file in the directory list: <file_name>,<file_type>,<file_size> As the windows file system has an extension that indicates file type, <file_type> is always empty. <file_size> provides the size of the file in bytes. For directories, <file_entry> is surrounded by square brackets and both <file_type> and <file_size> are empty
Initial S/W Revision	Prior to A.02.00

Mass Storage Change Directory (Remote Command Only)

Key path	SCPI Only
Remote Command	:MMEMory:CDIRectory [<directory_name>] :MMEMory:CDIRectory?
Notes	The string must be a valid logical path. Changes the default directory for a mass memory file system. The <directory_name> parameter is a string. If no parameter is specified, the directory is set to the *RST value.

	At *RST, this value is set to the default user data storage area, that is defined as System.Environment.SpecialFolder.Personal. Query returns full path of the default directory.
Initial S/W Revision	Prior to A.02.00

Mass Storage Copy (Remote Command Only)

Key path	SCPI Only
Remote Command	:MMEMory:COpy <string>,<string>[,<string>,<string>]
Notes	<p>The string must be a valid logical path.</p> <p>Copies an existing file to a new file or an existing directory to a new directory.</p> <p>Two forms of parameters are allowed. The first form has two parameters. In this form, the first parameter specifies the source, and the second parameter specifies the destination.</p> <p>The second form has four parameters. In this form, the first and third parameters specify the source. The second and fourth parameters specify the directories. The first pair of parameters specifies the source. The second pair specifies the destination. An error is generated if the source doesn't exist or the destination file already exists.</p> <p>This command will generate an "access denied" error if the destination is a restricted folder (e.g., C:\Windows) and the current user does not have Power User or Administrator privileges.</p>

Mass Storage Device Copy (Remote Command Only)

This command transfers data to/from a file and a peripheral device.

Key path	SCPI Only
Remote Command	:MMEMory:COpy:DEvice <source_string>,<dest_string>
Notes	<p>The strings must be a valid logical path or a valid device keyword. If the dest_string is a device keyword, the data is copied from the source file to the device. If the source_string is a device keyword, the data is copied to the source file from the device.</p> <p>Valid device keywords are:</p> <p>SNS (smart noise source)</p> <p>An error is generated if the file or device is not found.</p>

Mass Storage Delete (Remote Command Only)

Key path	SCPI Only
Remote Command	:MMEMory:DElete <file_name>[,<directory_name>]
Notes	<p>The string must be a valid logical path.</p> <p>Removes a file from the specified directory. The <file_name> parameter specifies the file name to be removed. This command will generate an "access denied" error if the file is in a restricted folder (e.g.,</p>

	C:\Windows) and the current user does not have Power User or Administrator privileges.
Initial S/W Revision	Prior to A.02.00

Mass Storage Data (Remote Command Only)

Creates a file containing the specified data OR queries the data from an existing file.

Key path	SCPI Only
Remote Command	:MMEMory:DATA <file_name>, <data> :MMEMory:DATA? <file_name>
Notes	The string must be a valid logical path. The command form is MMEMory:DATA <file_name>,<data>. It loads <data> into the file <file_name>. <data> is in 488.2 block format. <file_name> is string data. The query form is MMEMory:DATA? <file_name> with the response being the associated <data> in block format.
Initial S/W Revision	Prior to A.02.00

Mass Storage Make Directory (Remote Command Only)

Key path	SCPI Only
Remote Command	:MMEMory:MDIRectory <directory_name>
Notes	The string must be a valid logical path. Creates a new directory. The <directory_name> parameter specifies the name to be created. This command will generate an “access denied” error if the new directory would be in a restricted folder (e.g., C:\Windows) and the current user does not have Power User or Administrator privileges.
Initial S/W Revision	Prior to A.02.00

Mass Storage Move (Remote Command Only)

Key path	SCPI Only
Remote Command	:MMEMory:MOVE <string>,<string>[,<string>,<string>]
Notes	The string must be a valid logical path. Moves an existing file to a new file or an existing directory to a new directory. Two forms of parameters are allowed. The first form has two parameters. In this form, the first parameter specifies the source, and the second parameter specifies the destination. The second form has four parameters. In this form, the first and third parameters specify the source. The second and fourth parameters specify the directories. The first pair of parameters specifies the source. The second pair specifies the destination. An error is generated if the source doesn't exist or the destination file already exists.

This command will generate an “access denied” error if the destination is a restricted folder (e.g., C:\Windows) and the current user does not have Power User or Administrator privileges.

Initial S/W Revision Prior to A.02.00

Mass Storage Remove Directory (Remote Command Only)

Key path **SCPI Only**

Remote Command :MMEMory:RDIrectory <directory_name>

Notes The string must be a valid logical path.

Removes a directory. The <directory_name> parameter specifies the directory name to be removed. All files and directories under the specified directory shall also be removed.

This command will generate an “access denied” error if the folder is a restricted folder (e.g., C:\Windows) or is in a restricted folder and the current user does not have Power User or Administrator privileges.

Initial S/W Revision Prior to A.02.00

Mass Storage Determine Removable Media (Remote Command Only)

This command is used to determine if any removable media devices are connected to the instrument. Primarily, these are USB memory devices plugged-in to the front panel or rear panel USB ports. On instruments with PC6 or PC7 CPU's, one SD card slot is available for removable media. The instrument's primary disk drive is not a removable media device.

Key Path **SCPI Only**

Remote Command :MMEMory:RMEDia:LIST?

Notes The return value will be a string containing a list of partition identifiers which are removable media devices. Each identifier will be separated by a comma. If no removable media is present, an empty string will be returned.

Examples:

One removable device present will result in a return string of “F:”.

Two removable devices present will result in a return string of “F:,G:”.

No removable devices present will result in a return string of “”.

Initial S/W Revision x.15.00

Mass Storage Determine Removable Media Label (Remote Command Only)

This command is used to set or query a removable media device's label.

Key Path **SCPI Only**

Remote Command	:MMEMory:RMEDia:LABel <partition>,<string> :MMEMory:RMEDia:LABel? <partition>
Example	MMEM:RMED:LAB "F:","My Device"
Notes	If the <partition> specified does not exist or is not a removable media device the error -252,"Missing Media" will be generated. Setting the removable media label requires Administrative privileges. If the currently logged in user does not have appropriate privileges the error "-221.9900,Settings conflict;Administrator privileges required" is generated.
Initial S/W Revision	x.15.00

Mass Storage Determine Removable Media Write-protect status (Remote Command Only)

This command is used to query a removable media device's write-protect status.

Key Path	SCPI Only
Remote Command	:MMEMory:RMEDia:WPRotect? <partition>
Example	MMEM:RMED:WPR? "F:"
Notes	The return value is 1 if the device is write-protected, and 0 if the device is write-enabled. If the <partition> specified does not exist or is not a removable media device the error -252,"Missing Media" will be generated.
Preset	The return value will be depending on SD card installed.
Initial S/W Revision	x.15.00

Mass Storage Determine Removable Media size (Remote Command Only)

This command is used to query a removable media device's total memory size (not available memory size).

Key Path	SCPI Only
Remote Command	:MMEMory:RMEDia:SIZE? <partition>
Example	MMEM:RMED:SIZE? "F:"
Notes	The return value is integer value in GBytes. Any device which is less than 1 GB will return 0 GB. If the <partition> specified does not exist or is not a removable media device the error -252,"Missing Media" will be generated.
Initial S/W Revision	x.15.00

Trace (+State)

The **Save Trace (+State)** menu lets you choose a register or file specifying where to save the Trace+State state file.

A saved state contains all of the settings and data required to return the analyzer as closely as possible to the exact setup it had when the save occurred. This includes the Input/Output settings, even though they are outside of the Mode's state, because they are needed to restore the complete setup. A Trace+State file also includes trace data from one trace or all traces, which will load in View mode when the Trace+State file is recalled.

After the save completes, the message "File <filename> saved" or "Trace Register <register number> saved" is displayed.

For rapid saves, the Trace (+State) menu lists 5 registers to save to. Pressing a Register key initiates the save. You can also select a file to save to.

The default path for all State Files including .trace files is:

My Documents\<mode name>\state

where <mode name> is the parameter used to select the mode with the INST:SEL command (for example, Basic for the IQAnalyzer).

This key is grayed out for measurements that do not support trace saves. It is blanked for modes that do not support trace saves. Saving **Trace** is identical to saving State except a .trace extension is used on the file instead of .state, and internal flags are set in the file indicating which trace was saved. You may select to save one trace or ALL traces.

Key Path	Save
Mode	SA
Remote Command	:MMEMory:STORe:TRACe TRACE1 TRACE2 TRACE3 TRACE4 TRACE5 TRACE6 ALL,<filename> :MMEMory:STORe:TRACe:REGister TRACE1 TRACE2 TRACE3 TRACE4 TRACE5 TRACE6 ALL,<integer>
Example	:MMEM:STOR:TRAC TRACE1, "myState.trace" saves the file myState.trace on the default path and flags it as a "single trace" file with Trace 1 as the single trace (even though all of the traces are in fact stored). :MMEM:STOR:TRAC ALL, "myState.trace" saves the file myState.trace on the default path and flags it as an "all traces" file :MMEM:STOR:TRAC:REG TRACE1, 2 stores trace 1 data in trace register 2
Notes	This command actually performs a save state, which in the Swept SA measurement includes the trace data. However it flags it (in the file) as a "save trace" file of the specified trace (or all traces). Some modes and measurements do not have available all 6 traces. The Phase Noise mode command, for example, is: MMEMory:STORe:TRACe TRACE1 TRACE2 TRACE3 ALL,<filename> Some modes and measurements have more than 6 traces available. The Realtime SA mode command, for example, is: MMEMory:STORe:TRACe TRACE1 TRACE2 TRACE3 TRACE4 TRACE5 TRACE6 TRACE7 TRACE8 TRACE9 TRACE10 TRACE11 TRACE12 ALL,<filename> The range for the register parameter is 1-5 When you initiate a save, if the file already exists, a dialog will appear that allows you to replace the existing file by selecting OK or you can Cancel the request. If you select OK, the file will be overwritten. Using the C: drive is strongly discouraged, since it runs the risk of being overwritten during an instrument software upgrade. Both single and double quotes are supported for any filename parameter over remote.

After saving to a register, that register's menu key is updated with the date and time of the save.
After saving to a register, you remain in the **Save Trace** menu, so that you can see the Register key update. After saving to a file, the analyzer automatically returns to the previous menu and any Save As dialog goes away.

Initial S/W Revision	Prior to A.02.00
----------------------	------------------

From Trace

Accesses a menu that enables you to select the trace to be saved. Once a trace is selected, the key returns to the Save Trace menu and the selected trace number is annotated on the key. The default is the currently selected trace, selected in this menu or in the Trace/Det, Export Data, Import Data or Recall Trace menus, except if you have chosen All then it remains chosen until you specifically change it to a single trace. To save the Trace you must select the **Save As** key in the Save Trace menu.

When you select a trace, it makes that trace the current trace, so it displays on top of all of the other traces.

Key Path	Save, Trace + State
Mode	SA
Initial S/W Revision	Prior to A.02.00

From File...

When you press "From File", the analyzer brings up a Windows dialog and a menu entitled "**File Open.**" This menu allows you to navigate to the various fields in the Windows dialog without using a keyboard or mouse. The **Tab** and **Arrow** keys can also be used for dialog navigation.

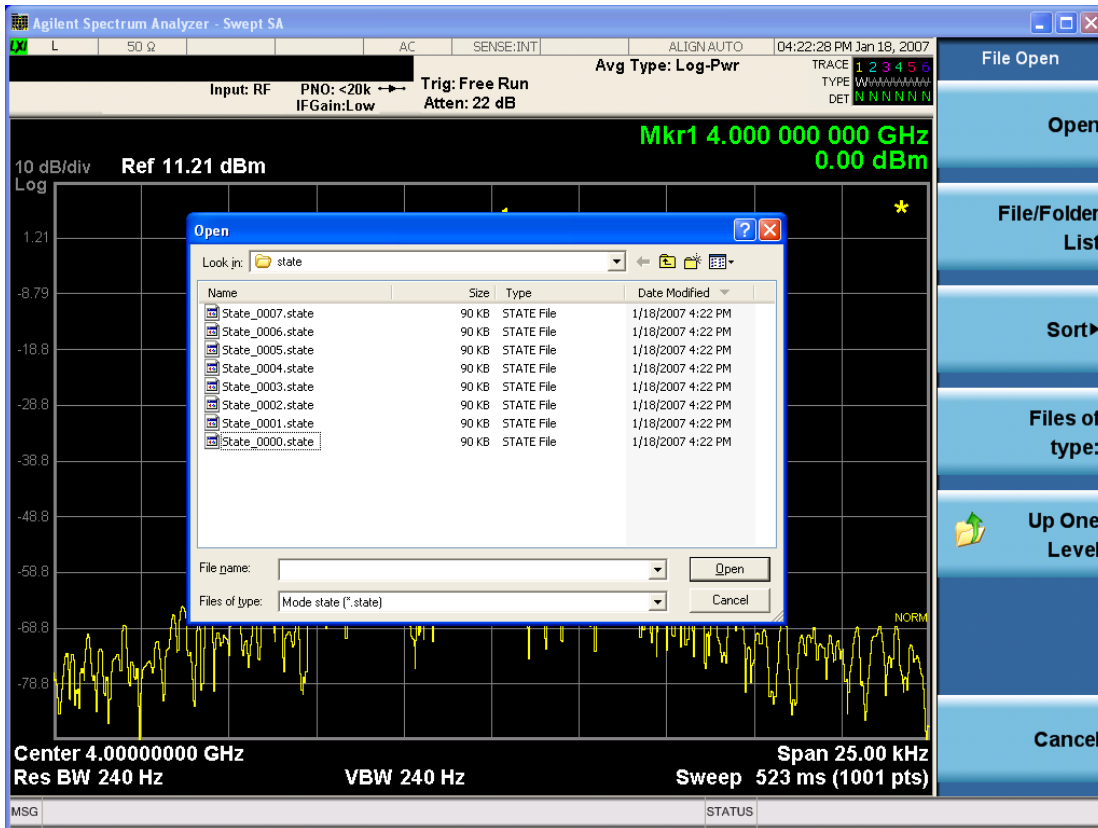

Listed below are the functions of the various fields in the dialog, and the corresponding softkeys:

Open

Performs the recall of the specified file. While the recall is being performed, the floppy icon appears briefly in the Meas bar.

File/Folder List

Enables you to navigate to the center of the dialog that contains the list of files and folders. Once here you can get information about the file and use the tab keys to navigate to the other fields in the dialog, such as Look In.

Look In

The **Look In** field shows the path from which the file will be recalled and allows you to change the path using the up and down arrow keys to navigate to other paths; the Enter key to open a directory; and the Backspace key to go back one directory. The **Look In field** first uses the last path from the Save As dialog **Save In:** path for that same file type. There is no softkey for directly navigating to the Look In field, but you can use the left tab to get here from the File/Folder List.

User specified paths are remembered when you leave and return to a Mode and are reset back to the default using **Restore Mode Defaults**.

Sort

Accesses a menu that enables you to sort the files within the File Open dialog. Only one sorting type can be selected at a time and the sorting happens immediately. The sorting types are **By Date**, **By Name**, **By extension**, and **By Size**.

Files of Type

This field shows the file suffix for the type of file you have selected to recall. For example, if you navigated here while recalling State, "Mode state (*.state)" is in the field. If you navigated here while recalling Trace, ""Mode state (*.trace)" is in the field. If you navigated here while importing a trace data file, "Trace Data (*.csv)" is in the field. For some file types, there is more than one choice in the dropdown menu, which you can select by using the up and down arrow keys and Enter.

Up One Level

This key corresponds to the icon of a folder with the up arrow that is in the tool bar of the dialog. When pressed, it causes the file and folder list to navigate up one level in the directory structure. The Backspace key does the same thing.

Cancel

This key corresponds to the **Cancel** selection in the dialog. It causes the current **Open** request to be cancelled. The ESC key does the same thing.

Key Path	Recall, State
Notes	Brings up the Open dialog for recalling a State Save Type
Initial S/W Revision	Prior to A.02.00

Register 1 thru Register 16

Selecting any one of these register menu keys causes the State of the currently active mode to be saved to the specified Register. The registers are provided for rapid saving and recalling, since you do not need to specify a filename or navigate to a file. Each of the register menu keys annotates whether it is empty or at what date and time it was last modified. In addition, you can use the **Edit Register Names** key to enter custom names for each register.

Although these 16 registers are the only registers available from the front panel, there are 128 state registers available in the instrument. Registers 17–128 are only available from the SCPI interface, using the *SAV command.

There is one set of 128 state registers in the instrument, not one set for each Mode. When a state is saved, the Mode it was saved from is saved with it; then when it is recalled, the instrument switches to that Mode.

After the save completes, the corresponding register menu key annotation is updated with the date and time and the message "Register <register number> saved" is displayed.

Key Path	Save, State
Mode	All
Example	*SAV 1
Range	1–16 from front panel, 1–128 from SCPI

Readback	Date and time with seconds resolution are displayed on the key OR A custom name of up to 30 characters entered using the Edit Register Names key OR “(empty)” if no prior save operation has been performed to this register.
Initial S/W Revision	Prior to A.02.00
Modified at S/W Revision	A.11.00

Data (Export)

Exporting a data file stores data from the current measurement to mass storage files. The Export Menu only contains data types that are supported by the current measurement.

Since the commonly exported data files are in .csv format, the data can be edited by you prior to importing. This allows you to export a data file, manipulate the data in Excel (the most common PC Application for manipulating .csv files) and then import it.

Selecting an Export Data menu key will not actually cause the exporting to occur, since the analyzer still needs to know where you wish to save the data. Pressing the Save As key in this menu brings up the Save As dialog and Save As menu that allows you to specify the destination file and directory. Once a filename has been selected or entered in the Open menu, the export will occur as soon as the Save key is pressed.

Key Path	Save
Mode	All
Notes	The menu is built from whatever data types are available for the mode. So the key locations in the sub menu will vary. No SCPI command directly controls the Data Type that this key controls. The Data Type is included in the MMEM:STORe commands.
Dependencies	If a file type is not used by a certain measurement, that type is grayed out for that measurement. The key for a file type will not show at all if there are no measurements in the Mode that support it.
Preset	Is not affected by a Preset or shutdown, but is reset during Restore Mode Defaults
Readback	The data type that is currently selected
Initial S/W Revision	Prior to A.02.00

Parameter Set

Enables you to export format parameter set data to files. Selecting this key displays a menu that enables you to select the data source. After making this selection, depress Save As... and use the file dialog to enter the file name to save. You can import the exported file by selecting Parameter Set under Recall, Data.

Default path:

Default path of this import type is “My Documents\MSR\data\params” folder. Note that “My Documents” is an alias to a directory and its location depends on which user is logged in. If the file path is specified without root folder, the export file is determined with the default path. For example if “folder1\paramData.prms” is specified, “My Documents\MSR\data\params\folder1\paramData.fps” is exported.

File Extension: fps

Default Prefix: ParamSet_

File Dialog Filter: Format Parameter Set Files (*.fps)

Key Path	Save, Data
Mode	MSR
Remote Command	MMEMory:STORE:PSET LTEFdd1 LTEFdd2 LTEFdd3 WCDMa1 WCDMa2 WCDMa3 GSM1 GSM2 GSM3 CDMA1 CDMA2 CDMA3 EVDO1 EVDO2 EVDO3 LTETdd1 LTETdd2 LTETdd3 TDSCdma1 TDSCdma2 TDSCdma3,<string>
Example	MMEM:STOR:PSET WCDM1,"WCDMA.fps"
Notes	The first enum selects the source format parameter set from which the file data are exported.
Initial S/W Revision	A.10.00
Modified at S/W Revision	A.12.00, A.16.00

Meas Results

Different types of results are available for each particular measurement. The results that are available are documented under the individual measurements. These measurement results are the same as the results that are returned when using the MEASure:<measurement> command (usually for sub-opcode 1).

Measurement results may not be available for all measurements.

Key Path	Save, Data
Mode	MSR
Example	MMEM:STOR:RES "MyResultsFile.xml" This stores the measurement results data in the file MyResultsFile.xml in the default directory.
Notes	The key will not show if the measurements in the Mode do not support it.
Initial S/W Revision	A.10.00

Save As . . .

When you press “Save As”, the analyzer brings up a Windows dialog and a menu entitled “Save As.” This menu allows you to navigate to the various fields in the Windows dialog without using a keyboard or mouse. The **Tab** and **Arrow** keys can also be used for dialog navigation.

See "To File . . ." on page 2444 in **Save, State** for a full description of this dialog and menu.

The default path for saving files is:

For all of the Trace Data Files:

My Documents\<>mode name>\data\traces

For all of the Limit Data Files:

My Documents\<>mode name>\data\limits

For all of the Measurement Results Data Files:

My Documents\<>mode name>\data\<>measurement name>\results

For all of the Capture Buffer Data Files:

My Documents\<>mode name>\data\captureBuffer

Key Path	Save, Data
Mode	All
Notes	The key location is mode-dependent and will vary. Brings up the Save As dialog for saving a <mode specific> Save Type. The save is performed immediately and does not wait until the measurement is complete.
Initial S/W Revision	Prior to A.02.00

Screen Image

Pressing Screen Image accesses a menu of functions that enable you to specify a format and location for the saved screen image. It brings up a menu that allows you to specify the color scheme of the Screen Image (Themes) or navigate to the Save As dialog to perform the actual save.

Screen Image files contain an exact representation of the analyzer display. They cannot be loaded back onto the analyzer, but they can be loaded into your PC for use in many popular applications.

The image to be saved is actually captured when the **Save** front panel key is pressed, and kept in temporary storage to be used if you ask for a Screen Image save. When the Screen Image key is pressed, a "thumbnail" of the captured image is displayed, as shown below:

15 Monitor Spectrum Measurement

Save

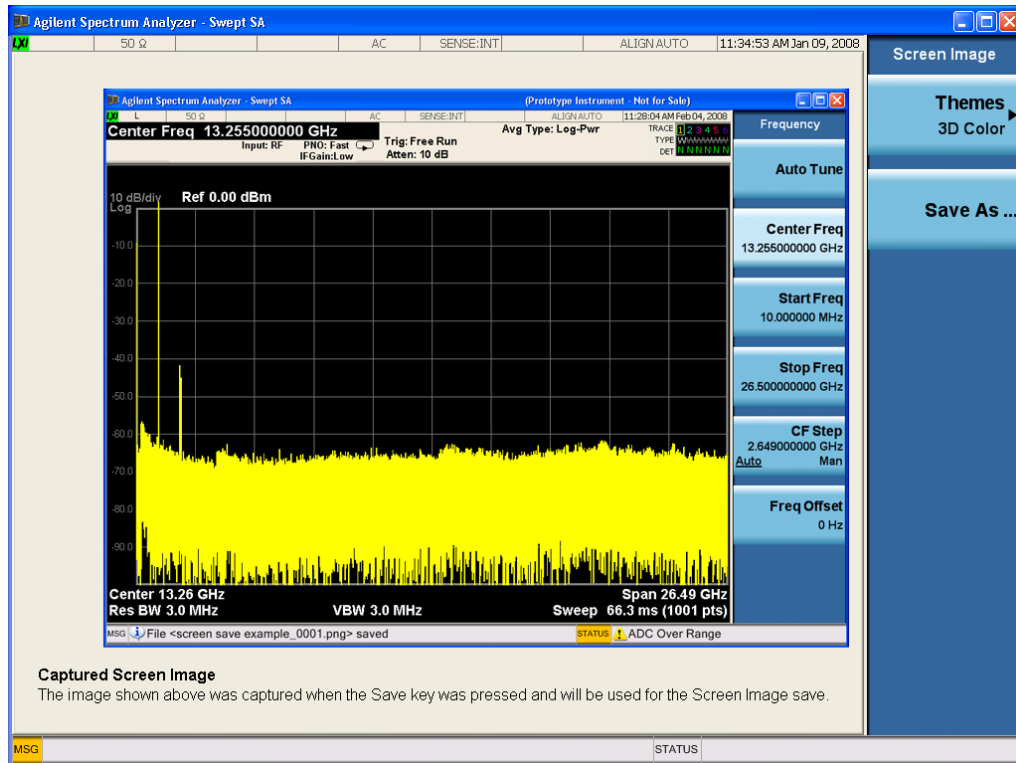

When you continue on into the **Save As** menu and complete the Screen Image save, the image depicted in the thumbnail is the one that gets saved, showing the menus that were on the screen before going into the **Save** menus. The save is performed immediately and does not wait until the measurement is complete.

After you have completed the save, the **Quick Save** front-panel key lets you quickly repeat the last save performed, using an auto-named file, with the current screen data.

NOTE

For versions previous to A.01.55, if you initiate a screen image save by navigating through the Save menus, the image that is saved will contain the Save menu softkeys, not the menus and the active function that were on the screen when you first pressed the Save front panel key.

Key Path	Save
Mode	All
Remote Command	:MMEMory:STORe:SCReem <filename>
Example	:MMEM:STOR:SCR "myScreen.png" This stores the current screen image in the file MyScreenFile.png in the default directory.
Initial S/W Revision	Prior to A.02.00

Themes

Accesses a menu of functions that enable you to choose the theme to be used when saving the screen image.

The **Themes** option is the same as the **Themes** option under the **Display** and **Page Setup** dialogs. It allows you to choose between themes to be used when saving the screen image.

Key Path	Save, Screen Image
Remote Command	:MMEMory:STORe:SCReen:THEMe TDColor TDMonochrome FCOLOR FMONochrome :MMEMory:STORe:SCReen:THEMe?
Example	:MMEM:STOR:SCR:THEM TDM
Preset	3D Color; Is not part of Preset, but is reset by Restore Misc Defaults or Restore System Defaults All and survives subsequent running of the modes.
Readback	3D Color 3D Mono Flat Color Flat Mono
Backwards Compatibility Notes	In ESA and PSA we offer the choice of "Reverse Bitmap" or "Reverse Metafile" when saving screen images. This is much like the "Flat Color" theme available in X-Series. Also, if you selected Reverse Bitmap AND a black & white screen image, that would be much like "Flat Monochrome". In other words, each of the X-Series themes has a similar screen image type in ESA/PSA. But they are not identical.
Initial S/W Revision	Prior to A.02.00

3D Color

Selects a standard color theme with each object filled, shaded and colored as designed.

Key Path	Save, Screen Image, Themes
Example	MMEM:STOR:SCR:THEM TDC
Readback	3D Color
Initial S/W Revision	Prior to A.02.00

3D Monochrome

Selects a format that is like 3D color but shades of gray are used instead of colors.

Key Path	Save, Screen Image, Themes
Example	MMEM:STOR:SCR:THEM TDM
Readback	3D Mono
Initial S/W Revision	Prior to A.02.00

Flat Color

Selects a format that is best when the screen is to be printed on an ink printer.

Key Path	Save, Screen Image, Themes
-----------------	-----------------------------------

Example	MMEM:STOR:SCR:THEM FCOL
Readback	Flat Color
Initial S/W Revision	Prior to A.02.00

Flat Monochrome

Selects a format that is like Flat Color. But only black is used (no colors, not even gray), and no fill.

Key Path	Save, Screen Image, Themes
Example	MMEM:STOR:SCR:THEM FMON
Readback	Flat Mono
Initial S/W Revision	Prior to A.02.00

Save As...

When you press "Save As", the analyzer brings up a Windows dialog and a menu entitled "**Save As.**" This menu allows you to navigate to the various fields in the Windows dialog without using a keyboard or mouse. The **Tab** and **Arrow** keys can also be used for dialog navigation.

See "[To File . . .](#)" on page 2444 in **Save, State** for a full description of this dialog and menu.

The default path for Screen Images is

My Documents\`<mode name>`\screen.

where `<mode name>` is the parameter used to select the mode with the INST:SEL command (for example, SA for the Spectrum Analyzer).

Key Path	Save, Screen Image
Notes	Brings up Save As dialog for saving a Screen Image Save Type
Initial S/W Revision	Prior to A.02.00

Single (Single Measurement/Sweep)

Sets the analyzer for Single measurement operation. The single/continuous state is Meas Global, so the setting will affect all the measurements. If you are Paused, pressing **Single** does a Resume.

See "[More Information](#)" on page 2221

Key Path	Front-panel key
Example	:INIT:CONT OFF
Notes	See Cont key description.
Backwards Compatibility Notes	<p>For Spectrum Analysis mode in ESA and PSA, the Single hardkey and the INITiate:IMM switched from continuous measurement to single measurement and restarted sweeps and averages (displayed average count reset to 1), but did not restart Max Hold and Min Hold. In the X-Series, the Single hardkey and the INITiate:IMM command initiate a sweep/ measurement/ average sequence/hold sequence including MaxHold and MinHold.</p> <p>For Spectrum Analysis mode in ESA and PSA, the Single hardkey restarted the sweep regardless of whether or not you were in an active sweep or sweep sequence. In the X-Series, Restart does this but Single only restarts the sweep or sweep sequence if you are in the idle state.</p> <p>INIT[:IMM] in ESA & PSA Spectrum Analysis Mode does an implied ABORt. In some other PSA Modes, INIT[:IMM] is ignored if not in the idle state. . The X-Series follows the ESA/PSA SA Mode model, which may cause some Modes to have compatibility problems.</p>
Initial S/W Revision	Prior to A.02.00

More Information

See "[Restart](#)" on page 2441 for details on the INIT:IMMediate (Restart) function.

If you are already in single sweep, the INIT:CONT OFF command has no effect.

If you are already in Single Sweep, then pressing the **Single** key in the middle of a sweep does not restart the sweep or sequence. Similarly, pressing the **Single** key does not restart the sweep or sequence if the sweep is not in the idle state (for example, if you are taking a very slow sweep, or the analyzer is waiting for a trigger). Instead, it results in a message. "Already in Single, press Restart to initiate a new sweep or sequence". Even though pressing the **Single** key in the middle of a sweep does not restart the sweep, sending INIT:IMMediate does reset it.

To take one more sweep without resetting the average count, increment the average count by 1, by pressing the step up key while **Average/Hold Number** is the active function, or sending the remote command CALC:AVER:TCON UP.

Source

There is no Source control functionality for this measurement. When this key is pressed, the screen either displays a blank menu, or the previously-selected menu remains unchanged.

Key Path	Front-panel key
----------	-----------------

Span X Scale

Accesses a menu of functions that enable you to set the horizontal scale parameters.

Key Path	Front-panel key
Initial S/W Revision	Prior to A.02.00

Span

Changes the frequency range symmetrically about the center frequency.

For details of WiDEN preset values, see ["IDEN Mode Span Preset for Monitor Spectrum" on page 2224](#).

Key Path	Span X Scale
Mode	All except SA, BASIC
Remote Command	[:SENSe] :MONitor:FREQuency:SPAN <freq> [:SENSe] :MONitor:FREQuency:SPAN?
Example	MON:FREQ:SPAN 1 MHz MON:FREQ:SPAN?
Couplings	Changing the span causes the resolution bandwidth to change automatically, and affects data acquisition time.
Preset	WCDMA: 10.0 MHz WIMAX OFDMA: 50.0 MHz C2K: 2.5MHz PN: 1.0 MHz GSM/EDGE: 1.0 MHz TD-SCDMA: 3.2 MHz 1xEVDO: 2.0MHz DVB-T/H: 10.0MHz DTMB (CTTB): 10.0MHz ISDB-T: 10.0MHz CMMB: 10.0MHz LTE, LTETDD: 20 MHz IDEN: See the table below Digital Cable TV: 10.0MHz WLAN: If Radio Std is 802.11a/b/g 802.11n(20MHz) 802.11ac(20MHz): 25 MHz If Radio Std is 802.11n(40MHz), 802.11ac (40MHz): 50 MHz If Radio Std is 802.11ac(80MHz): 100MHz If Radio Std is 802.11ac(160MHz): 200MHz MSR: 20.0 MHz

	LTEAFDD, LTEATDD: 20.0MHz
State Saved	Saved in instrument state.
Min	10 Hz
Max	Hardware Dependent: Option 503 = 3.7 GHz Option 507 = 7.1GHz Option 508 = 8.5 GHz Option 513 = 13.8 GHz Option 526 = 27.0 GHz
Initial S/W Revision	Prior to A.02.00
Modified at S/W Revision	A.02.00
Modified at S/W Revision	A.03.00

IDEN Mode Span Preset for Monitor Spectrum

IDEN Slot Format	WiDEN Slot Format 25kHz	WiDEN Slot Format 50kHz	WiDEN Slot Format 75kHz	WiDEN Slot Format 100kHz	WiDEN Slot Format 50kHz Out
60kHz	60kHz	85kHz	110kHz	135kHz	135kHz

Full Span

Changes the Span to show the full frequency range of the analyzer.

Key Path	Span X Scale
Mode	All except SA and BASIC
Remote Command	[:SENSe] :MONitor:FREQuency:SPAN:FULL
Example	MON:FREQ:SPAN:FULL
Couplings	Sets the span to the full frequency range, and adjusts the center frequency accordingly.
Initial S/W Revision	Prior to A.02.00

Last Span

Changes the measurement span to the span setting of the previous measurement. If there is no existing previous span value, then the span remains unchanged.

Key Path	Span X Scale
Mode	All except SA and BASIC

Remote Command	[:SENSE] :MONitor:FREQuency:SPAN:PREVious
Example	MON:FREQ:SPAN:PREV
Couplings	Selecting last span changes the measurement span value.
Initial S/W Revision	Prior to A.02.00

Adjust Span to Carrier Config (MSR and LTE-Advanced FDD/TDD mode only)

This immediate action key sets Span to cover all the configured carriers.

Key Path	Front-panel key
Mode	MSR, LTEAFTDD, LTEATDD
Remote Command	[:SENSE] :MONitor:FREQuency:SPAN:ADJust
Example	MON:SPAN:ADJ
Initial S/W Revision	A.11.00

Sweep/Control

Access a menu of functions that enable you to set up and control the sweep time for the current measurement

Key Path	Front-panel key
Initial S/W Revision	Prior to A.02.00

Sweep Time

Selects the length of time in which the spectrum analyzer sweeps the displayed frequency span. Additional overhead time is required by the analyzer. It impacts the sweep rate, but is not calculated as part of the sweep time. Reducing the sweep time increases the rate of sweeps.

Key Path	Sweep/Control
Mode	All except SA and BASIC
Remote Command	[:SENSe]:MONitor:SWEep:TIME <time> [:SENSe]:MONitor:SWEep:TIME? [:SENSe]:MONitor:SWEep:TIME:AUTO OFF ON 0 1 [:SENSe]:MONitor:SWEep:TIME:AUTO?
Example	MON:SWE:TIME 100 ms MON:SWE:TIME? MON:SWE:TIME:AUTO ON MON:SWE:TIME:AUTO?
Preset	Automatically Calculated
State Saved	Saved in instrument state.
Min	1 ms
Max	4000 s
Initial S/W Revision	Prior to A.02.00
MIN/MAX/DEF Support	Yes

Pause

Pauses a measurement after the current data acquisition is complete.

When Paused, the label on the key changes to **Resume**. Pressing **Resume** continues the measurement at the point where it had been paused.

See "[Pause/Resume](#)" on page 2468 under Sweep/Control for more information.

Key Path	Sweep/Control
Initial S/W Revision	Prior to A.02.00

Gate

Accesses a menu that enables you to control the gating function. The Gate functionality is used to view signals best viewed by qualifying them with other events.

Gate setup parameters are the same for all measurements – they do not change as you change measurements. Settings like these are called “Meas Global” and are unaffected by Meas Preset.

Note that Sweep Time autocoupling rules and annotation are changed by Gate being on.

Key Path	Sweep/Control
Scope	Meas Global
Readback	The state and method of Gate, as [Off, LO] or [On, Video]. Note that for measurements that only support gated LO, the method is nonetheless read back, but always as LO.
Initial S/W Revision	Prior to A.02.00

Gate On/Off

Turns the gate function on and off.

When the Gate Function is on, the selected Gate Method is used along with the gate settings and the signal at the gate source to control the sweep and video system with the gate signal. Not all measurements allow every type of Gate Methods.

When Gate is on, the annunciation in the measurement bar reflects that it is on and what method is used, as seen in the following "Gate: LO" annunciator graphic.

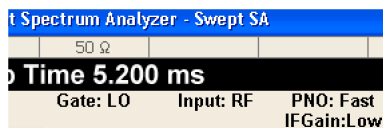

Key Path	Sweep/Control, Gate
Remote Command	[:SENSe] :SWEep:EGATe [:STATe] OFF ON 0 1 [:SENSe] :SWEep:EGATe [:STATe] ?
Example	SWE:EGAT ON SWE:EGAT?
Dependencies	The function is unavailable (grayed out) and Off when:

- Gate Method is LO or Video and FFT Sweep Type is manually selected.
- Gate Method is FFT and Swept Sweep Type is manually selected.
- Marker Count is ON.

The following are unavailable whenever Gate is on:

- FFT under Sweep Type when Method=LO or Video or Swept under Sweep Type when Method=FFT
- **Marker Count**

While Gate is on, the Auto Rules for Sweep Type are modified so that the choice agrees with the Gate Method: i.e., FFT for Method = FFT and Swept for Method = LO or Video.

The Gate softkey and all SCPI under the [:SENSe]:SWEep:EGATe SCPI node are grayed out when Source Mode is Tracking with an external source. This is because the Gate circuitry is used to sync the external source. If the Tracking Source is turned on, the Gate is turned off.

When in the ACP measurement:

- When Meas Method is RBW or FAST, this function is unavailable and the key is grayed out.
- Whenever Gate is on, Meas Method, RBW or FAST is unavailable and keys for those are grayed out.
- When Gate is on, Offset Res BW and Offset Video BW are ignored (if you set these values) and the measurement works as if all Offset Res BW and all Offset Video BW are coupled with the Res BW and the Video BW under the BW menu. When Gate is on, the Offset BW key in the Offset/Limit menu is grayed out.

Preset	Off LTETDD: On
State Saved	Saved in instrument state
Range	On Off
Backwards Compatibility SCPI	[:SENSe]:SWEep:TIME:GATE[:STATe] ESA compatibility
Backwards Compatibility Notes	In ESA, Trig Delay (On) and Gate (On) could not be active at the same time.. This dependency does not exist in PSA or in the X-Series.
Initial S/W Revision	Prior to A.02.00

Gate View On/Off

Turning on Gate View in the Swept SA measurement provides a single-window gate view display..

Turning on Gate View in other measurements shows the split-screen Gate View. In these measurements, when the Gate View is on, the regular view of the current measurement traces and results are reduced vertically to about 70% of the regular height. The Zero Span window, showing the positions of the Gate, is shown between the Measurement Bar and the reduced measurement window. By reducing the height of the measurement window, some of the annotation on the Data Display may not fit and is not shown.

Key Path	Sweep/Control, Gate
Remote Command	[:SENSe]:SWEep:EGATe:VIEW ON OFF 1 0 [:SENSe]:SWEep:EGATe:VIEW?

Example	SWE:EGAT:VIEW ON turns on the gate view.
Dependencies	<p>In the Swept SA measurement:</p> <p>In Gate View, the regular Sweep Time key is grayed out . When pressed, the grayed out key puts up the informational message "Use Gate View Sweep Time in the Gate menu."</p> <p>In the other measurements:</p> <p>When you turn Gate View on, the lower window takes on the current state of the instrument. Upon leaving Gate View, the instrument takes on the state of the lower window.</p> <p>When you turn Gate View on, the upper window Sweep Time is set to the gate view sweep time.</p>
Couplings	<p>These couplings apply to the Swept SA measurement:</p> <ul style="list-style-type: none"> • When Gate View is turned on, the instrument is set to Zero Span. • Gate View automatically turns off whenever a Span other than Zero is selected. • Gate View automatically turns off if you press the Last Span key while in Gate View, and the instrument returns to the Span it was in before entering Gate View (even if that is Zero Span). • When Gate View is turned on, the sweep time used is the gate view sweep time. This is set according to the rules in section "Gate View Setup" on page 2231 • When Gate View is turned off, Sweep Time is set to the normal Swept SA measurement sweep time. • If Gate View is on and Gate is off, then turning on Gate turns off Gate View.
Preset	OFF
State Saved	Saved in instrument state
Range	On Off
Initial S/W Revision	Prior to A.02.00

A sample of the Gate View screen in the Swept SA measurement is shown in the following graphic :

Turning Gate View off returns the analyzer to the Normal measurement view.

In the Swept SA, the normal measurement view is the single-window Swept SA view. When returning to this view, the Swept SA measurement returns to the Span it was in before entering **Gate View** (even if that is Zero Span).

The **Gate View** window is triggered from the Gate Source, with zero trigger delay. Also, when updating the **Gate View** window, the Gate itself must not operate. So it is internally shut off while the gate view window is being updated. For the Swept SA measurement, this means that the Gate is internally shut off whenever the gate view window is displayed. The measurement bar and softkeys continue to show the Trigger source for the main sweep window and give no indication that the Gate is shut off or that the Gate View window is triggered from the Gate Source.

When in **Gate View**, vertical lines are displayed in the Gate View window as follows:

- Green lines are displayed at the gate edges as follows: in Edge Gate, a line is shown for Delay and one for the end of the Gate period, defined by Length. In Level Gate a line is shown only for Delay. You can adjust the position of the green lines by adjusting the gate length and the gate delay. These lines update in the Gate View window as the active function changes, even if the window is not being updated. In Gated LO and Gated Video, these lines are positioned relative to the delay reference line (not relative to 0 time). In Gated FFT, their location is relative to the left edge of the screen.
- A blue line is displayed showing the delay reference, that is, the reference point for the Gate Delay within the Zero Span window. The blue line represents where (in time) the effective location of the gate start would be if the gate were programmed to zero delay.
-
- The second blue line is labeled "MIN FAST" as shown in the figure above because it represents the minimum Gate Delay for fast Gated LO operation. This line is only displayed in Gated LO. You cannot scroll (knob) or decrement (down key) the Gate Delay to less than that represented by the position of this line, it can only be set below this position manually, although once there it can be moved freely with the knob while below the line.
- A yellow line in the Gated Video case only, is displayed at Blength, where Blength is the display point (bucket) length for the swept trace, which is given by the sweep time for that trace divided by number of Points – 1. So it is referenced to 0 time, not to the delay reference. This line is labeled NEXT PT (it is not shown in the figure above because the figure above is for Gated LO).
- The yellow line represents the edge of a display point (bucket). Normally in Gated Video, the bucket length must be selected so that it exceeds the off time of the burst. There is another way to use the analyzer in Gated Video measurements, and that is to set the bucket width much shorter than the off time of the burst. Then use the Max Hold trace function to fill in "missing" buckets more slowly. This allows you to see some of the patterns of the Gated Video results earlier, though seeing a completely filled-in spectrum later.

Gate View Setup

Accesses a menu that enables you to setup parameters relevant to the Gate View

Key Path	Sweep/Control, Gate
Scope	Meas Global
Initial S/W Revision	A.10.00

Gate View Sweep Time

Controls the sweep time in the Gate View window. To provide an optimal view of the gate signal, the analyzer initializes Gate View Sweep Time based on the current settings of Gate Delay and Gate Length.

Key Path	Sweep/Control, Gate, Gate View Setup
Remote Command	[:SENSe] :SWEep:EGATe:TIME <time> [:SENSe] :SWEep:EGATe:TIME?
Example	SWE:EGAT:TIME 500 ms
Dependencies	Gate View Sweep Time is initialized: <ul style="list-style-type: none"> • On Preset (after initializing delay and length). • Every time the Gate Method is set/changed. <p>Additionally, in the Swept SA measurement, whenever you do a Preset, or leave Gate View, the analyzer remembers the Gate Delay and Gate Length settings. Then, when returning to Gate View, if the current Gate Delay and/or Gate Length do not match the remembered values Gate View Sweep Time is re-initialized.</p> <ol style="list-style-type: none"> 1. Compute the location of the "gate stop" line, which you know is at time $t = t_{min} + GateDelay + GateLength$.
Preset	519.3 μ s WiMAX OFDMA: 5 ms GSM/EDGE: 1 ms
State Saved	Saved in instrument state
Max	6000 s
Initial S/W Revision	Prior to A.02.00

Gate View Start Time

Controls the time at the left edge of the Gate View.

Key Path	Sweep/Control, Gate, Gate View Setup
Remote Command	[:SENSe] :SWEep:EGATe:VIEW:STARt <time> [:SENSe] :SWEep:EGATe:VIEW:STARt?
Example	SWE:EGAT:VIEW:STAR 10ms
Notes	Units of time are required or no units; otherwise an invalid suffix error message will be generated. See error -131.
Preset	0 ms
State Saved	Saved in instrument state
Min	0
Max	500 ms
Initial S/W Revision	A.10.00

Gate Delay

Controls the length of time from the time the gate condition goes True until the gate is turned on.

Key Path	Sweep/Control, Gate
Remote Command	[:SENSe] :SWEep:EGATe:DELay <time> [:SENSe] :SWEep:EGATe:DELay?
Example	SWE:EGAT:DELay 500ms SWE:EGAT:DELay?
Notes	Units of time are required or no units; otherwise an invalid suffix error message will be generated.
Preset	57.7 us WiMAX OFDMA: 71 us GSM/EDGE: 600 us WLAN: 500 us
State Saved	Saved in instrument state
Min	0.0 us
Max	100 s
Backwards Compatibility SCPI	[:SENSe] :SWEep:TIME:GATE:DELay ESA compatibility
Initial S/W Revision	Prior to A.02.00

Gate Length

Controls the length of time that the gate is on after it opens.

Key Path	Sweep/Control, Gate
Remote Command	[:SENSe] :SWEep:EGATe:LENGth <time> [:SENSe] :SWEep:EGATe:LENGth?
Example	SWE:EGAT:LENG 1 SWE:EGAT:LENG?
Notes	Units of time are required or no units; otherwise an invalid suffix error message will be generated.
Dependencies	<p>Grayed out when Gate Method is set to FFT in which case the label changes to that shown below.</p> <div style="border: 1px solid gray; padding: 5px; display: inline-block;"> <p>Gate Length (=1.83/RBW) 2.8 ms</p> </div> <p style="margin-left: 20px;">vsd 39-1</p> <p>The key is also grayed out if Gate Control = Level.</p>
Preset	461.6 us

	WiMAX OFDMA: 50 us GSM/EDGE: 200 us WLAN: 1.54 ms
State Saved	Saved in instrument state
Min	100 ns
Max	5 s
Backwards Compatibility SCPI	[:SENSe]:SWEep:TIME:GATE:LENGth ESA compatibility
Initial S/W Revision	Prior to A.02.00

Gate Source

The menus under the **Gate Source** key are the same as those under the **Trigger key**, with the exception that neither **Free Run** nor **Video** are available as Gate Source selections. However, a different SCPI command is used to select the Gate Source (see table below) because you may independently set the Gate Source and the Trigger Source.

Any changes to the settings in the setup menus under each Gate Source selection key (for example: Trigger Level, Trigger Delay, etc.) also affect the corresponding settings under the Trigger menu keys. The SCPI commands used for these are the same for Trigger and Gate, since there is only one setting which affects both Gate and Trigger. Example: to set the Trigger Level for External 1 you use the command :TRIG:EXT1:LEV regardless of whether you are using External 1 as a Trigger Source or a Gate Source.

Key Path	Sweep/Control, Gate
Remote Command	[:SENSe]:SWEep:EGATE:SOURce EXTernal1 EXTernal2 LINE FRAME RFBurst [:SENSe]:SWEep:EGATE:SOURce?
Dependencies	In some models, there is no second External input. In these models, the External 2 key is blanked and the EXTernal2 parameter will generate a "Hardware missing; Not available for this model number" error.
Preset	EXTernal 1 GSM/EDGE, MSR: FRAME LTETDD: EXTernal 1When Direction is Downlink, FRAME when Direction is Uplink.
Backwards Compatibility Notes	In ESA, there is a single Gate input port. In PSA, the Gate Source may be taken from one of two specified input ports. In the X-Series, any Trigger Source can be a Gate Source.
Initial S/W Revision	Prior to A.02.00
Modified at S/W Revision	A.03.00, A.14.00

Line

Pressing this key, when it is not selected, selects the line signal as the trigger. A new sweep/measurement will start synchronized with the next cycle of the line voltage. Pressing this key, when it is already selected, access the line trigger setup menu.

Key Path	Trigger
Example	TRIG:SOUR LINE Swept SA measurement TRIG:<meas>:SOUR LINE Measurements other than Swept SA
Dependencies	Line trigger is not available when operating from a "dc power source", for example, when the instrument is powered from batteries.
State Saved	Saved in instrument state
Status Bits/OPC dependencies	The Status Operation Register bit 5 "Waiting for Trigger" is set at the same time as the Sweeping or Measuring bit is set. It is cleared when the trigger actually occurs (that is, after the trigger event occurs and all the applicable trigger criteria have been met). A corresponding pop-up message ("Waiting for trigger") is generated if no trigger signal appears after approximately 2 sec. This message goes away when a trigger signal appears.
Initial S/W Revision	Prior to A.02.00

Trig Slope

Controls the trigger polarity. It is set positive to trigger on a rising edge and negative to trigger on a falling edge.

Key Path	Trigger, Line
Remote Command	:TRIGger[:SEquence]:LINE:SLOPe POSitive NEGative :TRIGger[:SEquence]:LINE:SLOPe?
Example	TRIG:LINE:SLOP NEG
Preset	POSitive
State Saved	Saved in instrument state
Backwards Compatibility Notes	The legacy :TRIGger[:SEquence]:SLOPe command affects the slopes for the VID, LINE, EXT1, EXT2, and RFB triggers.
Initial S/W Revision	Prior to A.02.00

External 1

Pressing this key, when it is not selected, selects an external input signal as the trigger. A new sweep/measurement will start when the external trigger condition is met using the external 1 input connector on the rear panel.

Pressing this key, when it is already selected, accesses the external 1 trigger setup menu.

Key Path	Trigger
Example	TRIG:SOUR EXT1 Swept SA measurement TRIG:<meas>:SOUR EXT1 Measurements other than Swept SA
Dependencies	Grayed out if in use by Point Trigger in the Source Setup menu. Forced to Free Run if already selected and Point Trigger is set to External 1.
State Saved	Saved in instrument state
Status Bits/OPC dependencies	The Status Operation Register bit 5 "Waiting for Trigger" is set at the same time as the Sweeping or Measuring bit is set. It is cleared when the trigger actually occurs (that is, after the trigger event occurs and all the applicable trigger criteria have been met). A corresponding pop-up message ("Waiting for trigger") is generated if no trigger signal appears after approximately 2 sec. This message goes away when a trigger signal appears.
Initial S/W Revision	Prior to A.02.00

Trigger Level

Sets the value where the external 1 trigger input will trigger a new sweep/measurement.

Key Path	Trigger, External 1
Remote Command	:TRIGger[:SEquence]:EXTernal1:LEVel <level> :TRIGger[:SEquence]:EXTernal1:LEVel?
Example	TRIG:EXT1:LEV 0.4 V
Couplings	This same level is used for the Ext1 trigger source in the Trigger menu, for the Ext1 selection in the Periodic Timer sync source (in the Trigger menu and in the Gate Source menu), and also for the Ext1 selection in the Gate Source menu.
Preset	1.2 V
State Saved	Saved in instrument state
Min	-5 V
Max	5 V
Default Unit	V
Backwards Compatibility SCPI	:TRIGger[:SEquence]:EXTernal:LEVel For backward compatibility, the parameter EXTernal is mapped to EXTernal1
Backwards Compatibility SCPI	:TRIGger[:SEquence]:FRAME:EXTernal1:LEVel
Initial S/W Revision	Prior to A.02.00

Trig Slope

Controls the trigger polarity. It is set positive to trigger on a rising edge and negative to trigger on a falling edge.

Key Path	Trigger, External 1
Remote Command	:TRIGger[:SEquence]:EXTernal1:SLOPe POSitive NEGative :TRIGger[:SEquence]:EXTernal1:SLOPe?
Example	TRIG:EXT1:SLOP NEG
Couplings	This same slope is used in the Ext1 selection for the trigger source in the Trigger menu and for the period timer sync source (in the Trigger menu and in the Gate Source menu).
Preset	POSitive
State Saved	Saved in instrument state
Backwards Compatibility SCPI	:TRIGger[:SEquence]:EXTernal:SLOPe For backward compatibility, the parameter EXTernal is mapped to EXTernal1
Backwards Compatibility SCPI	:TRIGger[:SEquence]:FRAMe:EXTernal1:SLOPe
Backwards Compatibility Notes	The legacy :TRIGger[:SEquence]:SLOPe command affects the slopes for the VID, LINE, EXT1, EXT2, and RFB triggers.
Initial S/W Revision	Prior to A.02.00

Zero Span Delay Comp On/Off

In zero span, there is a natural delay in the signal path, which comes from the RBW filter. This is usually desirable, as it allows you to trigger on events and also see those events, because the signal is delayed from the trigger event. However, in some cases it is desirable to eliminate this delay, so that trigger events line up exactly with the zero time point in zero span. You can use the **Zero Span Delay Comp On/Off** feature to enable or disable zero span delay compensation.

Key Path	Trigger, External 1
Remote Command	:TRIGger[:SEquence]:EXTernal1:DELAy:COMPensation OFF ON 0 1 :TRIGger[:SEquence]:EXTernal1:DELAy:COMPensation?
Example	TRIG:EXT1:DEL:COMP ON
Dependencies	No effect except in zero-span, but not locked out in nonzero spans. Blanked in modes that do not support zero-span measurements. If the SCPI command is sent when the key is blanked, an error is returned: -221, "Settings conflict; Feature not supported for this measurement" In analyzers shipping N9060A, this feature requires N9060A-7FP.
Preset	OFF
State Saved	Saved in instrument state
Initial S/W Revision	A.11.00

External 2

Pressing this key, when it is not selected, selects an external input signal as the trigger. A new sweep/measurement will start when the external trigger condition is met using the external 2 input

connector. The external trigger 2 input connector is on the rear panel.

Pressing this key, when it is already selected, accesses the external 2 trigger setup menu.

Key Path	Trigger
Example	TRIG:SOUR EXT2 Swept SA measurement TRIG:<meas>:SOUR EXT2 Measurements other than Swept SA
Dependencies	In some models, there is no second External input. In these models, the External 2 key is blanked and the EXTernal2 parameter will generate a "Hardware missing; Not available for this model number" message. Grayed out if in use by Point Trigger in the Source Setup menu. Forced to Free Run if already selected and Point Trigger is set to External 2.
State Saved	Saved in instrument state
Status Bits/OPC dependencies	The Status Operation Register bit 5 "Waiting for Trigger" is set at the same time as the Sweeping or Measuring bit is set. It is cleared when the trigger actually occurs (that is, after the trigger event occurs and all the applicable trigger criteria have been met). A corresponding pop-up message ("Waiting for trigger") is generated if no trigger signal appears after approximately 2 sec. This message goes away when a trigger signal appears.
Initial S/W Revision	Prior to A.02.00
Modified at S/W Revision	A.03.00

Trigger Level

Sets the value where the external 2 trigger input will trigger a new sweep/measurement.

Key Path	Trigger, External 2
Remote Command	:TRIGger[:SEquence]:EXTernal2:LEVel :TRIGger[:SEquence]:EXTernal2:LEVel?
Example	TRIG:EXT2:LEV 1.1 V
Couplings	This same level is used for the Ext2 trigger source in the Trigger menu, for the Ext2 selection in the Periodic Timer sync source (in the Trigger menu and in the Gate Source menu), and also for the Ext2 selection in the Gate Source menu.
Preset	1.2 V
State Saved	Saved in instrument state
Min	-5 V
Max	5 V
Default Unit	V
Backwards Compatibility SCPI	:TRIGger[:SEquence]:FRAME:EXTernal2:LEVel
Initial S/W Revision	Prior to A.02.00

Trig Slope

Controls the trigger polarity. It is set positive to trigger on a rising edge and negative to trigger on a falling edge.

Key Path	Trigger, External 2
Remote Command	:TRIGger[:SEquence]:EXTernal2:SLOPe POSitive NEGative :TRIGger[:SEquence]:EXTernal2:SLOPe?
Example	TRIG:EXT2:SLOP NEG
Couplings	This same slope is used in the Ext2 selection for the trigger source in the Trigger menu and for the period timer sync source (in the Trigger menu and in the Gate Source menu).
Preset	POSitive
State Saved	Saved in instrument state
Backwards Compatibility SCPI	:TRIGger[:SEquence]:FRAMe:EXTernal2:SLOPe
Backwards Compatibility Notes	The legacy :TRIGger[:SEquence]:SLOPe command affects the slopes for the VID, LINE, EXT1, EXT2, and RFB triggers.
Initial S/W Revision	Prior to A.02.00

Zero Span Delay Comp On/Off

In zero span, there is a natural delay in the signal path, which comes from the RBW filter. This is usually desirable, as it allows you to trigger on events and also see those events, because the signal is delayed from the trigger event. However, in some cases it is desirable to eliminate this delay, so that trigger events line up exactly with the zero time point in zero span. You can use the **Zero Span Delay Comp On/Off** feature to enable or disable zero span delay compensation.

Key Path	Trigger, External 2
Remote Command	:TRIGger[:SEquence]:EXTernal2:DELAy:COMPensation OFF ON 0 1 :TRIGger[:SEquence]:EXTernal2:DELAy:COMPensation?
Example	TRIG:EXT2:DEL:COMP ON
Dependencies	No effect except in zero-span, but not locked out in nonzero spans. Blanked in modes that do not support zero-span measurements. If the SCPI command is sent when the key is blanked, an error is returned: -221, "Settings conflict; Feature not supported for this measurement" In analyzers shipping N9060A, this feature requires N9060A-7FP.
Preset	OFF
State Saved	Saved in instrument state
Initial S/W Revision	A.11.00

RF Burst

Pressing this key, when it is not selected, selects the RF Burst as the trigger. A new sweep/measurement will start when an RF burst envelope signal is identified from the signal at the RF Input connector. Pressing this key, when it is already selected, accesses the RF Burst trigger setup menu.

In some models, a variety of burst trigger circuitry is available, resulting in various available burst trigger bandwidths. The analyzer automatically chooses the appropriate trigger path based on the hardware configuration and other settings of the analyzer.

Key Path	Trigger
Example	TRIG:SOUR RFB Swept SA measurement TRIG:< meas>:SOUR RFB Measurements other than Swept SA
State Saved	Saved in instrument state
Status Bits/OPC dependencies	The Status Operation Register bit 5 "Waiting for Trigger" is set at the same time as the Sweeping or Measuring bit is set. It is cleared when the trigger actually occurs (that is, after the trigger event occurs and all the applicable trigger criteria have been met). A corresponding pop-up message ("Waiting for trigger") is generated if no trigger signal appears after approximately 2 sec. This message goes away when a trigger signal appears.
Backwards Compatibility Notes	The legacy command: :TRIGger[:SEquence]:RFBurst:FSElectivity[:STATE] OFF ON 0 1 is not supported in the X-Series, as the hardware to do Frequency Selective burst triggers does not exist in X-Series.
Initial S/W Revision	Prior to A.02.00
Modified at S/W Revision	A.04.00

Absolute Trigger Level

Sets the absolute trigger level for the RF burst envelope.

When using the External Mixing path, the Absolute Trigger Level is uncalibrated because the factory default was set to accommodate the expected IF levels for the RF path.

Key Path	Trigger, RF Burst
Scope	Meas Global
Remote Command	:TRIGger[:SEquence]:RFBurst:LEVel:ABSolute <ampl> :TRIGger[:SEquence]:RFBurst:LEVel:ABSolute?
Example	TRIG:RFB:LEV:ABS 10 dBm sets the trigger level of the RF burst envelope signal to the absolute level of 10 dBm
Notes	Sending this command does not switch the setting from relative to absolute; to switch it you need to send the :TRIGger[:SEquence]:RFBurst:LEVel:TYPE command, below. Amplitude Corrections are not taken into account by the Absolute Trigger Level. For example, if you have given yourself effective gain with an amplitude correction factor, the Absolute Trigger will not fire until you have set the trigger level that far below the displayed signal level, rather than simply to

	the displayed signal level. This is only true for Amplitude Corrections, not External Gain or Ref Level Offset functions. If mode is Bluetooth, the default value is -50 dBm.
Couplings	This same level is used for the RF Burst trigger source in the Trigger menu, for the RF Burst selection in the Periodic Timer sync source (in the Trigger menu and in the Gate Source menu), and also for the RF Burst selection in the Gate Source menu
Preset	-20 dBm
State Saved	Saved in instrument state
Min	-200 dBm
Max	100 dBm
Default Unit	depends on the current selected Y-Axis unit
Backwards Compatibility SCPI	:TRIGger[:SEquence]:FRAMe:RFBurst:LEVel:ABSolute
Initial S/W Revision	Prior to A.02.00
Modified at S/W Revision	A.04.00

Key Path	Trigger, RF Burst
Remote Command	:TRIGger[:SEquence]:RFBurst:LEVel:TYPE ABSolute RELative :TRIGger[:SEquence]:RFBurst:LEVel:TYPE?
Example	TRIG:RFB:LEV:TYPE REL sets the trigger level type of the RF burst trigger to Relative.
Preset	ABSolute
State Saved	Saved in instrument state
Initial S/W Revision	Prior to A.02.00
Modified at S/W Revision	A.04.00

Relative Trigger Level

Sets the relative trigger level for the RF burst envelope.

In some models, the relative burst trigger function is implemented in hardware. In other models, without the advanced triggering hardware required, the relative burst trigger function is implemented in software in some measurements, and is unavailable in other measurements.

When implemented in software, the relative RF Burst trigger function is implemented as follows:

1. The measurement starts with the absolute RF Burst trigger setting. If it cannot get a trigger with that level, auto trigger fires and the acquisition starts anyway. After the acquisition, the measurement searches for the peak in the acquired waveform and saves it.

2. Now, in the next cycle of the measurement, the measurement determines a new absolute RF Burst level based on the peak value from the first measurement and the Relative RF Burst Trigger Level (always 0 or negative dB) set by the user. The following formula is used:
 3. absolute RF Burst level = peak level of the previous acquisition + relative RF Burst level
 4. If the new absolute RF Burst level differs from the previous by more than 0.5 dB, the new level is sent to the hardware; otherwise it is not updated (to avoid slowing down the acquisition)
- Steps 2 and 3 repeat for subsequent measurements.

Key Path	Trigger, RF Burst
Scope	Meas Global
Remote Command	:TRIGger[:SEquence]:RFBurst:LEVel:RELative <rel_ampl> :TRIGger[:SEquence]:RFBurst:LEVel:RELative?
Example	TRIG:RFB:LEV:REL -10 dB sets the trigger level of the RF burst envelope signal to the relative level of -10 dB
Notes	Sending this command does not switch the setting from absolute to relative; to switch it you need to send the :TRIGger[:SEquence]:RFBurst:LEVel:TYPE command, above. The relative trigger level is not available in some measurements. In those measurements the RELative parameter, and the :TRIGger[:SEquence]:RFBurst:LEVel:TYPE command (above), will generate an error if sent.
Dependencies	This key is grayed out and Absolute Trigger Level selected if the required hardware is not present in your analyzer and the current measurement does not support Relative triggering.
Preset	-6 dB GSM: -25 dB
State Saved	Saved in instrument state
Min	-45 dB
Max	0 dB
Default Unit	dB or dBc
Backwards Compatibility SCPI	:TRIGger[:SEquence]:RFBurst:LEVel This legacy command is aliased to :TRIGger[:SEquence]:RFBurst:LEVel:RELative because the PSA had ONLY relative burst triggering
Initial S/W Revision	Prior to A.02.00
Modified at S/W Revision	A.04.00

Trigger Slope

It is set positive to trigger on a rising edge and negative to trigger on a falling edge.

Key Path	Trigger, RF Burst
Remote Command	:TRIGger[:SEquence]:RFBurst:SLOPe POSitive NEGative :TRIGger[:SEquence]:RFBurst:SLOPe?

Example	TRIG:RFB:SLOP NEG
Couplings	This same slope is used in the RF Burst selection for the trigger source in the Trigger menu and for the period timer sync source (in the Trigger menu and in the Gate Source menu).
Preset	POSitive
State Saved	Saved in instrument state
Backwards Compatibility SCPI	:TRIGger[:SEQuence]:FRAMe:RFBurst:SLOPe
Backwards Compatibility Notes	The legacy :TRIGger[:SEQuence]:SLOPe command affects the slopes for the VID, LINE, EXT1, EXT2, and RFB triggers.
Initial S/W Revision	Prior to A.02.00

Periodic Timer (Frame Trigger)

Pressing this key, when it is not selected, selects the internal periodic timer signal as the trigger. Triggering occurrences are set by the **Period** parameter, which is modified by the **Sync Source** and **Offset**. Pressing this key, when it is already selected, accesses the periodic timer trigger setup functions.

If you do not have a sync source selected (it is Off), then the internal timer will not be synchronized with any external timing events.

Key Path	Trigger
Example	TRIG:SOUR FRAM Swept SA measurement TRIG:<meas>:SOUR FRAM Measurements other than Swept SA
State Saved	Saved in instrument state
Readback	[Sync: <value of Sync Source>], for example, [Sync: External 1]
Status Bits/OPC dependencies	The Status Operation Register bit 5 "Waiting for Trigger" is set at the same time as the Sweeping or Measuring bit is set. It is cleared when the trigger actually occurs (that is, after the trigger event occurs and all the applicable trigger criteria have been met). A corresponding pop-up message ("Waiting for trigger") is generated if no trigger signal appears after approximately 2 sec. This message goes away when a trigger signal appears.
Initial S/W Revision	Prior to A.02.00

Periodic Timer Triggering:

This feature selects the internal periodic timer signal as the trigger. Trigger occurrences are set by the **Periodic Timer** parameter, which is modified by the **Sync Source** and **Offset**.

The figure below shows the action of the periodic timer trigger. Before reviewing the figure, we'll explain some uses for the periodic trigger.

A common application is measuring periodic burst RF signals for which a trigger signal is not easily available. For example, we might be measuring a TDMA radio which bursts every 20 ms. Let's assume that the 20 ms period is very consistent. Let's also assume that we do not have an external trigger source

available that is synchronized with the period, and that the signal-to-noise ratio of the signal is not high enough to provide a clean RF burst trigger at all of the analysis frequencies. For example, we might want to measure spurious transmissions at an offset from the carrier that is larger than the bandwidth of the RF burst trigger. In this application, we can set the Periodic Timer to a 20.00 ms period and adjust the offset from that timer to position our trigger just where we want it. If we find that the 20.00 ms is not exactly right, we can adjust the period slightly to minimize the drift between the period timer and the signal to be measured.

A second way to use this feature would be to use **Sync Source** temporarily, instead of **Offset**. In this case, we might tune to the signal in a narrow span and use the RF Burst trigger to synchronize the periodic timer. Then we would turn the sync source off so that it would not miss-trigger. Miss-triggering can occur when we are tuned so far away from the RF burst trigger that it is no longer reliable.

A third example would be to synchronize to a signal that has a reference time element of much longer period than the period of interest. In some CDMA applications, it is useful to look at signals with a short periodicity, by synchronizing that periodicity to the "even-second clock" edge that happens every two seconds. Thus, we could connect the even-second clock trigger to Ext1 and use then Ext1 as the sync source for the periodic timer.

The figure below illustrates this third example. The top trace represents the even-second clock. It causes the periodic timer to synchronize with the leading edge shown. The analyzer trigger occurs at a time delayed by the accumulated offset from the period trigger event. The periodic timer continues to run, and triggers continue to occur, with a periodicity determined by the analyzer time base. The timer output (labeled "late event") will drift away from its ideal time due to imperfect matching between the time base of the signal being measured and the time base of the analyzer, and also because of imperfect setting of the period parameter. But the synchronization is restored on the next even-second clock event. ("Accumulated offset" is described in the in the **Offset** function section.)

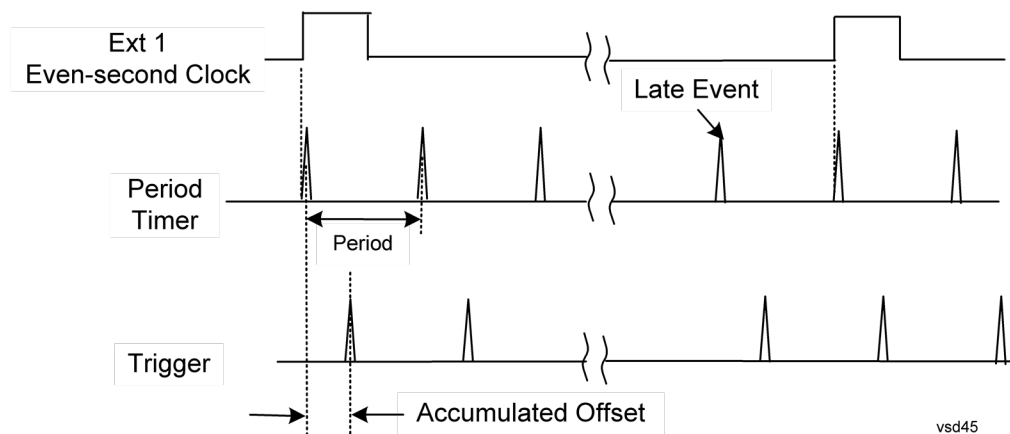

Period

Sets the period of the internal periodic timer clock. For digital communications signals, this is usually set to the frame period of your current input signal. In the case that sync source is not set to OFF, and the external sync source rate is changed for some reason, the periodic timer is synchronized at the every external synchronization pulse by resetting the internal state of the timer circuit.

Key Path	Trigger, Periodic Timer
Remote Command	:TRIGger[:SEquence]:FRAME:PERiod <time>

	:TRIGger[:SEquence]:FRAMe:PERiod?
Example	TRIG:FRAM:PER 100 ms
Dependencies	The invalid data indicator turns on when the period is changed, until the next sweep/measurement completes.
Couplings	The same period is used in the Gate Source selection of the period timer.
Preset	20 ms GSM: 4.615383
State Saved	Saved in instrument state
Min	100.000 ns
Max	559.0000 ms
Default Unit	S
Initial S/W Revision	Prior to A.02.00

Offset

Adjusts the accumulated offset between the periodic timer events and the trigger event. Adjusting the accumulated offset is different than setting an offset, and requires explanation.

The periodic timer is usually not synchronized with any external events, so the timing of its output events has no absolute meaning. Since the timing relative to external events (RF signals) is important, you need to be able to adjust (offset) it. However, you have no direct way to see when the periodic timer events occur. All that you can see is the trigger timing. When you want to adjust the trigger timing, you will be changing the internal offset between the periodic timer events and the trigger event. Because the absolute value of that internal offset is unknown, we will just call that the accumulated offset. Whenever the Offset parameter is changed, you are changing that accumulated offset. You can reset the displayed offset using Reset Offset Display. Changing the display does not change the value of the accumulated offset, and you can still make additional changes to accumulated offset.

To avoid ambiguity, we define that an increase in the "offset" parameter, either from the knob or the SCPI adjust command, serves to delay the timing of the trigger event.

Key Path	Trigger, Periodic Timer
Remote Command	:TRIGger[:SEquence]:FRAMe:OFFSet <time> :TRIGger[:SEquence]:FRAMe:OFFSet?
Example	TRIG:FRAM:OFFS 1.2 ms
Notes	The front panel interface (for example, the knob), and this command, adjust the accumulated offset, which is shown on the active function display. However, the actual amount sent to the hardware each time the offset is updated is the delta value, that is, the current accumulated offset value minus the previous accumulated offset value. Note that the accumulated offset value is essentially arbitrary; it represents the accumulated offset from the last time the offset was zeroed (with the Reset Offset Display key). Note that this command does not change the period of the trigger waveform. Note also that Offset is used only when the sync source is set to OFF, otherwise delay is used, see section "Trig Delay" on page 476.

	An increase in the "offset" parameter, either from the knob or the SCPI adjust command, serves to delay the timing of the trigger event.
Notes	When the SCPI command is sent the value shown on the key (and the Active Function, if this happens to be the active function) is updated with the new value. However, the actual amount sent to the hardware is the delta value, that is, the current accumulated offset value minus the previous accumulated offset value. The SCPI query simply returns the value currently showing on the key.
Dependencies	The invalid data indicator turns on when the offset is changed, until the next sweep/measurement completes.
Couplings	The same offset is used in the Gate Source selection of the period timer.
Preset	0 s
State Saved	Saved in instrument state
Min	-10.000 s
Max	10.000 s
Default Unit	S
Initial S/W Revision	Prior to A.02.00

Offset Adjust (Remote Command Only)

This remote command does not work at all like the related front panel keys. This command lets you advance the phase of the frame trigger by the amount you specify.

It does not change the period of the trigger waveform. If the command is sent multiple times, it advances the phase of the frame trigger an additional amount each time it is sent. Negative numbers are permitted.

Remote Command	:TRIGger[:SEquence]:FRAMe:ADJust <time>
Example	TRIG:FRAM:ADJ 1.2 ms
Notes	Note also that Offset is used only when the sync source is set to OFF, otherwise delay is used, see section "Trig Delay" on page 476 An increase in the "offset" parameter, either from the knob or the SCPI adjust command, serves to delay the timing of the trigger event.
Notes	The front panel interface (for example, the knob) and the :TRIG:FRAM:OFFS command adjust the accumulated offset, which is shown on the active function display. However, the actual amount sent to the hardware is the delta value, that is, the current offset value minus the previous offset value. When the SCPI command is sent the value shown on the key (and the Active Function, if this happens to be the active function) is updated by increasing it (or decreasing it if the value sent is negative) by the amount specified in the SCPI command. This is a "command only" SCPI command, with no query.
Dependencies	The invalid data indicator turns on when the offset is changed, until the next sweep/measurement completes.
Couplings	The same offset is used in the Gate Source selection of the period timer.
Preset	0 s

State Saved	Saved in instrument state
Min	-10.000 s
Max	10.000 s
Default Unit	S
Initial S/W Revision	Prior to A.02.00

Reset Offset Display

Resets the value of the periodic trigger offset display setting to 0.0 seconds. The current displayed trigger location may include an offset value defined with the **Offset** key. Pressing this key redefines the currently displayed trigger location as the new trigger point that is 0.0 s offset. The **Offset** key can then be used to add offset relative to this new timing.

Key Path	Trigger, Periodic Timer
Remote Command	:TRIGger[:SEquence]:FRAMe:OFFSet:DISPlay:RESet
Example	TRIG:FRAM:OFFS:DISP:RES
Initial S/W Revision	Prior to A.02.00

Sync Source

Selects a signal source for you to synchronize your periodic timer trigger to, otherwise you are triggering at some arbitrary location in the frame. Synchronization reduces the precision requirements on the setting of the period.

For convenience you may adjust the level and slope of the selected sync source in a conditional branch setup menu accessed from the Sync Source menu. Note that these settings match those in the **Trigger** and **Gate Source** menus; that is, each trigger source has only one value of level and slope, regardless of which menu it is accessed from.

Key Path	Trigger, Periodic Timer
Remote Command	:TRIGger[:SEquence]:FRAMe:SYNC EXTernal1 EXTernal2 RFBurst OFF :TRIGger[:SEquence]:FRAMe:SYNC?
Example	TRIG:FRAM:SYNC EXT2
Dependencies	In some models, there is no second External input. In these models, the External 2 key is blanked and the EXTernal2 parameter will generate a "Hardware missing; Not available for this model number" message.
Preset	Off GSM/EDGE, MSR,LTE,LTETDD: RFBurst
State Saved	Saved in instrument state
Readback	The current setting is read back to this key and it is also Readback to the previous Periodic Timer trigger key.

Backwards Compatibility SCPI	:TRIGger[:SEquence]:FRAMe:SYNC EXTernal
Initial S/W Revision	Prior to A.02.00
Modified at S/W Revision	A.03.00, A.14.00

Off

Turns off the sync source for your periodic trigger. With the sync source off, the timing will drift unless the signal source frequency is locked to the analyzer frequency reference.

Key Path	Trigger, Periodic Timer, Sync Source
Example	TRIG:FRAM:SYNC OFF
Readback	Off
Initial S/W Revision	Prior to A.02.00

External 1

Pressing this key, when it is not selected, selects an external input signal as the trigger. A new sweep/measurement will start when the external trigger condition is met using the external 1 input connector on the rear panel.

Pressing this key, when it is already selected, accesses the external 1 trigger setup menu.

Key Path	Trigger
Example	TRIG:SOUR EXT1 Swept SA measurement TRIG:<meas>:SOUR EXT1 Measurements other than Swept SA
Dependencies	Grayed out if in use by Point Trigger in the Source Setup menu. Forced to Free Run if already selected and Point Trigger is set to External 1.
State Saved	Saved in instrument state
Status Bits/OPC dependencies	The Status Operation Register bit 5 "Waiting for Trigger" is set at the same time as the Sweeping or Measuring bit is set. It is cleared when the trigger actually occurs (that is, after the trigger event occurs and all the applicable trigger criteria have been met). A corresponding pop-up message ("Waiting for trigger") is generated if no trigger signal appears after approximately 2 sec. This message goes away when a trigger signal appears.
Initial S/W Revision	Prior to A.02.00

Trigger Level

Sets the value where the external 1 trigger input will trigger a new sweep/measurement.

Key Path	Trigger, External 1
Remote Command	:TRIGger[:SEquence]:EXTernal1:LEVel <level> :TRIGger[:SEquence]:EXTernal1:LEVel?
Example	TRIG:EXT1:LEV 0.4 V
Couplings	This same level is used for the Ext1 trigger source in the Trigger menu, for the Ext1 selection in the Periodic Timer sync source (in the Trigger menu and in the Gate Source menu), and also for the Ext1 selection in the Gate Source menu.
Preset	1.2 V
State Saved	Saved in instrument state
Min	-5 V
Max	5 V
Default Unit	V
Backwards Compatibility SCPI	:TRIGger[:SEquence]:EXTernal:LEVel For backward compatibility, the parameter EXTernal is mapped to EXTernal1
Backwards Compatibility SCPI	:TRIGger[:SEquence]:FRame:EXTernal1:LEVel
Initial S/W Revision	Prior to A.02.00

Trig Slope

Controls the trigger polarity. It is set positive to trigger on a rising edge and negative to trigger on a falling edge.

Key Path	Trigger, External 1
Remote Command	:TRIGger[:SEquence]:EXTernal1:SLOPe POSitive NEGative :TRIGger[:SEquence]:EXTernal1:SLOPe?
Example	TRIG:EXT1:SLOP NEG
Couplings	This same slope is used in the Ext1 selection for the trigger source in the Trigger menu and for the period timer sync source (in the Trigger menu and in the Gate Source menu).
Preset	POSitive
State Saved	Saved in instrument state
Backwards Compatibility SCPI	:TRIGger[:SEquence]:EXTernal:SLOPe For backward compatibility, the parameter EXTernal is mapped to EXTernal1
Backwards Compatibility SCPI	:TRIGger[:SEquence]:FRame:EXTernal1:SLOPe
Backwards Compatibility Notes	The legacy :TRIGger[:SEquence]:SLOPe command affects the slopes for the VID, LINE, EXT1, EXT2, and RFB triggers.
Initial S/W Revision	Prior to A.02.00

External 2

Pressing this key, when it is not selected, selects an external input signal as the trigger. A new sweep/measurement will start when the external trigger condition is met using the external 2 input connector. The external trigger 2 input connector is on the rear panel.

Pressing this key, when it is already selected, accesses the external 2 trigger setup menu.

Key Path	Trigger
Example	TRIG:SOUR EXT2 Swept SA measurement TRIG:<meas>:SOUR EXT2 Measurements other than Swept SA
Dependencies	In some models, there is no second External input. In these models, the External 2 key is blanked and the EXTERNAL2 parameter will generate a "Hardware missing; Not available for this model number" message. Grayed out if in use by Point Trigger in the Source Setup menu. Forced to Free Run if already selected and Point Trigger is set to External 2.
State Saved	Saved in instrument state
Status Bits/OPC dependencies	The Status Operation Register bit 5 "Waiting for Trigger" is set at the same time as the Sweeping or Measuring bit is set. It is cleared when the trigger actually occurs (that is, after the trigger event occurs and all the applicable trigger criteria have been met). A corresponding pop-up message ("Waiting for trigger") is generated if no trigger signal appears after approximately 2 sec. This message goes away when a trigger signal appears.
Initial S/W Revision	Prior to A.02.00
Modified at S/W Revision	A.03.00

Trigger Level

Sets the value where the external 2 trigger input will trigger a new sweep/measurement.

Key Path	Trigger, External 2
Remote Command	:TRIGger[:SEquence]:EXTernal2:LEVel :TRIGger[:SEquence]:EXTernal2:LEVel?
Example	TRIG:EXT2:LEV 1.1 V
Couplings	This same level is used for the Ext2 trigger source in the Trigger menu, for the Ext2 selection in the Periodic Timer sync source (in the Trigger menu and in the Gate Source menu), and also for the Ext2 selection in the Gate Source menu.
Preset	1.2 V
State Saved	Saved in instrument state
Min	-5 V
Max	5 V
Default Unit	V
Backwards Compatibility SCPI	:TRIGger[:SEquence]:FRAME:EXTernal2:LEVel

Initial S/W Revision	Prior to A.02.00
----------------------	------------------

Trig Slope

Controls the trigger polarity. It is set positive to trigger on a rising edge and negative to trigger on a falling edge.

Key Path	Trigger, External 2
Remote Command	:TRIGger[:SEquence]:EXTernal2:SLOPe POSitive NEGative :TRIGger[:SEquence]:EXTernal2:SLOPe?
Example	TRIG:EXT2:SLOP NEG
Couplings	This same slope is used in the Ext2 selection for the trigger source in the Trigger menu and for the period timer sync source (in the Trigger menu and in the Gate Source menu).
Preset	POSitive
State Saved	Saved in instrument state
Backwards Compatibility SCPI	:TRIGger[:SEquence]:FRAMe:EXTernal2:SLOPe
Backwards Compatibility Notes	The legacy :TRIGger[:SEquence]:SLOPe command affects the slopes for the VID, LINE, EXT1, EXT2, and RFB triggers.
Initial S/W Revision	Prior to A.02.00

RF Burst

Pressing this key, when it is not selected, selects the RF Burst as the trigger. A new sweep/measurement will start when an RF burst envelope signal is identified from the signal at the RF Input connector. Pressing this key, when it is already selected, accesses the RF Burst trigger setup menu.

In some models, a variety of burst trigger circuitry is available, resulting in various available burst trigger bandwidths. The analyzer automatically chooses the appropriate trigger path based on the hardware configuration and other settings of the analyzer.

Key Path	Trigger
Example	TRIG:SOUR RFB Swept SA measurement TRIG:<meas>:SOUR RFB Measurements other than Swept SA
State Saved	Saved in instrument state
Status Bits/OPC dependencies	The Status Operation Register bit 5 "Waiting for Trigger" is set at the same time as the Sweeping or Measuring bit is set. It is cleared when the trigger actually occurs (that is, after the trigger event occurs and all the applicable trigger criteria have been met). A corresponding pop-up message ("Waiting for trigger") is generated if no trigger signal appears after approximately 2 sec. This message goes away when a trigger signal appears.
Backwards Compatibility Notes	The legacy command:

	:TRIGger[:SEquence]:RFBurst:FSElectivity[:STATE] OFF ON 0 1 is not supported in the X-Series, as the hardware to do Frequency Selective burst triggers does not exist in X-Series.
Initial S/W Revision	Prior to A.02.00
Modified at S/W Revision	A.04.00

Absolute Trigger Level

Sets the absolute trigger level for the RF burst envelope.

When using the External Mixing path, the Absolute Trigger Level is uncalibrated because the factory default was set to accommodate the expected IF levels for the RF path.

Key Path	Trigger, RF Burst
Scope	Meas Global
Remote Command	:TRIGger[:SEquence]:RFBurst:LEVel:ABSolute <ampl> :TRIGger[:SEquence]:RFBurst:LEVel:ABSolute?
Example	TRIG:RFB:LEV:ABS 10 dBm sets the trigger level of the RF burst envelope signal to the absolute level of 10 dBm
Notes	Sending this command does not switch the setting from relative to absolute; to switch it you need to send the :TRIGger[:SEquence]:RFBurst:LEVel:TYPE command, below. Amplitude Corrections are not taken into account by the Absolute Trigger Level. For example, if you have given yourself effective gain with an amplitude correction factor, the Absolute Trigger will not fire until you have set the trigger level that far below the displayed signal level, rather than simply to the displayed signal level. This is only true for Amplitude Corrections, not External Gain or Ref Level Offset functions. If mode is Bluetooth, the default value is -50 dBm.
Couplings	This same level is used for the RF Burst trigger source in the Trigger menu, for the RF Burst selection in the Periodic Timer sync source (in the Trigger menu and in the Gate Source menu), and also for the RF Burst selection in the Gate Source menu
Preset	-20 dBm
State Saved	Saved in instrument state
Min	-200 dBm
Max	100 dBm
Default Unit	depends on the current selected Y-Axis unit
Backwards Compatibility SCPI	:TRIGger[:SEquence]:FRAMe:RFBurst:LEVel:ABSolute
Initial S/W Revision	Prior to A.02.00
Modified at S/W Revision	A.04.00

Key Path	Trigger, RF Burst
Remote Command	:TRIGger[:SEquence]:RFBurst:LEVel:TYPE ABSolute RELative :TRIGger[:SEquence]:RFBurst:LEVel:TYPE?
Example	TRIG:RFB:LEV:TYPE REL sets the trigger level type of the RF burst trigger to Relative.
Preset	ABSolute
State Saved	Saved in instrument state
Initial S/W Revision	Prior to A.02.00
Modified at S/W Revision	A.04.00

Trigger Slope

It is set positive to trigger on a rising edge and negative to trigger on a falling edge.

Key Path	Trigger, RF Burst
Remote Command	:TRIGger[:SEquence]:RFBurst:SLOPe POSitive NEGative :TRIGger[:SEquence]:RFBurst:SLOPe?
Example	TRIG:RFB:SLOP NEG
Couplings	This same slope is used in the RF Burst selection for the trigger source in the Trigger menu and for the period timer sync source (in the Trigger menu and in the Gate Source menu).
Preset	POSitive
State Saved	Saved in instrument state
Backwards Compatibility SCPI	:TRIGger[:SEquence]:FRAMe:RFBurst:SLOPe
Backwards Compatibility Notes	The legacy :TRIGger[:SEquence]:SLOPe command affects the slopes for the VID, LINE, EXT1, EXT2, and RFB triggers.
Initial S/W Revision	Prior to A.02.00

Sync Holdoff

Sync Holdoff specifies the duration that the sync source signal must be kept false before the transition to true to be recognized as the sync timing. The periodic timer phase is aligned when the sync source signal becomes true, after the Holdoff time is satisfied.

A holdoff of 2 ms will work with most WiMAX signals, but there may be cases where the burst off duration is less than 1 ms and this value will need to be changed.

Key Path	Trigger, Periodic Timer
Remote Command	:TRIGger[:SEquence]:FRAMe:SYNC:HOLDoff <time> :TRIGger[:SEquence]:FRAMe:SYNC:HOLDoff? :TRIGger[:SEquence]:FRAMe:SYNC:HOLDoff:STATe OFF ON 0 1

	:TRIGger[:SEquence]:FRAMe:SYNC:HOLDoff:STATE?
Preset	On, 1.000 ms
State Saved	Saved in instrument state
Min	0 ms
Max	+500 ms
Default Unit	s
Initial S/W Revision	Prior to A.02.00

Aux IO Control (Remote Command Only)

Sets/Queries the value for all 8 data lines.

Key Path	SCPI only
Remote Command	OUTPut:AUX:IO <Value> OUTPut:AUX:IO?
Example	OUTPut:AUX:IO 31
Couplings	State of data 0 to data 7 under the AUX I/O Control panel (Input/Output menu) will change accordingly base on the AUX IO's value that key in.
Preset	31
Min	0
Max	255
Backwards Compatibility SCPI	OUTPut:UPORt <Value>
Initial S/W Revision	A.16.00

Control Edge/Level

Sets the method of controlling the gating function from the gating signal.

Edge

In Edge triggering, the gate opens (after the Delay) on the selected edge (for example, positive) of the gate signal and closes on the alternate edge (for example, negative).

Level

In Level triggering, the gate opens (after the Delay) when the gate signal has achieved a certain level and stays open as long as that level is maintained.

Key Path	Sweep/Control, Gate
Remote Command	[:SENSe]:SWEep:EGATe:CONTRol EDGE LEVel [:SENSe]:SWEep:EGATe:CONTRol?
Example	SWE:EGAT:CONT EDGE
Dependencies	If the Gate Method is FFT the Control key is grayed out and Edge is selected.

	If the Gate Source is TV, Frame or Line, the Control key is grayed out and Edge is selected.
Preset	EDGE
State Saved	Saved in instrument state
Backwards Compatibility SCPI	<code>[:SENSe]:SWEep:TIME:GATE:TYPE</code> ESA Compatibility
Initial S/W Revision	Prior to A.02.00

Gate Holdoff

Lets you increase or decrease the wait time after a gate event ends before the analyzer will respond to the next gate signal.

After any Gate event finishes, the analyzer must wait for the sweep system to settle before it can respond to another Gate signal. The analyzer calculates a "wait time," taking into account a number of factors, including RBW and Phase Noise Optimization settings. The goal is to achieve the same accuracy when gated as in ungated operation. The figure below illustrates this concept:

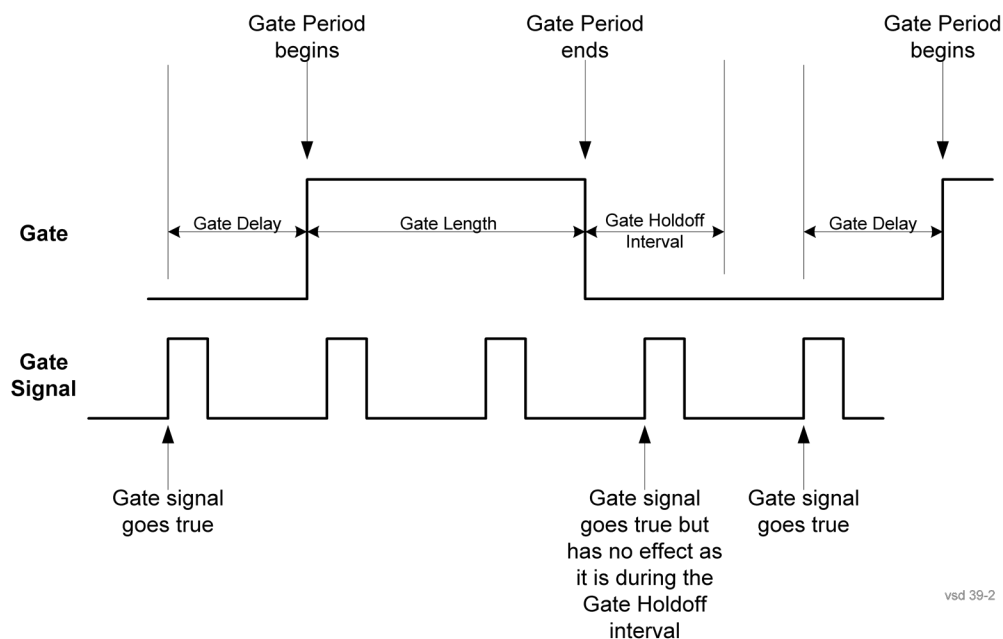

When Gate Holdoff is in Auto, the wait time calculated by the analyzer is used. When Gate Time is in Manual, the user may adjust the wait time, usually decreasing it in order to achieve greater speed, but at the risk of decreasing accuracy.

When the **Method** key is set to **Video** or **FFT**, the **Gate Holdoff** function has no effect.

In measurements that do not support Auto, the value shown when Auto is selected is "---" and the manually set holdoff is returned to a query.

Key Path	Sweep/Control, Gate
----------	----------------------------

Remote Command	<pre>[:SENSe] :SWEep:EGATe:HOLDoff <time> [:SENSe] :SWEep:EGATe:HOLDoff? [:SENSe] :SWEep:EGATe:HOLDoff:AUTO OFF ON 0 1 [:SENSe] :SWEep:EGATe:HOLDoff:AUTO?</pre>
Example	<pre>SWE:EGAT:HOLD 0.0002 SWE:EGAT:HOLD? SWE:EGAT:HOLD:AUTO ON SWE:EGAT:HOLD:AUTO?</pre>
Couplings	<p>When Gate Holdoff is Auto, the Gate Holdoff key shows the value calculated by the analyzer for the wait time.</p> <p>Pressing the Gate Holdoff key while it is in Auto and not selected, causes the key to become selected and allows the user to adjust the value. If the value is adjusted, the setting changes to Man.</p> <p>Pressing the Gate Holdoff key, while it is in Auto and selected, does not change the value of Gate Holdoff, but causes the setting to change to Man. Now the user can adjust the value.</p> <p>Pressing the key while it is in Man and selected, cause the value to change back to Auto.</p> <p>Pressing the key while it is in Man and not selected, causes the key to become selected and allows the user to adjust the value.</p> <p>When Method is set to Video or FFT, the Gate Holdoff function has no effect.</p>
Preset	<pre>Auto Auto/On</pre>
State Saved	Saved in instrument state
Min	1 µsec
Max	1 sec
Initial S/W Revision	Prior to A.02.00

Gate Delay Compensation

This function allows you to select an RBW-dependent value by which to adjust the gate delay, to compensate for changes in the delay caused by RBW effects.

You can select between uncompensated operation and two types of compensation, **Delay Until RBW Settled** and **Compensate for RBW Group Delay**.

See "[More Information](#)" on page 2257

Key Path	Sweep/Control, Gate
Scope	Meas Global
Remote Command	<pre>[:SENSe] :SWEep:EGATe:DELAy:COMPensation:TYPE OFF SETTled GDELAy [:SENSe] :SWEep:EGATe:DELAy:COMPensation:TYPE?</pre>
Example	<pre>SWE:EGAT:DEL:COMP:TYPE SETT SWE:EGAT:DEL:COMP:TYPE?</pre>

Notes	<p>Although this function is Meas Global, there are some measurements that do not support this function. In those measurements the operation will be Uncompensated. Going into one of those measurements will not change the Meas Global selection; it will simply display the grayed-out menu key with “Uncompensated” showing as the selection. This is a non-forceful grayout, so the SCPI command is still accepted.</p> <p>If Gate Delay Compensation is not supported at all within a particular mode, the key is not displayed, and if the SCPI command is sent while in a measurement within that mode, an “Undefined Header” message is generated.</p> <p>Measurements that do not support this function include: Swept SA</p>
Preset	<p>TD-SCDMA mode: Compensate for RBW Group Delay</p> <p>All other modes: Delay Until RBW Settled</p>
State Saved	Saved in instrument state
Range	Uncompensated Delay Until RBW Settled Compensate for RBW Group Delay
Readback text	Uncompensated Settled Group Delay
Initial S/W Revision	Prior to A.02.00
Modified at S/W Revision	A.11.0

More Information

Selecting **Uncompensated** means that the actual gate delay is as you sets it.

Selecting **Delay Until RBW Settled** causes the gate delay to be increased above the user setting by an amount equal to $3.06/\text{RBW}$. This compensated delay causes the GATE START and GATE STOP lines on the display to move by the compensation amount, and the actual hardware gate delay to be increased by the same amount. All the other gate lines (for example, MIN FAST) are unaffected. If the RBW subsequently changes, the compensation is readjusted for the new RBW. The value shown on the **Gate Delay** key does NOT change.

Delay Until RBW Settled allows excellent measurements of gated signals, by allowing the IF to settle following any transient that affects the burst. Excellent measurements also require that the analysis region not extend into the region affected by the falling edge of the burst. Thus, excellent measurements can only be made over a width that declines with narrowing RBWs, which is achieved by decreasing the gate length below the user setting by an amount equal to $2.53/\text{RBW}$. Therefore, for general purpose compensation, you will still want to change the gate length with changes in RBW even if the gate delay is compensated. The compensated Gate Length is limited by the analyzer so that it will never go below 10% of the value shown on the Gate Length key, as otherwise the sweep times could get very long. Anytime the **Gate Length and RBW** values combine in such a way that this limiting takes place, a warning is displayed. For measurements which contain multiple sweeps with different RBW like SEM and SPUR, the smallest RBW is used for this limiting.

Selecting **Compensate for RBW Group Delay** causes the gate delay to be increased above the user setting by an amount equal to $1.81/\text{RBW}$. This compensated delay causes the GATE START, GATE STOP lines on the display to move by the compensation amount, and the actual hardware gate delay to be increased by the same amount. All the other gate lines (for example, MIN FAST) are unaffected. If the RBW

subsequently changes, the compensation is readjusted for the new RBW. The value shown on the **Gate Delay** key does NOT change. **Compensate for RBW Group Delay** also includes gate length compensation; the gate length itself is adjusted as necessary to attempt to compensate for delay effects imposed by the RBW.

Compensate for RBW Group Delay is similar to **Delay Until RBW Settled**, but compensates for the group delay of the RBW filter, rather than the filter settling time. As the RBW gets narrow, this can allow the settling tail of the RBW to affect the beginning part of the gated measurement, and allow the beginning of the RBW settling transient to affect the end of the gated measurement. These two effects are symmetric because the RBW response is symmetric. Because the gate length is not automatically compensated, some users might find this compensation to be more intuitive than compensation for RBW settling.

Min Fast Position Query (Remote Command Only)

This command queries the position of the MIN FAST line, relative to the delay reference (REF) line. See section "[Gate View On/Off](#)" on page 2228. If this query is sent while not in gate view, the MinFast calculation is performed based on the current values of the appropriate parameters and the result is returned. Knowing this value lets you set an optimal gate delay value for the current measurement setup.

Remote Command	<code>[:SENSe] :SWEep:EGATe:MINFast?</code>
Example	<code>SWE:EGAT:MIN?</code>
Initial S/W Revision	Prior to A.02.00

Gate Preset (Remote Command Only)

Presets the time-gated spectrum analysis capability.

This command sets gate parameter values to the ESA preset values, as follows:

Gate trigger type = edge

Gate polarity = positive

Gate delay = 1 us

Gate length = 1 us

Remote Command	<code>[:SENSe] :SWEep:TIME:GATE:PRESet ESA Compatibility</code>
Initial S/W Revision	Prior to A.02.00

Gate Level (Remote Command Only)

Sets the gate input transition point level for the external TRIGGER inputs on the front and rear panel. This is a legacy command for PSA compatibility. It is simply an alias to the equivalent trigger level command.

Remote Command	<code>[:SENSe] :SWEep:EGATe:EXTernal [1] 2:LEVel <voltage></code> <code>[:SENSe] :SWEep:EGATe:EXTernal [1] 2:LEVel?</code>
Notes	This command is simply an alias to

	:TRIGger[:SEQuence]:EXTerna[1]2:LEVel For details refer
Initial S/W Revision	Prior to A.02.00

Gate Polarity (Remote Command Only)

Sets the polarity for the gate signal. This setup is now done using the gate trigger's slope setting.

When Positive (Pos) is selected, a positive-going edge (Edge) or a high voltage (Level) will satisfy the gate condition, after the delay set with the Gate Delay key. When Negative (Neg) is selected, a negative-going edge (Edge) or a low voltage (Level) will satisfy the gate condition after the delay.

Remote Command	[:SENSe] :SWEep:EGATe:POLarity NEGative POSitive [:SENSe] :SWEep:EGATe:POLarity?
Example	SWE:EGAT:POL NEG SWE:EGAT:POL?
Preset	POSitive
State Saved	Saved in instrument state
Backwards Compatibility SCPI	[:SENSe] :SWEep:TIME:GATE:POLarity ESA compatibility
Initial S/W Revision	Prior to A.02.00

Remote Command	[:SENSe] :SWEep:TIME:GATE:LEVel HIGH LOW [:SENSe] :SWEep:TIME:GATE:LEVel? ESA compatibility
Preset	HIGH
Initial S/W Revision	Prior to A.02.00

Points

Sets the number of points per sweep. The resolution of setting the sweep time depends on the number of points selected. If **Preset** is selected, the number of points per sweep defaults to 1001. The current value of points is displayed parenthetically, next to the sweep time in the lower right corner of the display.

Key Path	Sweep/Control
Mode	All except SA and BASIC
Remote Command	[:SENSe] :MONitor:SWEep:POINts <integer> [:SENSe] :MONitor:SWEep:POINts?
Example	:MON:SWE:POIN 1000 :MON:SWE:POIN?

15 Monitor Spectrum Measurement
Sweep/Control

Couplings	Whenever the number of sweep points changes, the sweep time is re-quantized.
Preset	1001
State Saved	Saved in instrument state.
Range	1 to 20001
Min	1
Max	20001
Initial S/W Revision	Prior to A.02.00

System

See "System" on page 368

Trace/Detector

Accesses a menu that enables you to control the display, storage, detection and manipulation of trace data. Each trace is comprised of a series of data points in which X and Y axis information is stored. The analyzer updates the information for the active trace with each sweep of the current measurement.

Key Path	Front-panel key
Initial S/W Revision	Prior to A.02.00

Select Trace

Allows you to select which trace you want to use for the current measurement. You can select one of three traces. Monitor Spectrum supports 3 traces, numbered 1 through 3.

Key Path	Trace/Detector
Mode	All except SA and BASIC
Preset	Trace 1
State Saved	The number of the selected trace is saved in Instrument State
Initial S/W Revision	Prior to A.02.00

Trace Type

Allows you to select the type of trace you want to use for the current measurement. You can assign a trace type to one of the three available traces.

The first page of this menu contains a 1-of-N selection of the trace type for the selected trace:

WRITe	Clear Write
AVERAge	Average
MAXHold	Max Hold
MINHold	Min Hold

Key Path	Trace/Detector
Mode	All except SA and BASIC
Remote Command	:TRACe[1] 2 3:MONitor:TYPE WRITe AVERAge MAXHold MINHold :TRACe[1] 2 3:MONitor:TYPE?
Example	TRAC:MON:TYPE WRIT TRAC:MON:TYPE?
Preset	WRITe
State Saved	Saved in instrument state.

Range	WRITe AVERAge MAXHold MINHold for traces 1 through 3
Backwards Compatibility SCPI	:DISPlay:MONitor:VIEW:WINDow:TRACe [1] 2 3 :TYPE
Initial S/W Revision	Prior to A.02.00

Update

Toggles a trace state between Update and Off. The Off selection makes the trace inactive (or a *stored trace*). This does not affect whether the trace is visible or not. To change the trace visibility, see "[Display](#)" on page 2263.

Key Path	Trace/Detector
Mode	All except SA and BASIC
Remote Command	:TRACe [1] 2 3 :MONitor:UPDate[:STATe] ON OFF 0 1 :TRACe [1] 2 3 :MONitor:UPDate[:STATe]?
Example	TRAC3:MON:UPD OFF TRAC3:MON:UPD?
Preset	ON
State Saved	Saved in instrument state.
Range	On Off (View)
Initial S/W Revision	Prior to A.02.00

Display

Controls the visibility of a trace. When set to **Blank**, traces do not display nor appear on printouts but are otherwise unaffected. They may be queried and markers may be placed on them.

Key Path	Trace/Detector
Mode	All except SA and BASIC
Remote Command	:TRACe [1] 2 3 :MONitor:DISPlay[:STATe] ON OFF 0 1 :TRACe [1] 2 3 :MONitor:DISPlay[:STATe]?
Example	TRAC:MON:DISP ON TRAC:MON:DISP?
Preset	ON OFF OFF
State Saved	Saved in instrument state.
Range	Show Blank
Initial S/W Revision	Prior to A.02.00

Detector

Accesses a menu of functions that enable you to control the detectors for the current measurement. The following choices are available:

- **Auto** – the detector selected depends on marker functions, trace functions, average type, and the trace averaging function. See "[Auto](#)" on page 2265.
- **Normal** – the detector determines the peak of the CW-like signals, and it yields alternating maximums and minimums of noise-like signals. This is also referred to as Rosenfell detection.
- **Average** – the detector determines the average of the signal within the sweep points. The averaging method depends upon the Average Type selection (voltage, power or log scales).
- **Peak** – the detector determines the maximum of the signal within the sweep points.
- **Sample** – the detector indicates the instantaneous level of the signal at the center of the sweep points represented by each display point.
- **Negative Peak** – the detector determines the minimum of the signal within the sweep points.

In swept analysis, the time interval of the data collection for the display sweep points also represents a frequency interval. In FFT analysis, the sweep points represent just a frequency interval. The detector determines the relationship between the spectrum computed by the FFT and the single data point displayed for the sweep points.

Key Path	Trace/Detector
Mode	All except SA and BASIC
Remote Command	<code>[:SENSe] :MONitor:DETEctor:TRACe AVERage NEGative NORMal POSitive SAMPle [:SENSe] :MONitor:DETEctor:TRACe?</code>
Example	MON:DET:TRAC NORM MON:DET:TRAC?
Notes	The query returns a name that corresponds to the detector type as shown below. String Returned - Definition <ul style="list-style-type: none"> • NORM - Normal • AVER - Average • POS - Peak • SAMP - Sample • NEG - Negative Peak
Couplings	When the Detector choice is Auto , the detector selected depends on average type.
Preset	NORMal
State Saved	Saved in instrument state.
Range	Normal Average(RMS) Peak Sample Negative Peak
Backwards Compatibility SCPI	<code>[:SENSe] :MONitor:DETEctor [:FUNction]</code>
Initial S/W Revision	Prior to A.02.00

Auto

Sets the detector for the currently selected trace to **Auto**. When the detector choice is **Auto**, the analyzer selects the detector. The selected detector depends on marker functions, trace functions, and trace averaging functions for the current measurement.

Key Path	Trace/DetectorTrace/Detector, Detector
Mode	All except SA and BASIC
Remote Command	<code>[:SENSe] :MONitor :DETECTOR :AUTO ON OFF 1 0</code> <code>[:SENSe] :MONitor :DETECTOR :AUTO ?</code>
Example	<code>MON:DET:AUTO OFF</code> <code>MON:DET:AUTO ?</code>
Couplings	When the Detector choice is Auto, the detector selected depends on average state and trace type.
Preset	ON
State Saved	Saved in instrument state.
Range	Auto Man
Initial S/W Revision	Prior to A.02.00

Clear Trace

Clears the selected trace from the display.

Key Path	Trace/Detector
Mode	All except SA and BASIC
Remote Command	<code>:TRACe :MONitor :CLEAr [TRACE1] TRACE2 TRACE3</code>
Example	<code>TRAC:MON:CLE</code>
Initial S/W Revision	Prior to A.02.00

Mode	All except SA and BASIC
Remote Command	<code>:DISPlay :MONitor :VIEW :WINDow :TRACe [1] 2 3 :CLEAr</code>
Example	<code>DISP:MON:VIEW:WIND:TRAC:CLE</code>
Initial S/W Revision	Prior to A.02.00

Clear All Traces

Clears all traces from the display.

Key Path	Trace/Detector
Mode	All except SA and BASIC

Remote Command	:TRACe:MONitor:CLEar:ALL
Example	TRAC:MON:CLE:ALL
Backwards Compatibility SCPI	:DISPlay:MONitor:VIEW:WINDow:TRACe:CLEar:ALL
Initial S/W Revision	Prior to A.02.00

Trigger

See ["Trigger" on page 444](#)

Free Run

See ["Free Run " on page 451](#)

Video

See ["Video \(IF Envelope\) " on page 452](#)

Trigger Level

See ["Trigger Level " on page 452](#)

Trig Slope

See ["Trig Slope " on page 453](#)

Trig Delay

See ["Trig Delay " on page 454](#)

Line

See ["Line " on page 2235](#)

Trig Slope

See ["Trig Slope " on page 2235](#)

Trig Delay

See ["Trig Delay " on page 456](#)

External 1

See ["External 1 " on page 2248](#)

Trigger Level

See ["Trigger Level " on page 2248](#)

Trig Slope

See ["Trig Slope " on page 2249](#)

Trig Delay

See ["Trig Delay " on page 459](#)

Zero Span Delay Comp

See ["Zero Span Delay Comp On/Off" on page 2237](#)

External 2

See ["External 2 "](#) on page 2250

Trigger Level

See ["Trigger Level "](#) on page 2250

Trig Slope

See ["Trig Slope "](#) on page 2251

Trig Delay

See ["Trig Delay "](#) on page 461

Zero Span Delay Comp

See ["Zero Span Delay Comp On/Off"](#) on page 2239

RF Burst

See ["RF Burst "](#) on page 2251

Absolute Trigger

See ["Absolute Trigger Level"](#) on page 2252

Relative Trigger

See ["Relative Trigger Level"](#) on page 2241

Trig Slope

See ["Trigger Slope "](#) on page 2253

Trig Delay

See ["Trig Delay "](#) on page 466

Periodic Timer

See ["Periodic Timer \(Frame Trigger\) "](#) on page 2243

Period

See ["Period "](#) on page 2244

Offset

See ["Offset "](#) on page 2245

Reset Offset Display

See ["Reset Offset Display "](#) on page 2247

Sync Source

See "Sync Source " on page 2247

Off

See "Off " on page 2248

External 1

See "External 1 " on page 2248

Trigger Level

See "Trigger Level " on page 2248

Trig Slope

See "Trig Slope " on page 2249

External 2

See "External 2 " on page 2250

Trigger Level

See "Trigger Level " on page 2250

Trig Slope

See "Trig Slope " on page 2251

RF Burst

See "RF Burst " on page 2251

Absolute Trigger

See "Absolute Trigger Level" on page 2252

Trig Slope

See "Trigger Slope " on page 2253

Trig Delay

See "Trig Delay" on page 476

Auto/Holdoff

See "Auto/Holdoff " on page 477

Auto Trig

See "Auto Trig " on page 477

Trig Holdoff

See "Trig Holdoff " on page 478

15 Monitor Spectrum Measurement
Trigger

Holdoff Type

See "[Holdoff Type](#)" on page 478

User Preset

Accesses a menu that gives you the following three choices:

- **User Preset** – recalls a state previously saved using the Save User Preset function.
- **User Preset All Modes** – presets all of the modes in the analyzer
- **Save User Preset**– saves the current state for the current mode

Key Path	Front-panel key
Backwards Compatibility Notes	<p>User Preset is actually loading a state, and in legacy analyzers, it was possible to load a state without affecting the trace data, limit lines or correction data. Similarly it was possible to do a User Preset without affecting the trace data, limit lines or correction data.</p> <p>In the X-Series, “state” always includes all of this data; so whenever state is loaded, or User Preset is executed, all of the traces, limit lines and corrections are affected. Although this differs from previous behavior, it is desirable behavior, and should not cause adverse issues for users.</p> <p>On ESA and PSA, User Preset affected the entire instrument’s state. In the X-Series, User Preset only recalls the state for the active mode. There is a User Preset file for each mode. User Preset can never cause a mode switch as it can in legacy analyzers. If you want to recall all modes to their user preset file state, you will need to do a User Preset after mode switching into each mode.</p> <p>User Preset recalls mode state which can now include data like traces; whereas on ESA and PSA, User Preset did not affect data.</p>
Initial S/W Revision	Prior to A.02.00

User Preset

User Preset sets the state of the currently active mode back to the state that was previously saved for this mode using the Save User Preset menu key or the SCPI command, `SYST:PRES:USER:SAV`. It not only recalls the Mode Preset settings, but it also recalls all of the mode persistent settings, and the Input/Output system setting that existed at the time Save User Preset was executed.

If a Save User Preset has not been done at any time, User Preset recalls the default user preset file for the currently active mode. The default user preset files are created if, at power-on, a mode detects there is no user preset file. There will never be a scenario when there is no user preset file to restore. For each mode, the default user preset state is the same state that would be saved if a Save User Preset is performed in each mode right after doing a Restore Mode Default and after a Restore Input/Output Defaults.

The User Preset function does the following:

- Aborts the currently running measurement.
- Sets the mode State to the values defined by Save User Preset.
- Makes the saved measurement for the currently running mode the active measurement.
- Brings up the saved menu for the power-on mode.
- Clears the input and output buffers.
- Sets the Status Byte to 0.

Key Path	User Preset
Remote Command	:SYSTem:PRESet:USER
Example	:SYST:PRES:USER:SAVE:SYST:PRES:USER
Notes	:SYST:PRES:USER:SAVE is used to save the current state as the user preset state. Clears all pending OPC bits. The Status Byte is set to 0. Pressing the User Preset front-panel key while already in the User Preset menu will cause the User Preset to get executed
Couplings	A user preset will cause the currently running measurement to be aborted and cause the saved measurement to be active. Recalling a User Preset file has the same issues that recalling a Save State file has. Some settings may need to be limited and therefore re-coupled, since the capabilities of the mode may have changes when the User Preset file was last saved.
Initial S/W Revision	Prior to A.02.00

User Preset All Modes

Recalls all of the User Preset files for each mode, switches to the power-on mode, and activates the saved measurement from the power-on mode User Preset file.

NOTE

When the instrument is secured, all of the user preset files are converted back to their default user preset files.

The User Preset function does the following:

- Aborts the currently running measurement.
- Switches the Mode to the power-on mode.
- Restores the User Preset files for each mode.
- Makes the saved measurement for the power-on mode the active measurement.
- Brings up the saved menu for the power-on mode.
- Clears the input and output buffers.
- Sets the Status Byte to 0.

Key Path	User Preset
Remote Command	:SYSTem:PRESet:USER:ALL
Example	:SYST:PRES:USER:SAVE:SYST:PRES:USER:ALL
Notes	Clears all pending OPC bits. The Status Byte is set to 0. :SYST:PRES:USER:SAVE is used to save the current state as the user preset state.
Couplings	A user preset will cause the currently running measurement to be aborted, cause a mode switch to the power-on mode, and cause the saved measurement to be active in the power-on mode. Recalling a User Preset file has the same issues that recalling a Save State file has. Some settings may need to be limited and therefore re-coupled, since the capabilities of the mode may have changes when the User Preset file was last saved.

Initial S/W Revision	Prior to A.02.00
----------------------	------------------

Save User Preset

Saves the currently active mode and its State. You can recall this User Preset file by pressing the User Preset menu key or sending the SYST:PRES:USER remote command. This same state is also saved by the Save State function.

Key Path	User Preset
Remote Command	:SYSTem:PRESet:USER:SAVE
Example	:SYST:PRES:USER:SAVE
Notes	:SYST:PRES:SAVE creates the same file as if the user requested a *SAV or a MMEM:STOR:STAT, except User Preset Save does not allow the user to specify the filename or the location of the file.
Initial S/W Revision	Prior to A.02.00

View/Display

Accesses a menu of functions that enable you to control certain functions related to the display of the analyzer.

The available views and related commands depend on the currently-selected mode. This section includes the following topics:

- "View for all modes except MSR, 1xEV-DO, LTE-Advanced FDD/TDD" on page 2274, LTE-Advanced FDD/TDD
- "1xEV-DO Mode View" on page 2275
- "MSR and LTE-Advanced FDD/TDD Mode Views" on page 2275
- "View Selection by Name (MSR and LTE-Advanced FDD/TDD mode only)" on page 2276
- "View Selection by Number (MSR and LTE-Advanced FDD/TDD mode only)" on page 2276

View for all modes except MSR, 1xEV-DO, LTE-Advanced FDD/TDD

When the current mode is **not** MSR, LTE-Advanced FDD/TDD or 1xEV-DO, there is a single trace view for this measurement, as shown below:

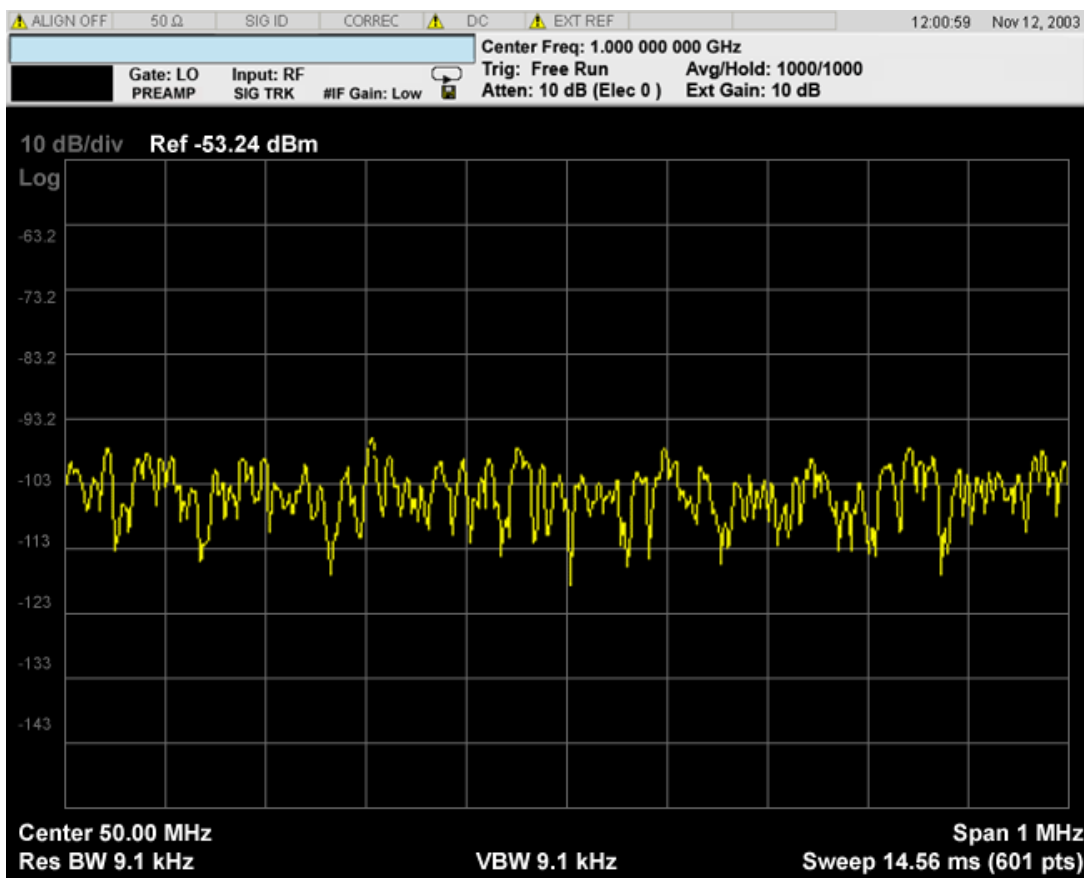

1xEV-DO Mode View

When the current mode is 1xEV-DO, a single view is available, as shown in the example below:

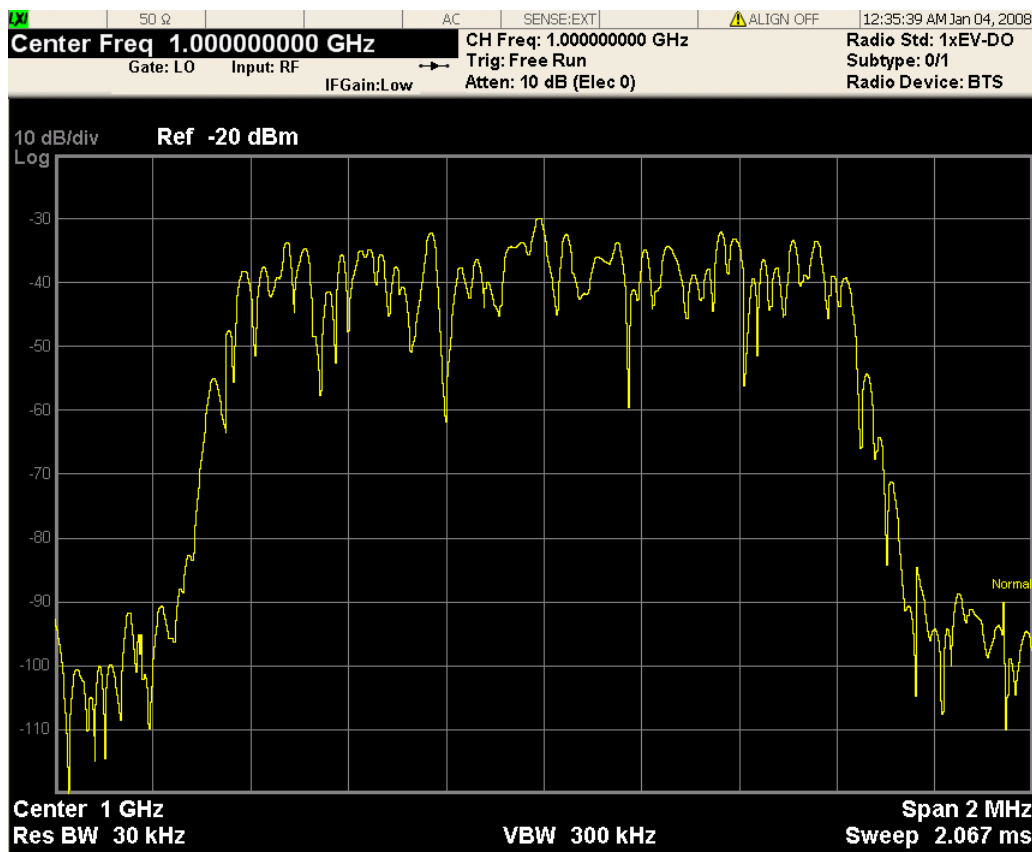

The measurement has no results, but has a number of features that make it flexible and simple to use.

MSR and LTE-Advanced FDD/TDD Mode Views

When the current mode is MSR and LTE-Advanced FDD/TDD, there are two views, Result Trace and Carrier Info, as described in the table below. The Result Trace view is the same as the common Monitor Spectrum view in other modes. Carrier Info is available on the spectrum trace.

Result Trace	The spectrum trace and power bars are displayed in the upper window. Carrier and offset powers are summarized in the lower window. For more details, see " Result Trace (MSR and LTE-Advanced FDD/TDD mode only) " on page 2285.
Carrier Info	Carrier center frequency can be displayed in either offset or absolute frequency depending on Carrier Freq. The table can be scrolled by Select Carrier in the Config Carriers menu. The highlighted row changes as Select Carrier is changed. The highlighted row and Select Carrier are not coupled. For more details, see " Carrier Info (MSR and LTE-Advanced FDD/TDD mode only) " on page 2286.

View Selection by Name (MSR and LTE-Advanced FDD/TDD mode only)

Key Path	Display
Mode	MSR, LTEAFDD, LTEATDD
Remote Command	:DISPlay:MONitor:VIEW[:SElect] RTRace CINformation :DISPlay:MONitor:VIEW[:SElect]?
Example	DISP:MON:VIEW RTR DISP:MON:VIEW?
Preset	RTRace
State Saved	Saved in instrument state
Range	Power Results Carrier Info
Initial S/W Revision	A.10.00

View Selection by Number (MSR and LTE-Advanced FDD/TDD mode only)

Key Path	DISP:MON:VIEW
Mode	MSR, LTEAFDD, LTEATDD
Remote Command	:DISPlay:MONitor:VIEW:NSElect <integer> :DISPlay:MONitor:VIEW:NSElect?
Example	DISP:MON:VIEW:NSEL 1 DISP:MON:VIEW:NSEL?
Preset	1
State Saved	Saved in instrument state
Min	1
Max	2
Initial S/W Revision	A.10.00

Key Path	Front-panel key
Initial S/W Revision	Prior to A.02.00

Display

The Display menu is common to most measurements, and is used for configuring items on the display. Some Display menu settings apply to all the measurements in a mode, and some only to the current measurement. Those under the **System Display Settings** key apply to all measurements in all modes.

Key Path	Display
-----------------	----------------

Key Path	View/Display
Initial S/W Revision	Prior to A.02.00

Annotation

Turns on and off various parts of the display annotation. The annotation is divided up into four categories:

1. Meas Bar: This is the measurement bar at the top of the screen. It does not include the settings panel or the Active Function. Turning off the Meas Bar turns off the settings panel and the Active Function. When the Meas Bar is off, the graticule area expands to fill the area formerly occupied by the Meas Bar.
2. Screen Annotation: this is the annotation and annunciation around the graticule, including any annotation on lines (such as the display line, the threshold line, etc.) This does NOT include the marker number or the N dB result. When off, the graticule expands to fill the entire graticule area.
3. Trace annotation: these are the labels on the traces, showing their detector (or their math mode).
4. Active Function annotation: this is the active function display in the meas bar, and all of the active function values displayed on softkeys.

See the figure below. Each type of annotation can be turned on and off individually.

15 Monitor Spectrum Measurement
View/Display

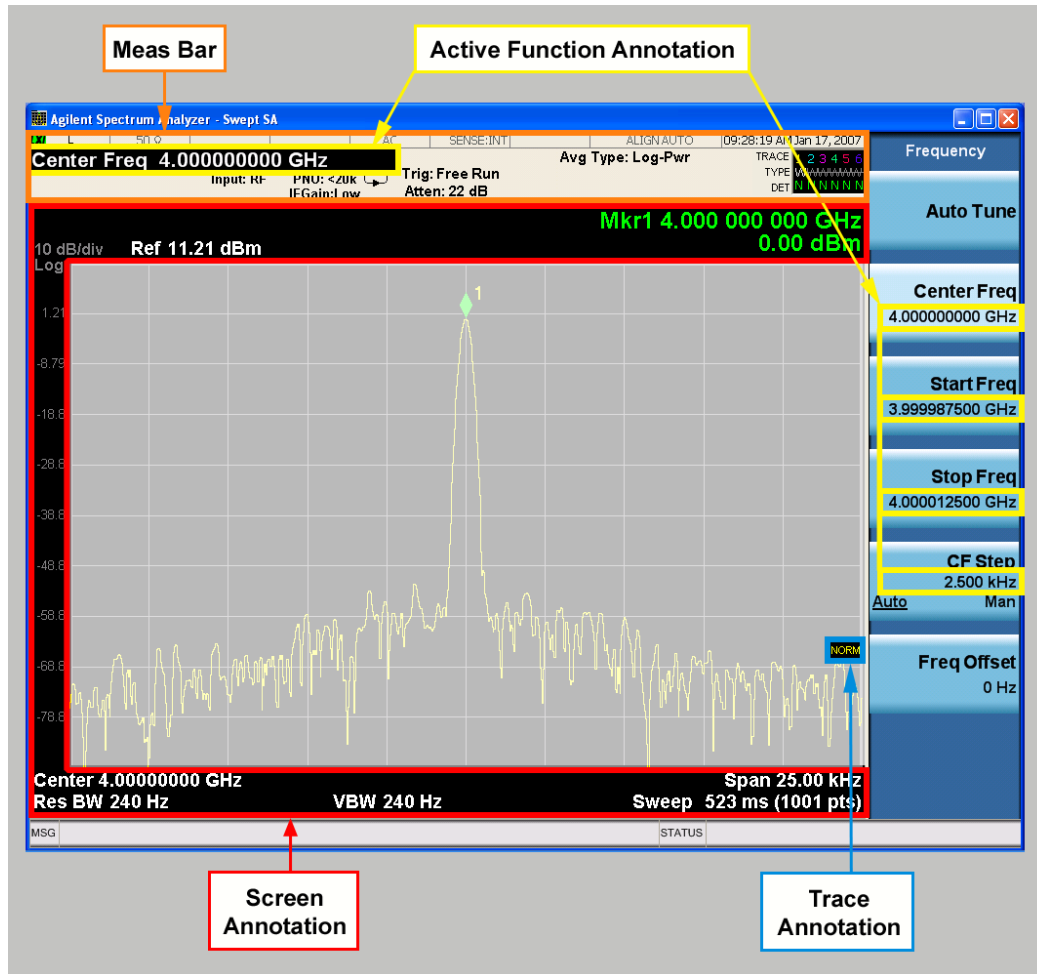

Key Path	View/Display, Display
Initial S/W Revision	Prior to A.02.00

Meas Bar On/Off

This function turns the Measurement Bar on and off, including the settings panel. When off, the graticule area expands to fill the area formerly occupied by the Measurement Bar.

Key Path	View/Display, Display, Annotation
Remote Command	:DISPlay:ANNOtation:MBAR[:STATe] OFF ON 0 1 :DISPlay:ANNOtation:MBAR[:STATe]?
Example	DISP:ANN:MBAR OFF
Dependencies	Grayed out and forced to OFF when System Display Settings, Annotation is set to Off.
Preset	On This should remain Off through a Preset when System DisplaySettings, Annotation is set to Off.

State Saved	Saved in instrument state.
Initial S/W Revision	Prior to A.02.00

Screen

This controls the display of the annunciation and annotation around the graticule, including any annotation on lines (such as the display line, the threshold line, etc.) and the y-axis annotation. This does NOT include marker annotation (or the N dB result). When off, the graticule expands to fill the entire graticule area, leaving only the 1.5% gap above the graticule as described in the Trace/Detector chapter.

Key Path	View/Display, Display, Annotation
Remote Command	:DISPlay:ANNotation:SCReen[:STATe] OFF ON 0 1 :DISPlay:ANNotation:SCReen[:STATe]?
Example	DISP:ANN:SCR OFF
Dependencies	Grayed-out and forced to OFF when System Display Settings, Annotation is set to Off.
Preset	On This should remain Off through a Preset when System DisplaySettings, Annotation is set to Off
State Saved	Saved in instrument state.
Initial S/W Revision	Prior to A.02.00

Active Function Values On/Off

Turns on and off the active function display in the Meas Bar, and all of the active function values displayed on the softkeys.

Note that all of the softkeys that have active functions have these numeric values blanked when this function is on. This is a security feature..

15 Monitor Spectrum Measurement
View/Display

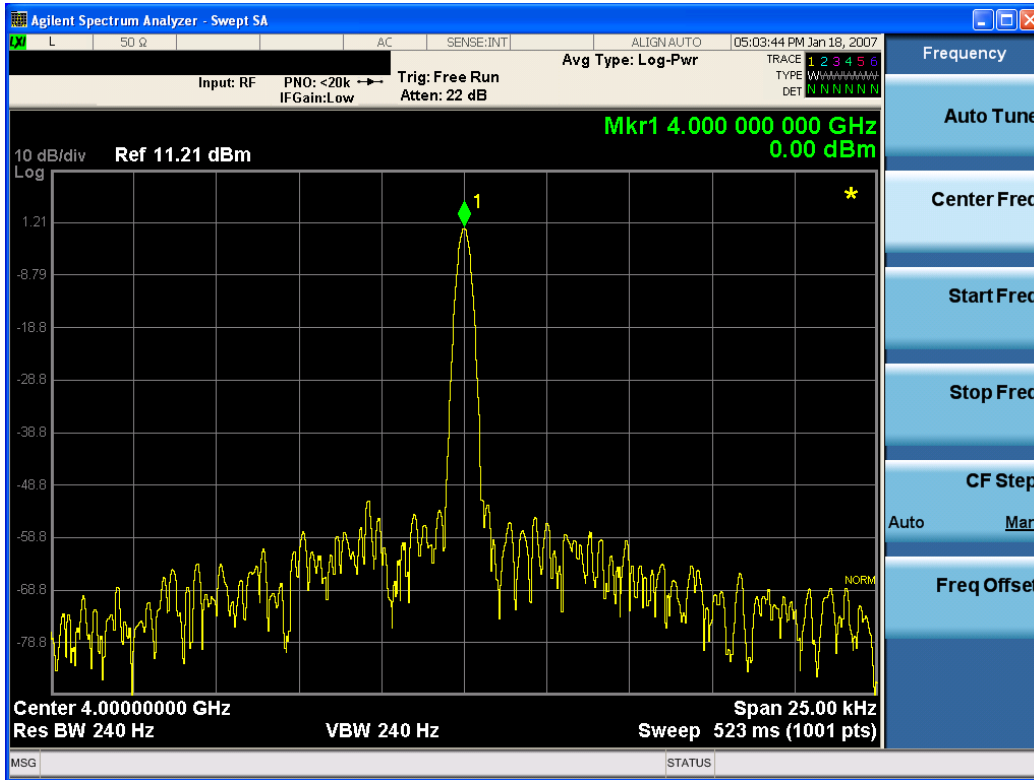

Key Path	View/Display, Display, Annotation
Remote Command	:DISPlay:ACTivefunc[:STATE] ON OFF 1 0 :DISPlay:ACTivefunc[:STATE] ?
Example	DISP:ACT OFF
Dependencies	Grayed out and forced to OFF when System Display Settings, Annotation is set to Off.
Preset	On This should remain Off through a Preset when System DisplaySettings, Annotation is set to Off
State Saved	Saved in instrument state.
Initial S/W Revision	Prior to A.02.00

Title

Displays menu keys that enable you to change or clear a title on your display.

Key Path	View/Display, Display
Initial S/W Revision	Prior to A.02.00

Change Title

Writes a title into the "measurement name" field in the banner, for example, "Swept SA".

Press Change Title to enter a new title through the alpha editor. Press Enter or Return to complete the entry. Press ESC to cancel the entry and preserve your existing title.

The display title will replace the measurement name. It remains for this measurement until you press **Change Title** again, or you recall a state, or a Preset is performed. A title can also be cleared by pressing **Title, Clear Title**.

NOTE

Notice the inclusion of the <measurement> parameter in the command below. Because each measurement remembers the Display Title, the command must be qualified with the measurement name. For the Swept SA measurement this is not the case; no <measurement> parameter is used when changing the Display Title for the Swept SA measurement.

Key Path	View/Display, Display, Title
Mode	All
Remote Command	:DISPlay:<measurement>:ANNotation:TITLe:DATA <string> :DISPlay:<measurement>:ANNotation:TITLe:DATA?
Example	DISP:ANN:TITL:DATA "This Is My Title" This example is for the Swept SA measurement in the Spectrum Analyzer mode. The SANalyzer <measurement> name is not used. DISP:ACP:ANN:TITL:DATA "This Is My Title" This example is for Measurements other than Swept SA. Both set the title to: This Is My Title
Notes	Pressing this key cancels any active function. When a title is edited the previous title remains intact (it is not cleared) and the cursor goes at the end so that characters can be added or BKSP can be used to go back over previous characters.
Preset	No title (measurement name instead)
State Saved	Saved in instrument state.
Initial S/W Revision	Prior to A.02.00

Clear Title

Clears a title from the front-panel display. Once cleared, the title cannot be retrieved. After the title is cleared, the current Measurement Name replaces it in the title bar.

Key Path	View/Display, Display, Title
Example	The following commands clear the title and restore the measurement's original title: DISP:ANN:TITL:DATA "" This example is for the Swept SA measurement in the Spectrum Analyzer mode. The SANalyzer <measurement> name is not used. DISP:ACP:ANN:TITL:DATA "" This example is for ACP; in measurements other than Swept SA the measurement name is required.
Notes	Uses the :DISPlay:<measurement>:ANNotation:TITLe:DATA <string> command with an empty string (in the Swept SA, the <measurement> is omitted).

Preset	Performed on Preset.
Initial S/W Revision	Prior to A.02.00

Graticule

Pressing Graticule turns the display graticule On or Off. It also turns the graticule y-axis annotation on and off.

Key Path	View/Display, Display
Remote Command	:DISPlay:WINDow[1]:TRACe:GRATicule:GRID[:STATe] OFF ON 0 1 :DISPlay:WINDow[1]:TRACe:GRATicule:GRID[:STATe]?
Example	DISP:WIND:TRAC:GRAT:GRID OFF
Notes	The graticule is the set of horizontal and vertical lines that make up the grid/divisions for the x-axis and y-axis.
Preset	On
State Saved	Saved in instrument state
Initial S/W Revision	Prior to A.02.00

System Display Settings

These settings are "Mode Global" – they affect all modes and measurements and are reset only by **Restore Misc Defaults** or **Restore System Defaults** under System.

Key Path	View/Display, Display
Initial S/W Revision	Prior to A.02.00

Annotation Local Settings

This is a Mode Global override of the meas local annotation settings. When it is **All Off**, it forces **ScreenAnnotation, Meas Bar, Trace, and Active Function Values** settings to be **OFF** for all measurements in all modes. This provides the security based "annotation off" function of previous analyzers; hence it uses the legacy SCPI command.

When it is **All Off**, the **Screen, Meas Bar, Trace, and Active Function Values** keys under the **Display, Annotation** menu are grayed out and forced to **Off**. When **Local Settings** is selected, you are able to set the local annotation settings on a measurement by measurement basis.

Key Path	View/Display, Display, System Display Settings
Remote Command	:DISPlay:WINDow[1]:ANNotation[:ALL] OFF ON 0 1 :DISPlay:WINDow[1]:ANNotation[:ALL]?
Example	:DISP:WIND:ANN OFF

Preset	On (Set by Restore Misc Defaults)
State Saved	Not saved in instrument state.
Backwards Compatibility Notes	The WINDow parameter and optional subopcode is included for backwards compatibility but ignored – all windows are equally affected.
Initial S/W Revision	Prior to A.02.00

Themes

Accesses a menu of functions that enable you to choose the theme to be used when saving the screen image.

The **Themes** option is the same as the **Themes** option under the **Display** and **Page Setup** dialogs. It allows you to choose between themes to be used when saving the screen image.

Key Path	Save, Screen Image
Remote Command	:MMEMory:STORe:SCReen:THEMe TDColor TDMonochrome FCOLOR FMONochrome :MMEMory:STORe:SCReen:THEMe?
Example	:MMEM:STOR:SCR:THEM TDM
Preset	3D Color; Is not part of Preset, but is reset by Restore Misc Defaults or Restore System Defaults All and survives subsequent running of the modes.
Readback	3D Color 3D Mono Flat Color Flat Mono
Backwards Compatibility Notes	In ESA and PSA we offer the choice of "Reverse Bitmap" or "Reverse Metafile" when saving screen images. This is much like the "Flat Color" theme available in X-Series. Also, if you selected Reverse Bitmap AND a black & white screen image, that would be much like "Flat Monochrome". In other words, each of the X-Series themes has a similar screen image type in ESA/PSA. But they are not identical.
Initial S/W Revision	Prior to A.02.00

3D Color

Selects a standard color theme with each object filled, shaded and colored as designed.

Key Path	Save, Screen Image, Themes
Example	MMEM:STOR:SCR:THEM TDC
Readback	3D Color
Initial S/W Revision	Prior to A.02.00

3D Monochrome

Selects a format that is like 3D color but shades of gray are used instead of colors.

Key Path	Save, Screen Image, Themes
Example	MMEM:STOR:SCR:THEM TDM
Readback	3D Mono
Initial S/W Revision	Prior to A.02.00

Flat Color

Selects a format that is best when the screen is to be printed on an ink printer.

Key Path	Save, Screen Image, Themes
Example	MMEM:STOR:SCR:THEM FCOL
Readback	Flat Color
Initial S/W Revision	Prior to A.02.00

Flat Monochrome

Selects a format that is like Flat Color. But only black is used (no colors, not even gray), and no fill.

Key Path	Save, Screen Image, Themes
Example	MMEM:STOR:SCR:THEM FMON
Readback	Flat Mono
Initial S/W Revision	Prior to A.02.00

Backlight

Accesses the display backlight on/off keys. This setting may interact with settings under the Windows "Power" menu.

When the backlight is off, pressing ESC, TAB, SPACE, ENTER, UP, DOWN, LEFT, RIGHT, DEL, BKSP, CTRL, or ALT turns the backlight on without affecting the application. Pressing any other key will turn backlight on and could potentially perform the action as well.

Key Path	View/Display, Display, System Display Settings
Remote Command	:DISPlay:BACKlight ON OFF :DISPlay:BACKlight?
Preset	ON (Set by Restore Misc Defaults)
Initial S/W Revision	Prior to A.02.00

Backlight Intensity

An active function used to set the backlight intensity. It goes from 0 to 100 where 100 is full on and 0 is off. This value is independent of the values set under the Backlight on/off key.

Key Path	View/Display, Display, System Display Settings
Remote Command	:DISPlay:BACKlight:INTensity <integer> :DISPlay:BACKlight:INTensity?
Example	DISP:BACK:INT 50
Preset	100 (Set by Restore Misc Defaults)
Min	0
Max	100
Initial S/W Revision	Prior to A.02.00

Result Trace (MSR and LTE-Advanced FDD/TDD mode only)

The spectrum trace and power bars are displayed in the upper window.

Carrier and offset powers are summarized in the lower window.

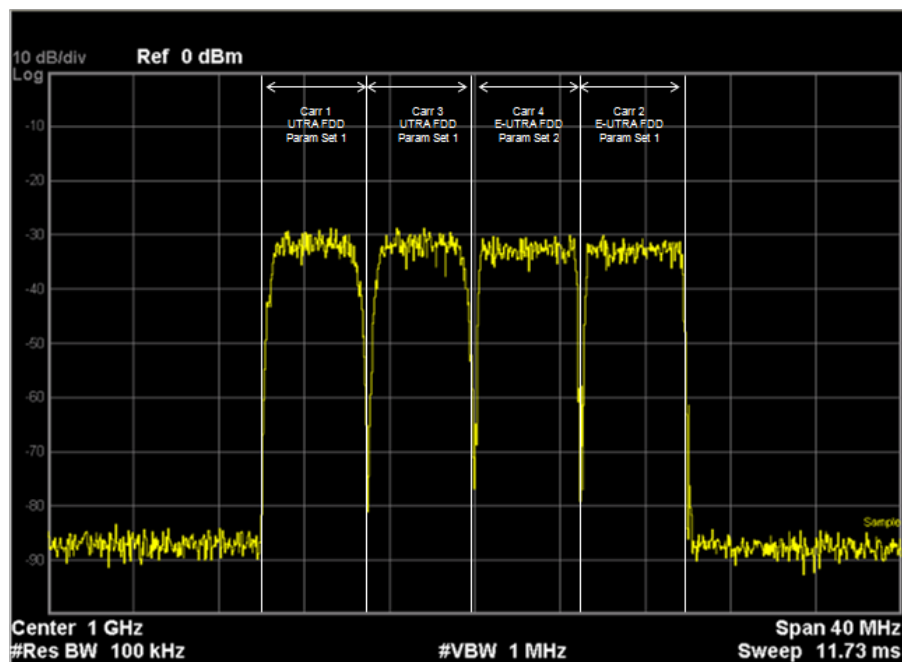

15 Monitor Spectrum Measurement
View/Display

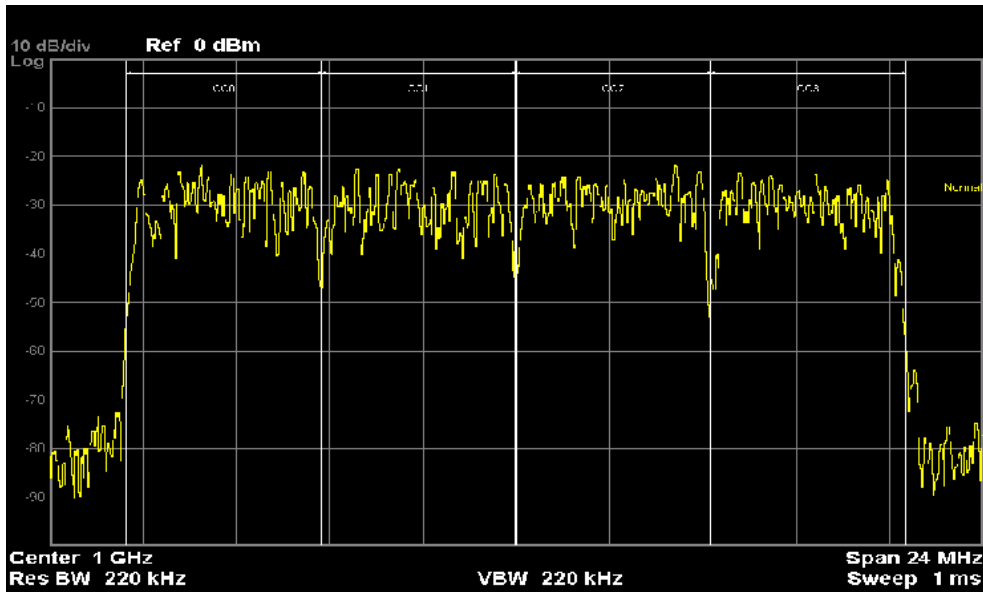

Key Path View/Display

Initial S/W Revision A.10.00

Carrier Info (MSR and LTE-Advanced FDD/TDD mode only)

Carrier center frequency can be displayed in either offset or absolute frequency depending on Carrier Freq. The table can be scrolled by Select Carrier on Config Carriers menu. The highlighted row changes as Select Carrier is changed. The highlighted row and Select Carrier are not coupled.

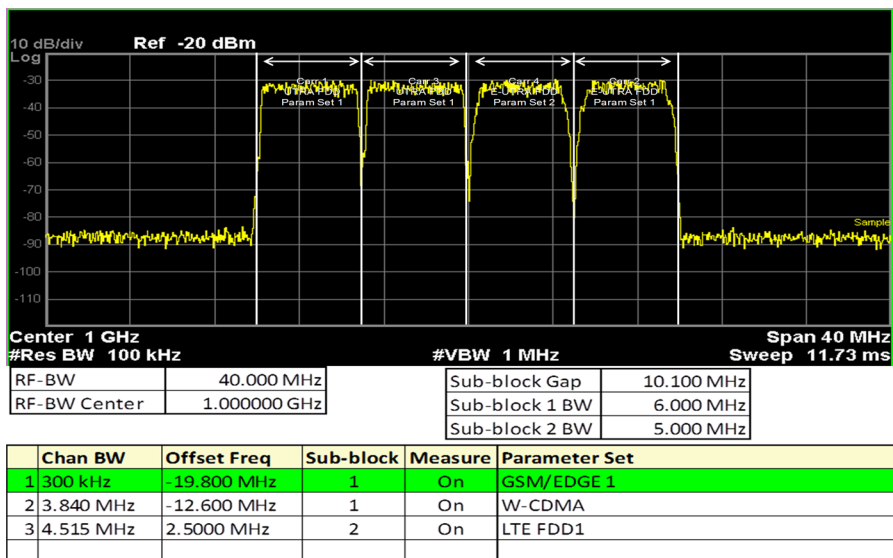

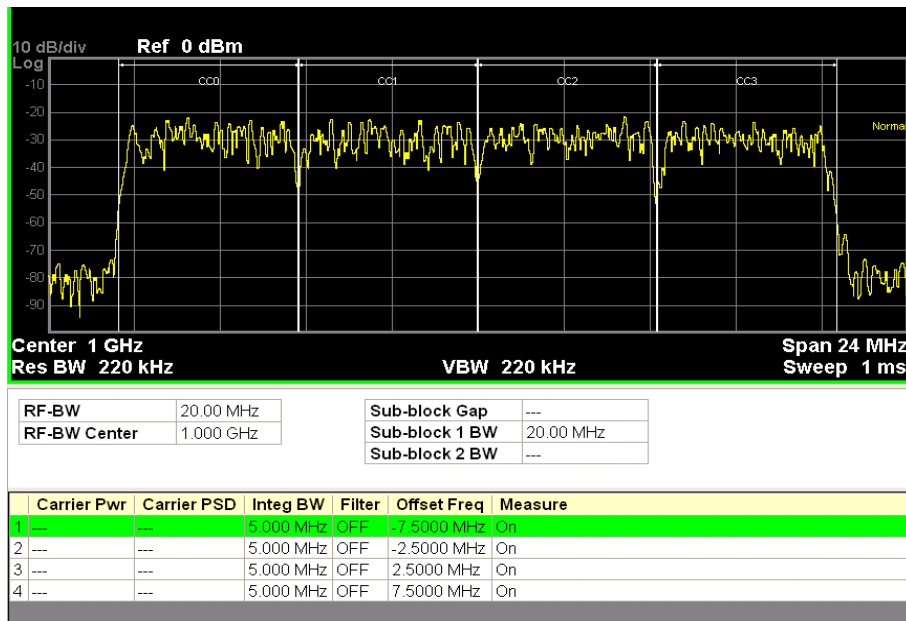

Key Path	View/Display
Initial S/W Revision	A.10.00
Modified at S/W Revision	A.13.00

Carrier Freq (MSR and LTE-Advanced FDD/TDD mode only)

Selects frequency display type between:

- **OFFSet**: carrier frequencies in the carrier table are shown as offsets from Carrier Ref Freq.
- **ABSolute**: absolute frequencies are displayed.

Key Path	View/Display, Carrier Info
Mode	MSR, LTEAFDD, LTEATDD
Remote Command	:DISPlay:MONitor:VIEW:WINDow:CINFormation:FREQuency OFFSet ABSolute :DISPlay:MONitor:VIEW:WINDow:CINFormation:FREQuency?
Example	DISP:MON:VIEW:WIND:CINF:FREQ ABS DISP:MON:VIEW:WIND:CINF:FREQ?
Notes	You must be in the MS and LTE-Advanced FDD/TDDR mode to use this command. Use :INSTrument:SElect to set the mode.
Preset	OFFSet
State Saved	Saved in instrument state
Range	Offset Absolute
Initial S/W Revision	A.10.00

Carrier Attribute (MSR and LTE-Advanced FDD/TDD mode only)

Toggles whether or not carrier information is shown on the spectrum trace.

Carrier attributes are displayed as shown below left. When the Span is greater, there is insufficient space to display this texts. In this case, only vertical lines and arrows are displayed, without text.

The attribute text elements may overlap, as shown below right.

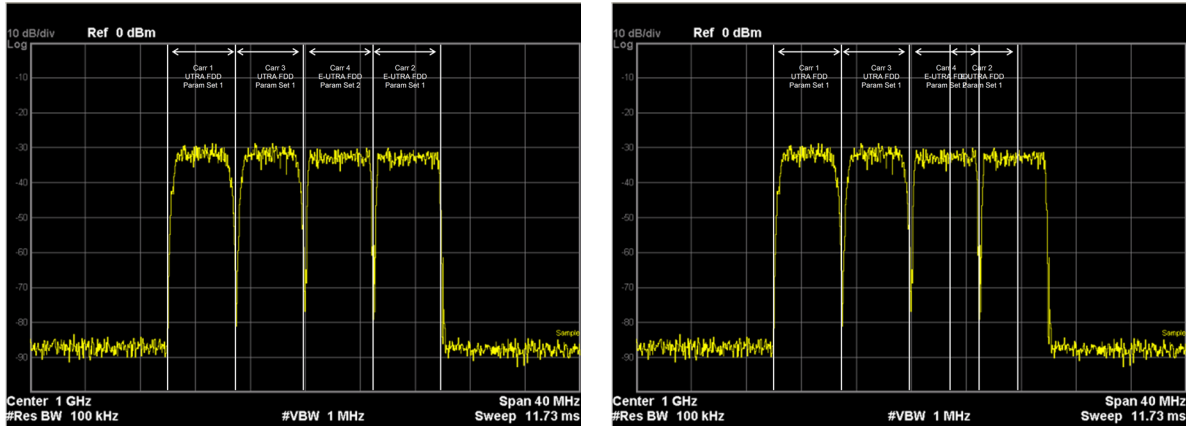

Key Path	View/Display
Mode	MSR, LTEAFDD, LTEATDD
Remote Command	:DISPlay:MONitor:VIEW:WINDow:CATtribute OFF ON 0 1 :DISPlay:MONitor:VIEW:WINDow:CATtribute?
Example	DISP:MON:VIEW:WIND:CATT 0 DISP:MON:VIEW:WIND:CATT?
Notes	You must be in MSR and LTE-Advanced FDD/TDD to use this command. Use :INSTrument:SELEct to set the mode.
Preset	ON
State Saved	Saved in instrument state.
Range	On Off
Initial S/W Revision	A.10.00

Sub-block Attribute (Only for MSR and LTE-Advanced FDD/TDD)

Toggles the sub-block information on the spectrum trace. Sub-block attributes are displayed as shown below.

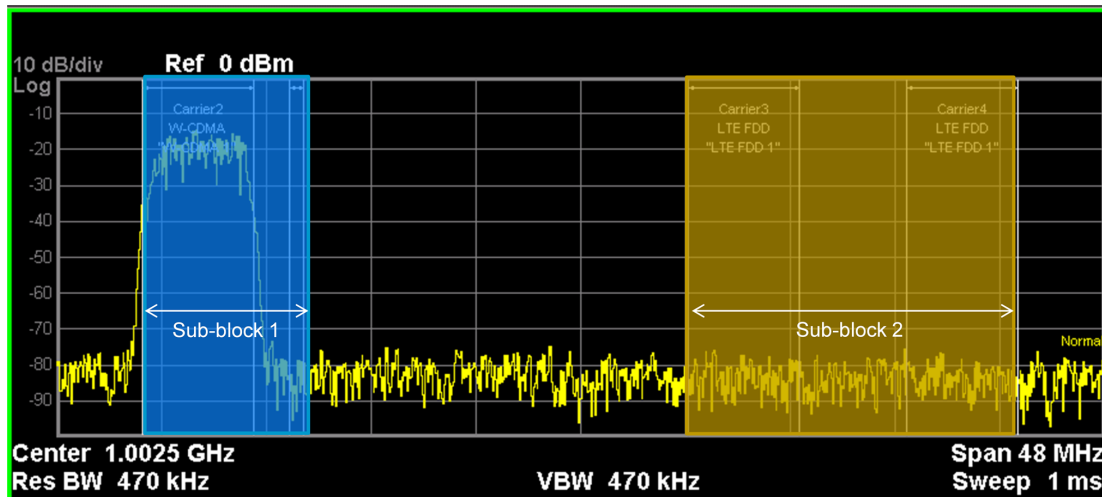

Key Path	View/Display
Mode	MSR, LTEAFDD, LTEATDD
Remote Command	:DISPlay:MONitor:VIEW:WINDow:SATtribute[:STATE] OFF ON 0 1 :DISPlay:MONitor:VIEW:WINDow:SATtribute[:STATE]?
Example	DISP:MON:VIEW:WIND:SATT 0 DISP:MON:VIEW:WIND:SATT?
Notes	You must be in MSR and LTE-Advanced FDD/TDD to use this command. Use :INSTRument:SElect to set the mode.
Preset	OFF
State Saved	Saved in instrument state.
Range	On Off
Initial S/W Revision	A.13.00

16 Waveform Measurement

The waveform measurement is a generic measurement for viewing the input signal waveforms in the time domain. This measurement represents how the instrument performs the zero span functionality found in traditional spectrum analyzers. For more details, see ["Waveform Measurement Description" on page 2294](#) below.

This topic contains the following sections:

["Measurement Commands for Waveform" on page 2292](#)

["Remote Command Results for the Waveform Measurement" on page 2293](#)

Measurement Commands for Waveform

The general functionality of CONFigure, INITiate, FETCh, MEASure, and READ are described at this section.

:CONFigure:WAVEform

:CONFigure:WAVEform:NDEFault

:INITiate:WAVEform

:FETCh:WAVEform[n]?

:MEASure:WAVEform[n]?

:READ:WAVEform[n]?

For more measurement related commands, see the SENSE subsystem, and the section ["Remote Measurement Functions" on page 2381](#).

Remote Command Results for the Waveform Measurement

The following table denotes the returned results from the FETCh|MEASure|READ commands:

n	Results Returned
0	Returns unprocessed I/Q trace data, as a series of trace point values, in volts. The I values are listed first in each pair, using the 0 through even-indexed values. The Q values are the odd-indexed values.
1	<p>Returns the following scalar results:</p> <ol style="list-style-type: none"> 1. Sample Time is a floating point number representing the time between samples when using the trace queries (n=0, 2, and so forth). 2. Mean Power is the mean power (in dBm). This is the power across the entire trace. If averaging is on, the power is for the latest acquisition. 3. Mean Power Averaged is the power (in dBm) for N averages, if averaging is on. This is the power across the entire trace. If averaging is on, the power is for the latest acquisition. If averaging is off, the value of the mean power averaged is the same as the value of the mean power. 4. Number of samples is the number of data points in the captured signal. This number is useful when performing a query on the signal (i.e. when n=0, 2, etc.). 5. Peak-to-mean ratio has units of dB. This is the ratio of the maximum signal level to the mean power. Valid values are only obtained with averaging turned off. If averaging is on, the peak-to-mean ratio is calculated using the highest peak value, rather than the displayed average peak value. 6. Maximum value is the maximum of the most recently acquired data (in dBm). 7. Minimum value is the minimum of the most recently acquired data (in dBm).
2	Returns trace point values of the entire captured signal envelope trace data. These data points are floating point numbers representing the power of the signal (in dBm). There are N data points, where N is the number of samples. The period between the samples is defined by the sample time.

Waveform Measurement Description

Also available under the basic Waveform measurement is an I/Q window, which shows the I and Q signal waveforms in parameters of voltage versus time to disclose the voltages that comprise the complex modulated waveform of a digital signal.

The waveform measurement can also be used to perform general purpose power measurements to a high degree of accuracy.

Key Path	Front-panel key
Initial S/W Revision	Prior to A.02.00

AMPTD Y Scale

Accesses a menu of functions that enable you to set the vertical scale parameters.

Key Path	Front-panel key
Initial S/W Revision	Prior to A.02.00

Ref Value (RF Envelope View)

Sets the Y Scale reference value (in dBm) when the RF Envelope View is active. By default, the measurement determines the reference value with Auto Scaling. Entering a reference value manually turns Auto Scaling off.

Key Path	AMPTD Y Scale
Mode	BASIC, PNOISE, WCDMA, C2K, GSM, WIMAXOFDMA, TDSCDMA, 1XEVD0, DVB, DTMB, ISDBT, CMMB, LTE, LTETDD, DCATV, WLAN,LTEATDD, LTEAFDD
Remote Command	:DISPlay:WAVeform:VIEW[1]:WINDow[1]:TRACe:Y[:SCALE]:RLEVel <ampl> :DISPlay:WAVeform:VIEW[1]:WINDow[1]:TRACe:Y[:SCALE]:RLEVel?
Example	DISP:WAV:VIEW:WIND:TRAC:Y:RLEV -50 dBm DISP:WAV:VIEW:WIND:TRAC:Y:RLEV?
Notes	You must be in the mode that includes Waveform measurement to use this command. Use INSTRument:SElect to set the mode.
Couplings	When Auto Scaling is On, this value is automatically determined by the measurement result. When you set a value manually, Auto Scaling automatically changes to Off.
Preset	10.00 dBm
State Saved	Saved in instrument state.
Range	-250.00 dBm to 250.00 dBm
Min	-250.00 dBm
Max	250.00 dBm
Initial S/W Revision	Prior to A.02.00
Modified at S/W Revision	A.03.00

Attenuation

This menu controls the attenuator functions and interactions between the attenuation system components.

There are two attenuator configurations in the X-Series. One is a dual attenuator configuration consisting of a mechanical attenuator and an optional electronic attenuator. The other configuration uses a single attenuator with combined mechanical and electronic sections that controls all the attenuation functions. Different models in the X-Series come with different configurations.

See "[Dual Attenuator Configurations:](#)" on page 2296

See ["Single Attenuator Configuration:" on page 2297](#)

Most Attenuation settings are the same for all measurements – they do not change as you change measurements. Settings like these are called “Meas Global” and are unaffected by Meas Preset.

Key Path	AMPTD Y Scale
Scope	Meas Global
Dependencies	In measurements that support the I/Q inputs, this key is unavailable when I/Q is the selected input, and is replaced by the Range key in that case.
Readback Line	Contains a summary in [] brackets of the current total attenuation. See the descriptions of the , " (Mech) Atten " on page 2297, and " Enable Elec Atten " on page 2299 keys for more detail on the contributors to the total attenuation. Note that when "Pre-Adjust for Min Clip" is on, this value can change at the start of every measurement.
Initial S/W Revision	Prior to A.02.00
Modified at S/W Revision	A.03.00

Dual Attenuator Configurations:

Configuration 1: Mechanical attenuator + optional electronic attenuator

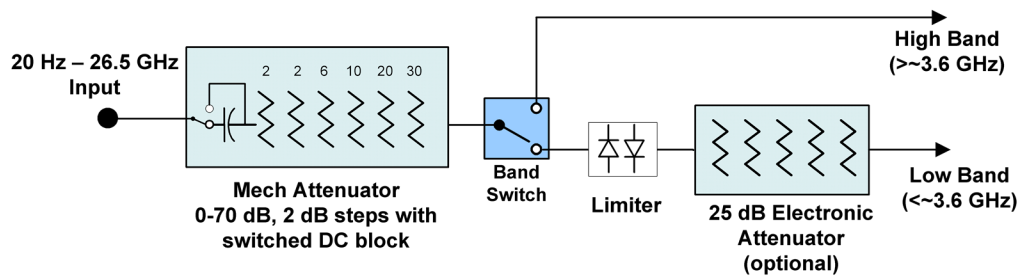

Configuration 2: Mechanical attenuator, no optional electronic attenuator

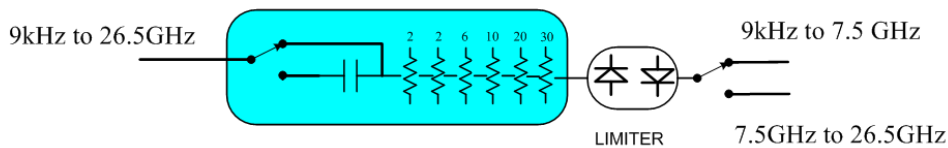

(note that Configuration 2 is not strictly speaking a dual-section attenuator, since there is no electronic section available. However, it behaves exactly like Configuration 1 without the Electronic Attenuator option EA3, therefore for the sake of this document it is grouped into the “Dual Attenuator” configuration)

Single Attenuator Configuration:

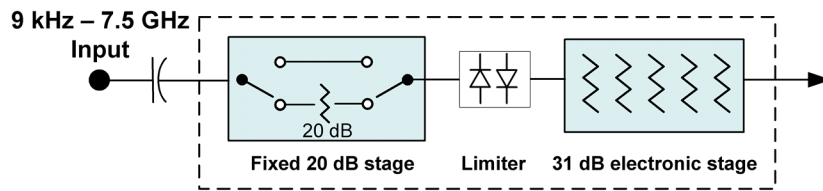

You can tell which attenuator configuration you have by pressing the Attenuation key, which (in most Modes) opens the Attenuation menu. If the first key in the Attenuation menu says **Mech Atten** you have the dual attenuator configuration. If the first key says **Atten** you have the single attenuator configuration.

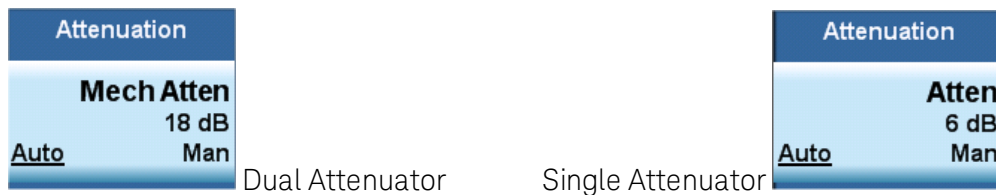

In the single attenuator configuration, you control the attenuation with a single control, as the fixed stage has only two states. In the dual attenuator configuration, both stages have significant range so you are given separate control of the mechanical and electronic attenuator stages.

When you have the dual attenuator configuration, you may still have only a single attenuator, because unless option EA3 (the Electronic Attenuator option) is available, and you purchase it, you will have only the mechanical attenuator.

(Mech) Atten

This key is labeled **Mech Atten** in dual attenuator models and **Atten** in single attenuator models. In the dual attenuator configuration, this key only affects the mechanical attenuator.

This key lets you modify the attenuation applied to the RF input signal path. This value is normally auto coupled to the Ref Level, the Internal Preamp Gain, any External Gain that is entered, and the Max Mixer Level, as described in the table below.

See "[Attenuator Configurations and Auto/Man](#)" on page 2299

Key Path	AMPTD Y Scale, Attenuation
Remote Command	<pre>[:SENSe]:POWer[:RF]:ATTenuation <rel_amp1> [:SENSe]:POWer[:RF]:ATTenuation? [:SENSe]:POWer[:RF]:ATTenuation:AUTO OFF ON 0 1 [:SENSe]:POWer[:RF]:ATTenuation:AUTO?</pre>
Example	<p>POW:ATT 20</p> <p>Dual attenuator configuration: sets the mechanical attenuator to 20 dB</p> <p>Single attenuator mode: sets the main attenuation to 20 dB (see below for definition of "main" attenuation).</p> <p>If the attenuator was in Auto, it sets it to Manual.</p>
Dependencies	Some measurements do not support the Auto setting of (Mech) Atten . In these measurements, the

Auto/Man selection is not available, and the Auto/Man line on the key disappears.

In dual attenuator configurations, when the electronic attenuator is enabled, the mechanical attenuator has no auto setting and the Auto/Man line on the key disappears. The state of Auto/Man is remembered and restored when the electronic attenuator is once again disabled. This is described in more detail in the ["Enable Elec Atten" on page 2299](#) key description.

See ["Attenuator Configurations and Auto/Man" on page 2299](#) for more information on the Auto/Man functionality of Attenuation.

Couplings

When **(Mech) Atten** is in Auto, it uses the following algorithm to determine a value:

If the USB Preamp is connected to USB, use 0 dB.

Otherwise, $Atten = ReferenceLevel + PreAmpGain + ExternalGain - RefLevelOffset - MaxMixerLevel + IF\ Gain$.

Limit this value to be between 6 dB and the Max value. No value below 6 dB can ever be chosen by Auto.

The resulting value is rounded up to the largest value possible given the attenuation step setting. That is, 50.01 dB would change to 60 dB (for a 10 dB attenuation step).

The "IF Gain" term in the equation above is either 0 dB or +10 dB, depending on the settings of FFT IF Gain, Swept IF Gain, max Ref Level and the Auto/Man setting of Mech Atten.

In External Mixing and BBIQ, where the Attenuator is not in the signal path, the Attenuator setting changes as described above when **(Mech) Atten** is in Auto, but no changes are made to the actual attenuator hardware setting until the input is changed back to the RF Input.

Preset The preset for Mech Attenuation is "Auto."
 The Auto value of attenuation is:
 CXA, EXA, MXA and PXA: 10 dB

State Saved Saved in instrument state

Min 0 dB

The attenuation set by this key cannot be decreased below 6 dB with the knob or step keys. To get to a value below 6 dB it has to be directly entered from the keypad or via SCPI. This protects from adjusting the attenuation to a dangerously small value which can put the instrument at risk of damage to input circuitry. However, if the current mechanical attenuation is below 6 dB it can be increased with the knob and step keys, but not decreased.

Max CXA N9000A-503/507: 50 dB
 CXA N9000A-513/526: 70dB
 EXA: 60 dB
 MXA and PXA: 70 dB

In the single attenuator configuration, the total of ATT and EATT cannot exceed 50 dB, so if the EATT is set to 24 dB first, the main attenuation cannot be greater than 26 dB and will be reduced accordingly; if the main attenuator is set to 40 dB first, EATT cannot be greater than 10 dB.

Initial S/W Revision Prior to A.02.00

Modified at S/W Revision A.03.00

Attenuator Configurations and Auto/Man

As described in the Attenuation key description, there are two distinct attenuator configurations available in the X-Series, the single attenuator and dual attenuator configurations. In dual attenuator configurations, we have the mechanical attenuation and the electronic attenuation, and the current total attenuation is the sum of the electronic + mechanical attenuation. In single attenuator configurations, we refer to the attenuation set using the **(Mech) Atten** key (or POW:ATT SCPI) as the “main” attenuation; and the attenuation that is set by the SCPI command POW:EATT as the “soft” attenuation (the POW:EATT command is honored even in the single attenuator configuration, for compatibility purposes). Then the current total attenuation is the sum of the main + soft attenuation. See the **Elec Atten** key description for more on “soft” attenuation.

In the dual attenuator configuration, when the electronic attenuator is enabled, there is no Auto/Man functionality for the mechanical attenuator, and the third line of the key label (the Auto/Man line) disappears:

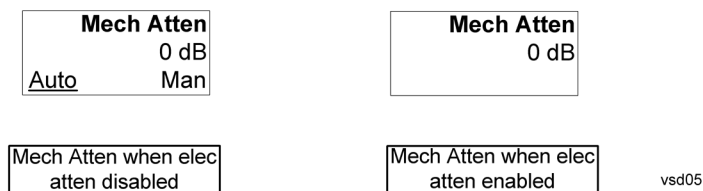

Enable Elec Atten

Enables the Electronic Attenuator.

The electronic attenuator offers finer steps than the mechanical attenuator, has no acoustical noise, is faster, and is less subject to wear. These advantages primarily aid in remote operation and are negligible for front panel use. See ["Using the Electronic Attenuator: Pros and Cons" on page 2301](#) for a detailed discussion of the pros and cons of using the electronic attenuator.

For the single attenuator configuration, for SCPI backwards compatibility, the “soft” attenuation feature replaces the dual attenuator configuration’s electronic attenuator. All the same couplings and limitations apply. See ["Attenuator Configurations and Auto/Man" on page 2299](#)

See ["More Information" on page 2300](#)

Key Path	AMPTD Y Scale, Attenuation
Remote Command	[:SENSe] :POWer [:RF] :EATTenuation :STATE OFF ON 0 1 [:SENSe] :POWer [:RF] :EATTenuation :STATE ?
Example	POW:EATT:STAT ON
Dependencies	This key only appears in Dual Attenuator models with an Electronic Attenuator installed. It does not appear in models with the Single Attenuator configuration, as in the single attenuator configuration there is no “electronic attenuator” there is only a single integrated attenuator (which has both a mechanical and electronic stage). However, in the single attenuator configuration, EATT SCPI commands are accepted for compatibility with other X-series instruments and set a “soft” attenuation as described in "Attenuator Configurations and Auto/Man" on page 2299 . The electronic attenuator (and the “soft” attenuation function provided in single attenuator configurations) is unavailable above 3.6 GHz. Therefore, if the Stop Frequency of the analyzer is > 3.6 GHz then the Enable Elec Atten key will be OFF and grayed out.

If the Internal Preamp is on, meaning it is set to Low Band or Full, the electronic attenuator (and the “soft” attenuation function provided in single attenuator configurations) is unavailable. In this case the **Enable Elec Atten** key will be OFF and grayed out.

If either of the above is true, if the SCPI command is sent, an error indicating that the electronic attenuator is unavailable will be sent.

If the electronic/soft Attenuator is enabled, then the Stop Freq of the analyzer is limited to 3.6 GHz and the Internal Preamp is unavailable.

The SCPI-only “soft” electronic attenuation for the single-attenuator configuration is not available in all measurements; in particular, it is not available in the Swept SA measurement.

Couplings	Enabling and disabling the Electronic Attenuator affects the setting of the Mechanical Attenuator (in dual attenuator configurations). This is described in more detail below this table.
Preset	OFF for Swept SA measurement; ON for all other measurements that support the electronic attenuator
State Saved	Saved in instrument state
Initial S/W Revision	Prior to A.02.00
Modified at S/W Revision	A.03.00

More Information

Mechanical Attenuator Transition Rules

When the Electronic Attenuator is enabled, the Mechanical Attenuator transitions to a state that has no Auto function. Below are the rules for transitioning the Mechanical Attenuator. NOTE that the information below ONLY applies to the dual attenuator configurations, and ONLY when the Electronic Attenuator is installed:

When the Electronic Attenuation is enabled from a disabled state:

- The Mechanical Attenuator is initialized to 10 dB (this is its optimal performance setting). You can then set it as desired with SCPI, numeric keypad, step keys, or knob, and it behaves as it normally would in manual mode
- The Auto/Man state of (Mech) Atten is saved
- The Auto/Man line on the (Mech) Atten key disappears and the auto rules are disabled
- The Electronic Attenuator is set to 10 dB less than the previous value of the Mechanical Attenuator, within the limitation that it must stay within the range of 0 to 24 dB of attenuation.

Examples in the dual attenuator configuration:

- Mech Atten at 20 dB. Elec Atten enabled, Mech Atten set to 10 dB, and Elec Atten set to 10 dB. New total attenuation equals the value before Elec Atten enabled.
- Mech Atten at 0 dB. Elec Atten enabled, Mech Atten set to 10 dB, and Elec Atten set to 0 dB. New total attenuation does not equal the value before Elec Atten enabled.
- Mech Atten at 40 dB. Elec Atten enabled, Mech Atten set to 10 dB, and Elec Atten set to 24 dB. New total attenuation does not equal the value before Elec Atten enabled.

When the Electronic Attenuation is disabled from an enabled state:

- The Elec Atten key is grayed out
- The Auto/Man state of (Mech) Atten is restored
- If now in Auto, (Mech) Atten recouples
- If now in Man, (Mech) Atten is set to the value of total attenuation that existed before the Elec Atten was disabled. The resulting value is rounded up to the smallest value possible given the (Mech) Atten Step setting - (That is, 57 dB changes to 58 dB when (Mech) Atten Step is 2 dB.)

Using the Electronic Attenuator: Pros and Cons

The electronic attenuator offers finer steps than the mechanical attenuator, has no acoustical noise, is faster, and is less subject to wear.

The “finer steps” advantage of the electronic attenuator is beneficial in optimizing the alignment of the analyzer dynamic range to the signal power in the front panel as well as remote use. Thus, you can achieve improved relative signal measurement accuracy. Compared to a mechanical attenuator with 2 dB steps, the 1 dB resolution of the electronic attenuator only gives better resolution when the odd-decibel steps are used. Those odd-decibel steps are less accurately calibrated than the even-decibel steps, so one tradeoff for this superior relative accuracy is reduced absolute amplitude accuracy.

Another disadvantage of the electronic attenuator is that the spectrum analyzer loses its “Auto” setting, making operation less convenient.

Also, the relationship between the dynamic range specifications (TOI, SHI, compression and noise) and instrument performance are less well-known with the electrical attenuator. With the mechanical attenuator, TOI, SHI and compression threshold levels increase dB-for-dB with increasing attenuation, and the noise floor does as well. With the electronic attenuator, there is an excess attenuation of about 1 to 3 dB between 0 and 3.6 GHz, making the effective TOI, SHI, and so forth, less well known. Excess attenuation is the actual attenuation relative to stated attenuation. Excess attenuation is accounted for in the analyzer calibration

Elec Atten

Controls the Electronic Attenuator in dual attenuator configurations. This key does not appear in single attenuator configurations, as the control of both the mechanical and electronic stages of the single attenuator is integrated into the single **Atten** key.

Key Path	AMPTD Y Scale, Attenuation
Remote Command	<code>[:SENSe] :POWer [:RF] :EATTenuation <rel_ampl></code> <code>[:SENSe] :POWer [:RF] :EATTenuation?</code>
Notes	Electronic Attenuation's specification is defined only when Mechanical Attenuation is 6 dB.
Dependencies	This key only appears in Dual Attenuator models with an Electronic Attenuator installed. It does not appear in models with the Single Attenuator configuration, as in the single attenuator configuration there is no “electronic attenuator” there is only a single integrated attenuator (which has both a mechanical and electronic stage). However, in the single attenuator configuration, EATT SCPI commands are accepted for compatibility with other X-series instruments and set a “soft” attenuation as described in "Attenuator Configurations and Auto/Man" on page 2299 . The “soft” attenuation is treated as an addition to the “main” attenuation value set by the Atten softkey or the

	POW:ATT SCPI command and affects the total attenuation displayed on the Attenuation key and the Meas Bar. When Enable Elec Atten is off or grayed out, the Elec Atten key is grayed out.
Preset	0 dB
State Saved	Saved in instrument state
Min	0 dB
Max	Dual attenuator configuration: 24 dB Single attenuator configuration: the total of ATT and EATT cannot exceed 50 dB, so if the EATT is set to 24 dB first, the main attenuation cannot be greater than 26 dB and will be reduced accordingly; if the main attenuator is set to 40 dB first, EATT cannot be greater than 10 dB
Initial S/W Revision	Prior to A.02.00
Modified at S/W Revision	A.03.00

Adjust Atten for Min Clip

Sets the combination of mechanical and electronic attenuation and gain based on the current measured signal level so that clipping will be at a minimum.

This is an "immediate action" function, that is, it executes once, when the key is pressed.

This key is grayed out in measurements that do not support this functionality. The spectrum analyzer measurement, Swept SA, does not support this functionality.

Key Path	AMPTD Y Scale, Attenuation
Remote Command	<code>[:SENSe] :POWer [:RF] :RANGe :OPTimize IMMEDIATE</code>
Initial S/W Revision	Prior to A.02.00
Modified at S/W Revision	A.03.00

Pre-Adjust for Min Clip

If this function is on, it does the adjustment described under "[Adjust Atten for Min Clip](#)" on page 2302 each time a measurement restarts. Therefore, in Continuous measurement mode, it only executes before the first measurement.

In dual attenuator models, you can set **Elec+Mech Atten**, in which case both attenuators participate in the autoranging, or **Elec Atten Only**, in which case the mechanical attenuator does not participate in the autoranging. This latter case results in less wear on the mechanical attenuator and is usually faster.

This key is grayed out in measurements that do not support this functionality. The spectrum analyzer measurement, Swept SA, does not support this functionality.

Key Path	AMPTD Y Scale, Attenuation
Remote Command	<code>[:SENSe] :POWer [:RF] :RANGe :OPTimize :ATTenuation OFF ELECTRICAL COMBINED</code>

	<code>[:SENSe] :POWer [:RF] :RANGe:OPTimize:ATTenuation?</code>
Notes	The SCPI parameter ELECTrical sets this function to On in single attenuator models. The SCPI parameter COMBined is mapped to ELECTrical in single attenuator models; if you send COMBined , it sets the function to On and returns ELEC to a query.
Dependencies	This key only appears in Dual Attenuator models with an Electronic Attenuator installed. In instruments with Dual Attenuator model, when Enable Elec Atten is off or grayed out, the Pre-Adjust for Min Clip key is grayed out.
Preset	OFF for Swept SA measurement; ON for all other measurements that support Pre-Adjust for Min Clip
State Saved	Saved in instrument state
Range	Dual attenuator models: Off Elec Atten Only Mech + Elec Atten Single attenuator models: Off On
Initial S/W Revision	Prior to A.02.00
Modified at S/W Revision	A.03.00

Remote Command	<code>[:SENSe] :POWer [:RF] :RANGe:AUTO ON OFF 1 0</code> <code>[:SENSe] :POWer [:RF] :RANGe:AUTO?</code>
Notes	ON aliases to "Elec Atten Only" (:POW:RANG:OPT:ATT ELEC) OFF aliases to "Off" (:POW:RANG:OPT:ATT OFF) The query :POW:RANG:AUTO? returns true if :POW:RANG:OPT:ATT is not "Off"
Initial S/W Revision	Prior to A.02.00

Off

Turns **Pre-Adjust for Min Clip** off. This is the default setting.

This key is grayed out in measurements that do not support this functionality. The spectrum analyzer measurement, Swept SA, does not support this functionality.

Key Path	AMPTD Y Scale, Attenuation, Pre-Adjust for Min Clip
Example	:POW:RANGe:OPT:ATT OFF
Initial S/W Revision	Prior to A.02.00

Elec Atten Only

Selects only the electric attenuator to participate in auto ranging. This offers less wear on the mechanical attenuator and is usually faster.

This key is grayed out in measurements that do not support this functionality. The spectrum analyzer measurement, Swept SA, does not support this functionality.

Key Path	AMPTD Y Scale, Attenuation, Pre-Adjust for Min Clip
Example	:POW:RANGe:OPT:ATT ELEC
Initial S/W Revision	Prior to A.02.00

Mech + Elec Atten

In dual attenuator models, this selects both attenuators participate in the autoranging.

This key is grayed out in measurements that do not support this functionality. The spectrum analyzer measurement, Swept SA, does not support this functionality.

Key Path	AMPTD Y Scale, Attenuation, Pre-Adjust for Min Clip
Example	:POW:RANGe:OPT:ATT COMB
Initial S/W Revision	Prior to A.02.00

(Mech) Atten Step

This controls the step size used when making adjustments to the input attenuation.

This key is labeled **Mech Atten Step** in dual attenuator models and **Atten Step** in single attenuator models. In the dual attenuator configuration, this key only affects the step size of the mechanical attenuator.

Key Path	AMPTD Y Scale, Attenuation
Remote Command	<code>[:SENSe] :POWer [:RF] :ATTenuation :STEP [:INCRement] 10 dB 2 dB</code> <code>[:SENSe] :POWer [:RF] :ATTenuation :STEP [:INCRement] ?</code>
Example	POW:ATT:STEP 2
Notes	Note this feature works like a 1-N choice from the front panel, but it takes a specific value (in dB) when used remotely. The only valid values are 2 and 10.
Dependencies	Blanked in CXA and EXA if option FSA (2 dB steps) is not present. If blanked, attempts to set it via SCPI will yield an error.
Couplings	When the attenuation step size changes, the current mechanical attenuation value is adjusted (if necessary) to be quantized to the new step size. That is, if step is set to 10 dB, mech atten is increased if necessary so it is a multiple of 10 dB
Preset	PXA and MXA: 2 dB EXA and CXA: 10 dB (2 dB with option FSA)
State Saved	Saved in instrument state
Initial S/W Revision	Prior to A.02.00
Modified at S/W Revision	A.03.00

Adjust Atten (Remote Command only)

Allows you to select;

-Electric attenuator only

-Combination of Electric attenuator and Mechanical attenuator

when the SCPI command [:SENSe]:POWer[:RF]:RANGe:OPTimize IMMEDIATE is executed.

Remote Command	[:SENSe]:POWer[:RF]:RANGe:OPTimize:TYPE EONLY COMBined [:SENSe]:POWer[:RF]:RANGe:OPTimize:TYPE?
Example	POW:RANG:OPT:TYPE EONL POW:RANG:OPT:TYPE?
Preset	COMBined
State Saved	Saved in instrument state
Initial S/W Revision	A.16.00

Scale/Div (RF Envelope View)

Sets the scale per division for the RF Envelope result waveform (time domain) measurements in the graph window.

Key Path	AMPTD Y Scale
Mode	BASIC, PNOISE, WCDMA, C2K, GSM, WIMAXOFDMA, TDSCDMA, 1XEVD0, DVB, DTMB, ISDBT, CMMB, LTE, LTETDD, DCATV, WLAN,LTEATDD, LTEAFDD
Remote Command	:DISPlay:WAVeform:VIEW[1]:WINDow[1]:TRACe:Y[:SCALe]:PDIVision <rel_ ampl> :DISPlay:WAVeform:VIEW[1]:WINDow[1]:TRACe:Y[:SCALe]:PDIVision?
Example	DISP:WAV:VIEW:WIND:TRAC:Y:PDIV 5 DISP:WAV:VIEW:WIND:TRAC:Y:PDIV?
Notes	You must be in a mode that includes the Waveform measurement to use this command. Use INSTRument:SElect to set the mode.
Couplings	When Auto Scaling is On, this value is automatically determined by the measurement result. When you set a value manually, Auto Scaling automatically changes to Off.
Preset	10.00 dB
State Saved	Saved in instrument state.
Range	0.10 dB to 20.00 dB
Min	0.10 dB
Max	20.00 dB
Initial S/W Revision	Prior to A.02.00
Modified at S/W Revision	A.03.00

Presel Center

When this key is pressed, the centering of the preselector filter is adjusted to optimize the amplitude accuracy at the frequency of the selected marker. If the selected marker is not on when Presel Center is pressed, the analyzer will turn on the selected marker, perform a peak search, and then perform centering on the marker's center frequency. If the selected marker is already on and between the start and stop frequencies of the analyzer, the analyzer performs the preselector calibration on that marker's frequency. If the selected marker is already on, but outside the frequency range between Start Freq and Stop Freq, the analyzer will first perform a peak search, and then perform centering on the marker's center frequency.

The value displayed on the **Presel Adjust** key will change to reflect the new preselector tuning (see **Presel Adjust**).

A number of considerations should be observed to ensure proper operation. See "[Proper Preselector Operation](#)" on page 2306.

Key Path	AMPTD Y Scale
Remote Command	[:SENSe] :POWer [:RF] :PCENter
Example	POW:PCEN
Notes	Note that the rules outlined above under the key description apply for the remote command as well as the key. The result of the command is dependent on marker position, and so forth. Any message shown by the key press is also shown in response to the remote command.
Dependencies	<ul style="list-style-type: none"> • Grayed out if the microwave preselector is off.) • If the selected marker's frequency is below Band 1, advisory message 0.5001 is generated and no action is taken. • Grayed out if entirely in Band 0. • Blank in models that do not include a preselector, such as option 503. If the SCPI is sent in these instruments, it is accepted without error, and the query always returns 0. • Grayed out in the Spectrogram View.
Couplings	<p>The active marker position determines where the centering will be attempted.</p> <p>If the analyzer is in a measurement such as averaging when centering is initiated, the act of centering the preselector will restart averaging but the first average trace will not be taken until the centering is completed.</p>
Status Bits/OPC dependencies	<p>When centering the preselector, *OPC will not return true until the process is complete and a subsequent measurement has completed, nor will results be returned to a READ or MEASure command.</p> <p>The Measuring bit should remain set while this command is operating and should not go false until the subsequent sweep/measurement has completed.</p>
Initial S/W Revision	Prior to A.02.00
Modified at S/W Revision	A.03.00

Proper Preselector Operation

A number of considerations should be observed to ensure proper operation:

1. If the selected marker is off, the analyzer will turn on a marker, perform a peak search, and adjust the preselector using the selected marker's frequency. It uses the "highest peak" peak search method unqualified by threshold or excursion, so that there is no chance of a 'no peak found' error. It continues with that peak, even if it is the peak of just noise. Therefore, for this operation to work properly, there should be a signal on screen in a preselected range for the peak search to find.
2. If the selected marker is already on, the analyzer will attempt the centering at that marker's frequency. There is no preselector for signals below about 3.6 GHz, therefore if the marker is on a signal below 3.6 GHz, no centering will be attempted and an advisory message generated
3. In some models, the preselector can be bypassed. If it is bypassed, no centering will be attempted in that range and a message will be generated.

Preselector Adjust

Allows you to manually adjust the preselector filter frequency to optimize its response to the signal of interest. This function is only available when "[Presel Center](#)" on page 2306 is available.

For general purpose signal analysis, using Presel Center is recommended. Centering the filter minimizes the impact of long-term preselector drift. Presel Adjust can be used instead to manually optimize the preselector. One application of manual optimization would be to peak the preselector response, which both optimizes the signal-to-noise ratio and minimizes amplitude variations due to small (short-term) preselector drifting.

Key Path	AMPTD Y Scale
Scope	Meas Global
Remote Command	[:SENSe] :POWer [:RF] :PADJust <freq> [:SENSe] :POWer [:RF] :PADJust?
Example	POW:PADJ 100KHz POW:PADJ?
Notes	The value on the key reads out to 0.1 MHz resolution.
Dependencies	<ul style="list-style-type: none"> • Grayed out if microwave preselector is off.) • Grayed out if entirely in Band 0. • Blank in models that do not include a preselector, such as option 503. If the SCPI is sent in these instruments, it is accepted without error, and the query always returns 0. • Grayed out in the Spectrogram View.
Preset	0 MHz
State Saved	The Presel Adjust value set by Presel Center , or by manually adjusting Presel Adjust , is not saved in instrument state, and does not survive a Preset or power cycle.
Min	-500 MHz
Max	500 MHz
Default Unit	Hz
Backwards Compatibility SCPI	[:SENSe] :POWer [:RF] :MW:PADJust [:SENSe] :POWer [:RF] :MMW:PADJust

	PSA had multiple preselectors, but the X-Series has only one. These commands simply alias to [:SENSe]:POWer[:RF]:PADJust
Initial S/W Revision	Prior to A.02.00
Modified at S/W Revision	A.03.00

Remote Command	[:SENSe]:POWer[:RF]:PADJust:PRESelector MWAVE MMWave EXTERNAL [:SENSe]:POWer[:RF]:PADJust:PRESelector?
Notes	PSA had multiple preselectors, and you could select which preselector to adjust. Since the X-Series has only one mm/uW preselector, the preselector selection softkey is no longer available. However, to provide backward compatibility, we accept the legacy remote commands. The command form has no effect, the query always returns MWAVE
Initial S/W Revision	Prior to A.02.00

μW Path Control

The **μW Path Control** functions include the **μW Preselector Bypass** (Option MPB) and **Low Noise Path** (Option LNP) controls in the High Band path circuits.

When the μW Preselector is bypassed, the user has better flatness, but will be subject to spurs from out of band interfering signals. When the Low Noise Path is enabled, the analyzer automatically switches around certain circuitry in the high frequency bands which can contribute to noise, when it is appropriate based on other analyzer settings.

For most applications, the preset state is Standard Path, which gives the best remote-control throughput, minimizes acoustic noise from switching and minimizes the risk of wear out in the hardware switches. For applications that utilize the wideband IF paths, the preset state is the μW Preselector Bypass path, if option MPB is present. This is because, when using a wideband IF such as the 140 MHz IF, the μW Preselector's bandwidth can be narrower than the available IF bandwidth, causing degraded amplitude flatness and phase linearity, so it is desirable to bypass the preselector in the default case.

Users may choose Low Noise Path Enable. It gives a lower noise floor, especially in the 21–26.5 GHz region, though without improving many measures of dynamic range, and without giving the best possible noise floor. The preamp, if purchased and used, gives better noise floor than does the Low Noise Path, however its compression threshold and third-order intercept are much poorer than that of the non-preamp Low Noise Path. There are some applications, typically for signals around –30 dBm, for which the third-order dynamic range of the standard path is good enough, but the noise floor is not low enough even with 0 dB input attenuation. When the third-order dynamic range of the preamp path is too little and the noise floor of the standard path is too high, the Low Noise Path can provide the best dynamic range.

Key Path	AMPTD Y Scale
Mode	SA, BASIC, PNOISE, VSA, LTE, LTETDD
Scope	Meas Global
Remote Command	[:SENSe]:POWer[:RF]:MW:PATH STD LNPath MPBypass FULL

	[:SENSe] :POWer [:RF] :MW: PATH?
Example	:POW:MW:PATH LNP Enables the Low Noise path
Notes	<p>If a Presel Center is performed, the analyzer will momentarily switch to the Standard Path, regardless of the setting of μW Path Control</p> <p>The DC Block will always be switched in when the low noise path is switched in, to protect succeeding circuitry from DC. Note that this does not mean “when the low noise path is enabled” but when, based on the Low Noise Path rules, the path is actually switched in. This can happen when the selection is Low Noise Path Enable . In the case where the DC Block is switched in the analyzer is now AC coupled. However, if the user has selected DC coupling, the UI will still behave as though it were DC coupled, including all annunciation, warnings, status bits, and responses to SCPI queries. This is because, based on other settings, the analyzer could switch out the low noise path at any time and hence go back to being DC coupled.</p> <p>Alignment switching ignores the settings in this menu, and restores them when finished.</p>
Dependencies	Unavailable in BBIQ and External Mixing
Preset	<p>All modes other than IQ Analyzer mode and VXA: STD</p> <p>IQ Analyzer, VXA and WLAN mode:</p> <p>MPB option present and licensed: MPB</p> <p>MPB option not present and licensed: STD</p>
State Saved	Save in instrument state
Readback	Value selected in the submenu
Initial S/W Revision	A.04.00
Modified at S/W Revision	A.10.00

Standard Path

This path gives the best remote-control throughput, minimizes acoustic noise from switching and minimizes the risk of wear in the hardware switches, particularly in remote test scenarios where both low band and high band setups will follow in rapid succession.

In this path, the bypass of the low band/high band switch and microwave preamp is never activated, which can cause some noise degradation but preserves the life of the bypass switch.

Key Path	AMPTD Y Scale, μW Path Control
Example	:POW:MW:PATH STD
Readback Text	Standard Path
Initial S/W Revision	A.04.00

Low Noise Path Enable

You may choose Low Noise Path Enable, which gives a lower noise floor under some circumstances, particularly when operating in the 21–26.5 GHz region. With the Low Noise Path enabled, the low band/high band switch and microwave preamp are bypassed whenever all of the following are true:

- The analyzer is not in the Low Band, meaning:
- the start frequency is above 3.5 GHz and
- the stop frequency is above 3.6 GHz.
- the internal preamp is not installed or (if installed) is set to **Off** or **Low Band**

Note that this means that, when any part of a sweep is done in Low Band, the Low Noise Path is not used, whether or not the **Low Noise Path Enable** is selected in the user interface. Also, if the preamp is turned on, the Low Noise Path is not used, whether or not the **Low Noise Path Enable** is selected in the user interface. The only time the Low Noise Path is used is when **Low Noise Path Enable** is selected, the sweep is completely in High Band (> 3.6 GHz) and no preamp is in use.

See "[More Information](#)" on page 2310

Key Path	AMPTD Y Scale, μW Path Control
Measurement	Swept SA
Example	:POW:MW:PATH LNP
Notes	<p>For measurements that use IQ acquisition, the low noise path is used when the Center Frequency is in High Band (> 3.6 GHz) and no preamp is in use.</p> <p>In other words, the rules above are modified to use only the center frequency to qualify which path to switch in.</p> <p>This is not the case for FFT's in the Swept SA measurement; they use the same rules as swept measurements.</p>
Dependencies	<p>Key is blanked if current mode does not support it.</p> <p>Key is grayed out if mode supports it but current measurement does not support it.</p> <p>Unless Option LNP is present and licensed, key is blank and if SCPI command sent, error -241, "Hardware missing; Option not installed" is generated.</p>
Readback Text	Low Noise Path Enable
Initial S/W Revision	A.04.00

More Information

The user should understand that the Low Noise Path, while giving improved DANL, has the disadvantage of decreased TOI performance and decreased gain compression performance relative to the standard path.

The user should also understand that the bypass switch is a mechanical switch and has finite life, so if the **Low Noise Path** is enabled, it is possible to cause frequent cycling of this switch by frequently changing analyzer settings such that the above conditions hold true only some of the time. A user making tests of this nature should consider opting for the **Standard Path**, which will never throw the bypass switch, at the expense of some degraded noise performance.

The low noise path is useful for situations where the signal level is so low that the analyzer performance is dominated by noise even with 0 dB attenuation, but still high enough that the preamp option would have excessive third-order intermodulation or compression. The preamp, if purchased and used, gives better noise floor than does the "Low Noise Path." However, its compression threshold and third-order intercept are much poorer than that of the non-preamp path. There are some applications, typically for signals around -30 dBm, for which the third-order dynamic range of the standard path is good enough, but the

noise floor is not low enough even with 0 dB input attenuation. When the third-order dynamic range of the preamp path is too little and the noise floor of the standard path is too high, the Low Noise Path can provide the best dynamic range

The graph below illustrates the concept. It shows, in red, the performance of an analyzer at different attenuation settings, both with the preamp on and off, in a measurement that is affected by both analyzer noise and analyzer TOI. The green shows the best available dynamic range, offset by 0.5 dB for clarity. The blue shows how the best available dynamic range improves for moderate signal levels with the low noise path switched in. In this illustration, the preamp improves the noise floor by 15 dB while degrading the third-order intercept by 30 dB, and the low noise path reduces loss by 8 dB. The attenuator step size is 2 dB.

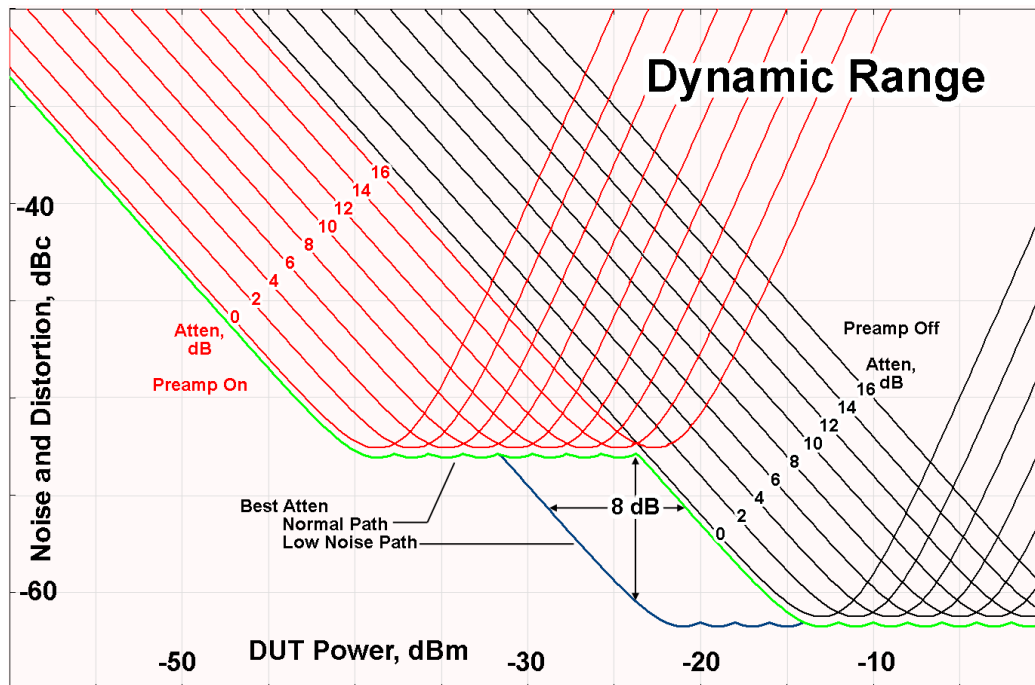

There are other times where selecting the low noise path improves performance, too. Compression-limited measurements such as finding the nulls in a pulsed-RF spectrum can profit from the low noise path in a way similar to the TOI-limited measurement illustrated. Accuracy can be improved when the low noise path allows the optimum attenuation to increase from a small amount like 0, 2 or 4 dB to a larger amount, giving better return loss at the analyzer input. Harmonic measurements, such as second and third harmonic levels, are much improved using the low noise path because of the superiority of that path for harmonic (though not intermodulation) distortion performance.

μ W Preselector Bypass

This key toggles the preselector bypass switch for band 1 and higher. When the microwave preselector is on, the signal path is preselected. When the microwave preselector is off, the signal path is not preselected. The preselected path is the normal path for the analyzer.

The preselector is a tunable bandpass filter which prevents signals away from the frequency of interest from combining in the mixer to generate in-band spurious signals (images). The consequences of using a preselector filter are its limited bandwidth, the amplitude and phase ripple in its passband, and any amplitude and phase instability due to center frequency drift.

Option MPB or pre-selector bypass provides an unpreselected input mixer path for certain X-Series signal analyzers with frequency ranges above 3.6 GHz. This signal path allows a wider bandwidth and less amplitude variability, which is an advantage when doing modulation analysis and broadband signal analysis. The disadvantage is that, without the preselector, image signals will be displayed. Another disadvantage of bypassing the preselector is increased LO emission levels at the front panel input port.

Image responses are separated from the real signal by twice the 1st IF. For IF Paths of 10 MHz and 25 MHz, the 1st IF is 322.5 MHz, so the image response and the real signal will be separated by 645 MHz. The 1st IF will be different for other IF Path settings. When viewing a real signal and its corresponding image response in internal mixing, the image response will be to the left of the real signal.

Also, the image response and the real signal typically have the same amplitude and exhibit the same shape factor.

However, if Option FS1, Fast Sweep Capability, is enabled, the image response in the Swept SA measurement will appear lower in amplitude and have a much wider shape factor compared to the real signal.

Key Path	AMPTD Y Scale, μW Path Control
Example	:POW:MW:PATH MPB
Dependencies	Key is blanked if current mode does not support it. Key is grayed out if mode supports it but current measurement does not support it. Key is blank unless Option MPB is present and licensed. If SCPI command sent when MPB not present, error -241, "Hardware missing; Option not installed" is generated.
Readback Text	μ W Preselector Bypass
Initial S/W Revision	A.04.00

Remote Command	[:SENSE] :POWER [:RF] :MW:PRESelector [:STATE] ON OFF 0 1 [:SENSE] :POWER [:RF] :MW:PRESelector [:STATE] ?
Example	:POW:MW:PRES OFF Bypasses the microwave preselector
Notes	The ON parameter sets the STD path (:POW:MW:PATH STD) The OFF parameter sets path MPB (:POW:MW:PATH MPB)
Preset	ON

Internal Preamp

Accesses a menu of keys that control the internal preamps. Turning on the preamp gives a better noise figure, but a poorer TOI to noise floor dynamic range. You can optimize this setting for your particular measurement.

The instrument takes the preamp gain into account as it sweeps. If you sweep outside of the range of the preamp the instrument will also account for that. The displayed result will always reflect the correct gain.

For some measurements, when the preamp is on and any part of the displayed frequency range is below the lowest frequency for which the preamp has specifications, a warning condition message appears in the status line. For example, for a preamp with a 9 kHz lowest specified frequency: "Preamp: Accy unspec'd below 9 kHz".

Key Path	AMPTD Y Scale
Scope	Meas Global
Remote Command	[:SENSe] :POWer [:RF] :GAIN [:STATe] OFF ON 0 1 [:SENSe] :POWer [:RF] :GAIN [:STATe] ?
Dependencies	Preamp is not available on all hardware platforms. If the preamp is not present or is unlicensed, the key is not shown. The preamp is not available when the electronic/soft attenuator is enabled.
Couplings	The act of connecting the U7227A USB Preamplifier to one of the analyzer's USB ports will cause the Internal Preamp to be switched on. When this happens an informational message will be generated: "Internal Preamp turned on for optimal operation with USB Preamp." Note that if the Internal Preamp was already on, there will be no change to the setting, but if it was Off it will be switched On, to Full Range. Note that this same action occurs when the SA mode is selected while the USB Preamp is connected to one of the analyzer's USB ports, if it is the first time that the SA mode has run since powerup, or if the last time the SA mode was running the USB Preamp was NOT connected. Subsequently disconnecting the USB Preamp from USB does not change the Internal Preamp setting nor restore the previous setting.
Preset	OFF
State Saved	Saved in instrument state
Initial S/W Revision	Prior to A.02.00
Modified at S/W Revision	A.14.00

Key Path	AMPTD Y Scale, Internal Preamp
Scope	Meas Global
Remote Command	[:SENSe] :POWer [:RF] :GAIN :BAND LOW FULL [:SENSe] :POWer [:RF] :GAIN :BAND ?
Dependencies	Preamp is not available on all hardware platforms. If the preamp is not present or is unlicensed, the key is not shown. If a POW:GAIN:BAND FULL command is sent when a low band preamp is available, the preamp band parameter is to LOW instead of FULL, and an "Option not installed" message is generated.
Preset	LOW
State Saved	Saved in instrument state
Initial S/W Revision	Prior to A.02.00

Off

Turns the internal preamp off

Key Path	AMPTD Y Scale, Internal Preamp
Example	:POW:GAIN OFF
Readback	Off
Initial S/W Revision	Prior to A.02.00

Low Band

Sets the internal preamp to use only the low band.

The frequency range of the installed (optional) low-band preamp is displayed in square brackets on the **Low Band** key label.

Key Path	AMPTD Y Scale, Internal Preamp
Example	:POW:GAIN ON :POW:GAIN:BAND LOW
Readback	Low Band
Initial S/W Revision	Prior to A.02.00

Full Range

Sets the internal preamp to use its full range. The low band (0–3.6 GHz or 0–3GHz, depending on the model) is supplied by the low band preamp and the frequencies above low band are supplied by the high band preamp.

The frequency range of the installed (optional) preamp is displayed in square brackets on the **Full Range** key label. If the high band option is not installed the Full Range key does not appear.

Key Path	AMPTD Y Scale, Internal Preamp
Example	:POW:GAIN ON :POW:GAIN:BAND FULL
Readback	Full Range
Initial S/W Revision	Prior to A.02.00

Ref Position (RF Envelope View)

Positions the reference level at the top, center or bottom of the Y Scale display. Changing the reference position does not change the reference level value.

Key Path	AMPTD Y Scale
Mode	BASIC, PNOISE, WCDMA, C2K, GSM, WIMAXOFDMA, TDSCDMA, 1XEVD0, DVB, DTMB, ISDBT, CMMB, LTE, LTETDD, DCATV, WLAN,LTEATDD, LTEAFDD
Remote Command	:DISPlay:WAVeform:VIEW[1]:WINDow[1]:TRACe:Y[:SCALe]:RPOSition TOP CENTER BOTTom :DISPlay:WAVeform:VIEW[1]:WINDow[1]:TRACe:Y[:SCALe]:RPOSition?
Example	DISP:WAV:VIEW:WIND:TRAC:Y:RPOS CENT DISP:WAV:VIEW:WIND:TRAC:Y:RPOS?
Notes	You must be in a mode that includes the Waveform measurement to use this command. Use INSTRument:SElect to set the mode.
Preset	TOP
State Saved	Saved in instrument state.
Range	Top Ctr Bot
Initial S/W Revision	Prior to A.02.00
Modified at S/W Revision	A.03.00

Auto Scaling

Toggles the Auto Scaling function between On and Off. When the **Restart** front-panel key is pressed, this function automatically determines the scale per division and reference values based on the measurement results.

Key Path	AMPTD Y Scale
Mode	BASIC, PNOISE, WCDMA, C2K, GSM, WIMAXOFDMA, TDSCDMA, 1XEVD0, DVB, DTMB, ISDBT, CMMB, LTE, LTETDD, DCATV, WLAN,LTEATDD, LTEAFDD
Remote Command	:DISPlay:WAVeform:VIEW[1] 2:WINDow[1]:TRACe:Y[:SCALe]:COUPle 0 1 OFF ON :DISPlay:WAVeform:VIEW[1] 2:WINDow[1]:TRACe:Y[:SCALe]:COUPle?
Example	DISP:WAV:VIEW:WIND:TRAC:Y:COUP OFF DISP:WAV:VIEW:WIND:TRAC:Y:COUP?
Notes	You must be in a mode that includes the Waveform measurement to use this command. Use INSTRument:SElect to set the mode.
Couplings	When Auto Scaling is On, upon pressing the Restart front-panel key, this function automatically switches the scale per division and reference values into the defaults. When you set a value to either Scale/Div or Ref Value manually, Auto Scaling automatically changes to Off.
Preset	OFF
State Saved	Saved in instrument state.
Range	On Off
Initial S/W Revision	Prior to A.02.00
Modified at S/W Revision	A.03.00

Range

This key is only available when I/Q is the selected input. It replaces the Attenuation key in that case.

Each input channel (I and Q) has four internal gain ranges. The maximum allowed voltage in each gain range is slightly more than the nominal value, so the break point between ranges is a couple of millivolts higher than the nominal (setting a peak voltage of 0.502 mV will still map to the 0.5 V Peak range).

Gain Setting	Volts RMS	Volts Peak	Volts Peak - Peak	dBm (50Ω)	Break Point
0 dB	0.7071	1.0	2.0	10	n/a
6 dB	0.3536	0.5	1.0	4	0.502 V Peak
12 dB	0.1768	0.25	0.5	-2	0.252 V Peak
18 dB	0.0884	0.125	0.25	-8	0.127 V Peak

Key Path	AMPTD Y Scale
Notes	Visible only when the selected input is I/Q.
State Saved	No
Readback Text	When Range is Auto, "[Auto]" When Range is Man and I & Q are the same, "[<range value>]" When Range is Man and I & Q are different: "[: <I range value> Q: <Q range value>]" See I Range and Q Range for the <range value> enumeration definition.
Initial S/W Revision	Prior to A.02.00

Range Auto/Man

The Auto setting for Range causes the range to be set based on the Y Scale settings. When Range is "Auto", the I & Q Range are set based on the top of the Y Scale when the Y scale is in dB units (for example, power), or to the max(abs(top), abs(bottom)) when the Y scale reference is not at the top of the screen.

Not all measurements support Range Auto/Man. If Auto is not supported in the current measurement, this key is grayed out and shows "Man" and MAN is returned to a SCPI query, but this does NOT change the Auto/Man setting for Range. When you go to a measurement that supports Auto, it goes back to Auto if it was previously in Auto mode.

Key Path	AMPTD Y Scale, Range
Scope	Meas Global
Remote Command	[:SENSe]:VOLTage:IQ:RANGe:AUTO OFF ON 0 1 [:SENSe]:VOLTage:IQ:RANGe:AUTO?
Example	Put the I Range and Q Range in manual.

	VOLT:IQ:RANG:AUTO OFF
Dependencies	If Auto is not supported, sending the SCPI command will generate an error.
Couplings	When in Auto, both I Range and Q Range are set to the same value, computed as follows: Maximum absolute value is computed for the Y Scale. The top and bottom of the graph are computed based on Ref Value, Scale/Div, and Ref Position. Formula: YMax = max(abs(top), abs(bottom)). The I Range and Q Range are then set to YMax.
Preset	ON
State Saved	Saved in instrument state
Range	Auto Man
Initial S/W Revision	Prior to A.02.00

Remote Command	[:SENSe] :POWer: IQ:RANGe:AUTO OFF ON 0 1 [:SENSe] :POWer: IQ:RANGe:AUTO?
Example	Put the I Range and Q Range in manual. POW:IQ:RANG:AUTO OFF
Notes	The POW:IQ:RANG:AUTO is an alternate form of the VOLT:IQ:RANG:AUTO command. This is to maintain consistency with I Range and Q Range, which support both the POWER and VOLTage forms of the command.
Preset	ON
Range	Auto Man
Initial S/W Revision	Prior to A.02.00

I Range

This is the internal gain range for the I channel when Input Path is I Only or I and I/Q, and it is used for both the I and Q channels when the Input Path is I+jQ. See ["I/Q Gain Ranges" on page 2321](#).

Key Path	AMPTD Y Scale, Range
Remote Command	[:SENSe] :VOLTage: IQ[:I]:RANGe[:UPPer] <voltage> [:SENSe] :VOLTage: IQ[:I]:RANGe[:UPPer]?
Example	Set the I Range to 0.5 V Peak VOLT:IQ:RANG 0.5 V
Notes	The numeric entries are mapped to the smallest gain range whose break point is greater than or equal to the value, or 1 V Peak if the value is greater than 1 V.
Couplings	When Q Same as I is On, the I Range value will be copied to the Q Range. Changing the value will also set Range = Man.
Preset	1 V Peak
State Saved	Saved in instrument state

Range	1 V Peak 0.5 V Peak 0.25 V Peak 0.125 V Peak
Min	0.125 V
Max	1 V
Initial S/W Revision	Prior to A.02.00

Remote Command	<code>[:SENSe] :POWer :IQ [:I] :RANGe [:UPPer] <ampl></code> <code>[:SENSe] :POWer :IQ [:I] :RANGe [:UPPer] ?</code>
-----------------------	---

Example	Set the I Range to 0.5 V Peak when Reference Z is 50Ω, and to 1.0 V Peak when Reference Z is 75Ω. POW:IQ:RANG 4 dBm
----------------	--

Notes	The POWer form of the command is provided for convenience. It maps to the same underlying gain range parameter as the VOLTage form of the command. The Reference Z (not the I channel Input Z) is used to convert the power to peak voltage, which is then used to set the I Range as with the VOLTage form of the command. The power values of the 4 range states (1V Peak, 0.5V Peak, 0.25V Peak, and 0.125V Peak) will vary with Reference Z. Here are some examples: 50Ω: 10, 4, -2, -8 75Ω: 8.2, 2.2, -3.8, -9.8 600Ω: -0.8, -6.8, -12.8, -18.9
-------	--

Preset	10.0 dBm
Range	-20 dBm to 10 dBm
Min	-20 dBm
Max	10 dBm
Initial S/W Revision	Prior to A.02.00

1 V Peak

Set the channel gain state to 1 Volt Peak.

Key Path	AMPTD Y Scale, I Range Q Range
Initial S/W Revision	Prior to A.02.00

0.5 V Peak

Set the channel gain state to 0.5 Volt Peak.

Key Path	AMPTD Y Scale, I Range Q Range
Initial S/W Revision	Prior to A.02.00

0.25 V Peak

Set the channel gain state to 0.25 Volt Peak.

Key Path	AMPTD Y Scale, I Range Q Range
Initial S/W Revision	Prior to A.02.00

0.125 V Peak

Set the channel gain state to 0.125 Volt Peak.

Key Path	AMPTD Y Scale, I Range Q Range
Initial S/W Revision	Prior to A.02.00

Q Range Value

This is the internal gain range for the Q channel. See "[I/Q Gain Ranges](#)" on page 2321. The Q Range only applies to Input Path Q Only and Ind I/Q. For input I+jQ the I Range determines both I and Q channel range settings.

Key Path	AMPTD Y Scale, Range
Remote Command	[:SENSe] :VOLTage:IQ:Q:RANGe [:UPPer] <voltage> [:SENSe] :VOLTage:IQ:Q:RANGe [:UPPer] ?
Example	Set the Q Range to 0.5 V Peak VOLT:IQ:Q:RANG 0.5 V
Notes	The numeric entries are mapped to the smallest gain range whose break point is greater than or equal to the value, or 1 V Peak if the value is greater than 1 V. The Q Range is only used for Input Path Q Only and Ind I/Q. For input I+jQ the I Range determines both I and Q channel range settings.
Couplings	When Q Same as I is On, the I Range value will be copied to the Q Range and the range value keys are disabled. Changing the value will also set Range = Man.
Preset	1 V Peak
State Saved	Saved in instrument state
Range	1 V Peak 0.5 V Peak 0.25 V Peak 0.125 V Peak
Min	0.125 V
Max	1 V
Initial S/W Revision	Prior to A.02.00

Remote Command	[:SENSe] :POWer:IQ:Q:RANGe [:UPPer] <ampl> [:SENSe] :POWer:IQ:Q:RANGe [:UPPer] ?
-----------------------	---

Example	Will set the Q Range to 0.5 V Peak when Reference Z is 50Ω, and to 1.0 V Peak when Reference Z is 75Ω. POW:IQ:Q:RANG 4 dBm
Notes	The POWER form of the command is provided for convenience. It maps to the same underlying gain range parameter as the VOLTage form of the command. The Reference Z (not the Q channel Input Z) is used to convert the power to peak voltage, which is then used to set the Q Range as with the VOLTage form of the command. The power values of the 4 range states (1V Peak, 0.5V Peak, 0.25V Peak, and 0.125V Peak) will vary with Reference Z. Here are some examples: 50Ω: 10, 4, -2, -8 75Ω: 8.2, 2.2, -3.8, -9.8 600Ω: -0.8, -6.8, -12.8, -18.9
Preset	10.0 dBm
Range	-20 dBm to 10 dBm
Min	-20 dBm
Max	10 dBm
Initial S/W Revision	Prior to A.02.00

Q Same as I

Many, but not all, usages require the I and Q channels to have an identical setup. To simplify channel setup, the Q Same as I will cause the Q channel range to be mirrored from the I channel. That way you only need to set up one channel (the I channel). The I channel values are copied to the Q channel, so at the time Q Same as I is Off, the I and Q channel setups will be identical.

Key Path	AMPTD Y Scale, Range, Q Range
Remote Command	[:SENSe] :VOLTage POWer : IQ : MIRRored OFF ON 0 1 [:SENSe] :VOLTage POWer : IQ : MIRRored ?
Example	Turn off the mirroring of I Range to Q Range. VOLT:IQ:MIRR OFF POW:IQ:MIRR OFF
Couplings	When On, the I Range value is mirrored (copied) to the Q Range.
Preset	On
State Saved	Saved in instrument state.
Range	On Off
Readback Text	"Q Same as I" when On, otherwise none.
Initial S/W Revision	Prior to A.02.00

1 V Peak

Set the channel gain state to 1 Volt Peak.

Key Path	AMPTD Y Scale, I Range Q Range
Initial S/W Revision	Prior to A.02.00

0.5 V Peak

Set the channel gain state to 0.5 Volt Peak.

Key Path	AMPTD Y Scale, I Range Q Range
Initial S/W Revision	Prior to A.02.00

0.25 V Peak

Set the channel gain state to 0.25 Volt Peak.

Key Path	AMPTD Y Scale, I Range Q Range
Initial S/W Revision	Prior to A.02.00

0.125 V Peak

Set the channel gain state to 0.125 Volt Peak.

Key Path	AMPTD Y Scale, I Range Q Range
Initial S/W Revision	Prior to A.02.00

I/Q Gain Ranges

See the following sections:

["1 V Peak" on page 2321](#)

["0.5 V Peak" on page 2322](#)

["0.25 V Peak" on page 2322](#)

["0.125 V Peak" on page 2322](#)

1 V Peak

Set the channel gain state to 1 Volt Peak.

Key Path	AMPTD Y Scale, I Range Q Range
Initial S/W Revision	Prior to A.02.00

0.5 V Peak

Set the channel gain state to 0.5 Volt Peak.

Key Path	AMPTD Y Scale, I Range Q Range
Initial S/W Revision	Prior to A.02.00

0.25 V Peak

Set the channel gain state to 0.25 Volt Peak.

Key Path	AMPTD Y Scale, I Range Q Range
Initial S/W Revision	Prior to A.02.00

0.125 V Peak

Set the channel gain state to 0.125 Volt Peak.

Key Path	AMPTD Y Scale, I Range Q Range
Initial S/W Revision	Prior to A.02.00

Ref Value

Sets the absolute power reference value. However, since Auto Scaling is defaulted to On, this value is automatically determined by the measurement result. When you set a value manually, Auto Scaling automatically changes to Off.

This functionality depends on the selected view:

- ["Ref Value \(RF Envelope View\)" on page 2322](#)
- ["Ref Value \(I/Q Waveform View\)" on page 2323](#)

Ref Value (RF Envelope View)

Sets the Y Scale reference value (in dBm) when the RF Envelope View is active. By default, the measurement determines the reference value with Auto Scaling. Entering a reference value manually turns Auto Scaling off.

Key Path	AMPTD Y Scale
Mode	BASIC, PNOISE, WCDMA, C2K, GSM, WIMAXOFDMA, TDSCDMA, 1XEVD0, DVB, DTMB, ISDBT, CMMB, LTE, LTETDD, DCATV, WLAN, LTEATDD, LTEAFDD
Remote Command	:DISPlay:WAVeform:VIEW[1]:WINDow[1]:TRACe:Y[:SCALe]:RLEVel <ampl> :DISPlay:WAVeform:VIEW[1]:WINDow[1]:TRACe:Y[:SCALe]:RLEVel?
Example	DISP:WAV:VIEW:WIND:TRAC:Y:RLEV -50 dBm

	DISP:WAV:VIEW:WIND:TRAC:Y:RLEV?
Notes	You must be in the mode that includes Waveform measurement to use this command. Use INSTRUMENT:SElect to set the mode.
Couplings	When Auto Scaling is On, this value is automatically determined by the measurement result. When you set a value manually, Auto Scaling automatically changes to Off.
Preset	10.00 dBm
State Saved	Saved in instrument state.
Range	-250.00 dBm to 250.00 dBm
Min	-250.00 dBm
Max	250.00 dBm
Initial S/W Revision	Prior to A.02.00
Modified at S/W Revision	A.03.00

Ref Value (I/Q Waveform View)

Sets the Y Scale reference value (in volts) when the I/Q Waveform View is active. By default, the measurement determines the reference value with Auto Scaling. Entering a reference value manually turns Auto Scaling off.

Key Path	AMPTD Y Scale
Mode	BASIC, PNOISE, WCDMA, C2K, GSM, WIMAXOFDMA, TDSCDMA, 1XEVD0, DVB, DTMB, ISDB-T, CMMB, LTE, LTETDD, DCATV, WLAN,LTEATDD, LTEAFDD
Remote Command	:DISPlay:WAVeform:VIEW2:WINDow[1]:TRACe:Y[:SCALe]:RLEVel <voltage> :DISPlay:WAVeform:VIEW2:WINDow[1]:TRACe:Y[:SCALe]:RLEVel?
Example	DISP:WAV:VIEW2:WIND:TRAC:Y:RLEV 25 V DISP:WAV:VIEW2:WIND:TRAC:Y:RLEV?
Notes	You must be in a mode that includes the Waveform measurement to use this command. Use INSTRUMENT:SElect to set the mode.
Couplings	When Auto Scaling is On, this value is automatically determined by the measurement result. When you set a value manually, Auto Scaling automatically changes to Off.
Preset	0 V
State Saved	Saved in instrument state.
Min	-250 V
Max	250 V
Initial S/W Revision	Prior to A.02.00
Modified at S/W Revision	A.03.00

Scale/Div

Sets the units per division of vertical scale in the logarithmic display. However, since Auto Scaling is defaulted to On, this value is automatically determined by the measurement result. When you set a value manually, Auto Scaling automatically changes to Off.

This functionality depends on the selected view:

- "Scale/Div (RF Envelope View)" on page 2324
- "Scale/Div (I/Q Waveform View)" on page 2324

Scale/Div (RF Envelope View)

Sets the scale per division for the RF Envelope result waveform (time domain) measurements in the graph window.

Key Path	AMPTD Y Scale
Mode	BASIC, PNOISE, WCDMA, C2K, GSM, WIMAXOFDMA, TDSCDMA, 1XEVD0, DVB, DTMB, ISDBT, CMMB, LTE, LTETDD, DCATV, WLAN,LTEATDD, LTEAFDD
Remote Command	:DISPlay:WAVeform:VIEW[1]:WINDow[1]:TRACe:Y[:SCALE]:PDIVision <rel_ ampl> :DISPlay:WAVeform:VIEW[1]:WINDow[1]:TRACe:Y[:SCALE]:PDIVision?
Example	DISP:WAV:VIEW:WIND:TRAC:Y:PDIV 5 DISP:WAV:VIEW:WIND:TRAC:Y:PDIV?
Notes	You must be in a mode that includes the Waveform measurement to use this command. Use INSTRument:SElect to set the mode.
Couplings	When Auto Scaling is On, this value is automatically determined by the measurement result. When you set a value manually, Auto Scaling automatically changes to Off.
Preset	10.00 dB
State Saved	Saved in instrument state.
Range	0.10 dB to 20.00 dB
Min	0.10 dB
Max	20.00 dB
Initial S/W Revision	Prior to A.02.00
Modified at S/W Revision	A.03.00

Scale/Div (I/Q Waveform View)

Sets the scale per division for the I/Q signal waveform graph.

Key Path	AMPTD Y Scale
Mode	BASIC, PNOISE, WCDMA, C2K, GSM, WIMAXOFDMA, TDSCDMA, 1XEVD0, DVB, DTMB, ISDBT, CMMB, LTE, LTETDD, DCATV, WLAN,LTEATDD, LTEAFDD
Remote Command	:DISPlay:WAVeform:VIEW2:WINDow[1]:TRACe:Y[:SCALE]:PDIVision <voltage>

	:DISPlay:WAVeform:VIEW2:WINDow[1]:TRACe:Y[:SCALe]:PDIVision?
Example	DISP:WAV:VIEW2:WIND:TRAC:Y:PDIV 25mV DISP:WAV:VIEW2:WIND:TRAC:Y:PDIV?
Notes	You must be in a mode that includes the Waveform measurement to use this command. Use INSTRument:SElect to set the mode.
Couplings	When Auto Scaling is On, this value is automatically determined by the measurement result. When you set a value manually, Auto Scaling automatically changes to Off.
Preset	100.0 mV
State Saved	Saved in instrument state.
Min	1.0 nV
Max	20 V
Initial S/W Revision	Prior to A.02.00
Modified at S/W Revision	A.03.00

Ref Position

Positions the reference level at the top, center or bottom of the Y Scale display. Changing the reference position does not change the reference level value.

This functionality depends on the selected view:

- ["Ref Position \(RF Envelope View\)" on page 2325](#)
- ["Ref Position \(I/Q Waveform View\)" on page 2326](#)

Ref Position (RF Envelope View)

Positions the reference level at the top, center or bottom of the Y Scale display. Changing the reference position does not change the reference level value.

Key Path	AMPTD Y Scale
Mode	BASIC, PNOISE, WCDMA, C2K, GSM, WIMAXOFDMA, TDSCDMA, 1XEVD0, DVB, DTMB, ISDBT, CMMB, LTE, LTETDD, DCATV, WLAN,LTEATDD, LTEAFDD
Remote Command	:DISPlay:WAVeform:VIEW[1]:WINDow[1]:TRACe:Y[:SCALe]:RPOSition TOP CENTER BOTTom :DISPlay:WAVeform:VIEW[1]:WINDow[1]:TRACe:Y[:SCALe]:RPOSition?
Example	DISP:WAV:VIEW:WIND:TRAC:Y:RPOS CENT DISP:WAV:VIEW:WIND:TRAC:Y:RPOS?
Notes	You must be in a mode that includes the Waveform measurement to use this command. Use INSTRument:SElect to set the mode.
Preset	TOP
State Saved	Saved in instrument state.
Range	Top Ctr Bot

Initial S/W Revision	Prior to A.02.00
Modified at S/W Revision	A.03.00

Ref Position (I/Q Waveform View)

Positions the reference level at the top, center or bottom of the Y Scale display. Changing the reference position does not change the reference level value.

Key Path	AMPTD Y Scale
Mode	BASIC, PNOISE, WCDMA, C2K, GSM, WIMAXOFDMA, TDSCDMA, 1XEVD0, DVB, DTMB, ISDBT, CMMB, LTE, LTETDD, DCATV, WLAN, LTEATDD, LTEAFDD
Remote Command	:DISPlay:WAVEform:VIEW2:WINDow[1]:TRACe:Y[:SCALe]:RPOSition TOP CENTER BOTTom :DISPlay:WAVEform:VIEW2:WINDow[1]:TRACe:Y[:SCALe]:RPOSition?
Example	DISP:WAV:VIEW2:WIND:TRAC:Y:RPOS CENT DISP:WAV:VIEW2:WIND:TRAC:Y:RPOS?
Notes	You must be in a mode that includes the Waveform measurement to use this command. Use INSTRument:SElect to set the mode.
Preset	CENT
State Saved	Saved in instrument state.
Range	Top Ctr Bot
Initial S/W Revision	Prior to A.02.00
Modified at S/W Revision	A.03.00

Auto Couple

The Auto Couple feature provides a quick and convenient way to automatically couple multiple instrument settings. This helps ensure accurate measurements and optimum dynamic range. When the Auto Couple feature is activated, either from the front panel or remotely, all parameters of the current measurement that have an Auto/Manual mode are set to Auto mode and all measurement settings dependent on (or coupled to) the Auto/Man parameters are automatically adjusted for optimal performance.

However, the Auto Couple key actions are confined to the current measurement only. It does not affect other measurements in the mode, and it does not affect markers, marker functions, or trace or display attributes.

See "[More Information](#)" on page 2327

Key Path	Front-panel key
Remote Command	:COUPle ALL NONE
Example	:COUP ALL
Notes	:COUPle ALL puts all Auto/Man parameters in Auto mode (equivalent to pressing the Auto Couple key). :COUPLE NONE puts all Auto/Man parameters in manual mode. It decouples all the coupled instrument parameters and is not recommended for making measurements.
Initial S/W Revision	Prior to A.02.00

More Information

There are two types of functions that have Auto/Manual modes.

Auto/Man Active Function keys

An Auto/Man toggle key controls the binary state associated with an instrument parameter by toggling between **Auto** (where the parameter is automatically coupled to the other parameters it is dependent upon) and **Man** (where the parameter is controlled independent of the other parameters), as well as making the parameter the active function. The current mode is indicated on the softkey with either **Auto** or **Man** underlined as illustrated below.

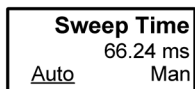

vsd07

Auto/Man 1-of-N keys

An Auto/Man 1-of-N key allows you to manually pick from a list of parameter values, or place the function in Auto, in which case the value is automatically selected (and indicated) as shown below. If in Auto, Auto is underlined on the calling key. If in manual operation, manual is indicated on the calling key. But the calling key does not actually toggle the function, it simply opens the menu.

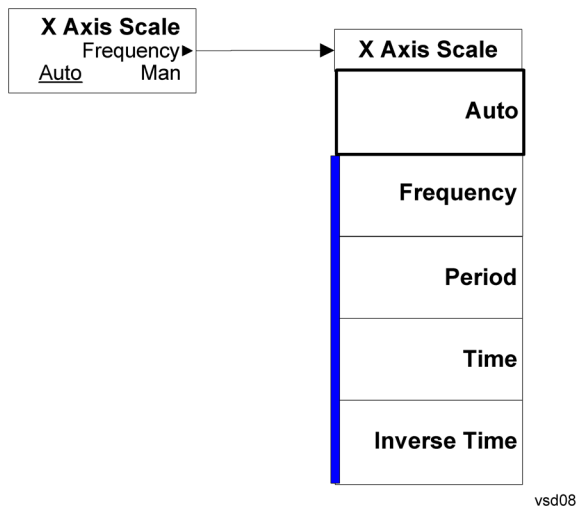

BW

Accesses a menu that enables you to control the information bandwidth functions of the instrument. You can also select the filter type for the measurement.

Key Path	Front-panel key
Initial S/W Revision	Prior to A.02.00

Digital IF BW

Enables you to set the Digital IF (formerly Info BW) bandwidth of the instrument.

Key Path	BW
Mode	BASIC, PNOISE, WCDMA, C2K, GSM, WIMAXOFDMA, TD-SCDMA, 1XEVD0, DVB, DTMB, ISDBT, CMMB, LTE, LTETDD, DCATV, WLAN, MSR,LTEATDD, LTEAFDD
Remote Command	[:SENSe] :WAVeform :DIF :BANDwidth <freq> [:SENSe] :WAVeform :DIF :BANDwidth?
Example	WAV:DIF:BAND 1kHz WAV:DIF:BAND?
Notes	Max value depends on the IF Path Selection
Remote Command Notes	You must be in a mode that includes the Waveform measurements to use this command. Use INSTRument:SElect to set the mode.
Dependencies	For applications that have the IF Path Selection menu such as the BASIC mode, if IF Path Auto is OFF, the maximum value depends on which IF Path is currently selected. If 10 MHz, 25 MHz, 40 MHz, 85 MHz, 125 MHz, 140 MHz or 160 MHz paths are selected, the maximum value of this parameter will be 10, 25, 40, 85, 125, 140 or 160 MHz, respectively. If IF Path Auto is ON, the maximum value will be the maximum Digital IF BW available in the instrument regardless of the current IF Path Selection. For example, if the instrument has the options B25, B40, and B1X installed, the maximum available Digital IF BW of the instrument is 140 MHz. Thus, if IF Path Auto is ON and IF Path Selection is 25 MHz, the maximum Digital IF BW is not limited to 25 MHz but is 140 MHz.
Preset	All except the following list: 100 kHz GSM/EDGE: 510 kHz TDSCDMA: 1.3 MHz 1xEVD0: 1.3 MHz DVB-T/H: 8.0 MHz DTMB (CTTB): 8.0 MHz ISDB-T: 6.0 MHz CMMB: 8.0 MHz Digital Cable TV: 8 MHz LTEAFDD, LTEATDD: 6 MHz LTETDD: 6 MHz

	LTE: 6 MHz WLAN: Hardware Dependent No option = 10 MHz Option B25 = 25 MHz Option B40: if Radio Std is 802.11a/b/g/n(20MHz) = 25 MHz if Radio Std is 802.11n(40MHz) = 40 MHz if Radio Std is 802.11ac(20MHz) = 25 MHz if Radio Std is 802.11ac(40MHz) = 40 MHz Option B1X: if Radio Std is 802.11ac(80MHz) = 80 MHz Option B1Y: if Radio Std is 802.11ac(160MHz) = 160 MHz
State Saved	Saved in instrument state.
Min	10 Hz
Max	Hardware Dependent: RF Input: No Option = 10 MHz Option B25 = 25 MHz Option B40 = 40 MHz Option B85 = 85.0 MHz Option B1A = 125.0 MHz Option B1X = 140 MHz Option B1Y = 160 MHz I/Q Input: No Option = 10 MHz per channel (20 MHz for I+jQ) Option B25 = 25 MHz per channel (50 MHz for I+jQ) Option S40 = 40 MHz per channel (80 MHz for I+jQ)
Backwards Compatibility SCPI	[:SENSe] :WAVeform: BANDwidth [:RESolution]
	[:SENSe] :WAVeform: BWIDth [:RESolution]
Initial S/W Revision	Prior to A.02.00
Modified at S/W Revision	A.03.00, A.13.00

Filter Type

Selects the type of bandwidth filter that is used.

Besides the Gaussian filter shape, a variety of other filter types are available with variable alpha settings for maximum control over the filter shape..

Key Path	BW
Mode	BASIC, PNOISE, WCDMA, C2K, GSM, WIMAXOFDMA, TDSCDMA, 1XEVD0, DVB, DTMB, ISDBT, CMMB, LTE, LETDD, DCATV, WLAN, MSR,,LTEATDD, LTEAFDD
Remote Command	[:SENSe]:WAVeform:DIF:FILTer:TYPE GAUSSian FLATtop [:SENSe]:WAVeform:DIF:FILTer:TYPE? (With DIF40 and/or WBDIF) [:SENSe]:WAVeform:DIF:FILTer:TYPE GAUSSian FLATtop SNYquist RSNYquist RCOSine RRCosine [:SENSe]:WAVeform:DIF:FILTer:TYPE?
Example	WAV:DIF:FILT:TYPE GAUS WAV:DIF:FILT:TYPE?
Remote Command Notes	You must be in a mode that includes the Waveform measurements to use this command. Use INSTRument:SElect to set the mode.
Dependencies	Gaussian and Flattop are available in all DIF configurations. For the other filter types, the filters are only available when Option DP2, B40, or wider IF Bandwidth option is installed.
Preset	BASIC with DP2, B40, or wider IF Bandwidth option: FLATtop All other apps: GAUSSian
State Saved	Saved in instrument state.
Range	Gaussian FlatTop When Option DP2, B40, or wider IF Bandwidth option is installed, the range is as follows. Gaussian Flattop Short nyquist Root Short Nquist Raised Cosine Root RaisedCosine
Backwards Compatibility SCPI	[:SENSe]:WAVeform:BANDwidth:SHApe [:SENSe]:WAVeform:BWIDth:SHApe [:SENSe]:WAVeform:BANDwidth BWIDth[:RESolution]:TYPE
Initial S/W Revision	Prior to A.02.00
Modified at S/W Revision	A.03.00, A.13.00

Filter BW

This feature is only available when Option DP2, B40, or wider IF Bandwidth option is installed.

Key Path	BW
Mode	BASIC
Remote Command	[:SENSe]:WAVeform:DIF:FILTer:BANDwidth <freq> [:SENSe]:WAVeform:DIF:FILTer:BANDwidth? [:SENSe]:WAVeform:DIF:FILTer:BANDwidth:AUTO ON OFF 1 0 [:SENSe]:WAVeform:DIF:FILTer:BANDwidth:AUTO?
Example	WAV:DIF:FILT:BAND 1MHz

	WAV:DIF:FILT:BAND? WAV:DIF:FILT:BAND:AUTO 0 WAV:DIF:FILT:BAND:AUTO?
Notes	You must be in the IQ Analyzer (Basic) mode to use this command. Use INSTRUMENT:SElect to set the mode.
Dependencies	This feature is only available when Option DP2, B40, or wider IF Bandwidth option is installed.
Couplings	Sets the same value as the current Digital IF BW value upon a preset or when Channel Filter Bandwidth Auto is ON.
Preset	Same value as Digital IF BW ON
State Saved	Saved in instrument state.
Min	10 Hz
Max	Clipped to the current Digital IF BW value.
Initial S/W Revision	A.04.00, A.13.00

Filter Alpha

Sets the filter alpha for the DIF filter. This feature is only available when Option DP2, B40, or wider IF Bandwidth option is installed.

Key Path	BW
Mode	BASIC
Remote Command	[:SENSe]:WAVeform:DIF:FILTer:ALPHa <real> [:SENSe]:WAVeform:DIF:FILTer:ALPHa?
Example	WAV:DIF:FILT:ALPH 0.5 WAV:DIF:FILT:ALPH?
Notes	You must be in the IQ Analyzer (Basic) mode to use this command. Use INSTRUMENT:SElect to set the mode.
Dependencies	This feature is only available when Option DP2, B40, or wider IF Bandwidth option is installed.
Preset	0.2
State Saved	Saved in instrument state.
Min	0.01
Max	1.00
Backwards Compatibility SCPI	[:SENSe]:WAVeform:WBIF:FILTer:ALPHa
Modified at S/W Revision	A.13.00

Filter Type Bwcc

This parameter is strictly for Bwcc purposes.

Remote Command	<code>[:SENSe] :WAVeform:WBIF:FILTer[:TYPE] GAUSSian NONE NYQuist RNYQuist RCOSine RRCosine</code> <code>[:SENSe] :WAVeform:WBIF:FILTer[:TYPE] ?</code>
Preset	BASIC with Option DP2, B40, or wider IF Bandwidth option: FLATtop All other apps: GAUSSian

Gaussian

When Option DP2, B40, or wider IF Bandwidth option is installed, the capability for arbitrary Digital IF bandwidths is available. However, for instruments without DP2, B40, or wider IF Bandwidth option, the selectable Gaussian filter bandwidths are predetermined as shown in the following list. There are 160 Info BWs (RBWs) arranged in a 24-per-decade sequence from 1 Hz through 3 MHz, plus the 4, 5, 6 and 8 MHz settings.

The following table list all 160 Gaussian filter types

Gaussian filters

Normal (-3 dB)	-6 dB	Noise	Impulse
1.0 Hz	1.41 Hz	1.06 Hz	1.49 Hz
1.1 Hz	1.55 Hz	1.16 Hz	1.63 Hz
1.2 Hz	1.69 Hz	1.27 Hz	1.77 Hz
1.3 Hz	1.83 Hz	1.37 Hz	1.92 Hz
1.5 Hz	2.11 Hz	1.59 Hz	2.22 Hz
1.6 Hz	2.25 Hz	1.69 Hz	2.37 Hz
1.8 Hz	2.53 Hz	1.90 Hz	2.66 Hz
2.0 Hz	2.81 Hz	2.12 Hz	2.96 Hz
2.2 Hz	3.09 Hz	2.33 Hz	3.25 Hz
2.4 Hz	3.38 Hz	2.54 Hz	3.55 Hz
2.7 Hz	3.80 Hz	2.86 Hz	3.99 Hz
3.0 Hz	4.22 Hz	3.17 Hz	4.44 Hz
3.3 Hz	4.64 Hz	3.49 Hz	4.88 Hz
3.6 Hz	5.06 Hz	3.81 Hz	5.32 Hz
3.9 Hz	5.49 Hz	4.12 Hz	5.77 Hz
4.3 Hz	6.05 Hz	4.55 Hz	6.36 Hz
4.7 Hz	6.61 Hz	4.97 Hz	6.95 Hz
5.1 Hz	7.17 Hz	5.39 Hz	7.54 Hz
5.6 Hz	7.87 Hz	5.92 Hz	8.27 Hz
6.2 Hz	8.72 Hz	6.56 Hz	9.17 Hz
6.8 Hz	9.55 Hz	7.18 Hz	10.0 Hz

7.5 Hz	10.5 Hz	7.93 Hz	11.1 Hz
8.2 Hz	11.5 Hz	8.66 Hz	12.1 Hz
9.1 Hz	12.8 Hz	9.64 Hz	13.5 Hz
10 Hz	14.0 Hz	10.6 Hz	14.8 Hz
11 Hz	15.4 Hz	11.6 Hz	16.2 Hz
12 Hz	16.9 Hz	12.7 Hz	17.7 Hz
13 Hz	18.3 Hz	13.7 Hz	19.2 Hz
15 Hz	21.1 Hz	15.9 Hz	22.2 Hz
16 Hz	22.5 Hz	16.9 Hz	23.7 Hz
18 Hz	25.3 Hz	19.1 Hz	26.6 Hz
20 Hz	28.1 Hz	21.1 Hz	29.5 Hz
22 Hz	30.9 Hz	23.2 Hz	32.5 Hz
24 Hz	33.8 Hz	25.4 Hz	35.5 Hz
27 Hz	38.0 Hz	28.6 Hz	40.0 Hz
30 Hz	42.3 Hz	31.8 Hz	44.5 Hz
33 Hz	46.3 Hz	34.8 Hz	48.7 Hz
36 Hz	50.7 Hz	38.1 Hz	53.3 Hz
39 Hz	54.9 Hz	41.3 Hz	57.7 Hz
43 Hz	60.5 Hz	45.5 Hz	63.6 Hz
47 Hz	66.1 Hz	49.7 Hz	69.5 Hz
51 Hz	71.7 Hz	53.9 Hz	75.3 Hz
56 Hz	78.9 Hz	59.3 Hz	83.0 Hz
62 Hz	87.3 Hz	65.6 Hz	91.7 Hz
68 Hz	95.5 Hz	71.8 Hz	100 Hz
75 Hz	106 Hz	79.4 Hz	111 Hz
82 Hz	115 Hz	86.8 Hz	121 Hz
91 Hz	128 Hz	96.4 Hz	135 Hz
100 Hz	141 Hz	106 Hz	148 Hz
110 Hz	154 Hz	116 Hz	162 Hz
120 Hz	169 Hz	127 Hz	178 Hz
130 Hz	183 Hz	137 Hz	192 Hz
150 Hz	211 Hz	159 Hz	222 Hz
160 Hz	225 Hz	169 Hz	237 Hz
180 Hz	253 Hz	190 Hz	266 Hz
200 Hz	281 Hz	211 Hz	295 Hz
220 Hz	309 Hz	232 Hz	325 Hz
240 Hz	337 Hz	254 Hz	355 Hz

270 Hz	380 Hz	286 Hz	400 Hz
300 Hz	422 Hz	317 Hz	444 Hz
330 Hz	463 Hz	348 Hz	487 Hz
360 Hz	507 Hz	381 Hz	533 Hz
390 Hz	550 Hz	413 Hz	578 Hz
430 Hz	605 Hz	455 Hz	636 Hz
470 Hz	662 Hz	498 Hz	696 Hz
510 Hz	718 Hz	540 Hz	755 Hz
560 Hz	789 Hz	593 Hz	829 Hz
620 Hz	872 Hz	655 Hz	916 Hz
680 Hz	958 Hz	720 Hz	1.01 kHz
750 Hz	1.06 kHz	794 Hz	1.11 kHz
820 Hz	1.15 kHz	866 Hz	1.21 kHz
910 Hz	1.28 kHz	964 Hz	1.35 kHz
1.0 kHz	1.41 kHz	1.06 kHz	1.48 kHz
1.1 kHz	1.55 kHz	1.17 kHz	1.63 kHz
1.2 kHz	1.69 kHz	1.27 kHz	1.78 kHz
1.3 kHz	1.83 kHz	1.38 kHz	1.93 kHz
1.5 kHz	2.11 kHz	1.59 kHz	2.22 kHz
1.6 kHz	2.26 kHz	1.70 kHz	2.37 kHz
1.8 kHz	2.54 kHz	1.91 kHz	2.67 kHz
2.0 kHz	2.82 kHz	2.12 kHz	2.96 kHz
2.2 kHz	3.10 kHz	2.33 kHz	3.26 kHz
2.4 kHz	3.38 kHz	2.54 kHz	3.56 kHz
2.7 kHz	3.80 kHz	2.86 kHz	4.00 kHz
3.0 kHz	4.23 kHz	3.18 kHz	4.44 kHz
3.3 kHz	4.65 kHz	3.49 kHz	4.89 kHz
3.6 kHz	5.06 kHz	3.81 kHz	5.32 kHz
3.9 kHz	5.48 kHz	4.12 kHz	5.76 kHz
4.3 kHz	6.07 kHz	4.56 kHz	6.38 kHz
4.7 kHz	6.62 kHz	4.98 kHz	6.96 kHz
5.1 kHz	7.16 kHz	5.38 kHz	7.53 kHz
5.6 kHz	7.87 kHz	5.92 kHz	8.27 kHz
6.2 kHz	8.74 kHz	6.57 kHz	9.18 kHz
6.8 kHz	9.58 kHz	7.20 kHz	10.1 kHz
7.5 kHz	10.5 kHz	7.92 kHz	11.1 kHz
8.2 kHz	11.5 kHz	8.66 kHz	12.1 kHz

9.1 kHz	12.8 kHz	9.64 kHz	13.5 kHz
10 kHz	14.1 kHz	10.6 kHz	14.8 kHz
11 kHz	15.4 kHz	11.6 kHz	16.2 kHz
12 kHz	16.9 kHz	12.7 kHz	17.8 kHz
13 kHz	18.3 kHz	13.7 kHz	19.2 kHz
15 kHz	21.2 kHz	15.9 kHz	22.3 kHz
16 kHz	22.4 kHz	16.8 kHz	23.5 kHz
18 kHz	25.2 kHz	19.0 kHz	26.5 kHz
20 kHz	28.4 kHz	21.3 kHz	29.8 kHz
22 kHz	31.2 kHz	23.4 kHz	32.8 kHz
24 kHz	33.8 kHz	25.4 kHz	35.6 kHz
27 kHz	38.1 kHz	28.7 kHz	40.1 kHz
30 kHz	42.1 kHz	31.7 kHz	44.3 kHz
33 kHz	46.8 kHz	35.2 kHz	49.2 kHz
36 kHz	50.1 kHz	37.7 kHz	52.7 kHz
39 kHz	54.8 kHz	41.2 kHz	57.6 kHz
43 kHz	61.1 kHz	46.0 kHz	64.3 kHz
47 kHz	66.2 kHz	49.8 kHz	69.6 kHz
51 kHz	72.3 kHz	54.3 kHz	76.0 kHz
56 kHz	79.5 kHz	59.8 kHz	83.6 kHz
62 kHz	86.3 kHz	64.9 kHz	90.8 kHz
68 kHz	96.5 kHz	72.6 kHz	101 kHz
75 kHz	106 kHz	79.7 kHz	111 kHz
82 kHz	114 kHz	86.0 kHz	120 kHz
91 kHz	129 kHz	97.3 kHz	136 kHz
100 kHz	140 kHz	105 kHz	147 kHz
110 kHz	154 kHz	116 kHz	162 kHz
120 kHz	169 kHz	127 kHz	178 kHz
130 kHz	182 kHz	137 kHz	192 kHz
150 kHz	210 kHz	158 kHz	221 kHz
160 kHz	223 kHz	168 kHz	235 kHz
180 kHz	253 kHz	190 kHz	266 kHz
200 kHz	280 kHz	211 kHz	295 kHz
220 kHz	308 kHz	232 kHz	324 kHz
240 kHz	336 kHz	253 kHz	353 kHz
270 kHz	380 kHz	286 kHz	400 kHz
300 kHz	420 kHz	316 kHz	441 kHz

330 kHz	467 kHz	352 kHz	491 kHz
360 kHz	506 kHz	380 kHz	532 kHz
390 kHz	550 kHz	414 kHz	578 kHz
430 kHz	599 kHz	451 kHz	629 kHz
470 kHz	660 kHz	497 kHz	693 kHz
510 kHz	715 kHz	538 kHz	750 kHz
560 kHz	786 kHz	592 kHz	826 kHz
620 kHz	867 kHz	653 kHz	912 kHz
680 kHz	952 kHz	717 kHz	1.00 MHz
750 kHz	1.05 MHz	791 kHz	1.10 MHz
820 kHz	1.14 MHz	859 kHz	1.19 MHz
910 kHz	1.27 MHz	960 kHz	1.34 MHz
1.0 MHz	1.40 MHz	1.06 MHz	1.47 MHz
1.1 MHz	1.53 MHz	1.15 MHz	1.61 MHz
1.2 MHz	1.66 MHz	1.26 MHz	1.75 MHz
1.3 MHz	1.80 MHz	1.36 MHz	1.89 MHz
1.5 MHz	2.06 MHz	1.56 MHz	2.17 MHz
1.6 MHz	2.19 MHz	1.66 MHz	2.29 MHz
1.8 MHz	2.51 MHz	1.91 MHz	2.63 MHz
2.0 MHz	2.75 MHz	2.10 MHz	2.88 MHz
2.2 MHz	3.00 MHz	2.30 MHz	3.14 MHz
2.4 MHz	3.30 MHz	2.54 MHz	3.45 MHz
2.7 MHz	3.63 MHz	2.81 MHz	3.78 MHz
3.0 MHz	4.09 MHz	3.18 MHz	4.22 MHz
4 MHz	5.30 MHz	4.23 MHz	5.30 MHz
5 MHz	5.78 MHz	4.81 MHz	5.41 MHz
6 MHz	6.31 MHz	5.50 MHz	5.82 MHz
8 MHz	8.07 MHz	7.21 MHz	6.90 MHz

Flattop

When Option DP2, B40, or wider IF Bandwidth option is installed, the capability for arbitrary Digital IF bandwidths is available. However, for instruments without Option DP2, B40 or wider IF Bandwidth option, the selectable Flattop filter bandwidths are predefined as shown in the following table. There are 134 Digital IF BWs (RBWs).

The table in the section "[Flattop Filters](#)" on page 2338 lists all 134 Flattop filter types.

Flattop Filters

3.0 Hz	3.3 Hz	3.6 Hz	3.9 Hz
4.3 Hz	4.7 Hz	5.1 Hz	5.6 Hz
6.2 Hz	6.8 Hz	7.5 Hz	8.2 Hz
9.1 Hz	10 Hz	11 Hz	12 Hz
13 Hz	15 Hz	16 Hz	18 Hz
20 Hz	22 Hz	24 Hz	27 Hz
30 Hz	33 Hz	36 Hz	39 Hz
43 Hz	47 Hz	51 Hz	56 Hz
62 Hz	68 Hz	75 Hz	82 Hz
91 Hz	100 Hz	110 Hz	120 Hz
130 Hz	150 Hz	160 Hz	180 Hz
200 Hz	220 Hz	240 Hz	270 Hz
300 Hz	330 Hz	360 Hz	390 Hz
430 Hz	470 Hz	510 Hz	560 Hz
620 Hz	680 Hz	750 Hz	820 Hz
910 Hz	1.0 kHz	1.1 kHz	1.2 kHz
1.3 kHz	1.5 kHz	1.6 kHz	1.8 kHz
2.0 kHz	2.2 kHz	2.4 kHz	2.7 kHz
3.0 kHz	3.3 kHz	3.6 kHz	3.9 kHz
4.3 kHz	4.7 kHz	5.1 kHz	5.6 kHz
6.2 kHz	6.8 kHz	7.5 kHz	8.2 kHz
9.1 kHz	10 kHz	11 kHz	12 kHz
13 kHz	15 kHz	16 kHz	18 kHz
20 kHz	22 kHz	24 kHz	27 kHz
30 kHz	33 kHz	36 kHz	39 kHz
43 kHz	47 kHz	51 kHz	56 kHz
62 kHz	68 kHz	75 kHz	82 kHz
91 kHz	100 kHz	110 kHz	120 kHz
130 kHz	150 kHz	160 kHz	180 kHz
200 kHz	220 kHz	240 kHz	270 kHz
300 kHz	330 kHz	390 kHz	430 kHz
510 kHz	620 kHz	750 kHz	1.0 MHz
1.5 MHz	3.0 MHz	4 MHz	5 MHz
6 MHz	8 MHz		

Channel Filter Bandwidth Bwcc (Remote Command Only)

This is the backward compatibility command for Channel Filter Bandwidth.

Mode	BASIC
Remote Command	[:SENSe] :WAVeform:WBIF:FILTer:BA NDwidth <real> [:SENSe] :WAVeform:WBIF:FILTer:BA NDwidth?
Example	WAV:WBIF:FILT:BA ND 0.3 WAV:WBIF:FILT:BA ND?
Notes	You must be in the IQ Analyzer (Basic) mode to use this command. Use INSTRument:SElect to set the mode.
Dependencies	This feature is only available when Option DP2, B40, or wider IF Bandwidth option is installed.
Couplings	The value is determined by the following equation. $\text{ChannelFilterBwBwcc} = (\text{ChannelFilterBw} / (\text{DigitalIFBw} * \text{OverSampleRatio}))$
Preset	0.8
State Saved	Saved in instrument state.
Min	0.01
Max	1.0
Initial S/W Revision	A.04.00
Modified at S/W Revision	A.13.00

Cont (Continuous Measurement/Sweep)

Sets the analyzer for Continuous measurement operation. The single/continuous state is Meas Global so the setting will affect all measurements. If you are Paused, pressing **Cont** does a Resume.

Key Path	Front-panel key
Remote Command	:INITiate:CONTinuous OFF ON 0 1 :INITiate:CONTinuous?
Example	:INIT:CONT 0 puts analyzer in Single measurement operation. :INIT:CONT 1 puts analyzer in Continuous measurement operation
Preset	ON (Note that SYST:PRESet sets INIT:CONT to ON but *RST sets INIT:CONT to OFF)
State Saved	Saved in instrument state
Backwards Compatibility Notes	For Spectrum Analysis mode in ESA and PSA, there is no Cont hardkey, instead there is a Sweep Single/Cont key. In these analyzers, switching the Sweep Single/Cont key from Single to Cont restarts averages (displayed average count reset to 1), but does not restart Max Hold and Min Hold . The X-Series has Single and Cont keys in place of the SweepSingleCont key. In the X-Series, if in single measurement, the Cont key (and INIT:CONT ON) switches to continuous measurement, but never restarts a measurement and never resets a sweep.
Initial S/W Revision	Prior to A.02.00

In Swept SA Measurement (Spectrum Analysis Mode):

The analyzer takes repetitive sweeps, averages, measurements, etc., when in Continuous mode. When the average count reaches the Average/Hold Number the count stops incrementing, but the analyzer keeps sweeping. See the Trace/Detector section for the averaging formula used both before and after the Average/Hold Number is reached. The trigger condition must be met prior to each sweep. The type of trace processing for multiple sweeps, is set under the Trace/Detector key, with choices of **Trace Average**, **Max Hold**, or **Min Hold**.

In Other Measurements/Modes:

With **Avg/Hold Num** (in the **Meas Setup** menu) set to **Off** or set to **On** with a value of 1, a sweep is taken after the trigger condition is met; and the analyzer continues to take new sweeps after the current sweep has completed and the trigger condition is again met. However, with **Avg/Hold Num** set to On with a value >1, multiple sweeps (data acquisitions) are taken for the measurement. The trigger condition must be met prior to each sweep. The sweep is not stopped when the average count k equals the number N set for Avg/Hold Num is reached, but the number k stops incrementing. A measurement average usually applies to all traces, marker results, and numeric results. But sometimes it only applies to the numeric results.

If the analyzer is in Single measurement, pressing the **Cont** key does not change k and does not cause the sweep to be reset; the only action is to put the analyzer into Continuous measurement operation.

If it is already in continuous sweep:

the INIT:CONT 1 command has no effect

the INIT:CONT 0 command will place the analyzer in Single Sweep but will have no effect on the current sequence until $k = N$, at which point the current sequence will stop and the instrument will go to the idle state.

16 Waveform Measurement
File

File

See "File" on page 362

FREQ Channel

Accesses a menu of keys that allow you to control the Frequency and Channel parameters of the instrument.

Some features in the Frequency menu are the same for all measurements - they do not change as you change measurements. Settings like these are called "Meas Global" and are unaffected by Meas Preset. For example, the Center Freq setting is the same for all measurements - it does not change as you change measurements.

Key Path	Front Panel
Mode	MSR
Initial S/W Revision	A.10.00

Center Freq

Sets center frequency used in Monitor Spectrum, IQ Waveform and Power Stat CCDF. Center Freq, Center Freq Offset and Carrier Ref Freq are coupled with this equation, $\text{Center Freq} = \text{Carrier Ref Freq} + \text{Center Freq Offset}$. When Center Freq is changed, Center Freq Offset is updated and Carrier Ref Freq is not.

When auto, Center Freq Offset remains the same value. Thus Center Freq changes the same amount of Carrier Ref Freq change when Carrier Ref Freq is changed. The auto state changes to manual when either Center Freq is changed.

Key Path	FREQ Channel
Mode	MSR
Measurement	Monitor Spectrum, IQ Waveform, Power Stat CCDF
Remote Command	[:SENSe]:FREQuency:CENTer <freq> [:SENSe]:FREQuency:CENTer? [:SENSe]:FREQuency:CENTer:AUTO ON OFF 1 0 [:SENSe]:FREQuency:CENTer:AUTO?
Example	FREQ:CENT 1.0GHz FREQ:CENT? FREQ:CENT:AUTO OFF FREQ:CENT:AUTO?
Preset	Automatically calculated ON
State Saved	Saved in instrument state
Min	Depends on instrument minimum frequency.
Max	Depends on instrument maximum frequency.
Initial S/W Revision	A.10.00

Center Freq Offset

Sets Center Freq Offset which is coupled with center frequency used in Monitor Spectrum, IQ Waveform and Power Stat CCDF as the offset from Carrier Ref Freq. Center Freq, Center Freq Offset and Carrier Ref Freq are coupled with this equation, Center Freq = Carrier Ref Freq + Center Freq Offset. When Center Freq Offset is changed, Center Freq is updated and Carrier Ref Freq is not.

Key Path	FREQ Channel
Mode	MSR
Measurement	Monitor Spectrum, IQ Waveform, Power Stat CCDF
Remote Command	<code>[:SENSe] :FREQuency:CENTer:OFFSet <freq></code> <code>[:SENSe] :FREQuency:CENTer:OFFSet?</code>
Example	FREQ:CENT:OFFS 100kHz FREQ:CENT:OFFS?
Notes	Center Freq State is changed to man when Center Freq Offset is changed.
Preset	0 GHz
State Saved	Saved in instrument state
Min	Minimum of Center Frequency - Carrier Ref Frequency
Max	Maximum of Center Frequency - Carrier Ref Frequency
Initial S/W Revision	A.10.00

Carrier Ref Freq

Sets carrier reference frequency. The center frequencies of carriers are defined as offset frequency from this value. This reference frequency is also the reference of carrier configuration preset.

Key Path	FREQ Channel
Mode	MSR
Measurement	all
Remote Command	<code>[:SENSe] :CARRier:REFerence <freq></code> <code>[:SENSe] :CARRier:REFerence?</code>
Example	CARR:REF 2GHz CARR:REF?
Preset	1GHz
State Saved	Saved in instrument state
Min	Depends on instrument minimum center frequency. Same as Center Freq
Max	Depends on instrument maximum center frequency. Same as Center Freq
Initial S/W Revision	A.10.00

Carrier Setup

Accesses the Carrier Setup menu.

Key Path	FREQ Channel
Initial S/W Revision	A.10.00

Carriers

Specifies how many carriers are used in MSR measurements. Base station RF bandwidth is determined from the carrier 1 to the carrier specified by this value whatever carriers' Present Pwr states are. Select Carrier can be select up to this value.

Key Path	FREQ Channel, Carrier Setup
Measurement	All
Remote Command	<code>[:SENSe] :CARRier:COUNT <integer></code> <code>[:SENSe] :CARRier:COUNT?</code>
Example	CARR:COUN 10 CARR:COUN?
Preset	1
State Saved	Saved in instrument state.
Min	1
Max	100
Initial S/W Revision	A.10.00

Configure Carriers

Accesses a menu of commonly used carrier configuration parameters.

Key Path	FREQ Channel, Carrier Setup
Initial S/W Revision	A.10.00

Select Carrier

Selects which carrier's configuration menu is displayed.

This key is also connected to the carrier info tables of some measurements. When the value is changed in a measurement which has carrier table view, the highlight in the table moves to Select Carrier. The highlight of the table and Select Carrier are not coupled.

Key Path	FREQ Channel, Carrier Setup, Configure Carriers
Preset	1

State Saved	No
Min	1
Max	Value of Carriers
Initial S/W Revision	A.10.00

Measure Carrier

Sets whether to measure this carrier or not.

Key Path	FREQ Channel, Carrier Setup, Configure Carriers
Remote Command	[:SENSe] :CARRier<n> [:STATe] OFF ON 0 1 [:SENSe] :CARRier<n> [:STATe] ?
Example	CARR10 1 CARR10?
Notes	The command is used with a sub-op code <n> (default=1) to specify the carrier for configuration. The range of the sub-op code is determined by the number of carriers.
Preset	ON
State Saved	Saved in instrument state
Range	On Off
Initial S/W Revision	A.10.00

Carrier Offset

Sets the carrier center frequency as offset from Carrier Ref Frequency.

Key Path	FREQ Channel, Carrier Setup, Configure Carriers
Remote Command	[:SENSe] :CARRier<n> :FREQuency:OFFSet <freq> [:SENSe] :CARRier<n> :FREQuency:OFFSet ?
Example	CARR10:FREQ:OFFS 10MHz CARR10:FREQ:OFFS?
Notes	The command is used with a sub-op code <n> (default=1) to specify the carrier for configuration. The range of the sub-op code is determined by the number of carriers.
Preset	0Hz
State Saved	Saved in instrument state
Min	-1GHz
Max	1GHz
Initial S/W Revision	A.10.00

Radio Format

Selects a format parameter set to set the radio format of the selected carrier.

NONE – No format is specified. Channel spacing, measurement BW and FOffset, RAT are values of defaults of LTE FDD 5MHz.

LTE FDD Parameter Set 1 – Selects LTE FDD parameter set 1. LTE FDD (E-UTRA FDD) is the radio format of the carrier.

LTE FDD Parameter Set 2 – Selects LTE FDD parameter set 2. LTE FDD (E-UTRA FDD) is the radio format of the carrier.

LTE FDD Parameter Set 3 – Selects LTE FDD parameter set 3. LTE FDD (E-UTRA FDD) is the radio format of the carrier.

W-CDMA Parameter Set 1 – Selects W-CDMA parameter set 1. W-CDMA (UTRA FDD) is the radio format of the carrier.

W-CDMA Parameter Set 2 – Selects W-CDMA parameter set 2. W-CDMA (UTRA FDD) is the radio format of the carrier.

W-CDMA Parameter Set 3 – Selects W-CDMA parameter set 3. W-CDMA (UTRA FDD) is the radio format of the carrier.

GSM/EDGE Parameter Set 1 – Selects GSM/EDGE parameter set 1. GSM/EDGE is the radio format of the carrier.

GSM/EDGE Parameter Set 2 – Selects GSM/EDGE parameter set 2. GSM/EDGE is the radio format of the carrier.

GSM/EDGE Parameter Set 3 – Selects GSM/EDGE parameter set 3. GSM/EDGE is the radio format of the carrier.

cdma2000 Parameter Set 1 – Selects cdma2000 parameter set 1. cdma2000 is the radio format of the carrier.

cdma2000 Parameter Set 2 – Selects cdma2000 parameter set 2. cdma2000 is the radio format of the carrier.

cdma2000 Parameter Set 3 – Selects cdma2000 parameter set 3. cdma2000 is the radio format of the carrier.

1xEV-DO Parameter Set 1 – Selects 1xEV-DO parameter set 1. 1xEV-DO is the radio format of the carrier.

1xEV-DO Parameter Set 2 – Selects 1xEV-DO parameter set 2. 1xEV-DO is the radio format of the carrier.

1xEV-DO Parameter Set 3 – Selects 1xEV-DO parameter set 3. 1xEV-DO is the radio format of the carrier.

LTE TDD Parameter Set 1 – Selects LTE TDD parameter set 1. LTE TDD (E-UTRA TDD) is the radio format of the carrier.

LTE TDD Parameter Set 2 – Selects LTE TDD parameter set 2. LTE TDD (E-UTRA TDD) is the radio format of the carrier.

LTE TDD Parameter Set 3 – Selects LTE TDD parameter set 3. LTE TDD (E-UTRA TDD) is the radio format of the carrier.

TD-SCDMA Parameter Set 1 – Selects TD-SCDMA parameter set 1. TD-SCDMA (UTRA-TDD LCR) is the radio format of the carrier.

TD-SCDMA Parameter Set 2 – Selects TD-SCDMA parameter set 2. TD-SCDMA (UTRA-TDD LCR) is the radio format of the carrier.

TD-SCDMA Parameter Set 3 – Selects TD-SCDMA parameter set 3. TD-SCDMA (UTRA-TDD LCR) is the radio format of the carrier.

Key Path	FREQ Channel, Carrier Setup, Configure Carriers
Remote Command	[:SENSe]:CARRier<n>:FORMat NONE LTEFdd1 LTEFdd2 LTEFdd3 WCDMa1 WCDMa2 WCDMa3 GSM1 GSM2 GSM3 CDMA1 CDMA2 CDMA3 EVDO1 EVDO2 EVDO3 LETETdd1 LETETdd2 LETETdd3 TDSCdma1 TDSCdma2 TDSCdma3 [:SENSe]:CARRier<n>:FORMat ?
Example	CARR10:FORM LTEF1 CARR10:FORM?
Notes	The command is used with a sub-op code <n> (default=1) to specify the carrier for configuration. The range of the sub-op code is determined by the number of carriers.
Dependencies	The following licenses are required for each key to be displayed. Without the licenses, corresponding enum values cannot be set even via the SCPI command. <ul style="list-style-type: none"> • LTE FDD - N9080A-1FP or W9080A-1FP • W-CDMA - N9073A-1FP or W9073A-1FP • GSM/EDGE - N9071A-2FP or W9071A-2FP • cdma2000 - N9072A-2FP or W9072A-2FP • 1xEV-DO - N9076A-1FP or W9076A-1FP • LTE TDD - N9082A-1FP or W9082A-1FP • TD-SCDMA - N9079A-1FP or W9079A-1FP
State Saved	Saved in instrument state
Range	None LTE FDD [Parameter Set 1] Parameter Set 1 ("LTE FDD 1") Parameter Set 2 ("LTE FDD 2") Parameter Set 3 ("LTE FDD 3") W-CDMA [Parameter Set 1] Parameter Set 1 ("W-CDMA 1") Parameter Set 2 ("W-CDMA 2") Parameter Set 3 ("W-CDMA 3") GSM/EDGE [Parameter Set 1] Parameter Set 1 ("GSM/EDGE 1") Parameter Set 2 ("GSM/EDGE 2") Parameter Set 3 ("GSM/EDGE 3") cdma2000 [Parameter Set 1] Parameter Set 1 ("cdma2000 1")

	Parameter Set 2 ("cdma2000 2") Parameter Set 3 ("cdma2000 3") 1xEV-DO [Parameter Set 1] Parameter Set 1 ("1xEV-DO 1") Parameter Set 2 ("1xEV-DO 2") Parameter Set 3 ("1xEV-DO 3") LTE TDD [Parameter Set 1] Parameter Set 1 ("LTE TDD 1") Parameter Set 2 ("LTE TDD 2") Parameter Set 3 ("LTE TDD 3") TD-SCDMA [Parameter Set 1] Parameter Set 1 ("TD-SCDMA 1") Parameter Set 2 ("TD-SCDMA 2") Parameter Set 3 ("TD-SCDMA 3")
Readback	The readback line on this key shows the currently selected Radio Format in square brackets.
Initial S/W Revision	A.10.00
Modified at S/W Revision	A.12.00, A.16.00

Carrier Allocation

Specifies the carrier frequency allocation. There are two types of allocation, contiguous and non-contiguous. Non-Contiguous frequency allocation is defined as an allocation where two sub-blocks are separated with a sub-block gap.

Contiguous – All the carriers belong to one block and no sub-block gap exists.

Non-Contiguous – Carriers are separated into two sub-blocks. Allocation Break Pt Carrier determines how sub-blocks are configured.

Key Path	FREQ Channel, Carrier Setup
Scope	Meas Global
Remote Command	[:SENSe]:CARRier:CONFig:ALLocation CONTiguous NCONtiguous [:SENSe]:CARRier:CONFig:ALLocation?
Example	CARR:CONF:ALL CONT CARR:CONF:ALL?
Preset	CONtiguous
State Saved	Saved in instrument state.
Range	Contiguous Non-Contiguous
Initial S/W Revision	A.13.00

Non-Contiguous

Opens a menu that enables you to set a non-contiguous parameter.

Key Path	FREQ Channel, Carrier Setup, Carrier Allocation
Initial S/W Revision	A.13.00

Allocation Break Pt Carrier

Specifies an allocation break point in non-contiguous carrier allocation. First sub-block starts from the lowest frequency carrier and stops at the allocation break point carrier. Next sub-block starts from the next upper frequency carrier and ends at the highest frequency carrier.

Two examples are shown below. In these examples carrier indices are not in the order of carrier frequency. In the first example, Allocation Break Pt Carrier is 2. It means that sub-block 1 ends at carrier 2 and sub-block 2 starts at carrier 5. Sub-block gap is located between carrier 2 and 5. In the second example, Allocation Break Pt Carrier is 3 and the sub-block gap comes between carrier 3 and 2.

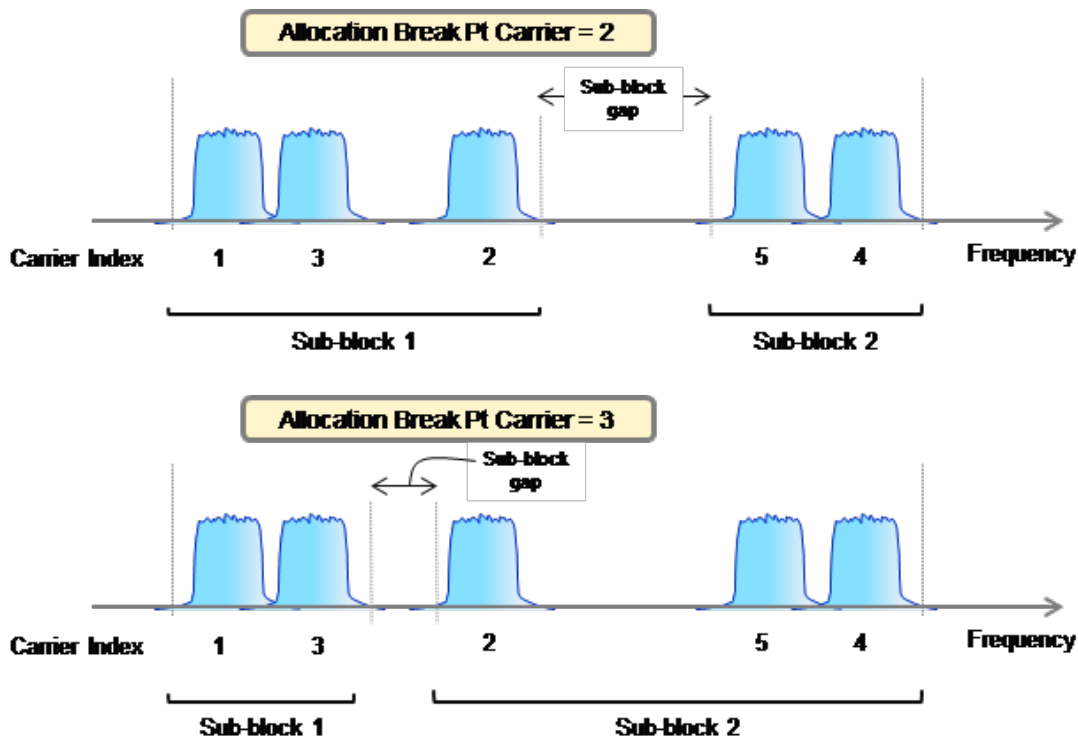

Key Path	FREQ Channel, Carrier Setup, Carrier Allocation, Non-Contiguous
Scope	Meas Global
Remote Command	[[:SENSe]:CARRier:CONFig:ALLocation:NCONtiguous:ABPoint <integer> [[:SENSe]:CARRier:CONFig:ALLocation:NCONtiguous:ABPoint?
Example	CARR:CONF:ALL:NCON:ABP 5 CARR:CONF:ALL:NCON:ABP?

Dependencies	The maximum value depends on the number of carriers.
Couplings	This value can change when you decrease the number of carriers.
Preset	1
State Saved	Saved in instrument state.
Min	1
Max	99
Initial S/W Revision	A.13.00

Carrier Conf Presets

Pressing this key pops up Conf Presets. Each parameter under this menu initiate carrier configuration preset when its value is changed.

Appropriate licenses are required to select carrier config enum. Required licenses are shown here. Note that N/W means N or W license, i.e. N/W9073A-1FP means either N9073A-1FP or W9073A-1FP is required.

TC1a (FDD): N/W9073A-1FP (W-CDMA)

TC2 (FDD): N/W9080A-1FP (LTE FDD)

TC3a (FDD): N/W9073A-1FP (W-CDMA) and N9080A-1FP (LTE FDD)

TC4a (FDD): N/W9071A-2FP (GSM/EDGE) and N/W9073A-1FP (W-CDMA)

TC4b (FDD): N/W9071A-2FP (GSM/EDGE) and N9080A-1FP (LTE FDD)

TC4c (FDD): N/W9071A-2FP (GSM/EDGE), N/W9073A-1FP (W-CDMA) and N9080A-1FP (LTE FDD)

TC4d (FDD): N/W9071A-2FP (GSM/EDGE) and N/W9073A-1FP (W-CDMA)

TC4e (FDD): N/W9071A-2FP (GSM/EDGE) and N9080A-1FP (LTE FDD)

TC4a (FDD) Two Carriers: N/W9071A-2FP (GSM/EDGE) and N/W9073A-1FP (W-CDMA)

TC4b (FDD) Two Carriers: N/W9071A-2FP (GSM/EDGE) and N9080A-1FP (LTE FDD)

TC4c (FDD) Two Carriers: N/W9071A-2FP (GSM/EDGE), N/W9073A-1FP (W-CDMA) and N9080A-1FP (LTE FDD)

NTC1a (FDD): N/W9073A-1FP (W-CDMA)

NTC2 (FDD): N/W9080A-1FP (LTE FDD)

NTC3a (FDD): N/W9073A-1FP (W-CDMA) and N9080A-1FP (LTE FDD)

NTC4a (FDD): N/W9071A-2FP (GSM/EDGE) and N/W9073A-1FP (W-CDMA)

NTC4b (FDD): N/W9071A-2FP (GSM/EDGE) and N9080A-1FP (LTE FDD)

NTC4c (FDD): N/W9071A-2FP (GSM/EDGE), N/W9073A-1FP (W-CDMA) and N9080A-1FP (LTE FDD)

LTE FDD: N/W9080A-1FP (LTE FDD)

W-CDMA: N/W9073A-1FP (W-CDMA)

GSM/EDGE: N/W9071A-2FP (GSM/EDGE)

cdma2000: N/W9072A-2FP (cdma2000)

1xEV-DO: N/W9076A-1FP (1xEV-DO)

Enum keys don't appear on the menu if required licenses are not installed.

Key Path	FREQ Channel, Carrier Setup
Remote Command	[:SENSe] :CARRier:CONFig?
Example	CARR:CONF TC1AFDD CARR:CONF?
Notes	The softkey for NONE is not available.
State Saved	Saved in instrument state
Initial S/W Revision	A.10.00
Modified at S/W Revision	A.12.00, A.13.00

MSR Test Config

Accesses the menu to select MSR Test Configurations.

Key Path	FREQ Channel, Carrier Setup
Initial S/W Revision	A.10.00

Carrier Conf Presets

Pressing this key pops up Conf Presets. Each parameter under this menu initiate carrier configuration preset when its value is changed.

Appropriate licenses are required to select carrier config enum. Required licenses are shown here. Note that N/W means N or W license, i.e. N/W9073A-1FP means either N9073A-1FP or W9073A-1FP is required.

TC1a (FDD): N/W9073A-1FP (W-CDMA)

TC2 (FDD): N/W9080A-1FP (LTE FDD)

TC3a (FDD): N/W9073A-1FP (W-CDMA) and N9080A-1FP (LTE FDD)

TC4a (FDD): N/W9071A-2FP (GSM/EDGE) and N/W9073A-1FP (W-CDMA)

TC4b (FDD): N/W9071A-2FP (GSM/EDGE) and N9080A-1FP (LTE FDD)

TC4c (FDD): N/W9071A-2FP (GSM/EDGE), N/W9073A-1FP (W-CDMA) and N9080A-1FP (LTE FDD)

TC4d (FDD): N/W9071A-2FP (GSM/EDGE) and N/W9073A-1FP (W-CDMA)

TC4e (FDD): N/W9071A-2FP (GSM/EDGE) and N9080A-1FP (LTE FDD)

TC4a (FDD) Two Carriers: N/W9071A–2FP (GSM/EDGE) and N/W9073A–1FP (W-CDMA)
 TC4b (FDD) Two Carriers: N/W9071A–2FP (GSM/EDGE) and N9080A–1FP (LTE FDD)
 TC4c (FDD) Two Carriers: N/W9071A–2FP (GSM/EDGE), N/W9073A–1FP (W-CDMA) and N9080A–1FP (LTE FDD)
 NTC1a (FDD): N/W9073A–1FP (W-CDMA)
 NTC2 (FDD): N/W9080A–1FP (LTE FDD)
 NTC3a (FDD): N/W9073A–1FP (W-CDMA) and N9080A–1FP (LTE FDD)
 NTC4a (FDD): N/W9071A–2FP (GSM/EDGE) and N/W9073A–1FP (W-CDMA)
 NTC4b (FDD): N/W9071A–2FP (GSM/EDGE) and N9080A–1FP (LTE FDD)
 NTC4c (FDD): N/W9071A–2FP (GSM/EDGE), N/W9073A–1FP (W-CDMA) and N9080A–1FP (LTE FDD)
 LTE FDD: N/W9080A–1FP (LTE FDD)
 W-CDMA: N/W9073A–1FP (W-CDMA)
 GSM/EDGE: N/W9071A–2FP (GSM/EDGE)
 cdma2000: N/W9072A–2FP (cdma2000)
 1xEV-DO: N/W9076A–1FP (1xEV-DO)

Enum keys don't appear on the menu if required licenses are not installed.

Key Path	FREQ Channel, Carrier Setup
Remote Command	<code>[:SENSe] :CARRier:CONFIg?</code>
Example	CARR:CONF TC1AFDD CARR:CONF?
Notes	The softkey for NONE is not available.
State Saved	Saved in instrument state
Initial S/W Revision	A.10.00
Modified at S/W Revision	A.12.00, A.13.00

Max W-CDMA Carriers (FDD)

Sets max W-CDMA carriers placed when the carrier configuration preset runs. When this value is changed, the carrier configuration preset is initiated.

Key Path	FREQ Channel, Carrier Setup, Carrier Conf Presets, MSR Test Config, TC1a (FDD)FREQ Channel, Carrier Setup, Carrier Conf Presets, MSR Test Config, TC3a (FDD)FREQ Channel, Carrier Setup, Carrier Conf Presets, MSR Test Config, TC4a (FDD)FREQ Channel, Carrier Setup, Carrier Conf Presets, MSR Test Config, TC4c (FDD)FREQ Channel, Carrier Setup, Carrier Conf Presets, Single RAT Config, W-CDMA
-----------------	---

Remote Command	<code>[:SENSe] :CARRier :CONFig :WCDMa :CMAX <integer></code> <code>[:SENSe] :CARRier :CONFig :WCDMa :CMAX?</code>
Example	<code>CARR:CONF:WCDM:CMAX 8</code> <code>CARR:CONF:WCDM:CMAX?</code>
Preset	100
State Saved	Saved in instrument state
Min	1
Max	100
Initial S/W Revision	A.10.00

Max LTE FDD Carriers

Sets max LTE FDD carriers placed when the carrier configuration preset runs. When this value is changed, the carrier configuration preset is initiated.

Key Path	FREQ Channel, Carrier Setup, Carrier Conf Presets, MSR Test Config, TC2 (FDD)FREQ Channel, Carrier Setup, Carrier Conf Presets, MSR Test Config, TC3a (FDD)FREQ Channel, Carrier Setup, Carrier Conf Presets, MSR Test Config, TC4b (FDD)FREQ Channel, Carrier Setup, Carrier Conf Presets, MSR Test Config, TC4c (FDD)FREQ Channel, Carrier Setup, Carrier Conf Presets, Single RAT Config, LTE FDD
Remote Command	<code>[:SENSe] :CARRier :CONFig :LTEFdd :CMAX <integer></code> <code>[:SENSe] :CARRier :CONFig :LTEFdd :CMAX?</code>
Example	<code>CARR:CONF:LTEF:CMAX 8</code> <code>CARR:CONF:LTEF:CMAX?</code>
Preset	100
State Saved	Saved in instrument state
Min	1
Max	100
Initial S/W Revision	A.10.00

LTE FDD BW

Sets bandwidth of LTE FDD carriers placed when the carrier configuration preset runs. When this value is changed, the carrier configuration preset is initiated.

Key Path	FREQ Channel, Carrier Setup, Carrier Conf Presets, MSR Test Config, TC2 (FDD)FREQ Channel, Carrier Setup, Carrier Conf Presets, MSR Test Config, TC3a (FDD)FREQ Channel, Carrier Setup, Carrier Conf Presets, MSR Test Config, TC4b (FDD)FREQ Channel, Carrier Setup, Carrier Conf Presets, MSR Test Config, TC4c (FDD)FREQ Channel, Carrier Setup, Carrier Conf Presets, MSR Test Config, TC4d (FDD)FREQ Channel, Carrier Setup, Carrier Conf Presets, Single RAT Config, LTE FDD
Remote Command	<code>[:SENSe] :CARRier :CONFig :LTEFdd :BANDwidth B1M4 B3M B5M B10M B15M</code>

	B20M [:SENSe]:CARRier:CONFig:LTEFdd:BANDwidth?
Example	CARR:CONF:LTEF:BAND B5M CARR:CONF:LTEF:BAND?
Preset	B5M
State Saved	Saved in instrument state
Range	1.4MHz 3MHz 5MHz 10MHz 15MHz 20MHz
Readback	The currently selected LTE FDD BW
Initial S/W Revision	A.10.00

Narrowest LTE FDD BW

Sets narrowest bandwidth of LTE FDD carriers placed for TC2 when the carrier configuration preset runs. When this value is changed, the carrier configuration preset is initiated.

Key Path	FREQ Channel, Carrier Setup, Carrier Conf Presets, MSR Test Config, TC2 (FDD)
Remote Command	[:SENSe]:CARRier:CONFig:LTEFdd:BANDwidth:NARRowest B1M4 B3M B5M B10M B15M B20M [:SENSe]:CARRier:CONFig:LTEFdd:BANDwidth:NARRowest?
Example	CARR:CONF:LTEF:BAND:NARR B1M4 CARR:CONF:LTEF:BAND:NARR?
Preset	B1M4
State Saved	Saved in instrument state
Range	1.4MHz 3MHz 5MHz 10MHz 15MHz 20MHz
Readback	The currently selected Narrowest LTE FDD BW
Initial S/W Revision	A.10.00

Max GSM/EDGE Carriers

Sets max GSM/EDGE carriers placed when the carrier configuration preset runs. When this value is changed, the carrier configuration preset is initiated.

Key Path	FREQ Channel, Carrier Setup, Carrier Conf Presets, MSR Test Config, TC4a (FDD)FREQ Channel, Carrier Setup, Carrier Conf Presets, MSR Test Config, TC4b (FDD)FREQ Channel, Carrier Setup, Carrier Conf Presets, MSR Test Config, TC4c (FDD)FREQ Channel, Carrier Setup, Carrier Conf Presets, Single RAT Config, GSM/EDGE
Remote Command	[:SENSe]:CARRier:CONFig:GSM:CMAX <integer> [:SENSe]:CARRier:CONFig:GSM:CMAX?
Example	CARR:CONF:GSM:CMAX 8 CARR:CONF:GSM:CMAX?

Preset	100
State Saved	Saved in instrument state
Min	1
Max	100
Initial S/W Revision	A.10.00

LTE FDD Location

Sets the location of LTE FDD carriers when carriers are configured as TC4c. This parameter is effective only for TC4c.

TC4c (FDD)

LTE FDD Location

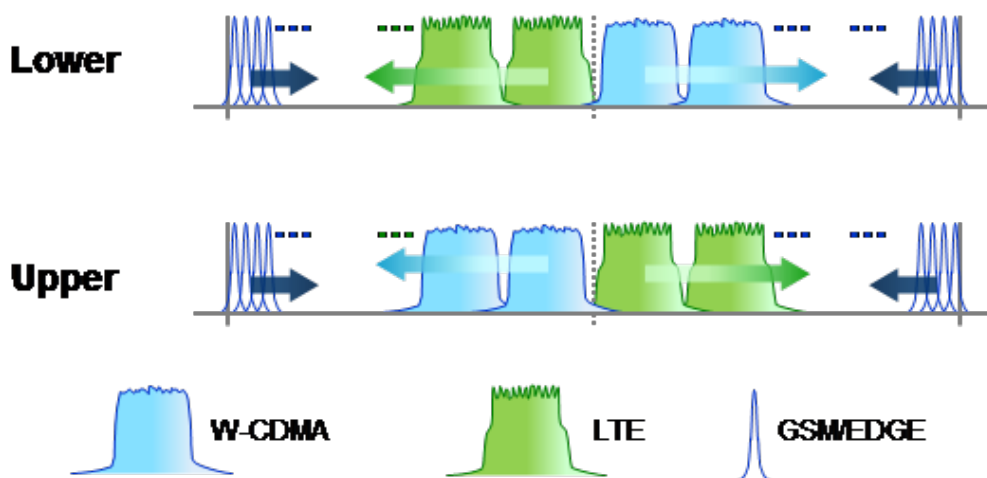

Key Path	FREQ Channel, Carrier Setup, Carrier Conf Presets, MSR Test Config, TC4c (FDD)
Remote Command	[[:SENSE]:CARRIER:CONFIG:LTEFdd:LOCATION UPPER LOWER [:SENSE]:CARRIER:CONFIG:LTEFdd:LOCATION?
Example	CARR:CONF:LTEF:LOC LOW CARR:CONF:LTEF:LOC?
Notes	This setting is effective only for TC4c.
Preset	UPPER
State Saved	Saved in instrument state
Range	Lower (Lower than W-CDMA) Upper (Higher than W-CDMA)
Initial S/W Revision	A.11.00

MSR Non-Contig Test Config

Accesses the menu to select MSR Non-Contiguous Test Configurations.

Key Path	FREQ Channel, Carrier Setup
Initial S/W Revision	A.13.00

Carrier Conf Presets

Pressing this key pops up Conf Presets. Each parameter under this menu initiate carrier configuration preset when its value is changed.

Appropriate licenses are required to select carrier config enum. Required licenses are shown here. Note that N/W means N or W license, i.e. N/W9073A-1FP means either N9073A-1FP or W9073A-1FP is required.

TC1a (FDD): N/W9073A-1FP (W-CDMA)

TC2 (FDD): N/W9080A-1FP (LTE FDD)

TC3a (FDD): N/W9073A-1FP (W-CDMA) and N9080A-1FP (LTE FDD)

TC4a (FDD): N/W9071A-2FP (GSM/EDGE) and N/W9073A-1FP (W-CDMA)

TC4b (FDD): N/W9071A-2FP (GSM/EDGE) and N9080A-1FP (LTE FDD)

TC4c (FDD): N/W9071A-2FP (GSM/EDGE), N/W9073A-1FP (W-CDMA) and N9080A-1FP (LTE FDD)

TC4d (FDD): N/W9071A-2FP (GSM/EDGE) and N/W9073A-1FP (W-CDMA)

TC4e (FDD): N/W9071A-2FP (GSM/EDGE) and N9080A-1FP (LTE FDD)

TC4a (FDD) Two Carriers: N/W9071A-2FP (GSM/EDGE) and N/W9073A-1FP (W-CDMA)

TC4b (FDD) Two Carriers: N/W9071A-2FP (GSM/EDGE) and N9080A-1FP (LTE FDD)

TC4c (FDD) Two Carriers: N/W9071A-2FP (GSM/EDGE), N/W9073A-1FP (W-CDMA) and N9080A-1FP (LTE FDD)

NTC1a (FDD): N/W9073A-1FP (W-CDMA)

NTC2 (FDD): N/W9080A-1FP (LTE FDD)

NTC3a (FDD): N/W9073A-1FP (W-CDMA) and N9080A-1FP (LTE FDD)

NTC4a (FDD): N/W9071A-2FP (GSM/EDGE) and N/W9073A-1FP (W-CDMA)

NTC4b (FDD): N/W9071A-2FP (GSM/EDGE) and N9080A-1FP (LTE FDD)

NTC4c (FDD): N/W9071A-2FP (GSM/EDGE), N/W9073A-1FP (W-CDMA) and N9080A-1FP (LTE FDD)

LTE FDD: N/W9080A-1FP (LTE FDD)

W-CDMA: N/W9073A-1FP (W-CDMA)

GSM/EDGE: N/W9071A-2FP (GSM/EDGE)

cdma2000: N/W9072A-2FP (cdma2000)

1xEV-DO: N/W9076A-1FP (1xEV-DO)

Enum keys don't appear on the menu if required licenses are not installed.

Key Path	FREQ Channel, Carrier Setup
Remote Command	<code>[:SENSe] :CARRier:CONFig?</code>
Example	CARR:CONF TC1AFDD CARR:CONF?
Notes	The softkey for NONE is not available.
State Saved	Saved in instrument state
Initial S/W Revision	A.10.00
Modified at S/W Revision	A.12.00, A.13.00

LTE FDD BW

Sets bandwidth of LTE FDD carriers placed when the carrier configuration preset runs. When this value is changed, the carrier configuration preset is initiated.

Key Path	FREQ Channel, Carrier Setup, Carrier Conf Presets, MSR Test Config, TC2 (FDD)FREQ Channel, Carrier Setup, Carrier Conf Presets, MSR Test Config, TC3a (FDD)FREQ Channel, Carrier Setup, Carrier Conf Presets, MSR Test Config, TC4b (FDD)FREQ Channel, Carrier Setup, Carrier Conf Presets, MSR Test Config, TC4c (FDD)FREQ Channel, Carrier Setup, Carrier Conf Presets, MSR Test Config, TC4d (FDD)FREQ Channel, Carrier Setup, Carrier Conf Presets, Single RAT Config, LTE FDD
Remote Command	<code>[:SENSe] :CARRier:CONFig:LTEFdd: BANDwidth B1M4 B3M B5M B10M B15M B20M</code> <code>[:SENSe] :CARRier:CONFig:LTEFdd: BANDwidth?</code>
Example	CARR:CONF:LTEF: BAND B5M CARR:CONF:LTEF: BAND?
Preset	B5M
State Saved	Saved in instrument state
Range	1.4MHz 3MHz 5MHz 10MHz 15MHz 20MHz
Readback	The currently selected LTE FDD BW
Initial S/W Revision	A.10.00

NTC4 Carriers

Sets NTC4 carriers placed when the NTC4 carrier configuration preset runs. When this value is changed, the carrier configuration preset is initiated.

Key Path	FREQ Channel, Carrier Setup, Carrier Conf Presets, MSR Non-Contig Test Config, NTC4a (FDD)FREQ Channel, Carrier Setup, Carrier Conf Presets, MSR Non-Contig Test Config, NTC4b (FDD)FREQ Channel, Carrier Setup, Carrier Conf Presets, MSR Non-Contig Test Config, NTC4c(FDD)
-----------------	--

Remote Command	<code>[:SENSe] :CARRier:CONFIg:NTC4:COUNT <integer></code> <code>[:SENSe] :CARRier:CONFIg:NTC4:COUNT?</code>
Example	<code>CARR:CONF:NTC4:COUN 6</code> <code>CARR:CONF:NTC4:COUN?</code>
Preset	6
State Saved	Saved in instrument state
Min	3
Max	6
Initial S/W Revision	A.13.00

Single RAT Config

Accesses the menu to select Single RAT Configurations.

Key Path	FREQ Channel, Carrier Setup
Initial S/W Revision	A.10.00

Carrier Conf Presets

Pressing this key pops up Conf Presets. Each parameter under this menu initiate carrier configuration preset when its value is changed.

Appropriate licenses are required to select carrier config enum. Required licenses are shown here. Note that N/W means N or W license, i.e. N/W9073A-1FP means either N9073A-1FP or W9073A-1FP is required.

TC1a (FDD): N/W9073A-1FP (W-CDMA)

TC2 (FDD): N/W9080A-1FP (LTE FDD)

TC3a (FDD): N/W9073A-1FP (W-CDMA) and N9080A-1FP (LTE FDD)

TC4a (FDD): N/W9071A-2FP (GSM/EDGE) and N/W9073A-1FP (W-CDMA)

TC4b (FDD): N/W9071A-2FP (GSM/EDGE) and N9080A-1FP (LTE FDD)

TC4c (FDD): N/W9071A-2FP (GSM/EDGE), N/W9073A-1FP (W-CDMA) and N9080A-1FP (LTE FDD)

TC4d (FDD): N/W9071A-2FP (GSM/EDGE) and N/W9073A-1FP (W-CDMA)

TC4e (FDD): N/W9071A-2FP (GSM/EDGE) and N9080A-1FP (LTE FDD)

TC4a (FDD) Two Carriers: N/W9071A-2FP (GSM/EDGE) and N/W9073A-1FP (W-CDMA)

TC4b (FDD) Two Carriers: N/W9071A-2FP (GSM/EDGE) and N9080A-1FP (LTE FDD)

TC4c (FDD) Two Carriers: N/W9071A-2FP (GSM/EDGE), N/W9073A-1FP (W-CDMA) and N9080A-1FP (LTE FDD)

NTC1a (FDD): N/W9073A-1FP (W-CDMA)

NTC2 (FDD): N/W9080A–1FP (LTE FDD)

NTC3a (FDD): N/W9073A–1FP (W-CDMA) and N9080A–1FP (LTE FDD)

NTC4a (FDD): N/W9071A–2FP (GSM/EDGE) and N/W9073A–1FP (W-CDMA)

NTC4b (FDD): N/W9071A–2FP (GSM/EDGE) and N9080A–1FP (LTE FDD)

NTC4c (FDD): N/W9071A–2FP (GSM/EDGE), N/W9073A–1FP (W-CDMA) and N9080A–1FP (LTE FDD)

LTE FDD: N/W9080A–1FP (LTE FDD)

W-CDMA: N/W9073A–1FP (W-CDMA)

GSM/EDGE: N/W9071A–2FP (GSM/EDGE)

cdma2000: N/W9072A–2FP (cdma2000)

1xEV-DO: N/W9076A–1FP (1xEV-DO)

Enum keys don't appear on the menu if required licenses are not installed.

Key Path	FREQ Channel, Carrier Setup
Remote Command	<code>[:SENSe] :CARRier :CONFig?</code>
Example	CARR:CONF TC1AFDD CARR:CONF?
Notes	The softkey for NONE is not available.
State Saved	Saved in instrument state
Initial S/W Revision	A.10.00
Modified at S/W Revision	A.12.00, A.13.00

Max LTE FDD Carriers

Sets max LTE FDD carriers placed when the carrier configuration preset runs. When this value is changed, the carrier configuration preset is initiated.

Key Path	FREQ Channel, Carrier Setup, Carrier Conf Presets, MSR Test Config, TC2 (FDD)FREQ Channel, Carrier Setup, Carrier Conf Presets, MSR Test Config, TC3a (FDD)FREQ Channel, Carrier Setup, Carrier Conf Presets, MSR Test Config, TC4b (FDD)FREQ Channel, Carrier Setup, Carrier Conf Presets, MSR Test Config, TC4c (FDD)FREQ Channel, Carrier Setup, Carrier Conf Presets, Single RAT Config, LTE FDD
Remote Command	<code>[:SENSe] :CARRier :CONFig :LTEFdd :CMAX <integer></code> <code>[:SENSe] :CARRier :CONFig :LTEFdd :CMAX?</code>
Example	CARR:CONF:LTEF:CMAX 8 CARR:CONF:LTEF:CMAX?
Preset	100
State Saved	Saved in instrument state

Min	1
Max	100
Initial S/W Revision	A.10.00

LTE FDD BW

Sets bandwidth of LTE FDD carriers placed when the carrier configuration preset runs. When this value is changed, the carrier configuration preset is initiated.

Key Path	FREQ Channel, Carrier Setup, Carrier Conf Presets, MSR Test Config, TC2 (FDD)FREQ Channel, Carrier Setup, Carrier Conf Presets, MSR Test Config, TC3a (FDD)FREQ Channel, Carrier Setup, Carrier Conf Presets, MSR Test Config, TC4b (FDD)FREQ Channel, Carrier Setup, Carrier Conf Presets, MSR Test Config, TC4c (FDD)FREQ Channel, Carrier Setup, Carrier Conf Presets, MSR Test Config, TC4d (FDD)FREQ Channel, Carrier Setup, Carrier Conf Presets, Single RAT Config, LTE FDD
Remote Command	<code>[:SENSe] :CARRier:CONFig:LTEFdd:BANDwidth B1M4 B3M B5M B10M B15M B20M</code> <code>[:SENSe] :CARRier:CONFig:LTEFdd:BANDwidth?</code>
Example	<code>CARR:CONF:LTEF:BAND B5M</code> <code>CARR:CONF:LTEF:BAND?</code>
Preset	B5M
State Saved	Saved in instrument state
Range	1.4MHz 3MHz 5MHz 10MHz 15MHz 20MHz
Readback	The currently selected LTE FDD BW
Initial S/W Revision	A.10.00

Max W-CDMA Carriers (FDD)

Sets max W-CDMA carriers placed when the carrier configuration preset runs. When this value is changed, the carrier configuration preset is initiated.

Key Path	FREQ Channel, Carrier Setup, Carrier Conf Presets, MSR Test Config, TC1a (FDD)FREQ Channel, Carrier Setup, Carrier Conf Presets, MSR Test Config, TC3a (FDD)FREQ Channel, Carrier Setup, Carrier Conf Presets, MSR Test Config, TC4a (FDD)FREQ Channel, Carrier Setup, Carrier Conf Presets, MSR Test Config, TC4c (FDD)FREQ Channel, Carrier Setup, Carrier Conf Presets, Single RAT Config, W-CDMA
Remote Command	<code>[:SENSe] :CARRier:CONFig:WCDMa:CMAx <integer></code> <code>[:SENSe] :CARRier:CONFig:WCDMa:CMAx?</code>
Example	<code>CARR:CONF:WCDM:CMAx 8</code> <code>CARR:CONF:WCDM:CMAx?</code>
Preset	100

State Saved	Saved in instrument state
Min	1
Max	100
Initial S/W Revision	A.10.00

Max GSM/EDGE Carriers

Sets max GSM/EDGE carriers placed when the carrier configuration preset runs. When this value is changed, the carrier configuration preset is initiated.

Key Path	FREQ Channel, Carrier Setup, Carrier Conf Presets, MSR Test Config, TC4a (FDD)FREQ Channel, Carrier Setup, Carrier Conf Presets, MSR Test Config, TC4b (FDD)FREQ Channel, Carrier Setup, Carrier Conf Presets, MSR Test Config, TC4c (FDD)FREQ Channel, Carrier Setup, Carrier Conf Presets, Single RAT Config, GSM/EDGE
Remote Command	<code>[:SENSe] :CARRier :CONFig :GSM :CMAX <integer></code> <code>[:SENSe] :CARRier :CONFig :GSM :CMAX ?</code>
Example	CARR:CONF:GSM:CMAX 8 CARR:CONF:GSM:CMAX ?
Preset	100
State Saved	Saved in instrument state
Min	1
Max	100
Initial S/W Revision	A.10.00

Max cdma2000 Carriers

Sets max cdma2000 carriers placed when the carrier configuration preset runs. When this value is changed, the carrier configuration preset is initiated.

Key Path	FREQ Channel, Carrier Setup, Carrier Conf Presets, Single RAT Config, cdma2000
Remote Command	<code>[:SENSe] :CARRier :CONFig :CDMA :CMAX <integer></code> <code>[:SENSe] :CARRier :CONFig :CDMA :CMAX ?</code>
Example	CARR:CONF:CDMA:CMAX 8 CARR:CONF:CDMA:CMAX ?
Preset	100
State Saved	Saved in instrument state
Min	1
Max	100
Initial S/W Revision	A.12.00

Max 1xEV-DO Carriers

Sets max 1xEV-DO carriers placed when the carrier configuration preset runs. When this value is changed, the carrier configuration preset is initiated.

Key Path	FREQ Channel, Carrier Setup, Carrier Conf Presets, Single RAT Config, 1xEV-DO
Remote Command	<code>[:SENSe] :CARRier:CONFig:EVDO:CMAX <integer></code> <code>[:SENSe] :CARRier:CONFig:EVDO:CMAX?</code>
Example	<code>CARR:CONF:EVDO:CMAX 8</code> <code>CARR:CONF:EVDO:CMAX?</code>
Preset	100
State Saved	Saved in instrument state
Min	1
Max	100
Initial S/W Revision	A.12.00

Max BS RF Bandwidth

Sets max BS RF bandwidth used when the carrier configuration preset runs. When this value is changed, the carrier configuration preset is initiated.

Key Path	FREQ Channel, Carrier Setup, Carrier Conf Presets
Remote Command	<code>[:SENSe] :CARRier:CONFig:RFBWidth <freq></code> <code>[:SENSe] :CARRier:CONFig:RFBWidth?</code>
Example	<code>CARR:CONF:RFBW 40MHz</code> <code>CARR:CONF:RFBW?</code>
Preset	40MHz
State Saved	Saved in instrument state
Min	600 kHz
Max	200 MHz
Initial S/W Revision	A.10.00

Channel Spacing Delta

Carriers are placed based on channel spacing assigned to the corresponding radio format, when they are configured by the carrier config preset. However, channel spacing can be adjusted using channel spacing delta parameters.

This key accesses the menu to set channel spacing delta of each radio format.

Key Path	FREQ Channel, Carrier Setup, Carrier Conf Presets
Initial S/W Revision	A.10.00

LTE FDD

Sets delta channel spacing for LTE FDD used when the carrier configuration preset runs. Channel spacing for LTE FDD is determined from this value and the default channel spacing defined in the standard, i.e. Channel spacing = (BWchan1 + BWchan2) * 0.5 + [the delta spacing]. Since this value is a difference from the default spacing, this value can be negative to allow narrower channel spacing. When this value is changed, the carrier configuration preset is initiated.

Key Path	FREQ Channel, Carrier Setup, Carrier Conf Presets, Channel Spacing Delta
Remote Command	[:SENSe] :CARRier:CONFig:LTEFdd:SPACing:DELTA <freq> [:SENSe] :CARRier:CONFig:LTEFdd:SPACing:DELTA?
Example	CARR:CONF:LTEF:SPAC:DELT -200kHz CARR:CONF:LTEF:SPAC:DELT?
Preset	0Hz
State Saved	Saved in instrument state
Min	- 1.0 MHz
Max	10.0 MHz
Initial S/W Revision	A.10.00
Modified at S/W Revision	A.11.00

W-CDMA

Sets delta channel spacing for W-CDMA used when the carrier configuration preset runs. Channel spacing for W-CDMA is determined from this value and the default channel spacing defined in the standard, i.e. Channel spacing = 5.0 MHz + [the delta spacing]. Since this value is a difference from the default spacing, this value can be negative to allow narrower channel spacing. When this value is changed, the carrier configuration preset is initiated.

Key Path	FREQ Channel, Carrier Setup, Carrier Conf Presets, Channel Spacing Delta
Remote Command	[:SENSe] :CARRier:CONFig:WCDma:SPACing:DELTA <freq> [:SENSe] :CARRier:CONFig:WCDma:SPACing:DELTA?
Example	CARR:CONF:WCDM:SPAC:DELT 0 CARR:CONF:WCDM:SPAC:DELT?
Preset	0 Hz
State Saved	Saved in instrument state
Min	- 1.0 MHz
Max	10.0 MHz
Initial S/W Revision	A.10.00
Modified at S/W Revision	A.11.00

GSM/EDGE

Sets delta channel spacing for GSM/EDGE used when the carrier configuration preset runs. Channel spacing for GSM/EDGE is determined from this value and the default channel spacing defined in the standard, i.e. Channel spacing = 600 kHz + [the delta spacing]. Since this value is a difference from the default spacing, this value can be negative to allow narrower channel spacing. When this value is changed, the carrier configuration preset is initiated.

Key Path	FREQ Channel, Carrier Setup, Carrier Conf Presets, Channel Spacing Delta
Remote Command	<code>[:SENSe] :CARRier:CONFig:GSM:SPACing:DELTA <freq></code> <code>[:SENSe] :CARRier:CONFig:GSM:SPACing:DELTA?</code>
Example	<code>CARR:CONF:GSM:SPAC:DELT 0</code> <code>CARR:CONF:GSM:SPAC:DELT?</code>
Preset	0 Hz
State Saved	Saved in instrument state
Min	- 0.4 MHz
Max	10.0 MHz
Initial S/W Revision	A.10.00
Modified at S/W Revision	A.11.00

cdma2000

Sets delta channel spacing for cdma2000 used when the carrier configuration preset runs. Channel spacing for cdma2000 is determined from this value and the default channel spacing defined in the standard, i.e. Channel spacing = 1.25 MHz + [the delta spacing]. Since this value is a difference from the default spacing, this value can be negative to allow narrower channel spacing.

Key Path	FREQ Channel, Carrier Setup, Carrier Conf Presets, Channel Spacing Delta
Remote Command	<code>[:SENSe] :CARRier:CONFig:CDMA:SPACing:DELTA <freq></code> <code>[:SENSe] :CARRier:CONFig:CDMA:SPACing:DELTA?</code>
Example	<code>CARR:CONF:CDMA:SPAC:DELT 0</code> <code>CARR:CONF:CDMA:SPAC:DELT?</code>
Preset	0 Hz
State Saved	Saved in instrument state
Min	-1 MHz
Max	10 MHz
Initial S/W Revision	A.12.00

1xEV-DO

Sets delta channel spacing for 1xEV-DO used when the carrier configuration preset runs. Channel spacing for 1xEV-DO is determined from this value and the default channel spacing defined in the standard, i.e.

Channel spacing = 1.25 MHz + [the delta spacing]. Since this value is a difference from the default spacing, this value can be negative to allow narrower channel spacing.

Key Path	FREQ Channel, Carrier Setup, Carrier Conf Presets, Channel Spacing Delta
Remote Command	<code>[:SENSe] :CARRier:CONFig:EVDO:SPACing:DELTA <freq></code> <code>[:SENSe] :CARRier:CONFig:EVDO:SPACing:DELTA?</code>
Example	<code>CARR:CONF:EVDO:SPAC:DELT 0</code> <code>CARR:CONF:EVDO:SPAC:DELT?</code>
Preset	0 Hz
State Saved	Saved in instrument state
Min	-1 MHz
Max	10 MHz
Initial S/W Revision	A.12.00

Apply to Meas Offset/Limits

This immediate action key sets the following measurement parameters.

- ACP: Offset and limit parameters under Offset/Limits.
- Spectrum Emission Mask: Offset and limit parameters under Offset/Limits.
- Spurious Emissions: Range frequency and limit parameters under Range Table.

These offset and limit values are determined by the carrier configuration parameters, Band Category and Assumed Adj Channels.

Each of these measurement has a local key, “Apply Carrier Config to ...”, which performs in the same way only for its parameters. So pressing this key is equivalent to pressing “Apply Carrier Config to ...” of all these measurements.

Key Path	FREQ Channel, Carrier Setup
Remote Command	<code>[:SENSe] :MCONdition:IMMediate</code>
Example	<code>MCON:IMM</code>
Initial S/W Revision	A.11.00

RF Bandwidth (Remote Command Only)

Returns the RF bandwidth calculated from the outermost carriers and their Foffset_RAT.

Key Path	SCPI only
Mode	MSR
Remote Command	<code>[:SENSe] :CARRier:RFBWidth?</code>
Example	<code>CARR:RFBW?</code>

Preset	Calculated from preset values of carrier config parameters
State Saved	No
Initial S/W Revision	A.13.00

RF Bandwidth Center (Remote Command Only)

Returns the center frequency of RF bandwidth.

Key Path	SCPI only
Mode	MSR
Remote Command	[:SENSE] :CARRier:RFBWidth:CENTer?
Example	CARR:RFBW:CENT?
Preset	Calculated from preset values of carrier config parameters
State Saved	No
Initial S/W Revision	A.13.00

Sub-block Center (Remote Command Only)

Returns the center frequency of sub-block when Carrier Allocation is Non-Contiguous.

Key Path	SCPI only
Mode	MSR
Remote Command	[:SENSE] :CARRier:SBLock[1] 2:CENTer?
Example	CARR:SBL:CENT?
Notes	When Carrier Allocation is Contiguous, 9.91E+37 is returned.
Preset	Calculated from preset values of carrier config parameters
State Saved	No
Initial S/W Revision	A.13.00

Sub-block Bandwidth (Remote Command Only)

Returns the bandwidth of sub-block calculated from outermost carriers and corresponding Foffset_RAT.

Key Path	SCPI only
Mode	MSR
Remote Command	[:SENSE] :CARRier:SBLock[1] 2:BWIDth?
Example	CARR:SBL:BWID?
Notes	When Carrier Allocation is Contiguous, 9.91E+37 is returned.

Preset	Calculated from preset values of carrier config parameters
State Saved	No
Initial S/W Revision	A.13.00

Sub-block Gap (Remote Command Only)

Returns the sub-block gap.

Key Path	SCPI only
Mode	MSR
Remote Command	<code>[:SENSe] :CARRier :SBLock :GAP?</code>
Example	<code>CARR:SBL:GAP?</code>
Notes	When Carrier Allocation is Contiguous, 9.91 E+37 is returned.
Preset	Calculated from preset values of carrier config parameters
State Saved	No
Initial S/W Revision	A.13.00

Input/Output

See "Input/Output" on page 190

Marker

Accesses a menu that enables you to select, set up and control the markers for the current measurement.

Key Path	Front-panel key
Initial S/W Revision	Prior to A.02.00

Select Marker

Displays 12 markers available for selection.

Key Path	Marker
Initial S/W Revision	Prior to A.02.00

Marker Type

Sets the marker control mode to **Normal**, **Delta**, **Fixed** or **Off**. All interactions and dependencies detailed under the key description are enforced when the remote command is sent. If the selected marker is Off, pressing Marker sets it to Normal and places it at the center of the screen on the trace determined by the **Marker Trace** rules. At the same time, the Marker X Axis Value appears on the Active Function area.

The default active function is the active function for the currently selected marker control mode. If the current control mode is Off, there is no active function and the active function is turned off.

Key Path	Marker
Mode	BASIC, PNOISE, WCDMA, C2K, GSM, WIMAXOFDMA, TDSCDMA, 1XEVD0, DVB, DTMB, ISDBT, CMMB, LTE, LTETDD, DCATV, WLAN,,LTEATDD, LTEAFDD
Remote Command	:CALCulate:WAVeform:MARKer[1] 2 ... 12:MODE POSition DELTa OFF :CALCulate:WAVeform:MARKer[1] 2 ... 12:MODE?
Example	CALC:WAV:MARK:MODE OFF CALC:WAV:MARK:MODE?
Notes	If the selected marker is Off, pressing Marker sets it to Normal and places it at the center of the screen on the trace determined by the Marker Trace rules. At the same time, Marker X Axis Value appears on the Active Function area. Default Active Function: the active function for the selected marker's current control mode. If the current control mode is Off, there is no active function and the active function is turned off. Active Function Display: the marker X axis value entered in the active function area displays the marker value to its full entered precision. You must be in a mode that includes the Waveform measurement to use this command. Use INSTRument:SElect to set the mode.
Preset	OFF
State Saved	Saved in instrument state.

Range	Normal Delta Off
Initial S/W Revision	Prior to A.02.00
Modified at S/W Revision	A.03.00

Properties

Accesses the marker properties menu.

Key Path	Marker
Initial S/W Revision	Prior to A.02.00

Select Marker

Displays 12 markers available for selection.

Key Path	Marker
Initial S/W Revision	Prior to A.02.00

Relative To

Selects the marker that the selected marker is relative to (its *reference marker*).

Key Path	Marker, Properties
Mode	BASIC, PNOISE, WCDMA, C2K, GSM, WIMAXOFDMA, TDSCDMA, 1XEVD0, DVB, DTMB, ISDBT, CMMB, LTE, LTETDD, DCATV, WLAN,,LTEATDD, LTEAFDD
Remote Command	:CALCulate:WAVEform:MARKer[1] 2 ... 12:REFerence <integer> :CALCulate:WAVEform:MARKer[1] 2 ... 12:REFerence?
Example	CALC:WAV:MARK:REF 8 CALC:WAV:MARK:REF?
Notes	A marker cannot be relative to itself so that choice is grayed out, and if sent from SCPI generates error -221: "Settings conflict; marker cannot be relative to itself." When queried a single value is returned (the specified marker numbers relative marker). You must be in a mode that includes the Waveform measurement to use this command. Use INSTRument:SElect to set the mode.
Preset	2 3 4 5 6 7 8 9 10 11 12 1
State Saved	Saved in instrument state.
Min	1
Max	12
Initial S/W Revision	Prior to A.02.00
Modified at S/W Revision	A.03.00

Marker Trace

Assigns the specified marker to the designated trace.

Key Path	Marker
Mode	BASIC, PNOISE, WCDMA, C2K, GSM, WIMAXOFDMA, TDSCDMA, 1XEVD0, DVB, DTMB, ISDBT, CM MB, LTE, LTETDD, DCATV, WLAN,,LTEATDD, L TEAFDD
Remote Command	:CALCulate:WAVeform:MARKer[1] 2 ... 12:TRACe RFENvelope I Q IQ :CALCulate:WAVeform:MARKer[1] 2 ... 12:TRACe?
Example	CALC:WAV:MARK:TRAC RFEN CALC:WAV:MARK:TRAC?
Notes	Assigns the specified marker to the designated trace. The IQ selection is for backward compatibility purposes. It is recommended that the users use the I and/or Q selection instead. You must be in a mode that includes the Waveform measurement to use this command. Use INSTRument:SElect to set the mode.
Preset	RFEN
State Saved	Saved in instrument state.
Range	RF Envelope I Q IQ
Initial S/W Revision	Prior to A.02.00
Modified at S/W Revision	A.03.00

Couple Markers

Toggles the state of the markers to be coupled On or Off. When this function is true (On), moving any marker causes an equal X-axis movement of every other marker which is not Off. "Equal X-axis movement" refers to the difference between each marker's X-Axis value (in the fundamental x-axis units of the trace that marker is on) and the X-Axis value of the marker being moved (in the same fundamental x-axis units) are preserved.

Key Path	Marker
Mode	BASIC, PNOISE, WCDMA, C2K, GSM, WIMAXOFDMA, TDSCDMA, 1XEVD0, DVB, DTMB, ISDBT, CM MB, LTE, LTETDD, DCATV, WLAN,,LTEATDD, L TEAFDD
Remote Command	:CALCulate:WAVeform:MARKer:COUPle[:STATe] ON OFF 1 0 :CALCulate:WAVeform:MARKer:COUPle[:STATe]?
Example	CALC:WAV:MARK:COUP ON CALC:WAV:MARK:COUP ON
Notes	You must be in a mode that includes the Waveform measurement to use this command. Use INSTRument:SElect to set the mode.
Preset	OFF

State Saved	Saved in instrument state.
Range	On Off
Initial S/W Revision	Prior to A.02.00
Modified at S/W Revision	A.03.00

All Markers Off

Turns off all markers.

Key Path	Marker
Mode	BASIC, PNOISE, WCDMA, C2K, GSM, WIMAXOFDMA, TDSCDMA, 1XEVD0, DVB, DTMB, ISDBT, CMMB, LTE, LTETDD, DCATV, WLAN,LTEATDD, LTEAFDD
Remote Command	:CALCulate:WAVeform:MARKer:AOFF
Example	CALC:WAV:MARK:AOFF
Notes	You must be in a mode that includes the Waveform measurement to use this command. Use INSTRument:SElect to set the mode.
Initial S/W Revision	Prior to A.02.00
Modified at S/W Revision	A.03.00

Marker X Axis Value (Remote Command Only)

Sets the marker X Axis value in the current marker X Axis Scale unit. It has no effect if the control mode is Off, but is the SCPI equivalent of entering an X value if the control mode is Normal or Delta.

Mode	BASIC, PNOISE, WCDMA, C2K, GSM, WIMAXOFDMA, TDSCDMA, 1XEVD0, DVB, DTMB, ISDBT, CMMB, LTE, LTETDD, DCATV, WLAN,,LTEATDD, LTEAFDD
Remote Command	:CALCulate:WAVeform:MARKer[1] 2 ... 12:X <time> :CALCulate:WAVeform:MARKer[1] 2 ... 12:X?
Example	CALC:WAV:MARK:X 50 ms CALC:WAV:MARK:X?
Notes	If no suffix is sent, uses the fundamental units for the current marker X Axis Scale. If a suffix is sent that does not match the current marker X Axis Scale unit, an error "Invalid suffix" is generated. If the specified marker is Fixed and a Marker Function is on, error -221 "Settings conflict; cannot adjust Fixed marker while Marker Function is on" is generated. The query returns the marker's absolute X Axis value if the control mode is Normal , or the offset from the marker's reference marker if the control mode is Delta . The query is returned in the fundamental units for the current marker X Axis scale: Hz for Frequency and Inverse Time , seconds for Period and Time . If the marker is Off the response is not a number. You must be in a mode that includes the Waveform measurement to use this command. Use INSTRument:SElect to set the mode.
Preset	0

Preset	After a preset, all markers are turned OFF, so Marker X Axis Value query returns a not a number (NAN).
State Saved	No
Min	(9.9E+37
Max	9.9E+37
Initial S/W Revision	Prior to A.02.00
Modified at S/W Revision	A.03.00

Marker X Axis Position (Remote Command Only)

Sets the marker X position in trace points. It has no effect if the control mode is Off, but is the SCPI equivalent of entering a value if the control mode is Normal or Delta. The entered value is immediately translated into the current X Axis Scale units for setting the value of the marker.

Mode	BASIC, PNOISE, WCDMA, C2K, GSM, WIMAXOFDMA, TDSCDMA, 1XEVD0, DVB, DTMB, ISDBT, CMMB, LTE, LTETDD, DCATV, WLAN,,LTEATDD, LTEAFDD
Remote Command	:CALCulate:WAVeform:MARKer[1] 2 ... 12:X:POSition <real> :CALCulate:WAVeform:MARKer[1] 2 ... 12:X:POSition?
Example	CALC:WAV:MARK:X:POS 500 CALC:WAV:MARK:X:POS?
Notes	The query returns the marker's absolute X Axis value in trace points if the control mode is Normal or the offset from the marker's reference marker in trace points if the control mode is Delta . The value is returned as a real number, not an integer, corresponding to the translation from X Axis Scale units to trace points. You must be in a mode that includes the Waveform measurement to use this command. Use INSTRument:SElect to set the mode.
Preset	0
Preset	After a preset, all markers are turned OFF, so Marker X Axis Value query returns a not a number (NAN).
State Saved	No
Min	(9.9E+37
Max	9.9E+37
Initial S/W Revision	Prior to A.02.00
Modified at S/W Revision	A.03.00

Marker Y Axis Value (Remote Command Only)

Queries the marker Y Axis value in the current marker Y Axis unit.

Mode	BASIC, PNOISE, WCDMA, C2K, GSM, WIMAXOFDMA, TDSCDMA, 1XEVD0, DVB, DTMB, ISDBT, CMMB, LTE, LTETDD, DCATV, WLAN,,LTEATDD, LTEAFDD
------	---

Remote Command	:CALCulate:WAVeform:MARKer[1] 2 ... 12:Y?
Example	CALC:WAV:MARK11:Y?
Notes	<p>When the marker is on, IQ waveform returns I and Q values.</p> <p>Case #1 - Trace RF, I or Q: returns a single double value.</p> <p>>:CALC:WAV:MARK1:Y? -2.402406506109E+001</p> <p>Case #2 - Trace IQ: returns a double array of two values, the first is I, and the second is Q.</p> <p>>:CALC:WAV:MARK1:Y? -3.006944493834E-003,+9.9870666467354E-004</p> <p>The IQ selection is for backward compatibility purposes. It is recommended that the users use the I and/or Q selection instead.</p> <p>You must be in a mode that includes the Waveform measurement to use this command. Use INSTRument:SElect to set the mode.</p>
Preset	Result dependent on the marker setup and signal source.
State Saved	No
Backwards Compatibility SCPI	:CALCulate:WAVeform:MARKer[1] 2 ... 12:FUNCTion:RESult?
Initial S/W Revision	Prior to A.02.00
Modified at S/W Revision	A.03.00

Backward Compatibility SCPI Commands

Sets or queries the state of a marker. Setting a marker that is OFF to state ON or 1 puts it in Normal mode and places it at the center of the screen.

Mode	BASIC, PNOISE, WCDMA, CDMA2K, EDGE GSM, WIMAX OFDMA, TDSCDMA, CDMA1XEV, DVB, DTMB, ISDBT, CMMB, LTE, LTETDD, DCATV, WLAN
Remote Command	:CALCulate:WAVeform:MARKer[1] 2 ... 12:STATe OFF ON 0 1 :CALCulate:WAVeform:MARKer[1] 2 ... 12:STATe?
Example	CALC:WAV:MARK:STAT ON CALC:WAV:MARK:STAT?
Notes	You must be in a mode that includes the Waveform measurement to use this command. Use INSTRument:SElect to set the mode.
Preset	OFF
State Saved	Saved in instrument state.
Range	On Off
Initial S/W Revision	Prior to A.02.00
Modified at S/W Revision	A.03.00

Marker ->

There is no 'Marker ->' functionality supported in Waveform measurements. The front-panel key displays a blank menu when pressed.

Key Path	Front-panel key
Initial S/W Revision	Prior to A.02.00

Marker Function

Accesses a menu of marker functions that perform post-processing operations on markers based on the measurement specifications. Marker functions are distinct from measurement functions, which automatically perform complex sequences of setup, data acquisition, and display operations in order to measure specified signal characteristics. Marker Functions are specified for each individual marker and may be turned on individually for each marker.

The Marker Function menu controls which marker functions are turned on and allows you to adjust the setup parameters for each function. These parameters include the following, but only one parameter can be assigned to a given marker:

- Marker Noise
- BandInterval Power
- Band/Interval Density
- Marker Function Off

Key Path	Front-panel key
Initial S/W Revision	Prior to A.02.00

Select Marker

Displays 12 markers available for selection.

Key Path	Marker
Initial S/W Revision	Prior to A.02.00

Marker Function Type

Sets the marker control function type to, Marker Noise, Band/Interval Power, Band Interval Density, or Marker Function Off

Key Path	Marker Function
Mode	BASIC, PNOISE, WCDMA, C2K, GSM, WIMAXOFDMA, TDSCDMA, 1XEVD0, DVB, DTMB, ISDBT, CMMB, LTE, LTETDD, DCATV, WLAN,,LTEATDD, LTEAFDD
Remote Command	:CALCulate:WAVeform:MARKer[1] 2 ... 12:FUNCTION BPOwer BDENsity OFF :CALCulate:WAVeform:MARKer[1] 2 ... 12:FUNCTION?
Example	CALC:WAV:MARK:FUNC BPOW CALC:WAV:MARK:FUNC?
Notes	You must be in a mode that includes the Waveform measurement to use this command. Use INSTRument:SElect to set the mode.
Preset	OFF
State Saved	Saved in instrument state.

Range	Band/Interval Power Band Interval Density Marker Function Off
Initial S/W Revision	Prior to A.02.00
Modified at S/W Revision	A.03.00

Band Adjust

Accesses a menu that enables you to set the frequency span width and the left and right edge, or time values, for the band or interval of the selected marker.

Key Path	Marker Function
Initial S/W Revision	Prior to A.02.00

Band/Interval Span for Time Domain

Sets the width of the frequency span for the selected marker.

Key Path	Marker Function
Mode	BASIC, PNOISE, WCDMA, C2K, GSM, WIMAXOFDMA, TDSCDMA, 1XEVD0, DVB, DTMB, ISDBT, CMMB, LTE, LTETDD, DCATV, WLAN,LTEATDD, LTEAFDD
Remote Command	:CALCulate:WAVEform:MARKer[1] 2 ... 12:FUNction:BAND:SPAN <time> :CALCulate:WAVEform:MARKer[1] 2 ... 12:FUNction:BAND:SPAN?
Example	CALC:WAV:MARK:FUNC:BAND:SPAN 20 ms CALC:WAV:MARK:FUNC:BAND:SPAN?
Notes	You must be in a mode that includes the Waveform measurement to use this command. Use INSTRument:SElect to set the mode.
Couplings	Changing the Band/Interval Span necessarily changes the Band/Interval Left and Band/Interval Right values
Preset	0
Preset	10% of Meas Time
State Saved	Saved in instrument state.
Min	0
Max	100 s
Backwards Compatibility SCPI	:CALCulate:WAVEform:MARKer[1] 2 ... 4:X:SPAN
Initial S/W Revision	Prior to A.02.00
Modified at S/W Revision	A.03.00

Band/Interval Left for Time Domain

Sets the left edge frequency or time value for the band of the selected marker.

Key Path	Marker Function
Mode	BASIC, PNOISE, WCDMA, C2K, GSM, WIMAXOFDMA, TDSCDMA, 1XEVD0, DVB, DTMB, ISDBT, CMMB, LTE, LTETDD, DCATV, WLAN,,LTEATDD, LTEAFDD
Remote Command	:CALCulate:WAVeform:MARKer[1] 2 ... 12:FUNction:BAND:LEFT <time> :CALCulate:WAVeform:MARKer[1] 2 ... 12:FUNction:BAND:LEFT?
Example	CALC:WAV:MARK12:FUNC:BAND:LEFT 1 s CALC:WAV:MARK12:FUNC:BAND:LEFT?
Notes	You must be in a mode that includes the Waveform measurement to use this command. Use INSTRument:SElect to set the mode.
Couplings	Changing the Band/Interval Left necessarily changes the Band/Interval Span and Band/Interval Right values
Preset	0
Preset	5% of Meas Time
State Saved	Saved in instrument state.
Min	0
Max	100 s
Initial S/W Revision	Prior to A.02.00
Modified at S/W Revision	A.03.00

Band/Interval Right for Time Domain

Sets the right edge frequency or time value for the band of the selected marker.

Key Path	Marker Function
Mode	BASIC, PNOISE, WCDMA, C2K, GSM, WIMAXOFDMA, TDSCDMA, 1XEVD0, DVB, DTMB, ISDBT, CMMB, LTE, LTETDD, DCATV, WLAN,,LTEATDD, LTEAFDD
Remote Command	:CALCulate:WAVeform:MARKer[1] 2 ... 12:FUNction:BAND:RIGHT <time> :CALCulate:WAVeform:MARKer[1] 2 ... 12:FUNction:BAND:RIGHT?
Example	CALC:WAV:MARK12:FUNC:BAND:RIGH 1 s CALC:WAV:MARK12:FUNC:BAND:RIGH?
Notes	You must be in a mode that includes the Waveform measurement to use this command. Use INSTRument:SElect to set the mode.
Couplings	Changing the Band/Interval Left necessarily changes the Band/Interval Span and Band/Interval Right values
Preset	0
Preset	5% of Meas Time
State Saved	Saved in instrument state.
Min	0
Max	100 s

16 Waveform Measurement
Marker Function

Initial S/W Revision	Prior to A.02.00
Modified at S/W Revision	A.03.00

Meas

The information in this section is common to all measurements. For key and remote command information for a specific measurement, refer to the section that describes the measurement of interest.

Measurements available under the Meas key are specific to the current Mode.

When viewing Help for measurements, note the following:

NOTE

Operation for some keys differs between measurements. The information displayed in Help pertains to the current measurement. To see how a key operates in a different measurement, exit Help (press the Cancel Esc key), select the measurement, then reenter Help (press the Help key) and press that key.

Key Path	Front-panel key
Initial S/W Revision	Prior to A.02.00

Remote Measurement Functions

This section contains the following topics:

"Measurement Group of Commands" on page 2382

"Current Measurement Query (Remote Command Only)" on page 2384

"Limit Test Current Results (Remote Command Only)" on page 2384

"Data Query (Remote Command Only)" on page 2384

"Calculate/Compress Trace Data Query (Remote Command Only)" on page 2385

"Calculate Peaks of Trace Data (Remote Command Only)" on page 2390

"Hardware-Accelerated Fast Power Measurement (Remote Command Only)" on page 2391

"Format Data: Numeric Data (Remote Command Only)" on page 2405

"Format Data: Byte Order (Remote Command Only)" on page 2406

Initial S/W Revision	Prior to A.02.00
----------------------	------------------

Measurement Group of Commands

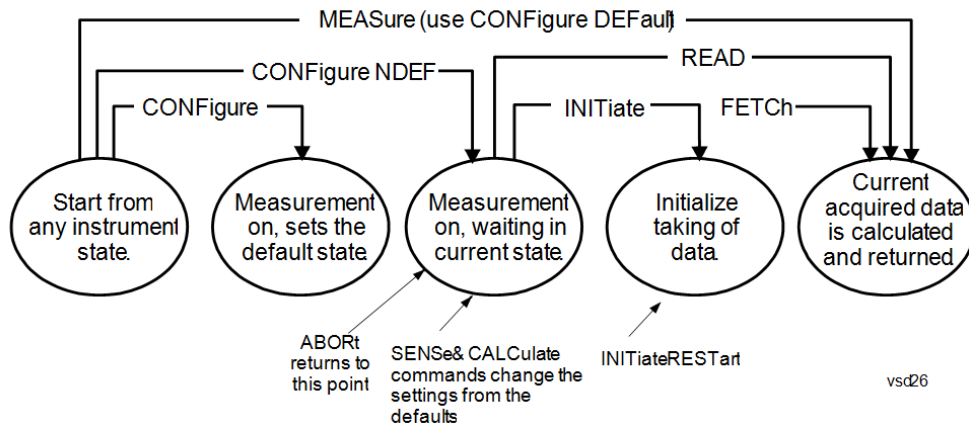

Measure Commands:

:MEASure:<measurement>[n]?

This is a fast single-command way to make a measurement using the factory default instrument settings. These are the settings and units that conform to the Mode Setup settings (e.g. radio standard) that you have currently selected.

- Stops the current measurement (if any) and sets up the instrument for the specified measurement using the factory defaults
- Initiates the data acquisition for the measurement
- Blocks other SCPI communication, waiting until the measurement is complete before returning results.
- If the function does averaging, it is turned on and the number of averages is set to 10.
- After the data is valid it returns the scalar results, or the trace data, for the specified measurement. The type of data returned may be defined by an [n] value that is sent with the command.
- The scalar measurement results will be returned if the optional [n] value is not included, or is set to 1. If the [n] value is set to a value other than 1, the selected trace data results will be returned. See each command for details of what types of scalar results or trace data results are available.
- ASCII is the default format for the data output. (Older versions of Spectrum Analysis and Phase Noise mode measurements only use ASCII.) The binary data formats should be used for handling large blocks of data since they are smaller and faster than the ASCII format. Refer to the FORMat:DATA command for more information.

If you need to change some of the measurement parameters from the factory default settings you can set up the measurement with the CONFigure command. Use the commands in the SENSE:<measurement> and CALCulate:<measurement> subsystems to change the settings. Then you can use the READ? command to initiate the measurement and query the results.

If you need to repeatedly make a given measurement with settings other than the factory defaults, you can use the commands in the SENSE:<measurement> and CALCulate:<measurement> subsystems to set up the measurement. Then use the READ? command to initiate the measurement and query results.

Measurement settings persist if you initiate a different measurement and then return to a previous one. Use READ:<measurement>? if you want to use those persistent settings. If you want to go back to the default settings, use MEASure:<measurement>?.

Configure Commands:

:CONFigure:<measurement>

This command stops the current measurement (if any) and sets up the instrument for the specified measurement using

the factory default instrument settings. It does not initiate the taking of measurement data unless INIT:CONTInuous is ON. If you change any measurement settings after using the CONFigure command, the READ command can be used to initiate a measurement without changing the settings back to their defaults.

In the Swept SA measurement in Spectrum Analyzer mode the CONFigure command also turns the averaging function on and sets the number of averages to 10 for all measurements.

:CONFigure: <measurement>: NDEFault stops the current measurement and changes to the specified measurement. It does not change the settings to the defaults. It does not initiate the taking of measurement data unless INIT:CONTInuous is ON.

The CONFigure? query returns the current measurement name.

The CONFigure:CATalog? query returns a quoted string of all licensed measurement names in the current mode. For example, "SAN, CHP, OBW, ACP, PST, TXP, SPUR, SEM, LIST".

Fetch Commands:

:FETCh:<measurement>[n]?

This command puts selected data from the most recent measurement into the output buffer. Use FETCh if you have already made a good measurement and you want to return several types of data (different [n] values, for example, both scalars and trace data) from a single measurement. FETCh saves you the time of re-making the measurement. You can only FETCh results from the measurement that is currently active, it will not change to a different measurement. An error message is reported if a measurement other than the current one is specified.

If you need to get new measurement data, use the READ command, which is equivalent to an INITiate followed by a FETCh.

The scalar measurement results will be returned if the optional [n] value is not included, or is set to 1. If the [n] value is set to a value other than 1, the selected trace data results will be returned. See each command for details of what types of scalar results or trace data results are available. The binary data formats should be used for handling large blocks of data since they are smaller and transfer faster than the ASCII format. (FORMat:DATA)

FETCh may be used to return results other than those specified with the original READ or MEASure command that you sent.

INITiate Commands:

:INITiate:<measurement>

This command is not available for measurements in all the instrument modes:

- Initiates a trigger cycle for the specified measurement, but does not output any data. You must then use the FETCh<meas> command to return data. If a measurement other than the current one is specified, the instrument will switch to that measurement and then initiate it.
- For example, suppose you have previously initiated the ACP measurement, but now you are running the channel power measurement. If you send INIT:ACP? it will change from channel power to ACP and will initiate an ACP measurement.
- Does not change any of the measurement settings. For example, if you have previously started the ACP measurement and you send INIT:ACP? it will initiate a new ACP measurement using the same instrument settings as the last time ACP was run.
- If your selected measurement is currently active (in the idle state) it triggers the measurement, assuming the trigger conditions are met. Then it completes one trigger cycle. Depending upon the measurement and the number of averages, there may be multiple data acquisitions, with multiple trigger events, for one full trigger cycle. It also holds off additional commands on GPIB until the acquisition is complete.

READ Commands:

:READ:<measurement>[n]?

- Does not preset the measurement to the factory default settings. For example, if you have previously initiated the ACP
-

measurement and you send READ:ACP? it will initiate a new measurement using the same instrument settings.

- Initiates the measurement and puts valid data into the output buffer. If a measurement other than the current one is specified, the instrument will switch to that measurement before it initiates the measurement and returns results.
 - For example, suppose you have previously initiated the ACP measurement, but now you are running the channel power measurement. Then you send READ:ACP? It will change from channel power back to ACP and, using the previous ACP settings, will initiate the measurement and return results.
 - Blocks other SCPI communication, waiting until the measurement is complete before returning the results
 - If the optional [n] value is not included, or is set to 1, the scalar measurement results will be returned. If the [n] value is set to a value other than 1, the selected trace data results will be returned. See each command for details of what types of scalar results or trace data results are available. The binary data formats should be used when handling large blocks of data since they are smaller and faster than the ASCII format. (FORMat:DATA)
-

Initial S/W Revision	Prior to A.02.00
----------------------	------------------

Current Measurement Query (Remote Command Only)

This command returns the name of the measurement that is currently running.

Remote Command	:CONFigure?
-----------------------	-------------

Example	CONF?
----------------	-------

Initial S/W Revision	Prior to A.02.00
----------------------	------------------

Limit Test Current Results (Remote Command Only)

Queries the status of the current measurement limit testing. It returns a 0 if the measured results pass when compared with the current limits. It returns a 1 if the measured results fail any limit tests.

Remote Command	:CALCulate:CLIMits:FAIL?
-----------------------	--------------------------

Example	CALC:CLIM:FAIL? queries the current measurement to see if it fails the defined limits. Returns a 0 or 1: 0 it passes, 1 it fails.
----------------	--

Initial S/W Revision	Prior to A.02.00
----------------------	------------------

Data Query (Remote Command Only)

Returns the designated measurement data for the currently selected measurement and subopcode.

n = any valid subopcode for the current measurement. See the measurement command results table for your current measurement, for information about what data is returned for the subopcodes.

This command uses the data setting specified by the FORMat:BORDER and FORMat:DATA commands and can return real or ASCII data. (See the format command descriptions under Input/Output in the Analyzer Setup section.)

Remote Command	:CALCulate:DATA[n]?
Notes	The return trace depends on the measurement. In CALCulate:<meas>:DATA[n], n is any valid subopcode for the current measurement. It returns the same data as the FETCH:<measurement>? query where <measurement> is the current measurement.
Initial S/W Revision	Prior to A.02.00

Calculate/Compress Trace Data Query (Remote Command Only)

Returns compressed data for the currently selected measurement and sub-opcode [n].

n = any valid sub-opcode for that measurement. See the MEASure:<measurement>? command description of your specific measurement for information on the data that can be returned.

The data is returned in the current Y Axis Unit of the analyzer. The command is used with a sub-opcode <n> (default=1) to specify the trace. With trace queries, it is best if the analyzer is not sweeping during the query. Therefore, it is generally advisable to be in Single Sweep, or Update=Off.

This command is used to compress or decimate a long trace to extract and return only the desired data. A typical example would be to acquire N frames of GSM data and return the mean power of the first burst in each frame. The command can also be used to identify the best curve fit for the data.

Remote Command	:CALCulate:DATA<n>:COMPRESS? BLOCK CFIT MAXimum MINimum MEAN DMEan RMS RMSCubed SAMPLE SDEVIation PPHase [,<soffset> [,<length>[,<roffset>[,<rlimit>]]]]
Example	To query the mean power of a set of GSM bursts: Supply a signal that is a set of GSM bursts. Select the IQ Waveform measurement (in IQ Analyzer Mode). Set the sweep time to acquire at least one burst. Set the triggers such that acquisition happens at a known position relative to a burst. Then query the mean burst levels using, CALC:DATA2:COMP? MEAN, 24e-6, 526e-6 (These parameter values correspond to GSM signals, where 526e-6 is the length of the burst in the slot and you just want 1 burst.)
Notes	The command supports 5 parameters. Note that the last 4 (<soffset>, <length>, <roffset>, <rlimit>) are optional. But these optional parameters must be entered in the specified order. For example, if you want to specify <length>, then you must also specify <soffset>. See details below for a definition of each of these parameters. This command uses the data in the format specified by FORMat:DATA, returning either binary or ASCII data.
Initial S/W Revision	Prior to A.02.00

- BLOCK or block data - returns all the data points from the region of the trace data that you specify. For example, it could be used to return the data points of an input signal over several timeslots, excluding the portions of the trace data that you do not want. (This is x,y pairs for trace data and I,Q pairs for complex data.)

- CFIT or curve fit - applies curve fitting routines to the data. <soffset> and <length> are required to define the data that you want. <roffset> is an optional parameter for the desired order of the curve equation. The query will return the following values: the x-offset (in seconds) and the curve coefficients ((order + 1) values).

MIN, MAX, MEAN, DME, RMS, RMSC, SAMP, SDEV and PPH return one data value for each specified region (or <length>) of trace data, for as many regions as possible until you run out of trace data (using <roffset> to specify regions). Or they return the number of regions you specify (using <rlimit>) ignoring any data beyond that.

- MINimum - returns the minimum data point (y value) for the specified region(s) of trace data. For I/Q trace data, the minimum magnitude of the I/Q pairs is returned.
- MAXimum - returns the maximum data point (y value) for the specified region(s) of trace data. For I/Q trace data, the maximum magnitude of the I/Q pairs is returned.
- MEAN - returns a single value that is the arithmetic mean of the data point values (in dB/ dBm) for the specified region(s) of trace data. For I/Q trace data, the mean of the magnitudes of the I/Q pairs is returned. See the following equations.

•

NOTE

If the original trace data is in dB, this function returns the arithmetic mean of those log values, not log of the mean power which is a more useful value. The mean of the log is the better measurement technique when measuring CW signals in the presence of noise. The mean of the power, expressed in dB, is useful in power measurements such as Channel Power. To achieve the mean of the power, use the RMS option.

Equation 1

Mean Value of Data Points for Specified Region(s)

$$MEAN = \frac{1}{n} \sum_{X_i \in \text{region}(s)} X_i$$

where X_i is a data point value, and n is the number of data points in the specified region(s).

Equation 2

Mean Value of I/Q Data Pairs for Specified Region(s)

$$MEAN = \frac{1}{n} \sum_{X_i \in \text{region}(s)} |X_i|$$

where $|X_i|$ is the magnitude of an I/Q pair, and n is the number of I/Q pairs in the specified region(s).

- DMEan - returns a single value that is the mean power (in dB/ dBm) of the data point values for the specified region(s) of trace data. See the following equation:

Equation 3

DMEan Value of Data Points for Specified Region(s)

$$\text{DME} = 10 \times \log_{10} \left(\frac{1}{n} \sum_{X_i \in \text{region}(s)} 10^{\frac{X_i}{10}} \right)$$

- RMS - returns a single value that is the average power on a root-mean-squared voltage scale (arithmetic rms) of the data point values for the specified region(s) of trace data. See the following equation.

NOTE For I/Q trace data, the rms of the magnitudes of the I/Q pairs is returned. See the following equation. This function is very useful for I/Q trace data. However, if the original trace data is in dB, this function returns the rms of the log values which is not usually needed.

Equation 4

RMS Value of Data Points for Specified Region(s)

$$\text{RMS} = \sqrt{\frac{1}{n} \sum_{X_i \in \text{region}(s)} X_i^2}$$

where X_i is a data point value, and n is the number of data points in the specified region(s).

Equation 5

RMS Value of I/Q Data Pairs for Specified Region(s)

$$\text{RMS} = \sqrt{\frac{1}{n} \sum_{X_i \in \text{region}(s)} X_i X_i^*}$$

where X_i is the complex value representation of an I/Q pair, X_i^* its conjugate complex number, and n is the number of I/Q pairs in the specified region(s).

Once you have the rms value for a region of trace data (linear or I/Q), you may want to calculate the mean power. You must convert this rms value (peak volts) to power in dBm:

$$10 \times \log[10 \times (\text{rms value})^2]$$

- SAMPLe - returns the first data value (x,y pair) for the specified region(s) of trace data. For I/Q trace data, the first I/Q pair is returned.
- SDEViation - returns a single value that is the arithmetic standard deviation for the data point values for the specified region(s) of trace data. See the following equation.
- For I/Q trace data, the standard deviation of the magnitudes of the I/Q pairs is returned. See the following equation.

Equation 6

Standard Deviation of Data Point Values for Specified Region(s)

$$\text{SDEV} = \sqrt{\frac{1}{n} \sum_{X_i \in \text{region}(s)} (X_i - \bar{X})^2}$$

where X_i is a data point value, \bar{X} is the arithmetic mean of the data point values for the specified region (s), and n is the number of data points in the specified region(s).

$$\text{SDEV} = \sqrt{\frac{1}{n} \sum_{|X_i| \in \text{region}(s)} (|X_i| - \bar{X})^2}$$

where $|X_i|$ is the magnitude of an I/Q pair, \bar{X} is the mean of the magnitudes for the specified region(s), and n is the number of data points in the specified region(s).

- PPHase - returns the x,y pairs of both rms power (dBm) and arithmetic mean phase (radian) for every specified region and frequency offset (Hz). The number of pairs is defined by the specified number of regions. This parameter can be used for I/Q vector ($n=0$) in Waveform (time domain) measurement and all parameters are specified by data point in PPHase.

The rms power of the specified region may be expressed as:

$$\text{Power} = 10 \times \log [10 \times (\text{RMS I/Q value})] + 10.$$

The RMS I/Q value (peak volts) is:

$$\sqrt{\frac{1}{n} \sum_{X_i \in \text{region}} X_i X_i^*}$$

where X_i is the complex value representation of an I/Q pair, X_i^* its conjugate complex number, and n is the number of I/Q pairs in the specified region.

The arithmetic mean phase of the specified region may be expressed as:

$$\frac{1}{n} \sum_{Y_i \in \text{region}} Y_i$$

where Y_i is the unwrapped phase of I/Q pair with applying frequency correction and n is the number of I/Q pairs in the specified region.

The frequency correction is made by the frequency offset calculated by the arithmetic mean of every specified region's frequency offset. Each frequency offset is calculated by the least square method against the unwrapped phase of I/Q pair.

Sample Trace Data - Constant Envelope

(See below for explanation of variables.)

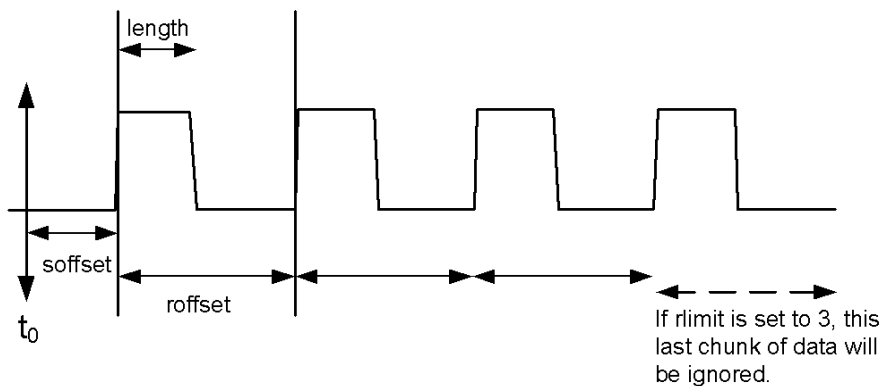

Sample Trace Data - Not Constant Envelope

(See below for explanation of variables.)

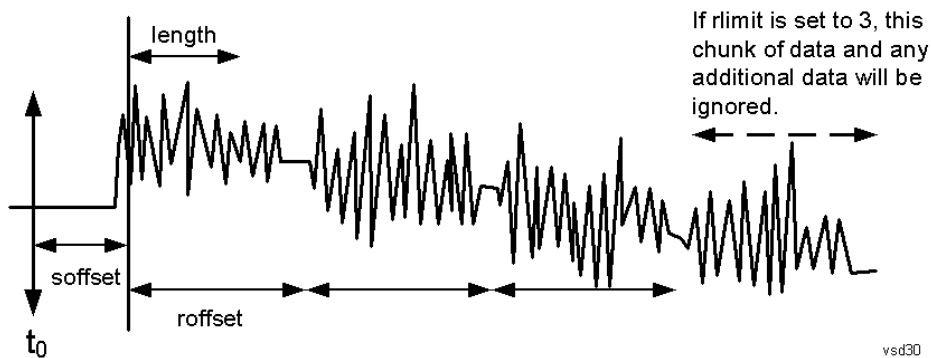

<soffset> - start offset is an optional real number. (It is in seconds for time-domain traces, and is a dimensionless index 0 to Npoints - 1, for frequency-domain traces). It specifies the amount of data at the beginning of the trace that will be ignored before the decimation process starts. It is the time or frequency change from the start of the trace to the point where you want to start using the data. The default value is zero.

<length> - is an optional real number. (It is in seconds for time-domain traces, and is a dimensionless index 0 to Npoints - 1, for frequency-domain traces). It defines how much data will be compressed into one value. This parameter has a default value equal to the current trace length.

<roffset> - repeat offset is an optional real number. (It is in seconds for time-domain traces, and is a dimensionless index 0 to Npoints - 1, for frequency-domain traces). It defines the beginning of the next field of trace elements to be compressed. This is relative to the beginning of the previous field. This parameter has a default value equal to the <length> variable. Note that this parameter is used for a completely different purpose when curve fitting (see CFIT above).

<rlimit> - repeat limit is an optional integer. It specifies the number of data items that you want returned. It will ignore any additional items beyond that number. You can use the Start offset and the Repeat limit to pick out exactly what part of the data you want to use. The default value is all the data.

Calculate Peaks of Trace Data (Remote Command Only)

Returns a list of all the peaks for the currently selected measurement and sub-opcode [n]. The peaks must meet the requirements of the peak threshold and excursion values.

n = any valid sub-opcode for the current measurement. See the MEASure:<measurement> command description of your specific measurement for information on the data that can be returned.

The command can only be used with specific sub-opcodes with measurement results that are trace data. Both real and complex traces can be searched, but complex traces are converted to magnitude in dBm. In many measurements the sub-opcode n=0, is the raw trace data which cannot be searched for peaks. And Sub-opcode n=1, is often calculated results values which also cannot be searched for peaks.

This command uses the data setting specified by the FORMat:BORDER and FORMat:DATA commands and can return real or ASCII data. If the format is set to INT,32, it returns REAL,32 data.

The command has four types of parameters:

- Threshold (in dBm)
- Excursion (in dB)
- Sorting order (amplitude, frequency, time)
- Optional in some measurements: Display line use (all, > display line, < display line)

Remote Command	<p>For Swept SA measurement:</p> <pre>:CALCulate:DATA[1] 2 ... 6:PEAKs? <threshold>,<excursion>[,AMPLitude FREQuency TIME[,ALL GTDLine LTDLine]]</pre> <p>For most other measurements:</p> <pre>:CALCulate:DATA[1] 2 ... 6:PEAKs? <threshold>,<excursion>[,AMPLitude FREQuency TIME]</pre>
-----------------------	--

Example	<p>Example for Swept SA measurement in Spectrum Analyzer Mode:</p> <p>CALC:DATA4:PEAK? -40, 10, FREQ, GTDL This will identify the peaks of trace 4 that are above -40 dBm, with excursions of at least 10 dB. The peaks are returned in order of increasing frequency, starting with the lowest frequency. Only the peaks that are above the display line are returned.</p> <p>Query Results 1:</p> <p>With FORMat:DATA REAL, 32 selected, it returns a list of floating-point numbers. The first value in the list is the number of peak points that are in the following list. A peak point consists of two values: a peak amplitude followed by its corresponding frequency (or time).</p> <p>If no peaks are found the peak list will consist of only the number of peaks, (0).</p>
----------------	---

Notes	<p><n> - is the trace that will be used</p> <p><threshold> - is the level below which trace data peaks are ignored. Note that the threshold value is required and is always used as a peak criterion. To effectively disable the threshold criterion for this command, provide a substantially low threshold value such as -200 dBm. Also note that the threshold value used in this command is independent of and has no effect on the threshold value stored under the Peak Criteria menu.</p> <p><excursion> - is the minimum amplitude variation (rise and fall) required for a signal to be identified as peak. Note that the excursion value is required and is always used as a peak criterion. To effectively disable the excursion criterion for this command, provide the minimum value of 0.0 dB. Also note that the excursion value used in this command is independent of and has no effect on the</p>
--------------	---

excursion value stored under the Peak Criteria menu.

Values must be provided for threshold and excursion. The sorting and display line parameters are optional (defaults are AMPLitude and ALL).

Note that there is always a Y-axis value for the display line, regardless of whether the display line state is on or off. It is the current Y-axis value of the display line which is used by this command to determine whether a peak should be reported. Sorting order:

AMPLitude - lists the peaks in order of descending amplitude, with the highest peak first (default if optional parameter not sent)

FREQUENCY - lists the peaks in order of occurrence, left to right across the x-axis.

TIME - lists the peaks in order of occurrence, left to right across the x-axis.

Peaks vs. Display Line:

ALL - lists all of the peaks found (default if optional parameter not sent).

GTDLine (greater than display line) - lists all of the peaks found above the display line.

LTDLine (less than display line) - lists all of the peaks found below the display line.

Initial S/W Revision	Prior to A.02.00
----------------------	------------------

Hardware-Accelerated Fast Power Measurement (Remote Command Only)

The Fast Power option (FP2) enables very fast channel power measurements for instruments with the prerequisite hardware (DP2 and/or B40). It accomplishes this by performing real-time overlapped FFTs at the hardware layer, using software for basic post-processing before returning the result to the user. The upshot of this approach is improved throughput for user applications that require many sequential power measurements.

The analysis bandwidth of FP2 is limited by the licenses in the instrument, but its maximum overall analysis bandwidth per acquisition is 40 MHz.

FP2 is remote-only, which means the instrument does not switch to any particular mode or measurement. FP2 commands can be sent while another application is in use on the front panel.

Each Fast Power measurement can be predefined using an array index, and up to 1,000 measurements can be stored. In the following documentation, instances of [1,2,...,999] can be substituted with a particular measurement index, e.g. CALC:FPOW:POW1?, CALC:FPOW:POW2?, CALC:FPOW:POW134?. In this way, power measurements can be defined one time in a batch, and then executed multiple times without having to redefine them, similar to “list mode” on other measurements.

In addition to basic channel power measurements, there are a number of other measurement “functions” for each channel, including peak power, peak frequency, and power spectral density. See the Function parameter for more information.

Reset Fast Power Measurement (Remote Command Only)

Resets the measurement configuration to the defaults.

Mode	All
Remote Command	:CALCulate:FPOW:POW[1,2,...,999]:RESet
Example	:CALC:FPOW:POW1:RES

Notes	Option FP2 is required.
Initial S/W Revision	A.14.00

Define Fast Power Measurement (Remote Command Only)

Fast Power acquisitions are configured using the DEFine command. This command accepts a comma-delimited string of configuration parameters and their appropriate values, which are all specified in the subsection below.

Mode	All
Remote Command	:CALCulate:FPOWer:POWer[1,2,...,999]:DEFine "configuration string"
Example	:CALC:FPOW:POW1:DEF "CenterFrequency=2e9, AcquisitionTime=0.005"
Notes	See below for a list of measurement variables that can be defined in the configuration string.
Initial S/W Revision	A.14.00

Acquisition Time

Example	CALC:FPOW:POW1:DEF "AcquisitionTime=0.002"
Notes	The acquisition time parameter sets the time in which the entire spectrum is measured. An increase in the acquisition time yields an improvement in measurement repeatability.
Preset	0.001 s
Range	0 s to 1 s
Default Unit	Time (s)
Initial S/W Revision	A.14.00

Center Frequency

Example	CALC:FPOW:POW1:DEF "CenterFrequency=2e9"
Notes	The center frequency parameter sets the frequency in which the measurement is centered around. The OffsetFrequency parameter is calculated relative to the center frequency.
Preset	1 GHz
Range	0 Hz to maximum instrument frequency
Default Unit	Frequency (Hz)
Initial S/W Revision	A.14.00

DC Coupled

Example	CALC:FPOW:POW1:DEF "DCCoupled=True"
Notes	The DC coupled parameter allows the user to specify whether the DC blocking capacitor is utilized. Set parameter to true when measuring frequencies below 10 MHz.
Preset	False
Range	True (DC Coupled) or False (AC Coupled)
Default Unit	Boolean
Initial S/W Revision	A.14.00

DetectorType

Example	CALC:FPOW:POW1:DEF "DetectorType=Peak"
Notes	Option FP2 is required. The detector type parameter allows the user to choose whether a RMS average or peak value is used during the measurement.
Preset	RmsAverage
Range	RmsAverage, Peak
Initial S/W Revision	A.14.00

Do Noise Correction

Example	CALC:FPOW:POW1:DEF "DoNoiseCorrection=True"
Notes	When noise correction is enabled, the linear noise power contributed by the analyzer is subtracted from all measurements. This effectively lowers the noise floor of the analyzer. When noise correction is enabled, the first measurement for a given set of input parameters will take extra time. This is because the analyzer takes an extra acquisition with the RF input disconnected from the analyzer's front end to measure the noise of just the analyzer. The measured noise floor is stored in a cache so the noise acquisition will occur only once for the same state settings. In other words, if noise correction was turned on and the analyzer made an acquisition at frequency A, then frequency B, and back again to frequency A, the hidden initial noise floor acquisition would only occur for the first acquisition at frequency A and the cached noise floor would be used the second time frequency A was measured.
Preset	False
Range	True (enable noise correction) or False (disable noise correction)
Default Unit	Boolean
Initial S/W Revision	A.14.00

Do Spur Suppression

Example	CALC:FPOW:POW1:DEF "DoSpurSuppression=True"
Notes	<p>When measuring very low level signals, or when large out-of-band inputs are input into the analyzer, sometimes unwanted spurs and residuals can appear in the measured spectrum. Spur suppression is a method to help minimize the levels of these internally generated spurs and residuals.</p> <p>When spur suppression is enabled, the analyzer will automatically take two acquisitions using two different internal analog LO frequencies. The FFT spectrums from both acquisitions are combined by taking the minimum power between both traces on a per FFT bin basis. External signals will have the same amplitude for both traces and therefore will return the expected amplitudes. However, low level spurs and residuals generated internally to the analyzer tend to move to different FFT bins depending on the internal analog LO frequency used, and therefore tend to be suppressed using this spur suppression method.</p> <p>Because two acquisitions, rather than a single acquisition, are made when spur suppression is enabled, the measurement time will always be slower when spur suppression is enabled.</p>
Preset	False
Range	True (enable spur suppression) or False (disable spur suppression)
Default Unit	Boolean
Initial S/W Revision	A.14.00

Electronic Attenuator Bypass

Example	CALC:FPOW:POW1:DEF "ElecAttBypass =False"
Notes	The electronic attenuation bypass parameter allows the user to either utilize or bypass the electronic attenuator. The electronic attenuator is only available for frequencies up to 3.6 GHz. Set parameter to true when using frequencies above 3.6 GHz and set the parameter to false when using the preamp.
Preset	True
Range	True (bypass electronic attenuator) or False (use electronic attenuator)
Default Unit	Boolean
Initial S/W Revision	A.14.00

Electronic Attenuation

Example	CALC:FPOW:POW1:DEF "ElecAttenuation=10"
Notes	<p>Option EA3 is required.</p> <p>The electronic attenuation value parameter sets the amount of electrical attenuation from 0 to 24 dB (1 dB steps).</p> <p>Set "ElecAttBypass=False" to make sure the electronic attenuator path is enabled.</p>
Preset	0 dB
Range	0 – 24 dB (1 dB steps)

Default Unit	dB
Initial S/W Revision	A.14.00

IF Gain

Example	CALC:FPOW:POW1:DEF "IFGain=10"
Notes	The IF gain parameter allows the user to specify the gain at the IF stage anywhere from -6 to 16 dB (1 dB steps). This is an advanced feature, and for most cases this should remain at its default value of 0 dB.
Preset	0 dB
Range	-6 - 16 dB (1 dB steps)
Default Unit	dB
Initial S/W Revision	A.14.00

IF Type

Example	CALC:FPOW:POW1:DEF "IFType=B25M"
Notes	The IF type parameter allows the user to select between different IF paths. For example, if the signal is less than 25 MHz wide, then the user can select the B25M path to take advantage of additional filtering on this analog IF path.
Preset	B40M
Range	B10M, B25M, B40M
Initial S/W Revision	A.14.00

Include Power Spectrum

Example	CALC:FPOW:POW1:DEF "IncludePowerSpectrum=True"
Notes	The power spectrum parameter allows the user to read data on the entire spectrum for diagnostic purposes. It is not recommended for production use. See CALC:FPOW:POW[n]:READ2? for details on the binary format of the response.
Preset	False
Range	True (return both channel power and full power spectrum) or False (returns only channel power)
Default Unit	Boolean
Initial S/W Revision	A.14.00

Mechanical Attenuation

Example	CALC:FPOW:POW1:DEF "MechAttenuation=10"
Notes	The mechanical attenuation value parameter sets the amount of mechanical attenuation anywhere from 0 to 70 dB (2 dB steps).
Preset	0 dB
Range	0 – 70 dB (2 dB steps)
Default Unit	dB
Initial S/W Revision	A.14.00

Preamp Mode

Example	CALC:FPOW:POW1:DEF "PreAmpMode=Low"
Notes	The license for the appropriate preamp is required. The preamp mode parameter specifies whether the preamps are being utilized. Low allows any preamps up to 3.6 GHz, and Full allows all licensed preamps. Set "ElecAttBypass=True" in order to utilize any preamps.
Preset	Off
Range	Off, Low, Full
Initial S/W Revision	A.14.00

Resolution Bandwidth Mode

Example	CALC:FPOW:POW1:DEF "PreAmpMode=Low"
Notes	The resolution bandwidth mode parameter allows the user to choose whether the RBW filter is automatically or manually set. The BestSpeed value minimizes measurement time, while the Narrowest value minimizes RBW size (minimum of two FFT bins per RBW). To manually specify an RBW, set this parameter to Explicit, and set the ResolutionBW parameter to the desired value.
Preset	BestSpeed
Range	BestSpeed, Narrowest, Explicit
Initial S/W Revision	A.14.00

Resolution Bandwidth

Example	CALC:FPOW:POW1:DEF "ResolutionBW=25e3"
Notes	The resolution bandwidth parameter sets the 3-dB bandwidth of the RBW filter. The ResolutionBWMode parameter must be set to Explicit in order to manually set the RBW.

Preset	0 Hz
Default Unit	Hz
Initial S/W Revision	A.14.00

Trigger Delay

Example	CALC:FPOW:POW1:DEF "TriggerDelay=0.025"
Notes	The trigger delay parameter sets the time after an external trigger is detected until the measurement is performed.
Preset	0 s
Range	0 – 1 s
Default Unit	Seconds
Initial S/W Revision	A.14.00

Trigger Level

Example	CALC:FPOW:POW1:DEF "TriggerLevel=2"
Notes	The trigger level parameter sets the voltage value at which an external trigger is detected.
Preset	1.2 V
Range	-5 to 5 V
Default Unit	Volts
Initial S/W Revision	A.14.00

Trigger Slope

Example	CALC:FPOW:POW1:DEF "TriggerSlope=Negative"
Notes	The trigger slope parameter indicates the direction of the edge trigger voltage for detection.
Preset	Positive
Range	Positive, Negative
Initial S/W Revision	A.14.00

Trigger Source

Example	CALC:FPOW:POW1:DEF "TriggerSource=Ext1"
Notes	The trigger source parameter allows the user to choose between measurement's triggering freely or controlled by an external input. Ext1 and Ext2 correspond to Trigger 1 In and Trigger 2 In, respectively.
Preset	Free
Range	Free, Ext1, Ext2
Initial S/W Revision	A.14.00

Trigger Timeout

Example	CALC:FPOW:POW1:DEF "TriggerTimeout=0.1"
Notes	The trigger timeout parameter sets the time in which the analyzer will wait for a trigger before automatically performing the measurement.
Preset	1 s
Range	0 - 1 s
Default Unit	Seconds
Initial S/W Revision	A.14.00

Signal Input

Example	CALC:FPOW:POW1:DEF "SignalInput=Fp50MHzCW"
Notes	The signal input parameter allows the user to select between using the main RF input or the internal analyzer reference CW signal of 50 MHz.
Preset	FpMainRf
Range	FpMainRf, Fp50MHzCW
Initial S/W Revision	A.14.00

Use Preselector

Example	CALC:FPOW:POW1:DEF "UsePreSelector=True"
Notes	The preselector parameter allows the user to either utilize or bypass the front end tunable filter at frequencies above 3.6 GHz. For frequencies below 3.6 GHz, the preselector is automatically bypassed, so you do not need to set this parameter to False in those cases.
Preset	False
Range	True (use preselector above 3.6 GHz), or False (preselector bypassed)

Default Unit	Boolean
Initial S/W Revision	A.14.00

Channel Bandwidth Array

Example	CALC:FPOW:POW1:DEF "Bandwidth=[3.84e6, 5e6, 3.84e6]"
Notes	The bandwidth parameter array defines the bandwidth of each channel that will be measured. All array parameters should have the same number of elements. Alternatively, if all the elements are the same value, a single number with no square brackets can be used to define the parameter.
Preset	[1 e6]
Range	0 to 40 MHz
Default Unit	Hz
Initial S/W Revision	A.14.00

Channel Filter Type Array

Example	CALC:FPOW:POW1:DEF "FilterType=[RRC, IBW, RRC]"
Notes	The filter type parameter allows the user to choose between an integration bandwidth (IBW) filter or a root-raised-cosine (RRC) filter. The integration bandwidth filter weighs all frequencies within the bandwidth equally. The root-raised-cosine filter has an associated shape parameter, defined by the FilterAlpha parameter. All array parameters should have the same number of elements. Alternatively, if all the elements are the same value, a single value with no square brackets can be used to define the parameter.
Preset	[IBW]
Range	IBW, RRC
Initial S/W Revision	A.14.00

Channel Filter Alpha Array

Example	CALC:FPOW:POW1:DEF "FilterAlpha=[0.5, 0.0, 0.5]"
Notes	The filter alpha parameter allows the user to adjust the alpha value associated with the root-raised-cosine (RRC) filter type. Set FilterType to RRC in order to utilize this parameter. All array parameters should have the same number of elements. Alternatively, if all the elements are the same value, a single number with no square brackets can be used to define the parameter.
Preset	[0.22]
Range	0.0 - 1.0

Initial S/W Revision	A.14.00
-------------------------	---------

Channel Measurement Function Array

Example	CALC:FPOW:POW1:DEF "Function=[BandPower, PeakPower, BandPower]"
Notes	<p>This parameter array defines what measurement is being made for each individually-specified channel:</p> <p>BandPower: Total power within the specified bandwidth of the channel (dBm)</p> <p>BandDensity: Total power density within the specified bandwidth of the channel (dBm/Hz)</p> <p>PeakPower: The peak power value within the specified bandwidth of the channel (dBm)</p> <p>PeakFrequency: The frequency which corresponds to the peak power value within the specified bandwidth of the channel. This frequency is relative to the center frequency (Hz)</p> <p>XdBBandwidth: The half power (-3.01 dB) bandwidth of the highest amplitude signal that resides within the channel (Hz), dB is configurable using XdBBandwidth parameter</p> <p>OccupiedBandwidth: The bandwidth at which 99% of the total power resides within the channel (Hz), percentage configurable using OccupiedBandwidthPercent parameter</p> <p>All array parameters should have the same number of elements. Alternatively, if all the elements are the same value, a single value with no square brackets can be used to define the parameter.</p>
Preset	[BandPower]
Range	BandPower, BandDensity, PeakPower, PeakFrequency, XdBBandwidth, OccupiedBandwidth
Initial S/W Revision	A.14.00

Channel Offset Frequency Array

Example	CALC:FPOW:POW1:DEF "OffsetFrequency=[-5e6, 0, 5e6]"
Notes	<p>The offset frequency parameter array defines the difference between the center frequency to the center frequency of each channel.</p> <p>All array parameters should have the same number of elements.</p>
Preset	[0]
Range	0 to 20 MHz
Default Unit	Hz
Initial S/W Revision	A.14.00

Channel Occupied Bandwidth Percent Array

Example	CALC:FPOW:POW1:DEF "OccupiedBandwidthPercent =[0.95, 0.95, 0.95]"
Notes	This parameter only applies for channels whose Function is set to OccupiedBandwidth. The occupied

bandwidth percent parameter specifies the percent of total power in these channels. The valid range for this parameter is 0.0 to 1.0, where 1.0 represents 100%. The default for this parameter is 0.99, which will return the bandwidth that contains 99% of the total channel power.

Preset	[0.99]
Range	0 – 1.0
Initial S/W Revision	A.14.00

Channel x-dB Bandwidth Array

Example	CALC:FPOW:POW1:DEF " XdBBandwidth =[-6.02, -3.01, -1.0]"
Notes	This parameter only applies for channels whose Function is set to XdBBandwidth. The X dB bandwidth parameter is used to specify the power relative to the peak channel power over which the bandwidth is calculated. The parameter value must be a negative number.
Preset	[-3.01]
Range	-200 to 0 dB
Default Unit	dB
Initial S/W Revision	A.14.00

Define Fast Power Measurement Query (Remote Command Only)

The DEFine? command is used to retrieve a list of all defined parameters in an ASCII string format

```

M All
o
d
e
R :CALCulate:FPOWER:POWER[1,2,...,999]:DEFine?
e
m
o
t
e
C
o
m
m
a
n
d
E :CALC:FPOW:POW1:DEF?

```

```
x
a
m
p
l
e
N This command query is used to retrieve a list of all defined parameters in an ASCII format.
o The following is an example of the returned results:
t "DCCoupled=False,ElecAttBypass=True,ElecAttenuation=0,IFGain=0,MechAttenuation=0,PreAmpMode=Off,PreSelectorOffset
e =0,UsePreSelector=False,ExternalReferenceFrequency=10000000,FrequencyReferenceSource=AutoExternalFrequencyRefer
s ence,IFType=B40M,LOMode=SLW,SignalInput=FpMainRf,AcquisitionTime=0.001,CenterFrequency=1000000000,Resolution
BW=0,ResolutionBWMode=BestSpeed,DetectorType=RmsAverage,Bandwidth=[1000000],OffsetFrequency=[0],Function=
[BandPower],FilterType=[IBW],FilterAlpha=[0.22],OccupiedBandwidthPercent=[0.99],XdBBandwidth=[-
3.01],DoNoiseCorrection=False,DoSpurSuppression=False,MeasurementMethod=HardwareFFT,IncludePowerSpectrum=False,
e,TriggerDelay=0,TriggerLevel=1.2,TriggerSlope=Positive,TriggerSource=Free,TriggerTimeout=1 "
I A.14.00
n
i
t
i
a
l
S
/
W
R
e
v
i
s
i
o
n
```

Configure Fast Power Measurement (Remote Command Only)

The configure command begins hardware setup and returns immediately, with no acquisition made. This can be used in parallel with other hardware operations to effectively hide the hardware setup time.

Mode	All
Remote Command	:CALCulate:FPOWer:POWer[1,2,...,999]:CONFigure
Example	:CALC:FPOW:POW1:CONF
Notes	Option FP2 is required.
Initial S/W Revision	A.14.00

Initiate Fast Power Measurement (Remote Command Only)

The INITiate command begins an acquisition and returns immediately. The results of the measurement can be retrieved using FETCh.

Mode	All
Remote Command	:CALCulate:FPOWER:POWer[1,2,...,999]:INITiate
Example	:CALC:FPOW:POW1:INIT
Notes	Option FP2 is required.
Initial S/W Revision	A.14.00

Fetch Fast Power Measurement (Remote Command Only)

The FETCh command query is used to retrieve the results of an acquisition initiated by the INIT command. The returned results are in ASCII string format. The string begins and ends with quotation marks.

Mode	All
Remote Command	:CALCulate:FPOWER:POWer[1,2,...,999]:FETCh?
Example	:CALC:FPOW:POW1:FETC?
Notes	Option FP2 is required. Returns m comma-separated ASCII values, where m corresponds to the number of bandwidths defined. 1. Declared function return in the 1st specified channel 2. Declared function return in the 2nd specified channel ... m. Declared function return in the last specified channel The INIT and FETC? command sequence performs the same functionality of a single CALC:FPOW:POW[n]? query. Units of the returned values are dependent on the Function parameter for each channel.
Initial S/W Revision	A.14.00

Execute Fast Power Measurement (Remote Command Only)

This command query is used as shorthand for an INIT command immediately followed by a FETC? command. The returned results are in ASCII string format. The string begins and ends with quotation marks.

Mode	All
Remote Command	:CALCulate:FPOWER:POWer[1,2,...,999]?
Example	:CALC:FPOW:POW1?

Notes	Option FP2 is required. See notes for Fast Power Fetch for return format.
Initial S/W Revision	A.14.00

Binary Read Fast Power Measurement (Remote Command Only)

This command query is used as shorthand for an INIT command immediately followed by a FETC? command. The returned results are in a binary format.

Mode	All
Remote Command	:CALCulate:FPOWER:POWER[1,2,...,999]:READ? :CALCulate:FPOWER:POWER[1,2,...,999]:READ1?
Example	:CALC:FPOW:POW1:READ? :CALC:FPOW:POW1:READ1?
Notes	Option FP2 is required. Returns m 4 byte floating point binary values (Little-Endian), where m corresponds to the number of bandwidths defined.
Initial S/W Revision	A.14.00

Diagnostic Binary Read Fast Power Measurement (Remote Command Only)

This command query is used as shorthand for an INIT command immediately followed by a FETC? command. The returned results are in a binary format. This command is used primarily for diagnostic purposes to test for ADC overloads and to visibly inspect the spectrum.

Mode	All
Remote Command	:CALCulate:FPOWER:POWER[1,2,...,999]:READ2?
Example	:CALC:FPOW:POW1:READ2?
Notes	Option FP2 is required. Note: Spectrum data is only returned if the IncludePowerSpectrum parameter is set to True. If IncludePowerSpectrum is False, the number of spectrum points will be zero (0). Units of the returned values are dependent on the Function parameter per channel (e.g. dBm for BandPower, Hz for PeakFrequency). Returns binary data (Little-Endian) that contains information on m amount of channels, along with ADC over range and full spectrum data. The following is the binary format of the response. Bandwidth Return Value 1. Number of channels specified, m [4 byte int] 2. Declared function result for the 1st specified channel [4 byte float]

	3. Declared function result for the 2nd specified channel [4 byte float]
	...
	(m + 1). Declared function result for the last (mth) specified channel [4 byte float]
	ADC Over Range
	1. ADC over-range occurred (1: true, 0: false) [2 byte short]
	Spectrum Data
	1. Number of points in the spectrum data, k [4 byte int]
	2. Start frequency of spectrum data (Hz) [8 byte double]
	3. Step frequency of spectrum data (Hz) [8 byte double]
	4. FFT bin at 1st point (dBm) [4 byte float]
	5. FFT bin at 2nd point (dBm) [4 byte float]
	...
	(k + 3). FFT bin at last (kth) point (dBm) [4 byte float]

Initial S/W Revision	A.14.00
-------------------------	---------

Format Data: Numeric Data (Remote Command Only)

This command specifies the format of the trace data input and output. It specifies the formats used for trace data during data transfer across any remote port. It affects only the data format for setting and querying trace data for the :TRACe[:DATA], TRACe[:DATA]?, :CALCulate:DATA[n]? and FETCh:SANalyzer [n]? commands and queries.

Remote Command	:FORMat[:TRACe][:DATA] ASCii INTEger,32 REAL,32 REAL,64 :FORMat[:TRACe][:DATA]?
Notes	The query response is: ASCii: ASC,8 REAL,32: REAL,32 REAL,64: REAL,64 INTEger,32: INT,32 When the numeric data format is REAL or ASCii, data is output in the current Y Axis unit. When the data format is INTEger, data is output in units of m dBm (.001 dBm). The INT,32 format returns binary 32-bit integer values in internal units (m dBm), in a definite length block.
Dependencies	Sending a data format spec with an invalid number (for example, INT,48) generates no error. The analyzer simply uses the default (8 for ASCii, 32 for INTEger, 32 for REAL). Sending data to the analyzer which does not conform to the current FORMat specified, results in an error. Sending ASCII data when a definite block is expected generates message -161 "Invalid Block Data" and sending a definite block when ASCII data is expected generates message -121 "Invalid Character in Number".
Preset	ASCii
Backwards Compatibility	Note that the INT,32 format is only applicable to the command, TRACe:DATA. This preserves

Notes	backwards compatibility for the Swept SA measurement. For all other commands/queries which honor FORMat:DATA, if INT,32 is sent the analyzer will behave as though it were set to REAL,32.
Initial S/W Revision	Prior to A.02.00

The specs for each output type follow:

ASCIi - Amplitude values are in ASCII, in the current Y Axis Unit, one ASCII character per digit, values separated by commas, each value in the form:

SX.YYYYYEsZZ

Where:

S = sign (+ or -)

X = one digit to left of decimal point

Y = 5 digits to right of decimal point

E = E, exponent header

s = sign of exponent (+ or -)

ZZ = two digit exponent

REAL,32 - Binary 32-bit real values in the current Y Axis Unit, in a definite length block.

REAL,64 - Binary 64-bit real values in the current Y Axis Unit, in a definite length block.

Format Data: Byte Order (Remote Command Only)

This command selects the binary data byte order for data transfer and other queries. It controls whether binary data is transferred in normal or swapped mode. This command affects only the byte order for setting and querying trace data for the :TRACe[:DATA], TRACe[:DATA]? , :CALCulate:DATA[n]? and FETCh:SANalyzer[n]? commands and queries.

By definition any command that says it uses FORMat:DATA uses any format supported by FORMat:DATA.

The NORMal order is a byte sequence that begins with the most significant byte (MSB) first, and ends with the least significant byte (LSB) last in the sequence: 1|2|3|4. SWAPped order is when the byte sequence begins with the LSB first, and ends with the MSB last in the sequence: 4|3|2|1.

Remote Command	:FORMat:BORDer NORMal SWAPped :FORMat:BORDer?
Preset	NORMal
Initial S/W Revision	Prior to A.02.00

Meas Setup

Displays the setup menu keys that enable you to control the parameters for the current measurement.

Key Path	Front-panel key
Initial S/W Revision	Prior to A.02.00

Average/Hold Num

Sets the number of sweeps (average counts) that are averaged. After the specified number of sweeps, the averaging mode (terminal control) setting determines the averaging action.

Key Path	Meas Setup
Mode	BASIC, PNOISE, WCDMA, C2K, GSM, WIMAXOFDMA, TDSCDMA, 1XEVD0, DVB, DTMB, ISDBT, CMMB, LTE, LTETDD, DCATV, WLAN, MSR,LTEATDD, LTEAFDD
Remote Command	[:SENSe]:WAVeform:AVERAge:COUNT <integer> [:SENSe]:WAVeform:AVERAge:COUNT? [:SENSe]:WAVeform:AVERAge[:STATe] OFF ON 0 1 [:SENSe]:WAVeform:AVERAge[:STATe]?
Example	WAV:AVER:COUN 1001 WAV:AVER:COUN? WAV:AVER ON WAV:AVER?
Notes	You must be in a mode that includes the Waveform measurement to use this command. Use INSTRument:SElect to set the mode.
Preset	10 OFF
State Saved	Saved in instrument state.
Min	1
Max	20001
Initial S/W Revision	Prior to A.02.00
Modified at S/W Revision	A.03.00

Avg Mode

Enables you to set the averaging mode.

- When set to Exponential (Exp) the measurement averaging continues using the specified number of averages to compute each averaged value. The average is displayed at the end of each sweep.
- When set to Repeat, the measurement resets the average counter each time the specified number of averages is reached.

Key Path	Meas Setup
Mode	BASIC, PNOISE, WCDMA, C2K, GSM, WIMAXOFDMA, TDSCDMA, 1XEVD0, DVB, DTMB, ISDBT, CMMB, LTE, LTETDD, DCATV, WLAN, MSR,LTEATDD, LTEAFDD
Remote Command	<code>[:SENSe] :WAVeform:AVERage:TCONtrol EXPonential REPEAT</code> <code>[:SENSe] :WAVeform:AVERage:TCONtrol?</code>
Example	WAV:AVER:TCON REP WAV:AVER:TCON?
Notes	You must be in a mode that includes the Waveform measurement to use this command. Use INSTRUMENT:SElect to set the mode.
Preset	EXPonential
State Saved	Saved in instrument state.
Range	Exp Repeat
Initial S/W Revision	Prior to A.02.00
Modified at S/W Revision	A.03.00

Avg Type

Selects the type of averaging.

Key Path	Meas Setup
Mode	BASIC, PNOISE, WCDMA, C2K, GSM, WIMAXOFDMA, TDSCDMA, 1XEVD0, DVB, DTMB, ISDBT, CMMB, LTE, LTETDD, DCATV, WLAN, MSR,LTEATDD, LTEAFDD
Remote Command	<code>[:SENSe] :WAVeform:AVERage:TYPE LOG MAXimum MINimum RMS SCALar</code> <code>[:SENSe] :WAVeform:AVERage:TYPE?</code>
Example	WAV:AVER:TYPE RMS WAV:AVER:TYPE?
Notes	The SCPI selection of MAX and MIN are kept for BWCC, but they are removed from the front panel access because they are not an Average function. You must be in a mode that includes the Waveform measurement to use this command. Use INSTRUMENT:SElect to set the mode.
Preset	RMS
State Saved	Saved in instrument state.
Range	Pwr Avg(RMS) Log-Pwr Avg(Video) Voltage Avg
Initial S/W Revision	Prior to A.02.00
Modified at S/W Revision	A.03.00

Avg Type Auto

When **Auto** is selected, the analyzer chooses the type of averaging. When one of the average types is selected manually, the analyzer uses that type regardless of other analyzer settings, and shows **Man** on the **Average Type** softkey.

Key Path	Meas Setup, Avg Type
Remote Command	[:SENSe] :WAVeform:AVERage:TYPE:AUTO [:STATe] ON OFF 1 0 [:SENSe] :WAVeform:AVERage:TYPE:AUTO [:STATe] ?
Example	WAV:AVER:TYPE:AUTO 0 WAV:AVER:TYPE:AUTO?
Couplings	Auto selects Power (RMS) averaging if a Marker Function (Marker Noise, Band/Intvl Power) is on.
Preset	ON
State Saved	Saved in instrument state.
Range	Auto Man
Modified at S/W Revision	A.14.00

Time Avg Num

Sets the number of HW averages to be executed per each data acquisition.

Key Path	Meas Setup
Remote Command	[:SENSe] :WAVeform:AVERage:TACount <integer> [:SENSe] :WAVeform:AVERage:TACount? [:SENSe] :WAVeform:AVERage:TACount:AUTO OFF ON 0 1 [:SENSe] :WAVeform:AVERage:TACount:AUTO?
Example	WAV:AVER:TAC 10WAV:AVER:TAC?WAV:AVER:TAC:AUTO ONWAV:AVER:TAC:AUTO?
Notes	This feature is only available when Option DP2, B40, or wider IF Bandwidth option is installed.
Dependencies	a)Sample Rate \leq 20[MHz] (or 50[MHz] depending on which IF Path is used) b)Acquisition Points \leq 2048
Preset	1 OFF
State Saved	Saved in instrument state
Min	1
Max	65535
Default Unit	Enter

Meas Time

Sets how long the measurement is performed. X Scale only changes the representation of the display.

Key Path	Meas Setup
Mode	BASIC, PNOISE, WCDMA, C2K, GSM, WIMAXOFDMA, TDSCDMA, 1XEVD0, DVB, DTMB, ISDBT, CMMB, LTE, LTETDD, DCATV, WLAN, MSR,LTEATDD, LTEAFDD
Remote Command	[:SENSe] :WAVeform:SWEep:TIME <time> [:SENSe] :WAVeform:SWEep:TIME?
Example	WAV:SWE:TIME 50 ms WAV:SWE:TIME?
Notes	Specifies and returns how long the measurement is performed. It is the time record length of the measurement waveform. The Max time may be reduced when the sample frequency is high due to the memory limitation. You must be in a mode that includes the Waveform measurement to use this command. Use INSTRument:SElect to set the mode.
Preset	All except the following list: 2.000000 ms LTEAFDD, LTEATDD: 10 ms LTETDD: 10 ms LTE: 10 ms
State Saved	Saved in instrument state.
Range	1.000 (s to 100.00 s)
Min	1.000 us
Max	3200 s
Initial S/W Revision	Prior to A.02.00
Modified at S/W Revision	A.03.00, A.14.00

Sample Rate

Enables you to set an arbitrary sample rate for the acquired data to be processed.

Key Path	Meas Setup
Mode	BASIC
Remote Command	[:SENSe] :WAVeform:SRATe <freq> [:SENSe] :WAVeform:SRATe?
Example	WAV:SRAT 1.3636 MHz
Notes	Command and query available when Option DP2, B40, or wider IF Bandwidth option is installed. For other configuration, only query is available.
Couplings	The coupling between Sample Rate and IF BW depends on Physics implementation.
Preset	125.0 kHz

Min	12.5 Hz
Max	<ul style="list-style-type: none"> • (For Option DP2, B40 or wider IF Bandwidth option) • Digital IF 10 MHz path: 12.5 MHz • Digital IF 25 MHz path: 31.25 MHz • Digital IF 40 MHz path: 50 MHz • Option B85 85 MHz path: 106.25 MHz • Option B1A 125 MHz path: 156.25 MHz • Option B1X 140 MHz path: 175 MHz • Option B1Y 160 MHz path: 200 MHz • (For all other configuration) • 10 MHz path: 15 MHz • Option B25 25 MHz path: 45 MHz
Modified at S/W Revision	13.00

PhNoise Opt

Selects the LO (local oscillator) phase noise behavior for various desired operating conditions.

Key Path	Meas Setup
Remote Command	[:SENSe]:WAVeform:FREQuency:SYNThesis[:STATe] 1 2 3 [:SENSe]:WAVeform:FREQuency:SYNThesis[:STATe]?
Example	WAV:FREQ:SYNT 2 Selects optimization for best wide offset phase noise
Notes	Parameter: 1 optimizes phase noise for small frequency offsets from the carrier. 2 optimizes phase noise for wide frequency offsets from the carrier. 3 optimizes LO for tuning speed (In PXA, the local oscillator hardware provides for extra-low phase noise at the expense of some speed.)
Dependencies	Does not appear in all models. The key is blank in those models, but the SCPI command is accepted for compatibility (although no action is taken).
Preset	Because this function is in Auto after preset, and because Digital IF BW after preset < 150 kHz for MXA/EXA and > 400 kHz for PXA the state of this function after Preset will be 1 for MXA/EXA and 2 for PXA.
State Saved	Saved in instrument state.
Min	1
Min	1
Max	3
Initial S/W Revision	Prior to A.07.00
Modified at S/W Revision	A.07.00

Auto

Selects the LO (local oscillator) phase noise behavior to optimize dynamic range and speed for various instrument operating conditions.

The X-Series has two grades of LO; a high performance LO that gives the best phase noise performance; and a medium-performance LO that gives excellent performance.

In models with the high performance LO, Auto will choose:

	Best Close in Phase Noise	Best Wide-offset Phase Noise
Filter BW	≤ 400 kHz	> 400 kHz

In models with the medium-performance LO, Auto will choose:

	Best Close in Phase Noise	Best Wide-offset Phase Noise
Filter BW	≤ 150 kHz	>150 kHz

Note that Fast Tuning will not be selected when in Auto.

Key Path	Meas Setup, PhNoise Opt
Remote Command	[:SENSe] :WAVeform:FREQuency:SYNTHeSis:AUTO[:STATe] OFF ON 0 1 [:SENSe] :WAVeform:FREQuency:SYNTHeSis:AUTO[:STATe] ?
Example	WAV:FREQ:SYNT:AUTO ON
Preset	ON
State Saved	Saved in instrument state.
Initial S/W Revision	Prior to A.07.00

Best Close-in P Noise

The LO phase noise is optimized for smaller offsets from the carrier, at the expense of phase noise farther out.

Key Path	Meas Setup, PhNoise Opt
Example	WAV:FREQ:SYNT 1
Couplings	<p>The frequency below which the phase noise is optimized is model dependent:</p> <ul style="list-style-type: none"> • CXA: n/a • EXA: [offset ≤150 kHz] • MXA: [offset ≤150 kHz] • PXA: [offset ≤400 kHz]

Readback	Close-in. If manually selected, “Man” will be underlined. The actual frequency offset within which noise is optimized is shown with in square brackets, as this can vary depending on the hardware set in use. For example, in some analyzers this annotation appears as [offset <150 kHz]
Initial S/W Revision	Prior to A.07.00

Best Wide-offset P Noise

The LO phase noise is optimized for wider offsets from the carrier. Closer offsets are compromised and the throughput of measurements (especially remote measurements where the center frequency is changing rapidly), is reduced.

Key Path	Meas Setup, PhNoise Opt
Example	WAV:FREQ:SYNT 2
Couplings	The frequency below which the phase noise is optimized is model dependent: CXA: n/a EXA: [offset >150 kHz] MXA: [offset >150 kHz] PXA: [offset >400 kHz]
Readback	Wide-offset. If manually selected, “Man” will be underlined. The actual frequency offset beyond which noise is optimized is shown with in square brackets, as this can vary depending on the hardware set in use. For example, in some analyzers this annotation appears as [offset >150 kHz]
Initial S/W Revision	Prior to A.07.00

Fast Tuning

In this mode, the LO behavior compromises phase noise at many offsets from the carrier in order to allow rapid measurement throughput when changing the center frequency. The term “fast tuning” refers to the time it takes to move the local oscillator to the start frequency and begin a capture; this setting does not impact the actual measurement time in any way.

Key Path	Meas Setup, PhNoise Opt
Example	WAV:FREQ:SYNT 3
State Saved	Saved in instrument state.
Readback	Fast Tuning. If manually selected the “Man” will be underlined.
Initial S/W Revision	Prior to A.07.00

Advanced

Accesses a menu of advanced functions that are used for specific applications. These settings should not be changed for most measurements.

Key Path	Meas Setup
Initial S/W Revision	Prior to A.02.00

ADC Dither

Accesses the ADC Dither control menu.

Key Path	Meas Setup, Advanced
Initial S/W Revision	Prior to A.02.00

ADC Dither Auto

Sets ADC dithering to automatically select whether dithering is needed.

Key Path	Meas Setup, Advanced, ADC Dither
Mode	BASIC, PNOISE, WCDMA, C2K, GSM, WIMAXOFDMA, TDSCDMA, 1XEVDO, DVB, DTMB, ISDBT, CMMB, LTE, LTETDD, DCATV, WLAN, MSR,LTEATDD, LTEAFDD
Remote Command	[:SENSe] :WAVeform:ADC:DITHer:AUTO [:STATe] OFF ON 0 1 [:SENSe] :WAVeform:ADC:DITHer:AUTO [:STATe] ?
Example	WAV:ADC:DITH:AUTO ON WAV:ADC:DITH:AUTO?
Notes	The dither function improves linearity for low level signals, at the expense of a higher noise floor. You must be in a mode that includes the Waveform measurement to use this command. Use INSTRument:SElect to set the mode.
Preset	OFF
State Saved	Saved in instrument state.
Range	On Off
Initial S/W Revision	Prior to A.02.00
Modified at S/W Revision	A.03.00

ADC Dither

Toggles the dither function On and Off. The dither function improves linearity for low level signals, at the expense of a higher noise floor.

The reduced clipping-to-noise ratio results in higher noise, because the clipping level of the ADC relative to the front terminals remains unchanged with the introduction of dither. The enhanced linearity is mostly improved scale fidelity.

With dither on, the third-order distortions are usually invisible for mixer levels below -35 dBm. With dither off, these distortions can be visible, with typical power levels of -110 dBm referred to the mixer. Detection nonlinearity can reach 1 dB for dither off at mixer levels around -70 dBm and lower, while the specified nonlinearity is many times smaller with dither on.

Key Path	Meas Setup, Advanced, ADC Dither
Mode	BASIC, PNOISE, WCDMA, C2K, GSM, WIMAXOFDMA, TDSCDMA, 1XEVD0, DVB, DTMB, ISDBT, CMMB, LTE, LTETDD, DCATV, WLAN, MSR,LTEATDD, LTEAFDD
Remote Command	[:SENSe] :WAVeform:ADC:DITHer [:STATe] OFF ON 0 1 [:SENSe] :WAVeform:ADC:DITHer [:STATe] ?
Example	WAV:ADC:DITH ON WAV:ADC:DITH?
Notes	The dither function improves linearity for low level signals, at the expense of a higher noise floor. . You must be in a mode that includes the Waveform measurement to use this command. Use INSTRument:SElect to set the mode.
Preset	OFF
State Saved	Saved in instrument state.
Range	Auto Man
Backwards Compatibility SCPI	[:SENSe] :WAVeform:WBIF:ADC:DITHer [:SENSe] :WAVeform:PDITHer
Initial S/W Revision	Prior to A.02.00
Modified at S/W Revision	A.03.00

IF Gain

Accesses the keys to select the IF Gain settings.

When in Autorange mode, the IF checks its range once for data acquisition, to provide the best signal to noise ratio. You can specify the range for the best speed, and optimize for noise or for large signals.

When the IF Gain is set to Autorange, the IF Gain is set to High initially for each chunk of data. The data is then acquired. If the IF overloads, then the IF Gain is set to Low and the data is re-acquired. Because of this operation, the Autorange setting uses more measurement time as the instrument checks/resets its range. You can get faster measurement speed by forcing the range to either the high or low gain setting. But you must know that your measurement conditions will not overload the IF (in the high gain range) and that your signals are well above the noise floor (for the low gain range), and that the signals are not changing.

When Digital Bus Out (under the Input/Output menu) is ON, the IF Gain State Autorange selection is not allowed. Thus, in this case, IF Gain State will be set to Low.

This only applies to the RF input. It does not apply to baseband I/Q input.

Key Path	Meas Setup, Advanced
Initial S/W Revision	Prior to A.02.00

IF Gain Auto

Activates the auto rules for IF Gain

Key Path	Meas Setup, Advanced, IF Gain
Mode	BASIC, PNOISE, WCDMA, C2K, GSM, WIMAXOFDMA, TDSCDMA, 1XEVDO, DVB, DTMB, ISDBT, CMMB, LTE, LTETDD, DCATV, WLAN, MSR,LTEATDD, LTEAFDD
Remote Command	[:SENSe] :WAVeform:IF:GAIN:AUTO[:STATe] ON OFF 1 0 [:SENSe] :WAVeform:IF:GAIN:AUTO[:STATe] ?
Example	WAV:IF:GAIN:AUTO ON WAV:IF:GAIN:AUTO?
Notes	This only applies to the RF input. It does not apply to baseband I/Q input. You must be in a mode that includes the Waveform measurement to use this command. Use INSTRument:SElect to set the mode.
Preset	ON
State Saved	Saved in instrument state.
Range	On Off
Initial S/W Revision	Prior to A.02.00
Modified at S/W Revision	A.03.00

IF Gain State

Selects the range of IF gain.

Key Path	Meas Setup, Advanced, IF Gain
Mode	BASIC, PNOISE, WCDMA, C2K, GSM, WIMAXOFDMA, TDSCDMA, 1XEVDO, DVB, DTMB, ISDBT, CMMB, LTE, LTETDD, DCATV, WLAN, MSR,LTEATDD, LTEAFDD
Remote Command	[:SENSe] :WAVeform:IF:GAIN[:STATe] AUTOrange LOW HIGH [:SENSe] :WAVeform:IF:GAIN[:STATe] ?
Example	WAV:IF:GAIN HIGH WAV:IF:GAIN?
Notes	This only applies to the RF input and does not apply to baseband I/Q input. You must be in a mode that includes the Waveform measurement to use this command. Use INSTRument:SElect to set the mode. If the user tries to select Autorange while Digital Bus Out is ON, an error message -221 "Settings conflict; "IF Gain Autorange not allowed when Digital Bus Out is ON" is displayed.
Couplings	If the user tries to select Autorange via SCPI while Digital Bus Out is ON, an error message -

	224, "Illegal parameter value; "IF Gain Autorange not allowed when Digital Bus Out is on" is displayed. If the user tries to select Autorange via front panel while Digital Bus Out is ON, an advisory message "IF Gain Autorange not allowed when Digital Bus Out is on" is displayed.
Preset	LOW
State Saved	Saved in instrument state.
Range	Autorange (Slower Follows Signals) Low (Best for Large Signals) High (Best Noise Level)
Readback Text	Autorange Low High
Initial S/W Revision	Prior to A.02.00
Modified at S/W Revision	A.03.00

IF Gain Offset

Sets the IF Gain offset in 2 dB step from -6 dB to +6 dB. Increasing the gain can increase the amplitude of small signals as long as you do not overdrive the hardware. Wideband gain should usually be adjusted after setting the input attenuation.

Internally, the IF Gain value will change based on the current configuration of the hardware. If you choose to offset this value, you may do so with this parameter. The value specified is not an absolute value but relative to the current internal IF Gain setting.

For example:

IF Gain Low + IF Gain Offset +4 dB = Total IF Gain of +4 dB (0 + 4 = 4)

IF Gain High + IF Gain Offset +4 dB = Total IF Gain of +14 dB (10 + 4 = 14)

IF Gain Low + IF Gain Offset -6 dB = Total IF Gain of -6 dB (0 - 6 = -6)

IF Gain High + IF Gain Offset -6 dB = Total IF Gain of +6 dB (10 - 6 = 4)

The total IF Gain range when IF Gain Offset is available is a minimum of 0 - 6 = -6 dB and a maximum of 10 + 6 = 16 dB. The available IF Gain depends on the IF Path and center frequency. The maximum IF Gain may not be achievable at all times depending on the configuration.

Key Path	Meas Setup, Advanced
Remote Command	<code>[:SENSe] :WAVeform:IF:GAIN:OFFSet <rel_ampl ></code> <code>[:SENSe] :WAVeform:IF:GAIN:OFFSet?</code>
Example	<code>WAV:IF:GAIN:OFFS 2</code> Sets the IF Gain offset to 2
Preset	0
State Saved	Saved in instrument state.
Min	-6
Max	+6
Default Unit	dB

Meas Preset

Restores all the measurement parameters to their default values.

Key Path	Meas Setup
Mode	BASIC, PNOISE, WCDMA, C2K, GSM, WIMAXOFDMA, TDSCDMA, 1XEVD0, DVB, DTMB, ISDBT, CMMB, LTE, LTETDD, DCATV, WLAN, MSR,LTEATDD, LTEAFDD
Remote Command	:CONFigure:WAVeform
Example	CONF:WAV
Notes	Restore default values of all parameters. You must be in a mode that includes the Waveform measurement to use this command. Use INSTRument:SElect to set the mode.
Initial S/W Revision	Prior to A.02.00
Modified at S/W Revision	A.03.00

HW Averaging

Changes the number of time averages is to be made using hardware. This averaging is much faster than the standard averaging done in software. The hardware averaging is done on the complex voltage time trace data before any measurement application averaging is done. Both types of averaging (HW and SW) can be done on the same measurement data.

When time averaging is being done in HW, each trace update represents N fresh data acquisitions averaged together, where N is the number of averages. You cannot access the individual time data. Note that in the waveform measurement this averaging is done prior to the standard averaging done within the application. Thus the yellow trace in this measurement shows the result of the time averaging. Subsequent averaging is orthogonal to this hardware based time averaging.

So it is possible to turn off the averaging within the application but still have the HW averaging set to a certain number. In other words, turning averaging off within the measurement will not affect HW averaging. If HW averaging needs to be turned off, simply set the HW Averaging parameter to 1.

The default value for Time Avg Num is 1. This means that there is no HW averaging. When the value is set to something greater than 1, HW averaging is turned ON.

This feature is most useful for a periodic signal with known periods used in conjunction with the Periodic trigger. Thus, when in Auto, the Trigger Source automatically changes to Periodic trigger when Time Avg Num is turned ON. The trigger period will be set to the current Meas Time value. Any changes to Meas Time will change the Periodic trigger period to the same value and vice verca. If a trigger source other than Periodic trigger is manually selected, the Time Avg Num toggle is set to Man. To use this feature, one of the two conditions below has to be satisfied.

- a) Sample Rate \leq 20[MHz] (or 50[MHz] depending on which IF Path is used)
- b) Acquisition Points \leq 2048

If neither of the conditions are satisfied, the key will become disabled.

Time Avg Num

Sets the number of HW averages to be executed per each data acquisition.

Key Path	Meas Setup
Remote Command	[:SENSe]:WAVeform:AVERage:TACount <integer> [:SENSe]:WAVeform:AVERage:TACount? [:SENSe]:WAVeform:AVERage:TACount:AUTO OFF ON 0 1 [:SENSe]:WAVeform:AVERage:TACount:AUTO?
Example	WAV:AVER:TAC 10WAV:AVER:TAC?WAV:AVER:TAC:AUTO ONWAV:AVER:TAC:AUTO?
Notes	This feature is only available when Option DP2, B40, or wider IF Bandwidth option is installed.
Dependencies	a)Sample Rate \leq 20[MHz] (or 50[MHz] depending on which IF Path is used) b)Acquisition Points \leq 2048
Preset	1 OFF
State Saved	Saved in instrument state
Min	1
Max	65535
Default Unit	Enter

Sample Period (Aperture) Setting (Remote Command Only)

Returns the time between samples (sample period or aperture).

Mode	BASIC
Remote Command	[:SENSe]:WAVeform:APERture?
Example	WAV:APER?
Notes	Query only.
Couplings	Coupled to Sample Rate by the following equation. Sample Period = 1/(Sample Rate)
Preset	1/(Sample Rate Default)
Min	1/(Max Sample Rate)
Max	1/(Min Sample Rate)

16 Waveform Measurement
Mode

Mode

See "[Mode](#)" on page 276

Mode Preset

Returns the active mode to a known state.

Mode Preset does the following for the currently active mode:

- Aborts the currently running measurement.
- Brings up the default menu for the mode, with no active function.
- Sets measurement Global settings to their preset values for the active mode only.
- Activates the default measurement.
- Brings up the default menu for the mode.
- Clears the input and output buffers.
- Sets Status Byte to 0.

Mode Preset does not:

- Cause a mode switch
- Affect mode persistent settings
- Affect system settings
- See "[How-To Preset](#)" on page 2422 for more information.

Key Path	Front-panel key
Remote Command	:SYSTem:PRESet
Example	:SYST:PRES
Notes	*RST is preferred over :SYST:PRES for remote operation. *RST does a Mode Preset, as done by the :SYST:PRES command, and it sets the measurement mode to Single measurement rather than Continuous for optimal remote control throughput. Clears all pending OPC bits. The Status Byte is set to 0.
Couplings	A Mode Preset aborts the currently running measurement, activates the default measurement, and gets the mode to a consistent state with all of the default couplings set.
Backwards Compatibility Notes	In the X-Series, the legacy "Factory Preset" has been replaced with Mode Preset, which only presets the currently active mode, not the entire instrument. In the X-Series, the way to preset the entire instrument is by using System, Restore System Defaults All, which behaves essentially the same way as restore System Defaults does on ESA and PSA. There is also no "Preset Type" as there is on the PSA. There is a green Mode Preset front-panel key that does a Mode Preset and a white-with-green-letters User Preset front-panel key that does a User Preset. The old PRESet:TYPE command is ignored (without generating an error), and SYST:PRES without a parameter does a Mode Preset, which should cover most backward code compatibility issues. The settings and correction data under the Input/Output front-panel key (examples: Input Z Corr, Ext Amp Gain, etc.) are no longer part of any Mode, so they will not be preset by a Mode Preset. They are preset using Restore Input/Output Defaults, Restore System Defaults All. Note that because User Preset does a Recall State, and all of these settings are saved in State, they ARE recalled when using

	User Preset.
Initial S/W Revision	Prior to A.02.00

How-To Preset

The table below shows all possible presets, their corresponding SCPI commands and front-panel access (key paths). Instrument settings depend on the current measurement context. Some settings are local to the current measurement, some are global (common) across all the measurements in the current mode, and some are global to all the available modes. In a similar way, restoring the settings to their preset state can be done within the different contexts.

Auto Couple - is a measurement local key. It sets all Auto/Man parameter couplings in the measurement to Auto. Any Auto/Man selection that is local to other measurements in the mode will not be affected.

Meas Preset - is a measurement local key. Meas Preset resets all the variables local to the current measurement except the persistent ones.

Mode Preset - resets all the current mode's measurement local and measurement global variables except the persistent ones.

Restore Mode Defaults - resets ALL the Mode variables (and all the Meas global and Meas local variables), including the persistent ones.

Type Of Preset	SCPI Command	Front Panel Access
Auto Couple	:COUPle ALL	Auto Couple front-panel key
Meas Preset	:CONFigure:<Measurement>	Meas Setup Menu
Mode Preset	:SYSTem:PRESet	Mode Preset (green key)
Restore Mode Defaults	:INSTrument:DEFault	Mode Setup Menu
Restore All Mode Defaults	:SYSTem:DEFault MODes	System Menu; Restore System Default Menu
*RST	*RST	not possible (Mode Preset with Single)
Restore Input/Output Defaults	:SYSTem:DEFault INPUt	System Menu; Restore System Default Menu
Restore Power On Defaults	:SYSTem:DEFault PON	System Menu; Restore System Default Menu
Restore Alignment Defaults	:SYSTem:DEFault ALIGN	System Menu; Restore System Default Menu
Restore Miscellaneous Defaults	:SYSTem:DEFault MISC	System Menu; Restore System Default Menu
Restore All System Defaults	:SYSTem:DEFault [ALL] :SYSTem:PRESet:PERsistent	System Menu; Restore System Default Menu
User Preset	:SYSTem:PRESet:USER	User Preset Menu
User Preset All Modes	:SYSTem:PRESet:USER:ALL	User Preset Menu

Power On Mode Preset	:SYSTem:PON:TYPE MODE	System Menu
Power On User Preset	:SYSTem:PON:TYPE USER	System Menu
Power On Last State	:SYSTem:PON:TYPE LAST	System Menu

Preset Type (Remote Command Only)

As stated in the Backward Compatibility section, to be compatible with ESA/PSA the PRESet:TYPE command will be implemented as a no-op.

Mode	All
Remote Command	:SYSTem:PRESet:TYPE FACTory MODE USER :SYSTem:PRESet:TYPE?
Example	:SYST:PRES:TYPE FACT
Notes	This command is supported for backward compatibility only. It is a no-op which does not change the behavior of any preset operation.
Preset	This is unaffected by Preset but is set to Mode on a “Restore System Defaults->All”
State Saved	No
Initial S/W Revision	Prior to A.02.00

Mode Setup

See "[Mode Setup](#)" on page 306

Peak Search

Places the selected marker on the trace point with the maximum y-axis value for that marker's trace and accesses a menu that enables you to select to do a next peak or minimum peak search.

Key Path	Front-panel key
Mode	BASIC, PNOISE, WCDMA, C2K, GSM, WIMAXOFDMA, TDSCDMA, 1XEVD0, DVB, DTMB, ISDBT, CMMB, LTE, LTETDD, DCATV, WLAN, MSR,LTEATDD, LTEAFDD
Remote Command	:CALCulate:WAVeform:MARKer[1] 2 ... 12:MAXimum
Example	CALC:WAV:MARK2:MAX
Notes	You must be in a mode that includes the Waveform measurement to use this command. Use INSTRument:SElect to set the mode.
Initial S/W Revision	Prior to A.02.00
Modified at S/W Revision	A.03.00

Next Peak

Moves the selected marker to the next highest local maximum with a value less than that of the current marker.

Key Path	Peak Search
Mode	BASIC, PNOISE, WCDMA, C2K, GSM, WIMAXOFDMA, TDSCDMA, 1XEVD0, DVB, DTMB, ISDBT, CMMB, LTE, LTETDD, DCATV, WLAN, MSR,LTEATDD, LTEAFDD
Remote Command	:CALCulate:WAVeform:MARKer[1] 2 ... 12:MAXimum:NEXT
Example	CALC:WAV:MARK:MAX:NEXT
Notes	You must be in a mode that includes the Waveform measurement to use this command. Use INSTRument:SElect to set the mode.
Initial S/W Revision	Prior to A.02.00
Modified at S/W Revision	A.03.00

Min Search

Moves the selected marker to the minimum y-axis value on the current trace.

Key Path	Peak Search
Mode	BASIC, PNOISE, WCDMA, C2K, GSM, WIMAXOFDMA, TDSCDMA, 1XEVD0, DVB, DTMB, ISDBT, CMMB, LTE, LTETDD, DCATV, WLAN, MSR,LTEATDD, LTEAFDD
Remote Command	:CALCulate:WAVeform:MARKer[1] 2 ... 12:MINimum
Example	CALC:WAV:MARK:MIN
Notes	You must be in a mode that includes the Waveform measurement to use this command. Use INSTRument:SElect to set the mode.

16 Waveform Measurement
Peak Search

Initial S/W Revision	Prior to A.02.00
Modified at S/W Revision	A.03.00

Print

See "Print " on page 367

Quick Save

The Quick Save front-panel key repeats the most recent save that was performed from the Save menu, with the following exceptions:

- Register saves are not remembered as Saves for the purpose of the Quick Save function
- If the current measurement does not support the last non-register save that was performed, an informational message is generated, “File type not supported for this measurement”

Quick Save repeats the last type of qualified save (that is, a save qualified by the above criteria) in the last save directory by creating a unique filename using the Auto File Naming algorithm described below.

If Quick Save is pressed after startup and before any qualified Save has been performed, the Quick Save function performs a Screen Image save using the current settings for Screen Image saves (current theme, current directory), which then becomes the “last save” for the purpose of subsequent Quick Saves.

The Auto File Naming feature automatically generates a file name for use when saving a file. The filename consists of a prefix and suffix separated by a dot, as is standard for the Windows® file system. A default prefix exists for each of the available file types:

Type	Default Prefix	Menu
State	State_	(Save/Recall)
Trace + State	State_	(Save/Recall)
Screen	Screen_	(Save/Recall)
Amplitude Corrections	Ampcor_	(Import/Export)
Traces	Trace_	(Import/Export)
Limit Lines	LLine_	(Import/Export)
Measurement Result	MeasR_	(Import/Export)
Capture Buffer	CapBuf_	(Import/Export)

A four digit number is appended to the prefix to create a unique file name. The numbering sequence starts at 0000 within each Mode for each file type and updates incrementally to 9999, then wraps to 0000 again. It remembers where it was through a Mode Preset and when leaving and returning to the Mode. It is reset by Restore Misc Defaults and Restore System Defaults and subsequent running of the instrument application. So, for example, the first auto file name generated for State files is State_0000.state. The next is State_0001, and so forth.

One of the key features of Auto File Name is that we guarantee that the Auto File Name will never conflict with an existing file. The algorithm looks for the next available number. If it gets to 9999, then it looks for holes. If it find no holes, that is no more numbers are available, it gives an error.

For example, if when we get to State_0010.state there is already a State_0010.state file in the current directory, it advances the counter to State_0011.state to ensure that no conflict will exist (and then it verifies that State_0011.state also does not exist in the current directory and advances again if it does, and so forth).

If you enter a file name for a given file type, then the prefix becomes the filename you entered instead of the default prefix, followed by an underscore. The last four letters (the suffix) are the 4-digit number.

For example, if you save a measurement results file as “fred.csv”, then the next auto file name chosen for a measurement results save will be fred_0000.csv.

NOTE

Although 0000 is used in the example above, the number that is used is actually the current number in the Meas Results sequence, that is, the number that would have been used if you had not entered your own file name.

NOTE

If the filename you entered ends with _dddd, where d=any number, making it look just like an auto file name, then the next auto file name picks up where you left off with the suffix being dddd + 1.

Key Path	Front-panel key
Notes	No remote command for this key specifically.
Initial S/W Revision	Prior to A.02.00

Recall

In the MSR mode, two types of recall functions are available under the Data menu: Parameter Sets and Masks. Masks enables setting of a preset limit mask for Power Suite-based measurements, and currently it is available for the SEM, ACP and SPUR measurements in the MSR mode.

Key Path	Front Panel
Mode	MSR
Initial S/W Revision	A.10.00

State

The **Recall State** menu lets you choose a register or file from which to recall the state.

The content of a state file includes all of the settings and data required to return the analyzer as closely as possible to the Mode it was in, with the exact settings that were in place, when the save occurred. The Mode settings in each state file include the settings that are affected by Mode Preset, as well as the additional settings affected by Restore Mode Defaults; all of the Mode's settings. In addition, all of the settings of the **Input/Output** system are included, even though they are outside of the Mode's state, because they are needed to restore the complete setup. Persistent System settings (for example, GPIB address) are not affected by either a Mode Preset or Restore Mode Defaults, nor are they included in a saved State file.

Since each state file is only for one Mode, the settings for other Modes are unaffected when it is loaded. **Recall State** will cause a mode switch if the state being recalled is not from the current active mode.

After the recall completes, the message "File <filename> recalled" or "Recalled State Register <register number>" is displayed.

For rapid recalls, the State menu lists 16 registers that you can choose from to recall. Pressing a Register key initiates the recall. You can also select a file from which to recall.

The default path for all State Files is:

My Documents\<mode name>\state

where <mode name> is the parameter used to select the mode with the INST:SEL command (for example, SA for the Spectrum Analyzer).

See "[More Information](#)" on page 2431.

Key Path	Recall
Mode	All
Remote Command	:MMEMory:LOAD:STATe <filename>
Example	:MMEM:LOAD:STAT "myState.state" This recalls the file myState.state on the default path
Example	MMEM:LOAD:STAT "MyStateFile.state" This loads the state file data (on the default file directory path) into the instrument state.

Notes	<p>When you pick a file to recall, the analyzer first verifies that the file is recallable in the current instrument by checking the software version and model number of the instrument. If everything matches, a full recall proceeds by aborting the currently running measurement, clearing any pending operations, and then loading the State from the saved state file. You can open state files from any mode, so recalling a State file switches to the mode that was active when the save occurred. After switching to the mode of the saved state file, mode settings and data (if any for the mode) are loaded with values from the saved file. The saved measurement of the mode becomes the newly active measurement and the data relevant to the measurement (if there is any) is recalled.</p> <ul style="list-style-type: none"> • If there is a mismatch between file version or model number or instrument version or model number, the recall function tries to recall as much as possible and returns a warning message. It may limit settings that differ based on model number, licensing or version number. <p>After recalling the state, the Recall State function does the following:</p> <ul style="list-style-type: none"> • Makes the saved measurement for the mode the active measurement. • Clears the input and output buffers. • Status Byte is set to 0. • Executes a *CLS <p>If the file specified is empty an error is generated. If the specified file does not exist, another error is generated. If there is a mismatch between the file and the proper file type, an error is generated. If there is a mismatch between file version or model number or instrument version or model number, a warning is displayed. Then it returns to the State menu and File Open dialog goes away.</p> <p>After the Recall, the analyzer exits the Recall menu and returns to the previous menu.</p>
Backwards Compatibility SCPI	<pre>:MMEMory:LOAD:STATe 1,<filename></pre> <p>For backwards compatibility, the above syntax is supported. The "1" is simply ignored.</p>
Initial S/W Revision	Prior to A.02.00

More Information

In measurements that support saving Traces, for example, Swept SA, the Trace data is saved along with the State in the State file. When recalling the State, the Trace data is recalled as well. Traces are recalled exactly as they were stored, including the writing mode and update and display modes. If a Trace was updating and visible when the State was saved, it will come back updating and visible, and its data will be rewritten right away. When you use State to save and recall traces, any trace whose data must be preserved should be placed in View or Blank mode before saving.

The following table describes the Trace Save and Recall possibilities:

You want to recall state and one trace's data, leaving other traces unaffected.	Save Trace+State from 1 trace. Make sure that no other traces are updating (they should all be in View or Blank mode) when the save is performed.	On Recall, specify the trace you want to load the one trace's data into. This trace will load in View. All other traces' data will be unaffected, although their trace mode will be as it was when the state save was performed.
You want to recall all traces	Save Trace+State from ALL traces.	On Recall, all traces will come back in View (or Blank if they were in Blank or Background when

saved)

You want all traces to load exactly as they were when saved.

Save State

On recall, all traces' mode and data will be exactly as they were when saved. Any traces that were updating will have their data immediately overwritten.

From File...

When you press “From File”, the analyzer brings up a Windows dialog and a menu entitled “File Open.” This menu allows you to navigate to the various fields in the Windows dialog without using a keyboard or mouse. The **Tab** and **Arrow** keys can also be used for dialog navigation.

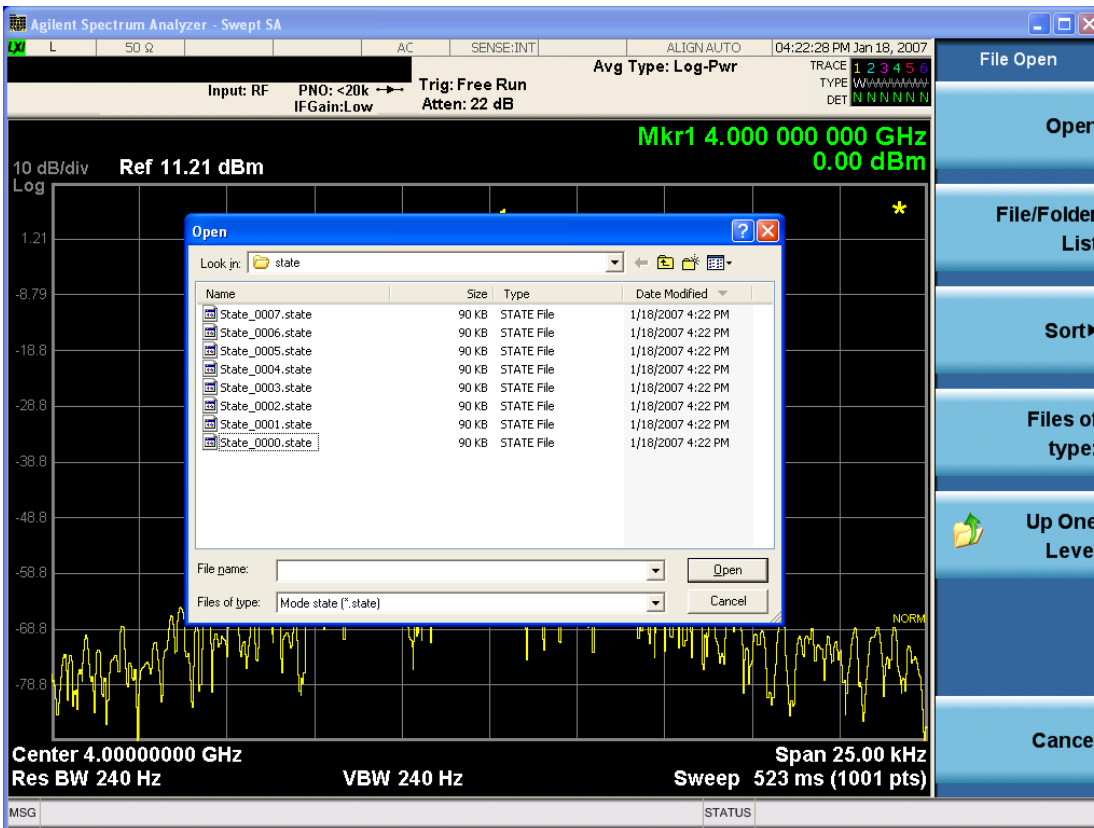

Listed below are the functions of the various fields in the dialog, and the corresponding softkeys:

Open

Performs the recall of the specified file. While the recall is being performed, the floppy icon appears briefly in the Meas bar.

File/Folder List

Enables you to navigate to the center of the dialog that contains the list of files and folders. Once here you can get information about the file and use the tab keys to navigate to the other fields in the dialog, such as Look In.

Look In

The **Look In** field shows the path from which the file will be recalled and allows you to change the path using the up and down arrow keys to navigate to other paths; the Enter key to open a directory; and the Backspace key to go back one directory. The **Look In field** first uses the last path from the Save As dialog **Save In:** path for that same file type. There is no softkey for directly navigating to the Look In field, but you can use the left tab to get here from the File/Folder List.

User specified paths are remembered when you leave and return to a Mode and are reset back to the default using **Restore Mode Defaults**.

Sort

Accesses a menu that enables you to sort the files within the File Open dialog. Only one sorting type can be selected at a time and the sorting happens immediately. The sorting types are **By Date, By Name, By extension, and By Size**.

Files of Type

This field shows the file suffix for the type of file you have selected to recall. For example, if you navigated here while recalling State, "Mode state (*.state)" is in the field. If you navigated here while recalling Trace, ""Mode state (*.trace)" is in the field. If you navigated here while importing a trace data file, "Trace Data (*.csv)" is in the field. For some file types, there is more than one choice in the dropdown menu, which you can select by using the up and down arrow keys and Enter.

Up One Level

This key corresponds to the icon of a folder with the up arrow that is in the tool bar of the dialog. When pressed, it causes the file and folder list to navigate up one level in the directory structure. The Backspace key does the same thing.

Cancel

This key corresponds to the **Cancel** selection in the dialog. It causes the current **Open** request to be cancelled. The ESC key does the same thing.

Key Path	Recall, State
Notes	Brings up the Open dialog for recalling a State Save Type
Initial S/W Revision	Prior to A.02.00

Edit Register Names

You may enter a custom name on any of the Register keys, to help you remember what you are using that state to save. To do this, press the **Edit Register Names** key, choose the register whose name you wish to edit, and then enter the desired label using the Alpha Editor or an external PC keyboard.

The maximum number of characters that can be added is 30. In most cases, 30 characters will fit on two lines of the key.

For more information and the SCPI command, see Edit Register Names under the **Save, State** function.

Key Path	Recall, State
Mode	All
Dependencies	N9060A-7FP or N9060B-2FP license required to edit the register names. When the feature is not licensed, sending the SCPI command generates an error, -221, "Settings conflict;Option not available"
Initial S/W Revision	A.11.00

Register 1 thru Register 16

Selecting any one of these register keys causes the State of the mode from the specified Register to be recalled. Each of the register keys annotates whether it is empty or at what date and time it was last modified. In addition, you can use the **Edit Register Names** key under **Save, State** to enter custom names for each register.

Registers are shared by all modes, so recalling from any one of the registers will cause a mode switch to the mode that was active when the save to the Register occurred.

Although these 16 registers are the only registers available from the front panel, there are 128 state registers available in the instrument. Registers 17-128 are only available from the SCPI interface, using the *RCL command.

After the recall completes, the message "Register <register number> recalled" appears in the message bar. If you are in the Spectrum Analyzer Mode, and you are recalling a register that was saved in the Spectrum Analyzer Mode, then after the recall, you will still be in the Recall Register menu. If the Recall causes you to switch modes, then after the Recall, you will be in the Frequency menu.

If a requested register is empty an error is generated.

Key Path	Recall, State
Example	*RCL 1
Range	1-16 from front panel, 1-128 from SCPI
Readback	Date and time with seconds resolution are displayed on the key OR A custom name of up to 30 characters entered using the Save, State,Edit Register Names key OR "(empty)" if no prior save operation has been performed to this register.
Initial S/W Revision	Prior to A.02.00
Modified at S/W Revision	Prior to A.11.00

Register 1 thru Register 16

Selecting any one of these register keys causes the State of the mode from the specified Register to be recalled. Each of the register keys annotates whether it is empty or at what date and time it was last

modified. In addition, you can use the **Edit Register Names** key under **Save, State** to enter custom names for each register.

Registers are shared by all modes, so recalling from any one of the registers will cause a mode switch to the mode that was active when the save to the Register occurred.

Although these 16 registers are the only registers available from the front panel, there are 128 state registers available in the instrument. Registers 17–128 are only available from the SCPI interface, using the *RCL command.

After the recall completes, the message "Register <register number> recalled" appears in the message bar. If you are in the Spectrum Analyzer Mode, and you are recalling a register that was saved in the Spectrum Analyzer Mode, then after the recall, you will still be in the Recall Register menu. If the Recall causes you to switch modes, then after the Recall, you will be in the Frequency menu.

If a requested register is empty an error is generated.

Key Path	Recall, State
Example	*RCL 1
Range	1–16 from front panel, 1–128 from SCPI
Readback	Date and time with seconds resolution are displayed on the key OR A custom name of up to 30 characters entered using the Save, State,Edit Register Names key OR “(empty)” if no prior save operation has been performed to this register.
Initial S/W Revision	Prior to A.02.00
Modified at S/W Revision	Prior to A.11.00

Data (Import)

Importing a data file loads data that was previously saved from the current measurement or from other measurements and/or modes that produce compatible data files. The Import Menu only contains Data Types that are supported by the current measurement.

Since the commonly exported data files are in .csv format, the data can be edited by the user prior to importing. This allows you to export a data file, manipulate the data in Excel (the most common PC Application for manipulating .csv files) and then import it.

Importing Data loads measurement data from the specified file into the specified or default destination, depending on the data type selected. Selecting an Import Data menu key will not actually cause the importing to occur, since the analyzer still needs to know from where to get the data. Pressing the Open key in this menu brings up the Open dialog and Open menu that provides you with the options from where to recall the data. Once a filename has been selected or entered in the Open menu, the recall occurs as soon as the Open button is pressed.

Key Path	Recall
Mode	All

Notes	The menu is built from whatever data types are available for the mode. Some keys will be missing completely, so the key locations in the sub-menu will vary. No SCPI command directly controls the Data Type that this key controls. The Data Type is included in the MMEM:LOAD commands.
Dependencies	If a file type is not used by a certain measurement, it is grayed out for that measurement. The key for a file type will not show at all if there are no measurements in the Mode that support it.
Preset	Is not affected by Preset or shutdown, but is reset during Restore Mode Defaults
Readback	The data type that is currently selected
Initial S/W Revision	Prior to A.02.00

Parameter Set

Enables you to import format parameter set data to specified format parameter sets. Selecting this key displays a menu that enables you to select the destination parameter set. After making this selection, depress Open... and use the file dialog to select the file you wish to recall.

Supported import file formats are dependent on radio formats.

LTE FDD: Format Parameter Set Files (*.fps), LTE FDD app state files (*.state), 89601 VSA Setup Files (*.set, *.setx) and Signal Studio Setup Files (*.scp)

W-CDMA:Format Parameter Set Files (*.fps) and W-CDMA app state files (*.state)

GSM/EDGE:Format Parameter Set Files (*.fps) and GSM/EDGE app state files (*.state)

cdma2000:Format Parameter Set Files (*.fps) and cdma2000 app state files (*.state)

1xEV-DO:Format Parameter Set Files (*.fps) and 1xEV-DO app state files (*.state)

LTE TDD: Format Parameter Set Files (*.fps), LTE TDD app state files (*.state), 89601 VSA Setup Files (*.set, *.setx) and Signal Studio Setup Files (*.scp)

TD-SCDMA:Format Parameter Set Files (*.fps) and TD-SCDMA app state files (*.state)

Format Parameter Set Files

Extention: fps

Basic file type of format parameter set. This file contains a format parameter set exported using Parameter Set under Recall, Data (Export). It is imported if the radio format of the file matches the destination radio format. If not, an error message, -230 "Data corrupt or stale", is issued with the specified file name.

App State Files

Extention: state

The state file of each mode can be imported to the corresponding parameter set. If the mode name in the state file matches the selected destination format, the state file data are imported. If not, an error message, -230 "Data corrupt or stale", is issued with the specified file name.

The parameters to be imported are ones referred in a particular measurement of each mode. The relevant measurements are listed below.

LTE FDD: Modulation Analysis

W-CDMA: Mod Accuracy

GSM/EDGE: EDGE EVM

cdma2000: Mod Accuracy

1xEV-DO: Mod Accuracy

LTE TDD: Modulation Analysis

TD-SCDMA: Mod Accuracy

Note that Integ BW and Measurement Noise BW parameters of ACP, SEM and CHP are not imported.

89601 VSA Setup Files

Extention: set, setx

The 89600 Vector Signal Analyzer Setup file created using the 89600 Vector Signal Analyzer Option BHD (LTE FDD)/Option BHE (LTE TDD) can be imported as LTE FDD/LTE TDD parameter set. If the setup file is not loaded successfully, an error message, -230 “Data corrupt or stale”, is issued with the specified file name.

Signal Studio Setup Files

Extention: scp

The Keysight Signal Studio setup file created using Signal Studio (N7624B/N7625B) can be imported as LTE FDD/LTE TDD parameter set. Supported carrier types are listed in the table below:

<i>Signal Studio</i>	<i>Carrier Type</i>
N7624B Signal Studio for 3GPP LTE	Advanced LTE FDD Downlink (2009-03)
	Advanced LTE FDD Downlink (2009-12)
	Advanced LTE FDD Downlink (2010-06)
	Advanced LTE FDD Uplink (2009-12)
	Advanced LTE FDD Uplink (2010-06)
	Basic LTE FDD Downlink (2009-03)
	Basic LTE FDD Downlink (2009-12)
	Basic LTE FDD Downlink (2010-06)
	Basic LTE FDD Uplink (2009-03)
	Basic LTE FDD Uplink (2009-12)
	Basic LTE FDD Uplink (2010-06)
N7625B Signal Studio for 3GPP LTE TDD	Advanced LTE TDD (2009-03)
	Advanced LTE TDD (2009-12)
	Basic LTE TDD (2009-03)
	Basic LTE TDD (2009-12)
	Advanced LTE TDD R9

Basic LTE TDD R9 PRACH

If the setup file is not loaded successfully, an error message, -230 “Data corrupt or stale”, is issued with the specified file name.

Default path of this import type is “My Documents\MSR\data\params” folder. Note that “**My Documents**” is an alias to a directory and its location depends on which user is logged in. If the file path is specified without root folder, the import file is determined with the default path. For example if “folder1\paramData.prms” is specified, “My Documents\MSR\data\params\folder1\paramData.prms” is imported.

File Dialog Filter

Since supported import file formats differ between radio formats, file filters available in the open file dialog vary depending on the selected radio format. This table below defines file name filters available for each format.

<i>Radio Format</i>	<i>File Name Filters</i>
LTE FDD	All Supported Format Parameter Setup Files (*.fps; *.state; *.set; *.setx; *.scp) Format Parameter Setup Files (*.fps) State Files (*.state) 89601 VSA Setup Files (*.set; *.setx) Signal Studio Setup Files (*.scp)
W-CDMA	All Supported Format Parameter Setup Files (*.fps; *.state) Format Parameter Setup Files (*.fps) W-CDMA State Files (*.state)
GSM/EDGE	All Supported Format Parameter Setup Files (*.fps; *.state) Format Parameter Setup Files (*.fps) State Files (*.state)
cdma2000	All Supported Format Parameter Set Files (*.fps; *.state) Format Parameter Set Files (*.fps) State Files (*.state)
1xEV-DO	All Supported Format Parameter Set Files (*.fps; *.state) Format Parameter Set Files (*.fps) State Files (*.state)
LTE TDD	All Supported Format Parameter Setup Files (*.fps; *.state; *.set; *.setx; *.scp) Format Parameter Setup Files (*.fps) State Files (*.state) 89601 VSA Setup Files (*.set; *.setx) Signal Studio Setup Files (*.scp)
TD-SCDMA	All Supported Format Parameter Set Files (*.fps; *.state) Format Parameter Set Files (*.fps) State Files (*.state)

Key Path	Recall, Data
Mode	MSR
Remote Command	MMEMoRY:LOAD:PSET LTEFdd1 LTEFdd2 LTEFdd3 WCDMa1 WCDMa2 WCDMa3 GSM1 GSM2 GSM3 CDMA1 CDMA2 CDMA3 EVDO1 EVDO2 EVDO3 LTETdd1 LTETdd2 LTETdd3 TDSCdma1 TDSCdma2 TDSCdma3, <string>
Example	MMEM:LOAD:PSET LTEF1,"LTE FDD.set"
Notes	The first enum selects the destination format parameter set to which the file data are imported.
Initial S/W Revision	A.10.00
Modified at S/W Revision	A.12.00, A.16.00

Masks

This key enables you to recall a preset mask file which contains Offset and Limit settings. Parameters except them will not be overwritten. You cannot change or create preset mask files since they are binary files. This key is valid for the Spectrum Emission Mask, ACP and Spurious Emissions measurements.

Default path: "My Documents\MSR\data\masks"

Note that "**My Documents**" is an alias to a directory and its location depends on which user is logged in. At XSA start up, all of the limit mask files in the current user's "My Documents\MSR\data\masks" directory are overwritten.

File type: Binary

Filename: The filename follows the rule below with the words connected using underscores.

<Measurement>_<Condition>.mask

Where

<Measurement> Measurement the limit mask file is applied to: SEM, ACP or SPUR

<Condition> Condition. It depends on the measurement.

File extension: .mask

File Dialog Filter: Preset Mask Files (*.mask)

Selecting OPEN... under the Import Data menu opens the above directory enabling you to select a mask file.

Details of the masks are provided in a PDF file in the default folder of masks.

Key Path	Recall, Data
Mode	MSR
Remote Command	MMEMoRY:LOAD:MASK <string>
Example	MMEM:LOAD:MASK "ACP_BS\ACP_BS_3MHz_pairE-UTRA_CatA.mask"

Notes	Parameters related to Limit and Offset are overwritten by the contents of the preset mask file.
Initial S/W Revision	A.10.00

Open...

When you press “Open”, the analyzer brings up a Windows dialog and a menu entitled “**File Open.**” This menu allows you to navigate to the various fields in the Windows dialog without using a keyboard or mouse. The **Tab** and **Arrow** keys can also be used for dialog navigation.

See "[From File...](#)" on page 2454 in **Recall, State**, for a full description of this dialog and menu.

Key Path	Recall, Data
Notes	The key location is mode-dependent and will vary. Brings up Open dialog for recalling a <mode specific> Save Type
Initial S/W Revision	Prior to A.02.00

Restart

The Restart function restarts the current sweep, or measurement, or set of averaged/held sweeps or measurements. If you are Paused, pressing Restart does a Resume.

The Restart function is accessed in several ways:

- Pressing the Restart key
- Sending the remote command INIT:IMMEDIATE
- Sending the remote command INIT:RESTART

See "[More Information](#)" on page 2441

Key Path	Front-panel key
Remote Command	:INITiate[:IMMEDIATE] :INITiate:RESTART
Example	:INIT:IMM :INIT:REST
Notes	:INITiate:RESTART and :INITiate:IMMEDIATE perform exactly the same function.
Couplings	Resets average/hold count k. For the first sweep overwrites all active (update=on) traces with new current data. For application modes, it resets other parameters as required by the measurement.
Status Bits/OPC dependencies	This is an Overlapped command. The STATUS:OPERation register bits 0 through 8 are cleared. The STATUS:QUESTIONable register bit 9 (INTEgrity sum) is cleared. The SWEEPING bit is set. The MEASURING bit is set.
Backwards Compatibility Notes	For Spectrum Analysis mode in ESA and PSA, the Restart hardkey and the INITiate:RESTART command restart trace averages (displayed average count reset to 1) for a trace in Clear Write , but did not restart Max Hold and Min Hold . In the X-Series, the Restart hardkey and the INITiate:RESTART command restart not only Trace Average , but MaxHold and MinHold traces as well. For wireless comms modes in ESA and PSA, the Restart hardkey and the INITiate:RESTART command restart every measurement, which includes all traces and numeric results. There is no change to this operation.
Initial S/W Revision	Prior to A.02.00

More Information

The **Restart** function first aborts the current sweep/measurement as quickly as possible. It then resets the sweep and trigger systems, sets up the measurement and initiates a new data measurement sequence with a new data acquisition (sweep) taken once the trigger condition is met.

If the analyzer is in the process of aligning when **Restart** is executed, the alignment finishes before the restart function is performed.

Even when set for Single operation, multiple sweeps may be taken when Restart is pressed (for example, when averaging/holding is on). Thus when we say that **Restart** "restarts a measurement," we may mean:

- It restarts the current sweep
- It restarts the current measurement
- It restarts the current set of sweeps if any trace is in Trace Average, Max Hold or Min Hold
- It restarts the current set of measurements if Averaging, or Max Hold, or Min Hold is on for the measurement
- depending on the current settings.

With **Average/Hold Number** (in **Meas Setup** menu) set to 1, or Averaging off, or no trace in Trace Average or Hold, a single sweep is equivalent to a single measurement. A single sweep is taken after the trigger condition is met; and the analyzer stops sweeping once that sweep has completed. However, with **Average/Hold Number** > 1 and at least one trace set to **Trace Average, Max Hold, or Min Hold (SA Measurement)** or **Averaging on (most other measurements)**, multiple sweeps/data acquisitions are taken for a single measurement. The trigger condition must be met prior to each sweep. The sweep is stopped when the average count k equals the number N set for **Average/Hold Number**. A measurement average usually applies to all traces, marker results, and numeric results; but sometimes it only applies to the numeric results.

Once the full set of sweeps has been taken, the analyzer will go to idle state. To take one more sweep without resetting the average count, increment the average count by 1, by pressing the step up key while **Average/Hold Number** is the active function, or sending the remote command **CALC:AVR:TCON UP**.

Save

In the MSR mode, two types of save functions are available under the Data menu: Parameter Sets and Meas Results.

Key Path	Front Panel
Mode	MSR
Initial S/W Revision	Prior to A.10.00
Modified at S/W Revision	A.10.00

State

The Save State menu lets you choose a register or file for saving the state.

The content of a state file includes all of the settings and data required to return the analyzer as closely as possible to the Mode it was in, with the exact settings which were in place, when the save occurred. The Mode settings in each state file include the settings that are affected by Mode Preset, as well as the additional settings affected by Restore Mode Defaults; all of the Mode's settings. In addition, all of the settings of the **Input/Output** system are included, even though they are outside of the Mode's state, because they are needed to restore the complete setup. Persistent **System** settings (for example, Verbose SCPI) are not affected by either Mode Preset or Restore Mode Defaults, nor are they included in a saved State file.

After the save completes, the message "File <filename> saved" or "State Register <register number> saved" is displayed.

For rapid saving, the State menu lists 16 registers to save to. Pressing a Register key initiates the save. You can also select a file to save to.

The default path for all State Files is:

My Documents\<<mode name>\state

where <mode name> is the parameter used to select the mode with the INST:SEL command (for example, SA for the Spectrum Analyzer).

Key Path	Save
Mode	All
Remote Command	:MMEMory:STORe:STATe <filename>
Example	MMEM:STOR:STATe "MyStateFile.state" This stores the current instrument state data in the file MyStateFile.state in the default directory.
Notes	Both single and double quotes are supported for any filename parameter over remote. After saving to a register, that register's menu key is updated with the date the time, unless a custom label has been entered for that key. After saving to a register, you remain in the Save State menu, so that you can see the Register key update. After saving to a file, the analyzer automatically returns to the previous menu and any Save As dialog goes away.

Backwards Compatibility SCPI	:MMEMory:STORE:STATE 1,<filename> For backwards compatibility, the above syntax is supported. The "1" is simply ignored. The command is sequential.
Initial S/W Revision	Prior to A.02.00

To File . . .

When you press “To File”, the analyzer brings up a Windows dialog and a menu entitled “Save As.” This menu allows you to navigate to the various fields in the Windows dialog without using a keyboard or mouse. The **Tab** and **Arrow** keys can also be used for dialog navigation.

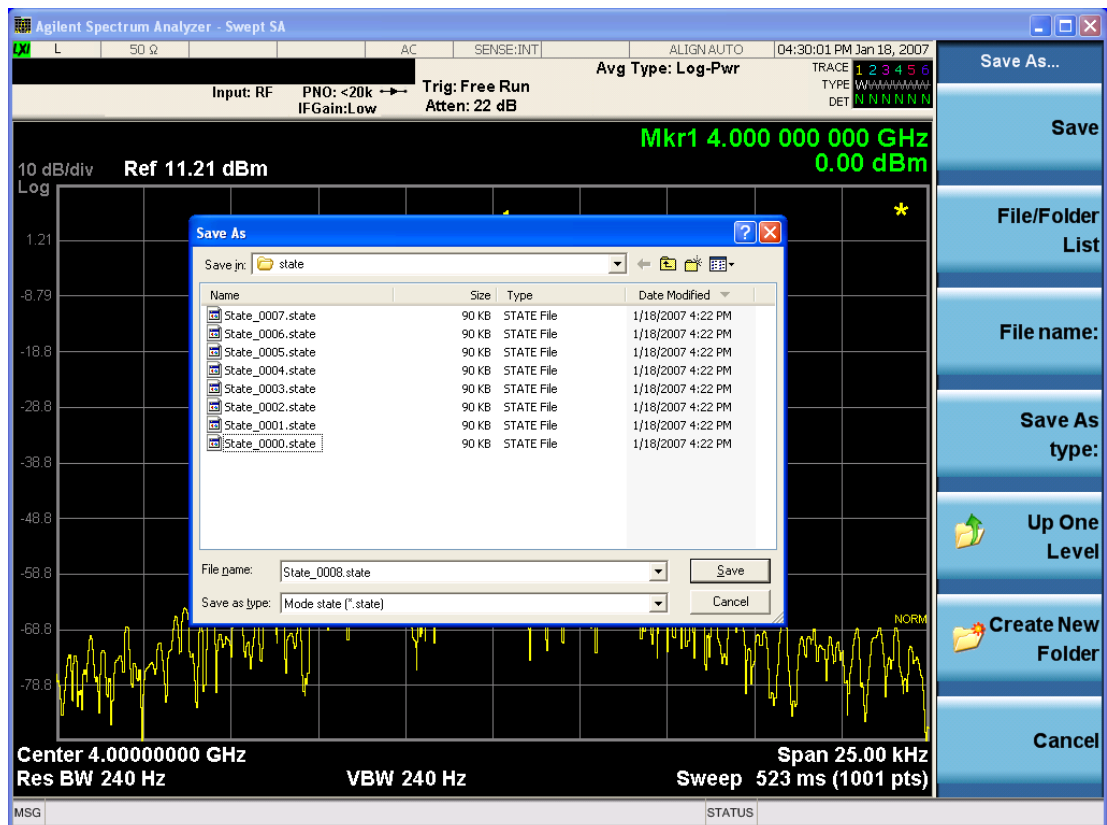

The Listed below

are the functions of the various fields in the dialog, and the corresponding softkeys:

Save

Performs the save to the specified file of the selected type. If the file already exists, a dialog will appear that allows you to replace the existing file by selecting **OK**, or you can Cancel the request. If you select OK, the file will be overwritten. Using the C: drive is strongly discouraged, since it runs the risk of being overwritten during an instrument software upgrade.

While the save is being performed, the floppy icon appears briefly in the Meas bar.

File/Folder List

Enables you to navigate to the center of the dialog that contains the list of files and folders. Once here you can get information about the file and use the tab keys to navigate to the other fields in the dialog, such as Save In.

Save In

The Save In field shows the path to which the file will be saved and allows you to change the path using the up and down arrow keys to navigate to other paths; the Enter key to open a directory; and the Backspace key to go back one directory. The **Save In field** defaults to the default path for this type of file and remembers the last path you used to save this type of file. There is no softkey for directly navigating to the Save In field but you can use left tab to get here from the File/Folder List.

User specified paths are remembered when you leave and return to a Mode and are reset back to the default using **Restore Mode Defaults**.

File Name

The **File Name** field is initially loaded with an automatically generated filename specific to the appropriate Save Type. The automatically generated filename is guaranteed not to conflict with any filename currently in the directory. You may replace or modify this filename using the File Name key. See the "[Quick Save](#)" on [page 2428](#) documentation for more on the automatic file naming algorithm.

When you press the **File Name** key the analyzer displays the Alpha Editor. Use the knob to choose the letter to add and the front-panel Enter key to add the letter to the file name. The BK character moves you back and the FW character moves you forward in the filename. The Select key on the front panel generates a space character. When you are done entering the filename press the **Done** softkey. This returns back to the **File Open** dialog and menu, but does not cause the save to occur.

Save As Type

This field shows the file suffix for the type of file you have selected to save. For example, if you navigated here while saving State, "Mode state (*.state)" is in the field. If you navigated here from saving Trace, ""Mode state (*.trace)" is in the field. If you navigated here while exporting a trace data file, "Trace Data (*.csv)" is in the field. For some file types, there is more than one choice in the dropdown, which you can select by using the up and down arrow keys and Enter.

Up One Level

This key corresponds to the icon of a folder with the up arrow that is in the tool bar of the dialog. When pressed, it causes the file and folder list to navigate up one level in the directory structure. The Backspace key does the same thing.

Create New Folder

This key corresponds to the icon of a folder with the "*" that is in the tool bar of the dialog. When pressed, a new folder is created in the current directory with the name **New Folder** and you can enter a new folder name using the Alpha Editor.

Cancel

This key corresponds to the **Cancel** selection in the dialog. It causes the current **Save As** request to be cancelled. The ESC key does the same thing.

Key Path	Save, State
----------	-------------

Mode	All
Notes	Brings up Save As dialog for saving a State Save Type
Initial S/W Revision	Prior to A.02.00

Edit Register Names

You may enter a custom name on any of the Register keys, to help you remember what you are using that state to save. To do this, press the **Edit Register Names** key, choose the register whose name you wish to edit, and then enter the desired label using the Alpha Editor or an external PC keyboard.

The maximum number of characters that can be added is 30. In most cases, 30 characters will fit on two lines of the key.

See ["More Information" on page 2446](#)

Key Path	Save, State
Mode	All
Remote Command	:MMEMory:REGister:STATe:LABel <reg number>,"label" :MMEMory:REGister:STATe:LABel? <reg number>
Example	:MMEM:REG:STAT:LAB 1,"my label"
Notes	<reg number> is an integer from 1 to 16. If the SCPI specifies an invalid register number an error message is generated, -222,"Data out of range;Invalid register label number" "label" is a string from 0 to 30 characters in length. If a label exceeds 30 characters, an error message is generated, -150,"String data error;Label clipped to 30 characters" "label" of length 0 erases the custom label and restores the default (time and date) label. E.g.: :MMEM:REG:STAT:LAB 1,""
Dependencies	N9060A-7FP or N9060B-2FP license required to edit the register names. When the feature is not licensed, sending this command generates an error, -221,"Settings conflict;Option not available"
Preset	The names are unaffected by Preset or power cycle but are set to the default label (time and date) on a "Restore System Defaults->Misc"
Initial S/W Revision	A.11.00

More Information

When you edit one of the register names, the time and date field will be replaced by the custom name.

If you delete all the characters in the custom name, it restores the default (time and date).

The register names are stored within the state files, but they are not part of the instrument state; that is, once you have edited a register name, loading a new state will not change that register name. Another consequence of this is that the names will be persistent through a power cycle. Also, if a named state file is transferred to another analyzer, it will bring its custom name along with it.

If you try to edit the name of an empty register, the analyzer will first save the state to have a file to put the name in. If you load a named state file into an analyzer with older firmware it will ignore the metadata.

The *SAV and *RCL commands will not be affected by the custom register names, nor will the MMEM commands.

Register 1 thru Register 16

Selecting any one of these register menu keys causes the State of the currently active mode to be saved to the specified Register. The registers are provided for rapid saving and recalling, since you do not need to specify a filename or navigate to a file. Each of the register menu keys annotates whether it is empty or at what date and time it was last modified. In addition, you can use the **Edit Register Names** key to enter custom names for each register.

Although these 16 registers are the only registers available from the front panel, there are 128 state registers available in the instrument. Registers 17–128 are only available from the SCPI interface, using the *SAV command.

There is one set of 128 state registers in the instrument, not one set for each Mode. When a state is saved, the Mode it was saved from is saved with it; then when it is recalled, the instrument switches to that Mode.

After the save completes, the corresponding register menu key annotation is updated with the date and time and the message "Register <register number> saved" is displayed.

Key Path	Save, State
Mode	All
Example	*SAV 1
Range	1–16 from front panel, 1–128 from SCPI
Readback	Date and time with seconds resolution are displayed on the key OR A custom name of up to 30 characters entered using the Edit Register Names key OR “(empty)” if no prior save operation has been performed to this register.
Initial S/W Revision	Prior to A.02.00
Modified at S/W Revision	A.11.00

Register 1 thru Register 16

Selecting any one of these register menu keys causes the State of the currently active mode to be saved to the specified Register. The registers are provided for rapid saving and recalling, since you do not need to specify a filename or navigate to a file. Each of the register menu keys annotates whether it is empty or at what date and time it was last modified. In addition, you can use the **Edit Register Names** key to enter custom names for each register.

Although these 16 registers are the only registers available from the front panel, there are 128 state registers available in the instrument. Registers 17–128 are only available from the SCPI interface, using the *SAV command.

There is one set of 128 state registers in the instrument, not one set for each Mode. When a state is saved, the Mode it was saved from is saved with it; then when it is recalled, the instrument switches to that Mode.

After the save completes, the corresponding register menu key annotation is updated with the date and time and the message "Register <register number> saved" is displayed.

Key Path	Save, State
Mode	All
Example	*SAV 1
Range	1-16 from front panel, 1-128 from SCPI
Readback	Date and time with seconds resolution are displayed on the key OR A custom name of up to 30 characters entered using the Edit Register Names key OR “(empty)” if no prior save operation has been performed to this register.
Initial S/W Revision	Prior to A.02.00
Modified at S/W Revision	A.11.00

Mass Storage Catalog (Remote Command Only)

Key path	SCPI Only
Remote Command	:MMEMory:CATalog? [<directory_name>]
Notes	The string must be a valid logical path. Queries disk usage information (drive capacity, free space available) and obtains a list of files and directories in a specified directory in the following format: <numeric_value>,<numeric_value>,{<file_entry>} It returns two numeric parameters and as many strings as there are files and directories. The first parameter indicates the total amount of storage currently used in bytes. The second parameter indicates the total amount of storage available, also in bytes. The <file_entry> is a string. Each <file_entry> indicates the name, type, and size of one file in the directory list: <file_name>,<file_type>,<file_size> As the windows file system has an extension that indicates file type, <file_type> is always empty. <file_size> provides the size of the file in bytes. For directories, <file_entry> is surrounded by square brackets and both <file_type> and <file_size> are empty
Initial S/W Revision	Prior to A.02.00

Mass Storage Change Directory (Remote Command Only)

Key path	SCPI Only
Remote Command	:MMEMory:CDIRectory [<directory_name>] :MMEMory:CDIRectory?
Notes	The string must be a valid logical path. Changes the default directory for a mass memory file system. The <directory_name> parameter is a string. If no parameter is specified, the directory is set to the *RST value.

	At *RST, this value is set to the default user data storage area, that is defined as System.Environment.SpecialFolder.Personal. Query returns full path of the default directory.
Initial S/W Revision	Prior to A.02.00

Mass Storage Copy (Remote Command Only)

Key path	SCPI Only
Remote Command	:MMEMory:COpy <string>,<string>[,<string>,<string>]
Notes	<p>The string must be a valid logical path.</p> <p>Copies an existing file to a new file or an existing directory to a new directory.</p> <p>Two forms of parameters are allowed. The first form has two parameters. In this form, the first parameter specifies the source, and the second parameter specifies the destination.</p> <p>The second form has four parameters. In this form, the first and third parameters specify the source. The second and fourth parameters specify the directories. The first pair of parameters specifies the source. The second pair specifies the destination. An error is generated if the source doesn't exist or the destination file already exists.</p> <p>This command will generate an "access denied" error if the destination is a restricted folder (e.g., C:\Windows) and the current user does not have Power User or Administrator privileges.</p>

Mass Storage Device Copy (Remote Command Only)

This command transfers data to/from a file and a peripheral device.

Key path	SCPI Only
Remote Command	:MMEMory:COpy:DEvice <source_string>,<dest_string>
Notes	<p>The strings must be a valid logical path or a valid device keyword. If the dest_string is a device keyword, the data is copied from the source file to the device. If the source_string is a device keyword, the data is copied to the source file from the device.</p> <p>Valid device keywords are:</p> <p>SNS (smart noise source)</p> <p>An error is generated if the file or device is not found.</p>

Mass Storage Delete (Remote Command Only)

Key path	SCPI Only
Remote Command	:MMEMory:DElete <file_name>[,<directory_name>]
Notes	<p>The string must be a valid logical path.</p> <p>Removes a file from the specified directory. The <file_name> parameter specifies the file name to be removed. This command will generate an "access denied" error if the file is in a restricted folder (e.g.,</p>

	C:\Windows) and the current user does not have Power User or Administrator privileges.
Initial S/W Revision	Prior to A.02.00

Mass Storage Data (Remote Command Only)

Creates a file containing the specified data OR queries the data from an existing file.

Key path	SCPI Only
Remote Command	:MMEMory:DATA <file_name>, <data> :MMEMory:DATA? <file_name>
Notes	The string must be a valid logical path. The command form is MMEMory:DATA <file_name>,<data>. It loads <data> into the file <file_name>. <data> is in 488.2 block format. <file_name> is string data. The query form is MMEMory:DATA? <file_name> with the response being the associated <data> in block format.
Initial S/W Revision	Prior to A.02.00

Mass Storage Make Directory (Remote Command Only)

Key path	SCPI Only
Remote Command	:MMEMory:MDIRectory <directory_name>
Notes	The string must be a valid logical path. Creates a new directory. The <directory_name> parameter specifies the name to be created. This command will generate an “access denied” error if the new directory would be in a restricted folder (e.g., C:\Windows) and the current user does not have Power User or Administrator privileges.
Initial S/W Revision	Prior to A.02.00

Mass Storage Move (Remote Command Only)

Key path	SCPI Only
Remote Command	:MMEMory:MOVE <string>,<string>[,<string>,<string>]
Notes	The string must be a valid logical path. Moves an existing file to a new file or an existing directory to a new directory. Two forms of parameters are allowed. The first form has two parameters. In this form, the first parameter specifies the source, and the second parameter specifies the destination. The second form has four parameters. In this form, the first and third parameters specify the source. The second and fourth parameters specify the directories. The first pair of parameters specifies the source. The second pair specifies the destination. An error is generated if the source doesn't exist or the destination file already exists.

This command will generate an “access denied” error if the destination is a restricted folder (e.g., C:\Windows) and the current user does not have Power User or Administrator privileges.

Initial S/W Revision Prior to A.02.00

Mass Storage Remove Directory (Remote Command Only)

Key path **SCPI Only**

Remote Command :MMEMory:RDIrectory <directory_name>

Notes The string must be a valid logical path.

Removes a directory. The <directory_name> parameter specifies the directory name to be removed. All files and directories under the specified directory shall also be removed.

This command will generate an “access denied” error if the folder is a restricted folder (e.g., C:\Windows) or is in a restricted folder and the current user does not have Power User or Administrator privileges.

Initial S/W Revision Prior to A.02.00

Mass Storage Determine Removable Media (Remote Command Only)

This command is used to determine if any removable media devices are connected to the instrument. Primarily, these are USB memory devices plugged-in to the front panel or rear panel USB ports. On instruments with PC6 or PC7 CPU's, one SD card slot is available for removable media. The instrument's primary disk drive is not a removable media device.

Key Path **SCPI Only**

Remote Command :MMEMory:RMEDia:LIST?

Notes The return value will be a string containing a list of partition identifiers which are removable media devices. Each identifier will be separated by a comma. If no removable media is present, an empty string will be returned.

Examples:

One removable device present will result in a return string of “F:”.

Two removable devices present will result in a return string of “F:,G:”.

No removable devices present will result in a return string of “”.

Initial S/W Revision x.15.00

Mass Storage Determine Removable Media Label (Remote Command Only)

This command is used to set or query a removable media device's label.

Key Path **SCPI Only**

Remote Command	:MMEMory:RMEDia:LABel <partition>,<string> :MMEMory:RMEDia:LABel? <partition>
Example	MMEM:RMED:LAB "F:","My Device"
Notes	If the <partition> specified does not exist or is not a removable media device the error -252,"Missing Media" will be generated. Setting the removable media label requires Administrative privileges. If the currently logged in user does not have appropriate privileges the error "-221.9900,Settings conflict;Administrator privileges required" is generated.
Initial S/W Revision	x.15.00

Mass Storage Determine Removable Media Write-protect status (Remote Command Only)

This command is used to query a removable media device's write-protect status.

Key Path	SCPI Only
Remote Command	:MMEMory:RMEDia:WPRotect? <partition>
Example	MMEM:RMED:WPR? "F:"
Notes	The return value is 1 if the device is write-protected, and 0 if the device is write-enabled. If the <partition> specified does not exist or is not a removable media device the error -252,"Missing Media" will be generated.
Preset	The return value will be depending on SD card installed.
Initial S/W Revision	x.15.00

Mass Storage Determine Removable Media size (Remote Command Only)

This command is used to query a removable media device's total memory size (not available memory size).

Key Path	SCPI Only
Remote Command	:MMEMory:RMEDia:SIZE? <partition>
Example	MMEM:RMED:SIZE? "F:"
Notes	The return value is integer value in GBytes. Any device which is less than 1 GB will return 0 GB. If the <partition> specified does not exist or is not a removable media device the error -252,"Missing Media" will be generated.
Initial S/W Revision	x.15.00

Trace (+State)

The **Save Trace (+State)** menu lets you choose a register or file specifying where to save the Trace+State state file.

A saved state contains all of the settings and data required to return the analyzer as closely as possible to the exact setup it had when the save occurred. This includes the Input/Output settings, even though they are outside of the Mode's state, because they are needed to restore the complete setup. A Trace+State file also includes trace data from one trace or all traces, which will load in View mode when the Trace+State file is recalled.

After the save completes, the message "File <filename> saved" or "Trace Register <register number> saved" is displayed.

For rapid saves, the Trace (+State) menu lists 5 registers to save to. Pressing a Register key initiates the save. You can also select a file to save to.

The default path for all State Files including .trace files is:

My Documents\<mode name>\state

where <mode name> is the parameter used to select the mode with the INST:SEL command (for example, Basic for the IQAnalyzer).

This key is grayed out for measurements that do not support trace saves. It is blanked for modes that do not support trace saves. Saving **Trace** is identical to saving State except a .trace extension is used on the file instead of .state, and internal flags are set in the file indicating which trace was saved. You may select to save one trace or ALL traces.

Key Path	Save
Mode	SA
Remote Command	:MMEMory:STORe:TRACe TRACE1 TRACE2 TRACE3 TRACE4 TRACE5 TRACE6 ALL,<filename> :MMEMory:STORe:TRACe:REGister TRACE1 TRACE2 TRACE3 TRACE4 TRACE5 TRACE6 ALL,<integer>
Example	:MMEM:STOR:TRAC TRACE1, "myState.trace" saves the file myState.trace on the default path and flags it as a "single trace" file with Trace 1 as the single trace (even though all of the traces are in fact stored). :MMEM:STOR:TRAC ALL, "myState.trace" saves the file myState.trace on the default path and flags it as an "all traces" file :MMEM:STOR:TRAC:REG TRACE1, 2 stores trace 1 data in trace register 2
Notes	This command actually performs a save state, which in the Swept SA measurement includes the trace data. However it flags it (in the file) as a "save trace" file of the specified trace (or all traces). Some modes and measurements do not have available all 6 traces. The Phase Noise mode command, for example, is: MMEMory:STORe:TRACe TRACE1 TRACE2 TRACE3 ALL,<filename> Some modes and measurements have more than 6 traces available. The Realtime SA mode command, for example, is: MMEMory:STORe:TRACe TRACE1 TRACE2 TRACE3 TRACE4 TRACE5 TRACE6 TRACE7 TRACE8 TRACE9 TRACE10 TRACE11 TRACE12 ALL,<filename> The range for the register parameter is 1-5 When you initiate a save, if the file already exists, a dialog will appear that allows you to replace the existing file by selecting OK or you can Cancel the request. If you select OK, the file will be overwritten. Using the C: drive is strongly discouraged, since it runs the risk of being overwritten during an instrument software upgrade. Both single and double quotes are supported for any filename parameter over remote.

After saving to a register, that register's menu key is updated with the date and time of the save.
After saving to a register, you remain in the **Save Trace** menu, so that you can see the Register key update. After saving to a file, the analyzer automatically returns to the previous menu and any Save As dialog goes away.

Initial S/W Revision	Prior to A.02.00
----------------------	------------------

From Trace

Accesses a menu that enables you to select the trace to be saved. Once a trace is selected, the key returns to the Save Trace menu and the selected trace number is annotated on the key. The default is the currently selected trace, selected in this menu or in the Trace/Det, Export Data, Import Data or Recall Trace menus, except if you have chosen All then it remains chosen until you specifically change it to a single trace. To save the Trace you must select the **Save As** key in the Save Trace menu.

When you select a trace, it makes that trace the current trace, so it displays on top of all of the other traces.

Key Path	Save, Trace + State
Mode	SA
Initial S/W Revision	Prior to A.02.00

From File...

When you press "From File", the analyzer brings up a Windows dialog and a menu entitled "**File Open.**" This menu allows you to navigate to the various fields in the Windows dialog without using a keyboard or mouse. The **Tab** and **Arrow** keys can also be used for dialog navigation.

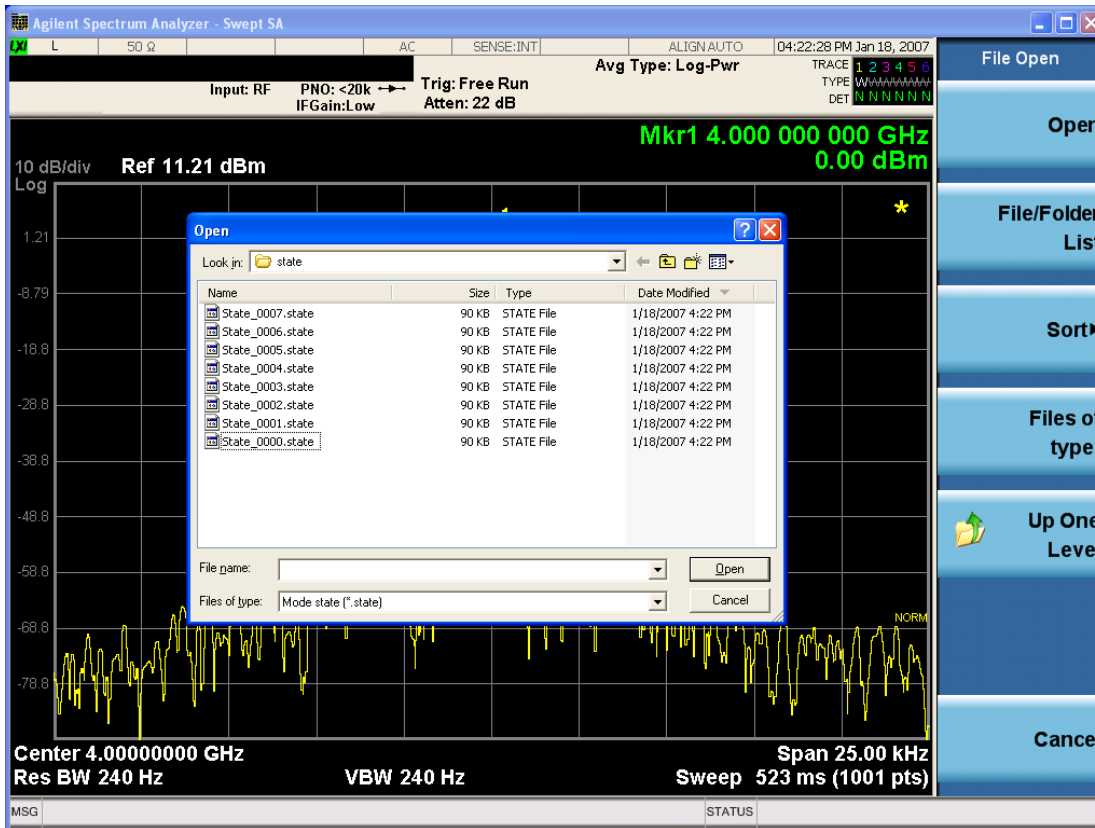

Listed below are the functions of the various fields in the dialog, and the corresponding softkeys:

Open

Performs the recall of the specified file. While the recall is being performed, the floppy icon appears briefly in the Meas bar.

File/Folder List

Enables you to navigate to the center of the dialog that contains the list of files and folders. Once here you can get information about the file and use the tab keys to navigate to the other fields in the dialog, such as Look In.

Look In

The **Look In** field shows the path from which the file will be recalled and allows you to change the path using the up and down arrow keys to navigate to other paths; the Enter key to open a directory; and the Backspace key to go back one directory. The **Look In** field first uses the last path from the Save As dialog **Save In:** path for that same file type. There is no softkey for directly navigating to the Look In field, but you can use the left tab to get here from the File/Folder List.

User specified paths are remembered when you leave and return to a Mode and are reset back to the default using **Restore Mode Defaults**.

Sort

Accesses a menu that enables you to sort the files within the File Open dialog. Only one sorting type can be selected at a time and the sorting happens immediately. The sorting types are **By Date**, **By Name**, **By extension**, and **By Size**.

Files of Type

This field shows the file suffix for the type of file you have selected to recall. For example, if you navigated here while recalling State, "Mode state (*.state)" is in the field. If you navigated here while recalling Trace, ""Mode state (*.trace)" is in the field. If you navigated here while importing a trace data file, "Trace Data (*.csv)" is in the field. For some file types, there is more than one choice in the dropdown menu, which you can select by using the up and down arrow keys and Enter.

Up One Level

This key corresponds to the icon of a folder with the up arrow that is in the tool bar of the dialog. When pressed, it causes the file and folder list to navigate up one level in the directory structure. The Backspace key does the same thing.

Cancel

This key corresponds to the **Cancel** selection in the dialog. It causes the current **Open** request to be cancelled. The ESC key does the same thing.

Key Path	Recall, State
Notes	Brings up the Open dialog for recalling a State Save Type
Initial S/W Revision	Prior to A.02.00

Register 1 thru Register 16

Selecting any one of these register menu keys causes the State of the currently active mode to be saved to the specified Register. The registers are provided for rapid saving and recalling, since you do not need to specify a filename or navigate to a file. Each of the register menu keys annotates whether it is empty or at what date and time it was last modified. In addition, you can use the **Edit Register Names** key to enter custom names for each register.

Although these 16 registers are the only registers available from the front panel, there are 128 state registers available in the instrument. Registers 17–128 are only available from the SCPI interface, using the *SAV command.

There is one set of 128 state registers in the instrument, not one set for each Mode. When a state is saved, the Mode it was saved from is saved with it; then when it is recalled, the instrument switches to that Mode.

After the save completes, the corresponding register menu key annotation is updated with the date and time and the message "Register <register number> saved" is displayed.

Key Path	Save, State
Mode	All
Example	*SAV 1
Range	1–16 from front panel, 1–128 from SCPI

Readback	Date and time with seconds resolution are displayed on the key OR A custom name of up to 30 characters entered using the Edit Register Names key OR “(empty)” if no prior save operation has been performed to this register.
Initial S/W Revision	Prior to A.02.00
Modified at S/W Revision	A.11.00

Data (Export)

Exporting a data file stores data from the current measurement to mass storage files. The Export Menu only contains data types that are supported by the current measurement.

Since the commonly exported data files are in .csv format, the data can be edited by you prior to importing. This allows you to export a data file, manipulate the data in Excel (the most common PC Application for manipulating .csv files) and then import it.

Selecting an Export Data menu key will not actually cause the exporting to occur, since the analyzer still needs to know where you wish to save the data. Pressing the Save As key in this menu brings up the Save As dialog and Save As menu that allows you to specify the destination file and directory. Once a filename has been selected or entered in the Open menu, the export will occur as soon as the Save key is pressed.

Key Path	Save
Mode	All
Notes	The menu is built from whatever data types are available for the mode. So the key locations in the sub menu will vary. No SCPI command directly controls the Data Type that this key controls. The Data Type is included in the MMEM:STORe commands.
Dependencies	If a file type is not used by a certain measurement, that type is grayed out for that measurement. The key for a file type will not show at all if there are no measurements in the Mode that support it.
Preset	Is not affected by a Preset or shutdown, but is reset during Restore Mode Defaults
Readback	The data type that is currently selected
Initial S/W Revision	Prior to A.02.00

Parameter Set

Enables you to export format parameter set data to files. Selecting this key displays a menu that enables you to select the data source. After making this selection, depress Save As... and use the file dialog to enter the file name to save. You can import the exported file by selecting Parameter Set under Recall, Data.

Default path:

Default path of this import type is “My Documents\MSR\data\params” folder. Note that “My Documents” is an alias to a directory and its location depends on which user is logged in. If the file path is specified without root folder, the export file is determined with the default path. For example if “folder1\paramData.prms” is specified, “My Documents\MSR\data\params\folder1\paramData.fps” is exported.

File Extension: fps

Default Prefix: ParamSet_

File Dialog Filter: Format Parameter Set Files (*.fps)

Key Path	Save, Data
Mode	MSR
Remote Command	MMEMory:STORE:PSET LTEFdd1 LTEFdd2 LTEFdd3 WCDMa1 WCDMa2 WCDMa3 GSM1 GSM2 GSM3 CDMA1 CDMA2 CDMA3 EVDO1 EVDO2 EVDO3 LTETdd1 LTETdd2 LTETdd3 TDSCdma1 TDSCdma2 TDSCdma3,<string>
Example	MMEM:STOR:PSET WCDM1,"WCDMA.fps"
Notes	The first enum selects the source format parameter set from which the file data are exported.
Initial S/W Revision	A.10.00
Modified at S/W Revision	A.12.00, A.16.00

Meas Results

Different types of results are available for each particular measurement. The results that are available are documented under the individual measurements. These measurement results are the same as the results that are returned when using the MEASure:<measurement> command (usually for sub-opcode 1).

Measurement results may not be available for all measurements.

Key Path	Save, Data
Mode	MSR
Example	MMEM:STOR:RES "MyResultsFile.xml" This stores the measurement results data in the file MyResultsFile.xml in the default directory.
Notes	The key will not show if the measurements in the Mode do not support it.
Initial S/W Revision	A.10.00

Save As . . .

When you press “Save As”, the analyzer brings up a Windows dialog and a menu entitled “Save As.” This menu allows you to navigate to the various fields in the Windows dialog without using a keyboard or mouse. The **Tab** and **Arrow** keys can also be used for dialog navigation.

See "To File . . ." on page 2444 in **Save, State** for a full description of this dialog and menu.

The default path for saving files is:

For all of the Trace Data Files:

My Documents\`<mode name>`\data\traces

For all of the Limit Data Files:

My Documents\`<mode name>`\data\limits

For all of the Measurement Results Data Files:

My Documents\`<mode name>`\data\`<measurement name>`\results

For all of the Capture Buffer Data Files:

My Documents\`<mode name>`\data\captureBuffer

Key Path	Save, Data
Mode	All
Notes	The key location is mode-dependent and will vary. Brings up the Save As dialog for saving a <code><mode specific></code> Save Type. The save is performed immediately and does not wait until the measurement is complete.
Initial S/W Revision	Prior to A.02.00

Screen Image

Pressing Screen Image accesses a menu of functions that enable you to specify a format and location for the saved screen image. It brings up a menu that allows you to specify the color scheme of the Screen Image (Themes) or navigate to the Save As dialog to perform the actual save.

Screen Image files contain an exact representation of the analyzer display. They cannot be loaded back onto the analyzer, but they can be loaded into your PC for use in many popular applications.

The image to be saved is actually captured when the **Save** front panel key is pressed, and kept in temporary storage to be used if you ask for a Screen Image save. When the Screen Image key is pressed, a "thumbnail" of the captured image is displayed, as shown below:

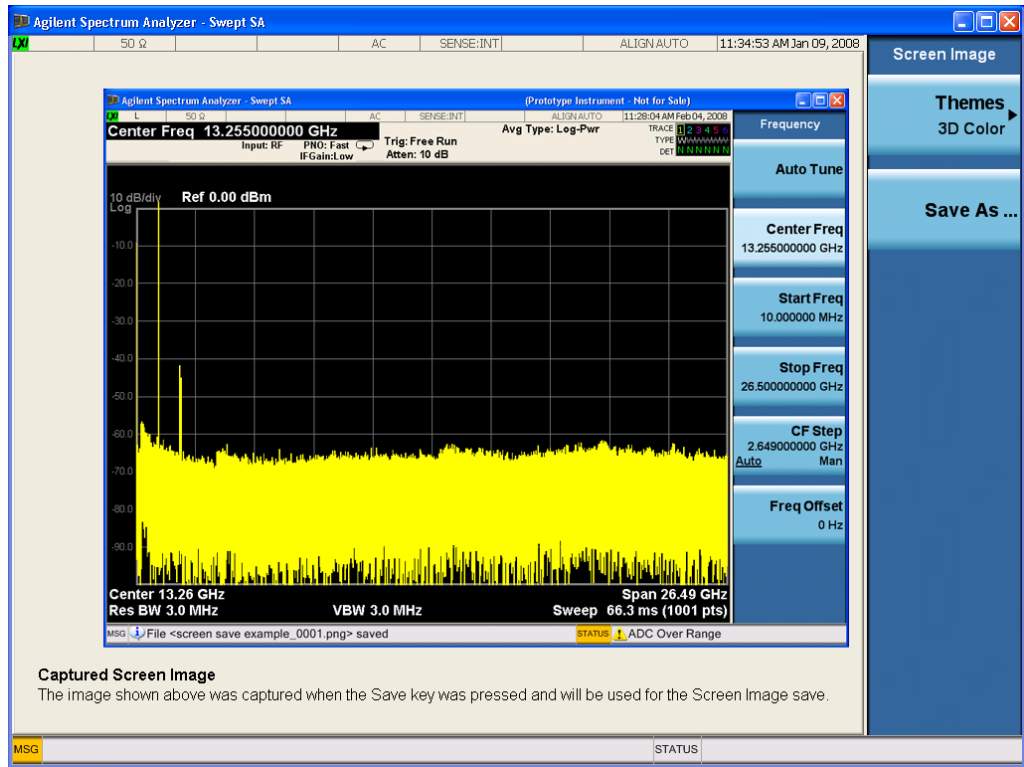

When you continue on into the **Save As** menu and complete the Screen Image save, the image depicted in the thumbnail is the one that gets saved, showing the menus that were on the screen before going into the **Save** menus. The save is performed immediately and does not wait until the measurement is complete.

After you have completed the save, the **Quick Save** front-panel key lets you quickly repeat the last save performed, using an auto-named file, with the current screen data.

NOTE For versions previous to A.01.55, if you initiate a screen image save by navigating through the Save menus, the image that is saved will contain the Save menu softkeys, not the menus and the active function that were on the screen when you first pressed the Save front panel key.

Key Path	Save
Mode	All
Remote Command	:MMEMory:STORe:SCReem <filename>
Example	:MMEM:STOR:SCR "myScreen.png" This stores the current screen image in the file MyScreenFile.png in the default directory.
Initial S/W Revision	Prior to A.02.00

Themes

Accesses a menu of functions that enable you to choose the theme to be used when saving the screen image.

The **Themes** option is the same as the **Themes** option under the **Display** and **Page Setup** dialogs. It allows you to choose between themes to be used when saving the screen image.

Key Path	Save, Screen Image
Remote Command	:MMEMory:STORe:SCReen:THEMe TDColor TDMonochrome FCOLOR FMONochrome :MMEMory:STORe:SCReen:THEMe?
Example	:MMEM:STOR:SCR:THEM TDM
Preset	3D Color; Is not part of Preset, but is reset by Restore Misc Defaults or Restore System Defaults All and survives subsequent running of the modes.
Readback	3D Color 3D Mono Flat Color Flat Mono
Backwards Compatibility Notes	In ESA and PSA we offer the choice of "Reverse Bitmap" or "Reverse Metafile" when saving screen images. This is much like the "Flat Color" theme available in X-Series. Also, if you selected Reverse Bitmap AND a black & white screen image, that would be much like "Flat Monochrome". In other words, each of the X-Series themes has a similar screen image type in ESA/PSA. But they are not identical.
Initial S/W Revision	Prior to A.02.00

3D Color

Selects a standard color theme with each object filled, shaded and colored as designed.

Key Path	Save, Screen Image, Themes
Example	MMEM:STOR:SCR:THEM TDC
Readback	3D Color
Initial S/W Revision	Prior to A.02.00

3D Monochrome

Selects a format that is like 3D color but shades of gray are used instead of colors.

Key Path	Save, Screen Image, Themes
Example	MMEM:STOR:SCR:THEM TDM
Readback	3D Mono
Initial S/W Revision	Prior to A.02.00

Flat Color

Selects a format that is best when the screen is to be printed on an ink printer.

Key Path	Save, Screen Image, Themes
-----------------	-----------------------------------

Example	MMEM:STOR:SCR:THEM FCOL
Readback	Flat Color
Initial S/W Revision	Prior to A.02.00

Flat Monochrome

Selects a format that is like Flat Color. But only black is used (no colors, not even gray), and no fill.

Key Path	Save, Screen Image, Themes
Example	MMEM:STOR:SCR:THEM FMON
Readback	Flat Mono
Initial S/W Revision	Prior to A.02.00

Save As...

When you press "Save As", the analyzer brings up a Windows dialog and a menu entitled "**Save As.**" This menu allows you to navigate to the various fields in the Windows dialog without using a keyboard or mouse. The **Tab** and **Arrow** keys can also be used for dialog navigation.

See "[To File . . .](#)" on page 2444 in **Save, State** for a full description of this dialog and menu.

The default path for Screen Images is

My Documents\`<mode name>`\screen.

where `<mode name>` is the parameter used to select the mode with the INST:SEL command (for example, SA for the Spectrum Analyzer).

Key Path	Save, Screen Image
Notes	Brings up Save As dialog for saving a Screen Image Save Type
Initial S/W Revision	Prior to A.02.00

Single (Single Measurement/Sweep)

Sets the analyzer for Single measurement operation. The single/continuous state is Meas Global, so the setting will affect all the measurements. If you are Paused, pressing **Single** does a Resume.

See "[More Information](#)" on page 2463

Key Path	Front-panel key
Example	:INIT:CONT OFF
Notes	See Cont key description.
Backwards Compatibility Notes	<p>For Spectrum Analysis mode in ESA and PSA, the Single hardkey and the INITiate:IMM switched from continuous measurement to single measurement and restarted sweeps and averages (displayed average count reset to 1), but did not restart Max Hold and Min Hold. In the X-Series, the Single hardkey and the INITiate:IMM command initiate a sweep/ measurement/ average sequence/hold sequence including MaxHold and MinHold.</p> <p>For Spectrum Analysis mode in ESA and PSA, the Single hardkey restarted the sweep regardless of whether or not you were in an active sweep or sweep sequence. In the X-Series, Restart does this but Single only restarts the sweep or sweep sequence if you are in the idle state.</p> <p>INIT[:IMM] in ESA & PSA Spectrum Analysis Mode does an implied ABORt. In some other PSA Modes, INIT[:IMM] is ignored if not in the idle state. . The X-Series follows the ESA/PSA SA Mode model, which may cause some Modes to have compatibility problems.</p>
Initial S/W Revision	Prior to A.02.00

More Information

See "[Restart](#)" on page 2441 for details on the INIT:IMMEDIATE (Restart) function.

If you are already in single sweep, the INIT:CONT OFF command has no effect.

If you are already in Single Sweep, then pressing the **Single** key in the middle of a sweep does not restart the sweep or sequence. Similarly, pressing the **Single** key does not restart the sweep or sequence if the sweep is not in the idle state (for example, if you are taking a very slow sweep, or the analyzer is waiting for a trigger). Instead, it results in a message. "Already in Single, press Restart to initiate a new sweep or sequence". Even though pressing the **Single** key in the middle of a sweep does not restart the sweep, sending INIT:IMMEDIATE does reset it.

To take one more sweep without resetting the average count, increment the average count by 1, by pressing the step up key while **Average/Hold Number** is the active function, or sending the remote command CALC:AVER:TCON UP.

Source

There is no Source control functionality for this measurement. When this key is pressed, the screen either displays a blank menu, or the previously-selected menu remains unchanged.

Key Path	Front-panel key
----------	-----------------

Span X Scale

Accesses a menu of functions that enable you to set the horizontal scale parameters.

Key Path	Front-panel key
Initial S/W Revision	Prior to A.02.00

Ref Value

Sets the reference value for time on the horizontal axis. When Auto Scaling is set to On, the displayed plots use a Scale/Div value determined by the analyzer, based on the measurement result.

Key Path	SPAN X Scale
Mode	BASIC, PNOISE, WCDMA, C2K, GSM, WIMAXOFDMA, TDSCDMA, 1XEVDO, DVB, DTMB, ISDBT, CMMB, LTE, LTE4DD, DCATV, WLAN, MSR, LTE4TDD, LTE4FDD
Remote Command	:DISPlay:WAVeform:VIEW[1] 2:WINDow[1]:TRACe:X[:SCALe]:RLEVel <time> :DISPlay:WAVeform:VIEW[1] 2:WINDow[1]:TRACe:X[:SCALe]:RLEVel?
Example	DISP:WAV:VIEW:WIND:TRAC:X:RLEV 10 ms DISP:WAV:VIEW:WIND:TRAC:X:RLEV?
Notes	You must be in a mode that includes the Waveform measurement to use this command. Use INSTRument:SElect to set the mode.
Couplings	If Auto Scaling is set to On, this value is automatically determined by the measurement result. When you set this value manually, Auto Scaling automatically changes to Off.
Preset	0.00 s
State Saved	Saved in instrument state.
Min	-1.000 s
Max	10.00 s
Initial S/W Revision	Prior to A.02.00
Modified at S/W Revision	A.03.00

Scale/Div

Sets the horizontal scale by changing a time value per division.

Key Path	SPAN X Scale
Mode	BASIC, PNOISE, WCDMA, C2K, GSM, WIMAXOFDMA, TDSCDMA, 1XEVDO, DVB, DTMB, ISDBT, CMMB, LTE, LTE4DD, DCATV, WLAN, MSR, LTE4TDD, LTE4FDD
Remote Command	:DISPlay:WAVeform:VIEW[1] 2:WINDow[1]:TRACe:X[:SCALe]:PDIVision <time> :DISPlay:WAVeform:VIEW[1] 2:WINDow[1]:TRACe:X[:SCALe]:PDIVision?
Example	DISP:WAV:VIEW:WIND:TRAC:X:PDIV 500 us DISP:WAV:VIEW:WIND:TRAC:X:PDIV?

Notes	You must be in a mode that includes the Waveform measurement to use this command. Use INSTRUMENT:SElect to set the mode.
Couplings	If Auto Scaling is set to On, this value is automatically determined by the measurement result. When you set this value manually, Auto Scaling automatically changes to Off.
Preset	All except the following list: 200.0 us LTEAFDD, LTEATDD: 1.000 ms LTETDD: 1.000 ms LTE: 1.000 ms
State Saved	Saved in instrument state.
Min	1.000 ns
Max	320 s
Initial S/W Revision	Prior to A.02.00
Modified at S/W Revision	A.03.00, A.14.00

Ref Position

Sets the reference position for the X axis to Left, Center or Right.

Key Path	SPAN X Scale
Mode	BASIC, PNOISE, WCDMA, C2K, GSM, WIMAXOFDMA, TDSCDMA, 1XEVD0, DVB, DTMB, ISDBT, CMMB, LTE, LTETDD, DCATV, WLAN, MSR,LTEATDD, LTEAFDD
Remote Command	:DISPlay:WAVeform:VIEW[1] 2:WINDow[1]:TRACe:X[:SCALE]:RPOSition LEFT CENTer RIGHT :DISPlay:WAVeform:VIEW[1] 2:WINDow[1]:TRACe:X[:SCALE]:RPOSition?
Example	DISP:WAV:VIEW:WIND:TRAC:X:RPOS LEFT DISP:WAV:VIEW:WIND:TRAC:X:RPOS?
Notes	Allows you to set the reference position to Left, Ctr (center) or Right. You must be in a mode that includes the Waveform measurement to use this command. Use INSTRUMENT:SElect to set the mode.
Preset	LEFT
State Saved	Saved in instrument state.
Range	Left Ctr Right
Initial S/W Revision	Prior to A.02.00
Modified at S/W Revision	A.03.00

Auto Scaling

Toggles the scale coupling function between On and Off.

Key Path	SPAN X Scale
Mode	BASIC, PNOISE, WCDMA, C2K, GSM, WIMAXOFDMA, TDSCDMA, 1XEVD0, DVB, DTMB, ISDBT, CMMB, LTE, LTETDD, DCATV, WLAN, MSR,LTEATDD, LTEAFDD
Remote Command	:DISPlay:WAVeform:VIEW[1] 2:WINDow[1]:TRACe:X[:SCALe]:COUPle 0 1 OFF ON :DISPlay:WAVeform:VIEW[1] 2:WINDow[1]:TRACe:X[:SCALe]:COUPle?
Example	DISP:WAV:VIEW:WIND:TRAC:X:COUP ON DISP:WAV:VIEW:WIND:TRAC:X:COUP?
Notes	You must be in a mode that includes the Waveform measurement to use this command. Use INSTRument:SElect to set the mode.
Couplings	When Auto Scaling is On and the Restart front-panel key is pressed, this function automatically determines the scale per division and reference values based on the measurement results. When you set a value to either Scale/Div or Ref Value manually, Auto Scaling automatically changes to Off.
Preset	1
State Saved	Saved in instrument state.
Range	On Off
Initial S/W Revision	Prior to A.02.00
Modified at S/W Revision	A.03.00

Sweep/Control

Accesses a menu that enables you to configure the Sweep and Control functions of the analyzer, such as Sweep Time and Gating.

Key Path	Front-panel key
Initial S/W Revision	Prior to A.02.00

Pause/Resume

Pauses a measurement after the current data acquisition is complete.

When Paused, the label on the key changes to Resume. Pressing Resume un-pauses the measurement. When you are Paused, pressing **Restart**, **Single** or **Cont** does a Resume.

Key Path	Sweep/Control
Remote Command	:INITiate:PAUSE
Dependencies	Grayed out in Measurements that do not support Pausing. Blanked in Modes that do not support Pausing.
Initial S/W Revision	Prior to A.02.00

Key Path	Sweep/Control
Remote Command	:INITiate:RESume
Dependencies	Grayed out in Measurements that do not support Pausing. Blanked in Modes that do not support Pausing.
Initial S/W Revision	Prior to A.02.00

Abort (Remote Command Only)

This command is used to stop the current measurement. It aborts the current measurement as quickly as possible, resets the sweep and trigger systems, and puts the measurement into an "idle" state. If the analyzer is in the process of aligning when ABORT is sent, the alignment finishes before the abort function is performed. So ABORT does not abort an alignment.

If the analyzer is set for Continuous measurement, it sets up the measurement and initiates a new data measurement sequence with a new data acquisition (sweep) taken once the trigger condition is met.

If the analyzer is set for Single measurement, it remains in the "idle" state until an :INIT:IMM command is received.

Remote Command	:ABORT
Example	:ABOR

Notes	<p>If :INITiate:CONTInuous is ON, then a new continuous measurement will start immediately; with sweep (data acquisition) occurring once the trigger condition has been met.</p> <p>If :INITiate:CONTInuous is OFF, then :INITiate:IMMEdiate is used to start a single measurement; with sweep (data acquisition) occurring once the trigger condition has been met.</p>
Dependencies	<p>For continuous measurement, ABORt is equivalent to the Restart key.</p> <p>Not all measurements support the abort command.</p>
Status Bits/OPC dependencies	<p>The STATus:OPERation register bits 0 through 8 are cleared.</p> <p>The STATus:QUEStionable register bit 9 (INTegrity sum) is cleared.</p> <p>Since all the bits that feed into OPC are cleared by the ABORt, the ABORt will cause the *OPC query to return true.</p>
Initial S/W Revision	<p>Prior to A.02.00</p>

16 Waveform Measurement
System

System

See "[System](#)" on page 368

Trace/Detector

There is no Trace/Detector functionality supported in the Waveform measurement. The front-panel key displays a blank menu when pressed.

Key Path	Front-panel key
Initial S/W Revision	Prior to A.02.00

Trigger

See ["Trigger" on page 444](#)

Free Run

See ["Free Run " on page 451](#)

Video

See ["Video \(IF Envelope\) " on page 452](#)

Trigger Level

See ["Trigger Level " on page 452](#)

Trig Slope

See ["Trig Slope " on page 453](#)

Trig Delay

See ["Trig Delay " on page 454](#)

Line

See ["Line " on page 2235](#)

Trig Slope

See ["Trig Slope " on page 2235](#)

Trig Delay

See ["Trig Delay " on page 456](#)

External 1

See ["External 1 " on page 2248](#)

Trigger Level

See ["Trigger Level " on page 2248](#)

Trig Slope

See ["Trig Slope " on page 2249](#)

Trig Delay

See ["Trig Delay " on page 459](#)

Zero Span Delay Comp

See ["Zero Span Delay Comp On/Off" on page 2237](#)

External 2

See ["External 2 "](#) on page 2250

Trigger Level

See ["Trigger Level "](#) on page 2250

Trig Slope

See ["Trig Slope "](#) on page 2251

Trig Delay

See ["Trig Delay "](#) on page 461

Zero Span Delay Comp

See ["Zero Span Delay Comp On/Off"](#) on page 2239

RF Burst

See ["RF Burst "](#) on page 2251

Absolute Trigger

See ["Absolute Trigger Level"](#) on page 2252

Relative Trigger

See ["Relative Trigger Level"](#) on page 2241

Trig Slope

See ["Trigger Slope "](#) on page 2253

Trig Delay

See ["Trig Delay "](#) on page 466

Periodic Timer

See ["Periodic Timer \(Frame Trigger\) "](#) on page 2243

Period

See ["Period "](#) on page 2244

Offset

See ["Offset "](#) on page 2245

Offset Adjust (Remote Command Only)

See ["Offset Adjust \(Remote Command Only\)"](#) on page 2246

Reset Offset Display

See ["Reset Offset Display "](#) on page 2247

Sync Source

See ["Sync Source "](#) on page 2247

Off

See ["Off "](#) on page 2248

External 1

See ["External 1 "](#) on page 2248

Trigger Level

See ["Trigger Level "](#) on page 2248

Trig Slope

See ["Trig Slope "](#) on page 2249

External 2

See ["External 2 "](#) on page 2250

Trigger Level

See ["Trigger Level "](#) on page 2250

Trig Slope

See ["Trig Slope "](#) on page 2251

RF Burst

See ["RF Burst "](#) on page 2251

Absolute Trigger

See ["Absolute Trigger Level"](#) on page 2252

Trig Slope

See ["Trigger Slope "](#) on page 2253

Trig Delay

See ["Trig Delay"](#) on page 476

Auto/Holdoff

See ["Auto/Holdoff "](#) on page 477

Auto Trig

See ["Auto Trig "](#) on page 477

Trig Holdoff

See ["Trig Holdoff "](#) on page 478

Holdoff Type

See ["Holdoff Type"](#) on page 478

Baseband I/Q

See [___](#) on page X

I/Q Mag

See [___](#) on page X

Trigger Level

See [___](#) on page X

Trig Slope

See [___](#) on page X

Trig Delay

See [___](#) on page X

I

See [___](#) on page X

Trigger Level

See [___](#) on page X

Trig Slope

See [___](#) on page X

Trig Delay

See [___](#) on page X

Q

See [___](#) on page X

Trigger Level

See [___](#) on page X

Trig Slope

See [___](#) on page X

Trig Delay

See [___](#) on page X

Input I

See ___ on page X

Trigger Level

See ___ on page X

Trig Slope

See ___ on page X

Trig Delay

See ___ on page X

Input Q

See ___ on page X

Trigger Level

See ___ on page X

Trig Slope

See ___ on page X

Trig Delay

See ___ on page X

Aux Channel Center Freq

See ___ on page X

Trigger Level

See ___ on page X

Trig Slope

See ___ on page X

Trig Delay

See ___ on page X

Trigger Center Freq

See ___ on page X

Trigger BW

See ___ on page X

User Preset

Accesses a menu that gives you the following three choices:

- **User Preset** – recalls a state previously saved using the Save User Preset function.
- **User Preset All Modes** – presets all of the modes in the analyzer
- **Save User Preset**– saves the current state for the current mode

Key Path	Front-panel key
Backwards Compatibility Notes	<p>User Preset is actually loading a state, and in legacy analyzers, it was possible to load a state without affecting the trace data, limit lines or correction data. Similarly it was possible to do a User Preset without affecting the trace data, limit lines or correction data.</p> <p>In the X-Series, “state” always includes all of this data; so whenever state is loaded, or User Preset is executed, all of the traces, limit lines and corrections are affected. Although this differs from previous behavior, it is desirable behavior, and should not cause adverse issues for users.</p> <p>On ESA and PSA, User Preset affected the entire instrument’s state. In the X-Series, User Preset only recalls the state for the active mode. There is a User Preset file for each mode. User Preset can never cause a mode switch as it can in legacy analyzers. If you want to recall all modes to their user preset file state, you will need to do a User Preset after mode switching into each mode.</p> <p>User Preset recalls mode state which can now include data like traces; whereas on ESA and PSA, User Preset did not affect data.</p>
Initial S/W Revision	Prior to A.02.00

User Preset

User Preset sets the state of the currently active mode back to the state that was previously saved for this mode using the Save User Preset menu key or the SCPI command, `SYST:PRES:USER:SAV`. It not only recalls the Mode Preset settings, but it also recalls all of the mode persistent settings, and the Input/Output system setting that existed at the time Save User Preset was executed.

If a Save User Preset has not been done at any time, User Preset recalls the default user preset file for the currently active mode. The default user preset files are created if, at power-on, a mode detects there is no user preset file. There will never be a scenario when there is no user preset file to restore. For each mode, the default user preset state is the same state that would be saved if a Save User Preset is performed in each mode right after doing a Restore Mode Default and after a Restore Input/Output Defaults.

The User Preset function does the following:

- Aborts the currently running measurement.
- Sets the mode State to the values defined by Save User Preset.
- Makes the saved measurement for the currently running mode the active measurement.
- Brings up the saved menu for the power-on mode.
- Clears the input and output buffers.
- Sets the Status Byte to 0.

Key Path	User Preset
Remote Command	:SYSTem:PRESet:USER
Example	:SYST:PRES:USER:SAVE:SYST:PRES:USER
Notes	:SYST:PRES:USER:SAVE is used to save the current state as the user preset state. Clears all pending OPC bits. The Status Byte is set to 0. Pressing the User Preset front-panel key while already in the User Preset menu will cause the User Preset to get executed
Couplings	A user preset will cause the currently running measurement to be aborted and cause the saved measurement to be active. Recalling a User Preset file has the same issues that recalling a Save State file has. Some settings may need to be limited and therefore re-coupled, since the capabilities of the mode may have changes when the User Preset file was last saved.
Initial S/W Revision	Prior to A.02.00

User Preset All Modes

Recalls all of the User Preset files for each mode, switches to the power-on mode, and activates the saved measurement from the power-on mode User Preset file.

NOTE

When the instrument is secured, all of the user preset files are converted back to their default user preset files.

The User Preset function does the following:

- Aborts the currently running measurement.
- Switches the Mode to the power-on mode.
- Restores the User Preset files for each mode.
- Makes the saved measurement for the power-on mode the active measurement.
- Brings up the saved menu for the power-on mode.
- Clears the input and output buffers.
- Sets the Status Byte to 0.

Key Path	User Preset
Remote Command	:SYSTem:PRESet:USER:ALL
Example	:SYST:PRES:USER:SAVE:SYST:PRES:USER:ALL
Notes	Clears all pending OPC bits. The Status Byte is set to 0. :SYST:PRES:USER:SAVE is used to save the current state as the user preset state.
Couplings	A user preset will cause the currently running measurement to be aborted, cause a mode switch to the power-on mode, and cause the saved measurement to be active in the power-on mode. Recalling a User Preset file has the same issues that recalling a Save State file has. Some settings may need to be limited and therefore re-coupled, since the capabilities of the mode may have changes when the User Preset file was last saved.

Initial S/W Revision	Prior to A.02.00
----------------------	------------------

Save User Preset

Saves the currently active mode and its State. You can recall this User Preset file by pressing the User Preset menu key or sending the SYST:PRES:USER remote command. This same state is also saved by the Save State function.

Key Path	User Preset
Remote Command	:SYSTem:PRESet:USER:SAVE
Example	:SYST:PRES:USER:SAVE
Notes	:SYST:PRES:SAVE creates the same file as if the user requested a *SAV or a MMEM:STOR:STAT, except User Preset Save does not allow the user to specify the filename or the location of the file.
Initial S/W Revision	Prior to A.02.00

View/Display

Accesses a menu of functions that enable you to set up and control the display parameters for the current measurement.

This topic contains the following sections:

["View Selection by name \(Remote Command Only\)" on page 2480](#)

["View Selection by number \(Remote Command Only\)" on page 2480](#)

View Selection by name (Remote Command Only)

Selects the results view.

Key Path	View/Display
Mode	BASIC, PNOISE, WCDMA, C2K, GSM, WIMAXOFDMA, TDSCDMA, 1XEVD0, DVB, DTMB, ISDBT, CMMB, LTE, LTETDD, DCATV, WLAN, MSR,LTEATDD, LTEAFDD
Remote Command	:DISPlay:WAVeform:VIEW[:SElect] RFENvelope IQ :DISPlay:WAVeform:VIEW[:SElect]?
Example	DISP:WAV:VIEW RFEN DISP:WAV:VIEW?
Notes	You must be in a mode that includes the Waveform measurement to use this command. Use INSTRument:SElect to set the mode.
Preset	RFENvelope
State Saved	Saved in instrument state.
Range	RF Envelope IQ Waveform
Initial S/W Revision	Prior to A.02.00
Modified at S/W Revision	A.03.00

View Selection by number (Remote Command Only)

Displays the numeric values of the measurement results.

Mode	BASIC, PNOISE, WCDMA, C2K, GSM, WIMAXOFDMA, TDSCDMA, 1XEVD0, DVB, DTMB, ISDBT, CMMB, LTE, LTETDD, DCATV, WLAN, MSR,LTEATDD, LTEAFDD
Remote Command	:DISPlay:WAVeform:VIEW:NSElect <integer> :DISPlay:WAVeform:VIEW:NSElect?
Example	DISP:WAV:VIEW:NSEL 1 DISP:WAV:VIEW:NSEL?
Notes	You must be in a mode that includes the Waveform measurement to use this command. Use INSTRument:SElect to set the mode.
Preset	1
State Saved	Saved in instrument state.

Min	1
Max	2
Initial S/W Revision	Prior to A.02.00
Modified at S/W Revision	A.03.00

Key Path	Front-panel key
Initial S/W Revision	Prior to A.02.00

Display

The Display menu is common to most measurements, and is used for configuring items on the display. Some Display menu settings apply to all the measurements in a mode, and some only to the current measurement. Those under the **System Display Settings** key apply to all measurements in all modes.

Key Path	Display
Key Path	View/Display
Initial S/W Revision	Prior to A.02.00

Annotation

Turns on and off various parts of the display annotation. The annotation is divided up into four categories:

1. Meas Bar: This is the measurement bar at the top of the screen. It does not include the settings panel or the Active Function. Turning off the Meas Bar turns off the settings panel and the Active Function. When the Meas Bar is off, the graticule area expands to fill the area formerly occupied by the Meas Bar.
2. Screen Annotation: this is the annotation and annunciation around the graticule, including any annotation on lines (such as the display line, the threshold line, etc.) This does NOT include the marker number or the N dB result. When off, the graticule expands to fill the entire graticule area.
3. Trace annotation: these are the labels on the traces, showing their detector (or their math mode).
4. Active Function annotation: this is the active function display in the meas bar, and all of the active function values displayed on softkeys.

See the figure below. Each type of annotation can be turned on and off individually.

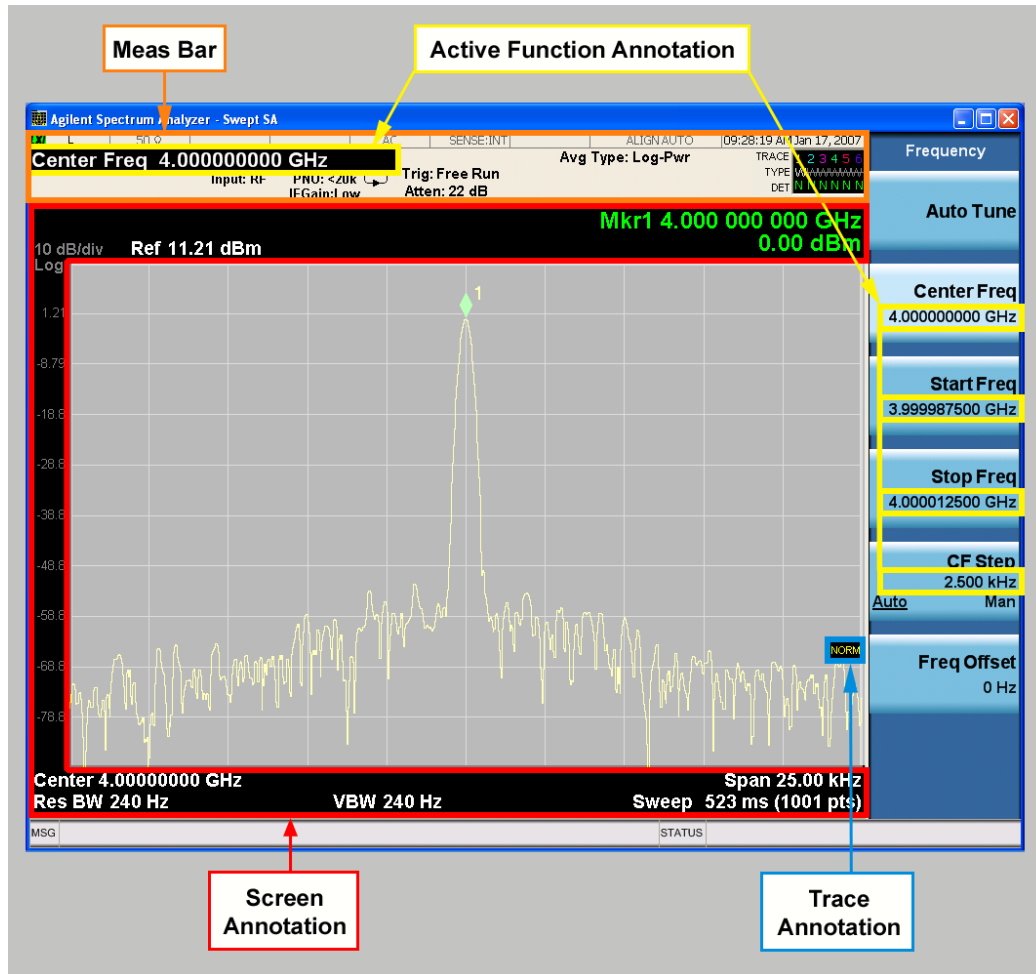

Key Path	View/Display, Display
Initial S/W Revision	Prior to A.02.00

Meas Bar On/Off

This function turns the Measurement Bar on and off, including the settings panel. When off, the graticule area expands to fill the area formerly occupied by the Measurement Bar.

Key Path	View/Display, Display, Annotation
Remote Command	:DISPlay:ANNOtation:MBAR[:STATe] OFF ON 0 1 :DISPlay:ANNOtation:MBAR[:STATe]?
Example	DISP:ANN:MBAR OFF
Dependencies	Grayed out and forced to OFF when System Display Settings, Annotation is set to Off.
Preset	On This should remain Off through a Preset when System DisplaySettings, Annotation is set to Off.

State Saved	Saved in instrument state.
Initial S/W Revision	Prior to A.02.00

Screen

This controls the display of the annunciation and annotation around the graticule, including any annotation on lines (such as the display line, the threshold line, etc.) and the y-axis annotation. This does NOT include marker annotation (or the N dB result). When off, the graticule expands to fill the entire graticule area, leaving only the 1.5% gap above the graticule as described in the Trace/Detector chapter.

Key Path	View/Display, Display, Annotation
Remote Command	:DISPlay:ANNotation:SCReen[:STATe] OFF ON 0 1 :DISPlay:ANNotation:SCReen[:STATe]?
Example	DISP:ANN:SCR OFF
Dependencies	Grayed-out and forced to OFF when System Display Settings, Annotation is set to Off.
Preset	On This should remain Off through a Preset when System DisplaySettings, Annotation is set to Off
State Saved	Saved in instrument state.
Initial S/W Revision	Prior to A.02.00

Active Function Values On/Off

Turns on and off the active function display in the Meas Bar, and all of the active function values displayed on the softkeys.

Note that all of the softkeys that have active functions have these numeric values blanked when this function is on. This is a security feature..

16 Waveform Measurement
View/Display

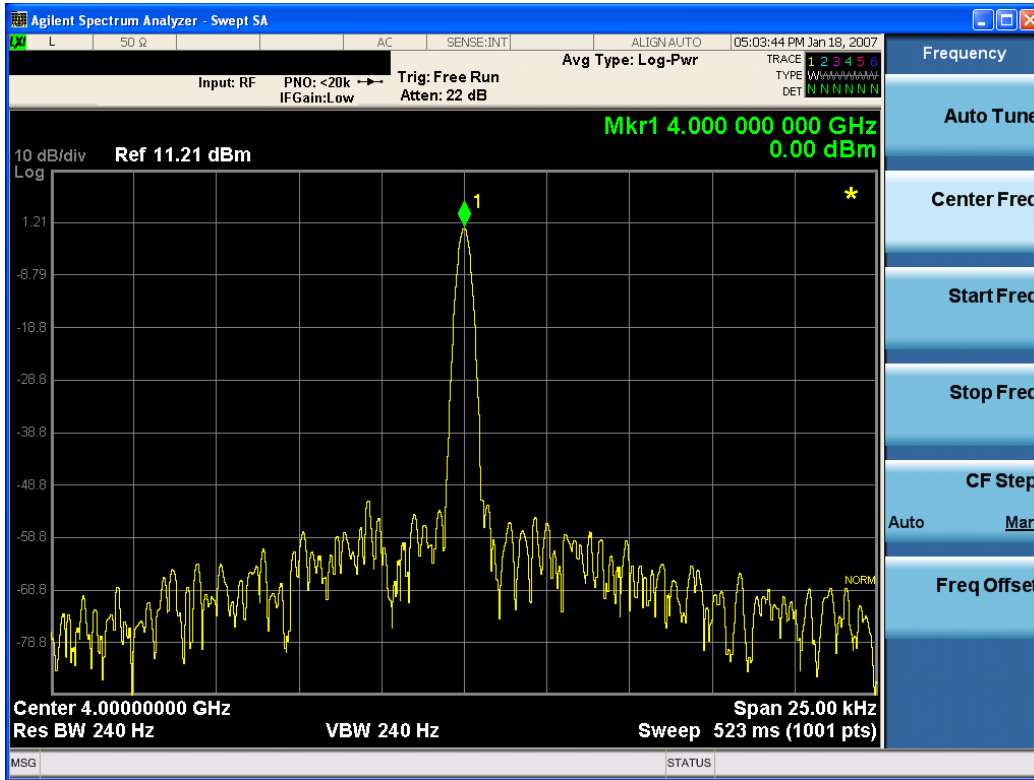

Key Path	View/Display, Display, Annotation
Remote Command	:DISPlay:ACTivefunc[:STATE] ON OFF 1 0 :DISPlay:ACTivefunc[:STATE] ?
Example	DISP:ACT OFF
Dependencies	Grayed out and forced to OFF when System Display Settings, Annotation is set to Off.
Preset	On This should remain Off through a Preset when System DisplaySettings, Annotation is set to Off
State Saved	Saved in instrument state.
Initial S/W Revision	Prior to A.02.00

Title

Displays menu keys that enable you to change or clear a title on your display.

Key Path	View/Display, Display
Initial S/W Revision	Prior to A.02.00

Change Title

Writes a title into the "measurement name" field in the banner, for example, "Swept SA".

Press Change Title to enter a new title through the alpha editor. Press Enter or Return to complete the entry. Press ESC to cancel the entry and preserve your existing title.

The display title will replace the measurement name. It remains for this measurement until you press **Change Title** again, or you recall a state, or a Preset is performed. A title can also be cleared by pressing **Title, Clear Title**.

NOTE

Notice the inclusion of the <measurement> parameter in the command below. Because each measurement remembers the Display Title, the command must be qualified with the measurement name. For the Swept SA measurement this is not the case; no <measurement> parameter is used when changing the Display Title for the Swept SA measurement.

Key Path	View/Display, Display, Title
Mode	All
Remote Command	:DISPlay:<measurement>:ANNotation:TITLe:DATA <string> :DISPlay:<measurement>:ANNotation:TITLe:DATA?
Example	DISP:ANN:TITL:DATA "This Is My Title" This example is for the Swept SA measurement in the Spectrum Analyzer mode. The SANalyzer <measurement> name is not used. DISP:ACP:ANN:TITL:DATA "This Is My Title" This example is for Measurements other than Swept SA. Both set the title to: This Is My Title
Notes	Pressing this key cancels any active function. When a title is edited the previous title remains intact (it is not cleared) and the cursor goes at the end so that characters can be added or BKSP can be used to go back over previous characters.
Preset	No title (measurement name instead)
State Saved	Saved in instrument state.
Initial S/W Revision	Prior to A.02.00

Clear Title

Clears a title from the front-panel display. Once cleared, the title cannot be retrieved. After the title is cleared, the current Measurement Name replaces it in the title bar.

Key Path	View/Display, Display, Title
Example	The following commands clear the title and restore the measurement's original title: DISP:ANN:TITL:DATA "" This example is for the Swept SA measurement in the Spectrum Analyzer mode. The SANalyzer <measurement> name is not used. DISP:ACP:ANN:TITL:DATA "" This example is for ACP; in measurements other than Swept SA the measurement name is required.
Notes	Uses the :DISPlay:<measurement>:ANNotation:TITLe:DATA <string> command with an empty string (in the Swept SA, the <measurement> is omitted).

Preset	Performed on Preset.
Initial S/W Revision	Prior to A.02.00

Graticule

Pressing Graticule turns the display graticule On or Off. It also turns the graticule y-axis annotation on and off.

Key Path	View/Display, Display
Remote Command	:DISPlay:WINDow[1]:TRACe:GRATicule:GRID[:STATe] OFF ON 0 1 :DISPlay:WINDow[1]:TRACe:GRATicule:GRID[:STATe]?
Example	DISP:WIND:TRAC:GRAT:GRID OFF
Notes	The graticule is the set of horizontal and vertical lines that make up the grid/divisions for the x-axis and y-axis.
Preset	On
State Saved	Saved in instrument state
Initial S/W Revision	Prior to A.02.00

System Display Settings

These settings are "Mode Global" – they affect all modes and measurements and are reset only by **Restore Misc Defaults** or **Restore System Defaults** under System.

Key Path	View/Display, Display
Initial S/W Revision	Prior to A.02.00

Annotation Local Settings

This is a Mode Global override of the meas local annotation settings. When it is **All Off**, it forces **ScreenAnnotation, Meas Bar, Trace, and Active Function Values** settings to be **OFF** for all measurements in all modes. This provides the security based "annotation off" function of previous analyzers; hence it uses the legacy SCPI command.

When it is **All Off**, the **Screen, Meas Bar, Trace, and Active Function Values** keys under the **Display, Annotation** menu are grayed out and forced to **Off**. When **Local Settings** is selected, you are able to set the local annotation settings on a measurement by measurement basis.

Key Path	View/Display, Display, System Display Settings
Remote Command	:DISPlay:WINDow[1]:ANNotation[:ALL] OFF ON 0 1 :DISPlay:WINDow[1]:ANNotation[:ALL]?
Example	:DISP:WIND:ANN OFF

Preset	On (Set by Restore Misc Defaults)
State Saved	Not saved in instrument state.
Backwards Compatibility Notes	The WINDow parameter and optional subopcode is included for backwards compatibility but ignored – all windows are equally affected.
Initial S/W Revision	Prior to A.02.00

Themes

Accesses a menu of functions that enable you to choose the theme to be used when saving the screen image.

The **Themes** option is the same as the **Themes** option under the **Display** and **Page Setup** dialogs. It allows you to choose between themes to be used when saving the screen image.

Key Path	Save, Screen Image
Remote Command	:MMEMory:STORe:SCReem:THEMe TDColor TDMonochrome FCOLOR FMONochrome :MMEMory:STORe:SCReem:THEMe?
Example	:MMEM:STOR:SCR:THEM TDM
Preset	3D Color; Is not part of Preset, but is reset by Restore Misc Defaults or Restore System Defaults All and survives subsequent running of the modes.
Readback	3D Color 3D Mono Flat Color Flat Mono
Backwards Compatibility Notes	In ESA and PSA we offer the choice of "Reverse Bitmap" or "Reverse Metafile" when saving screen images. This is much like the "Flat Color" theme available in X-Series. Also, if you selected Reverse Bitmap AND a black & white screen image, that would be much like "Flat Monochrome". In other words, each of the X-Series themes has a similar screen image type in ESA/PSA. But they are not identical.
Initial S/W Revision	Prior to A.02.00

3D Color

Selects a standard color theme with each object filled, shaded and colored as designed.

Key Path	Save, Screen Image, Themes
Example	MMEM:STOR:SCR:THEM TDC
Readback	3D Color
Initial S/W Revision	Prior to A.02.00

3D Monochrome

Selects a format that is like 3D color but shades of gray are used instead of colors.

Key Path	Save, Screen Image, Themes
Example	MMEM:STOR:SCR:THEM TDM
Readback	3D Mono
Initial S/W Revision	Prior to A.02.00

Flat Color

Selects a format that is best when the screen is to be printed on an ink printer.

Key Path	Save, Screen Image, Themes
Example	MMEM:STOR:SCR:THEM FCOL
Readback	Flat Color
Initial S/W Revision	Prior to A.02.00

Flat Monochrome

Selects a format that is like Flat Color. But only black is used (no colors, not even gray), and no fill.

Key Path	Save, Screen Image, Themes
Example	MMEM:STOR:SCR:THEM FMON
Readback	Flat Mono
Initial S/W Revision	Prior to A.02.00

Backlight

Accesses the display backlight on/off keys. This setting may interact with settings under the Windows "Power" menu.

When the backlight is off, pressing ESC, TAB, SPACE, ENTER, UP, DOWN, LEFT, RIGHT, DEL, BKSP, CTRL, or ALT turns the backlight on without affecting the application. Pressing any other key will turn backlight on and could potentially perform the action as well.

Key Path	View/Display, Display, System Display Settings
Remote Command	:DISPlay:BACKlight ON OFF :DISPlay:BACKlight?
Preset	ON (Set by Restore Misc Defaults)
Initial S/W Revision	Prior to A.02.00

Backlight Intensity

An active function used to set the backlight intensity. It goes from 0 to 100 where 100 is full on and 0 is off. This value is independent of the values set under the Backlight on/off key.

Key Path	View/Display, Display, System Display Settings
Remote Command	:DISPlay:BACKlight:INTensity <integer> :DISPlay:BACKlight:INTensity?
Example	DISP:BACK:INT 50
Preset	100 (Set by Restore Misc Defaults)
Min	0
Max	100
Initial S/W Revision	Prior to A.02.00

RF Envelope

This view shows an example of the RF Envelope result for the waveform (time domain) measurements in the graph window. The measured values for the mean power and peak-to-mean power are shown in the text window.

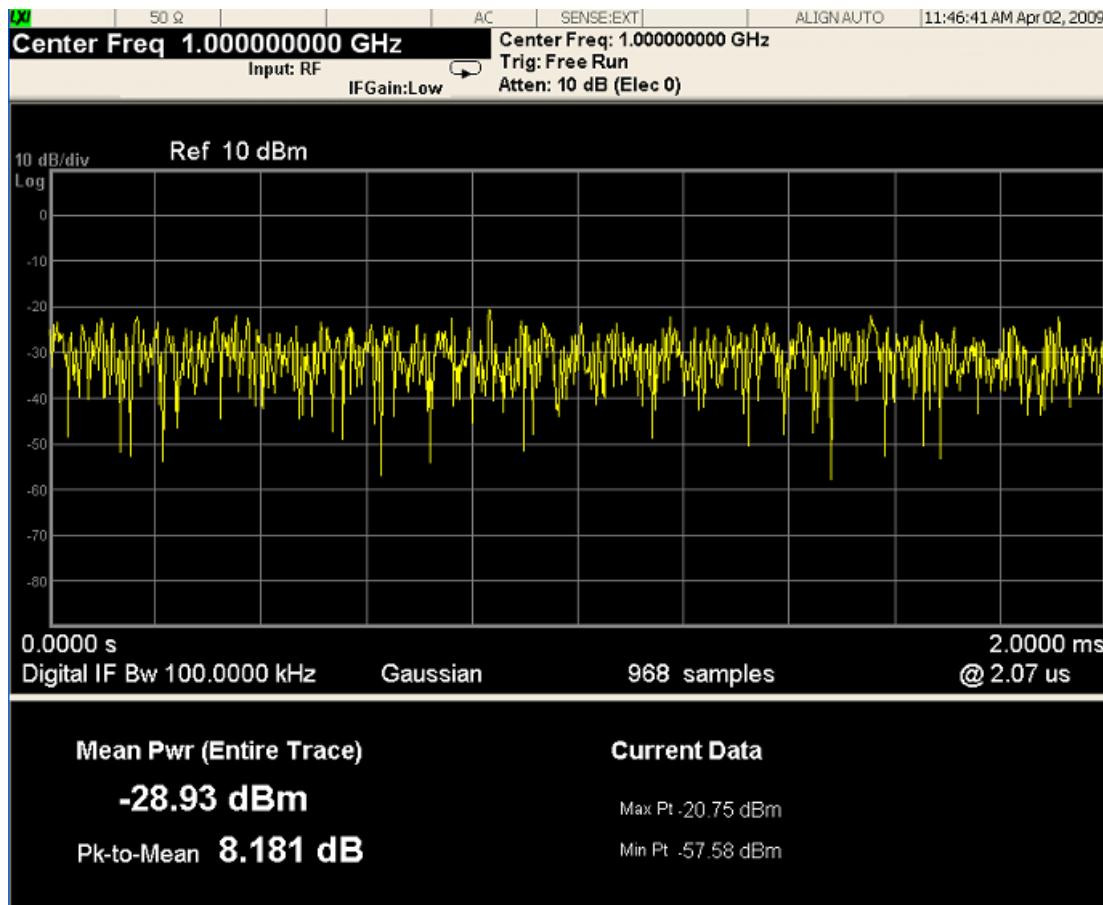

Numeric Results

Name	Type	Description	Unit	Format
Mean Pwr	Float64	The mean power (dBm). This is either the power across the entire trace, or the power between markers if the markers are enabled.	dBm	XX.XX dBm
Pk-to-Mean	Float64	This is the ratio of the maximum signal level to the mean power.	dB	XX.XX dB
Max Pt	Float64	The maximum of the most recently acquired data.	dBm	XX.XX dBm
Min Pt	Float64	The minimum of the most recently acquired data.	dBm	XX.XX dBm

Key Path	View/Display
Initial S/W Revision	Prior to A.02.00

I/Q Waveform

This view shows the I and Q signal waveforms in parameters of voltage versus time.

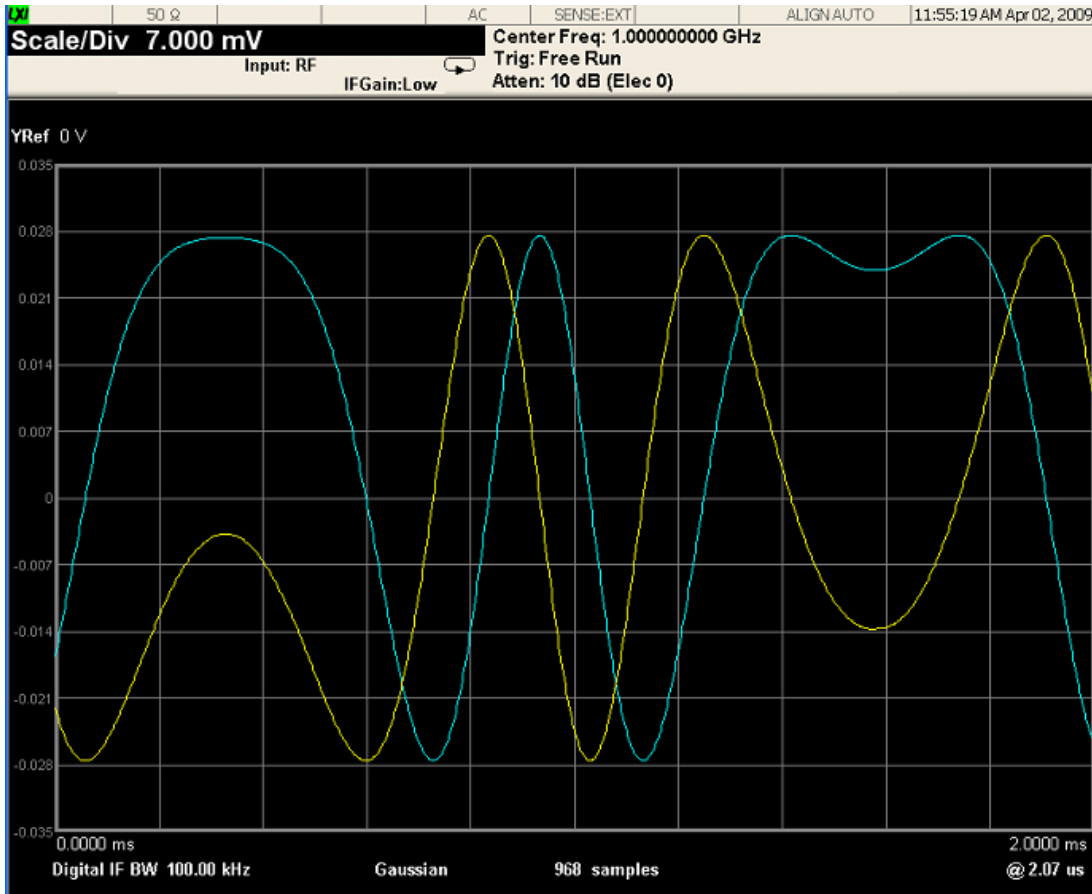

Key Path	View/Display
Initial S/W Revision	Prior to A.02.00



This information is subject to change without notice.

© Keysight Technologies 2011-2015

Edition 1, June 2015

N9083-90001

www.keysight.com