

# Keysight X-Series Signal Analyzers

This manual provides documentation for the following models:

N9040B UXA

N9030B PXA

N9020B MXA

N9010B EXA

N9000B CXA

N8973B NFA

SA Mode  
Measurement  
Guide

# Notices

© Keysight Technologies,  
Inc. 2015-2016

No part of this manual may be reproduced in any form or by any means (including electronic storage and retrieval or translation into a foreign language) without prior agreement and written consent from Keysight Technologies, Inc. as governed by United States and international copyright laws.

## Trademark Acknowledgments

## Manual Part Number

N9060-90037

## Edition

Edition 1, February 2016

Supersedes: January 2015

Published by:  
Keysight Technologies  
1400 Fountaingrove Parkway  
Santa Rosa, CA 95403

## Warranty

THE MATERIAL CONTAINED IN THIS DOCUMENT IS PROVIDED "AS IS," AND IS SUBJECT TO BEING CHANGED, WITHOUT NOTICE, IN FUTURE EDITIONS. FURTHER, TO THE MAXIMUM EXTENT PERMITTED BY APPLICABLE LAW, KEYSIGHT DISCLAIMS ALL WARRANTIES, EITHER EXPRESS OR IMPLIED WITH REGARD TO THIS MANUAL AND ANY INFORMATION CONTAINED HEREIN, INCLUDING BUT NOT LIMITED TO THE IMPLIED WARRANTIES OF MERCHANTABILITY AND FITNESS FOR A PARTICULAR PURPOSE. KEYSIGHT SHALL NOT BE LIABLE FOR ERRORS OR FOR INCIDENTAL OR CONSEQUENTIAL DAMAGES IN CONNECTION WITH THE FURNISHING, USE, OR PERFORMANCE OF THIS DOCUMENT OR ANY INFORMATION CONTAINED HEREIN. SHOULD KEYSIGHT AND THE USER HAVE A SEPARATE WRITTEN AGREEMENT WITH WARRANTY TERMS COVERING THE MATERIAL IN THIS

DOCUMENT THAT CONFLICT WITH THESE TERMS, THE WARRANTY TERMS IN THE SEPARATE AGREEMENT WILL CONTROL.

## Technology Licenses

The hardware and/or software described in this document are furnished under a license and may be used or copied only in accordance with the terms of such license.

## U.S. Government Rights

The Software is "commercial computer software," as defined by Federal Acquisition Regulation ("FAR") 2.101. Pursuant to FAR 12.212 and 27.405-3 and Department of Defense FAR Supplement ("DFARS") 227.7202, the U.S. government acquires commercial computer software under the same terms by which the software is customarily provided to the public.

Accordingly, Keysight provides the Software to U.S. government customers under its standard commercial license, which is embodied in its End User License Agreement (EULA), a copy of which can be found at

<http://www.keysight.com/find/sweula>

The license set forth in the EULA represents the exclusive authority by which the U.S. government may use, modify, distribute, or disclose the Software. The EULA and the license set forth therein, does not require or permit, among other things, that Keysight: (1) Furnish technical information related to commercial computer software or commercial computer software documentation that is not customarily provided to the public; or (2) Relinquish to, or otherwise provide, the government rights in excess of these rights customarily provided to the public to use, modify, reproduce, release, perform, display, or disclose commercial computer software or commercial computer software documentation. No additional

government requirements beyond those set forth in the EULA shall apply, except to the extent that those terms, rights, or licenses are explicitly required from all providers of commercial computer software pursuant to the FAR and the DFARS and are set forth specifically in writing elsewhere in the EULA. Keysight shall be under no obligation to update, revise or otherwise modify the Software. With respect to any technical data as defined by FAR 2.101, pursuant to FAR 12.211 and 27.404.2 and DFARS 227.7102, the U.S. government acquires no greater than Limited Rights as defined in FAR 27.401 or DFAR 227.7103-5 (c), as applicable in any technical data.

## Safety Notices

### CAUTION

A **CAUTION** notice denotes a hazard. It calls attention to an operating procedure, practice, or the like that, if not correctly performed or adhered to, could result in damage to the product or loss of important data. Do not proceed beyond a CAUTION notice until the indicated conditions are fully understood and met.

### WARNING

A **WARNING** notice denotes a hazard. It calls attention to an operating procedure, practice, or the like that, if not correctly performed or adhered to, could result in personal injury or death. Do not proceed beyond a WARNING notice until the indicated conditions are fully understood and met.

## Where to Find the Latest Information

Documentation is updated periodically. For the latest information about these products, including instrument software upgrades, application information, and product information, browse to one of the following URLs, according to the name of your product:

<http://www.keysight.com/find/N9040B>

<http://www.keysight.com/find/N9030B>

<http://www.keysight.com/find/N9020B>

<http://www.keysight.com/find/N9010B>

<http://www.keysight.com/find/N9000B>

<http://www.keysight.com/find/N8973B>

To receive the latest updates by email, subscribe to Keysight Email Updates at the following URL:

<http://www.keysight.com/find/MyKeysight>

Information on preventing instrument damage can be found at:

[www.keysight.com/find/PreventingInstrumentRepair](http://www.keysight.com/find/PreventingInstrumentRepair)

## Is your product software up-to-date?

Periodically, Keysight releases software updates to fix known defects and incorporate product enhancements. To search for software updates for your product, go to the Keysight Technical Support website at:

<http://www.keysight.com/find/techsupport>



## Table of Contents

### Getting Started with the Spectrum Analyzer Measurement Application 11

- Technical Documentation for Your Analyzer 12
- Multitouch UI Controls Vs. Hardkeys 13
- Presetting the Signal Analyzer 14
  - Creating and Using a User Preset 15
- Entering Numeric Data 16
- Using the Measurement Panel Drop Down Box to Configure a Measurement 18
- Selecting the Mode, Measurement, and View 19
- Accessing the Help System 21
- Viewing a Signal 23
- Reading Frequency and Amplitude 24
- Changing the Reference Level 25
- Improving Frequency Accuracy 26
- Recommended Test Equipment 27

### Measuring Multiple Signals 29

- Comparing Signals Using Marker Delta 29
- Comparing Signals Using the Marker Delta When One is not on the Display Grid 32
- Resolving Signals of Equal Amplitude 35
- Resolving Small Signals Hidden by Large Signals 40
- Decreasing the Frequency Span Around the Signal 45
- Measure Varying Levels of Modulated Power Compared to a Reference 48

### Measuring a Low-Level Signal 53

- Reducing Input Attenuation 53
- Decreasing the Resolution Bandwidth 57
- Using the Average Detector and Increased Sweep Time 60
- Trace Averaging 63

### Improving Frequency Resolution and Accuracy 67

- Using a Frequency Counter to Improve Frequency Resolution and Accuracy 67

## Contents

### Tracking Drifting Signals 69

Measuring the Frequency Drift of a Source 69

Tracking a Signal 73

### Making Distortion Measurements 77

Identifying Analyzer Generated Distortion 77

One-Button Harmonics Measurement 82

Third-Order Intermodulation Distortion 85

One-Button TOI Measurement 89

### Measuring Noise 93

Measuring Signal-to-Noise 93

Measuring Noise Using Marker Noise 96

Measuring Noise-Like Signals Using Band/Interval Density Markers 100

Measuring Noise-Like Signals Using the Channel Power Measurement 104

Measuring the Carrier-to-Noise Ratio of a Modulated Carrier 106

Improving Phase Noise Measurements by Subtracting Signal Analyzer Noise 112

### Making Time-Gated Measurements 119

Viewing a Pulsed-RF FM Signal 120

Digitizing Oscilloscope Setup 123

Connecting Instruments to Make Time-Gated Measurements 125

Signal source setup 126

Gated LO Measurement 128

Gated Video Measurement 132

Gated FFT Measurement 136

### Measuring Digital Communications Signals 139

Making Channel Power Measurements 140

Making Occupied Bandwidth Measurements 143

Troubleshooting hints 144

Making Adjacent Channel Power (ACP) Measurements 145

- Making Statistical Power Measurements (CCDF) 151
- Making Burst Power Measurements 157
- Making Spurious Emissions Measurements 164
  - Troubleshooting hints 167
- Making Spectrum Emission Mask Measurements 168
  - Troubleshooting hints 170
- Making List Sweep Measurements 171

## Demodulating AM Signals 173

- Measuring the Modulation Rate of an AM Signal 173
- Measuring the Modulation Index of an AM Signal 180

## IQ Analyzer Measurement 185

- Capturing Wideband Signals for Further Analysis 185
- Complex Spectrum Measurement 186
- IQ Waveform (Time Domain) Measurement 189

## Concepts 195

- Resolving Closely Spaced Signals 195
  - Resolving Signals of Equal Amplitude 195
  - Resolving Small Signals Hidden by Large Signals 196
- Trigger Concepts 197
  - Selecting a Trigger 197
- Time Gating Concepts 201
  - Introduction: Using Time Gating on a Simplified Digital Radio Signal 201
  - How Time Gating Works 203
  - Measuring a Complex/Unknown Signal 209
  - Quick Rules for Making Time-Gated Measurements 214
  - Using the Edge Mode or Level Mode for Triggering 217
  - Noise Measurements Using Time Gating 218
- AM and FM Demodulation Concepts 219
  - Demodulating an AM Signal Using the Analyzer as a Fixed-Tuned Receiver (Time-Domain) 219

## Contents

Demodulating an FM Signal Using the Analyzer as a Fixed-Tuned Receiver (Time-Domain)	219
IQ Analysis Concepts	220
Purpose	220
Complex Spectrum Measurement	220
IQ Waveform Measurement	221
Spurious Emissions Measurement Concepts	222
Purpose	222
Measurement Method	222
Spectrum Emission Mask Measurement Concepts	223
Purpose	223
Measurement Method	223
Occupied Bandwidth Measurement Concepts	224
Purpose	224
Measurement Method	224
Burst Power Measurement Concepts	225
Purpose	225
Measurement Method	225
Channel Power Measurement Concepts	227
Purpose	227
Measurement Method	227
Adjacent Channel Power (ACP) Measurement Concepts	228
Purpose	228
Measurement Method	228
Power Statistics CCDF Measurement Concepts	229
Purpose	229
Measurement Method	229
TOI Measurement Concepts	231
Purpose	231
Measurement Method	231
Harmonics Measurement Concepts	233
Purpose	233



Measurement Method 233  
List Sweep Measurement Concepts 235  
Purpose 235



# 1 Getting Started with the Spectrum Analyzer Measurement Application

This measurement guide covers the Spectrum Analyzer and IQ Analyzer Measurement Application Modes in the following Keysight signal analyzers:

- N9040B UXA
- N9030B PXA
- N9020B MXA
- N9010B EXA
- N9000B CXA
- N8973B NFA

In this document, unless otherwise noted, the word "analyzer" is used to refer to all of the models noted above. The topics in this chapter include:

- [Technical Documentation for Your Analyzer](#)
- [Multitouch UI Controls Vs. Hardkeys](#)
- [Presetting the Signal Analyzer](#)
- [Entering Numeric Data](#)
- [Using the Measurement Panel Drop Down Box to Configure a Measurement](#)
- [Selecting the Mode, Measurement, and View](#)
- [Accessing the Help System](#)
- [Viewing a Signal](#)
- [Reading Frequency and Amplitude](#)
- [Changing the Reference Level](#)
- [Improving Frequency Accuracy](#)
- [Recommended Test Equipment](#)

**CAUTION**

Ensure that the total power of all signals at the analyzer input do not exceed +30 dBm (1 watt).

---

## Technical Documentation for Your Analyzer

The table below lists the sources of information available for your analyzer.

<b>Basic information about your signal analyzer:</b>	
Getting Started	<ul style="list-style-type: none"> <li>– Turn on process</li> <li>– Windows 7 use/configuration</li> <li>– Front and rear panel controls and connections</li> </ul>
Specifications	Specifications for all available measurement applications and optional hardware (for example, Spectrum Analyzer and Phase Noise)
Functional Testing	Quick checks for verifying instrument operation
Instrument Messages	Descriptions of Information, Warning and Error messages
<b>Measurement Applications and Help for your signal analyzer:</b> (Spectrum Analyzer Measurement Application)	
Measurement Guide	Examples of measurements using the front panel keys, Multitouch screen, or a remote interface
User's and Programmer's Reference	Provides descriptions of specific analyzer functions for the Spectrum Analyzer Measurement Application.
SA Mode Help	Embedded in the instrument's firmware. Provides context-sensitive descriptions of front panel key functionality and corresponding SCPI commands.
Web Help	A Help file that is available for download at <a href="http://www.Keysight.com">http://www.Keysight.com</a> . Allows access to descriptions of front panel key functionality and the corresponding SCPI commands.

## Multitouch UI Controls Vs. Hardkeys

This section contains information about the analyzer front panel controls used most frequently to make the measurements in this guide.

For a fuller description of the front panel controls, consult the *Getting Started Guide* or Help system in your analyzer.

**Figure 1-1** shows the front panel controls on the front panel of the analyzer.

There are two ways to configure the analyzer for making measurements via the front panel:

- The measurement and number hardkeys.
- The Multitouch User Interface (Multitouch UI). The Multitouch UI includes the Hardkey Drop Down box and other on-screen controls.

All of the functions in the Measurement Hardkey Drop Down box have equivalent hardkeys. Tapping a control has the same effect as pressing its equivalent hardkey. When making a measurement, you can use either method. In this guide, a combination of hardkeys and Multitouch UI controls are used.

Figure 1-1 Multitouch UI Controls and Hardkeys on the Front Panel

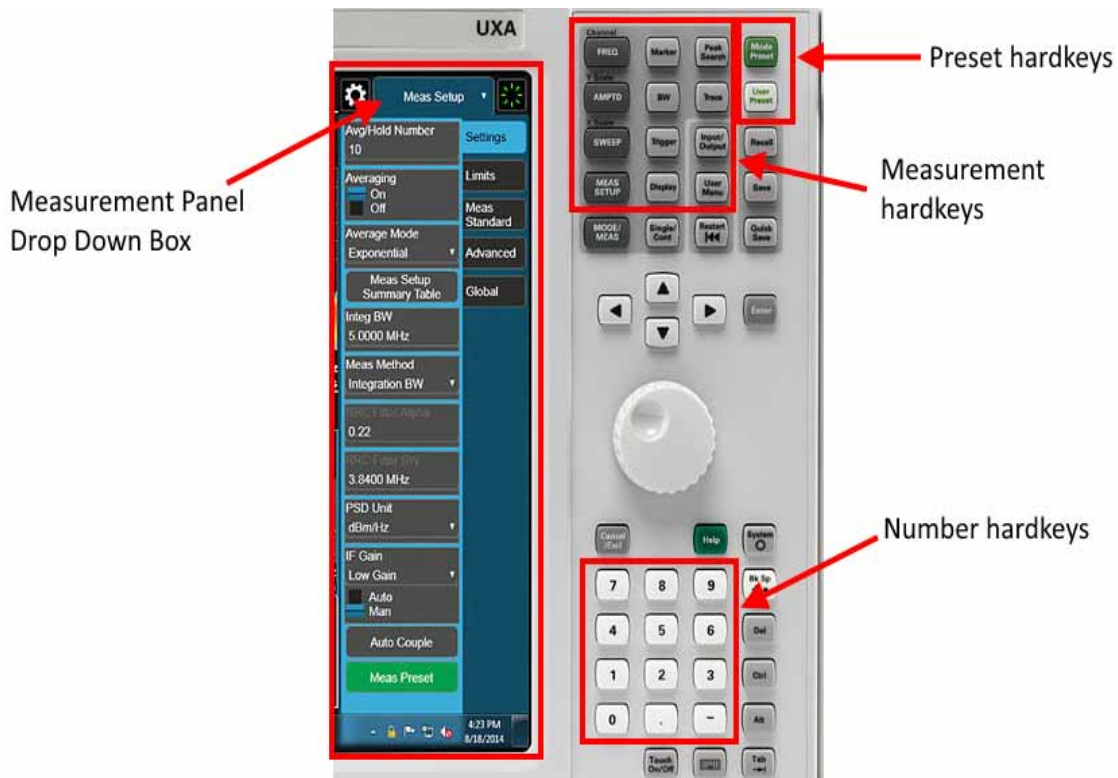

## Presetting the Signal Analyzer

The preset functions provide a convenient way to create and set the analyzer to pre-configured measurement states. The two types of presets are:

- **Default Presets.** These are set at the factory.
- **User Preset.** This is a user-defined measurement state that can be applied to the analyzer by pressing **User Preset**.

To access the **Preset** controls:

- Tap the green **Preset** icon in the upper right corner of the display (**Figure 1-2**).

Figure 1-2 Accessing the Preset Panel



The Preset functions used most frequently in this guide are described below.

**Mode Preset** Restores the analyzer to a default state for the current mode. This affects most of the parameters of the mode, but does not affect the Input/Output or System variables. Mode Preset can be set either by the hard key on the front panel, or by tapping Mode Preset on the Preset drop down box (**Figure 1-2**).

Mode Preset only presets the current screen. It does not affect any other screens.

**Restore Mode Defaults** Resets all of the additional settings of the current mode as well as all of the Mode Preset settings.

**Input/Output Preset** Resets the group of settings and data associated with the Input/Output front-panel key to their default values. These settings are not affected by a Mode Preset because they are generally associated with connections to the instrument.

Using Input/Output Preset and Restore Mode Defaults, a full preset of the current mode is performed. Note that since Input/Output Preset is a global function, it affects ALL modes.

Input/Output Preset can be executed from the Input/Output menu, from the Preset drop down, or from the Restore Defaults menu under the System key.

**User Preset** Restores the analyzer to a user-defined state. This affects all parameters in the selected mode as well as the Input/Output variables, but does not affect System variables. Available as a hardkey and Multitouch icon.

**Save User Preset** Restores the analyzer to a user-defined state. This affects all parameters in the selected mode as well as the Input/Output variables, but does not affect System variables.

**NOTE**

Mode Preset does not preset all settings in the analyzer. For a more complete preset, tap Restore Mode Defaults and Input/Output Preset in the Preset menu.

### Creating and Using a User Preset

The following steps describe how to create a user-defined preset if you frequently need a consistent measurement configuration that is not a default configuration.

Step	Action	Notes
1	Set analyzer parameters as desired.	
2	Set the current parameters as the user preset state.	a. Tap the <b>Preset</b> icon and select <b>Save User Preset</b> .
3	Select a preset state.	a. Tap the <b>Preset</b> icon (or press the <b>User Preset</b> hardkey), and select <b>User Preset</b> .

## Entering Numeric Data

When setting up or changing the parameters of a function, numeric values are often entered. There are two ways to enter numeric data into the analyzer:

- **Number hardkeys:** see [Figure 1-1](#).
- **Numeric Entry Panel:** see [Figure 1-3](#).

Both methods are described below.

Figure 1-3

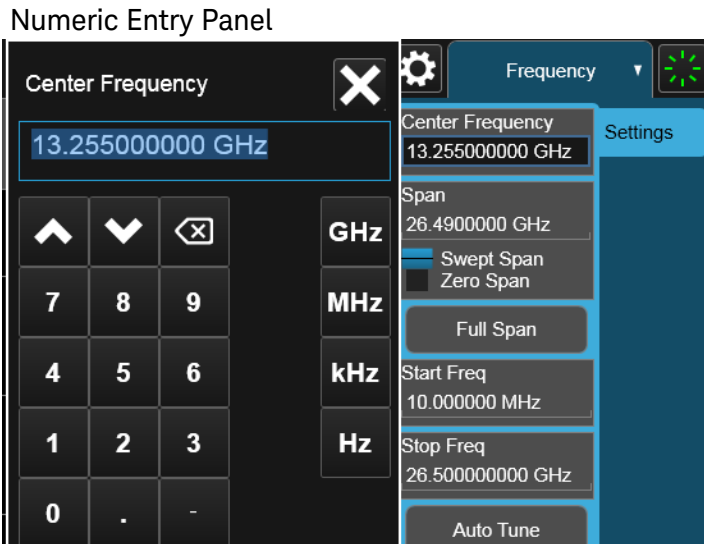

### Entering Numeric Data into the Analyzer

Step	Action	Notes
1	Select the function you want to enter numeric data into.	Select a function by doing one of the following: <ul style="list-style-type: none"> <li>▪ Press a measurement hardkey.</li> <li>▪ Tap the top of the Measurement Hardkey Drop Down box, then select the desired function.</li> </ul>
2	Activate a function.	a. On the multitouch screen, tap a function to activate it. <p>See <a href="#">Figure 1-4</a>. Center Frequency is the active function. Note that the number has a black background and blue border, indicating it's active.</p>

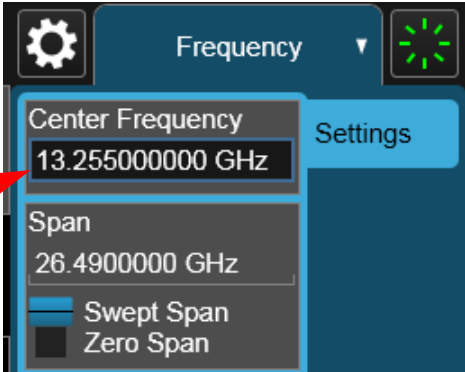

Step	Action	Notes
Figure 1-4	An Active Function	 The screenshot shows a mobile application interface for a spectrum analyzer. At the top, there is a 'Frequency' dropdown menu. Below it, the 'Center Frequency' field is highlighted with a blue border and a black background, containing the value '13.25500000 GHz'. A red arrow points to this field. Below the 'Center Frequency' field is the 'Span' field, which contains '26.4900000 GHz'. At the bottom, there are two options: 'Swept Span' (indicated by a blue bar) and 'Zero Span' (indicated by a black bar). A 'Settings' button is visible on the right side of the interface.
Note that the number has a black background and blue border. This indicates the function is active.		
3 Do you want to use the number hardkeys, or the numeric entry panel?	<b>Number hardkeys</b> , go to the next step. <b>Numerical Entry Panel</b> , go to Step 5.	
4 Enter a numerical value using the number hardkeys.	<ol style="list-style-type: none"><li>Press a number hardkey (Figure 1-1). This opens the Numerical Entry Panel (Figure 1-3).</li><li>Continue entering the desired number using the number hardkeys.</li><li>Using the Numerical Entry Panel, enter the desired units (i.e., MHz, GHz, etc.).</li><li>The numeric entry panel closes.</li></ol>	
5 Enter a numerical value using the Numerical Entry Panel.	<ol style="list-style-type: none"><li>Tap the active function to open the Numerical Entry Panel (Figure 1-3).</li><li>Enter the number.</li><li>Enter the units (MHz, GHz, etc.). The panel closes.</li></ol>	

## Using the Measurement Panel Drop Down Box to Configure a Measurement

The Measurement Panel Drop Down Box (**Figure 1-5**) is where you access and change the settings for the measurement functions. Tap the top of the box to display all of the available measurement functions, then tap on a function's name to access its settings.

Descriptions of the most commonly used functions in this guide are listed on the following pages. For more information about the front panel controls, refer to the *Getting Started Guide* or the on-screen Help system.

Figure 1-5

Accessing the Measurement Hardkey Drop Down Box

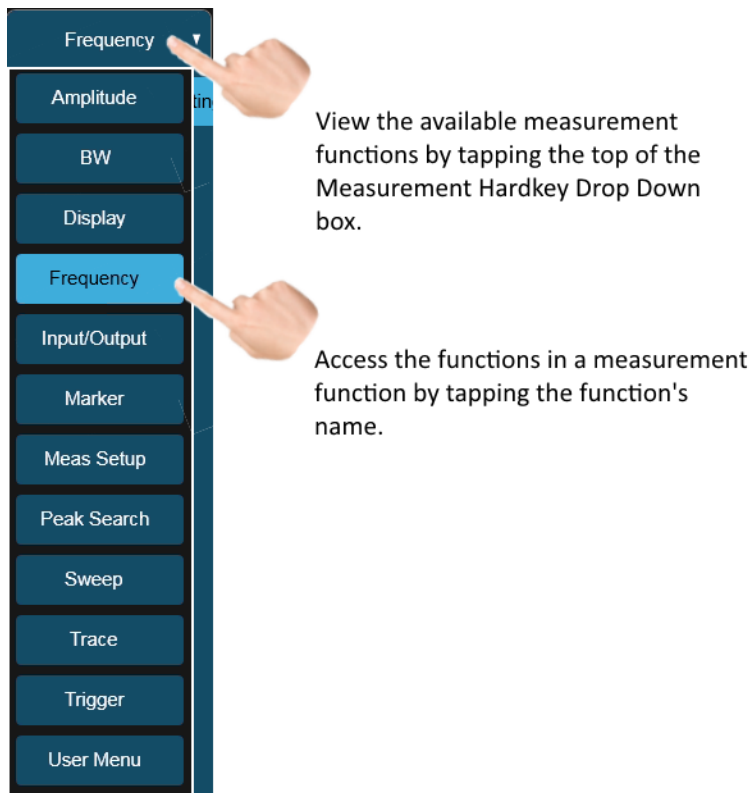

## Selecting the Mode, Measurement, and View

The Mode/Measure/View screen (Figure 1-6) is where you select the desired Mode, Measurement, and/or View.

There are two ways to access this screen:

- Press the **MODE/MEAS** hardkey (Figure 1-7).
- Tap the **Screen Tab** (Figure 1-8).

Figure 1-6 The MODE/MEAS/VIEW Selector

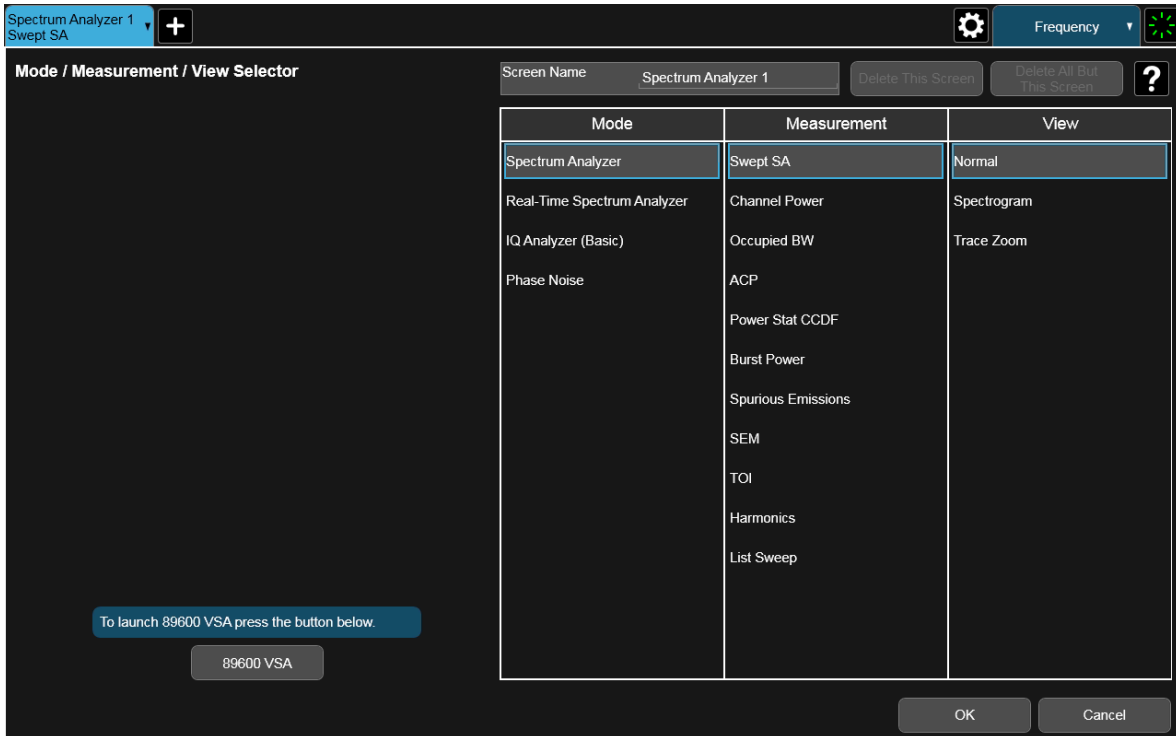

Figure 1-7

The MODE/MEAS Hardkey



Figure 1-8

The Screen Tab

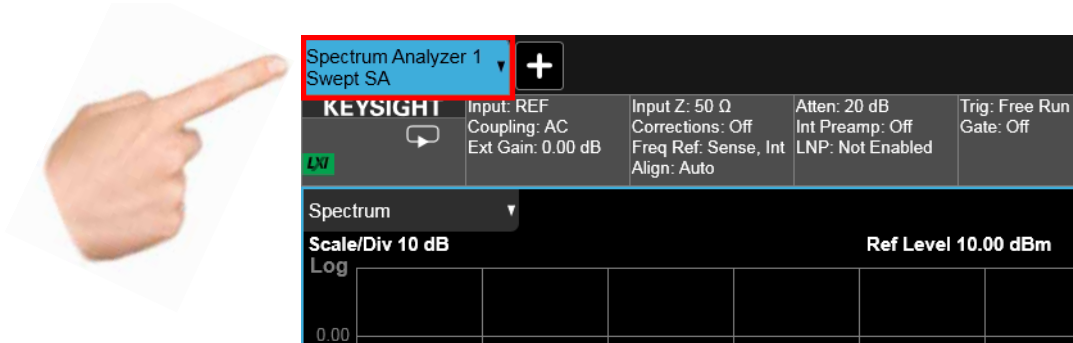

### Using the Mode/Measurement/View Selector

Step	Action	Notes
1	Open the Mode/Measurement/View selector. Or, Tap the Screen Tab.	
2	Select the desired Mode, Measurement, and View.	Select the desired Mode, Measurement and View from the corresponding columns.
3	Close the Mode/Measurement/View Selector.	Tap OK at the bottom of the screen. This action enables your selections and closes the Mode/Measurement/View selector.

## Accessing the Help System

The analyzer has an embedded Help System that can answer many of your questions about the use and function of the instrument. There are three ways to access the embedded Help System on your analyzer:

- Tap the question mark (?) in the bottom-left corner of the display (Figure 1-9).
- Press the green Help hardkey (Figure 1-10).
- Touch and hold a control on the display screen.

Figure 1-11 shows the Help screen.

Figure 1-9 Accessing The Help System: Tap the ? Icon

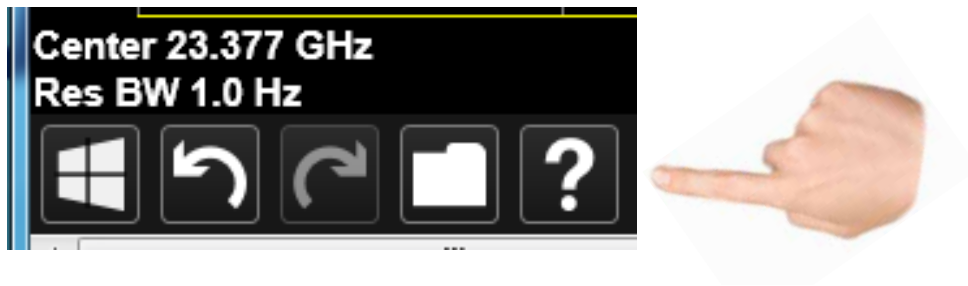
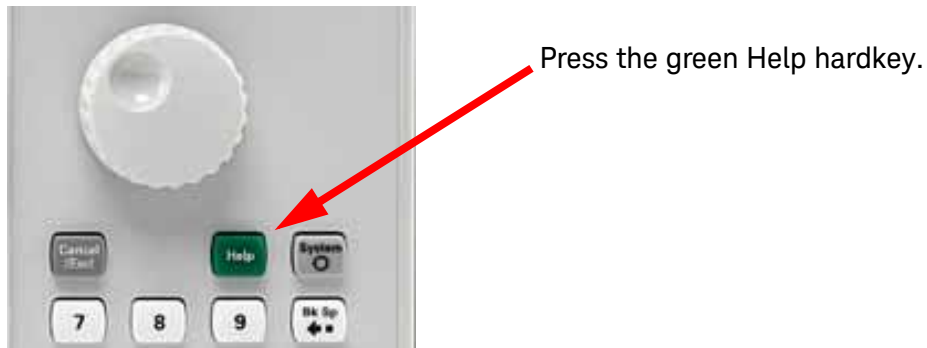
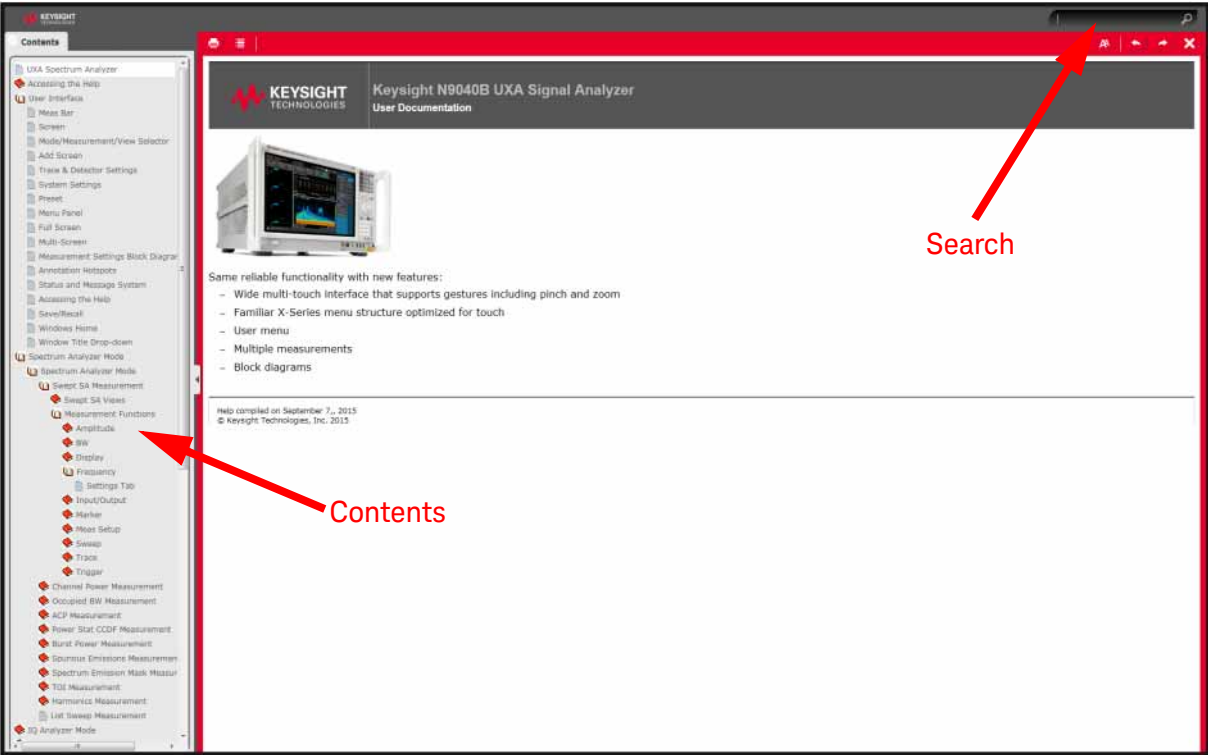

Figure 1-10 Accessing The Help System: Press the Green Help Hardkey



Getting Started with the Spectrum Analyzer Measurement Application  
Accessing the Help System

Figure 1-11 The Help System



## Viewing a Signal

Step	Action	Notes
1	Preset the analyzer.	a. Press the <b>Mode Preset</b> hardkey.
<div style="background-color: #cccccc; padding: 5px; display: inline-block;"><b>NOTE</b></div>		Mode Preset does not preset all settings in the analyzer. For a more complete preset, tap Restore Mode Defaults and Input/Output Preset in the Preset menu.
2	Route the internal 50 MHz signal to the analyzer input.	a. Press the <b>Input/Output</b> key. b. Tap the <b>RF Calibrator</b> on the menu panel and select <b>50 MHz</b> .
3	Set the reference level to 10 dBm.	a. Press the <b>AMPTD</b> key. b. Tap the <b>Ref Level</b> control and enter <b>10 dBm</b> in the pop-up window.
4	Set the center frequency to 50 MHz.	a. Press the <b>FREQ</b> key. b. Double tap the <b>Center Frequency</b> control and enter <b>50 MHz</b> .
5	Set the frequency span to 40 MHz.	a. Tap the <b>Span</b> control and enter <b>40 MHz</b> in the pop-up window.

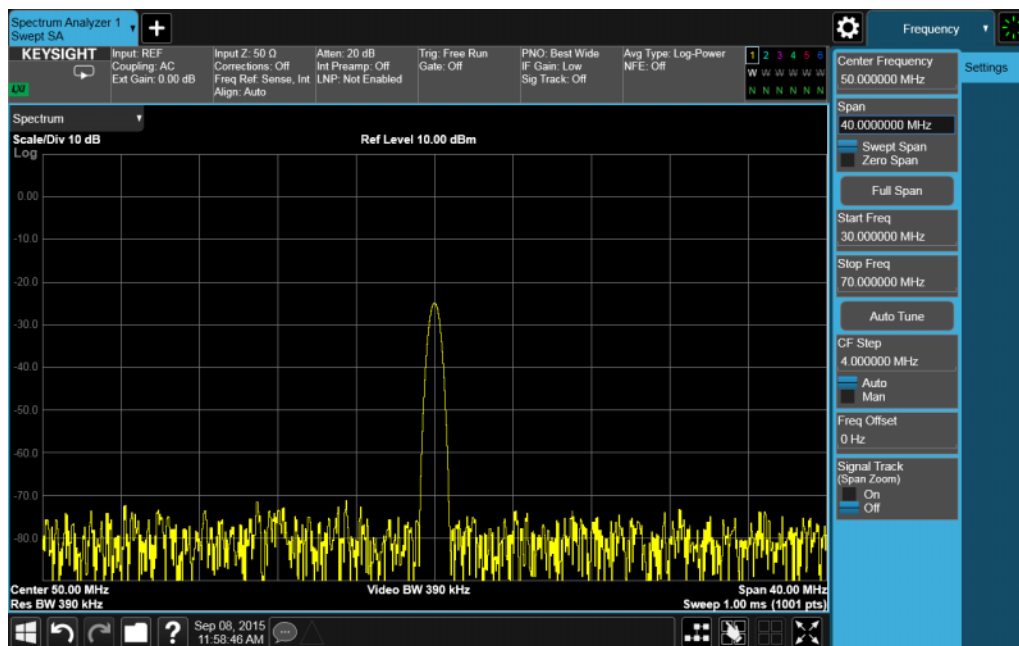

## Reading Frequency and Amplitude

Step	Action	Notes
1	Activate a marker and place it on the highest amplitude signal. Press Peak Search on the front panel; or; tap the Menu Panel Drop Down Box and select Peak Search.	The frequency and amplitude of the marker appear in the active function block in the upper-right corner of the display (see next page)

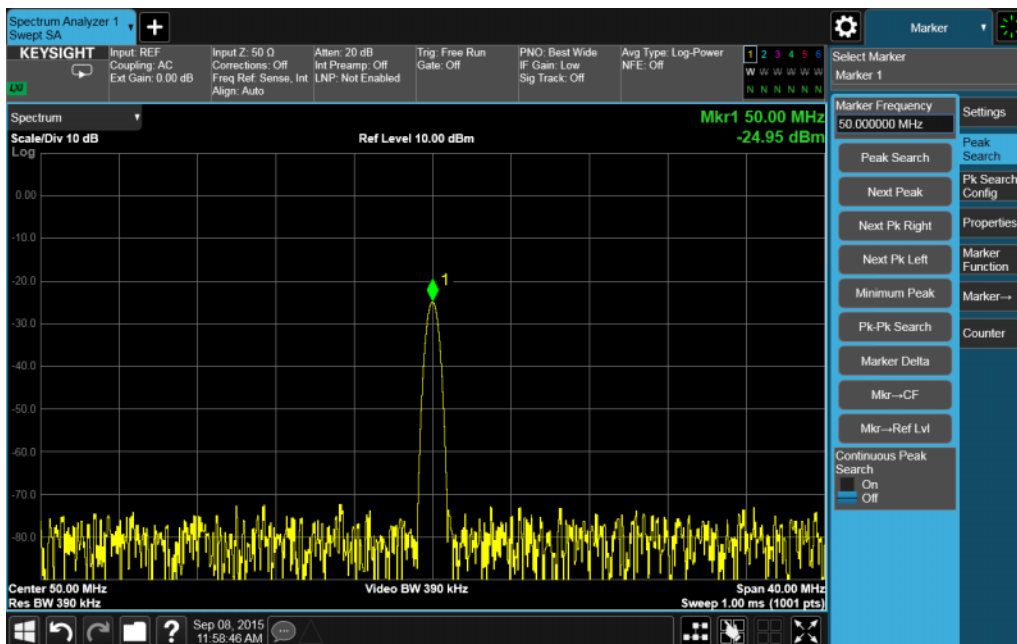



## Changing the Reference Level

Step	Action	Notes
1	Change the reference level. a. Tap <b>Mkr</b> → <b>Ref Lvl</b> .	The reference level is now the active function.

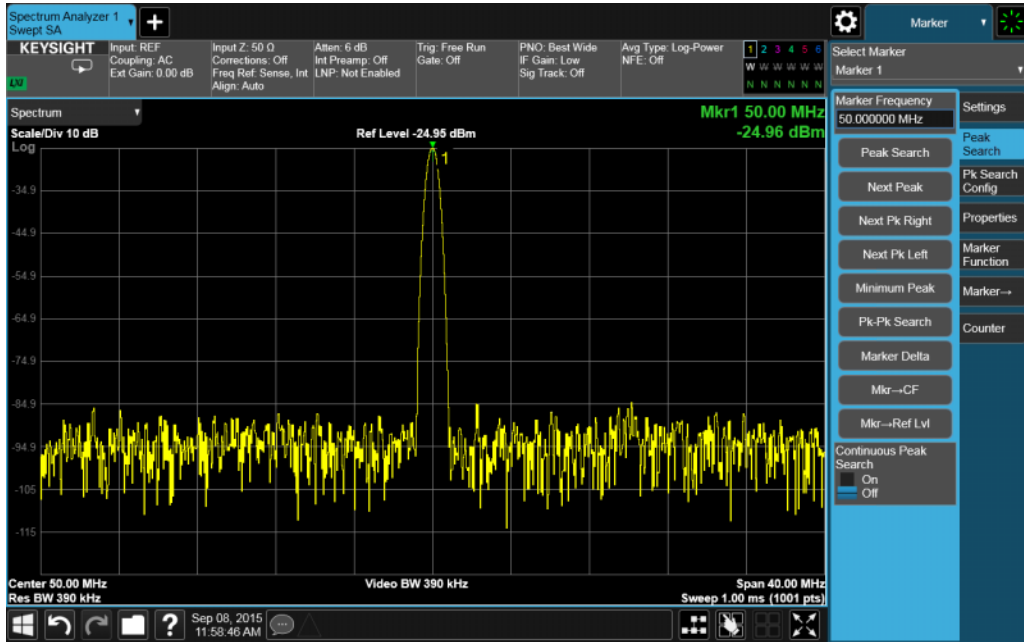

## Improving Frequency Accuracy

**NOTE**

When using the frequency count function, a display message may appear that you need to reduce the Span/RBW ratio. This message appears if the resolution bandwidth is too narrow (the ratio of the resolution bandwidth to the span is less than 0.002).

Step	Action	Notes
1	<p>Activate the Marker Count menu.</p> <p>a. Select <b>Counter</b> tab from the menu panel.</p>	
	<p>Increase the accuracy of the frequency reading in the marker annotation.</p> <p>a. Toggle <b>Marker Count</b> to the On state.</p>	<p>The marker active function annotation changes from Mkr1 to Cnt1.</p>
2	<p>Move the signal peak to the center of the display.</p> <p>a. Select <b>Peak Search</b> tab and tap <b>Mkr-&gt; CF</b>.</p>	<p>The displayed resolution in the marker annotation improves.</p>

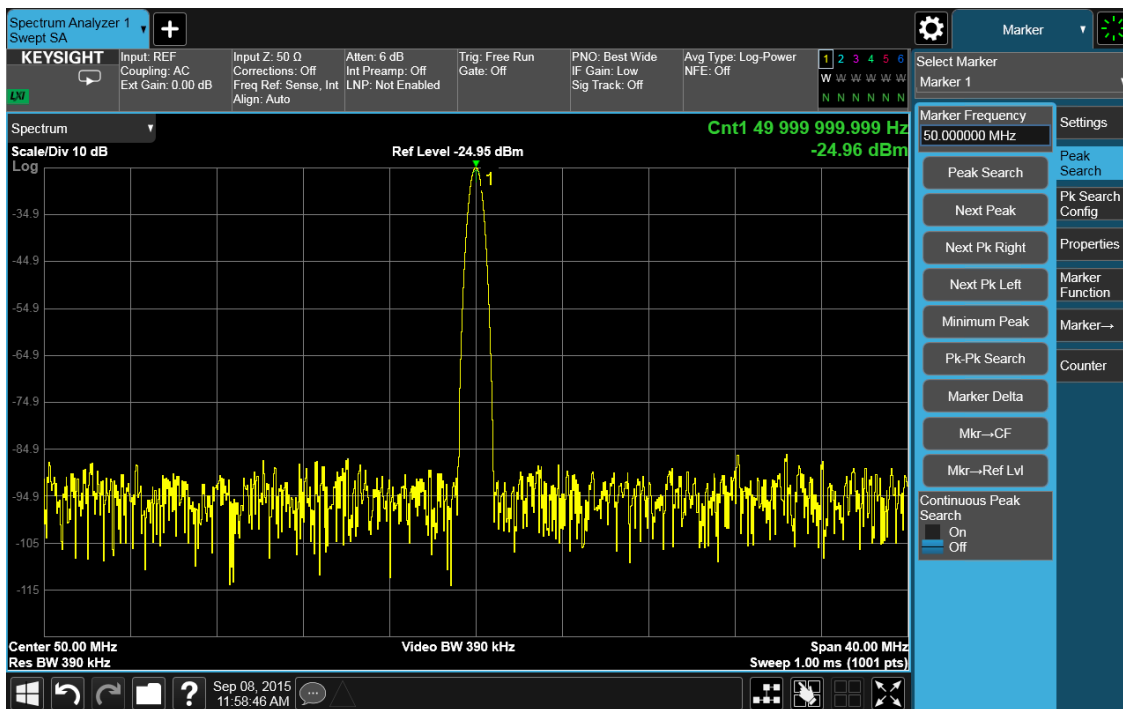

## Recommended Test Equipment

The following table lists the test equipment needed to perform the example measurements described in this manual.

Test Equipment	Specifications	Recommended Model
<b>Signal Sources</b>		
Signal Generator (Two signal generators are used in some procedures.)	9 kHz to 6.0 GHz Ext Ref Input	MXG 5182B
<b>Adapters</b>		
Type-N (m) to BNC (f) (6)		1250-0780
<b>Cables</b>		
BNC, 122 cm (48 in) (3)		10503A
<b>Miscellaneous</b>		
Directional Bridge		86205A RF Bridge

## Getting Started with the Spectrum Analyzer Measurement Application Recommended Test Equipment

## 2 Measuring Multiple Signals

### Comparing Signals Using Marker Delta

Use the delta marker function to compare the frequency and amplitude of two signals on the display grid.

In this procedure, the analyzer's 10 MHz signal is used as an input. The analyzer is set up to view the fundamental frequency and a harmonic of 10MHz. Two markers are then created, one for the fundamental peak, and another for the harmonic. These markers are used to measure the frequency and amplitude differences between the two signals ([Figure 2-1](#)).

Figure 2-1 Comparing Signals on the Display Grid

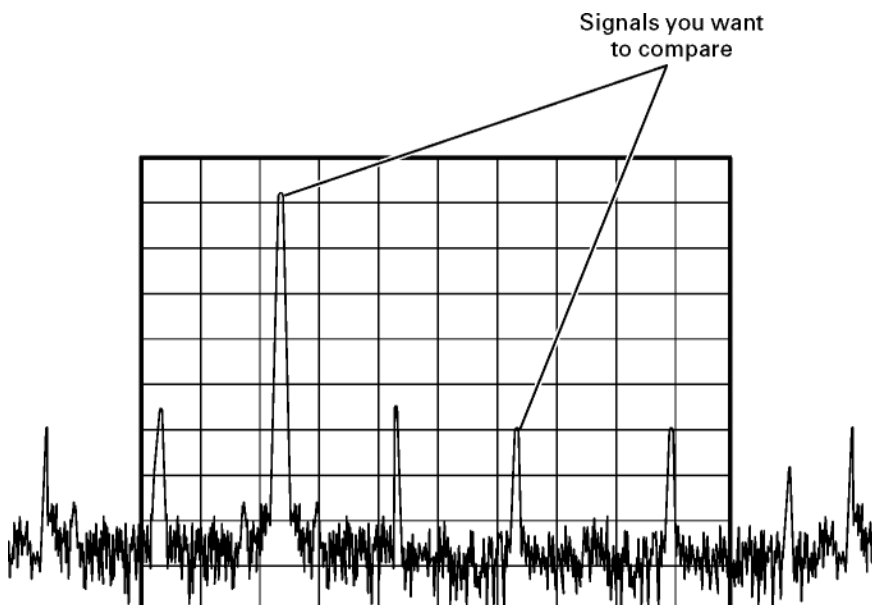

Step	Action	Notes
1	Connect the 10 MHz OUT from the rear panel to the front panel RF input.	

Measuring Multiple Signals  
Comparing Signals Using Marker Delta

Step	Action	Notes
2 Preset the analyzer.	a. Press the <b>Mode Preset</b> key.	The default Mode and Measurement of the analyzer is Spectrum Analyzer and Swept SA. If necessary, you can verify (and select) the mode by pressing the MODE/MEAS key.
<b>NOTE</b>	Mode Preset does not preset all settings in the analyzer. For a more complete preset, tap Restore Mode Defaults and Input/Output Preset in the Preset menu.	
3 Set the center frequency and span to view the 10 MHz signal and its harmonics up to 50 MHz.	a. Press the <b>FREQ</b> key. b. In the menu panel, double tap <b>Center Frequency</b> and enter <b>30 MHz</b> . c. Double tap <b>Span</b> and enter <b>50 MHz</b> .	
4 Set the analyzer reference level.	a. Press the <b>AMPTD</b> key. b. On the menu panel, double tap <b>Ref Level</b> and enter <b>20 dBm</b> .	
5 Place a marker at the highest peak on the display (10 MHz).	a. Press the <b>Peak Search</b> key Or Tap the menu panel title drop down box and select <b>Peak Search</b> from the drop down menu.	The marker should be on the 10 MHz reference signal. You can use Next Pk Right and Next Pk Left to move the marker from peak to peak.
6 Anchor the first marker and activate a second delta marker.	a. Tap the <b>Settings</b> tab. b. In the <b>Marker Mode</b> selection list, check <b>Delta</b> .	The symbol for the first marker is changed from a diamond to X2, indicating that it is the fixed marker (reference point). The second marker symbol is labeled 1Δ2, indicating it is the delta marker. When you first press the Delta key, both markers are at the same frequency with the symbols superimposed over each other. It is not until you move the delta marker to a new frequency that the different marker symbols are easy to discern.

Measuring Multiple Signals  
Comparing Signals Using Marker Delta

Step	Action	Notes
7	<p>Move the delta marker to another signal peak.</p> <p>a. Select the <b>Peak Search</b> tab.</p> <p>b. Tap <b>Next Peak</b> to place the marker on the harmonic signal.</p>	<p>See <a href="#">Figure 2-2</a>.</p> <p>The difference between the amplitude and frequency markers is displayed in the marker results area in the upper right corner of the screen.</p>

Figure 2-2 Using the Delta Marker Function

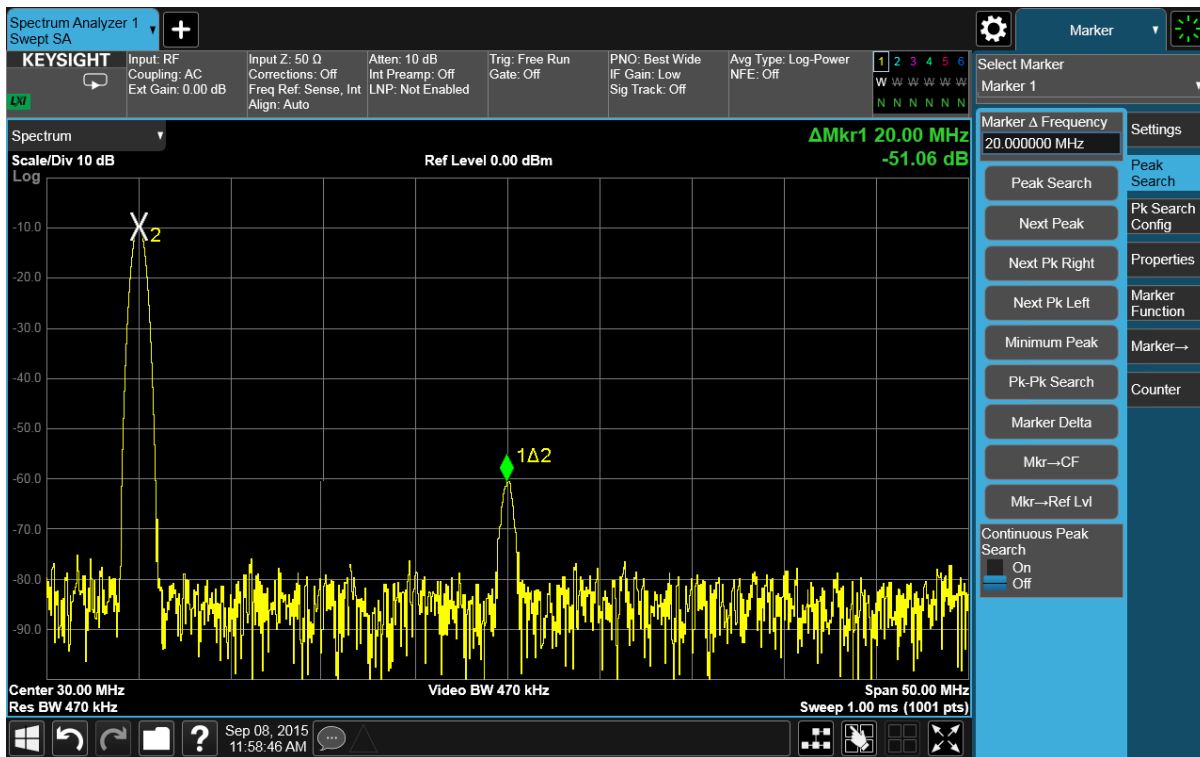

**NOTE**

The frequency resolution of the marker readings can be increased by turning on the marker count function. Tap the **Counter** tab in the **Marker** menu, then toggle **Marker Count** to **On**.

## Comparing Signals Using the Marker Delta When One is not on the Display Grid

Measure the frequency and amplitude difference between two signals when one of them is not on the display grid. This technique is useful for harmonic distortion tests when narrow span and narrow bandwidth are necessary to measure low level harmonics.

This procedure uses the analyzer's 10 MHz signal as an input. Two markers are created, one for the fundamental peak, and another for a harmonic. Due to the analyzer's settings, one of the markers is not on the display grid (see the figure below). These markers are used to measure the frequency and amplitude differences between the two signals (Figure 2-3).

Figure 2-3 Comparing Two Signals When One Signal is not on the Display Grid

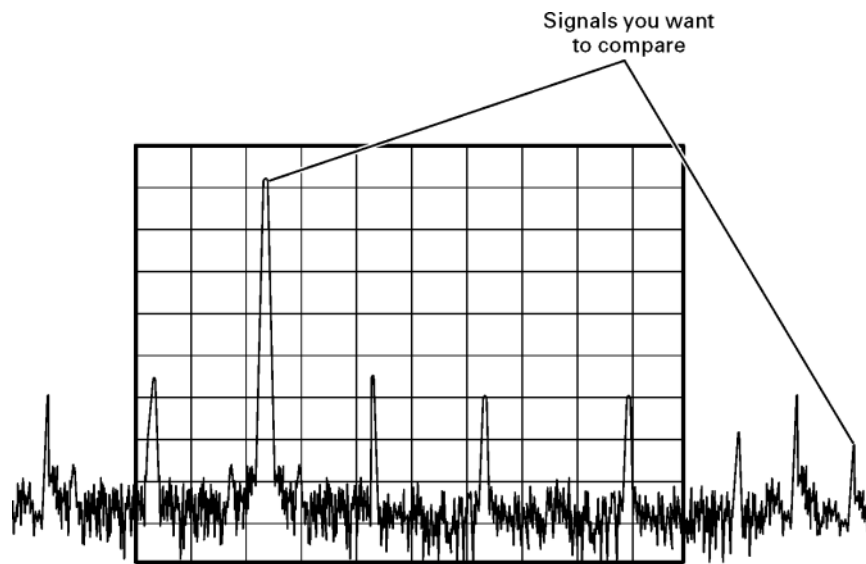

Step	Action	Notes
1	Connect the 10 MHz OUT from the rear panel to the front panel RF input.	
2	Preset the analyzer. <ul style="list-style-type: none"> <li>a. Press the <b>Mode Preset</b> key.</li> </ul>	The default Mode and Measurement of the analyzer is Spectrum Analyzer and Swept SA. If necessary, you can verify (and select) the mode by pressing the MODE/MEAS key.

**NOTE**

Mode Preset does not preset all settings in the analyzer. For a more complete preset, tap Restore Mode Defaults and Input/Output Preset in the Preset menu.



Measuring Multiple Signals  
 Comparing Signals Using the Marker Delta When One is not on the Display Grid

Step	Action	Notes	
3	Set the center frequency and span to view the 10 MHz signal and its harmonics up to 50 MHz.	a. Press the <b>FREQ</b> key. b. On the menu panel, double tap <b>Center Frequency</b> and enter <b>10 MHz</b> . c. Double tap <b>Span</b> and enter <b>5 MHz</b> .	
4	Set the analyzer reference level.	a. Press the <b>AMPTD</b> key. b. On the menu panel, double tap <b>Ref Level</b> and enter <b>0 dBm</b> .	
5	Place a marker at the highest peak on the display (10 MHz).	a. Press the <b>Peak Search</b> key Or Tap the menu panel and select <b>Peak Search</b> .	
6	Set the center frequency step size equal to the marker frequency.	a. Tap the <b>Marker -&gt;</b> tab. b. Tap <b>Mkr -&gt;CF Step</b> .	
7	Activate the marker delta function.	a. Tap the <b>Settings</b> tab. b. In the <b>Marker Mode</b> selection list, check <b>Delta</b> .	
8	Increase the center frequency by 10 MHz.	a. Press the <b>FREQ</b> key. b. Double tap <b>Center Frequency</b> and enter <b>20 MHz</b> .	The first marker and delta markers move to the left edge of the screen, at the amplitude of the first signal peak.
9	Move the delta marker to the new center frequency.	a. Press the <b>Peak Search</b> key Or Tap the menu panel and select <b>Peak Search</b> .	<b>Figure 2-4</b> shows the reference annotation for the first marker (2) at the left side of the display, indicating that the 10 MHz reference signal is at a lower frequency than the frequency range currently displayed. The delta marker (1Δ2) appears on the peak of the 20 MHz component. The delta marker results area displays the amplitude and frequency difference between the 10 and 20 MHz signal peaks.

Measuring Multiple Signals  
 Comparing Signals Using the Marker Delta When One is not on the Display Grid

Step	Action	Notes
------	--------	-------

Figure 2-4 Delta Marker with Reference Signal Off-Screen

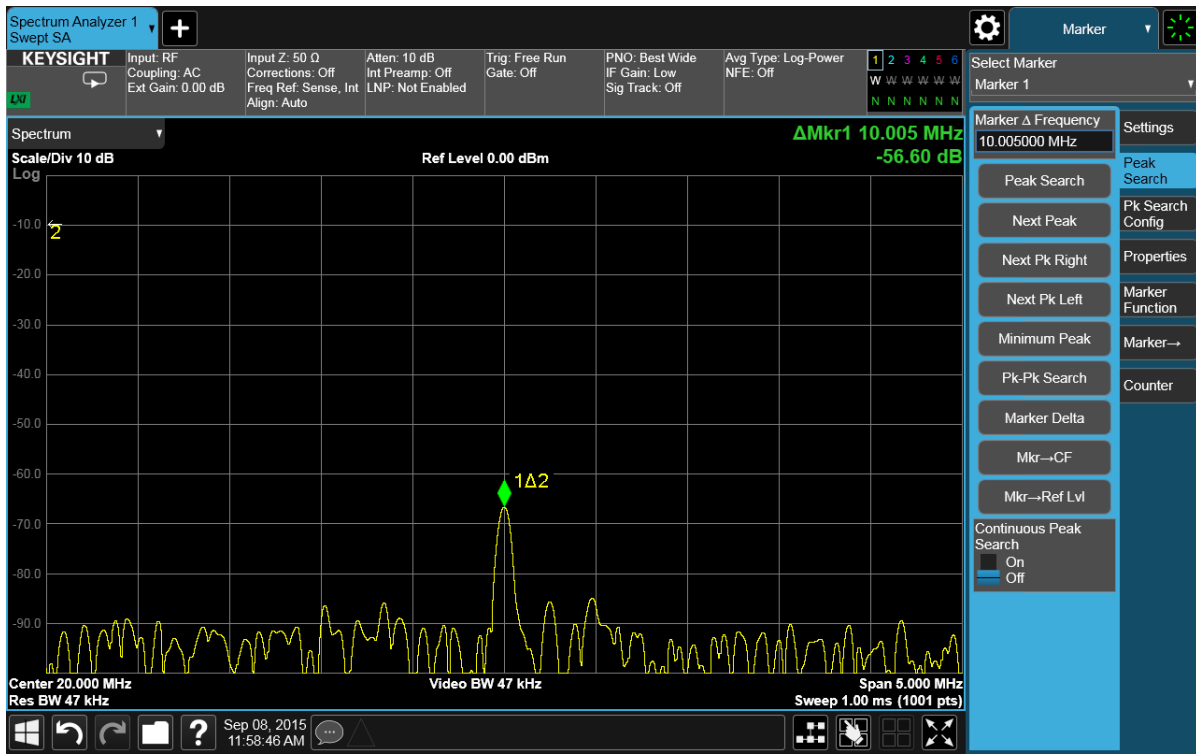

10 Turn the markers off. a. Press **Marker, Off**.

## Resolving Signals of Equal Amplitude

In this procedure, the resolution bandwidth and video bandwidth on the analyzer are decreased in order to resolve two signals of equal amplitude with a frequency separation of 100 kHz. Note that the final RBW selection used to resolve the signals is the same width as the signal separation, while the VBW is slightly narrower than the RBW.

An MXG signal source is used in this procedure. Any comparable signal source that can output a multitone signal can be used.

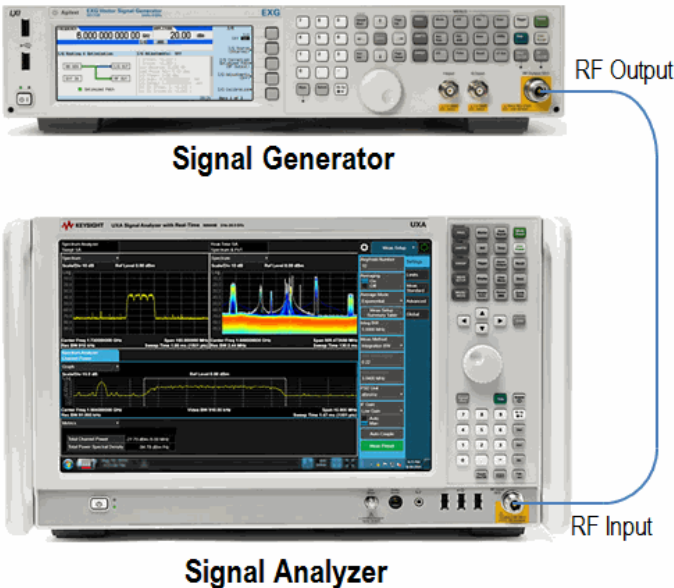
Step	Action	Notes
1	Connect the signal generator to the analyzer RF INPUT as shown.	
		
2	<p>Set up the signal source to output a multitone (two tone) signal.</p> <ol style="list-style-type: none"> <li>Set the frequency to 300.05 MHz.</li> <li>Set the amplitude to -20 dBm.</li> <li>Press <b>Mode</b> on the front panel and press the <b>Multitone</b> key.</li> <li>Turn Multitone <b>On</b>.</li> <li>Press <b>Initialize Table</b>.</li> <li>Set <b>Number Of Tones</b> to 2.</li> <li>Set <b>Freq Spacing</b> to 100 kHz.</li> <li>Press <b>Done</b>.</li> <li>Press <b>Apply Multitone</b>.</li> <li>Turn the RF Output <b>On</b>.</li> </ol>	<p>The second signal is 100 kHz higher than the first signal in frequency, with the same amplitude.</p>

Measuring Multiple Signals  
Resolving Signals of Equal Amplitude

Step	Action	Notes
3	Preset the analyzer. a. Press the <b>Mode Preset</b> key.	The default Mode and Measurement of the analyzer is Spectrum Analyzer and Swept SA. If necessary, you can verify (and select) the mode by pressing the MODE/MEAS key.
<div style="background-color: #cccccc; padding: 5px; display: inline-block;"><b>NOTE</b></div> Mode Preset does not preset all settings in the analyzer. For a more complete preset, tap Restore Mode Defaults and Input/Output Preset in the Preset menu.		
4	Set the center frequency and span. a. Press the <b>FREQ</b> key. b. Double tap <b>Center Frequency</b> and enter <b>300 MHz</b> . c. Double tap <b>Span</b> and enter <b>2 MHz</b> .	
5	Set the analyzer resolution BW. a. Press the <b>BW</b> key. b. Double tap <b>Res BW</b> and enter <b>300 kHz</b> .	A single signal peak is visible. See <a href="#">Figure 2-5</a> .

Figure 2-5 Unresolved Signals of Equal Amplitude

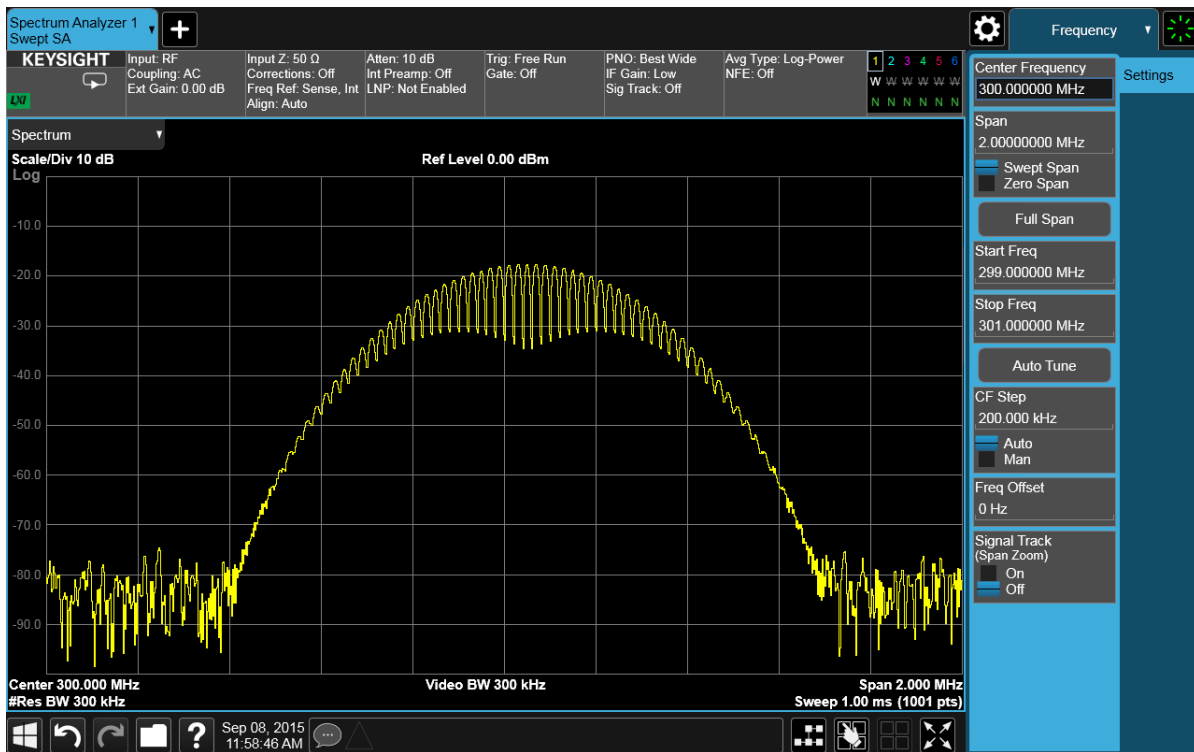

Measuring Multiple Signals  
Resolving Signals of Equal Amplitude

Step	Action	Notes
6 Change the RBW.	a. Double tap <b>Res BW</b> and enter <b>100 kHz</b> .	The RBW setting is less than or equal to the frequency separation of the two signals.
7 Decrease the video BW.	a. Double tap <b>Video BW</b> and enter <b>10 kHz</b> .	Notice that the peak of the signal has become two peaks separated by a 2.5 dB dip indicating that two signals may be present. See <a href="#">Figure 2-6</a> .

Figure 2-6 Unresolved Signals of Equal Amplitude

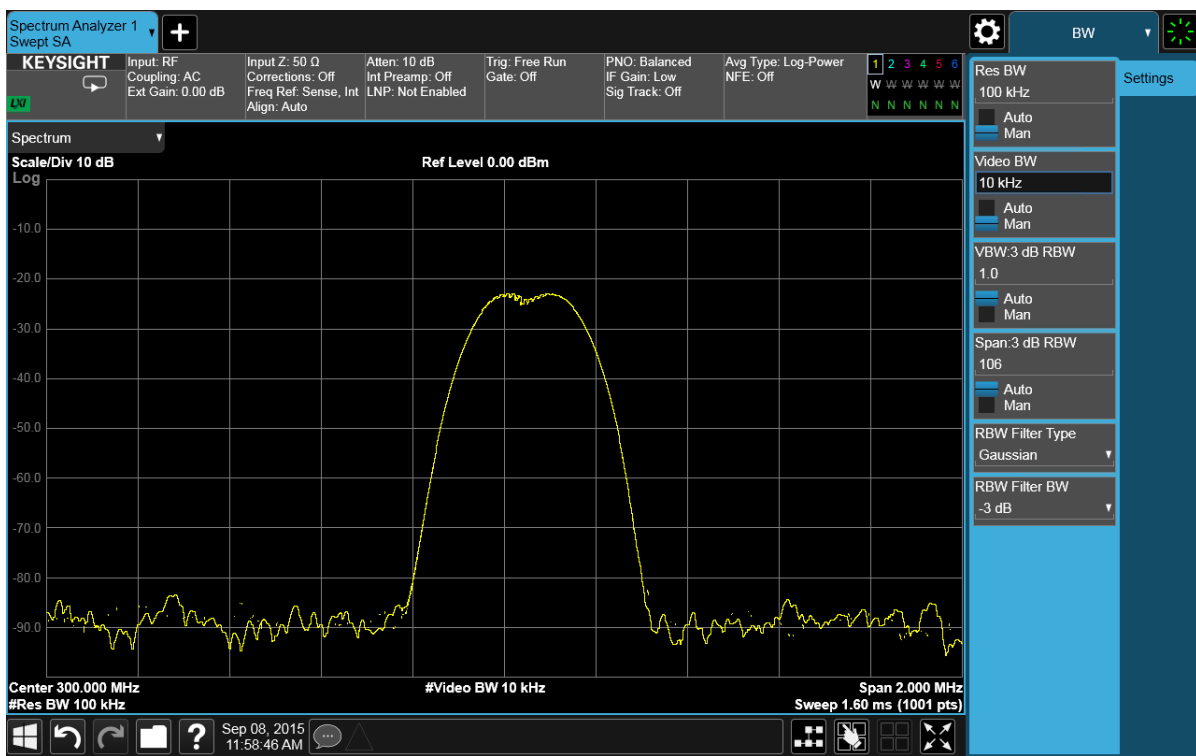

8 Decrease the RBW.	a. Double tap <b>Res BW</b> and enter <b>10 kHz</b> .	Two signals are now visible, see <a href="#">Figure 2-7</a> . If necessary, use the front-panel knob or step keys to further reduce the resolution bandwidth and better resolve the signals.
---------------------	---	--

## Measuring Multiple Signals Resolving Signals of Equal Amplitude

Step

Action

Notes

Figure 2-7 Resolving Signals of Equal Amplitude

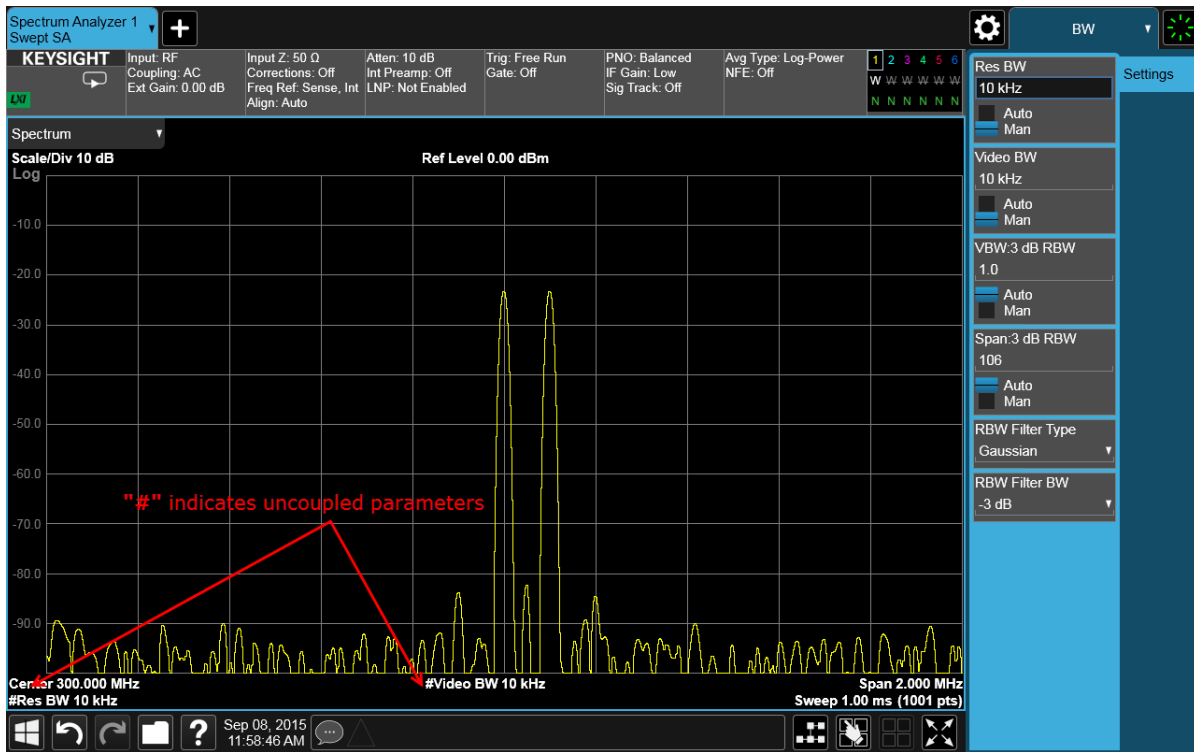

As the resolution bandwidth is decreased, the resolution of the individual signals improves, and the sweep time increases (see [“Resolving Closely Spaced Signals” on page 195](#) in the Concepts chapter for more information.) For fastest measurement times, use the widest possible resolution bandwidth. Under mode preset conditions, the resolution bandwidth is “coupled” (or linked) to the span.

Since the resolution bandwidth has been changed from the coupled value, a # mark appears next to Res BW in the lower-left corner of the screen, indicating that the resolution bandwidth is uncoupled. (For more information on coupling, refer to the Auto Couple key description in the *Keysight Technologies X-Series User’s and Programmer’s Reference*.)

### NOTE

A simple method for resolving two signals with equal amplitudes is to use the **Auto Tune** Function as follows:

- 1 Press the **Mode Preset** key.
- 2 Tap **Auto Tune**.

The two signals are fully resolved with a marker placed on the highest peak. Refer to [Figure 2-8](#).

Measuring Multiple Signals  
Resolving Signals of Equal Amplitude

Figure 2-8 Resolving Signals of Equal Amplitude

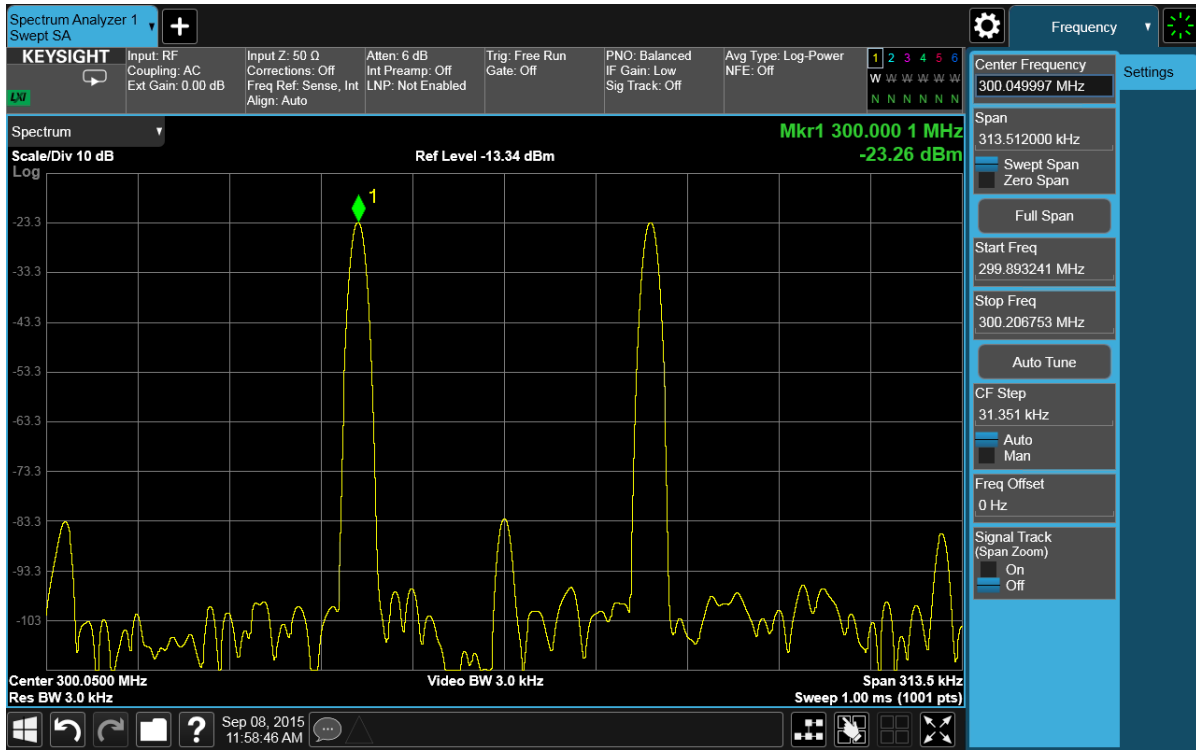

## Resolving Small Signals Hidden by Large Signals

This procedure uses narrow resolution bandwidths to resolve two input signals with a frequency separation of 50 kHz and an amplitude difference of 60 dB.

This procedure uses an MXG signal generator. Any comparable signal generator can be used.

Step	Action	Notes
1	Connect the signal generator to the analyzer RF INPUT as shown.	

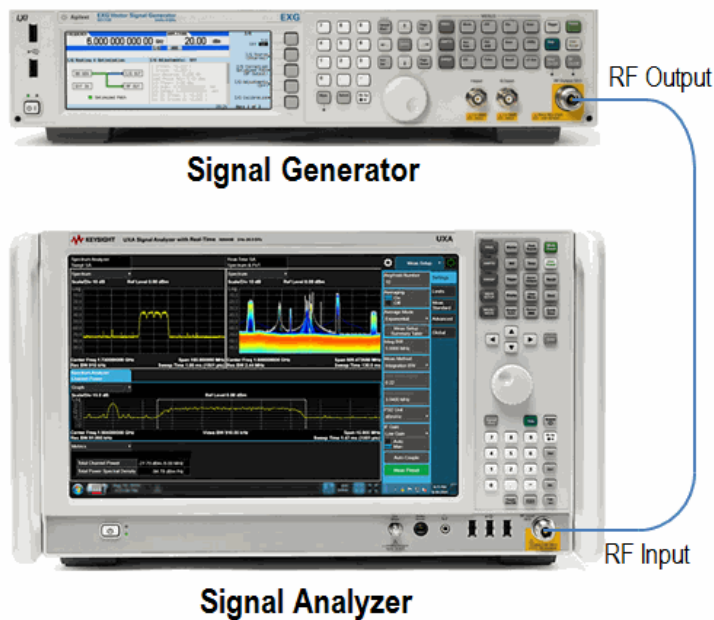



Measuring Multiple Signals  
Resolving Small Signals Hidden by Large Signals

Step	Action	Notes
<b>2</b> Set up the signal generator to output a multitone (two tone) signal.	a. Set the frequency to 300.025 MHz. b. Set the amplitude to -10 dBm. c. Press <b>Mode</b> on the front-panel and press the <b>Multitone</b> key. d. Turn Multitone <b>On</b> . e. Press <b>Initialize Table</b> . f. Set <b>Number Of Tones</b> to 2. g. Set <b>Freq Spacing</b> to 50 kHz. h. Press <b>Done</b> . i. Press <b>Edit Table</b> . j. Set the <b>Power of Tone 2</b> to -60 dB. k. Press <b>Return</b> . l. Press <b>Apply Multitone</b> .	The second signal is 50 kHz higher in frequency than the first signal, and 60 dB below the first signal.
<b>3</b> Preset the analyzer.	Press the <b>Mode Preset</b> key.	The default Mode and Measurement of the analyzer is Spectrum Analyzer and Swept SA. If necessary, you can verify (and select) the mode by pressing the MODE/MEAS key.
<b>NOTE</b>	Mode Preset does not preset all settings in the analyzer. For a more complete preset, tap Restore Mode Defaults and Input/Output Preset in the Preset menu.	
<b>4</b> Set the center frequency and span.	a. Press the <b>FREQ</b> key. b. On the menu panel, double tap <b>Center Frequency</b> and enter <b>300 MHz</b> . c. Double tap <b>Span</b> and enter <b>500 kHz</b> .	
<b>5</b> Set the analyzer resolution BW.	a. Press the <b>BW</b> key. b. On the menu panel, double tap <b>Res BW</b> and enter <b>30 kHz</b> .	

Measuring Multiple Signals  
Resolving Small Signals Hidden by Large Signals

Step	Action	Notes
6	<p>Set the 300 MHz signal peak to the reference level.</p> <p>a. Press <b>Peak Search</b> on the front panel Or Tap the menu panel and select <b>Peak Search</b>.</p> <p>b. Tap <b>Mkr -&gt;Mkr Ref Lvl</b>.</p>	<p>The analyzer's 30 kHz filter shape factor of 4.1:1 has a bandwidth of 123 kHz at the 60 dB point. The half-bandwidth, or 61.5 kHz, is NOT narrower than the frequency separation of 50 kHz, so the input signals can not be resolved. See <a href="#">Figure 2-9</a>.</p>

Figure 2-9 Signal Resolution with a 30 kHz RBW

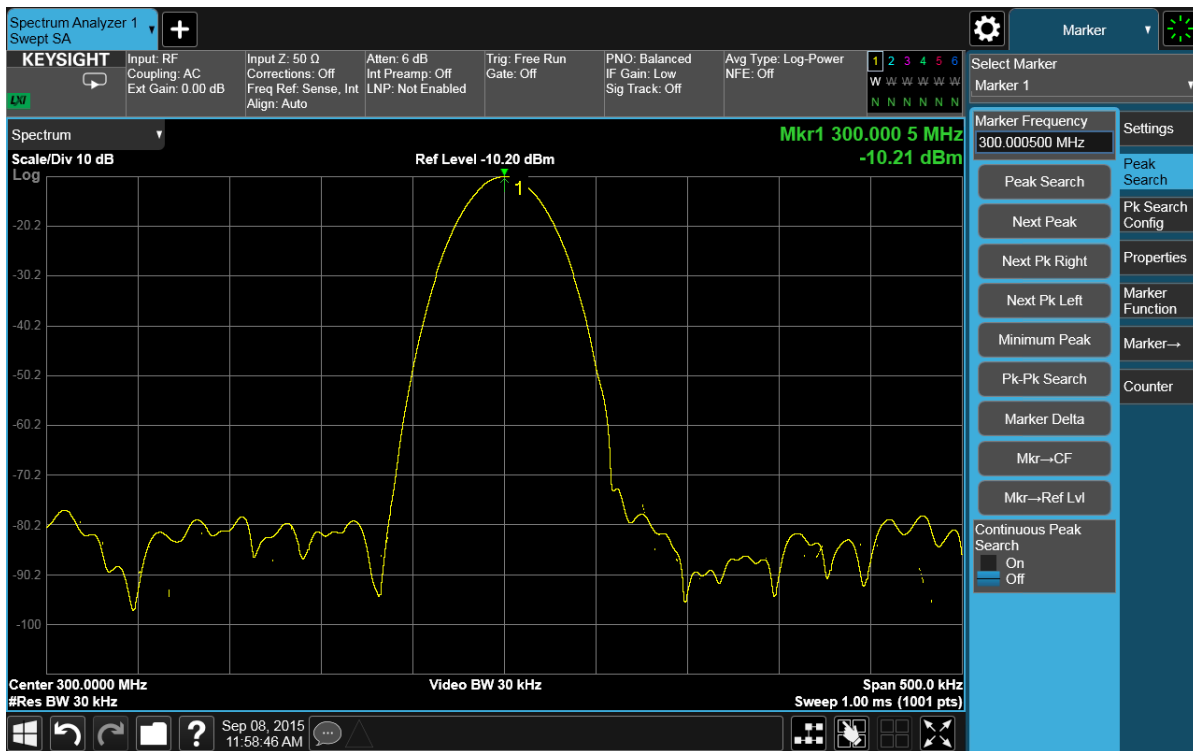

7	<p>Decrease the RBW.</p> <p>a. Press the <b>BW</b> key.</p> <p>b. On the drop down menu, double tap <b>Res BW</b> and enter <b>10 kHz</b>.</p>	<p>The reduced resolution bandwidth filter allows you to view the smaller hidden signal.</p>
8	<p>Place a delta marker on the smaller signal.</p> <p>a. Press the <b>Peak Search</b> key.</p> <p>b. On the drop down menu, tap <b>Marker Delta</b>.</p> <p>c. Tap <b>Marker Δ Frequency</b> and enter <b>50 kHz</b>.</p>	<p>The analyzer's 10 kHz filter shape factor of 4.1:1 has a bandwidth of 4.1 kHz at the 60 dB point. The half-bandwidth, or 20.5 kHz, is narrower than 50 kHz, so the input signals can be resolved. See <a href="#">Figure 2-10</a>.</p>

Measuring Multiple Signals  
Resolving Small Signals Hidden by Large Signals

Step Action Notes

Figure 2-10 Signal Resolution with a 10 kHz RBW

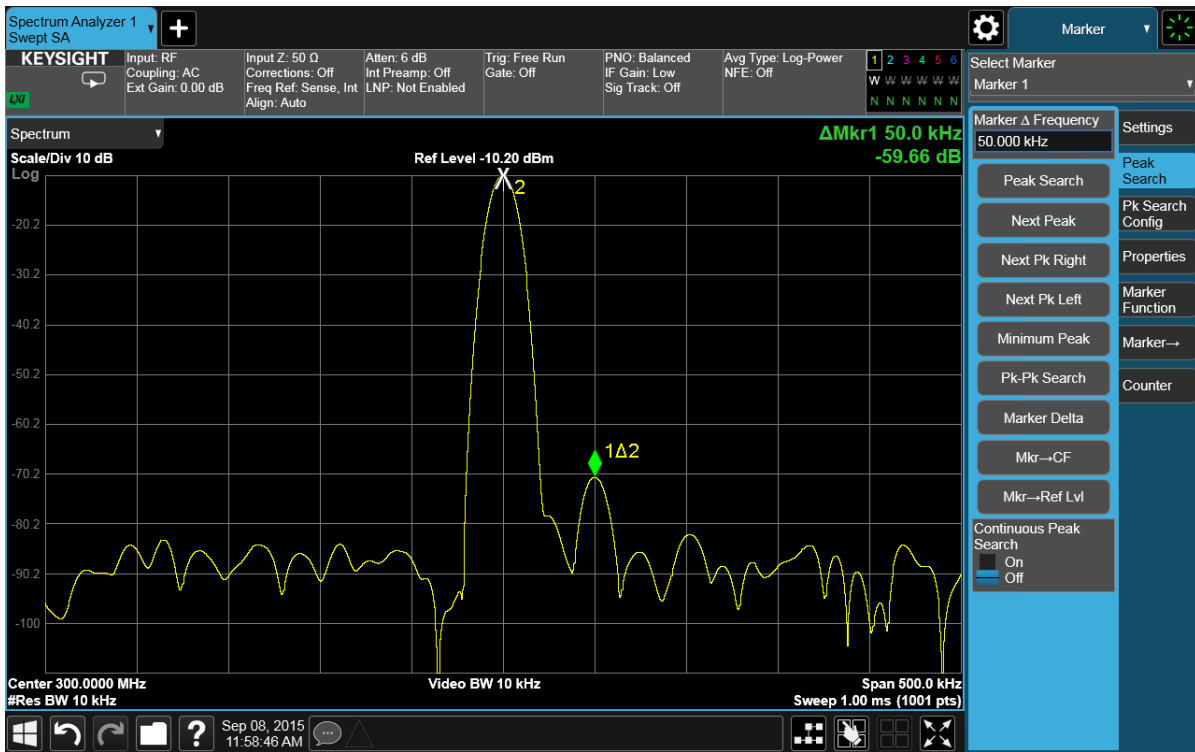

NOTE

To ensure an accurate measurement and optimum dynamic range, you can use the Auto Couple function:

- a. Press the **MEAS SETUP** key.
- b. On the menu panel, tap **Auto Couple**. See [Figure 2-11](#).

Measuring Multiple Signals  
Resolving Small Signals Hidden by Large Signals

Figure 2-11 Using Auto Couple

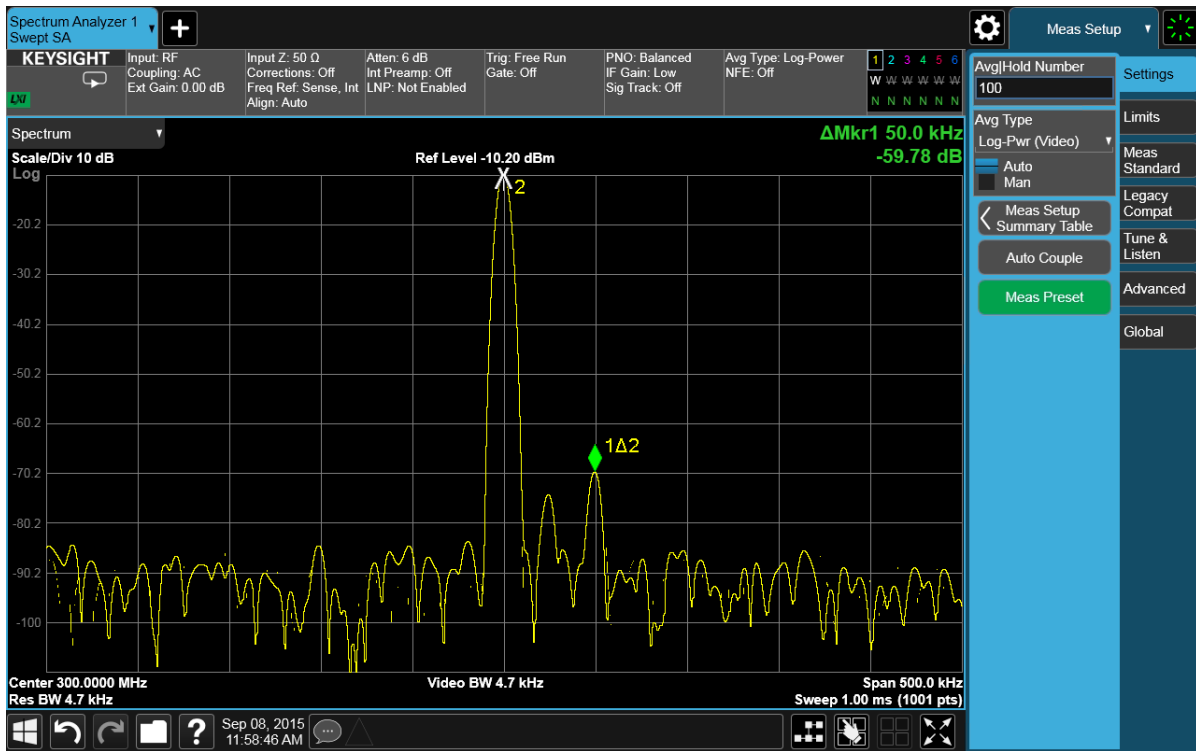

## Decreasing the Frequency Span Around the Signal

You can use the Signal Track function to quickly decrease the frequency span while keeping the signal at the center frequency. This is a fast way to magnify the area around a signal in order to identify signals that would otherwise not be resolved.

This procedure uses signal tracking with span zoom to view the analyzer 50 MHz reference signal in a 200 kHz span.

Step	Action	Notes
1 Preset the analyzer.	a. Press the <b>Mode Preset</b> key.	The default Mode and Measurement of the analyzer is Spectrum Analyzer and Swept SA. If necessary, you can verify (and select) the mode by pressing the MODE/MEAS key.
<b>NOTE</b>	Mode Preset does not preset all settings in the analyzer. For a more complete preset, tap Restore Mode Defaults and Input/Output Preset in the Preset menu.	
2 Enable the internal 50 MHz amplitude reference signal.	a. Press the <b>Input/Output</b> key. b. Tap <b>RF Calibrator</b> and select <b>50 MHz</b> .	
3 Set the center frequency and span.	a. Press the <b>FREQ</b> key. b. On the menu panel, double tap <b>Start Frequency</b> and enter <b>20 MHz</b> . c. Double tap <b>Stop Frequency</b> and enter <b>1 GHz</b> .	
4 Turn on the signal tracking function.	a. Tap <b>Signal Track (Span Zoom)</b> and toggle it to <b>On</b> .	This places a marker at the peak, moves the signal to the center of the screen, and initiates Signal Track.  See <b>Figure 2-12</b> .

Measuring Multiple Signals  
Decreasing the Frequency Span Around the Signal

Step

Action

Notes

Figure 2-12 Signal Tracking On Before Span Decrease

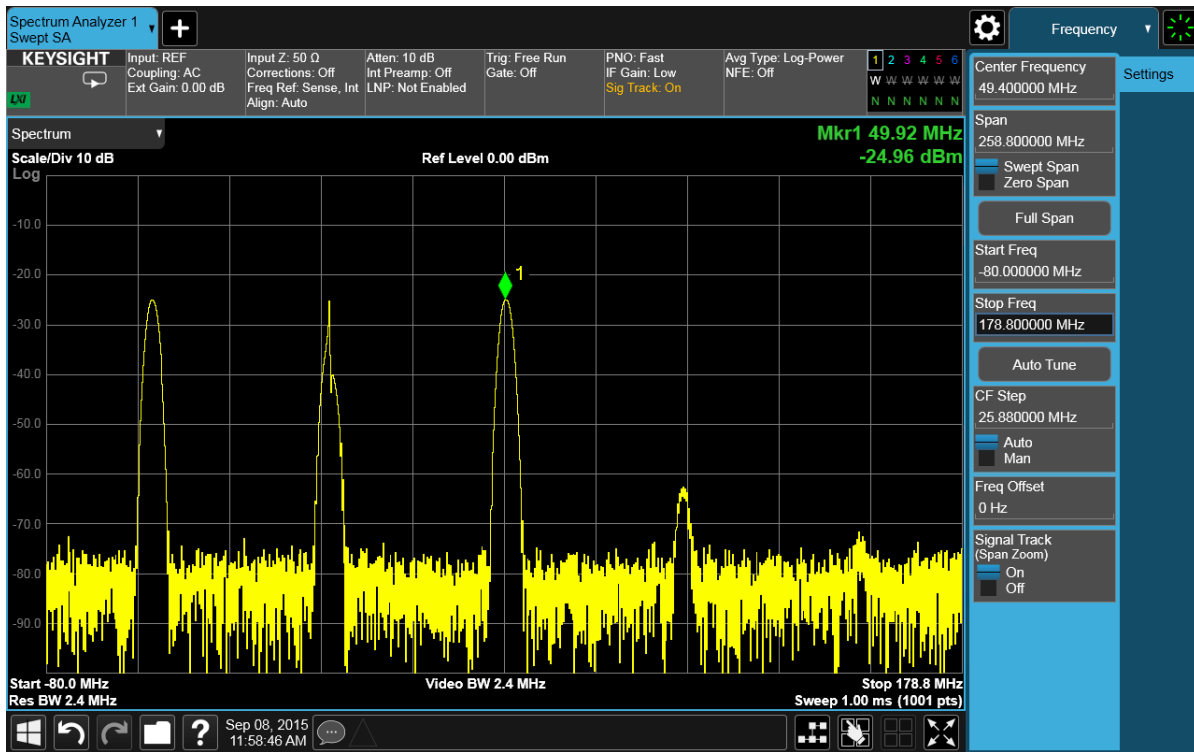

5 Set the calibration signal to the reference level.

- a. Press **Marker** on the front-panel  
Or  
Tap the menu panel and select **Marker**.
- b. Select the **Mkr->** tab.
- c. Tap **Mkr-> Ref Lvl**.

The signal track function automatically maintains the signal at the center of the screen, so you can reduce the span quickly for a closer look. If the signal drifts off of the screen as you decrease the span, use a wider frequency span.

6 Reduce the span and resolution bandwidth.

- a. Press the **FREQ** key.
- b. On the menu panel, double tap **Span** and enter **200 kHz**.

If the span change is large enough, the span decreases in steps as automatic zoom is completed. You can also use the front-panel knob or step keys to decrease the span and resolution bandwidth values.

See **Figure 2-13**.

Measuring Multiple Signals  
Decreasing the Frequency Span Around the Signal

Step	Action	Notes
------	--------	-------

Figure 2-13 Signal Tracking After Zooming in on the Signal

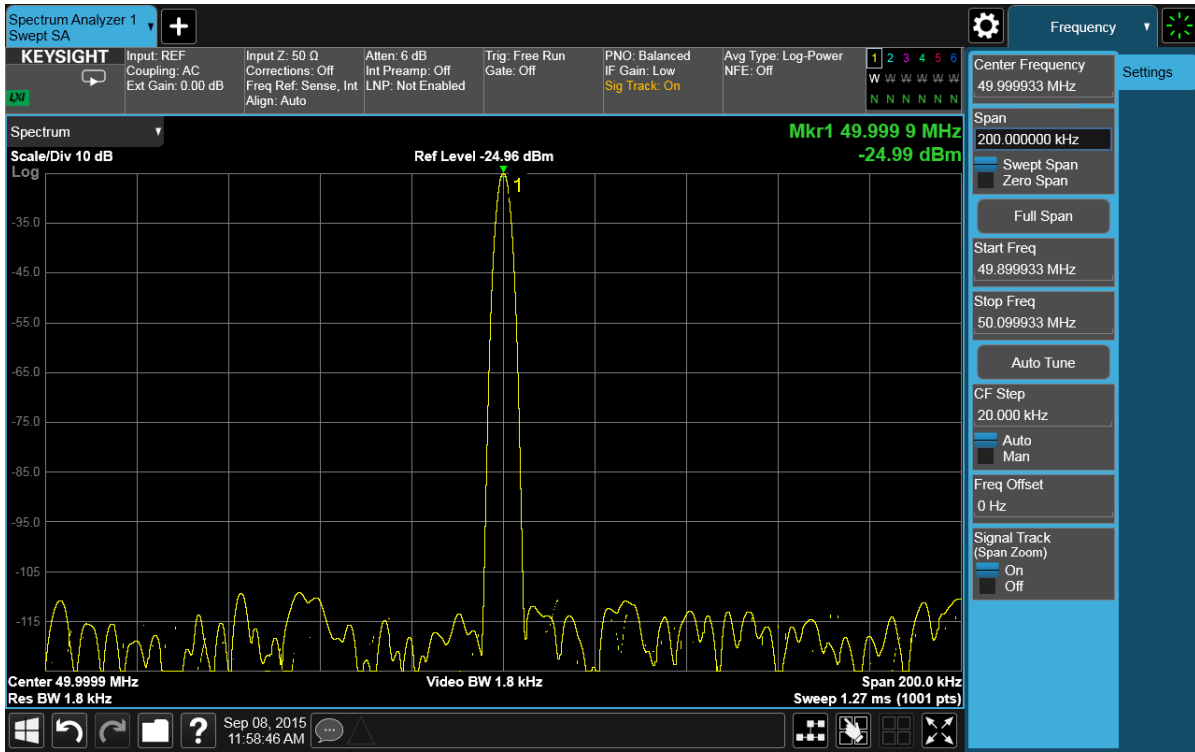

- |                             |                                       |
|-----------------------------|---------------------------------------|
| 7 Turn Signal Tracking off. | a. Toggle <b>Signal Track</b> to Off. |
|-----------------------------|---------------------------------------|

## Measure Varying Levels of Modulated Power Compared to a Reference

This procedure demonstrates how to use the Delta Band/Interval Power Marker function to measure and capture the complex modulated power of a reference device or setup, and then measure and compare the same parameters after adjustments and changes are made to the reference device or setup.

An important key to making accurate Band Power Marker measurements is to insure that the Average Type under the Meas Setup key is set to Auto.

Step	Action	Notes
1	Connect the source RF OUTPUT to the analyzer RF INPUT as shown.	
<p>The diagram illustrates the connection between a Signal Generator and a Signal Analyzer. The Signal Generator (EXG) is positioned above the Signal Analyzer (UXA). A blue line indicates the connection from the RF Output of the Signal Generator to the RF Input of the Signal Analyzer. The Signal Analyzer's screen displays a spectrum plot with several distinct peaks, representing the modulated power being measured.</p>		
2	Set up the signal source.	<ol style="list-style-type: none"> <li>a. Set up a 4-carrier W-CDMA signal (with frequency offset: -7.5 MHz, -2.5 MHz, 2.5 MHz, 7.5 MHz)</li> <li>b. Set the source frequency to 1.96 GHz.</li> <li>c. Set the source amplitude to -10 dBm.</li> </ol>
3	Preset the analyzer.	<ol style="list-style-type: none"> <li>a. Press the <b>Mode Preset</b> key.</li> </ol> <p>The default Mode and Measurement of the analyzer is Spectrum Analyzer and Swept SA. If necessary, you can verify (and select) the mode by pressing the MODE/MEAS key.</p>



Measuring Multiple Signals  
 Measure Varying Levels of Modulated Power Compared to a Reference

Step	Action	Notes
<b>NOTE</b>	Mode Preset does not preset all settings in the analyzer. For a more complete preset, tap Restore Mode Defaults and Input/Output Preset in the Preset menu.	
<b>4</b> Tune to the W-CDMA signal.	a. Press the <b>FREQ</b> key. b. On the menu panel, tap <b>Auto Tune</b> .	
<b>5</b> Set the analyzer reference level.	a. Press the <b>AMPTD</b> key. b. On the menu panel, double tap <b>Ref Level</b> and enter <b>0 dBm</b> .	
<b>6</b> Enable trace averaging.	a. Press the <b>Trace</b> key. b. In <b>Trace Type</b> selection list, check <b>Trace Average</b> .	
<b>7</b> Enable the Band Power Marker function.	a. Press <b>Marker</b> on the front-panel Or Tap the menu panel and select <b>Marker</b> . b. Select the <b>Marker Function</b> tab. c. Tap <b>Band Function</b> and select <b>Band Power</b> .	This measures the total power of the reference 4 carrier W-CDMA signal.
<b>8</b> Center the frequency of the Band/Interval Power marker.	a. Double tap <b>Marker Frequency</b> and enter <b>1.96 GHz</b> .	This centers the marker on the 4-carrier reference signal envelope.
<b>9</b> Adjust the width (or span) of the Band/Interval Power marker.	a. Double tap <b>Band Span</b> and enter <b>20 MHz</b> .	This encompasses the entire 4-carrier W-CDMA reference signal. See <b>Figure 2-14</b> .  Note the green vertical lines of Marker 1 representing the span of signals included in the Band/Interval Power measurement and the carrier power indicated in Markers Result Block.

Measuring Multiple Signals  
 Measure Varying Levels of Modulated Power Compared to a Reference

Step	Action	Notes
------	--------	-------

Figure 2-14 Measured Power of Reference 4-carrier W-CDMA Signal Using Band/Interval Power Marker

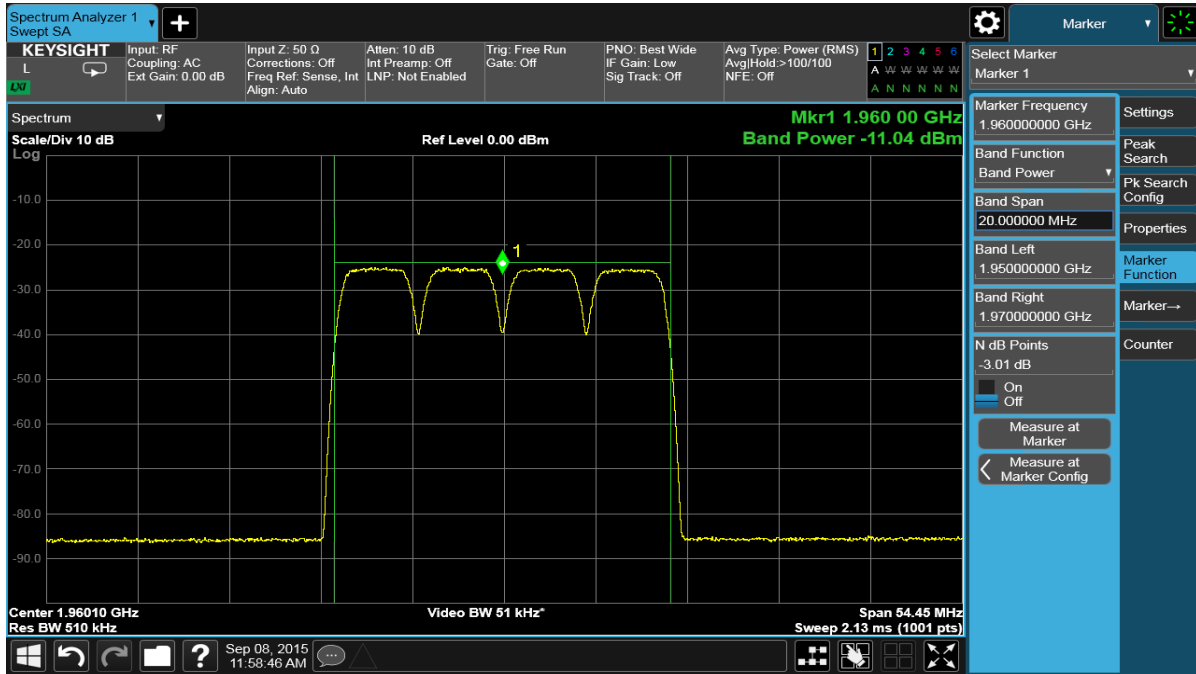

10 Enable the Delta Band Power Marker functionality.

- Select the **Settings** tab.
- In the **Marker Mode** selection list, check **Delta**.

This changes the reference Band Power Marker into a fixed power value (labeled X2) and initiates a second Band Power Marker (labeled 1Δ) to measure any changes in power levels relative to the reference Band Power Marker X2.

11 Simulate a varying power level resulting from either adjustments, changes to the reference DUT, or a different DUT by lowering the signal source power.

- Set the source amplitude to **-20 dBm**.

Note the Delta Band Power Marker value displayed in the Marker Result Block showing the 10 dB difference between the modulated power of the reference and the changed power level.

See [Figure 2-15](#).

Measuring Multiple Signals  
 Measure Varying Levels of Modulated Power Compared to a Reference

Step	Action	Notes
Figure 2-15	Delta Band Power Markers Displaying Lower Modulated Power Level Compared to a Reference	

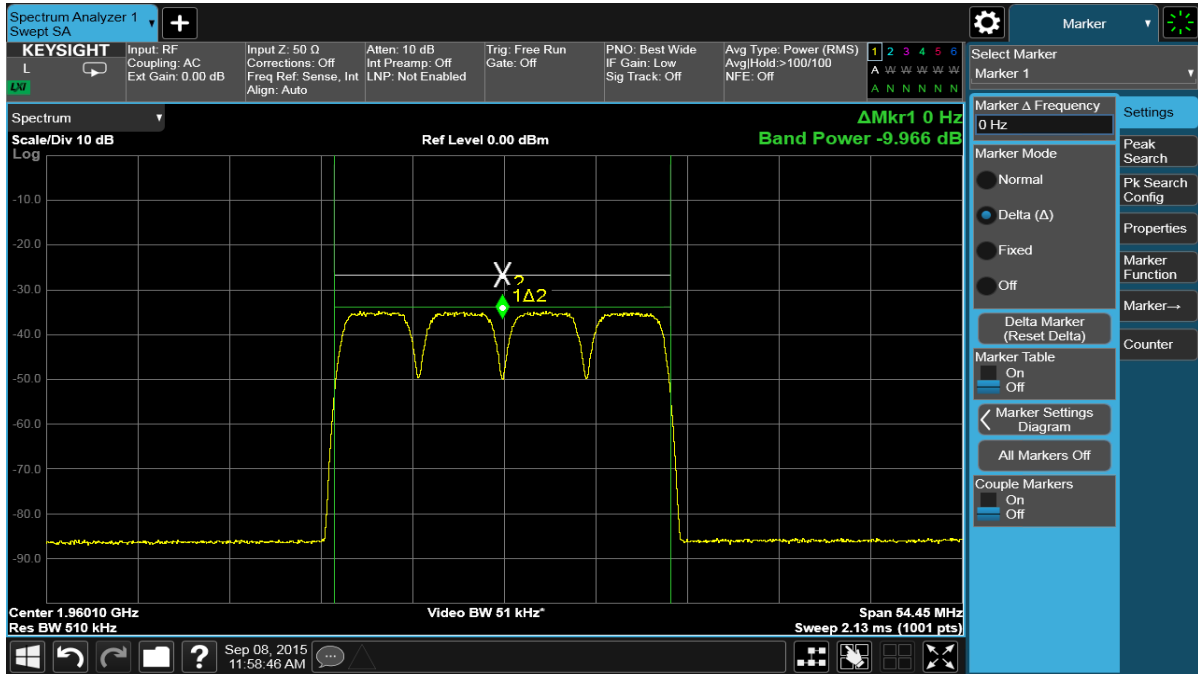

Measuring Multiple Signals  
Measure Varying Levels of Modulated Power Compared to a Reference

### 3 Measuring a Low-Level Signal

#### Reducing Input Attenuation

Low-level signal measurement can be challenging due to internally-generated noise in the signal analyzer. The measurement setup can be changed in several ways to improve the display of low-level signals.

The input attenuator of the analyzer reduces a signal passing into the instrument. If a signal is very close to the noise floor, lowering the amount of input attenuation can raise the signal above the noise.

**CAUTION**

Ensure that the total power of all input signals at the analyzer RF input does not exceed +30 dBm (1 watt).

Step	Action	Notes
1	Set up the signal generator. a. Set the frequency to 300 MHz. b. Set the amplitude to -80 dBm.	
2	Connect the source RF OUTPUT to the analyzer RF INPUT as shown below.	

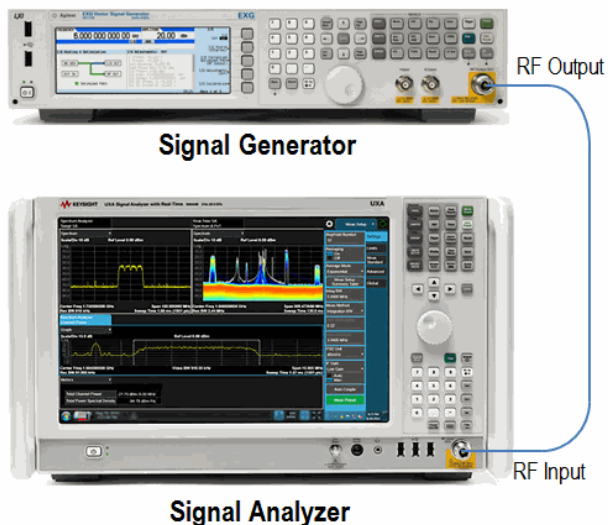

Step	Action	Notes
<b>3</b> Preset the analyzer.	a. Press the <b>Mode Preset</b> key.	The default Mode and Measurement of the analyzer is Spectrum Analyzer and Swept SA. If necessary, you can verify (and select) the mode by pressing the MODE/MEAS key.
<b>NOTE</b>	Mode Preset does not preset all settings in the analyzer. For a more complete preset, tap Restore Mode Defaults and Input/Output Preset in the Preset menu.	
<b>4</b> Set the center frequency and span.	a. Press the <b>FREQ</b> key. b. In the menu panel, double tap <b>Center Frequency</b> and enter <b>300 MHz</b> . c. Double tap <b>Span</b> and enter <b>5 MHz</b> .	
<b>5</b> Set the analyzer reference level.	a. Press the <b>AMPTD</b> key. b. In the menu panel, double tap <b>Ref Level</b> and enter <b>-40 dBm</b> .	
<b>6</b> Move the peak to the center of the display.	a. Press <b>Peak Search</b> on the front panel Or Tap the menu panel and select <b>Peak Search</b> . b. In the menu panel, tap <b>Mkr → CF</b> .	
<b>7</b> Reduce the span.	a. Press the <b>FREQ</b> key. b. On the menu panel, double tap <b>Span</b> and enter <b>1 MHz</b> .	If necessary, re-center the peak.
<b>8</b> Set the attenuation.	a. Press the <b>AMPTD</b> key. b. On the menu panel, tap the <b>Attenuation</b> tab. c. Double tap <b>Mech Atten</b> and enter <b>20 dB</b> .	Increasing the attenuation reduces the signal level, moving it closer to the noise floor. A “#” mark appears next to the <b>Atten</b> annotation at the top of the display, indicating that the attenuation is no longer coupled to other analyzer settings. See <a href="#">Figure 3-1</a> .

Measuring a Low-Level Signal  
Reducing Input Attenuation

Step	Action	Notes
------	--------	-------

Figure 3-1 Measuring a Low-Level Signal Using Mechanical Attenuation

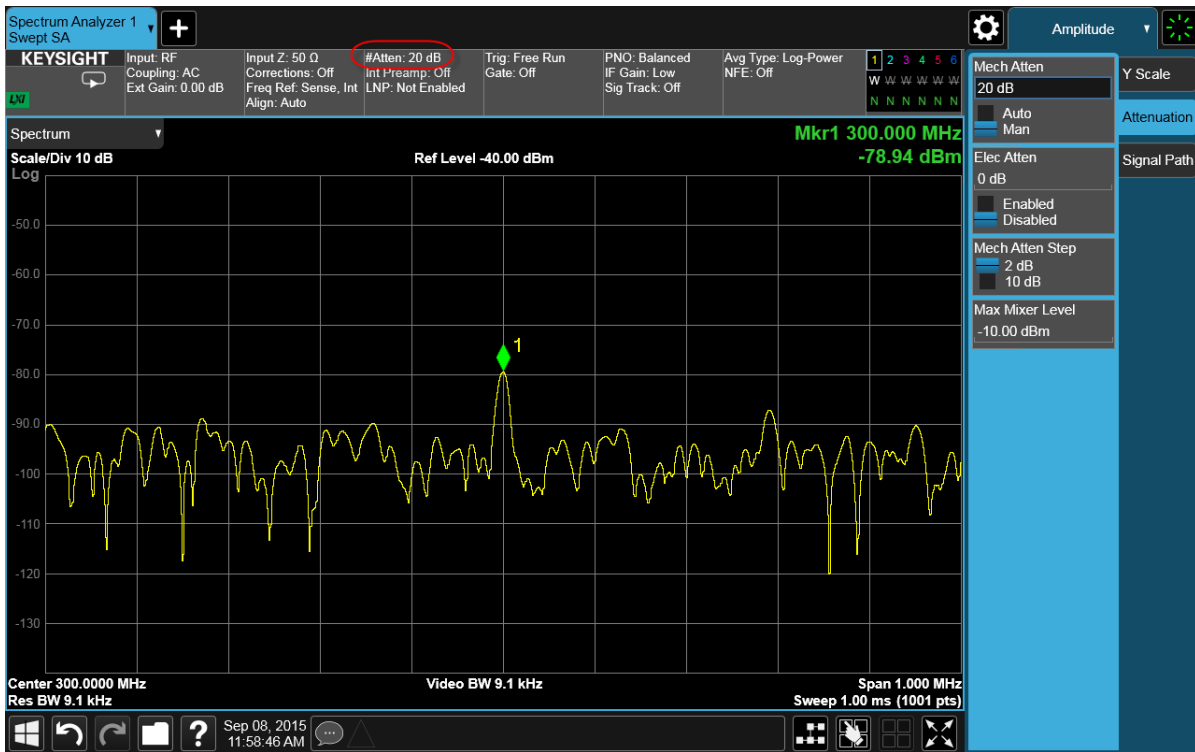

- |   |  |  |
|---|--|--|
| 9 | Change the attenuation to see the signal more clearly. | a. Double tap <b>Mech Atten</b> and enter <b>0 dB</b> . See <a href="#">Figure 3-2</a> . |
|---|--|--|

## Measuring a Low-Level Signal Reducing Input Attenuation

Step	Action	Notes
------	--------	-------

Figure 3-2 Measuring a Low-Level Signal Using 0 dB Attenuation

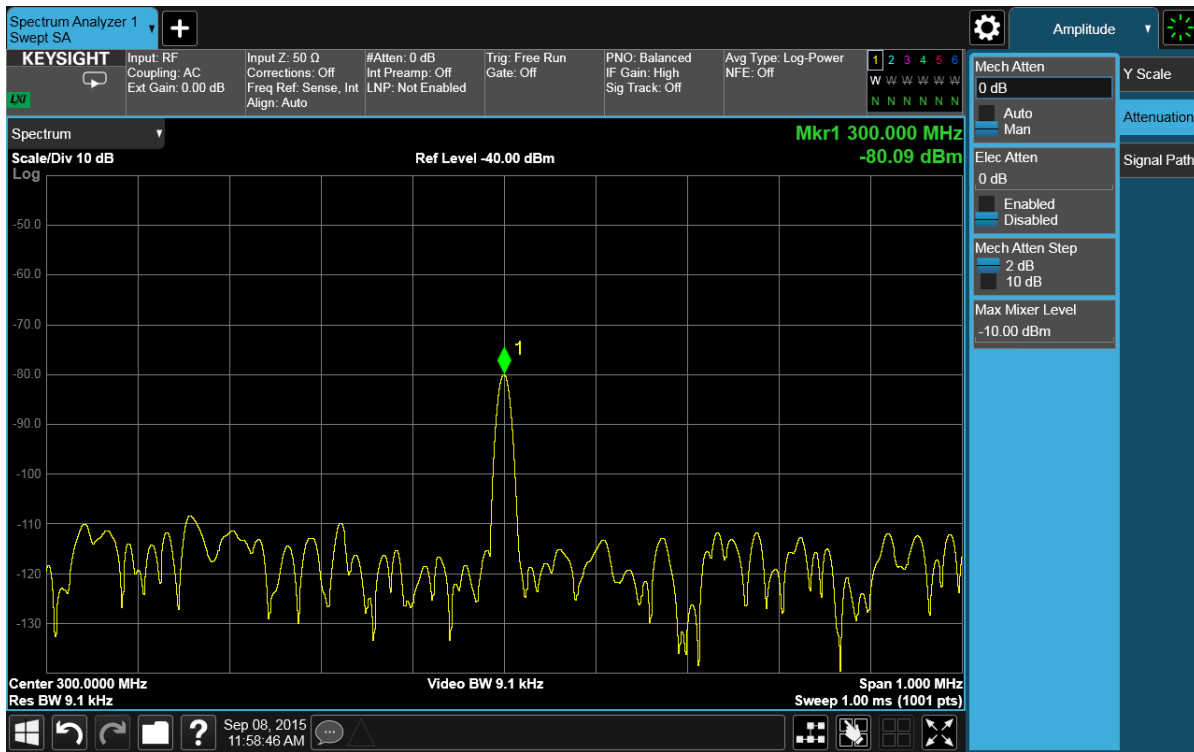

- 10 Increase the attenuation to protect the analyzer RF input.
  - a. Tap **Mech Atten** and toggle its state to **Auto**.

### CAUTION

When you finish this example, increase the attenuation to protect the analyzer RF input.



## Decreasing the Resolution Bandwidth

Resolution bandwidth settings affect the displayed level of internal noise without affecting the amplitude of continuous wave (CW) signals. Decreasing the RBW a decade lowers the noise floor 10 dB.

Step	Action	Notes
1	Set up the signal generator. <ol style="list-style-type: none"> <li>Set the frequency to 300 MHz.</li> <li>Set the amplitude to <math>-80</math> dBm.</li> </ol>	
2	Connect the source RF OUTPUT to the analyzer RF INPUT as shown.	

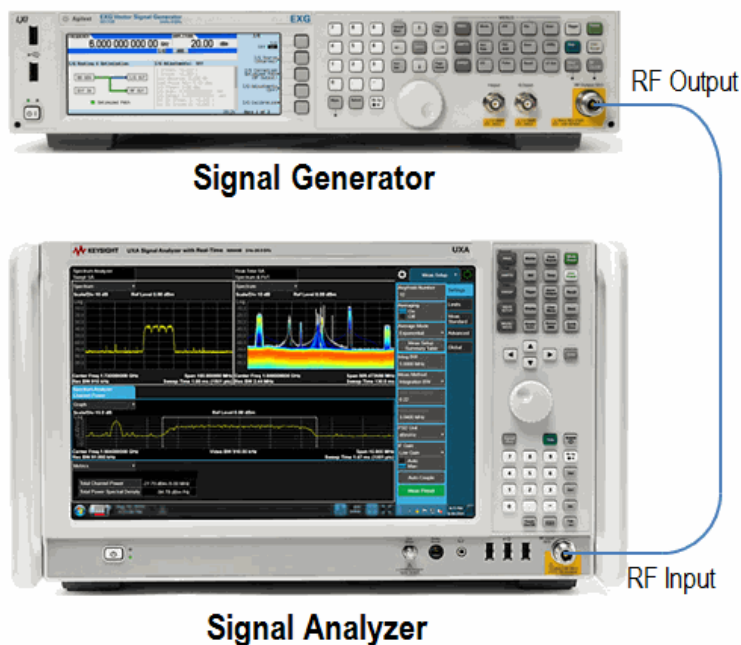

3	Preset the analyzer. <ol style="list-style-type: none"> <li>Press the <b>Mode Preset</b> key.</li> </ol>	The default Mode and Measurement of the analyzer is Spectrum Analyzer and Swept SA. If necessary, you can verify (and select) the mode by pressing the MODE/MEAS key.
---	--	---

**NOTE**

Mode Preset does not preset all settings in the analyzer. For a more complete preset, tap Restore Mode Defaults and Input/Output Preset in the Preset menu.

Measuring a Low-Level Signal  
Decreasing the Resolution Bandwidth

Step	Action	Notes
4	Set the center frequency and span. a. Press the <b>FREQ</b> key. b. In the menu panel, double tap <b>Center Frequency</b> and enter <b>300 MHz</b> . c. Double tap <b>Span</b> and enter <b>50 MHz</b> .	
5	Set the analyzer reference level. a. Press the <b>AMPTD</b> key. b. In the menu panel, double tap <b>Ref Level</b> and enter <b>-40 dBm</b> .	

Figure 3-3 Default Resolution Bandwidth

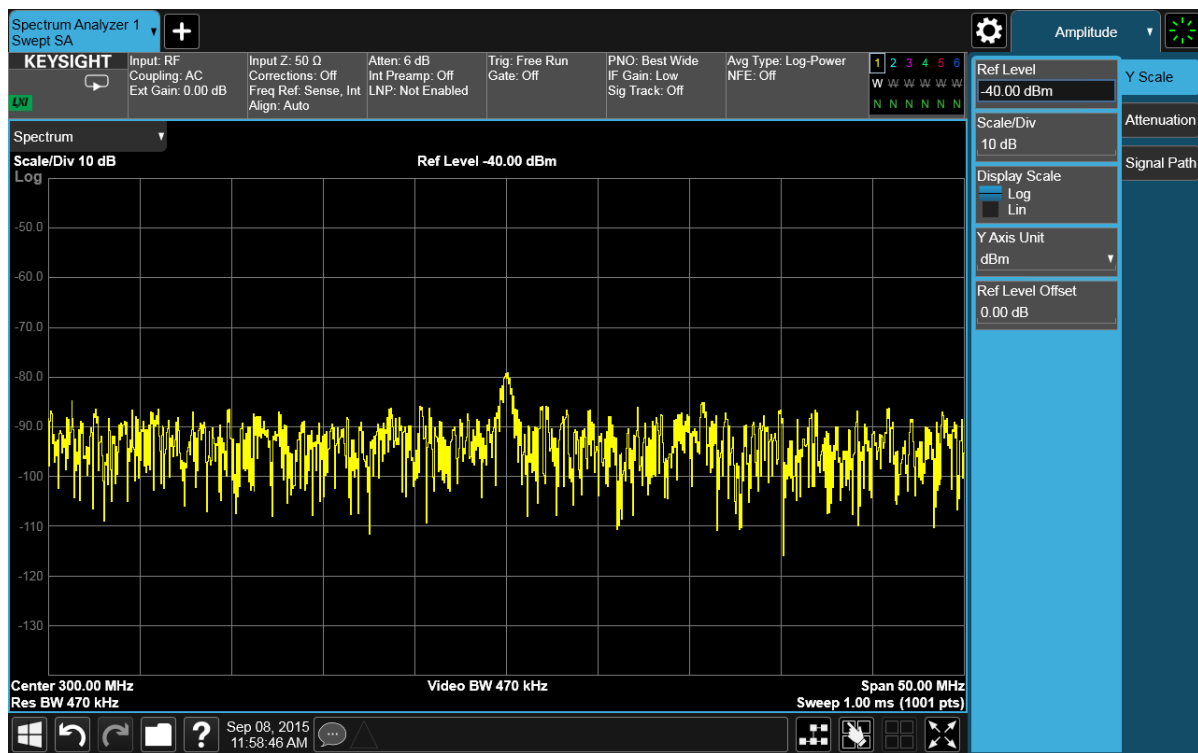

6	Decrease the RBW. a. Press the <b>BW</b> key. b. In the menu panel, double tap <b>Res BW</b> and enter <b>47 kHz</b> .	The low-level signal appears more clearly because the displayed noise level is reduced. See <b>Figure 3-4</b> .
---	--	---

## Measuring a Low-Level Signal Decreasing the Resolution Bandwidth

Step	Action	Notes
------	--------	-------

Figure 3-4 Decreasing Resolution Bandwidth

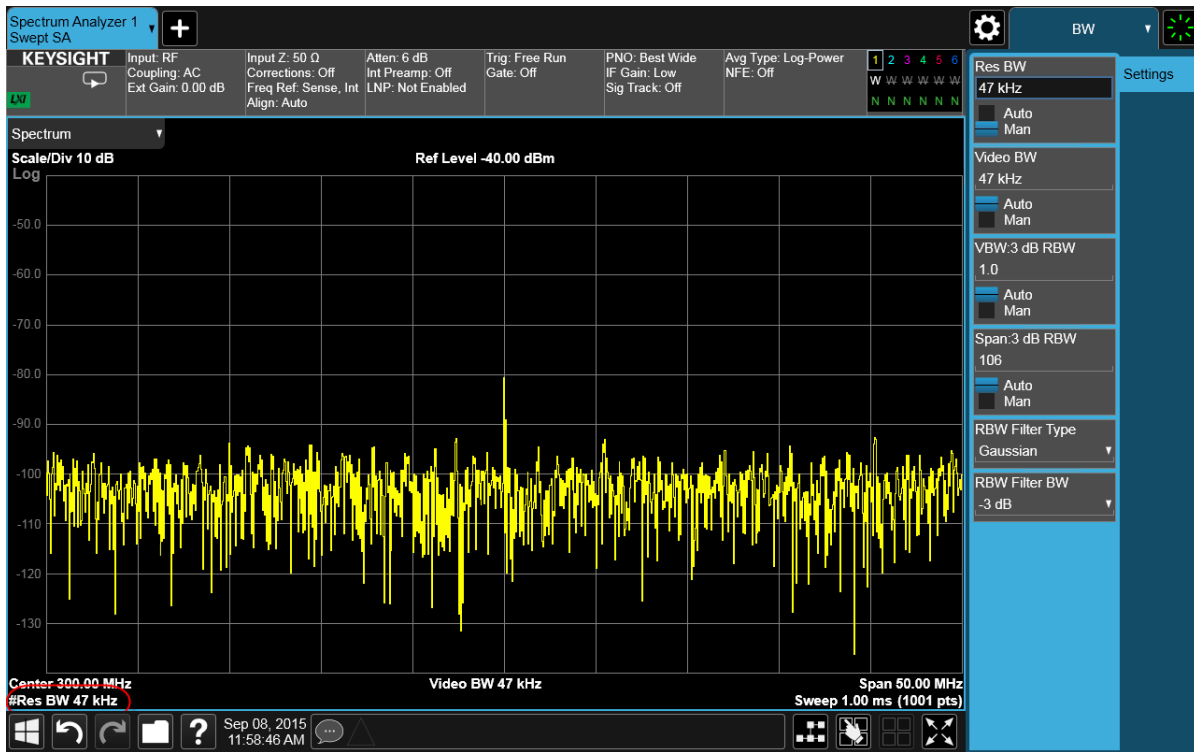

A “#” mark appears next to the Res BW annotation in the lower left corner of the screen, indicating that the resolution bandwidth is uncoupled.

**RBW Selections** You can use the step keys (up arrow or down arrow) to change the RBW in a 1–3–10 sequence.

All of the signal analyzer RBWs are digital and have a selectivity ratio of 4.1:1. Choosing the next lower RBW (in a 1–3–10 sequence) for better sensitivity increases the sweep time approximately 10:1 for swept measurements, and 3:1 for FFT measurements (within the limits of RBW). Using the knob or keypad, you can select RBWs from 1 Hz to 3 MHz in approximately 10% increments, plus 4, 5, 6 and 8 MHz.

## Using the Average Detector and Increased Sweep Time

If the analyzer noise masks low-level signals, using the average detector and increasing the sweep time smooths the noise and can improve signal visibility. Increasing the sweep time increases averaging, which increases the smoothing effect on noise.

Step	Action	Notes
1 Set up the signal generator.	a. Set the frequency to 300 MHz. b. Set the amplitude to $-80$ dBm.	
2 Connect the source RF OUTPUT to the analyzer RF INPUT as shown.		
<p>The diagram illustrates the physical connection between the two instruments. The Signal Generator is positioned above the Signal Analyzer. A blue cable connects the RF Output port on the right side of the Signal Generator to the RF Input port on the right side of the Signal Analyzer. The Signal Generator's display shows a frequency of 300.000000 MHz and an amplitude of -80.00 dBm. The Signal Analyzer's display shows a spectrum plot with a prominent peak at 300 MHz, indicating successful signal reception.</p>		
3 Preset the analyzer.	a. Press the <b>Mode Preset</b> key.	The default Mode and Measurement of the analyzer is Spectrum Analyzer and Swept SA. If necessary, you can verify (and select) the mode by pressing the MODE/MEAS key.
<b>NOTE</b>	Mode Preset does not preset all settings in the analyzer. For a more complete preset, tap Restore Mode Defaults and Input/Output Preset in the Preset menu.	
4 Set the center frequency and span.	a. Press the <b>FREQ</b> key. b. In the menu panel, double tap <b>Center Frequency</b> and enter <b>300 MHz</b> . c. Double tap <b>Span</b> and enter <b>5 MHz</b> .	

Measuring a Low-Level Signal  
Using the Average Detector and Increased Sweep Time

Step	Action	Notes
5 Set the analyzer reference level.	<ul style="list-style-type: none"> <li>a. Press the <b>AMPTD</b> key.</li> <li>b. In the menu panel, double tap <b>Ref Level</b> and enter <b>-40 dBm</b>.</li> </ul>	
6 Select the average detector.	<ul style="list-style-type: none"> <li>a. Press the <b>Trace</b> key.</li> <li>b. In the menu panel, tap the <b>Detector</b> tab.</li> <li>c. In the <b>Detector</b> selection list, check <b>Average (Log/RMS/V)</b>.</li> </ul>	The number 1 (Trace 1 indicator) in the Trace/Detector panel (in the upper right-hand corner of the display) changes from green to white, indicating that the detector has been chosen manually. In addition, the letter in the Det row has been set to "A" indicating that the Average detector has been selected. See <b>Figure 3-5</b> .
7 Increase the sweep time.	<ul style="list-style-type: none"> <li>a. Press the <b>SWEEP</b> key.</li> <li>b. In the menu panel, double tap <b>Sweep Time</b> and enter <b>100 ms</b>.</li> </ul>	You have increased the sweep time. This decreases the noise because there is more time to average the values for each of the displayed data points.
8 Change the average type to log averaging.	<ul style="list-style-type: none"> <li>a. Press the <b>MEAS SETUP</b> key.</li> <li>b. In the menu panel, tap <b>Average Type</b> and select <b>Log-Pwr (Video)</b>.</li> </ul>	Note how the noise level drops.

Measuring a Low-Level Signal  
Using the Average Detector and Increased Sweep Time

Step	Action	Notes
------	--------	-------

Figure 3-5 Varying the Sweep Time With the Average Detector

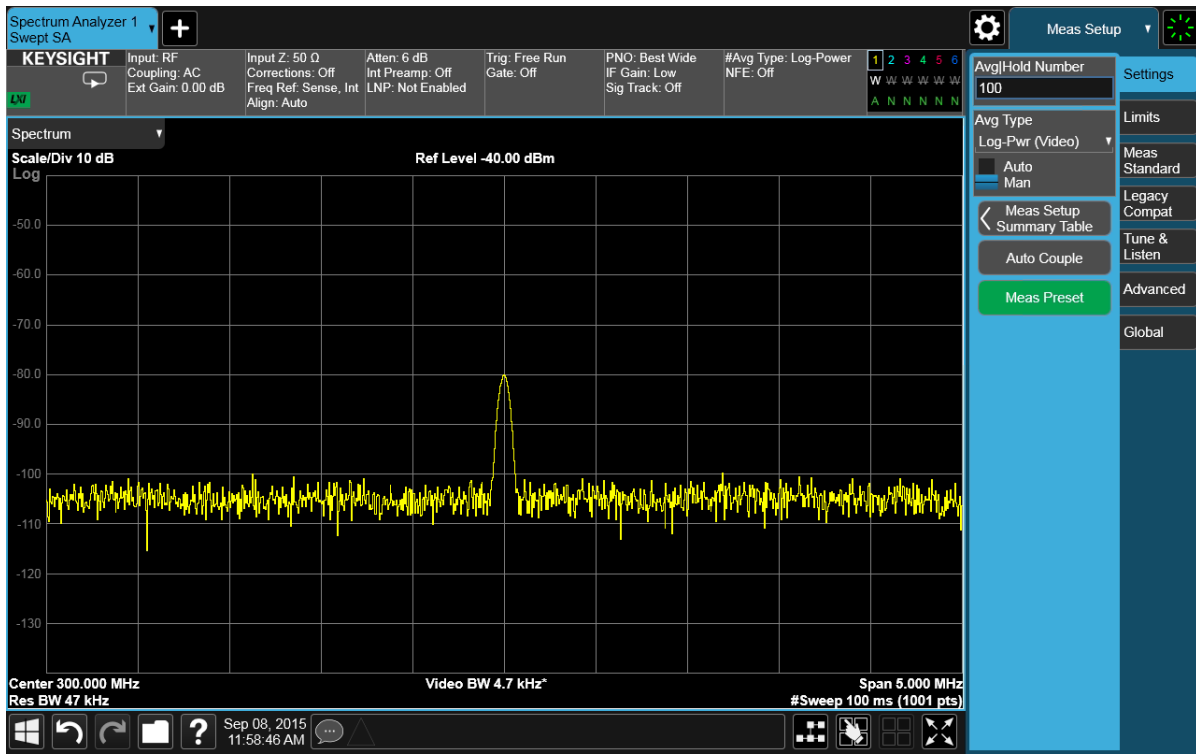

## Trace Averaging

Averaging is a digital process in which each trace point is averaged with the previous average for the same trace point. When the analyzer is autocoupled, selecting averaging changes the detection mode from normal to sample. Sample mode may not measure a signal amplitude as accurately as normal mode, because it may not find the true peak.

### NOTE

This is a trace processing function and is not the same as using the average detector (as described on [page 60](#)).

Step	Action	Notes
1	Set up the signal generator. <ol style="list-style-type: none"> <li>a. Set the frequency to 300 MHz.</li> <li>b. Set the amplitude to <math>-80</math> dBm.</li> </ol>	
2	Connect the source RF OUTPUT to the analyzer RF INPUT as shown.	

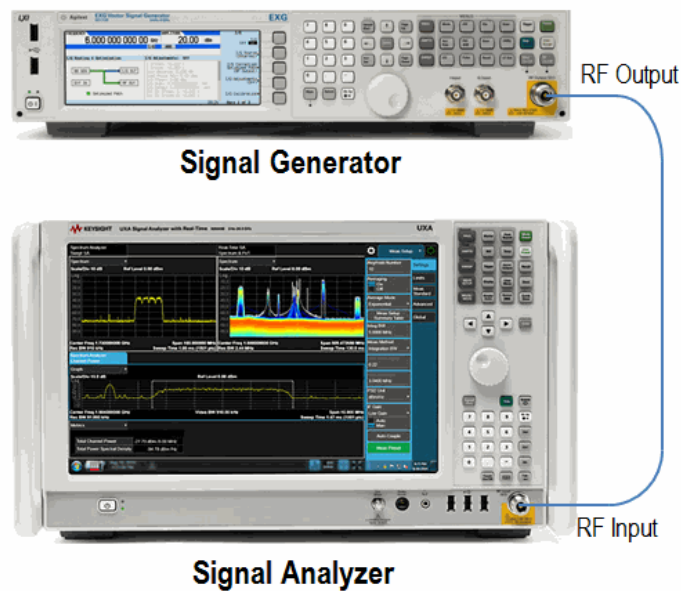

3	Preset the analyzer. <ol style="list-style-type: none"> <li>a. Press the <b>Mode Preset</b> key.</li> </ol>	The default Mode and Measurement of the analyzer is Spectrum Analyzer and Swept SA. If necessary, you can verify (and select) the mode by pressing the MODE/MEAS key.
---	---	---

### NOTE

Mode Preset does not preset all settings in the analyzer. For a more complete preset, tap Restore Mode Defaults and Input/Output Preset in the Preset menu.

Measuring a Low-Level Signal  
Trace Averaging

Step	Action	Notes
4 Set the center frequency and span.	<ol style="list-style-type: none"><li>Press the <b>FREQ</b> key.</li><li>In the menu panel, double tap <b>Center Frequency</b> and enter <b>300 MHz</b>.</li><li>Double tap <b>Span</b> and enter <b>5 MHz</b>.</li></ol>	
5 Set the analyzer reference level.	<ol style="list-style-type: none"><li>Press the <b>AMPTD</b> key.</li><li>On the menu panel, double tap <b>Ref Level</b> and enter <b>-40 dBm</b>.</li></ol>	
6 Turn on Averaging.	<ol style="list-style-type: none"><li>Press the <b>Trace</b> key.</li><li>In the menu panel, check <b>Trace Average</b>.</li></ol>	<p>Trace Averaging smooths the trace, making low-level signals more visible. Avg Hold: &gt;100/100 appears in the measurement bar near the top of the screen. See <b>Figure 3-6</b>.</p> <p>Annotation above the graticule in the measurement bar to the right of center shows the type of averaging, Log-Power. Also, the number of traces averaged is shown on the Average/Hold Number key.</p>
7 Set number of averages.	<ol style="list-style-type: none"><li>Press the <b>MEAS SETUP</b> key.</li><li>On the menu panel, double tap <b>Average/Hold Number</b> and enter the number for your test.</li></ol>	



## Measuring a Low-Level Signal Trace Averaging

Step	Action	Notes
------	--------	-------

Figure 3-6 Trace Averaging

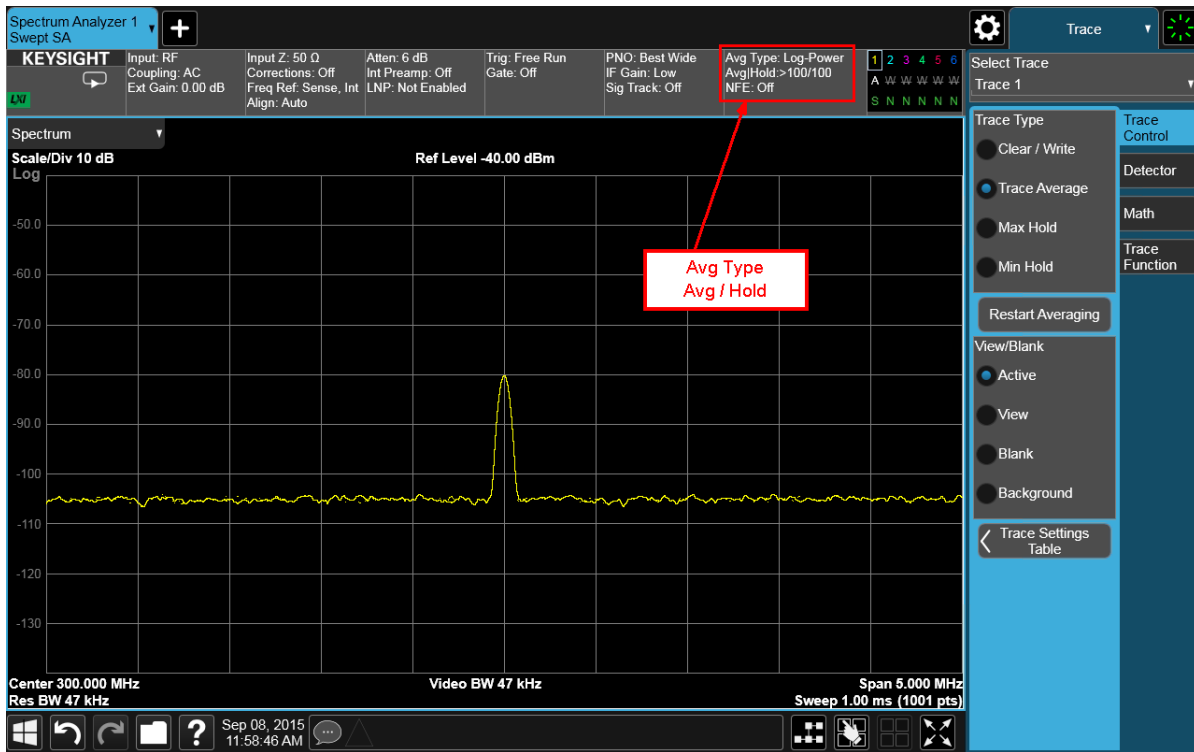

Changing most active functions restarts averaging, as does pressing the **Restart** key. Once the set number of sweeps completes, the analyzer continues to provide a running average based on this set number.

### NOTE

If you want to stop measurement after a set number of sweeps, use single sweep: Press **Single** and then press the **Restart** key on the front panel.

Measuring a Low-Level Signal  
Trace Averaging

## 4 Improving Frequency Resolution and Accuracy

### Using a Frequency Counter to Improve Frequency Resolution and Accuracy

This procedure uses the signal analyzer's internal frequency counter to increase the resolution and accuracy of the frequency readout.

Step	Action	Notes	
1	Preset the analyzer.	a. Press the <b>Mode Preset</b> key.	The default Mode and Measurement of the analyzer is Spectrum Analyzer and Swept SA. If necessary, you can verify (and select) the mode by pressing the MODE/MEAS key.
<div style="background-color: #cccccc; padding: 5px; display: inline-block;"><b>NOTE</b></div>		Mode Preset does not preset all settings in the analyzer. For a more complete preset, tap Restore Mode Defaults and Input/Output Preset in the Preset menu.	
2	Enable the internal reference signal.	a. Press the <b>Input/Output</b> key. b. In the menu panel, tap <b>RF Calibrator</b> and select <b>50 MHz</b> .	
3	Set the center frequency and span.	a. Press the <b>FREQ</b> key. b. In the menu panel, double tap <b>Center Frequency</b> and enter <b>50 MHz</b> . c. Double tap <b>Span</b> and enter <b>80 MHz</b> .	
4	Turn the frequency counter on.	a. Press <b>Marker</b> on the front-panel Or Tap the menu panel and select <b>Marker</b> . b. Select the <b>Counter</b> tab. c. Toggle <b>Marker Count</b> to On.	The marker counter remains on until turned off.

Improving Frequency Resolution and Accuracy  
Using a Frequency Counter to Improve Frequency Resolution and Accuracy

Step	Action	Notes
------	--------	-------

Figure 4-1 Using Marker Counter

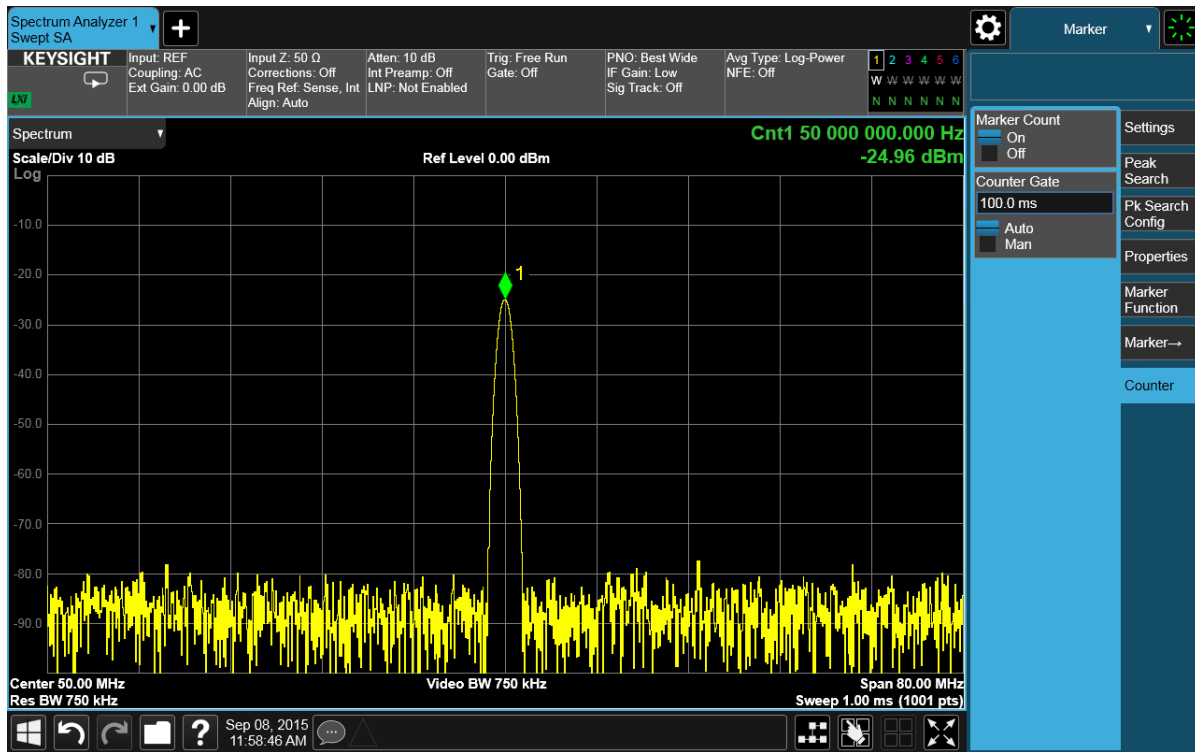

- 5 Turn the marker counter off.
  - a. Toggle **Marker Count** to Off.  
Or  
Select the **Settings** tab and tap **All Markers Off**.

## 5 Tracking Drifting Signals

### Measuring the Frequency Drift of a Source

The analyzer can measure the short- and long-term stability of a source. The maximum amplitude and the frequency drift of an input signal trace can be displayed and held by using the maximum-hold function. You can also use the maximum hold function to determine how much of the frequency spectrum a signal occupies.

This procedure uses signal tracking to keep a drifting signal in the center of the display. The drift is captured by the analyzer using maximum hold.

Step	Action	Notes
1	Set up the signal generator. a. Set the output frequency to 300 MHz. b. Set the output amplitude to $-20$ dBm.	
2	Connect the source RF OUTPUT to the analyzer RF INPUT as shown.	

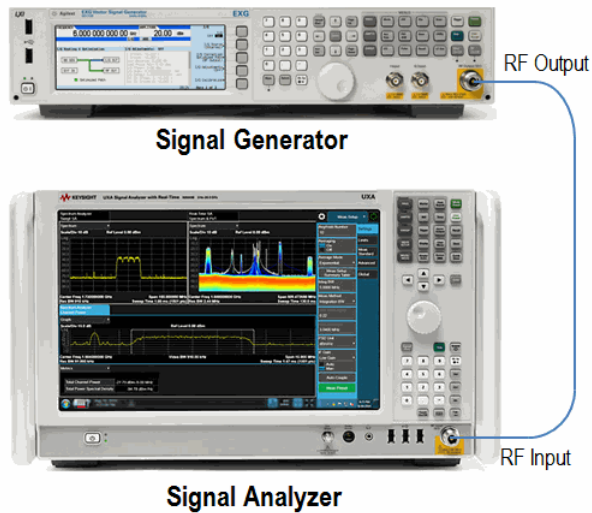

Tracking Drifting Signals  
Measuring the Frequency Drift of a Source

Step	Action	Notes
<b>3</b> Preset the analyzer.	a. Press the <b>Mode Preset</b> key.	The default Mode and Measurement of the analyzer is Spectrum Analyzer and Swept SA. If necessary, you can verify (and select) the mode by pressing the MODE/MEAS key.
<b>NOTE</b>	Mode Preset does not preset all settings in the analyzer. For a more complete preset, tap Restore Mode Defaults and Input/Output Preset in the Preset menu.	
<b>4</b> Turn on the signal generator output.	a. On the front panel of the signal generator, press the <b>RF On/Off</b> key.	
<b>5</b> On the analyzer, set the center frequency and span on the analyzer.	a. Press the <b>FREQ</b> key. b. In the menu panel, double tap <b>Center Frequency</b> and enter <b>300 MHz</b> . c. Double tap <b>Span</b> and enter <b>1 MHz</b> .	
<b>6</b> Set the analyzer reference level.	a. Press the <b>AMPTD</b> key. b. In the menu panel, double tap <b>Ref Level</b> and enter <b>-5 dBm</b> . c. Double tap <b>Scale/Div</b> and enter <b>15 dB</b> .	
<b>7</b> Set the analyzer RBW.	a. Press the <b>BW</b> key. b. In the menu panel, double tap <b>Res BW</b> and enter <b>30 Hz</b> .	
<b>8</b> Place a marker on the peak of the signal.	a. Press <b>Peak Search</b> on the front panel Or Tap the menu panel and select <b>Peak Search</b> .	
<b>9</b> Turn on the signal tracking function.	a. Press the <b>FREQ</b> key. b. In the menu panel, tap <b>Signal Track</b> to toggle it to On.	
<b>10</b> Reduce the span.	a. Double tap <b>Span</b> and enter <b>50 kHz</b> .	Notice that the signal is held in the center of the display.
<b>11</b> Turn off the signal track function.	a. Toggle <b>Signal Track</b> to Off.	

Tracking Drifting Signals  
Measuring the Frequency Drift of a Source

Step	Action	Notes
<b>12</b> Measure the excursion of the signal.	<ol style="list-style-type: none"><li>Press the <b>Trace</b> key.</li><li>In the menu panel, in <b>Trace Type</b>, select <b>Max Hold</b>.</li></ol>	<p>As the signal varies, Max Hold maintains the maximum variations of the input signal.</p> <p>On the display, the annotation in the upper right corner indicates the trace mode (see <b>Figure 5-1</b>). In this example, the <b>M</b> in the Type row under <b>TRACE 1</b> indicates trace 1 is in maximum-hold mode.</p>
<b>13</b> Activate trace 2 and change the mode to continuous sweeping.	<ol style="list-style-type: none"><li>Tap <b>Select Trace</b> and select <b>Trace 2</b>.</li><li>Tap <b>Clear and Write</b>.</li></ol>	<p>Trace 1 remains in maximum hold mode to show any drift in the signal.</p>
<b>14</b> Slowly change the frequency of the signal generator $\pm 2$ kHz in 100 Hz increments.	<ol style="list-style-type: none"><li>Set <b>Incr Set</b> of Frequency to 100 Hz.</li><li>Use the up and down arrows on the signal generator to vary the output around 300 MHz.</li></ol>	<p>Your analyzer display should look similar to <b>Figure 5-1</b>.</p>

# Tracking Drifting Signals Measuring the Frequency Drift of a Source

Step	Action	Notes
------	--------	-------

Figure 5-1 Viewing a Drifting Signal With Max Hold and Clear Write

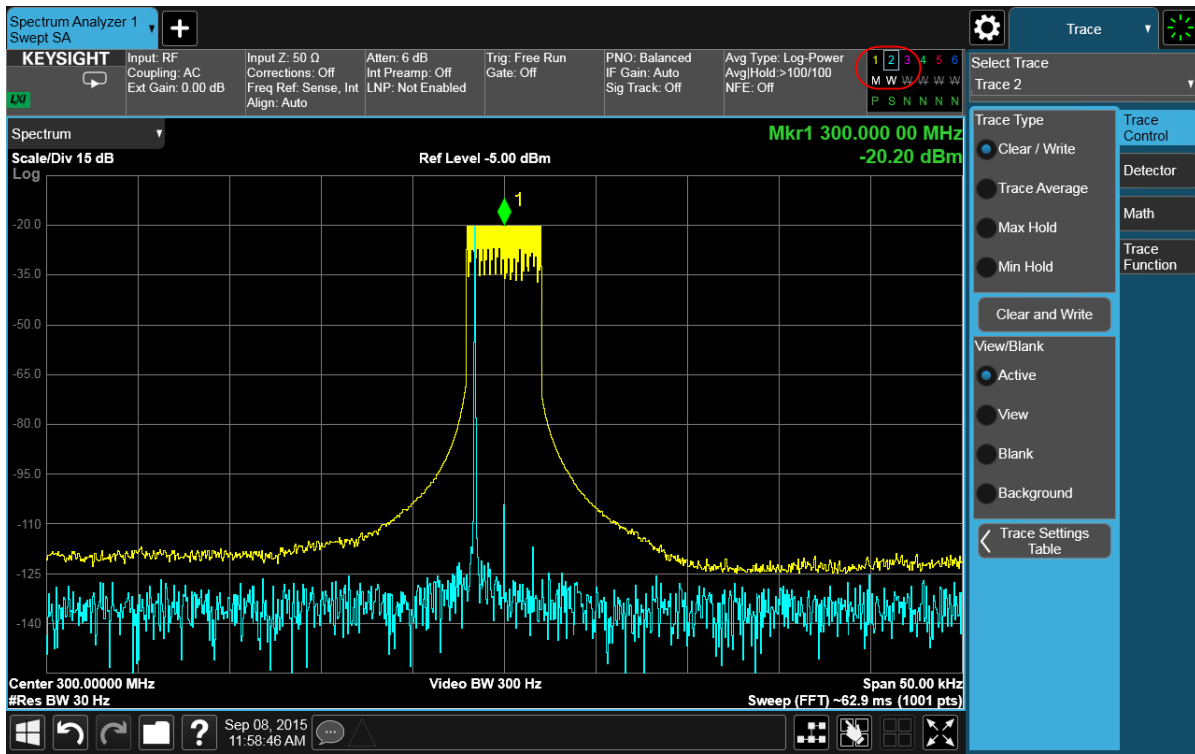



## Tracking a Signal

This procedure demonstrates how to keep a drifting signal centered in the display by using the Signal Track function.

Note that the signal of interest will not stay in the center of the display if the analyzer's Center Frequency setting is changed. If you change the analyzer's Center Frequency setting when the Signal Track function is enabled, check to ensure that the signal found by the tracking function is the correct signal.

Step	Action	Notes
1	Set up the signal source. <ol style="list-style-type: none"> <li>Set the output frequency to 300 MHz.</li> <li>Set the output amplitude to -20 dBm.</li> </ol>	
2	Connect the source RF OUTPUT to the analyzer RF INPUT as shown.	

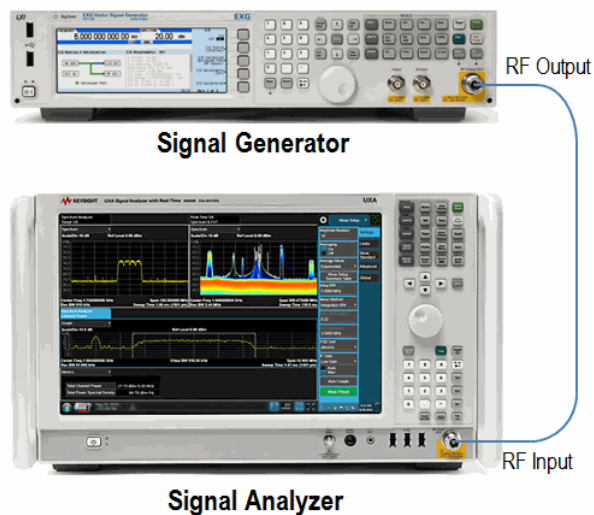

3	Preset the analyzer. <ol style="list-style-type: none"> <li>Press the <b>Mode Preset</b> key.</li> </ol>	The default Mode and Measurement of the analyzer is Spectrum Analyzer and Swept SA. If necessary, you can verify (and select) the mode by pressing the MODE/MEAS key.
---	--	---

**NOTE**

Mode Preset does not preset all settings in the analyzer. For a more complete preset, tap Restore Mode Defaults and Input/Output Preset in the Preset menu.

4	Turn on the signal generator output. <ol style="list-style-type: none"> <li>On the signal generator, set the RF Output <b>On</b>.</li> </ol>	
---	--	--

Tracking Drifting Signals  
Tracking a Signal

Step	Action	Notes
5	On the analyzer, set the center frequency and span.  a. Press the <b>FREQ</b> key. b. In the menu panel, double tap <b>Center Frequency</b> and enter <b>301 MHz</b> . c. Double tap <b>Span</b> and enter <b>10 MHz</b> .	
6	Place a marker on the peak of the signal.  a. Press <b>Peak Search</b> on the front panel Or Tap the menu panel and select <b>Peak Search</b> from the drop down menu.	
7	Turn on the signal tracking function.  a. Press the <b>FREQ</b> key. b. Toggle <b>Signal Track</b> to On.	Notice that signal tracking places a marker on the highest amplitude peak and then moves the selected peak to the center of the display. After each sweep, the tracked signal is maintained in the center of the display.
8	Turn on the delta marker.  a. Press <b>Marker</b> on the front-panel Or Tap the menu panel and select <b>Marker</b> .  b. In <b>Marker Mode</b> selection list, check <b>Delta</b> .	
9	Change the frequency of the signal generator in 2 MHz increments.	Notice that as the signal's frequency is changed, it is kept in the center of the analyzer's display. The marker annotation shows the difference, in frequency and amplitude, from the original. See <b>Figure 5-2</b> .

# Tracking Drifting Signals Tracking a Signal

Step	Action	Notes
------	--------	-------

Figure 5-2 Tracking a Drifting Signal

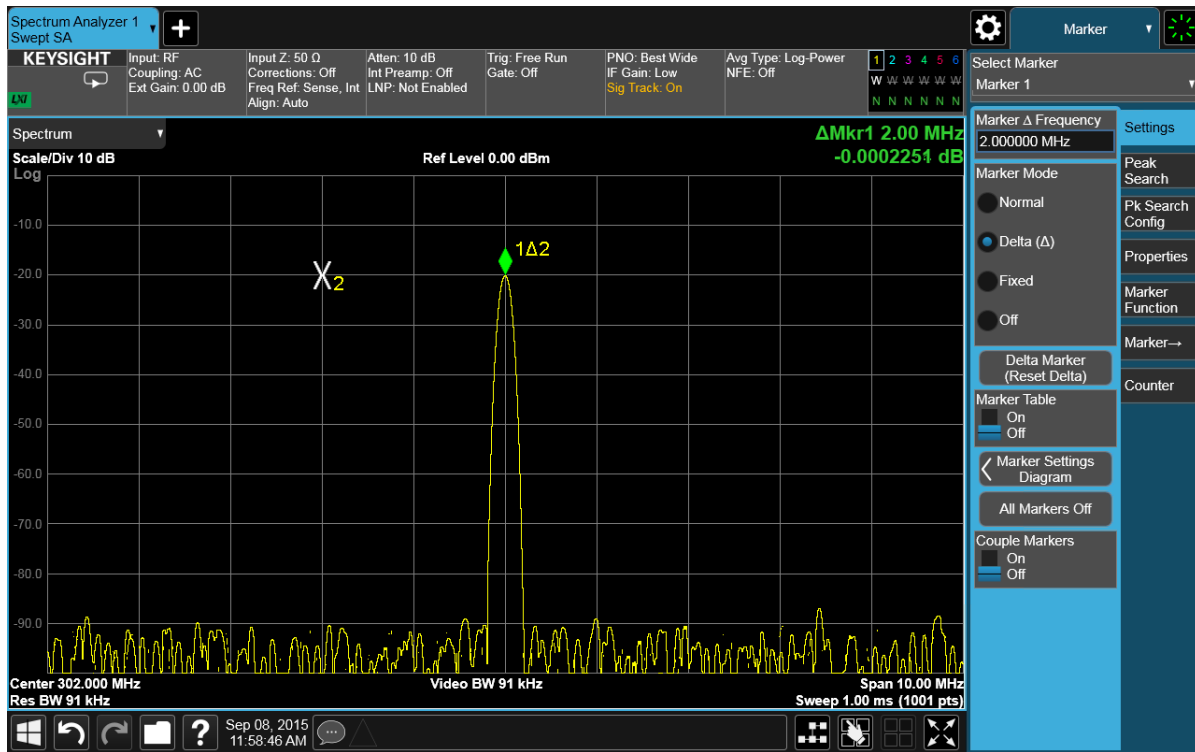

Tracking Drifting Signals  
Tracking a Signal

## 6 Making Distortion Measurements

### Identifying Analyzer Generated Distortion

Large input signals can cause distortion products in the analyzer that could mask real distortion on the input signal. Using Trace 2 and the RF attenuator, you can determine which signals, if any, are internally generated distortion products.

This procedure demonstrates how to use a signal from a signal generator to determine whether harmonic distortion is generated by the analyzer, or is part of the input signal.

Step	Action	Notes
1	Set up the signal generator. a. Set the frequency to 200 MHz. b. Set the amplitude to 0 dBm.	
2	Connect the source RF OUTPUT to the analyzer RF INPUT as shown.	

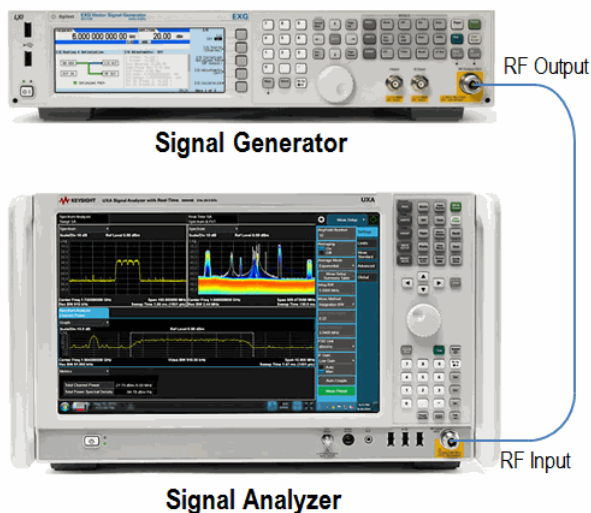

Making Distortion Measurements  
Identifying Analyzer Generated Distortion

Step	Action	Notes
<b>3</b> Preset the analyzer.	a. Press the <b>Mode Preset</b> key.	The default Mode and Measurement of the analyzer is Spectrum Analyzer and Swept SA. If necessary, you can verify (and select) the mode by pressing the MODE/MEAS key.
<b>NOTE</b>	Mode Preset does not preset all settings in the analyzer. For a more complete preset, tap Restore Mode Defaults and Input/Output Preset in the Preset menu.	
<b>4</b> Turn on the signal generator output.	a. Turn the RF Output <b>On</b> .	
<b>5</b> On the analyzer, set the center frequency and span.	a. Press the <b>FREQ</b> key. b. In the menu panel, double tap <b>Center Frequency</b> and enter <b>400 MHz</b> . c. Double tap <b>Span</b> and enter <b>500 MHz</b> .	
<b>6</b> Set the analyzer bandwidth.	a. Press the <b>BW</b> key. b. In the menu panel, double tap <b>Video BW</b> and enter <b>30 kHz</b> .	The signal produces harmonic distortion products (spaced 200 MHz from the original 200 MHz signal) in the analyzer input mixer as shown in <b>Figure 6-1</b> .

Making Distortion Measurements  
Identifying Analyzer Generated Distortion

Step	Action	Notes
------	--------	-------

Figure 6-1 Harmonic Distortion

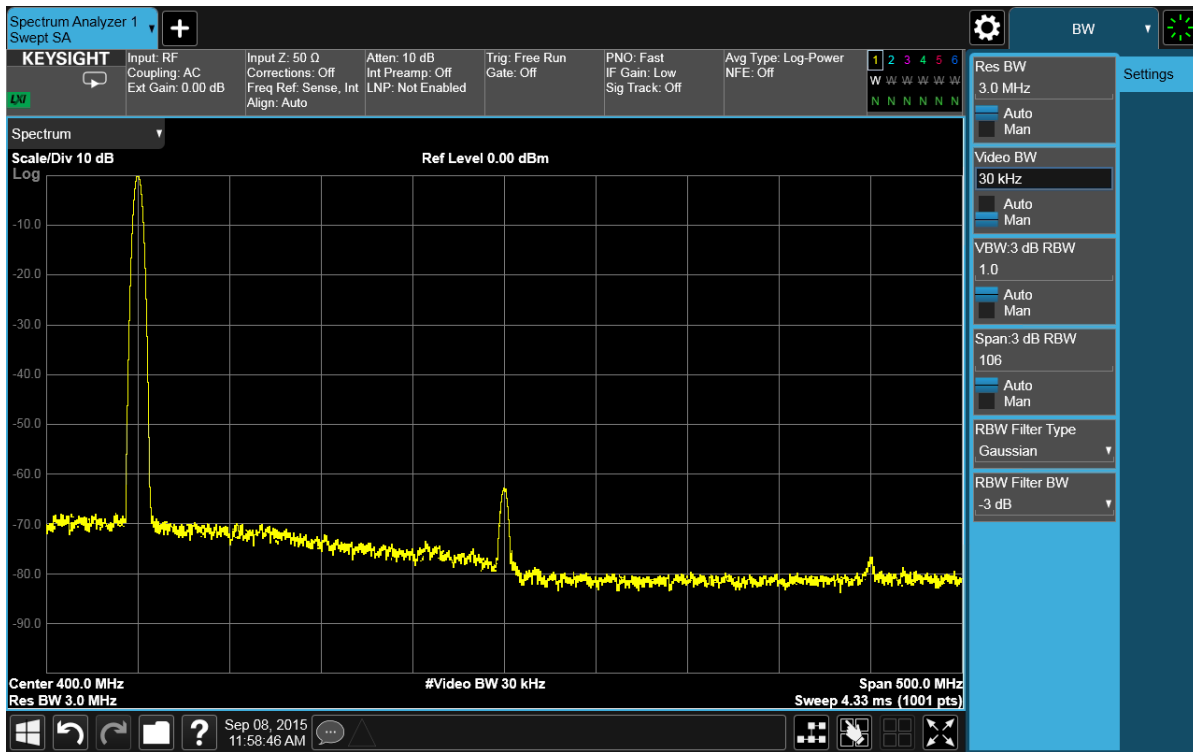

- |  |   |
|--|---|
| <p><b>7</b> Change the center frequency to the value of the second harmonic.</p> | <p>a. Press the <b>Peak Search</b> key on the front-panel,<br/>Or<br/>Tap the menu panel and select <b>Peak Search</b>.</p> <p>b. In the menu panel, tap <b>Next Peak</b>.</p> <p>c. Tap <b>Mkr→CF</b>.</p>   |
| <p><b>8</b> Change the span to 50 MHz and re-center the signal.</p>              | <p>a. Press the <b>FREQ</b> key.</p> <p>b. In the menu panel, double tap <b>Span</b> and enter <b>50 MHz</b>.</p> <p>c. Press the <b>Peak Search</b> key.</p> <p>d. In the menu panel, tap <b>Mkr→CF</b>.</p> |
| <p><b>9</b> Set the attenuation to 0 dB.</p>                                     | <p>a. Press the <b>AMPTD</b> key.</p> <p>b. In the menu panel, tap the <b>Attenuation</b> tab.</p> <p>c. Double tap <b>Mech Atten</b> and enter <b>0 dB</b>.</p>  |

Making Distortion Measurements  
Identifying Analyzer Generated Distortion

Step	Action	Notes
10 Save the trace data in trace 2.	<ul style="list-style-type: none"> <li>a. Press the <b>Trace</b> key.</li> <li>b. Tap <b>Select Trace</b> and select <b>Trace 2</b>.</li> <li>c. Tap <b>Clear and Write</b>.</li> </ul>	
11 Allow trace 2 to update.	<ul style="list-style-type: none"> <li>a. In <b>View/Blank</b> selection list, check <b>View</b>.</li> </ul>	Allow a minimum of two sweeps
12 Place a delta marker on the harmonic of trace 2.	<ul style="list-style-type: none"> <li>a. Press the <b>Peak Search</b> key.</li> <li>b. In the menu panel, tap <b>Marker Delta</b>.</li> </ul>	The analyzer display shows the stored data in trace 2 and the measured data in trace 1. The $\Delta$ Mkr1 annotation displays the amplitude difference between the reference and active markers.
13 Increase the RF attenuation to 10 dB.	<ul style="list-style-type: none"> <li>a. Press the <b>AMPTD</b> key.</li> <li>b. Select the <b>Attenuation</b> tab.</li> <li>c. Double tap <b>Mech Atten</b> and enter <b>10 dB</b>.</li> </ul>	The $\Delta$ Mkr1 annotation now displays the amplitude difference between the 0 dB and 10 dB input attenuation settings. If the $\Delta$ Mkr1 amplitude is approximately $\geq 1$ dB for an input attenuator change of 10 dB, the distortion is being generated, at least in part, by the analyzer. In this case more input attenuation is necessary. Increase the input attenuation until $\Delta$ Mkr1 amplitude stops increasing or decreasing in value. Return to the previous attenuator step and the input signal distortion measured will be minimally impacted by the analyzer internally generated distortion. See <b>Figure 6-2</b> .



Making Distortion Measurements  
Identifying Analyzer Generated Distortion

Step	Action	Notes
------	--------	-------

Figure 6-2 RF Attenuation of 10 dB

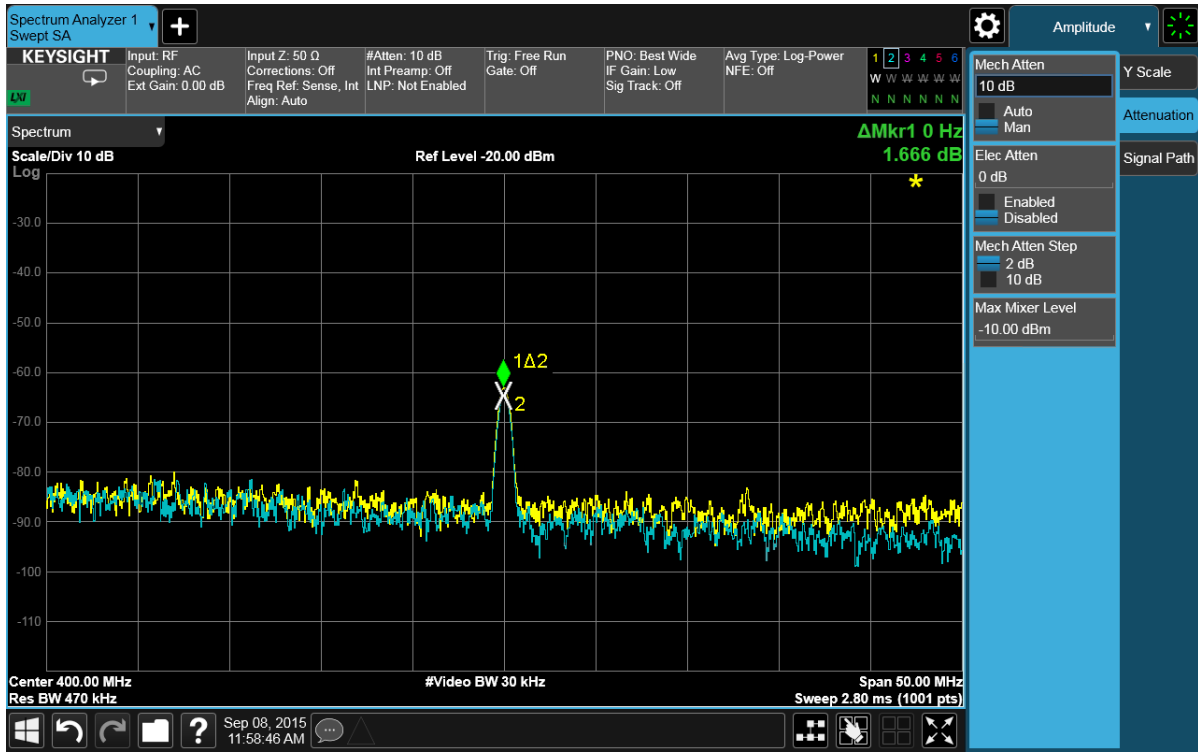

## One-Button Harmonics Measurement

Large input signals may cause distortion products in the analyzer that could mask real distortion on the input signal. Using Trace 2 and the RF attenuator, you can determine which signals, if any, are internally generated distortion products.

This procedure demonstrates how to use a signal from a signal generator to determine whether harmonic distortion is generated by the analyzer, or is part of the input signal.

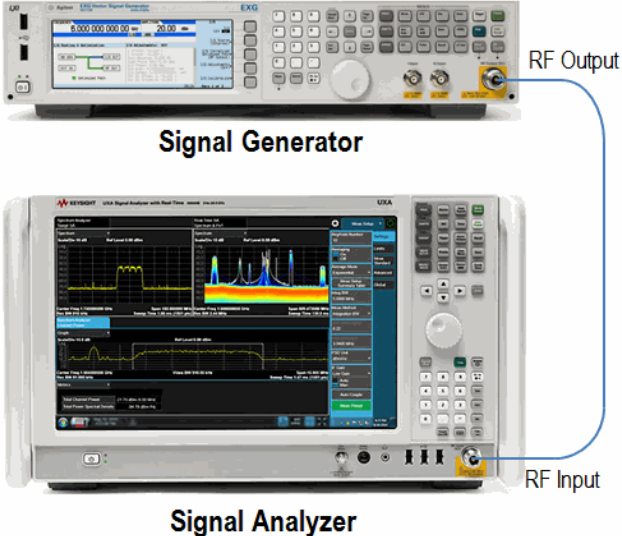
Step	Action	Notes
1 Set up the signal generator.	a. Set the frequency to 400 MHz. b. Set the amplitude to 0 dBm.	
Connect the source RF OUTPUT to the analyzer RF INPUT as shown.		
		
2 Preset the analyzer.	a. Press the <b>Mode Preset</b> key.	
<div style="background-color: #cccccc; padding: 5px; display: inline-block;"><b>NOTE</b></div>	Mode Preset does not preset all settings in the analyzer. For a more complete preset, tap Restore Mode Defaults and Input/Output Preset in the Preset menu.	
3 Select the Mode/Measurement /View.	a. Press the <b>MODE/MEAS</b> key. b. Select <b>Harmonics</b> in the Measurement column. c. Tap <b>OK</b> button at the bottom of the display.	The default Mode and Measurement of the analyzer is Spectrum Analyzer and Swept SA. If necessary, you can verify (and select) the mode by pressing the MODE/MEAS key.
4 Turn on the signal generator output.	a. On the signal generator, turn the RF Output <b>On</b> .	

Step	Action	Notes
5	View the measurement results on the analyzer.	<p>The signal produces harmonic distortion products (spaced 400 MHz from the original 400 MHz signal) in the analyzer input mixer as shown in <b>Figure 6-3</b>.</p> <p>When the Range Table is turned off, or the Fundamental frequency or Res BW is set in Sense mode, tap <b>Meas Preset</b> to restart the measurement.</p>

Figure 6-3 Harmonics Measurement Result

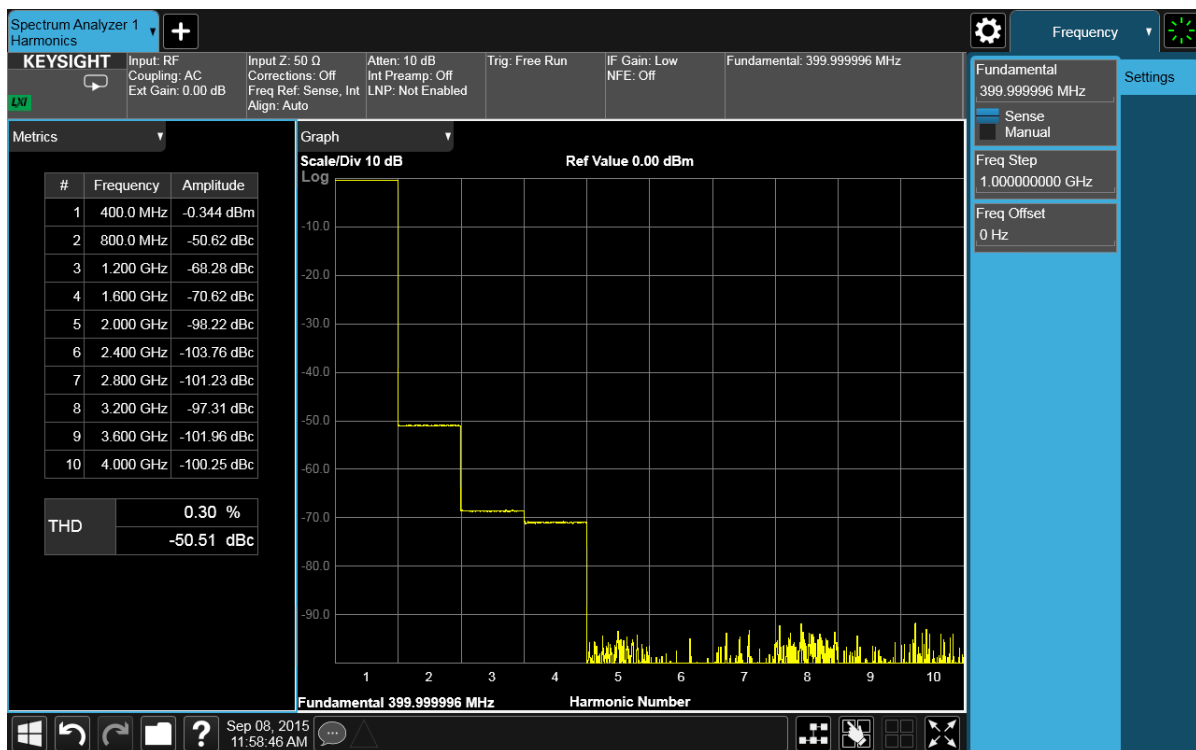

6	Adjust the Range Table to independently set parameters for each harmonic.	<ol style="list-style-type: none"> <li>Press the <b>MEAS SETUP</b> key.</li> <li>Toggle the <b>Range Table</b> state to On.</li> <li>Tap <b>Range Table</b> to edit the table.</li> </ol>	Up to 10 harmonics can be measured. See <b>Figure 6-4</b> .
---	---	---	---

Making Distortion Measurements  
One-Button Harmonics Measurement

Step

Action

Notes

Figure 6-4 Harmonics Measurement - Range Table

The screenshot displays the 'Range Table' window in a Spectrum Analyzer. The window title is 'Range Table' and it includes a 'Close' button. At the top, there is a 'Range Table' dropdown menu set to 'Off' and an 'Auto Fill' button. The main area contains a table with 10 rows, each representing a harmonic. The columns are: Harmonic, Measure Tone, Frequency, RBW Auto, RBW, Dwell Time Auto, and Dwell Time. All 'Measure Tone' and 'Dwell Time Auto' cells contain a blue checkmark. The 'Frequency' column shows '1.000000000 GHz' for all harmonics. The 'RBW' column shows '10.000 kHz' for all harmonics. The 'Dwell Time' column shows '20.0000 ms' for all harmonics. To the right of the table is a sidebar with various settings. The 'Range Table' option is highlighted with a red circle. Other settings include 'Avg|Hold Number' (10), 'Averaging' (On/Off), 'Average Mode' (Repeat), 'Harmonics' (10), and 'Range Table' (On/Off). At the bottom of the screen, a Windows taskbar is visible with the date 'Sep 08, 2015' and time '11:58:46 AM'.

Harmonic	Measure Tone	Frequency	RBW Auto	RBW	Dwell Time Auto	Dwell Time
1	✓	1.000000000 GHz	✓	10.000 kHz	✓	20.0000 ms
2	✓	1.000000000 GHz	✓	10.000 kHz	✓	20.0000 ms
3	✓	1.000000000 GHz	✓	10.000 kHz	✓	20.0000 ms
4	✓	1.000000000 GHz	✓	10.000 kHz	✓	20.0000 ms
5	✓	1.000000000 GHz	✓	10.000 kHz	✓	20.0000 ms
6	✓	1.000000000 GHz	✓	10.000 kHz	✓	20.0000 ms
7	✓	1.000000000 GHz	✓	10.000 kHz	✓	20.0000 ms
8	✓	1.000000000 GHz	✓	10.000 kHz	✓	20.0000 ms
9	✓	1.000000000 GHz	✓	10.000 kHz	✓	20.0000 ms
10	✓	1.000000000 GHz	✓	10.000 kHz	✓	20.0000 ms

## Third-Order Intermodulation Distortion

When two different signals are present in a non-linear system, they can interact and create third-order intermodulation distortion products that are close in frequency to the original signals. These distortion products are generated by system components such as amplifiers and mixers. Testing for third-order intermodulation distortion is common in communication systems.

This procedure describes how to assemble and characterize a test setup for third-order intermodulation distortion. The test setup can then be used to measure the third-order intermodulation distortion of a device-under-test (DUT) that is connected between the input of the analyzer and the test setup.

Two sources are used, one set to 300 MHz and the other to 301 MHz. These signals are combined in a directional coupler, resulting in a two-tone signal with very low intermodulation distortion. Although the distortion from this setup may be below the measurable range of the analyzer, it is useful for determining the TOI performance of the source/analyzer combination. After the test setup has been characterized, the DUT (for example, an amplifier) can be inserted between the directional coupler and the analyzer, and its performance compared to the baseline characterization.

Step	Action	Notes
1	Connect two sources to the analyzer RF INPUT as shown.	The coupler should have high isolation between the two input ports so the sources do not intermodulate.

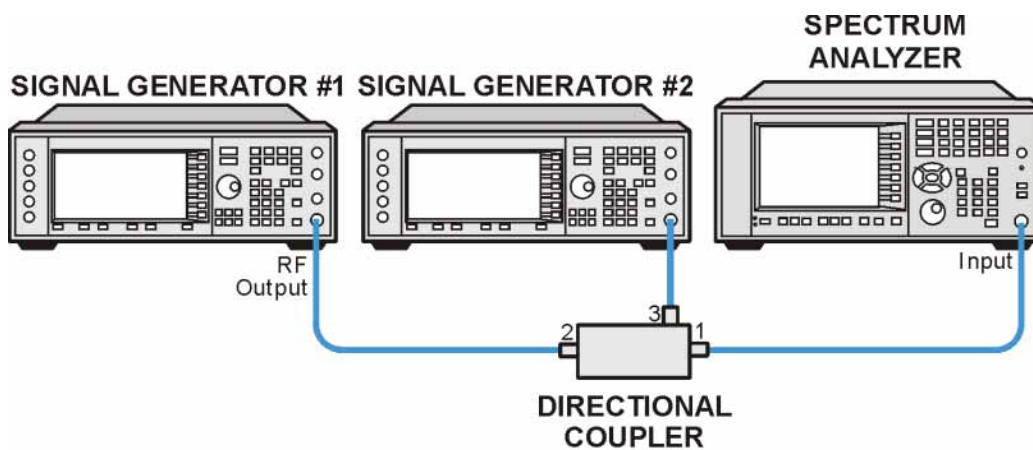

mx-a-pl790b

Step	Action	Notes
2 Set up the signal sources.	<ul style="list-style-type: none"> <li>a. Set the frequency of signal generator #1 to 300 MHz.</li> <li>b. Set the frequency of signal generator #2 to 301 MHz.</li> <li>c. Set the amplitudes of both signals to -5 dBm.</li> </ul>	<p>This produces two signals of equal amplitude and 1 MHz apart.</p> <p>The two signals may be attenuated differently as they pass through the directional coupler. If necessary, adjust the smaller signal to match the amplitude of the larger signal on the analyzer display.</p>
3 Preset the analyzer.	<ul style="list-style-type: none"> <li>a. Press the <b>Mode Preset</b> key.</li> </ul>	<p>The default Mode and Measurement of the analyzer is Spectrum Analyzer and Swept SA. If necessary, you can verify (and select) the mode by pressing the MODE/MEAS key.</p>
<b>NOTE</b>	<p>Mode Preset does not preset all settings in the analyzer. For a more complete preset, tap Restore Mode Defaults and Input/Output Preset in the Preset menu.</p>	
4 Set the center frequency and span.	<ul style="list-style-type: none"> <li>a. Press the <b>FREQ</b> key.</li> <li>b. Double tap <b>Center Frequency</b> and enter <b>300.5 MHz</b>.</li> <li>c. Double tap <b>Span</b> and enter <b>5 MHz</b>.</li> </ul>	
5 Set the analyzer detector to Peak.	<ul style="list-style-type: none"> <li>a. Press the <b>Trace</b> key.</li> <li>b. Select the <b>Detector</b> tab.</li> <li>c. In the <b>Detector</b> selection list, and check <b>Peak</b>.</li> </ul>	
6 Set the mixer level to improve dynamic range.	<ul style="list-style-type: none"> <li>a. Press the <b>AMPTD</b> key.</li> <li>b. Select the <b>Attenuation</b> tab.</li> <li>c. Double tap <b>Max Mixer Lvl</b> and enter <b>-10 dBm</b>.</li> </ul>	<p>The analyzer automatically sets the attenuation so that a signal at the reference level has a maximum value of -10 dBm at the input mixer.</p>
7 Move the signal to the reference level.	<ul style="list-style-type: none"> <li>a. Press the <b>Peak Search</b> key.</li> <li>b. Tap <b>Mkr → Ref Lvl</b>.</li> </ul>	
8 Reduce the RBW until the distortion products are visible.	<ul style="list-style-type: none"> <li>a. Press the <b>BW</b> key.</li> <li>b. Double tap <b>Res BW</b> and set it to 10kHz.</li> </ul>	

Making Distortion Measurements  
Third-Order Intermodulation Distortion

Step	Action	Notes
<b>9</b> Activate the second marker and place it on the peak of the distortion product closest to the marker test signal.	<ol style="list-style-type: none"><li>Press the <b>Peak Search</b> key.</li><li>Tap <b>Marker Delta</b>.</li><li>Tap <b>Next Left</b> (as appropriate).</li></ol>	Use the <b>Next Right</b> key (if the first marker is on the right test signal) or <b>Next Left</b> key (if the first marker is on the left test signal): See <b>Figure 6-5</b> .
<b>10</b> Measure the other distortion product	<ol style="list-style-type: none"><li>Select <b>Settings</b> tab., <b>Normal, Peak Search, Next Peak</b>.</li><li>In <b>Marker Mode</b> selection list., check <b>Normal, Peak Search, Next Peak</b>.</li><li>Select <b>Peak Search</b> tab.</li><li>Tap <b>Next Peak</b>.</li></ol>	
<b>11</b> Activate the second marker and place it on the peak of the distortion product closest to the marked test signal.	<ol style="list-style-type: none"><li>Tap <b>Marker Delta</b>.</li><li>Tap <b>Next Left</b> (as appropriate).</li></ol>	See <b>Figure 6-6</b> .

Making Distortion Measurements  
Third-Order Intermodulation Distortion

Step Action Notes

Figure 6-5 Measuring the Distortion Product - the first signal and its distortion product

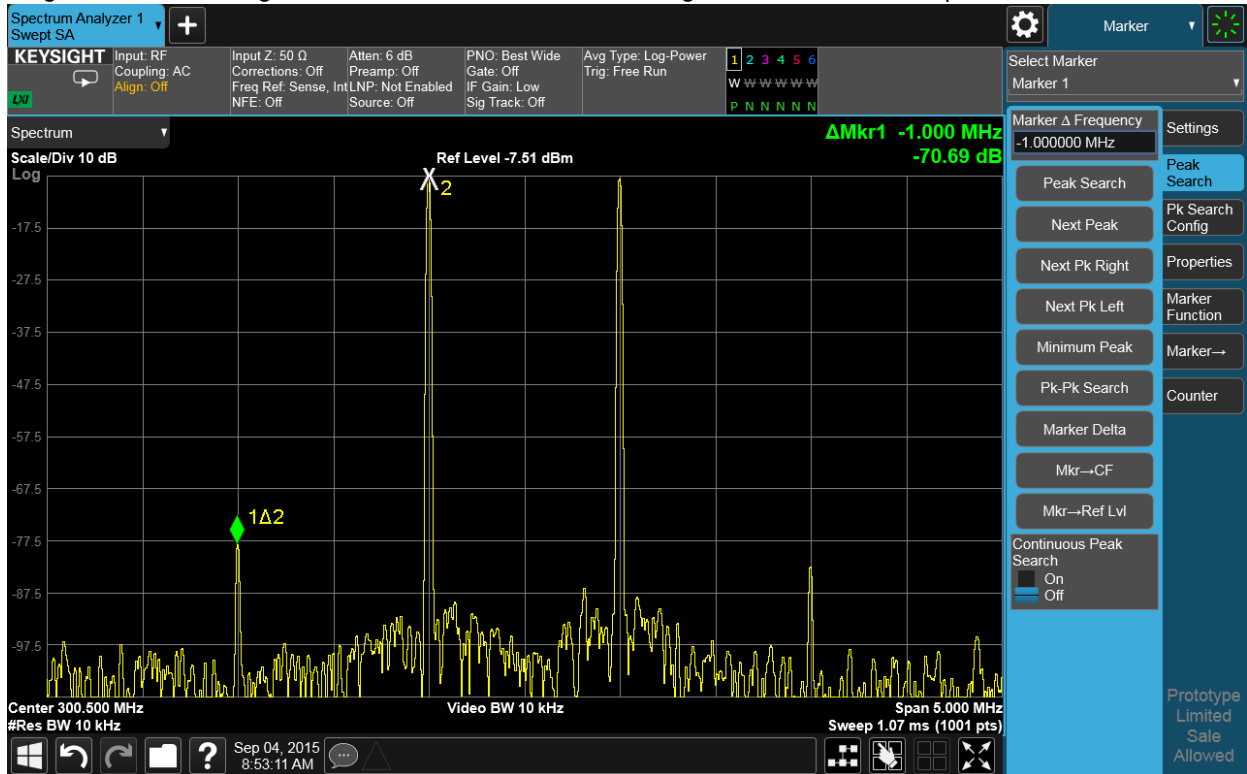
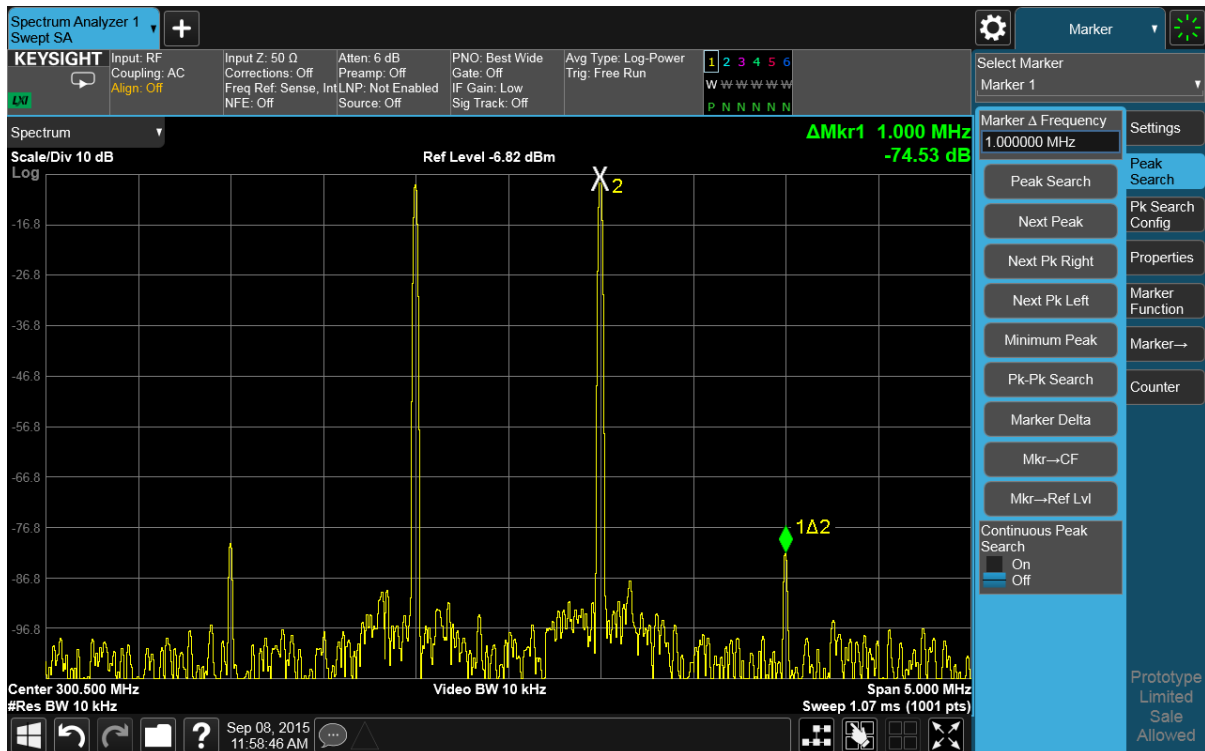

Figure 6-6 Measuring the Distortion Product - the second signal and its distortion product





## One-Button TOI Measurement

When two different signals are present in a non-linear system, they can interact and create third-order intermodulation distortion products that are close in frequency to the original signals. These distortion products are generated by system components such as amplifiers and mixers. Testing for third-order intermodulation distortion is common in communication systems.

This procedure describes how to simplify third order intermodulation distortion measurements by selecting the TOI measurement function. In this example, a 300 MHz signal and 301 MHz are combined in a directional coupler, and the combined signal sent to the analyzer.

Although the distortion from this setup may be below the measurement limits of the analyzer, it is useful for determining the TOI performance of the source/analyzer combination. After the performance of the source/analyzer combination has been verified, the device-under-test (DUT) (for example, an amplifier) would be inserted between the test setup and the analyzer input.

Step	Action	Notes
1	Connect the signal generators to the analyzer as shown.	

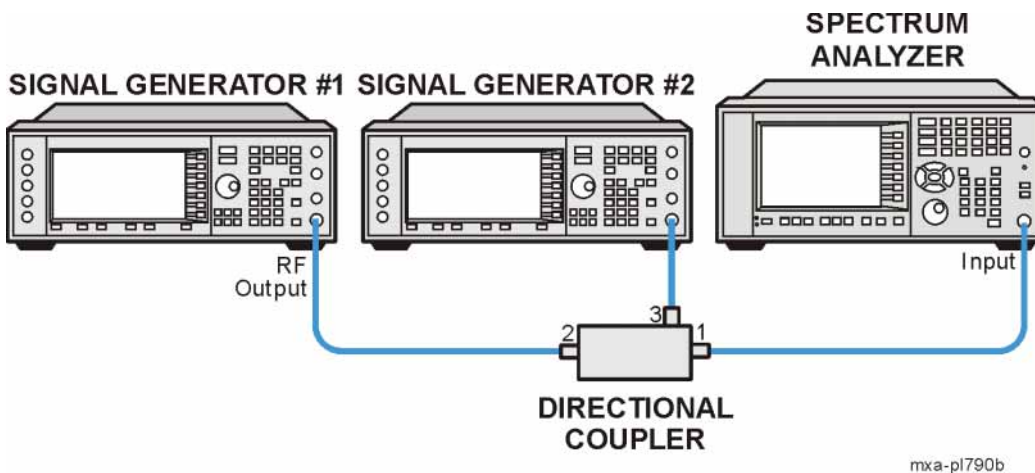

Step	Action	Notes
2 Set up the signal sources.	<ul style="list-style-type: none"> <li>a. Set the frequency of signal generator #1 to 300 MHz.</li> <li>b. Set the frequency of signal generator #2 to 301 MHz.</li> <li>c. Set signal generator #1 amplitude to -5 dBm.</li> <li>d. Set signal generator #2 amplitude to -5 dBm.</li> </ul>	<p>This setup produces two signals of equal amplitude, 1 MHz apart.</p> <p><b>NOTE:</b> The two signals may be attenuated differently as they pass through the directional coupler. If necessary, adjust the amplitudes of the two signals at the signal generators to be equal on the analyzer display.</p>
3 Preset the analyzer.	<ul style="list-style-type: none"> <li>a. Press the <b>Mode Preset</b> key.</li> </ul>	<p>The default Mode and Measurement of the analyzer is Spectrum Analyzer and Swept SA. If necessary, you can verify (and select) the mode by pressing the MODE/MEAS key.</p>
<b>NOTE</b>	<p>Mode Preset does not preset all settings in the analyzer. For a more complete preset, tap Restore Mode Defaults and Input/Output Preset in the Preset menu.</p>	
4 Select the Mode/Measurement/View.	<ul style="list-style-type: none"> <li>a. Press the <b>MODE/MEAS</b> key.</li> <li>b. Select <b>Spectrum Analyzer</b> in the Mode column.</li> <li>c. Select <b>TOI</b> in the Measurement column.</li> <li>d. Tap <b>OK</b> at the bottom of the display.</li> </ul>	
5 Set the center frequency and span.	<ul style="list-style-type: none"> <li>a. Press the <b>FREQ</b> key.</li> <li>b. Double tap <b>Center Frequency</b> and enter <b>300.5 MHz</b>.</li> <li>c. Double tap <b>Span</b> and enter <b>5 MHz</b>.</li> </ul>	<p>You can also easily read the measurement result by tapping <b>Auto Tune</b>.</p>

In the Graph window, you can see the base and intermod peaks are annotated with a number in white:

See [Figure 6-7](#).

- 1 - Lower intermodulation
- 2 - Lower base
- 3 - Upper base
- 4 - Upper intermodulation

Making Distortion Measurements  
One-Button TOI Measurement

Step	Action	Notes
------	--------	-------

Figure 6-7 TOI Measurement

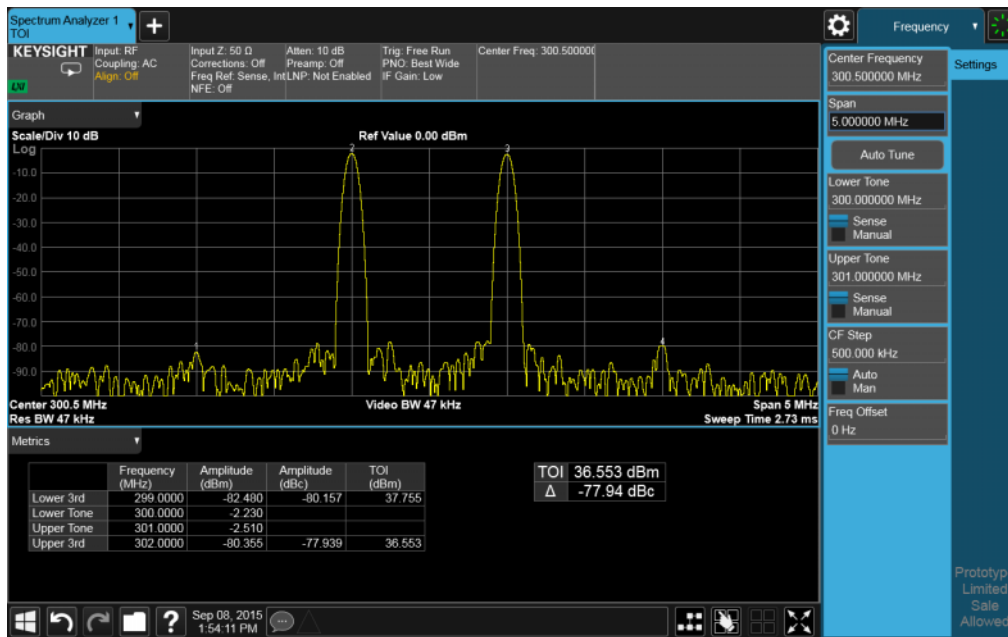

6 Turn on Zero Span Measurement to get a more accurate result.

- Press the **MEAS SETUP** key.
- Select the **ZeroSpan** tab.
- Toggle **Zero Span Measurement to On**.

See **Figure 6-8**. The results are superimposed on the graticule in the form of a blue box. The TOI number is the worse (lower) of the two calculated intercept points, while the delta is the worse (higher) of the measured dBc values.

# Making Distortion Measurements

## One-Button TOI Measurement

Step Action Notes

Figure 6-8 TOI Measurement Result - Zero Span

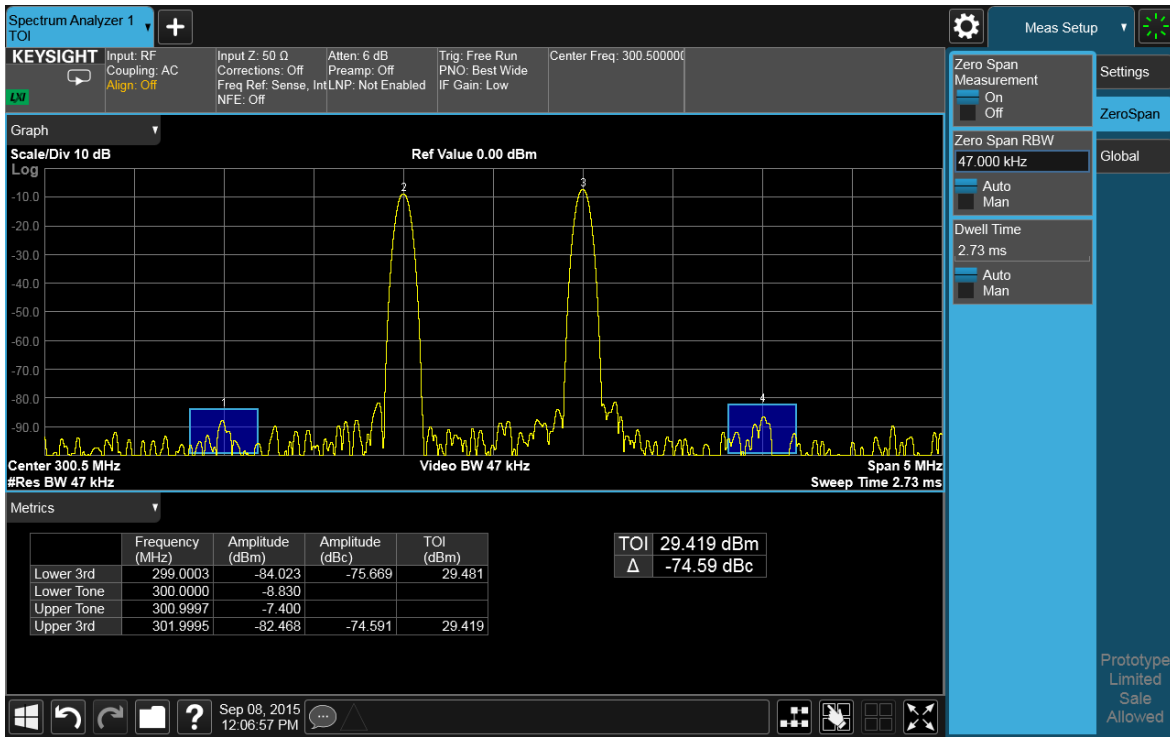

## 7 Measuring Noise

### Measuring Signal-to-Noise

Signal-to-noise ratio (SNR), is widely used as a measure of noise in a system. Typically, the more signals added to a system, the greater the noise level. This lowers the SNR, making it more difficult to demodulate modulated signals. SNR is also referred to as carrier-to-noise in some communication systems.

The SNR measurement procedure below may be adapted to measure any signal in a system if the signal (carrier) is a discrete tone. If the signal in your system is modulated, it is necessary to modify the procedure to correctly measure the modulated signal level.

In this example, the analyzer's internal 50 MHz reference signal is the signal of interest, and the internal noise of the analyzer is measured as the system noise. To do this, the input attenuator must be set so that both the signal and the noise are well within the calibrated region of the display.

Step	Action	Notes	
1	Preset the analyzer.	a. Press the <b>Mode Preset</b> key.	The default Mode and Measurement of the analyzer is Spectrum Analyzer and Swept SA. If necessary, you can verify (and select) the mode by pressing the MODE/MEAS key.
<div style="background-color: #cccccc; padding: 5px; display: inline-block;"><b>NOTE</b></div>		Mode Preset does not preset all settings in the analyzer. For a more complete preset, tap Restore Mode Defaults and Input/Output Preset in the Preset menu.	
2	Enable the internal reference signal.	a. Press the <b>Input/Output</b> key. b. In the menu panel, tap <b>RF Calibrator</b> and select <b>50 MHz</b> .	
3	Set the center frequency and span.	a. Press the <b>FREQ</b> key. b. In the menu panel, double tap <b>Center Frequency</b> and enter <b>50 MHz</b> . c. Double tap <b>Span</b> and enter <b>1 MHz</b> .	

Measuring Noise  
Measuring Signal-to-Noise

Step	Action	Notes
4 Set the reference level and attenuation.	<ol style="list-style-type: none"><li>Press the <b>AMPTD</b> key.</li><li>In the menu panel, double tap <b>Ref Level</b> and enter <b>-10 dBm</b>.</li><li>Tap the <b>Attenuation</b> tab.</li><li>Double tap <b>Mech Atten</b> and enter <b>40 dB</b>.</li></ol>	
5 Place a marker on the peak of the signal and place a delta marker in the noise.	<ol style="list-style-type: none"><li>Press the <b>Peak Search</b> key on the front panel Or Tap the menu panel and select <b>Peak Search</b> from the drop down menu.</li><li>In the menu panel, tap <b>Marker Delta</b> and <b>Marker <math>\Delta</math> Frequency</b>, then enter <b>200 kHz</b>.</li></ol>	
6 Turn on the marker noise function.	<ol style="list-style-type: none"><li>Select <b>Marker Function</b> tab.</li><li>Tap <b>Band Function</b> and select <b>Marker Noise</b>.</li></ol>	<p>This enables you to view the signal-to-noise measurement results.</p> <p>See <b>Figure 7-1</b>.</p>

Measuring Noise  
Measuring Signal-to-Noise

Step	Action	Notes
------	--------	-------

Figure 7-1 Measuring Signal-to-Noise

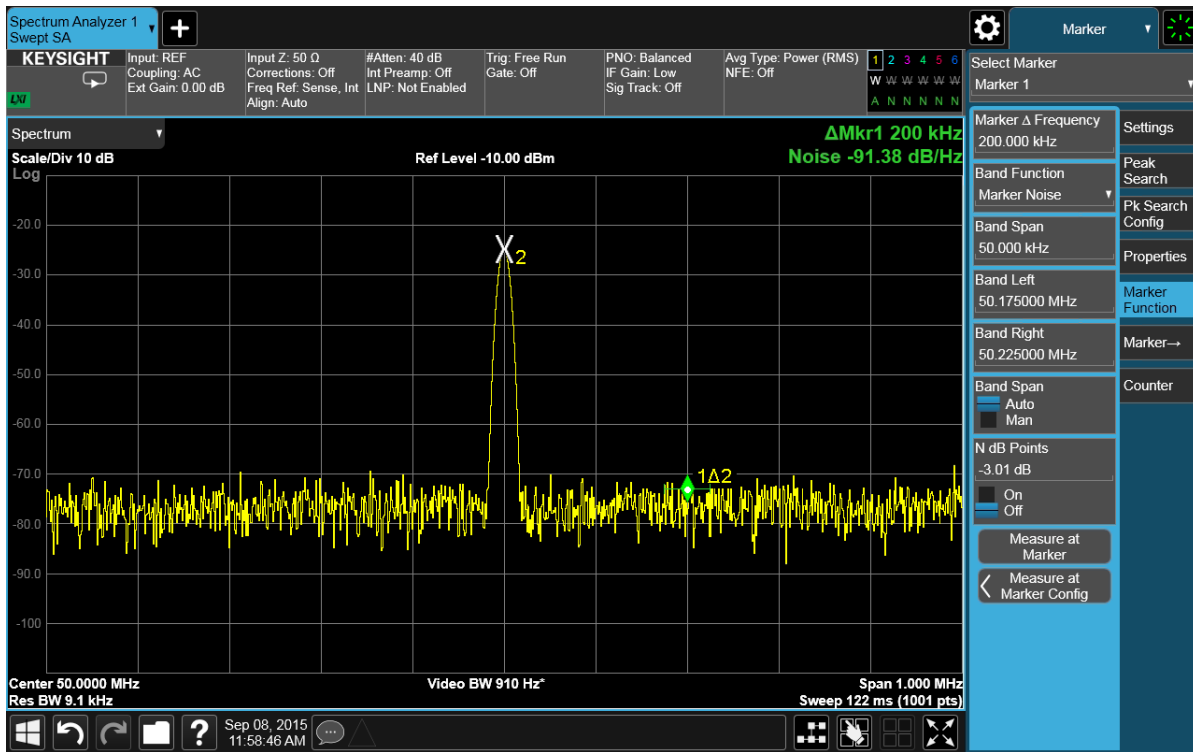

Read the SNR in dB/Hz, that is, with the noise value determined for a 1 Hz noise bandwidth. If you wish the noise value for a different bandwidth, decrease the ratio by  $10 \times \log(BW)$ . For example, if the analyzer reading is -70 dB/Hz but you have a channel bandwidth of 30 kHz:

$$S/N = -70 \text{ dB/Hz} + 10 \times \log(30 \text{ kHz}) = -25.23 \text{ dB}/(30 \text{ kHz})$$

**NOTE**

When Marker Noise is activated, the Trace/Detector mode is set to **Average (Log/RMS/V)**.

## Measuring Noise Using Marker Noise

This procedure uses the marker function **Marker Noise** to measure noise in a 1 Hz bandwidth. The noise marker measurement is made near the 50 MHz reference signal to illustrate the use of **Marker Noise**.

Step	Action	Notes	
1	Preset the analyzer.	a. Press the <b>Mode Preset</b> key.	The default Mode and Measurement of the analyzer is Spectrum Analyzer and Swept SA. If necessary, you can verify (and select) the mode by pressing the MODE/MEAS key.
<div style="background-color: #cccccc; padding: 5px; display: inline-block;"><b>NOTE</b></div>		Mode Preset does not preset all settings in the analyzer. For a more complete preset, tap Restore Mode Defaults and Input/Output Preset in the Preset menu.	
2	Enable the internal reference signal.	a. Press the <b>Input/Output</b> key. b. Tap <b>RF Calibrator</b> and select <b>50 MHz</b> .	
3	Set the center frequency and span.	a. Press the <b>FREQ</b> key. b. In the menu panel, double tap <b>Center Frequency</b> and enter <b>49.98 MHz</b> . c. Double tap <b>Span</b> and enter <b>100 kHz</b> .	
4	Set the reference level and attenuation.	a. Press the <b>Amplitude</b> key. b. In the menu panel, double tap <b>Ref Level</b> and enter <b>-10 dBm</b> . c. Select the <b>Attenuation</b> tab. d. Double tap <b>Mech Atten</b> and enter <b>40 dB</b> .	



Step	Action	Notes
<p><b>5</b> Turn on the marker noise function.</p>	<p>a. Press the <b>Marker</b> key. b. In the menu panel, select the <b>Marker Function</b> tab. c. Tap <b>Band Function</b> and select <b>Marker Noise</b>.</p>	<p>This enables you to view the signal-to-noise measurement results.</p> <p>Note that display detection automatically changes to “Avg”. Average detection calculates the noise marker from an average value of the displayed noise. Notice that the noise marker floats between the maximum and minimum displayed noise points. The marker readout is in dBm (1 Hz) or dBm per unit bandwidth.</p> <p>For noise power in a different bandwidth, add <math>10 \times \log(BW)</math>. For example, for noise power in a 1 kHz bandwidth, dBm (1 kHz), add <math>10 \times \log(1000)</math> or 30 dB to the noise marker value.</p>
<p><b>6</b> Reduce the variations of the sweep-to-sweep marker value by increasing the sweep time.</p>	<p>a. Press the <b>SWEEP</b> key. b. Double tap <b>Sweep Time</b> and enter <b>3 s</b>.</p>	<p>Increasing the sweep time when the average detector is enabled allows the trace to average over a longer time interval, thus reducing the variations in the results (increases measurement repeatability).</p>
<p><b>7</b> Move the marker.</p>	<p>a. Press the <b>Marker</b> key. b. Double tap <b>Marker Frequency</b> and enter <b>50 MHz</b>.</p>	<p>The noise marker value is based on the mean of 5% of the total number of sweep points centered at the marker in the initially-selected span. The points that are averaged span one-half of a division. Changing spans after enabling the noise marker will result in the marker averaging a progressively wider or narrower portion of the newly-selected span and corresponding sweep points. This occurs because the marker is locked to 5% of the initially selected span.</p>
<p><b>8</b> Adjust the width of the noise marker relative to the span.</p>	<p>a. Select the <b>Marker Function</b> tab. b. Double tap <b>Band Span</b> and enter <b>1 Hz</b>.</p>	

Measuring Noise  
 Measuring Noise Using Marker Noise

Step	Action	Notes
9	Widen the resolution band width. a. Press the <b>BW</b> key. b. In the menu panel, double tap <b>Res BW</b> and enter <b>10 kHz</b> .	This allows the marker to make a more accurate peak power measurement using the noise marker as shown in <b>Figure 7-2</b> .

Figure 7-2 Noise Marker

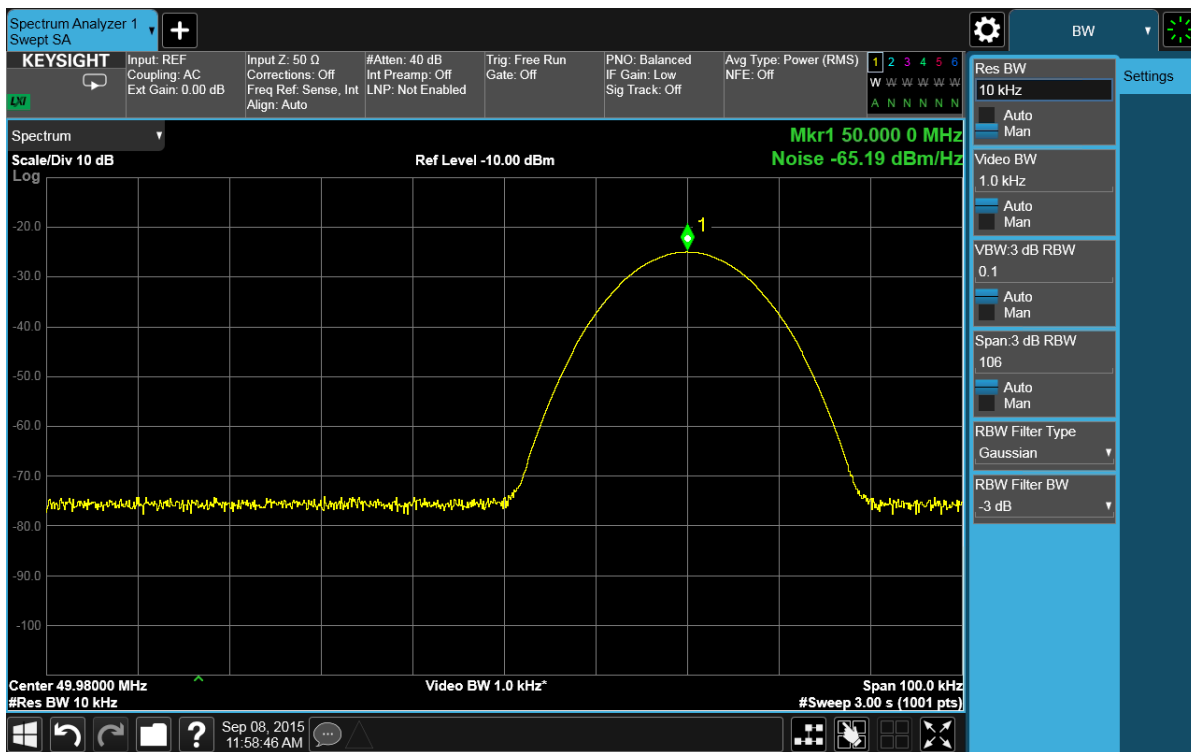

Measuring Noise  
Measuring Noise Using Marker Noise

Step	Action	Notes
10	<p>Set the analyzer to zero span at the marker frequency.</p> <ol style="list-style-type: none"> <li>Press the <b>Marker</b> key.</li> <li>In the menu panel, select <b>Mkr</b>→ tab and tap <b>Mkr</b>→<b>CF</b>.</li> <li>Press the <b>FREQ</b> key.</li> <li>In the menu panel, tap <b>Span</b> and toggle to <b>Zero Span</b>.</li> </ol>	<p>Note that the marker amplitude value is now correct since all averaged points are at the same frequency and not influenced by the shape of the bandwidth filters. See <b>Figure 7-3</b>.</p> <p>Recall that the noise marker calculates a value based on an average of the points around the frequency of interest. Generally when making power measurements using the noise marker on discrete signals, first tune to the frequency of interest and then make your measurement in zero span (time domain).</p>

Figure 7-3 Marker Noise with Zero Span

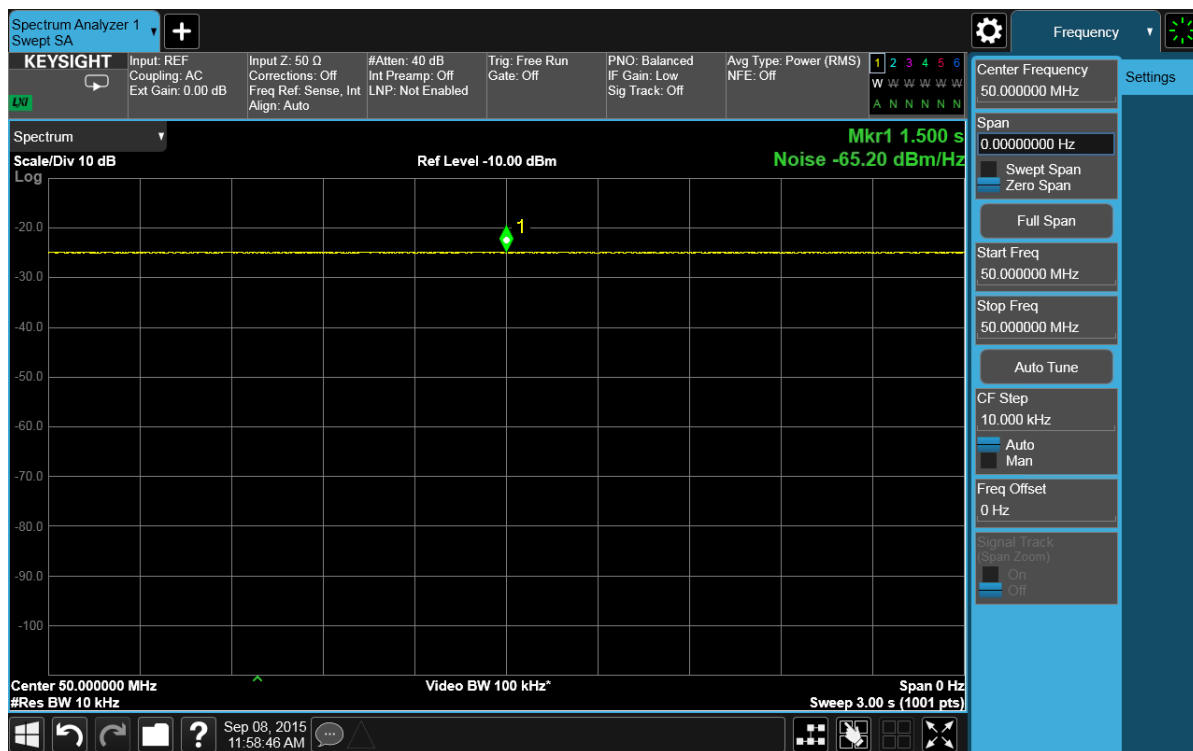

## Measuring Noise-Like Signals Using Band/Interval Density Markers

Band/Interval Density Markers let you measure power over a frequency span. The markers allow you to easily select any portion of the displayed signal.

Note that in this procedure, some of the analyzer's parameters are autocoupled to make sure the analyzer is responding to power (rms voltage-responding). Other parameters are not coupled, and must set.

Step	Action	Notes	
1	Preset the analyzer.	a. Press the <b>Mode Preset</b> key.	The default Mode and Measurement of the analyzer is Spectrum Analyzer and Swept SA. If necessary, you can verify (and select) the mode by pressing the MODE/MEAS key.
<div style="background-color: #cccccc; padding: 5px; display: inline-block;"><b>NOTE</b></div>		Mode Preset does not preset all settings in the analyzer. For a more complete preset, tap Restore Mode Defaults and Input/Output Preset in the Preset menu.	
2	Enable the internal reference signal.	a. Press the <b>Input/Output</b> key. b. In the menu panel, tap <b>RF Calibrator</b> and select <b>50 MHz</b> .	
3	Set the center frequency and span.	a. Press the <b>FREQ</b> key. b. In the menu panel, double tap <b>Center Frequency</b> and enter <b>50 MHz</b> . c. Double tap <b>Span</b> and enter <b>100 kHz</b> .	
4	Set the reference level and attenuation.	a. Press the <b>AMPTD</b> key. b. In the menu panel, double tap <b>Ref Level</b> and enter <b>-20 dBm</b> . c. Select the <b>Attenuation</b> tab. d. Double tap <b>Mech Atten</b> and enter <b>40 dB</b> .	
5	Measure the total noise power between the markers.	a. Press the <b>Marker</b> key. b. In the menu panel, select the <b>Marker Function</b> tab. c. Tap <b>Band Function</b> and select <b>Band Density</b> .	
6	Set the band span.	a. Double tap <b>Band Span</b> and enter <b>40 kHz</b> .	

Measuring Noise  
Measuring Noise-Like Signals Using Band/Interval Density Markers

Step	Action	Notes
7	<p>Set the resolution and video bandwidths.</p> <p>a. Press the <b>BW</b> key.</p> <p>b. In the menu panel, double tap <b>Res BW</b> and enter <b>1 kHz</b>.</p> <p>c. Double tap <b>Video BW</b> and enter <b>10 kHz</b>.</p>	<p>Common practice is to set the resolution bandwidth from 1% to 3% of the measurement (marker) span, 40 kHz in this example. See <b>Figure 7-4</b>.</p>

Figure 7-4 Band/Interval Density Measurement

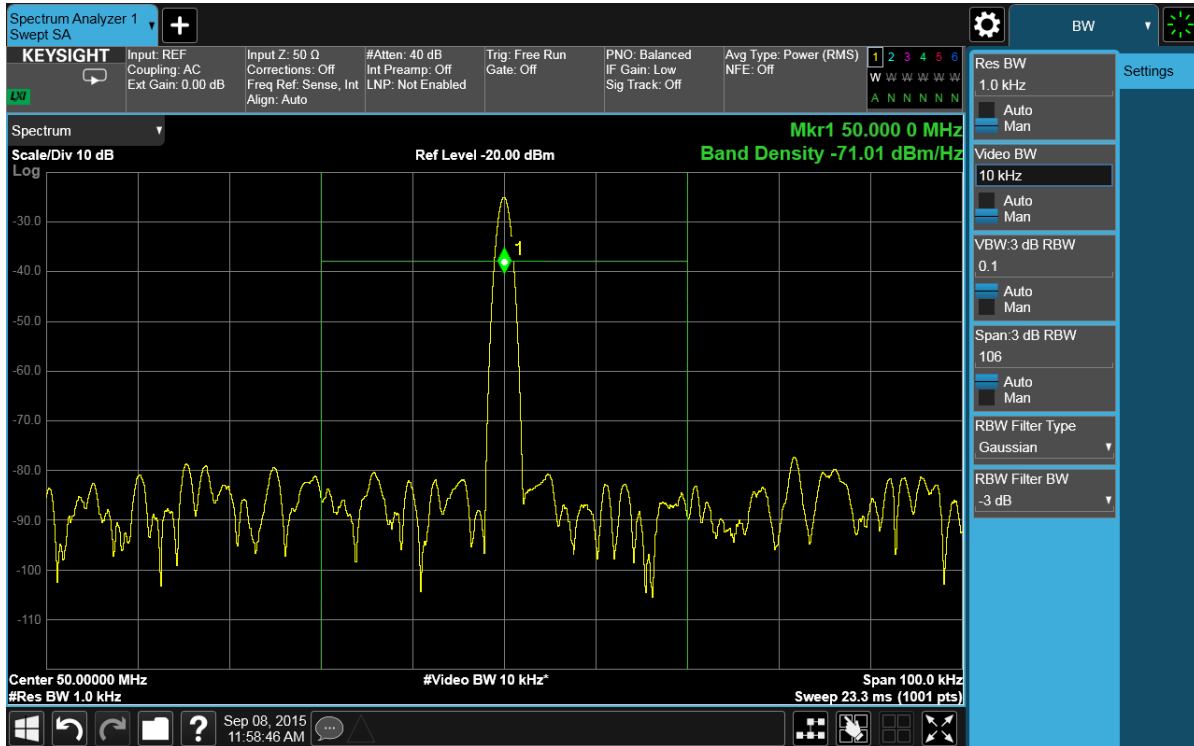

8	<p>Set the Band/Interval Density Markers.</p> <p>a. Drag the <b>Marker 1</b> (green diamond) to the appropriate point for your test.</p>	<p>This allows you to move the markers (set at 40 kHz span) around without changing the Band/Interval span. Touch the display and drag the band power markers and note the change in the power reading.</p> <p>See <b>Figure 7-5</b> on the next page.</p>
---	--	--

Measuring Noise  
Measuring Noise-Like Signals Using Band/Interval Density Markers

Step Action Notes

Figure 7-5 Band/Interval Density Measurement

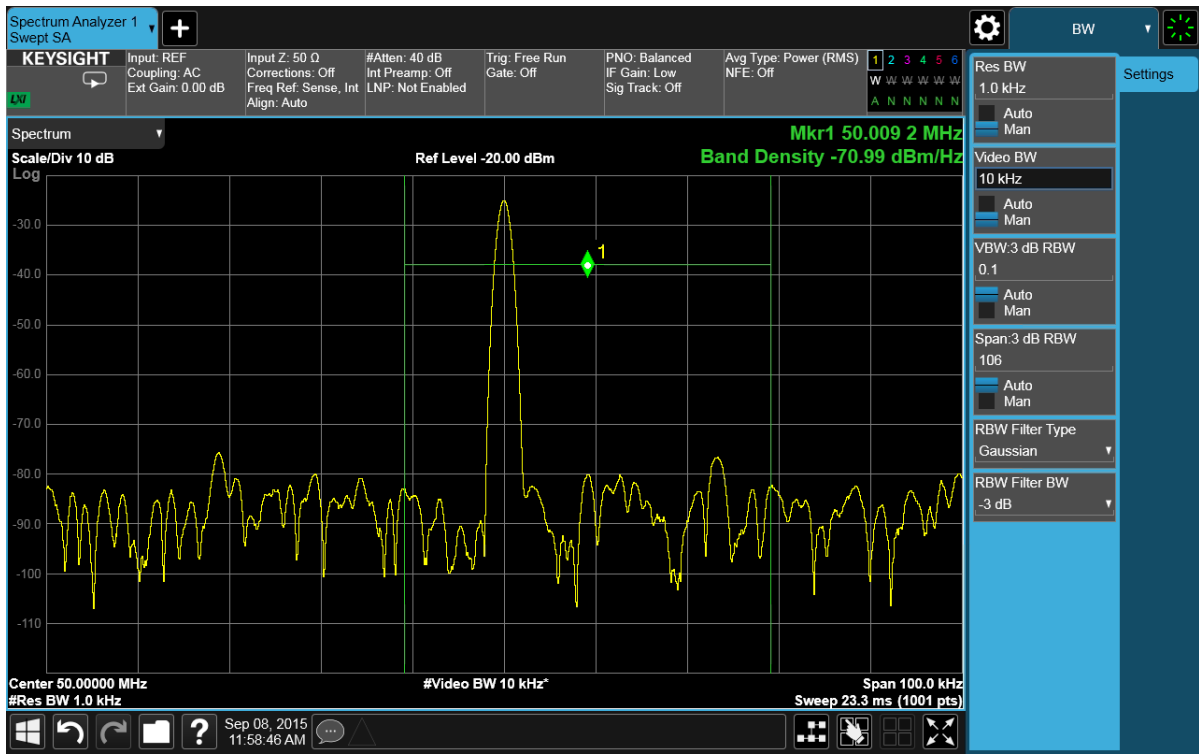

Measuring Noise  
Measuring Noise-Like Signals Using Band/Interval Density Markers

Step	Action	Notes
------	--------	-------

Figure 7-6 Band/Interval Power Measurement

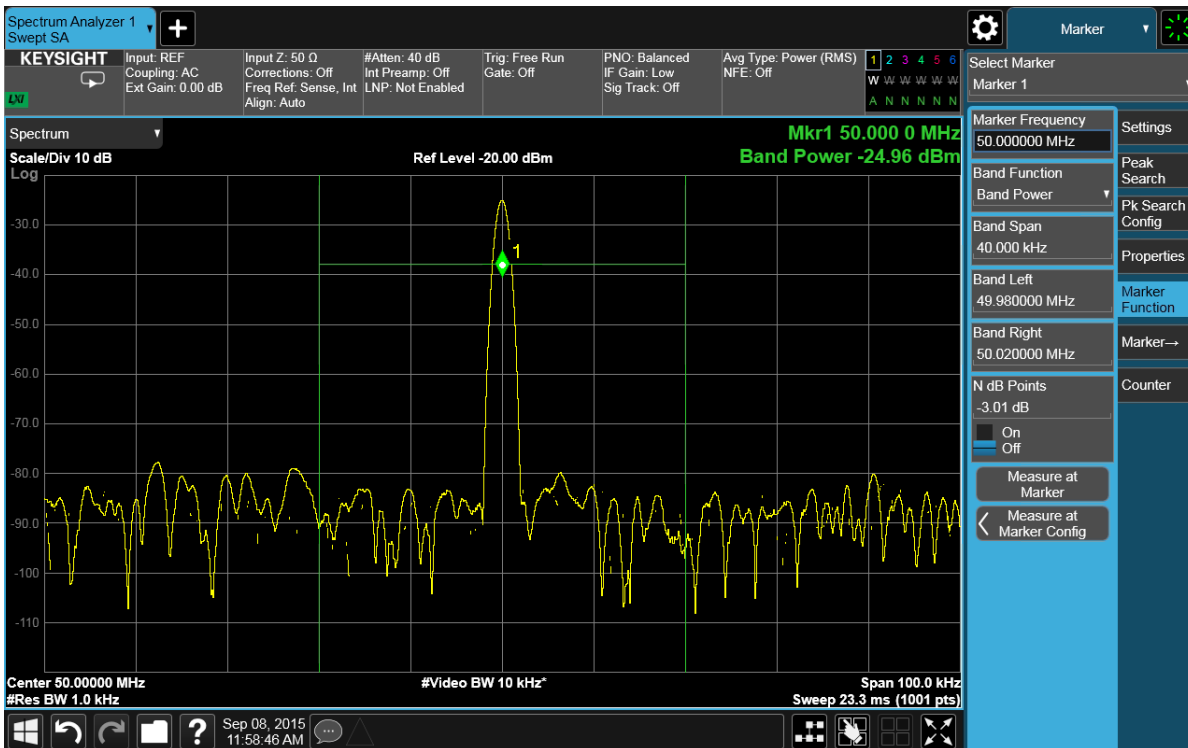

**NOTE**

Band/Interval Density Markers can be changed to read the total absolute power. Press **Marker**, tap **Band Function**, and select **Band Power** in the drop down menu. See [Figure 7-6](#).

## Measuring Noise-Like Signals Using the Channel Power Measurement

You may want to measure the total power of a noise-like signal that occupies some bandwidth. Typically, channel power measurements are used to measure the total (channel) power in a selected bandwidth for a modulated (noise-like) signal. Alternatively, to manually calculate the channel power for a modulated signal, use the noise marker value and add  $10 \times \log(\text{channel BW})$ . However, if you are not certain of the characteristics of the signal, or if there are discrete spectral components in the band of interest, you can use the channel power measurement. This example uses the noise of the analyzer, adds a discrete tone, and assumes a channel bandwidth (integration bandwidth) of 2 MHz. If desired, a specific signal may be substituted.

Step	Action	Notes	
1	Preset the analyzer.	a. Press the <b>Mode Preset</b> key.	
	<b>NOTE</b>	Mode Preset does not preset all settings in the analyzer. For a more complete preset, tap Restore Mode Defaults and Input/Output Preset in the Preset menu.	
2	Select the Mode/Measurement /View.	a. Press the <b>MODE/MEAS</b> key. b. Select <b>Spectrum Analyzer</b> in the Mode column. c. Select <b>Channel Power</b> in the Measurement column. d. Select <b>Normal</b> from the View column. e. Tap <b>OK</b> button at the bottom of the display.	The default Mode and Measurement of the analyzer is Spectrum Analyzer and Swept SA. If necessary, you can verify (and select) the mode by pressing the MODE/MEAS key.
3	Enable the analyzer's internal 50 MHz reference signal.	a. Press the <b>Input/Output</b> key. b. In the menu panel, tap <b>RF Calibrator</b> and select <b>50 MHz</b> .	This routes a discrete tone to the input to see the effects on the reading.
4	Set the center frequency.	a. Press the <b>FREQ</b> key. b. In the menu panel, double tap <b>Center Frequency</b> and enter <b>50 MHz</b> .	
5	Enable the bar graph.	a. Press the <b>Display</b> key. b. In the menu panel, toggle <b>Bar Graph</b> to <b>On</b> .	
6	Optimize the analyzer attenuation level setting.	a. Press the <b>AMPTD</b> key. b. Select the <b>Attenuation</b> tab. c. Tap <b>Adjust Atten for Min Clipping</b> .	Your display should be similar to <a href="#">Figure 7-7</a> .



Measuring Noise  
 Measuring Noise-Like Signals Using the Channel Power Measurement

Step Action Notes

Figure 7-7 Measuring Channel Power

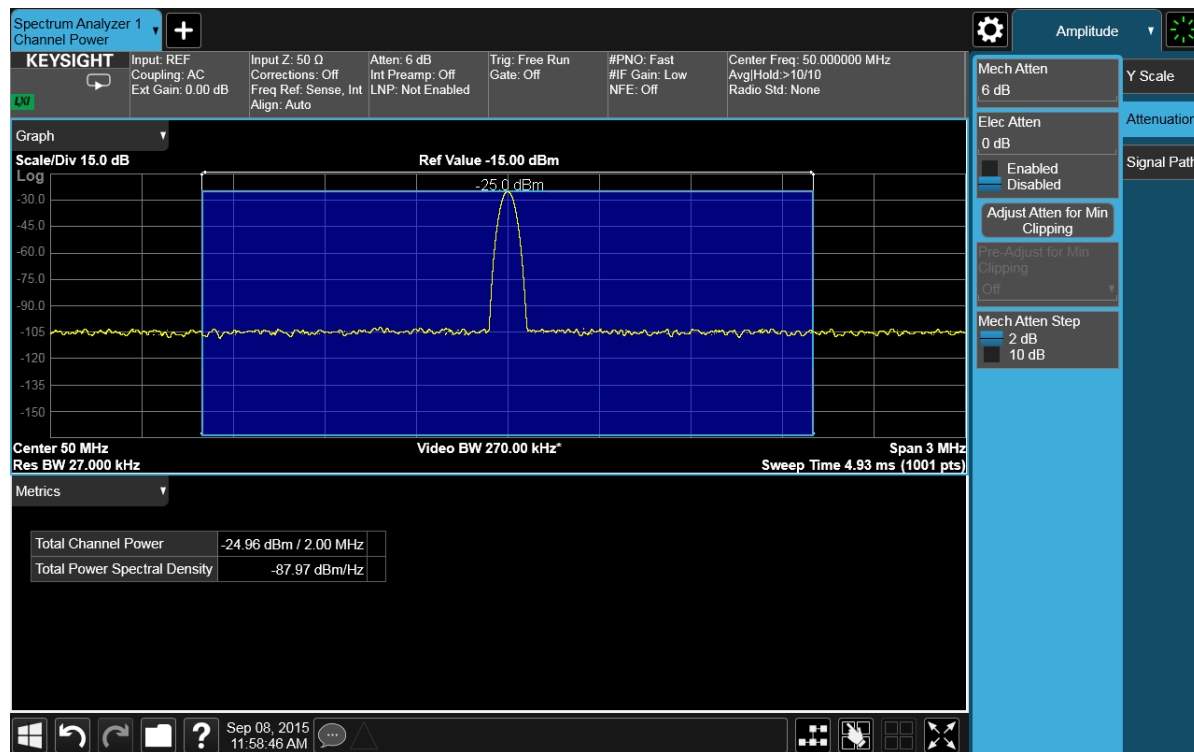

The power reading is essentially that of the tone. The total noise power is far enough below that of the tone that the noise power contributes very little to the total.

The algorithm that computes the total power works equally well for signals of any statistical variant, whether tone-like, noise-like, or a combination.

## Measuring the Carrier-to-Noise Ratio of a Modulated Carrier

In modulated carrier systems, carrier-to-noise ratio (CNR), is used to define the noise performance of the system. Typically, the more signals added to the system, or increase in the complexity of the modulation scheme, can add to the noise level. This can reduce the CNR and impact the quality of the demodulated signal. For example, a reduced CNR in digital systems may cause an increase in error vector magnitude (EVM).

With modern complex digital modulation schemes, measuring the power in a modulated carrier requires capturing all of its power accurately. This procedure uses the Band Power Marker with an RMS average detector to accurately measure the carrier's power within a user-adjustable region. A Noise Marker (normalized to a 1 Hz noise power bandwidth) with an adjustable noise region is also employed to allow the user to select and accurately measure the system noise of interest. An important key to making accurate Band Power Marker and Noise Power measurements is to insure that the Average Type under the Meas Setup key is set to "Auto".

In this example, a 4-carrier W-CDMA digitally-modulated carrier is used as the fundamental signal, and the internal noise of the analyzer is measured as the system noise.

Step	Action	Notes
1 Set up the signal generator.	a. Set up a 4 carrier W-CDMA signal. b. Set the source frequency to 1.96 GHz. c. Set the source amplitude to -10 dBm.	

Connect the source RF OUTPUT to the analyzer RF INPUT as shown below.

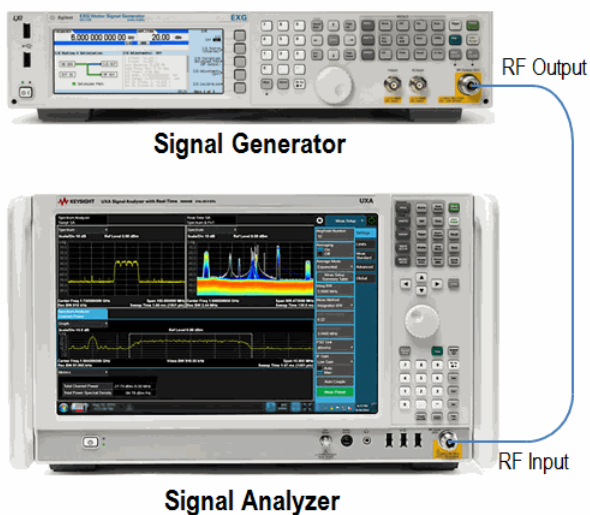

Measuring Noise  
Measuring the Carrier-to-Noise Ratio of a Modulated Carrier

Step	Action	Notes
2	Preset the analyzer. a. Press the <b>Mode Preset</b> key.	The default Mode and Measurement of the analyzer is Spectrum Analyzer and Swept SA. If necessary, you can verify (and select) the mode by pressing the MODE/MEAS key.
<div style="background-color: #cccccc; padding: 5px; display: inline-block;"><b>NOTE</b></div>		Mode Preset does not preset all settings in the analyzer. For a more complete preset, tap Restore Mode Defaults and Input/Output Preset in the Preset menu.
3	Turn on the signal generator output. a. Switch the signal generator output <b>On</b> .	
4	Tune to the W-CDMA signal on the analyzer. a. Press the <b>FREQ</b> key. b. In the menu panel, tap <b>Auto Tune</b> .	
5	Enable the Band Power Marker function. a. Press the <b>Marker</b> key. b. In the menu panel, select the <b>Marker Function</b> tab. c. Tap <b>Band Function</b> and select <b>Band Power</b> .	This measures the total power of the 4 carrier W-CDMA signal.
6	Center the frequency of the Band Power marker on the signal. a. Double tap <b>Marker Frequency</b> and enter <b>1.96 GHz</b> .	
7	Adjust the width (or span) of the Band Power marker. a. Double tap <b>Band Span</b> and enter <b>20 MHz</b> .	This encompasses the entire 4 carrier W-CDMA signal. See <a href="#">Figure 7-8</a> .

Measuring Noise  
Measuring the Carrier-to-Noise Ratio of a Modulated Carrier

Step	Action	Notes
------	--------	-------

Figure 7-8 4 Carrier W-CDMA Signal Power Using Band Power Marker

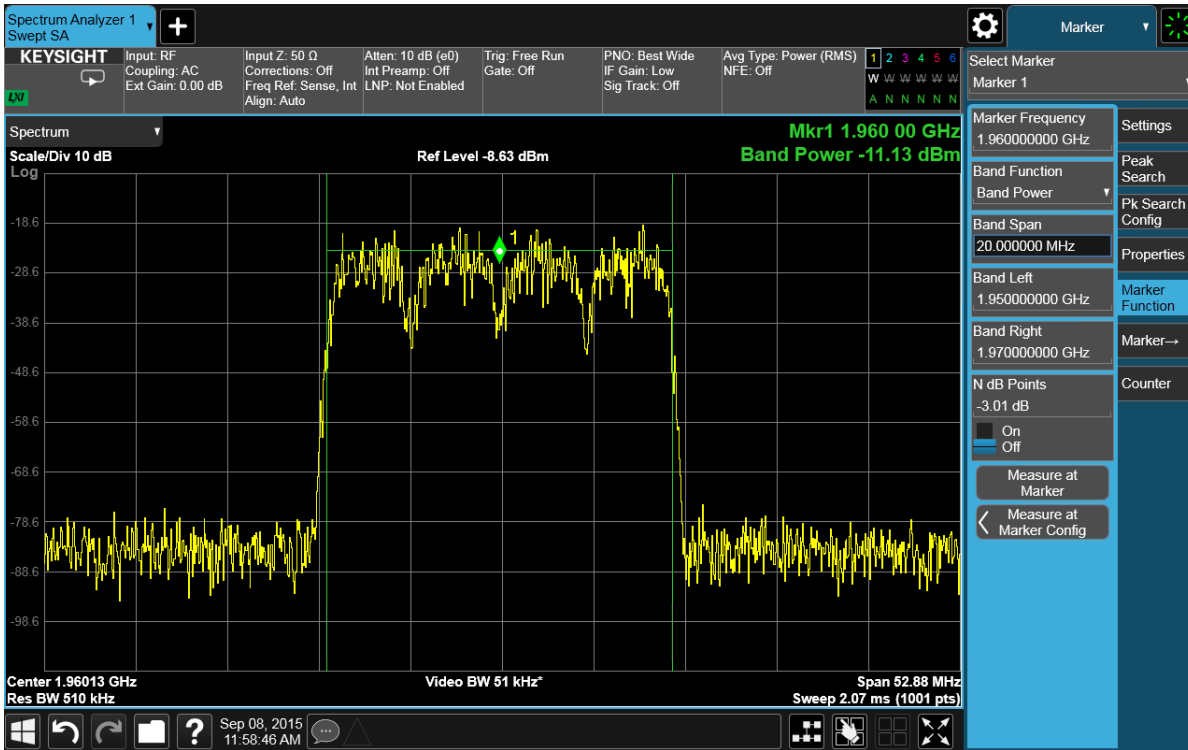

Note the green vertical lines of Marker 1 representing the span of signals included in the Band Power measurement and the carrier power indicated in the Markers Result Block (the green text on the screen).

<p><b>8</b> Enable the Noise Marker using marker 2.</p>	<p>a. Tap <b>Select Marker</b> and select <b>Marker 2</b>.</p> <p>b. Tap <b>Band Function</b> and select <b>Marker Noise</b> in the drop down menu.</p>	<p>This measures the system noise power.</p>
<p><b>9</b> Move Noise Marker 2 to the system noise frequency of interest.</p>	<p>a. Double tap <b>Marker Frequency</b> and enter <b>1.979 GHz</b>.</p>	<p>This encompasses the desired noise power.</p>
<p><b>10</b> Adjust the width of the noise marker region.</p>	<p>a. Double tap <b>Band Span</b> and enter <b>5 MHz</b>.</p>	<p>See <a href="#">Figure 7-9</a>.</p>

Measuring Noise  
Measuring the Carrier-to-Noise Ratio of a Modulated Carrier

Step	Action	Notes
------	--------	-------

Figure 7-9 Noise Marker Measuring System Noise

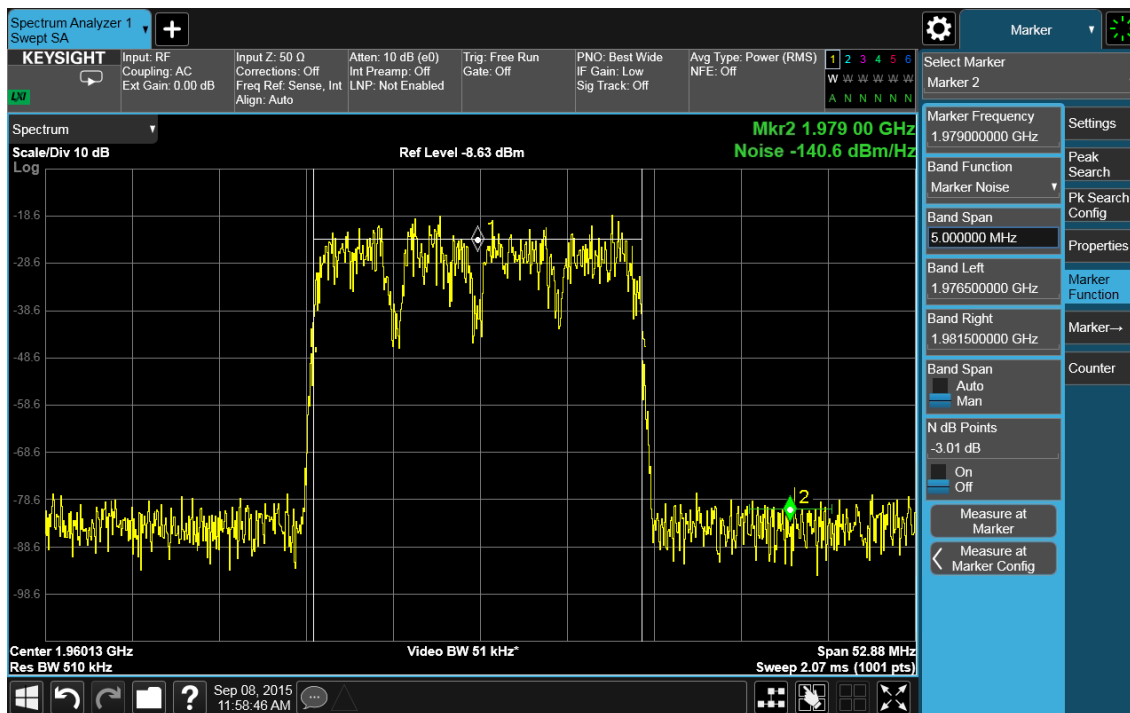

**NOTE**

Note the green “wings” of Marker 2 outlining the noise region to be included in the measurement and the resulting noise power expressed in dBm/Hz as shown in the Marker Results Block.

11 Measure the carrier-to-noise ratio by making the Noise Marker relative to the carrier's Band Power Marker.

- a. Select the **Properties** tab.
- b. Tap **Relative to** and select **Marker 1**.

See [Figure 7-10](#).

Measuring Noise  
Measuring the Carrier-to-Noise Ratio of a Modulated Carrier

Step	Action	Notes
------	--------	-------

Figure 7-10 Signal-to-Noise Measurement

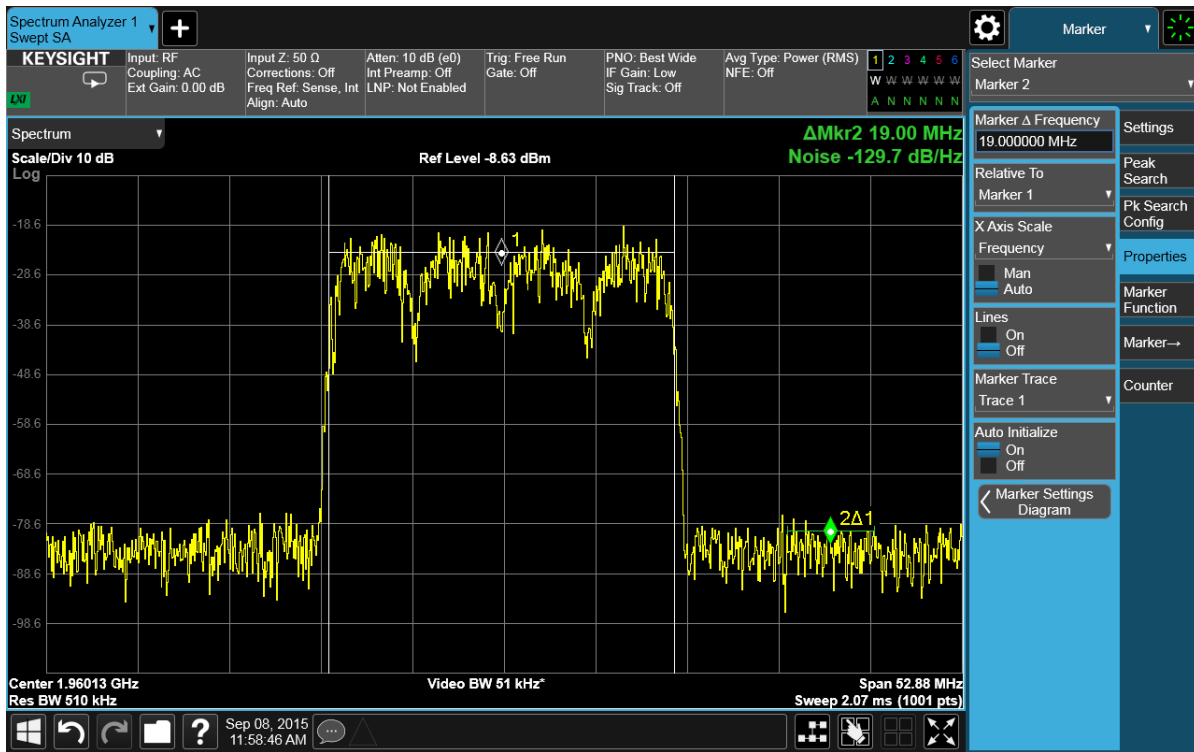

**12** Simultaneously measure carrier-to-noise on a second region of the system by enabling another Noise Marker.

- Tap **Select Marker** and select **Marker 3**.
- Select the **Marker Function** tab.
- Tap **Band Function** and select **Marker Noise**.
- Double tap **Marker Frequency** and enter **1.941 GHz**.
- Double tap **Band Span** and enter **5 MHz**.
- Select the **Properties** tab.
- Tap **Relative to** and select **Marker 1**.

**13** Enable the Marker Table.

- Select the **Settings** tab.
- Tap **Marker Table** and toggle it to **On**.

This enables you to view results of both carrier-to-noise measurements and all other markers. See **Figure 7-11**.

# Measuring Noise Measuring the Carrier-to-Noise Ratio of a Modulated Carrier

Step Action Notes

Figure 7-11 Multiple Signal-to Noise Measurements with a Marker Table

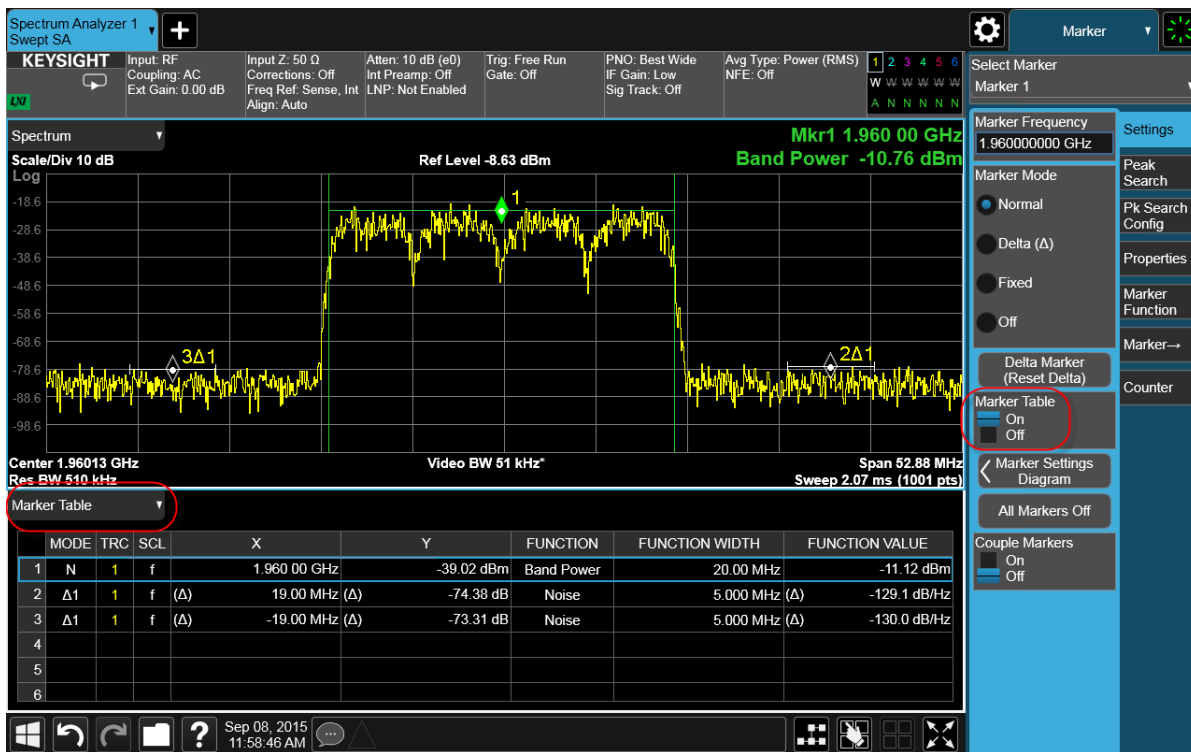

## Improving Phase Noise Measurements by Subtracting Signal Analyzer Noise

Making noise power measurements (such as phase noise) near the noise floor of the signal analyzer can be challenging, where every dB improvement is important. Using the analyzer trace math function Power Diff and three separate traces, you can measure the DUT phase noise in one trace, the analyzer noise floor in a second trace, and in the third trace view the DUT phase noise with the analyzer noise removed.

In this procedure, a signal generator is used instead of a DUT. In practice, a DUT would be connected to the analyzer's input.

Step	Action	Notes
1	Set up the signal generator. <ol style="list-style-type: none"> <li>a. Setup an unmodulated signal.</li> <li>b. Set the source frequency to 1.96 GHz.</li> <li>c. Set the source amplitude to -30 dBm.</li> </ol>	
2	Connect the source RF OUTPUT to the analyzer RF INPUT as shown.	

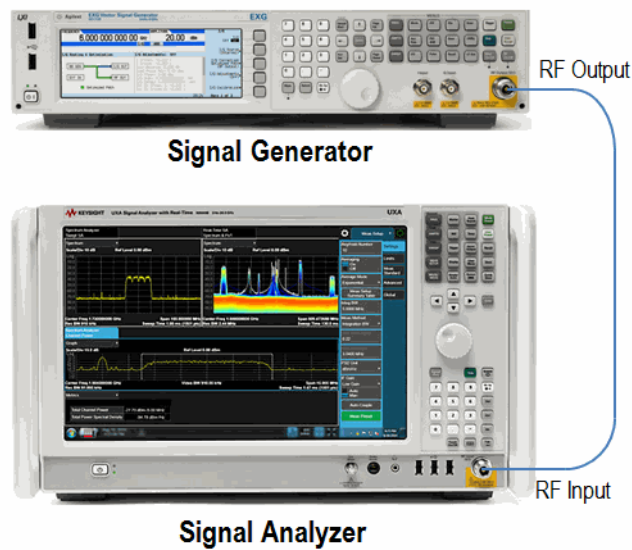

3	Enable the signal generator output. <ol style="list-style-type: none"> <li>a. Switch the signal generator output <b>On</b>.</li> </ol>	
4	Preset the analyzer. <ol style="list-style-type: none"> <li>a. Press the <b>Mode Preset</b> key.</li> </ol>	The default Mode and Measurement of the analyzer is Spectrum Analyzer and Swept SA. If necessary, you can verify (and select) the mode by pressing the MODE/MEAS key.



Step	Action	Notes
<b>NOTE</b>	Mode Preset does not preset all settings in the analyzer. For a more complete preset, tap Restore Mode Defaults and Input/Output Preset in the Preset menu.	
<b>5</b>	Tune to the signal. a. Press the <b>FREQ</b> key. b. In the menu panel, tap <b>Auto Tune</b> .	
<b>6</b>	Tune to the signal, adjust the span, RBW and Ref Level. a. Double tap <b>Span</b> and enter <b>5 kHz</b> . b. Press the <b>BW</b> key. c. In the menu panel, double tap <b>Res BW</b> and enter <b>10 Hz</b> . d. Press the <b>AMPTD</b> key. e. In the menu panel, double tap <b>Ref Level</b> and enter <b>-15 dBm</b> . f. Double tap <b>Scale/Div</b> and enter <b>15 dB</b> .	
<b>7</b>	Measure and store the signal generator's phase noise plus the analyzer noise. a. Press the <b>Trace</b> key. b. Tap <b>Select Trace</b> and select <b>Trace 1</b> . c. In <b>Trace Type</b> selection list, check <b>Trace Average</b> . d. Let the analyzer run a few seconds in order to get an accurate average e. In the <b>View/Blank</b> selection list, check <b>View</b> .	See <b>Figure 7-12</b> .

Step	Action	Notes
------	--------	-------

Figure 7-12 Measurement of Signal Generator and Analyzer Noise

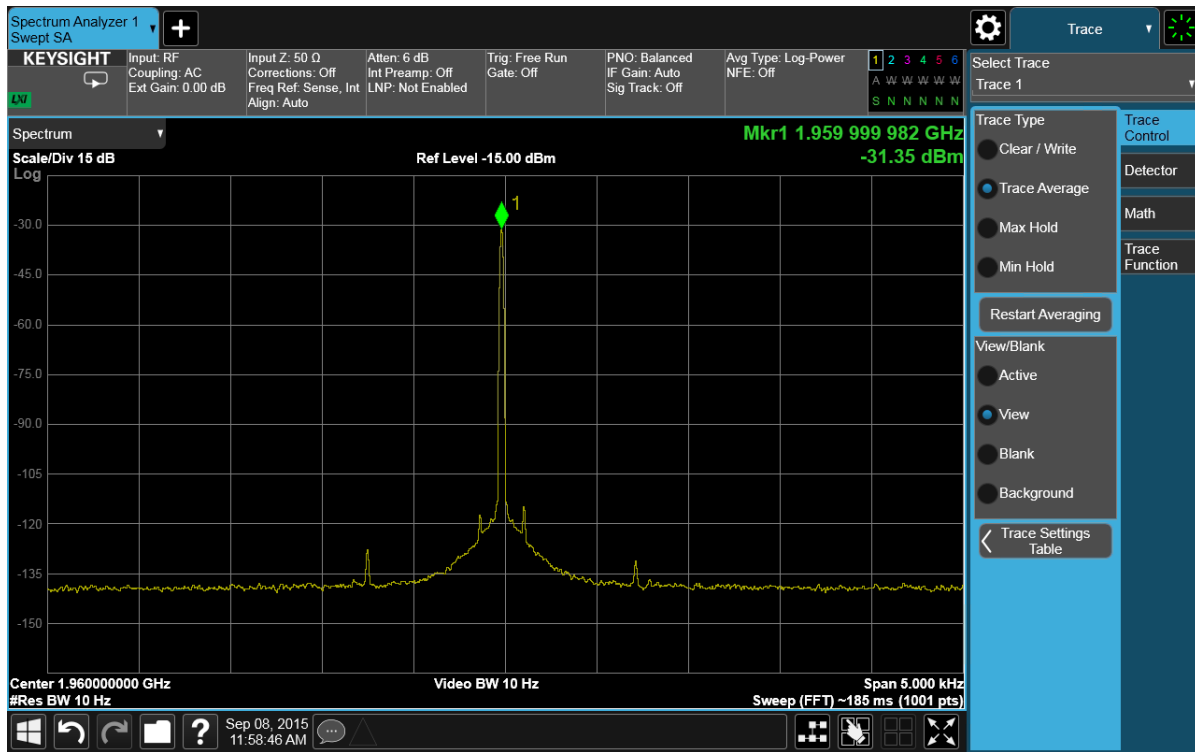

- |  |   |                                |
|--|---|--------------------------------|
| <p>8 Measure the analyzer noise using trace 2 (blue trace) with trace averaging.</p> | <p>a. Turn off the signal generator’s output to (or remove the DUT from) the RF input of the analyzer.</p> <p>b. Tap <b>Select Trace</b> and select <b>Trace 2</b>.</p> <p>c. Tap <b>Clear and Write</b>.</p> <p>d. In <b>Trace Type</b> selection list, check <b>Trace Average</b>.</p> <p>e. Let the analyzer run a few seconds in order to get an accurate average</p> <p>f. In <b>View/Blank</b> selection list, check <b>View</b>.</p> | <p>See <b>Figure 7-13</b>.</p> |
|--|---|--------------------------------|

Step Action Notes

Figure 7-13 Measurement of Analyzer Noise

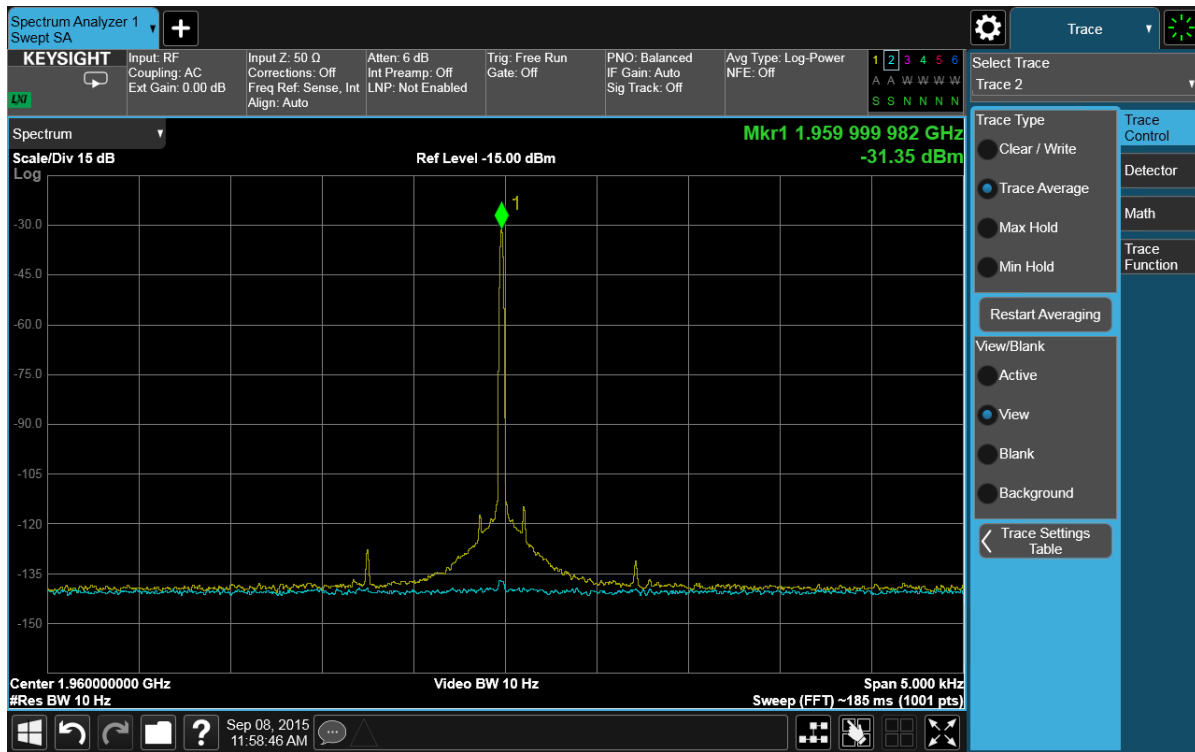

9 Subtract the noise from the signal generator (or DUT) noise measurement using the Power Diff math function.

- a. Turn on or connect the DUT signal to the RF input of the analyzer.
- b. Tap **Select Trace** and select **Trace 1**.
- c. In **View/Blank** selection list, check **Active**.
- d. Tap **Select Trace** and select **Trace 3**.
- e. Tap **Clear and Write**.
- f. Select **Math** tab.
- g. Tap **Math Function** and select **Power Difference**.
- h. Tap **Operand 1** and select **Trace 1**.
- i. Tap **Operand 2** and select **Trace 2**.

Notice the phase noise improvement at 1 kHz offset between trace 1 (yellow trace) and trace 3 (magenta trace).

See [Figure 7-14](#).

Measuring Noise  
 Improving Phase Noise Measurements by Subtracting Signal Analyzer Noise

Step Action Notes

Figure 7-14 Improved Phase Noise Measurement

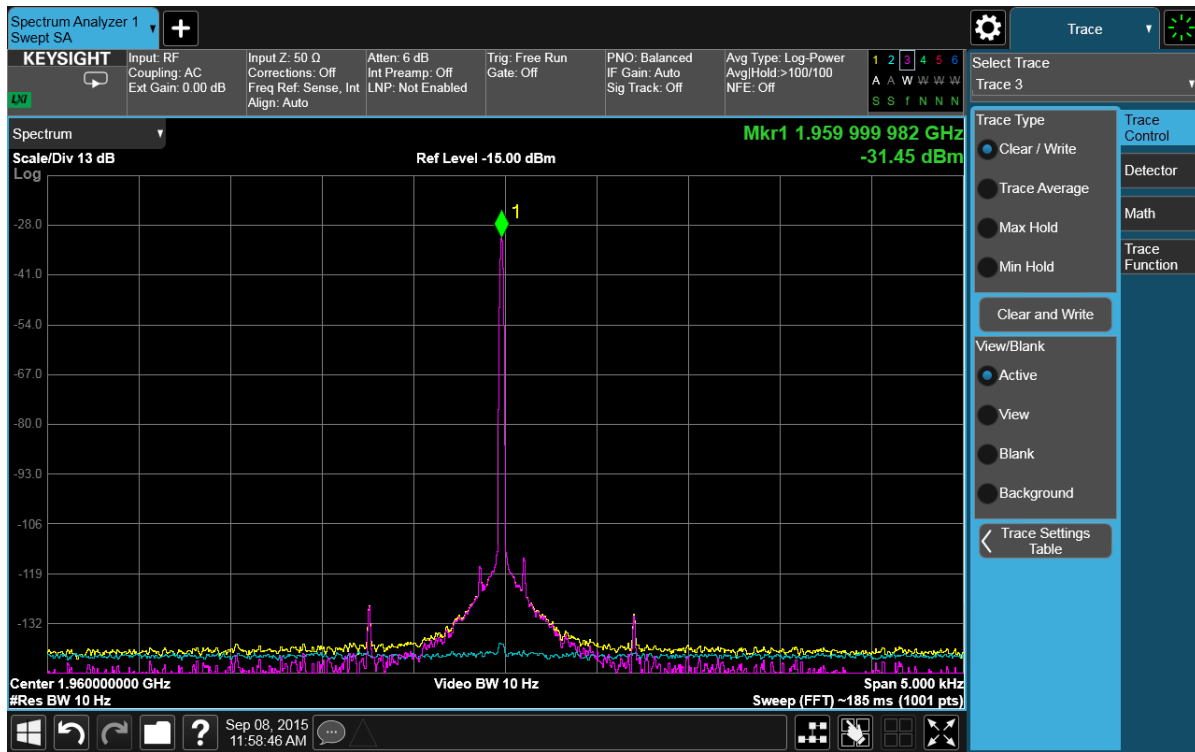

Step	Action	Notes
10 Measure the improvement in noise measurement with delta Noise markers between traces.	<ol style="list-style-type: none"><li>a. Press the <b>Marker</b> key.</li><li>b. Tap <b>Select Marker</b> and select <b>Marker 1</b>.</li><li>c. In <b>Marker Mode</b> selection list, check <b>Normal</b>.</li><li>d. Select the <b>Properties</b> tab.</li><li>e. Tap <b>Marker Trace</b> and select <b>Trace 1</b>.</li><li>f. Drag Marker 1 (green diamond) on the display to approximately 900 Hz offset from the carrier on trace 1.</li><li>g. Tap <b>Select Marker</b> and select <b>Marker 2</b>.</li><li>h. Tap <b>Marker Trace</b> and select <b>Trace 3</b>.</li><li>i. Tap <b>Relative To</b> and select <b>Marker 1</b>.</li><li>j. Select the <b>Settings</b> tab.</li><li>k. In the <b>Marker Mode</b> selection list, check <b>Delta</b>.</li><li>l. Drag Marker 2 (green diamond) on the display to approximately 900 Hz offset from the carrier on trace 3.</li><li>m. Select the <b>Marker Function</b> tab.</li><li>n. Tap <b>Select Marker</b> and select <b>Marker 1</b>.</li><li>o. Tap <b>Band Function</b> and select <b>Marker Noise</b>.</li><li>p. Tap <b>Select Marker</b> and select <b>Marker 2</b>.</li><li>q. Tap <b>Band Function</b> and select <b>Marker Noise</b>.</li></ol>	Note around 2 dB improvement in the Marker results. See <a href="#">Figure 7-15</a> .

Measuring Noise  
 Improving Phase Noise Measurements by Subtracting Signal Analyzer Noise

Step Action Notes

Figure 7-15 Improved Phase Noise Measurement with Delta Noise Markers

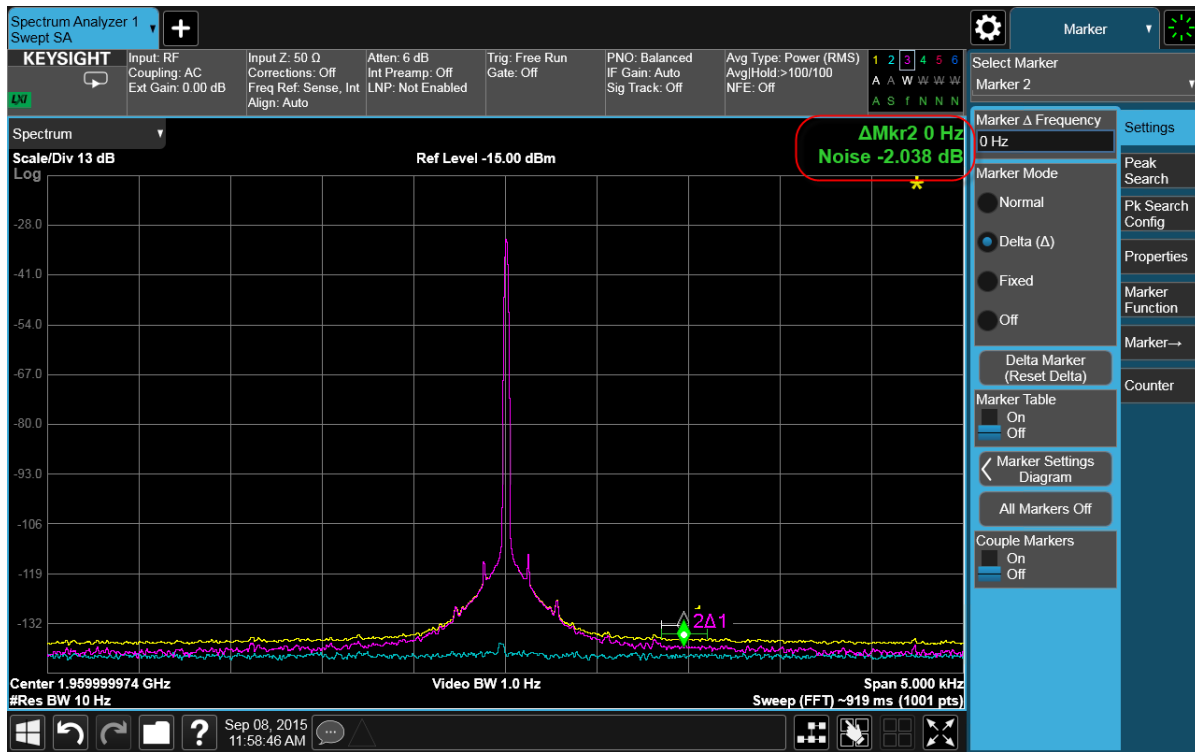

## 8 Making Time-Gated Measurements

Traditional frequency-domain spectrum analysis provides only limited information for certain signals. Examples of signals that can be challenging to analyze include the following:

- Pulsed-RF
- Time multiplexed
- Interleaved or intermittent
- Time domain multiple access (TDMA) radio formats
- Modulated burst

This chapter presents several time gating measurement examples using simple, frequency-modulated, pulsed-RF signals. The goal is to view the spectrum of the FM carrier as if it were continually on, rather than pulsed. This reveals low-level modulation components that are hidden by the pulse spectrum.

## Viewing a Pulsed-RF FM Signal

This section describes how to perform the Gated LO Measurement, (page 128), Gated Video Measurement, (page 132), and the Gated FFT Measurement (page 136) using a pulsed FM signal from a signal generator.

When performing these measurements, you can use your Keysight X-Series signal analyzer (using Gate View) or a digitizing oscilloscope to set up the gated signal.

To set up a digitizing oscilloscope to view the trigger, gate and RF signals, see [Digitizing Oscilloscope Setup, on page 123](#).

Use the first three steps below to set up the signal generator to output a pulsed FM signal.

Step	Action	Notes
1	Connect the signal generator output to the signal analyzer input.	
2	Set up the signal generator to output an FM signal.	<ul style="list-style-type: none"> <li>a. Set FM mode to <b>ON</b>.</li> <li>b. Set the frequency to 40 MHz.</li> <li>c. Set the FM deviation to 1 kHz.</li> <li>d. Set the FM rate to 50 kHz.</li> <li>e. Set the amplitude to 0 dBm.</li> </ul>
3	Set up the signal generator to pulse the FM signal, and turn ON the output.	<ul style="list-style-type: none"> <li>a. Set the pulse mode to <b>ON</b>.</li> <li>b. Set the pulse period to 5 ms.</li> <li>c. Set the pulse width to 4 ms.</li> <li>d. Turn the modulation (Mod) <b>ON</b>.</li> <li>e. Turn the RF output <b>ON</b>.</li> </ul>
4	Preset the analyzer.	a. Press the <b>Mode Preset</b> key.  The default Mode and Measurement of the analyzer is Spectrum Analyzer and Swept SA. If necessary, you can verify (and select) the mode by pressing the MODE/MEAS key.

**NOTE**

Mode Preset does not preset all settings in the analyzer. For a more complete preset, tap Restore Mode Defaults and Input/Output Preset in the Preset menu.



- |  |   |
|--|---|
| 5 Set the center frequency and span.   | a. Press the <b>FREQ</b> key.<br>b. In the menu panel, double tap <b>Center Frequency</b> and enter <b>40 MHz</b> .<br>c. Double tap <b>Span</b> and enter <b>500 kHz</b> . |
| 6 Set the analyzer reference level.  | a. Press the <b>AMPTD</b> key.<br>b. In the menu panel, double tap <b>Ref Level</b> and enter <b>5.4 dBm</b> .  |
| 7 Set the analyzer BW.   | a. Press the <b>BW</b> key.<br>b. In the menu panel, double tap <b>Res BW</b> and enter <b>100 kHz</b> .  |
| 8 Set the gate source to the rear external trigger input.  | a. Press the <b>Trigger</b> key.<br>b. In the menu panel, select the <b>Gate Source</b> tab.<br>c. Tap <b>Select Gate Source</b> and select <b>RF Burst</b> .               |
| 9 Enable Gate View and set gate sweep time.  | a. Select the <b>Gate Settings</b> tab.<br>b. Toggle <b>Gate View</b> to On.<br>c. Double tap <b>Gate View Sweep Time</b> and enter <b>10 ms</b> .                          |
| 10 Set the gate delay and gate length so that the gate will open during the middle third of the pulse. | a. Double tap <b>Gate Delay</b> and enter <b>1.33 ms</b> .<br>b. Double tap <b>Gate Length</b> and enter <b>1.33 ms</b> .<br>c. Toggle <b>Control</b> to Edge.              |
- This example uses a gate delay of approximately 1.33 ms and a gate length of approximately 1.33 ms. Also, check that the gate trigger is set to edge. See [Figure 8-1](#).

# Making Time-Gated Measurements Viewing a Pulsed-RF FM Signal

Figure 8-1 Gated RF Signal

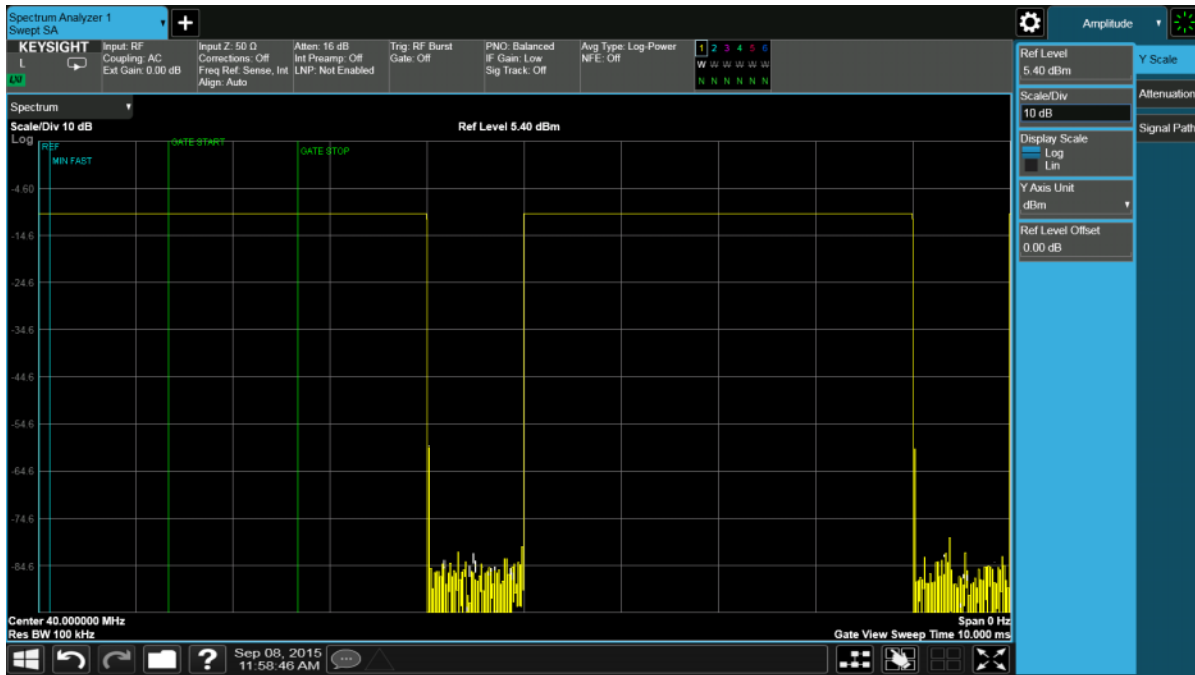

11 Set the RBW to auto, gate view to off, gate method to LO, and gate view to on.

- Toggle **Gate View** to Off.
- Press the **BW** key.
- Tap **Res BW** and toggle to Auto.
- Press the **Trigger** key.
- In the menu panel, select **Gate Settings** tab.
- Tap **Gate Method** and select **LO**.
- Toggle **Gate View** to On.

See [Figure 8-2](#).

Figure 8-2 Gated RF Signal with Auto RBW

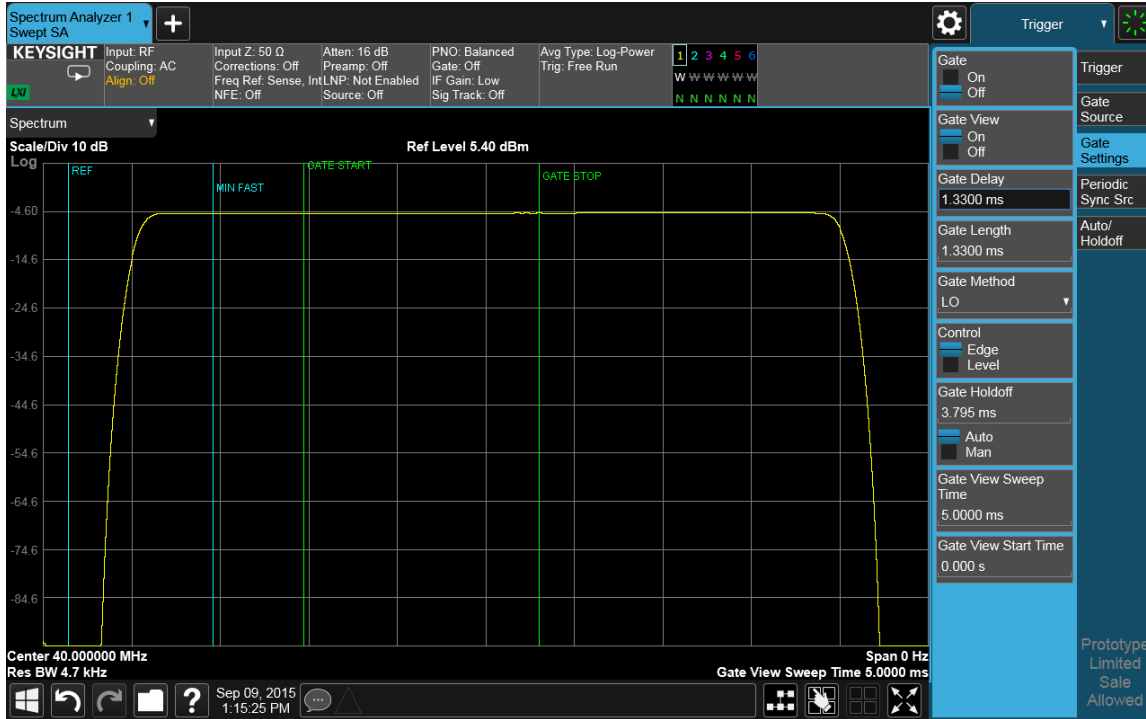

### Digitizing Oscilloscope Setup

If you are using a digitizing oscilloscope, set up the oscilloscope to view the trigger, gate and RF signals as follows (see [Figure 8-3](#) for an example of the oscilloscope display):

Timebase	1 ms/div
Channel 1	ON, 2 V/div, OFFSET = 2 V, DC coupled, 1 M $\Omega$ input, connect to the pulse signal (ESG LF OUTPUT or pulse generator OUTPUT). Adjust channel 1 settings as necessary.
Channel 2	ON, 500 mV/div, OFFSET = 2 V, DC coupled, 1 M $\Omega$ input, connect to the signal analyzer TRIGGER 2 OUT connector. Adjust channel 2 settings as needed when gate is active.
Channel 3	ON, 500 mV/div, OFFSET = 0 V, Timebase = 20 ns/div, DC coupled, 50 $\Omega$ input, connect to the ESG RF OUTPUT pulsed-RF signal. Adjust channel 3 settings as necessary.
Channel 4	OFF
Trigger	Edge, channel 1, level = 1.5 V, or as needed

Figure 8-3

Viewing the Gate Timing with an Oscilloscope

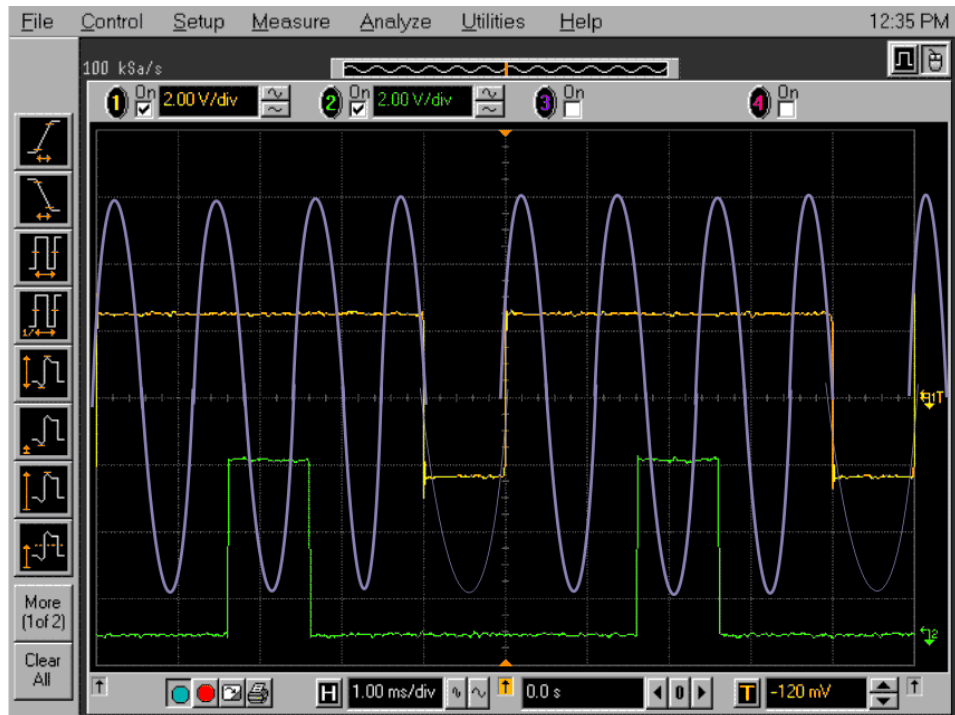

Figure 8-3 oscilloscope channels:

1. Channel 1 (yellow trace) - the trigger signal.
2. Channel 2 (green trace) - the gate signal (gate signal is not active until the gate is on in the spectrum analyzer).
3. Channel 3 (purple) - the RF output of the signal generator.

## Connecting Instruments to Make Time-Gated Measurements

**Figure 8-4** shows a test setup to create a pulsed FM signal, where you can view the signal spectra on a signal analyzer, and the timing signals on an oscilloscope. This setup is helpful when making gated measurements on unknown signals. Signal generator #2 provides a pulse signal from its LF Output to the EXT 2 INPUT of signal generator #1, and provides the trigger for the oscilloscope (if used), and analyzer. The oscilloscope is useful for illustrating timing interactions between the trigger signal and the gate. The Gate View feature of the analyzer could be used in place of the oscilloscope.

If an oscilloscope is not available, use the setup shown in **Figure 8-5**. Begin by using the Gate View feature to set up the gate parameters and then turn Gate View Off to view the signal spectra.

Figure 8-4 Instrument Connection Diagram with Oscilloscope

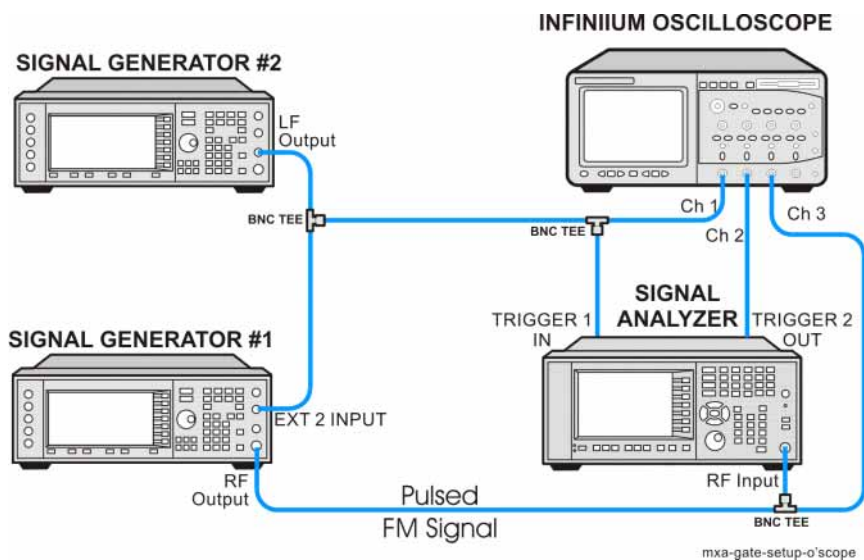
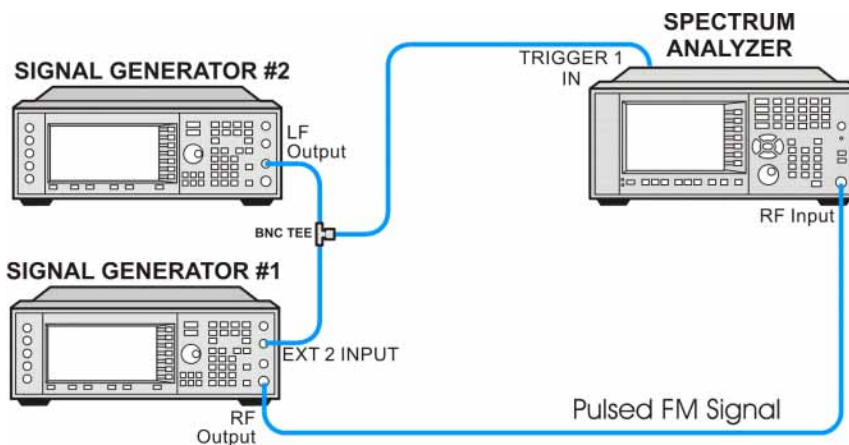

Figure 8-5 Instrument Connection Diagram without Oscilloscope



## Signal source setup

### Step 1. Set up signal generator #2 (the pulse source).

This procedure demonstrates how to create a pulse signal using a Keysight signal source that has an LF Out port. However, any signal source can be used if it can deliver a pulse with the specifications shown in [Table 8-1](#).

Use [Table 8-1](#) if you are using a generic pulse generator.

Use [Table 8-2](#) if you are using a signal generator with an LF Out Port, such as a Keysight signal generator.

Table 8-1

Generic Pulse Generator

Period	5 ms (or pulse frequency equal to 200 Hz)
Pulse width	4 ms
High output level	2.5 V
Waveform	pulse
Low output level	-2.5 V
Delay	0 or minimum

Table 8-2

Keysight Signal Generator With LF Out Port

LF Out Source	FuncGen
LF Out Waveform	Pulse
LF Out Period	5 ms
LF Out Width (pulse width)	4 ms
LF Out Amplitude	2.5 Vp
LF Out	On
RF On/Off	Off
Mod On/Off	On

### Step 2. Set up signal generator #1 (the pulsed-FM signal source).

Signal generator #1 generates the pulsed FM signal. The pulse signal created in step 1 is connected to the `EXT 2 INPUT` on the front of signal generator #1. Signal generator #1 provides the pulsed-FM signal that is analyzed by the spectrum analyzer. See [Table 8-3](#) for setting up signal generator #1.

Table 8-3 Signal Generator #1 Instrument Settings

Frequency	40 MHz
Amplitude	0 dBm
Pulse	On
Pulse Source	Ext2 DC
FM	On
FM Path	1
FM Dev	1 kHz
FM Source	Internal
FM Rate	50 kHz
RF On/Off	On
Mod On/Off	On

## Gated LO Measurement

This procedure uses gated LO to gate an FM signal. Refer to the following to set up this procedure:

[“Viewing a Pulsed-RF FM Signal” on page 120](#)

[“Connecting Instruments to Make Time-Gated Measurements” on page 125](#)

For concept and theory information about gated LO, see [“How Time Gating Works” on page 203](#).

Step	Action	Notes
1	Preset the analyzer.	a. Press the <b>Mode Preset</b> key.
		The default Mode and Measurement of the analyzer is Spectrum Analyzer and Swept SA. If necessary, you can verify (and select) the mode by pressing the MODE/MEAS key.
<b>NOTE</b>		Mode Preset does not preset all settings in the analyzer. For a more complete preset, tap Restore Mode Defaults and Input/Output Preset in the Preset menu.
2	Set the center frequency and span.	a. Press the <b>FREQ</b> key. b. In the menu panel, double tap <b>Center Frequency</b> and enter <b>40 MHz</b> . c. Double tap <b>Span</b> and enter <b>500 kHz</b> .
3	Set the analyzer reference level.	a. Press the <b>AMPTD</b> key. b. In the menu panel, double tap <b>Ref Level</b> and enter <b>10 dBm</b> .
4	Set the gate source to the rear external trigger input.	a. Press the <b>Trigger</b> key. b. In the menu panel, select <b>Gate Source</b> tab. c. Tap <b>Select Gate Source</b> and select <b>External 1</b> .
5	Set the gate delay, gate length, gate sweep time, and gate trigger.	a. Select the <b>Gate Settings</b> tab. b. Double tap <b>Gate Delay</b> and enter <b>2 ms</b> . c. Double tap <b>Gate Length</b> and enter <b>1 ms</b> . d. Double tap <b>Gate View Sweep Time</b> and enter <b>5 ms</b> . e. Toggle <b>Control</b> to Edge.



Step	Action	Notes
6	Access the analyzer gate view display. a. Toggle <b>Gate View</b> to On.	Use this function to confirm the gate “on” time during the RF burst interval. Alternatively, you could use the oscilloscope to view the gate settings.  See <b>Figure 8-6</b> .

Figure 8-6 Viewing the Gate Settings with Gated LO

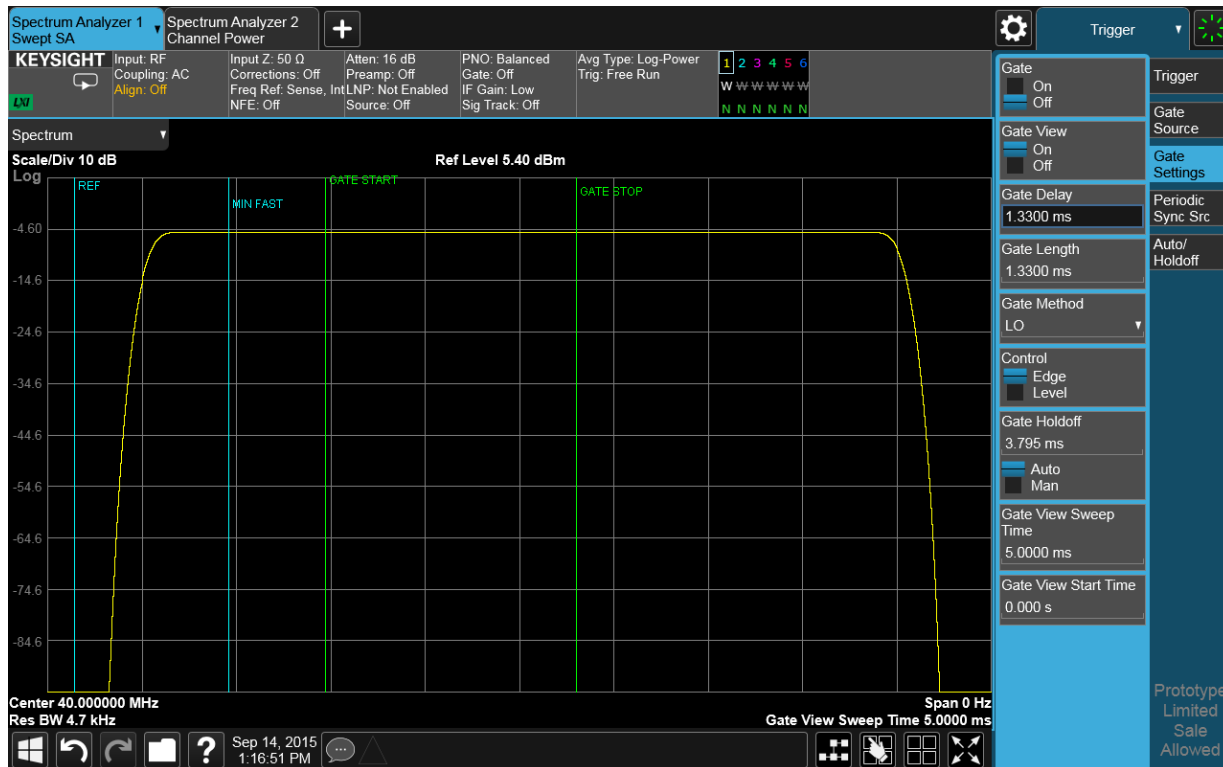

The blue vertical line (the far left line outside of the RF envelope) represents the location equivalent to a zero gate delay. The vertical green parallel bars represent the gate settings. The first (left) bar (GATE START) is set at the delay time while the second (right) bar (GATE STOP) is set at the gate length, measured from the first bar. The trace of the signal in this time-domain view is the RF envelope. The gate signal is triggered off of the positive edge of the trigger signal. When positioning the gate, a good starting point is to have it extend from 20% to 80% of the way through the pulse. While gate view mode is on, move the gate delay, length and polarity around. Notice the changes in the vertical gate bars while making your changes. Set the gate delay, length and polarity back to the step 3 settings.

**NOTE** The analyzer time gate triggering mode uses positive edge, negative edge, and level triggering.

7	Turn the gate view off. a. Toggle <b>Gate View</b> to Off.	See <b>Figure 8-7</b> .
---	---	-------------------------

Making Time-Gated Measurements  
Gated LO Measurement

Step	Action	Notes
------	--------	-------

Figure 8-7 Pulsed RF FM Signal

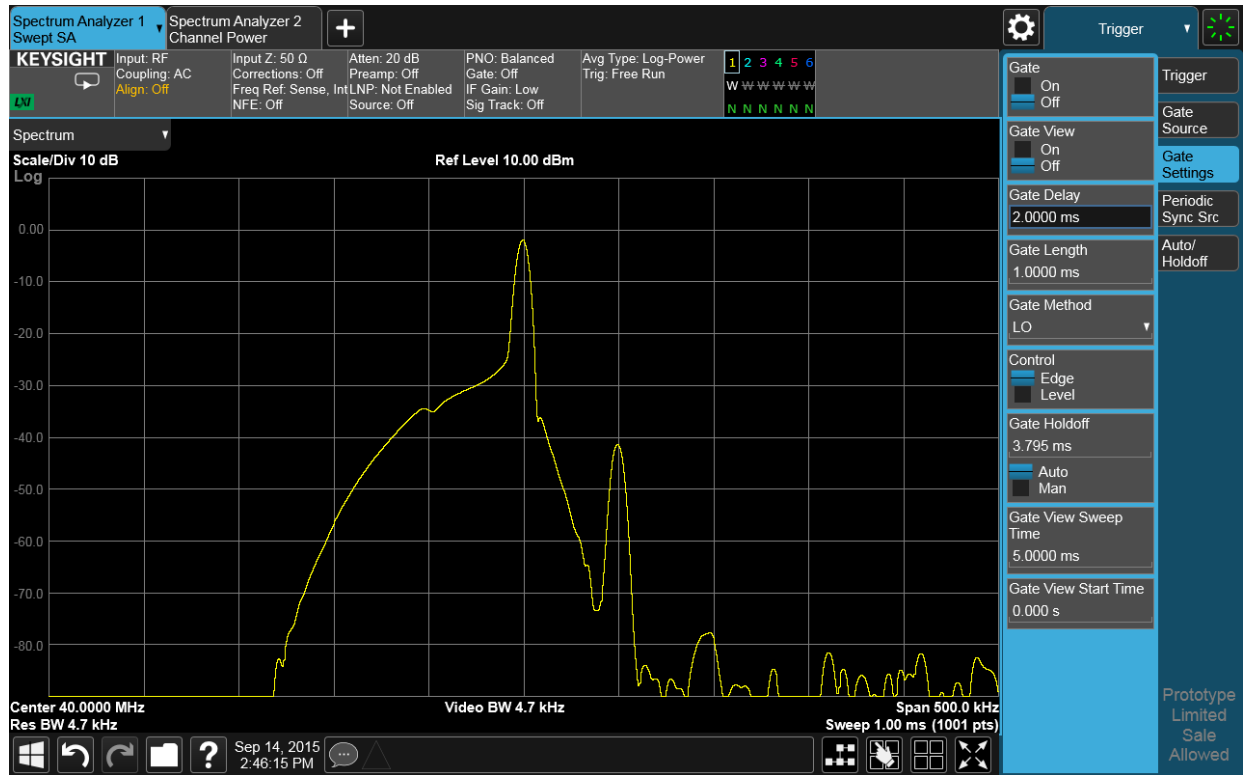

The moving signals are a result of the pulsed signal. Using time gating, these signals will be blocked out, leaving the original FM signal.

- |   |                                     |                               |
|---|-------------------------------------|-------------------------------|
| <p><b>8</b> Enable the gate settings.</p> | <p>a. Toggle <b>Gate</b> to On.</p> | <p>See <b>Figure 8-8</b>.</p> |
|---|-------------------------------------|-------------------------------|

Making Time-Gated Measurements  
Gated LO Measurement

Step	Action	Notes
------	--------	-------

Figure 8-8 Pulsed and Gated Signal

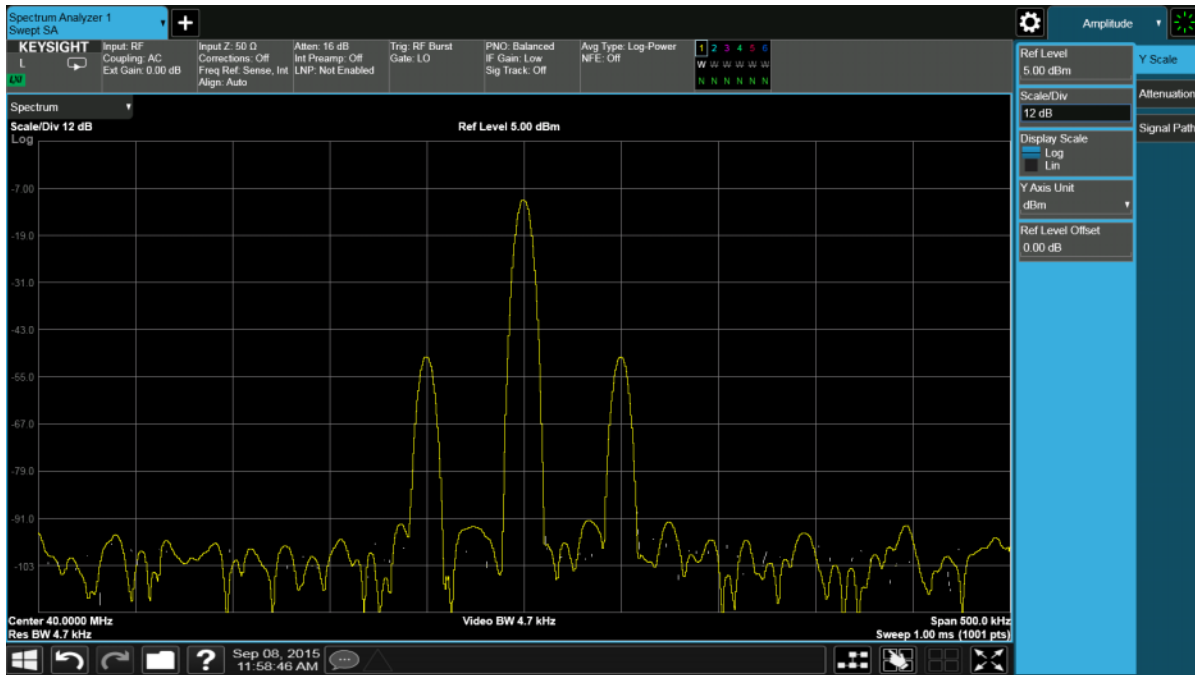

9 Turn off the pulse modulation of the FM signal on signal generator #1.

a. Toggle **Pulse** to Off.

Notice that the gated spectrum is much cleaner than the ungated spectrum (as seen in the **Pulsed-RF FM Signal** above). The displayed spectrum with the gate on is the same as an unpulsed FM signal. The displayed spectrum does not change and in both cases, you can see the two low-level modulation sidebands caused by the narrow-band FM.

## Gated Video Measurement

This procedure utilizes gated video to gate the FM signal. Refer to the following to setup for this procedure:

[“Viewing a Pulsed-RF FM Signal” on page 120](#)

[“Connecting Instruments to Make Time-Gated Measurements” on page 125](#)

For concept and theory information about gated video see [“How Time Gating Works” on page 203](#).

Step	Action	Notes
1 Preset the analyzer.	a. Press the <b>Mode Preset</b> key.	The default Mode and Measurement of the analyzer is Spectrum Analyzer and Swept SA. If necessary, you can verify (and select) the mode by pressing the MODE/MEAS key.
<div style="background-color: #cccccc; padding: 5px; display: inline-block;"><b>NOTE</b></div>		Mode Preset does not preset all settings in the analyzer. For a more complete preset, tap Restore Mode Defaults and Input/Output Preset in the Preset menu.
2 Set the center frequency and span.	a. Press the <b>FREQ</b> key. b. In the menu panel, double tap <b>Center Frequency</b> and enter <b>40 MHz</b> . c. Double tap <b>Span</b> and enter <b>500 kHz</b> .	
3 Set the analyzer reference level.	a. Press the <b>AMPTD</b> key. b. In the menu panel, double tap <b>Ref Level</b> and enter <b>10 dBm</b> .	
4 Set the gate source to the rear external trigger input.	a. Press the <b>SWEEP</b> key. b. In the menu panel, select the <b>Sweep Config</b> tab. c. Double tap <b>Points</b> and enter <b>401</b> . d. Select <b>Sweep Control</b> tab. e. Double tap <b>Sweep Time</b> and enter <b>2000 ms</b> .	
5 Set analyzer points to 401 and sweep time to 2000 ms.	a. Select <b>Sweep Config</b> tab, Double tap <b>Points</b> and enter <b>401</b> . b. Select <b>Sweep Control</b> tab. Double tap <b>Sweep Time</b> and enter <b>2000 ms</b> .	

Step	Action	Notes
------	--------	-------

For gated video, the calculated sweep time should be set to at least  $(\# \text{ sweep points} - 1) \times \text{PRI (pulse repetition interval)}$  to ensure that the gate is on at least once during each of the 401 sweep points. In this example, the PRI is 5 ms, so you should set the sweep time to 401 minus 1 times 5 ms, or 2 s. If the sweep time is set too fast, some trace points may show values of zero power or other incorrect low readings. If the trace seems incomplete or erratic, try a longer sweep time.

**NOTE**

**Good practices for determining the minimum sweep time for gated video:**

In the event that the signal is not noisy, the sweep time can be set to less than  $(\# \text{ sweep points} - 1) \times \text{PRI (pulse repetition interval)}$  (as calculated above). Instead of using PRI in the previous sweep time calculation, we can use the “gate off time” where sweep time equals  $(\# \text{ sweep points} - 1) \times \text{gate off time}$ . (Gate off time is defined as  $\text{PRI} - \text{GL}$ , where GL = Gate Length.) In our example we could use a sweep time of 400 points times 1 ms or 400 ms -  $(401 - 1) \times (5\text{ms} - 4\text{ms}) = 400\text{ms}$ . Increase the video bandwidth to improve the probability of capturing the pulse using “gate off time”. If trace points are still showing values of zero power, increase the sweep time by small increments until there are no more dropouts.

- |  |  |                               |
|--|--|-------------------------------|
| <p><b>6</b> Set the Gate source to the external trigger input on the rear panel:</p> | <p>a. Press the <b>Trigger</b> key.<br/>b. Select the <b>Gate Source</b> tab.<br/>c. Tap <b>Select Gate Source</b> and select <b>External 1</b>.</p> | <p>See <b>Figure 8-9</b>.</p> |
|--|--|-------------------------------|

Figure 8-9 Viewing a Pulsed RF FM Signal Without Gating

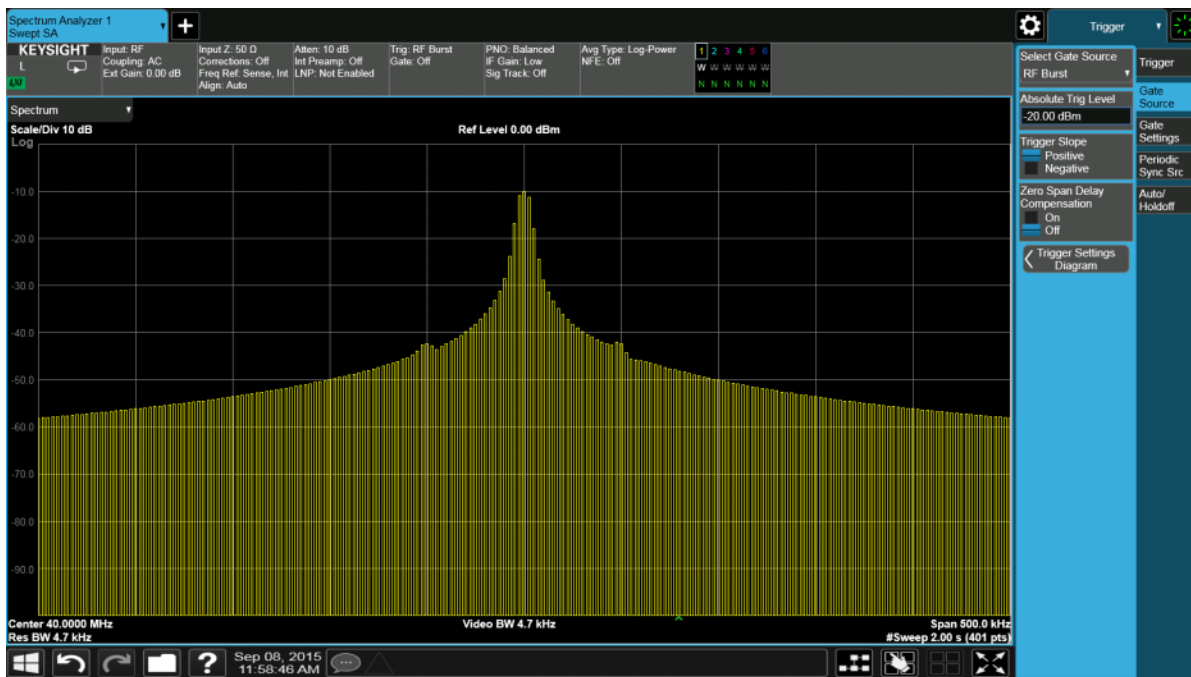

Step	Action	Notes
7	<p>Set the gate delay and gate length.</p> <ol style="list-style-type: none"> <li>Select <b>Gate Settings</b>, Toggle <b>Control</b> to Edge.</li> <li>Double tap <b>Gate Delay</b> and enter <b>2 ms</b>.</li> <li>Double tap <b>Gate Length</b> and enter <b>1 ms</b>.</li> </ol>	Ensure that the gate control is set to Edge.
8	<ol style="list-style-type: none"> <li>Tap <b>Gate Method</b> and select <b>Video</b>.</li> <li>Toggle <b>Gate</b> to On.</li> </ol>	See <a href="#">Figure 8-10</a> .

Figure 8-10 Viewing a Pulsed RF FM Signal Using Gated Video

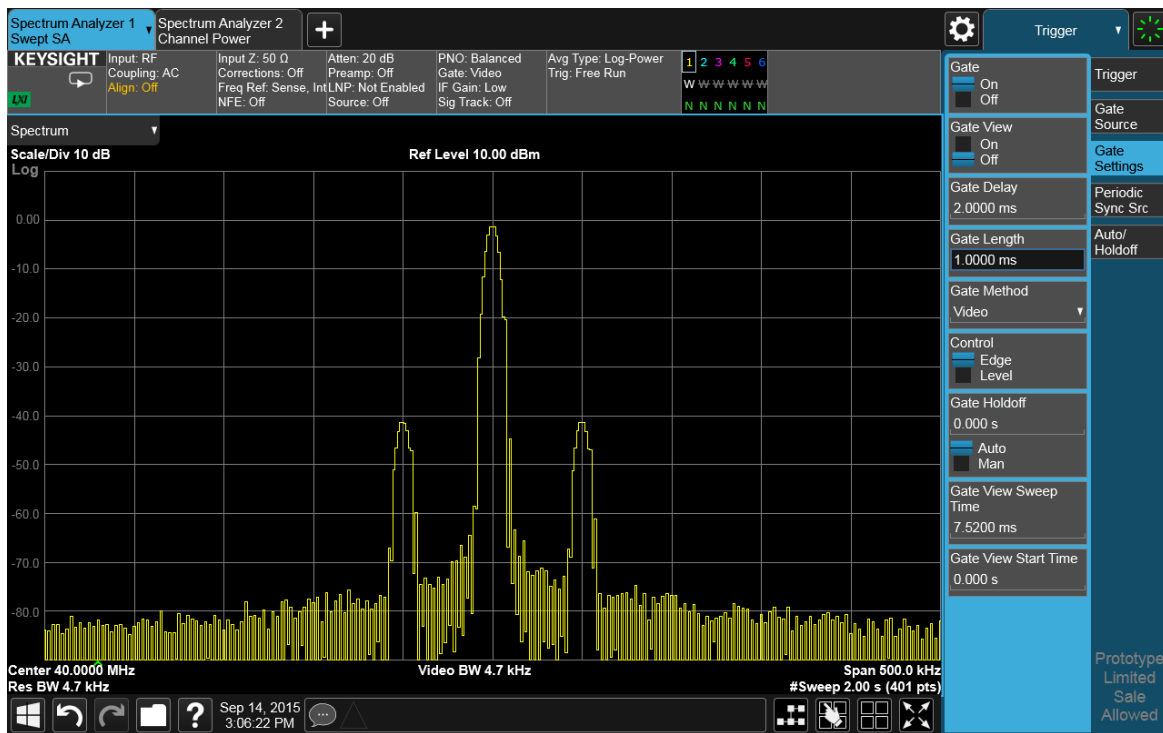

Notice that the gated spectrum is much cleaner than the ungated spectrum ([Figure 8-9](#)). The displayed spectrum is the same as an FM signal without pulsing. To prove this, turn off pulse modulation of the FM signal on signal generator #1 by toggling **Pulse** to Off. The displayed spectrum does not change.

If you have used an oscilloscope, check the oscilloscope display and ensure that the gate is positioned under the pulse. The gate should be set so that it is on somewhere between 20% to 80% of the pulse. If necessary, adjust gate length and gate delay. [Figure 8-11](#) shows the oscilloscope display when the gate is positioned correctly (the bottom trace).

Making Time-Gated Measurements  
Gated Video Measurement

Step Action Notes

Figure 8-11 The Oscilloscope Display

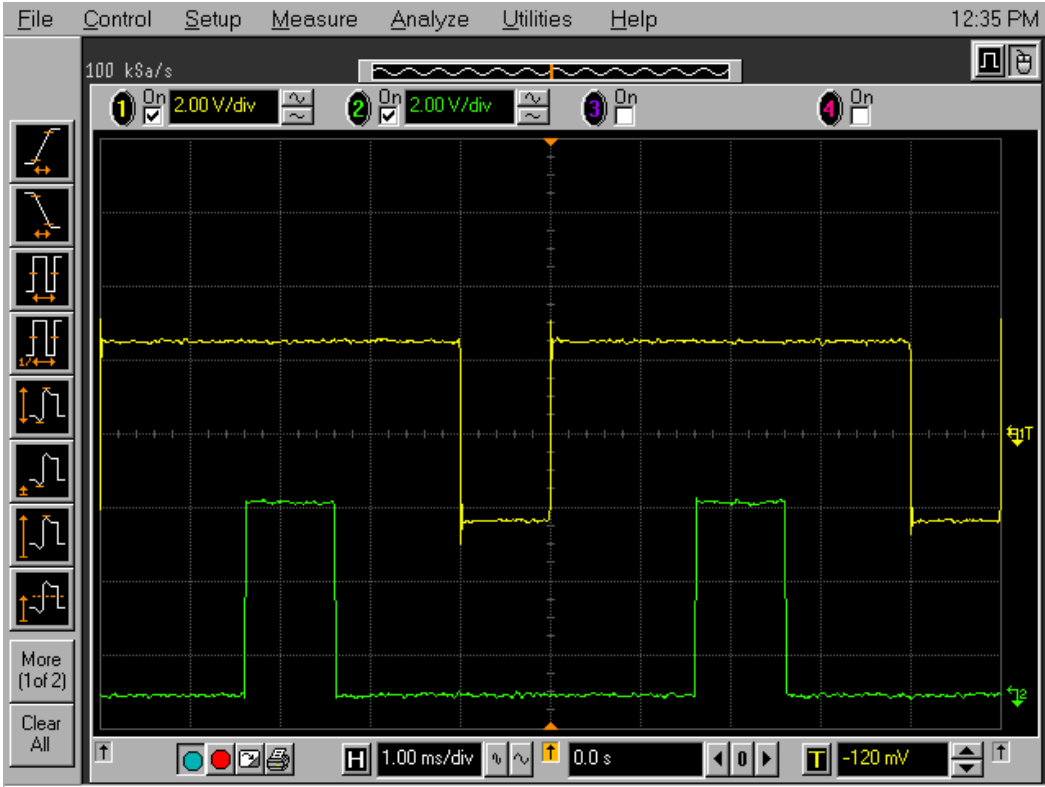

## Gated FFT Measurement

This procedure utilizes gated FFT to gate the FM signal. Refer to the following to setup this procedure:

[“Viewing a Pulsed-RF FM Signal” on page 120](#)

[“Connecting Instruments to Make Time-Gated Measurements” on page 125](#)

For concept and theory information about gated FFT see [“How Time Gating Works” on page 203](#).

Step	Action	Notes
1 Preset the analyzer.	a. Press the <b>Mode Preset</b> key.	The default Mode and Measurement of the analyzer is Spectrum Analyzer and Swept SA. If necessary, you can verify (and select) the mode by pressing the MODE/MEAS key.
<b>NOTE</b>	Mode Preset does not preset all settings in the analyzer. For a more complete preset, tap Restore Mode Defaults and Input/Output Preset in the Preset menu.	
2 Set the center frequency and span.	a. Press the <b>FREQ</b> key. b. In the menu panel, double tap <b>Center Frequency</b> and enter <b>40 MHz</b> . c. Double tap <b>Span</b> and enter <b>500 kHz</b> .	
3 Set the analyzer reference level.	a. Press the <b>AMPTD</b> key. b. In the menu panel, double tap <b>Ref Level</b> and enter <b>10 dBm</b> .	
4 Set the Gate source to the external trigger input on the rear panel.	a. Press the <b>Trigger</b> key. b. In the menu panel, select the <b>Gate Source</b> tab and Select <b>External 1</b> .	
5 Set the gate method and turn gate on.	a. Select the <b>Gate Settings</b> tab. b. Tap <b>Gate Method</b> and select <b>FFT</b> . c. Toggle <b>Gate</b> to On.	
6 Select the minimum resolution bandwidth required.	a. Press the <b>BW</b> key. b. In the menu panel, tap <b>Res BW</b> and toggle to Auto.	See <a href="#">Figure 8-12</a> .



## Making Time-Gated Measurements Gated FFT Measurement

Step

Action

Notes

Figure 8-12 Viewing the Gated FFT Measurement results

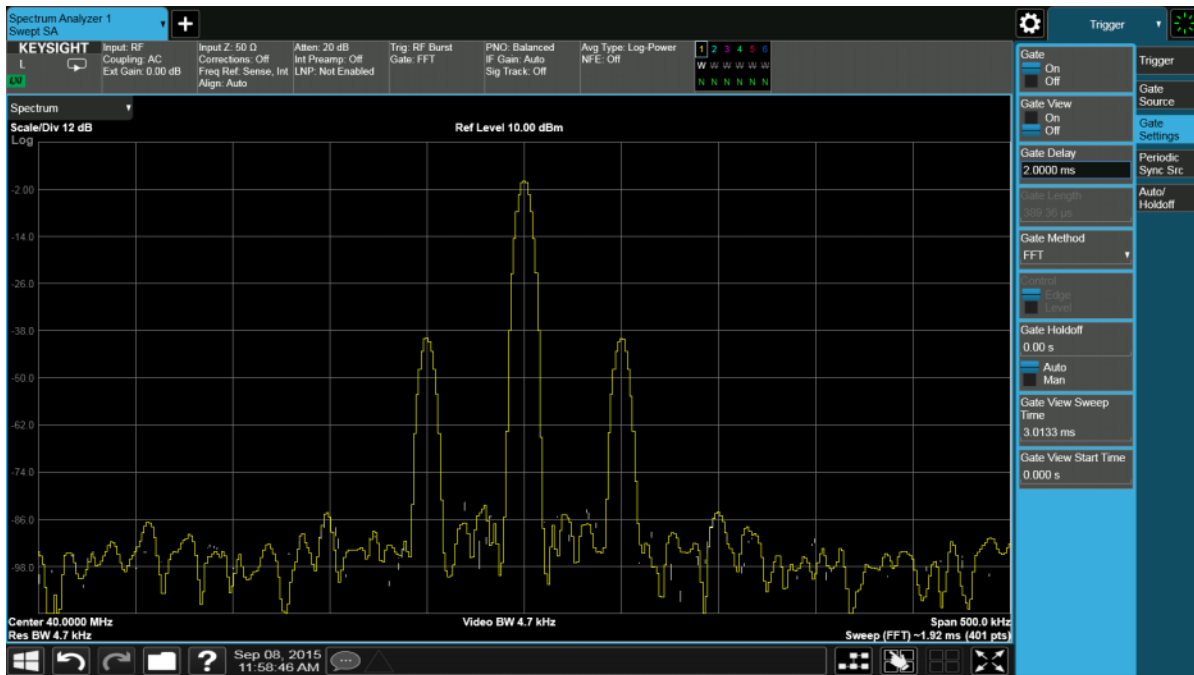

RBW determines the duration of the analysis. Divide 1.83 by 4 ms to calculate the minimum RBW. The pulse width in our case is 4 ms so we need a minimum RBW of 458 Hz. In this case the RBW is narrow, so let the analyzer choose the RBW for the current analyzer settings (span). Check that the RBW is greater than 458 Hz. Vary the RBW settings and note that the signal changes shape as the RBW transitions from 1 kHz to 300 Hz.

### NOTE

If the trigger event needs to be delayed use the **Trig Delay** function under the **Trigger** menu. Apply some small amount of trigger delay to allow time for the device under test to settle.

Making Time-Gated Measurements  
Gated FFT Measurement

## 9 Measuring Digital Communications Signals

The signal analyzer makes power measurements on digital communication signals fast and repeatable by providing a comprehensive suite of power-based, one-button automated measurements with preset standards-based format setups. The automated measurements also include pass/fail functionality, further increasing test throughput.

This chapter provides examples of the following measurements:

- **Making Channel Power Measurements**
- **Making Occupied Bandwidth Measurements**
- **Making Adjacent Channel Power (ACP) Measurements**
- **Making Statistical Power Measurements (CCDF)**
- **Making Burst Power Measurements**
- **Making Spurious Emissions Measurements**
- **Making Spectrum Emission Mask Measurements**
- **Making List Sweep Measurements**

## Making Channel Power Measurements

This section describes how to make a channel power measurement on a W-CDMA (3GPP) mobile station. A signal generator is used to simulate a station. This test measures the total RF power present in the channel. The results are displayed graphically as well as in total power (dB) and power spectral density (dBm/Hz).

Step	Action	Notes
1	Set up the signal generator.	a. Set the mode to W-CDMA. b. Set the frequency to 1.920 GHz. c. Set the amplitude to $-20$ dBm.
2	Connect the source RF OUTPUT to the analyzer RF INPUT as shown.	

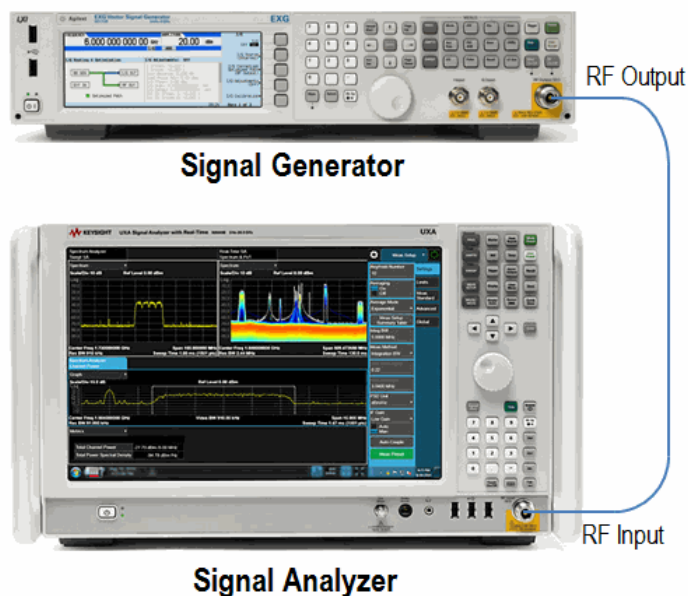

3	Preset the analyzer.	a. Press the <b>Mode Preset</b> key.
---	----------------------	--------------------------------------

**NOTE**

Mode Preset does not preset all settings in the analyzer. For a more complete preset, tap Restore Mode Defaults and Input/Output Preset in the Preset menu.

Step	Action	Notes
4 Select the Measurement.	<ol style="list-style-type: none"><li>Press the <b>MODE/MEAS</b> key.</li><li>Select <b>Spectrum Analyzer</b> in the Mode column.</li><li>Select <b>Channel Power</b> in the Measurement column.</li><li>Tap <b>OK</b> at the bottom of the display.</li></ol>	The default Mode and Measurement of the analyzer is Spectrum Analyzer and Swept SA. If necessary, you can verify (and select) the mode by pressing the MODE/MEAS key.
5 Set the radio standard and type of station.	<ol style="list-style-type: none"><li>Press the <b>MEAS SETUP</b> key.</li><li>In the menu panel, select the <b>Meas Standard</b> tab.</li><li>Tap <b>Radio Std Presets</b> and select <b>Cellular, 3GPP W-CDMA, MS</b> in the table.</li><li>Tap <b>OK</b> at the bottom of the display.</li></ol>	
6 Set the center frequency.	<ol style="list-style-type: none"><li>Press the <b>FREQ</b> key.</li><li>In the menu panel, double tap <b>Center Frequency</b> and enter <b>1.92 GHz</b>.</li></ol>	The channel power measurement result should look like <b>Figure 9-1</b> .

Measuring Digital Communications Signals  
Making Channel Power Measurements

Step

Action

Notes

Figure 9-1 Channel Power Measurement Result.

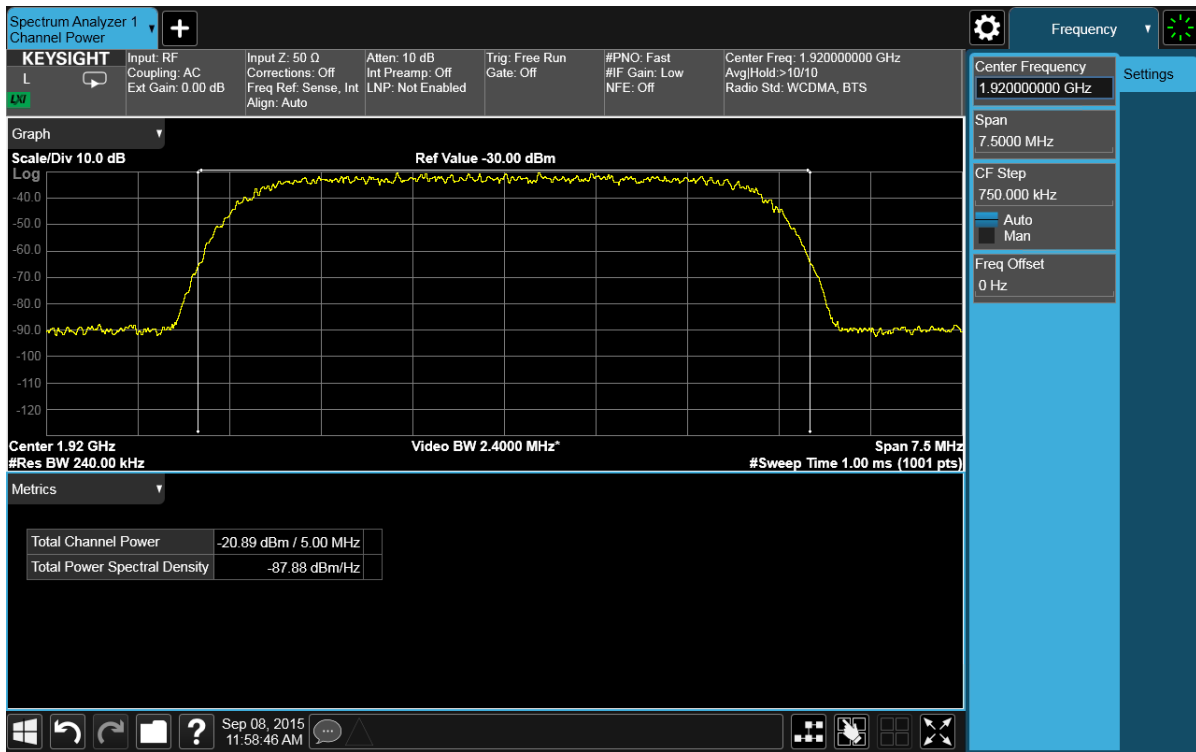

The graph window and the text window showing the absolute power and its mean power spectral density values over 5 MHz are displayed.

To change the measurement parameters from their default condition, press the **MEAS SETUP** key.

## Making Occupied Bandwidth Measurements

This section explains how to measure the occupied bandwidth on a W-CDMA (3GPP) mobile station. A signal generator is used to simulate the station. The instrument measures power across the band, and then calculates its 99.0% power bandwidth.

Step	Action	Notes
1	Set up the signal generator. <ol style="list-style-type: none"> <li>Set the mode to W-CDMA.</li> <li>Set the frequency to 1.920 GHz.</li> <li>Set the amplitude to -20 dBm.</li> </ol>	
2	Connect the source RF OUTPUT to the analyzer RF INPUT as shown.	

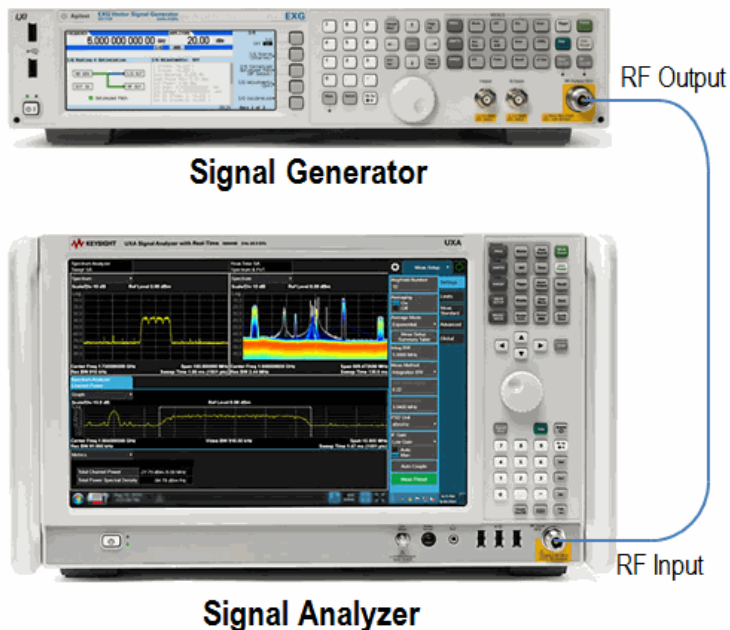

3	Preset the analyzer. <ol style="list-style-type: none"> <li>Press the <b>Mode Preset</b> key.</li> </ol>	
---	--	--

**NOTE**

Mode Preset does not preset all settings in the analyzer. For a more complete preset, tap Restore Mode Defaults and Input/Output Preset in the Preset menu.

4	Select the Measurement. <ol style="list-style-type: none"> <li>Press the <b>MODE/MEAS</b> key.</li> <li>Select <b>Spectrum Analyzer</b> in the Mode column.</li> <li>Select <b>Occupied BW</b> in the Measurement column.</li> <li>Tap <b>OK</b> at the bottom of the display.</li> </ol>	The default Mode and Measurement of the analyzer is Spectrum Analyzer and Swept SA. If necessary, you can verify (and select) the mode by pressing the MODE/MEAS key.
---	---	---

Step	Action	Notes
5	Set the radio standard and type of station. <ol style="list-style-type: none"> <li>Press the <b>MEAS SETUP</b> key.</li> <li>In the menu panel, select the <b>Meas Standard</b> tab.</li> <li>Tap <b>Radio Std Presets</b> and select <b>Cellular, 3GPP W-CDMA, MS</b> in the table.</li> <li>Tap <b>OK</b> at the bottom of the display.</li> </ol>	
6	Set the center frequency. <ol style="list-style-type: none"> <li>Press the <b>FREQ</b> key.</li> <li>In the menu panel, double tap <b>Center Frequency</b> and enter <b>1.92 GHz</b>.</li> </ol>	The occupied BW measurement result should look like <b>Figure 9-2</b> .

Figure 9-2 Occupied BW Measurement Result

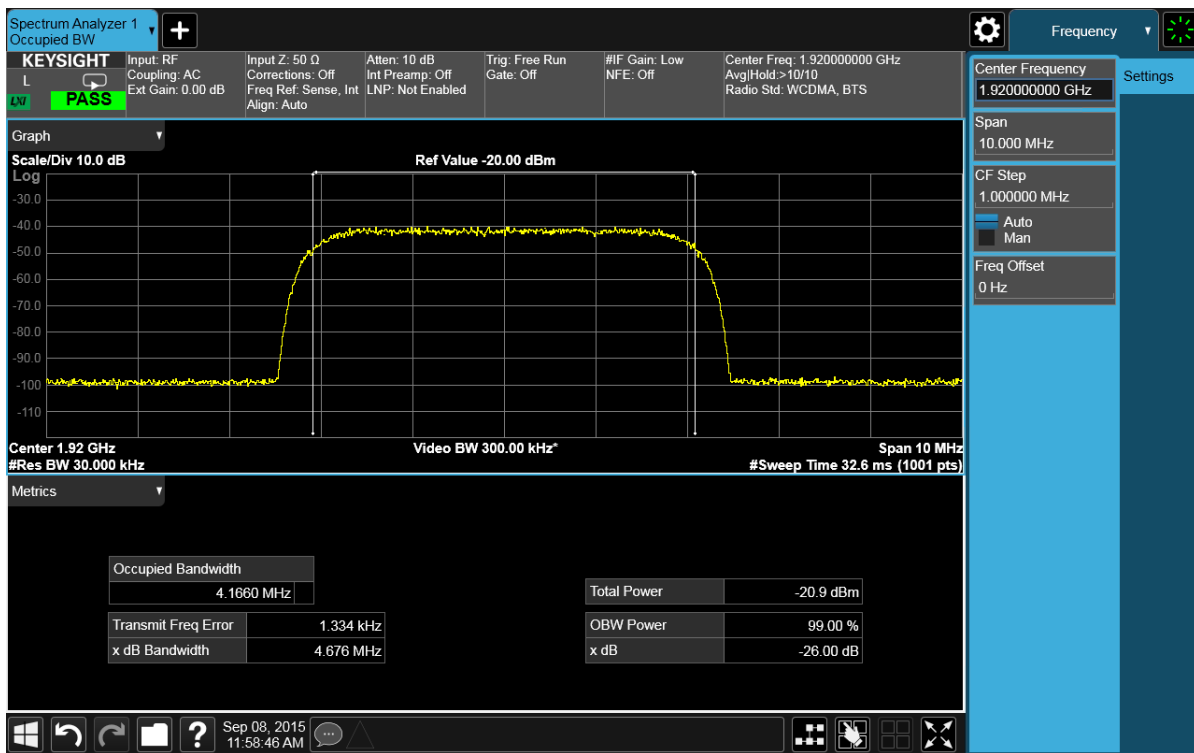

### Troubleshooting hints

Any distortion such as harmonics or intermodulation produces undesirable power outside the specified bandwidth.

Shoulders on either side of the spectrum shape indicate spectral regrowth and intermodulation. Rounding or sloping of the top shape can indicate filter shape problems.



## Making Adjacent Channel Power (ACP) Measurements

The adjacent channel power (ACP) measurement is also referred to as the adjacent channel power ratio (ACPR) and adjacent channel leakage ratio (ACLR). In this document, the term ACP is used.

ACP measures the total power (rms voltage) in the specified channel and up to six pairs of offset frequencies (channels). The measurement result reports the ratios of the offset (channel) powers to the main channel power.

The following example shows how to make an ACP measurement on a W-CDMA base station signal broadcasting at 1.96 GHz. A signal generator is used to simulate the station.

Step	Action	Notes
1	Set up the signal generator. <ol style="list-style-type: none"> <li>Set the mode to W-CDMA.</li> <li>Set the frequency to 1.920 GHz.</li> <li>Set the amplitude to <math>-10</math> dBm.</li> </ol>	
2	Connect the source RF OUTPUT to the analyzer RF INPUT as shown.	

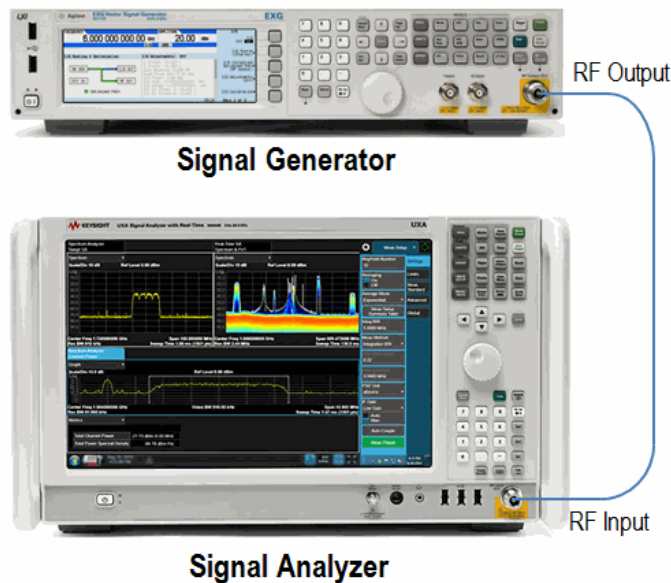

3	Preset the analyzer. <ol style="list-style-type: none"> <li>Press the <b>Mode Preset</b> key.</li> </ol>	
<div style="background-color: #cccccc; padding: 5px; display: inline-block;"><b>NOTE</b></div> Mode Preset does not preset all settings in the analyzer. For a more complete preset, tap Restore Mode Defaults and Input/Output Preset in the Preset menu.		

Step	Action	Notes
4 Select the Measurement.	a. Press the <b>MODE/MEAS</b> key. b. Select <b>Spectrum Analyzer</b> in the Mode column. c. Select <b>ACP</b> in the Measurement column. d. Tap <b>OK</b> at the bottom of the display.	The default Mode and Measurement of the analyzer is Spectrum Analyzer and Swept SA. If necessary, you can verify (and select) the mode by pressing the MODE/MEAS key.
5 Set the radio standard and type of station.	a. Press the <b>MEAS SETUP</b> key. b. In the menu panel, select the <b>Meas Standard</b> tab. c. Tap <b>Radio Std Presets</b> and select <b>Cellular, 3GPP W-CDMA, BTS</b> in the table. d. Tap <b>OK</b> at the bottom of the display.	
6 Set the center frequency.	a. Press the <b>FREQ</b> key. b. In the menu panel, double tap <b>Center Frequency</b> and enter <b>1.92 GHz</b> .	The ACP measurement result should look like <b>Figure 9-3</b> .
7 Optimize the attenuation setting.	a. Press the <b>AMPTD</b> key. b. In the menu panel, select the <b>Attenuation</b> tab. c. Tap <b>Adjust Atten for Min Clipping</b> .	Adjust Atten for Min Clipping protects against input signal overloads, but does not necessarily set the input attenuation and reference level for optimum measurement dynamic range.  To improve the measurement repeatability, increase the sweep time to smooth out the trace (average detector must be selected). Measurement repeatability can be traded off with sweep time.
8 To increase dynamic range, <b>Noise Correction</b> can be used to factor out the added power of the noise floor effects.	a. Press the <b>MEAS SETUP</b> key. b. In the menu panel, select the <b>Advanced</b> tab. c. Toggle <b>Noise Correction</b> to On.	

Step Action Notes

Figure 9-3 ACP Measurement on a Base Station W-CDMA Signal

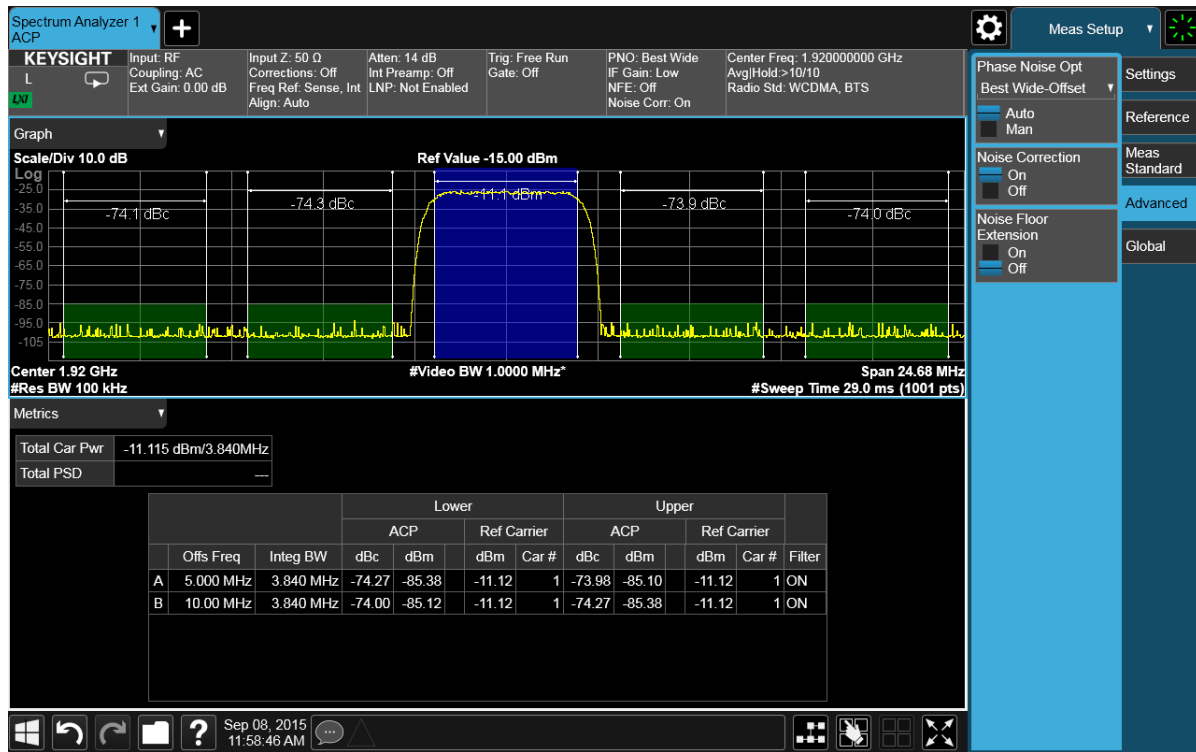

Two vertical white lines, in the center of the screen, indicate the bandwidth limits of the central channel being measured. The frequency offsets, channel integration bandwidths, and span settings can all be modified from the default settings. Offsets A and B are designated by the adjacent pairs of white lines, in this case: 5 MHz and 10 MHz from the center frequency respectively.

**9 Define a new, third pair of offset frequencies.**

- a. Select the **Settings** tab.
- b. Tap **Carr/Offset/Limits Config**.
- c. In the left **Configuration** column, tap **Offset**.
- d. In the Offset setting table, enable **C** (check box) and change **Offset Freq** to **15 MHz**.
- e. Close this page by tapping the **Close** icon in the upper right corner.

This third pair of offset frequencies are offset by 15.0 MHz from the center frequency as shown in **Figure 9-4**. Three further pairs of offset frequencies (D, E and F) are also available.

Measuring Digital Communications Signals  
 Making Adjacent Channel Power (ACP) Measurements

Step Action Notes

Figure 9-4 Configuring Carrier/Offset/Limits

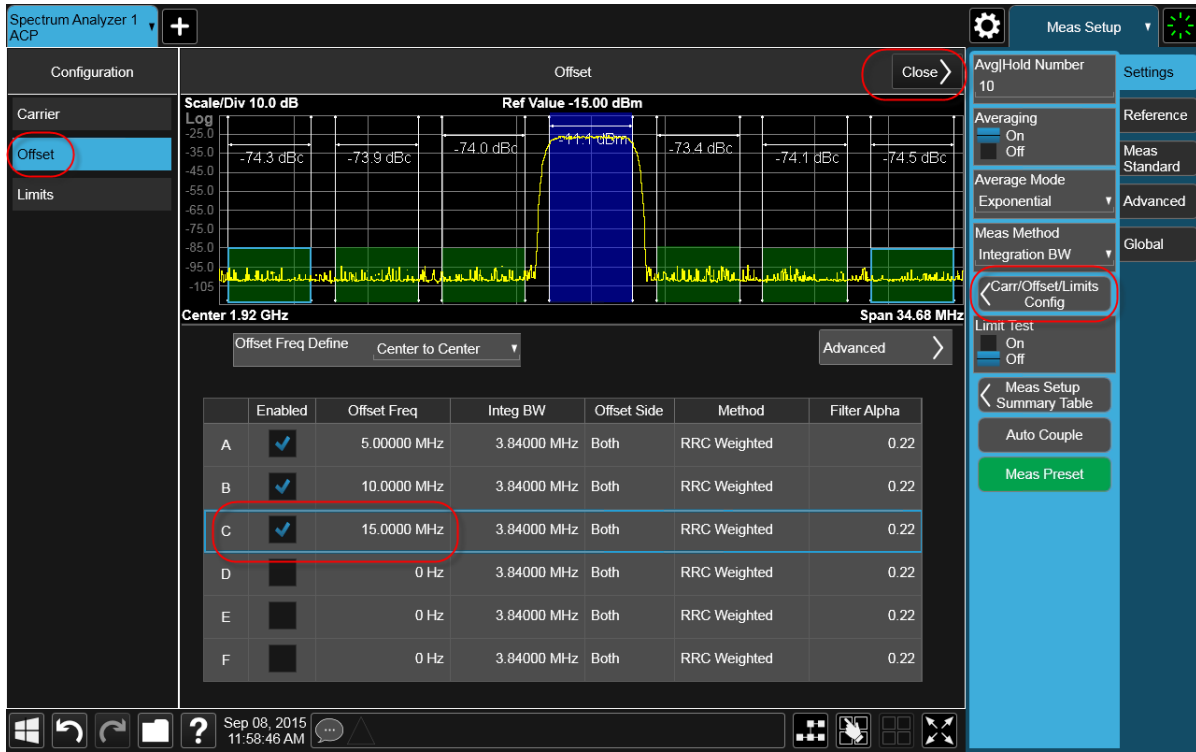

Measuring Digital Communications Signals  
Making Adjacent Channel Power (ACP) Measurements

Step Action Notes

Figure 9-5 Measuring a Third Adjacent Channel

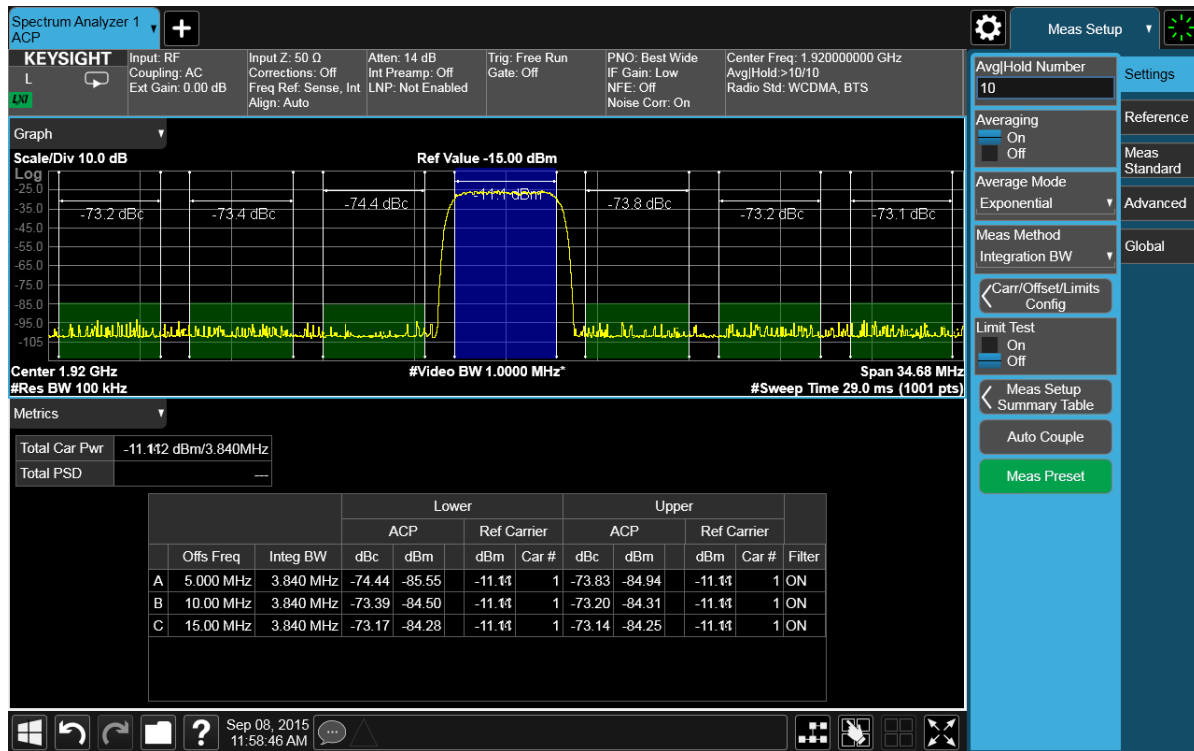

10 Set pass/fail limits for each offset.

- Select the **Settings** tab.
- Tap **Carr/Offset/Limits Config**.
- In the left **Configuration** column, tap **Limits**.
- In the Limits setting table, for Offset A, change **Rel Limit (Car)** to **-55 dB**.
- Change Offset B **Rel Limit (Car)** to **-75 dB**.
- Change Offset C **Rel Limit (Car)** to **-60 dB**.
- Close this page by tapping the **Close** icon in the upper right corner.

See **Figure 9-5**.

Measuring Digital Communications Signals  
 Making Adjacent Channel Power (ACP) Measurements

Step	Action	Notes
11	Turn the limit test on. a. In the menu panel, toggle <b>Limit Test</b> to On.	In <b>Figure 9-6</b> notice that offsets A and C have passed, however offset B has failed. Power levels that fall above our specified -75 dB for offset B, fail. The offset bar graph and the associated power level value are shaded red to identify a failure. The offset limits are shown as dashed lines.

Figure 9-6 Setting Offset Limits

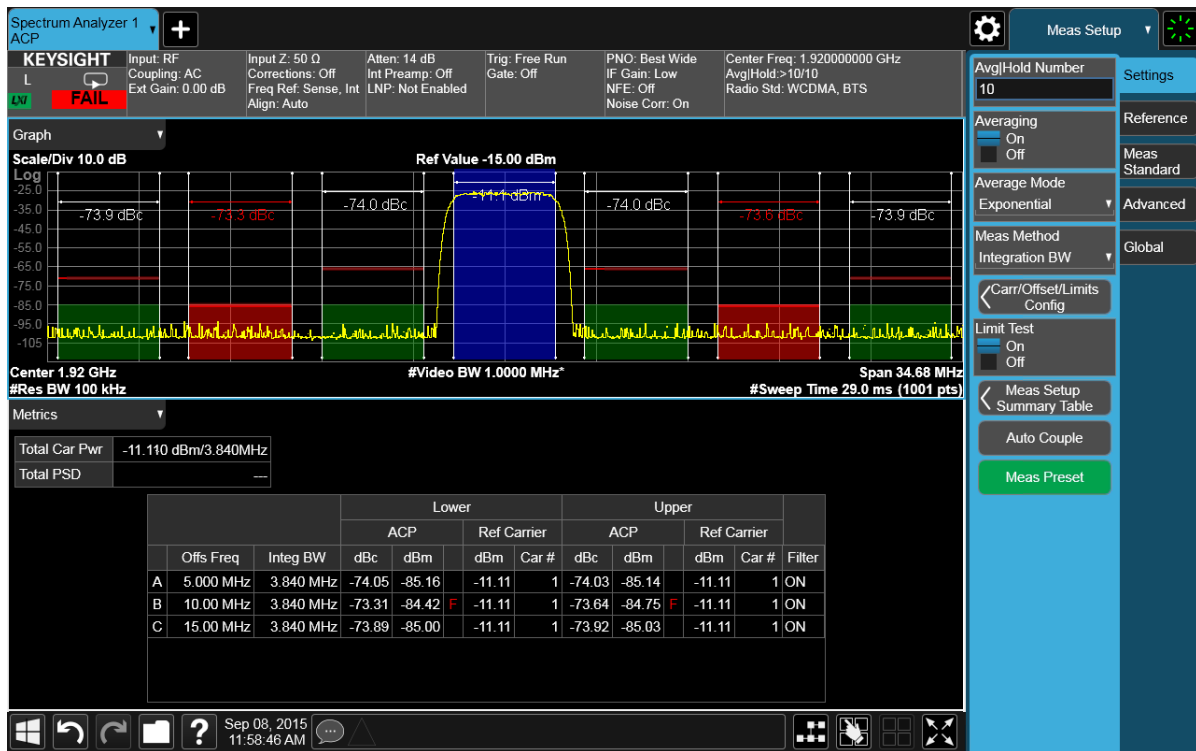

**NOTE** You may increase the measurement repeatability by increasing the sweep time.

## Making Statistical Power Measurements (CCDF)

Complementary cumulative distribution function (CCDF) curves characterize a signal by providing information about how much time the signal spends at or above a given power level. Percentage is on the vertical axis and power (in dB) is on the horizontal axis.

All CDMA signals, and W-CDMA signals in particular, are characterized by high power peaks that occur infrequently. If these power peaks are not maintained, separate data channels can not be received properly. Too many peak signals can also cause spectral regrowth. If a CDMA system works well most of the time and only fails occasionally, this can often be caused by compression of the higher peak signals.

The following example shows how to make a CCDF measurement on a W-CDMA signal broadcasting at 1.96 GHz. A signal generator is used to simulate a base station.

Step	Action	Notes
1	Set up the signal generator. a. Setup a W-CDMA down link signal. b. Set the frequency to 1.92 GHz. c. Set the amplitude to $-10$ dBm.	
2	Connect the source RF OUTPUT to the analyzer RF INPUT as shown below.	

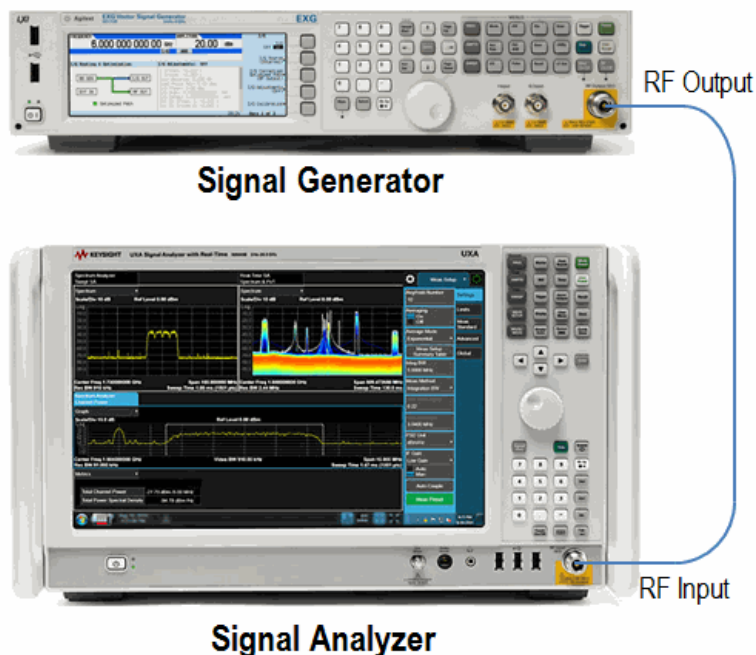

Step	Action	Notes
3 Preset the analyzer.	a. Press the <b>Mode Preset</b> key.	
<b>NOTE</b>	Mode Preset does not preset all settings in the analyzer. For a more complete preset, tap Restore Mode Defaults and Input/Output Preset in the Preset menu.	
4 Select the Measurement.	a. Press the <b>Mode/Meas</b> key. b. Select <b>Spectrum Analyzer</b> in the Mode column. c. Select <b>Power Stat CCDF</b> in the Measurement column d. Tap <b>OK</b> at the bottom of the display.	The default Mode and Measurement of the analyzer is Spectrum Analyzer and Swept SA. If necessary, you can verify (and select) the mode by pressing the MODE/MEAS key.
5 Set the radio standard and type of station.	a. Press the <b>MEAS SETUP</b> key. b. In the menu panel, select the <b>Meas Standard</b> tab. c. Tap <b>Radio Std Presets</b> and select <b>Cellular, 3GPP W-CDMA, BTS</b> in the table. d. Tap <b>OK</b> at the bottom of the display.	
6 Set the center frequency.	a. Press the <b>FREQ</b> key. b. In the menu panel, double tap <b>Center Frequency</b> and enter <b>1.92 GHz</b> .	
7 Optimize the attenuation setting.	a. Press the <b>AMPTD</b> key. b. In the menu panel, select the <b>Attenuation</b> tab. c. Tap <b>Adjust Atten for Min Clipping</b> .	Adjust Atten for Min Clip protects against input signal overloads, but may not set the input attenuation and reference level for optimum measurement dynamic range.  To improve the measurement repeatability, increase the sweep time to smooth out the trace (average detector must be selected). Measurement repeatability can be traded off with sweep time.



Measuring Digital Communications Signals  
Making Statistical Power Measurements (CCDF)

**Step**                      **Action**                      **Notes**

---

Figure 9-7                      Power Statistics CCDF Measurement on a W-CDMA Signal

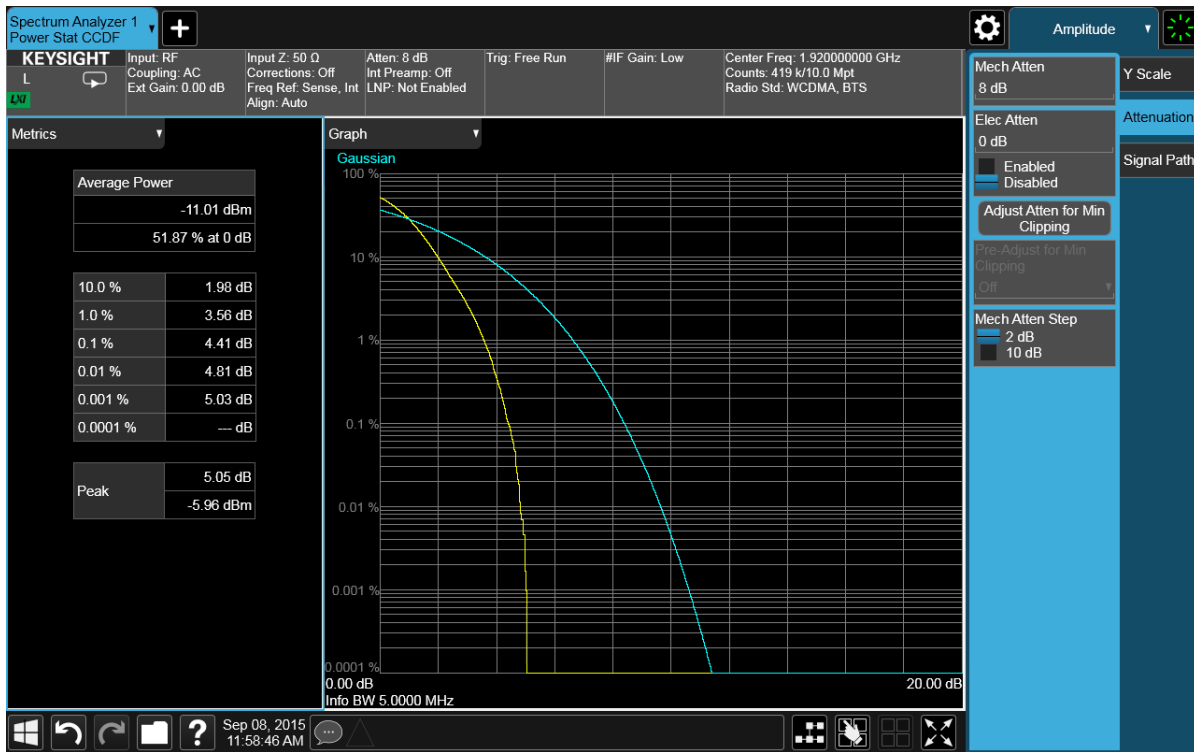

**8** Store your current measurement trace for future reference.

a. Press the **Trace** key.

b. In the menu panel, tap **Store Ref Trace**.

When the power stat CCDF measurement is first made, the display should show a signal typical of pure noise. This is labeled Gaussian, and is shown in aqua. Your CCDF measurement is displayed as a yellow plot. You have stored this measurement plot for easy comparison with subsequent measurements. Refer to **Figure 9-7**.

**9** Display the stored trace.

a. Toggle **Ref Trace** to On.

**10** Change the measurement bandwidth to 1 MHz.

a. Press the **BW** key.

b. In the menu panel, double tap **Info BW** and enter **1 MHz**.

The stored trace from your last measurement is displayed as a magenta plot (as shown in **Figure 9-8**), and allows direct comparison with your current measurement (yellow trace).

Step Action Notes

Figure 9-8 Storing and Displaying a Power Stat CCDF Measurement

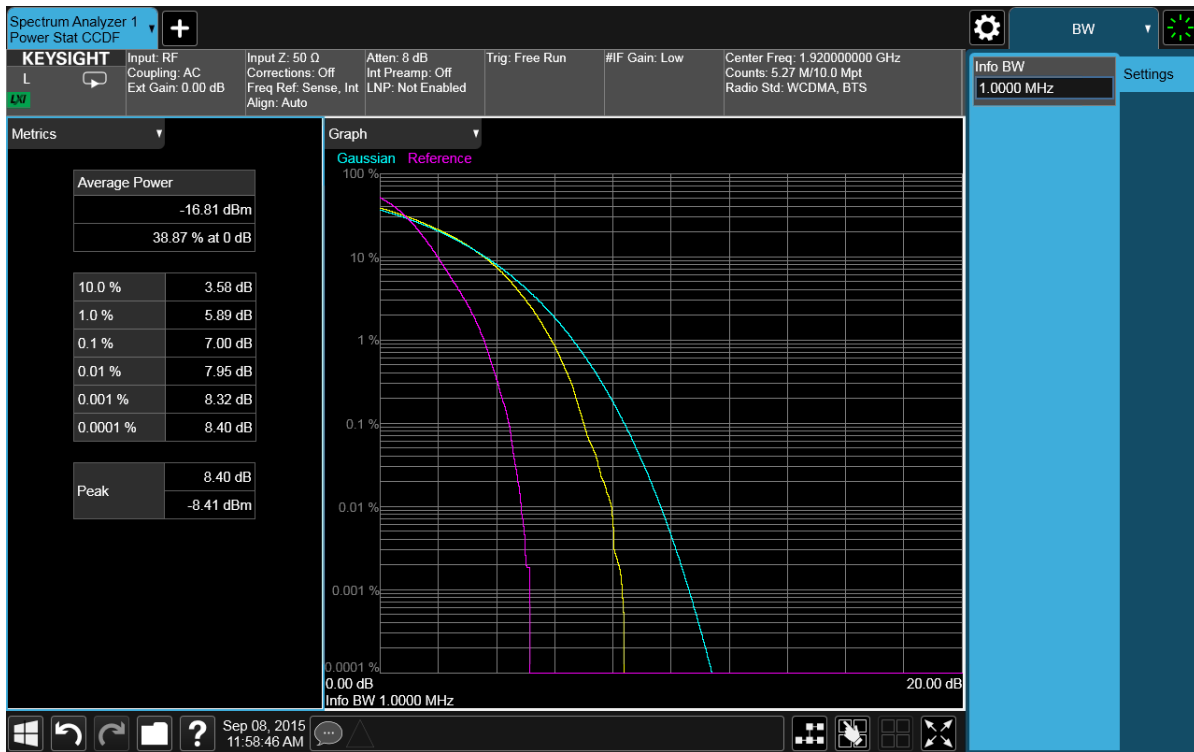

**NOTE** If you choose a measurement band width setting that the analyzer cannot display, it automatically sets itself to the closest available band width setting.

11 Change the number of measured points from 10,000,000 (10.0Mpt) to 1,000 (1kpt).

- a. Press the **MEAS SETUP** key.
- b. In the menu panel, double tap **Counts** and enter **1 kpt**.

Reducing the number of points decreases the measurement time. However, the number of points is a factor in determining measurement uncertainty and repeatability. Notice that the displayed plot is not as smooth when you decrease the number of measurement points. The measurement is faster, but repeatability is reduced and uncertainty is increased. Refer to **Figure 9-9**.

Step

Action

Notes

Figure 9-9 Reducing the Measurement Points to 1 kpt

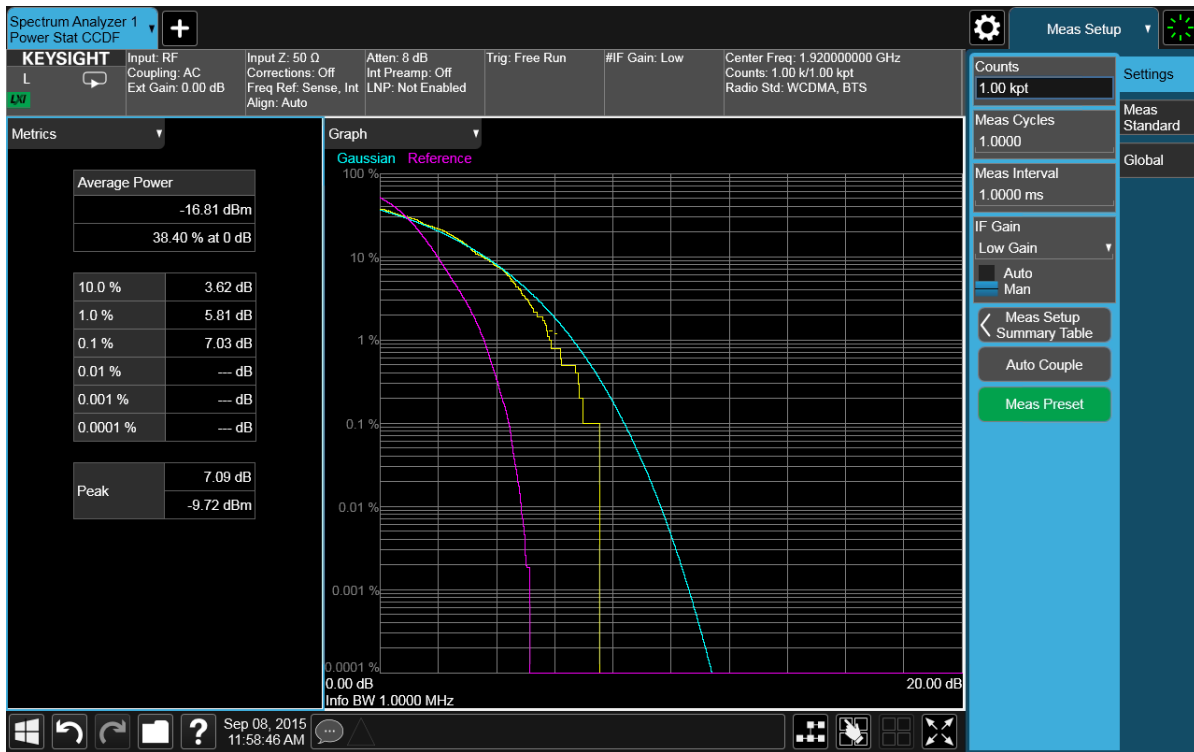

**NOTE** The number of measurement samples per sweep is dependent on the sampling rate and the measurement interval. The number of samples that have been processed are indicated at the top of the screen. The graphical plot is continuously updated so you can see it getting smoother as measurement uncertainty is reduced and repeatability improves.

12 Change the scaling of the X-axis to 1 dB per division to optimize your particular measurement.

- a. Press the **SWEEP** key.
- b. In the menu panel, select the **X Scale** tab.
- c. Double tap **Scale/Div** and enter **1 dB**.

Refer to **Figure 9-10**.

Measuring Digital Communications Signals  
 Making Statistical Power Measurements (CCDF)

Step

Action

Notes

Figure 9-10 Reducing the X Scale to 1 dB

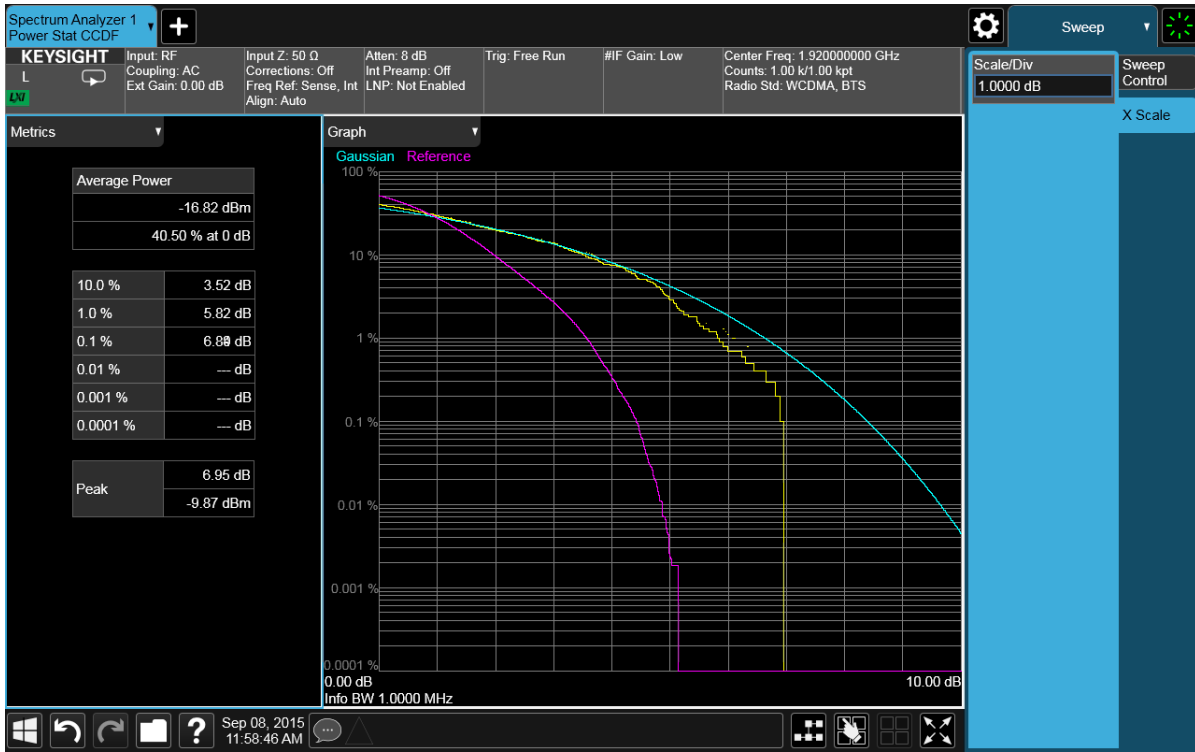

## Making Burst Power Measurements

The following example demonstrates how to make a burst power measurement on a simulated Bluetooth® signal broadcasting at 2.402 GHz. A signal generator is used to simulate a Bluetooth® signal.

Step	Action	Notes
1	Set up the signal source. <ol style="list-style-type: none"> <li>Setup a Bluetooth® signal transmitting DH1 packets.</li> <li>Set the source frequency to 2.402 GHz.</li> <li>Set the source amplitude to -10 dBm.</li> </ol>	
2	Connect the source RF OUTPUT to the analyzer RF INPUT as shown.	

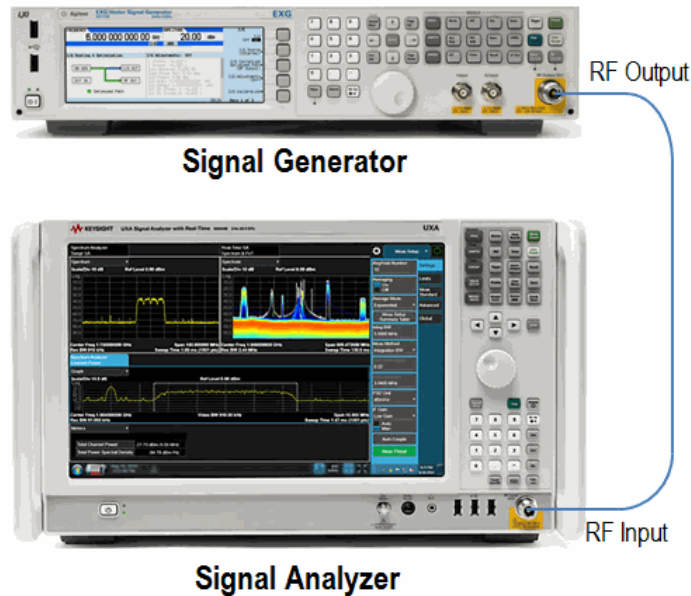

3	Preset the analyzer. <ol style="list-style-type: none"> <li>Press the <b>Mode Preset</b> key.</li> </ol>	
<div style="background-color: #cccccc; padding: 5px; display: inline-block;"><b>NOTE</b></div> Mode Preset does not preset all settings in the analyzer. For a more complete preset, tap Restore Mode Defaults and Input/Output Preset in the Preset menu.		
4	Select the Mode/Measurement /View. <ol style="list-style-type: none"> <li>Press the <b>MODE/MEAS</b> key.</li> <li>Select <b>Spectrum Analyzer</b> in the Mode column.</li> <li>Select <b>Burst Power</b> in the Measurement column.</li> <li>Tap <b>OK</b> at the bottom of the display.</li> </ol>	The default Mode and Measurement of the analyzer is Spectrum Analyzer and Swept SA. If necessary, you can verify (and select) the mode by pressing the MODE/MEAS key.

Step	Action	Notes
5	Set the center frequency. <ol style="list-style-type: none"> <li>Press the <b>FREQ</b> key.</li> <li>In the menu panel, double tap <b>Center Frequency</b> and enter <b>2.402 GHz</b>.</li> </ol>	
6	Set the analyzer radio mode to Bluetooth. <ol style="list-style-type: none"> <li>Press the <b>MEAS SETUP</b> key.</li> <li>In the menu panel, select the <b>Meas Standard</b> tab.</li> <li>Tap <b>Radio Std Presets</b> and select <b>Wireless, Bluetooth, DH1</b>.</li> <li>Tap <b>OK</b>.</li> </ol>	Check to make sure packet type DH1 is selected.
7	Optimize the attenuation level. <ol style="list-style-type: none"> <li>Press the <b>AMPTD</b> key.</li> <li>In the menu panel, select the <b>Attenuation</b> tab.</li> <li>Tap <b>Adjust Atten for Min Clipping</b>.</li> </ol>	
8	View the results of the burst power measurement using the full screen. <ol style="list-style-type: none"> <li>Tap the <b>Full Screen</b> icon at the bottom of the display.</li> </ol>	See <a href="#">Figure 9-11</a> .



Measuring Digital Communications Signals  
 Making Burst Power Measurements

Step

Action

Notes

Figure 9-11 Full Screen Display of Burst Power Measurement Results

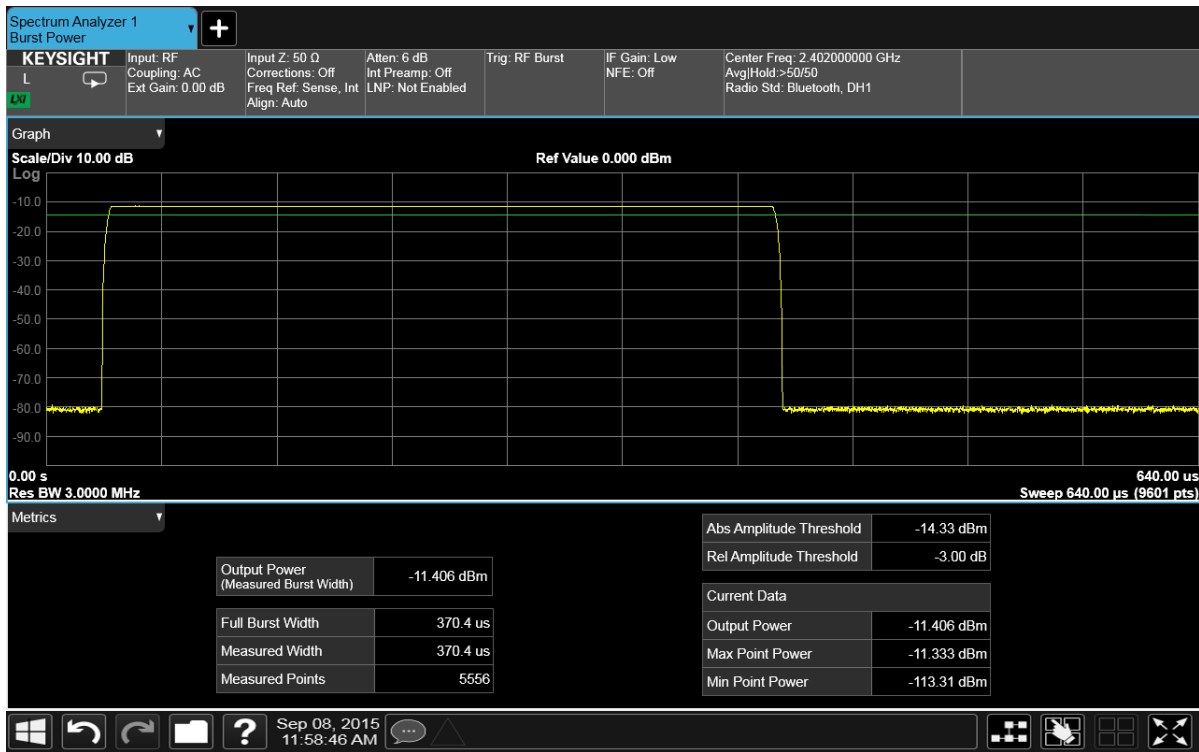

**NOTE**

Tap the **Full Screen** icon again to exit the full screen display without changing any parameter values. Refer to [Figure 9-12](#).

## Measuring Digital Communications Signals Making Burst Power Measurements

Step

Action

Notes

Figure 9-12

Normal Screen Display of Burst Power Measurement Results



9 Select one of the following three trigger methods to capture the signal bursts:

- Periodic Timer Triggering
- Video
- RF Burst Wideband Triggering (RF Burst is recommended, if available)

- a. Tap the menu panel and select **Trigger**.
- b. Tap **Select Trig Source** and select **RF Burst**.

Although the trigger level allows the analyzer to detect the presence of a burst, the time samples contributing to the burst power measurement are determined by the threshold level, as described next.

For more information on trigger selections see **“Trigger Concepts” on page 197**.



Measuring Digital Communications Signals  
Making Burst Power Measurements

Step	Action	Notes
10	<p>Set the relative threshold level above which the burst power measurement is calculated.</p> <ol style="list-style-type: none"> <li>Press the <b>MEAS SETUP</b> key.</li> <li>Select the <b>Settings</b> tab.</li> <li>Tap <b>Threshold Lvl</b> and enter <b>-10 dB</b>.</li> </ol>	<p>The burst power measurement includes all points above the threshold and no points below. The threshold level is indicated on the display by the green horizontal line. In this example, the threshold level has been set to be 10 dB below the relative level of the burst. The mean power of the burst is measured from all data above the threshold level. Refer to <b>Figure 9-13</b>.</p>

Figure 9-13 Burst Power Measurement Results with Threshold Level Set

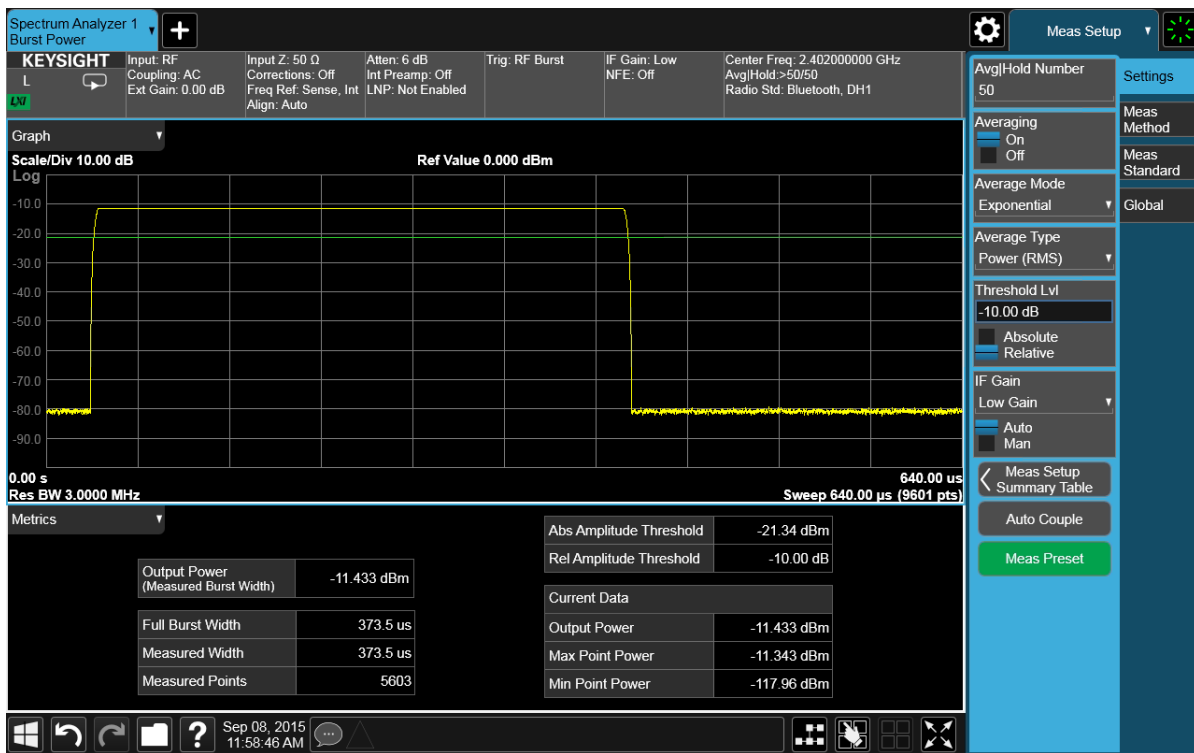

Step	Action	Notes
11	<ol style="list-style-type: none"> <li>Press the <b>Display</b> key.</li> <li>In the menu panel, toggle the <b>Bar Graph</b> to On.</li> <li>Press the <b>MEAS SETUP</b> key.</li> <li>In the menu panel, select the <b>Meas Method</b> tab.</li> <li>Tap <b>Meas Method</b> and select <b>Burst Width</b>.</li> <li>Toggle <b>Burst Width Auto Detection</b> to Off.</li> <li>Double tap <b>Burst Width</b> and enter <b>200 <math>\mu</math>s</b>.</li> </ol>	<p>The burst width is indicated on the screen by two vertical white lines and a blue power bar. Manually setting the burst width allows you to make it a long time interval (to include the rising and falling edges of the burst) or to make it a short time interval, measuring a small central section of the burst. Refer to <a href="#">Figure 9-14</a>.</p>

Figure 9-14 Bar Graph Results with Measured Burst Width Set

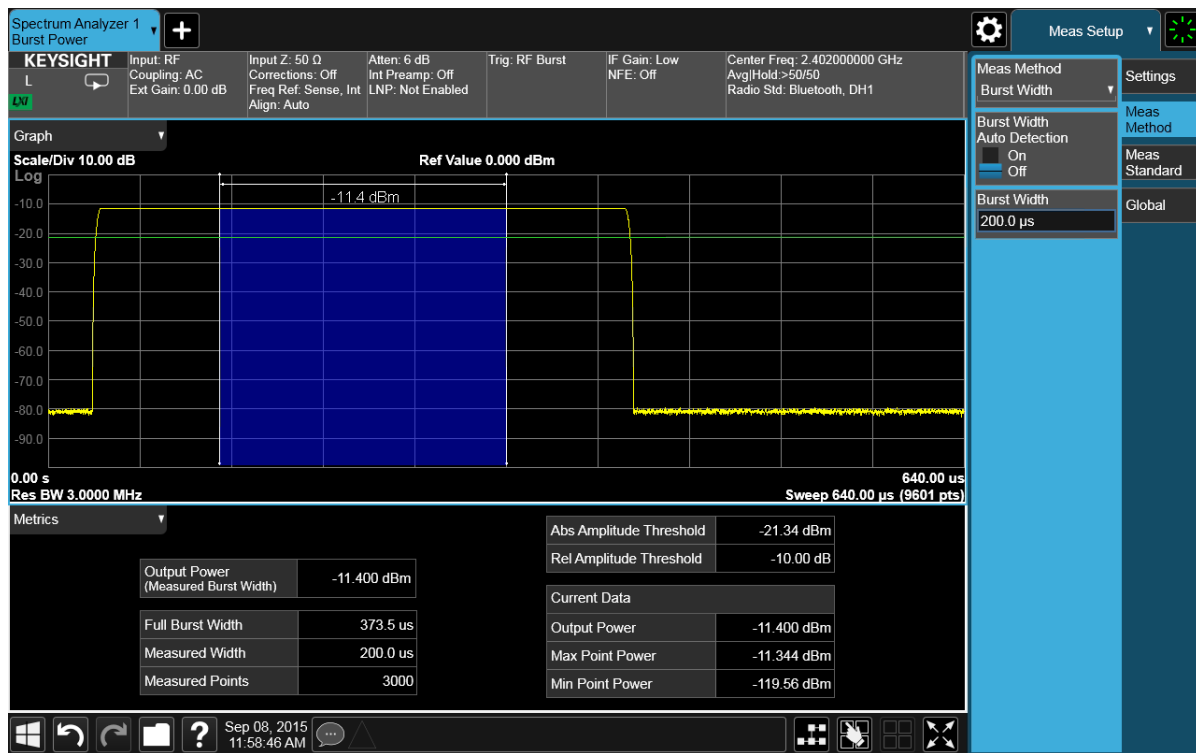

**NOTE**

If you set the burst width manually to be wider than the screen's display, the vertical white lines move off the edges of the screen. This could give misleading results as only the data on the screen can be measured.

The Bluetooth® standard states that power measurements should be taken over at least 20% to 80% of the duration of the burst.

Step	Action	Notes
12	Increase the sweep time to display more than one burst at a time. a. Press the <b>SWEEP</b> key. b. In the menu panel, double tap <b>Sweep Time</b> and enter <b>6200 <math>\mu</math>s</b> (or <b>6.2 ms</b> ).	The screen display shows several bursts in a single sweep as in <b>Figure 9-15</b> . The burst power measurement measures the mean power of the first burst, indicated by the vertical white lines and blue power bar.

Figure 9-15 Displaying Multiple Bursts



**NOTE**

Although the burst power measurement runs correctly when several bursts are displayed simultaneously, the timing accuracy of the measurement is degraded. For the best results (including the best trade-off between measurement variations and averaging time), it is recommended that the measurement be performed on a single burst.

## Making Spurious Emissions Measurements

This example demonstrates how to make a spurious emissions measurement on a multitone signal that simulates a spurious emission in a defined spectrum.

Step	Action	Notes
1	<p>Setup the signal source.</p> <ol style="list-style-type: none"> <li>Setup a multitone signal with 8 tones with a 2.0 MHz frequency spacing.</li> <li>Set the source frequency to 1.950 GHz.</li> <li>Set the source amplitudes to <math>-50</math> dBm.</li> </ol>	
2	Connect the source RF OUTPUT to the analyzer RF INPUT as shown.	

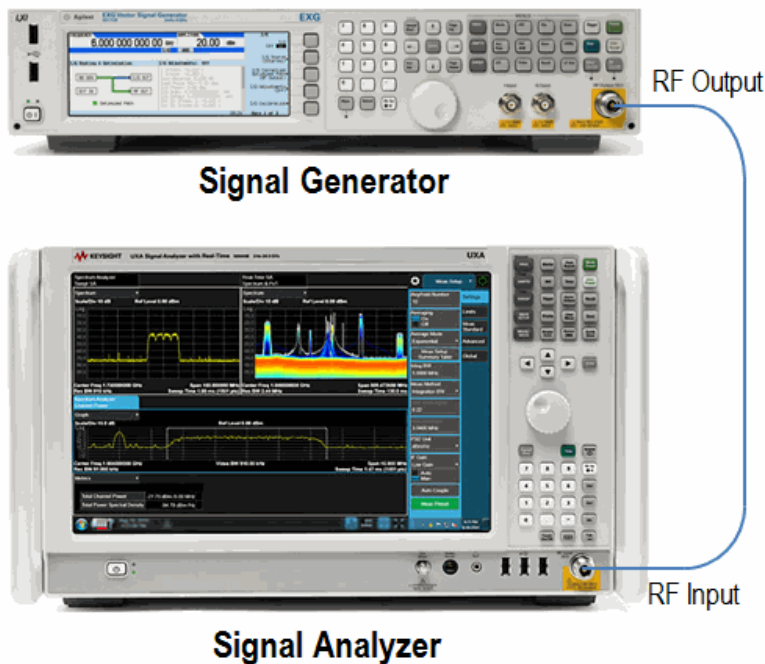

3	<p>Preset the analyzer.</p> <ol style="list-style-type: none"> <li>Press the <b>Mode Preset</b> key.</li> </ol>	<p>The default Mode and Measurement of the analyzer is Spectrum Analyzer and Swept SA. If necessary, you can verify (and select) the mode by pressing the MODE/MEAS key.</p>
---	---	--

**NOTE**

Mode Preset does not preset all settings in the analyzer. For a more complete preset, tap Restore Mode Defaults and Input/Output Preset in the Preset menu.

Step	Action	Notes
4	Select the Measurement. <ol style="list-style-type: none"> <li>Press the <b>MODE/MEAS</b> key.</li> <li>Select <b>Spectrum Analyzer</b> in the Mode column.</li> <li>Select <b>Spurious Emissions</b> in the Measurement column.</li> <li>Tap <b>OK</b> at the bottom of the display.</li> </ol>	Once you activate the measurement, the center frequency is set, and a marker is placed on the trace.  The spurious emission result should look similar to <b>Figure 9-16</b> . The table at the bottom of the display shows the detected emission peaks. Each emission peak, (spur number), shows the range, power, and limit value against which the spur amplitude is tested.

Figure 9-16 Spurious Emission Measurement Result

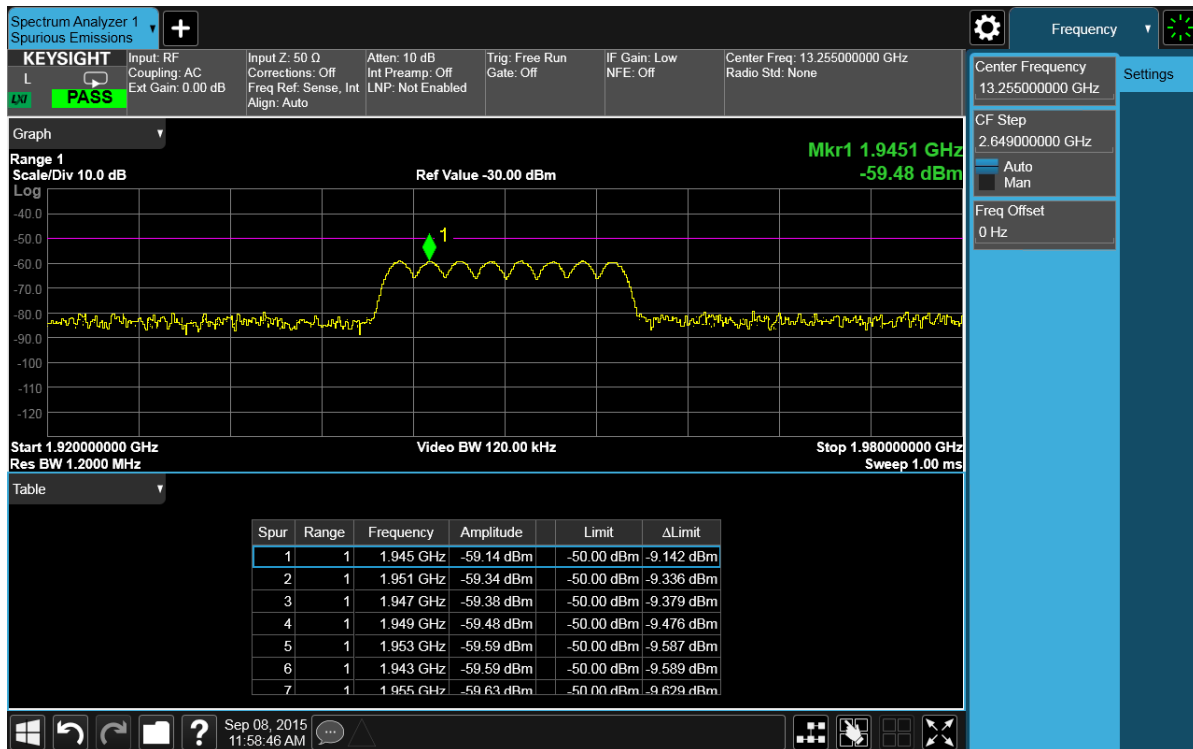

5	Move Marker on the trace by specifying a specific spurious emissions signal. <ol style="list-style-type: none"> <li>Tap the line of Spur #6.</li> </ol>	The marker on the trace moves accordingly. See <b>Figure 9-17</b> .
---	---	---

Measuring Digital Communications Signals  
Making Spurious Emissions Measurements

Step Action Notes

Figure 9-17 Spurious Emission Measurement - Spur Focus

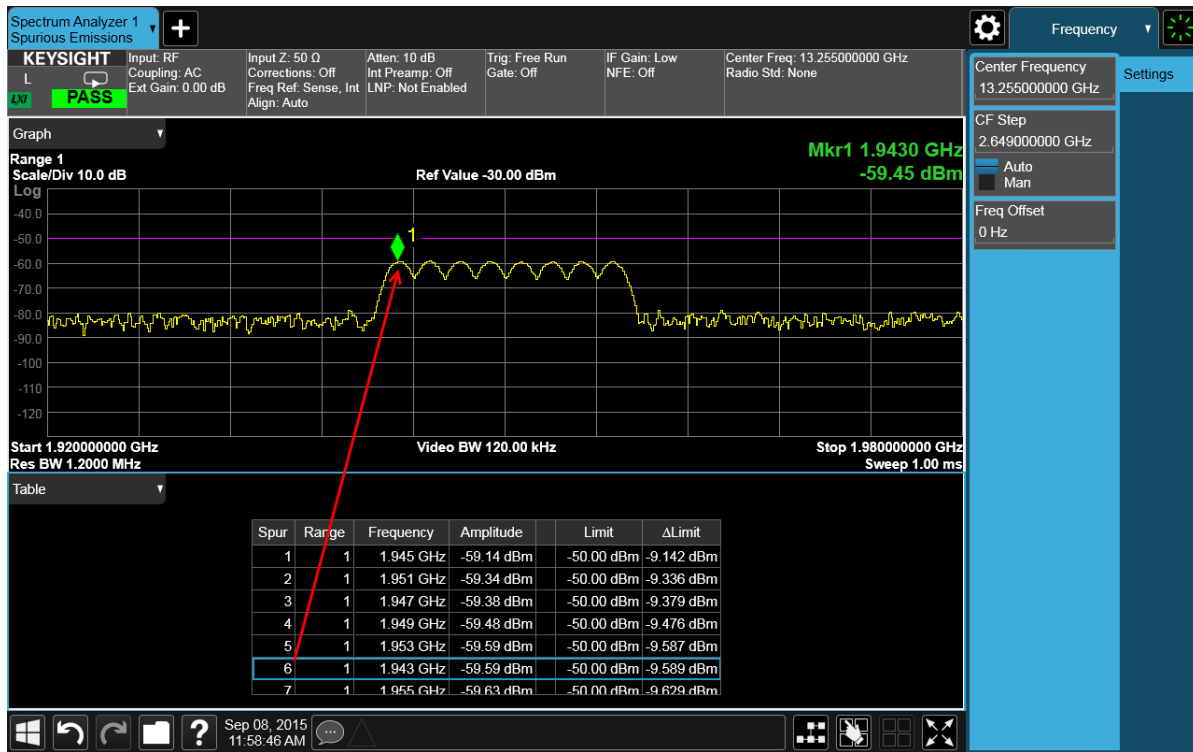

- 6 You can customize the ranges for spurious emissions. Initially, six default ranges, with parameters, are loaded into the range table.
- Press the **MEAS SETUP** key. See **Figure 9-18**.
  - Tap **Range Settings**, then select and edit the available parameters by tapping the cell.

Step Action Notes

Figure 9-18 Spurious Emission Measurement - Range Settings



### Troubleshooting hints

Spurious emissions measurements can reveal the presence of degraded or defective parts in the transmitter section of the UUT. The following are examples of problems which may be indicated by testing:

- Faulty DC power supply control of the transmitter power amplifier
- RF power controller of the pre-power amplifier stage
- I/Q control of the baseband stage
- Reduction in the gain and output power level of the amplifier due to a degraded gain control and/or increased distortion
- Degradation of amplifier linearity and other performance characteristics

Power amplifiers are one of the final stage elements of a base transmitter and play a critical part in meeting the important power and spectral efficiency specifications. Measuring the spectral response of these amplifiers to complex wideband signals is crucial to linking amplifier linearity and other performance characteristics to stringent system specifications.

## Making Spectrum Emission Mask Measurements

This section explains how to make the spectrum emission mask, (SEM), measurement on a W-CDMA (3GPP) mobile station. A signal generator is used to simulate a mobile station. SEM compares the total power level within the defined carrier bandwidth and offset channels on both sides of the carrier frequency, to levels allowed by the standard. Results of the measurement of each offset segment can be viewed separately.

Step	Action	Notes
1 Set up the signal source.	a. Setup a W-CDMA uplink signal. b. Set the source frequency to 1,920 MHz (Channel. Number: $5 \times 1,920 = 9,600$ ). c. Set the source amplitudes to 0 dBm.	
2 Connect the source RF OUTPUT to the analyzer RF INPUT as shown.		

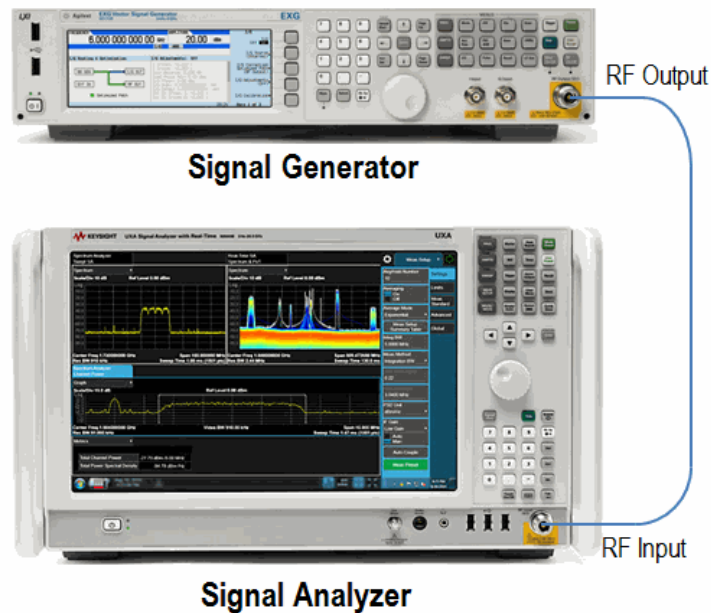

3 Preset the analyzer.	a. Press the <b>Mode Preset</b> key.	
<b>NOTE</b>	Mode Preset does not preset all settings in the analyzer. For a more complete preset, tap Restore Mode Defaults and Input/Output Preset in the Preset menu.	



Measuring Digital Communications Signals  
Making Spectrum Emission Mask Measurements

Step	Action	Notes
4 Select the Measurement.	<ol style="list-style-type: none"><li>Press the <b>MODE/MEAS</b> key.</li><li>Select <b>Spectrum Analyzer</b> in the Mode column.</li><li>Select <b>SEM</b> in the Measurement column.</li><li>Tap <b>OK</b> at the bottom of the display.</li></ol>	The default Mode and Measurement of the analyzer is Spectrum Analyzer and Swept SA. If necessary, you can verify (and select) the mode by pressing the MODE/MEAS key.
5 Set the radio standard and station type.	<ol style="list-style-type: none"><li>Press the <b>MEAS SETUP</b> key.</li><li>In the menu panel, select the <b>Meas Standard</b> tab.</li><li>Tap <b>Radio Std</b> and select <b>Cellular, 3GPP W-CDMA, MS</b> in the table.</li><li>Tap <b>OK</b>.</li></ol>	
6 Set the center frequency.	<ol style="list-style-type: none"><li>Press the <b>FREQ</b> key.</li><li>In the menu panel, double tap <b>Center Frequency</b> and enter <b>1.92 GHz</b>.</li></ol>	The Spectrum Emission Mask measurement result should look like <b>Figure 9-19</b> . The text window shows the reference total power and the absolute peak power levels which correspond to the frequency bands on both sides of the reference channel.

## Measuring Digital Communications Signals Making Spectrum Emission Mask Measurements

Step

Action

Notes

Figure 9-19 Spectrum Emission Mask Measurement Result - (Default) View

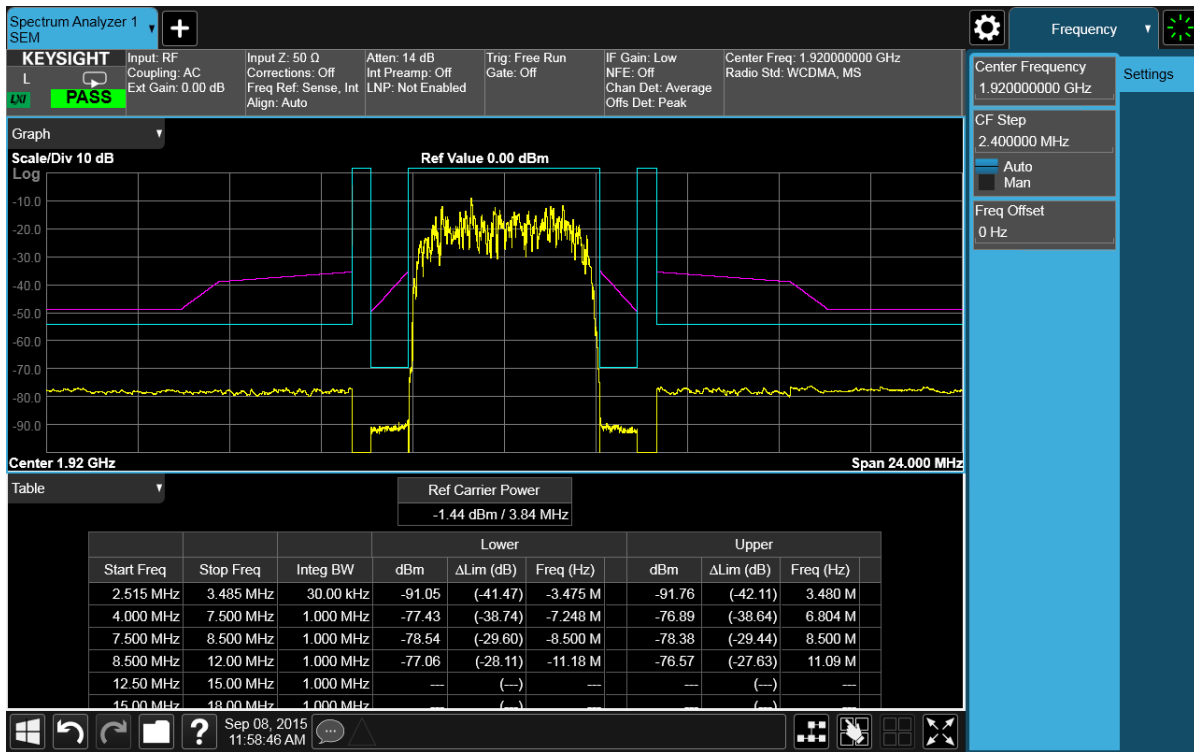

### Troubleshooting hints

This spectrum emission mask measurement can reveal degraded or defective parts in the transmitter section of the UUT. The following examples are those areas to be checked further.

- Faulty DC power supply control of the transmitter power amplifier.
- RF power controller of the pre-power amplifier stage.
- I/Q control of the baseband stage.
- Some degradation in the gain and output power level of the amplifier due to the degraded gain control and/or increased distortion.
- Some degradation of the amplifier linearity or other performance characteristics.

Power amplifiers are one of the final stage elements of a base or mobile transmitter and are a critical part of meeting the important power and spectral efficiency specifications. Since spectrum emission mask measures the spectral response of the amplifier to a complex wideband signal, it is a key measurement linking amplifier linearity and other performance characteristics to the stringent system specifications.

## Making List Sweep Measurements

The List Sweep Measurement is designed for fast measurement throughput and remote data collection.

You can configure a list of single-point frequency and power measurements, and set up the analyzer to repeatedly run through the list, saving analyzer setup time and reducing I/O overhead and traffic. The measurements are all performed in zero-span.

There are some differences of the List Sweep feature from other measurements:

- List Sweep only allows single measurement mode.
- List Sweep does not support front panel data display in order to meet optimum high throughput.

List Sweep Measurements can be enabled using the front panel key or the remote command. Measurement setup control is only available remotely. While in the List Sweep measurement, the screen is blanked while displaying the message.

### Executing List Sweep measurement from Remote Control port

Any key press exits the measurement and returns to the default measurement for the mode (Swept SA for SA mode). To prevent accidental key presses from terminating the measurement, there are two ways to lock out the front panel keys:

- Accessing the instrument over GPIB (IEEE-488) puts the analyzer in remote operation.
- Send the SYSTem:KLOCK ON command.

Step	Action	Notes
1 Set up the signal source.	<ol style="list-style-type: none"><li>Set up a 4-tone signal.</li><li>Set the frequency list as 0.98 GHz, 1.0GHz, 1.02 GHz, 1.04 GHz.</li><li>Set the amplitude list as -40 dBm, -30dBm, -20 dBm, -10 dBm.</li></ol>	

Measuring Digital Communications Signals  
Making List Sweep Measurements

Step	Action	Notes
2	Connect the source RF OUTPUT to the analyzer RF INPUT as shown.	

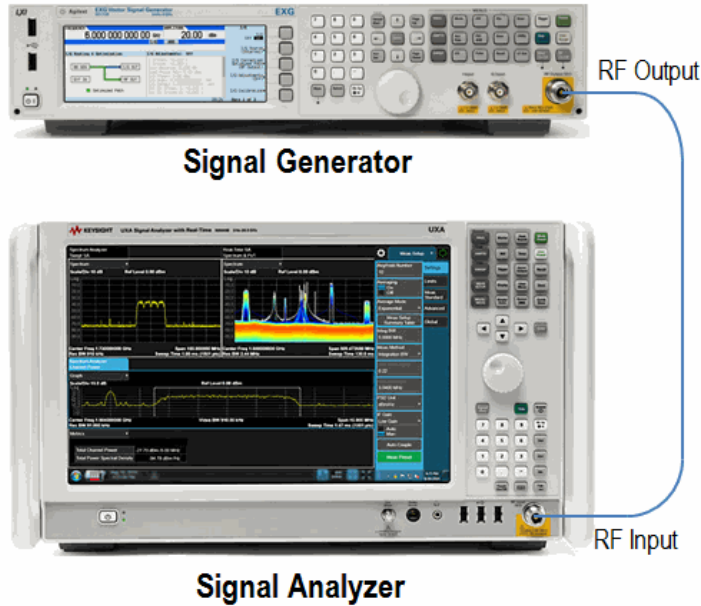

Step	Command
3	Remote control the analyzer via Keysight Connection Expert.
4	Initiate the List Sweep Measurement. INIT:LIST
5	Set the frequency list. LIST:FREQ 0.98GHz,1.0GHz,1.02GHz,1.04GHz
6	Read the measurement results. READ:LIST?

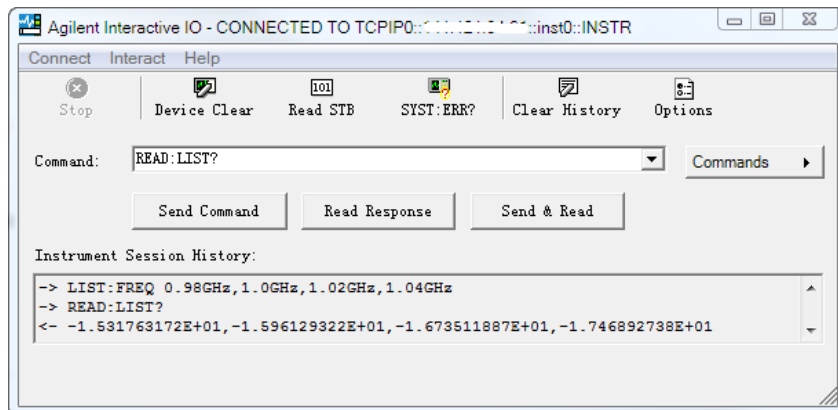

## 10 Demodulating AM Signals

### Measuring the Modulation Rate of an AM Signal

This section demonstrates how to measure AM signal parameters, such as modulation rate and modulation index (depth), by using frequency and time domain measurements. See the concepts chapter [“AM and FM Demodulation Concepts” on page 219](#) for more information.

To obtain an AM signal, you can either connect a source transmitting an AM signal, or connect an antenna to the analyzer input and tune to a commercial AM broadcast station. For this example, an RF source is used to generate an AM signal.

Step	Action	Notes
1 Set up the signal source.	<ol style="list-style-type: none"><li>Set the source frequency to 300 MHz.</li><li>Set the source amplitude to <math>-20</math> dBm.</li><li>Set the AM depth to 80%.</li><li>Set the AM rate to 1 kHz.</li><li>Turn AM on.</li></ol>	

Demodulating AM Signals  
Measuring the Modulation Rate of an AM Signal

Step	Action	Notes
2	Connect the source RF OUTPUT to the analyzer RF INPUT as shown.	

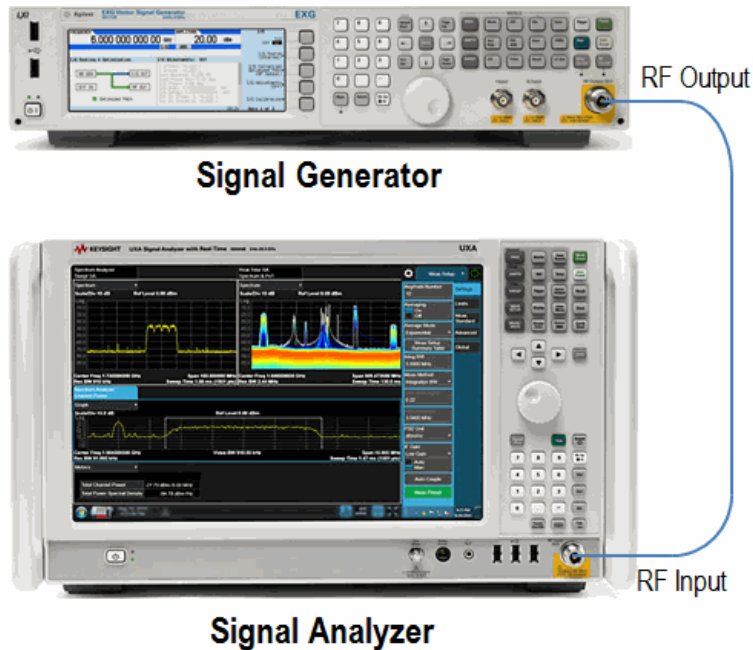

3	Preset the analyzer.	<p>a. Press the <b>Mode Preset</b> key.</p> <p>The default Mode and Measurement of the analyzer is Spectrum Analyzer and Swept SA. If necessary, you can verify (and select) the mode by pressing the MODE/MEAS key.</p>
---	----------------------	--

**NOTE**

Mode Preset does not preset all settings in the analyzer. For a more complete preset, tap Restore Mode Defaults and Input/Output Preset in the Preset menu.

4	Turn on the signal generator.	a. Turn <b>ON</b> the signal generator output.
5	Set the measurement center frequency and span.	<p>a. Press the <b>FREQ</b> key.</p> <p>b. In the menu panel, double tap <b>Center Frequency</b> and enter <b>300 MHz</b>.</p> <p>c. Double tap <b>Span</b> and enter <b>500 kHz</b>.</p>
6	Set the RBW.	<p>a. Press the <b>BW</b> key.</p> <p>b. In the menu panel, double tap <b>Res BW</b> and enter <b>30 kHz</b>.</p>

Demodulating AM Signals  
Measuring the Modulation Rate of an AM Signal

Step	Action	Notes
7	Set the sweep time. a. Press the <b>SWEEP</b> key. b. In the menu panel, double tap <b>Sweep Time</b> and enter <b>20 ms</b> .	
8	Change the y-scale type to linear. a. Press the <b>AMPTD</b> key. b. In the menu panel, tap <b>Display Scale</b> and toggle to <b>Lin</b> .	The y-axis units defaults to <b>mV</b> (millivolts).
9	Position the signal peak near the first graticule below the reference level. a. Using a mouse connected to the analyzer: click and drag the signal peak up the display. b. Using your finger: touch and drag the signal peak up the display.	See <b>Figure 10-1</b> .

Figure 10-1 Raising the Peak of the Signal

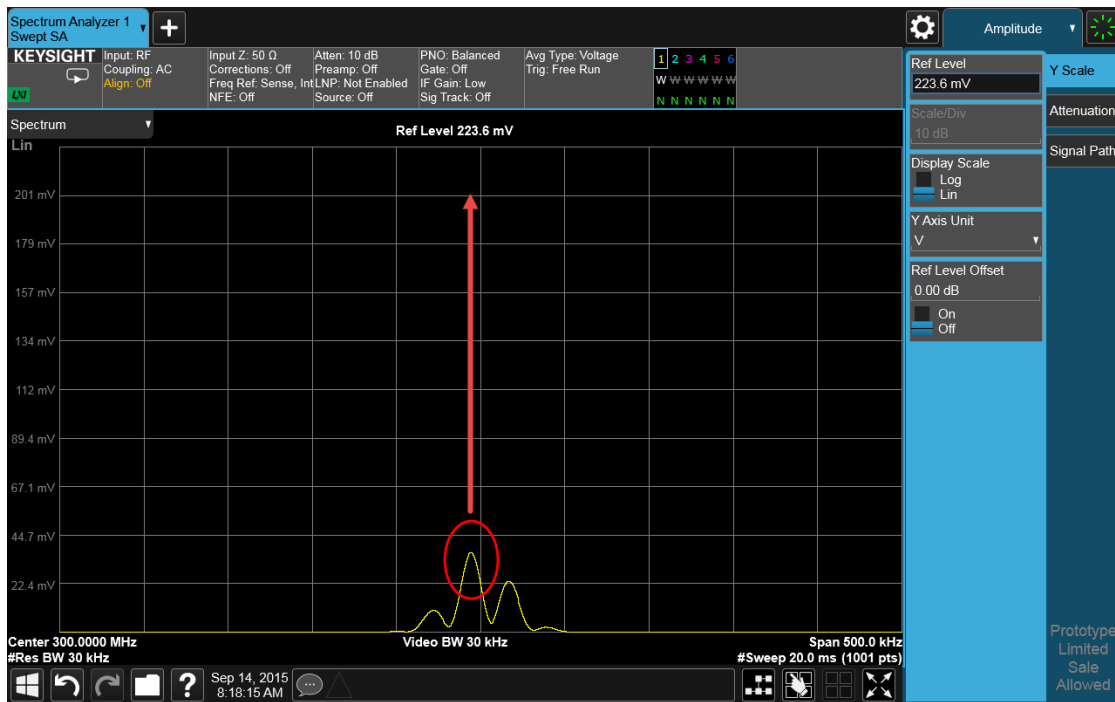

10	Set the analyzer to zero span to make time-domain measurements. a. Press the <b>FREQ</b> key. b. In the menu panel, tap <b>Span</b> and toggle to <b>Zero Span</b> . c. Press the <b>SWEEP</b> key. d. In the menu panel, double tap <b>Sweep Time</b> and enter <b>5 ms</b> .	
----	--	--

Demodulating AM Signals  
Measuring the Modulation Rate of an AM Signal

Step	Action	Notes
11	Adjust the trigger level so that the signal is vertically centered on the display. a. Press the <b>Trigger</b> key. b. Tap <b>Trigger Level</b> . c. Note the value in mV of the middle of the Y-axis. Enter this value for the Trigger Level.	See <a href="#">Figure 10-2</a> .

Figure 10-2 Setting the Trigger Level

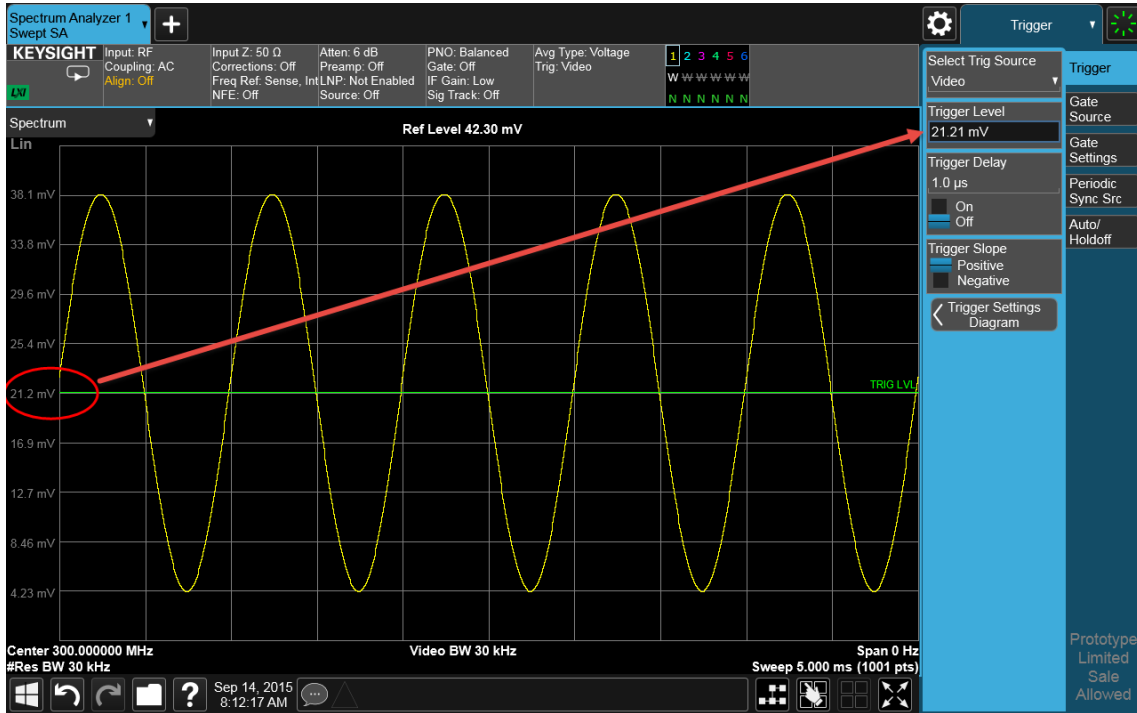

12	Measure the AM rate using delta markers. a. Press the <b>Peak Search</b> key. b. In the menu panel, tap <b>Marker Delta</b> , <b>Next Right</b> or <b>Next Left</b> .	
----	---	--



Demodulating AM Signals  
Measuring the Modulation Rate of an AM Signal

Step	Action	Notes
------	--------	-------

Since the modulation is a steady tone, you can use video trigger to trigger the analyzer sweep on the waveform and stabilize the trace, much like an oscilloscope. See [Figure 10-3](#).

If the trigger level is set too high or too low when video trigger mode is activated, the sweep stops. Adjust the trigger level up or down until the sweep begins again.

Use markers and delta markers to measure the AM rate. Place the marker on a peak and then use a delta marker to measure the time difference between the peaks (this is the AM rate of the signal).

Figure 10-3 Measuring Time Parameters

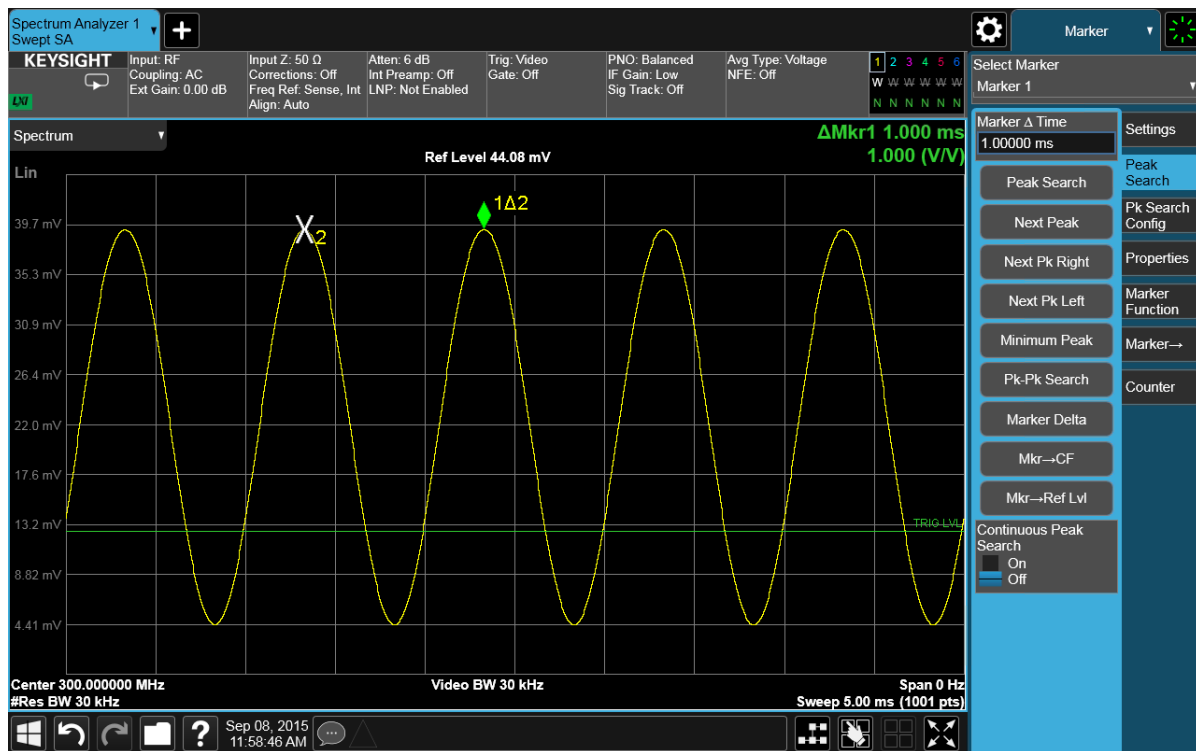

**NOTE** Make sure the delta markers above are placed on adjacent peaks. See [Figure 10-3](#). The frequency or the AM rate is 1 divided by the time between adjacent peaks:

$$\text{AM Rate} = 1/1.0 \text{ ms} = 1 \text{ kHz}$$

The signal analyzer can also make this rate calculation by changing the marker readout to inverse time. See the following step.

- |   |  |
|---|--|
| <p><b>13</b> Change the marker readout to inverse time.</p> | <ol style="list-style-type: none"> <li>Press the <b>Marker</b> key. See <a href="#">Figure 10-4</a>.</li> <li>In the menu panel, select the <b>Properties</b> tab.</li> <li>Tap <b>X Axis Scale</b> and select <b>Inverse time</b>.</li> </ol> |
|---|--|

Demodulating AM Signals  
 Measuring the Modulation Rate of an AM Signal

Step	Action	Notes
------	--------	-------

Figure 10-4 Measuring Time Parameters with Inverse Time Readout

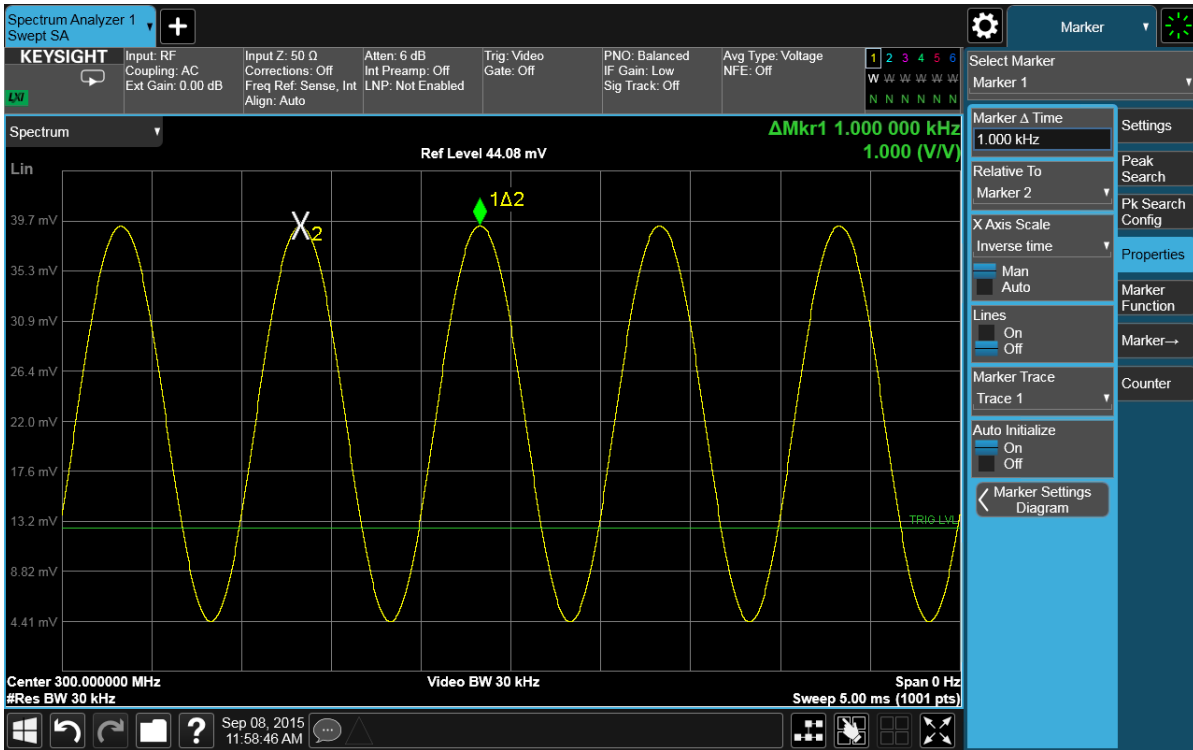

# Demodulating AM Signals

## Measuring the Modulation Rate of an AM Signal

Step	Action	Notes
------	--------	-------

Another way to calculate the modulation rate is to view the signal in the frequency domain and measure the delta frequency between the peak of the carrier and the first sideband. See [Figure 10-5](#).

Figure 10-5 Measuring Modulation Rate in Frequency Domain

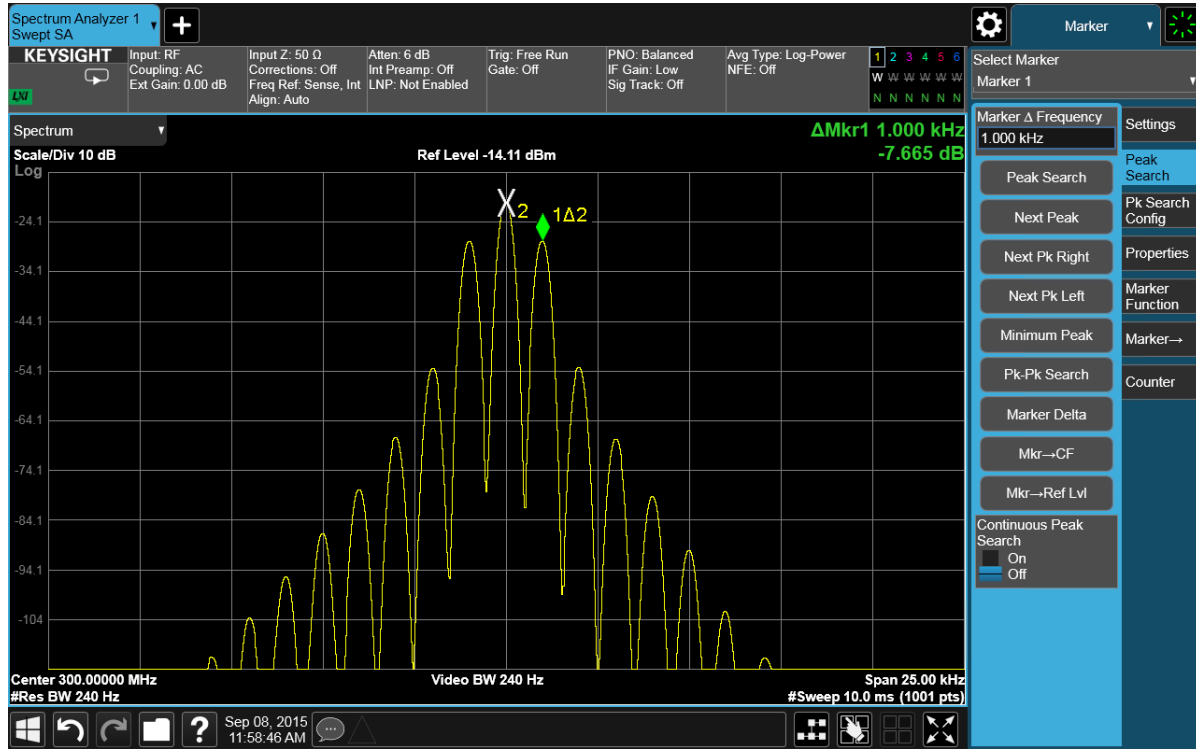

## Measuring the Modulation Index of an AM Signal

This procedure demonstrates how to use the signal analyzer as a fixed-tuned (time-domain) receiver to measure the modulation index as a percent AM value of an AM signal.

Step	Action	Notes
1	Set up the signal source. <ol style="list-style-type: none"> <li>Set the source frequency to 300 MHz.</li> <li>Set the source amplitude to <math>-20</math> dBm.</li> <li>Set the AM depth to 80%.</li> <li>Set the AM rate to 1 kHz.</li> <li>Turn AM on.</li> </ol>	
2	Connect the source RF OUTPUT to the analyzer RF INPUT as shown.	

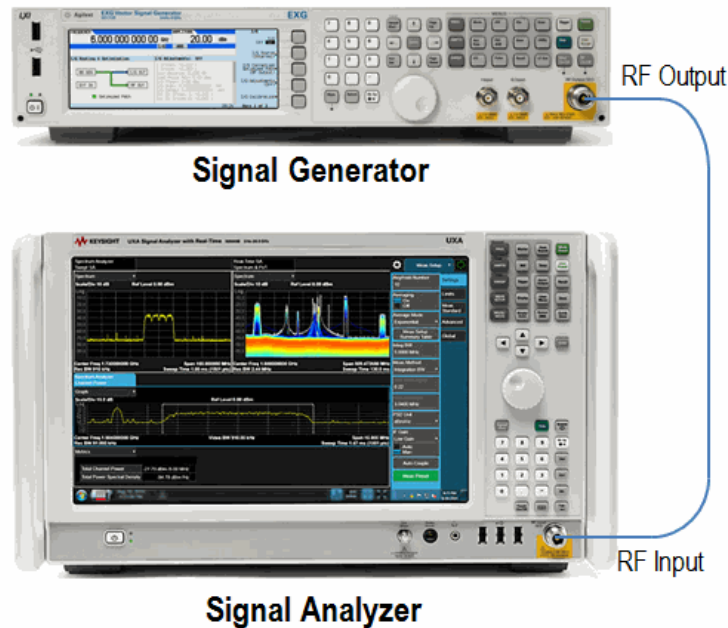

3	Preset the analyzer. <ol style="list-style-type: none"> <li>Press the <b>Mode Preset</b> key.</li> </ol>	The default Mode and Measurement of the analyzer is Spectrum Analyzer and Swept SA. If necessary, you can verify (and select) the mode by pressing the MODE/MEAS key.
---	--	---

**NOTE**

Mode Preset does not preset all settings in the analyzer. For a more complete preset, tap Restore Mode Defaults and Input/Output Preset in the Preset menu.

Demodulating AM Signals  
 Measuring the Modulation Index of an AM Signal

Step	Action	Notes
4	Turn on the signal generator output.	
5	Set the measurement center frequency and span.	
6	Set the RBW.	
7	Set the sweep time.	
8	Change the y-scale type to linear.	The y-axis units defaults to <b>mV</b> (millivolts).
9	Position the signal peak near the first graticule below the reference level.	See <b>Figure 10-6</b> .

Demodulating AM Signals  
Measuring the Modulation Index of an AM Signal

Step	Action	Notes
------	--------	-------

Figure 10-6 Raising the Peak of the Signal

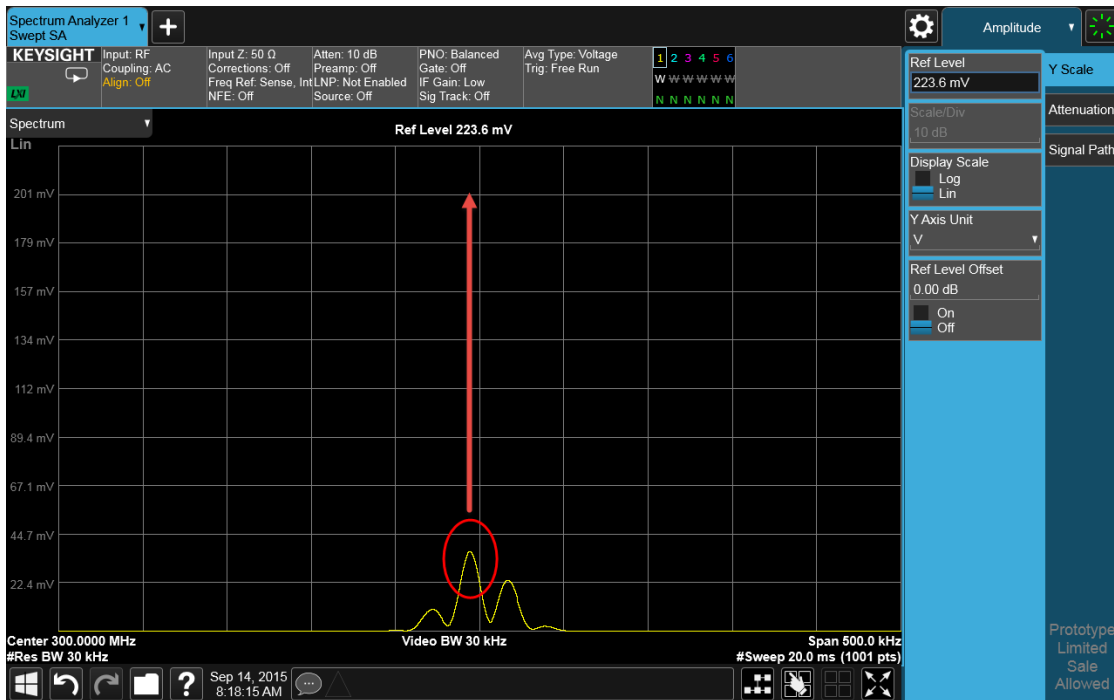

- |  |  |
|--|--|
| 10 Set the analyzer to zero span to make time-domain measurements. | <ol style="list-style-type: none"> <li>Press the <b>FREQ</b> key.</li> <li>In the menu panel, toggle <b>Span</b> to <b>Zero Span</b>.</li> <li>Press the <b>SWEEP</b> key.</li> <li>Double tap <b>Sweep Time</b> and enter <b>5 ms</b>.</li> </ol> |
|--|--|

- |  |  |
|--|--|
| 11 Use the video trigger to stabilize the trace. | <ol style="list-style-type: none"> <li>Press the <b>Trigger</b> key.</li> <li>In the menu panel, tap <b>Select Trig Source</b> and select <b>Video</b>.</li> </ol> |
|--|--|

- |   |   |
|---|---|
| 12 Adjust the trigger level so that the signal is vertically centered on the display. | <ol style="list-style-type: none"> <li>Tap <b>Trigger Level</b>.</li> <li>Note the value in mV of the middle of the Y-axis. Enter this value for the <b>Trigger Level</b>.</li> </ol> |
|---|---|

See [Figure 10-7](#).

Demodulating AM Signals  
Measuring the Modulation Index of an AM Signal

Step Action Notes

Figure 10-7 Setting the Trigger Level

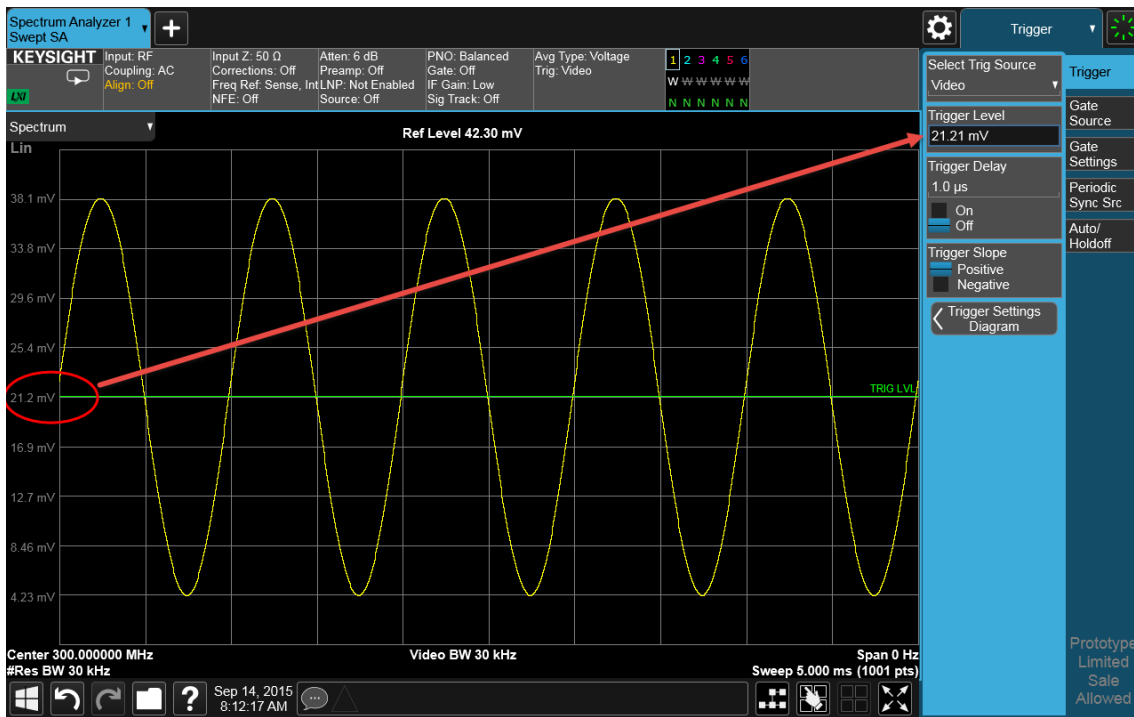

**13** Measure the modulation index of the AM signal.

To measure the modulation index as % AM, read the trace as follows (see **Figure 10-8** for display examples): 100% AM extends from the top graticule down to the bottom graticule. 80% AM (as in this example) is when the top of the signal is at 1 division below the top graticule and 1 division above the bottom graticule. To determine % AM of your signal count each y-axis division as 10%.

# Demodulating AM Signals

## Measuring the Modulation Index of an AM Signal

Step

Action

Notes

Figure 10-8 AM Signal Measured in the Time Domain



LEFT: 100% AM Signal (Modulation Index = 1)

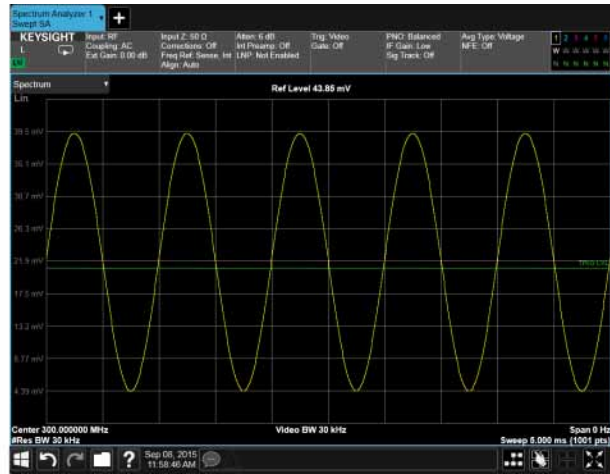

RIGHT: 80% AM Signal (Modulation Index = 0.8)

**NOTE**

You can demonstrate how the analyzer reacts to different modulation indexes by varying the modulation index (or depth) of the signal generator.



## 11 IQ Analyzer Measurement

### Capturing Wideband Signals for Further Analysis

This section provides two procedures that describe how to configure the analyzer to make time domain measurements of complex wideband signals. This mode captures the instantaneous vector relationships of time, frequency, phase and amplitude within selected signals, for output as IQ data. This IQ data can then be used internally or output over LAN, USB or GPIB for use with external analysis tools. Each measurement description specifies the types of data available remotely for that measurement.

The standard 10 MHz analysis BW and optional 25 MHz, 40 MHz, 255 MHz or 510 MHz analysis BW digitizers used to capture the wideband signals can be accessed from the front panel in IQ Analyzer (Basic) mode. This mode provides basic setup, RF (FFT-based), and IQ analysis tools

Within the IQ Analyzer mode, basic frequency domain, time domain and IQ measurements are available as initial signal and data verification tools in preparation for deriving the IQ data output.

The first procedure, Complex Spectrum Measurement, provides a display in the upper window of power versus frequency with current (yellow trace) and average (blue trace) data. In addition, an IQ waveform of voltage versus time is provided in the lower window.

The second procedure, IQ Waveform (Time Domain) Measurement, provides a time domain view of the RF signal envelope with power versus time or an IQ waveform of voltage versus time.

## Complex Spectrum Measurement

This procedure describes how to perform measurements on a complex 4-carrier W-CDMA waveform. A signal generator is used to simulate a base station. This type of analysis in the time domain reveals the voltages of a digitally-modulated complex waveform.

Step	Action	Notes
1	<p>Set up the signal source.</p> <ol style="list-style-type: none"> <li>Set the mode to W-CDMA 3GPP with 4 carriers.</li> <li>Set the frequency of the signal source to 1.96 GHz.</li> <li>Set the amplitude to -20 dBm.</li> </ol>	
2	Connect the source RF OUTPUT to the analyzer RF INPUT as shown.	

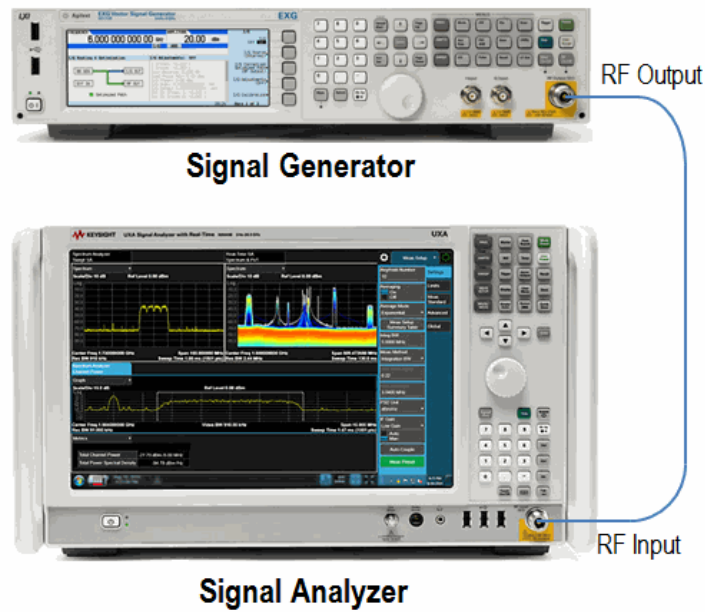

3	<p>Select Mode/Measurement /View on the analyzer</p> <ol style="list-style-type: none"> <li>Press the <b>MODE/MEAS</b> key.</li> <li>Select <b>IQ Analyzer (Basic)</b> in the Mode column.</li> <li>Select <b>Complex Spectrum</b> in the Measurement column.</li> <li>Tap <b>OK</b> at the bottom of the display.</li> </ol>	<p>The default Mode and Measurement of the analyzer is Spectrum Analyzer and Swept SA. If necessary, you can verify (and select) both by pressing the MODE/MEAS key.</p>
4	<p>Preset the analyzer.</p> <ol style="list-style-type: none"> <li>Press the <b>Mode Preset</b> key.</li> </ol>	

Step	Action	Notes
<b>NOTE</b>	Mode Preset does not preset all settings in the analyzer. For a more complete preset, tap Restore Mode Defaults and Input/Output Preset in the Preset menu.	
<b>5</b> Turn on the signal generator's RF output.	a. Turn <b>ON</b> the RF output on the signal generator.	
<b>6</b> Set the measurement center frequency on the analyzer.	a. Press the <b>FREQ</b> key. b. In the menu panel, double tap <b>Center Frequency</b> and enter <b>1.96 GHz</b> .	
<b>7</b> Set the measurement span/analysis bandwidth.	a. Double tap <b>Span</b> and enter <b>10 MHz</b> .	See <a href="#">Figure 11-1</a> .

The measurement results show an FFT-derived spectrum in the upper window and an IQ Waveform in the lower window. The active window is outlined in blue. You can tap a window to activate it. Pinch open to zoom in to observe more details of the signal. Pinch close to zoom out.

Figure 11-1 Spectrum and I/Q Waveform (Span 10 MHz)

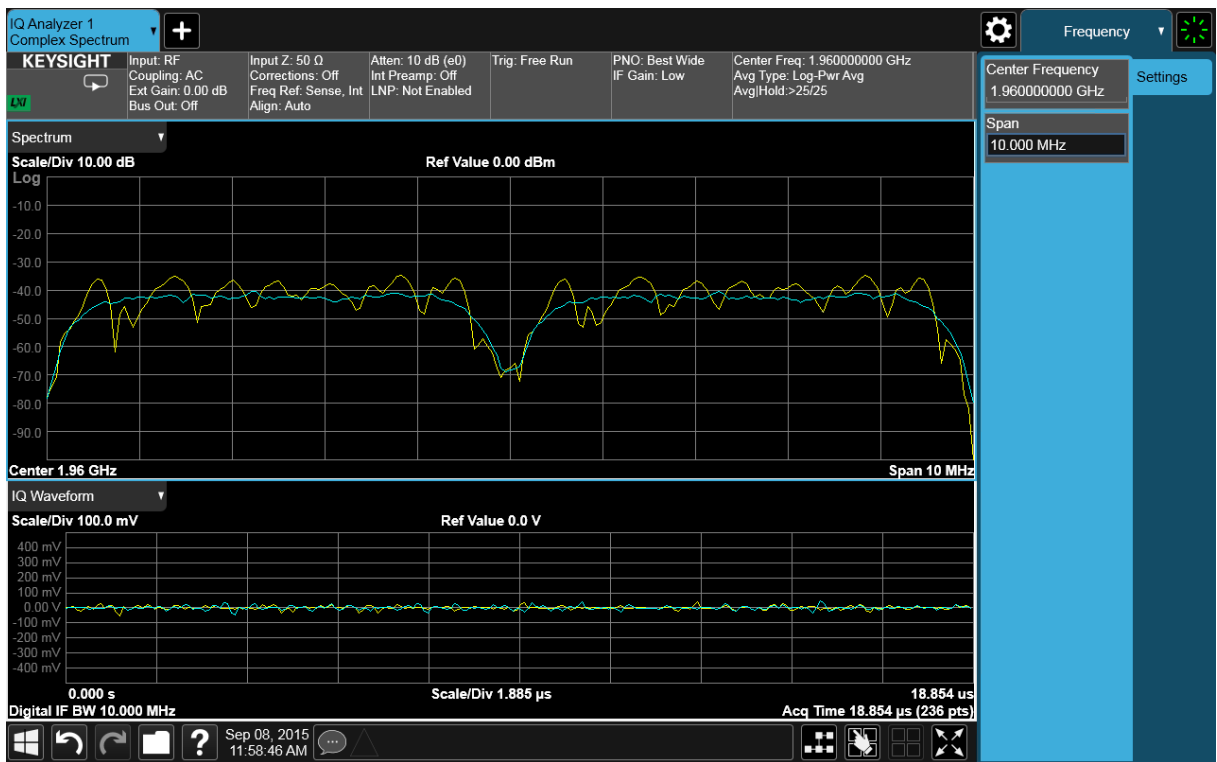

IQ Analyzer Measurement  
Complex Spectrum Measurement

Step	Action	Notes
8	Increase the measurement span/analysis bandwidth.	
	a. Double tap <b>Span</b> and enter <b>25 MHz</b> .	See <b>Figure 11-2</b> .

Figure 11-2 Spectrum and I/Q Waveform with a 25 MHz Span

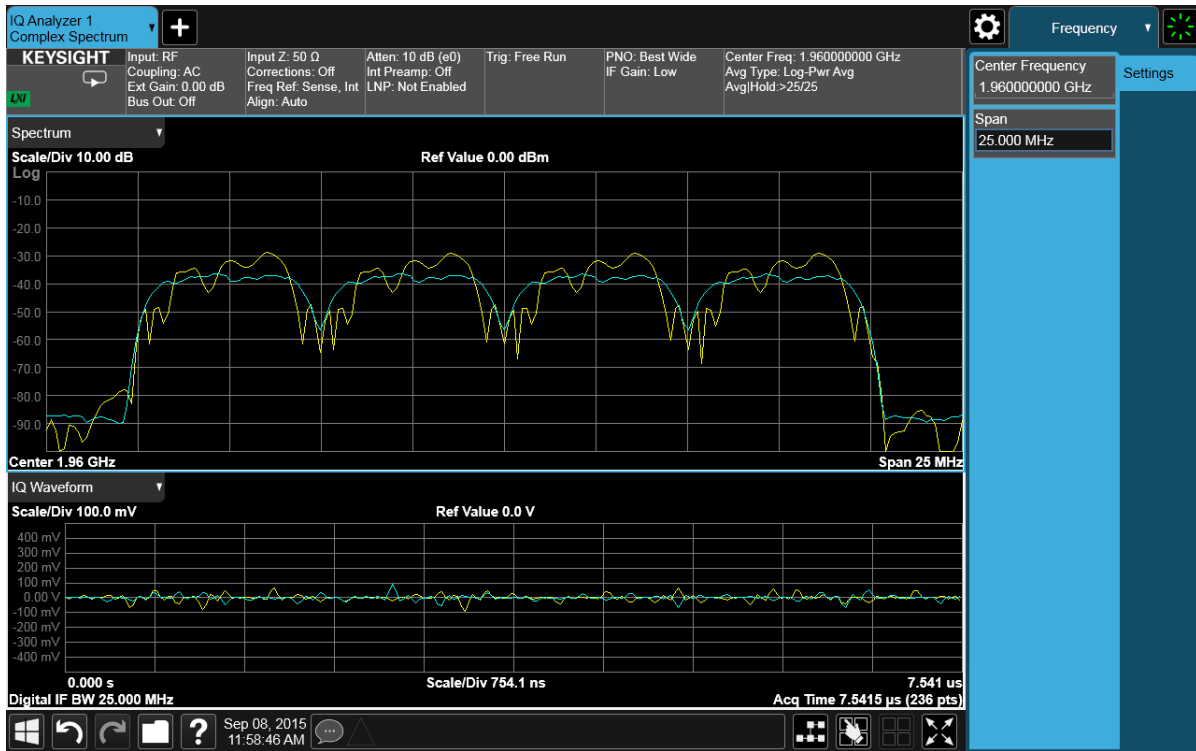

## IQ Waveform (Time Domain) Measurement

This section explains how to make a waveform (time domain) measurement on a W-CDMA signal. A signal generator is used to simulate a base station. The analysis of I and Q modulated waveforms in the time domain provides a view of the RF signal envelope with power versus time or an IQ waveform of voltage versus time.

Step	Action	Notes
1	Set up the signal source. <ol style="list-style-type: none"> <li>Set the mode to W-CDMA 3GPP with 4 carriers.</li> <li>Set the frequency of the signal source to 1.96 GHz.</li> <li>Set the source amplitude to -20 dBm.</li> </ol>	
2	Connect the source RF OUTPUT to the analyzer RF INPUT as shown.	

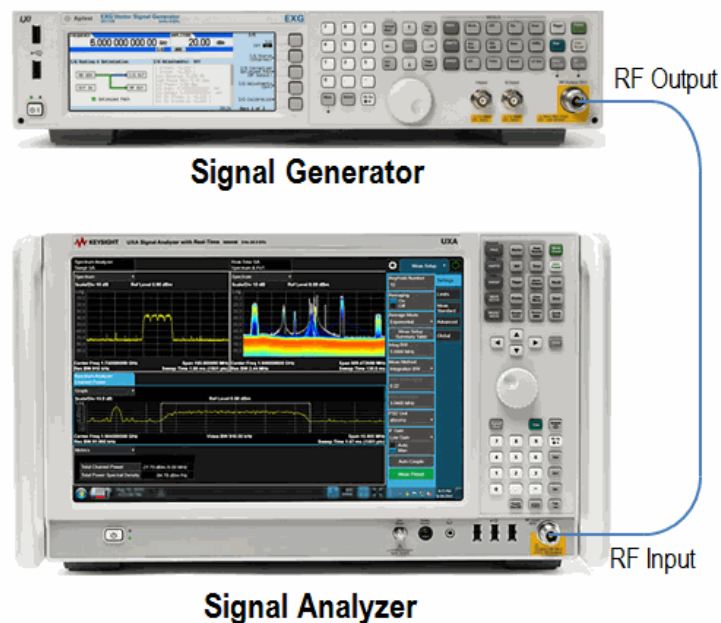

3	Preset the analyzer. <ol style="list-style-type: none"> <li>Press the <b>Mode Preset</b> key.</li> </ol>	
<div style="background-color: #cccccc; padding: 5px; display: inline-block;"><b>NOTE</b></div>		Mode Preset does not preset all settings in the analyzer. For a more complete preset, tap Restore Mode Defaults and Input/Output Preset in the Preset menu.
4	Turn on the signal generator's RF output. <ol style="list-style-type: none"> <li>Turn <b>ON</b> the RF output on the signal generator.</li> </ol>	

Step	Action	Notes
<b>5</b> On the analyzer, select the Mode/Measurement /View.	a. Press the <b>MODE/MEAS</b> key. b. Select <b>IQ Analyzer (Basic)</b> in the Mode column. c. Select <b>I/Q Waveform</b> in the Measurement column. d. Select <b>RF Envelope</b> from the View column. e. Tap <b>OK</b> at the bottom of the display.	The default Mode and Measurement of the analyzer is Spectrum Analyzer and Swept SA. If necessary, you can verify (and select) both by pressing the MODE/MEAS key.
<b>6</b> Set the measurement center frequency.	a. Press the <b>FREQ</b> key. b. In the menu panel, double tap <b>Center Frequency</b> and enter <b>1.96 GHz</b> .	
<b>7</b> Set the analysis bandwidth.	a. Press the <b>BW</b> key. b. In the menu panel, double tap <b>Digital IF BW</b> and enter <b>10 MHz</b> . c. Tap <b>Filter Type</b> and select <b>Gaussian</b> .	See <b>Figure 11-3</b> .

Step	Action	Notes
------	--------	-------

The measurement results show the RF signal envelope with power versus time in the upper window and the metrics in the lower text window.

Figure 11-3 IQ Waveform Measurement - RF Envelope View (10 MHz BW)

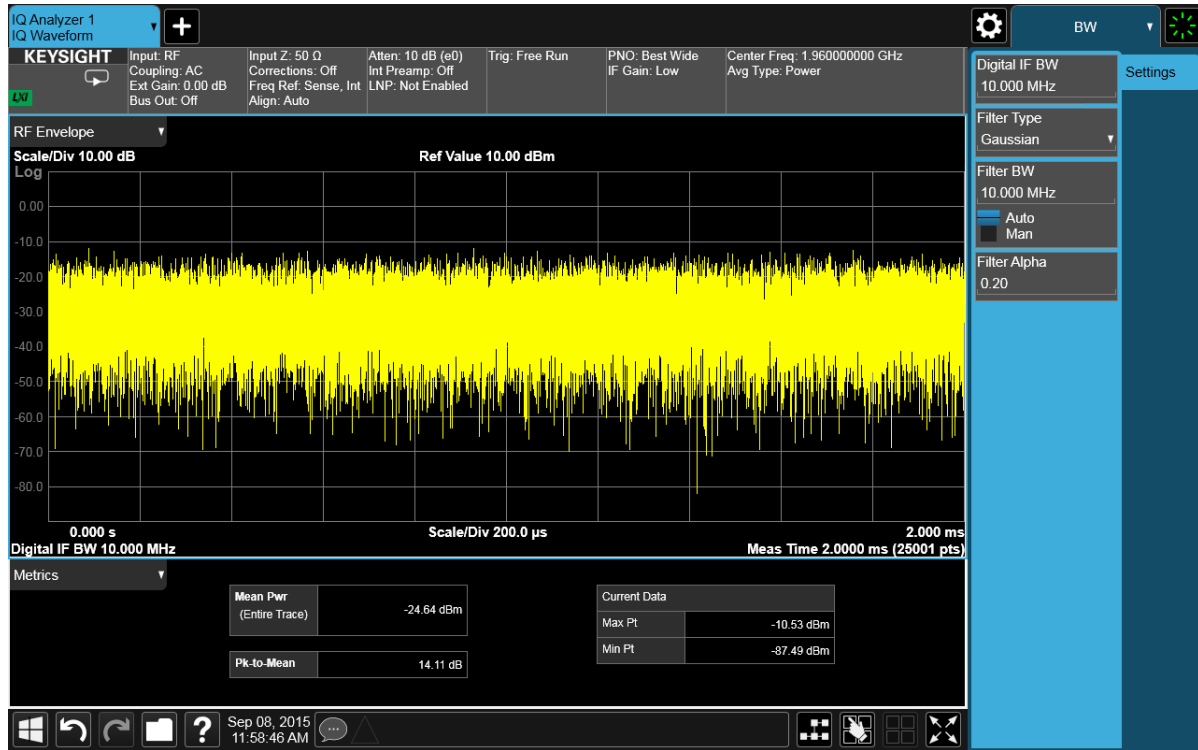

- |  |  |   |
|--|--|---|
| <p><b>8</b> Increase the analysis bandwidth.</p> | <p>a. Double tap <b>Digital IF BW</b> and enter <b>25 MHz</b>.</p> | <p>See <a href="#">Figure 11-4</a>.</p> |
|--|--|---|

Step	Action	Notes
------	--------	-------

Figure 11-4 IQ Waveform Measurement - RF Envelop View (25 MHz BW)

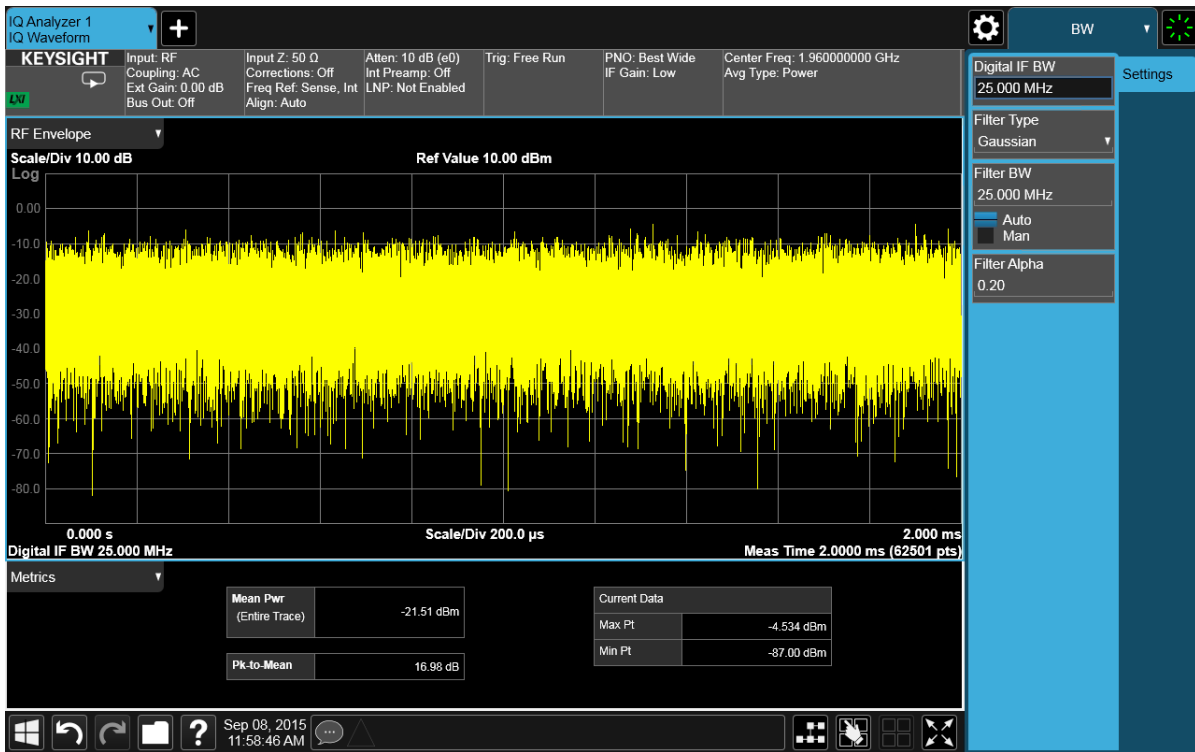

- |                         |   |  |
|-------------------------|---|--|
| 9 View the IQ Waveform. | <ol style="list-style-type: none"> <li>Press the <b>MODE/MEAS</b> key.</li> <li>Select <b>IQ Analyzer (Basic)</b> in the Mode column.</li> <li>Select <b>I/Q Waveform</b> in the Measurement column.</li> <li>Select <b>I/Q Waveform</b> in the View column.</li> <li>Tap <b>OK</b> button at the bottom of the display.</li> </ol> |  |
|-------------------------|---|--|

- |                        |  |  |
|------------------------|--|--|
| 10 Set the time scale. | <ol style="list-style-type: none"> <li>Press the <b>SWEEP</b> key.</li> <li>In the menu panel, select <b>X Scale</b>.</li> <li>Double tap <b>Scale/Div</b> and enter <b>200 ns</b>.</li> </ol> |  |
|------------------------|--|--|

- |                    |   |                                   |
|--------------------|---|-----------------------------------|
| 11 Enable markers. | <ol style="list-style-type: none"> <li>Press the <b>Marker</b> key</li> <li>Select the <b>Properties</b> tab.</li> <li>Tap <b>Marker Trace</b> and select <b>Real (I)</b>.</li> </ol> | See <a href="#">Figure 11-5</a> . |
|--------------------|---|-----------------------------------|



IQ Analyzer Measurement  
 IQ Waveform (Time Domain) Measurement

Step	Action	Notes
------	--------	-------

Figure 11-5 IQ Waveform Measurement - IQ Waveform view

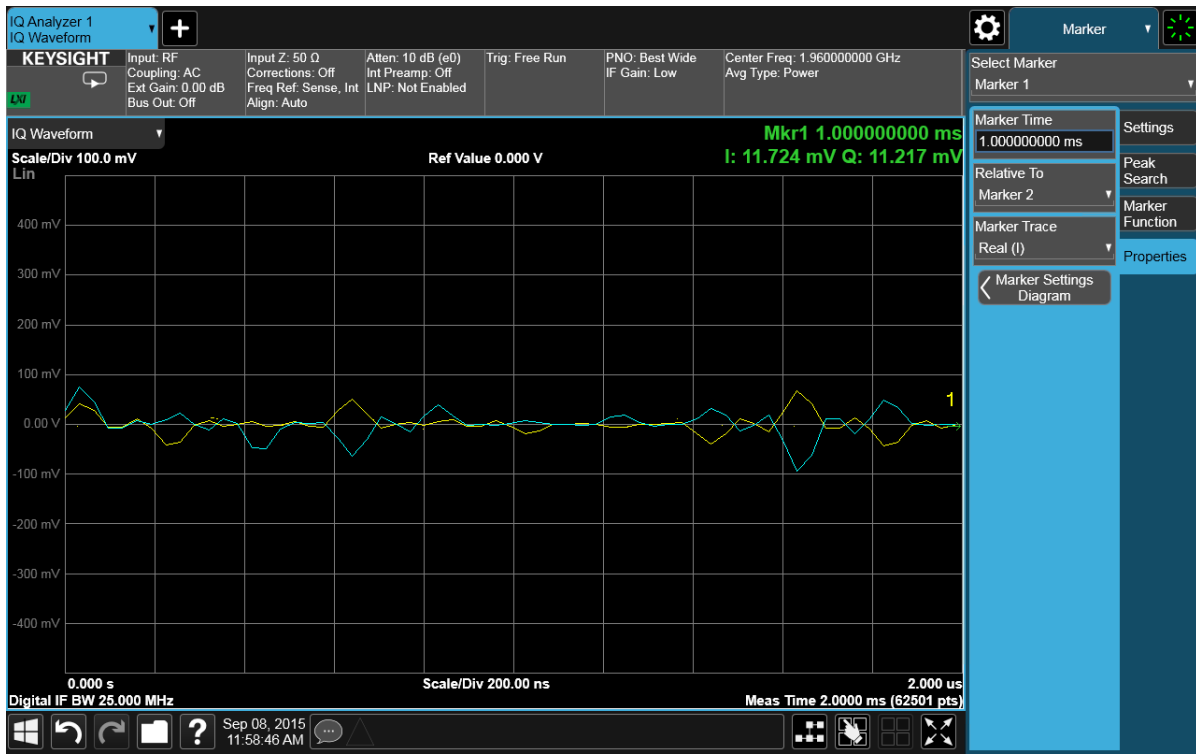

IQ Analyzer Measurement  
IQ Waveform (Time Domain) Measurement

## 12 Concepts

### Resolving Closely Spaced Signals

#### Resolving Signals of Equal Amplitude

Two equal-amplitude input signals that are close in frequency can appear as a single signal trace on the analyzer display. Changing the bandwidth of the analyzer's intermediate frequency (IF) filter (typically referred to as the resolution bandwidth or RBW filter) can help resolve these signals and make them visible on the display. As you change the IF filter bandwidth, you change the width of the displayed response. If a wide filter is used and two equal-amplitude input signals are close enough in frequency, then the two signals will appear as one signal. If the IF filter is narrowed enough, the two input signals can be displayed as separate peaks. Thus, signal resolution is determined by the IF filters in the analyzer.

The bandwidth of the IF filter determines how close together equal amplitude signals can be and still be distinguished from each other. Resolution bandwidth (RBW) selects an IF filter setting for a measurement. Typically, resolution bandwidth is defined as the 3 dB bandwidth of the filter. However, resolution bandwidth may also be defined as the 6 dB or impulse bandwidth of the filter.

Generally, to resolve two signals of equal amplitude, the RBW must be less than or equal to the frequency separation of the two signals. If the bandwidth is equal to the separation and the video bandwidth is less than the resolution bandwidth, a dip of approximately 3 dB is seen between the peaks of the two equal signals, and it is clear that more than one signal is present.

For signal analyzers in swept mode, sweep time is automatically set to a value that is inversely proportional to the square of the RBW, ( $1/BW^2$ ), to keep the analyzer measurement calibrated. For example, if the resolution bandwidth is reduced by a factor of 10, the sweep time is increased by a factor of 100 when sweep time and bandwidth settings are coupled. For the shortest measurement times, use the widest resolution bandwidth that still permits discrimination of all desired signals. Sweep time is also a function of which detector is in use. Peak and normal detectors sweep as fast or more quickly than sample or average detectors. The analyzer allows RBW selections up to 8 MHz in 1, 3, 10 steps and it has the flexibility to fine tune RBWs in increments of 10% for a total of 160 RBW settings.

For the best sweep times that maintain analyzer calibration, set the sweep time (**Sweep/Control, Sweep Time**) to **Auto**, and the sweep type (**Sweep/Control, Sweep Setup, Sweep Type**) to **Auto**. Use the widest RBW and the narrowest span that still permits resolution of all desired signals.

## Resolving Small Signals Hidden by Large Signals

To resolve signals that are close together and of different amplitudes, you must consider the shape of the IF filter of the analyzer, as well as its 3 dB bandwidth. (See **“Resolving Signals of Equal Amplitude”** on page 195 for more information.) The shape, or "selectivity" of a filter, is the ratio of the 60 dB bandwidth to the 3 dB bandwidth. If a small signal is too close to a larger signal, the smaller signal can be hidden by the skirt of the larger signal.

To view the smaller signal, select a resolution bandwidth such that **k** is less than **a** (see **Figure 12-1**). The separation between the two signals (**a**) must be greater than half the filter width of the larger signal (**k**), measured at the amplitude level of the smaller signal.

The digital filters in the analyzer have filter widths about one-third as wide as typical analog RBW filters. This enables you to resolve close signals with a wider RBW (for a faster sweep time).

Figure 12-1

RBW Requirements for Resolving Small Signals

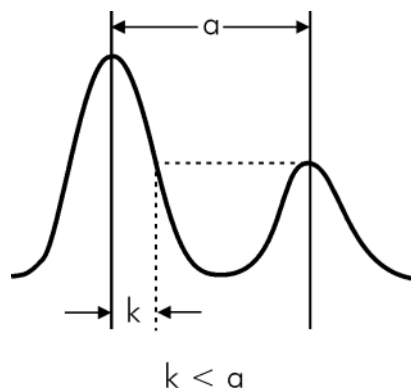

## Trigger Concepts

### NOTE

The trigger functions let you select the trigger settings for a sweep or measurement. When using a trigger source other than Free Run, the analyzer will begin a sweep only when the selected trigger conditions are met. A trigger event is defined as the point at which your trigger source signal meets the specified trigger level and polarity requirements (if any). In FFT measurements, the trigger controls when the data is acquired for FFT conversion.

### Selecting a Trigger

#### 1. Free Run Triggering

Pressing this key, when it is not selected, selects free-run triggering. Free run triggering occurs immediately after the sweep/measurement is initiated.

Press **Trigger, Free Run**

#### 2. Video Triggering

When selected, Video Triggering occurs when the video signal (the filtered and detected version of the input signal, including both RBW and VBW filtering), crosses the video trigger level. The measurement is made at the point at which the rising signal crosses the video trigger horizontal green line on the display.

Press **Trigger, Video, Video, Trigger Level, -30, dBm**. (If Video trigger was not previously selected, you must press Video a second time to get to the Trigger Level function.)

#### 3. External Triggering

The analyzer's measurement can be synchronized with a burst or other event by connecting a trigger signal to the **Trigger 1 In** or **Trigger 2 In** input connector on the rear of the analyzer. The trigger level might need to be adjusted by rotating the front panel knob or by entering the numeric value on the keypad.

Press **Trigger, External 1** or **External 2, Trigger Level**, and adjust as necessary.

#### 4. RF Burst Wideband Triggering

RF burst triggering occurs in the IF circuitry, as opposed to after the video detection circuitry with video triggering. When video triggering is used, the detection filters are limited to the maximum width of the resolution bandwidth filters. To overcome this limitation, use the RF burst trigger mode.

Press **Trigger, RF Burst**.

## 5. Line Triggering

Line triggering selects the ac line voltage as the trigger. Sweep/measurements are started every cycle of the line voltage. Pressing this key, when it is already selected, accesses the line trigger setup menu.

Press **Trigger, Line**.

## 6. Periodic Timer Triggering

This feature selects the internal periodic timer signal as the trigger. Trigger is set by the **Periodic Timer** parameter, which is modified by the **Sync Source** and **Offset**. [Figure 12-2](#) shows the action of the periodic timer trigger. Before reviewing the figure, we'll explain some uses for the periodic trigger.

A common application is measuring periodic burst RF signals for which a trigger signal is not easily available. For example, we might be measuring a TDMA radio which bursts every 20 ms. Let's assume that the 20 ms period is very consistent. Let's also assume that we do not have an external trigger source available that is synchronized with the period, and that the signal-to-noise ratio of the signal is not high enough to provide a clean RF burst trigger at all of the analysis frequencies. For example, we might want to measure spurious transmissions at an offset from the carrier that is larger than the bandwidth of the RF burst trigger. In this application, we can set the **Periodic Timer** to a 20.00 ms period and adjust the offset from that timer to position our trigger just where we want it. If we find that the 20.00 ms is not exactly right, we can adjust the period slightly to minimize the drift between the period timer and the signal to be measured.

A second way to use this feature would be to use **Sync Source** temporarily, instead of **Offset**. In this case, we might tune to the signal in a narrow span and use the **RF Burst** trigger to synchronize the periodic timer. Then we would turn the sync source off to avoid false triggering. False triggering can occur when we are tuned so far away from the RF burst trigger that it is no longer reliable.

A third example would be to synchronize to a signal that has a reference time element that has a much longer period than the period of interest. In some CDMA applications, it is useful to look at signals with a short periodicity, by synchronizing that periodicity to the "even-second clock" edge that happens every two seconds. Thus, we could connect the even-second clock trigger to Ext1 and then use Ext1 as the sync source for the periodic timer.

The figure below illustrates this third example. The top trace represents the even-second clock. It causes the periodic timer to synchronize with the leading edge shown. The analyzer trigger occurs at a time delayed by the accumulated offset from the period trigger event. The periodic timer continues to run, and triggers continue to occur, with a periodicity determined by the analyzer time base. The timer output (labeled "late event") will drift away from its ideal time due to imperfect matching

between the time base of the signal being measured and the time base of the analyzer, and also because of imperfect setting of the period parameter. But the synchronization is restored on the next even-second clock event. (“Accumulated offset” is described in the in the **Offset** function section.)

**Figure 12-2** Frame Triggering

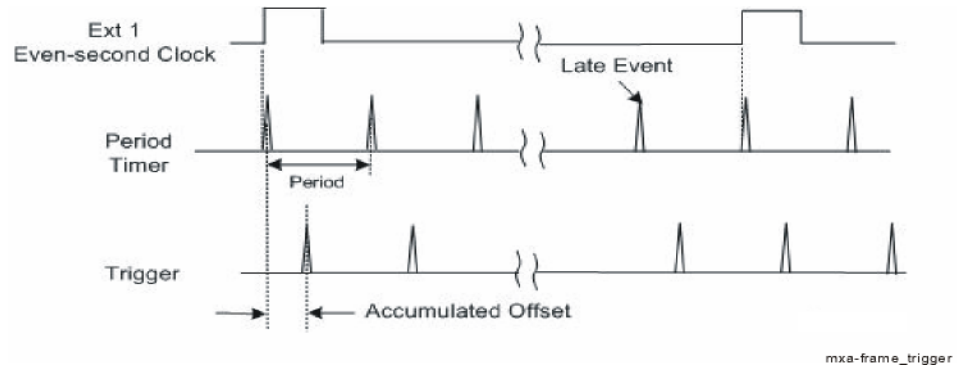

**a. Period**

Sets the period of the internal periodic timer clock. For digital communications signals, this is usually set to the frame period of your current input signal. If the sync source is not set to OFF, and the external sync source rate is changed for some reason, the periodic timer is synchronized at the every external synchronization pulse by resetting the internal state of the timer circuit.

Press **Trigger, Periodic Timer**.

**b. Offset**

Adjusts the accumulated offset between the periodic timer events and the trigger event. Adjusting the accumulated offset is different than setting an offset, as explained below.

The periodic timer is usually unsynchronized with external events. Since the timing relative to external events (RF signals) is important, you need to be able to adjust (offset) it. However, you can't see directly when the periodic timer events occur. All you can see is the trigger timing. When you adjust the trigger timing, you change the internal offset between the periodic timer events and the trigger event. The absolute value of the internal offset is unknown, and can be called the accumulated offset. Whenever the **Offset** parameter is changed, the accumulated offset is changed. The displayed offset can be changed by using **Reset Offset Display**. Changing the display does not change the value of the accumulated offset, and additional changes can still be made to the accumulated offset.

Press **Trigger, Periodic Timer**.

**c. Reset Offset Display**

Resets the value of the periodic trigger offset display setting to 0.0 seconds. The current displayed trigger location may include an offset value defined with the **Offset** key. Pressing this key redefines the currently displayed trigger location as the new trigger point that is 0.0 s offset. The **Offset** key can then be used to add offset relative to this new timing

Press **Trigger**, **Periodic Timer**.



## Time Gating Concepts

### Introduction: Using Time Gating on a Simplified Digital Radio Signal

This section describes the concepts of using time gating on a simplified digital radio signal. The section on Making Time-Gated Measurements demonstrates time gating examples.

**Figure 12-3** shows a signal with two radios, radio 1 and radio 2, that are time-sharing a single frequency channel. Radio 1 transmits for 1 ms then radio 2 transmits for 1 ms.

Figure 12-3

Simplified Digital Mobile-Radio Signal in the Time Domain

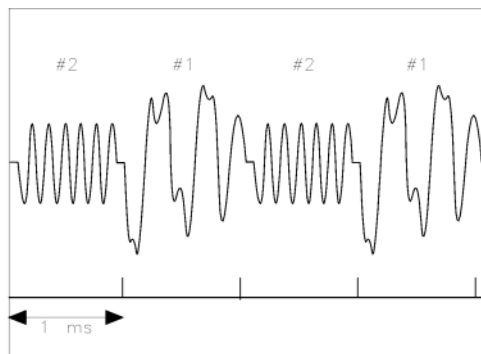

aj154e

We want to measure the unique frequency spectrum of each transmitter.

A signal analyzer without time gating cannot do this. By the time the signal analyzer has completed its measurement sweep, which lasts about 50 ms, the radio transmissions switch back and forth 25 times. Because the radios are both transmitting at the same frequency, their frequency spectra overlap, as shown in **Figure 12-4**. The signal analyzer shows the combined spectrum; you cannot tell which part of the spectrum results from which signal.

Figure 12-4

Frequency Spectra of the Combined Radio Signals

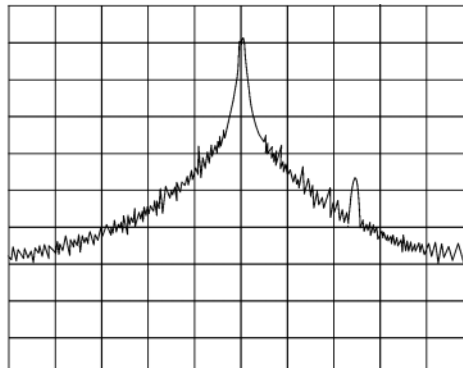

- 146 -

Time gating allows you to see the separate spectrum of radio 1 or radio 2 to determine the source of a spurious signal, as shown in **Figure 12-5** and **Figure 12-6**.

Figure 12-5 Time-Gated Spectrum of Radio 1

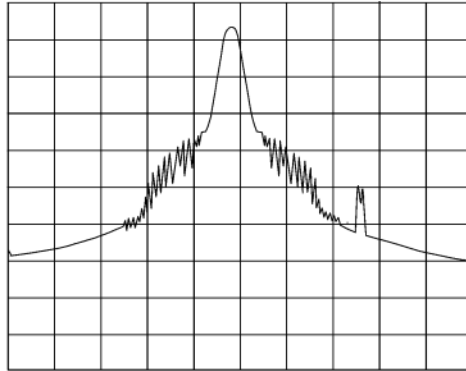
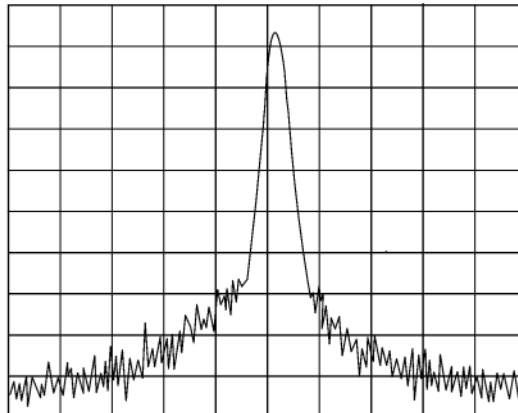

Figure 12-6 Time-Gated Spectrum of Radio 2



Time gating lets you define a time window (or time gate) of when a measurement is performed. This lets you specify the part of a signal that you want to measure, and exclude or mask other signals that might interfere.

## How Time Gating Works

Time gating is achieved by selectively interrupting the path of the detected signal with a gate, as shown in [Figure 12-8](#) and [Figure 12-9](#). The gate determines when the analyzer captures measurement data. When the gate is turned “on,” under the Gate menu, the signal is being passed, and when the gate is “off,” the signal is blocked. Ideally, the analyzer measures only those signals at its input when the gate is on. With the correct signal analyzer settings, all other signals are masked out.

There are typically two main types of gate events, **edge** and **level**:

- **Edge Gating** The gate is triggered by selecting either the rising or falling edge of a trigger signal, typically an external periodic TTL signal that rises and falls synchronously with the rise and fall of the pulsed radio signal.
- The gate is further controlled by setting the gate delay and gate length parameters (see [Figure 12-7](#)). The gate passes a signal on the edge of the trigger signal after the set gate delay time, and blocks the signal at the end of the gate length.
- With **Level Gating**, the gate passes a signal when the gate signal meets the specified level (high or low). The gate blocks the signal when the level conditions are no longer satisfied (level gating does not use gate length or gate delay parameters).

Figure 12-7 Edge Trigger Timing Relationships

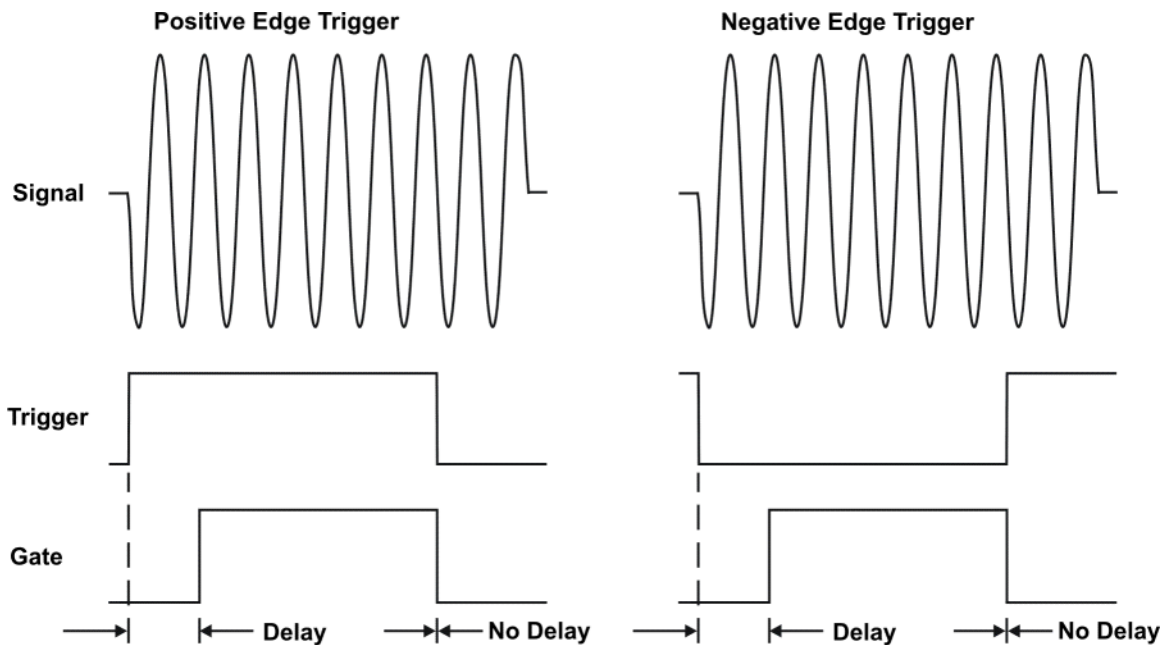

Keysight signal analyzers use three different methods for time gating: gated video, gated LO, and gated FFT.

### Gated Video Concepts

Gated video may be thought of as a simple gate switch, which connects the signal to the input of the signal analyzer. When the gate is “on” (under the Gate menu) the gate is passing a signal. When the gate is “off,” the gate is blocking the signal. Whenever the gate is passing a signal, the analyzer sees the signal. In **Figure 12-8** notice that the gate is placed after the envelope detector and before the video bandwidth filter in the IF path (hence “gated video”).

Gating occurs after the RF section of the signal analyzer, before video processing. Consequently, there are some limitations on the gate settings because of signal response times in the RF signal path.

With video gating, the analyzer is continually sweeping, independent of the position and length of the gate. There is a minimum sweep time (see the sweep time calculations later in this chapter) necessary to capture the signal when the gate is passing a signal. Because of this, video gating is typically slower than gated LO and gated FFT.

**Figure 12-8** Gated Video Signal Analyzer Block Diagram

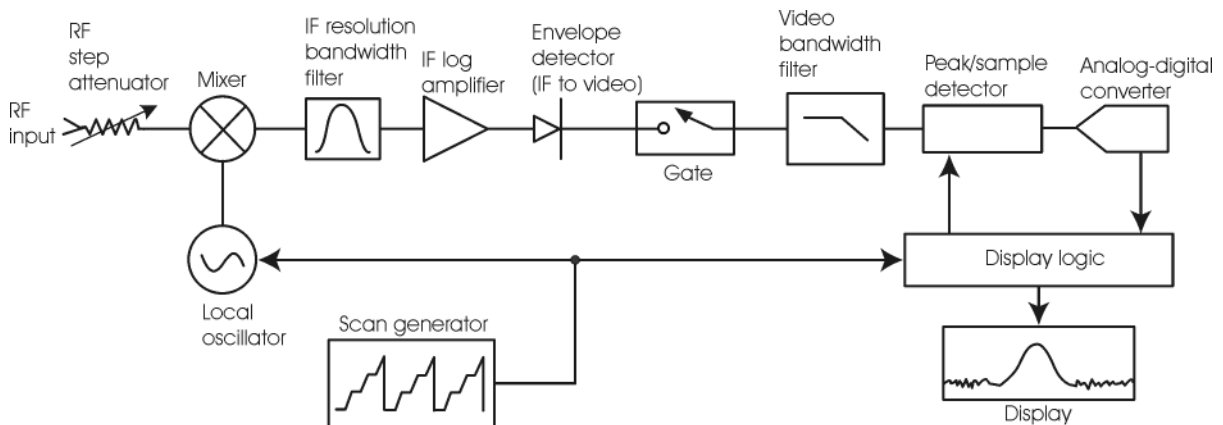

### Gated LO Concepts

Gated LO is a very sophisticated type of gating that sweeps the LO only while the gate is “on” and the gate is passing a signal. See **Figure 12-9** for a simplified block diagram of gated LO operation. Notice that the gate control signal controls when the scan generator is sweeping and when the gate passes or blocks a signal. This allows the analyzer to sweep only during periods when the gate passes a signal. Gated LO is faster than Gated Video because Gated Video constrains sweep time so that each point is long enough to include a burst event. In Gated LO, multiple points may be swept during each gate.

Figure 12-9 Gated LO Signal Analyzer Block Diagram

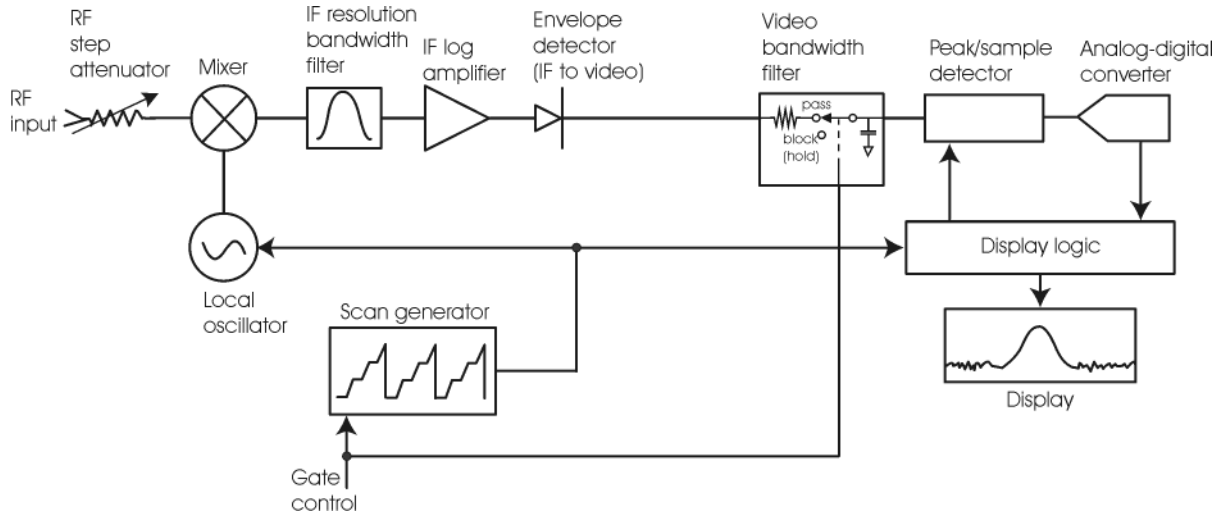

### Gated FFT Concepts

Gated FFT (Fast-Fourier Transform) is an FFT measurement which begins when the trigger conditions are satisfied.

Processing a spectrum measurement with FFTs is inherently a “gated” process, because the spectrum is computed from a time record of short duration, much like a gate signal in swept-gated analysis.

Using the analyzer in FFT mode, the duration of the time record to be gated is:

$$FFT \text{ Time Record (to be gated)} = \frac{1.83}{RBW}$$

The duration of the time record is within a tolerance of approximately 3% for resolution bandwidths up through 1 MHz. Unlike swept gated analysis, the duration of the analysis in gated FFT is fixed by the RBW, not by the gate signal. Because FFT analysis is faster than swept analysis (up to 7.99 MHz), the gated FFT measurements can have better frequency resolution (a narrower RBW) than swept analysis for a given duration of the signal to be analyzed.

Figure 12-10

Gated FFT Timing Diagram

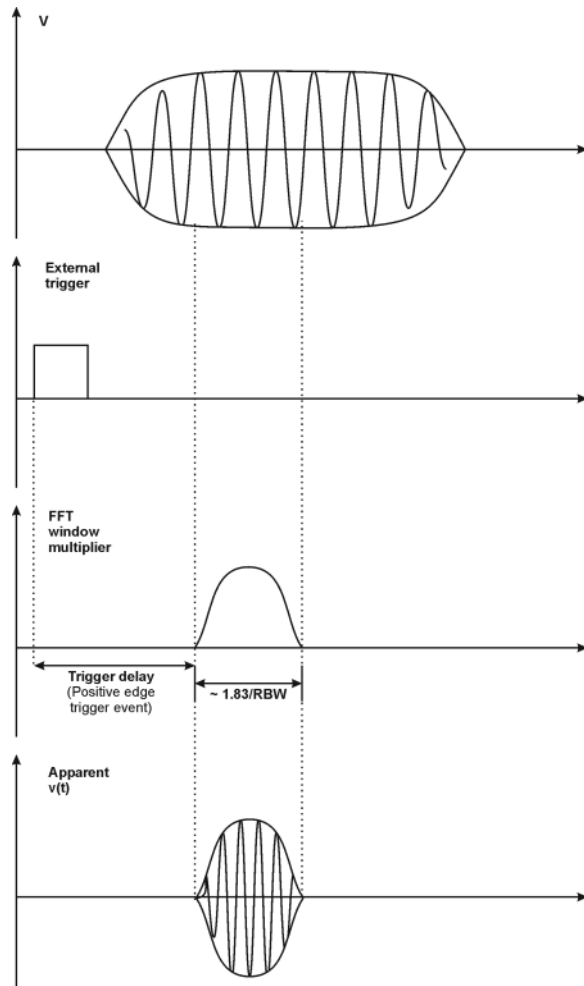

### Time Gating Basics (Gated LO and Gated Video)

The gate parameters are the following:

- Trigger condition - Usually an external transistor-transistor logic (TTL) periodic signal for edge triggering or a high/low TTL signal for level triggering.
- Gate delay - The time after the trigger condition occurs before the gate starts to pass a signal.
- Gate length - The duration the signal is allowed to pass.

To understand time gating better, consider a spectrum measurement performed on two pulsed-RF signals sharing the same frequency spectrum. Consider the timing interaction of three signals with this example:

- The composite of the two pulsed-RF signals.
- The gate trigger signal (a periodic TTL level signal).

- The gate signal. This TTL signal is low when the gate is “off” (blocking) and high when the gate is “on” (passing).

The timing interactions between the three signals are best understood if they are observed in the time domain (see **Figure 12-11**).

The main goal is to measure the spectrum of signal 1 and determine if it has any low-level modulation or spurious signals.

Because the pulse trains of signal 1 and signal 2 have almost the same carrier frequency, their spectra overlap. Signal 2 dominates in the frequency domain due to its greater amplitude. Without gating, the spectrum of signal 1 isn't visible; it is masked by signal 2.

To measure signal 1, the gate must be on only during the pulses from signal 1. The gate will be off at all other times, thus excluding all other signals. To position the gate, set the gate delay and gate length, as shown in **Figure 12-11**, so that the gate is on only during some central part of the pulse. Carefully avoid positioning the gate over the rising or falling pulse edges. When gating is activated, the gate output signal will indicate actual gate position in time, as shown in the line labeled “Gate.”

Figure 12-11

Timing Relationship of Signals During Gating

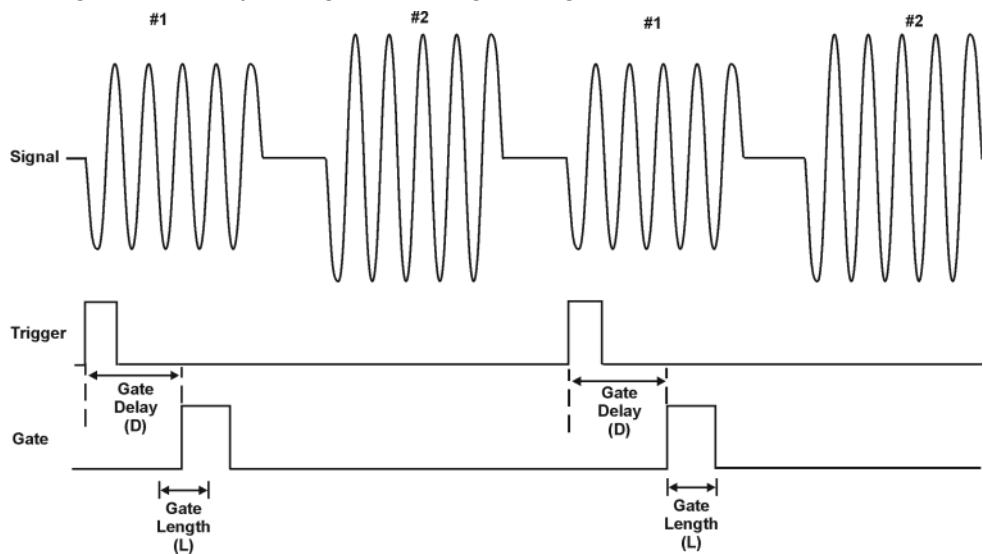

Once the signal analyzer is set up to perform the gate measurement, the spectrum of signal 1 is visible and the spectrum of signal 2 is excluded, as shown in **Figure 12-13**. In addition, when viewing signal 1, you also will have eliminated the pulse spectrum generated from the pulse edges. Gating has allowed you to view spectral components that otherwise would be hidden.

Figure 12-12 Signal Within Pulse #1 (Time-Domain View)

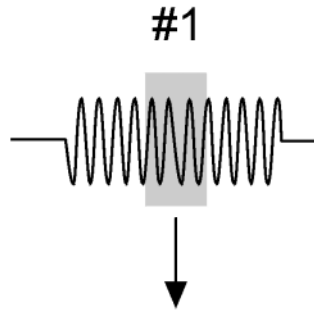

aj159e

Figure 12-13 Using Time Gating to View Signal 1 (spectrum view)

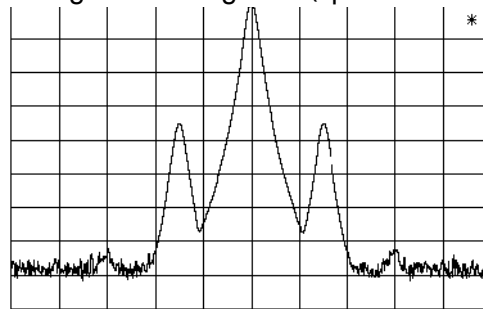

Moving the gate so that it is positioned over the middle of signal 2 produces a result as shown in **Figure 12-15**. Here, you see only the spectrum within the pulses of signal 2; signal 1 is excluded.

Figure 12-14 Signal Within Pulse #2 (Time-Domain View)

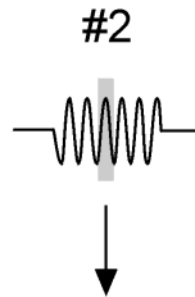

aj160e



Figure 12-15 Using Time Gating to View Signal 2 (spectrum view)

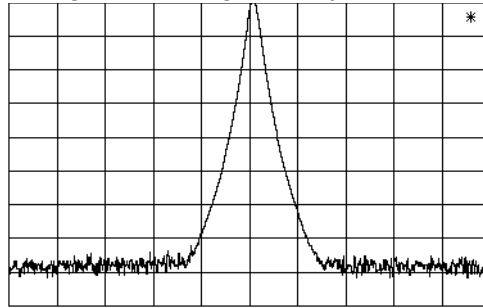

### Measuring a Complex/Unknown Signal

**NOTE**

The steps below help to determine the signal analyzer settings when using time gating. The steps apply to the gated LO and gated video time gating.

This example describes how to use time gating to measure a very specific signal. Most signals requiring time gating are fairly complex and in some cases extra steps may be required to perform a measurement.

- Step 1.** Determine how the signal under test appears in the time domain and how it can be synchronized to the trigger signal.

This helps you determine the delay of the gate relative to the trigger signal

To set the delay, you must know the timing relationship between the trigger and the signal under test. If you don't know how the two signals look in the time domain, you can examine the signals with an oscilloscope to determine the following parameters:

- Trigger type (edge or level triggering)
- Pulse repetition interval (PRI), which is the length of time between trigger events (the trigger period).
- Pulse width, or  $\tau$ , of the signal under test.
- Signal delay (SD), which is the length of time occurring between the trigger event and when the signal is present and stable. If the trigger occurs at the same time as the signal, signal delay will be zero.

Figure 12-16

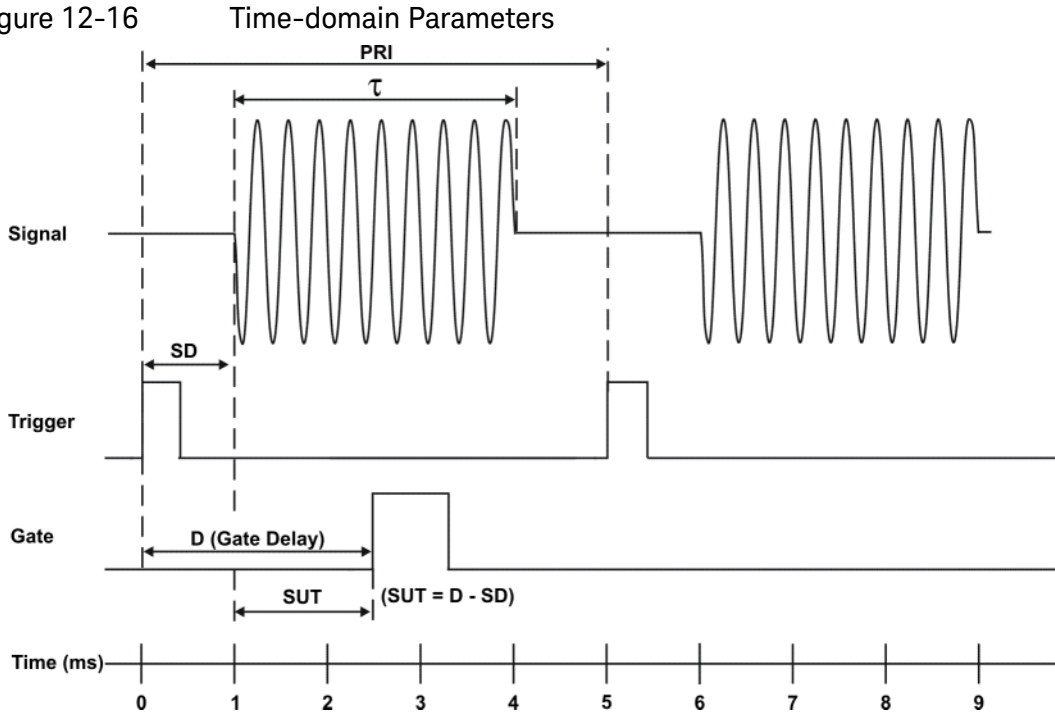

In **Figure 12-16**, the parameters are:

- Pulse repetition interval (PRI) is 5 ms.
- Pulse width ( $\tau$ ) is 3 ms.
- Signal delay (SD) is 1 ms for positive edge trigger (0.6 ms for negative edge trigger).
- Gate delay (D) is 2.5 ms.
- Setup time (SUT) is 1.5 ms.

**Step 2.** Set the signal analyzer sweep time:

**Gated LO:** Sweep time does not affect the results of gated LO unless the sweep time is set too fast. In the event the sweep time is set too fast,  $Meas_{Uncal}$  is displayed, indicating the sweep time needs to be increased.

**Gated Video:** Sweep time does affect the results from gated video. The sweep time must be set accordingly for correct time gating results. The recommended sweep time is at least the number of **sweep points - 1** multiplied by the **PRI (pulse repetition interval)**. Measurements can be made with sweep times as fast as  $(\text{sweep points} - 1) * (\text{PRI} - \tau)$ .

**Step 3.** Locate the signal under test on the display of the signal analyzer. Set the center frequency and span to view the signal characteristics that you are interested in measuring. Although the analyzer is not yet configured for correct gated measurements, you will want to determine the approximate frequency and span in which to display the signal of interest. If the signal is

erratic or intermittent, you can hold the maximum value of the signal with **Max Hold** (located under the **Trace/Detector** menu) to determine the frequency of peak energy.

To optimize measurement speed in Gated LO, set the span narrow enough so that the signal characteristics you want to measure are displayed. For example, if you want to look for spurious signals within a 200 kHz range, set the frequency span to just over 200 kHz.

- Step 4.** Determine the setup time and signal delay to set up the gate signal. Turn on the gate and adjust the gate parameters including gate delay and gate length as shown below.

Generally, the gate should be positioned over a part of the signal that is stable, not over a pulse edge or other transition that might disturb the spectrum. Starting the gate at the center of the pulse gives a setup time of about half the pulse width. Setup time describes the length of time during which that signal is present and stable before the gate comes on. The setup time (SUT) must be long enough for the RBW filters to settle following the burst-on transients. Signal delay (SD) is the length of time after the trigger, but before the signal of interest occurs and becomes stable. If the trigger occurs simultaneously with the signal of interest, SD is equal to zero, and SUT is equal to the gate delay. Otherwise, SUT is equal to the gate delay minus SD. See [Figure 12-17](#).

Figure 12-17

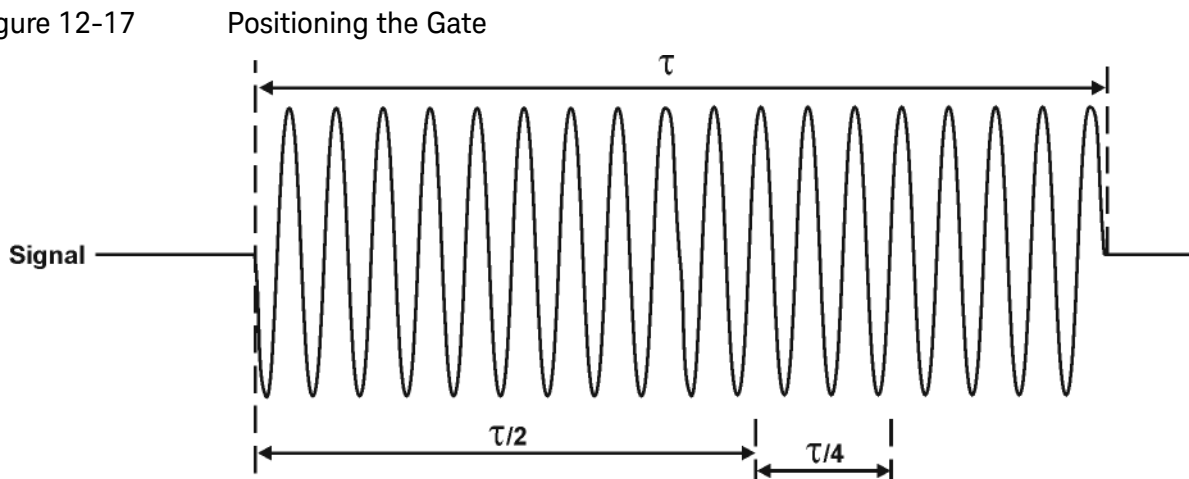

There is flexibility in positioning the gate, but some positions offer a wider choice of resolution bandwidths. As a starting point, position the gate between 20 % to 90 % of the burst width. This provides a reasonable compromise between setup time and gate length.

Figure 12-18

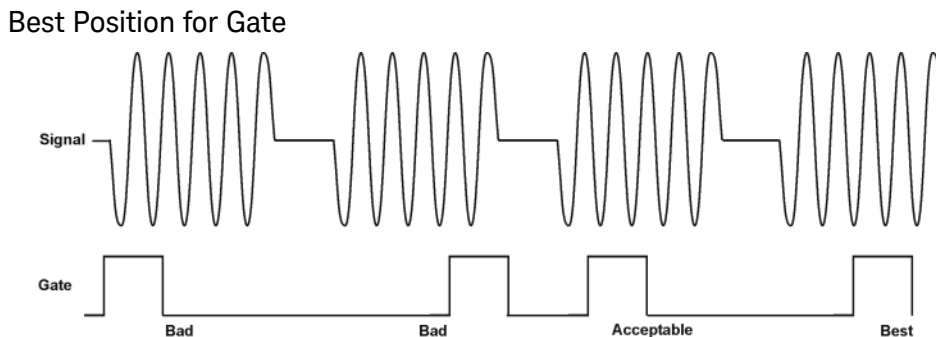

Generally, the best measurement results are obtained if you position the gate relatively late within the signal of interest, but without extending the gate over the trailing pulse edge or signal transition. Doing so maximizes setup time and provides the resolution bandwidth filters of the signal analyzer the most time to settle before a gated measurement is made. “Relatively late,” in this case, means allowing a setup time of at least  $3.84/\text{resolution bandwidth}$  (see [step 5](#) for RBW calculations).

As an example, if you want to use a 1 kHz RBW for measurements, you need to allow a setup time of at least 3.84 ms.

Note that the signal does not need to be an RF pulse. It could be simply a particular period of modulation in a signal that is continuously operating at full power, or it could even be during the off time between pulses. Depending on your specific application, adjust the gate position to allow for progressively longer setup times (ensuring that the gate is not left on over another signal change such as a pulse edge or transient), and select the gate delay and length that offer the best representation of the signal characteristics of interest on the display.

To measure the spectrum between pulses, use the same (or longer) setup time after the pulse ends, but before the gate goes on. This lets the RBW filters fully discharge the large pulse before the measurement is made on the low-level interpulse signal.

Figure 12-19

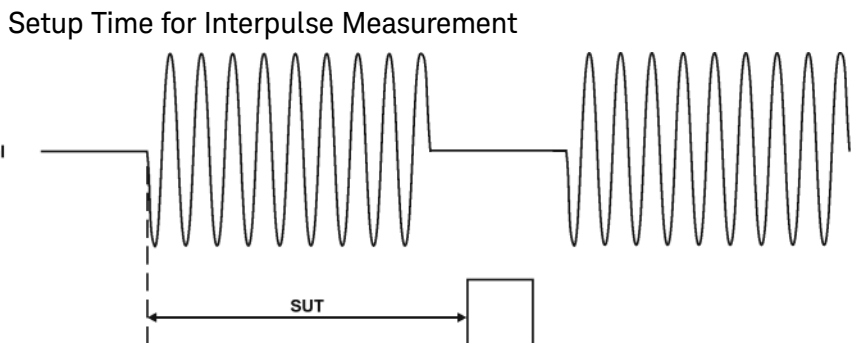

**Step 5.** The resolution bandwidth must be adjusted for gated LO and gated video. The video bandwidth only needs to be adjusted for gated video.

### Resolution Band width:

The choice of RBW is determined by the gate position, so you can trade-off longer setup times for narrower resolution band widths. This trade-off is due to the time required for the resolution band width filters to fully charge before the gate opens. Recall that setup time is the length of time that the signal is present and stable before the gate comes on.

Figure 12-20

Resolution Bandwidth Filter Charge-Up Effects

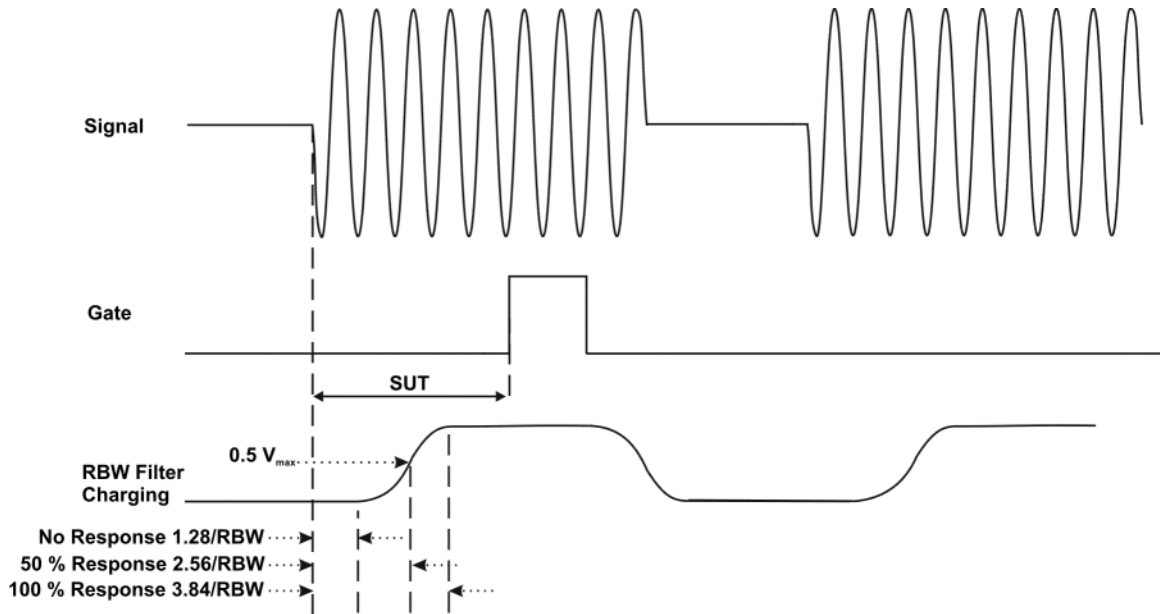

The resolution-bandwidth filters are band-limited devices, so consequently require a finite amount of time to react to changing conditions. Specifically, the filters take time to charge fully after the analyzer is exposed to a pulsed signal.

Because setup time should be greater than filter charge times, be sure that:

$$SUT > \frac{3.84}{RBW}$$

where SUT is the same as the gate delay in this example. In this example with SUT equal to 1.5 ms, RBW is greater than 2.56 kHz; that is, RBW is greater than 1333 Hz. The resolution band width should be set to the next larger value, 2.7 kHz.

### Video Band width:

For gated LO measurements, the VBW filter tracks-and-holds between sweep times. With this behavior, the VBW does not need to reset on each restart of the sweep.

**Step 6.** Adjust the span as necessary, and perform your measurement.

The analyzer is set up to perform accurate measurements. Freeze the trace data by activating single sweep, or by placing your active trace in view mode. Use the markers to measure the signal parameters you chose in step 1. If necessary, adjust span, but do not decrease resolution bandwidth, video bandwidth, or sweep time.

### Quick Rules for Making Time-Gated Measurements

This section summarizes the rules described in the previous sections.

Table 12-1 Determining Signal Analyzer Settings for Viewing a Pulsed RF Signal

Signal Analyzer Function	Signal Analyzer Setting	Comments
Sweep Time (gated video only)	Set the sweep time to be equal to or greater than (number of sweep points - 1) × pulse repetition interval (PRI):	Because the gate must be on at least once per trace point, the sweep time should be set such that the sweep time for each trace point is greater than or equal to the pulse repetition interval.
Gate Delay	The gate delay is equal to the signal delay plus one-fourth the pulse width: Gate Delay = Signal Delay + $\tau/5$	The gate delay must be set so that the gating captures the pulse. If the gate delay is too short or too long, the gating can miss the pulse or include resolution bandwidth transient responses.
Gate Length	The gate length minimum is equal to one-fourth the pulse width (maximum about one-half): Gate Length = $0.7 \times \tau/4$	If the gate length is too long, the signal display can include transients caused by the signal analyzer filters.  The recommendation for gate placement can be between 20 % to 90 % of the pulse width.
Resolution Bandwidth	Set the resolution bandwidth: RBW > $19.5/\tau$	The resolution bandwidth must be wide enough so that the charging time for the resolution bandwidth filters is less than the pulse width of the signal.

Figure 12-21

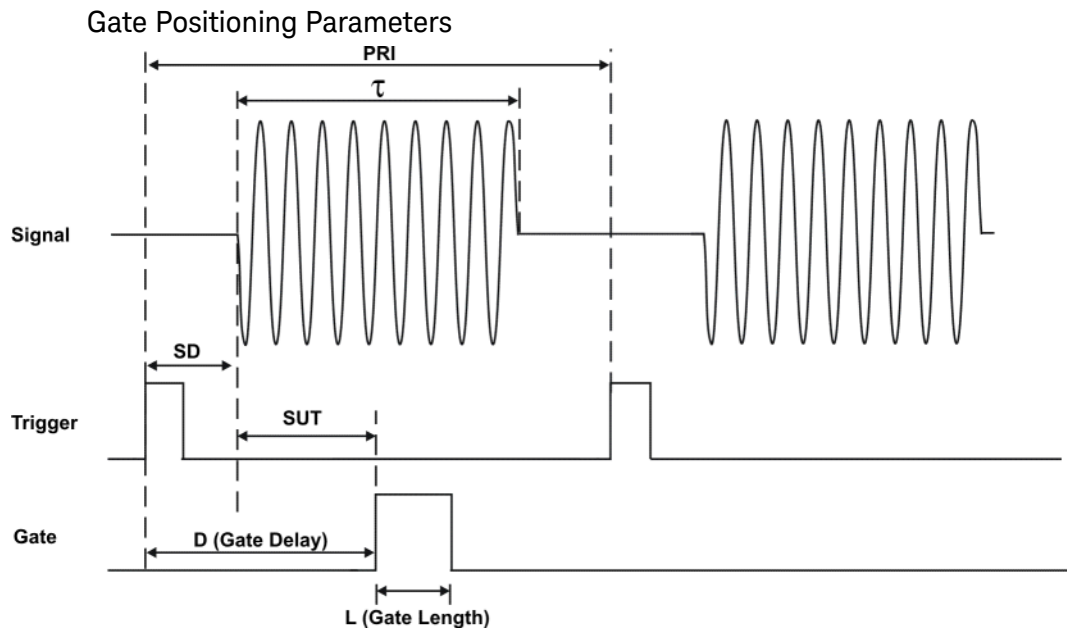

Most control settings are determined by two key parameters of the signal under test: the pulse repetition interval (PRI) and the pulse width ( $\tau$ ). If you know these parameters, you can begin by picking some standard settings. **Table 12-2** summarizes the parameters for a signal whose trigger event occurs at the same time as the beginning of the pulse (in other words, SD is 0). If your signal has a non-zero delay, just add it to the recommended gate delay.

Table 12-2 Suggested Initial Settings for Known Pulse Width ( $\tau$ ) and Zero Signal Delay

Pulse width ( $\tau$ )	Gate Delay ( $SD + \tau/5$ )	Resolution Band width ( $>19.5/\tau$ )	Gate Length ( $0.7 \times \tau/4$ )
4 $\mu$ s	0.8 $\mu$ s	4.875 MHz	0.7 $\mu$ s
10 $\mu$ s	2 $\mu$ s	1.95 MHz	1.753 $\mu$ s
50 $\mu$ s	10 $\mu$ s	390 kHz	8.75 $\mu$ s
63.5 $\mu$ s	12.7 $\mu$ s	307 kHz	11.11 $\mu$ s
100 $\mu$ s	20 $\mu$ s	195 kHz	17.5 $\mu$ s
500 $\mu$ s	100 $\mu$ s	39 kHz	87.5 $\mu$ s
1 ms	200 $\mu$ s	19.5 kHz	0.175 ms
5 ms	1 ms	3.9 kHz	0.875 ms
10 ms	2 ms	1.95 kHz	1.75 ms
16.6 ms	3.32 ms	1.175 kHz	2.905 ms
33 ms	6.6 ms	591 Hz	5.775 ms
50 ms	10 ms	390 Hz	8.75 ms

Table 12-2 Suggested Initial Settings for Known Pulse Width ( $\tau$ ) and Zero Signal Delay

Pulse width ( $\tau$ )	Gate Delay (SD + $\tau/5$ )	Resolution Band width ( $>19.5/\tau$ )	Gate Length ( $0.7 \times \tau/4$ )
100 ms	20 ms	195 Hz	17.5 ms
$\geq 130$ ms	26 ms	151 Hz	22.75 ms

Table 12-3 If You Have a Problem with Time-Gated Measurement

Symptom	Possible Causes	Suggested Solution
Erratic analyzer trace with dropouts that are not removed by increasing analyzer sweep time; oscilloscope view of gate output signal jumps erratically in time domain.	Gate Delay may be greater than trigger repetition interval.	Reduce Gate Delay until it is less than trigger interval.  Check <b>Gate View</b> to make sure the gate delay is timed properly.
Gate does not trigger.	1) Gate trigger voltage may be wrong. 2) Gate may not be activated. 3) <b>Gate Source</b> selection may be wrong.	With external gate trigger: ensure that the trigger threshold is set near the midpoint of the waveform (view the waveform on and oscilloscope using high input impedance, not 50 $\Omega$ ). With RF Burst Gate Source: ensure that the start and stop frequencies are within 10 MHz of the center frequency of the carrier. Check to see if other connections to trigger signal may be reducing voltage. If using an oscilloscope, check that all inputs are high impedance, not 50 $\Omega$ .
Display spectrum does not change when the gate is turned on.	Insufficient setup time.	Increase setup time for the current resolution bandwidth, or increase resolution bandwidth.
Displayed spectrum too low in amplitude.	Resolution bandwidth or video bandwidth filters not charging fully.	Widen resolution bandwidth or video bandwidth, or both.



## Using the Edge Mode or Level Mode for Triggering

Depending on the trigger signal that you are working with, you can trigger the gate in one of two separate modes: edge or level. This gate-trigger function is separate from the normal external trigger capability of the signal analyzer, which initiates a sweep of a measurement trace based on an external signal.

### Edge Mode

Edge mode lets you position the gate relative to either the rising or falling edge of a trigger signal. The left diagram of **Figure 12-22** shows triggering on the positive edge of the trigger signal while the right diagram shows negative edge triggering.

Example of key presses to initiate positive edge triggering:  
Press **Sweep, Gate, More, Polarity** (Pos).

Figure 12-22 Using Positive or Negative Edge Triggering

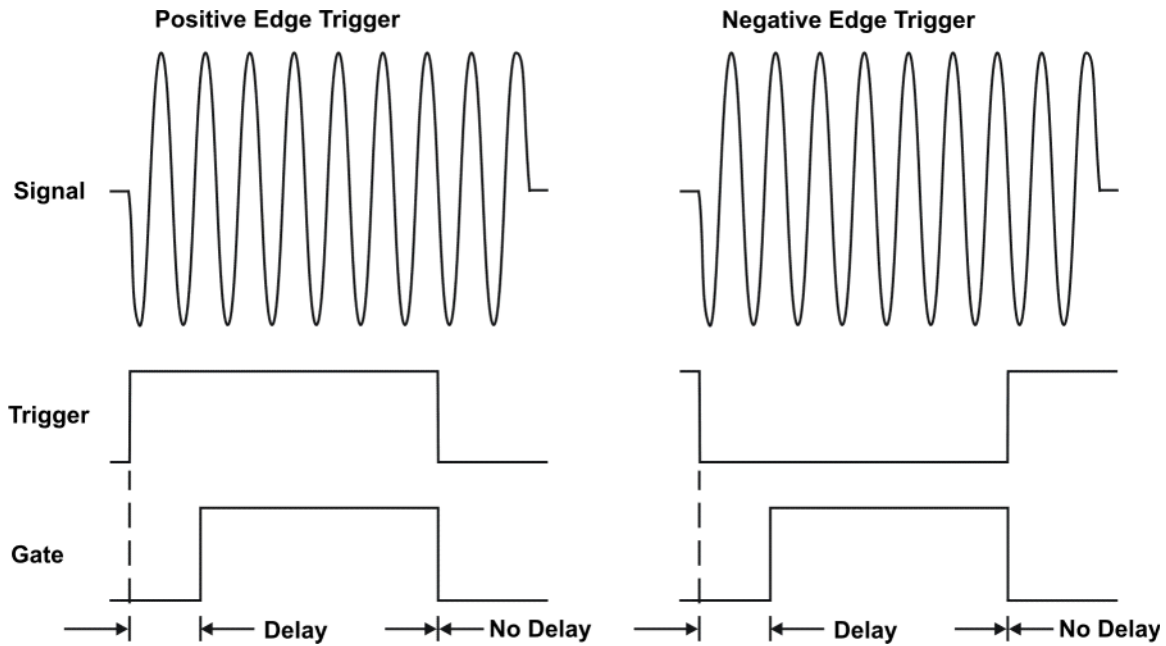

### Level Mode

In level gate-control mode, an external trigger signal opens and closes the gate. Either the TTL high level or TTL low level opens the gate, depending on the setting of **Trig Slope**. Gate delay affects the start of the gate but not the end. Gate length is applicable when using level mode triggering. Level mode is useful when your trigger signal occurs at exactly the same time as does the portion of the signal you want to measure.

## Noise Measurements Using Time Gating

Time gating can be used to measure many types of signals. Noise and noise-like signals are often a special case in spectrum analysis. With the history of gated measurements, these signals are especially noteworthy.

The average detector is the best detector to use for measuring noise-like signals because it uses all the available noise power all the time in its measurement. The sample detector is also a good choice because it, too, is free from the peak biases of the peak detector, normal and negative peak detectors.

When using the average or sample detector, noise density measurements using the noise marker or band/interval density marker can be made without any consideration of the use of gating--gated measurements work just as well as non-gated measurements. Thus, the average detector is recommended for noise density measurements.

Older analyzers only had the gated video version of gating available, and these only worked with the peak detector, so the rest of this section will discuss the trade-offs associated with trying to replicate these measurements with an X-Series analyzer.

Unlike older analyzers, X-Series analyzers can make competent measurements of noise density using the noise marker with all detectors, not just those that are ideal for noise measurements. Thus, X-Series analyzers can make noise density measurements with peak detection, compensating for the extent to which peak detection increases the average response of the analyzer to noise. When comparing a gated video measurement using the noise marker between an X-Series and an older analyzer where both use the peak detector, the X-Series answer will be approximately correct, while the older analyzer will need a correction factor. That correction factor is discussed in Keysight Technologies Application Note 1303, Spectrum Analyzer Measurements and Noise, in the section on Peak-detected Noise and TDMA ACP Measurements.

When making measurements of Band/Interval Power or Band/Interval Density, the analyzer does not make compensations for peak detection. For best measurements with these marker functions, average or sample detection should be used.

## AM and FM Demodulation Concepts

### Demodulating an AM Signal Using the Analyzer as a Fixed-Tuned Receiver (Time-Domain)

The zero span mode can be used to recover amplitude modulation on a carrier signal.

The following functions establish a clear display of the waveform:

- Triggering stabilizes the waveform trace by triggering on the modulation envelope. If the modulation of the signal is stable, video trigger synchronizes the sweep with the demodulated waveform.
- Linear display mode should be used in amplitude modulation (AM) measurements to avoid distortion caused by the logarithmic amplifier when demodulating signals.
- Sweep time to view the rate of the AM signal.
- RBW and VBW are selected according to the signal bandwidth.

### Demodulating an FM Signal Using the Analyzer as a Fixed-Tuned Receiver (Time-Domain)

To recover the frequency modulated signal, a spectrum analyzer can be used as a manually tuned receiver (zero span). However, in contrast to AM, the signal is not tuned into the passband center, but to one slope of the filter curve as shown in **Figure 12-23**.

Figure 12-23 Determining FM Parameters Using FM to AM Conversion

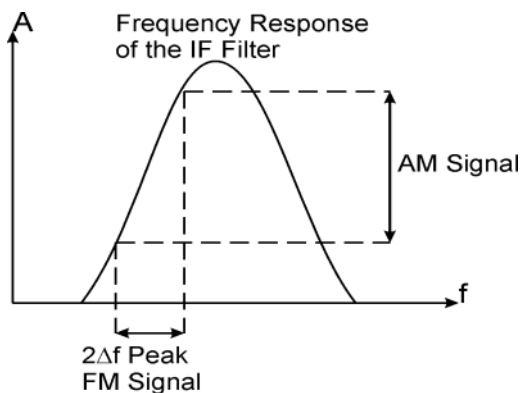

Here the frequency variations of the FM signal are converted into amplitude variations (FM to AM conversion) utilizing the slope of the selected bandwidth filter. The reason we want to measure the AM component is that the envelope detector responds only to AM variations. There are no changes in amplitude if the frequency changes of the FM signal are limited to the flat part of the RBW (IF filter). The resultant AM signal is then detected with the envelope detector and displayed in the time domain.

## IQ Analysis Concepts

### Purpose

IQ Analysis (Basic) mode is used to capture complex time domain data from wide bandwidth RF signals. This mode preserves the instantaneous vector relationships of time, frequency, phase and amplitude contained within the selected digitizer span or analysis BW, at the analyzer's center frequency, for output as IQ data. This IQ data can then be utilized internally or output over LAN, USB or GPIB for use with external analysis tools. Each measurement description specifies the types of data available remotely for that measurement.

Within the IQ Analyzer mode, basic frequency domain, time domain and IQ measurements are available as initial signal and data verification tools in preparation for deriving the IQ data output. This is accomplished using the Complex Spectrum and IQ Waveform measurements. Although Complex Spectrum and IQ Waveform are defined as measurements in the IQ Analyzer (Basic) mode, they act primarily as tools to verify the signals and data as stated above.

### Complex Spectrum Measurement

#### Purpose

This measurement is FFT (Fast Fourier Transform) based. The FFT-specific parameters are located in the **Advanced** menu. The Complex Spectrum measurement provides a display in the upper window of power versus frequency with current (yellow trace) and average (blue trace) data. In addition, an IQ waveform of voltage versus time is provided in the lower window. One advantage of having an I/Q view available while in the spectrum measurement is that it allows you to view complex components of the same signal without changing settings or measurements.

#### Measurement Method

The measurement uses digital signal processing to sample the input signal and convert it to the frequency domain. With the instrument tuned to a fixed center frequency, samples are digitized at a high rate, converted to I and Q components with DSP hardware, and then converted to the frequency domain with FFT software.

#### Troubleshooting Hints

Changes made by the user to advanced spectrum settings, particularly to ADC range settings, can inadvertently result in spectrum measurements that are invalid and cause error messages to appear. Care needs to be taken when using advanced features.

## IQ Waveform Measurement

### **Purpose**

The IQ Waveform measurement provides a time domain view of the RF signal envelope with power versus time or an IQ waveform with the I and Q signal waveforms in parameters of voltage versus time. The RF Envelope view provides the power versus time display, and the I/Q Waveform view provides the voltage versus time display. One advantage of having an I/Q Waveform view available while making a waveform measurement is that it allows you to view complex components of the same signal without changing settings or measurements.

The waveform measurement can be used to perform general purpose power measurements in the time domain with excellent accuracy.

### **Measurement Method**

The instrument makes repeated power measurements at a set frequency, similar to the way a swept-tuned signal analyzer makes zero span measurements. The input analog signal is converted to a digital signal, which then is processed into a representation of a waveform measurement. The measurement relies on a high rate of sampling to create an accurate representation of a time domain signal.

## Spurious Emissions Measurement Concepts

### Purpose

Spurious signals can be caused by different combinations of signals in the transmitter. The spurious emissions from the transmitter should be minimized to guarantee minimum interference with other frequency channels in the system. Harmonics are distortion products caused by nonlinear behavior in the transmitter. They are integer multiples of the transmitted signal carrier frequency.

This measurement verifies the frequency ranges of interest are free of interference by measuring the spurious signals specified by the user defined range table.

### Measurement Method

Table-driven measurement has the flexibility to set up custom parameters such as frequency, span, resolution bandwidth, and video bandwidth. Up to the top 40 spurs can be viewed.

For each range that you specify and activate, the analyzer scans the band using the specified Range Table settings. Then using the Peak Excursion and Peak Threshold values, determines which spurs to report.

As each band is swept, any signal which is above the Peak Threshold value and has a peak excursion of greater than the Peak Excursion value will be added to a list of spurs displayed in the lower results window. A total of 200 spurs can be recorded for one measurement, with a limit of 10 spurs per frequency range. To improve repeatability, you can increase the number of averages.

From the spurs in the list, those with peak amplitude greater than the Absolute Limit for that range will be logged as a measurement failure and denoted by an 'F' in the 'Amplitude' column of the table. If no spurs are reported, but the measured trace exceeds the limit line for any range, the fail flag is set to fail.

This measurement has the ability to display two traces using different detectors on the display simultaneously. All spur detection and limit line testing are only applied to the trace associated with Detector 1, which will be colored yellow. The trace associated with Detector 2 will be colored cyan.

If the sweep time for the range exceeds 2 seconds, a flashing message "Sweeping...Please Wait" will appear in the annunciator area. This advises you that the time to complete the sweep is between 2 and 2000 seconds, and is used as without it the display would appear stagnant and you may think the measurement is not functional.

## Spectrum Emission Mask Measurement Concepts

### Purpose

The Spectrum Emission Mask measurement includes the in-band and out-of-band spurious emissions. It is the power contained in a specified frequency bandwidth at certain offsets relative to the total carrier power. It may also be expressed as a ratio of power spectral densities between the carrier and the specified offset frequency band.

This spectrum emission mask measurement is a composite measurement of out-of-channel emissions, combining both in-band and out-of-band specifications. It provides useful figures-of-merit for the spectral regrowth and emissions produced by components and circuit blocks, without the rigor of performing a full spectrum emissions mask measurement.

### Measurement Method

The spectrum emission mask measurement measures spurious signal levels in up to 12 pairs of offset/region frequencies and relates them to the carrier power.

The integration bandwidth method is used to perform a data acquisition. The reference channel integration bandwidth (Meas BW) is analyzed using the user defined resolution bandwidth (Res BW), which is much narrower than the channel bandwidth. The measurement computes an average power of the channel or offset/region over a specified number of data acquisitions, automatically compensating for resolution bandwidth and noise bandwidth.

This measurement requires the user to specify the measurement bandwidths of carrier channel and each of the offset/region frequency pairs up to 12 (A - L). Each pair may be defined with unique measurement bandwidths. The results are displayed both as relative power in dBc, and as absolute power in dBm.

## Occupied Bandwidth Measurement Concepts

### Purpose

Occupied bandwidth measures the bandwidth containing 99.0% of the total transmission power.

The spectrum shape of a signal can give useful qualitative insight into transmitter operation. Any distortion to the spectrum shape can indicate problems in transmitter performance.

### Measurement Method

The instrument uses digital signal processing (DSP) to sample the input signal and convert it to the frequency domain. With the instrument tuned to a fixed center frequency, samples are digitized at a high rate with DSP hardware, and then converted to the frequency domain with FFT software.

The total absolute power within the measurement frequency span is integrated for its 100% of power. The lower and upper frequencies containing 0.5% each of the total power are then calculated to get 99.0% bandwidth.



## Burst Power Measurement Concepts

### Purpose

Burst Power (Transmit Power) is the measure of in-channel power for digital communication systems. Mobile stations and base transceiver stations must transmit enough power, with sufficient modulation accuracy, to maintain a call of acceptable quality without leaking into frequency channels or timeslots allocated for others. Dynamic power control is used to ensure that each link is maintained with minimum power. This gives two fundamental benefits: overall system interference is kept to a minimum and, in the case of mobile stations, battery life is maximized.

The Burst (Transmit) Power measurement determines the average power for an RF signal burst at or above a specified threshold value. The threshold value may be absolute, or relative to the peak value of the signal.

At the base transceiver station, the purpose of the Transmit Power measurement is to determine the power delivered to the antenna system on the radio-frequency channel under test. The Transmit Power measurement verifies the accuracy of the mean transmitted RF carrier power. This can be done across the frequency range and at each power step.

### Measurement Method

This analyzer acquires a signal in the time domain with the IQ data capture method. The average power level above the threshold, or measured burst width, is then computed and displayed.

This measurement can use either of two calculation methods - the "Above Threshold" or the "Measured Burst Width" methods. The power-above-threshold method has the advantages of being faster and allows power measurements to be made at somewhat lower power levels. It also has the advantage of not requiring the carrier to have a valid TSC (Training Sequence Code).

#### **Above Threshold Method**

This method uses the "power-above-threshold" method instead of the "useful part of the burst" method defined in the GSM standards. A time record is captured, then the analyzer averages only those points in the time record that exceed the user-specified threshold level. No attempt is made to position the burst, or to calculate and display burst widths. You can use this to measure continuous signals, or burst signals where the Measured Burst Width method is too restrictive. Note that this measurement does not provide a way to specify which timeslot is to be measured. Therefore if multiple timeslots are on, they should all be set at the same power level, or the levels of those timeslots to be excluded need to be kept below the threshold level. If you want to measure

Transmit Carrier Power using the GSM-specified useful part of the burst method, use the Power vs. Time or EDGE Power vs. Time measurements, which also measure the power ramping of the burst.

### **Measured Burst Width**

This method uses the threshold level to calculate the burst center and averages those points that lie within a user-specified burst width that is centered upon the burst. When Burst Width Mode is set to manual you may enter a fixed-time value in seconds or specify the burst width as a percentage of the last measured burst width (the result is in bottom-left corner of display). If you specify the burst width as a percentage, the fixed-value time is instantaneously calculated and displayed in the softkey.

### **For Both Methods**

The analyzer attenuator is automatically set to the optimum value based on the measured carrier power level, to get the best dynamic range when restarted, if Pre-Adjust for Min Clip (in AMPTD Y Scale menu) is set to any other setting than Off.

Max/Min Hold Traces exist only as a visible reference, they do not affect the measurement results. Measurement results are calculated by the latest acquired data and Measure Trace. Max/Min Hold Traces are held during the averaging cycle.

## Channel Power Measurement Concepts

### Purpose

The Channel Power measurement is a common test used in the wireless industry to measure the total transmitted power of a radio within a defined frequency channel. This procedure measures the total power within the defined bandwidth. This measurement is applied to design, characterize, evaluate, and verify transmitters and their components or devices.

### Measurement Method

The Channel Power measurement reports the total transmitted power and the calculated power spectral density within the integration bandwidth. It takes a sweep and the measurement acquires power in the channel.

The power calculation method used to determine the channel power is a traditional method known as the integration bandwidth (IBW) method. The measurement uses the frequency sweep mode, the RBW filter is set narrow relative to the desired integration bandwidth. You can change the RBW and VBW settings. It is important to correctly set the RBW before making this measurement, because if the RBW filter setting is too narrow the signal will be under-sampled and not all of the signal power will be measured. If the setting is too wide, it will reduce the accuracy of the Channel Power measurement.

To improve repeatability, you can increase the number of averages. The channel power graph is shown in the graph window, while the absolute channel power in dBm and the mean power spectral density in dBm/Hz are shown in the text window.

## Adjacent Channel Power (ACP) Measurement Concepts

### Purpose

Adjacent Channel Power (ACP), is the power contained in a specified frequency channel bandwidth relative to the total carrier power. It may also be expressed as a ratio of power spectral densities between the carrier and the specified offset frequency band.

As a composite measurement of out-of-channel emissions, ACP combines both in-band and out-of-band specifications to provide useful figures-of-merit for spectral regrowth and emissions produced by components and circuit blocks without the rigor of performing a full spectrum emissions mask measurement.

To maintain a quality call by avoiding channel interference, it is important to measure and reduce any adjacent channel leakage power transmitted from a mobile phone. The characteristics of adjacent channel leakage power are mainly determined by the transmitter design, particularly the low-pass filter.

### Measurement Method

This ACP measurement analyzes the total power levels within the defined carrier bandwidth and at given frequency offsets on both sides of the carrier frequency. This measurement requires the user to specify measurement bandwidths of the carrier channel and each of the offset frequency pairs. Each pair may be defined with unique measurement bandwidths.

For Meas Method of RBW, it uses an appropriate RBW and capture all of the power in the carrier channel and the offsets. For Meas Method of integration bandwidth (IBW), the channel integration bandwidth is analyzed using the user defined resolution bandwidth (RBW), which is much narrower than the channel bandwidth. The measurement computes an average power of the channel over a specified number of data acquisitions, automatically compensating for resolution bandwidth and noise bandwidth.

If **Total Pwr Ref** is selected as the measurement type, the results are displayed as relative power in dBc and as absolute power in dBm. If **PSD Ref** (Power Spectral Density Reference) is selected, the results are displayed as relative power in dB, and as absolute power in dBm/Hz.

## Power Statistics CCDF Measurement Concepts

### Purpose

Many of the digitally modulated signals appear noise-like in the time and frequency domain. This means that statistical measurements of the signals can be a useful characterization. Power Complementary Cumulative Distribution Function (CCDF) curves characterize the higher-level power statistics of a digitally-modulated signal. The curves can be useful in determining design parameters for digital communications systems.

The power statistics CCDF measurement can be affected by many factors. For example, modulation filtering, modulation format, combining the multiple signals at different frequencies, number of active codes and correlation between symbols on different codes with spread spectrum systems. These factors are all related to modulation and signal parameters. External factors such as signal compression and expansion by non-linear components, group delay distortion from filtering, and power control within the observation interval also affect the measurement.

CCDF curves can help you in several situations:

- To determine the headroom required when designing a component.
- To confirm the power statistics of a given signal or stimulus. CCDF curves allow you to verify if the stimulus signal provided by another design team is adequate. For example, RF designers can use CCDF curves to verify that the signal provided by the digital signal processing (DSP) section is realistic.
- To confirm that a component design is adequate or to troubleshoot your subsystem or system design, you can make CCDF measurements at several points of a system. For example, if the ACLR of a transmitter is too high, you can make CCDF measurements at the input and output of the PA. If the PA design is correct, the curves will coincide. If the PA compresses the signal, the PAR of the signal is lower at the output of the PA.

### Measurement Method

The power measured in power statistics CCDF curves is actually instantaneous envelope power defined by the equation:

$$P = (I^2 + Q^2)/Z_0$$

(where I and Q are the quadrature voltage components of the waveform and  $Z_0$  is the characteristic impedance).

A CCDF curve is defined by how much time the waveform spends at or above a given power level. The percent of time the signal spends at or above the level defines the probability for that particular power level. To make the power statistics CCDF measurement, the instrument uses digital signal processing (DSP) to sample the input signal in the channel bandwidth.

## Concepts

### Power Statistics CCDF Measurement Concepts

The Gaussian distribution line as the band-limited Gaussian noise CCDF reference line, the user-definable reference trace, and the currently measured trace can be displayed on a semi-log graph. If the currently measured trace is above the user reference trace, it means that the higher peak power levels against the average power are included in the input signal.

## TOI Measurement Concepts

### Purpose

Two-tone, third-order intermodulation distortion is a common test in communication systems. When two signals are present in a non-linear system, they can interact and create third-order intermodulation distortion products that are located close to the original signals. These distortion products are generated by system components such as amplifiers and mixers.

TOI Measurement provides a one-button measurement of the third-order intercept of a two-tone signal. If the base tones are separated by a frequency  $Df$ , the third order intermodulation products will appear as signals  $Df$  above the higher tone, and  $Df$  below the lower tone. As the amplitude of the two-tone signal increases, the amplitude of the third-order intermodulation products increases at three times the rate.

Third-order intercept (TOI) is a calculated value which estimates the output amplitude in the theoretical case in which the third-order intermodulation amplitude increases to equal to the base tone amplitude. A practical device will never reach that power; nonetheless the TOI has become a useful figure of merit for comparing the linearity of practical devices.

### Measurement Method

The TOI measurement begins by taking a sweep using the current center frequency and span. It chooses the two highest peaks as the lower and upper tone frequencies,  $F_{Lower}$  and  $F_{Upper}$ . Then, the third-order intermodulation frequencies are computed as:

$$f_{Lower} = 2F_{Lower} - F_{Upper}$$

$$f_{Upper} = 2F_{Upper} - F_{Lower}$$

The power is then measured at the four frequencies (unless either intermod frequency falls outside the span).

The third order intercept level is defined (all values expressed in dBm) as:

$$TOI_{Lower} = \frac{P_{Upper}}{2} + P_{Lower} - \frac{P_{LowerIntermod}}{2}$$

$$TOI_{Upper} = \frac{P_{Lower}}{2} + P_{Upper} - \frac{P_{UpperIntermod}}{2}$$

The third order delta level is defined (all values expressed in dBm) as:

$$\Delta_{Lower} = P_{LowerIntermod} - \frac{2 \times P_{Lower} + P_{Upper}}{3}$$

$$\Delta_{Upper} = P_{UpperIntermod} - \frac{2 \times P_{Upper} + P_{Lower}}{3}$$

Both values are computed and the TOI is reported as the worst of the two measurements.

There are two approaches to TOI measurement acquisition. The first approach is a simple method to use a single sweep. This method gives the quickest approximate measurement and highest usability. (The span must be sufficient to encompass both the lower and upper intermod frequencies.)

The second approach is to supplement the above with zero-span acquisitions (typically with a lower resolution bandwidth) at the intermod frequencies. Because we spend the majority of our acquisition time at key frequencies, this technique gives more accurate measurement of low-power intermodulation distortion signals.



## Harmonics Measurement Concepts

### Purpose

The Harmonics Measurement provides a simple (one-button) measurement of the harmonics of a specified carrier frequency.

At each cycle, the instrument will do a zero-span measurement at the fundamental and at each harmonic frequency. With that information, it will calculate and report each harmonic in dBc, and will also calculate and report the total harmonic distortion.

In most use cases, this approach is sufficient. In cases where a specialized harmonic measurement is required, such as measuring the harmonics of a baseband amplifier when looking at the carrier signal, the user may separately specify the parameters of each harmonic measurement.

### Measurement Method

<b>First Sweep</b>	The first sweep of the harmonics measurement is used to find the fundamental frequency and bandwidth.
<b>First Sweep Initiation</b>	<p>The first sweep is not used when the <b>Range Table</b> is turned on, or when all parameters are in Manual mode. It is only used when at least one of the following parameters is in Sense mode:</p> <ul style="list-style-type: none"><li>– Fundamental frequency</li><li>– Resolution Bandwidth</li></ul> <p>If one of the above parameters is in Sense, the first sweep occurs when any of the following happen:</p> <ul style="list-style-type: none"><li>– First enter the measurement</li><li>– After a preset</li><li>– When a parameter change causes a measurement restart in continuous sweep mode</li><li>– When the user initiates a sweep.</li></ul>
<b>First Sweep Action</b>	<p>If Fundamental Frequency is set to Sense, the first sweep sets the fundamental frequency to the largest amplitude signal between 10 MHz and half the bandwidth of the spectrum analyzer. Use span zoom (or frequency count) to give a good measurement of the fundamental frequency.</p> <p>If Resolution Bandwidth is set to Sense, the first sweep sets the resolution bandwidth to the lowest available Resolution Bandwidth greater than the 3.5 times the 99% occupied bandwidth of the signal, to a minimum of 30 Hz. By</p>

Concepts  
Harmonics Measurement Concepts

default, the video bandwidth and sweep time are coupled to those parameters. Also by default, all harmonic parameters are coupled to the fundamental parameters.

Note that, even though the automatic RBW is limited to a minimum of 30 Hz, the actual value measured should be retained. When multiplying the RBW for the 2nd and subsequent harmonics, use the maximum of the calculated value and 30 Hz.

For example, assume that the occupied bandwidth calculation results in desired RBW of 12 Hz. The fundamental RBW will use 30 Hz, the second harmonic RBW will use 30 Hz. If the calculated RBW for the third and subsequent harmonics exceeds 30 Hz, the calculated value should be used when measuring those harmonics.

In the typical case, the measured signals are all multiples of the fundamental, using a resolution bandwidth that is a multiple of the fundamental resolution bandwidth. For maximum speed and accuracy, all harmonics measurements are done at zero span. To customize the measurement of individual harmonics, set the **Range Table** to On, and adjust the details in the table.

## List Sweep Measurement Concepts

### Purpose

List Sweep is an independent measurement in the Spectrum Analyzer Mode.

This measurement is only available remotely. It is designed for a single purpose: measurement throughput. It provides a fast way for users to remotely extract amplitude values for multiple detectors at known frequencies.

List Sweep allows the programmer to configure the analyzer to make a list of single-point measurements. By making the list in advance, the analyzer can run through the list without requiring the measurements to be set up again for each iteration. This reduces the overhead of turning around the I/O and excess I/O traffic. The measurements are all performed in zero-span.

This feature is directed at customers who must constantly find ways to reduce the cost of test in volume manufacturing. High throughput testing dictates that speed takes precedent priority over user-friendliness in the design consideration. The number of error messages, complexity of SCPI commands, and coupling among various components must be kept at a minimum. Assumption is that the users are experts and they strictly follow the guidelines given in the User's and Programmer's Reference.



This information is subject to change without notice.

© Keysight Technologies 2015-2016

Edition 1, February 2016

N9060-90037

[www.keysight.com](http://www.keysight.com)