

Digital Video Broadcasting (DVB) Satellite Communication Analysis

PathWave Vector Signal Analysis (89600 VSA)

Option 89601DVBC

- Navigate complex DVB-S2 and DVB-S2X signals with ease using comprehensive demodulation analysis
- Utilize a wide range of quality metrics for DVB-S2 / S2X signals, including frame-level results, EVM results for individual frame segments (SOF, PLSCODE, Pilot and Data), constellation diagrams, and frequency, symbol clock, magnitude and phase errors etc.
- Enhance link level system analysis precision with Bit Error Rate (BER) metrics supported by full de-framing and channel decoding
- Efficiently analyze multiple carriers at once, each configured independently
- Improve signal integrity assessment with cross-correlated EVM analysis across multiple channels

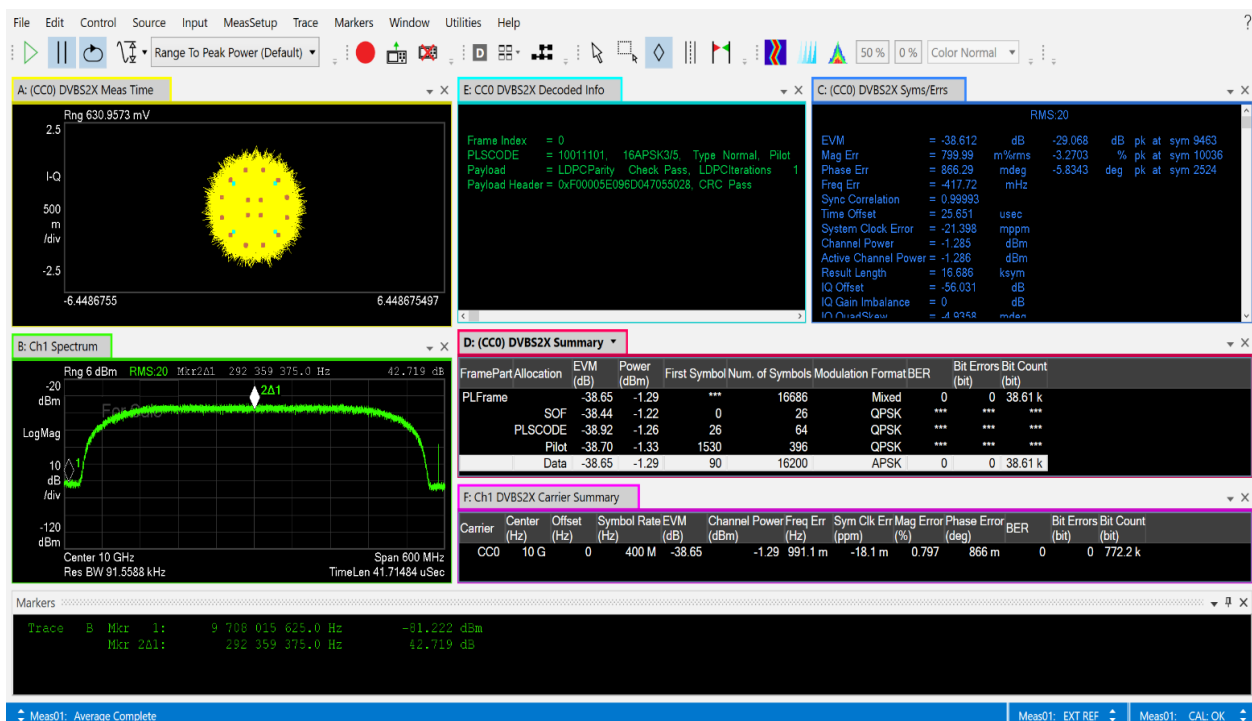

Table of Contents

DVB-S2 / S2X SatComm Modulation Analysis	3
Analysis and Troubleshooting	4
Effortless Setup with Comprehensive Parameter Control	5
Testing Beyond EVM with BER.....	6
Software Features.....	10
Ordering Information	15
Additional Resources	16

DVB-S2 / S2X SatComm Modulation Analysis

The 89600 VSA software's DVB SatComm (Satellite Communication) measurement extension, 89601DVBC, provides a comprehensive array of analysis capabilities in frequency, time, and modulation domains for DVB-S2 and DVB-S2X signals based on ETSI EN 300 307 specification (www.etsi.org). DVB-S2 / S2X is one of over 75 signal standards and modulation types supported by the 89600 VSA software, a comprehensive set of tools for demodulation and vector signal analysis. These tools enable you to explore virtually every facet of a signal and optimize even the most advanced designs. As you assess and focus on your design tradeoffs, the 89600 VSA helps you cut through the complexity.

The software delivers simultaneous frequency, time, and modulation-domain analysis results within a single measurement. By configuring result traces for spectrum, acquisition time, and DVB-S2 / S2X specific modulation quality traces and tables, engineers can easily identify signal characteristics and troubleshoot issues such as intermittent errors or recurring synchronization failures.

To streamline automated testing, .NET API and SCPI remote interfaces are available to accelerate design processes, enabling a smoother transition to design verification and manufacturing phases.

Analysis and Troubleshooting

Perform DVB-S2 / S2X transmitter measurements

89601DVBC supports DVB-S2 / S2X modulation analysis measurements according to ETSI EN 302 307-1 (DVB-S2) and 302 307-2 (DVB-S2X) specifications. Supported features include:

- Comprehensive PLFrame signal analysis for each frame part: SOF, PLSCODE, Pilot, and Data
- Compatibility with all standard-defined MODCOD formats, encompassing a combination of code rate and modulation from QPSK, Pi / 2-BPSK, 8PQSK, 16 / 32 / 64 / 128 / 256 APSK
- Options for standard-defined roll-off factors from 0.05 to 0.35 or customized roll-off factors

DVB-S2X – PHY Layer Framing

FOR BOTH DVB-S2 AND DVB-S2X

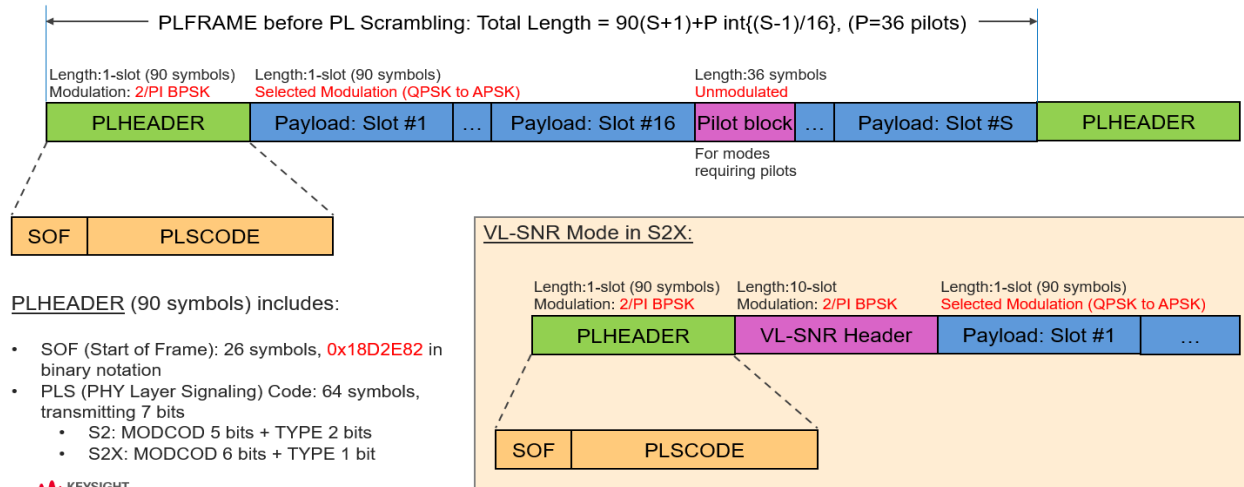

Figure 1. With the 89600 VSA software, you can analyze the entire frame of DVB-S2 / S2X signals

Effortless Setup with Comprehensive Parameter Control

Configure your VSA effortlessly using the intuitive graphical user interface (GUI). This measurement provides a fully DVB-S2 / S2X standard-based representation of the VSA measurement setup, with each Demod Properties menu item corresponding to a set of related parameters.

The Dynamic Help feature allows for easy access to help text, enabling an understanding of the DVB-S2 / S2X format and the features available for option 89601DVBC. Detaching and repositioning the Dynamic Help window, as shown in Figure 2, enables easier viewing as it adjusts to your menu choices. You can also lock it to stay fixed on important Help data topics.

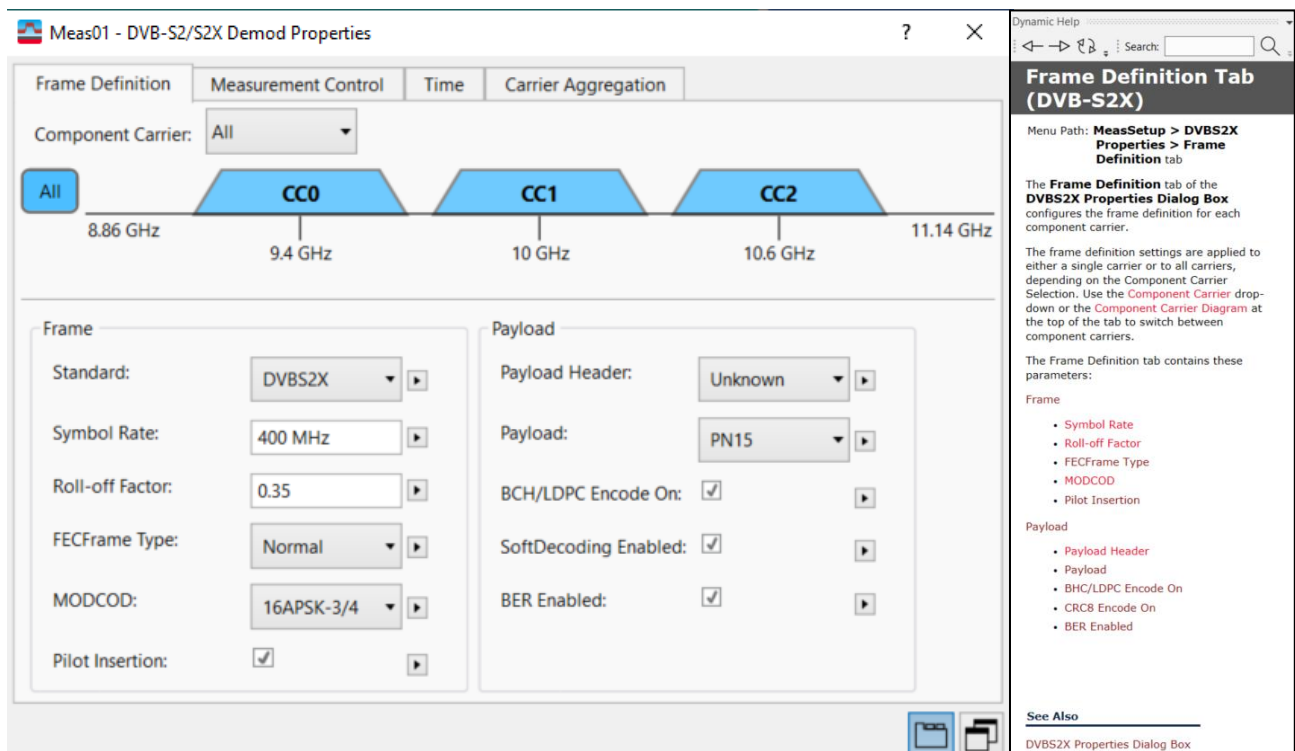

Figure 2. Setup is simplified with comprehensive parameter control. Dynamic Help provides essential information explaining measurements and other important DVB-S2 / S2X and 89600 VSA software operations.

Testing Beyond EVM with BER

In addition to the conventional demodulation analysis results like EVM, the DVB-S2 / S2 measurement extension also provides Bit Error Rate (BER) results. This allows users to verify the accuracy of the transmitted signal's CRC and payload decoding. However, we must consider where in the functional block diagram we are wishing to compare measured versus expected bits. The following figure shows the functional block diagram of a DVB-S2 system (taken from the ETSI standard).

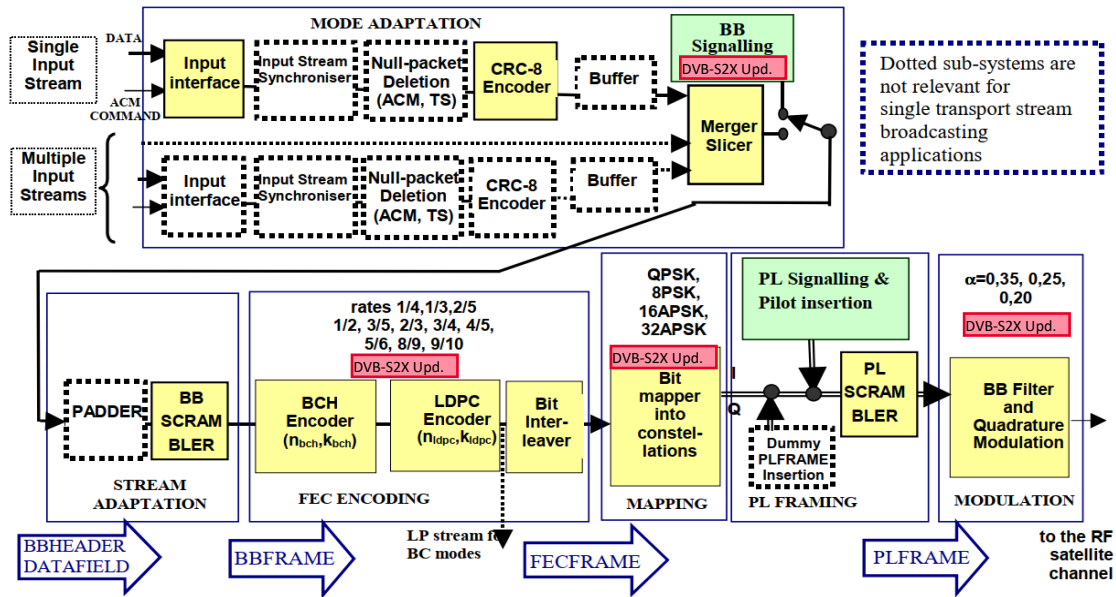

Figure 3. Functional block diagram of the DVB-S2 Tx System

Now, if we invert the functions of the transmitter to the receiver, we obtain the following block diagram, shown in Figure 4.

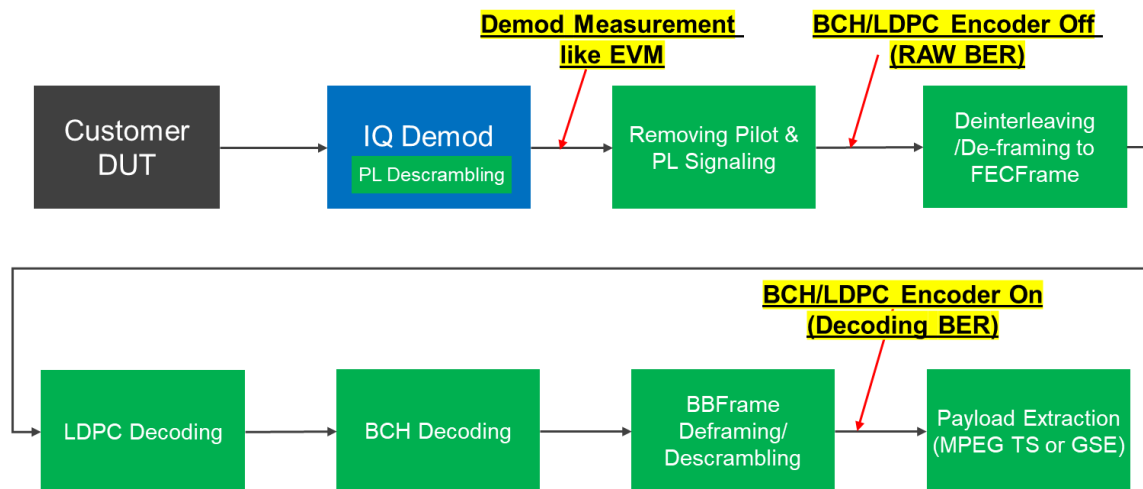

Figure 4. DVB-S2 / S2X Demodulation and Decoding Diagram

The software supports BER measurements with BCH / LDPC encoder either on or off.

- When the BCH / LDPC encoder is off, it measures the raw BER without BCH / LDPC decoding at the FECFRAME reference plane.
- When the BCH / LDPC encoder is on, it measures the payload after BCH / LDPC decoding at the BBFRAME reference plane.

To make a BER measurement, users must specify the data payload type – include PN sequences (PN9, PN11, PN15, PN20, PN23), or fixed patterns (All Ones, All Zeros, or user-defined bit sequence). This user-defined sequence can be imported from a .txt file, the digital data of which may be delimited by None, Comma, Tab or Newline. Figure 5 below shows how you can access the 'Decoded Info' in Trace E, alongside Trace C, D and E's BER, Bit Errors, and Bit Count information for the overall frame, frame segments and component carriers.

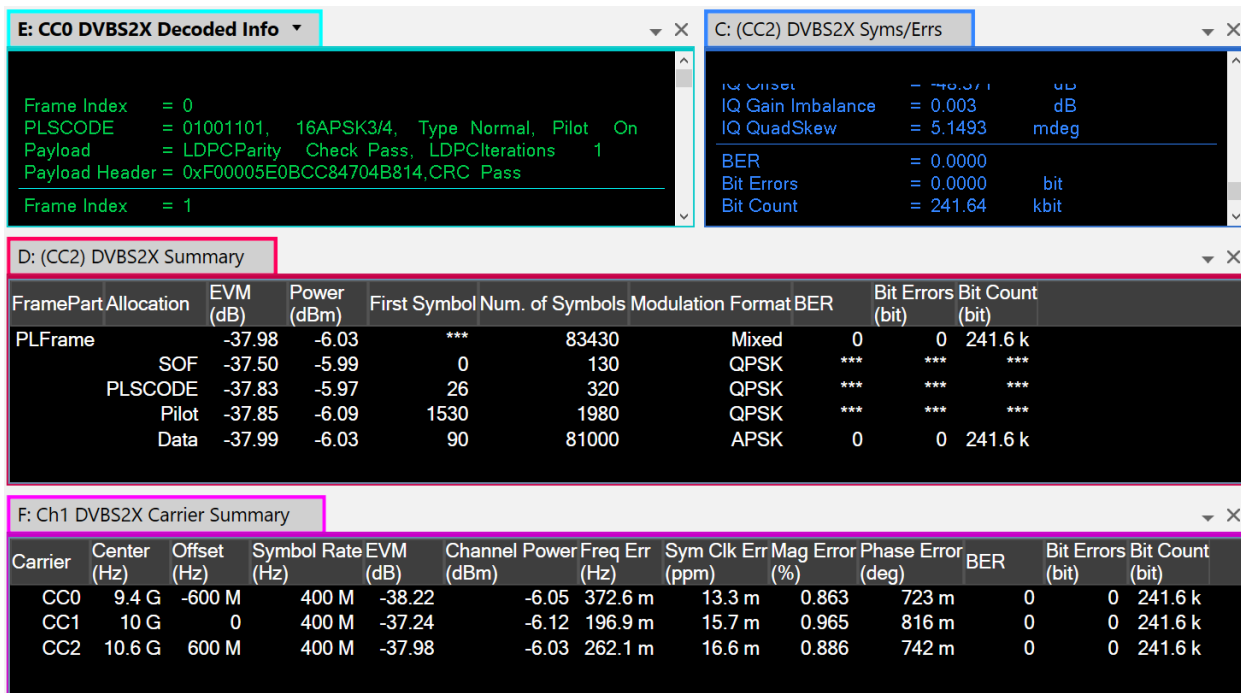

Figure 5. VSA's DVB-S2 / S2X Decoded Info, and BER results showing in Syms / Err, Summary and Carrier Summary

Understanding DVB-S2 / S2X signal quality

Thanks to the VSA's great documentation, signal analysis configuration and trace types, you may learn about the structure and quality of the transmitted DVB-S2 / S2X signal. You have full autonomy and complete flexibility to choose the trace format and the number of concurrent traces. Figure 6 shows a downlink DVB-S2X signal example. The different traces provide a comprehensive view of the signal, and many more views are possible.

Description of some of the digital demodulation traces

- Trace A (top left, labeled “Meas Time”) shows a composite IQ constellation of the demodulated signal containing 16APSK
- Trace B (bottom left, labeled as “Spectrum”) displays the spectrum of 3 component carriers, each with 400 MHz bandwidth
- Trace E (top center, labeled as “Decoded Info”) presents the decoded results for each frame, including Frame Index, PLSCODE, Mod Format, Type, Pilot On / Off, Payload LDPC Parity, Payload Header and CRC Pass / Fail
- Trace C (top right, labeled as “Syms / Err”) shows the demodulation results for the specified carrier, featuring EVM, Mag Err, Phase Err, Freq Err, Channel Power, IQ Offset, IQ Gain, IQ Skew, and BER results
- Trace D (bottom center, labeled “ Summary”) shows the whole frame result for each segment (including SOF, PLSCODE, Pilot and Data) and results with EVM, Power, First Symbol, Num of Symbols, Modulation Format, and BER results
- Trace F (bottom right, labeled “Carrier Summary”) presents the results for all configured carriers, including Carrier#, Center, Offset, Symbol Rate, EVM, Channel Power, Freq Err, Sym Clock Error, Mag Error, Phase Error, and BER results

Note: To display BER results, you must specify the payload type and enable the BER setting.

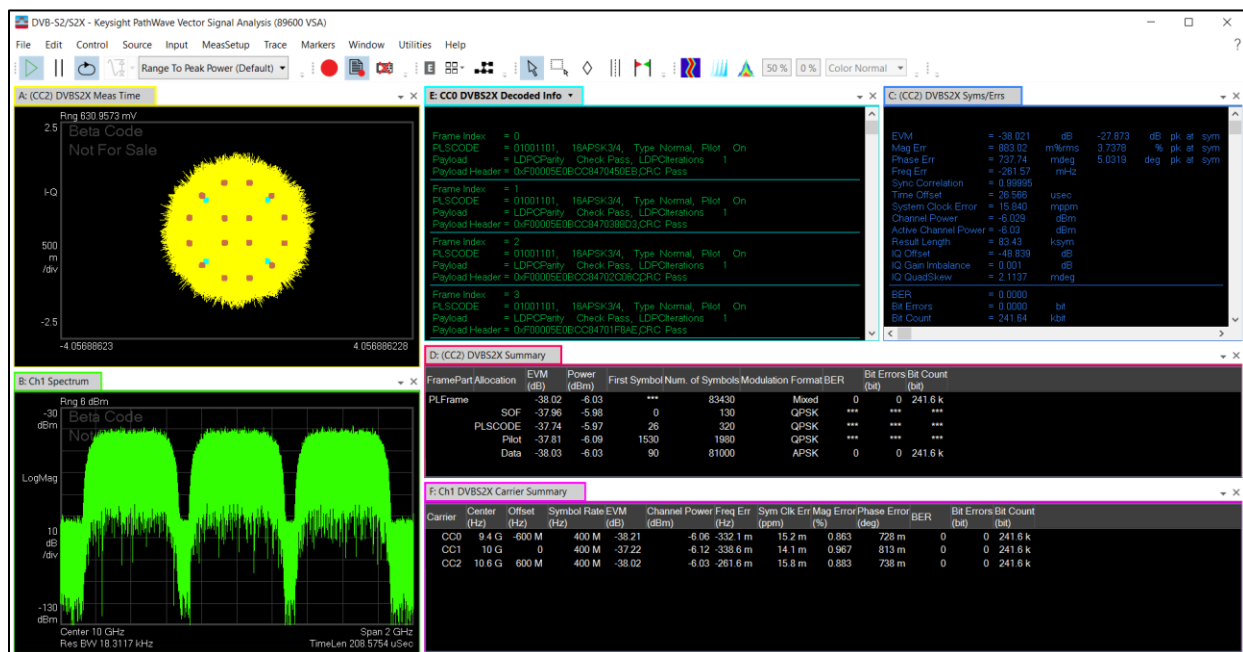

Figure 6. Example analysis of a DVB-S2X signal, at 10 center frequency, with 3 Carrier each with 400 MHz

Cross-Correlated EVM

Cross-Correlated EVM (ccEVM) is a technique used to extend the dynamic range of a receiver for optimal EVM performance. This method involves two receivers capturing and demodulation the same signal simultaneously. The software performs a cross-correlation calculation on the error vectors to cancel out any uncorrelated noise added by the receivers, resulting in an EVM measurement of significantly higher fidelity. Consequently, the resulting ccEVM measurement primarily consists of the noise and distortion effects from the device under test (DUT). In the case of an amplifier measurement, the ccEVM would represent the noise at the input of the amplifier plus the DUT noise and distortion effects. Note that this feature within 89601DVBC requires the 89601EVMC (EVM measurement fidelity) option.

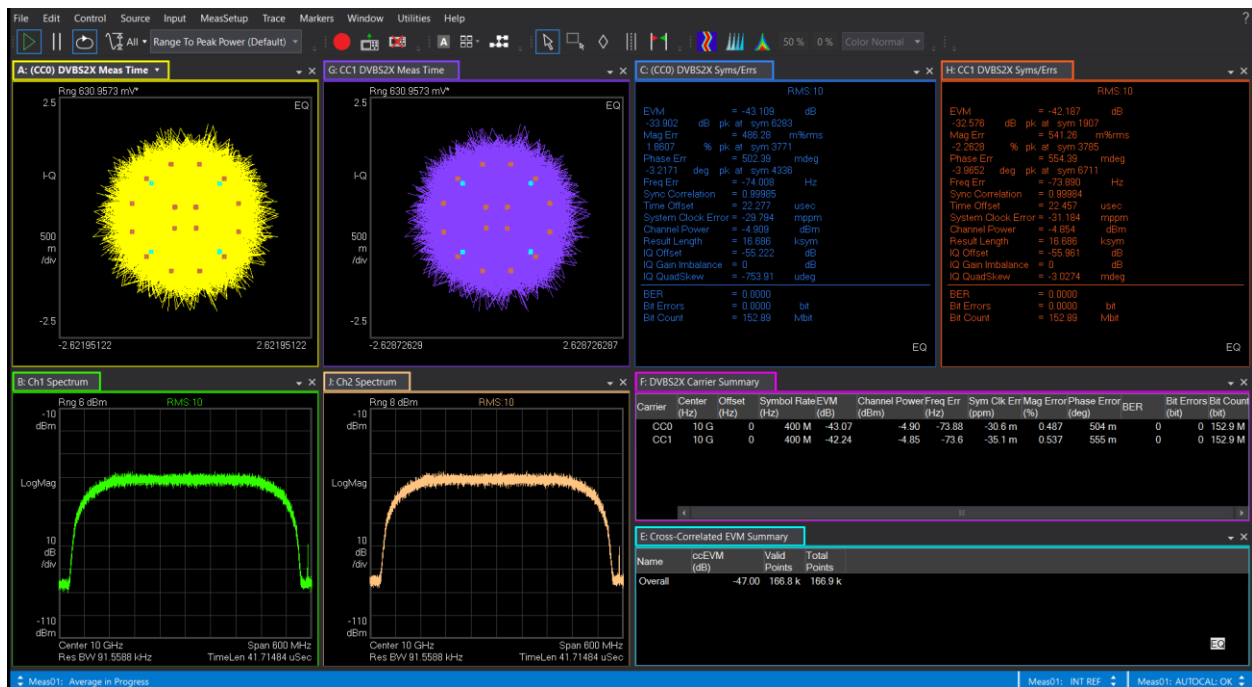

Figure 7. Cross-correlated EVM (Trace E) compared with EVM of individual receiver (Traces C, H and F). In this example, the output of a signal generator is split and looped back to two receivers. The resulting ccEVM shows a 4~5 dB EVM improvement with a 400 MHz, 256APSK DVB-S2X signal.

Software Features

Supported signal configuration

Feature	Description
Standard	ETSI EN 302 307-1 (March 2005) ETSI EN 302 307-2 v1.3.1 (April 2021)
Frame definition	
Component Carriers (CC)	CC0 for single CC. More may be added as CC1, CC2, etc. for multi-carrier case. Frame definition settings may be applied uniquely for each CC or uniformly across all CC's.
Standard	DVB-S2, DVB-S2X
Symbol Rate	20 MHz as default, or manual input
Roll-off Factor	Describing the transition band of a Root-Raised-Cosine (RRC) filter, this parameter may range from 0.05 to 0.35 as per standard or be user-defined.
FEC Frame Type	Normal, Short, or Medium Note: short means FEC Frame size as 32,400 bits; Normal or Medium means FEC Frame size as 64,800 bits
MODCOD	Encapsulates the modulation type (like QPSK vs. APSK) and coding rate (i.e. 9 / 10 vs. 1 / 4) as a single parameter, defined in Table 17a of ETSI EN 302 307-2 v1.2.1
Pilot Insertion	Allows the system to enable or disable the insertion of pilot data symbols typically used for channel estimation and synchronization. Possible values are On or Off
Payload Header	Typically providing information such as payload size, type, encoding and error correction, the VSA offers two options: Unknown and None.
Payload	Specifies the data sequence of the payload. The choices range from specific binary patterns like AllOnes or AllZeros, to pseudorandom sequences (PN9, PN11, PN15, PN20, PN23), or a custom sequence defined by the user. "Unknown" is used if the payload sequence is not known and must be determined by the receiver. Note: You can import the payload data using None-, Comma-, Tab- or Newline-delimited text data. You can also export the bit sequence in the custom Payload data field to a .txt file for later reuse. In the drop-down, select the type of delimiter to insert between data bits as None, Comma, Tab or Newline.
BCH / LDPC Encoder	BCH (Bose-Chaudhuri-Hocquenghem) and LDPC (Low-Density Parity-Check) error-correcting codes add redundancy to the data, allowing the receiver to detect and correct a certain number of errors. This parameter enables or disables the error correction coding to be applied to the payload data before transmission.
Soft Decision Decoding Enabled	Enables or disables a probabilistic approach to determine whether a received symbol represents a "0" or "1", considering the precise signal strength and noise level at the receiver.
BER Enabled	Enables or disables the calculation of Bit Error Ratio (BER), Bit Errors and Bit Count based on the payload data only.

Feature	Description
Measurement Control	
Component Carrier	Select which component carrier the measurement control parameters should be applied. The choices are All, CC0, (and CC1, CC2, etc. if added)
Reference Bits Plane	In the calculation of EVM and BER, a reference signal must be calculated. The underlying data bits for the creation of this reference signal may be represented at different points in the block diagram. In reference to Figure 3, the choices are: "Measured at FECFrame", "Measured at BBHEADER / DATAFIELD" or "User supplied at BBHEADER / DATAFIELD"
Frequency Estimation Mode	The choices are "Normal" or "Off." "Normal" implies that the frequency error is estimated and compensated during the measurement interval. "Off" implies no frequency error estimation or compensation.
Compensate Symbol Clock Error	Enables or disables compensation for the measured symbol clock error.
Compensate IQ Offset	Enables or disables compensation for measured IQ offset.
Compensate IQ Gain Imbalance	Enables or disables compensation for measured IQ imbalance.
Use Multi-Carrier Filter	Enables or disables filtering of nearby, unwanted carrier signals, thereby minimizing leakage into the carrier of interest.
Show EVM in dB	Represent EVM measurements in dB or %rms (default)
Equalization Mode	2 Modes are available for channel frequency response equalization: <ul style="list-style-type: none"> • Least Mean Squares minimization between measured and reference signal. • Using the cross-correlation between the error vector and input data.
Channel Estimation Source	Configures which part(s) of the frame are used for channel estimation. In reference to Figure 1, the choices are None, Start of Frame (SOF), Pilots, SOF and Pilots, SOF, Pilots and Data.
Normalized Channel Delay Spread	This parameter sets the expected time difference, in units of symbols, between the arrival of the first and last components of a signal affected by multipath propagation. It is used to determine the length of the equalization filter applied to mitigate inter-symbol interference.
EQ Tracking	Controls how the equalization impulse response, which compensates for channel impairments, is updated across acquisitions (and by extension, time). The choices are Off, Track, Hold
Tracking Convergence	Only available when the Equalization Mode is set to XCorrelation, this controls the rate of convergence of the adaptive equalizer

Feature	Description
Time	
Component Carrier	Select which component carrier the Time parameters should be applied. The choices are All, CC0, (and CC1, CC2, etc. if added)
Frame Trigger On	When enabled, Frame Trigger improves synchronization in low SNR conditions and reduces measurement time based on a shorter capture length.
Frame Trigger Margin	When Frame Trigger is enabled, this parameter specifies the uncertainty range of the frame trigger relative to the real frame boundary as defined by the SOF.
Result Length (PLFrames)	Sets the number of Physical Layer Frames to be analyzed.
Carrier Aggregation	
Preset Measurement	Automatically configures the measurement configuration to typical values.
Reference Frequency	A frequency (in Hz) used as a basis for defining component carriers as an offset from this reference frequency.
Selected CC for Trace Display	Defines which component carrier shall be used for calculating carrier-specific trace data. Choices are CC0, (CC1, CC2, ...if configured with multiple carriers)
Cross-Correlated EVM	Enabled or disabled. Note that this requires an 89601EVMC license. A dialog window enables the user to duplicate the selected CC to CC0 and CC1, assigning input channels appropriately and turning on ccEVM.
Component Carrier Configuration	
Enabled	Selected or cleared
Absolute center	Copied from the Reference Frequency, in Hz
Offset	Defined relative to the reference frequency, in Hz
Symbol Rate	In Hz
Assigned Channels	Ch1 (default) for CC0

Supported measurements

Feature	Description
General statistics and frequency measurements	
CCDF	Displays the complementary cumulative distribution function (CCDF) for the selected input channel
CCDF summary	Summary data including average and peak power, power level at different percentages of the power, and total number of points accumulated.
CDF	Cumulative density function for the data in the measurement interval
Correction	Correction curve used to correct for the frequency response of the input hardware and input digital filtering
Instantaneous spectrum	Spectrum computed before data is averaged
PDF	Probability density function (PDF) of the signal
Raw main time	Raw time data read from the input hardware or playback file for the selected channel, prior to correction or resampling
Search time	Time record data after resampling and time adjustment, used to search for the pulse (or burst)
Spectrum	Frequency spectrum of the pre-demodulated Time trace data
Time	Time data of the signal that is to be demodulated
Demodulation results for DVB-S2 / S2X signals	
Ch frequency response	Shows the channel frequency response calculated from the reference signal
Decoded Info	For each Frame Index, shows decoded information such as PLSCODE, modulation type, Payload Header, CRC Pass / Fail, etc.
Eq impulse response	Shows the impulse response of the equalization filter for the component carrier
Error vector spectrum	Shows the spectrum of the Error Vector Time trace.
Error vector time	Shows the time-domain error vector trace data results. This trace contains the computed error vectors between corresponding symbol points in the I/Q measured and I/Q reference signals
Frame summary	For each Frame Part and Allocation, this table shows EVM (dB or %), Power (dBm), First Symbol, Number of Symbols, Modulation Format, BER, Bit Errors (bits), Bit Count (bits)
Inst error spectrum vector spectrum	Shows the instantaneous spectrum of the Error Vector Time trace.
Inst IQ Meas spectrum	Shows the instantaneous spectrum of the IQ Ref Time trace.
Inst IQ Ref spectrum	Shows instantaneous spectrum of the IQ Ref Time trace.
IQ Meas spectrum	Frequency spectrum of the IQ Meas Time
IQ Meas Time	Show measured IQ data in time domain
IQ Ref spectrum	Frequency spectrum of IQ Ref Time trace data
IQ Ref Time	Show reference IQ data in time domain
Mag Error	Provides the normalized error between measured I/Q signal magnitude vs. reference I/Q signal magnitude.

Feature	Description
Demodulation results for DVB-S2 / S2X signals	
Meas BER Bits	Shows the BER-Enabled measured bits in hexadecimal or binary format
Meas Decoded Bits	Shows the decoded bits in hexadecimal or binary format. The level of decoding depends on the "BCH / LDPC Encode On" control parameter
Phase error	Compares the unwrapped phase, point-by-point, between the I/Q measured signal with the unwrapped phase of the I/Q reference signal.
Syms / Errs	This summary table contains both error-related metrics (EVM, magnitude error, phase error and BER) and general signal characteristics (symbol rate, time offset, channel power and IQ offset). Synchronization information and the total amount of data analyzed are also provided.
Cross Channels	
Cross Correlation EVM Summary	Displays calculated cross-correlated EVM results when Cross-Correlated EVM Enable is selected (true) including ccEVM (dB), Valid Points, Total Points

Ordering Information

Software licensing and configuration

Flexible licensing and configuration

- **Perpetual:** License can be used in perpetuity.
- **Subscription:** License is time limited to a defined period, such as 12-months.
- **Node-locked:** Allows you to use the license on one specified instrument / computer.
- **Transportable:** Allows you to use the license on one instrument/computer at a time. This license may be transferred to another instrument/computer using Keysight's online tool.
- **Floating:** Allows you to access the license on networked instruments / computers from a server, one at a time. For concurrent access, multiple licenses may be purchased.
- **USB portable:** Allows you to move the license from one instrument / computer to another by end-user only with certified USB dongle, purchased separately.
- **Software support subscription:** Allows the license holder access to Keysight technical support and all software upgrades

Basic vector signal analysis and hardware connectivity (89601200C) (required) and Digital Video Broadcasting Modulation Analysis (89601DVBC)

Software license type	Software license	Support subscription
Node-locked perpetual	R-Y5A-001-A	R-Y6A-001-z ²
Node-locked subscription	R-Y4A-001-z ¹	Included
Transportable perpetual	R-Y5A-004-D	R-Y6A-004-z ²
Transportable subscription	R-Y4A-004-z ¹	Included
Floating perpetual (single site)	R-Y5A-002-B	R-Y6A-002-z ²
Floating subscription (single site)	R-Y4A-002-z ¹	Included
Floating perpetual (regional)	R-Y5A-006-F	R-Y6A-006-z ²
Floating subscription (regional)	R-Y4A-006-z ¹	Included
Floating perpetual (worldwide)	R-Y5A-010-J	R-Y6A-010-z ²
Floating subscription (worldwide)	R-Y4A-010-z ¹	Included
USB portable perpetual	R-Y5A-005-E	R-Y6A-005-z ²
USB portable subscription	R-Y4A-005-z ¹	Included

1. z means different subscription license duration. F for six months, L for 12 months, X for 24 months, and Y for 36 months. All subscription licenses have included the support subscription same as the subscription license duration.

2. z means different support subscription duration. L for 12 months (as default), X for 24 months, Y for 36 months, and Z for 60-months. Support subscription must be purchased for all perpetual licenses with 12-months as the default. All software upgrades and KeysightCare support are provided for software licenses with valid support subscription.

Hardware configuration

The 89600 VSA software supports more than 45 Keysight hardware platforms including signal analyzers, one-box-testers, and oscilloscopes. For a complete list of currently supported hardware, please visit: www.keysight.com/find/89600_hardware

Upgrade

- All 89600 VSA options can be added after your initial purchase and are license-key enabled.
- For more information, please refer to www.keysight.com/find/89600_upgrades

Additional Resources

Literature

Model-option	Description
5990-6553EN	PathWave Vector Signal Analysis (89600 VSA) Software - Brochure
5990-6386EN	PathWave Vector Signal Analysis (89600 VSA) Software - Configuration Guide
5992-4210EN	Option 89601200C Basic Vector Signal Analysis & Hardware Connectivity, 89600 VSA Software - Technical Overview

Web

- www.keysight.com/find/vsa
- www.keysight.com/find/89600_dvb
- www.keysight.com/find/vsa_trial
- www.keysight.com/find/89600_software

For more information on Keysight Technologies' products, applications, or services, please visit: www.keysight.com



This information is subject to change without notice. © Keysight Technologies, 2023, Published in USA, July 18, 2023, 3123-1507.EN