EPM Series Power Meters

N1913A EPM Series

N1914A EPM Series

Notices

Copyright Notice

© Keysight Technologies 2009–2023

No part of this manual may be reproduced in any form or by any means (including electronic storage and retrieval or translation into a foreign language) without prior agreement and written consent from Keysight Technologies as governed by United States and international copyright laws.

Manual Part Number

N1913-90008

Edition

Edition 18, March 27, 2023

Printed in:

Printed in Malaysia

Published by:

Keysight Technologies
Bayan Lepas Free Industrial Zone,
11900 Penang, Malaysia

Technology Licenses

The hardware and/or software described in this document are furnished under a license and may be used or copied only in accordance with the terms of such license.

Declaration of Conformity

Declarations of Conformity for this product and for other Keysight products may be downloaded from the Web. Go to <http://www.keysight.com/go/conformity>. You can then search by product number to find the latest Declaration of Conformity.

U.S. Government Rights

The Software is “commercial computer software,” as defined by Federal Acquisition Regulation (“FAR”) 2.101. Pursuant to FAR 12.212 and 27.405-3 and Department of Defense FAR Supplement (“DFARS”) 227.7202, the U.S. government acquires commercial computer software under the same terms by which the software is customarily provided to the public. Accordingly, Keysight provides the Software to U.S. government customers under its standard commercial license, which is embodied in its End User License Agreement (EULA), a copy of which can be found at <http://www.keysight.com/find/sweula>. The license set forth in the EULA represents the exclusive authority by which the U.S. government may use, modify, distribute, or disclose the Software. The EULA and the license set forth therein, does not require or permit, among other things, that Keysight: (1) Furnish technical information related to commercial computer software or commercial computer software documentation that is not customarily provided to the public; or (2) Relinquish to, or otherwise provide, the government rights in excess of these rights customarily provided to the public to use, modify, reproduce, release, perform, display, or disclose commercial computer software or commercial computer software documentation. No additional government requirements beyond those set forth in the EULA shall apply, except to the extent that those terms, rights, or licenses are explicitly required from all providers of commercial computer software pursuant to the FAR and the DFARS and are set forth specifically in writing elsewhere in the EULA. Keysight shall be under no obligation to update, revise or otherwise modify the Software. With respect to any technical data as defined by FAR 2.101, pursuant to FAR 12.211 and 27.404.2 and DFARS 227.7102, the U.S. government acquires no greater than Limited Rights as defined in FAR 27.401 or DFAR 227.7103-5 (c), as applicable in any technical data.

Warranty

THE MATERIAL CONTAINED IN THIS DOCUMENT IS PROVIDED “AS IS,” AND IS SUBJECT TO BEING CHANGED, WITHOUT NOTICE, IN FUTURE EDITIONS. FURTHER, TO THE MAXIMUM EXTENT PERMITTED BY APPLICABLE LAW, KEYSIGHT DISCLAIMS ALL WARRANTIES, EITHER EXPRESS OR IMPLIED, WITH REGARD TO THIS MANUAL AND ANY INFORMATION CONTAINED HEREIN, INCLUDING BUT NOT LIMITED TO THE IMPLIED WARRANTIES OF MERCHANTABILITY AND FITNESS FOR A PARTICULAR PURPOSE. KEYSIGHT SHALL NOT BE LIABLE FOR ERRORS OR FOR INCIDENTAL OR CONSEQUENTIAL DAMAGES IN CONNECTION WITH THE FURNISHING, USE, OR PERFORMANCE OF THIS DOCUMENT OR OF ANY INFORMATION CONTAINED HEREIN. SHOULD KEYSIGHT AND THE USER HAVE A SEPARATE WRITTEN AGREEMENT WITH WARRANTY TERMS COVERING THE MATERIAL IN THIS DOCUMENT THAT CONFLICT WITH THESE TERMS, THE WARRANTY TERMS IN THE SEPARATE AGREEMENT SHALL CONTROL.

Safety Information

CAUTION

A CAUTION notice denotes a hazard. It calls attention to an operating procedure, practice, or the like that, if not correctly performed or adhered to, could result in damage to the product or loss of important data. Do not proceed beyond a CAUTION notice until the indicated conditions are fully understood and met.

WARNING

A WARNING notice denotes a hazard. It calls attention to an operating procedure, practice, or the like that, if not correctly performed or adhered to, could result in personal injury or death. Do not proceed beyond a WARNING notice until the indicated conditions are fully understood and met.

General Warranty

The material contained in this document is provided “as is,” and is subject to being changed, without notice, in future editions. Further, to the maximum extent permitted by applicable law, Keysight disclaims all warranties, either express or implied with regard to this manual and any information contained herein, including but not limited to the implied warranties of merchantability and fitness for a particular purpose. Keysight shall not be liable for errors or for incidental or consequential damages in connection with the furnishing, use, or performance of this document or any information contained herein. Should Keysight and the user have a separate written agreement with warranty terms covering the material in this document that conflict with these terms, the warranty terms in the separate agreement shall control. Duration and conditions of warranty for this product may be superseded when the product is integrated into (becomes a part of) other Keysight products. During the warranty period, Keysight will, at its option, either repair or replace products which prove to be defective. The warranty period begins on the date of delivery or on the date of installation if installed by Keysight.

Restricted Rights Legend

The Software and Documentation have been developed entirely at private expense. They are delivered and licensed as “commercial computer software” as defined in DFARS 252.227-7013 (Oct 1988), DFARS 252.211-7015 (May 1991), or DFARS 252.227-7014 (Jun 1995), as a “commercial item” as defined in FAR 2.101(a), or as “restricted computer software” as defined in FAR 52.227-19 (Jun 1987) (or any equivalent agency regulation or contract clause), whichever is applicable. You have only those rights provided for such Software and Documentation by the applicable FAR or DFARS clause or the Keysight standard software agreement for the product involved.

Equipment Operation

Warnings and Cautions

This guide uses warnings and cautions to denote hazards.

WARNING

A WARNING notice denotes a hazard. It calls attention to an operating procedure, practice, or the like that, if not correctly performed or adhered to, could result in personal injury or loss of life. Do not proceed beyond a WARNING notice until the indicated conditions are fully understood and met.

CAUTION

A CAUTION notice denotes a hazard. It calls attention to an operating procedure, practice, or the like that, if not correctly performed or adhered to, could result in damage to the product or loss of important data. Do not proceed beyond a CAUTION notice until the indicated conditions are fully understood and met.

Personal Safety Considerations

This is a Safety Class I product (provided with a protective earthing ground incorporated in the power cord). The mains plug shall only be inserted in a socket outlet provided with a protective earth contact. Any interruption of the protective conductor, inside or outside the instrument, is likely to make the instrument dangerous. Intentional interruption is prohibited. If this instrument is not used as specified, the protection provided by the equipment could be impaired. This instrument must be used in a normal condition (in which all means of protection are intact) only.

No operator serviceable parts inside. Refer servicing to qualified personnel. To prevent electrical shock, do not remove covers. For continued protection against fire hazard, replace the line fuse(s) only with fuses of the same type and rating (for example, normal blow, time delay, etc.). The use of other fuses or material is prohibited.

General Safety Considerations

The following general safety precautions must be observed during all phases of operation of this instrument. Failure to comply with these precautions or with specific warnings elsewhere in this manual violates safety standards of design, manufacture, and intended use of the instrument. Keysight Technologies assumes no liability for the customer's failure to comply with these requirements.

WARNING

- Before this instrument is switched on, make sure it has been properly grounded through the protective conductor of the ac power cable to a socket outlet provided with protective earth contact. Any interruption of the protective (grounding) conductor, inside or outside the instrument, or disconnection of the protective earth terminal can result in personal injury.
-

CAUTION

- Any adjustments or service procedures that require operation of the instrument with protective covers removed should be performed only by trained service personnel.
-

User Environment

This instrument is designed for indoor use only.

THIS PAGE HAS BEEN INTENTIONALLY LEFT BLANK.

Table of Contents

General Warranty	3
Restricted Rights Legend	3
Equipment Operation	4
General Safety Considerations	5
User Environment	5
1 Power Meter Remote Operation	
Introduction	26
Configuring the Remote Interface	27
Zeroing and Calibrating	31
Making Measurement	33
Using Frequency Dependent Offset Tables	49
Setting the Range, Resolution and Averaging	56
Setting Offsets	60
Setting Measurement Limits	62
Getting the Best Speed Performance	66
How Measurements are Calculated	71
Status Reporting	72
Saving and Recalling Power Meter Configurations	91
Using Device Clear to Halt Measurements	92
An Introduction to the SCPI Language	93
SCPI Compliance Information	101
Summary of Commands	103
2 MEASurement Commands	
MEASurement Commands	107
CONFigure[1] 2 3 4?	112
CONFigure [1] 2 3 4 Commands	117
CONFigure[1] 2 3 4[:SCALar][:POWer:AC]	

[<expected_value>[,<resolution>[,<source list>]]]	118
CONFigure[1] 2 3 4[:SCALar][:POWer:AC]:RELative [<expected_value>[,<resolution>[,<source list>]]]	121
CONFigure[1] 2 3 4[:SCALar][:POWer:AC]:DIFFerence [<expected_value>[,<resolution>[,<source list>]]]	124
CONFigure[1] 2 3 4[:SCALar][:POWer:AC]:DIFFerence: RELative [<expected_value>[,<resolution>[,<source list>]]]	127
CONFigure[1] 2 3 4[:SCALar][:POWer:AC]:RATio [<expected_value>[,<resolution>[,<source list>]]]	130
CONFigure[1] 2 3 4[:SCALar][:POWer:AC]:RATio: RELative [<expected_value>[,<resolution>[,<source list>]]]	133
FETCH[1] 2 3 4 Queries	136
FETCH[1] 2 3 4[:SCALar][:POWer:AC]? [<expected_value>[,<resolu- tion>[,<source list>]]]	137
FETCH[1] 2 3 4[:SCALar][:POWer:AC]:RELative? [<expected_value>[,<resolution>[,<source list>]]]	140
FETCH[1] 2 3 4[:SCALar][:POWer:AC]:DIFFerence? [<expected_value>[,<resolution>[,<source list>]]]	143
FETCH[1] 2 3 4[:SCALar][:POWer:AC]:DIFFerence: RELative? [<expected_value>[,<resolution>[,<source list>]]]	146
FETCH[1] 2 3 4[:SCALar][:POWer:AC]:RATio? [<expected_value>[,<resolution>[,<source list>]]]	149
FETCH[1] 2 3 4[:SCALar][:POWer:AC]:RATio:RELative? [<expected_val- ue>[,<resolution>[,<source list>]]]	152
READ[1] 2 3 4 Commands	155
READ[1] 2 3 4[:SCALar][:POWer:AC]? [<expected_value>[,<resolu- tion>[,<source list>]]]	156
READ[1] 2 3 4[:SCALar][:POWer:AC]:RELative? [<expected_value>[,<resolution>[,<source list>]]]	159
READ[1] 2 3 4[:SCALar][:POWer:AC]:DIFFerence? [<expected_value>[,<resolution>[,<source list>]]]	162
READ[1] 2 3 4[:SCALar][:POWer:AC]:DIFFerence: RELative? [<expected_value>[,<resolution>[,<source list>]]]	165

READ[1] 2 3 4[:SCALar][:POWer:AC]:RATio? [<expected_value>[,<resolution>[,<source list>]]]	168
READ[1] 2 3 4[:SCALar][:POWer:AC]:RATio:RELative? [<expected_value>[,<resolution>[,<source list>]]]	171
MEASure[1] 2 3 4 Commands	174
MEASure[1] 2 3 4[:SCALar][:POWer:AC]? [<expected_value>[,<resolution>[,<source list>]]]	175
MEASure[1] 2 3 4[:SCALar][:POWer:AC]:RELative? [<expected_value>[,<resolution>[,<source list>]]]	178
MEASure[1] 2 3 4[:SCALar][:POWer:AC]:DIFFerence? [<expected_value>[,<resolution>[,<source list>]]]	181
MEASure[1] 2 3 4[:SCALar][:POWer:AC]:DIFFerence:RELative? [<expected_value>[,<resolution>[,<source list>]]]	183
MEASure[1] 2 3 4[:SCALar][:POWer:AC]:RATio? [<expected_value>[,<resolution>[,<source list>]]]	186
MEASure[1] 2 3 4[:SCALar][:POWer:AC]:RATio:RELative? [<expected_value>[,<resolution>[,<source list>]]]	189

3 CALCulate Subsystem

CALCulate Subsystem	192
CALCulate[1] 2 3 4:HOLD:STAT <character_data>	195
CALCulate[1] 2 3 4:FEED[1] 2 <string>	197
CALCulate[1] 2 3 4:GAIN Commands	200
CALCulate[1] 2 3 4:GAIN[:MAGNitude] <numeric_value>	201
CALCulate[1] 2 3 4:GAIN:STATe <boolean>	203
CALCulate[1] 2 3 4:LIMit Commands	205
CALCulate[1] 2 3 4:LIMit:CLEar:AUTO <boolean> ONCE	206
CALCulate[1] 2 3 4:LIMit:CLEar[:IMMEDIATE]	208
CALCulate[1] 2 3 4:LIMit:FAIL?	209
CALCulate[1] 2 3 4:LIMit:FCOunt?	210
CALCulate[1] 2 3 4:LIMit:LOWer[:DATA] <numeric_value>	212
CALCulate[1] 2 3 4:LIMit:UPPer[:DATA] <numeric_value>	214

	CALCulate[1] 2 3 4:LIMit:STATe <boolean>	216
	CALCulate[1] 2 3 4:MATH Commands	218
	CALCulate[1] 2 3 4:MATH[:EXPRession] <string>	219
	CALCulate[1] 2 3 4:MATH[:EXPRession]:CATalog?	223
	CALCulate[1] 2 3 4:RELative Commands	225
	CALCulate[1] 2 3 4:RELative[:MAGNitude]:AUTO <boolean> ONCE	226
	CALCulate[1] 2 3 4:RELative:STATe <boolean>	228
4	CALibration Subsystem	
	CALibration Subsystem	232
	CALibration[1] 2 3 4[:ALL]	234
	CALibration[1] 2 3 4[:ALL]?	236
	CALibration[1] 2 3 4:AUTO <boolean> ONCE	238
	CALibration[1] 2:RCALibration <boolean>	240
	CALibration[1] 2:RCFactor <numeric_value>	242
	CALibration[1] 2 3 4:ZERO:AUTO <boolean> ONCE	244
	CALibration3 4:TYPE EXTernal INTernal	246
	CALibration3 4:ZERO:TYPE EXTernal INTernal	248
5	DISPlay Subsystem	
	DISPlay Subsystem	252
	DISPlay:ENABle <boolean>	253
	DISPlay:SCReen:FORMat <character_data>	254
	DISPlay[:WINDow[1] 2] Commands	256
	DISPlay[:WINDow[1] 2]:ANALog Commands	257
	DISPlay[:WINDow[1] 2]:ANALog:LOWer <numeric_value>	258
	DISPlay[:WINDow[1] 2]:ANALog:UPPer <numeric_value>	261
	DISPlay[:WINDow[1] 2]:FORMat <character_data>	264
	DISPlay[:WINDow[1] 2]:METer Commands	266
	DISPlay[:WINDow[1] 2]:METer:LOWer <numeric_value>	267
	DISPlay[:WINDow[1] 2]:METer:UPPer <numeric_value>	270

DISPlay[:WINDow[1]2]:NUMeric[1]2:RESolution <numeric_value>	273
DISPlay[:WINDow[1]2]:SElect[1]2	275
DISPlay[:WINDow[1]2][:STATe] <boolean>	277
6 FORMat Subsystem	
FORMat Subsystem	280
FORMat[:READings]:BORDER <character_data>	281
FORMat[:READings][:DATA] <character_data>	283
7 HCOpy Subsystem	
HCOpy Subsystem	286
HCOpy:SDUMp:DATA?	287
HCOpy:SDUMp:DATA:FORMat BMP PNG	288
8 LXI Subsystem	
LXI Subsystem	290
LXI:IDENtify[:STATe] <boolean>	291
9 MEMory Subsystem	
MEMory Subsystem	294
MEMory[:METer]:USB[1]2:CATalog Commands	296
MEMory[:METer]:USB[1]2:CATalog[:ALL]?	297
MEMory[:METer]:USB[1]2:CATalog:STATe?	300
MEMory[:METer]:USB[1]2:CATalog:TABLE?	301
MEMory[:METer]:USB[1]2:CLEar Commands	304
MEMory[:METer]:USB[1]2:CLEar[:NAME] <character_data>	305
MEMory[:METer]:USB[1]2:CLEar:TABLE	307
MEMory[:METer]:USB[1]2:FREE Commands	308
MEMory[:METer]:USB[1]2:FREE[:ALL]?	309
MEMory[:METer]:USB[1]2:FREE:STATe?	310
MEMory[:METer]:USB[1]2:FREE:TABLE?	311
MEMory[:METer]:USB[1]2:NSTATes?	312

MEMory[:METer]:USB[1]2:STATe Commands	313
MEMory[:METer]:USB[1]2:STATe:CATalog?	314
MEMory[:METer]:USB[1]2:STATe:DEFine <character_data>,<numeric_value>	315
MEMory[:METer]:USB[1]2:TABLE Commands	317
MEMory[:METer]:USB[1]2:TABLE:FREQUency <numeric_value>{,<numeric_value>}	318
MEMory[:METer]:USB[1]2:TABLE:FREQUency:POINts?	322
MEMory[:METer]:USB[1]2:TABLE:GAIN[:MAGNitude] <numeric_value>{,<numeric_value>}	323
MEMory[:METer]:USB[1]2:TABLE:GAIN[:MAGNitude]:POINts?	326
MEMory[:METer]:USB[1]2:TABLE:MOVE <character_data>,<character_data>	327
MEMory[:METer]:USB[1]2:TABLE:SElect <character_data>	329

10 OUTPut Subsystem

OUTPut Subsystem	332
OUTPut:REcorder[1]2:FEED <data_handle>	333
OUTPut:REcorder[1]2:LIMit:AUTO <boolean>	335
OUTPut:REcorder[1]2:LIMit:LOWer <numeric_value>	336
OUTPut:REcorder[1]2:LIMit:UPPer <numeric_value>	338
OUTPut:REcorder[1]2:STATe <boolean>	340
OUTPut:ROSCillator[:STATe] <boolean>	341
OUTPut:TRIGger[:STATe] <boolean>	342

11 SENSE Subsystem

[SENSe] Subsystem	347
[SENSe[1]]SENSe2 3 4:AVERAge Commands	350
[SENSe[1]]SENSe2 3 4:AVERAge:COUNt <numeric_value>	351
[SENSe[1]]SENSe2 3 4:AVERAge:COUNt:AUTO <boolean>	353
[SENSe[1]]SENSe2 3 4:AVERAge:SDETect <boolean>	356
[SENSe[1]]SENSe2 3 4:AVERAge[:STATe] <boolean>	358

[SENSe[1]] SENSe2:BUFFer:COUnT <numeric_value>	360
[SENSe[1]] SENSe2:CORection Commands	362
[SENSe[1]] SENSe2:CORection:CFACTOR GAIN[1][:INPut][:MAGNitude] <numeric_value>	363
[SENSe[1]] SENSe2:CORection:CSET[1]Commands	366
[SENSe[1]] SENSe2 3 4:CORection:CSET2 Commands	367
[SENSe[1]] SENSe2:CORection:CSET[1][:SElect] <string>	368
[SENSe[1]] SENSe2 3 4:CORection:CSET2[:SElect] <string>	370
[SENSe[1]] SENSe2:CORection:CSET[1]:STATe <boolean>	372
[SENSe[1]] SENSe2 3 4:CORection:CSET2:STATe <boolean>	374
[SENSe[1]] SENSe2 3 4:CORection:DCYClE GAIN3 Commands	376
[SENSe[1]] SENSe2 3 4:CORection:DCYClE GAIN3[:INPut] [:MAGNitude] <numeric_value>	377
[SENSe[1]] SENSe2 3 4:CORection:DCYClE GAIN3:STATe <boolean> .. 380	
[SENSe[1]] SENSe2 3 4:CORection:FDOFfset GAIN4[:INPut][:MAGNi- tude]?	382
[SENSe[1]] SENSe2:CORection:FDOFfset:UNIT <character_data> ..	383
[SENSe[1]] SENSe2 3 4:CORection:GAIN2 Commands	385
[SENSe[1]] SENSe2 3 4:CORection:GAIN2:STATe <boolean>	386
[SENSe[1]] SENSe2 3 4:CORection:GAIN2[:INPut][:MAGNitude] <numer- ic_value>	388
SENSe 3 4:DETEctor:FUNcTION <character_data>	390
[SENSe[1]] SENSe2 3 4:FREQuency[:CW]:FIXed] <numeric_value> ..	392
[SENSe[1]] SENSe2:FREQuency[:CW]:FIXed]:STARt <numeric_value> ... 394	
[SENSe[1]] SENSe2:FREQuency[:CW]:FIXed]:STEP <numeric_value>	397
[SENSe[1]] SENSe2:FREQuency[:CW]:FIXed]:STOP <numeric_value>	400
[SENSe[1]] SENSe2 3 4:MRATe <character_data>	403
[SENSe[1]] SENSe2 3 4:POWer:AC:RANGe <numeric_value>	406
[SENSe[1]] SENSe2 3 4:POWer:AC:RANGe:AUTO <boolean>	408

[SENSe[1]] SENSe2 3 4:SPEed <numeric_value>	410
[SENSe[1]] SENSe2:V2P ATYPe DTYPe	413
SENSe3 4:SWEep:APERture <numeric_value>	415
SENSe3 4:SWEep:APERture:AUTO <boolean>	417

12 SERVICE Subsystem

SERVICE Subsystem	421
SERVICE:BACKlight:BRIGHtness <numeric_value>	424
SERVICE:BACKlight:MODE <numeric_value>	426
SERVICE:BATTery:CAPacity?	428
SERVICE:BATTery:CHARge?	429
SERVICE:BATTery:TEMPerature?	430
SERVICE:BATTery:TIME?	431
SERVICE:BIST:CALibrator <boolean>	432
SERVICE:BIST:CW[1] 2:LINearity	433
SERVICE:BIST:CW[1] 2:LINearity:CORRection	434
SERVICE:BIST:CW[1] 2:LINearity:PERRor?	435
SERVICE:BIST:CW[1] 2:ZSET	436
SERVICE:BIST:CW[1] 2:ZSET:NUMber?	437
SERVICE:CALibrator:ADJ:COUR <numeric_value>	438
SERVICE:CALibrator:ADJ:FINE <numeric_value>	439
SERVICE:DISPlay:VGA <boolean>	440
SERVICE:DISPlay:BSCReen <boolean>	441
SERVICE:DISPlay:BSCReen:SECure:ACTivation <numeric_value>	442
SERVICE:DISPlay:BSCReen:SECure:DEACTivation <numeric_value>	443
SERVICE:FAN:FULL <boolean>	445
SERVICE:FAN:FULL?	446
SERVICE:LAN:PHOStname	447
SERVICE:OPTion?	448
SERVICE:SECure:ERASe	449

SERvice:SENSe:CABLe:OPTion <numeric_value>	450
SERvice:SENSor[1] 2 3 4:CDATe?	452
SERvice:SENSor[1] 2 3 4:CPLace?	453
SERvice:SENSor[1] 2 3 4:FREQuency:MAXimum?	454
SERvice:SENSor[1] 2 3 4:FREQuency:MINimum?	455
SERvice:SENSor[1] 2 3 4:POWer:AVERage:MAXimum?	456
SERvice:SENSor[1] 2 3 4:POWer:USABle:MAXimum?	457
SERvice:SENSor[1] 2 3 4:POWer:USABle:MINimum?	458
SERvice:SENSor[1] 2 3 4:RADC?	459
SERvice:SENSor[1] 2 3 4:SNUMber?	460
SERvice:SENSor[1] 2 3 4:TNUMber?	461
SERvice:SENSor[1] 2 3 4:TYPE?	462
SERvice:SENSor3 4:FREVision?	463
SERvice:SNUMber?	464
SERvice:STATe <boolean>	465
SERvice:VERSion:PROCCessor <character_data>	466
SERvice:VERSion:SYSTem <character_data>	467

13 STATUS Subsystem

STATus Subsystem	470
Status Register Set Commands	472
Device Status Register Sets	477
Operation Status Register Sets	479
STATus:OPERation	480
STATus:OPERation:CALibrating[:SUMMARY]	481
STATus:OPERation:LLFail[:SUMMARY]	482
STATus:OPERation:MEASuring[:SUMMARY]	483
STATus:OPERation:SENSe[:SUMMARY]	484
STATus:OPERation:TRIGger[:SUMMARY]	485
STATus:OPERation:ULFail[:SUMMARY]	486

STATus:PRESet	487
Questionable Status Register Sets	488
STATus:QUEStionable	489
STATus:QUEStionable:CALibration[:SUMMARY]	490
STATus:QUEStionable:POWer[:SUMMARY]	491
Status Block Diagram	493

14 SYSTEM Subsystem

SYSTEM Subsystem	497
SYSTEM:COMMunicate:GPIB[:SELF]:ADDRESS <numeric_value>	500
SYSTEM:COMMunicate:LAN:AIP[:STATE] <boolean>	502
SYSTEM:COMMunicate:LAN:CURRENT:ADDRESS?	503
SYSTEM:COMMunicate:LAN:CURRENT:DGATeway?	504
SYSTEM:COMMunicate:LAN:CURRENT:DNAMe?	505
SYSTEM:COMMunicate:LAN:CURRENT:SMASK?	506
SYSTEM:COMMunicate:LAN:ADDRESS <character_data>	507
SYSTEM:COMMunicate:LAN:DGATeway <character_data>	508
SYSTEM:COMMunicate:LAN:DHCP[:STATE] <boolean>	509
SYSTEM:COMMunicate:LAN:DNAMe <character_data>	510
SYSTEM:COMMunicate:LAN:HNAME <character_data>	511
SYSTEM:COMMunicate:LAN:MAC?	512
SYSTEM:COMMunicate:LAN:REStart	513
SYSTEM:COMMunicate:LAN:SMASK <character_data>	514
SYSTEM:COMMunicate:TCPip:CONTRol?	515
SYSTEM:DISPlay:BMP	516
SYSTEM:ERRor?	517
SYSTEM:HELP:HEADers?	525
SYSTEM:LANGUage <character_data>	526
SYSTEM:LICense:INSTall <license_string>	528
SYSTEM:LICense:LIST?	529

SYSTem:LIcense:REMove <license_string>	530
SYSTem:LOCAl	531
SYSTem:PERSonA:MANUFACTURER <"string">	532
SYSTem:PERSonA:MANUFACTURER:DEFault	534
SYSTem:Preset	535
SYSTem:REMOte	541
SYSTem:RWLOCK	542
SYSTem:SET <arbitrary_block_data>	543
SYSTem:VERSion?	544

15 TRIGger Subsystem

TRIGger Subsystem	546
ABORT[1] 2 3 4:	548
INITiate Commands	549
INITiate[1] 2 3 4:CONTinuous <boolean>	550
INITiate[1] 2 3 4[:IMMediate]	552
INITiate:CONTinuous:ALL <boolean>	553
INITiate:CONTinuous:SEquence[1] 2 3 4 <boolean>	555
INITiate[:IMMediate]:ALL	557
INITiate[:IMMediate]:SEquence[1] 2 3 4	558
TRIGger Commands	559
TRIGger[1] 2 3 4:DELay:AUTO <boolean>	560
TRIGger[1] 2 3 4[:IMMediate]	562
TRIGger[1] 2 3 4:SOURce BUS EXTErnal HOLD IMMediate	563
TRIGger3 4:SOURce EXTErnal	566
TRIGger[:SEquence[1] 2 3 4]:SLOPe <character_data>	567
TRIGger[:SEquence[1] 2 3 4]:COUNT <numeric_value>	569
TRIGger:SEquence3 4:DELay <numeric_value>	572
TRIGger[:SEquence[1] 2 3 4]:DELay:AUTO <boolean>	574
TRIGger:SEquence3 4:HOLDoff <numeric_value>	576

TRIGger[:SEQuence[1]]2 3 4:IMMediate	578
TRIGger[:SEQuence[1]]2 3 4:SOURce BUS EXTErnal HOLD IMMediate	579
16 UNIT Subsystem	
UNIT Subsystem	584
UNIT[1]]2 3 4:POWer <amplitude_unit>	585
UNIT[1]]2 3 4:POWer:RATio <ratio_unit>	587
17 IEEE 488.2 Command Reference	
SCPI Compliance Information	590
*CLS	591
*DDT <arbitrary block program data> <string program data>	592
*ESE <NRf>	594
*ESR?	596
*IDN?	597
*LRN?	598
*OPC	599
*OPT?	600
*RCL <NRf>	601
*RST	602
*SAV <NRf>	603
*SRE <NRf>	604
*STB?	606
*TRG	607
*TST?	608
*WAI	609
GPIO Universal Commands	610
18 Programming Examples	
Example 1: Identifying the EPM Series Power Meter In Use	616
Example 2: FETCh, MEASure, and READ Queries	617

Example 3: Making Repetitively Pulsed RF Power Measurement With Duty Cycle Correction	619
Example 4: CW Power Measurement	620
Example 5: Low Power Measurement	621
Example 6: Power Sweep Operation	622
Example 7: Frequency Sweep Operation	623
Example 8: Status of Various Settings	625
Example 9: Window Offset, Min/Max Hold, and Limits Settings	626
A Measurement Polling Example	
Measurement Polling Example using VEE program	628
B HP 436A/HP 437B/HP 438A Command Summary	
HP 436A Command Summary	632
HP 437B Command Summary	633
HP 438A Command Summary	637

THIS PAGE HAS BEEN INTENTIONALLY LEFT BLANK.

List of Figures

Figure 1-1	Frequency Dependent Offset Tables	50
Figure 1-2	Typical Averaged Readings on 8480 Series Sensors	57
Figure 1-3	Averaging Range Hysteresis	58
Figure 1-4	Limits Checking Application	62
Figure 1-5	Limits Checking Results	63
Figure 1-6	How Measurement are Calculated	71
Figure 1-7	Generalized Status Register Model	73
Figure 1-8	Typical Status Register Bit Changes	74
Figure 1-9	Status System	80
Figure 1-10	Hierarchical structure of SCPI	93
Figure 1-11	Format of <character_data>	96
Figure 1-12	Format of <non-decimal numeric>	97
Figure 1-13	Format of <NR1>	98
Figure 1-14	Format of <NR2>	98
Figure 1-15	Format of <NR3>	99
Figure 1-16	Format of <string>	100
Figure 2-1	Measurement Display CALCulate Block Window	108
Figure 3-1	Measurement Display CALCulate Block Window	192
Figure 3-2	CALCulate Block	193
Figure 11-1	Example of Averaged Readings	353
Figure 14-1	IEEE 488.2 Arbitrary Block Program Data Format	525
Figure 16-1	Measurement Display UNIT Block Window	584
Figure A-1	Example of VEE program used in measurement polling	

THIS PAGE HAS BEEN INTENTIONALLY LEFT BLANK.

List of Tables

Table 1-1	MEASure? and CONFigure Preset States	33
Table 1-2	Possibilities of the defaulted source list parameter	38
Table 1-3	Range of Values for Window Limits	64
Table 1-4	Model of Sensor and Measurement Rates	67
Table 1-5	Bit Definitions - Status Byte Register	81
Table 1-6	Bit Definitions - Standard Event Register	82
Table 1-7	Bit Definitions - Questionable Status Registers	84
Table 1-8	Bit change conditions for Questionable Status Register	84
Table 1-9	Bit Definitions - Operation Status	85
Table 1-10	Bit change conditions for Operation Status	86
Table 1-11	Bit Definitions - Device Status Register	87
Table 1-12	Bit change conditions for Device Status Register	88
Table 3-1	Measurement Units	212
Table 3-2	Measurement Units	214
Table 5-1	Measurement Units	258
Table 5-2	Measurement Units	261
Table 5-3	Measurement Units	267
Table 5-4	Measurement Units	270
Table 9-1	8480 Series Power Sensor Tables	298
Table 9-2	8480 Series Power Sensor Tables	302
Table 9-3	Frequency and Calibration/Offset Factor List	319
Table 9-4	Frequency and Calibration/Offset Factor List	323
Table 13-1	Commands and events affecting Status Register	470
Table 14-1	Preset Settings	535
Table 17-1	*ESE Mapping	594
Table 17-2	*ESR? Mapping	596
Table 17-3	*SRE Mapping	604
Table 17-4	*STB? Mapping	606
Table 17-5	PPD Mapping	611
Table 17-6	PPE Mapping	612

THIS PAGE HAS BEEN INTENTIONALLY LEFT BLANK.

1 Power Meter Remote Operation

Introduction	26
Configuring the Remote Interface	27
Zeroing and Calibrating	31
Making Measurement	33
Using Frequency Dependent Offset Tables	49
Setting the Range, Resolution and Averaging	56
Range	59
Setting Offsets	60
Setting Measurement Limits	62
Getting the Best Speed Performance	66
How Measurements are Calculated	71
Status Reporting	72
Saving and Recalling Power Meter Configurations	91
Using Device Clear to Halt Measurements	92
An Introduction to the SCPI Language	93
SCPI Compliance Information	101
Summary of Commands	103

This chapter describes the parameters that configure the power meter and helps you determine settings to optimize performance.

Introduction

This chapter describes the parameters which configure the power meter and help you determine settings to optimize performance. It contains the following sections:

- “Configuring the Remote Interface” on page 27.
- “Zeroing and Calibrating” on page 31.
- “Making Measurement” on page 33.
- “Using Frequency Dependent Offset Tables” on page 49.
- “Setting the Range, Resolution and Averaging” on page 56.
- “Setting Offsets” on page 60.
- “Setting Measurement Limits” on page 62.
- “Getting the Best Speed Performance” on page 66.
- “How Measurements are Calculated” on page 71.
- “Status Reporting” on page 72.
- “Saving and Recalling Power Meter Configurations” on page 91.
- “Using Device Clear to Halt Measurements” on page 92.
- “An Introduction to the SCPI Language” on page 93.
- “SCPI Compliance Information” on page 101.
- “Summary of Commands” on page 103.

Configuring the Remote Interface

This section briefly describes how to configure the GPIB, LAN and USB remote interfaces.

NOTE

For more information on configuring the remote interface connectivity, refer to the *Keysight Technologies USB/LAN/GPIB Interfaces Connectivity Guide*. If you have installed the *IO Libraries Suite*, you can access the *Connectivity Guide* via the Keysight IO Libraries Control icon. Alternatively, you can access the *Connectivity Guide* via the Web at www.keysight.com/find/connectivity.

Interface Selection

You can choose to control the power meter remotely using the GPIB, LAN or USB interfaces.

For information on selecting and configuring the remote interface manually from the front panel, refer to the *EPM Series Power Meters Installation Guide*.

NOTE

It is expected that most users will use the front panel keys to set up the remote interfaces. The remote interface commands are provided for completeness (for the front panel operation).

GPIB Address

Each device on the GPIB (IEEE-488) interface must have a unique address. You can set the power meter's address to any value between 0 and 30. The power meter is shipped with a default address set to 13. The GPIB address is stored in non-volatile memory, and does not change when the power meter is switched off, or after a remote interface reset.

Your GPIB bus controller has its own address. Avoid using the bus controller's address for any instrument on the interface bus. Keysight Technologies controllers generally use address 21.

For information on setting the GPIB address manually from the front panel, refer to the *EPM Series Power Meters Installation Guide*.

- To set the GPIB address from the remote interface use the:
SYSTem:COMMunicate:GPIB:ADDResS command.
- To query the GPIB address from the remote interface use the:
SYSTem:COMMunicate:GPIB:ADDResS? query.

LAN Configuration

The power meter has three LAN operating modes:

- Dynamic IP (Dynamic Host Configuration Protocol or DHCP)
- Auto IP (Local PC Control or isolated (non-site) LAN)
- Static IP (Manual mode)

These three modes can be set up from the front panel. For front panel operation refer to the *EPM Series Power Meter Installation Guide*.

Configuring the LAN Remotely

To automatically configure the LAN settings, enable DHCP operation using the **SYSTem:COMMunicate:LAN:DHCP[:STATe]** command.

In this Dynamic IP mode the IP Address, Subnet Mask, and Default Gateway values are obtained from a DHCP server. Using this Dynamic IP mode does not require a detailed knowledge of your network configuration.

The IP Address, Subnet Mask, Default Gateway, and Host settings can be changed manually or remotely. To individually specify the LAN settings, use the following commands:

- IP Address -**SYSTem:COMMunicate:LAN:ADDResS**
- Subnet Mask -**SYSTem:COMMunicate:LAN:SMASK**
- Default Gateway -**SYSTem:COMMunicate:LAN:DGATeway**
- Domain Name -**SYSTem:COMMunicate:LAN:DNAME**
- Hostname -**SYSTem:COMMunicate:LAN:HNAME**
- Restart Network -**SYSTem:COMMunicate:LAN:REStArt**

The **character_data** values for the IP address, Subnet Mask, and Default Gateway can range between 0.0.0.0 and 255.255.255.255.

NOTE

If you configure an invalid IP Address or an IP address that is used by another device or host, an error message is generated. This error can be read by using the `SYSTem:ERRor?` command.

The LAN setting values are stored in non-volatile memory and are not part of the save-recall function.

USB Configuration

The USB interface requires no front panel or remote configuration.

The USB address cannot be changed - it is set at the factory and is unique for each power meter.

NOTE

For further information about the USB configuration refer to the *EPM Series Power Meters Installation Guide*.

NOTE

Before connecting the USB cable, make sure that I/O software is installed on your computer.

NOTE

For more information about *Keysight IO Libraries* software refer to the *Connectivity Guide*.

If you have installed other I/O Software, refer to documentation that accompanies the software.

Programming Language Selection (Option 200)

N1913A Option 200 allows you to use SCPI, HP 436A, or HP 437B programming language to program the power meter from the remote interface. N1914A Option 200 allows you to use either SCPI or HP 438A programming language to program the power meter from the remote interface. The default language is SCPI when the power meter is shipped from the factory.

The language selection is stored in non-volatile memory and does not change when power has been off or either after a remote interface reset or a front panel preset.

For information on selecting the programming language from the front panel, refer to the *Keysight N1913/1914A EPM Series Power Meter Installation Guide*.

To select the interface language from the remote interface, use the **SYSTem:LANGuage** command.

To query the interface language from the remote interface, use the **SYSTem:LANGuage?** command.

To return to using the SCPI programming language when the power meter is in HP 436A/HP 437B/HP 438A mode, use the **SYSTem:LANGuage SCPI** command.

NOTE

Refer to [Appendix B, “HP 436A/HP 437B/HP 438A Command Summary”](#) on page 631 for the complete list of HP 436A/HP 437B/HP 438A command summary. HP 436A, HP 437B, and HP 438A language modes are not compatible with LAN or USBTM remote interface.

Zeroing and Calibrating

Zeroing

Zeroing adjusts the power meter's specified channel for a zero power reading.

The command **CALibration**[1]|2|3|4:**ZERO:AUTO** [**ONCE**|**ON**|**OFF**|**0**|**1**] causes the power meter to perform its zeroing routine on the specified channel when enabled. This adjusts the power meter for a zero power reading with no power supplied to the power sensor.

1|ON can only be used with a U2000 Series USB sensor or a U2040 X-Series USB sensor. When **1|ON** is enabled the zero is maintained by a combination of zero *on-the-fly* for measurements and temperature compensation.

Calibration

The command used to calibrate the power meter is:

CALibration[1|2]:AUTO ONCE

It is recommended that you zero the power meter before calibrating.

Calibration Sequence

This feature allows you to perform a complete calibration sequence with a single query. The query is:

CALibration[1|2][:ALL]?

The query assumes that the power sensor is connected to the power reference oscillator. It turns the power reference oscillator on, then after calibrating, returns the power reference oscillator to the same state it was in prior to the command being received. The calibration sequence consists of:

- 1 Zeroing the power meter (**CALibration[1|2]:ZERO:AUTO ONCE**)
- 2 Calibrating the power meter (**CALibration[1|2]:AUTO ONCE**)

The query enters a number into the output buffer when the sequence is complete. If the result is 0 the sequence was successful. If the result is 1 the sequence failed. Refer to “**CALibration[1|2|3|4][:ALL]?**” on page 236 for further information.

NOTE

The **CALibration[1|2|3|4][:ALL]** command is identical to the **CALibration[1|2|3|4][:ALL]?** query except that no number is returned to indicate the outcome of the sequence. You can examine the **Questionable Status Register** or the error queue to discover if the sequence has passed or failed. Refer to “**Status Reporting**” on page 72 for further information.

Making Measurement

The **MEASure?** and **CONFigure** commands provide a straight-forward method to program the power meter for measurements. You can select the measurement's expected power level, resolution and with the N1914A the measurement type (that is single channel, difference or ratio measurements) all in one command. The power meter automatically presets other measurement parameters to default values as shown in [Table 1-1](#) below.

Table 1-1 MEASure? and CONFigure Preset States

Command	MEASure? and CONFigure Setting
Trigger source (TRIGger:SOURce)	Immediate
Filter (SENSe:AVERage:COUNT:AUTO)	On
Filter state(SENSe:AVERage:STATE)	On
Trigger cycle (INITiate:CONTinuous)	Off
TriggerDelay (TRIGger:DELay:AUTO)	On

An alternative method to program the power meter is to use the lower level commands. The advantage of using the lower level commands over the **CONFigure** command is that they give you more precise control of the power meter. As shown in [Table 1-1](#), the **CONFigure** command presets various states in the power meter. It may be likely that you do not want to preset these states. Refer to [“Using the Lower Level Commands”](#) on page 47 for further information.

Using MEASure?

The simplest way to program the power meter for measurements is by using the **MEASure?** query. However, this command does not offer much flexibility. When you execute the command, the power meter selects the best settings for the requested configuration and immediately performs the measurement. You cannot change any settings (other than the expected power value, resolution and with the N1914A the measurement type) before the measurement is taken. This means you cannot fine tune the measurement, for example, you cannot change the filter length. To make more flexible and accurate measurements use the **CONFIgure** command. The measurement results are sent to the output buffer. **MEASure?** is a compound command which is equivalent to an **ABORT**, followed by a **CONFIgure**, followed by a **READ?**.

MEASure? Examples

The following commands show a few examples of how to use the **MEASure?** query to make a measurement. It is advisable to read through these examples in order as they become increasingly more detailed. These examples configure the power meter for a measurement (as described in each individual example), automatically place the power meter in the “wait-for-trigger” state, internally trigger the power meter to take one reading, and then sends the reading to the output buffer.

These examples give an overview of the **MEASure?** query. For further information on the **MEASure?** commands refer to the section “**MEASure[1]2|3|4 Commands**” on page 174.

Example 1 - The Simplest Method

The following commands show the simplest method of making single channel (for example A or B) measurements. Using **MEAS1?** results in an upper window measurement, and **MEAS2?** in a lower window measurement. The channel associated with the window can be set using the source list parameter (see **Example 2 - Specifying the Source List Parameter**), or defaults as in this example (see “**Keysight N1914A Only**” on page 37).

specifies window



MEAS1?

MEAS2?

Example 4 - Specifying the Resolution Parameter

The previous examples detailed the use of the expected value and source list parameters. The resolution parameter is used to set the resolution of the specified window. This parameter does not affect the resolution of the data, however it does affect the auto averaging setting (refer to [Figure 1-2](#)).

Since the filter length used for a channel with auto-averaging enabled is dependent on the window resolution setting, a conflict arises when a given channel is set up in both windows and the resolution settings are different. In this case, the higher resolution setting is used to determine the filter length.

The following example uses the resolution parameter to specify a resolution setting of 3. This setting represents 3 significant digits if the measurement suffix is W or %, and 0.01 dB if the suffix is dB or dBm. Refer to [Chapter 2, “MEASurement Commands,”](#) on page 107, for further details on the resolution parameter. The expected power and source list parameters are defaulted in the example. The expected power value remains unchanged at its current setting. The source list parameter defaults as described in the note [“Keysight N1914A Only”](#) on page 37. Note that as the source list parameter is the last specified parameter you do not have to specify DEF. The measurement is carried out on the upper window.

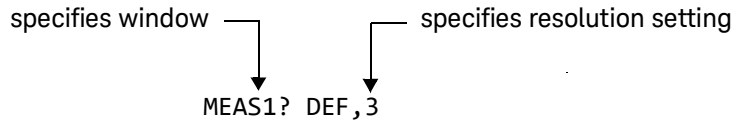

Example 5 - Making a Difference Measurement

The following command is performed on the N1914A. It queries the lower window to make a difference measurement of Channel B - Channel A. The expected power and resolution parameters are defaulted, leaving them at their current settings.

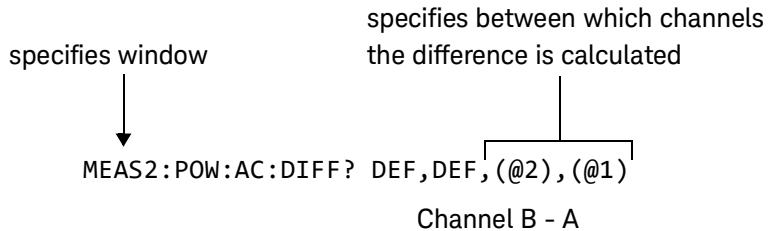

Example 6 - Making a Ratio Measurement

The following command is performed on the N1914A. It queries the upper window to make a ratio measurement of Channel A/B. The expected power and resolution parameters are defaulted, leaving them at their current settings.

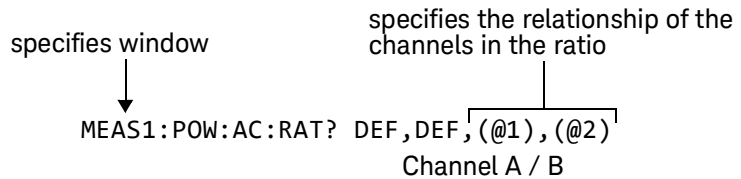

NOTE

Keysight N1914A Only

The operation of the MEASure? command when the source list parameter is defaulted depends on the current setup of the window concerned (for example, A, B, A/B, A-B etc.) and on the particular command used (for example, MEAS[:POW][:AC]? and MEAS:POW:AC:RAT?).

This means that when the source list parameter is defaulted, there are a number of possibilities.

Table 1-2 Possibilities of the defaulted source list parameter

Command	Current Window Setup		Measurement
MEAS1[:POW][AC]?	Upper Window:	A	A
		B	B
		Any Other	A
MEAS2[:POW][AC]?	Lower Window:	A	A
		B	B
		Any Other	B
MEAS1:POW:AC:RAT	Upper Window:	A/B	A/B
		B/A	B/A
		Any Other	A/B
MEAS2:POW:AC:RAT	Lower Window:	A/B	A/B
		B/A	B/A
		Any Other	A/B
MEAS1:POW:AC:DIFF?	Upper Window:	A-B	A-B
		B-A	B-A
		Any Other	A-B
MEAS2:POW:AC:DIFF?	Lower Window:	A-B	A-B
		B-A	B-A
		Any Other	A-B

Using the CONFigure Command

When you execute this command, the power meter presets the optimum settings for the requested configuration (like the **MEASure?** query). However, the measurement is not automatically started and you can change measurement parameters before making measurements. This allows you to change the power meter's configuration from the preset conditions. The power meter offers a variety of low-level commands in the **SENSe**, **CALCulate**, and **TRIGger** subsystems. For example, if you want to change the averaging use the `[SENSe[1]]|SENSe2:AVERAge:COUNT` command.

Use the INITiate or READ? query to initiate the measurement.

Using READ?

CONFigure does not take the measurement. One method of obtaining a result is to use the **READ?** query. The **READ?** query takes the measurement using the parameters set by the **CONFigure** command then sends the reading to the output buffer. Using the **READ?** query obtains new data.

Using INITiate and FETCh?

CONFigure does not take the measurement. One method of obtaining the result is to use the **INITiate** and **FETCh?** commands. The **INITiate** command causes the measurement to be taken. The **FETCh?** query retrieves a reading when the measurement is complete, and sends the reading to the output buffer. **FETCh?** can be used to display the measurement results in a number of different formats (for example, A/B and B/A) without taking fresh data for each measurement.

CONFigure Examples

The following program segments show how to use the commands **READ?**, **INITiate** and **FETCh?** and **CONFigure** to make measurements.

It is advisable to read through these examples in order as they become increasingly more detailed.

These examples give an overview of the **CONFigure** command. For further information on the **CONFigure** commands refer to [Chapter 2, "MEASurement Commands"](#).

Example 1 - The Simplest Method

The following program segments show the simplest method of querying the upper and lower window's measurement results respectively.

Using READ?

***RST** *Reset instrument*
CONF1 *Configure upper window -defaults to a Channel A measurement*
READ1? *Take upper window (Channel A) measurement*

***RST** *Reset instrument*
CONF2 *Configure lower window -defaults to a Channel A (N1913A),
Channel B (N1914A) measurement*
READ2? *Take lower window measurement (Channel A on N1913A, B on
N1914A)*

Using INITiate and FETCh?

***RST** *Reset instrument*
CONF1 *Configure upper window -defaults to a Channel A measurement*
INIT1? *Causes Channel A to make a measurement*
FETC1? *Retrieves the upper window's measurement*

For the N1913A only:

***RST** *Reset instrument*
CONF2 *Configure lower window -N1913A defaults to Channel A*
INIT1 *Causes Channel A to make a measurement*
FETC2? *Retrieves the lower window's measurement*

For the N1914A only:

***RST** *Reset instrument*
CONF2 *Configure lower window*
INIT2? *Causes Channel B to make a measurement*
FETC2? *Retrieves the lower window's measurement*

Example 2 - Specifying the Source List Parameter

The **CONF**igure and **READ**? commands have three optional parameters, an expected power value, a resolution and a source list. These parameters must be entered in the specified order. If parameters are omitted, they default from the right. The parameter **DEF**ault is used as a place holder.

The following examples use the source list parameter to specify the measurement channel as Channel A. The expected power and resolution parameters are defaulted, leaving them at their current settings. The measurement is carried out on the upper window.

Although the **READ**? and **FET**ch? queries have three optional parameters it is not necessary to define them as shown in these examples. If they are defined they must be identical to those defined in the **CONF**igure command otherwise an error occurs.

NOTE

For the N1913A it is not necessary to specify a channel as only one channel is available.

Using READ?

ABOR1	<i>Aborts Channel A</i>
CONF1 DEF,DEF,(@1)	<i>Configures the upper window to make a Channel A measurement using the current expected power and resolution settings</i>
READ1?	<i>Takes the upper window's measurement</i>

Using INITiate and FETCh?

ABOR1	<i>Aborts Channel A</i>
CONF1 DEF,DEF, (@1)	<i>Configures the upper window to make a Channel A measurement using the current expected power and resolution settings</i>
INIT1	<i>Causes Channel A to make a measurement</i>
FETC1? DEF,DEF, (@1)	<i>Retrieves the upper window's measurement</i>

Example 3 - Specifying the Expected Power Parameter

The previous example details the three optional parameters which can be used with the **CONFfigure** and **READ?** commands. The first optional parameter is used to enter an expected power value. Entering this parameter is only relevant if you are using an E-Series power sensor or N8480 Series power sensor (excluding Option CFT). The value entered determines which of the power sensor's two ranges is used for the measurement. If the current setting of the power sensor's range is no longer valid for the new measurement, specifying the expected power value decreases the time taken to obtain a result.

The following example uses the expected value parameter to specify a value of -50 dBm. This selects the power meter's lower range (refer to "Range" on page 59 for details of the range breaks). The resolution parameter is defaulted, leaving it at its current setting. The source list parameter specifies a Channel B measurement. The measurement is carried out on the upper window.

Using READ?

ABOR2	<i>Aborts Channel B</i>
CONF1 -50,DEF, (@2)	<i>Configures the upper window to make a Channel B measurement using an expected power of -50 dBm and the current resolution setting</i>
READ1?	<i>Takes the upper window's measurement</i>

Some fine tuning of measurements can be performed using the **CONFigure** and **READ?** commands. For example, in the above program segment some fine tuning can be performed by setting the filter length to 1024 and the trigger delay off.

```

1 ABOR2
2 CONF1 -50,DEF,(@2)
3 SENS2:AVER:COUN 1024
4 TRIG2:DEL:AUTO OFF
5 READ1?

```

Using INITiate and FETCh?

ABOR2	<i>Aborts Channel B</i>
CONF1 -50,DEF,(@2)	<i>Configures the upper window to make a Channel B measurement using an expected power of -50 dBm and the current resolution setting</i>
INIT2	<i>Causes Channel B to make a measurement</i>
FETC1? -50,DEF,(@2)	<i>Retrieves the upper window's measurement</i>

Some fine tuning of measurements can be carried out using the **CONFigure** command and **INITiate** and **FETCh?** commands. For example, in the above program segment some fine tuning can be carried out by setting the filter length to 1024 and the trigger delay off.

```

1 ABOR2
2 CONF1 -50,DEF,(@2)
3 SENS2:AVER:COUN 1024
4 TRIG2:DEL:AUTO OFF
5 INIT2
6 FETC1? -50,DEF,(@2)

```

Example 4 - Specifying the Resolution Parameter

The previous examples detailed the use of the expected value and source list parameters. The resolution parameter is used to set the resolution of the specified window. This parameter does not affect the resolution of the data, however it does affect the auto averaging setting (refer to [Figure 1-2](#) on page 57).

Since the filter length used for a channel with auto-averaging enabled is dependent on the window resolution setting, a conflict arises when a given channel is set up in both windows and the resolution settings are different. In this case, the higher resolution setting is used to determine the filter length.

The following example uses the resolution parameter to specify a resolution setting of 3. This setting represents 3 significant digits if the measurement suffix is W or %, and 0.01 dB if the suffix is dB or dBm (for further details on the resolution parameter refer to the commands in [Chapter 2, “MEASurement Commands”](#)). Also, in this example the expected power and source list parameters are defaulted. The expected power value is left unchanged at its current setting. The source list parameter is defaulted as described in the note [“Keysight N1914A Only”](#) on page 37. Note that as the source list parameter is the last specified parameter you do not have to specify DEF.

Using READ?

ABOR1	<i>Aborts Channel A</i>
CONF1 DEF, 3	<i>Configures the upper window to make a measurement using the current setting of the expected power and source list and a resolution setting of 3</i>
READ1?	<i>Takes the upper window's measurement. This is Channel A or B measurement depending on current window setup.</i>

Some fine tuning of the above program segment can be carried out for example, by setting the trigger delay off. The following program segment assumes that Channel A is currently being measured on the upper window.

```

1 ABOR1
2 CONF1 DEF, 3
3 TRIG1:DEL:AUTO OFF
4 READ1?

```

Using INITiate and FETCh?

The following program segment assumes that Channel A is currently being measured on the upper window.

ABOR1	<i>Aborts Channel A</i>
CONF1 DEF,3	<i>Configures the upper window to make a measurement using the current setting of the expected power and source list and a resolution setting of 3</i>
INIT1	<i>Causes Channel A to make a measurement</i>
FETC1? DEF,3	<i>Retrieves the upper window's measurement</i>

Some fine tuning of the above program segment can be carried out for example, by setting the trigger delay off.

```

1 ABOR1
2 CONF1 DEF,3
3 TRIG1:DEL:AUTO OFF
4 INIT1:IMM
5 FETC1? DEF,3

```

Example 5 - Making a Difference Measurement

The following program segment can be carried out on the N1914A. It queries the lower window to make a difference measurement of Channel A - Channel B. The expected power level and resolution parameters are defaulted, leaving them at their current settings. Some fine tuning of the measurement is carried out by setting the averaging, and the trigger delay to off.

Using READ?

```

ABOR1
ABOR2
CONF2:POW:AC:DIFF DEF,DEF,(@1),(@2)
SENS1:AVER:COUN 1024
SENS2:AVER:COUN 1024
TRIG1:DEL:AUTO OFF
TRIG2:DEL:AUTO OFF

```

```
READ2:POW:AC:DIFF?
```

```
READ2:POW:AC:DIFF? DEF,DEF,(@2),(@1) (A second READ? query is sent to make a Channel B - Channel A measurement using fresh measurement data).
```

Using INITiate and FETCh?

```
ABOR1
```

```
ABOR2
```

```
CONF2:POW:AC:DIFF DEF,DEF,(@1),(@2)
```

```
SENS1:AVER:COUN 1024
```

```
SENS2:AVER:COUN 1024
```

```
TRIG1:DEL:AUTO OFF
```

```
TRIG2:DEL:AUTO OFF
```

```
INIT1:IMM
```

```
INIT2:IMM
```

```
FETC2:POW:AC:DIFF?
```

```
FETC2:POW:AC:DIFF? DEF,DEF,(@2),(@1) (A second FETCh? query is sent to make a Channel B - Channel A measurement using the current measurement data).
```

Example 6 - Making a Ratio Measurement

The following program segment can be carried out on the N1914A. It queries the lower window to make a ratio measurement of Channel A/B. The expected power level and resolution parameters are defaulted, leaving them at their current settings. Some fine tuning of the measurement is carried out by setting the averaging.

Using READ?

```
ABOR1
```

```
ABOR2
```

```
CONF2:POW:AC:RAT DEF,DEF,(@1),(@2)
```

```
SENS1:AVER:COUN 512
```

```
SENS2:AVER:COUN 256
```

```
READ2:POW:AC:RAT?
```

```
READ2:POW:AC:RAT? DEF,DEF,(@2),(@1) (A second READ? query is sent to make a Channel B - Channel A ratio measurement using fresh measurement data.)
```

Using INITiate and FETCh?

```

ABOR1
ABOR2
CONF2:POW:AC:RAT DEF,DEF,(@1),(@2)
SENS1:AVER:COUN 512
SENS2:AVER:COUN 256
INIT1:IMM
INIT2:IMM
FETC2:POW:AC:RAT?
FETC2:POW:AC:RAT? DEF,DEF,(@2),(@1) (A second FETCh? query is sent to make
a Channel B - Channel A measurement using the current measurement data.)

```

Using the Lower Level Commands

An alternative method of making measurements is to use the lower level commands to set up the expected range and resolution. This can be done using the following commands:

```

[SENSe[1]]|SENSe2:POWER:AC:RANGE
DISPlay[:WINDow[1|2]]:RESolution

```

The measurement type can be set using the following commands in the **CALCuLate** subsystem:

```

CALCuLate[1|2]:MATH[:EXPRession]
CALCuLate[1|2]:RELative[:MAGNitude]

```

The advantage of using the lower level commands over the **CONFigure** command is that they give you more precise control of the power meter. As shown in [Table 1-1](#) the **CONFigure** command presets various states in the power meter. It may be likely that you do not want to preset these states.

Example

The following example sets the expected power value to -50 dBm and the resolution setting to 3 using the lower level commands. The measurement is a single Channel A measurement carried out on the lower window.

ABOR1	<i>Aborts Channel A</i>
CALC2:MATH:EXPR "(SENS1)"	<i>Displays Channel A on lower window</i>
SENS1:POW:AC:RANGE 0	<i>Sets lower range (E-Series sensors and N8480 Series sensors (excluding Option CFT) only)</i>
DISP:WIND2:RES 3	<i>Sets the lower window's resolution to setting 3</i>
INIT1	<i>Causes Channel A to make a measurement</i>
FETC2?	<i>Retrieves the lower window's measurement</i>

Using Frequency Dependent Offset Tables

This section describes how to use frequency dependent offset tables. These tables give you the ability to compensate for frequency effects in your test setup.

Overview

If the `[SENSe[1]]|SENSe2:CORRection:CSET2:STATE` command is **OFF**, the frequency dependent offset tables are not used. When `[SENSe[1]]|SENSe2:CORRection:CSET2:STATE` is **ON**, the frequency dependent offset tables are used, providing you with a quick and convenient method of compensating for your external test setup over a range of frequencies. Note that when selected, frequency dependent offset correction is **IN ADDITION** to any correction applied for sensor frequency response. The power meter is capable of storing 10 frequency dependent offset tables of 80 frequency points each.

To use frequency dependent offset tables you:

- 1 Edit a frequency dependent offset table if necessary.
- 2 Select the frequency dependent offset table.
- 3 Enable the frequency dependent offset table.
- 4 Zero and calibrate the power meter.

If you are using an 8480 Series sensors or N8480 Series sensor with Option CFT, the reference calibration factor used during the calibration must be entered manually.

- 5 Specify the frequency of the signal you want to measure. The required offset is automatically set by the power meter from the frequency dependent offset table.
- 6 Make the measurement.

Figure 1-1 illustrates how frequency dependent offset tables operate.

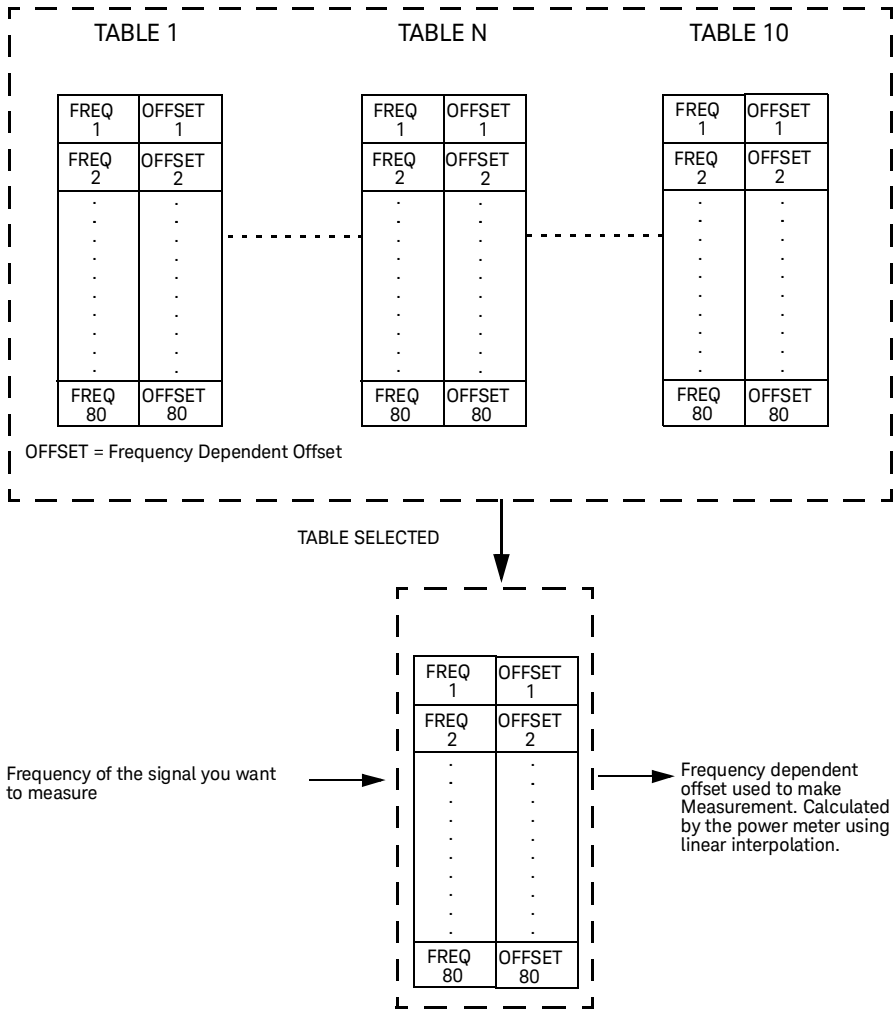

Figure 1-1 Frequency Dependent Offset Tables

Editing Frequency Dependent Offset Tables

It is not possible to create any additional frequency dependent offset tables. However, the 10 existing tables can be edited using the **MEMory** subsystem. To do this:

- 1 Select one of the existing tables using:
MEMory:TABLE:SElect <string>
 For information on naming frequency dependent offset tables see “[Naming Frequency Dependent Offset Tables](#)” on page 53. For information on the current names which you can select refer to “[Listing the Frequency Dependent Offset Table Names](#)” on page 52.
- 2 Enter the frequency data using:
MEMory:TABLE:FREQuency <numeric_value> {,<numeric_value>}
- 3 Enter the offset factors as shown in the table below using:
MEMory:TABLE:GAIN <numeric_value> {,<numeric_value>}

Frequency	Offset
Frequency 1	Offset 1
Frequency 2	Offset 2
..	..
Frequency n	Offset n

- 4 If required, rename the frequency dependent offset table using:
MEMory:TABLE:MOVE <string>,<string>. The first <string> parameter identifies the existing table name, and the second identifies the new table name.

NOTE

The legal frequency suffix multipliers are any of the IEEE suffix multipliers, for example, KHZ, MHZ, and GHZ. If no units are specified the power meter assumes the data is Hz.

PCT is the only legal unit for offset factors and can be omitted.

The frequency and offset data must be within range. Refer to the individual commands in [Chapter 4](#) for their specified ranges.

Any offset values entered into the table should exclude the effect of the sensor. Characterization of the test setup independently of the sensor allows the same table to be used with any sensor.

Ensure that the frequency points you use cover the frequency range of the signals you want to measure. If you measure a signal with a frequency outside the frequency range defined in the frequency dependent offset table, then the power meter uses the highest or lowest frequency point in the table to calculate the offset.

To make subsequent editing of a frequency dependent offset table simpler, it is recommended that you retain a copy of your data in a program.

Listing the Frequency Dependent Offset Table Names

To list the frequency dependent offset tables currently stored in the power meter, use the following command:

MEMory:CATalog:TABLE?

Note that all tables are listed; including sensor calibration tables.

The power meter returns the data in the form of two numeric parameters and a string list representing all stored tables.

– `<numeric_value>, <numeric_value>{, <string>}`

The first numeric parameter indicates the amount of memory, in bytes, used for storage of tables. The second parameter indicates the memory, in bytes, available for tables.

Each string parameter returned indicates the name, type and size of a stored frequency dependent offset table:

– `<string>, <type>, <size>`

The `<string>`, `<type>` and `<size>` are all character data. The `<type>` is always `TABL`. The `<size>` is displayed in bytes.

For example, a sample of the response may look like:

560,8020,"Offset_1,TABL,220","Offset_2,TABL,340"

Naming Frequency Dependent Offset Tables

To rename a frequency dependent offset table use:

MEMory:TABLE:MOVE <string>,<string>

The first <string> parameter identifies the existing table name, and the second identifies the new table name.

The following rules apply to frequency dependent offset table names:

- 1 Table names use a maximum of 12 characters.
- 2 All characters must be upper or lower case alphabetic characters, or numeric (0-9), or an underscore (_).

No spaces are allowed in the name.

Reviewing Table Data

To review the data stored in a frequency dependent offset table, use the following commands:

MEMory:TABLE:SElect "Offset1"

Select the sensor calibration table named "Offset1".

MEMory:TABLE:SElect?

Query command which returns the name of the currently selected table.

MEMory:TABLE:FREQuency:POINTs?

Query command which returns the number of stored frequency points.

MEMory:TABLE:FREQuency?

Query command which returns the frequencies stored in the frequency dependent offset table (in Hz).

MEMory:TABLE:GAIN[:MAGNitude]:POINTs?

Query command which returns the number of offset factor points stored in the frequency dependent offset table.

MEMory:TABLE:GAIN[:MAGNitude]?

Query command which returns the offset factors stored in the frequency dependent offset table.

Modifying Data

If you need to modify the frequency and offset factor data stored in a frequency dependent offset table you need to resend the complete data lists.

If you have retained the original data in a program, edit the program and resend the data.

Selecting a Frequency Dependent Offset Table

After you have created the frequency dependent offset table, you can select it using the following command:

```
[SENSe[1]]|SENSe2:CORRection:CSET2[:SElect] <string>
```

To find out which frequency dependent offset table is currently selected, use the query:

```
[SENSe[1]]|SENSe2:CORRection:CSET2[:SElect]?
```

Enabling a Frequency Dependent Offset Table

To enable the frequency dependent offset table, use the following command:

```
[SENSe[1]]|SENSe2:CORRection:CSET2:STATe ON
```

If you set [SENSe[1]]|SENSe2:CORRection:CSET2:STATe to ON and no frequency dependent offset table is selected error –221, “Settings conflict” occurs.

Making the Measurement

To make the power measurement, set the power meter for the frequency of the signal you want to measure. The power meter automatically sets the calibration factor. Use either the **INITiate**, **FETCh?** or the **READ?** query to initiate the measurement as shown in the following program segments:

INITiate Example

```
ABORt1
CONFIgure1:POWer:AC DEF,1,(@1)
SENS1:CORR:CSET2:SEL "Offset1"
SENS1:CORR:CSET2:STAT ON
```

```
SENSe1:FREQuency 500KHZ
INITiate1:IMMediate
FETCh1?
```

READ? Example

```
ABORt1
CONFIgure1:POWer:AC DEF,2,(@1)
SENS1:CORR:CSET2:SEL "Offset1"
SENS1:CORR:CSET2:STAT ON
SENSe1:FREQuency 500KHZ
READ1?
```

NOTE

If the measurement frequency does not correspond directly to a frequency in the frequency dependent offset table, the power meter calculates the offset using linear interpolation.

If you enter a frequency outside the frequency range defined in the frequency dependent offset table, then the power meter uses the highest or lowest frequency point in the table to set the offset.

To find out the value of the offset being used by the power meter to make a measurement, use the query command:

```
SENSe:CORRection:GAIN4|FDOFFset[:INPut][MAGNITUDE]?
```

The response may be an interpolated value.

Setting the Range, Resolution and Averaging

This section provides an overview of setting the range, resolution and averaging. For more detailed information about these features refer to the individual commands in [Chapter 11, “SENSe Subsystem”](#).

Resolution

You can set the window’s resolution using the following command:

```
DISPlay[:WINDow[1]|2][:NUMeric[1]|2]
:RESolution <numeric_value>
```

There are four levels of resolution available (1 through 4).

When the measurement suffix is W or % this parameter represents the number of significant digits. When the measurement suffix is dB or dBm, 1 through 4 represents 1, 0.1, 0.01, and 0.001 dB respectively.

Refer to the **:RESolution** command on [page 273](#) for further information.

Averaging

The power meter has a digital filter to average power readings. The number of readings averaged can range from 1 to 1024. This filter is used to reduce noise, obtain the desired resolution and to reduce the jitter in the measurement results. However, the time to take the measurement is increased. You can select the filter length or you can set the power meter to auto filter mode. To enable and disable averaging use the following command:

```
[SENSe[1]]|SENSe2:AVERage[:STATe] <boolean>
```

Auto Averaging Mode

To enable and disable auto filter mode, use the following command:

```
[SENSe[1]]|SENSe2:AVERAge:COUNT:AUTO <boolean>
```

When the auto filter mode is enabled, the power meter automatically sets the number of readings averaged together to satisfy the filtering requirements for most power measurements. The number of readings averaged together depends on the resolution and the power level currently being measured. Figure 1-2 lists the number of readings averaged for each range and resolution when the power meter is in auto filter mode.

NOTE

Figure 1-2 applies to 8480 Series only.

Power Sensor Dynamic Range	Minimum Sensor Power	Resolution Setting				Number of Averages
		1	2	3	4	
↑ ↓	10 dB ↑	8	8	128	128	↑ ↓
	10 dB ↓	1	1	16	256	
	10 dB ↓	1	1	2	32	
	10 dB ↓	1	1	1	16	
	10 dB ↓	1	1	1	8	
	Maximum Sensor Power					

Figure 1-2 Typical Averaged Readings on 8480 Series Sensors

Figure 1-3 illustrates part of the power sensor dynamic range hysteresis.

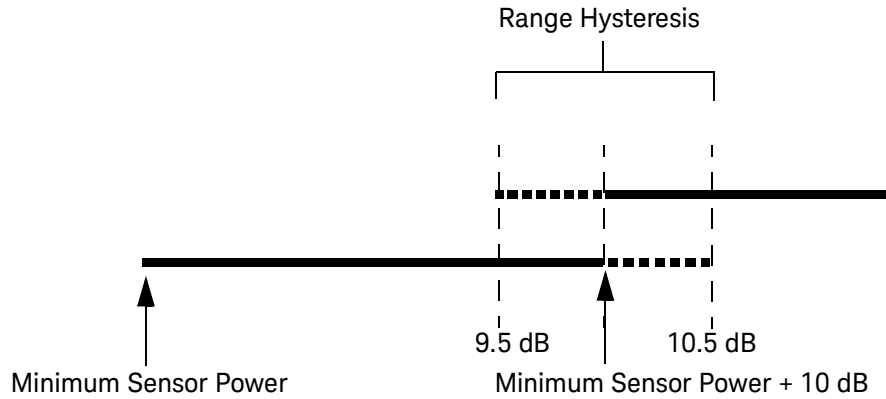

Figure 1-3 Averaging Range Hysteresis

Filter Length

You specify the filter length using the following command:

```
[SENSe[1]]|SENSe2:AVERage:COUNT <numeric_value>
```

The range of values for the filter length is 1 to 1024. Specifying this command disables automatic filter length selection. Increasing the value of the filter length reduces measurement noise. However, the time to take the measurement is increased.

Range

The power meter has no internal ranges which can be set. The only ranges that can be set are those of the E-Series power sensor and N8480 Series power sensors (excluding Option CFT). With an E-Series power sensor or N8480 Series power sensors (excluding Option CFT), the range can be set either automatically or manually. Use autoranging when you are not sure of the power level you will be measuring.

Setting the Range

To set the range manually use the following command:

```
[SENSe[1]]|SENSe2:POWer:AC:RANGe <numeric_value>
```

If the <numeric_value> is set to:

- 0, the sensor's lower range is selected. (For example, this range is -70 to -13.5 dBm for the E4412A power sensor.)
- 1, the sensor's upper range is selected. (For example, this range is -14.5 to +20 dBm for the E4412A power sensor.)

For details on the range limits of other E-Series power sensor and N8480 Series power sensor (excluding Option CFT), refer to the appropriate power sensor manual.

For further information on this command refer to [page 406](#).

To enable autoranging use the following command:

```
[SENSe[1]]|SENSe2:POWer:AC:RANGe:AUTO ON
```

Use autoranging when you are not sure of the power level you will be measuring.

Setting Offsets

Channel Offsets

The power meter can be configured to compensate for signal loss or gain in your test setup (for example, to compensate for the loss of a 10 dB attenuator). You use the **SENSe** command subsystem to configure the power meter. Gain and loss correction are a coupled system. This means that a gain set by `[SENSe[1]]|SENSe2:CORRection:GAIN2` is represented in the `[SENSe[1]]|SENSe2:CORRection:LOSS2?` command. If you enter an offset value the state is automatically enabled. However it can be enabled and disabled using either the `[SENSe[1]]|SENSe2:CORRection:GAIN2:STATe` or `[SENSe[1]]|SENSe2:CORRection:LOSS2:STATe` commands.

LOSS2 is coupled to **GAIN2** by the equation $Loss = \frac{1}{Gain}$ when the default unit is linear, and $Gain = -Loss$ when the default is logarithmic.

NOTE

You can only use **LOSS2** and **GAIN2** for external losses and gains. **LOSS1** and **GAIN1** are specifically for calibration factors.

Display Offsets

Display offset values can be entered using the `CALCuLate[1|2]:GAIN[:MAGNitude]` command. `CALCuLate[1|2]:GAIN:STATe` must be set to **ON** to enable the offset value. If you enter an offset value the state is automatically enabled. This offset is applied after any math calculations (refer to [Figure 1-6](#) on page 71).

Example

The following example program, in HP Basic, details how to use the channel and display offsets on an N1914A making a Channel A/B ratio measurement.

The final result is:

$$\left(\left(\frac{A_{dBm} - 10}{B_{dBm} - 10} \right) - 20 \right)_{dB}$$

```

10 !Create I/O path name
20 ASSIGN @POWER TO 713
30 !Clear the power meter's interface
40 CLEAR @POWER
50 !Set the power meter to a known state
60 OUTPUT @POWER;"*RST"
70 !Configure the Power Meter to make the measurement
80 OUTPUT @Power;"CONF:POW:AC:RAT 20DBM,2,(@1),(@2)"
90 !Set the measurement units to dBm
100 OUTPUT @POWER;"UNIT:POW DBM"
110 !Set the power meter for channel offsets of -10 dB
120 OUTPUT @POWER;"SENS1:CORR:GAIN2 -10"
130 OUTPUT @POWER;"SENS2:CORR:GAIN2 -10"
140 !Enable the gain correction
150 OUTPUT @POWER;"SENS:CORR:GAIN2:STATE ON"
160 OUTPUT @POWER;"SENS2:CORR:GAIN2:STATE ON"
170 !Set the power meter for a display offset of -20 dB
180 OUTPUT @POWER;"CALC1:GAIN -20 DB"
190 PRINT "MAKING THE MEASUREMENT"
200 !Initiate the measurement
210 OUTPUT @Power;"INIT1:IMM"
220 OUTPUT @Power;"INIT2:IMM"
230 ! ... and get the result
240 OUTPUT @Power;"FETC:POW:AC:RAT? 20DBM,2,(@1),(@2)"
250 ENTER @Power;Reading
260 !
270 PRINT "The measurement result is ";Reading;"dB."
280 END

```

For further information on channel offsets refer to [page 382](#). For further information on display offsets refer to [page 200](#).

Setting Measurement Limits

You can configure the power meter to detect when a measurement is outside of a predefined upper and/or lower limit value.

Limits are window or measurement display line based and can be applied to power, ratio or difference measurements.

Setting Limits

The power meter can be configured to verify the power being measured against an upper and/or lower limit value. The range of values that can be set for lower and upper limits is -150.00 dBm to $+230.00$ dBm. The default upper limit is $+90.00$ dBm and the default lower limit is -90.00 dBm.

A typical application for this feature is shown in [Figure 1-4](#).

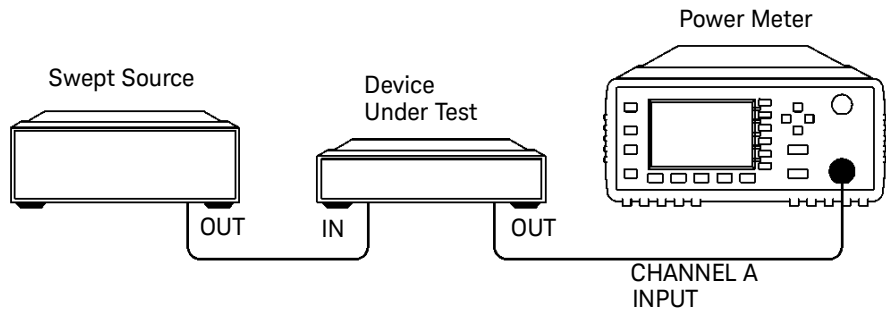

Figure 1-4 Limits Checking Application

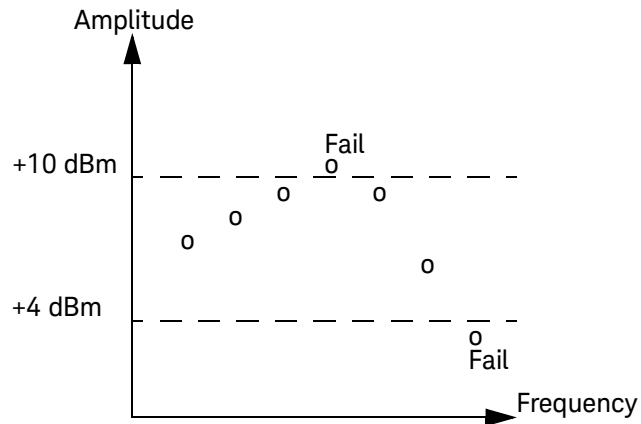

Figure 1-5 Limits Checking Results

The range of values that can be set for the upper and lower limits and the default values depends on the measurement units in the currently measurement line - see [Table 1-3](#).

Table 1-3 Range of Values for Window Limits

Window Units	Default			
	Maximum	Minimum	Maximum	Minimum
dB	+200 dB	-180 dB	60 dB	-120 dB
dBm	+230 dBm	-150 dBm	90 dBm	-90 dBm
%	999.9 X%	100.0 a%	100.0 M%	100.0 p%
W	100.000 XW	1.000 aW	1.000 MW	1.000 pW

Checking for Limit Failures

There are two ways to check for limit failures:

- 1 Use the **SENSE:LIMit:FAIL?** and **SENSE:LIMit:FCOunt?** commands for channel limits or the **CALCulate[1|2]:LIMit:FAIL?** and the **CALCulate[1|2]:LIMit:FCOunt?** for window limits
- 2 Use the **STATus** command subsystem

Using SENSE and CALCulate

Using **SENSE** to check the channel limit failures in [Figure 1-5](#) would return the following results:

SENSE:LIMit:FAIL?

Returns 1 if there has been 1 or more limit failures or 0 if there have been no limit failures. In this case 1 is returned.

SENSE:LIMit:FCOunt?

Returns the total number of limit failures, in this case 2.

Use the equivalent **CALCulate** commands for checking window limit failures.

NOTE

If `TRIGger:DElay:AUTO` is set to `ON`, then the number of failures returned by `SENSe:LIMit:FCOunt?` or `CALCuLate[1|2]:LIMit:FCOunt?` is affected by the current filter settings.

Using STATus

If using GPIB, you can use the **STATus** subsystem to generate an **SRQ** to interrupt your program when a limit failure occurs. This is a more efficient method than using **SENSe** or **CALCuLate**, since you do not need to check the limit failures after every power measurement.

Refer to [“Status Reporting”](#) on page 72 and [“STATus Subsystem”](#) on page 469 for further information.

Getting the Best Speed Performance

This section discusses the factors that influence the speed of operation (number of readings/sec) of a EPM Series power meter.

The following factors are those which have the greatest effect upon measurement speed (in no particular order):

- The selected measurement rate, i.e. **NORMa1**, **DOUBLe**, **FAST**.
- The sensor being used.
- The trigger mode (for example, free run, trigger with delay etc.).
- The output format: **ASCii** or **REAL**.
- The units used for the measurement.
- The command used to take a measurement.

In addition, in **FAST** mode there are other influences which are described in “Fast Mode” on page 70.

The following paragraphs give a brief description of the above factors and how they are controlled from SCPI.

Measurement Rate

There are three possible speed settings **NORMa1**, **DOUBLe** and **FAST**. These are set using the **SENSe:MRATe** command and can be applied to each channel independently.

In **NORMa1** and **DOUBLe** modes, full instrument functionality is available and these settings can be used with all sensors. **FAST** mode is only available for the E-Series sensors. Also, in FAST mode averaging, limits and ratio/difference math functions are disabled.

Refer to “Specifications” in the *EPM Series Power Meters User’s Guide* to see the influence of these speed settings on the accuracy and noise performance of the power meter.

Sensor

Different measurement rates are achievable depending on the sensor type being used, as shown in [Table 1-4](#):

Table 1-4 Model of Sensor and Measurement Rates

Sensor	Measurement Rate		
	NORMAL	DOUBLE	FAST
8480 Series and N8480 Series	20 reading/s	40 reading/s	NA
E-Series E4410 and E9300	50 ms	25 ms	Up to 400
	20 reading/s	40 reading/s	
U2000 Series	20 reading/s	40 reading/s	Up to 110 readings/s

Trigger Mode

The power meter has a very flexible triggering system. For simplicity, it can be described as having three modes:

- Free Run: When a channel is in Free Run, it continuously takes measurements on this channel. A channel is in free run when **INITiate:CONTinuous** is set to **ON** and **TRIGger:SOURce** is set to **IMMediate**.
- Triggered Free Run: When a channel is in Triggered Free Run Continuous Trigger, it takes a new measurement each time a trigger event is detected. A channel is in Triggered Free Run Continuous Trigger when **INITiate:CONTinuous** is set to **ON** and **TRIGger:SOURce** is not set to **IMMediate**.
- Single Shot: When a channel is in Single Shot, it takes a new measurement when a trigger event is detected and then returns to the idle state. A channel is in Single Shot when **INITiate:CONTinuous** is set to **OFF**. Note that a measurement can take several INT/EXT triggers depending on the filter settings. Refer to “**TRIGger[1]|2|3|4:DELay:AUTO <boolean>**” on page 560 for further information.

NOTE

A trigger event can be any of the following:

- The input signal meeting the trigger level criteria.
 - Auto-level triggering being used.
 - A TRIGger GET or *TRG command being sent.
 - An external TTL level trigger being detected.
-

Trigger with Delay

This can be achieved using the same sequences above (apart from the second) with **TRIG:DEL:AUTO** set to **ON**. Also, the **MEAS?** command operates in trigger with delay mode.

In trigger with delay mode, a measurement is not completed until the power meter filter is full. In this way, the reading returned is guaranteed to be settled. In all other modes, the result returned is simply the current result from the filter and may or may not be settled. This depends on the current length of the filter and the number of readings that have been taken since a change in power level.

With trigger with delay enabled, the measurement speed can be calculated roughly using the following equation:

$$\text{readings/sec} = \text{speed (as set by SENSE:SPEed)} / \text{filter length}$$

For example, with a filter length of 4 and **SENS:SPE** set to **20**, approximately 5 readings/sec is calculated by the power meter.

Typically, free run mode provides the best speed performance from the power meter (especially in 200 readings/sec mode).

Output Format

The power meter has two output formats for measurement results: **AScii** and **REAL**. These formats are selected using the **FORMat** command. When **FORMat** is set to **REAL**, the returned result is in IEEE 754 floating-point format (note that the byte order can be changed using **FORMat:BORDER**) plus <LF> as an end sentinel of the block.

The **REAL** format is likely to be required only for **FAST** mode as it reduces the amount of bus traffic.

Units

The power meter can output results in either linear or log units. The internal units are linear, therefore optimal performance is achieved when the results output are also in linear units (since the overhead of performing a log function is removed).

Command Used

In Free Run mode, **FETCh?** must be used to return a result.

In other trigger modes, there are a number of commands which can be used, for example, **MEASure?**, **READ?**, **FETCh?** Note that the **MEAS?** and **READ?** commands are compound commands—they perform a combination of other lower level commands. Typically, the best speed performance is achieved using the low level commands directly.

Trigger Count

To get the fastest measurement speed the a **TRIG:COUNT** must be set to return multiple measurements for each **FETCh** command. For average only measurements a count of 4 is required, however, 10 is recommended.

Fast Mode

In the highest speed setting, the limiting factor tends to be the speed of the controller being used to retrieve results from the power meter, and to a certain extent, the volume of remote traffic. The latter can be reduced using the **FORMat REAL** command to return results in binary format. The former is a combination of two factors:

- the hardware platform being used
- the programming environment being used

How Measurements are Calculated

Figure 1-6 details how measurements are calculated. It shows the order in which the various power meter functions are implemented in the measurement calculation.

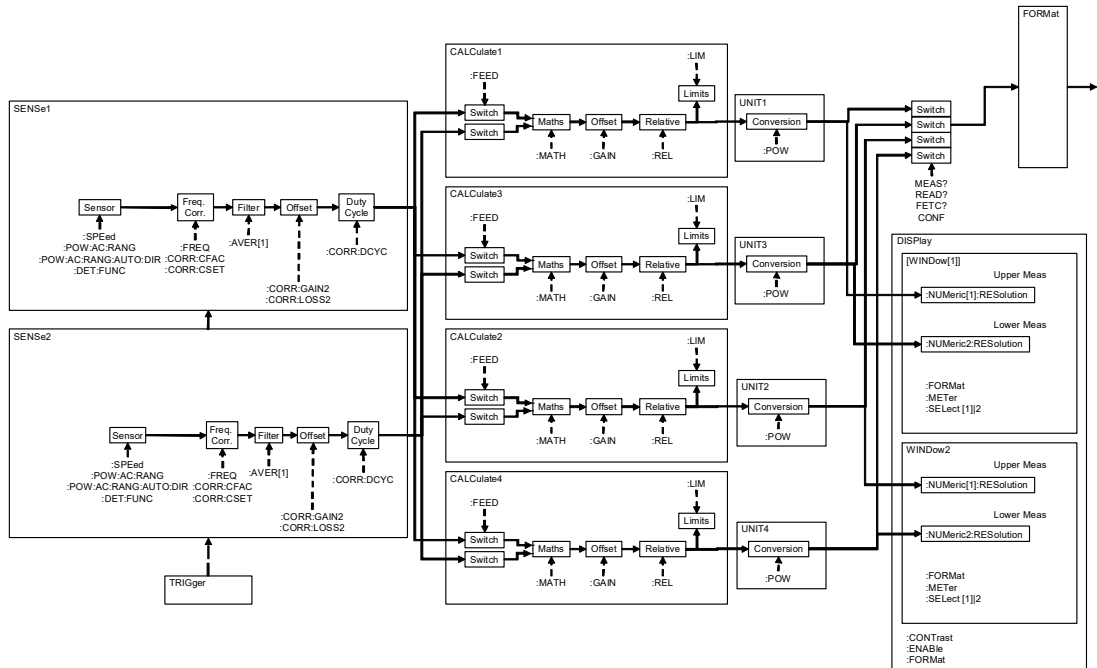

Figure 1-6 How Measurement are Calculated

The MEASure commands in this figure can be replaced with the FETCh? and READ? commands.

NOTE

All references to Channel B in the above diagram refer to the N1914A only.

Status Reporting

Status reporting is used to monitor the power meter to determine when events have occurred. Status reporting is accomplished by configuring and reading status registers.

The power meter has the following main registers:

- Status Register
- Standard Event Register
- Operation Status Register
- Questionable Status Register
- Device Status Register

There are other registers that exist “behind” the main registers, and are described later in this chapter.

Status and Standard Event registers are read using the IEEE-488.2 common commands.

Operation and Questionable Status registers are read using the SCPI **STATus** command subsystem.

The General Status Register Model

The generalized status register model shown in [Figure 1-7](#) is the building block of the SCPI status system. This model consists of a condition register, a transition filter, an event register and an enable register. A set of these registers is called a status group.

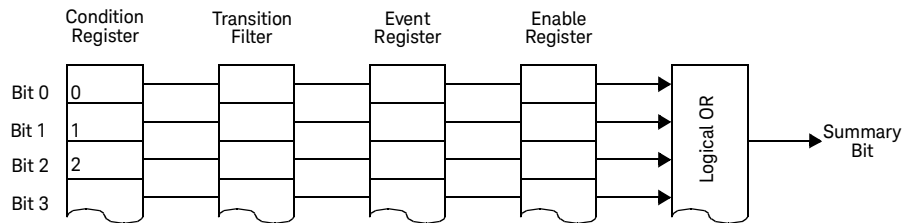

Figure 1-7 Generalized Status Register Model

When a status group is implemented in an instrument, it always contains all of the component registers. However, there is not always a corresponding command to read or write to every register.

Condition Register

The condition register continuously monitors the hardware and firmware status of the power meter. There is no latching or buffering for this register, it is updated in real time. Condition registers are read-only.

Transition Filter

The transition filter specifies which types of bit state changes in the condition registers and set corresponding bits in the event register. Transition filter bits may be set for positive transitions (PTR), negative transitions (NTR), or both. Transition filters are read-write. They are unaffected by ***CLS** or queries. After **STATUS:PRESet** the NTR register is set to **0** and all bits of the PTR are set to **1**.

Event Register

The event register latches transition events from the condition register as specified by the transition filter. Bits in the event register are latched and on setting they remain set until cleared by a query or a ***CLS**. Also on setting, an event bit is no longer affected by condition changes. It remains set until the event register is cleared; either when you read the register or when you send the ***CLS** (clear status) command. Event registers are read-only.

Enable Register

The enable register specifies the bits in the event register that can generate a summary bit. The instrument logically ANDs corresponding bits in the event and enable registers and ORs all the resulting bits to obtain a summary bit. Enable registers are read-write. Querying an enable register does not affect it.

An Example Sequence

Figure 1-8 illustrates the response of a single bit position in a typical status group for various settings. The changing state of the condition in question is shown at the bottom of the figure. A small binary table shows the state of the chosen bit in each status register at the selected times T1 to T5.

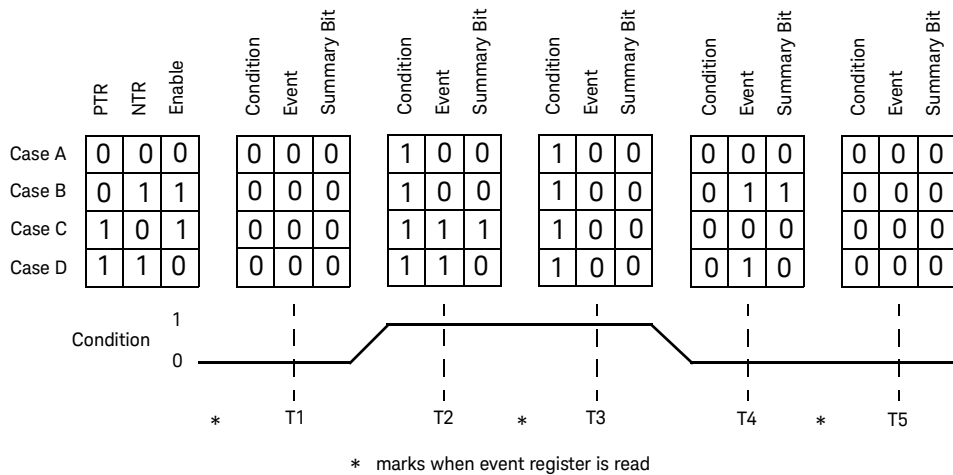

Figure 1-8 Typical Status Register Bit Changes

How to Use Register

There are two methods to access the information in status groups:

- the polling method, or
- the service request (SRQ) method. (GPIB mode only)

Use the polling method when:

- your language/development environment does not support SRQ interrupts.
- you want to write a simple, single purpose program and do not want to add the complexity of setting an SRQ handler.

Use the SRQ method when you:

- need time critical notification of changes.
- are monitoring more than one device which supports SRQ interrupts.
- need to have the controller do something else while it is waiting.
- cannot afford the performance penalty inherent to polling.

The Condition Polling Method

In this polling method, the power meter has a passive role. It only informs the controller that conditions have changed when the controller asks. When you monitor a condition with the polling method, you must:

- 1** Determine which register contains the bit that monitors the condition.
- 2** Send the unique query that reads that register.
- 3** Examine the bit to see if the condition has changed.

The polling method works well if you do not need to know about the changes the moment they occur. The SRQ method is more effective if you must know immediately when a condition changes. Detecting an immediate change in a condition using the polling method requires your program to continuously read the registers at very short intervals. This is not particularly efficient and there is a possibility that an event may be missed.

For example on measurement polling, refer to [Figure A-1](#) on page 629.

The SRQ Method

When a bit of the Status Register is set and has been enabled to assert **SRQ** (***SRE** command), the power meter sets the GPIB SRQ line true. This interrupt can be used to interrupt your program, suspending its current operation, and find out what service the power meter requires. Refer to your computer and language manuals for information on how to program the computer to respond to the interrupt.

To allow any of the Status Register bits to set the SRQ line true, you must enable the appropriate bit(s) with the ***SRE** command. For example, if your application requires an interrupt whenever a message is available in the output queue (Status Register bit 4, decimal weight 16). To enable bit 4 to assert **SRQ**, use the command ***SRE 16**.

NOTE

You can determine which bits are enabled in the Status Register using ***SRE?**. This command returns the decimal weighted sum of all the bits.

Procedure

- Send a bus device clear message
- Clear the event registers with the ***CLS** (clear status) command
- Set the ***ESE** (standard event register) and ***SRE** (status byte register) enable masks
- Enable your bus controller's IEEE-488 SRQ interrupt

Examples

The following two examples are written in HP BASIC and illustrate possible uses for SRQ. In both cases, it is assumed that the power meter has been zeroed and calibrated.

Example 1:

```

10  ! Program to generate an SRQ when a channel A sensor
20  ! connect or disconnect occurs
30  !
40  ASSIGN @Pm TO 713  ! Power meter GPIB address
50  ON ON INTR 7 GOTO Srq_i! Define service request handler
60  CLEAR @Pm          ! Selective device clear
70  OUTPUT @Pm;"*CLS;*RST" ! Clear registers and reset meter
80  !
90  ! Configure the device status register so that a sensor
100 ! connect or disconnect on channel A will cause an SRQ.
110 !
120 OUTPUT @Pm;"STAT:DEV:ENAB 2"
130 OUTPUT @Pm;"STAT:DEV:NTR 2"
140 OUTPUT @Pm;"STAT:DEV:PTR 2"
150 OUTPUT @Pm;"*SRE 2"
160 !
170 ENABLE INTR 7;2 ! Enable an SRQ to cause an interrupt
180 LOOP           ! Idle loop
190 ! Forever
200 END LOOP
210 !
220 ! When a SRQ is detected, the following routine will service it.
230 !
240   Srq_i:      !
250   St=SPOLL(@Pm) ! Serial Poll (reads status byte)
260   IF BIT(St,1)=1 THEN ! Device status reg bit set ?
270     OUTPUT @Pm;"STAT:DEV:EVEN?" ! Yes , read register
280     ENTER @Pm;Event           ! (this also clears it)
290     OUTPUT @Pm;"STAT:DEV:COND?"
300     ENTER @Pm;Cond
310     IF Cond=0 THEN
320       PRINT "Sensor disconnected"
330     ELSE
340       PRINT "Sensor connected"
350     END IF
360   END IF
370   GOTO 170           ! Return to idle loop
380   END

```

Example 2:

```

10  ! Program to generate an SRQ when an over limit
20  ! condition occurs.
30  !
40  ASSIGN @Pm TO 713      ! Power meter GPIB address
50  ON INTR 7 GOTO Srq_i  ! Define service request handler
60  CLEAR @Pm              ! Selective device clear
70  OUTPUT @Pm;"*CLS"      ! Clear registers
80  OUTPUT @Pm;"SYST:PRES" ! Preset meter
90  !
100 ! Set upper limit to 2dBm and configure the operation status
110 ! so that an over limit condition will cause an SRQ.
120 !
130 OUTPUT @Pm;"CALC:LIM:UPP 2DBM"
140 OUTPUT @Pm;"CALC:LIM:STAT ON"
150 OUTPUT @Pm;"STAT:OPER:PTR 4096"
160 OUTPUT @Pm;"STAT:OPER:ENAB 4096"
170 OUTPUT @Pm;"*SRE 128"
180 !
190 ENABLE INTR 7;2 ! Enable an SRQ to cause an interrupt
200 LOOP           ! Idle loop
210 ! Forever
220 END LOOP
230 !
240 ! When a SRQ is detected, the following routine will service it.
250 !

260 Srq_i:      !
270 St=SPOLL(@Pm) ! Serial Poll (reads status byte)
280 IF BIT(St,7)=1 THEN ! Operation status bit set?
290   OUTPUT @Pm;"STAT:OPER?"! Yes , read register
300   ENTER @Pm;Oper      ! (this also clears it)
310   OUTPUT @Pm;"STAT:OPER:ULF?"
320   ENTER @Pm;Ulf
330   IF Ulf=2 THEN PRINT "Over limit detected"
340 END IF
350 GOTO 190             ! Return to idle loop
360 END

```

Status Registers

The Status System in the power meter is shown in [Figure 1-9](#). The Operation Status and Questionable Status groups are 16 bits wide, while the Status Byte and Standard Event groups are 8 bits wide. In all 16-bit groups, the most significant bit (bit 15) is not used and is always set to 0.

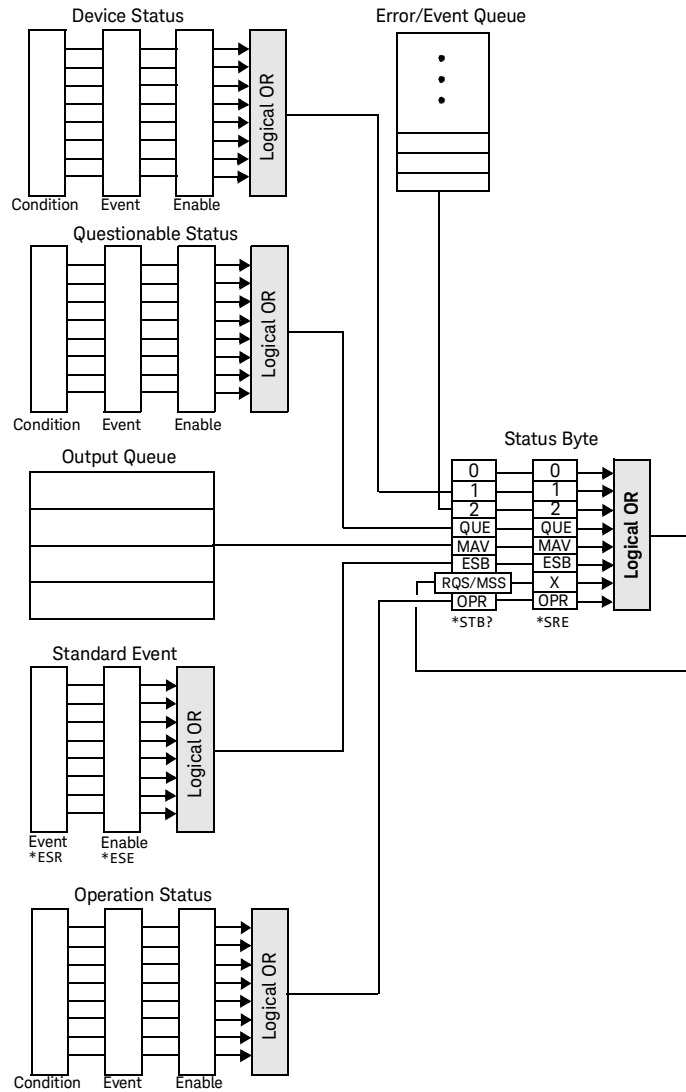

Figure 1-9 Status System

The Status Byte Summary Register

The status byte summary register reports conditions from other status registers. Query data waiting in the power meter's output buffer is immediately reported through the "message available" bit (bit 4). Clearing an event register clears the corresponding bits in the status byte summary register. Reading all messages in the output buffer, including any pending queries, clears the message available bit.

Table 1-5 Bit Definitions - Status Byte Register

Bit Number	Decimal Weight	Definition
0	1	Not Used (Always set to 0)
1	2	Device Status Register summary bit. One or more bits are set in the Device Status Register (bits must be "enabled" in enable register)
2	4	Error/Event Queue
3	8	Questionable Status Register summary bit. One or more bits are set in the Questionable Status Register (bits must be "enabled" in enable register).
4	16	Data Available Data is available in the power meter's output buffer.
5	32	Standard Event One or more bits are set in the Standard Event register (bits must be "enabled" in enable register).
6	64	Request Service The power meter is requesting service (serial poll).
7	128	Operation Status Register summary bit. One or more bits are set in the Operation Status Register (bits must be "enabled" in enable register).

Particular bits in the status byte register are cleared when:

- The standard event, Questionable status, operation status and device status are queried.
- The error/event queue becomes empty.
- The output queue becomes empty.

The status byte enable register (**SRE**, service request enable) is cleared when you:

- cycle the instrument power.
- execute a ***SRE 0** command.

Using ***STB?** to Read the Status Byte

The ***STB?** (status byte query) command is similar to a serial poll except it is processed like any other power meter command. The ***STB?** command returns the same result as an IEEE-488 serial poll except that the request service bit (bit 6) *is not* cleared if a serial poll has occurred. The ***STB?** command is not handled automatically by the IEEE-488 bus interface hardware and the command is executed only after previous commands have completed. Using the ***STB?** command does not clear the status byte summary register.

The Standard Event Register

The standard event register reports the following types of instrument events: power-on detected, command and syntax errors, command execution errors, self-test or calibration errors, query errors, or when an overlapped command completes following a ***OPC** command. Any or all of these conditions can be reported in the standard event summary bit through the enable register. You must write a decimal value using the ***ESE** (event status enable) command to set the enable register mask.

Table 1-6 Bit Definitions - Standard Event Register

Bit Number	Decimal Value	Definition
0	1	Operation Complete All overlapped commands following an *OPC command have been completed.
1	2	Not Used. (Always set to 0.)
2	4	Query Error A query error occurred, refer to error numbers 410 to 440 in the user's guide.
3	8	Device Error A device error occurred, refer to error numbers 310 to 350 in the user's guide.
4	16	Execution Error An execution error occurred, refer to error numbers 211 to 241 in the user's guide.
5	32	Command Error A command syntax error occurred, refer to error numbers 101 to 161 in the user's guide.

Bit Number	Decimal Value	Definition
6	64	User request.
7	128	Power On Power has been turned off and on since the last time the event register was read or cleared.

The standard event register is cleared when you:

- send a ***CLS** (clear status) command.
- query the event register using the ***ESR?** (event status register) command.

The standard event enable register is cleared when you:

- cycle the instrument power.
- execute a ***ESE 0** command.

Questionable Status Register

The questionable status register provides information about the quality of the power meter's measurement results. Any or all of these conditions can be reported in the questionable data summary bit through the enable register. You must write a value using the **STATus:QUESTionable:ENABLE** command to set the enable register mask.

The questionable status model is shown in the pullout at the end of this chapter.

The following bits in these registers are used by the power meter.

Table 1-7 Bit Definitions - Questionable Status Registers

Bit Number	Decimal Weight	Definition
0 to 2	-	Not used
3	8	POWer Summary
4 to 7	-	Not used
8	256	CALibration Summary
9	512	Power On Self Test
10 to 14	-	Not Used
15	-	Not used (always 0)

The condition bits are set and cleared under the following conditions:

Table 1-8 Bit change conditions for Questionable Status Register

Bit Number	Meaning	EVENTs Causing Bit Changes
3	POWer Summary	<p>This is a summary bit for the Questionable POWer Register.</p> <ul style="list-style-type: none"> - SET: <ul style="list-style-type: none"> Error -230, "Data corrupt or stale" Error -231, "Data questionable;Input Overload" Error -231, "Data questionable;Input Overload ChA"^[a] Error -231, "Data questionable;Input Overload ChB"^[a] Error -231, "Data questionable;PLEASE ZERO" Error -231, "Data questionable;PLEASE ZERO ChA"^[a] Error -231, "Data questionable;PLEASE ZERO ChB"^[a] Error -231, "Data questionable;Lower window log error"^[a] Error -231, "Data questionable;Upper window log error"^[a] - CLEARED: When no errors are detected by the power meter during a measurement covering the causes given for it to set.

Bit Number	Meaning	EVENTs Causing Bit Changes
8	CALibration Summary	<p>This is a summary bit for the Questionable CALibration Register.</p> <ul style="list-style-type: none"> - SET: These may be caused by CALibration[1 2]:ZERO:AUTO ONCE or CALibration[1 2]:AUTO ONCE or CALibration[1 2][:ALL] or CALibration[1 2][:ALL]? Error -231, "Data questionable; ZERO ERROR" Error -231, "Data questionable; ZERO ERROR ChA"^[a] Error -231, "Data questionable; ZERO ERROR ChB"^[a] Error -231, "Data questionable; CAL ERROR" Error -231, "Data questionable; CAL ERROR ChA"^[a] Error -231, "Data questionable; CAL ERROR ChB"^[a] - CLEARED: When any of the commands listed above succeed and no errors are placed on the error queue.
9	Power On Self Test	<ul style="list-style-type: none"> - SET: This bit is set when the power on self test fails. - CLEARED: When the power on self test passes.

[a] N1914A only

Operation Status

The Operation Status group monitors conditions in the power meter's measurement process.

The Operation status model is shown in the pullout at the end of this chapter.

The following bits in these registers are used by the power meter:

Table 1-9 Bit Definitions - Operation Status

Bit Number	Decimal Weight	Definition
0	1	CALibrating Summary
1 - 3	-	Not used
4	16	MEASuring Summary
5	32	Waiting for TRIGger Summary
6 - 9	-	Not used
10	1024	SENSe Summary

Bit Number	Decimal Weight	Definition
11	2048	Lower Limit Fail Summary
12	4096	Upper Limit Fail Summary
13 to 14	-	Not used
15	-	Not used (always 0)

The condition bits are set and cleared under the following conditions:

Table 1-10 Bit change conditions for Operation Status

Bit Number	Meaning	EVENTs Causing Bit Changes
0	CALibrating	This is a summary bit for the Operation CALibrating Register. <ul style="list-style-type: none"> - SET: At beginning of zeroing (CALibration:ZERO:AUTO ONCE) and at the beginning of calibration (CALibration:AUTO ONCE). Also for the compound command/query CALibration[:ALL]?, this bit is set when sensor zeroing begins. - CLEARED: At the end of zeroing or calibration.
4	MEASuring	This is a summary bit for the Operation MEASuring Register. <ul style="list-style-type: none"> - SET: When the power meter is taking a measurement. - CLEARED: When the measurement is finished.
5	Waiting for TRIGger	This is a summary bit for the Operation TRIGger Register. <ul style="list-style-type: none"> - SET: When the power meter enters the “wait for trigger” state. - CLEARED: When the power meter enters the “idle” state.
10	SENSe	This is a summary bit for the Operation SENSe Register. <ul style="list-style-type: none"> - SET: When the power meter is reading data from the power sensor’s EEPROM. - CLEARED: When the power meter is not reading data from the power sensor’s EEPROM.
11	Lower Limit Fail	This is a summary bit for the Lower Limit Fail Register. <ul style="list-style-type: none"> - SET: If a measurement is made and either a channel or window lower limit test fails. - CLEARED: If a measurement is made and the lower limit test is not enabled or the test is enabled and passes.
12	Upper Limit Fail	This is a summary bit for the Upper Limit Fail Register. <ul style="list-style-type: none"> - SET: If a measurement is made and either a channel or window upper limit test fails. - CLEARED: If a measurement is made and the upper limit test is not enabled or the test is enabled and passes.

Device Status Register

The device status register set contains bits which give device dependent information.

The following bits in these registers are used by the power meter:

Table 1-11 Bit Definitions - Device Status Register

Bit Number	Decimal Weight	Definition
0	-	Not used
1	2	Channel A sensor connected
2	4	Channel B sensor connected (N1914A only)
3	8	Channel A sensor error
4	16	Channel B sensor error (N1914A only)
5	32	Channel A sensor Front/Rear
6	64	Channel B sensor Front/Rear (N1914A only)
7	128	Channel C sensor connected
8	256	Channel D sensor connected
9	512	Not used
10	1024	Not used
11	2048	Battery critical
12	4096	Over temperature
13	8192	Fan failed
14	16384	Front panel key press
15	-	Bit 15 always 0

The condition bits are set and cleared under the following conditions:

Table 1-12 Bit change conditions for Device Status Register

Bit Number	Meaning	EVENTs Causing Bit Changes
1	Channel A sensor connected	<ul style="list-style-type: none"> – SET: When a power sensor is connected to the Channel A input. – CLEARED: When no power sensor is connected to the Channel A input.
2	Channel B sensor connected	<ul style="list-style-type: none"> – SET: When a power sensor is connected to the Channel B input. – CLEARED: When no power sensor is connected to the Channel B input.
3	Channel A error	<ul style="list-style-type: none"> – SET: If the power sensor EEPROM on Channel A has failed or if there are power sensors connected to both the rear and front panel Channel A connectors. – CLEARED: In every other condition.
4	Channel B error	<ul style="list-style-type: none"> – SET: If the power sensor EEPROM on Channel B has failed or if there are power sensors connected to both the rear and front panel Channel B connectors. – CLEARED: In every other condition.
5	Channel A Front/Rear	<ul style="list-style-type: none"> – SET: If a power sensor is connected to the Channel A rear panel. – CLEARED: If a power sensor is connected to the Channel A front panel.
6	Channel B Front/Rear	<ul style="list-style-type: none"> – SET: If a power sensor is connected to the Channel B rear panel. – CLEARED: If a power sensor is connected to the Channel B front panel.
7	Channel C sensor connected	<ul style="list-style-type: none"> – SET: When a power sensor is connected to the Channel C input. – CLEARED: When no power sensor is connected to the Channel C input.
8	Channel D sensor connected	<ul style="list-style-type: none"> – SET: When a power sensor is connected to the Channel D input. – CLEARED: When no power sensor is connected to the Channel D input.
11	Battery critical	This is an event, and DOES NOT set the condition register. The bit is set in the event register which is cleared when read. Note that the transition registers are of no use for this bit.
12	Over temperature	This is an event, and DOES NOT set the condition register. The bit is set in the event register which is cleared when read. Note that the transition registers are of no use for this bit.
13	Fan failed	This is an event, and DOES NOT set the condition register. The bit is set in the event register which is cleared when read. Note that the transition registers are of no use for this bit.
14	Front Panel Key Press	This is an event, and DOES NOT set the condition register. The bit is set in the event register which is cleared when read. Note that the transition registers are of no use for this bit.

Using the Operation Complete Commands

The ***OPC?** and ***OPC** commands allow you to maintain synchronization between the computer and the power meter. The ***OPC?** query command places an ASCII character 1 into the power meter's output queue when all pending power meter commands are complete. If your program reads this response before continuing program execution, you can ensure synchronization between one or more instruments and the computer.

The ***OPC** command sets bit 0 (Operation Complete) in the Standard Event Status Register when all pending power meter operations are complete. By enabling this bit to be reflected in the Status Register, you can ensure synchronization using the GPIB serial poll.

NOTE

For LAN and USB use the ***STB?** command. See [“Using *STB? to Read the Status Byte”](#) on page 82.

Procedure

- Send a device clear message to clear the power meter's output buffer.
- Clear the event registers with the ***CLS** (clear status) command.
- Enable operation complete using the ***ESE 1** command (standard event register).
- Send the ***OPC?** (operation complete query) command and enter the result to assure synchronization.
- Send your programming command string, and place the ***OPC** (operation complete) command as the last command.
- Send the ***STB?** (status byte query) command to poll the register. This command does not clear the status byte summary register.

In GPIB mode only you can use a serial poll to check to see when bit 5 (standard event) is set in the status byte summary register. You could also configure the power meter for an SRQ interrupt by sending ***SRE 32** (status byte enable register, bit 5).

Examples

This example program uses the ***OPC?** command to determine when the power meter has finished calibrating.

```
CAL:AUTO ONCE
*OPC?
MEAS:POW:AC?
```

This example GPIB program, in HP Basic, uses the ***OPC** command and serial poll to determine when the power meter has finished calibrating. The advantage to using this method over the ***OPC?** command is that the computer can perform other operations while it is waiting for the power meter to finish calibrating.

```
10 ASSIGN @Power TO 713
20 OUTPUT @Power;"*CLS"
30 OUTPUT @Power;"*ESE 1"
40 OUTPUT @Power;"CAL:AUTO ONCE;*OPC"
50 WHILE NOT BIT(S POLL(@Power),5)
60 !(Computer carries out other operations here)
70 END WHILE
80 OUTPUT @Power;"MEAS:POW:AC?"
90 ENTER @Power;Result
100 PRINT Result
110 END
```

Saving and Recalling Power Meter Configurations

To reduce repeated programming, up to ten power meter configurations can be stored in the power meter's non-volatile memory. The error list, remote addresses, sensor calibration table data, zeroing and calibration information are not stored.

How to Save and Recall a Configuration

Power meter configurations are saved and recalled with the following commands:

```
*SAV <NRF>
*RCL <NRF>
```

The range of values for <NRF> in the above commands is 1 to 10.

Example Program

```
10 ASSIGN @POWER TO 713
20 !Configure the power meter
30 OUTPUT @POWER;"UNIT:POW W"
40 OUTPUT @POWER;"SENS:CORR:LOSS2 -10"
50 OUTPUT @POWER;"SENS:CORR:LOSS2:STAT ON"
60 !Save the configuration
70 OUTPUT @POWER;"*SAV 5"
80 PRINT "Configuration Saved"
90 !Now reset the power meter
100 OUTPUT @POWER;"*RST"
110 ! Recall the configuration
120 OUTPUT @POWER;"*RCL 5"
130 PRINT "Configuration Recalled"
140 PRINT "Save and Recall complete"
150 END
```

Using Device Clear to Halt Measurements

Device clear is an IEEE-488 low-level bus message which can be used to halt measurements in progress. Different programming languages and IEEE-488 interface cards provide access to this capability through their own unique commands. The status registers, the error queue, and all configuration states are left unchanged when a device clear message is received. Device clear performs the following actions.

- All measurements in progress are aborted.
- The power meter returns to the trigger “idle state”.
- The power meter’s input and output buffers are cleared.
- The power meter is prepared to accept a new command string.

NOTE

For interfaces the that do not support a low-level device clear, use the **ABORT** command.

An Introduction to the SCPI Language

Standard Commands for Programmable Instruments (SCPI) defines how you communicate with an instrument from a bus controller. The SCPI language uses a hierarchical structure similar to the file systems used by many bus controllers. The command tree is organized with root-level commands (also called subsystems) positioned at the top, with multiple levels below each root-level command. You must specify the complete path to execute the individual lower-level commands.

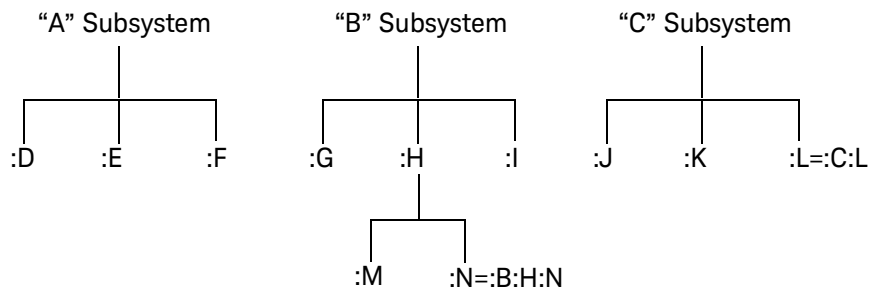

Figure 1-10 Hierarchical structure of SCPI

Mnemonic Forms

Each keyword has both a long and a short form. A standard notation is used to differentiate the short form keyword from the long form keyword. The long form of the keyword is shown, with the short form portion shown in uppercase characters, and the rest of the keyword shown in lowercase characters. For example, the short form of **TRIGger** is **TRIG**.

Using a Colon (:)

When a colon is the first character of a command keyword, it indicates that the next command mnemonic is a root-level command. When a colon is inserted between two command mnemonics, the colon moves the path down one level in the present path (for the specified root-level command) of the command tree. You *must* separate command mnemonics from each other using a colon. You *can omit* the leading colon if the command is the first of a new program line.

Using a Semicolon (;)

Use a semicolon to separate two commands within the same command string. The semicolon does not change the present path specified. For example, the following two statements are equivalent. Note that in the first statement the first colon is optional but the third is compulsory.

```
:DISP:FORM DIG;:DISP:RES 2  
:DISP:FORM DIG;RES 2
```

Using a Comma (,)

If a command requires more than one parameter, you must separate adjacent parameters using a comma.

Using Whitespace

You *must* use whitespace characters, [tab], or [space] to separate a parameter from a command keyword. Whitespace characters are generally ignored *only* in parameter lists.

Using “?” Commands

The bus controller may send commands at any time, but a SCPI instrument may only send responses when *specifically* instructed to do so. Only query commands (commands that end with a “?”) instruct the instrument to send a response message. Queries return either measured values or internal instrument settings.

NOTE

If you send two query commands without reading the response from the first, then attempt to read the second response, you may receive some data from the first response followed by the complete second response. To avoid this, do not send a query command without reading the response. When you cannot avoid this situation, send a device clear before sending the second query command.

Using “*” Commands

Commands starting with a “*” are called common commands. They are required to perform the identical function for *all* instruments that are compliant with the IEEE-488.2 interface standard. The “*” commands are used to control reset, self-test, and status operations in the power meter.

Syntax Conventions

Throughout this guide, the following conventions are used for SCPI command syntax.

- Square brackets ([]) indicate optional keywords or parameters.
- Braces ({}) enclose one or more parameters that may be included zero or more times.
- Triangle brackets (<>) indicate that you must substitute a value for the enclosed parameter.
- Bars (|) can be read as “or” and are used to separate alternative parameter options.

Syntax Diagram Conventions

- Solid lines represent the recommended path.
- Ovals enclose command mnemonics. The command mnemonic must be entered exactly as shown.
- Dotted lines indicate an optional path for by passing secondary keywords.
- Arrows and curved intersections indicate command path direction.

SCPI Data Types

The SCPI language defines different data formats for use in program messages and response messages. Instruments are flexible listeners and can accept commands and parameters in various formats. However, SCPI instruments are precise talkers. This means that SCPI instruments *always* respond to a particular query in a predefined, rigid format.

<boolean> Definition

Throughout this document <boolean> is used to represent **ON**|**OFF**|<NRF>. boolean parameters have a value of 0 or 1 and are unitless. **ON** corresponds to **1** and **OFF** corresponds to **0**.

On input, an <NRF> is rounded to an integer. A nonzero result is interpreted as **1**.

Queries always return a **1** or **0**, never **ON** or **OFF**.

<character_data> Definition

Throughout this document <character_data> is used to represent character data, that is, A -Z, a -z, 0 -9 and _ (underscore). For example: START and R6_5F. The format is defined as:

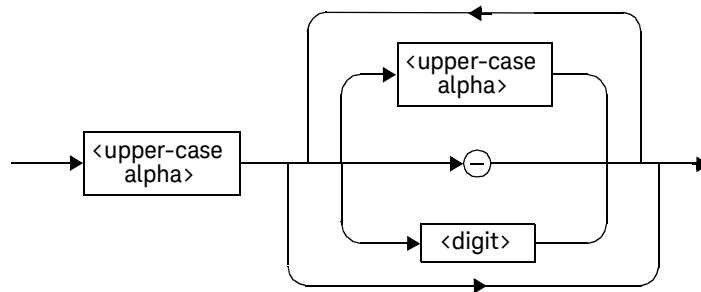

Figure 1-11 Format of <character_data>

<NaN> Definition

Not a number (NaN) is represented as 9.91 E37. Not a number is defined in IEEE 754.

<non-decimal numeric> Definition

Throughout this document <non-decimal numeric> is used to represent numeric information in bases other than ten (that is, hexadecimal, octal and binary). The following syntax diagram shows the standard for these three data structures. For examples, #HA2F, #ha4e, #Q62, #q15, #B01011.

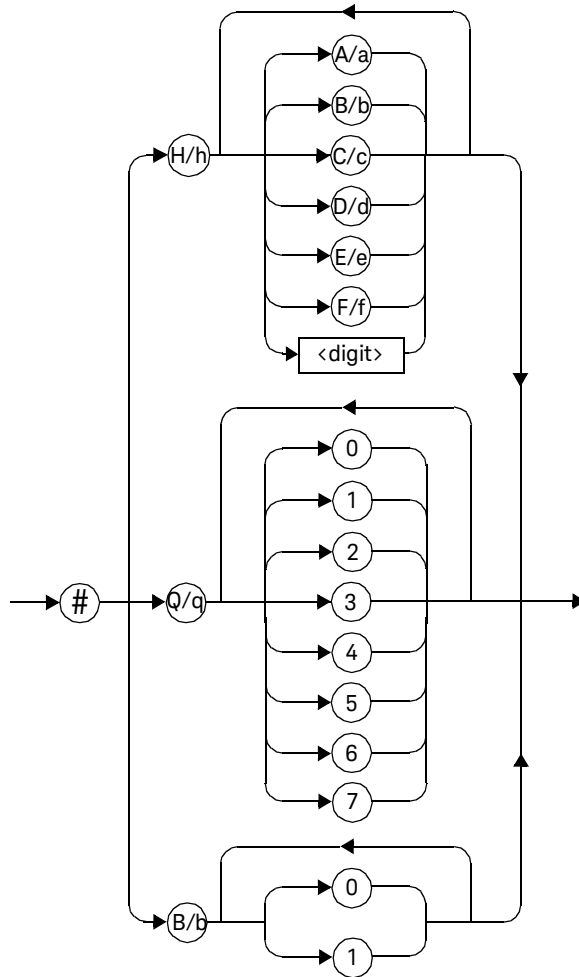

Figure 1-12 Format of <non-decimal numeric>

Refer to section 7.7.4.1 of IEEE 488.2 for further details.

<NRf> Definition

Throughout this document <NRf> is used to denote a flexible numeric representation. For example: +200; -56; +9.9E36. Refer to section 7.7.2.1 of IEEE 488.2 for further details.

<NR1> Definition

Throughout this document <NR1> numeric response data is defined as:

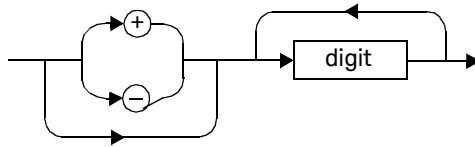

Figure 1-13 Format of <NR1>

For example:

- 146
- +146
- -12345

Refer to section 8.7.2 of IEEE 488.2 for further details.

<NR2> Definition

Throughout this document <NR2> numeric response data is defined as:

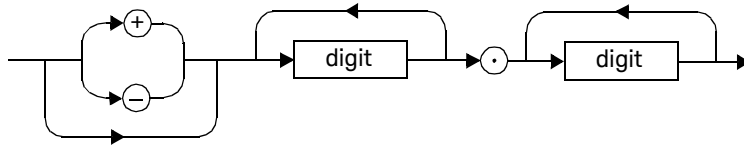

Figure 1-14 Format of <NR2>

For example:

- 12.3
- +1.2345
- -0.123

Refer to section 8.7.3 of IEEE 488.2 for further details.

<NR3> Definition

Throughout this document <NR3> numeric response data is defined as:

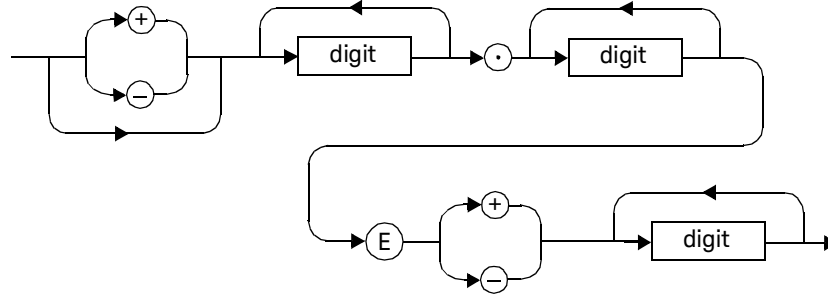

Figure 1-15 Format of <NR3>

For example:

- 1.23E+6
- 123.4E-54
- -1234.567E+90

Refer to section 8.7.4 of IEEE 488.2 for further details.

<numeric_value> Definition

Throughout this document the decimal numeric element is abbreviated to <numeric_value>. For example, <NRf>, MINimum, MAXimum, DEFault or Not A Number (NAN).

<string> Definition

Throughout this document <string> is used to represent 7-bit ASCII characters.

The format is defined as:

Program Data

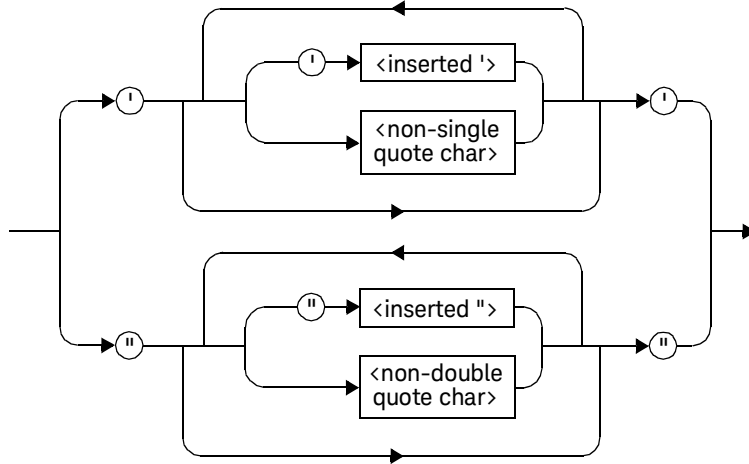

Response Data

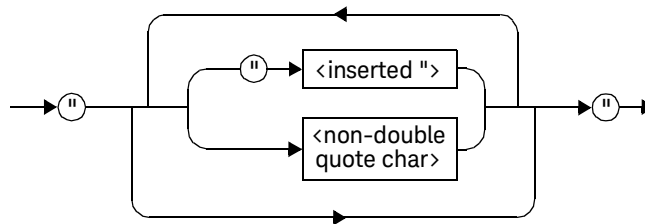

Figure 1-16 Format of <string>

Input Message Terminators

Program messages sent to a SCPI instrument *must* terminate with a <newline> character. The IEEE.488 EOI (end or identify) signal is interpreted as a <newline> character and may also be used to terminate a message in place of the <newline> character. A <carriage return> followed by a <newline> is also accepted. Many programming languages allow you to specify a message terminator character or EOI state to be automatically sent with each bus transaction. Message termination *always* sets the current path back to the root-level.

SCPI Compliance Information

The power meter complies with the rules and regulations of the present version of SCPI (Standard Commands for Programmable Instruments). You can determine the SCPI version with which the power meter's is in compliance by sending the **SYSTem:VERSion?** command from the remote interface.

The following commands are device-specific to the power meter. They are not included in the 1999.0 version of the SCPI standard. However, these commands are designed with the SCPI format in mind and they follow all of the syntax rules of the standard.

```

CALibration[1|2]:RCALibration
CALibration[1|2]:RCFactor
DISPlay[:WINDow[1|2]]:FORMat
DISPlay[:WINDow[1|2]]:METer:LOWer
DISPlay[:WINDow[1|2]]:METer:UPPer
DISPlay[:WINDow[1|2]]:RESolution
DISPlay[:WINDow[1|2]]:SElect
MEMory:CLEar[:NAME]
MEMory:TABLE:SElect
MEMory:STATE:DEFine
MEMory:TABLE:GAIN[:MAGNitude]
MEMory:TABLE:GAIN:POINTs?
MEMory:TABLE:MOVE
[SENSe[1]]|SENSe2:AVERage:SDETect
[SENSe[1]]|SENSe2:CORRection:CFACTOR
[SENSe[1]]|SENSe2:CORRection:DCYCLe
[SENSe[1]]|SENSe2:CORRection:FDOFFset
[SENSe[1]]|SENSe2:SPEEd
[SENSe[1]]|SENSe2:POWer:AC:RANGe
SERVice:SENSor[1|2]:CDATE?
SERVice:SENSor[1|2]:CPLace?
SERVice:SENSor[1|2]:SNUMber?
SERVice:SENSor[1|2]:TYPE?
SYSTem:COMMunicate:LAN:AIP
SYSTem:COMMunicate:LAN:CURRent:ADDReSS?
SYSTem:COMMunicate:LAN:CURRent:DGATeway?

```

1 Power Meter Remote Operation

```
SYSTem:COMMunicate:LAN:CURRent:DNAMe?  
SYSTem:COMMunicate:LAN:CURRent:SMASk?  
SYSTem:COMMunicate:LAN:ADDRes  
  
SYSTem:COMMunicate:LAN:DGATeway  
SYSTem:COMMunicate:LAN:DHCP  
SYSTem:COMMunicate:LAN:HNAME  
SYSTem:COMMunicate:LAN:REStArt  
SYSTem:COMMunicate:LAN:SMASk  
SYSTem:LOCAl  
SYSTem:REMOte  
SYSTem:RWLock  
UNIT[1|2]:POWer:RATio
```

Summary of Commands

For detail of each SCPI (Standard Commands for Programmable Instruments) command available to program the power meter, refer to later chapters for more details on each command.

NOTE

This Guide details the commands available for both the N1913A and the N1914A power meters. As the N1913A is a single channel power meter only Channel A can be selected. Where instances of channel selection are detailed in this document they are only relevant for the N1914A.

In different subsystems the numeric suffix of program mnemonics can represent either a channel selection or a window selection. Refer to the appropriate command description to verify the meaning of the numeric suffix.

With commands that require you to specify a channel, Channel A is represented by a 1 and Channel B by a 2. If you omit the channel number, Channel A is assumed.

With commands that require you to specify a window, the upper window is represented by a 1 and the lower window by a 2. If you omit the window number, the upper window is assumed.

All the commands listed also have queries unless otherwise stated in the “Notes” column.

THIS PAGE HAS BEEN INTENTIONALLY LEFT BLANK.

2 MEASurement Commands

MEASurement Commands	107
CONFigure[1] 2 3 4?	112
CONFigure [1] 2 3 4 Commands	117
CONFigure[1] 2 3 4[:SCALar][:POWer:AC] [<expected_value>[,<resolution>[,<source list>]]]	118
CONFigure[1] 2 3 4[:SCALar][:POWer:AC]:RELative [<expected_value>[,<resolution>[,<source list>]]]	121
CONFigure[1] 2 3 4[:SCALar][:POWer:AC]:DIFFerence [<expected_value>[,<resolution>[,<source list>]]]	124
CONFigure[1] 2 3 4[:SCALar][:POWer:AC]:DIFFerence: RELative [<expected_value>[,<resolution>[,<source list>]]]	127
CONFigure[1] 2 3 4[:SCALar][:POWer:AC]:RATio [<expected_value>[,<resolution>[,<source list>]]]	130
CONFigure[1] 2 3 4[:SCALar][:POWer:AC]:RATio: RELative[<expected_value>[,<resolution>[,<source list>]]]	133
FETCh[1] 2 3 4 Queries	136
FETCh[1] 2 3 4[:SCALar][:POWer:AC]? [<expected_value>[,<resolution>[,<source list>]]]	137
FETCh[1] 2 3 4[:SCALar][:POWer:AC]:RELative? [<expected_value>[,<resolution>[,<source list>]]]	140
FETCh[1] 2 3 4[:SCALar][:POWer:AC]:DIFFerence? [<expected_value>[,<resolution>[,<source list>]]]	143
FETCh[1] 2 3 4[:SCALar][:POWer:AC]:DIFFerence: RELative? [<expected_value>[,<resolution>[,<source list>]]]	146
FETCh[1] 2 3 4[:SCALar][:POWer:AC]:RATio? [<expected_value>[,<resolution>[,<source list>]]]	149
FETCh[1] 2 3 4[:SCALar][:POWer:AC]:RATio:RELative? [<expected_value>[,<resolution>[,<source list>]]]	152
READ[1] 2 3 4 Commands	155

READ[1]2 3 4[:SCALar][:POWer:AC]? [<expected_value>[,<resolution>[,<source list>]]]	156
READ[1]2 3 4[:SCALar][:POWer:AC]:RELative? [<expected_value>[,<resolution>[,<source list>]]]	159
READ[1]2 3 4[:SCALar][:POWer:AC]:DIFFerence? [<expected_value>[,<resolution>[,<source list>]]]	162
READ[1]2 3 4[:SCALar][:POWer:AC]:DIFFerence: RELative? [<expected_value>[,<resolution>[,<source list>]]]	165
READ[1]2 3 4[:SCALar][:POWer:AC]:RATio? [<expected_value>[,<resolution>[,<source list>]]]	168
READ[1]2 3 4[:SCALar][:POWer:AC]:RATio:RELative? [<expected_value>[,<resolution>[,<source list>]]]	171
MEASure[1]2 3 4 Commands	174
MEASure[1]2 3 4[:SCALar][:POWer:AC]? [<expected_value>[,<resolution>[,<source list>]]]	175
MEASure[1]2 3 4[:SCALar][:POWer:AC]:RELative? [<expected_value>[,<resolution>[,<source list>]]]	178
MEASure[1]2 3 4[:SCALar][:POWer:AC]:DIFFerence? [<expected_value>[,<resolution>[,<source list>]]]	181
MEASure[1]2 3 4[:SCALar][:POWer:AC]:DIFFerence: RELative? [<expected_value>[,<resolution>[,<source list>]]]	183
MEASure[1]2 3 4[:SCALar][:POWer:AC]:RATio? [<expected_value>[,<resolution>[,<source list>]]]	186
MEASure[1]2 3 4[:SCALar][:POWer:AC]:RATio:RELative? [<expected_value>[,<resolution>[,<source list>]]]	189

This chapter explains how to use the **MEASure** group of instructions to acquire data using a set of high level instructions.

MEASurement Commands

Measurement commands are high level commands used to acquire data. They enable you to trade interchangeability against fine control of the measurement process.

Measurement Command	Descriptions
MEASure?	Provides the simplest way to program a power meter for measurements. MEASure? is a compound command which is equivalent to an ABORT followed by a CONFiGure and a READ? . It does not enable much flexibility or control over measurement settings.
CONFiGure	Used to change the power meter's configuration values. CONFiGure must then be followed by another command which takes the measurement—for example, a READ? followed by a FETCh? .
READ?	Takes a measurement using parameters previously set up using either CONFiGure or lower level commands. READ? is equivalent to an ABORT followed by an INITiate1 (which performs the data acquisition) and a FETCh?
FETCh?	Retrieves measurements taken by INITiate ^[a] .

[a] **INITiate** is described in [Chapter 15, "TRIGger Subsystem"](#) on page 545.

The **CONFiGure**, **FETCh?**, **READ?** and **MEASure?** commands all have a numeric suffix which refers to a specific window/measurement. [Figure 2-1](#) shown an example of the configuration returned result windows.

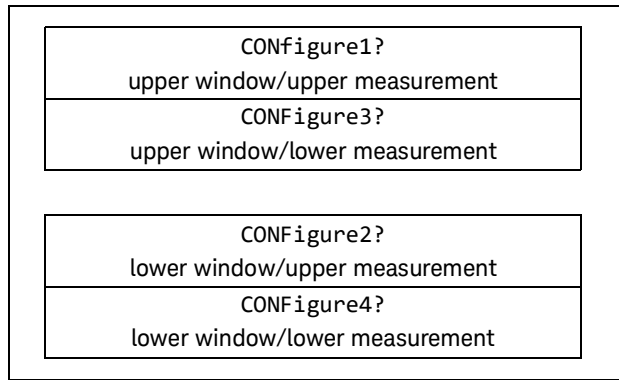

Figure 2-1 Measurement Display CALCulate Block Window

Optional Parameters

CONFigure, FETCH?, READ? and MEASure? have the following three optional parameters:

- An expected power value
- A resolution
- A source list

Expected Power Value

An **<expected_value>** parameter is only required if you are using an E-Series power sensor or N8480 Series power sensor (excluding Option CFT). It has no effect on 8480 Series power sensor or N8480 Series power sensor with Option CFT. The value entered determines which of the power sensor's two ranges is used for the measurement. If the current setting of the power sensor's range is no longer valid for the new measurement, specifying the expected power value decreases the time taken to obtain a result.

Resolution

The **<resolution>** parameter sets the resolution of the specified window. This parameter does not affect the resolution of the remote data but it does affect the auto averaging setting. Where a channel is set up in both the upper and lower

window and the **<resolution>** parameter settings for these windows are different, the highest resolution setting is taken to calculate the averaging. If you are making a ratio or difference measurement the **<resolution>** parameters are applied to both channels.

Source List

The **<source list>** parameter is used to define:

- What channels the measurements will be made on, for a dual channel measurement.
- Whether the calculation is A-B or B-A, for a dual channel difference measurement.
- Whether the calculation is A/B or B/A, for a ratio measurement.

Entering a **<source list>** is only required if you are using an N1914A. As the N1913A has a single channel only, the source list can only be Channel A.

The following commands are described in this chapter:

Keyword	Parameter Form	Notes	Page
CONFigure[1] 2 3 4?		[query only]	page 112
CONFigure[1] 2 3 4 [:SCALar]			
[:POWer:AC]	[<expected_value> [,<resolution>[,<source list>]]]	[no query]	page 118
:RELative	[<expected_value> [,<resolution>[,<source list>]]]	[no query] [non-SCPI]	page 121
:DIFFerence	[<expected_value> [,<resolution>[,<source list>]]]	[no query] [non-SCPI]	page 124
:RELative	[<expected_value> [,<resolution>[,<source list>]]]	[no query] [non-SCPI]	page 127
:RATio	[<expected_value> [,<resolution>[,<source list>]]]	[no query]	page 130
:RELative	[<expected_value> [,<resolution>[,<source list>]]]	[no query] [non-SCPI]	page 133

Keyword	Parameter Form	Notes	Page
FETCh[1] 2 3 4			
[:SCALar]			
[:POWer:AC]?	[<expected_value> [,<resolution>[,<source list>]]]	[query only]	page 137
:RELative?	[<expected_value> [,<resolution>[,<source list>]]]	[query only] [non-SCPI]	page 140
:DIFFerence?	[<expected_value> [,<resolution>[,<source list>]]]	[query only] [non-SCPI]	page 143
:RELative?	[<expected_value> [,<resolution>[,<source list>]]]	[query only] [non-SCPI]	page 146
:RATio?	[<expected_value> [,<resolution>[,<source list>]]]	[query only]	page 149
:RELative?	[<expected_value> [,<resolution>[,<source list>]]]	[query only] [non-SCPI]	page 152
READ[1] 2 3 4			
[:SCALar]			
[:POWer:AC]?	[<expected_value> [,<resolution>[,<source list>]]]	[query only]	page 156
:RELative?	[<expected_value> [,<resolution>[,<source list>]]]	[query only] [non-SCPI]	page 159
:DIFFerence?	[<expected_value> [,<resolution>[,<source list>]]]	[query only] [non-SCPI]	page 162
:RELative?	[<expected_value> [,<resolution>[,<source list>]]]	[query only] [non-SCPI]	page 165
:RATio?	[<expected_value> [,<resolution>[,<source list>]]]	[query only]	page 168
:RELative?	[<expected_value> [,<resolution>[,<source list>]]]	[query only] [non-SCPI]	page 171

Keyword	Parameter Form	Notes	Page
MEASure[1] 2 3 4			
[:SCALar]			
[:POWer:AC]?	[<expected_value> [,<resolution>[,<source list>]]]	[query only]	page 175
:RELative?	[<expected_value> [,<resolution>[,<source list>]]]	[query only] [non-SCPI]	page 178
:DIFFerence?	[<expected_value> [,<resolution>[,<source list>]]]	[query only] [non-SCPI]	page 181
:RELative?	[<expected_value> [,<resolution>[,<source list>]]]	[query only] [non-SCPI]	page 183
:RATio?	[<expected_value> [,<resolution>[,<source list>]]]	[query only]	page 186
:RELative?	[<expected_value> [,<resolution>[,<source list>]]]	[query only] [non-SCPI]	page 189

CONFigure[1] |2|3|4?

This query returns the present configuration of the specified window/
measurement.

Syntax

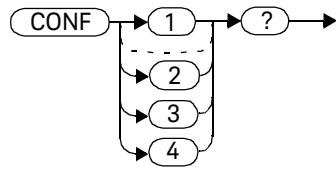

The string returned depends on the setting of the **CALCulate:MATH** and **CALCulate:RELative:STATe** commands.

The configuration is returned as a quoted string in the following format:

“<function> <expected_value>,<resolution>,<source list>”

CALCulate:MATH	CALCulate:RE Lative:STATe	Function	<source list>
(SENSe1)	OFF	:POW:AC	(@1)
(SENSe2) ^[a]	OFF	:POW:AC	(@2)
(SENSe1)	ON	:POW:AC:REL	(@1)
(SENSe2) ^[a]	ON	:POW:AC:REL	(@2)
(SENSe1 - SENSe2) ^[a]	OFF	:POW:AC:DIFF	(@1),(@2)
(SENSe2 - SENSe1) ^[a]	OFF	:POW:AC:DIFF	(@2),(@1)
(SENSe1 - SENSe2) ^[a]	ON	:POW:AC:DIFF:REL	(@1),(@2)
(SENSe2 - SENSe1) ^[a]	ON	:POW:AC:DIFF:REL	(@2),(@1)
(SENSe1 - SENSe1)	OFF	:POW:AC:DIFF	(@1),(@1)
(SENSe2 - SENSe2) ^[a]	OFF	:POW:AC:DIFF	(@2),(@2)
(SENSe1 - SENSe1)	ON	:POW:AC:DIFF:REL	(@1),(@1)
(SENSe2 - SENSe2) ^[a]	ON	:POW:AC:DIFF:REL	(@2),(@2)

CALCulate:MATH	CALCulate:RE Lative:STATe	Function	<source list>
(SENSe2/SENSe1) ^[a]	OFF	:POW:AC:RAT	(@1),(@2)
(SENSe2/SENSe1) ^[a]	OFF	:POW:AC:RAT	(@2),(@1)
(SENSe1/SENSe2) ^[a]	ON	:POW:AC:RAT:REL	(@1),(@2)
(SENSe2/SENSe1) ^[a]	ON	:POW:AC:RAT:REL	(@2),(@1)
(SENSe1/SENSe1)	OFF	POW:AC:RAT	(@1),(@1)
(SENSe2/SENSe2) ^[a]	OFF	POW:AC:RAT	(@2),(@2)
(SENSe1/SENSe1)	ON	POW:AC:RAT:REL	(@1),(@1)
(SENSe2/SENSe2) ^[a]	ON	POW:AC:RAT:REL	(@2),(@2)
(SENSe3) ^[b]	OFF	:POW:AC	(@3)
(SENSe4) ^[b]	OFF	:POW:AC	(@4)
(SENSe3) ^[b]	ON	:POW:AC:REL	(@3)
(SENSe4) ^[b]	ON	:POW:AC:REL	(@4)
(SENSe1 - SENSe3) ^[b]	OFF	:POW:AC:DIFF	(@3),(@4)
(SENSe1 - SENSe4) ^[b]	OFF	:POW:AC:DIFF	(@4),(@3)
(SENSe2 - SENSe3) ^[b]	OFF	:POW:AC:DIFF	(@4),(@3)
(SENSe2 - SENSe4) ^[b]	OFF	:POW:AC:DIFF	(@3),(@3)
(SENSe3 - SENSe1) ^[b]	OFF	:POW:AC:DIFF	(@4),(@4)
(SENSe3 - SENSe2) ^[b]	OFF	:POW:AC:DIFF	(@3),(@3)
(SENSe3 - SENSe3) ^[b]	OFF	:POW:AC:DIFF	(@4),(@4)
(SENSe3 - SENSe4) ^[b]	OFF	:POW:AC:DIFF	(@3),(@3)
(SENSe1 - SENSe3) ^[b]	ON	:POW:AC:DIFF:REL	(@4),(@4)
(SENSe1 - SENSe4) ^[b]	ON	:POW:AC:DIFF:REL	(@3),(@3)
(SENSe2 - SENSe3) ^[b]	ON	:POW:AC:DIFF:REL	(@4),(@4)

CALCulate:MATH	CALCulate:RE Lative:STAtE	Function	<source list>
(SENSe2 - SENSe4) ^[b]	ON	:POW:AC:DIFF:REL	(@3),(@3)
(SENSe3 - SENSe1) ^[b]	ON	:POW:AC:DIFF:REL	(@4),(@4)
(SENSe3 - SENSe2) ^[b]	ON	:POW:AC:DIFF:REL	(@3),(@3)
(SENSe3 - SENSe3) ^[b]	ON	:POW:AC:DIFF:REL	(@4),(@4)
(SENSe3 - SENSe4) ^[b]	ON	:POW:AC:DIFF:REL	(@3),(@3)
(SENSe1/SENSe3) ^[b]	OFF	:POW:AC:RAT	(@3),(@4)
(SENSe1/SENSe4) ^[b]	OFF	:POW:AC:RAT	(@4),(@3)
(SENSe2/SENSe3) ^[b]	OFF	:POW:AC:RAT	(@3),(@4)
(SENSe2/SENSe4) ^[b]	OFF	:POW:AC:RAT	(@4),(@3)
(SENSe3/SENSe1) ^[b]	OFF	:POW:AC:RAT	(@3),(@3)
(SENSe3/SENSe2) ^[b]	OFF	:POW:AC:RAT	(@4),(@4)
(SENSe3/SENSe3) ^[b]	OFF	:POW:AC:RAT	(@3),(@3)
(SENSe3/SENSe4) ^[b]	OFF	:POW:AC:RAT	(@4),(@4)
(SENSe4/SENSe1) ^[b]	OFF	:POW:AC:RAT	(@3),(@4)
(SENSe4/SENSe2) ^[b]	OFF	:POW:AC:RAT	(@3),(@4)
(SENSe4/SENSe3) ^[b]	OFF	:POW:AC:RAT	(@4),(@3)
(SENSe4/SENSe4) ^[b]	OFF	:POW:AC:RAT	(@3),(@4)
(SENSe1/SENSe3) ^[b]	ON	:POW:AC:RAT:REL	(@4),(@3)
(SENSe1/SENSe4) ^[b]	ON	:POW:AC:RAT:REL	(@3),(@3)
(SENSe2/SENSe3) ^[b]	ON	:POW:AC:RAT:REL	(@4),(@4)
(SENSe2/SENSe4) ^[b]	ON	:POW:AC:RAT:REL	(@3),(@3)
(SENSe3/SENSe1) ^[b]	ON	:POW:AC:RAT:REL	(@4),(@4)
(SENSe3/SENSe2) ^[b]	ON	:POW:AC:RAT:REL	(@3),(@4)

CALCulate:MATH	CALCulate:RE Lative:STATe	Function	<source list>
(SENSe3/SENSe3) ^[b]	ON	:POW:AC:RAT:REL	(@3),(@3)
(SENSe3/SENSe4) ^[b]	ON	:POW:AC:RAT:REL	(@4),(@4)
(SENSe4/SENSe1) ^[b]	ON	:POW:AC:RAT:REL	(@3),(@4)
(SENSe4/SENSe2) ^[b]	ON	:POW:AC:RAT:REL	(@3),(@4)
(SENSe4/SENSe3) ^[b]	ON	:POW:AC:RAT:REL	(@4),(@3)
(SENSe4/SENSe4) ^[b]	ON	:POW:AC:RAT:REL	(@3),(@4)

[a] N1914A only.

[b] USB Option only.

<expected_value> returns the expected value sent by the last **CONFigure** command or +20 dBm by default. Note that when the display is showing dual windows this value is meaningless.

The <resolution> returned is the same as the value returned by **DISPlay:WINDow:RESolution?**. The format of the return is <NR1> in the range 1 through 4.

Example

CONF2?

This command queries the current configuration of the lower window/upper measurement.

Reset Condition

On reset:

The command function is set to **:POWer:AC**.

The expected power level is set to +20 dBm.

The resolution is set to 3.

The source list on the N1913A is set to Channel A on both windows and their measurements. However, on a meter with USB option installed, the source list on

the N1913A is set to Channel A for the upper window upper measurement and lower window upper measurement, Channel C for the upper window lower measurement, and Channel D for the lower window lower measurement.

The source list on the N1914A is set to Channel A for the upper measurement on both windows and Channel B for the lower measurement on both windows. However, on a meter with USB option installed, the source list on the N1914A is set to Channel A for the upper window upper measurement, Channel B for the lower window upper measurement, Channel C for the upper window lower measurement, and Channel D for the lower window lower measurement.

CONFigure [1] |2|3|4 Commands

The **CONFigure** commands are used on the specified window/measurement to set:

- The expected power level being measured.
- The resolution of the window/measurement.
- The channel(s) on which the measurement is to be made.

The **CONFigure** commands do not make the power measurement after setting the configuration. Use **READ?**, or alternatively use **INITiate** followed by a **FETCh?** to make the measurement.

The **CONFigure** command also applies the following defaults to the channel(s) which are in the specified window (the channel(s) in the window are specified in the `<source list>` parameter):

Default Settings	Description
INITiate:CONTinuous OFF	Sets the power meter to make one trigger cycle when INITiate is sent.
TRIGger:SOURce IMMEDIATE	When TRIG:SOUR is set to BUS or HOLD , sets the power meter to make the measurement immediately a trigger is received.
TRIGger:DELay:AUTO ON	Enables automatic delay before making the measurement.
SENSE:AVERAge:COUNt:AUTO ON	Enables automatic filter length selection.
SENSE:AVERAge:STATe ON	Enables averaging.

CONFigure[1]|2|3|4[:SCALar][:POWer:AC]
 [<expected_value>[,<resolution>[,<source list>]]]

This command is used on the specified window/measurement to set:

- The expected power level of the measurement.
- The resolution of the window/measurement.
- The channel on which the measurement will be made.

Syntax

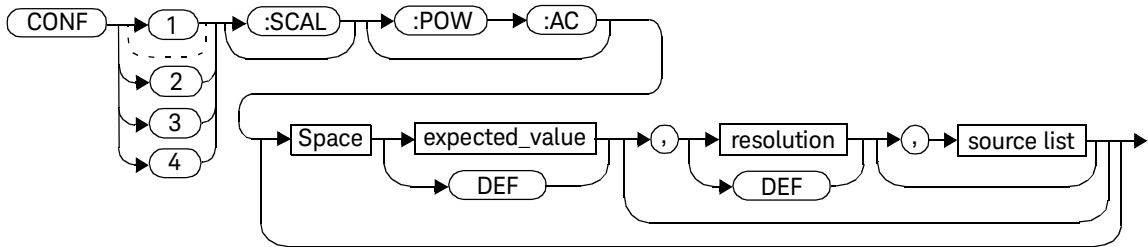

Parameters

Refer to “Optional Parameters” on page 108 for additional details on the parameters in this command.

Item	Description/Default	Range of Values
expected_value	A numeric value for the expected power level. The units of measurement are dBm and W. The default units are defined by UNIT:POWer .	Sensor dependent. DEF ^[a]
resolution	A numeric value for the resolution. If unspecified the current resolution setting is used.	1 to 4 ^[b] 1.0, 0.1, 0.01, 0.001 DEF ^[a]

Item	Description/Default	Range of Values
source list	The channel which the command is implemented on. If unspecified the current window setup is used. However, if window shows a ratio or difference measurement on a meter with USB option installed, on the N1913A, the upper upper window defaults to Channel A, the upper lower window defaults to Channel A, the upper lower window defaults to Channel C, the lower upper window defaults to Channel A and the lower lower window defaults to Channel D while on the N1914A, the upper upper window defaults to Channel A, the upper lower window defaults to Channel C, the lower upper window defaults to Channel B and the lower lower window defaults to Channel D. Otherwise, on a meter without the USB option installed, the upper window defaults to Channel A and the lower window to Channel B on the N1914A if the window shows a ratio or difference measurement.	(@1) (@2) ^[c] (@3) ^[d] (@4) ^[d]

[a] The mnemonic **DEF** means DEFAult. This is not equivalent to the DEFAult parameter used in the command sub-systems. The parameters must be entered in the specified order. If parameters are omitted, they default from the right. The parameter DEFAult is used as a place holder. Specifying **DEF** leaves the parameter value unchanged.

[b] When the measurement result is linear this parameter represents the number of significant digits. When the measurement result is logarithmic 1 to 4 represents of 1, 0.1, 0.01 and 0.001 respectively.

[c] N1914A only.

[d] USB Option only.

Example

```
CONF1:POW:AC DEF,2,(@1)
```

This command configures the upper window/upper measurement to measure the power of Channel A, using the current sensor range and a resolution setting of 2.

CONFigure[1]|2|3|4[:SCALar][:POWer:AC]:RELative
 [<expected_value>[,<resolution>[,<source list>]]]

This command sets the measurement function, range and resolution of the specified window. It sets the measurement function to single channel with relative mode on. The relative value used is that set by the **CALCulate:RELative:MAGNitude:AUTO** command.

Syntax

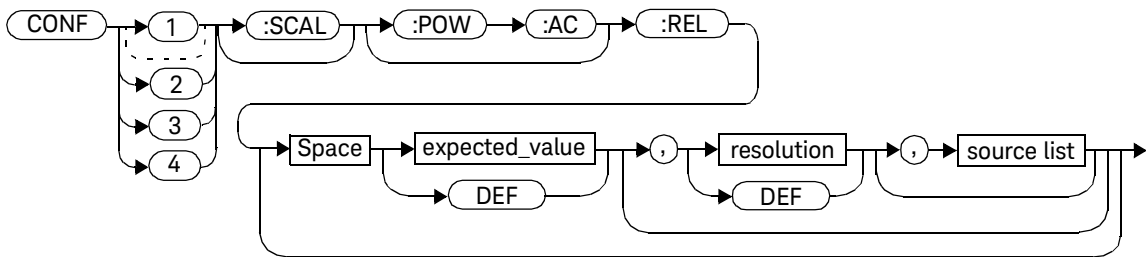

Parameters

Refer to “**Optional Parameters**” on page 108 for additional details on the parameters in this command.

Item	Description/Default	Range of Values
expected_value (for the expected power level)	A numeric value for the expected power level. The units of measurement are dBm and W. The default units are defined by UNIT:POWer .	sensor dependent DEF ^[a]
resolution	A numeric value for the resolution. If unspecified the current resolution setting is used.	1 to 4 ^[b] 1.0, 0.1, 0.01, 0.001 DEF ^[a]

2 MEASurement Commands

Item	Description/Default	Range of Values
source list	The channel which the command is implemented on. If unspecified the current window setup is used. However, if window shows a ratio or difference measurement on a meter with USB option installed, on the N1913A, the upper upper window defaults to Channel A, the upper lower window defaults to Channel C, the lower upper window defaults to Channel A and the lower lower window defaults to Channel D while on the N1914A, the upper upper window defaults to Channel A, the upper lower window defaults to Channel C, the lower upper window defaults to Channel B and the lower lower window defaults to Channel D. Otherwise, on a meter without the USB option installed, the upper window defaults to Channel A and the lower window to Channel B on the N1914A if the window shows a ratio or difference measurement.	(@1) (@2) ^[c] (@3) ^[d] (@4) ^[d]

[a] The mnemonic **DEF** means DEFault. This is not equivalent to the DEFault parameter used in the command sub-systems. The parameters must be entered in the specified order. If parameters are omitted, they default from the right. The parameter DEFault is used as a place holder. Specifying **DEF** leaves the parameter value unchanged.

[b] When the measurement result is linear this parameter represents the number of significant digits. When the measurement result is logarithmic 1 to 4 represents of 1, 0.1, 0.01 and 0.001 respectively.

[c] N1914A only.

[d] USB Option only.

Example

```
CONF2:REL -50DBM,3,(@1)
```

This command configures the lower window/upper measurement to measure the relative power of Channel A, using an expected power level of -50 dBm and a resolution setting of 3.

CONFigure[1]|2|3|4[:SCALar][:POWer:AC]:DIFFerence
 [<expected_value>[,<resolution>[,<source list>]]]

This command sets the measurement function and resolution of the specified window. It sets the measurement function to difference with relative mode off.

Syntax

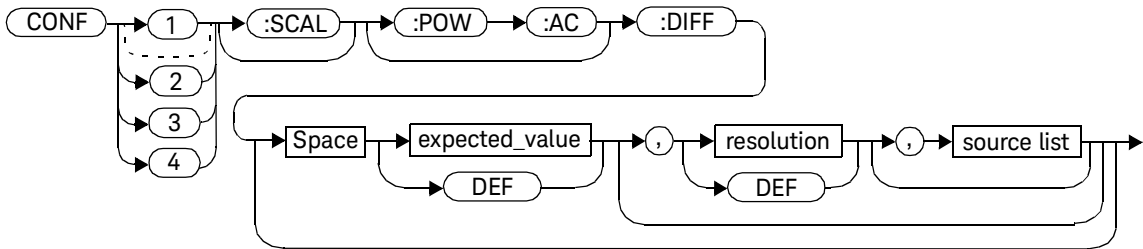

Parameters

Refer to “Optional Parameters” on page 108 for additional details on the parameters in this command.

Item	Description/Default	Range of Values
expected_value (for the expected power level)	The power meter ignores the numeric value entered in this parameter. Any value entered is treated like DEF.	sensor dependent DEF ^[a]
resolution	A numeric value for the resolution. If unspecified the current resolution setting is used.	1 to 4 ^[b] 1.0, 0.1, 0.01, 0.001 DEF ^[a]

Item	Description/Default	Range of Values
source list	This channel list specifies between which channels the difference is calculated. If unspecified and the current window setup is a difference measurement then this difference setup is used, otherwise on a meter without USB option installed, it defaults to Channel A-B (N1914A) or A-A (N1913A). However, on a meter with USB option installed, on the N1913A, the upper upper window and lower upper window defaults to Channel A-A, the upper lower window and lower lower window defaults to Channel C-D, while on the N1914A, the upper upper window and lower upper window defaults to Channel A-B, the upper lower window and lower lower window defaults to Channel C-D.	(@1),(@2) ^[c] (@2),(@1) ^[c] (@1),(@1) (@2),(@2) ^[c] (@1), (@3) ^[c] (@1), (@4) ^[d] (@2), (@3) ^[d] (@2), (@4) ^[d] (@3) ^[d] , (@1) (@3) ^[d] , (@2) (@3) ^[d] , (@3) ^[d] (@3) ^[d] , (@4) ^[d] (@4) ^[d] , (@1) (@4) ^[d] , (@2) (@4) ^[d] , (@3) ^[d] (@4) ^[d] , (@4) ^[d]

[a] The mnemonic **DEF** means DEFault. This is not equivalent to the DEFault parameter used in the command sub-systems. The parameters must be entered in the specified order. If parameters are omitted, they default from the right. The parameter DEFault is used as a place holder. Specifying **DEF** leaves the parameter value unchanged.

[b] When the measurement result is linear this parameter represents the number of significant digits. When the measurement result is logarithmic 1 to 4 represents a resolution of 1, 0.1, 0.01 and 0.001 respectively.

[c] N1914A only.

[d] USB Option only.

Example

```
CONF2:DIFF DEF,1,(@2),(@1)
```

This command configures the lower window/upper measurement to make a difference measurement of Channel B - Channel A, using the current sensor range and a resolution of 1 on both channels.

CONFigure[1]|2|3|4[:SCALar][:POWer:AC]:DIFFerence: RELative [<expected_value>[,<resolution>[,<source list>]]]

This command sets the measurement function, range and resolution of the specified window. It sets the measurement function to difference with relative mode on. The relative value used is set by the **CALCuLate:RELative:MAGNitude:AUTO** command.

Syntax

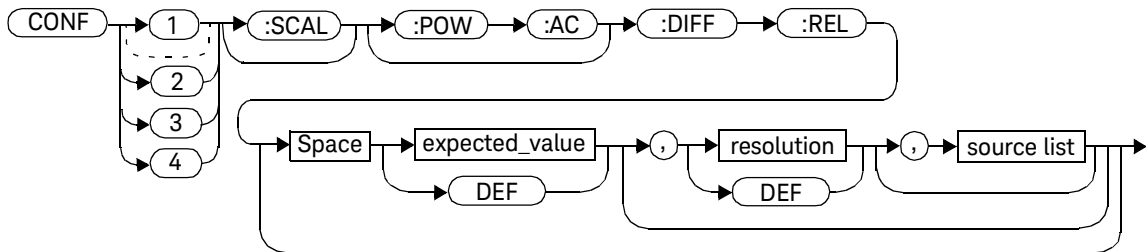

Parameters

Refer to **“Optional Parameters”** on page 108 for additional details on the parameters in this command.

Item	Description/Default	Range of Values
expected_value (for the expected power level)	The power meter ignores the numeric value entered in this parameter. Any value entered is treated like DEF .	sensor dependent DEF ^[a]
resolution	A numeric value for the resolution. If unspecified the current resolution setting is used.	1 to 4 ^[b] 1.0, 0.1, 0.01, 0.001 DEF ^[a]

2 MEASurement Commands

Item	Description/Default	Range of Values
source list	This channel list specifies between which channels the difference is calculated. If unspecified and the current window setup is a difference measurement then this difference setup is used, otherwise on a meter without USB option installed, it defaults to Channel A-B (N1914A) or A-A (N1913A). However, on a meter with USB option installed, on the N1913A, the upper upper window and lower upper window defaults to Channel A-A, the upper lower window and lower lower window defaults to Channel C-D, while on the N1914A, the upper upper window and lower upper window defaults to Channel A-B, the upper lower window and lower lower window defaults to Channel C-D.	(@1),(@2) ^[c] (@2),(@1) ^[c] (@1),(@1) (@2),(@2) ^[c] (@1), (@3) ^[d] (@1), (@4) ^[d] (@2), (@3) ^[d] (@2), (@4) ^[d] (@3) ^[d] , (@1) (@3) ^[d] , (@2) (@3) ^[d] , (@3) ^[d] (@3) ^[d] , (@4) ^[d] (@4) ^[d] , (@1) (@4) ^[d] , (@2) (@4) ^[d] , (@3) ^[d] (@4) ^[d] , (@4) ^[d]

[a] The mnemonic **DEF** means DEFault. This is not equivalent to the DEFault parameter used in the command sub-systems. The parameters must be entered in the specified order. If parameters are omitted, they default from the right. The parameter DEFault is used as a place holder. Specifying **DEF** leaves the parameter value unchanged.

[b] When the measurement result is linear this parameter represents the number of significant digits. When the measurement result is logarithmic 1 to 4 represents of 1, 0.1, 0.01 and 0.001 respectively.

[c] N1914A only.

[d] USB Option only.

Example

```
CONF1:DIFF:REL DEF,1,  
(@1),(@2)
```

This command configures the upper window/upper measurement to make a difference measurement of Channel A - Channel B with relative mode on, using the current sensor range and a resolution of 1 on both channels.

CONFigure[1]|2|3|4[:SCALar][:POWer:AC]:RATio
 [<expected_value>[,<resolution>[,<source list>]]]

This command sets the measurement function, range and resolution of the specified window. It sets the measurement function to ratio with relative mode off.

Syntax

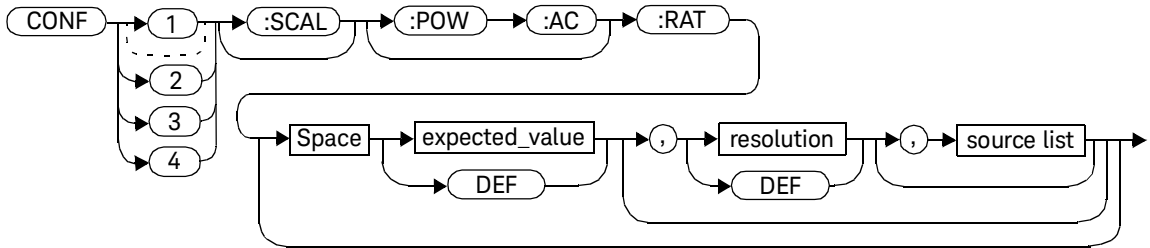

Parameters

Refer to “Optional Parameters” on page 108 for additional details on the parameters in this command.

Item	Description/Default	Range of Values
expected_value (for the expected power level)	The power meter ignores the numeric value entered in this parameter. Any value entered is treated like DEF.	sensor dependent DEF ^[a]
resolution	A numeric value for the resolution. If unspecified the current resolution setting is used.	1 to 4 ^[b] 1.0, 0.1, 0.01, 0.001 DEF ^[a]

Item	Description/Default	Range of Values
source list	This channel list specifies the channels used to calculate the ratio. If unspecified and the current window setup is a ratio measurement then this ratio setup is used, otherwise on a meter without USB option installed, it defaults to Channel A/B (N1914A) or A/A (N1913A). However, on a meter with USB option installed, on the N1913A, the upper upper window and lower upper window defaults to Channel A/A, the upper lower window and lower lower window defaults to Channel C/D, while on the N1914A, the upper upper window and lower upper window defaults to Channel A/B, the upper lower window and lower lower window defaults to Channel C/D.	(@1),(@2) ^[c] (@2),(@1) ^[c] (@1),(@1) (@2),(@2) ^[c] (@1), (@3) ^[d] (@1), (@4) ^[d] (@2), (@3) ^[d] (@2), (@4) ^[d] (@3) ^[d] , (@1) (@3) ^[d] , (@2) (@3) ^[d] , (@3) ^[d] (@3) ^[d] , (@4) ^[d] (@4) ^[d] , (@1) (@4) ^[d] , (@2) (@4) ^[d] , (@3) ^[d] (@4) ^[d] , (@4) ^[d]

[a] The mnemonic DEF means DEFault. This is not equivalent to the DEFault parameter used in the command sub-systems. The parameters must be entered in the specified order. If parameters are omitted, they default from the right. The parameter DEFault is used as a place holder. Specifying DEF leaves the parameter value unchanged.

[b] When the measurement result is linear this parameter represents the number of significant digits. When the measurement result is logarithmic 1 to 4 represents of 1, 0.1, 0.01 and 0.001 respectively.

[c] N1914A only.

[d] USB Option only.

Example

```
CONF1:RAT DEF,4,(@1),(@2)
```

This command configures the upper window/upper measurement to make a ratio measurement of Channel A over Channel B, using the current sensor range and a resolution setting of 4 on both channels.

CONFigure[1]|2|3|4[:SCALar][:POWer:AC]:RATio:
RELative[<expected_value>[,<resolution>[,<source list>]]]

This command sets the measurement function, range and resolution of the specified window. It sets the measurement function to ratio with relative mode on. The relative value used is that set by the **CALCuLate:RELative:MAGNitude:AUTO** command.

Syntax

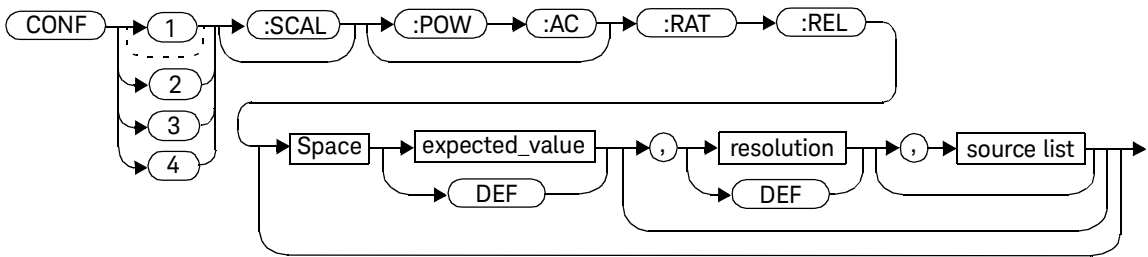

Parameters

Refer to “Optional Parameters” on page 108 for additional details on the parameters in this command.

Item	Description/Default	Range of Values
expected_value (for the expected power level)	The power meter ignores the numeric value entered in this parameter. Any value entered is treated like DEF.	sensor dependent DEF ^[a]
resolution	A numeric value for the resolution. If unspecified the current resolution setting is used.	1 to 4 ^[b] 1.0, 0.1, 0.01, 0.001 DEF ^[a]

2 MEASurement Commands

Item	Description/Default	Range of Values
source list	This channel list specifies the channels used to calculate the ratio. If unspecified and the current window setup is a ratio measurement then this ratio setup is used, otherwise on a meter without USB option installed, it defaults to Channel A/B (N1914A) or A/A (N1913A). However, on a meter with USB option installed, on the N1913A, the upper upper window and lower upper window defaults to Channel A/A, the upper lower window and lower lower window defaults to Channel C/D, while on the N1914A, the upper upper window and lower upper window defaults to Channel A/B, the upper lower window and lower lower window defaults to Channel C/D.	(@1),(@2) ^[c] (@2),(@1) ^[c] (@1),(@1) (@2),(@2) ^[c] (@1), (@3) ^[d] (@1), (@4) ^[d] (@2), (@3) ^[d] (@2), (@4) ^[d] (@3) ^[d] , (@1) (@3) ^[d] , (@2) (@3) ^[d] , (@3) ^[d] (@3) ^[d] , (@4) ^[d] (@4) ^[d] , (@1) (@4) ^[d] , (@2) (@4) ^[d] , (@3) ^[d] (@4) ^[d] , (@4) ^[d]

[a] The mnemonic DEF means DEFault. This is not equivalent to the DEFault parameter used in the command sub-systems. The parameters must be entered in the specified order. If parameters are omitted, they default from the right. The parameter DEFault is used as a place holder. Specifying DEF leaves the parameter value unchanged.

[b] When the measurement result is linear this parameter represents the number of significant digits. When the measurement result is logarithmic 1 to 4 represents of 1, 0.1, 0.01 and 0.001 respectively.

[c] N1914A only.

[d] USB Option only.

Example

```
CONF1:RAT:REL  
DEF,1,(@1),(@2)
```

This command configures the upper window/upper measurement to make a ratio measurement of Channel A over Channel B with relative mode on, using the current sensor range and a resolution setting of 1 on both channels.

FETCh[1]|2|3|4 Queries

The **FETCh?** queries set the specified window's measurement function. This can be set to either single channel, difference or ratio measurements, with relative mode either off or on. They then recalculate the measurement and place the result on the bus. The format of the result is set by **FORM[:READ][:DATA]**. Refer to [Chapter 6, "FORMat Subsystem"](#) on page 279 for further information.

The query returns a measurement result when it is valid. The measurement result is invalid under the following conditions:

- When ***RST** is executed.
- Whenever a measurement is initiated.
- When any **SENSe** parameter, such as frequency, is changed.

If data is invalid, the **FETCh?** query is not completed until all data becomes valid. The exceptions to this are, if the power meter is in the idle state and the data is invalid, or the power meter has been reconfigured as defined above and no new measurement has been initiated. In such cases, the **FETCh?** routine generates the error -230, "Data corrupt or stale" and no result is returned. A common cause for this error is receiving a **FETCh?** after a ***RST**. If the expected value and resolution parameters are not the same as those that were used to collect the data, error -221, "Settings conflict" occurs.

NOTE

When **TRIG:SOUR** is **INT1**, **INT2** or **EXT** and a new acquisition has been initiated (using the **INIT** command for example), **FETCh?** waits until the trigger takes place before executing. If trigger conditions are not satisfied - when the trigger level differs greatly from the signal level for example - this can give the impression that the power meter has hung.

To unlock the power meter and adjust trigger settings, an **SDC** (Selected Device Clear) GPIB Command must be performed. This is equivalent to "EXECUTE CLEAR" in Keysight VEE.

FETCH[1]|2|3|4[:SCALar][:POWER:AC]?
 [<expected_value>[,<resolution>[,<source list>]]]

This command sets the specified window's measurement function to single channel with relative mode off, recalculates the measurement and places the result on the bus. The result is a power based measurement and is expressed in the units defined by **UNIT[1]|2|3|4:POWER**.

Syntax

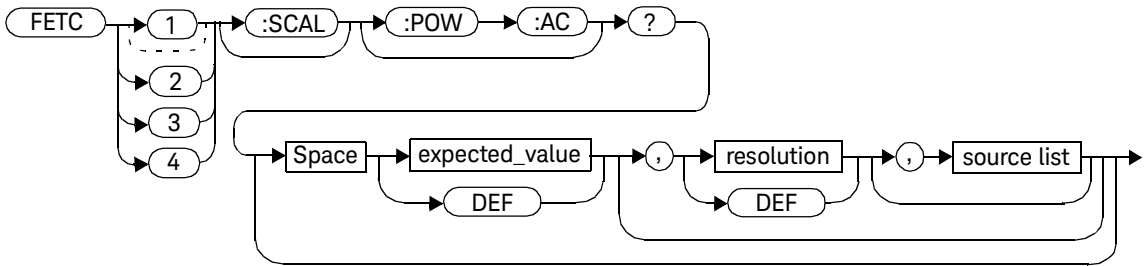

Parameters

Refer to **“Optional Parameters”** on page 108 for additional details on the parameters in this command.

Item	Description/Default	Range of Values
expected_value (for the expected power level)	The expected power level parameter can be set to DEF or a numeric value. If a value is entered it should correspond to that set by CONFigure otherwise an error occurs. The units of measurement are dBm and W. The default units are defined by UNIT:POWER .	sensor dependent DEF ^[a]
resolution	A numeric value for the resolution. If it is unspecified the current resolution setting is used. If a value is entered it should correspond to the current resolution setting otherwise an error occurs.	1 to 4 ^[b] 1.0, 0.1, 0.01, 0.001 DEF ^[a]

Item	Description/Default	Range of Values
source list	<p>The channel which the command is implemented on. If unspecified the current window setup is used. However, if window shows a ratio or difference measurement on a meter with USB option installed, on the N1913A, the upper upper window defaults to Channel A, the upper lower window defaults to Channel C, the lower upper window defaults to Channel A and the lower lower window defaults to Channel D while on the N1914A, the upper upper window defaults to Channel A, the upper lower window defaults to Channel C, the lower upper window defaults to Channel B and the lower lower window defaults to Channel D. Otherwise, on a meter without the USB option installed, the upper window defaults to Channel A and the lower window to Channel B on the N1914A if the window shows a ratio or difference measurement.</p>	<p>(@1) (@2) (N1914A only) (@3)^[c] (@4)^[c]</p>

-
- [a] The mnemonic **DEF** means DEFault. This is not equivalent to the DEFault parameter used in the command sub-systems. The parameters must be entered in the specified order. If parameters are omitted, they default from the right. The parameter DEFault is used as a place holder. Specifying **DEF** leaves the parameter value unchanged.
 - [b] When the measurement result is linear this parameter represents the number of significant digits. When the measurement result is logarithmic 1 to 4 represents of 1, 0.1, 0.01 and 0.001 respectively.
 - [c] USB Option only.

Example

FETC2:POW:AC?

*This command queries the lower window/
upper measurement result.*

Error Messages

- If the last measurement is not valid error -230, “Data corrupt or stale” occurs. A measurement is valid after it has been initiated. It becomes invalid when either a reset occurs or any measurement parameter, for example frequency, is changed.
- If the expected_value and resolution parameters are not the same as the current expected value and resolution setting on the specified window, error -221, “Settings conflict” occurs.

FETCh[1]|2|3|4[:SCALar][:POWer:AC]:RELative?
 [<expected_value>[,<resolution>[,<source list>]]]

This command sets the specified window's measurement function to single channel with relative mode on, recalculates the measurement and places the results on the bus. The result is a ratio based measurement and is expressed in the units defined by **UNIT[1]|2|3|4:POWer:RATio**. The relative value used is that set by the **CALCulate:RELative:MAGNitude:AUTO** command.

Syntax

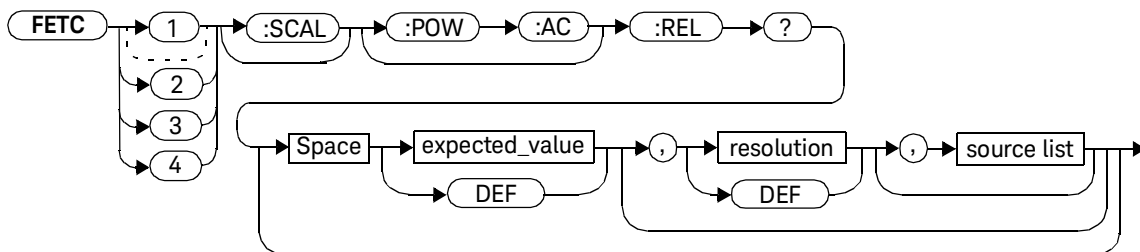

Parameters

Refer to **“Optional Parameters”** on page 108 for additional details on the parameters in this command.

Item	Description/Default	Range of Values
expected_value (for the expected power level)	The expected power level parameter can be set to DEF or a numeric value. If a value is entered it should correspond to that set by CONFigure otherwise an error occurs. The units of measurement are dBm and W. The default units are defined by UNIT:POWer .	sensor dependent DEF ^[a]
resolution	A numeric value for the resolution. If it is unspecified the current resolution setting is used. If a value is entered it should correspond to the current resolution setting otherwise an error occurs.	1 to 4 ^[b] 1.0, 0.1, 0.01, 0.001 DEF ^[a]

Item	Description/Default	Range of Values
source list	The channel which the command is implemented on. If unspecified the current window setup is used. However, if window shows a ratio or difference measurement on a meter with USB option installed, on the N1913A, the upper upper window defaults to Channel A, the upper lower window defaults to Channel C, the lower upper window defaults to Channel A and the lower lower window defaults to Channel D while on the N1914A, the upper upper window defaults to Channel A, the upper lower window defaults to Channel C, the lower upper window defaults to Channel B and the lower lower window defaults to Channel D. Otherwise, on a meter without the USB option installed, the upper window defaults to Channel A and the lower window to Channel B on the N1914A if the window shows a ratio or difference measurement.	(@1) (@2) (N1914A only) (@3) ^[c] (@4) ^[c]

[a] The mnemonic **DEF** means DEFault. This is not equivalent to the DEFault parameter used in the command sub-systems. The parameters must be entered in the specified order. If parameters are omitted, they default from the right. The parameter DEFault is used as a place holder. Specifying **DEF** leaves the parameter value unchanged.

[b] When the measurement result is linear this parameter represents the number of significant digits. When the measurement result is logarithmic 1 to 4 represents of 1, 0.1, 0.01 and 0.001 respectively.

[c] USB Option only

Example

```
FETC1:REL? DEF,2,(@2)
```

*This command queries the upper window/
upper measurement relative measurement of
Channel B, using the current sensor range
and a resolution setting of 2.*

Error Messages

- If the last measurement is not valid error -230, "Data corrupt or stale" occurs. A measurement is valid after it has been initiated. It becomes invalid when either a reset occurs or any measurement parameter, for example frequency, is changed.
- If the expected_value and resolution parameters are not the same as the current expected value and resolution settings on the specified window, error -221, "Settings conflict" occurs.

FETCh[1]|2|3|4[:SCALar][:POWer:AC]:DIFFerence? [<expected_value>[,<resolution>[,<source list>]]]

This command sets the specified window's measurement function to power difference with relative mode off, recalculates the measurement and places the results on the bus. The result is a power based measurement and is expressed in the units defined by **UNIT[1]|2|3|4:POWer**.

Syntax

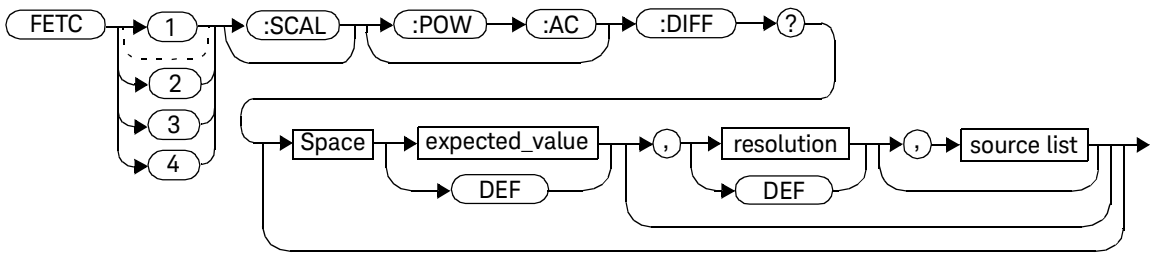

Parameters

Refer to **“Optional Parameters”** on page 108 for additional details on the parameters in this command.

Item	Description/Default	Range of Values
expected_value (for the expected power level)	The expected power level parameter can be set to DEF or a numeric value. If a value is entered it should correspond to that set by CONFigure otherwise an error occurs. The units of measurement are dBm and W. The default units are defined by UNIT:POWer .	sensor dependent DEF ^[a]
resolution	A numeric value for the resolution. If it is unspecified the current resolution setting is used. If a value is entered it should correspond to the current resolution setting otherwise an error occurs.	1 to 4 ^[b] 1.0, 0.1, 0.01, 0.001 DEF ^[a]

2 MEASurement Commands

Item	Description/Default	Range of Values
source list	This channel list specifies between which channels the difference is calculated. If unspecified and the current window setup is a difference measurement then this difference setup is used, otherwise on a meter without USB option installed, it defaults to Channel A-B (N1914A) or A-A (N1913A). However, on a meter with USB option installed, on the N1913A, the upper upper window and lower upper window defaults to Channel A-A, the upper lower window and lower lower window defaults to Channel C-D, while on the N1914A, the upper upper window and lower upper window defaults to Channel A-B, the upper lower window and lower lower window defaults to Channel C-D.	(@1),(@2) ^[c] (@2),(@1) ^[c] (@1),(@1) (@2),(@2) ^[c] (@1), (@3) ^[d] (@1), (@4) ^[d] (@2), (@3) ^[d] (@2), (@4) ^[d] (@3) ^[d] , (@1) (@3) ^[d] , (@2) (@3) ^[d] , (@3) ^[d] (@3) ^[d] , (@4) ^[d] (@4) ^[d] , (@1) (@4) ^[d] , (@2) (@4) ^[d] , (@3) ^[d] (@4) ^[d] , (@4) ^[d]

[a] The mnemonic **DEF** means DEFault. This is not equivalent to the DEFault parameter used in the command sub-systems. The parameters must be entered in the specified order. If parameters are omitted, they default from the right. The parameter DEFault is used as a place holder. Specifying **DEF** leaves the parameter value unchanged.

[b] When the measurement result is linear this parameter represents the number of significant digits. When the measurement result is logarithmic 1 to 4 represents of 1, 0.1, 0.01 and 0.001 respectively.

[c] N1914A only.

[d] USB Option only.

Example

FETC2:DIFF?

This command queries the difference measurement on the lower window/lower measurement.

Error Messages

- If the last measurement on either channel is not valid error –230, “Data corrupt or stale” occurs. A measurement is valid after it has been initiated. It becomes invalid when either a reset occurs or any measurement parameter, for example frequency, is changed.
- If the expected_value and resolution parameters are not the same as the current expected value and resolution settings on the specified window, error –221, “Settings conflict” occurs.

FETCh[1]|2|3|4[:SCALar][:POWer:AC]:DIFFerence:
RELative? [<expected_value>[,<resolution>[,<source list>]]]

This command sets the specified window's measurement function to power difference with relative mode on, recalculates the measurement and places the results on the bus. The result is a ratio based measurement and is expressed in the units defined by **UNIT[1]|2|3|4:Power:Ratio**. The relative value used is that set by the **CALCulate:RELative:MAGNitude:AUTO** command.

Syntax

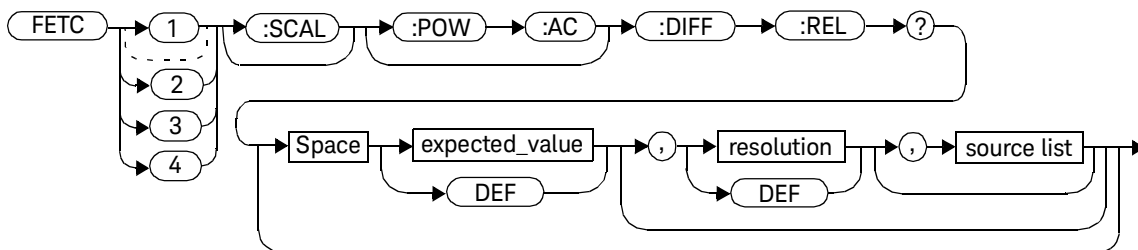

Parameters

Refer to **“Optional Parameters”** on page 108 for additional details on the parameters in this command.

Item	Description/Default	Range of Values
expected_value (for the expected power level)	The expected power level parameter can be set to DEF or a numeric value. If a value is entered it should correspond to that set by CONFigure otherwise an error occurs. The units of measurement are dBm and W. The default units are defined by UNIT:Power .	sensor dependent DEF ^[a]
resolution	A numeric value for the resolution. If it is unspecified the current resolution setting is used. If a value is entered it should correspond to the current resolution setting otherwise an error occurs.	1 to 4 ^[b] 1.0, 0.1, 0.01, 0.001 DEF ^[a]

Item	Description/Default	Range of Values
source list	This channel list specifies between which channels the difference is calculated. If unspecified and the current window setup is a difference measurement then this difference setup is used, otherwise on a meter without USB option installed, it defaults to Channel A-B (N1914A) or A-A (N1913A). However, on a meter with USB option installed, on the N1913A, the upper upper window and lower upper window defaults to Channel A-A, the upper lower window and lower lower window defaults to Channel C-D, while on the N1914A, the upper upper window and lower upper window defaults to Channel A-B, the upper lower window and lower lower window defaults to Channel C-D.	(@1),(@2) ^[c] (@2),(@1) ^[c] (@1),(@1) (@2),(@2) ^[c] (@1), (@3) ^[d] (@1), (@4) ^[d] (@2), (@3) ^[d] (@2), (@4) ^[d] (@3) ^[d] , (@1) (@3) ^[d] , (@2) (@3) ^[d] , (@3) ^[d] (@3) ^[d] , (@4) ^[d] (@4) ^[d] , (@1) (@4) ^[d] , (@2) (@4) ^[d] , (@3) ^[d] (@4) ^[d] , (@4) ^[d]

[a] The mnemonic **DEF** means DEFault. This is not equivalent to the DEFault parameter used in the command sub-systems. The parameters must be entered in the specified order. If parameters are omitted, they default from the right. The parameter DEFault is used as a place holder. Specifying **DEF** leaves the parameter value unchanged.

[b] When the measurement result is linear this parameter represents the number of significant digits. When the measurement result is logarithmic 1 to 4 represents of 1, 0.1, 0.01 and 0.001 respectively.

[c] N1914A only.

[d] USB Option only.

Example

```
FETC1:DIFF:REL? DEF,3,  
(@2),(@1)
```

*This command queries the upper window/
upper measurement relative difference
measurement of Channel B - Channel A,
using the current sensor range and a
resolution setting of 3 on both channels.*

Error Messages

- If the last measurement on either channel is not valid error -230, "Data corrupt or stale" occurs. A measurement is valid after it has been initiated. It becomes invalid when either a reset occurs or any measurement parameter, for example frequency, is changed.
- If the expected_value and resolution parameters are not the same as the current expected value and resolution settings on the specified window, error -221, "Settings conflict" occurs.

FETCh[1]|2|3|4[:SCALar][:POWer:AC]:RATio?
 [<expected_value>[,<resolution>[,<source list>]]]

This command sets the specified window's measurement function to power ratio with relative mode off, recalculates the measurement and places the results on the bus. The result is a ratio based measurement and is expressed in the units defined by **UNIT[1]|2|3|4:POWer:RATio**.

Syntax

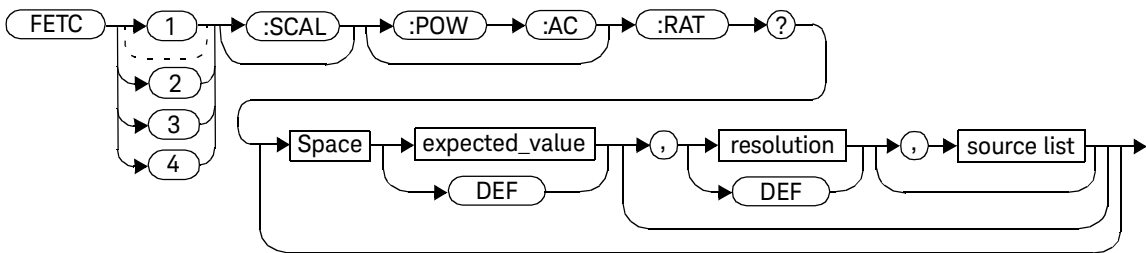

Parameters

Refer to “[Optional Parameters](#)” on page 108 for additional details on the parameters in this command.

Item	Description/Default	Range of Values
expected_value (for the expected power level)	The expected power level parameter can be set to DEF or a numeric value. If a value is entered it should correspond to that set by CONFigure otherwise an error occurs. The units of measurement are dBm and W. The default units are defined by UNIT:POWer .	sensor dependent DEF ^[a]
resolution	A numeric value for the resolution. If it is unspecified the current resolution setting is used. If a value is entered it should correspond to the current resolution setting otherwise an error occurs.	1 to 4 ^[b] 1.0, 0.1, 0.01, 0.001 DEF ^[a]

2 MEASurement Commands

Item	Description/Default	Range of Values
source list	This channel list specifies the channels used to calculate the ratio. If unspecified and the current window setup is a ratio measurement then this ratio setup is used, otherwise on a meter without USB option installed, it defaults to Channel A/B (N1914A) or A/A (N1913A). However, on a meter with USB option installed, on the N1913A, the upper upper window and lower upper window defaults to Channel A/A, the upper lower window and lower lower window defaults to Channel C/D, while on the N1914A, the upper upper window and lower upper window defaults to Channel A/B, the upper lower window and lower lower window defaults to Channel C/D.	(@1),(@2) ^[c] (@2),(@1) ^[c] (@1),(@1) (@2),(@2) ^[c] (@1), (@3) ^[d] (@1), (@4) ^[d] (@2), (@3) ^[d] (@2), (@4) ^[d] (@3) ^[d] , (@1) (@3) ^[d] , (@2) (@3) ^[d] , (@3) ^[d] (@3) ^[d] , (@4) ^[d] (@4) ^[d] , (@1) (@4) ^[d] , (@2) (@4) ^[d] , (@3) ^[d] (@4) ^[d] , (@4) ^[d]

[a] The mnemonic **DEF** means DEFault. This is not equivalent to the DEFault parameter used in the command sub-systems. The parameters must be entered in the specified order. If parameters are omitted, they default from the right. The parameter DEFault is used as a place holder. Specifying **DEF** leaves the parameter value unchanged.

[b] When the measurement result is linear this parameter represents the number of significant digits. When the measurement result is logarithmic 1 to 4 represents of 1, 0.1, 0.01 and 0.001 respectively.

[c] N1914A only.

[d] USB Option only.

Example

```
FETC2:RAT? DEF,1,(@1),(@2)
```

This command queries the lower window/upper measurement ratio measurement of Channel A over Channel B, using the current sensor range and a resolution of 1 on both channels.

Error Messages

- If the last measurement on either channel is not valid error –230, “Data corrupt or stale” occurs. A measurement is valid after it has been initiated. It becomes invalid when either a reset occurs or any measurement parameter, for example frequency, is changed.
- If the expected_value and resolution parameters are not the same as the current expected value and resolution settings on the specified window, error –221, “Settings conflict” occurs.

FETCh[1]|2|3|4[:SCALar][:POWer:AC]:RATio:RELative?
 [<expected_value>[,<resolution>[,<source list>]]]

This command sets the specified window's measurement function to power ratio with relative mode on, recalculates the measurement and places the results on the bus. The result is a ratio based measurement and is expressed in the units defined by **UNIT[1]|2|3|4:POWer:RATio**. The relative value used is that set by the **CALCulate:RELative:MAGNitude:AUTO** command.

Syntax

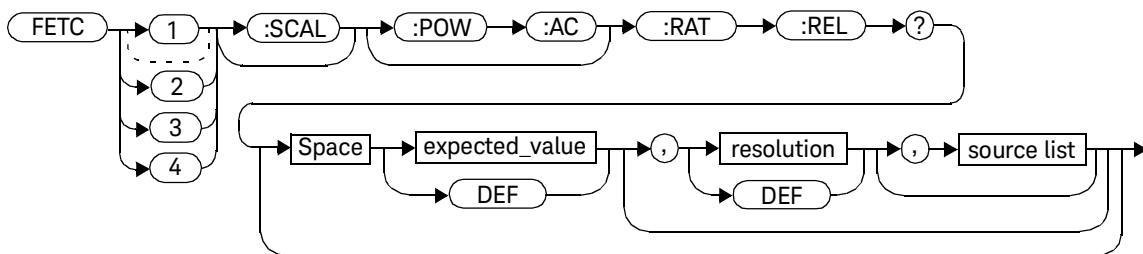

Parameters

Refer to **“Optional Parameters”** on page 108 for additional details on the parameters in this command.

Item	Description/Default	Range of Values
expected_value (for the expected power level)	The expected power level parameter can be set to DEF or a numeric value. If a value is entered it should correspond to that set by CONFigure otherwise an error occurs. The units of measurement are dBm and W. The default units are defined by UNIT:POWer .	sensor dependent DEF ^[a]
resolution	A numeric value for the resolution. If it is unspecified the current resolution setting is used. If a value is entered it should correspond to the current resolution setting otherwise an error occurs.	1 to 4 ^[b] 1.0, 0.1, 0.01, 0.001 DEF ^[a]

Item	Description/Default	Range of Values
source list	This channel list specifies the channels used to calculate the ratio. If unspecified and the current window setup is a ratio measurement then this ratio setup is used, otherwise on a meter without USB option installed, it defaults to Channel A/B (N1914A) or A/A (N1913A). However, on a meter with USB option installed, on the N1913A, the upper upper window and lower upper window defaults to Channel A/A, the upper lower window and lower lower window defaults to Channel C/D, while on the N1914A, the upper upper window and lower upper window defaults to Channel A/B, the upper lower window and lower lower window defaults to Channel C/D.	(@1),(@2) ^[c] (@2),(@1) ^[c] (@1),(@1) (@2),(@2) ^[c] (@1), (@3) ^[d] (@1), (@4) ^[d] (@2), (@3) ^[d] (@2), (@4) ^[d] (@3) ^[d] , (@1) (@3) ^[d] , (@2) (@3) ^[d] , (@3) ^[d] (@3) ^[d] , (@4) ^[d] (@4) ^[d] , (@1) (@4) ^[d] , (@2) (@4) ^[d] , (@3) ^[d] (@4) ^[d] , (@4) ^[d]

- [a] The mnemonic **DEF** means DEFault. This is not equivalent to the DEFault parameter used in the command sub-systems. The parameters must be entered in the specified order. If parameters are omitted, they default from the right. The parameter DEFault is used as a place holder. Specifying **DEF** leaves the parameter value unchanged.
- [b] When the measurement result is linear this parameter represents the number of significant digits. When the measurement result is logarithmic 1 to 4 represents of 1, 0.1, 0.01 and 0.001 respectively.
- [c] N1914A only.
- [d] USB Option only.

Example

FETC:RAT:REL?

This command queries the relative ratio measurement on the upper window/upper measurement.

Error Messages

- If the last measurement on either channel is not valid error -230, “Data corrupt or stale” occurs. A measurement is valid after it has been initiated. It becomes invalid when either a reset occurs or any measurement parameter, for example frequency, is changed.
- If the expected_value and resolution parameters are not the same as the current expected value and resolution settings on the specified window, error -221, “Settings conflict” occurs.

READ[1]|2|3|4 Commands

The **READ?** commands are most commonly used with the **CONFigure** command to cause a new power measurement to be taken and the result returned to the output buffer. The format of the result is set by **FORM[:READ][:DATA]**. Refer to [Chapter 6, “FORMat Subsystem”](#) on page 279 for further information.

- For the N1913A the **READ?** query is equivalent to:

```
ABORt
INITiate
FETCh?
```

- For the N1914A carrying out a single channel measurement the **READ?** queries are equivalent to:

```
ABORt1
INITiate1
FETCh1?
```

or

```
ABORt2
INITiate2
FETCh2?
```

- For the N1914A carrying out a difference measurement the **READ:DIFFerence?** queries are equivalent to:

```
ABORt1
and
ABORt2
INITiate1
INITiate2
FETCh:DIFFerence?
```

- For the N1914A carrying out a ratio measurement the **READ:RATio?** queries are equivalent to:

```
ABORt1
ABORt2
INITiate1
INITiate2
FETCh:RATio?
```

READ[1]|2|3|4[:SCALar][:POWer:AC]?
 [<expected_value>[,<resolution>[,<source list>]]]

This command sets the specified window's measurement function to single channel with relative mode off, aborts then initiates the specified channel, calculates the measurement result and places the result on the bus. The result is a power based measurement and is expressed in the units defined by **UNIT[1]|2|3|4:POWer**.

NOTE

INITiate:CONTinuous must be set to OFF, otherwise error -213, "INIT ignored" occurs. If **TRIGger:SOURce** is set to BUS, error -214, "Trigger deadlock" occurs.

Syntax

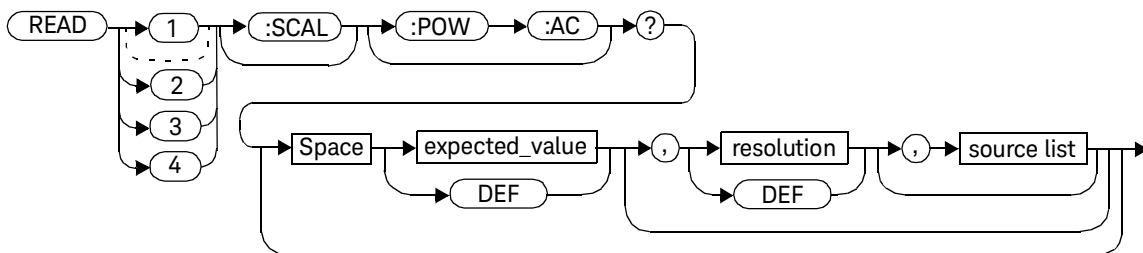

Parameters

Refer to [“Optional Parameters”](#) on page 108 for additional details on the parameters in this command.

Item	Description/Default	Range of Values
expected_value (for the expected power level)	The expected power level parameter can be set to DEF or a numeric value. If a value is entered it should correspond to that set by CONFigure otherwise an error occurs.	sensor dependent DEF ^[a]

Item	Description/Default	Range of Values
resolution	A numeric value for the resolution. If it is unspecified the current resolution setting is used. If a value is entered it should correspond to the current resolution setting otherwise an error occurs.	1 to 4 ^[b] 1.0, 0.1, 0.01, 0.001 DEF ^[a]
source list	The channel which the command is implemented on. If unspecified the current window setup is used. However, if window shows a ratio or difference measurement on a meter with USB option installed, on the N1913A, the upper upper window defaults to Channel A, the upper lower window defaults to Channel C, the lower upper window defaults to Channel A and the lower lower window defaults to Channel D while on the N1914A, the upper upper window defaults to Channel A, the upper lower window defaults to Channel C, the lower upper window defaults to Channel B and the lower lower window defaults to Channel D. Otherwise, on a meter without the USB option installed, the upper window defaults to Channel A and the lower window to Channel B on the N1914A if the window shows a ratio or difference measurement.	(@1) (@2) ^[c] (@3) ^[d] (@4) ^[d]

[a] The mnemonic **DEF** means DEFault. This is not equivalent to the DEFault parameter used in the command sub-systems. The parameters must be entered in the specified order. If parameters are omitted, they default from the right. The parameter DEFault is used as a place holder. Specifying **DEF** leaves the parameter value unchanged.

[b] When the measurement result is linear this parameter represents the number of significant digits. When the measurement result is logarithmic 1 to 4 represents of 1, 0.1, 0.01 and 0.001 respectively.

[c] N1914A only.

[d] USB Option only.

Example

READ2:POW:AC?

*This command queries the lower window/
upper measurement.*

Error Messages

- **INITiate:CONTinuous** must be set to **OFF**, otherwise error -213, "INIT ignored" occurs.
- If **TRIGger:SOURce** is set to **BUS** or **HOLD**, error -214, "Trigger deadlock" occurs.
- If the expected value and resolution parameters are not the same as the current expected value and resolution settings on the specified window, error -221, "Settings conflict" occurs.

READ[1]|2|3|4[:SCALar][:POWer:AC]:RELative?
 [<expected_value>[,<resolution>[,<source list>]]]

This command sets the specified window's measurement function to single channel with relative mode on, aborts then initiates the specified channel, calculates the measurement result and places the result on the bus. The result is a ratio based measurement and is expressed in the units defined by **UNIT[1]|2|3|4:POWer:RATio**. The relative value used is that set by the **CALCuLate:RELative:MAGNitude:AUTO** command.

NOTE

INITiate:CONTinuous must be set to OFF, otherwise error -213, "INIT ignored" occurs. If **TRIGger:SOURce** is set to BUS, error -214, "Trigger deadlock" occurs.

Syntax

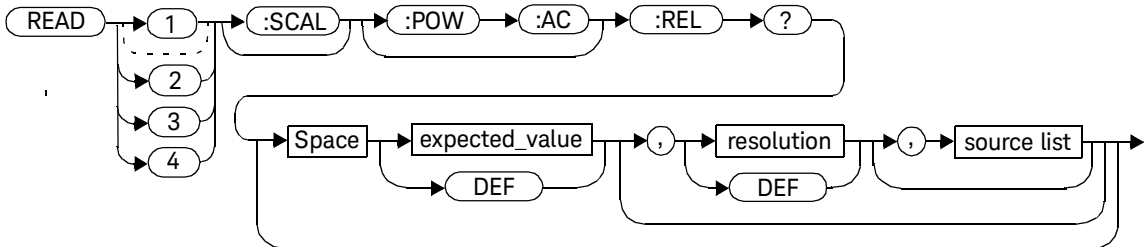

Parameters

Refer to “Optional Parameters” on page 108 for additional details on the parameters in this command.

Item	Description/Default	Range of Values
expected_value (for the expected power level)	The expected power level parameter can be set to DEF or a numeric value. If a value is entered it should correspond to that set by CONFigure otherwise an error occurs.	sensor dependent DEF ^[a]
resolution	A numeric value for the resolution. If it is unspecified the current resolution setting is used. If a value is entered it should correspond to the current resolution setting otherwise an error occurs.	1 to 4 ^[b] 1.0, 0.1, 0.01, 0.001 DEF ^[a]
source list	The channel which the command is implemented on. If unspecified the current window setup is used. However, if window shows a ratio or difference measurement on a meter with USB option installed, on the N1913A, the upper upper window defaults to Channel A, the upper lower window defaults to Channel C, the lower upper window defaults to Channel A and the lower lower window defaults to Channel D while on the N1914A, the upper upper window defaults to Channel A, the upper lower window defaults to Channel C, the lower upper window defaults to Channel B and the lower lower window defaults to Channel D. Otherwise, on a meter without the USB option installed, the upper window defaults to Channel A and the lower window to Channel B on the N1914A if the window shows a ratio or difference measurement.	(@1) (@2) ^[c] (@3) ^[d] (@4) ^[d]

[a] The mnemonic **DEF** means DEFault. This is not equivalent to the DEFault parameter used in the command sub-systems. The parameters must be entered in the specified order. If parameters are omitted, they default from the right. The parameter DEFault is used as a place holder. Specifying **DEF** leaves the parameter value unchanged.

[b] When the measurement result is linear this parameter represents the number of significant digits. When the measurement result is logarithmic 1 to 4 represents of 1, 0.1, 0.01 and 0.001 respectively.

[c] N1914A only.

[d] USB Option only.

Example

```
READ1:REL? DEF,1,(@2)
```

*This command queries the upper window/
upper measurement relative measurement of
Channel B, using the current sensor range
and a resolution of 1.*

Error Messages

- **INITiate:CONTinuous** must be set to **OFF**, otherwise error -213, "INIT ignored" occurs.
- If **TRIGger:SOURce** is set to **BUS** or **HOLD**, error -214, "Trigger deadlock" occurs.
- If the expected value and resolution parameters are not the same as the current expected value and resolution settings on the specified window, error -221, "Settings conflict" occurs.

READ[1]|2|3|4[:SCALar][:POWer:AC]:DIFFerence?
 [<expected_value>[,<resolution>[,<source list>]]]

This command sets the specified window's measurement function to difference mode with relative mode off, aborts then initiates both Channel A and B, calculates the difference measurement result and places the result on the bus. The result is a power based measurement and is expressed in the units defined by UNIT[1]|2|3|4:POWer.

NOTE

INITiate:CONTinuous must be set to OFF on both channels, otherwise error -213, "INIT ignored" occurs. If TRIGger:SOURce is set to BUS on either channel, error -214, "Trigger deadlock" occurs.

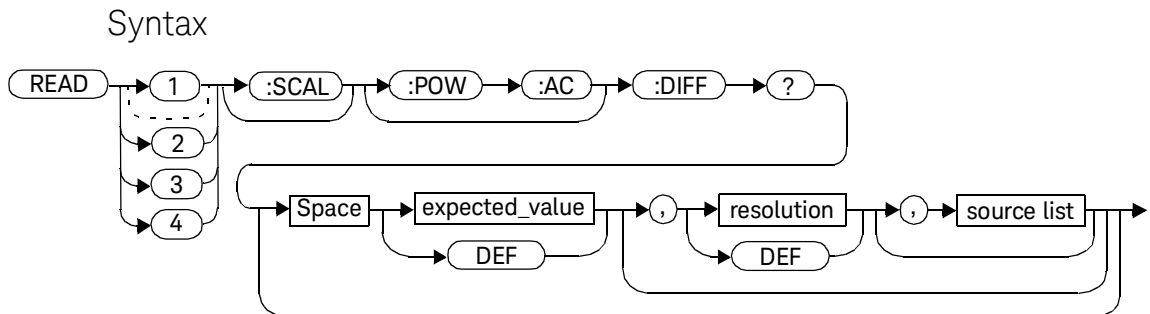

Parameters

Refer to [“Optional Parameters”](#) on page 108 for additional details on the parameters in this command.

Item	Description/Default	Range of Values
expected_value (for the expected power level)	The power meter ignores the numeric value entered in this parameter. Any value entered is treated like DEF.	sensor dependent DEF ^[a]
resolution	A numeric value for the resolution. If it is unspecified the current resolution setting is used. If a value is entered it should correspond to the current resolution setting otherwise an error occurs.	1 to 4 ^[b] 1.0, 0.1, 0.01, 0.001 DEF ^[a]
source list	This channel list specifies between which channels the difference is calculated. If unspecified and the current window setup is a difference measurement then this difference setup is used, otherwise on a meter without USB option installed, it defaults to Channel A-B (N1914A) or A-A (N1913A). However, on a meter with USB option installed, on the N1913A, the upper upper window and lower upper window defaults to Channel A-A, the upper lower window and lower lower window defaults to Channel C-D, while on the N1914A, the upper upper window and lower upper window defaults to Channel A-B, the upper lower window and lower lower window defaults to Channel C-D.	(@1),(@2) ^[c] (@2),(@1) ^[c] (@1),(@1) (@2),(@2) ^[c] (@1), (@3) ^[d] (@1), (@4) ^[d] (@2), (@3) ^[d] (@2), (@4) ^[d] (@3) ^[d] , (@1) (@3) ^[d] , (@2) (@3) ^[d] , (@3) ^[d] (@3) ^[d] , (@4) ^[d] (@4) ^[d] , (@1) (@4) ^[d] , (@2) (@4) ^[d] , (@3) ^[d] (@4) ^[d] , (@4) ^[d]

[a] The mnemonic DEF means DEFault. This is not equivalent to the DEFault parameter used in the command sub-systems. The parameters must be entered in the specified order. If parameters are omitted, they default from the right. The parameter DEFault is used as a place holder. Specifying DEF leaves the parameter value unchanged.

[b] When the measurement result is linear this parameter represents the number of significant digits. When the measurement result is logarithmic 1 to 4 represents of 1, 0.1, 0.01 and 0.001 respectively.

[c] N1914A only.

[d] USB Option only.

Example

READ2:DIFF?

This command queries difference measurement on the lower window/upper measurement.

Error Messages

- **INITiate:CONTinuous** must be set to **OFF** on both channels, otherwise error -213, "INIT ignored" occurs.
- If **TRIGger:SOURce** is set to **BUS** or **HOLD** on either channel, error -214, "Trigger deadlock" occurs.
- If the resolution parameter is not the same as the current resolution setting on the specified window, error -221, "Settings conflict" occurs.

READ[1]|2|3|4[:SCALar][:POWer:AC]:DIFFerence:
RELative? [<expected_value>[,<resolution>[,<source list>]]]

This command sets the specified window's measurement function to difference mode with relative mode on, aborts then initiates both Channel A and B, calculates the difference measurement result and places the result on the bus. The result is a ratio based measurement and is expressed in the units defined by **UNIT[1]|2|3|4:POWer:RATio**. The relative value used is that set by the **CALCuLate:RELative:MAGNitude:AUTO** command.

NOTE

INITiate:CONTinuous must be set to OFF on both channels, otherwise error -213, "INIT ignored" occurs. If TRIGger:SOURce is set to BUS on either channel, error -214, "Trigger deadlock" occurs.

Syntax

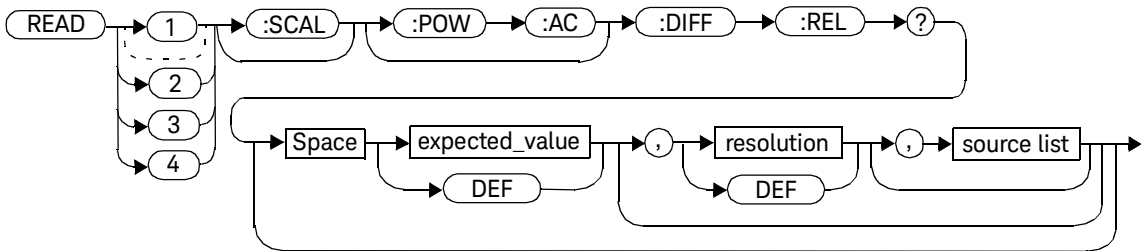

Parameters

Refer to “Optional Parameters” on page 108 for additional details on the parameters in this command.

Item	Description/Default	Range of Values
expected_value (for the expected power level)	The power meter ignores the numeric value entered in this parameter. Any value entered is treated like DEF .	sensor dependent DEF ^[a]
resolution	A numeric value for the resolution. If it is unspecified the current resolution setting is used. If a value is entered it should correspond to the current resolution setting otherwise an error occurs.	1 to 4 ^[b] 1.0, 0.1, 0.01, 0.001 DEF ^[a]
source list	This channel list specifies between which channels the difference is calculated. If unspecified and the current window setup is a difference measurement then this difference setup is used, otherwise on a meter without USB option installed, it defaults to Channel A-B (N1914A) or A-A (N1913A). However, on a meter with USB option installed, on the N1913A, the upper upper window and lower upper window defaults to Channel A-A, the upper lower window and lower lower window defaults to Channel C-D, while on the N1914A, the upper upper window and lower upper window defaults to Channel A-B, the upper lower window and lower lower window defaults to Channel C-D.	(@1),(@2) ^[c] (@2),(@1) ^[c] (@1),(@1) (@2),(@2) ^[c] (@1), (@3) ^[d] (@1), (@4) ^[d] (@2), (@3) ^[d] (@2), (@4) ^[d] (@3) ^[d] , (@1) (@3) ^[d] , (@2) (@3) ^[d] , (@3) ^[d] (@3) ^[d] , (@4) ^[d] (@4) ^[d] , (@1) (@4) ^[d] , (@2) (@4) ^[d] , (@3) ^[d] (@4) ^[d] , (@4) ^[d]

[a] The mnemonic **DEF** means DEFault. This is not equivalent to the DEFault parameter used in the command sub-systems. The parameters must be entered in the specified order. If parameters are omitted, they default from the right. The parameter DEFault is used as a place holder. Specifying **DEF** leaves the parameter value unchanged.

[b] When the measurement result is linear this parameter represents the number of significant digits. When the measurement result is logarithmic 1 to 4 represents of 1, 0.1, 0.01 and 0.001 respectively.

[c] N1914A only.

[d] USB Option only.

Example

```
READ1:DIFF:REL? DEF,4,(@2),(@1)
```

This command queries the upper window/upper measurement relative difference measurement of Channel B - Channel A, using the current sensor range and a resolution setting of 4 on both channels.

Error Messages

- **INITiate:CONTinuous** must be set to **OFF** on both channels, otherwise error -213, "INIT ignored" occurs.
- If **TRIGger:SOURce** is set to **BUS** or **HOLD** on either channel, error -214, "Trigger deadlock" occurs.
- If the resolution parameter is not the same as the current resolution setting on the specified window, error -221, "Settings conflict" occurs.

READ[1]|2|3|4[:SCALar][:POWer:AC]:RATio?
 [<expected_value>[,<resolution>[,<source list>]]]

This command sets the specified window's measurement function to ratio mode with relative mode off, aborts then initiates both Channel A and B, calculates the ratio measurement result and places the result on the bus. The result is a ratio based measurement and is expressed in the units defined by **UNIT[1]|2|3|4:POWer:RATio**.

NOTE

INITiate:CONTinuous must be set to OFF on both channels, otherwise error -213, "INIT ignored" occurs. If **TRIGger:SOURce** is set to BUS on either channel, error -214, "Trigger deadlock" occurs.

Syntax

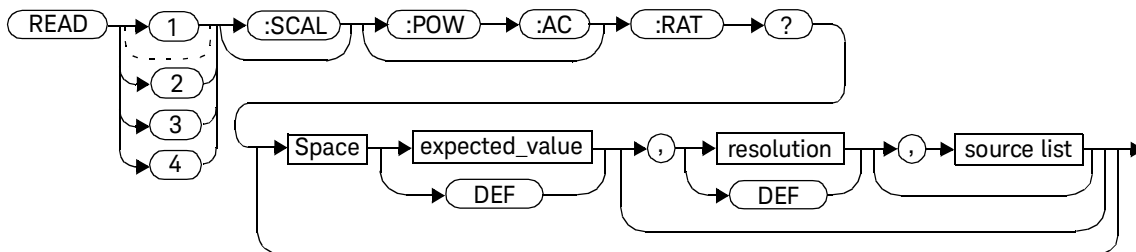

Parameters

Refer to [“Optional Parameters”](#) on page 108 for additional details on the parameters in this command.

Item	Description/Default	Range of Values
expected_value (for the expected power level)	The power meter ignores the numeric value entered in this parameter. Any value entered is treated like DEF .	sensor dependent DEF ^[a]
resolution	A numeric value for the resolution. If it is unspecified the current resolution setting is used. If a value is entered it should correspond to the current resolution setting otherwise an error occurs.	1 to 4 ^[b] 1.0, 0.1, 0.01, 0.001 DEF ^[a]
source list	This channel list specifies the channels used to calculate the ratio. If unspecified and the current window setup is a ratio measurement then this ratio setup is used, otherwise on a meter without USB option installed, it defaults to Channel A/B (N1914A) or A/A (N1913A). However, on a meter with USB option installed, on the N1913A, the upper upper window and lower upper window defaults to Channel A/A, the upper lower window and lower lower window defaults to Channel C/D, while on the N1914A, the upper upper window and lower upper window defaults to Channel A/B, the upper lower window and lower lower window defaults to Channel C/D.	(@1),(@2) ^[c] (@2),(@1) ^[c] (@1),(@1) (@2),(@2) ^[c] (@1), (@3) ^[d] (@1), (@4) ^[d] (@2), (@3) ^[d] (@2), (@4) ^[d] (@3) ^[d] , (@1) (@3) ^[d] , (@2) (@3) ^[d] , (@3) ^[d] (@3) ^[d] , (@4) ^[d] (@4) ^[d] , (@1) (@4) ^[d] , (@2) (@4) ^[d] , (@3) ^[d] (@4) ^[d] , (@4) ^[d]

[a] The mnemonic **DEF** means DEFault. This is not equivalent to the DEFault parameter used in the command sub-systems. The parameters must be entered in the specified order. If parameters are omitted, they default from the right. The parameter DEFault is used as a place holder. Specifying **DEF** leaves the parameter value unchanged.

[b] When the measurement result is linear this parameter represents the number of significant digits. When the measurement result is logarithmic 1 to 4 represents of 1, 0.1, 0.01 and 0.001 respectively.

[c] N1914A only.

[d] USB Option only.

Example

`READ2:RAT? DEF,1,(@1),(@2)` *This command queries the lower window/upper measurement ratio measurement of Channel A over Channel B, using the current sensor range and a resolution of 1 on both channels.*

Error Messages

- **INITiate:CONTinuous** must be set to **OFF** on both channels, otherwise error -213, "INIT ignored" occurs.
- If **TRIGger:SOURce** is set to **BUS** or **HOLD** on either channel, error -214, "Trigger deadlock" occurs.
- If the resolution parameter is not the same as the current resolution setting on the specified window, error -221, "Settings conflict" occurs.

READ[1]|2|3|4[:SCALar][:POWER:AC]:RATio:RELative?
 [<expected_value>[,<resolution>[,<source list>]]]

This command sets the specified window's measurement function to ratio mode with relative mode on, aborts then initiates both Channel A and B, calculates the ratio measurement result using the new sensor data and places the result on the bus. The result is a ratio based measurement and is expressed in the units defined by `UNIT[1]|2|3|4:POWER:RATio`. The relative value used is that set by the `CALCuLate:RELative:MAGNitude:AUTO` command.

NOTE

INITiate:CONTinuous must be set to OFF on both channels, otherwise error -213, "INIT ignored" occurs. If TRIGger:SOURce is set to BUS on either channel, error -214, "Trigger deadlock" occurs.

Syntax

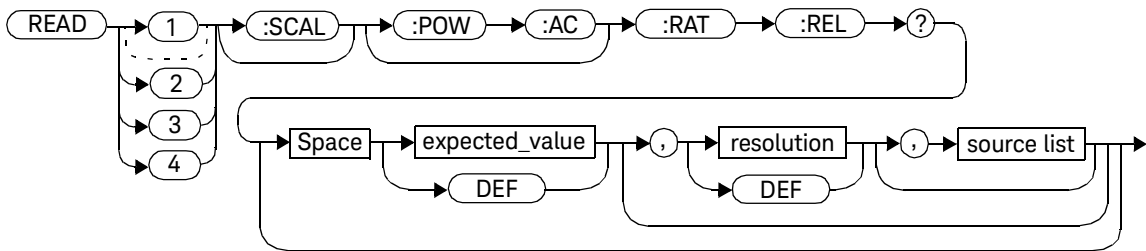

Parameters

Refer to “Optional Parameters” on page 108 for additional details on the parameters in this command.

Item	Description/Default	Range of Values
expected_value (for the expected power level)	The power meter ignores the numeric value entered in this parameter. Any value entered is treated like DEF .	sensor dependent DEF ^[a]
resolution	A numeric value for the resolution. If it is unspecified the current resolution setting is used. If a value is entered it should correspond to the current resolution setting otherwise an error occurs.	1 to 4 ^[b] 1.0, 0.1, 0.01, 0.001 DEF ^[a]
source list	This channel list specifies the channels used to calculate the ratio. If unspecified and the current window setup is a ratio measurement then this ratio setup is used, otherwise on a meter without USB option installed, it defaults to Channel A/B (N1914A) or A/A (N1913A). However, on a meter with USB option installed, on the N1913A, the upper upper window and lower upper window defaults to Channel A/A, the upper lower window and lower lower window defaults to Channel C/D, while on the N1914A, the upper upper window and lower upper window defaults to Channel A/B, the upper lower window and lower lower window defaults to Channel C/D.	(@1),(@2) ^[c] (@2),(@1) ^[c] (@1),(@1) (@2),(@2) ^[c] (@1), (@3) ^[d] (@1), (@4) ^[d] (@2), (@3) ^[d] (@2), (@4) ^[d] (@3) ^[d] , (@1) (@3) ^[d] , (@2) (@3) ^[d] , (@3) ^[d] (@3) ^[d] , (@4) ^[d] (@4) ^[d] , (@1) (@4) ^[d] , (@2) (@4) ^[d] , (@3) ^[d] (@4) ^[d] , (@4) ^[d]

[a] The mnemonic **DEF** means DEFault. This is not equivalent to the DEFault parameter used in the command sub-systems. The parameters must be entered in the specified order. If parameters are omitted, they default from the right. The parameter DEFault is used as a place holder. Specifying **DEF** leaves the parameter value unchanged.

[b] When the measurement result is linear this parameter represents the number of significant digits. When the measurement result is logarithmic 1 to 4 represents of 1, 0.1, 0.01 and 0.001 respectively.

[c] N1914A only.

[d] USB Option only.

Example

READ:RAT:REL?

This command queries the relative ratio measurement on the upper window/upper measurement.

Error Messages

- **INITiate:CONTinuous** must be set to **OFF** on both channels, otherwise error -213, "INIT ignored" occurs.
- If **TRIGger:SOURce** is set to **BUS** or **HOLD** on either channel, error -214, "Trigger deadlock" occurs.
- If the resolution parameter is not the same as the current resolution setting on the specified window, error -221, "Settings conflict" occurs.

MEASure[1]|2|3|4 Commands

The **MEASure?** commands configure the power meter to perform a power measurement with the given measurement function, relative mode setting, range and resolution then makes the measurement. The format of the result is set by **FORM[:READ][:DATA]**. Refer to [Chapter 6, “FORMat Subsystem”](#) on page 279 for further information.

MEASure? is a compound command which is equivalent to:

- For the N1913A the **MEASure?** query is equivalent to:

```
ABORt
CONFigure
READ?
```

- For the N1914A carrying out a single channel measurement the **MEASure?** queries are equivalent to:

```
ABORt1
CONFigure
READ1?
```

or

```
ABORt2
CONFigure
READ2?
```

- For the N1914A carrying out a difference measurement the **MEASure:DIFFerence?** queries are equivalent to:

```
ABORt1
ABORt2
CONFigure:DIFFerence
READ:DIFFerence?
```

- For the N1914A carrying out a ratio measurement the **MEASure:RATio?** queries are equivalent to:

```
ABORt1
ABORt2
CONFigure:RATio
READ:RATio?
```

```
MEASure[1]|2|3|4[:SCALar][:POWer:AC]?
[<expected_value>[,<resolution>[,<source list>]]]
```

This command sets the specified window's measurement function to single channel with relative mode off, aborts, configures the window then initiates Channel A or B, calculates the measurement result and places the result on the bus.

Syntax

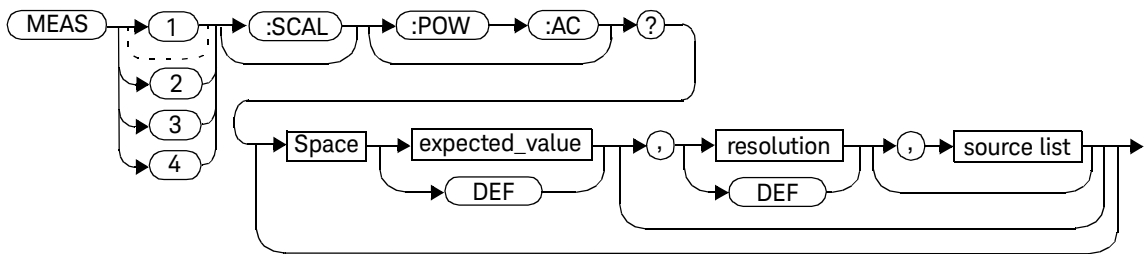

Parameters

Refer to “[Optional Parameters](#)” on page 108 for additional details on the parameters in this command.

Item	Description/Default	Range of Values
expected_value (for the expected power level)	A numeric value for the expected power level. The units of measurement are dBm and W. The default units are defined by UNIT:POWER .	sensor dependent DEF ^[a]
resolution	A numeric value for the resolution. If unspecified the current resolution setting is used.	1 to 4 ^[b] 1.0, 0.1, 0.01, 0.001 DEF ^[a]

Item	Description/Default	Range of Values
source list	The channel which the command is implemented on. If unspecified the current window setup is used. However, if window shows a ratio or difference measurement on a meter with USB option installed, on the N1913A, the upper upper window defaults to Channel A, the upper lower window defaults to Channel C, the lower upper window defaults to Channel A and the lower lower window defaults to Channel D while on the N1914A, the upper upper window defaults to Channel A, the upper lower window defaults to Channel C, the lower upper window defaults to Channel B and the lower lower window defaults to Channel D. Otherwise, on a meter without the USB option installed, the upper window defaults to Channel A and the lower window to Channel B on the N1914A if the window shows a ratio or difference measurement.	(@1) (@2) ^[c] (@3) ^[d] (@4) ^[d]

[a] The mnemonic **DEF** means DEFault. This is not equivalent to the DEFault parameter used in the command sub-systems. The parameters must be entered in the specified order. If parameters are omitted, they default from the right. The parameter DEFault is used as a place holder. Specifying **DEF** leaves the parameter value unchanged.

[b] When the measurement result is linear this parameter represents the number of significant digits. When the measurement result is logarithmic 1 to 4 represents of 1, 0.1, 0.01 and 0.001 respectively.

[c] N1914A only.

[d] USB Option only.

Example

`MEAS2:POW:AC? -70DBM,1,(@1)` *This command queries the lower window/upper measurement of Channel A, using an expected power level of -70 dBm and a resolution setting of 1.*

MEASure[1]|2|3|4[:SCALar][:POWer:AC]:RELative?
 [<expected_value>[,<resolution>[,<source list>]]]

This command sets the specified window's measurement function to single channel with relative mode on, aborts, configures then initiates the specified channel, calculates the measurement result and places the result on the bus. The result is a ratio based measurement and is expressed in the units defined by **UNIT[1]|2|3|4:POWer:RATio**. The relative value used is that set by the **CALCulate:RELative:MAGNitude:AUTO** command.

Syntax

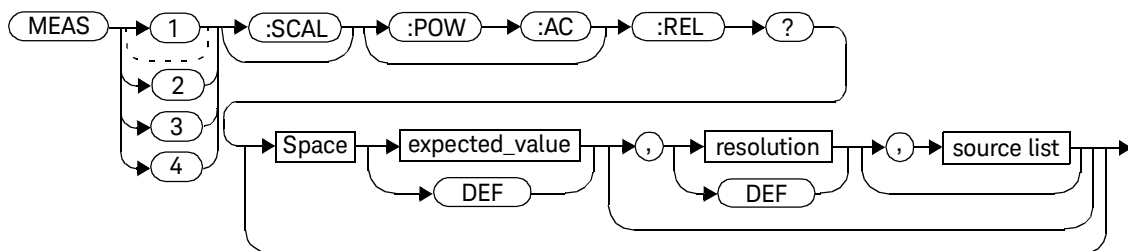

Parameters

Refer to “Optional Parameters” on page 108 for additional details on the parameters in this command.

Item	Description/Default	Range of Values
expected_value (for the expected power level)	A numeric value for the expected power level. The units of measurement are dBm and W. The default units are defined by UNIT:POWer .	sensor dependent DEF ^[a]
resolution	A numeric value for the resolution. If unspecified the current resolution setting is used.	1 to 4 ^[b] 1.0, 0.1, 0.01, 0.001 DEF ^[a]

Item	Description/Default	Range of Values
source list	The channel which the command is implemented on. If unspecified the current window setup is used. However, if window shows a ratio or difference measurement on a meter with USB option installed, on the N1913A, the upper upper window defaults to Channel A, the upper lower window defaults to Channel C, the lower upper window defaults to Channel A and the lower lower window defaults to Channel D while on the N1914A, the upper upper window defaults to Channel A, the upper lower window defaults to Channel C, the lower upper window defaults to Channel B and the lower lower window defaults to Channel D. Otherwise, on a meter without the USB option installed, the upper window defaults to Channel A and the lower window to Channel B on the N1914A if the window shows a ratio or difference measurement.	(@1) (@2) ^[c] (@3) ^[d] (@4) ^[d]

[a] The mnemonic **DEF** means DEFAult. This is not equivalent to the DEFAult parameter used in the command sub-systems. The parameters must be entered in the specified order. If parameters are omitted, they default from the right. The parameter DEFAult is used as a place holder. Specifying **DEF** leaves the parameter value unchanged.

[b] When the measurement result is linear this parameter represents the number of significant digits. When the measurement result is logarithmic 1 to 4 represents of 1, 0.1, 0.01 and 0.001 respectively.

[c] N1914A only.

[d] USB Option only.

Example

```
MEAS1:REL? -50DBM,2,(@2)
```

*This command queries the upper window/
upper measurement relative measurement of
Channel B, using an expected power level
of -50 dBm and a resolution setting of 2.*

MEASure[1]|2|3|4[:SCALar][:POWer:AC]:DIFFerence? [<expected_value>[,<resolution>[,<source list>]]]

This command applies to the N1914A power meter only, as it needs two measurement channels to make sense.

This command sets the specified window's measurement function to difference mode with relative mode off, aborts, configures then initiates both Channel A and B, calculates the difference measurement result and places the result on the bus. The result is a power based measurement and is expressed in the units defined by **UNIT[1]|2|3|4:POWer**.

Syntax

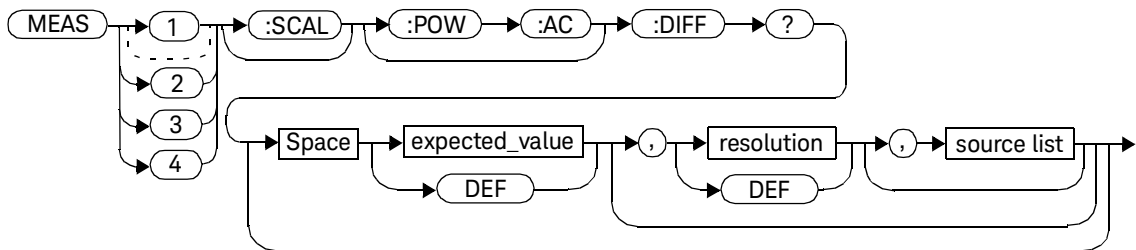

Parameters

Refer to **“Optional Parameters”** on page 108 for additional details on the parameters in this command.

Item	Description/Default	Range of Values
expected_value (for the expected power level)	The power meter ignores the numeric value entered in this parameter. Any value entered is treated like DEF .	sensor dependent DEF ^[a]
resolution	A numeric value for the resolution. If unspecified the current resolution setting is used.	1 to 4 ^[b] 1.0, 0.1, 0.01, 0.001 DEF ^[a]

Item	Description/Default	Range of Values
source list	This channel list specifies between which channels the difference is calculated. If unspecified and the current window setup is a difference measurement then this difference setup is used, otherwise on a meter without USB option installed, it defaults to Channel A-B (N1914A) or A-A (N1913A). However, on a meter with USB option installed, on the N1913A, the upper upper window and lower upper window defaults to Channel A-A, the upper lower window and lower lower window defaults to Channel C-D, while on the N1914A, the upper upper window and lower upper window defaults to Channel A-B, the upper lower window and lower lower window defaults to Channel C-D.	(@1),(@2) ^[c] (@2),(@1) ^[c] (@1),(@1) (@2),(@2) ^[c] (@1), (@3) ^[d] (@1), (@4) ^[d] (@2), (@3) ^[d] (@2), (@4) ^[d] (@3) ^[d] , (@1) (@3) ^[d] , (@2) (@3) ^[d] , (@3) ^[d] (@3) ^[d] , (@4) ^[d] (@4) ^[d] , (@1) (@4) ^[d] , (@2) (@4) ^[d] , (@3) ^[d] (@4) ^[d] , (@4) ^[d]

[a] The mnemonic **DEF** means DEFault. This is not equivalent to the DEFault parameter used in the command sub-systems. The parameters must be entered in the specified order. If parameters are omitted, they default from the right. The parameter DEFault is used as a place holder. Specifying **DEF** leaves the parameter value unchanged.

[b] When the measurement result is linear this parameter represents the number of significant digits. When the measurement result is logarithmic 1 to 4 represents of 1, 0.1, 0.01 and 0.001 respectively.

[c] N1914A only.

[d] USB Option only.

Example

MEAS2:DIFF?

This command queries the difference measurement on the lower window/upper measurement.

MEASure[1]|2|3|4[:SCALar][:POWer:AC]:DIFFerence:
RELative? [<expected_value>[,<resolution>[,<source list>]]]

This command sets the specified window's measurement function to difference mode with relative mode on, aborts, configures then initiates both Channel A and B, calculates the difference measurement result and places the result on the bus. The result is a ratio based measurement and is expressed in the units defined by **UNIT[1]|2|3|4:POWer:RATio**. The relative value used is that set by the **CALCulate:RELative:MAGNitude:AUTO** command.

Syntax

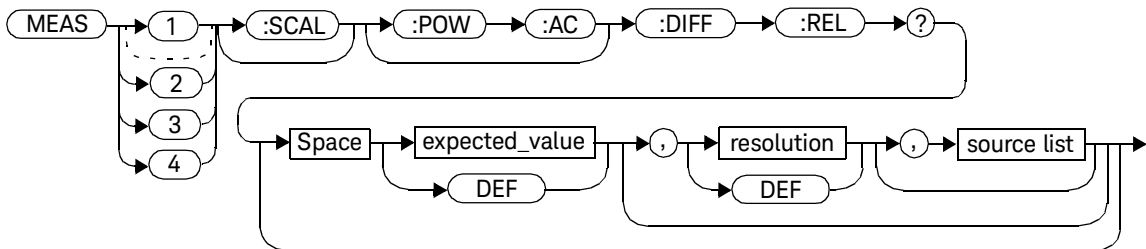

Parameters

Refer to “[Optional Parameters](#)” on page 108 for additional details on the parameters in this command.

Item	Description/Default	Range of Values
expected_value (for the expected power level)	The power meter ignores the numeric value entered in this parameter. Any value entered is treated like DEF .	sensor dependent DEF ^[a]
resolution	A numeric value for the resolution. If unspecified the current resolution setting is used.	1 to 4 ^[b] 1.0, 0.1, 0.01, 0.001 DEF ^[a]

Item	Description/Default	Range of Values
source list	This channel list specifies between which channels the difference is calculated. If unspecified and the current window setup is a difference measurement then this difference setup is used, otherwise on a meter without USB option installed, it defaults to Channel A-B (N1914A) or A-A (N1913A). However, on a meter with USB option installed, on the N1913A, the upper upper window and lower upper window defaults to Channel A-A, the upper lower window and lower lower window defaults to Channel C-D, while on the N1914A, the upper upper window and lower upper window defaults to Channel A-B, the upper lower window and lower lower window defaults to Channel C-D.	(@1),(@2) ^[c] (@2),(@1) ^[c] (@1),(@1) (@2),(@2) ^[c] (@1), (@3) ^[d] (@1), (@4) ^[d] (@2), (@3) ^[d] (@2), (@4) ^[d] (@3) ^[d] , (@1) (@3) ^[d] , (@2) (@3) ^[d] , (@3) ^[d] (@3) ^[d] , (@4) ^[d] (@4) ^[d] , (@1) (@4) ^[d] , (@2) (@4) ^[d] , (@3) ^[d] (@4) ^[d] , (@4) ^[d]

[a] The mnemonic **DEF** means DEFault. This is not equivalent to the DEFault parameter used in the command sub-systems. The parameters must be entered in the specified order. If parameters are omitted, they default from the right. The parameter DEFault is used as a place holder. Specifying **DEF** leaves the parameter value unchanged.

[b] When the measurement result is linear this parameter represents the number of significant digits. When the measurement result is logarithmic 1 to 4 represents of 1, 0.1, 0.01 and 0.001 respectively.

[c] N1914A only.

[d] USB Option only.

Example

```
MEAS1:DIFF:REL? DEF,3,  
(@2),(@1)
```

*This command queries the upper window/
upper measurement relative difference
measurement of Channel B - Channel A,
using the current sensor range and a
resolution setting of 3 on both channels.*

MEASure[1]|2|3|4[:SCALar][:POWer:AC]:RATio?
 [<expected_value>[,<resolution>[,<source list>]]]

This command sets the specified window's measurement function to ratio mode with relative mode off, aborts, configures then initiates both Channel A and B, calculates the ratio measurement result and places the result on the bus. The result is a ratio based measurement and is expressed in the units defined by **UNIT[1]|2|3|4:POWer:RATio**.

Syntax

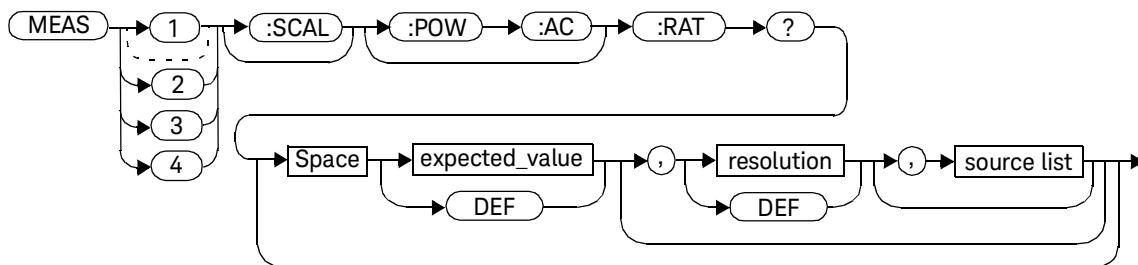

Parameters

Refer to **“Optional Parameters”** on page 108 for additional details on the parameters in this command.

Item	Description/Default	Range of Values
expected_value (for the expected power level)	The power meter ignores the numeric value entered in this parameter. Any value entered is treated like DEF .	sensor dependent DEF ^[a]
resolution	A numeric value for the resolution. If unspecified the current resolution setting is used.	1 to 4 ^[b] 1.0, 0.1, 0.01, 0.001 DEF ^[a]

Item	Description/Default	Range of Values
source list	This channel list specifies the channels used to calculate the ratio. If unspecified and the current window setup is a ratio measurement then this ratio setup is used, otherwise on a meter without USB option installed, it defaults to Channel A/B (N1914A) or A/A (N1913A). However, on a meter with USB option installed, on the N1913A, the upper upper window and lower upper window defaults to Channel A/A, the upper lower window and lower lower window defaults to Channel C/D, while on the N1914A, the upper upper window and lower upper window defaults to Channel A/B, the upper lower window and lower lower window defaults to Channel C/D.	(@1),(@2) ^[c] (@2),(@1) ^[c] (@1),(@1) (@2),(@2) ^[c] (@1), (@3) ^[d] (@1), (@4) ^[d] (@2), (@3) ^[d] (@2), (@4) ^[d] (@3) ^[d] , (@1) (@3) ^[d] , (@2) (@3) ^[d] , (@3) ^[d] (@3) ^[d] , (@4) ^[d] (@4) ^[d] , (@1) (@4) ^[d] , (@2) (@4) ^[d] , (@3) ^[d] (@4) ^[d] , (@4) ^[d]

- [a] The mnemonic **DEF** means DEFault. This is not equivalent to the DEFault parameter used in the command sub-systems. The parameters must be entered in the specified order. If parameters are omitted, they default from the right. The parameter DEFault is used as a place holder. Specifying **DEF** leaves the parameter value unchanged.
- [b] When the measurement result is linear this parameter represents the number of significant digits. When the measurement result is logarithmic 1 to 4 represents of 1, 0.1, 0.01 and 0.001 respectively.
- [c] N1914A only.
- [d] USB Option only.

Example

```
MEAS2:RAT? DEF,1,(@1),(@2)
```

This command queries the lower window/upper measurement ratio measurement of Channel A over Channel B, using the current sensor range and a resolution of 1 on both channels.

MEASure[1]|2|3|4[:SCALar][:POWer:AC]:RATio:RELative?
 [<expected_value>[,<resolution>[,<source list>]]]

This command sets the specified window's measurement function to ratio mode with relative mode on, aborts, configures then initiates both Channel A and B, calculates the ratio measurement and places the result on the bus. The result is a ratio based measurement and is expressed in the units defined by **UNIT[1]|2|3|4:POWer:RATio**. The relative value used is that set by the **CALCuLate:RELative:MAGNitude:AUTO** command.

Syntax

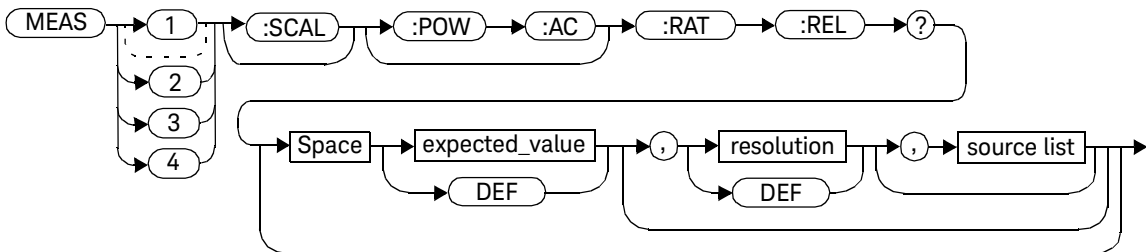

Parameters

Refer to “[Optional Parameters](#)” on page 108 for additional details on the parameters in this command.

Item	Description/Default	Range of Values
expected_value (for the expected power level)	The power meter ignores the numeric value entered in this parameter. Any value entered is treated like DEF .	sensor dependent DEF ^[a]
resolution	A numeric value for the resolution. If unspecified the current resolution setting is used.	1 to 4 ^[b] 1.0, 0.1, 0.01, 0.001 DEF ^[a]

Item	Description/Default	Range of Values
source list	This channel list specifies the channels used to calculate the ratio. If unspecified and the current window setup is a ratio measurement then this ratio setup is used, otherwise on a meter without USB option installed, it defaults to Channel A/B (N1914A) or A/A (N1913A). However, on a meter with USB option installed, on the N1913A, the upper upper window and lower upper window defaults to Channel A/A, the upper lower window and lower lower window defaults to Channel C/D, while on the N1914A, the upper upper window and lower upper window defaults to Channel A/B, the upper lower window and lower lower window defaults to Channel C/D.	(@1),(@2) ^[c] (@2),(@1) ^[c] (@1),(@1) (@2),(@2) ^[c] (@1), (@3) ^[d] (@1), (@4) ^[d] (@2), (@3) ^[d] (@2), (@4) ^[d] (@3) ^[d] , (@1) (@3) ^[d] , (@2) (@3) ^[d] , (@3) ^[d] (@3) ^[d] , (@4) ^[d] (@4) ^[d] , (@1) (@4) ^[d] , (@2) (@4) ^[d] , (@3) ^[d] (@4) ^[d] , (@4) ^[d]

- [a] The mnemonic **DEF** means DEFault. This is not equivalent to the DEFault parameter used in the command sub-systems. The parameters must be entered in the specified order. If parameters are omitted, they default from the right. The parameter DEFault is used as a place holder. Specifying **DEF** leaves the parameter value unchanged.
- [b] When the measurement result is linear this parameter represents the number of significant digits. When the measurement result is logarithmic 1 to 4 represents of 1, 0.1, 0.01 and 0.001 respectively.
- [c] N1914A only.
- [d] USB Option only.

Example

MEAS:RAT:REL?

This command queries the relative ratio measurement on the upper window/upper measurement.

3 CALCulate Subsystem

CALCulate Subsystem	192
CALCulate[1]2 3 4:HOLD:STAT <character_data>	195
CALCulate[1]2 3 4:FEED[1]2 <string>	197
CALCulate[1]2 3 4:GAIN Commands	200
CALCulate[1]2 3 4:GAIN[:MAGNitude] <numeric_value>	201
CALCulate[1]2 3 4:GAIN:STATe <boolean>	203
CALCulate[1]2 3 4:LIMit Commands	205
CALCulate[1]2 3 4:LIMit:CLEar:AUTO <boolean> ONCE	206
CALCulate[1]2 3 4:LIMit:CLEar[:IMMEDIATE]	208
CALCulate[1]2 3 4:LIMit:FAIL?	209
CALCulate[1]2 3 4:LIMit:FOUNT?	210
CALCulate[1]2 3 4:LIMit:LOWer[:DATA] <numeric_value>	212
CALCulate[1]2 3 4:LIMit:UPPer[:DATA] <numeric_value>	214
CALCulate[1]2 3 4:LIMit:STATe <boolean>	216
CALCulate[1]2 3 4:MATH Commands	218
CALCulate[1]2 3 4:MATH[:EXPRession] <string>	219
CALCulate[1]2 3 4:MATH[:EXPRession]:CATalog?	223
CALCulate[1]2 3 4:RELative Commands	225
CALCulate[1]2 3 4:RELative[:MAGNitude]:AUTO <boolean> ONCE	226
CALCulate[1]2 3 4:RELative:STATe <boolean>	228

This chapter explains how the **CALCulate** subsystem is used to perform post acquisition data processing.

CALCulate Subsystem

The **CALCulate** subsystem performs post acquisition data processing. Functions in the **SENSe** subsystem are related to data acquisition, while the **CALCulate** subsystem operates on the data acquired by a **SENSe** function.

There are four independent **CALCulate** blocks in the power meter: two for each window, as shown in [Figure 3-1](#). The numeric suffix of the **CALCulate** command determines which **CALCulate** block is used and where the measurement result is displayed.

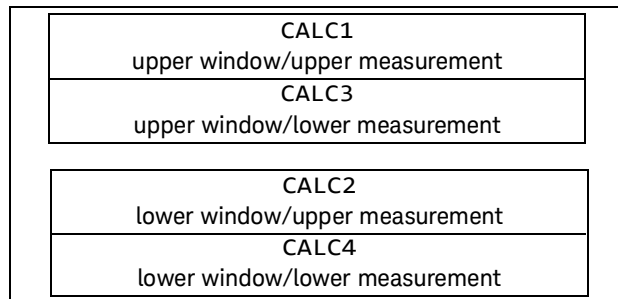

Figure 3-1 Measurement Display CALCulate Block Window

Data from both **SENSe** blocks may feed any or all of the **CALCulate** blocks via the **MATH** command. [Figure 3-1](#) details where the commands are applied with in the **CALCulate** block.

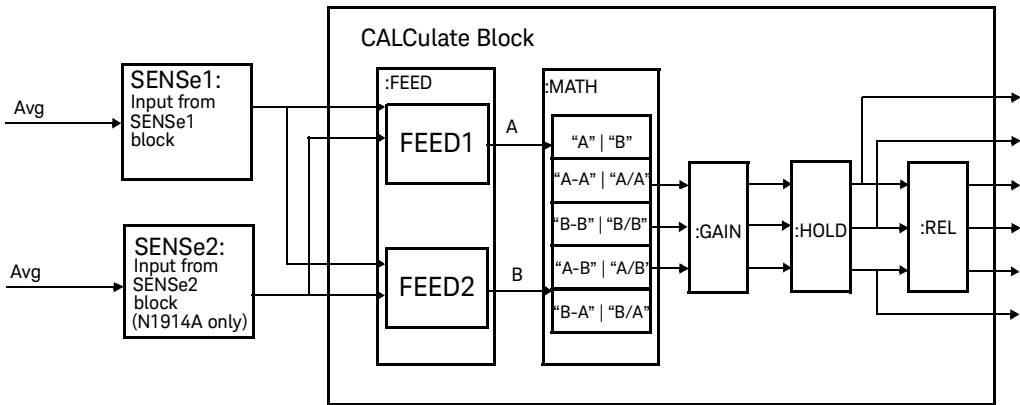

Figure 3-2 CALCulate Block

3 CALCulate Subsystem

Keyword	Parameter Form	Notes	Page
CALCulate[1] 2 3 4			
:HOLD			
:STAT	<string>		page 195
:FEED[1] 2	<data_handle>		page 195
:GAIN			
[:MAGNitude]	<numeric_value>		page 201
:STATe	<boolean>		page 203
:LIMit			
:CLEAr			
:AUTO	<boolean> ONCE		page 206
[:IMMediate]			page 208
:FAIL?		[query only]	page 209
:FCOunt?		[query only]	page 210
:LOWer			
[:DATA]	<numeric_value>		page 212
:UPPer			
[:DATA]	<numeric_value>		page 214
:STATe	<boolean>		page 216
:MATH			
[:EXPRession]	<string>		page 219
:CATalog?		[query only]	page 223
:RELative			
[:MAGNitude]			
:AUTO	<boolean> ONCE		page 226
:STATe	<boolean>		page 228

CALCulate[1]|2|3|4:HOLD:STAT <character_data>

This command sets the hold value to be either minimum or maximum of the power measured.

Syntax

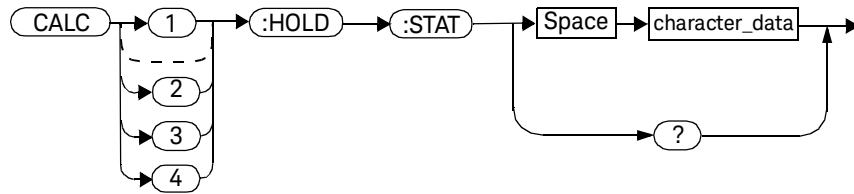

Parameters

Item	Description	Range of Values
character_data	Sets Hold value to Off	OFF
	Sets Hold value to Minimum	MIN
	Sets Hold value to Maximum	MAX

Example

CALC2:HOLD:STAT MIN	<i>This command sets hold value to minimum power detected.</i>
CALC2:HOLD:STAT MAX	<i>This command sets hold value to maximum power detected.</i>
CALC2:HOLD:STAT?	<i>This command returns the current state of the hold value.</i>

Reset Condition

On reset, the setting is set to OFF by default.

Query

CALC[1]|2|3|4:HOLD:STAT?

The query returns the current state of the hold value.

CALCulate[1]|2|3|4:FEED[1]|2 <string>

This command sets the input measurement mode to be fed to the specified input on the **CALC** block. It is applied to the measurement after the **CALC:MATH:EXPR** command has been used to specify which channel the feed is taken from.

Measurement modes are coupled for combination measurements (for example, ratio measurements).

Under certain circumstances the measurement mode is changed by the **CALC:MATH:EXPR** command. Refer to “CALCulate[1]|2|3|4:MATH[:EXPRession] <string>” on page 219 for further information.

Syntax

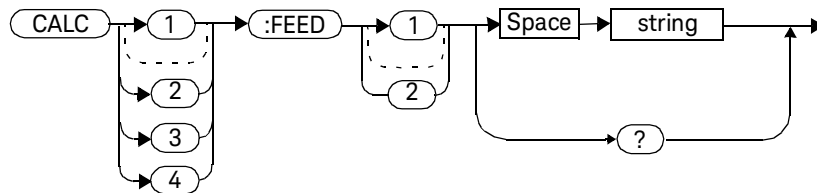

Parameters

Item	Description	Range of Values
string	<p>The input measurement type to be fed to the specific input on the CALC block:</p> <ul style="list-style-type: none"> – AVER: average – MIN: minimum power <p>Values may be followed by ON SWEEP[1] 2 3 4 where the numeric specifies the gate to be used for the feed. For example: "POW:AVER ON SWEEP2".</p> <p>If ON SWEEP[1] 2 3 4 is not supplied, the gate used is left unchanged.</p> <p>A feed of "" (empty string) disables the CALC block and switches off that display line.</p>	"POW:AVER" "POW:MIN"

Example

```
CALC3:FEED2 "POW:AVER ON SWEEP2"
```

This command selects the input for FEED2 of CALC block CALC3 to be average power, using gate 2. The channel from which the feed is taken is determined by CALC:MATH:EXPR.

Reset Condition

On reset, data_handle is set to **:POW:AVER**.

Query

```
CALCulate[1]|2|3|4:FEED[1]2?
```

The query returns the current value of the string.

Query Example

CALC1:FEED2?

This command queries the current setting of the data_handle on FEED2 of the upper window/upper measurement.

Error Message

- If the command is used when no sensor is attached, error -241 “Hardware missing” occurs.
- If <string> contains **ON SWEEP[1]|2|3|4** and the feed’s **TRIG:SOUR** is not **INT** or **EXT** (for single channel power meters) or **INT1**, **INT2** or **EXT** (for dual channel power meters), error -221 “Settings conflict” occurs.

CALCulate[1]|2|3|4:GAIN Commands

These commands are used to enter and enable a display offset on the specified window/measurement. The display offset is applied to the measurement signal after any math calculation.

The following commands are detailed in this section:

```
CALCulate[1]|2|3|4:GAIN[:MAGNitude] <numeric value>  
CALCulate[1]|2|3|4:GAIN:STATe <boolean>
```

CALCulate[1]|2|3|4:GAIN[:MAGNitude] <numeric_value>

This command is used to enter a value for the display offset on the specified window/measurement. The display offset is applied to the measurement signal after any math calculation.

Entering a value using this command automatically turns the **CALCulate[1]|2|3|4:GAIN:STATE** command to **ON**.

Syntax

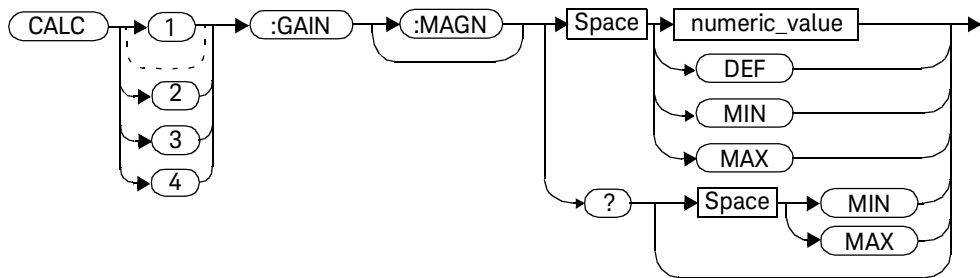

Parameters

Item	Description/Default	Range of Values
numeric_value	A numeric value for the display offset: - DEF : the default value is 0 dB - MIN : -100.000 dB - MAX : +100.000 dB	-100.000 to +100.000 dB DEF MIN MAX

Example

CALC2:GAIN 20

This command enters a display offset of 20 dB to the lower window/lower measurement.

Reset Condition

On reset, the display offset is set to 0 dB (**DEF**).

Query

CALCulate[1]|2|3|4:GAIN[:MAGNitude]? [MIN|MAX]

The query returns the current setting of the display offset or the value associated with **MIN** and **MAX**.

Query Example

CALC1:GAIN?

This command queries the current setting of the display offset on the upper window/upper measurement.

Error Message

If **CALCulate[1]|2|3|4:GAIN[:MAGNitude]** is set to ON while **SENSe:SPEed** is set to 200, error -221, “Settings Conflict” occurs.

CALCulate[1]|2|3|4:GAIN:STATe <boolean>

This command is used on the specified window/measurement to enable and disable the display offset set by the **CALCulate[1]|2|3|4:GAIN[:MAGNitude]** command.

Syntax

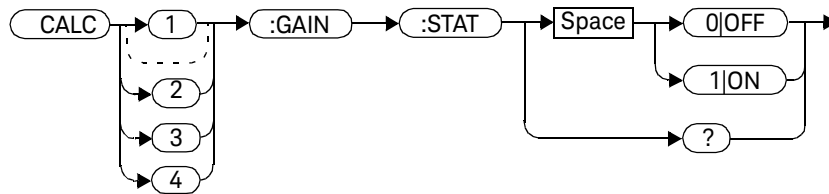

Example

CALC2:GAIN:STAT 1

This command enables the display offset for the lower window/ upper measurement.

Reset Condition

On reset, the gain is disabled.

Query

CALCulate[1]|2|3|4:GAIN:STATe?

The query enters a 1 or 0 into the output buffer indicating the status of the display offset.

- 1 is returned when the display offset feature is enabled
- 0 is returned when the display offset feature is disabled

3 CALCulate Subsystem

Query Example

CALC1:GAIN:STAT?

This command queries whether the display offset in the upper window/upper measurement is on or off.

Error Message

If **CALCu1ate[1]|2|3|4:GAIN:STATe** is set to **ON** while **SENSe:SPEEd** is set to 200, error -221, "Settings Conflict" occurs.

CALCulate[1]|2|3|4:LIMit Commands

These commands set the limits on both the upper and lower windows/measurements enabling you to:

- Set upper and lower level limits
- Query if there has been a failure
- Count the number of failures
- Clear the counter

The following commands are detailed in this section:

CALCulate[1]|2|3|4:LIMit:CLEar:AUTO <boolean>

CALCulate[1]|2|3|4:LIMit:CLEar[IMMediate]

CALCulate[1]|2|3|4:LIMit:FAIL?

CALCulate[1]|2|3|4:LIMit:FCOunt?

CALCulate[1]|2|3|4:LIMit:LOWer[:DATA]

CALCulate[1]|2|3|4:LIMit:UPPer[:DATA]

CALCulate[1]|2|3|4:LIMit:STATe <boolean>

CALCulate[1]|2|3|4:LIMit:CLEAr:AUTo <boolean>|ONCE

This command controls when the FCO (fail counter) is cleared of any limit failures. The FCO is used to determine the results returned by the **CALCulate[1]|2|3|4:LIMit:FAIL?** query.

- If **ON** is specified, the FCO is set to 0 each time a measurement is:
 - Initiated using **INITiate[:IMMediate]**
 - Initiated using **INITiate:CONTinuous ON**
 - Measured using **MEASure?**
 - Read using **READ?**
- If **OFF** is specified, the FCO is not cleared by the above commands.
- If **ONCE** is specified, the FCO is cleared only after the first initialization then starts accumulating any limit failures.

Syntax

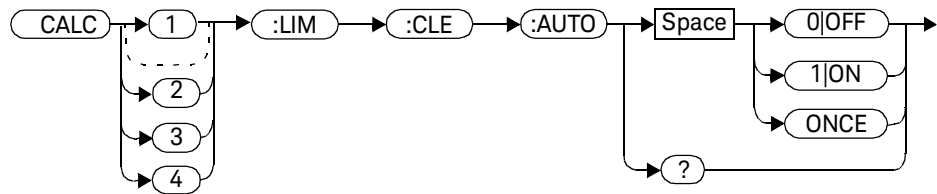

Example

CALC1:LIM:CLE:AUTO 1

This command switches on automatic clearing of the FCO for the upper window/upper measurement.

Reset Condition

On reset, both windows and their measurements are set to **ON**.

Query

CALCulate[1]|2|3|4:LIMit:CLEar:AUTO?

The query command enters a 1 or 0 into the output buffer indicating whether limit failures are cleared automatically when a new measurement is initiated on the specified window section.

- 1 is entered into the output buffer when limit failures are cleared automatically when a new measurement is initiated.
- 0 is entered into the output buffer when limit failures are not cleared automatically when a new measurement is initiated.

In the case where limit failures are cleared once, when a query occurs a 1 is entered into the output buffer if no measurement is initiated. If a measurement is initiated then 0 is entered.

Query Example

CALC1:LIM:CLE:AUTO?

This command queries when the FCO is cleared for the upper window/upper measurement.

CALCulate[1]|2|3|4:LIMit:CLEar[:IMMEDIATE]

This command immediately clears the FCO (fail counter) of any limit failures for the specified window. The FCO is used to determine the results returned by the **CALCulate[1]|2|3|4:LIMit:FAIL?** query.

Syntax

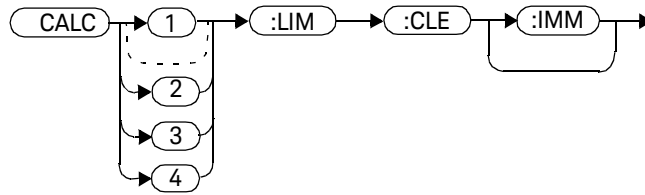

Example

CALC2:LIM:CLE:IMM

This command clears the FCO for the lower window/upper measurement.

CALCulate[1]|2|3|4:LIMit:FAIL?

This query enters a 1 or 0 into the output buffer indicating whether there have been any limit failures for the specified window. A limit failure is defined as **CALC[1]|2|3|4:LIMit:FCO?** being non-zero. The FCO (fail counter) can be zeroed using the **CALC[1]|2|3|4:LIMit:CLEar** command.

- 1 is returned when one or more limit failures have occurred
- 0 is returned when no limit failures have occurred

Syntax

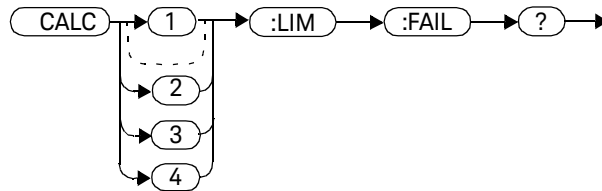

Example

CALC1:LIM:FAIL?

This command queries if there have been any limit failures on the upper window/upper measurement.

Reset Condition

On reset, the buffer is set to zero for both upper and lower window measurements.

CALCulate[1]|2|3|4:LIMit:FCOunt?

This query returns the total number of limit failures for the specified window/measurement.

If the appropriate **STATe** commands are set to **ON**, each time a measurement is initiated on the specified window/measurement and the result is outside the limits, the counter is incremented by one.

If the measured value is equal to a limit, this is a limit pass.

The counter is reset to zero by any of the following commands:

- ***RST**
- **CALCulate[1]|2|3|4:LIMit:CLEar:IMMEDIATE**
- **CALCulate[1]|2|3|4:LIMit:CLEar:AUTO ON**

When **CALCulate[1]|2|3|4:LIMit:CLEar:AUTO** is set to **ON**, the counter is set to zero *each* time a measurement is:

- measured using **MEASure?**
- read using **READ?**
- initiated using:
 - **INITiate[:IMMEDIATE]** or,
 - **INITiate:CONTinuous ON**

When **CALCulate[1]|2|3|4:LIMit:CLEar:AUTO** is set to **ONCE**, the counter is set to zero the *first* time a measurement is:

- measured using **MEASure?**
- read using **READ?**
- initiated using:
 - **INITiate[:IMMEDIATE]** or,
 - **INITiate:CONTinuous ON**

The maximum number of errors is $2^{16}-1$. If more than $2^{16}-1$ errors are detected the counter returns to zero.

Syntax

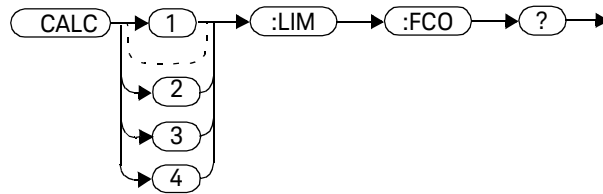

Example

CALC1:LIM:FCO?

This command queries the number of limit failures on the upper window/upper measurement.

Reset Condition

On reset, the counter is set to zero for both measurements of the upper and lower windows.

CALCulate[1]|2|3|4:LIMit:LOWer[:DATA] <numeric_value>

This command enters a value for the lower test limit for the specified window/ measurement used in the **CALCulate[1]|2|3|4:LIMit:FAIL?** test. The units used are dependent on the current setting of **UNIT:POWER** and **CALCulate:RELative:STATe** as shown in **Table 3-1**. When the measured value is less than the value specified in **CALCulate[1]|2|3|4:LIMit:LOWer[:DATA]**, **CALCulate[1]|2|3|4:LIMit:FAIL?** reports a fail. When the measured value is greater than or equal to the limit, a fail is not reported.

Table 3-1 Measurement Units

Measurement Mode	CALC:REL:STAT OFF		CALC:REL:STAT ON	
	Linear	Log	Linear	Log
Single Channel	Watt	dBm	%	dB
	%	dB	%	dB
Ratio	%	dB	%	dB
Difference	Watt	dBm	%	dB
	%	dB	%	dB

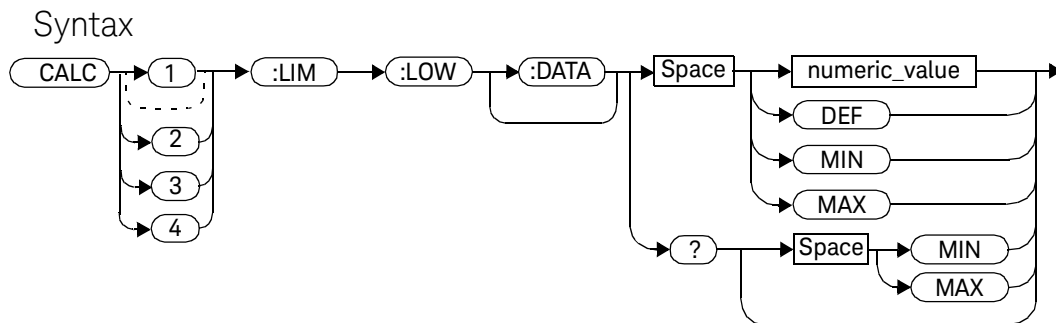

Parameters

Item	Description/Default	Range of Values
numeric_value	A numeric value for the lower test limit: – DEF : the default is –90.00 dBm or –90 db – MIN : –150 dBm or –180 dB – MAX : +230 dBm or +200 dB	–150 to +230 dBm or –180 to +200 dB DEF MIN MAX

Example

CALC2:LIM:LOW:DATA 0.1

This command enters a lower limit for the lower window/upper measurement depending on the window's units as follows:
dBm = 0.1 dBm
W = 100 mW
dB = 0.1 dB
% = 0.1 %

Reset Condition

On reset, both measurements of the upper and lower windows are set to –90.00 dBm or –90 dB (**DEF**).

Query

CALCulate[1]|2|3|4:LIMit:LOWer[:DATA]? [MIN|MAX]

The query returns the current setting of the lower limit or the values associated with **MIN** and **MAX** for the specified window.

Query Example

CALC2:LIM:LOW:DATA?

This command queries the lower limit set for the lower window upper measurement.

CALCulate[1]|2|3|4:LIMit:UPPer[:DATA] <numeric_value>

This command enters a value for the upper test limit for the specified window/ measurement used in the **CALCulate[1]|2|3|4:LIMit:FAIL?** test. The units used are dependent on the current setting of **UNIT:Power** and **CALCulate:RELative:STATE** as shown in [Table 3-2](#). When the measured power is greater than the value specified in **CALCulate[1]|2|3|4:LIMit:UPPer[:DATA]**, **CALCulate[1]|2|3|4:LIMit:FAIL?** reports a fail. When the measured level is less than or equal to the limit, a fail is not reported.

Table 3-2 Measurement Units

Measurement Mode	CALC:REL:STAT OFF		CALC:REL:STAT ON	
	Linear	Log	Linear	Log
Single Channel	Watt	dBm	%	dB
	%	dB	%	dB
Ratio	%	dB	%	dB
Difference	Watt	dBm	%	dB
	%	dB	%	dB

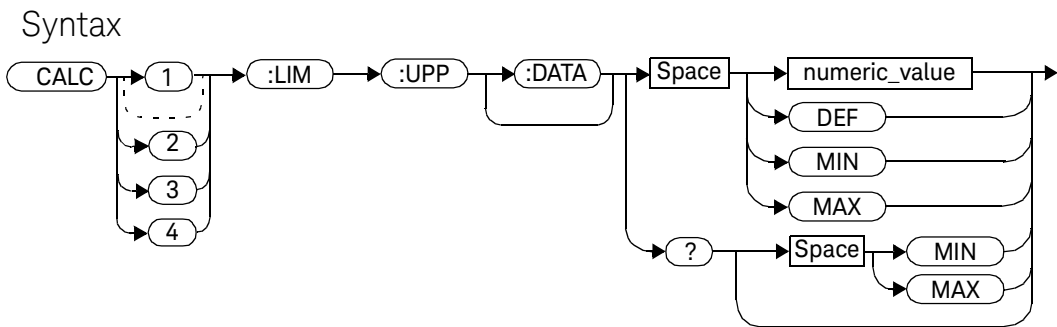

Parameters

Item	Description/Default	Range of Values
numeric_value	A numeric value for the lower test limit: – DEF : the default is –90.00 dBm or –90 dB – MIN : –150 dBm or –180 dB – MAX : +230 dBm or +200 dB	–150 to +230 dBm or –180 to +200 dB DEF MIN MAX

Example

CALC2:LIM:UPP:DATA 5

This command enters an upper limit for the lower window/upper measurement depending on the window's units as follows:
 dBm = 5 dBm
 W = 5 W
 dB = 5 dB
 % = 5 %

Reset Condition

On reset, both channels are set to +90.00 dBm or +90 dB.

Query

CALCulate[1]|2|3|4:LIMit:UPPer[:DATA]? [MIN|MAX]

Query Example

CALC2:LIM:UPP:DATA?

This command queries the setting of the upper limit for the lower window/upper measurement.

The query returns the current setting of the upper limit or the values associated with **MIN** and **MAX** for the specified window/measurement.

CALCulate[1]|2|3|4:LIMit:STATe <boolean>

This command enables/disables the test limits for the specified window.

Syntax

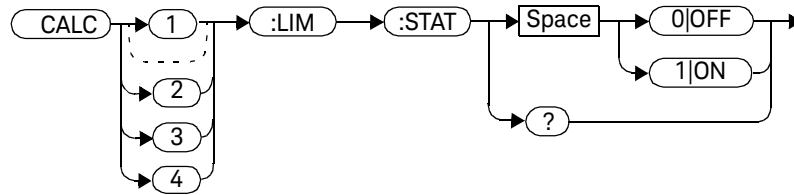

Example

CALC2:LIM:STAT 1

This command enables the limit checking function for the lower window upper measurement.

Reset Condition

On reset, limit checking is disabled.

Query

CALCulate[1]|2|3|4:LIMit:STATe?

The query enters 1 or 0 into the output buffer indicating the status of the limits testing feature for the specified window/measurement.

- 1 is returned when limits testing is enabled
- 0 is returned when limits testing is disabled

Query Example

CALC1:LIM:STAT?

This command queries whether the limit checking function for the upper window/upper measurement is on or off.

Error Message

If **CALCulate[1|2|3|4]:LIMit:STATe** is set to **ON** while **[SENSe[1]]|SENSe2:SPEed** is set to 200, error -221, "Settings Conflict" occurs.

CALCulate[1]|2|3|4:MATH Commands

These commands define and carry out the following mathematical transformations on **SENSe** data:

- Single channel
- Difference
- Ratio

The following commands are detailed in this section:

CALCulate[1]|2|3|4:MATH[:EXPRession] <string>

CALCulate[1]|2|3|4:MATH[:EXPRession]:CATalog?

CALCulate[1]|2|3|4:MATH[:EXPRession] <string>

This command sets the specified window/measurement to a single channel, difference or ratio measurement.

The command may result in a change to the measurement mode set by **CALC:FEED <string>**. The following sequence of commands provides an example:

- 1 SENS2:DET:FUN=AVERage
- 2 CALC:MATH "(SENS1)"
- 3 CALC:MATH "(SENS2)"

The **FEED1** measurement mode, set in step 3, is made invalid by step 4 and automatically changed to **"POW:AVER"**.

Syntax

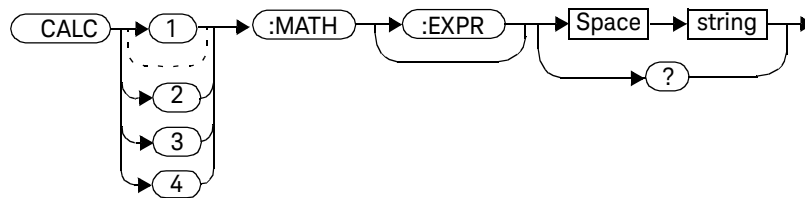

Parameters

Item	Description/Default	Range of Values
string	<p>A single string value detailing the measurement type:</p> <ul style="list-style-type: none"> For the Keysight N1913A the default is SENS1. However, for a meter with USB option installed, the default is SENS1 if the upper upper window or lower upper window is selected, or SENS3 if the upper lower window is selected, or SENS4 if the lower lower window is selected. For the Keysight N1914A the default is SENS1 if the upper window is selected, or SENS2 if the lower window is selected. However, for a meter with USB option installed, the default is SENS1 if the upper upper window or lower upper window is selected, or SENS3 if the upper lower window is selected, or SENS4 if the lower lower window is selected. 	<p>“(SENS1)”^[a] “(SENS2)”^{[a],[b]} “(SENS3)”^{[a],[b],[c]} “(SENS4)”^{[a],[b],[c]} “(SENS1-SENS1)”^{[a],[d]} “(SENS2-SENS2)”^{[a],[b],[d]} “(SENS3-SENS3)”^{[a],[b],[c],[d]} “(SENS4-SENS4)”^{[a],[b],[c],[d]} “(SENS1/SENS1)”^[a] “(SENS2/SENS2)”^{[a],[b]} “(SENS3/SENS3)”^{[a],[b],[c]} “(SENS4/SENS4)”^{[a],[b],[c]} “(SENS1-SENS2)”^{[a],[b],[d]} “(SENS1-SENS3)”^{[a],[b],[c],[d]} “(SENS1-SENS4)”^{[a],[b],[c],[d]} “(SENS2-SENS1)”^{[a],[b],[d]} “(SENS2-SENS3)”^{[a],[b],[c],[d]} “(SENS2-SENS4)”^{[a],[b],[c],[d]} “(SENS3-SENS1)”^{[a],[b],[c],[d]} “(SENS3-SENS2)”^{[a],[b],[c],[d]} “(SENS3-SENS1)”^{[a],[b],[c],[d]} “(SENS4-SENS1)”^{[a],[b],[c],[d]} “(SENS4-SENS2)”^{[a],[b],[c],[d]} “(SENS4-SENS3)”^{[a],[b],[c],[d]} “(SENS1/SENS2)”^{[a],[b]} “(SENS1/SENS3)”^{[a],[b],[c]} “(SENS1/SENS4)”^{[a],[b],[c]} “(SENS2/SENS1)”^{[a],[b]} “(SENS2/SENS3)”^{[a],[b],[c]} “(SENS2/SENS4)”^{[a],[b],[c]} “(SENS3/SENS1)”^{[a],[b],[c]} “(SENS3/SENS2)”^{[a],[b],[c]} “(SENS3/SENS4)”^{[a],[b],[c]} “(SENS4/SENS1)”^{[a],[b],[c]} “(SENS4/SENS2)”^{[a],[b],[c]} “(SENS4/SENS3)”^{[a],[b],[c]}</p>

- [a] Quotes are mandatory. Either single or double quotes may be used.
- [b] N1914A only.
- [c] USB Option only
- [d] The mathematical operation will be performed in linear scale

Example

CALC2:MATH "(SENS2/SENS1)" *This command sets the lower window/upper measurement to make a Channel B/A ratio measurement.*

Reset Condition

On reset, the Keysight N1913A upper and lower window measurements are set to Channel A ("**SENS1**"). On the N1914A the upper window measurements are set to Channel A ("**SENS1**") and the lower window measurements to Channel B ("**SENS2**"). However, for a meter with USB option installed, the Keysight N1913A upper upper and lower upper window measurements are set to Channel A ("**SENS1**"), while upper lower window measurement is set to Channel C ("**SENS3**") and lower lower window measurement is set to Channel D ("**SENS4**"). On the N1914A with USB option installed, the upper upper window measurement is set to Channel A ("**SENS1**"), the lower upper window measurement is set to Channel B ("**SENS2**"), the upper lower window measurement is set to Channel C ("**SENS3**") and the lower lower window measurement is set to Channel D ("**SENS4**").

Query

CALCulate[1]|2|3|4:MATH[:EXPRession]?

The query returns the current math measurement setting on the specified window.

Query Example

CALC1:MATH?

This command queries the current setting of the math expression on the upper window/upper measurement.

Error Messages

- For the single channel N1913A power meter: if **<string>** is not set to “(SENS1)” while **SENSe:SPEEd** is set to 200, error -221, “Settings Conflict” occurs.
- For the dual channel N1914A power meter: if **<string>** is not set to “(SENS1)” or “(SENS2)” while **SENS1:SPEED** or **SENS2:SPEED** is set to 200, error -221, “Settings Conflict” occurs.

CALCulate[1]]2|3|4:MATH[:EXPRession]:CATalog?

This query lists all the defined expressions. The response is a list of comma separated strings. Each string contains an expression.

- For the N1913A without the USB Option installed, the string is:
“(SENS1)”, “(SENS1-SENS1)”, “(SENS1/SENS1)”
- For the N1913A with the USB Option installed, the string is:
“(SENS1)”, “(SENS3)”, “(SENS4)”, “(SENS1/SENS1)”,
“(SENS3/SENS3)”, “(SENS4/SENS4)”, “(SENS1-SENS1)”,
“(SENS3-SENS3)”, “(SENS4-SENS4)”, “(SENS1/SENS3)”,
“(SENS1/SENS4)”, “(SENS1-SENS3)”, “(SENS1-SENS4)”,
“(SENS3/SENS1)”, “(SENS3/SENS4)”, “(SENS4/SENS1)”,
“(SENS4/SENS3)”, “(SENS3-SENS1)”, “(SENS3-SENS4)”,
“(SENS4-SENS1)”, “(SENS4-SENS3)”
- For the N1914A without the USB Option installed, the string is:
“(SENS1)”, “(SENS2)”, “(SENS1/SENS2)”,
“(SENS2/SENS1)”, “(SENS1-SENS2)”, “(SENS2-SENS1)”,
“(SENS1-SENS1)”, “(SENS2-SENS2)”, “(SENS1/SENS1)”,
“(SENS2/SENS2)”
- For the N1914A with the USB Option installed, the string is:
“(SENS1)”, “(SENS2)”, “(SENS3)”, “(SENS4)”,
“(SENS1/SENS1)”, “(SENS2/SENS2)”, “(SENS3/SENS3)”,
“(SENS4/SENS4)”, “(SENS1-SENS1)”, “(SENS2-SENS2)”,
“(SENS3-SENS3)”, “(SENS4-SENS4)”, “(SENS1/SENS2)”,
“(SENS1/SENS3)”, “(SENS1/SENS4)”, “(SENS2/SENS1)”,
“(SENS2/SENS3)”, “(SENS2/SENS4)”, “(SENS1-SENS2)”,
“(SENS1-SENS3)”, “(SENS1-SENS4)”, “(SENS2-SENS1)”,
“(SENS2-SENS3)”, “(SENS2-SENS4)”, “(SENS3/SENS1)”,
“(SENS3/SENS2)”, “(SENS3/SENS4)”, “(SENS4/SENS1)”,
“(SENS4/SENS2)”, “(SENS4/SENS3)”, “(SENS3-SENS1)”,
“(SENS3-SENS2)”, “(SENS3-SENS4)”, “(SENS4-SENS1)”,
“(SENS4-SENS2)”, “(SENS4-SENS3)”

Syntax

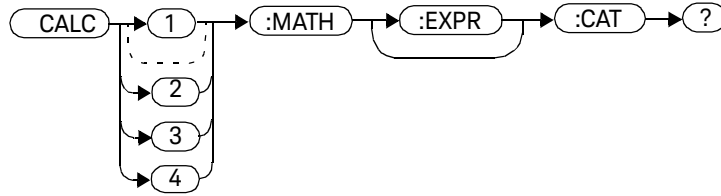

Example

`CALC1:MATH:CAT?`

This command lists all the defined math expressions.

CALCulate[1]|2|3|4:RELative Commands

These commands compare the measurement signal to a reference value.

Within the **CALCulate** block the relative value is applied to the measurement signal after any math calculations and display offsets have been applied.

The commands described in this section:

```
CALCulate[1]|2|3|4:RELative[:MAGNitude]:AUTO <boolean>|ONCE
```

```
CALCulate[1]|2|3|4:RELative:STATE <boolean>
```

CALCulate[1]|2|3|4:RELative[:MAGNitude]:AUTO <boolean>|ONCE

This command sets the reference value to be used in the relative measurement. Within the **CALCulate** block the relative value is applied to the measurement signal after any math calculations and display offsets have been applied.

The value should be set to **ONCE** to set the reference value to be used in relative measurements. Selecting **ONCE** sets the reference value to that of the measurement signal after any math calculations and display offsets have been applied. After the reference value has been set the command returns to **OFF**. Setting this command to **ONCE** turns the **CALCulate[1]|2|3|4:RELative:STATE** command to **ON**.

If **0|OFF** is selected, no reference value is applied to the measurement signal. There is no situation in which you would want to send this command with **OFF**. **OFF** is only available because it is required for the query response.

If **1|ON** is selected, it causes error -224, "Illegal parameter value" to occur.

Syntax

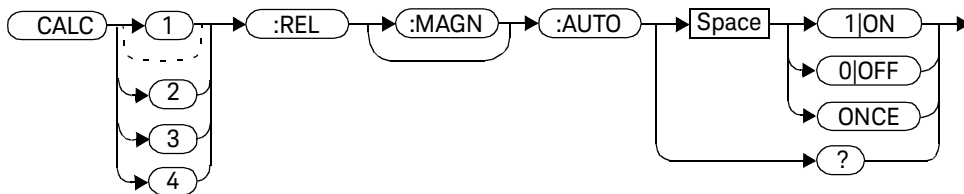

Example

CALC1:REL:AUTO ONCE

This command sets a reference value to be used in the relative measurement on the upper window/upper measurement.

Query

CALCulate[1]|2|3|4:RELative[:MAGNitude]:AUTO?

The query always returns **OFF**.

Error Message

- If **CALCulate:RELative[:MAGNitude]:AUTO** is set to **ONCE** while **SENSE:SPEEd** is set to 200, error -221, "Settings Conflict" occurs.
- If the value is set to **ON** error -224, "Illegal parameter value" occurs.

CALCulate[1]|2|3|4:RELative:STATe <boolean>

This command enables/disables relative mode. If the command is:

- disabled, the measurement signal remains unchanged.
- enabled, the current relative value set by **CALCulate:RELative:MAGnitude:AUTO** is applied to the measurement signal.

Syntax

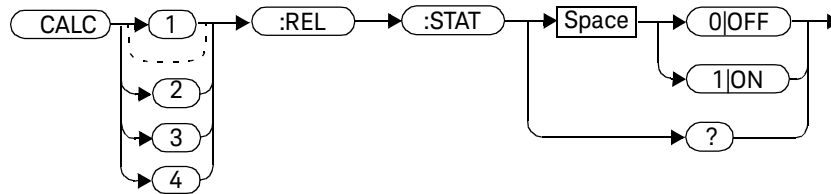

Example

CALC1:REL:STAT OFF

This command disables the relative mode on the upper window/upper measurement.

Reset Condition

On reset, relative mode is disabled.

Query

CALCulate[1]|2|3|4:RELative:STATe?

The query returns a 1 or 0 into the output buffer.

- 1 is returned when relative mode is enabled
- 0 is returned when relative mode is disabled

Query Example

CALC1:REL:STAT?

This command queries whether relative mode is off or on for the upper window/upper measurement.

Error Message

If **CALCulate:RELative:STATe** is set to **ON** while **SENSe:SPEed** is set to 200, error -221, "Settings Conflict" occurs.

THIS PAGE HAS BEEN INTENTIONALLY LEFT BLANK.

4 CALibration Subsystem

CALibration Subsystem	232
CALibration[1] 2 3 4[:ALL]	234
CALibration[1] 2 3 4[:ALL]?	236
CALibration[1] 2 3 4:AUTO <boolean> ONCE	238
CALibration[1] 2:RCALibration <boolean>	240
CALibration[1] 2:RCFactor <numeric_value>	242
CALibration[1] 2 3 4:ZERO:AUTO <boolean> ONCE	244
CALibration3 4:TYPE EXTernal INTernal	246
CALibration3 4:ZERO:TYPE EXTernal INTernal	248

This chapter explains how the **CALibration** command subsystem is used to zero and calibrate the power meter.

CALibration Subsystem

The **CALibration** command subsystem is used to zero and calibrate the power meter. It is also used to set the reference calibration factor for the power sensor which is being used.

The numeric suffix of the **CALibration** command refers to a specific channel:

- **CALibration1** represents Channel A
- **CALibration2** represent Channel B
- **CALibration3** represents Channel C (only applicable on meter with USB Option installed)
- **CALibration4** represents Channel D (only applicable on meter with USB Option installed)
- This command does not apply to the single channel N1913A power meter and results in the error "Header suffix out of range."

Zeroing and calibration of the power meter is recommended:

- When a 5 °C change in temperature occurs
- When you change the power sensor
- Every 24 hours
- Prior to measuring low level signals. For example, 10 dB above the lowest specified power for your sensor.

The following **CALibration** commands are overlapped commands:

- **CAL:ALL**
- **CAL:AUTO**
- **CAL:ZERO:AUTO**

An overlapped command allows the instrument to continue parsing and executing subsequent commands while it is still executing.

Keyword	Parameter Form	Notes	Page
CALibration[1] 2 3 4			
[:ALL]		[event; no query]	page 234
[:ALL]?		[event;query]	page 236
:AUTO	<boolean> ONCE		page 238
:ZERO			
:AUTO	<boolean> ONCE		page 244
CALibration1 2			
:RCALibration	<boolean>		page 240
:RCFactor	<numeric_value>	[non-SCPI]	page 242
CALibration3 4			
:TYPE	EXT INT		page 246
:ZERO			
:TYPE	EXT INT		page 248

CALibration[1]|2|3|4[:ALL]

NOTE

This command is identical to `CALibration[1]|2|3|4[:ALL]?`, however, unlike the query it does not provide a response to indicate whether the calibration has been successful or not.

This command causes the power meter to perform a calibration sequence on the specified channel. The command assumes that the power sensor is connected to the POWER REF output. The calibration sequence consists of:

- 1 Zeroing the power meter (**CALibration:ZERO:AUTO ONCE**), and
- 2 Calibrating the power meter (**CALibration:AUTO ONCE**).

For 8480 Series power sensors and N8480 Series power sensors with Option CFT, the reference calibration factor used during this calibration can be derived from either an active sensor calibration table or the value entered using **CALibration:RCFactor**. The actual value used is the one which was most recently set. That is, a value entered using **CALibration:RCFactor** is overridden if a sensor calibration table is subsequently selected and enabled. Conversely, **CALibration:RCFactor** overrides any reference calibration factor previously set from a sensor calibration table. To determine the currently set reference calibration factor use **CALibration:RCFactor?**.

E-Series power sensors and N8480 Series power sensors (excluding Option CFT) have their sensor calibration tables stored in EEPROM which means that the reference calibration factor is automatically downloaded by the power meter.

Syntax

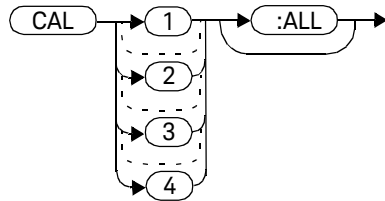

Example

CAL1:ALL

This command causes the power meter to perform a calibration sequence on Channel A.

Error Messages

- If the calibration was not carried out successfully the error -231, “Data Questionable; CAL ERROR” occurs. If you are using an N1914A the error message specifies which channel failed calibration.
- If zeroing was not carried out successfully the error -231, “Data Questionable; ZERO ERROR” occurs. If you are using an N1914A the error message specifies which channel failed calibration.
- If there is no sensor connected, the error -241, “Hardware Missing” occurs.

CALibration[1]|2|3|4[:ALL]?

NOTE

This query is identical to **CALibration[1]|2|3|4[:ALL]**, however, unlike the command, it provides a response to indicate whether the calibration has been successful or not.

This query causes the power meter to perform a calibration sequence on the specified channel. The query assumes that the power sensor is connected to the POWER REF output. The calibration sequence consists of:

- 1 Zeroing the power meter (**CALibration:ZERO:AUTO ONCE**), and
- 2 Calibrating the power meter (**CALibration:AUTO ONCE**).

When the calibration sequence is completed, 0 or 1 is entered into the output buffer to indicate if the sequence was successful. If the result is:

- 0, the calibration has passed
- 1, the calibration has failed

For the 8480 and N8480 Series power sensors with Option CFT the reference calibration factor used during this calibration can be derived from either an active sensor calibration table or the value entered using **CALibration:RCFactor**. The actual value used is the one which was most recently set. That is, a value entered using **CALibration:RCFactor** is overridden if a sensor calibration table is subsequently selected and enabled. Conversely, **CALibration:RCFactor** overrides any reference calibration factor previously set from a sensor calibration table. To determine the currently set reference calibration factor use **CALibration:RCFactor?**.

The E-Series power sensors and N8480 Series power sensors (excluding Option CFT) have their sensor calibration tables stored in EEPROM which means that the reference calibration factor is automatically downloaded by the power meter.

Syntax

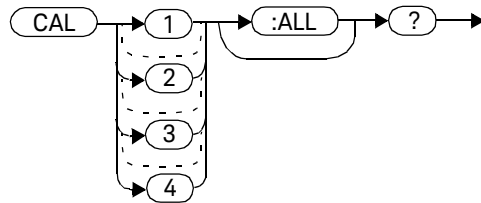

Query Example

CAL1:ALL?

This command causes the power meter to perform a calibration sequence on Channel A and return a result.

Error Messages

- If the calibration was not carried out successfully the error -231, “Data Questionable; CAL ERROR” occurs. If you are using an N1914A the error message specifies which channel failed calibration.
- If zeroing was not carried out successfully the error -231, “Data Questionable; ZERO ERROR” occurs. If you are using an N1914A the error message specifies which channel failed calibration.
- If there is no sensor connected, the error -241, “Hardware Missing” occurs.

CALibration[1]|2|3|4:AUTO <boolean>|ONCE

This command calibrates the specified channel when enabled. The command assumes that an 8480, E-Series or N8480 Series power sensor is connected to a 1 mW reference signal.

The E-Series power sensors and N8480 Series power sensors (excluding Option CFT) have their sensor calibration tables stored in EEPROM which means that the reference calibration factor is automatically downloaded by the power meter.

For 8480 Series power sensors and N8480 Series power sensors with Option CFT, the reference calibration factor used during this calibration can be obtained from an active sensor calibration table or the value entered using **CALibration:RCFactor**. The actual value used is the one which was most recently set. For example, a value entered using **CALibration:RCFactor** is overridden if a sensor calibration table is subsequently selected and enabled and **CALibration:RCFactor** overrides any reference calibration factor previously set from a sensor calibration table. To determine the current reference calibration factor, use **CALibration:RCFactor?**.

NOTE

If the power meter is using an 8480, E-Series or N8480 Series power sensor it should be zeroed before calibration using the **CALibration:ZERO:AUTO ONCE** command.

Syntax

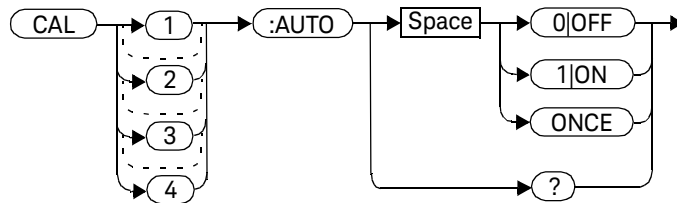

Example

CAL1:AUTO ONCE

This command causes the power meter to perform a calibration on Channel A.

Reset Condition

On reset, automatic calibration is disabled.

Query

CALibration[1]|2:AUTO?

The query always returns a value of 0.

Error Messages

- If this command is set to **ON** and an 8480 Series, E-Series or N8480 Series power sensor is connected the error -241, "Hardware missing" occurs.
- If the calibration was not carried out successfully the error -231, "Data Questionable; CAL ERROR" occurs. If you are using an N1914A the error message specifies which channel failed calibration.
- If there is no sensor connected, the error -241, "Hardware Missing" occurs.
- If this command is set to **ON** and **TRIGger[SEquence[1]|2]:COUNT** is set to a value >1, the error -221, "Setting conflict" occurs.

CALibration[1]|2:RCALibration <boolean>

This command enables and disables the zero/cal lockout facility. With the lockout facility enabled the power meter is stopped from making measurements until the connected sensor has been zeroed and calibrated.

Syntax

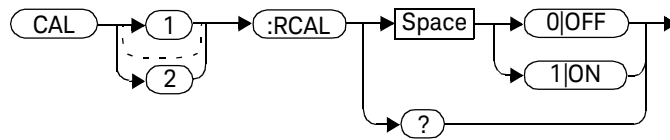

Example

CAL1:RCAL 1

This command enables the zero/cal lockout facility on Channel A.

Reset Condition

On reset, the state of the zero/cal lockout is unaffected.

Query

CALibration[1]|2:RCALibration?

The query enters a 1 or 0 into the output buffer indicating whether zero/cal lockout is enabled or disabled.

- 1 is returned if zero/cal lockout is enabled
- 0 is returned if zero/cal lockout is disabled

Query Example

CAL1:RCAL?

This command queries whether or not the zero/cal lockout facility is enabled for Channel A.

Error Messages

When **CAL[1]|2:RCAL** is **ON** and the sensor currently connected to the appropriate channel (A or B) has not been zeroed and calibrated, then any SCPI command which would normally return a measurement result (for example, **FETC?**, **READ?**, **MEAS?** etc) does not return a result and generates the error –230, “Data corrupt or stale; Please zero and Cal.”

After the sensor has been zeroed and calibrated the return measurement results commands function normally.

CALibration[1]|2:RCFactor <numeric_value>

This command is used with 8480 Series power sensors or N8480 Series power sensors with Option CFT to set the reference calibration factor of the specified channel. Reference calibration factors can also be set using sensor calibration tables. The power meter uses the most recently set reference calibration factor.

Syntax

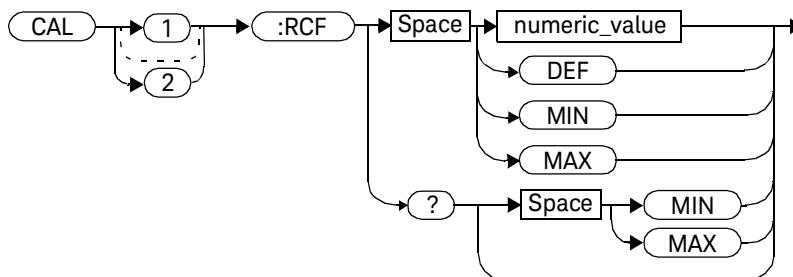

Parameters

Item	Description/Default	Range of Values
numeric_value	A numeric value: - DEF : the default is 100 % - MIN : 1 % - MAX :150 %	1.0 to 150.0 PCT DEF MIN MAX

Example

CAL1:RCF 98

This command enters a reference calibration factor of 98 % to Channel A.

Reset Condition

On reset, the reference calibration factor is set to 100%.

Query

CALibration[1]|2:RCFactor? [MIN|MAX]

The query returns the current setting of the reference calibration factor or the values associated with **MIN** and **MAX**.

Query Example

CAL2:RCF?

This command queries the reference calibration factor of Channel B.

Error Messages

If this command is used when an E-Series or N8480 Series power sensors (excluding Option CFT) is connected the error -241, "Hardware missing" occurs.

CALibration[1]|2|3|4:ZERO:AUTO <boolean>|ONCE

This command causes the power meter to perform its zeroing routine on the specified channel when enabled. This adjusts the power meter for a zero power reading with no power supplied to the power sensor.

1|ON can only be used with a U2000 Series USB sensor which is always associated with channel C and channel D. When **1|ON** is enabled the zero is maintained by a combination of *on-the-fly* zero measurements and temperature compensation.

The **0|OFF** parameter is only required for the query response and is ignored in the command.

This command assumes that a power sensor is not connected to a power source.

Syntax

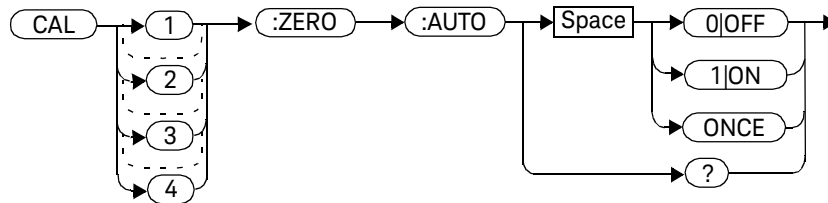

Example

CAL2:ZERO:AUTO ONCE

This command causes the power meter to perform a zeroing routine on Channel B.

Reset Condition

On reset, automatic zeroing is disabled.

Query

CALibration[1]|2|3|4:ZERO:AUTO?

The query always returns a value of 0.

Error Messages

- If this command is set to **ON** and an 8480 Series, E-Series or N8480 Series power sensor is connected the error -241, “Hardware missing” occurs.
- If zeroing was not carried out successfully the error -231, “Data Questionable; ZERO ERROR” occurs. If you are using an N1914A, the error message specifies which channel failed zeroing.
- If there is no sensor connected, the error -241, “Hardware Missing” occurs.
- If this command is set to **ON** and **TRIGger[:SEQuence[1]|2]:COUNT** setting is more than 1, the error -221, “Setting conflict” occurs.

CALibration3|4:TYPE EXTernal|INTernal

This command sets the U8480 Series power sensor to the external or internal calibration mode. External calibration requires a 50 MHz 1 mW power reference, while internal calibration utilizes the internal reference circuit to perform calibration and does not require the 50 MHz 1 mW power reference.

Upon power up, the U8480 Series power sensor defaults to the internal calibration mode.

NOTE

Setting this command to EXTERNAL will automatically set CALibration[1]|2|3|4:AUTO to OFF.

Syntax

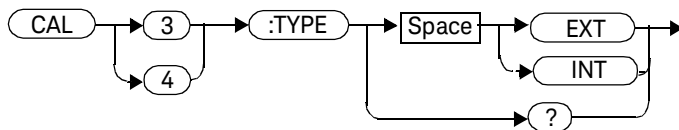

Example

CAL3:TYPE EXT

This command sets the external calibration mode for Channel C.

Reset Condition

On reset, the calibration mode is set to internal.

Query

CALibration3|4:TYPE?

This query returns the current calibration mode of either “INT” or “EXT”.

Query example

CAL3:TYPE?

Queries the calibration mode for the U8480 Series power sensor attached to Channel C.

Error Messages

This command is only able to set the calibration mode to “EXT” or “INT”.
Error -224, “Illegal parameter value” occurs for any other value.

CALibration3|4:ZERO:TYPE EXTernal|INTernal

This command is used to configure the U2000 Series power sensor or the U2040 X-Series power sensor either for external zeroing or internal zeroing.

NOTE

Setting this command to EXTernal will automatically set CALibration[1]|2|3|4:ZERO:AUTO to OFF.

Syntax

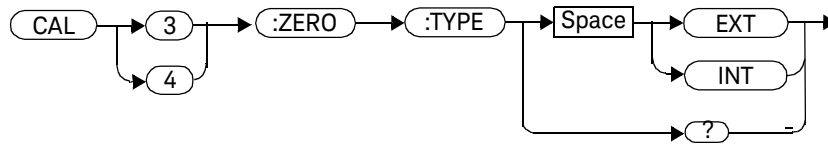

Example

CAL3:ZERO:TYPE EXT

This command changes the type of zeroing to external for the U2000 series power sensor or the U2040 X-Series power sensor attached to Channel C.

Reset Condition

The zeroing type is not affected by a reset.

Query

CALibration3|4:ZERO:TYPE?

The query returns the current zeroing type for the U2000 Series power sensor or the U2040 X-Series power sensor attached to Channel C.

Error Messages

This command is able to configure the zeroing type to “**EXT**” and “**INT**” only. Error -231, "Invalid character type" occurs for any other value.

THIS PAGE HAS BEEN INTENTIONALLY LEFT BLANK.

5 DISPLAY Subsystem

DISPlay Subsystem	252
DISPlay:ENABle <boolean>	253
DISPlay:SCReen:FORMat <character_data>	254
DISPlay[:WINDow[1]]2] Commands	256
DISPlay[:WINDow[1]]2]:ANALog Commands	257
DISPlay[:WINDow[1]]2]:ANALog:LOWer <numeric_value>	258
DISPlay[:WINDow[1]]2]:ANALog:UPPer <numeric_value>	261
DISPlay[:WINDow[1]]2]:FORMat <character_data>	264
DISPlay[:WINDow[1]]2]:METer Commands	266
DISPlay[:WINDow[1]]2]:METer:LOWer <numeric_value>	267
DISPlay[:WINDow[1]]2]:METer:UPPer <numeric_value>	270
DISPlay[:WINDow[1]]2]:NUMeric[1]]2]:RESolution <numeric_value>	273
DISPlay[:WINDow[1]]2]:SELect[1]]2	275
DISPlay[:WINDow[1]]2]:[STATE] <boolean>	277

This chapter explains how the **DISPlay** subsystem is used to control the selection and presentation of the windows used on the power meter's display.

DISPlay Subsystem

The **DISPlay** subsystem is used to control the selection and presentation of the windows used on the power meter's display.

Keyword	Parameter Form	Notes	Page
DISPlay			
:ENABle	<boolean>		page 253
:SCReen			
:FORMat	<character_data>		page 254
[:WINDow[1] 2]			
:ANALog			
:LOWer	<numeric_value>		page 258
:UPPer	<numeric_value>		page 261
:FORMat	<character_data>		page 264
:METer			
:LOWer	<numeric_value>	[non-SCPI]	page 267
:UPPer	<numeric_value>	[non-SCPI]	page 270
:NUMeric[1] 2			
:RESolution	<numeric_value>		page 273
:SElect[1] 2			page 275
[:STATe]	<boolean>		page 277

DISPlay:ENABLE <boolean>

This command is used to enable and disable the display. At power-up the display is always enabled.

Syntax

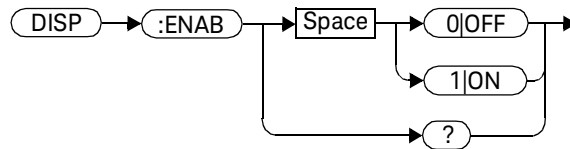

Example

DISP:ENAB 0

This command disables the display.

Reset Condition

On reset, the display is enabled.

Query

DISPlay:ENABle?

The query returns a 1 or 0 into the output buffer.

- 1 is returned when the display is enabled
- 0 is returned when the display is disabled

Query Example

DISP:ENAB?

This command queries whether the display is on or off.

DISPlay:SCReen:FORMat <character_data>

This command sets the display format.

Syntax

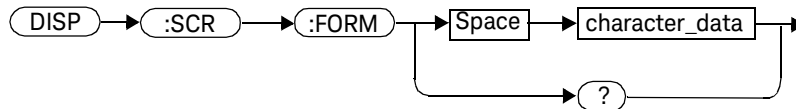

Parameters

Item	Description/Default	Range of Values
character_data	Sets the display format: <ul style="list-style-type: none"> - WINDowed: the windowed format provides two display windows. Each window can display two measurements. - EXPanded: the expanded format provides one display window which can display a single measurement. The EXP display format provides access to softkeys. - FSCReen: the full screen format provides one display window which can display a single measurement. The FSCR display format does not provide access to softkeys. 	WIND EXP FSCR

Example

DISP:SCReen:FORM FSCR

This command sets the display format to full screen.

Reset Condition

On reset, the display format is **WIND**.

Query

DISPPlay:SCReen:FORMat?

The query returns **WIND**, **EXP** or **FSCR**. .

Query Example

DISP:SCR:FORM?

This command queries the display format.

DISPlay[:WINDow[1]|2] Commands

These commands control various characteristics of the display windows. **WINDow1** and **WINDow2** represent the upper and lower windows respectively.

The following commands are detailed in this section:

DISPlay[:WINDow[1]|2]:ANALog:LOWer <numeric_value>

DISPlay[:WINDow[1]|2]:ANALog:UPPer <numeric_value>

DISPlay[:WINDow[1]|2]:FORMat <character_data>

DISPlay[:WINDow[1]|2]:METer:LOWer <numeric_value>

DISPlay[:WINDow[1]|2]:METer:UPPer <numeric_value>

DISPlay[:WINDow[1]|2]:NUMeric[1]|2:RESolution <numeric_value>

DISPlay[:WINDow[1]|2]:SELect[1]|2

DISPlay[:WINDow[1]|2][:STATe] <boolean>

DISPlay[:WINDow[1]|2]:ANALog Commands

These commands control the upper and lower scale limits of the analog meter.

The following commands are detailed in this section:

```
DISPlay[:WINDow[1]|2]:ANALog:LOWer <numeric_value>
```

```
DISPlay[:WINDow[1]|2]:ANALog:UPPer <numeric_value>
```

DISPlay[:WINDow[1]|2]:ANALog:LOWer <numeric_value>

This command sets the analog meter lower scale limit.

NOTE

This command has the same purpose as DISPlay[:WINDow[1]|2]:METer:LOWer <numeric_value>.

The units used are dependent on the current setting of UNIT:POWer and CALCulate:RELative:STATe as shown in [Table 5-1](#).

Table 5-1 Measurement Units

Measurement Mode	Measurement Type	CALC:REL:STAT OFF		CALC:REL:STAT ON	
		Linear	Log	Linear	Log
Single Channel	Avg	Watt	dBm	%	dB
Ratio	Avg	%	dB	%	dB
Difference	Avg	Watt	dBm	%	dB

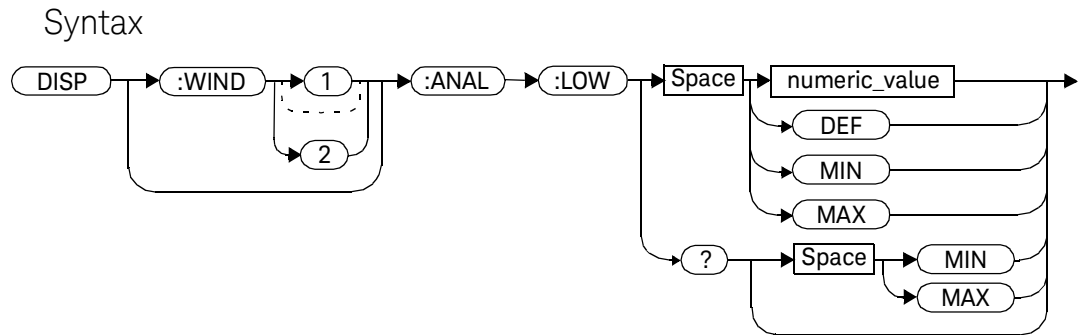

Parameters

Item	Description/Default	Range of Values
numeric_value	A numeric value for the analog meter lower scale limit: – DEF : the default is –70 dBm – MIN : –150 dBm – MAX : 230 dBm Units used are determined by the current setting of UNIT:POWer and CALCuLate:RELative:STAtE as shown in Table 5-1 .	–150 to 230 dBm DEF MIN MAX

Example

```
DISP:WIND1:ANAL:LOW -50
```

This command sets the upper window's analog meter lower scale limit to –50 dBm.

Reset Condition

On reset, the value is set to -70 dBm for both windows.

Query

DISP1ay:[WINDow[1]|2]:ANALog:LOW? [MIN|MAX]

The query returns the current setting of the analog meter's lower scale limit, or the value associated with **MIN** or **MAX**. The format of the response is **<NR3>**. The units in which the results are returned are determined by the current setting of **UNIT:POWer** and **CALCuLate:RELative:STATe** as shown in [Table 5-1](#).

Query Example

DISP:WIND1:ANAL:LOW?

This command queries the lower scale limit set on the analog meter in the upper window.

DISPlay[:WINDow[1]][2]:ANALog:UPPer <numeric_value>

This command sets the analog meter upper scale limit.

NOTE

This command has the same purpose as DISPlay[:WINDow[1]][2]:METer:UPPer <numeric_value>.

The units used are dependent on the current setting of UNIT:POWer and CALCulate:RELative:STATe as shown in [Table 5-2](#).

Table 5-2 Measurement Units

Measurement Mode	Measurement Type	CALC:REL:STAT OFF		CALC:REL:STAT ON	
		Linear	Log	Linear	Log
Single Channel	Avg	Watt	dBm	%	dB
Ratio	Avg	%	dB	%	dB
Difference	Avg	Watt	dBm	%	dB

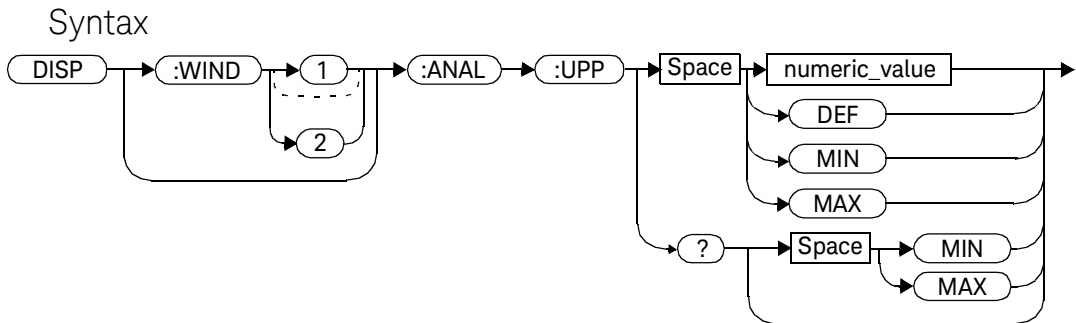

Parameters

Item	Description/Default	Range of Values
numeric_value	A numeric value for the analog meter upper scale limit: – DEF : the default is 20 dBm – MIN : -150 dBm – MAX : 230 dBm Units used are determined by the current setting of UNIT:Power and CALCulate:RELative:STATe as shown in Table 5-2 .	-150 to 230 dBm DEF MIN MAX

Example

DISP:WIND2:ANAL:UPP 50

This command sets the lower window's analog meter upper scale limit to 50 dBm.

Reset Condition

On reset, the upper scale limit is set to 20 dBm.

Query

DISPlay:[WINDow[1]|2]:ANALog:UPPer? [MIN|MAX]

The query returns the current setting of the analog meter's upper scale limit, or the value associated with **MIN** or **MAX**. The format of the response is **<NR3>**. The units in which the results are returned are determined by the current setting of **UNIT:POWer** and **CALCuLate:RELative:STATE** as shown in [Table 5-2](#).

Query Example

DISP:WIND2:ANAL:UPP?

This command queries the upper scale limit set on the analog meter in the lower window.

DISPlay[:WINDow[1]|2]:FORMat <character_data>

The command selects the format of the selected window.

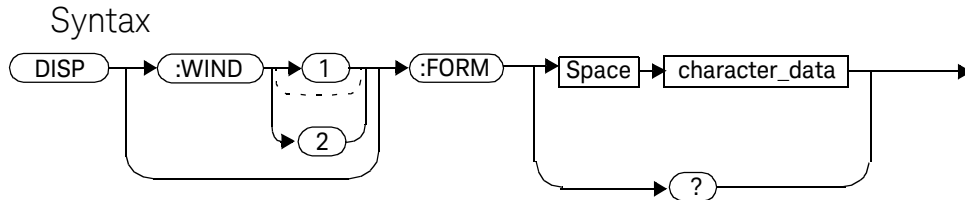

Parameters

Item	Description/Default	Range of Values
character_data	Sets the window format: <ul style="list-style-type: none"> – DIGital: sets the window to a digital display. This setting is the same as SNUMeric. – ANALog: sets the window to an analog display using the currently SELEted measurement. – SNUMeric: sets the window to a single numeric display. The currently SELEted measurement is displayed. This setting is the same as DIGital. – DNUMeric: sets the window to a dual numeric display. 	DIGital ANALog SNUMeric DNUMeric

Example

DISP:WIND2:FORM:DIG

This command sets the lower window to a digital display.

Reset Condition

On reset, the N1913A upper window is set to a digital display and the lower window is set to an analog display. For the N1914A, the upper and lower windows are set to digital displays. For the N1913/1914A with USB option installed, the upper and lower windows are set to dual numeric displays.

Query

DISP1ay:[WINDow[1]|2]:FORMat?

The query returns the current format of the selected window.

Query Example

DISP:FORM?

This command queries the current format of the upper window.

DISPlay[:WINDow[1]|2]:METer Commands

These commands control the upper and lower scale limits of the analog meter.

The following commands are detailed in this section:

```
DISPlay[:WINDow[1]|2]:METer:LOWer <numeric_value>
```

```
DISPlay[:WINDow[1]|2]:METer:UPPer <numeric_value>
```

DISPlay[:WINDow[1]][2]:METer:LOWer <numeric_value>

This command sets the analog meter lower scale limit.

NOTE

This command has the same purpose as DISPlay[:WINDow[1]][2]:ANALog:LOWer <numeric_value>.

The units used are dependent on the current setting of UNIT:POWer and CALCulate:RELative:STATe as shown in [Table 5-3](#).

Table 5-3 Measurement Units

Measurement Mode	Measurement Type	CALC:REL:STAT OFF		CALC:REL:STAT ON	
		Linear	Log	Linear	Log
Single Channel	Avg	Watt	dBm	%	dB
Ratio	Avg	%	dB	%	dB
Difference	Avg	Watt	dBm	%	dB

Syntax

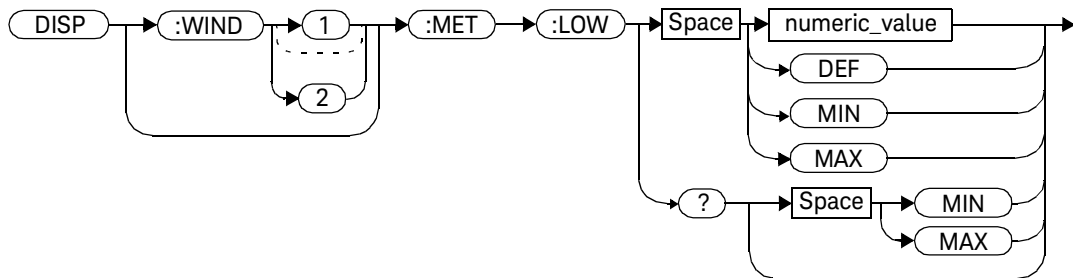

Parameters

Item	Description/Default	Range of Values
numeric_value	A numeric value for the analog meter lower scale limit: – DEF : the default is 20 dBm – MIN : -150 dBm – MAX : 230 dBm The default units are defined by UNIT:POWer and CALCuLate:RELative:STAtE .	-150 to 230 dBm DEF MIN MAX

Example

DISP:WIND2:MET:LOW 10

This command sets the lower window's analog meter lower scale limit.

Reset Condition

On reset, the lower scale limit is set to -70 dBm.

Query

DISPlay[:WINDow[1]|2]:METer:LOWer? [MIN|MAX]

The query returns the current setting of the analog meter's lower scale limit or the value associated with **MIN** and **MAX**. The format of the response is **<NR3>**. The units in which the results are returned is dependent on the current setting of **UNIT:POWer** and **CALCuLate:RELative:STATE** as shown in [Table 5-3](#).

Query Example

DISP:MET:LOW?

This command queries the lower scale limit set on the analog meter in the upper window.

DISPlay[:WINDow[1]|2]:METer:UPPer <numeric_value>

This command sets the analog meter upper scale limit.

NOTE

This command has the same purpose as DISPlay[:WINDow[1]|2]:ANALog:UPPer <numeric_value>.

The units used are dependent on the current setting of UNIT:POWer and CALCulate:RELative:STATe as shown in [Table 5-4](#).

Table 5-4 Measurement Units

Measurement Mode	Measurement Type	CALC:REL:STAT OFF		CALC:REL:STAT ON	
		Linear	Log	Linear	Log
Single Channel	Avg	Watt	dBm	%	dB
Ratio	Avg	%	dB	%	dB
Difference	Avg	Watt	dBm	%	dB

Syntax

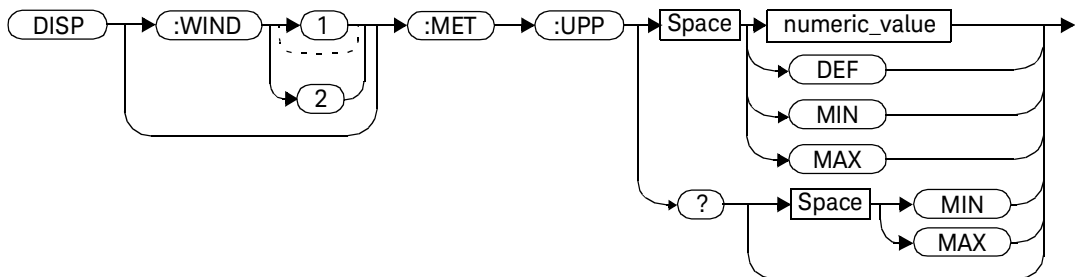

Parameters

Item	Description/Default	Range of Values
numeric_value	A numeric value for the analog meter upper scale limit: – DEF : the default is 20 dBm – MIN : -150 dBm – MAX : 230 dBm Units used are determined by the current setting of UNIT:POWer and CALCuLate:RELative:STaTe as shown in Table 5-4 .	-150 to 230 dBm DEF MIN MAX

Example

```
DISP:WIND2:MET:UPP 20
```

This command sets the lower window's analog meter upper scale limit.

Reset Condition

On reset, the upper scale limit is set to 20 dBm.

Query

DISP1ay[:WINDow[1]|2]:METer:UPPer? [MIN|MAX]

The query returns the current setting of the analog meter's upper scale limit or the value associated with **MIN** and **MAX**. The format of the response is **<NR3>**. The units in which the results are returned is dependent on the current setting of **UNIT:POWer** and **CALCu1ate:RELative:STATe** as shown in the previous table.

Query Example

DISP:WIND2:MET:UPP?

This command queries the upper scale limit set on the analog meter in the lower window.

DISPlay[:WINDow[1]][2]:NUMeric[1]]2:RESolution <numeric_value>

This command sets the resolution of the measurement result in the specified window.

Syntax

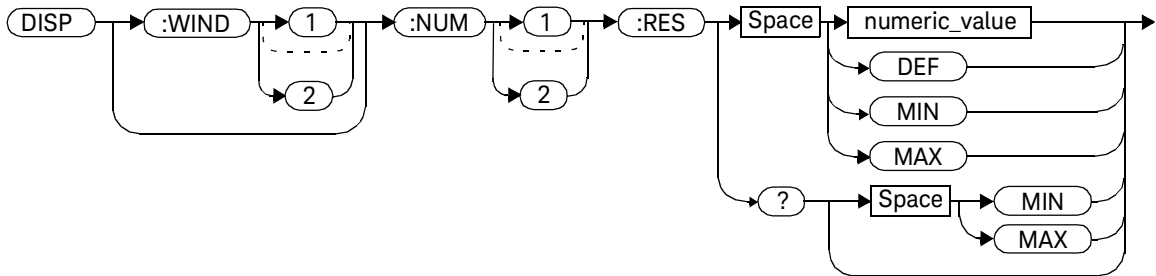

Parameters

Item	Description/Default	Range of Values
numeric_value	A numeric value for the window resolution:	1 to 4
	- DEF: 3	DEF
	- MIN: 1	MIN
	- MAX: 4	MAX

Example

DISP:WIND2:NUM1:RES 4

This command sets the lower window/upper measurement resolution to four significant digits if the measurement result is linear, or to 0.001 if the measurement result is logarithmic.

Reset Condition

On reset, the resolution is set to 3.

Query

DISPlay[:WINDow[1]|2]:NUMeric[1]|2:RESolution? [MIN|MAX]

The query returns the current setting of the window's resolution or the value associated with **MIN** and **MAX**. The format of the response is **<NR1>**.

Query Example

DISP:WIND1:NUM2:RES?

This command queries the resolution setting of the upper window/lower measurement.

DISPlay[:WINDow[1]][2]:SElect[1]|2

This command is used to select a specific measurement within a specific window. If the second numeric value is not sent, the upper measurement of the relevant window is selected. This command is used to specify which measurement is used for the analog or single numeric display.

Syntax

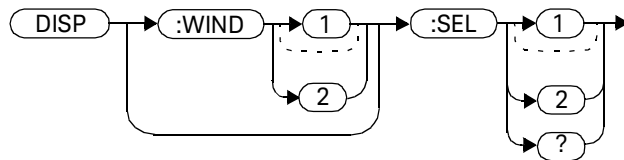

Example

DISP:WIND2:SEL1

This command selects the upper measurement in the lower window.

Reset Condition

On reset, the upper window upper measurement is selected.

Query

DISPlay[:WINDow[1]][2]:SElect[1]|2?

The query enters a 1 or 0 into the output buffer indicating whether the window specified is currently selected.

- 1 is returned if the specified window is selected
- 0 is returned if the specified window is not selected

Query Example

DISP:SEL1?

This command queries whether or not the upper measurement in the upper window is selected.

DISPlay[:WINDow[1]][2][:STATe] <boolean>

This command enables/disables the upper or lower window (**WINDow1** and **WINDow2** respectively) so that the display shows a single window only. The displayed window is presented in expanded format, showing a single measurement only: either the single measurement that was shown on the window, or the currently selected measurement, if two measurements had been shown.

Syntax

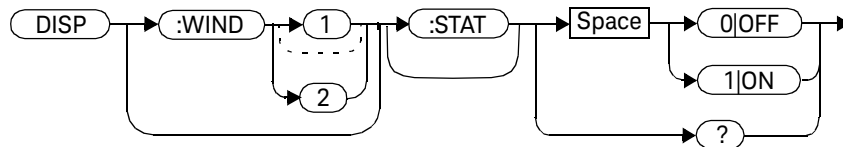

Examples

DISP:WIND2:STAT OFF

This command disables the lower window. The upper window is shown in expanded format, displaying its currently selected measurement.

DISP:WIND2:STAT ON

This command enables the lower window so that a dual window display is once more provided.

Reset Condition

On reset, both windows are enabled.

Query

DISPlay[:WINDow[1]|2]:STATe?

This enters a 1 or 0 in the output buffer indicating the selected window.

- 1 is returned if the window is enabled
- 0 is returned if the window is disabled

Query Example

DISP:WIND2:STAT?

This command queries whether or not the lower window is displayed.

6 FORMat Subsystem

FORMat Subsystem	280
FORMat[:READings]:BORDER <character_data>	281
FORMat[:READings][:DATA] <character_data>	283

This chapter explains how the **FORMat** subsystem is used to set a data format for transferring numeric information.

FORMat Subsystem

The **FORMat** subsystem sets a data format for transferring numeric information. This data format is used only for response data by commands that are affected by the **FORMat** subsystem.

The queries affected are:

- **FETCh?**
- **READ?**
- **MEASure?**

For the N1914A power meter the same **FORMat** is used on both channels.

Keyword	Parameter Form	Notes	Page
FORMat			
[:READings]			
:BORDER	<character_data>		page 281
[:DATA]	<character_data>		page 283

FORMat[:READings]:BORDER <character_data>

This command controls whether the binary data is transferred in normal or swapped Byte ORDER. It is only used when **FORMat[:READings][:DATA]** is set to **REAL**.

Syntax

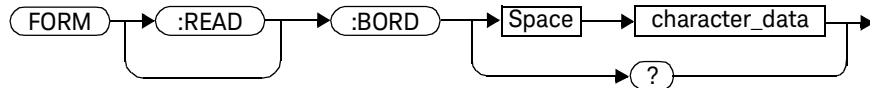

Parameters

Item	Description/Default	Range of Values
character_data	Byte order of binary data transfer: - NORMa1 - SWAPped	NORMa1 SWAPped

Example

FORM:BORDER SWAP

This command sets the byte order to swapped.

Reset Condition

On reset, this value is set to **NORMa1**.

Query

FORMat[:READings]:BORDER?

The query returns the current setting of the byte order. The format of the response is **NORMa1** or **SWAPped..**

Query Example

FORM:BORD?

This command queries the current byte order setting.

FORMat[:READings][:DATA] <character_data>

This command sets the data format for transferring numeric information to either **ASCIi** or **REAL**:

- When the format type is **ASCIi**, numeric data is output as ASCII bytes in the <NR3> format.
- When the format type is **REAL**, numeric data is output as IEEE 754 64 bit floating point numbers in a definite length block. The result is an 8 byte block per number. Each complete block is terminated by a line feed character.

For the N1914A power meter the same **FORMat** is used on both channels.

NOTE

FORMat data formatting is not affected by TRACe subsystem data formatting.

Syntax

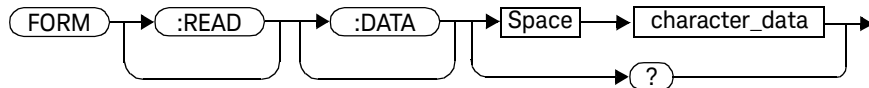

Parameters

Item	Description/Default	Range of Values
character_data	Data format for transferring data: - ASCIi - REAL	ASCIi REAL

Example

FORM REAL

This command sets the format to REAL.

Reset Condition

On reset, the format is set to **ASCIi**.

Query

FORMat[:READings][:DATA]?

The query returns the current setting of format: either **ASCIi** or **REAL**.

Query Example

FORM?

This command queries the current format setting.

7 HCOPy Subsystem

HCOPy Subsystem	286
HCOPy:SDUMp:DATA?	287
HCOPy:SDUMp:DATA:FORMat BMP PNG	288

This chapter explains how the **HCOPy** subsystem is used to output the screen image and select the image format.

HCOPy Subsystem

The **HCOPy** subsystem is used to output the image from the power meter's front panel screen and select the image format.

Keyword	Parameter Form	Notes	Page
HCOPy			
:SDUMp			
:DATA?		[query only]	page 287
:DATA			
:FORMat	BMP PNG		page 288

HCOPy:SDUMp:DATA?

This command returns the current screen image from the power meter as a file. The image file is in a format which is specified by **HCOPy:SDUMp:DATA:FORMat** command.

Syntax



Example

HCOP:SDUM:DATA?

This command outputs the screen image

HCOPy:SDUMp:DATA:FORMat BMP|PNG

This command is used to set the format of the screen image file which is returned by **HCOPy:SDUMp:DATA?** query command.

Syntax

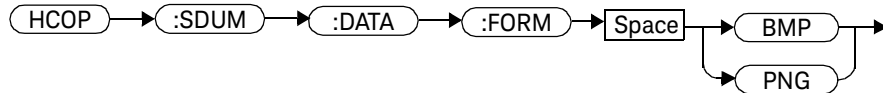

Parameters

Item	Description/Default	Range of Values
format	Available image format: – Bitmap: BMP – Portable Network Graphics: PNG	BMP PNG

Example

HCOP:SDUM:DATA:FORM BMP

This command sets the format of the screen image file.

Reset Condition

On reset, the format is **PNG**.

8 LXI Subsystem

LXI Subsystem	290
LXI:IDENTify[:STATe] <boolean>	291

This chapter explains how the **LXI** subsystem is used to enable and disable LXI identification.

LXI Subsystem

The **LXI** subsystem is used to enable and disable the LXI identification.

Keyword	Parameter Form	Notes	Page
LXI			
:IDENTify			
:[:STATe]	<boolean>		page 291

LXI:IDENTify[:STATe] <boolean>

This command enables or disables LXI identification.

Syntax

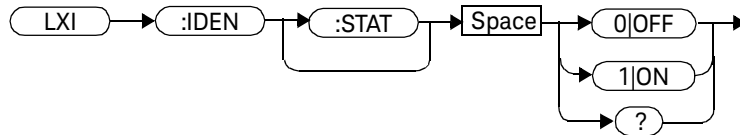

Example

LXI:IDEN 1

This command enables the LXI identification.

Query

LXI:IDENTify?

The query enters a **1** or **0** into the output buffer.

- **1** is returned if the LXI identification is enabled.
- **0** is returned if the LXI identification is disabled.

Query Example

LXI:IDEN?

This command queries whether or not the LXI identification is enabled.

THIS PAGE HAS BEEN INTENTIONALLY LEFT BLANK.

9 MEMory Subsystem

MEMory Subsystem	294
MEMory[:METER]:USB[1]2:CATalog Commands	296
MEMory[:METER]:USB[1]2:CATalog[:ALL]?	297
MEMory[:METER]:USB[1]2:CATalog:STATe?	300
MEMory[:METER]:USB[1]2:CATalog:TABLE?	301
MEMory[:METER]:USB[1]2:CLEar Commands	304
MEMory[:METER]:USB[1]2:CLEar[:NAME] <character_data>	305
MEMory[:METER]:USB[1]2:CLEar:TABLE	307
MEMory[:METER]:USB[1]2:FREE Commands	308
MEMory[:METER]:USB[1]2:FREE[:ALL]?	309
MEMory[:METER]:USB[1]2:FREE:STATe?	310
MEMory[:METER]:USB[1]2:FREE:TABLE?	311
MEMory[:METER]:USB[1]2:NSTATes?	312
MEMory[:METER]:USB[1]2:STATe Commands	313
MEMory[:METER]:USB[1]2:STATe:CATalog?	314
MEMory[:METER]:USB[1]2:STATe:DEFine <character_data>,<numeric_value>	315
MEMory[:METER]:USB[1]2:TABLE Commands	317
MEMory[:METER]:USB[1]2:TABLE:FREQuency <numeric_value>{,<numeric_value>}	318
MEMory[:METER]:USB[1]2:TABLE:FREQuency:POINts?	322
MEMory[:METER]:USB[1]2:TABLE:GAIN[:MAGNitude] <numeric_value>{,<numeric_value>}	323
MEMory[:METER]:USB[1]2:TABLE:GAIN[:MAGNitude]:POINts?	326
MEMory[:METER]:USB[1]2:TABLE:MOVE <character_data>,<character_data>	327
MEMory[:METER]:USB[1]2:TABLE:SElect <character_data>	329

This chapter explains how the **MEMory** command subsystem is used to create, edit and review sensor calibration tables.

MEMory Subsystem

The **MEMory** command subsystem is used to:

- Edit and review sensor calibration tables (8480 Series sensors and N8480 Series sensors with Option CFT only)
- Store sensor calibration tables (8480 Series sensors and N8480 Series sensors with Option CFT only)
- Edit and review sensor frequency dependent offset tables
- Store sensor frequency dependent offset tables
- Edit and review sensor save/recall registers

Stored tables remain in the power meter's memory during power down. The power meter is capable of storing 20 sensor calibration tables and 10 frequency dependent offset tables of 80 frequency points each.

To use the memory commands with the U2000 Series sensor, append **USB[1]** or **USB2** after **MEMory**: in the scpi syntax. **USB[1]** is to select the U2000 Series sensor attached to Channel C while **USB2** is to select the U2000 Series sensor attached to Channel D.

NOTE

The **MEMory** subsystem is not used for E-Series, N8480 Series (excluding Option CFT) and U2000 power sensors calibration tables. These are automatically downloaded to the power meter and cannot be reviewed or edited.

Keyword	Parameter Form	Notes	Page
MEMory			
	<code>[:METer] :USB[1] 2</code>		
	<code>:CATalog</code>		
	<code>[:ALL] ?</code>	[query only]	page 297
	<code>:STATe?</code>	[query only]	page 300
	<code>:TABLe?</code>	[query only]	page 301
	<code>:CLEar</code>		

Keyword	Parameter Form	Notes	Page
[:NAME]	<character_data>	[no query], [non-SCPI]	page 305
:TABLE		[no query]	page 307
:FREE			
[:ALL]?		[query only]	page 309
:STATE?		[query only]	page 310
:TABLE?		[query only]	page 311
:NSTates?		[query only]	page 312
:STATE			
:CATalog?		[query only]	page 314
:DEFine	<character_data> [,<numeric_value>]	[non-SCPI]	page 315
:TABLE			
:FREQuency	<numeric_value> [,<numeric_value>]		page 318
:POINTs?		[query only]	page 322
:GAIN			
[:MAGNitude]	<numeric_value> [,<numeric_value>]	[non-SCPI]	page 323
:POINTs?		[query only], [non-SCPI]	page 326
:MOVE	<character_data>, <character_data>	[no query], [non-SCPI]	page 327
:SElect	<character_data>	[no query], [non-SCPI]	page 329

MEMory[:METer]:USB[1]2:CATalog Commands

These commands are used to query information on the current contents of a power meter's:

- Sensor calibration tables (8480 Series sensors and N8480 Series sensors with Option CFT only)
- Frequency dependent offset tables
- Save/recall registers

The following commands are detailed in this section:

```
MEMory[:METer]:USB[1]2:CATalog[:ALL]?
```

```
MEMory[:METer]:USB[1]2:CATalog:STATe?
```

```
MEMory[:METer]:USB[1]2:CATalog:TABLE?
```

MEMory[:METer]:USB[1]2:CATalog[:ALL]?

This command lists stored sensor calibration tables (8480 Series sensors and N8480 Series Sensors with Option CFT only), frequency dependent offset tables and save/recall registers.

The power meter returns the data in the form of two numeric parameters and as many strings as there are stored tables and save/recall registers:

`<numeric_value>,<numeric_value>{,<string>}`

- The first numeric parameter indicates the amount of memory, in bytes, used for the storage of tables and registers.
- The second numeric parameter indicates the memory, in bytes, available for the storage of tables and registers.
- Each string parameter returned indicates the name, type and size of a stored table or save/recall register:
 - `<string>`, `<type>`, `<size>`
 - `<string>` indicates the name of the table or save/recall register.
 - `<type>` indicates **TABL** for sensor calibration and frequency dependent offset tables, or **STAT** for a save/recall register.
 - `<size>` indicates the size of the table or save/recall register in bytes.

A sample of a response may look like the following:

```
1178,26230,"DEFAULT,TABL,14","8481A,TABL,116",
"8482A,TABL,74",....."State0,STAT,1619",
"State1,STAT,1619","State2,STAT,1619" .....
```

The power meter is shipped with a set of predefined sensor calibration tables. The data in these sensor calibration tables is based on statistical averages for a range of Keysight Technologies power sensors. These tables can be edited. The predefined data is listed in your user's guide. These power sensors and table numbers are listed in [Table 9-1](#).

NOTE

Predefined sensor calibration table is not applicable for N8480 Series power sensors with Option CFT. Therefore you are required to create a new sensor calibration table for the sensors when a sensor calibration table is needed.

Table 9-1 8480 Series Power Sensor Tables

Table	Power Sensor	Table Name
0	None	DEFAULT ^[a]
1	8481A	8481A
2	8482A, 8482B, 8482H	8482A
3	8483A	8483A
4	8481D	8481D
5	8485A	8485A
6	R8486A	R8486A
7	Q8486A	Q8486A
8	R8486D	R8486D
9	8487A	8487A

[a] There are also ten sensor calibration tables named CUSTOM_0 through CUSTOM_9 and ten frequency dependent offset tables named CUSTOM_A through CUSTOM_J which do not contain any data when the power meter is shipped from the factory.

Syntax

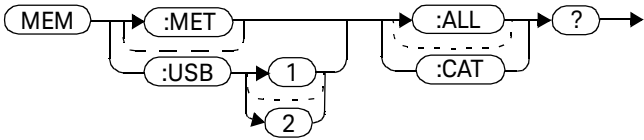

Example

MEM:MET:CAT?

MEM:USB:CAT?

This command queries the list of tables and save/recall registers.

MEMory[:METer][:USB[1]]2:CATalog:STATe?

This command is used to list the save/recall registers.

The power meter returns the data in the form of two numeric parameters and as many strings as there are save/recall registers.

<numeric_value>,<numeric_value>{,<string>}

- The first numeric parameter indicates the amount of memory, in bytes, used for the storage of registers.
- The second parameter indicates the memory, in bytes, available for the storage of registers.
- Each string parameter returned indicates the name, type and size of a save/recall register:
 - **<string>,<type>,<size>**
 - **<string>** indicates the name of the save/recall register.
 - **<type>** indicates **STAT** for save/recall register.
 - **<size>** indicates the size of the save/recall register in bytes.

For example, a sample of a response may look like:

0,16190,"State0,STAT,0", "State1,STAT,0"

Syntax

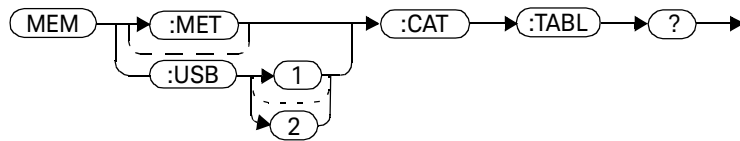

Example

MEM:CAT:STAT?

This command queries the list of save/recall registers.

MEM:USB:CAT:STAT?

MEMory[:METer]:USB[1]2:CATalog:TABLE?

This command is used to list the stored sensor calibration (8480 Series sensors and N8480 Series sensors with Option CFT only) and frequency dependent offset tables.

The power meter returns the data in the form of two numeric parameters and as many strings as there are stored tables.

`<numeric_value>,<numeric_value>{,<string>}`

- The first numeric parameter indicates the amount of memory, in bytes, used for the storage of tables.
- The second parameter indicates the memory, in bytes, available for the storage of tables.
- Each string parameter returned indicates the name, type and size of a stored table:
 - `<string>,<type>,<size>`
 - `<string>` indicates the name of the table.
 - `<type>` indicates **TABL** for a table.
 - `<size>` indicates the size of the table in bytes.

For example, a sample of a response may look like:

```
1178,10040,"DEFAULT,TABL,14","8481A,TABL,116",
"8482A,TABL,74","8483A,TABL,62".....
```

The power meter is shipped with a set of predefined sensor calibration tables. The data in these sensor calibration tables is based on statistical averages for a range of Keysight Technologies power sensors. These tables can be edited. The predefined data is listed in your user's guide. These power sensors and table numbers are listed in [Table 9-2](#).

NOTE

Predefined sensor calibration table is not applicable for N8480 Series power sensors with Option CFT. Therefore you are required to create a new sensor calibration table for the sensors when a sensor calibration table is needed.

Table 9-2 8480 Series Power Sensor Tables

Table	Power Sensor	Table Name
0	None	DEFAULT ^[a]
1	8481A	8481A
2	8482A, 8482B, 8482H	8482A
3	8483A	8483A
4	8481D	8481D
5	8485A	8485A
6	R8486A	R8486A
7	Q8486A	Q8486A
8	R8486D	R8486D
9	8487A	8487A

[a] Default is a sensor calibration table in which the reference calibration factor and calibration factors are 100%. This sensor calibration table can be used during the performance testing of the power meter

There are also ten sensor calibration tables named CUSTOM_0 through CUSTOM_9 and ten frequency dependent offset tables named CUSTOM_A through CUSTOM_J which do not contain any data when the power meter is shipped from the factory.

Syntax

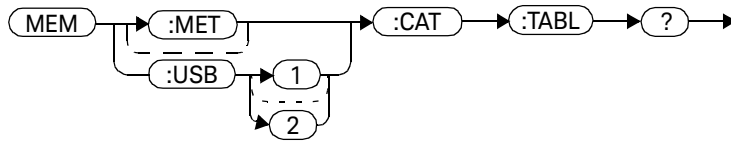

Example

MEM:CAT:TABL?

MEM:USB:CAT:TABL?

This command queries the list of stored tables.

MEMory[:METer]:USB[1]2:CLEar Commands

These commands are used to remove the contents stored in the sensor calibration tables (8480 Series sensors and N8480 Series sensors with Option CFT only), frequency dependent offset tables and save/recall registers. This subsystem removes the data contents but does not affect the name of the associated table or save/recall register.

The following commands are detailed in this section:

```
MEMory[:METer]:USB[1]2:CLEar:[NAME] <character_data>
```

```
MEMory[:METer]:USB[1]2:CLEar:TABLE
```

NOTE

The contents cleared using these commands are non-recoverable.

MEMory[:METer]:USB[1]|2:CLEar[:NAME] <character_data>

This command clears the contents of a specified sensor calibration table (8480 Series sensors and N8480 Series sensors with Option CFT only), frequency dependent offset table, or save/recall register.

Although the table remains, a **MEMory[:METer] | :USB[1] | 2:TABLE:FREQuency|GAIN:POINts?** query returns a 0 as there are no contents in the table.

For sensor calibration tables and frequency dependent offset tables, this command is an alternative form of the **MEMory:CLEar:TABLE** command, the only difference being the method in which the table is selected.

NOTE

The contents cleared using this command are non-recoverable.

Syntax

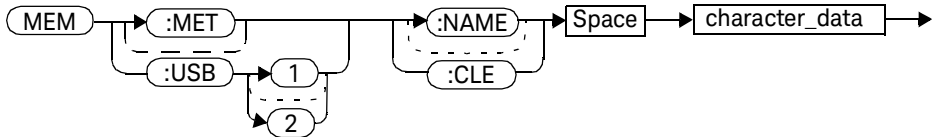

Parameters

Item	Description/Default	Range of Values
character_data	Contains an existing table name or save/recall register.	Any existing table name or save/recall register.

Example

MEM:CLE "8485A"

This command clears the contents of sensor calibration table 8485A.

Error Messages

If the table or save/recall register name does not exist, error -224, "Illegal parameter value" occurs.

MEMory[:METer][:USB[1]]2:CLEar:TABLE

This command is used to clear the contents of the table currently selected using **MEMory:TABLE:SELEct**. Although the table remains, a **MEMory:TABLE:FREQuency|GAIN:POINts?** query returns a 0 as the table contents are empty.

This command is an alternative form of the **MEMory:CLEar[:NAME]** command. The difference is the method in which the table is selected.

NOTE

The contents cleared using this command are non-recoverable.

Syntax

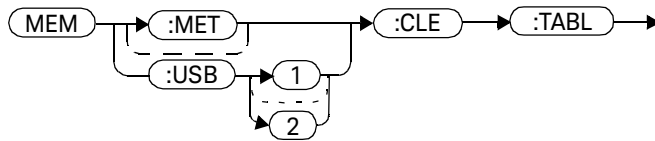

Example

MEM:CLE:TABL

MEM:USB:CLE:TABL

This command clears the contents of the currently selected table.

Error Message

If no table is selected, error -221, "Settings conflict" occurs.

MEMory[:METer]:USB[1]2:FREE Commands

These commands are used to return information on the amount of free memory space available for sensor calibration tables (8480 Series sensors and N8480 Series sensors with Option CFT only), frequency dependent offset tables, and save/recall registers.

The following commands are described in this section:

MEMory[:METer]:USB[1]2:FREE[:ALL]?

MEMory[:METer]:USB[1]2:FREE:STATE?

MEMory[:METer]:USB[1]2:FREE:TABLE?

MEMory[:METer][:USB[1]|2:FREE[:ALL]?]

This query returns the amount of memory free for sensor calibration tables (8480 Series sensors and N8480 Series sensors with Option CFT only), frequency dependent offset tables, and save/recall registers. The format of the response is:

<bytes_available>,<bytes_in_use>

Syntax

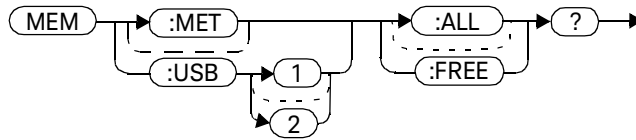

Example

MEM:FREE?

This command queries the amount of free memory in total.

MEM:USB:FREE?

MEMory[:METer][:USB[1]|2]:FREE:STATe?

This query returns the amount of memory free for save/recall registers. The format of the response is:

<bytes_available>,<bytes_in_use>

Syntax

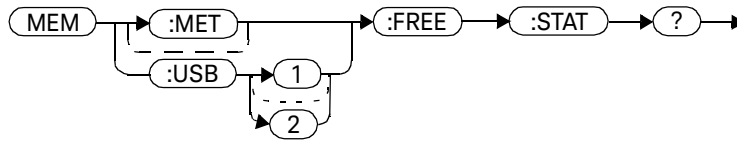

Example

MEM:FREE:STAT?

MEM:USB:FREE:STAT?

This command queries the amount of free memory for save/recall registers.

MEMory[:METer][:USB[1]]2:FREE:TABLE?

This query returns the amount of memory free for sensor calibration tables (8480 Series sensors and N8480 Series sensors with Option CFT only) and frequency dependent offset tables. The format of the response is:

<bytes_available>,<bytes_in_use>

Syntax

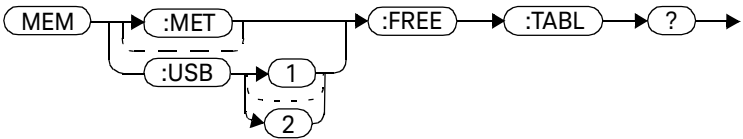

Example

MEM:FREE:TABL?

MEM:USB:FREE:TABL?

This command queries the amount of free memory for tables.

MEMory[:METer][:USB[1]]2:NStates?

This query returns the number of registers that are available for save/recall. As there are ten registers, this query always returns ten.

Syntax

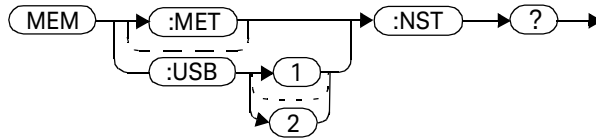

Example

MEM:NST?

MEM:USB:NST?

This command queries the number of registers available for save/recall.

MEMory[:METer]:USB[1]2:STATe Commands

These commands are used to query and define register names.

The following commands are described in this section:

MEMory[:METer]:USB[1]2:STATe:CATalog?

MEMory[:METer]:USB[1]2:STATe:DEFine

MEMory[:METer][:USB[1]]2:STATe:CATalog?

This query returns a list of the save/recall register names in ascending order of register number. The format of the response is:

<string>,<string>,<string>,<string>,<string>

Syntax

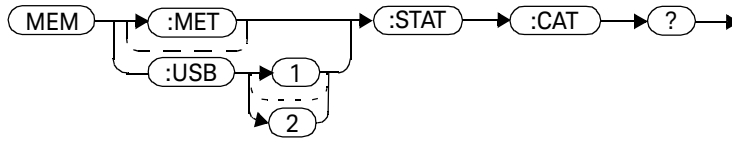

Example

MEM:STAT:CAT?

This command queries the register names.

MEM:USB:STAT:CAT?

MEMory[:METer][:USB[1]|2]:STATe:DEFine <character_data>,<numeric_value>

This command is used to associate a name with a save/recall register number.

Syntax

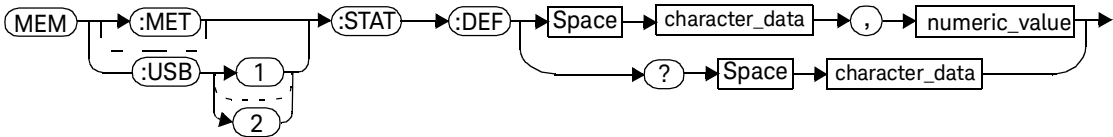

Parameters

Item	Description/Default	Range of Values
character_data	Details the register name. A maximum of 12 characters can be used.	A to Z (uppercase) a to z (lowercase) 0-9 _ (underscore)
numeric_value	A numeric value (<NRf>) for the register number.	0 to 9

Example

MEM:STAT:DEF "SETUP1",4 *This command names register 4 SETUP1.*

Query

MEMory:STATe:DEFine? <string>

The query returns the register number for the given register name.

Query Example

MEM:STAT:DEF? "SETUP1"

This command queries the register number of SETUP1.

Error Messages

- If the register number is out of range, error -222, "Data out of range" occurs.
- If the name is invalid, error -224, "Illegal parameter value" occurs.
- If a register or sensor calibration table with the same name already exists, error -257, "File name error" occurs (command only).

MEMory[:METer]:USB[1]2:TABLE Commands

These commands are used to define a sensor calibration table (8480 Series sensors and N8480 Series sensors with Option CFT only) or a frequency dependent offset table, and to write to and read data from it.

The following commands are described in this section:

```
MEMory[:METer]:USB[1]2:TABLE:FREQuency
<numeric_value>{,<numeric_value>}
```

```
MEMory[:METer]:USB[1]2:TABLE:FREQuency:POINts?
```

```
MEMory[:METer]:USB[1]2:TABLE:GAIN[:MAGNitude]
<numeric_value>{,<numeric_value>}
```

```
MEMory[:METer]:USB[1]2:TABLE:GAIN[:MAGNitude]:POINts?
```

```
MEMory[:METer]:USB[1]2:TABLE:MOVE <character_data>,<character_data>
```

```
MEMory[:METer]:USB[1]2:TABLE:SELEct <character_data>
```

```
MEMory[:METer][:USB[1]]2:TABLE:FREQuency  
<numeric_value>{,<numeric_value>}
```

This command is used to enter frequency data into the current selected table. Any previous frequency list is cleared before the new frequency list is stored. The frequencies must be entered in ascending order. Entries in the frequency lists correspond as shown in [Table 9-3](#) with entries in the calibration/offset factor lists.

NOTE

For sensor calibration tables only, the first calibration factor entered using the `MEMory:TABLE:GAIN` command is used as the reference calibration factor.

NOTE

Predefined sensor calibration table is not applicable for N8480 Series power sensors with Option CFT. Therefore you are required to create a new sensor calibration table for the sensors when a sensor calibration table is needed.

Table 9-3 Frequency and Calibration/Offset Factor List

Table	Power Sensor	Table Name
0	None	DEFAULT ^[a]
1	8481A	8481A
2	8482A, 8482B, 8482H	8482A
3	8483A	8483A
4	8481D	8481D
5	8485A	8485A
6	R8486A	R8486A
7	Q8486A	Q8486A
8	R8486D	R8486D
9	8487A	8487A

[a] Default is a sensor calibration table in which the reference calibration factor and calibration factors are 100%. This sensor calibration table can be used during the performance testing of the power meter.

For sensors calibration tables (8480 Series sensors and N8480 Series sensors with Option CFT only), the number of frequency points must be one less than the number of calibration factor points. This is verified when the sensor calibration table is selected using **SENSe:CORRection:CSET:SElect <string>**.

Ensure that the frequency points you use cover the frequency range of the signals that you want to measure. If you measure a signal with a frequency outside the frequency range defined in the table, then the power meter uses the highest or lowest point in the table to calculate the calibration factor/offset.

Depending on available memory, the power meter is capable of storing 20 sensor calibration tables and 10 frequency dependent offset tables, each containing 80 points.

Syntax

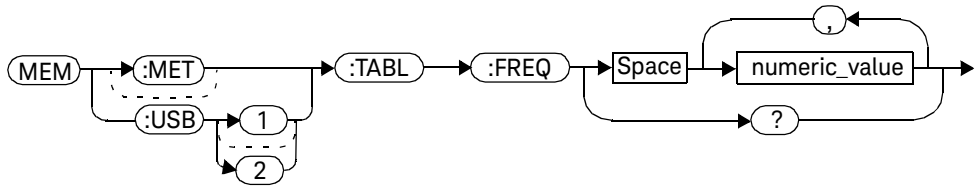

Parameters

Item	Description/Default	Range of Values
numeric_value	A numeric value for the frequency. The default units are Hz.	1 kHz to 1000.0 GHz ^{[a],[b]}

- [a] The following measurement units can be used:
 Hz
 kHz (10³)
 MHz (10⁶)
 GHz (10⁹)

- [b] All frequencies are truncated to a multiple of 1 kHz.

Example

MEM:TABLE:FREQ 200kHz,600kHz *This command enters frequencies of 200 kHz and 600 kHz into the currently selected table.*

Query

MEMory:TABLE:FREQuency?

The query returns a list of frequency points for the table currently selected. The frequencies are returned in Hz.

Query Example

MEM:TABLE:FREQ? *This command queries the frequency points in the currently selected table.*

Error Messages

- If more than 80 frequencies are in the list, error –108, “Parameter not allowed” occurs.
- If the frequencies are not entered in ascending order, error –220, “Parameter error;Frequency list must be in ascending order” occurs.
- If a table has not been specified using the **MEMory:TABLE:SElect** command, the data cannot be entered into the table and error –221, “Settings conflict” occurs.
- If a frequency is sent which is outside of the allowed frequency range, error –222, “Data out of range” occurs.

MEMory[:METer][:USB[1]]2:TABLE:FREQUency:POINts?

This query returns the number of frequency points for the table currently selected. The response format is **<NRf>**. If no frequency values have been set, this command returns 0. If no table is selected, this command returns **NAN**.

Syntax

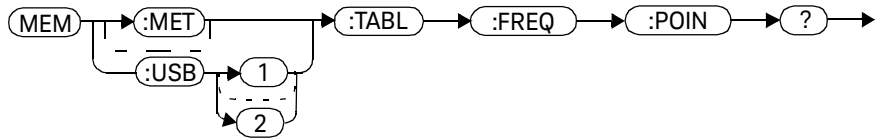

Example

MEM:TABL:FREQ:POIN?

This command queries the number of frequency points in the current table.

```
MEMory[:METer]:USB[1]2:TABLE:GAIN[:MAGNitude]
<numeric_value>{,<numeric_value>}
```

This command is used to enter calibration factors into the sensor calibration table (8480 Series sensors and N8480 Series sensors with Option CFT only) or offsets into the frequency dependent offset table, currently selected using

MEMory[:METer]:USB[1]2:TABLE:SElect. Any previous calibration factor list, or offset list is cleared before the new calibration factors/offsets are stored.

A maximum of 81 parameters for sensor calibration tables and 80 parameters for frequency dependent offset tables can be sent with this command. For sensor calibration tables only, the first parameter is the reference calibration factor, each subsequent parameter is a calibration factor point in the sensor calibration table.

Entries in the frequency lists correspond as shown in [Table 9-4](#) with entries in the calibration/offset factor lists.

Table 9-4 Frequency and Calibration/Offset Factor List

Frequency	Calibration Factor/Offset
-	Reference Calibration Factor (For Sensor Calibration Tables)
Frequency 1	Calibration Factor/Offset 1
"	"
Frequency 80	Calibration Factor/Offset 80

For sensor calibration tables the number of frequency points must be one less than the number of calibration factor data points. This is verified when the sensor calibration table is selected using **SENSe:CORRection:CSET1:SElect <string>**.

Syntax

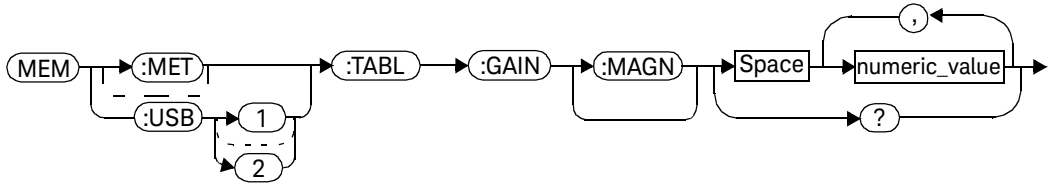

Parameters

Item	Description/Default	Range of Values
numeric_value	A numeric value for the calibration/ offset factors. The units are PCT.	1.0 to 150.0

Example

```
MEM:TABL:SEL "Sensor_1"
MEM:TABL:GAIN 97,99.5,97.4
```

This command enters a reference calibration factor of 97 % and calibration factors of 99.5 % and 97.4 % into the sensor calibration table.

Query

```
MEMory:TABLE:GAIN[:MAGNitude]?
```

The query returns a list of calibration factor/offset points for the currently selected table.

Query Example

MEM:TABLE:GAIN?

This command queries the calibration factor/offset in the current table.

Error Messages

- If more than 81 calibration factors for sensor calibration tables, or 80 offsets for frequency dependent offset tables are in the list, error –108, “Parameter not allowed” occurs.
- If a table is not specified using the **MEMory[:METER]:USB[1]|2:TABLE:SElect** command, the data cannot be entered and error –221, “Settings conflict” occurs.
- If any of the calibration/offset factors are outside of the allowed range, error –222, “Data out of range” occurs.

MEMory[:METer][:USB[1]]2:TABLE:GAIN[:MAGNitude]:POINts?

This query is used to return the number of calibration factor/offset points for the currently selected table. If the currently selected table is a sensor calibration table (8480 Series sensors and N8480 Series sensors with Option CFT only), the reference calibration factor is included

If no values have been set, 0 is returned. If no table is selected, **NAN** is returned.

Syntax

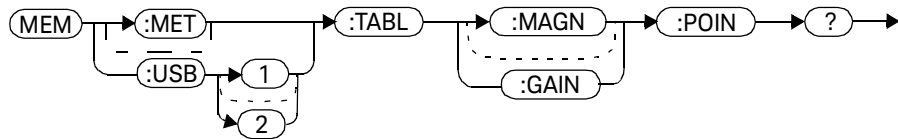

Example

MEM:TABLE:GAIN:POIN?

This command queries the number of calibration factor/offset points in the current table.

MEMory[:METer][:USB[1]|2]:TABLe:MOVE <character_data>,<character_data>

This command is used to rename a sensor calibration table (8480 Series sensors and N8480 Series sensors with Option CFT only) or a frequency dependent offset table.

Syntax

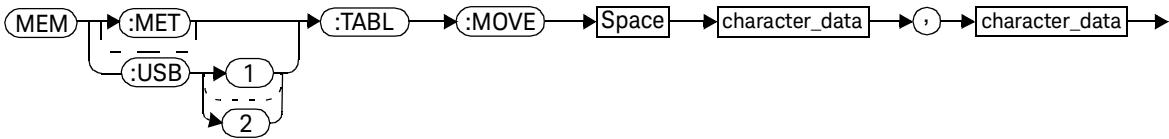

Parameters

Item	Description/Default	Range of Values
character_data 1st parameter)	Contains the existing table name.	existing table name
character_data(2nd parameter)	Details the new table name. A maximum of 12 characters can be used.	A to Z (uppercase) a to z (lowercase) 0 - 9 _ (underscore)

Example

MEM:TABL:MOVE "tab1","tab1a" *This command renames a table named tab1 to tab1a.*

Error Messages

- If either table name is invalid, error -224, "Illegal parameter value" occurs.
- If the first parameter does not match an existing table name, error -256, "File name not found" occurs.
- If the second parameter matches an existing table name or save/recall register, error -257, "File name error" occurs.

MEMory[:METer]:USB[1]|2:TABLE:SElect <character_data>

This command is used to activate either a sensor calibration table (8480 Series sensors and N8480 Series sensors with Option CFT only), or a frequency dependent offset table. A table must be activated before any operation can be performed on it.

Syntax

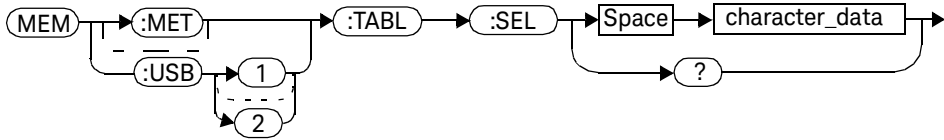

Parameters

Item	Description/Default	Range of Values
character_data	Details the new table name. A maximum of 12 characters can be used.	A to Z (uppercase) a to z (lowercase) 0 - 9 _ (underscore)

Example

MEM:TABL:SEL "Sensor1"

This command selects a sensor calibration table named "Sensor1".

Query

MEMory:TABLE:SElect?

The query returns the name of the currently selected table.

THIS PAGE HAS BEEN INTENTIONALLY LEFT BLANK.

10 OUTPut Subsystem

OUTPut Subsystem	332
OUTPut:REcorder[1]2:FEED <data_handle>	333
OUTPut:REcorder[1]2:LIMit:AUTO <boolean>	335
OUTPut:REcorder[1]2:LIMit:LOWer <numeric_value>	336
OUTPut:REcorder[1]2:LIMit:UPPer <numeric_value>	338
OUTPut:REcorder[1]2:STATe <boolean>	340
OUTPut:ROSCillator[:STATe] <boolean>	341
OUTPut:TRIGger[:STATe] <boolean>	342

This chapter explains how the **OUTPut** command subsystem is used to switch the POWER REF output on and off.

OUTPut Subsystem

The **OUTPut** command subsystem is used to control the trigger output, switch on and off the POWER REF output, and controls the recorder output.

Keyword	Parameter Form	Notes	Page
OUTPut			
:REcorder[1] 2			
:FEED	<data_handle>		page 333
:LIMit			
:AUTO	<boolean>		page 335
:LOWer	<numeric_value>		page 336
:UPPer	<numeric_value>		page 338
:STATe	<boolean>		page 340
:ROSCillator			
[:STATe]	<boolean>		page 341
:TRIGger			
[:STATe]	<boolean>		page 342

OUTPut:RECOder[1]|2:FEED <data_handle>

This command specifies which measurement is sent to the recorder output specified by the numeric value following **RECOder**. **RECOder1** applies to both single and dual channel power meters. **RECOder2** applies to dual channel power meters only.

Syntax

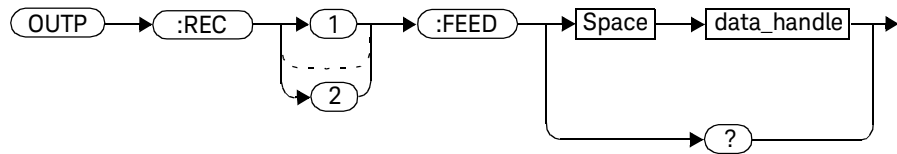

Parameters

Item	Description/Default	Range of Values
data_handle	The CALC block specifying the measurement to be sent to the recorder output.	"CALC1" or "CALC" "CALC2" "CALC3" "CALC4"

Example

OUTP:REC2:FEED "CALC1"

This command sends the CALC1 measurement to recorder output 2.

Reset Condition

On reset, **data_handle** is set to its previous value.

Query

OUTPut:REcorder[1]|2:FEED?

The query command returns the current value of data_handle.

Query Example

OUTP:REC2:FEED?

This command queries the value of data_handle for recorder output 2.

OUTPut:RECOder[1]|2:LIMit:AUTO <boolean>

This command enables or disables auto-scaling for specified recorder output. Presetting the power meter disables the auto-scaling.

Syntax

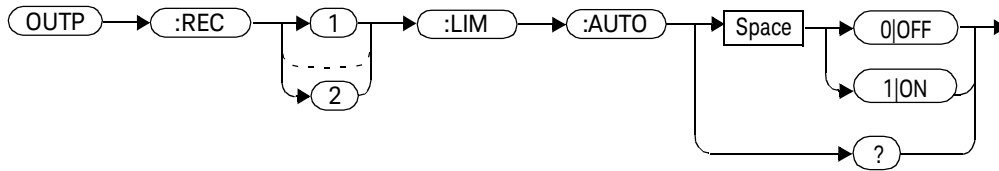

Example

OUTPut:REC2:LIM:AUTO 1

This command enables auto-scaling for recorder output 2.

Query

OUTPut:RECOder[1]|2:LIMit:AUTO?

The query returns the current state of auto-scaling.

Query Example

OUTPut:REC:LIM:AUTO?

This query returns the current state of auto-scaling for recorder output 1.

Error Messages

If **OUTPut:RECOder[1]|2:LIMit:AUTO** is set to **ON** while **CALCulate[1]|2|3|4:MATH[:EXPRession]** is set to channel C or D, difference, or ratio measurement, the error -221, "Settings conflict" occurs.

OUTPut:RECOder[1]|2:LIMit:LOWer <numeric_value>

This command sets the minimum scaling value for the specified recorder output. The units used are dependent on the units currently set for the CALC block specified in **OUTPut:RECOder[1]|2:FEED <data_handle>**.

Syntax

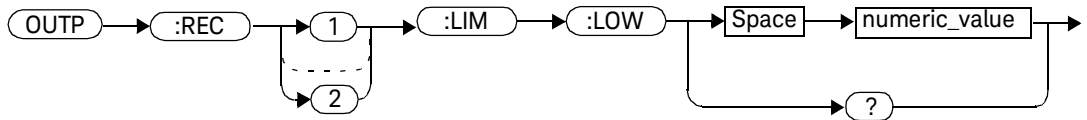

Parameters

Item	Description/Default	Range of Values
numeric_value	A numeric value for the minimum scaling value. The units used—dBm, W or %—are dependent on the units currently set for the CALC block specified in OUTPut:RECOder[1] 2:FEED <data_handle> .	-150 to +230 dBm 1 aW to 100 XW 0 % to 999 %

Example

OUTPut:REC:LIM:LOW -90

This command sets the minimum scaling value to -90.

Reset Condition

On reset, the minimum scaling value is set to -150 dBm.

Query

OUTPut:REcorder[1]|2:LIMit:LOWer?

The query command returns the minimum scaling value.

Query Example

OUTP:REC:LIM:LOW?

This command returns the minimum scaling value for the specified recorder output.

OUTPut:REcorder[1]|2:LIMit:UPPer <numeric_value>

This command sets the maximum scaling value for the specified recorder output. The units used are dependent on the units currently set for the CALC block specified in **OUTPut:REcorder[1]|2:FEED <data_handle>**.

Syntax

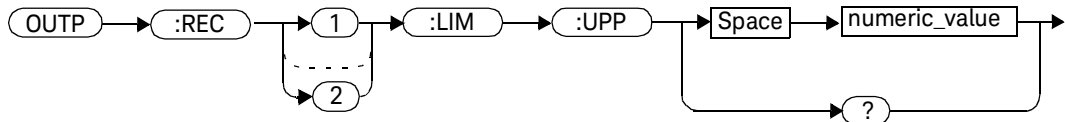

Parameters

Item	Description/Default	Range of Values
numeric_value	A numeric value for the minimum scaling value. The units used—dBm, W or %—are dependent on the units currently set for the CALC block specified in OUTPut:REcorder[1] 2:FEED <data_handle> .	-150 to +230 dBm 1 aW to 100 XW 0 % to 999 %

Example

OUTPut:REc:LIM:UPP 10

This command sets the maximum scaling value to 10.

Reset Condition

On reset, the maximum scaling value is set to +20 dBm.

Query

OUTPut:REcorder[1]|2:LIMit:UPPer?

The query command returns the maximum scaling value.

Query Example

OUTP:REC:LIM:UPP?

This command returns the maximum scaling value for the specified recorder output.

OUTPut:RECOder[1]|2:STATe <boolean>

This command enables or disables the specified recorder output.

Syntax

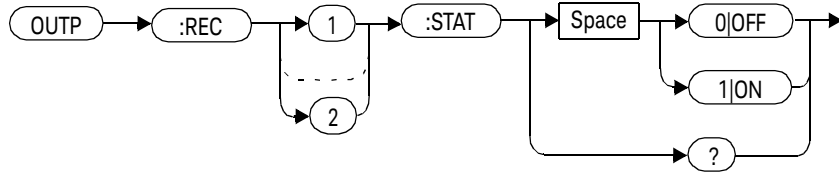

Example

OUTPut:REC1:STAT 1

This command enables the specified recorder output.

Reset Condition

On reset, the recorder output is **OFF**.

Query

OUTPut:RECOder[1]|2:STAT?

The query command enters a 1 or 0 into the output buffer indicating whether or not the specified recorder is switched on.

- 1 is returned when the recorder output is switched **ON**
- 0 is returned when the recorder output is switched **OFF**

Query Example

OUTPut:REC2:STAT?

This command queries the status of the recorder output.

OUTPut:ROSCillator[:STATe] <boolean>

This command enables or disables the POWER REF output.

Syntax

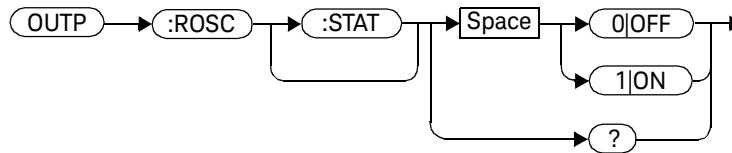

Example

OUTPut:ROSC:STAT 1

This command enables the POWER REF output.

Reset Condition

On reset, the POWER REF output is disabled.

Query

OUTPut:ROSCillator[:STATe]?

The query command enters a 1 or 0 into the output buffer indicating whether or not the POWER REF is enabled.

- 1 is returned when the POWER REF output is enabled
- 0 is returned when the POWER REF output is disabled

Query Example

OUTPut:ROSC?

This command queries the status of the POWER REF output.

OUTPut:TRIGger[:STATe] <boolean>

This command enables or disables the trigger output signal.

When sensor is in triggered average measurement mode, the trigger output signal will only be asserted after the measurement has settled.

NOTE

This command is also applicable when used with 8480, N8480, E4410, E9300 or U2000 sensor (Average mode only).

Syntax

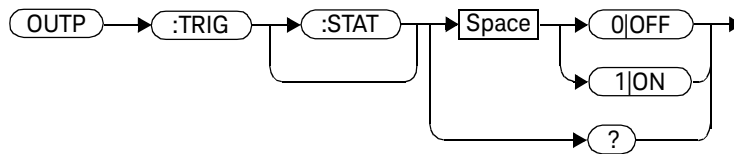

Example

OUTPut:TRIG:STAT 1

This command enables the trigger output signal.

Reset Condition

On reset, the trigger output signal is disabled.

Query

OUTPut:TRIGger[:STATe]?

The query command enters a 1 or 0 into the output buffer indicating whether or not the trigger output signal is enabled or disabled.

- 1 is returned when the trigger output signal is enabled
- 0 is returned when the trigger output signal is disabled

Query Example

OUTP:TRIG:STAT?

This command queries the status of the trigger output signal.

Error Messages

- If 8480, N8480, E4410, E9300 or U2000 sensor is connected and the trigger source is not set to external, error -221 "Settings conflict" occurs.

WKIV#SDJH#KD V#EHHQ#QWHQWIRQDOO\#DHIW#EODQN:

11 SENSE Subsystem

[SENSe] Subsystem	347
[SENSe[1]]SENSe2 3 4:AVERage Commands	350
[SENSe[1]]SENSe2 3 4:AVERage:COUNT <numeric_value>	351
[SENSe[1]]SENSe2 3 4:AVERage:COUNT:AUTO <boolean>	353
[SENSe[1]]SENSe2 3 4:AVERage:SDETect <boolean>	356
[SENSe[1]]SENSe2 3 4:AVERage[:STATe] <boolean>	358
[SENSe[1]]SENSe2:BUFFer:COUNT <numeric_value>	360
[SENSe[1]]SENSe2:CORRection Commands	362
[SENSe[1]]SENSe2:CORRection:CFACTOR GAIN[1][:INPut] [:MAGNitude] <numeric_value>	363
[SENSe[1]]SENSe2:CORRection:CSET[1]Commands	366
[SENSe[1]]SENSe2 3 4:CORRection:CSET2 Commands	367
[SENSe[1]]SENSe2:CORRection:CSET[1][:SElect] <string>	368
[SENSe[1]]SENSe2 3 4:CORRection:CSET2[:SElect] <string>	370
[SENSe[1]]SENSe2:CORRection:CSET[1]:STATe <boolean>	372
[SENSe[1]]SENSe2 3 4:CORRection:CSET2:STATe <boolean>	374
[SENSe[1]]SENSe2 3 4:CORRection:DCYClE GAIN3 Commands	376
[SENSe[1]]SENSe2 3 4:CORRection:DCYClE GAIN3[:INPut] [:MAGNitude] <numeric_value>	377
[SENSe[1]]SENSe2 3 4:CORRection:DCYClE GAIN3:STATe <boolean>	380
[SENSe[1]]SENSe2 3 4:CORRection:FDOFFset GAIN4 [:INPut][:MAGNitude]? <numeric_value>	382
[SENSe[1]]SENSe2:CORRection:FDOFFset:UNIT <character_data>	383
[SENSe[1]]SENSe2 3 4:CORRection:GAIN2 Commands	385
[SENSe[1]]SENSe2 3 4:CORRection:GAIN2:STATe <boolean>	386
[SENSe[1]]SENSe2 3 4:CORRection:GAIN2[:INPut][:MAGNitude] <numeric_value>	388
SENSe 3 4:DETEctor:FUNCTion <character_data>	390
[SENSe[1]]SENSe2 3 4:FREQuency[:CW]:FIXed <numeric_value>	392

[SENSe[1]] SENSe2:FREQuency[:CW]:FIXed]:START <numeric_value>	394
[SENSe[1]] SENSe2:FREQuency[:CW]:FIXed]:STEP <numeric_value>	397
[SENSe[1]] SENSe2:FREQuency[:CW]:FIXed]:STOP <numeric_value>	400
[SENSe[1]] SENSe2 3 4:MRATe <character_data>	403
[SENSe[1]] SENSe2 3 4:POWer:AC:RANGe <numeric_value>	406
[SENSe[1]] SENSe2 3 4:POWer:AC:RANGe:AUTO <boolean>	408
[SENSe[1]] SENSe2 3 4:SPeEd <numeric_value>	410
[SENSe[1]] SENSe2:V2P ATYPe DTYPe	413
SENSe3 4:SWeep:APERTure <numeric_value>	415
SENSe3 4:SWeep:APERTure:AUTO <boolean>	417

This chapter explains how the **SENSe** command subsystem directly affects device specific settings used to make measurements.

[SENSe] Subsystem

The **SENSe** command subsystem directly affects device specific settings used to make measurements. The **SENSe** subsystem is optional since this is the primary function of the power meter. The high level command **CONFigure** uses the **SENSe** commands to prepare the power meter for making measurements. At a lower level **SENSe** enables you to change the following parameters: **RANGE**, **FREQUency**, **LOSS**, **CFACator** | **GAIN1** (calibration factor), **GAIN2** (channel offset), **DCYCLe** (duty cycle) and **AVERAge**, without completely re-configuring the power meter.

The **SENSe** command subsystem also allows you to select the measurement speed, a sensor calibration table, and a frequency dependent offset table.

The numeric suffix of the **SENSe** program mnemonic in the **SENSe** commands refers to a channel, that is **SENSe1** and **SENSe2** represent Channel A and Channel B respectively.

NOTE

If you are using the single channel N1913A power meter the **SENSe2** commands are irrelevant and cause the error “Header suffix out of range.”

Keyword	Parameter Form	Notes	Page
[SENSe[1]] SENSe2 3 4			
:AVERAge			
:COUNT	<numeric_value>		page 351
:AUTO	<boolean>		page 353
:SDETECT	<boolean>	[non-SCPI]	page 356
[:STATe]	<boolean>		page 358
[SENSe[1]] SENSe2			
:BUFFer			
:COUNT	<numeric_value>		page 360
:CORRection			

Keyword	Parameter Form	Notes	Page
:CFACtor GAIN[1]		[non-SCPI]	
[:INPut]			
[:MAGNitude]	<numeric_value>		page 363
:CSET[1]			
[:SElect]	<string>		page 368
:STATe	<boolean>		page 372
[SENSe[1]] SENSe2 3 4			
:CORRection			
:CSET2			
[:SElect]	<string>		
:STATe	<boolean>		
:DCYClE GAIN3		[non-SCPI]	
[:INPut]			
[:MAGNitude]	<numeric_value>		page 377
:STATe	<boolean>		page 380
:FDOFfset GAIN4			
[:INPut]			
[:MAGNitude]		[query only]	page 382
:FDOFfset			
:UNIT	<character_data>		page 383
:GAIN2			
:STATe	<boolean>		page 386
[:INPut]			
[:MAGNitude]	<numeric_value>		page 388
:FREQuency			
[:CW FIXed]	<numeric_value>		page 392

Keyword	Parameter Form	Notes	Page
[SENSe[1]] SENSe2			
:FREQuency			
[:CW FIXed]			
:START	<numeric_value><unit>	[non-SCPI]	page 394
:STEP	<numeric_value>	[non-SCPI]	page 397
:STOP	<numeric_value><unit>	[non-SCPI]	page 400
[SENSe[1]] SENSe2 3 4			
:MRATe	<character_data>		page 403
:POWeR			
:AC			
:RANGe	<numeric_value>	[non-SCPI]	page 406
:AUTO	<boolean>		page 408
:SPEEd	<numeric_value>		page 410
[SENSe[1]] 2			
:V2P	ATYPe DTYPe	[non-SCPI]	page 413
SENSe3 4			
:DET			
:FUN	<character_data>		page 390
:SWEp			
:APERture	<numeric_value>	[non-SCPI]	page 415
:AUTO	<boolean>		page 417

[SENSe[1]]|SENSe2|3|4:AVERage Commands

These commands control the measurement averaging which is used to improve measurement accuracy. They combine successive measurements to produce a new composite result.

The following commands are detailed in this section:

```
[SENSe[1]]|SENSe2|3|4:AVERage:COUNT <numeric_value>  
[SENSe[1]]|SENSe2|3|4:AVERage:COUNT:AUTO <boolean>  
[SENSe[1]]|SENSe2|3|4:AVERage:SDETECT <boolean>  
[SENSe[1]]|SENSe2|3|4:AVERage[:STATE] <boolean>
```

[SENSe[1]]|SENSe2|3|4:AVERage:COUNT <numeric_value>

This command is used to enter a value for the filter length. If

[SENSe[1]]|SENSe2|3|4:AVERage:COUNT:AUTO is set to **ON** then entering a value for the filter length automatically sets it to **OFF**. Increasing the value of filter length increases measurement accuracy but also increases the time taken to make a power measurement.

Entering a value using this command automatically turns the [SENSe[1]]|SENSe2|3|4:AVERage:STATe command to **ON**.

NOTE

For most applications, automatic filter length selection ([SENSe[1]]|SENSe2|3|4:AVERage:COUNT:AUTO ON) is the best mode of operation. However, manual filter length selection ([SENSe[1]]|SENSe2|3|4:AVERage:COUNT <numeric_value>) is useful in applications requiring either high resolution or fast settling times, where signal variations rather than measurement noise need filtering, or when approximate results are needed quickly.

Syntax

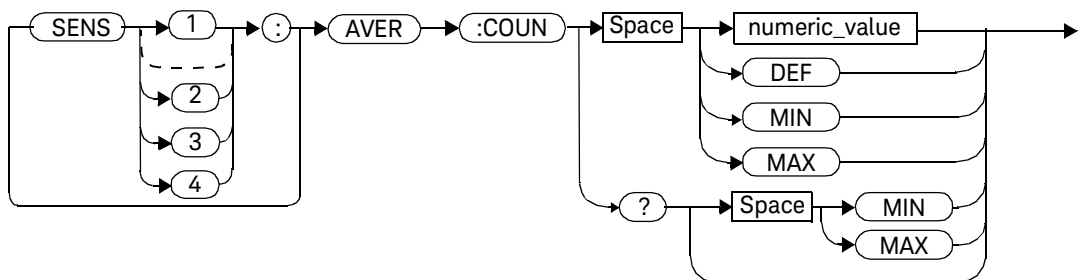

Parameters

Item	Description/Default	Range of Values
numeric_value	A numeric value defining the filter length. DEF: the default value is 4 MIN: 1 MAX: 1024	1 to 1024 DEF MIN MAX

Example

AVER:COUNT 400

This command enters a filter length of 400 for Channel A.

Reset Condition

On reset, the filter length is set to 4.

Query

AVERage:COUNT? [MIN|MAX]

The query returns the current setting of the filter length or the values associated with **MIN** and **MAX**. The format of the response is **<NR1>**.

Query Example

AVER:COUNT?

This command queries the filter length for Channel A.

Error Messages

If a filter length value is entered using **[SENSE[1]]|SENSE2|3|4:AVERage:COUNT** while **[SENSE[1]]|SENSE2:SPEed** is set to 200, the error -221, "Settings Conflict" occurs. However, the filter length value is set but the **[SENSE[1]]|SENSE2|3|4:AVERage:STATe** command is not automatically set **ON**.

[SENSe[1]]|SENSe2|3|4:AVERage:COUNT:AUtO <boolean>

This command enables and disables automatic averaging. **ONCE** has no effect on the power meter.

When the auto filter mode is enabled, the power meter automatically sets the number of readings averaged together to satisfy the averaging requirements for most power measurements. The number of readings averaged together depends on the resolution and the power level in which the power meter is currently operating. [Figure 11-1](#) is an example of the averaged number of readings for each range and resolution when the power meter is in auto measurement average mode and using a E932XX power sensor.

Setting this command to ON automatically sets the [SENSe[1]]|SENSe2|3|4:AVERage:STATe command to ON.

Power Sensor Dynamic Range	Maximum Sensor Power	Resolution Setting				Number of Averages
		1	2	3	4	
		1	1	1	8	
10 dB		1	1	1	16	
10 dB		1	1	2	32	
10 dB		1	1	16	256	
10 dB		1	8	128	128	
	Minimum Sensor Power					

Figure 11-1 Example of Averaged Readings

If [SENSe[1]]|SENSe2|3|4:AVERage:COUNT:AUtO is set to OFF, the filter length is set by the [SENSe[1]]|SENSe2|3|4:AVERage:COUNT command. Using the [SENSe[1]]|SENSe2|3|4:AVERage:COUNT command disables automatic averaging.

Auto averaging is enabled by the MEASure:POWer:AC? and CONFIgure:POWer:AC? commands.

NOTE

For most applications, automatic filter length selection ([SENSe[1]]|SENSe2|3|4:AVERage:COUNT:AUTO ON) is the best mode of operation. However, manual filter length selection ([SENSe[1]]|SENSe2|3|4:AVERage:COUNT <numeric_value>) is useful in applications requiring either high resolution or fast settling times, where signal variations rather than measurement noise need filtering, or when approximate results are needed quickly.

Syntax

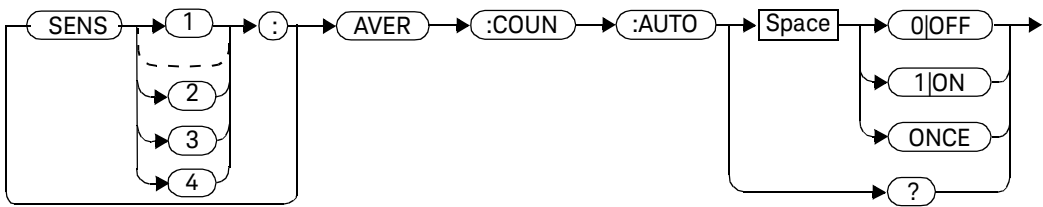

Example

```
AVER:COUN:AUTO OFF
```

This command disables automatic filter length selection for Channel A.

Reset Condition

On reset, automatic averaging is enabled.

Query

`[SENSe[1]]|SENSe2|3|4:AVERage:COUNT:AUTO?`

The query enters a 1 or 0 into the output buffer indicating whether automatic filter length is enabled or disabled.

- 1 is returned when automatic filter length is enabled
- 0 is returned when automatic filter length is disabled

Query Example

`AVER:COUNT:AUTO?`

This command queries whether automatic filter length selection is on or off for Channel A.

Error Messages

If `[SENSe[1]]|SENSe2|3|4:AVERage:COUNT:AUTO` is set to **ON** while `[SENSe[1]]|SENSe2:SPEEd` is set to 200, the error -221, "Settings Conflict" occurs. However, automatic averaging is enabled but the `[SENSe[1]]|SENSe2|3|4:AVERage:STATE` command is not automatically set **ON**.

[SENSe[1]]|SENSe2|3|4:AVERage:SDEText <boolean>

This command enables and disables step detection. In **AUTO** filter mode, the average of the last four values entered into the filter is compared to the average of the entire filter. If the difference between the two averages is greater than 12.5%, the digital filter is cleared. The filter then starts storing new measurement values. This feature shortens the filter time when the input power changes substantially. for the filter output to get to its final value. Note that this result appears to settle faster, although true settling to the final value is unaffected.

NOTE

Step detection is automatically disabled when TRIG:DEL:AUTO is ON and the trigger mode is set to free run.

Under this circumstances the value of SENS:AVER:SDET is ignored. Note also that SENS:AVER:SDET is not set by the instrument (that is, SENS:AVER:SDET retains its current setting which may indicate that step detection is ON).

NOTE

With certain pulsing signals step detect may operate on the pulses, preventing the final average being completed and making the results unstable. Under these conditions SDET should be set to OFF.

Syntax

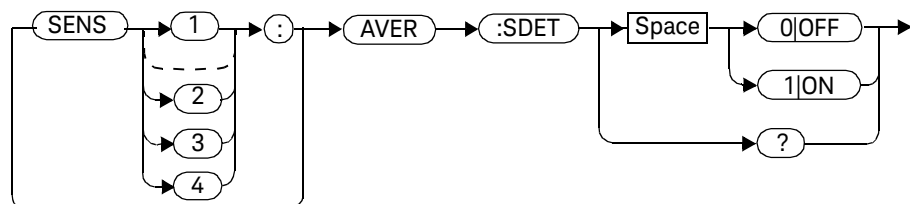

Example

```
SENS:AVER:SDET OFF
```

This command disables step detection.

Reset Condition

On reset, step detection is enabled.

Query

```
[SENSe[1]]|SENSe2|3|4:AVERage:SDETECT?
```

The query enters a 1 or 0 into the output buffer indicating the status of step detection.

- 1 is returned when step detection is enabled
- 0 is returned when step detection is disabled

Query Example

```
SENS:AVER:SDET?
```

This command queries whether step detection is on or off.

[SENSe[1]]|SENSe2|3|4:AVERage[:STATe] <boolean>

This command is used to enable and disable averaging.

Syntax

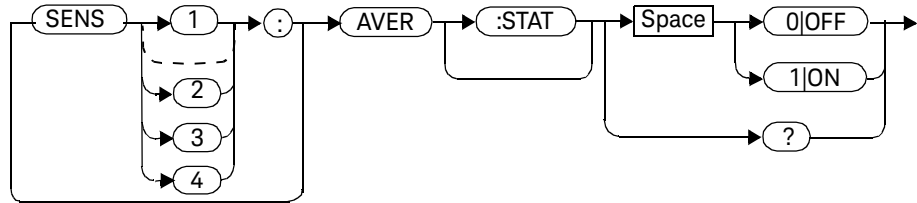

Example

AVER 1

This command enables averaging on Channel A.

Reset Condition

On reset, averaging is **ON**.

Query

[SENSe[1]]|SENSe2|3|4:AVERage[:STATe]?

The query enters a 1 or 0 into the output buffer indicating the status of averaging.

- 1 is returned when averaging is enabled
- 0 is returned when averaging is disabled

Query Example

`SENS2:AVER?`

This command queries whether averaging is on or off for Channel B.

Error Messages

If `[SENSe[1]]|SENSe2|3|4:AVERage:STATe` is set to **ON** while `[SENSe[1]]|SENSe2:SPEed` is set to 200, the error -221, "Settings Conflict" occurs.

[SENSe[1]]|SENSe2:BUFFer:COUNt <numeric_value>

This command sets the buffer size for average trigger measurement. It must be used in conjunction with external trigger.

It can only be set when frequency sweep is disabled (**FREQ:STEP 0**). Otherwise, this parameter will be automatically overwritten by frequency sweep step.

NOTE

This command is only applicable when used with 8480, N8480, E4410, or E9300 sensor (Average mode only).

Syntax

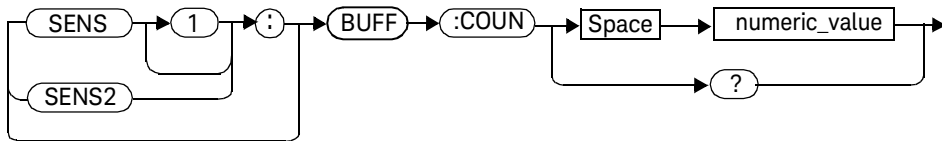

Parameters

Item	Description	Range of Values
numeric_value	A numeric value for buffer size.	1 to 2048

Example

BUFF:COUN 100

This command sets the average trigger measurement buffer size to 100 for Channel A.

Query

[SENSe[1]]|SENSe2:BUFFer:COUNT?

This query is used to retrieve the average trigger measurement buffer size.

Query Example

BUFF:COUNT?

This query returns the average trigger measurement buffer size for Channel A.

On Reset

On *RST, the value is set to 1.

Error Messages

- If no sensor or wrong sensor is connected to the channel, error –241, “Hardware missing” occurs.
- If E4410, N8480 (excluding Option CFT), E9300 or U2000 sensor is connected but acquisition mode is in free run, error –221, “Setting conflict. Invalid acquisition mode” occurs.
- If frequency sweep step is non-zero, error –221, “Settings conflict. Frequency sweep enabled. Buffer count overridden” occurs.
- If parameter is set lower than 1, error –222 “Data out of range; value clipped to lower limit” occurs.
- If parameter is set higher than 2048, error –222 “Data out of range; value clipped to upper limit” occurs.

[SENSe[1]]|SENSe2:CORRection Commands

These commands provide for changes to be applied to the measurement result. They are used to enter duty cycle values, calibration factors and other external gains and losses.

The following commands are detailed in this section:

```
[SENSe[1]]|SENSe2:CORRection:CFACTOR|GAIN[1][:INPut]
[:MAGNitude] <numeric_value>
[SENSe[1]]|SENSe2:CORRection:CSET[1]|CSET2
[:SElect] <string>
[SENSe[1]]|SENSe2:CORRection:CSET[1]|CSET2:STATe <boolean>
[SENSe[1]]|SENSe2:CORRection:DCYCLe|GAIN3[:INPut]
[:MAGNitude] <numeric_value>
[SENSe[1]]|SENSe2:CORRection:DCYCLe|GAIN3:STATe <boolean>
[SENSe[1]]|SENSe2:CORRection:FDOFfset|GAIN4[:INPut]
[:MAGNitude]?
[SENSe[1]]|SENSe2:CORRection:LOSS2[:INPut][:MAGNitude]
<numeric_value>
[SENSe[1]]|SENSe2:CORRection:LOSS2:STATe <boolean>
```

[SENSe[1]]|SENSe2:CORRection:CFACTOR|GAIN[1][[:INPut]][:MAGNitude] <numeric_value>

This command is used to enter a gain correction value for the calibration factor. The power meter corrects every measurement by this factor to compensate for the gain.

Either **CFACTOR** and **GAIN1** can be used in the command—both have an identical result. Using **GAIN1** complies with the SCPI standard, whereas **CFACTOR** does not—this may make your program easier to understand.

Syntax

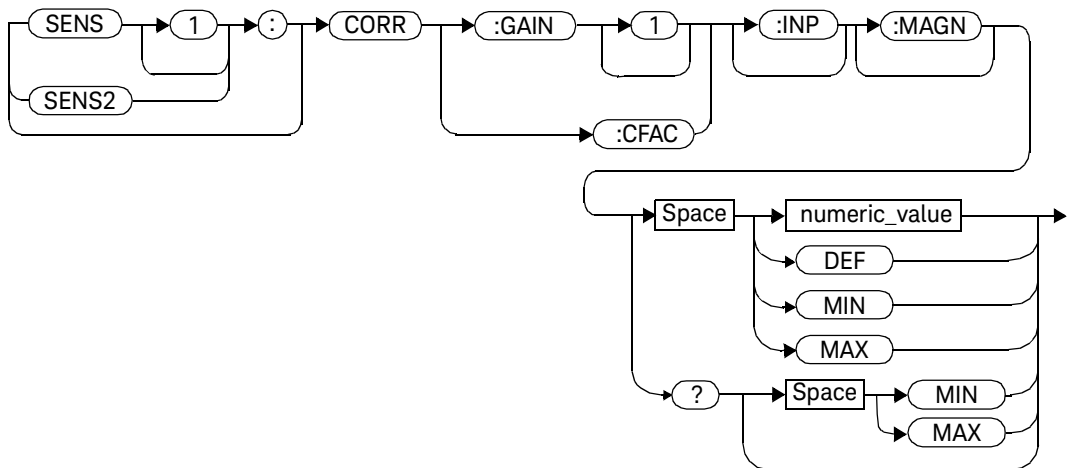

Parameters

Item	Description/Default	Range of Values
numeric_value (for CFACTOR and GAIN1)	A numeric value. – DEF : the default value is 100 % – MIN : 1 % – MAX : 150 %	1 to 150 PCT ^[a] DEF MIN MAX

[a] For example, a gain of 60 % corresponds to a multiplier of 0.6 and a gain of 150 % corresponds to a multiplier of 1.5.

Example

SENS2:CORR:GAIN1

This command sets a gain correction of 100% for Channel B.

Reset Condition

On reset, **CFACTOR|GAIN1** is set to 100 %.

Query

**[SENSe[1]]|SENSe2:CORRection:CFACTOR|GAIN[1][:INPut]
[:MAGNitude]? [MIN|MAX]**

The query returns the current gain correction setting or the values associated with **MIN** and **MAX**.

Query Example

CORR:GAIN1?

This command queries the current calibration factor setting for Channel A.

Error Messages

The **SENSe[1]]|SENSe2:CORRection:CFACTOR|GAIN1** command can be used for the 8480 Series power sensors and N8480 Series power sensor with Option CFT when no sensor calibration table has been set up. If a sensor calibration table is selected the error -221, "Settings Conflict" occurs.

[SENSe[1]]|SENSe2:CORRection:CSET[1]Commands

These commands are used to select the active sensor calibration table.

NOTE

If any of the CSET1 commands are used when a N8480 Series (excluding Option CFT) or E-Series power sensor is connected, the error -241, “Hardware missing” occurs.

The following commands are detailed in this section:

```
[SENSe[1]]|SENSe2:CORRection:CSET[1][:SElect] <string>  
[SENSe[1]]|SENSe2:CORRection:CSET[1]:STATE <boolean>
```

[SENSe[1]]|SENSe2|3|4:CORRection:CSET2 Commands

These commands are used to select the active frequency dependent offset table.

The following commands are detailed in this section:

```
[SENSe[1]]|SENSe2|3|4:CORRection:CSET2[:SElect] <string>
```

```
[SENSe[1]]|SENSe2|3|4:CORRection:CSET2:STATE <boolean>
```

[SENSE[1]]|SENSE2:CORRection:CSET[1][:SElect] <string>

This command enters the name of the sensor calibration table which is to be used. The calibration factor is interpolated from the table using the setting for [SENSE[1]]|SENSE2:FREQUENCY.

NOTE

If [SENSE[1]]|SENSE2:CORRection:CSET[1]:STATE is set to OFF, the selected sensor calibration table is not being used.

Syntax

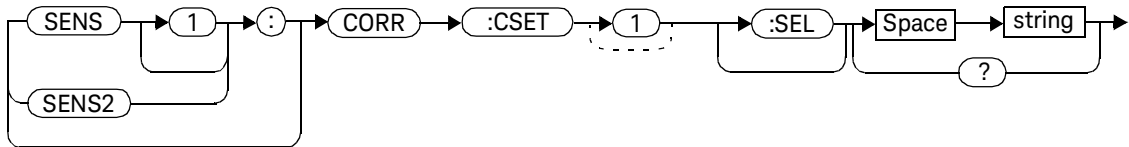

Parameters

Item	Description/Default	Range of Values
string	String data representing a sensor calibration table, or frequency dependent offset table name.	Any existing table name (Existing table names can be listed using MEMORY:CATalog:TABLE?).

Example

CORR:CSET1 'PW1'

This command enters the name of the sensor calibration table which is to be used on Channel A.

Reset Condition

On reset the selected table is not affected.

Query

`[SENSe[1]]|SENSe2:CORRection:CSET[1]:[SElect]?`

The name of the selected table is returned as a quoted string. If no table is selected an empty string is returned.

Query Example

`CORR:CSET1?`

This command queries the sensor calibration table currently used for Channel A.

Error Messages

- If `<string>` is not valid, error -224, “Illegal parameter value” occurs.
- If a table called `<string>` does not exist, error -256, “File name not found” occurs.
- When a sensor calibration table is selected, the power meter verifies that the number of calibration points defined is one more than the number of frequency points defined. When a frequency dependent offset table is selected, the power meter verifies that the number of offset points defined is equal to the number of frequency points defined. If this is not the case, error -226, “Lists not the same length” occurs.
- If the `CSET1` command is used when an E-Series power sensor or N8480 Series power sensor (excluding Option CFT) is connected the error -241, “Hardware missing” occurs.

[SENSe[1]]|SENSe2|3|4:CORRection:CSET2[:SElect] <string>

This command enters the name of the frequency dependent offset table which is to be used.

NOTE

If [SENSe[1]]|SENSe2|3|4:CORRection:CSET2:STATe is set to OFF, the selected sensor calibration table is not being used.

Syntax

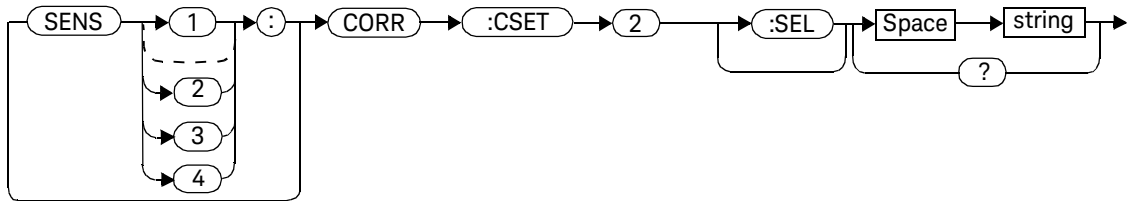

Parameters

Item	Description/Default	Range of Values
string	String data representing a sensor calibration table, or frequency dependent offset table name.	Any existing table name (Existing table names can be listed using MEMory:CATaLog:TABLE?).

Example

CORR:CSET2 'PW1'

This command enters the name of the frequency dependent offset table which is to be used on Channel A.

Reset Condition

On reset the selected table is not affected.

Query

SENSe[1]]|SENSe2|3|4:CORRection:CSET2[SELEct]?

The name of the selected table is returned as a quoted string. If no table is selected an empty string is returned.

Query Example

CORR:CSET2?

This command queries the frequency dependent offset table currently used for Channel A.

Error Messages

- If **<string>** is not valid, error -224, “Illegal parameter value” occurs.
- If a table called **<string>** does not exist, error -256, “File name not found” occurs.
- When a sensor calibration table is selected, the power meter verifies that the number of calibration points defined is one more than the number of frequency points defined. When a frequency dependent offset table is selected, the power meter verifies that the number of offset points defined is equal to the number of frequency points defined. If this is not the case, error -226, “Lists not the same length” occurs.
- If the **CSET1** command is used when an E-Series power sensor is connected the error -241, “Hardware missing” occurs.

[SENSe[1]]|SENSe2:CORRection:CSET[1]:STATe <boolean>

This command is to enable and disable the use of the currently active sensor calibration table . When a table has been selected and enabled, the calibration factors stored in it can be used by specifying the required frequency using the [SENSe[1]]|SENSe2:FREQUency command.

When the CSET1 command is set to ON, the reference calibration factor is taken from the sensor calibration table and is used during calibration.

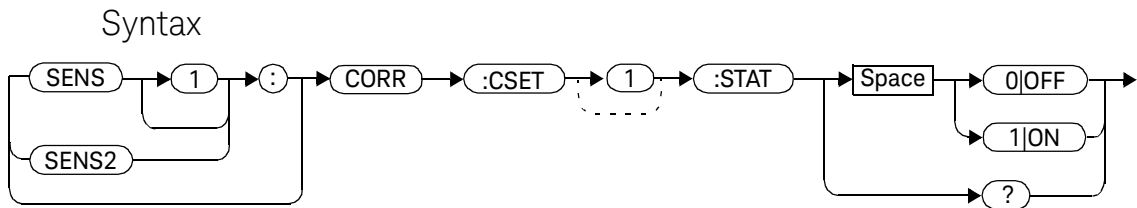

Example

CORR:CSET1:STAT 1

This command enables the use of the currently active sensor calibration table for Channel A.

Reset Condition

On reset, the sensor calibration table are not affected.

Query

[SENSe[1]]|SENSe2:CORRection:CSET[1]:STATe?

The query returns a 1 or 0 into the output buffer indicating whether a table is enabled or disabled.

- 1 is returned when the table is enabled
- 0 is returned when the table is disabled

Query Example

SENS2:CORR:CSET1:STAT?

This command queries whether there is currently an active sensor calibration table for Channel B.

Error Messages

- If you attempt to set this command to **ON** and no table has been selected using **[SENSe[1]]|SENSe2:CORRection:CSET[1]:[SELection]** then error -221, "Settings conflict" occurs and **[SENSe[1]]|SENSe2:CORRection:CSET[1]:STATe** remains **OFF**.
- If the **CSET1** command is used when a N8480 Series (excluding Option CFT) or an E-Series power sensor is connected, the error -241 "Hardware missing" occurs.

[SENSe[1]]|SENSe2|3|4:CORRection:CSET2:STATe <boolean>

This command is to enable and disable the use of the currently active frequency dependent offset table . When a table has been selected and enabled, the offsets stored in it can be used by specifying the required frequency using the [SENSe[1]]|SENSe2:FREQuency command.

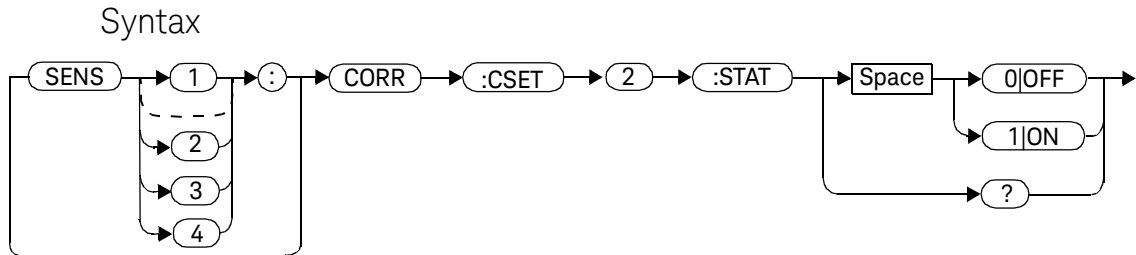

Example

CORR:CSET2:STAT 1

This command enables the use of the currently active frequency dependent offset table for Channel A.

Reset Condition

On reset, the frequency dependent offset table is not affected.

Query

[SENSe[1]]|SENSe2|3|4:CORRection:CSET2:STATe?

The query returns a 1 or 0 into the output buffer indicating whether a table is enabled or disabled.

- 1 is returned when the table is enabled
- 0 is returned when the table is disabled

Query Example

SENS2:CORR:CSET2:STAT?

This command queries whether there is currently an active sensor calibration table for Channel B.

Error Messages

- If you attempt to set this command to **ON** and no table has been selected using **[SENSe[1]]|SENSe2|3|4:CORRection:CSET2:[SElect]** then error -221, "Settings conflict" occurs and **[SENSe[1]]|SENSe2|3|4:CORRection:CSET2:STATe** remains **OFF**.
- If the **CSET1** command is used when a N8480 Series (excluding Option CFT) or an E-Series power sensor is connected, the error -241 "Hardware missing" occurs.

[SENSe[1]]|SENSe2|3|4:CORRection:DCYCLe|GAIN3 Commands

These commands control the pulse power measurement feature of the power meter.

The following commands are detailed in this section:

```
[SENSe[1]]|SENSe2|3|4:CORRection:DCYCLe|GAIN3[:INPut]
[:MAGNitude] <numeric_value>
[SENSe[1]]|SENSe2|3|4:CORRection:DCYCLe|GAIN3:STATe <boolean>
```

NOTE

You can use either DCYCLe or GAIN3 in these commands, both do the same. Using GAIN3 complies with the SCPI standard whereas DCYCLe does not, but may make your program more understandable.

```
[SENSe[1]]|SENSe2|3|4:CORRection:DCYClE|GAIN3[:INPut]
[:MAGNitude] <numeric_value>
```

This command is used to set the duty cycle for the pulse power measurement feature of the power meter. Pulse power measurements average out any deviations in the pulse, such as, overshoot or ringing. The result returned for a pulse power measurement is a mathematical representation of the pulse power rather than an actual measurement. The power meter measures the average power in the pulsed input signal and then divides the result by the duty cycle value to obtain a pulse power reading.

Entering a value using this command automatically turns the `SENSe[1]|2|3|4:CORRection:DCYClE|GAIN3:STATe` command to **ON**.

NOTE

Pulse measurements are not recommended using E-Series power sensors at power levels above -20 dBm.

Pulse power averages out any deviations in the pulse such as overshoot or ringing. Hence, it is called pulse power and not peak power or peak pulse power.

In order to ensure accurate pulse power readings, the input signal must be pulsed with a rectangular pulse. Other pulse shapes (such as triangle, chirp or Gaussian) cause incorrect results.

The pulse power on/off ratio must be much greater than the duty cycle ratio.

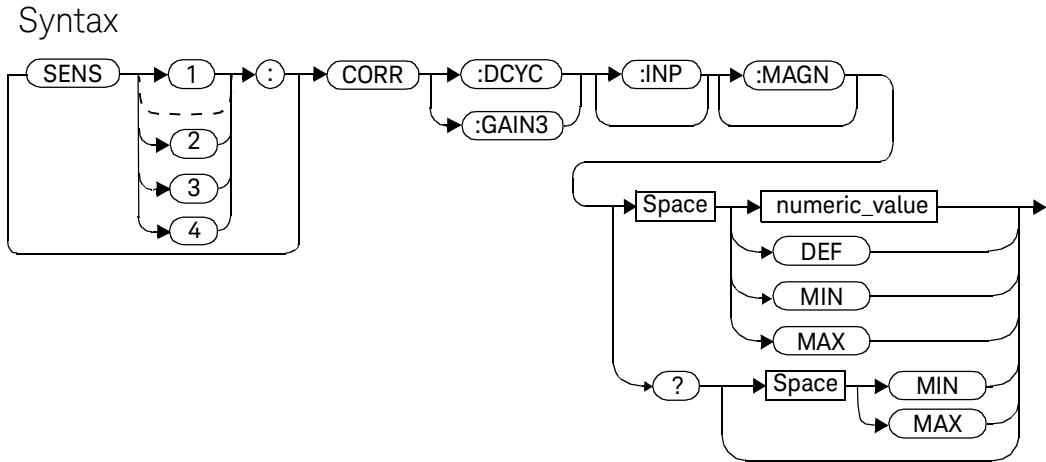

Parameters

Item	Description/Default	Range of Values
numeric_value	A numeric value for the duty cycle. - DEF : the default value is 1 % - MIN : 0.001 % - MAX : 99.999 % The units are PCT, and are optional.	0.001 to 99.999 PCT DEF MIN MAX

Example

CORR:DCYC 90PCT

This command sets a duty cycle of 90 % for Channel A.

Reset Condition

On reset, the duty cycle is set to 1 % (**DEF**).

Query

```
[SENSe[1]]|SENSe2|3|4:CORRection:DCYClE|GAIN3[:INPut]
[:MAGNitude]? [MIN|MAX]
```

The query returns the current setting of the duty cycle or the values associated with **MIN** and **MAX**.

Query Example

```
CORR:GAIN3?
```

This command queries the current setting of the duty cycle for Channel A.

Error Messages

- If a duty cycle value is entered using `[SENSe[1]]|SENSe2|3|4:CORRection:DCYClE|GAIN3` while `[SENSe[1]]|SENSe2:SPeEd` is set to 200, the error -221, "Settings Conflict" occurs. However, the duty cycle value is set but the `[SENSe[1]]|SENSe2|3|4:CORRection:DCYClE|GAIN3:STATe` command is not automatically set **ON**.
- If this command is used when an E4412A/E4413A power sensor is connected, the error -310, "System error;Dty Cyc may impair accuracy with ECP sensor" occurs. If you are using a dual channel power meter the error message specifies the channel.

[SENSe[1]]|SENSe2|3|4:CORRection:DCYClE|GAIN3:STATe
<boolean>

This command is used to enable and disable the pulse power measurement feature.

The [SENSe[1]]|SENSe2|3|4:CORRection:DCYClE|GAIN3 command should be used to enter the duty cycle of the signal you want to measure.

Syntax

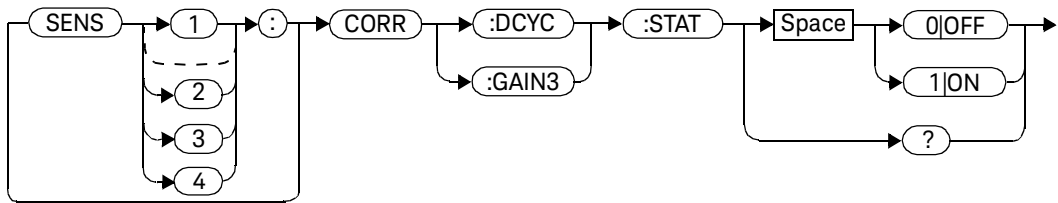

Example

CORR:DCYC:STAT 1

This command enables the pulse measurement feature on Channel A.

Reset Condition

On reset, the pulse power measurement feature is disabled.

Query

[SENSe[1]]|SENSe2|3|4:CORRection:DCYClE|GAIN3:STATe?

The query enters a 1 or 0 into the output buffer indicating the status of the pulse power measurement feature.

- 1 is returned when the pulse power measurement feature is enabled
- 0 is returned when the pulse power measurement feature is disabled

Query Example

CORR:GAIN3:STAT?

This command queries whether the pulse measurement feature is on or off.

Error Messages

- If [SENSe[1]]|SENSe2|3|4:CORRection:DCYClE:STATus is set to **ON** while [SENSe[1]]|SENSe2:SPEEd is set to 200, the error -221, "Settings Conflict" occurs.
- If this command is used when an E4412A/E4413A power sensor is connected, the error -310, "System error;Dty Cyc may impair accuracy with ECP sensor" occurs. If you are using a dual channel power meter the error message specifies the channel.

[SENSe[1]]|SENSe2|3|4:CORRection:FDOFfset[GAIN4[:INPut]][:MAGNitude]?

This command is used to return the presently applied frequency dependent offset correction.

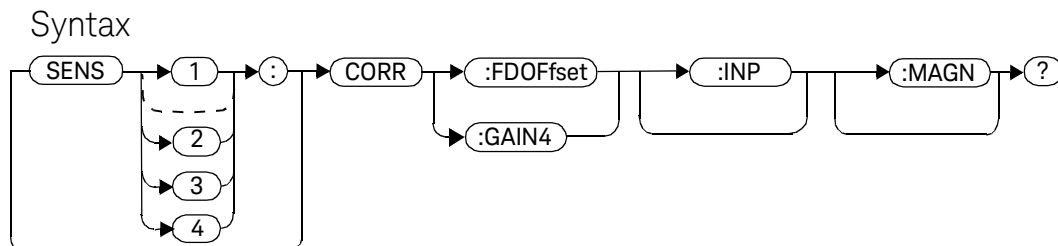

Example

CORR:GAIN4?

This command queries the current frequency dependent offset being applied to Channel A.

Reset Condition

On reset, the frequency dependent offset is not affected.

[SENSe[1]]|SENSe2:CORRection:FDOFFset:UNIT <character_data>

This command allows command and query access to the Frequency Dependency Offset (FDO) unit.

Syntax

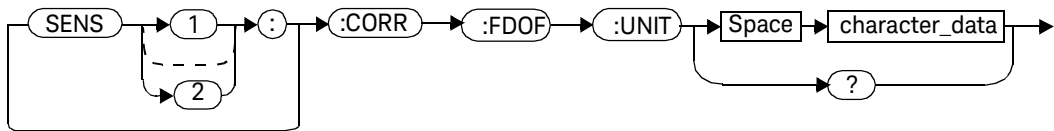

Parameter

Item	Description/Default	Range of Values
character_data	Sets the unit to percent (%)	PCT
	Sets the unit to dB	DB

Example

<code>SENSE:CORR:FDOF:UNIT PCT</code>	<i>This command sets the unit to percent (%).</i>
<code>SENSE:CORR:FDOF:UNIT DB</code>	<i>This command sets the unit to dB.</i>
<code>SENSE:CORR:FDOF:UNIT?</code>	<i>This command returns the current unit (PCT/DB).</i>

Error Messages

If no sensor or wrong sensor is connected to the channel, error -241 "Hardware missing" occurs.

[SENSe[1]]|SENSe2|3|4:CORRection:GAIN2 Commands

These commands provide a simple correction to a measurement for an external gain/loss.

The following commands are detailed in this section:

```
[SENSe[1]]|SENSe2|3|4:CORRection:GAIN2:STATe <boolean>
```

```
[SENSe[1]]|SENSe2|3|4:CORRection:GAIN2[:INPut][:MAGNitude]  
<numeric_value>
```

[SENSe[1]]|SENSe2|3|4:CORRection:GAIN2:STATe <boolean>

This command is used to enable/disable a channel offset for the power meter setup. The [SENSe[1]]|SENSe2|3|4:CORRection:GAIN2[:INPut] [:MAGNitude] command is used to enter the loss/gain value.

Syntax

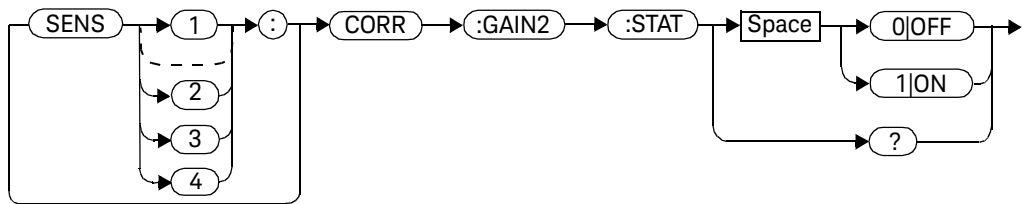

Example

CORR:GAIN2:STAT ON

This command enables a channel offset on Channel A.

Reset Condition

On reset, channel offsets are disabled.

Query

`[SENSe[1]]|SENSe2|3|4:CORRection:GAIN2:STATe?`

The query enters 1 or 0 into the output buffer indicating the status of the channel offsets.

- 1 is returned if a channel offset is enabled
- 0 is returned if a channel offset is disabled

Query Example

`CORR:GAIN2:STAT?`

This command queries whether or not there is a channel offset applied to Channel A.

Error Messages

If `[SENSe[1]]|SENSe2|3|4:CORRection:GAIN2:STATe` is set to **ON** while `[SENSe[1]]|SENSe2:SPEEd` is set to 200, the error -221, "Settings Conflict" occurs.

[SENSe[1]]|SENSe2|3|4:CORRection:GAIN2[:INPut][:MAGNitude]
 <numeric_value>

This command is used to enter a channel offset value for the power meter setup, for example cable loss. The power meter then corrects every measurement by this factor to compensate for the gain/loss.

Entering a value for **GAIN2** using this command automatically turns the [SENSe[1]]|SENSe2|3|4:CORRection:GAIN2:STATe command to **ON**.

Syntax

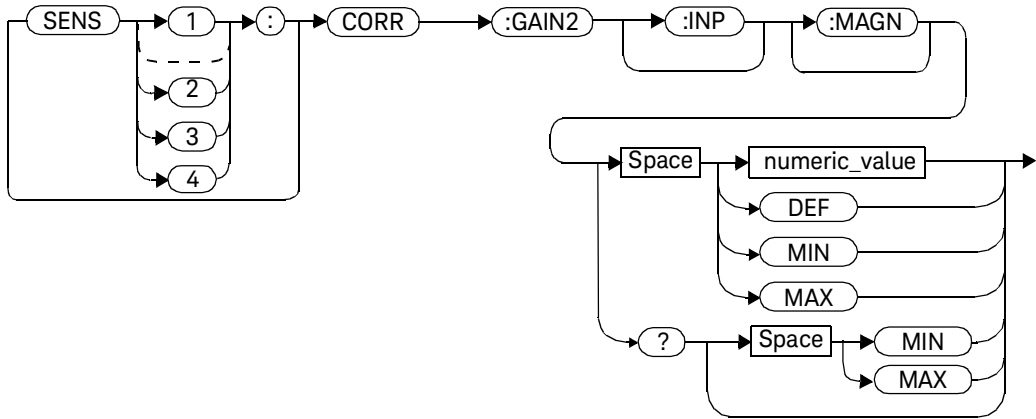

Parameters

Item	Description/Default	Range of Values
numeric_value	A numeric value: - DEF : the default is 0.00 dB - MIN : -100 dB - MAX : +100 dB	-100 to +100 dB DEF MIN MAX

Example

CORR:GAIN2 50

This command sets a channel offset of 50 dB for Channel A.

Reset Condition

On reset, **GAIN2** is set to 0.00 dB.

Query

[SENSe[1]]|SENSe2|3|4:CORRection:GAIN2[:INPut][:MAGNitude]? [MIN|MAX]

The query returns the current setting of the channel offset or the values associated with **MIN** and **MAX**.

Query Example

CORR:GAIN2?

This command queries the current setting of the channel offset on Channel A.

Error Messages

- If a loss/gain correction value is entered using **[SENSe[1]]|SENSe2|3|4:CORRection:GAIN2[:INPut][:MAGNitude]** while **[SENSe[1]]|SENSe2:SPEed** is set to 200, the error –221, “Settings Conflict” occurs. However, the correction value is set but the **[SENSe[1]]|SENSe2:CORRection:GAIN2:STATE** command is not automatically set **ON**.
- The **[SENSe[1]]|SENSe2|3|4:CORRection:GAIN2[:INPut][:MAGNitude]** command can be used for the 8480 Series power sensor when no sensor calibration table has been set up.

SENSE|3|4:DETECTOR:FUNCTION <character_data>

This command sets the measurement mode for the sensor to average mode.

Syntax

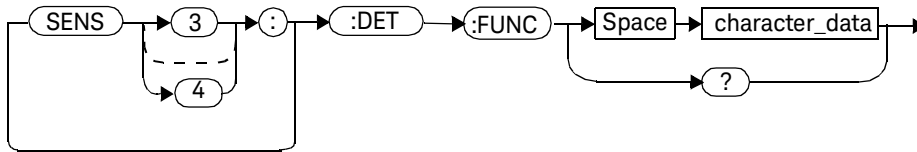

Parameter

Item	Description/Default	Range of Values
character_data	Sets the mode to Average	AVERage

Example

```
SENS3:DET:FUNC AVER
```

This command sets the sensor to average mode for Channel C.

Reset Condition

On reset, the mode is set to AVERage.

Query

```
SENSe3|4:DETECTOR:FUNCTION?
```

The query returns the current sensor mode setting.

Query Example

```
SENS4:DET:FUNC?
```

This query command returns the current sensor mode setting for Channel D.

Error Messages

- If the set command is used when no sensor connected on channel, an error -241, "Hardware missing" occurs.
- If the set command is used with the channel that is not set to normal speed mode, an error -221, "Settings conflict" occurs.

[SENSe[1]]|SENSe2|3|4:FREQuency[:CW]:FIXed] <numeric_value>

This command is used to enter a frequency. If the frequency does not correspond directly to a frequency in the sensor calibration table, the power meter calculates the calibration factor using linear interpolation.

For 8480 Series power sensors and N8480 Series power sensors with Option CFT, the power meter uses linear interpolation to calculate the calibration factor for the frequency entered if [SENSe[1]]|SENSe2:CORRection:CSEt:STATe is ON.

For E-Series power sensors and N8480 Series power sensors (excluding Option CFT), the appropriate corrections are applied for the frequency selected, dependent on the calibration data stored in the sensor's EEPROM.

Syntax

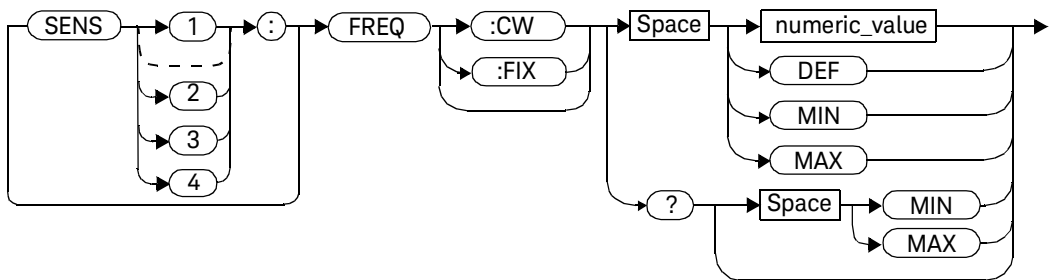

Parameters

Item	Description/Default	Range of Values
numeric_value	A numeric value for the frequency: – DEF : the default value is 50 MHz – MIN : 0 Hz – MAX : 1000.0 GHz The default units are Hz. The frequency value will be resolved to the closest 1 kHz.	0 Hz to 1000.0 GHz ^[a] DEF MIN MAX

[a] The following measurement units can be used:

- Hz
- kHz (10^3)
- MHz (10^6)
- GHz (10^9)

Example

FREQ 500kHz *This command enters a Channel A frequency of 500 kHz.*

Reset Condition

On reset, the frequency is set to 50 MHz (**DEF**).

Query

[SENSe[1]]|SENSe2|3|4:FREQuency[:CW|:FIXed]? [MIN|MAX]

The query returns the current frequency setting or the values associated with **MIN** and **MAX**. The units in which the results are returned are Hz.

Query Example

SENS2:FREQ? *This command queries the Channel B frequency setting.*

[SENSe[1]]|SENSe2:FREQuency[:CW|:FIXed]:STARt
<numeric_value>

This command sets the start frequency of frequency sweep. It must be used in conjunction with external trigger.

If frequency sweep is disabled (frequency sweep step set to 0), start frequency will be set but will not take effect.

NOTE

This command is only applicable when used with E4410, N8480 (excluding Option CFT), E9300 or U2000 sensor (Average mode only).

NOTE

SENS:FREQ:STAR, SENS:FREQ:STOP and SENS:FREQ:STEP are allowed to be set in any desirable sequence.

When frequency sweep mode is configured with frequency step size within its allowable range, 1 to 2048, the following applies:

- If frequency stop point is greater than frequency start point, the frequency range will be swept in an ascending order.
 - If frequency stop point is less than frequency start point, the frequency range will be swept in a descending order.
 - If frequency stop point and frequency start point are equal, it is the same as power sweep mode.
-

Syntax

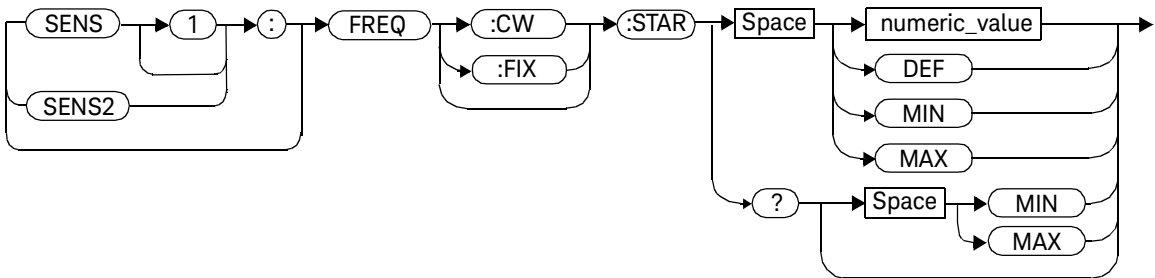

Parameters

Item	Description	Range of Values
numeric_value	A numeric value for the start frequency: - DEF : the default value is 50 MHz - MIN : 1 kHz - MAX : 1000.0 GHz The default units are Hz.	1 kHz to 1000.0 GHz ^[a] DEF MIN MAX

[a] The following measurement units can be used:

- Hz
- kHz (10³)
- MHz (10⁶)
- GHz (10⁹)

Example

FREQ:STAR 10MHz

This command sets frequency sweep to start at 10 MHz for Channel A.

Query

[SENSe[1]]|SENSe2:FREQuency[:CW|:FIXed]:STARt?

This query is used to retrieve start frequency of the average trigger frequency sweep. Frequency returned is in Hz.

Query Example

FREQ:STAR?

This query returns the start frequency of frequency sweep in Hz for Channel A.

On Reset

On *RST, the value is set to 50 MHz.

Error Messages

- If no sensor or wrong sensor is connected to the channel, error -241, "Hardware missing" occurs.
- If parameter set is lower than 1 kHz, error -222, "Data out of range; value clipped to lower limit" occurs.
- If parameter set is higher than 1000 GHz, error -222, "Data out of range; value clipped to upper limit" occurs.

[SENSe[1]]|SENSe2:FREQuency[:CW|:FIXEd]:STEP
<numeric_value>

This command sets the number of steps in frequency sweep. It must be used in conjunction with external trigger.

The frequency sweep range will be equally divided by the frequency step.

NOTE

Determine the Right Step to be Set

Number of frequency step can be calculated using equation below:

$$\text{Step} = (f_{\text{stop}} - f_{\text{start}} + \text{Interval})/\text{Interval}$$

where,

Step = Number of frequency step

f_{start} = Frequency sweep's start point

f_{stop} = Frequency sweep's stop point

Interval = Frequency step size

Example

When $f_{\text{start}} = 1$ GHz and $f_{\text{stop}} = 5$ GHz with given interval of 0.5 GHz, the Step should be set to

$$\text{Step} = (f_{\text{stop}} - f_{\text{start}} + \text{Interval})/\text{Interval}$$

$$= (5 \text{ GHz} - 1 \text{ GHz} + 0.5 \text{ GHz})/0.5 \text{ GHz}$$

$$= \underline{\underline{9}}$$

NOTE

This command is only applicable when used with E4410, N8480 (excluding Option CFT), E9300 or U2000 sensor (Average mode only).

NOTE

SENS:FREQ:STAR, SENS:FREQ:STOP and SENS:FREQ:STEP are allowed to be set in any desirable sequence.

Frequency step size calculated will be rounded to the nearest kHz with the minimum size of 1 kHz. When frequency range is less than frequency sweep step, the remaining steps will be repeated with the last frequency point.

Syntax

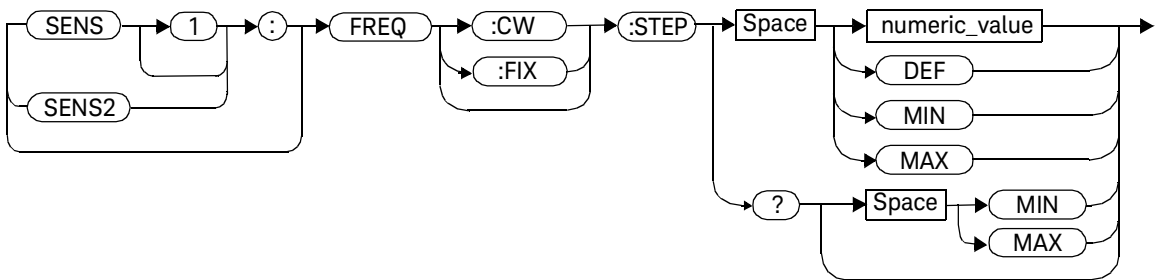

Parameters

Item	Description	Range of Values
numeric_value	A numeric value for number of step in the average trigger frequency sweep:	0 to 2048
	- DEF: the default value is 0	DEF
	- MIN: 0	MIN
	- MAX: 2048	MAX

Example

FREQ:STEP 10

This command sets frequency sweep with 10 steps for Channel A.

Query

[SENSe[1]] | SENSE2:FREQuency[:CW|:FIXed]:STEP?

This query is used to retrieve the number of steps in the average trigger frequency sweep.

Query Example

FREQ:STEP?

This query returns the number of steps in frequency sweep for Channel A.

On Reset

On *RST, the value is set to 0.

Error Messages

- If no sensor or wrong sensor is connected to the channel, error –241, “Hardware missing” occurs.
- If E4410, N8480 (excluding Option CFT), E9300 or U2000 sensor is connected but acquisition mode is in free run, error –221, “Setting conflict. Invalid acquisition mode” occurs.
- If parameter set is lower than 0, error –222, “Data out of range; value clipped to lower limit” occurs.
- If parameter set is higher than 2048, error –222, “Data out of range; value clipped to upper limit” occurs.

[SENSe[1]]|SENSe2:FREQuency[:CW|:FIXed]:STOP
 <numeric_value>

This command sets the stop frequency of frequency sweep. It must be used in conjunction with external trigger.

If frequency sweep is disabled (frequency sweep step set to 0), stop frequency will be set but will not take effect.

NOTE

This command is only applicable when used with E4410, N8480 (excluding Option CFT), E9300 or U2000 sensor (Average mode only).

NOTE

SENS:FREQ:STAR, SENS:FREQ:STOP and SENS:FREQ:STEP are allowed to be set in any desirable sequence.

When frequency sweep mode is configured with frequency step size within its allowable range, 1 to 2048, the following applies:

- If frequency stop point is greater than frequency start point, the frequency range will be sweep in an ascending order.
- If frequency stop point is less than frequency start point, the frequency range will be sweep in a descending order.
- If frequency stop point and frequency start point are equal, it is the same as power sweep mode.

Syntax

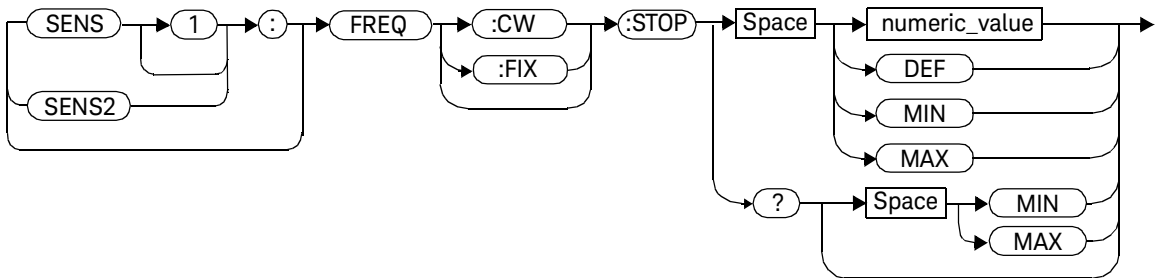

Parameters

Item	Description	Range of Values
numeric_value	A numeric value for stop frequency: – DEF : the default value is 50 MHz – MIN : 1 kHz – MAX : 1000.0 GHz The default units are Hz.	1 kHz to 1000.0 GHz ^[a] DEF MIN MAX

[a] The following measurement units can be used:

- Hz
- kHz (10^3)
- MHz (10^6)
- GHz (10^9)

Example

FREQ:STOP 10MHz

This command sets frequency sweep to stop at 10 MHz for Channel A.

Query

[SENSe[1]]|SENSe2:FREQuency[:CW|:FIXed]:STOP?

This query is used to retrieve stop frequency of the average trigger frequency sweep. Frequency returned is in Hz.

Query Example

FREQ:STOP?

This query returns the stop frequency of frequency sweep in Hz for Channel A.

On Reset

On *RST, the value is set to 50 MHz.

Error Messages

- If no sensor or wrong sensor is connected to the channel, error -241, "Hardware missing" occurs.
- If parameter set is lower than 1 kHz, error -222, "Data out of range; value clipped to lower limit" occurs.
- If parameter set is higher than 1000 GHz, error -222, "Data out of range; value clipped to upper limit" occurs.

[SENSe[1]]|SENSe2|3|4:MRATE <character_data>

This command sets the measurement speed on the selected channel.

When a channel is set to **FAST**, the following couplings occur:

Command	Status
[SENSe[1]] SENSe2 3 4:AVERAge:STATe	OFF ^[a]
[SENSe[1]] SENSe2 3 4:CORRection:DCYClE:STATe	OFF ^[a]
[SENSe[1]] SENSe2 3 4:CORRection:GAIN2:STATe	OFF ^[a]
CALCuLate[1 2 3 4]:GAIN:STATe	OFF ^[b]
CALCuLate[1 2 3 4]:RELative:STATe	OFF ^[b]
CALCuLate1 3:MATH:EXPRession	“(SENSe1)”
CALCuLate2 4:MATH:EXPRession	“(SENSe2)” ^[c]

[a] This change only occurs on the channel specified in the **SENSe:MRATE** command. When the specified channel is changed from **FAST** to **NORMa1** or **DOUB1e**, the settings that were in place when **FAST** was entered are restored.

[b] This change occurs when either channel is set to **FAST**. When both channels are changed from **FAST** to **NORMa1** or **DOUB1e**, the settings that were in place when **FAST** was entered are restored.

[c] Applicable to the N1914A dual channel power meter only.

Syntax

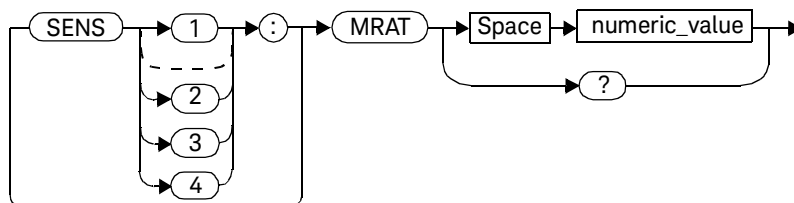

Parameters

Item	Description/Default	Range of Values
character_data	A numeric value for the measurement speed: – NORMa1 : 20 readings/second – DOUBLe : 40 readings/second – FAST ^[b] : 200 readings/second The default is NORMa1 .	NORMa1 ^[a] DOUBLe ^[a] FAST

[a] When a channel is set to **NORMa1** or **DOUBLe**, **TRIG:COUNT** is set automatically to 1.

[b] Although the **FAST** speed is 200 readings/second, the performance **FAST** speed is actually 400 readings/second. This is to ease the existing users so that they do not have to amend their codes. When using with U2000 Series power sensors, the **FAST** speed will be set to 110 readings/second.

Example

```
MRAT DOUBLe
```

This command sets the Channel A speed to 40 readings/second.

Reset Condition

On reset, the speed is set to **NORMa1**.

Query

[SENSe[1]]|SENSe2|3|4:MRAT?

The query returns the current speed setting, either **NORMa1**, **DOUBle** or **FAST**.

Query Example

MRAT?

This command queries the current speed setting for Channel A.

Error Messages

- If **<character_data>** is not set to **NORMa1**, **DOUBle** or **FAST**, error -224 “Illegal parameter value” occurs.
- If an E-Series power sensor is not connected and **<character_data>** is set to **FAST**, error -241 “Hardware missing” occurs.

[SENSe[1]]|SENSe2|3|4:POWer:AC:RANGe <numeric_value>

This command is only valid when used with an E-Series power sensors and N8480 Series power sensors (excluding Option CFT) to select one of two power ranges.

- If 0 is selected, the power sensor's lower range is selected
- If 1 is selected, the power sensor's upper range is selected

Setting a range with this command automatically switches [SENSe[1]]|SENSe2|3|4:POWer:AC:RANGe:AUTO to OFF.

Syntax

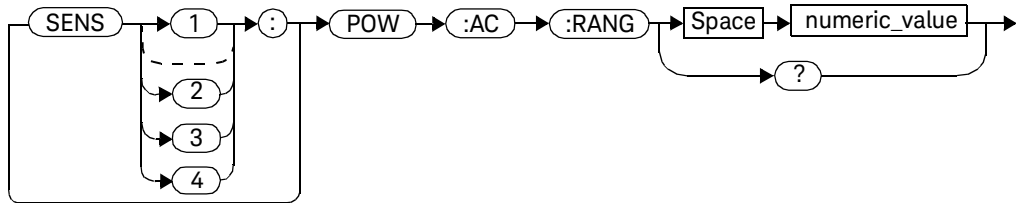

Example

`POW:AC:RANG 0`

This command sets the power sensor to its lower range.

Reset Condition

On reset, the upper range is selected.

Query

[SENSe[1]]|SENSe2|3|4:POWer:AC:RANGe?

The query enters a 1 or 0 into the output buffer indicating the status of the power sensor's range.

- 1 is returned when the upper range is selected
- 0 is returned when the lower range is selected

Query Example

POW:AC:RANG?

This command queries the current setting of the power sensor range.

Error Messages

This command is used with the E-Series power sensors and N8480 Series power sensors (excluding Option CFT). If one is not connected the error -241, "Hardware missing" occurs.

[SENSe[1]]|SENSe2|3|4:POWer:AC:RANGe:AUTO <boolean>

This command is only valid when used with an E-Series power sensor or N8480 Series power sensor (excluding Option CFT). Its purpose is to enable and disable autoranging. When autoranging is **ON**, the power meter selects the best measuring range for the measurement. When autoranging is set to **OFF**, the power meter remains in the currently set range.

The [SENSe[1]]|SENSe2|3|4:POWer:AC:RANGe command disables autoranging.

If **INITiate:CONTinuous** is set to **ON** and **TRIGger:SOURce** is set to **IMMediate**, the range tracks the input power if

[SENSe[1]]|SENSe2|3|4:POWer:AC:RANGe:AUTO is **ON**.

If the power meter is not making measurements then autoranging only occurs when the power meter is triggered.

Syntax

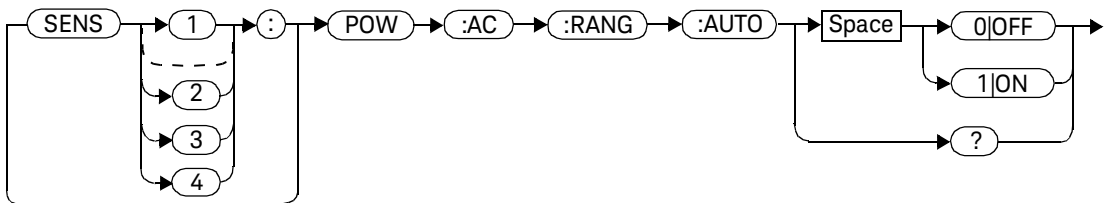

Example

POW:AC:RANG:AUTO 0

This command disables autoranging.

Reset Condition

On reset, autoranging is enabled.

Query

```
[SENSe[1]]|SENSe2|3|4:POWer:AC:RANGe:AUTO?
```

The query enters a 1 or 0 into the output buffer indicating the status of autoranging.

- 1 is returned when autoranging is enabled
- 0 is returned when autoranging is disabled

Query Example

```
POW:AC:RANG:AUTO?
```

This command queries whether auto ranging is on or off.

Error Messages

- If this command is set to **OFF** when there is not an E-Series power sensor or N8480 Series power sensor (excluding Option CFT) connected, the error -241, “Hardware missing” occurs.

[SENSe[1]]|SENSe2|3|4:SPEEd <numeric_value>

NOTE

It is recommended to use the [SENSe[1]]|SENSe2|3|4:MRATe <character_data> command to set the measurement speed.

This command sets the measurement speed on the selected channel. The speed values available are 20, 40, and 220 readings/second. When a channel is set to 200 readings/second, the following couplings occur.

Command	Status
[SENSe[1]] SENSe2 3 4:AVERAge:STATe	OFF ^[a]
[SENSe[1]] SENSe2 3 4:CORRection:DCYClE:STATe	OFF ^[a]
[SENSe[1]] SENSe2 3 4:CORRection:GAIN2:STATe	OFF ^[a]
CALCulate[1] 2 3 4:GAIN:STATe	OFF ^[b]
CALCulate[1] 2 3 4:RELative:STATe	OFF ^[b]
CALCulate1:MATH:EXPRession	“(SENSe1)”
CALCulate2:MATH:EXPRession	“(SENSe2)”
CALCulate3:MATH:EXPRession	“(SENSe3)”
CALCulate4:MATH:EXPRession	“(SENSe4)”

[a] This change only occurs on the channel specified in the **SENSe: SPEEd** command. When the specified channel is changed from 200 readings/second to either 20 or 40 readings/second, the settings that were in place when 200 readings/second mode was entered are restored.

[b] This change occurs when either channel is set to 200 readings/second. When both channels are changed from 200 readings/second to either 20 or 40 readings/second, the settings that were in place when 200 readings/second mode was entered are restored.

Syntax

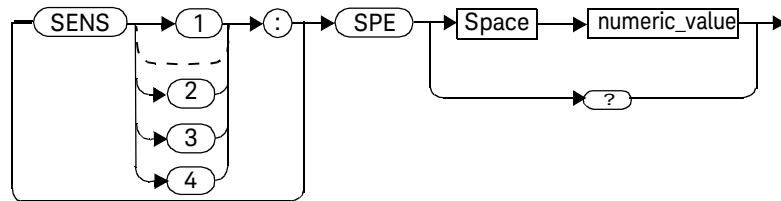

Parameters

Item	Description	Range of Values
numeric_value	A numeric value for the speed in readings/second. The default is 20 readings/second.	20 readings/second 40 readings/second 200 readings/second

Example

SPE 40

This command sets the the channel A speed to 40 readings/second.

Reset Condition

On reset, the speed is set to 20 readings/second.

Query

[SENSe[1]] | SENSe2:SPeed?

The query returns the current speed setting of either **20**, **40**, or **200**.

Query Example

SPE?

This command queries the current speed setting for channel A.

Error Messages

- If **<numeric_value>** is not set to **20**, **40**, or **200**, error -224, "Illegal parameter value" occurs.
- If an Keysight E-Series power sensor is not connected and the **<numeric_value>** is set to 200 readings/second, the error -241 "Hardware missing" occurs.

[SENSe[1]]|SENSe2:V2P ATYPe|DTYPe

This command is used to select the type of linearity correction that is applied to the channel sensors being used. For most 8480 Series sensors the correct (A type or D type) linearity correction table is automatically selected. However, for the V8486A, W8486A and E8486A (with option 100) sensors the automatic selection must be overridden and the D type (diode) correction selected.

NOTE

This command is only applicable for V8486A, W8486A and E8486A (with option 100) sensors.

Syntax

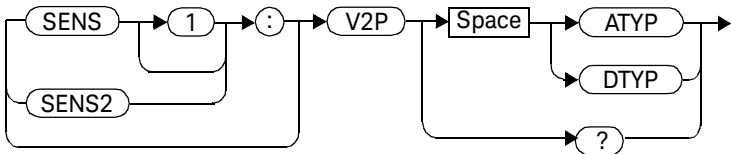

Example

`SENS2:V2P DTYP`

This command selects the D type linearity correction to be applied to Channel B.

Reset Condition

On reset, the linearity correction is set for A type.

Query

`[SENSe[1]]|SENSe2:V2P?`

The query returns the current type of linearity correction being displayed on the screen.

Query Example

`SENS:V2P?`

This command queries which linearity correction type is currently being displayed on the screen.

Error Messages

If no sensor is connected or the sensor is not an A type, the error –241, “Hardware missing” occurs.

SENSe3|4:SWEEp:APERture <numeric_value>

This command sets the aperture duration or measurement interval.

NOTE

Entering a value using this command automatically sets the SENSE3|4:SWEEp:APERture:AUTO to OFF.

Syntax

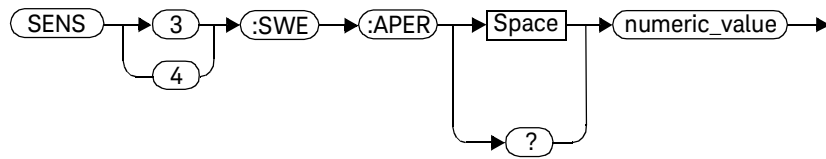

Parameters

Item	Description/Default	Range of Values
numeric_value	20E-6 ^[a] to 200E-3 s DEF MIN MAX	The aperture duration in seconds. – DEF : the default value is 50E-3 – MIN : 20E-6 ^[a] – MAX : 200E-3 Units are resolved to 100 ns.

[a] Only applicable for ≥ 300 MHz. For < 300 MHz, the minimum aperture size is 50 μ s. If the existing aperture size is set to < 50 μ s and the frequency is changed from ≥ 300 MHz to < 300 MHz, the aperture size will automatically be changed to 50 μ s.

Example

SENS3:SWE:APER 10E-3

This command sets the aperture duration to 10 ms.

Reset Condition

On reset, the aperture duration is set to 50 ms.

Query

SENSe3|4:SWEp:APERTure? [MIN|MAX]

The query returns the current aperture duration or the value associated with MIN and MAX.

Query Example

SENS3:SWE:APER? MIN

This command queries the current aperture duration or the value associated with MIN.

Error Messages

- If the limits of the values are exceeded, error -222, "Data out of range" occurs.
- If **SENS:SWE:APER** is set when **SENS:DET:FUNC** is set to **NORM** or when **SENS:MRAT** is not set to **NORM**, error -221, "Settings conflict" occurs.
- If **SENS:SWE:APER** is set to <50 μ s (for \geq 300 MHz) and the frequency is then changed to <300 MHz, the aperture duration will automatically be changed to 50 μ s with error -221, "Settings conflict;Aperture size too small. Changing to a minimum."

SENSe3|4:SWEep:APERture:AUTO <boolean>

This command enables and disables automatic selection of the aperture duration or measurement interval.

Setting this command to **ON** will automatically select the aperture duration corresponding to the current measurement rate.

Measurement rate	Aperture duration
NORMal: 20 readings/s	50 ms
DOUBle: 40 readings/s	25 ms
FAST: Up to 500 readings/s	2 ms

Syntax

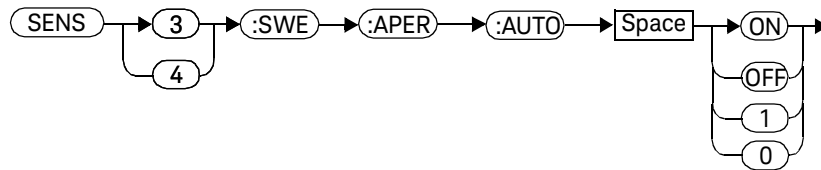

Example

SWE3:SWE:APER:AUTO OFF

Disables automatic selection of the aperture duration for Channel C.

Reset Condition

On reset, automatic selection of the aperture duration is enabled.

Query

SENSe3|4:SWEp:APERture:AUTO?

The query returns a 1 or 0 into the output buffer indicating whether automatic selection of the aperture duration is enabled or disabled.

- 1 is returned when automatic selection of the aperture duration is enabled.
- 0 is returned when automatic selection of the aperture duration is disabled.

Query Example

SENS3:SWE:APER:AUTO?

This command queries whether automatic selection of the aperture duration is enabled or disabled.

12 SERVICE Subsystem

SERVICE Subsystem	421
SERVICE:BACKlight:BRIGhtness <numeric_value>	424
SERVICE:BACKlight:MODE <numeric_value>	426
SERVICE:BATTery:CAPacity?	428
SERVICE:BATTery:CHARge?	429
SERVICE:BATTery:TEMPerature?	430
SERVICE:BATTery:TIME?	431
SERVICE:BIST:CALibrator <boolean>	432
SERVICE:BIST:CW[1]2:LINearity	433
SERVICE:BIST:CW[1]2:LINearity:CORRection	434
SERVICE:BIST:CW[1]2:LINearity:PERRor?	435
SERVICE:BIST:CW[1]2:ZSET	436
SERVICE:CALibrator:ADJ:COUR <numeric_value>	438
SERVICE:CALibrator:ADJ:FINE <numeric_value>	439
SERVICE:DISPlay:VGA <boolean>	440
SERVICE:DISPlay:BSCReen <boolean>	441
SERVICE:DISPlay:BSCReen:SECure:ACTivation <numeric_value>	442
SERVICE:DISPlay:BSCReen:SECure:DEACTivation <numeric_value>	443
SERVICE:FAN:FULL <boolean>	445
SERVICE:FAN:FULL?	446
SERVICE:LAN:PHOStname	447
SERVICE:OPTion?	448
SERVICE:SECure:ERASe	449
SERVICE:SENSe:CABLE:OPTion <numeric_value>	450
SERVICE:SENSor[1]2 3 4:CDATe?	452
SERVICE:SENSor[1]2 3 4:CPLace?	453
SERVICE:SENSor[1]2 3 4:FREQuency:MAXimum?	454
SERVICE:SENSor[1]2 3 4:FREQuency:MINimum?	455

SERVICE:SENSOR[1]|2|3|4:POWER:AVERage:MAXimum? 456
SERVICE:SENSOR[1]|2|3|4:POWER:USABLE:MAXimum? 457
SERVICE:SENSOR[1]|2|3|4:POWER:USABLE:MINimum? 458
SERVICE:SENSOR[1]|2|3|4:RADC? 459
SERVICE:SENSOR[1]|2|3|4:SNUMber? 460
SERVICE:SENSOR[1]|2|3|4:TNUMber? 461
SERVICE:SENSOR[1]|2|3|4:TYPE? 462
SERVICE:SENSOR3|4:FREvision? 463
SERVICE:SNUMber? 464
SERVICE:STATe <boolean> 465
SERVICE:VERSion:PROCCessor <character_data> 466
SERVICE:VERSion:SYSTem <character_data> 467

This chapter explains how the **SERVICE** command subsystem is used to obtain and set information useful for servicing the power meter.

SERvice Subsystem

The **SERvice** command subsystem is used to load information such as the power meter processor board revision version and obtain information such as the serial number of the current sensor(s) being used.

Keyword	Parameter Form	Notes	Page
SERvice			
:BACK			
:BRiGhtness	<numeric_value>		page 424
:MODE	<numeric_value>		page 426
:BATT			
:CAPacity?		[query only]	page 428
:CHARge?		[query only]	page 429
:TEMPerature			page 430
:TIME?		[query only]	page 431
:BIST			
:CALibrator	<boolean>		page 432
:CW[1] 2			
:LINearity		[No query]	page 433
CORRection		[No query]	page 434
:PERRor?		[query only]	page 435
:ZSET		[query only]	page 436
:CALibrator			
:ADJ			
:COUR	<numeric_value>		page 438
:FINE	<numeric_value>		page 439
:DISP			
:VGA ON OFF 0 1			page 440
:BSCreen		[No query]	page 441
:SECure			

Keyword	Parameter Form	Notes	Page
:ACTivation	<string>		page 442
:DEACTivation	<string>		page 443
<hr/>			
:LAN			
:PHOSName			page 447
:OPTion?		[query only]	page 448
:SECure			
:ERASe			page 449
:SENSe			
:CABLe			
:OPTion	<numeric_value>		page 450
:SENSor[1] 2			
:CALFactor	<cal_factor_data>		page 452
:SENSor[1] 2 3 4			
:CDATe?		[query only]	page 452
:CPLAcE?		[query only]	page 453
:FREQuency			
:MAXimum?		[query only]	page 454
:MINimum?		[query only]	page 455
:POWER			
:AVERAge			
:MAXimum?		[query only]	page 456
:USABLe			
:MAXimum?		[query only]	page 457
:MINimum?		[query only]	page 458
:RADc?		[query only]	page 459
:SNUMber?		[query only]	page 460
:TNUMber?		[query only]	page 461
:TYPE?		[query only]	page 462

Keyword	Parameter Form	Notes	Page
:SENSor3 4			
:FREvision?		[query only]	page 463
:SNUMber?		[query only]	page 464
:STATe	<boolean>		page 465
:VERSion			
:PROcEssor	<character_data>		page 466
:SYSTem	<character_data>		page 467

SERVICE:BACKlight:BRIGhtness <numeric_value>

This command sets the intensity of front panel's backlight.

Syntax

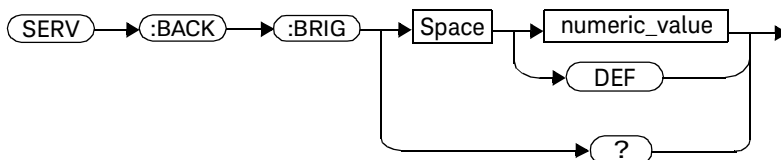

Parameters

Item	Description/Default	Range of Values
Numeric_value	Adjust the intensity level of the backlight. – DEF: the default value is 80	15 to 100

Example

SERV:BACK:BRIG 80

This command sets the intensity of front panel's backlight to 80.

Reset Condition

On reset, the intensity is set to 80 by default.

Query

SERV:BACK:BRIG?

The query returns the current intensity of the front panel's backlight.

Error Messages

- If backlight is not turned on, error -310 "System error" occurs.
- If out of input range, error -222 "Data out of range" error" occurs.

SERVICE:BACKlight:MODE <numeric_value>

This command sets the mode of front panel's backlight to ON, OFF or TIMED. When TIMED mode is selected, the backlight will turn off within 10 minutes after the last keypress. Press any keys on the front panel to turn the backlight on again.

Syntax

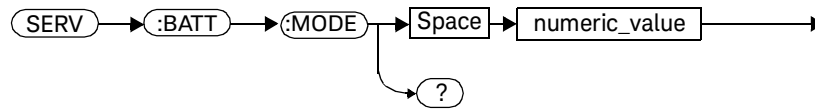

Parameters

Item	Description/Default	Range of Values
Numeric_value	Set the mode of the front panel's backlight. - 0 - Backlight ON - 1 - Backlight OFF - 2 - Backlight TIMED	0 to 2

Example

SERV:BACK:MODE 2

This command sets the mode of front panel's backlight to TIMED.

Reset Condition

On reset, the front panel's backlight mode is set to ON by default.

Query

SERV:BACK:MODE?

The query returns the current mode of the front panel's backlight.

Error Messages

- If no battery option is installed, error -310 "System error" occurs.
- If battery not in use or in charging mode, error -310 "System error" occurs.
- If out of input range, error -222 "Data out of range" error" occurs.

SERVICE:BATTERY:CAPACITY?

This query returns the remaining capacity of battery in milliampere-hour (mAh).

Syntax

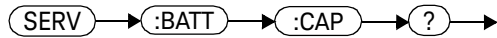

Example

SERV:BATT:CAP?

This command returns the capacity of the battery in mAh.

Error Messages

If no battery option installed, error -310 “System error” occurs.

SERvice:BATTery:CHARge?

This query returns the remaining charge of the battery in percentage (%).

Syntax

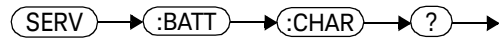

Example

SERV:BATT:CHAR?

This command returns the remaining charge of the battery in %.

Error Messages

If no battery option installed, error -310 "System error" occurs.

SERVICE:BATTERY:TEMPERATURE?

This query returns the current temperature of the battery in degree Celsius (°C).

Syntax

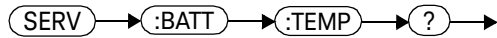

Example

SERV:BATT:TEMP?

This command returns the current temperature of the battery in °C.

Error Messages

If no battery option installed, error -310 “System error” occurs.

SERvice:BATTery:TIME?

This query returns the remaining time of the battery in minutes.

Syntax

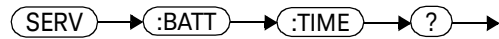

Example

SERV:BATT:TIME?

This command returns the remaining time of the battery in minutes.

Error Messages

If no battery option installed, error -310 "System error" occurs.

SERVICE:BIST:CALibrator <boolean>

This command enables/disables the calibrator self-test during power-up. It can be used to disable the self-test if it incorrectly indicates a failure. If a load, for example, a sensor, is connected to the calibrator port this could cause the self-test to fail. Also, if it fails the self-test, a Pop-up is displayed for 5 seconds, stating *-If Ref Calibrator test fails disconnect any load attached to it and re-try test.*

Syntax

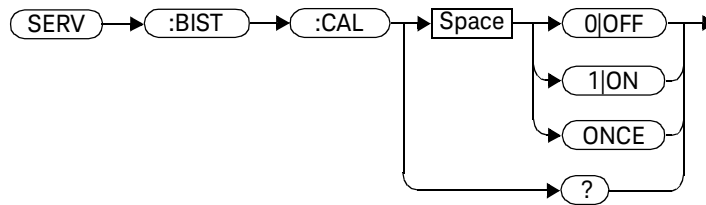

Example

SERV:BIST:CAL OFF

This command disables the calibrator self-test during power-up.

Query

SERVICE:BIST:CALibrator?

The query enters a 1 or 0 into the output buffer indicating the status of the self-test.

- 1 is returned when the self-test is enabled
- 0 is returned when the self-test is disabled

Query Example

SERV:BIST:CAL?

This command queries whether the self-test is enabled or disabled.

SERVice:BIST:CW[1]|2:LINearity

This command initiates the CW linearity test.

Syntax

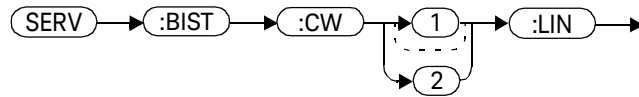

Example

`SERV:BIST:CW:LIN`

This command enables the CW linearity test.

SERVICE:BIST:CW[1]|2:LINEarity:CORRection

This command initiates the CW linearity test. The test includes the linearity correction for N8480 Series sensors at upper sensor range for all models. The correction factor will only be computed when no sensor is connected during the CW linearity test invoked by this SCPI.

Syntax

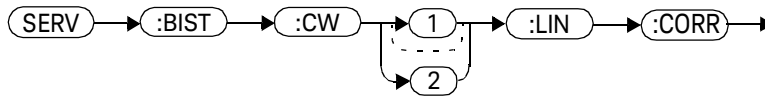

Example

SERV:BIST:CW:LIN:CORR

This command initiates CW linearity test including linearity correction at the upper range for N8480 Series sensors (no sensors should be connected).

SERvice:BIST:CW[1]|2:LINearity:PERRor?

This command returns the worst case error in the CW linearity test.

Syntax

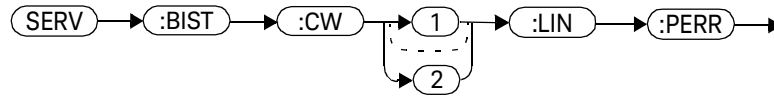

Example

SERV:BIST:CW:LIN:PERR?

This command queries the worst case error in the CW linearity test.

SERVice:BIST:CW[1]|2:ZSET

This command initiates the zero set and noise test for CW path for the specified channel.

Syntax

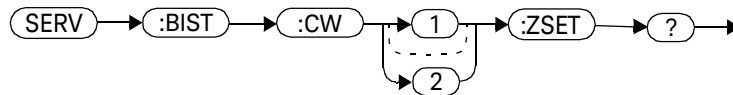

Example

SERV:BIST:CW:ZSET

This command triggers the zero set and noise test for channel A.

SERVice:BIST:CW[1]|2:ZSET:NUMber?

This command returns the worst case error in the CW Zero test invoked by "SERVice:BIST:CW[1 2]:ZSET"

Syntax

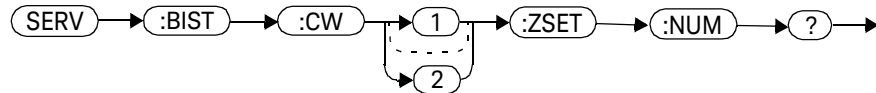

Example

SERV:BIST:CW:ZSET:NUM?

This command queries the worst case error in the CW zero test.

SERVICE:CALibrator:ADJ:COUR <numeric_value>

This command adjust the 1 mW calibrator output in coarse scale.

Syntax

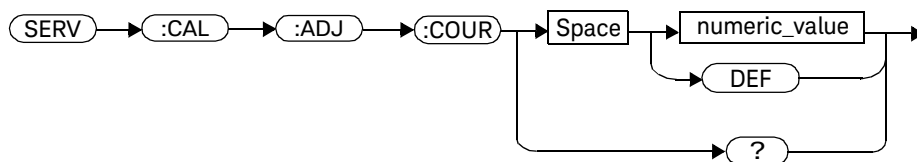

Parameters

Item	Description/Default	Range of Values
Numeric_value	Adjust the 1 mW Power Reference Level Increment Coarse by 1.	0 to 1023 (Unsigned Int 16)

Query

SERV:CAL:ADJ:COUR?

The query returns the Reference Calibrator power level in unsigned Int 16.

SERvice:CALibrator:ADJ:FINE <numeric_value>

This command adjust the 1 mW calibrator output in fine scale.

Syntax

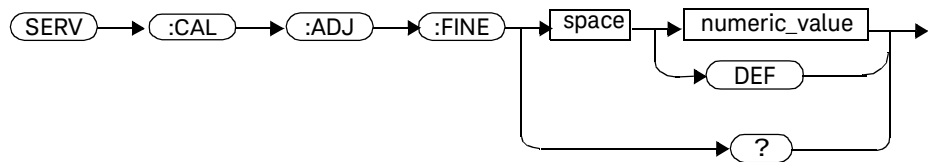

Parameters

Item	Description/Default	Range of Values
Numeric_value	Adjust the 1 mW Power Reference Level Increment Fine by 1.	0 to 1023 (Unsigned Int 16)

Query

SERV:CAL:ADJ:FINE?

The query returns the Reference Calibrator power level in unsigned Int 16.

SERVICE:DISPLAY:VGA <boolean>

This command enables or disables the state of VGA output.

Syntax

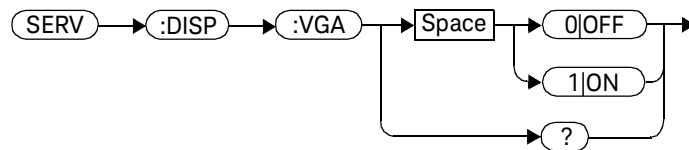

Example

SERV:DISP VGA 1

This command sets the VGA output state.

Remarks

This parameter is not affected by any reset operation and can only be changed by direct user access.

Query

SERV:DISP VGA?

The query returns the current setting of the VGA output state.

Error Messages

- If no VGA option installed, error -310, "System error" occurs.

SERVice:DISPlay:BSCReen <boolean>

This command enables or disables the Blank Screen feature of the front panel display.

Syntax

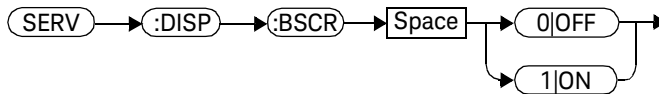

Example

SERV:DISP:BSCR ON|1

This command blanks the screen.

SERV:DISP:BSCR OFF|0

This command restores the screen.

Reset Condition

On reset, the Blank Screen feature is set to OFF by default.

SERVICE:DISPlay:BScreen:SECure:ACTivation <numeric_value>

This command activates the Secure Blank Screen feature using a 6-digit user-defined password.

Syntax

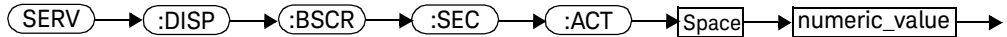

Parameter

Type	Description/Default	Range of Values
numeric_value	Numeric_value containing 6-digit password to activate Secure Blank Screen.	"000000" to "999999"

Example

```
SERV:DISP:BScreen:SEC:ACT "123456"
```

This command blanks the screen.

Remarks

Open quote "xxxxxx" is only applicable for remote operations.

Error Messages

- If Secure Blank Screen is already activated, error -221 "Settings conflict" occurs.
- If password is not 6 digits in length, error -222 "Data out of range; password is not 6 digits; please try again" occurs.

SERvice:DISPlay:BSCReen:SECure:DEACtivation <numeric_value>

This command deactivates the Secure Blank Screen with the 6-digit user-defined password that was used to activate Secure Blank Screen. The user is allowed three attempts to deactivate with the correct password; failing which the user will only be allowed to retry deactivation after two hours.

NOTE

The retry timer is a 2-hour duration with the power meter turned on. If the power meter is turned off at any time within this duration, the retry timer will be restarted.

Syntax

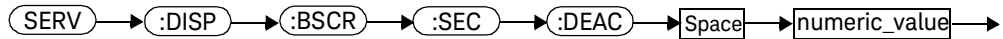

Parameter

Type	Description/Default	Range of Values
numeric_value	Numeric_value containing 6-digit password to deactivate the Secure Blank Screen.	"000000" to "999999"

Remarks

This parameter is only effective when the Secure Blank Screen is activated.

Example

**SERV:DISP:BSCR:SEC:DEAC
"123456"**

This command restores the screen if the correct 6-digit password has been entered.

Error Messages

- If Secure Blank Screen is not activated, error -221 "Settings conflict" occurs.
- If deactivation attempt password does not match activation password, error -120 "Numeric data error; password is incorrect; please try again" occurs.
- If number of attempts has been exceeded and retry timer has not expired, error -120 "Numeric data error; password is incorrect; please try again" occurs.

SERvice:FAN:FULL <boolean>

This command set the fan controller to run at full speed. At the first power-up, the default state is ON. If the user sets the state to OFF and power cycle, the state will be saved. On the next power cycle, the state will be set to OFF.

Syntax

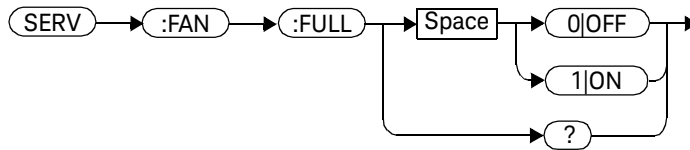

Parameter

Type	Description/Default	Range of Values
Boolean	0 OFF: Turns the fan controller off 1 ON: Turns the fan controller on	0 1 OFF ON

Example

```
SERV:FAN:FULL ON|1
```

This command sets the fan speed to full speed.

SERVICE:FAN:FULL?

This query returns the current setting of the fan speed.

Syntax

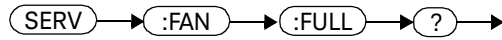

Example

SERV:FAN:FULL?

This command returns the current setting of the fan speed.

SERvice:LAN:PHOSname

This command presets the LAN hostname to its default value. It requires the serial number to be set-up.

The default value is "A-" + model number + "-" + last 5 digits of serial number, e.g.: A-N1913A-01346

Syntax

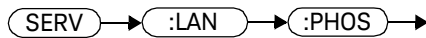

Example

SERV:LAN:PHOS

The command presets the LAN hostname to its default value.

SERVICE:OPTION?

The query returns the list of licensed options installed in the EPM Series power meter.

Syntax

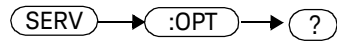

Example

SERV:OPT?

This query returns the list of licensed options installed in the EPM Series power meter.

SERvice:SECure:ERASe

This command erases the EPM Series power meter's memory, for example, before you return it to Keysight Technologies for repair or calibration, of all data stored in it.

The memory data erased, includes the save/recall states, FDO, Calibration Factor table, secure blank password, and power on last states.

Syntax

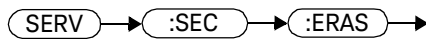

Example

SERV:SEC:ERAS

The command erases the EPM Series power meter's memory.

SERVICE:SENSe:CABLE:OPTion <numeric_value>

This command sets the type of connector cable for the sensors:

- Short cable option (for the sensor cable length of < 10 m, for example, 1.5 m/5 ft, 3 m/10 ft, or 6.1 m/20 ft) or,
- Long cable option (for the sensor cable length of > 10 m, for example, 15.2 m/50 ft, 30.5 m/100 ft, 61 m/200 ft).

Syntax

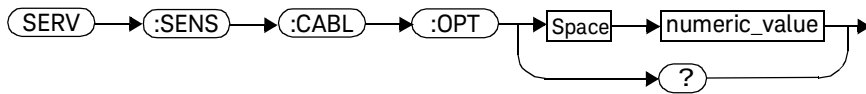

Parameter

Type	Description/Default	Range of Values
numeric_value	Numeric_value containing 0 or 1: - 0 for the short cable option - 1 for the long cable option	"0" or "1"

Example

SERV:SENSe:CABLE:OPT 1

This command sets the long cable option.

Query

SERVICE:SENSe:CABLE:OPTion?

The query returns the current setting of the cable option.

Query Example

SERV:SENS:CABL:OPT?

This query returns the current setting of the cable option.

Error Message

If the cable option value is out of range, error -222, "Data Out of Range" occurs.

SERVICE:SENSor[1]|2|3|4:CDATe?

This query returns the calibration date in E-Series, N8480, and U2000 Series sensors. Calibration date information is stored in the sensor's EEPROM.

Syntax

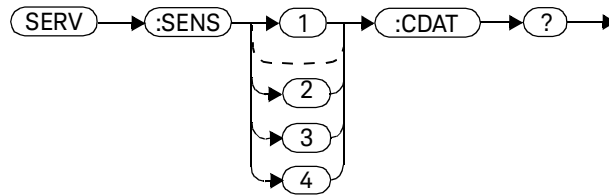

Example

SERV:SENS2:CDATe?

This query returns the calibration date of the E-Series sensor, N8480 Series or U2000 Series sensor connected to Channel B.

Error Messages

- If no power sensor is connected, error -241 "Hardware missing" occurs.
- If a sensor other than U2000 Series, N8480 Series or E-Series power sensor is connected, error -241 "Hardware missing" occurs.

SERvice:SENSor[1]|2|3|4:CPLace?

This query returns the calibration place in U2000 Series, E-Series sensors and N8480 Series sensors. Calibration place information is stored in the sensor's EEPROM.

Syntax

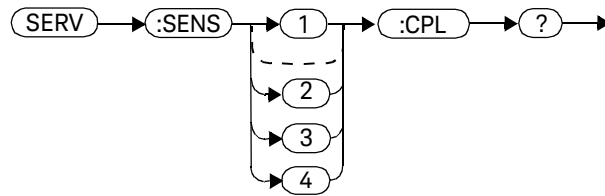

Example

SERV:SENS2:CPL?

This query returns the place of calibration of the U2000 Series, E-Series sensor or N8480 Series sensor connected to Channel B.

Error Messages

- If no power sensor is connected, error -241 "Hardware missing" occurs.
- If a sensor other than an U2000, N8480 Series or E-Series power sensor is connected, error -241 "Hardware missing" occurs.

SERVICE:SENSor[1]|2|3|4:FREQUENCY:MAXimum?

This query returns the maximum frequency that can be measured by the currently connected sensor. Maximum frequency information is stored in the sensor's EEPROM.

NOTE

This command is applicable to USB sensors only.

Syntax

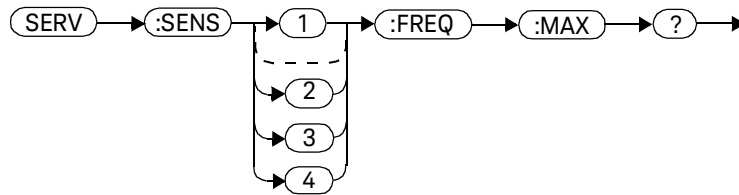

Example

SERV:SENS2:FREQ:MAX?

This query returns the maximum frequency that can be measured by a USB sensor currently connected to Channel B.

Error Messages

- If no sensor is connected, error -241, "Hardware missing" occurs.
- If a sensor other than a USB sensor is connected, error -241 "Hardware missing" occurs.
- If a USB sensor, currently connected, does not contain the necessary information in EEPROM, error -241 "Hardware missing" occurs.

SERVice:SENSor[1]|2|3|4:FREQUency:MINimum?

This query returns the minimum frequency that can be measured by the currently connected sensor. Minimum frequency information is stored in the sensor's EEPROM.

NOTE

This command is applicable to USB sensors only.

Syntax

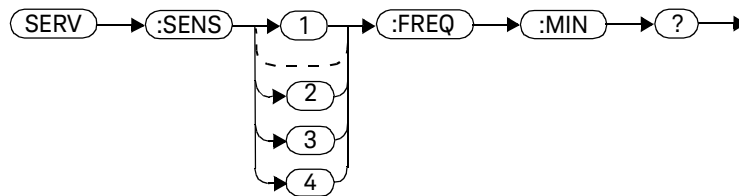

Example

`SERV:SENS1:FREQ:MIN?`

This query returns the minimum frequency that can be measured by a USB sensor currently connected to Channel A.

Error Messages

- If no sensor is connected, error -241, "Hardware missing" occurs.
- If a sensor other than a USB sensor is connected, error -241 "Hardware missing" occurs.
- If a USB sensor currently connected does not contain the necessary information in EEPROM, error -241 "Hardware missing" occurs.

SERVICE:SENSor[1]|2|3|4:POWER:AVERage:MAXimum?

This query returns the maximum average power that can be measured by the currently connected sensor. Maximum average power information is stored in the sensor's EEPROM.

NOTE

This command is applicable to USB sensors only.

Syntax

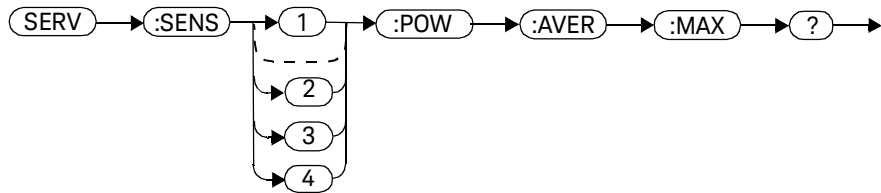

Example

`SERV:SENS:POWER:AVER:MAX?`

This query returns the maximum average power that can be measured by a USB sensor currently connected to Channel A.

Error Messages

- If no sensor is connected, error -241, "Hardware missing" occurs.
- If a sensor other than a USB sensor is connected, error -241 "Hardware missing" occurs.
- If a USB sensor currently connected does not contain the necessary information in EEPROM, error -241 "Hardware missing" occurs.

SERVice:SENSor[1]|2|3|4:POWer:USABle:MAXimum?

This query returns the maximum power that can be accurately measured by the currently connected sensor. Maximum power information is stored in the sensor's EEPROM.

NOTE

This command is applicable to USB sensors only.

Syntax

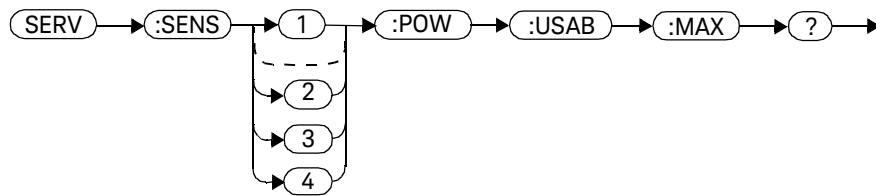

Example

SERV:SENS1:POW:USAB:MAX?

This query returns the maximum power that can be accurately measured by the USB sensor currently connected to Channel A.

Error Messages

- If no sensor is connected, error -241, “Hardware missing” occurs.
- If a sensor other than a USB sensor is connected, error -241 “Hardware missing” occurs.
- If a USB sensor currently connected does not contain the necessary information in EEPROM, error -241 “Hardware missing” occurs.

SERVICE:SENSor[1]|2|3|4:POWER:USABLE:MINimum?

This query returns the minimum power that can be accurately measured by the currently connected sensor. Maximum power information is stored in the sensor's EEPROM.

NOTE

This command is applicable to USB sensors only.

Syntax

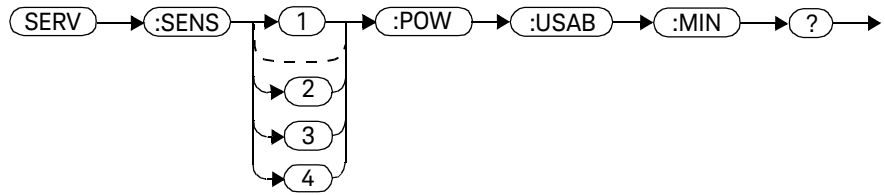

Example

`SERV:SENS:POWER:USABLE:MIN?`

This query returns the minimum power that can be accurately measured by a USB sensor currently connected to Channel A.

Error Messages

- If no sensor is connected, error -241, "Hardware missing" occurs.
- If a sensor other than a USB sensor is connected, error -241 "Hardware missing" occurs.
- If a USB sensor currently connected does not contain the necessary information in EEPROM, error -241 "Hardware missing" occurs.

SERvice:SENSor[1]|2|3|4:RADC?

This query returns a new raw uncorrected measurement in volts, as a 32 bit signed integer.

Syntax

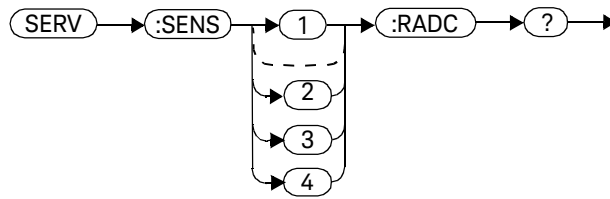

Example

`SERV:SENS2:RADC?`

This query returns a new raw uncorrected measurement for the sensor connected to Channel B.

Error Messages

- If `INIT:CONT` is set to `ON`, error -221 “Settings Conflict” occurs.

SERVICE:SENSor[1]|2|3|4:SNUMber?

This query returns the serial number for U2000 Series, E-Series sensors and N8480 Series sensors. Serial number information is stored in the sensor's EEPROM.

Syntax

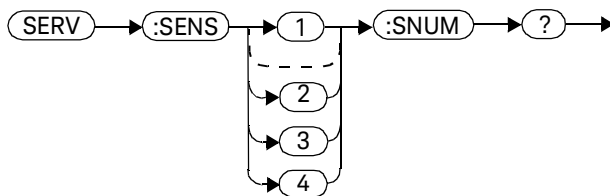

Example

SERV:SENS2:SNUM?

This query returns the serial number of the U2000 Series, E-Series sensor or N8480 Series sensor connected to Channel B.

Error Messages

- If no sensor is connected, error -241, "Hardware missing" occurs.
- If a sensor other than an U2000 Series, N8480 Series or E-Series power sensor is connected, error -241 "Hardware missing" occurs.

SERvice:SENSor[1]|2|3|4:TNUMber?

This query returns the tracking number for U2000 Series and E-Series sensors. Tracking number information is stored in the sensor's EEPROM.

Syntax

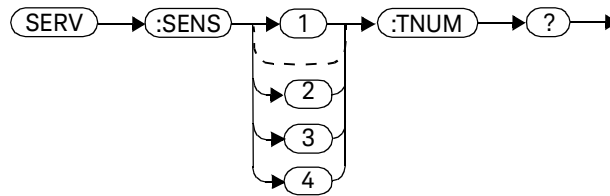

Example

SERV:SENS2:TNUM?

This query returns the serial number of the E-Series sensor connected to Channel B.

Error Messages

- If no sensor is connected, error -241, "Hardware missing" occurs.
- If a a sensor other than an U2000 Series or E-Series power sensor is connected, error -241 "Hardware missing" occurs.

SERVICE:SENSor[1]|2|3|4:TYPE?

This query identifies the sensor type connected to the power meter input channel(s). For Keysight 8480 Series Sensors, either “A”, “B”, “D”, or “H” is returned. For U2000 Series, E-Series and N8480 Series sensors, the model number stored in EEPROM is returned.

Syntax

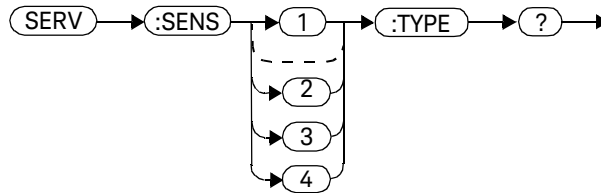

Example

SERV:SENS2:TYPE?

This query returns either, “A”, “B”, “D”, or “H” if a Keysight 8480 Series sensor is connected to Channel B, or the sensor model number if an P-Series, E-Series or N8480 Series sensors is connected to Channel B.

Error Messages

- If no sensor is connected, error -241, “Hardware missing” occurs.

SERVice:SENSor3|4:FREVision?

This query returns the firmware revision for the connected USB sensor.

Syntax

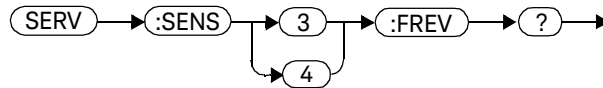

Example

SERV:SENS3:FREV?

This query returns the firmware revision for the USB sensor connected to Channel C.

Error Messages

- If no sensor is connected, error -241, "Hardware missing" occurs.
- If the connected sensor is not a U-Series sensor or an E-Series sensor, error -241, "Hardware missing" occurs.

SERVICE:SNUMber?

The query returns the power meter serial number in the form GB12345678 or US12345678.

Syntax

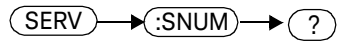

Example

SERV:SNUM?

This query returns the power meter serial number in the form GB12345678 or US12345678.

SERvice:STATe <boolean>

This command enables or disables the warm start feature. The warm start feature allows you to retain the meter's same states and settings upon power cycle or in the event of interrupted power. The default state is "ON".

Syntax

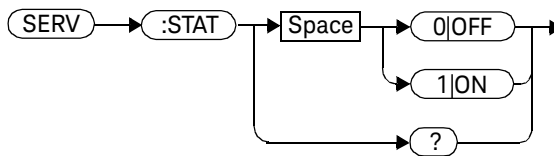

Example

SERV:STAT 1

This command enables the warm start state.

Remarks

This parameter is not affected by any reset operation and can only be changed by direct user access.

Query

SERvice:STATe?

The query returns the current setting of the warm start feature.

Error Messages

- If no non-volatile RAM on board, error –310, "System error" occurs.

SERVICE:VERSION:PROCESSOR <character_data>

This command loads the power meter with the processor board revision version.

Syntax

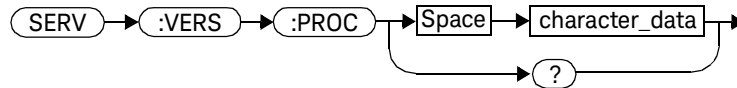

Parameters

Item	Description/Default	Range of Values
character_data	Details the processor board revision version. A maximum of 20 characters can be used.	A to Z (uppercase) a to z (lowercase) 0 - 9 _ (underscore)

Example

SERV:VERS:PROC "C"

This command loads the power meter with processor board revision version C.

Query

SERVICE:VERSION:PROCESSOR?

The query returns the current processor board revision version.

SERvice:VERSion:SYSTem <character_data>

This command loads the power meter with the system version number.

Syntax

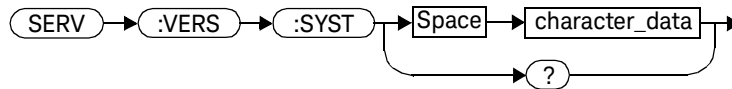

Parameters

Item	Description/Default	Range of Values
character_data	Details the system version number. A maximum of 20 characters can be used.	A to Z (uppercase) a to z (lowercase) 0 - 9 _ (underscore)

Example

SERvice:VERSion:SYST "1"

This command loads the power meter with system version number 1.

Query

SERvice:VERSion:SYSTem?

The query returns the current power meter system version number.

THIS PAGE HAS BEEN INTENTIONALLY LEFT BLANK.

13 STATUS Subsystem

STATUS Subsystem	470
Status Register Set Commands	472
Device Status Register Sets	477
Operation Status Register Sets	479
STATUS:OPERation	480
STATUS:OPERation:CALibrating[:SUMMARY]	481
STATUS:OPERation:LLFail[:SUMMARY]	482
STATUS:OPERation:MEASuring[:SUMMARY]	483
STATUS:OPERation:SENSe[:SUMMARY]	484
STATUS:OPERation:TRIGger[:SUMMARY]	485
STATUS:OPERation:ULFail[:SUMMARY]	486
STATUS:PRESet	487
Questionable Status Register Sets	488
STATUS:QUEStionable	489
STATUS:QUEStionable:CALibration[:SUMMARY]	490
STATUS:QUEStionable:POWer[:SUMMARY]	491
Status Block Diagram	493

This chapter explains how the **STATUS** command subsystem enables you to examine the status of the power meter by monitoring the “Device Status Register”, “Operation Status Register” and the “Questionable Status Register”.

STATUS Subsystem

The **STATUS** command subsystem enables you to examine the status of the power meter by monitoring the following status registers:

- Device status register
- Operation status register
- Questionable status register

The contents of these and other registers in the power meter are determined by one or more status registers.

Table 13-1 summarizes the effects of various commands and events on these status registers:

Table 13-1 Commands and events affecting Status Register

Status Register	*RST	*CLS	Power On	STATUS:PRESet
SCPI Transition Filters (NTR and PTR registers)	none	none	preset	preset
SCPI Enable Registers	none	none	preset	preset
SCPI Event Registers	none	clear	clear	none
SCPI Error/Event Queue enable	none	none	preset	preset
SCPI Error/Event Queue	none	clear	clear	none
IEEE488.2 Registers ESE SRE	none	none	clear	none
IEEE488.2 Registers SESR STB	none	clear	clear	none

The contents of the status registers are examined using the following status register set commands:

```

:CONDition?
:ENABle <NRf>|<non-decimal numeric>
[:EVENT?]
:NTRansition <NRf>|<non-decimal numeric>
:PTRansition <NRf>|<non-decimal numeric>

```

Each of these can be used to examine any of the following eleven status registers:

STATUS:DEVice ([page 477](#))

STATus:OPERation (page 480)
STATus:OPERation:CALibrating[:SUMMARY] (page 481)
STATus:OPERation:LLFail[:SUMMARY] (page 482)
STATus:OPERation:MEASuring[:SUMMARY] (page 483)
STATus:OPERation:SENSe[:SUMMARY] (page 484)
STATus:OPERation:TRIGger[:SUMMARY] (page 485)
STATus:OPERation:ULFail[:SUMMARY] (page 486)
STATus:PRESet (page 487)
STATus:QUEStionable (page 489)
STATus:QUEStionable:CALibration[:SUMMARY] (page 490)
STATus:QUEStionable:POWer[:SUMMARY] (page 491)

Examples

- To use the **:CONDition?** command to examine the **STATus:DEVIce** register:

STATus:DEVIce:CONDition?

- To use the **:NTRansition** command to examine the **STATus:OPERation:SENSe[:SUMMARY]** register:

STATus:OPERation:SENSe[:SUMMARY]:NTRansition

This chapter describes the status register set commands and the status registers which they are used to examine.

Status Register Set Commands

This section describes the five status register set commands. Each can be used to examine all of the eleven status registers listed on [page 470](#).

To apply a command to a specific register, prefix the command with the name of the appropriate register. For example, to apply the **:ENABLE** command to the **STATUS:QUESTIONable** register, use the following command:

STATUS:QUESTIONable:ENABLE

The Status Register Set commands detailed in this section are:

Keyword	Parameter Form	Notes	Page
:CONDition?		[query only]	page 472
:ENABLE	<NRf> <non-decimal numeric>		page 473
[:EVENT?]		[query only]	page 473
:NTRansition	<NRf> <non-decimal numeric>		page 474
:PTRansition	<NRf> <non-decimal numeric>		page 475

:CONDition?

This query returns a 16 bit decimal-weighted number representing the bits set in the Condition Register of the SCPI Register Set you require to control. The format of the return is **<NR1>** in the range of 0 to 32767 ($2^{15}-1$). The contents of the Condition Register remain unchanged after it is read.

Syntax



[:EVENT]?

This query returns a 16 bit decimal-weighted number representing the bits set in the Event Register of the SCPI Register Set you require to control. The format of the return is <NR1> in the range of 0 to 32767 ($2^{15}-1$). This query clears all bits in the register to 0.

NOTE

The [:EVENT]? is the default command if the STATUS SCPI are not accompanied by any of the Status Register Set commands (:COND, :ENAB, :NTR and :PTR).

Syntax



:ENABle <NRf>|<non-decimal numeric>

This command sets the Enable Register of the particular SCPI Register Set you require to control. The parameter value, when rounded to an integer and expressed in base 2 has its first 15 bits written into the Enable Register of the SCPI Register Set concerned. The last bit (bit 15) is always set to 0.

Syntax

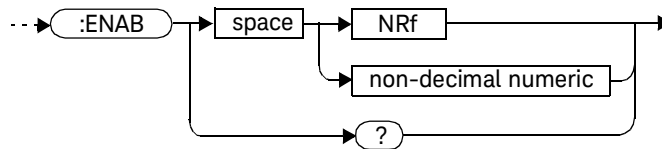

Parameters

Type	Description	Range of Values
NRf non-decimal numeric	The value used to set the Enable Register.	0 to $2^{16}-1$

Query

:ENABle?

The query returns a 15 bit decimal-weighted number representing the contents of the Enable Register of the SCPI Register Set being queried. The format of the return is <NR1> in the range of 0 to 32767 ($2^{15}-1$).

:NTRansition <NRf>|<non-decimal numeric>

This command sets the Negative Transition Register of the SCPI Register Set you require to control. The parameter value, when rounded to an integer and expressed in base 2 has its first 15 bits written into the Negative Transition Register of the SCPI Register Set concerned. The last bit (bit 15) is always set to 0.

Syntax

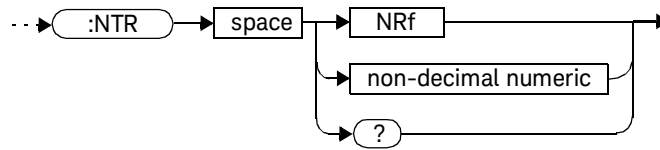

Parameters

Type	Description	Range of Values
NRf	The value used to set the NTR Register.	0 to $2^{16}-1$
non-decimal numeric		

Query

:NTRansition?

The query returns a 15 bit decimal-weighted number representing the contents of the Negative Transition Register of the SCPI register set being queried. The format of the return is **<NR1>** in the range of 0 to 32767 ($2^{15}-1$).

:PTRansition <NRf>|<non-decimal numeric>

This command is used to set the Positive Transition Register of the SCPI Register Set you require to control. The first 15 bits of the input parameter are written into the Positive Transition Register of the SCPI Register Set concerned. The last bit (bit 15) is always set to 0.

Syntax

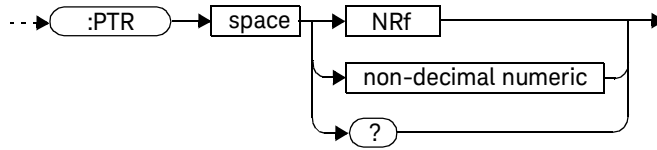

Parameters

Type	Description	Range of Values
NRf	The value used to set the PTR Register.	0 to $2^{16}-1$
non-decimal numeric		

Query

:PTRansition?

The query returns a 15 bit decimal-weighted number representing the contents of the Positive Transition Register of the SCPI register set being queried. The format of the return is **<NR1>** in the range of 0 to 32767 ($2^{15}-1$).

Device Status Register Sets

The status registers contain information which give device status information. The contents of the individual registers of these register sets may be accessed by appending the commands listed in [Status Register Set Commands](#).

The following command descriptions detail the SCPI register you require to control and some examples on the register set commands.

The one device status register set is:

STATus:DEVIce:

The following bits in these registers are used by the power meter:

Bit Number	Decimal Weight	Definition
0	-	Not used
1	2	Channel A sensor connected
2	4	Channel B sensor connected (N1914A only)
3	8	Channel A sensor error
4	16	Channel B sensor error (N1914A only)
5	32	Channel A sensor Front/Rear
6	64	Channel B sensor Front/Rear (N1914A only)
7	128	Channel C sensor connected (USB Option Only)
8	256	Channel D sensor connected (USB Option Only)
9	512	Not used
10	1024	Not used
11	2048	Battery critical
12	4096	Over temperature
13	8192	Fan failed
14	16384	Front panel key press
15	-	Bit 15 always 0

The Channel A and B sensor connected bits (bits 1 and 2), when queried with the **STATUS:DEVICE:CONDition?** query are set to:

- 1, when a power sensor is connected
- 0, when no power sensor is connected

The Channel A and B sensor connected bits (bits 1 and 2), when queried with the **STATUS:DEVICE:EVENT?** query indicate whether a power sensor has been connected or disconnected depending on the state of the corresponding bits of **STATUS:DEVICE:NTRansition** and **STATUS:DEVICE:PTRansition**. If the corresponding bit in:

- **STATUS:DEVICE:NTRansition** is 1, then **STATUS:DEVICE:EVENT?** is set when a power sensor is disconnected.
- **STATUS:DEVICE:PTRansition** is 1, then **STATUS:DEVICE:EVENT?** is set when a power sensor is connected.

NOTE

Querying **STATUS:DEVICE:EVENT?** clears the **STATUS:DEVICE:EVENT?** register.

The Channel A and B sensor error bits (3 and 4) are set to:

- 1, if the N8480 Series or E-Series power sensor EEPROM has failed or if there are power sensors connected to both the rear and front panel connectors.
- 0, for every other condition.

The Front Panel key press bit (bit 14), when queried with the **STATUS:DEVICE:EVENT?** query indicates whether any front panel keys have been pressed since power up or since you last queried the device status register. This bit ignores the **:NTRansition**, and **:PTRansition** registers and a **:CONDition?** query always returns a 0.

Operation Status Register Sets

The following registers contain information which is part of the power meter's normal operation. The contents of the individual registers of these register sets may be accessed by appending the commands listed in [Status Register Set Commands](#).

The following command descriptions detail the SCPI register you require to control and some examples of the Register Set commands.

The seven operation status register sets are:

STATUS:OPERation

STATus:OPERation:CALibrating[:SUMMARY]

STATus:OPERation:LLFail[:SUMMARY]

STATus:OPERation:MEASuring[:SUMMARY]

STATus:OPERation:SENSe[:SUMMARY]

STATus:OPERation:TRIGger[:SUMMARY]

STATus:OPERation:ULFail[:SUMMARY]

Further information on these register sets is provided on the following pages.

STATUS:OPERation

The operation status register set contains conditions which are a part of the operation of the power meter as a whole.

The following bits in these registers are used by the power meter:

Bit Number	Decimal Weight	Definition
0	-	CALibrating Summary
1	2	Selftest Started
2 - 3	-	Not used
4	16	MEASuring Summary
5	32	Waiting for TRIGger Summary
6 - 9	-	Not used
10	1024	SENSe Summary
11	2048	Lower Limit Fail Summary
12	4096	Upper Limit Fail Summary
13 to 15	-	Not used (bit 15 always 0)

Syntax



STATus:OPERation:CALibrating[:SUMM]ary]

The operation status calibrating summary register set contains information on the calibrating status of the power meter.

The following bits in these registers are used by the power meter:

Bit Number	Decimal Weight	Definition
0	-	Not used
1	2	Channel A CALibration Status
2	4	Channel B CALibration Status (N1914A only)
3	8	Channel C CALibration Status (USB Option Only)
4	16	Channel D CALibration Status (USB Option Only)
5-15	-	Not used

These bits are set at the beginning of zeroing (**CALibrating:ZERO:AUTO ONCE**) and at the beginning of calibration (**CALibrating:AUTO ONCE**). Also for the compound command/query **CALibration[:ALL]?**, this bit is set at the beginning of the calibration sequence.

These bits are cleared at the end of zeroing or calibration.

Syntax

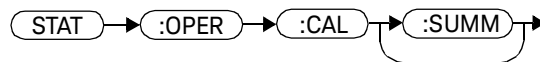

STATUS:OPERation:LLFail[:SUMM]ary]

The operation status lower limit fail summary register set contains information on the lower limit fail status of the power meter.

The following bits in these registers are used by the power meter:

Bit Number	Decimal Weight	Definition
0-2	-	Not used
3	8	Upper window LLFail Status
4	16	Lower window LLFail Status
5	32	Upper window lower measurement LLFail Status
6	64	Lower window lower measurement LLFail Status
7-15	-	Not used

The appropriate bits are set if a channel lower limit test fails or a window lower limit test fails.

These bits are cleared if a measurement is made and the test is enabled and passes.

Syntax

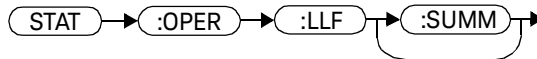

STATus:OPERation:MEASuring[:SUMM]ary]

The operation status measuring summary register set contains information on the measuring status of the power meter.

The following bits in these registers are used by the power meter:

Bit Number	Decimal Weight	Definition
0	-	Not used
1	2	Channel A MEASuring Status
2	4	Channel B MEASuring Status (N1914A only)
3-15	-	Not used

These bits are set when the power meter is taking a measurement.

These bits are cleared when the measurement is finished.

Syntax

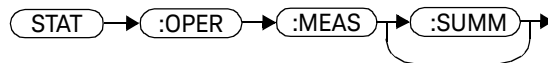

STATus:OPERation:SENSe[:SUMM]ary]

The operation status sense summary register set contains information on the status of the power sensors.

The following bits in these registers are used by the power meter:

Bit Number	Decimal Weight	Definition
0	-	Not used
1	2	Channel A SENSE Status
2	4	Channel B SENSE Status (N1914A only)
3-15	-	Not used

These bits are set when the power meter is reading data from the E-Series power sensor or N8480 Series power sensor EEPROM.

These bits are cleared when the power meter is not reading data from the E-Series power sensor or N8480 Series power sensor EEPROM.

Syntax

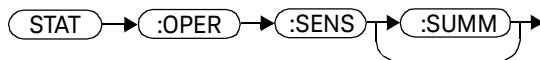

STATus:OPERation:TRIGger[:SUMM]ary

The operation status trigger summary register set contains information on the trigger status of the power meter.

The following bits in these registers are used by the power meter:

Bit Number	Decimal Weight	Definition
0	-	Not used
1	2	Channel A TRIGger Status
2	4	Channel B TRIGger Status (N1914A only)
3-15	-	Not used

Syntax

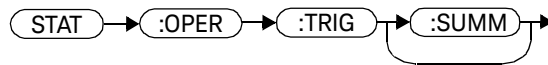

STATUS:OPERation:ULFail[:SUMMARY]

The operation status upper limit fail summary register set contains information on the upper limit fail status of the power meter.

The following bits in these registers are used by the power meter:

Bit Number	Decimal Weight	Definition
0-2	-	Not used
3	8	Upper window ULFail Status
4	16	Lower window ULFail Status
5	32	Upper window lower measurement ULFail Status
6	64	Lower window lower measurement ULFail Status
7-15	-	Not used

The appropriate bits are set if a channel upper limit test fails or a window upper limit test fails.

These bits are cleared if a measurement is made and the test is enabled and passes.

Syntax

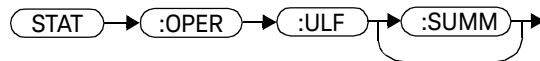

STATUS:PRESet

PRESet sets a number of the status registers to their preset values as shown below - all other registers are unaffected. Bit 15 is always 0.

Register	Filter/Enable	PRESet Value
OPERational	ENABLe	all zeros
	PTR	all ones
	NTR	all zeros
QUEStionable	ENABLe	all zeros
	PTR	all ones
	NTR	all zeros
All Others	ENABLe	all ones
	PTR	all ones
	NTR	all zeros

Syntax

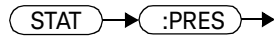

Questionable Status Register Sets

The questionable status register sets contain information which gives an indication of the quality of the data produced by the power meter. The contents of the individual registers in these register sets may be accessed by appending the commands listed in [Status Register Set Commands](#).

The following command descriptions detail the SCPI register you require to control but do not detail the register set commands.

The three questionable status register sets are:

STATus:QUEStionable

STATus:QUEStionable:CALibration[:SUMMary]

STATus:QUEStionable:POWer[:SUMMary]

STATus:QUEStionable

The questionable register set contains bits that indicate the quality of various aspects of signals processed by the power meter.

The following bits in these registers are used by the power meter:

Bit Number	Decimal Weight	Definition
0 to 2	-	Not used
3	8	POWer Summary
4 to 7	-	Not used
8	256	CALibration Summary
9	512	Power On Self Test
10 to 15	-	Not Used (bit 15 always 0)

Bit 3 is set by the logical OR outputs of the **STATus:QUEStionable:POWer:SUMMARY** register set.

Bit 8 is set by the logical OR outputs of the **STATus:QUEStionable:CALibration:SUMMARY** register set.

Bit 9 is set if power-on self-test fails, and cleared if it passes.

Syntax

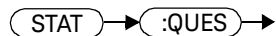

STATUS:QUESTIONABLE:CALibration[:SUMMARY]

The questionable calibration summary register set contains bits which give an indication of the quality of the data produced by the power meter due to its calibration status.

The following bits in these registers are used by the power meter:

Bit Number	Decimal Weight	Definition
0	-	Not used
1	2	Summary of Channel A CALibration
2	4	Summary of Channel B CALibration (N1914A only)
3	8	Summary of Channel C CALibration (USB Option Only)
4	16	Summary of Channel D CALibration (USB Option Only)
5-15	-	Not used

These bits are set by the following:

- Error -231, "Data questionable; CH<A|B>:ZERO ERROR"
- Error -231, "Data questionable; CAL ERROR"
- Error -231, "Data questionable; CAL ERROR ChA"
- Error -231, "Data questionable; CAL ERROR ChB"

These bits are cleared when any of the three commands listed above succeed and no errors are placed on the error queue.

Syntax

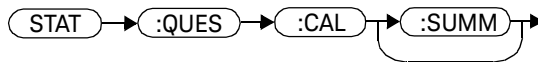

STATus:QUEStionable:POWer[:SUMMArY]

The questionable power summary register set contain bits that indicate the quality of the power data being acquired by the power meter.

The following bits in these registers shall be used by the power meter:

Bit Number	Decimal Weight	Definition
0	-	Not used
1	2	Channel A Power
2	4	Channel B Power
3	8	Upper Window Power
4	16	Lower Window Power
5	32	Channel A Please Zero
6	64	Channel B Please Zero
7	128	Upper Window Lower Measurement Power
8	256	Lower Window Lower Measurement Power
9	512	Channel C Power (USB Option Only)
10	1024	Channel D Power (USB Option Only)
11-15	-	Not used

Bit 1 is set when any of the following errors occur:

- Error -231, "Data questionable;Input Overload"
- Error -231, "Data questionable;Input Overload ChA"

Bit 2 is set when the following error occurs:

- Error -231, "Data questionable;Input Overload ChB"

Bits 3 is set when the following error occurs:

- Error -230, "Data corrupt or stale"
- Error -231, "Data questionable;Upper window log error"

Bit 4 is set when the following error occurs:

- Error -230, "Data corrupt or stale"
- Error -231, "Data questionable;Lower window log error"

Bit 5 is set when the following condition occurs:

- Channel A requires zeroing

Bit 6 is set when the following condition occurs (N1914A only):

- Channel B requires zeroing

These bits are cleared when no errors or events are detected by the power meter during a measurement covering the causes given for it to set.

Syntax

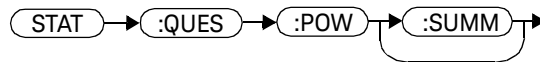

Status Block Diagram

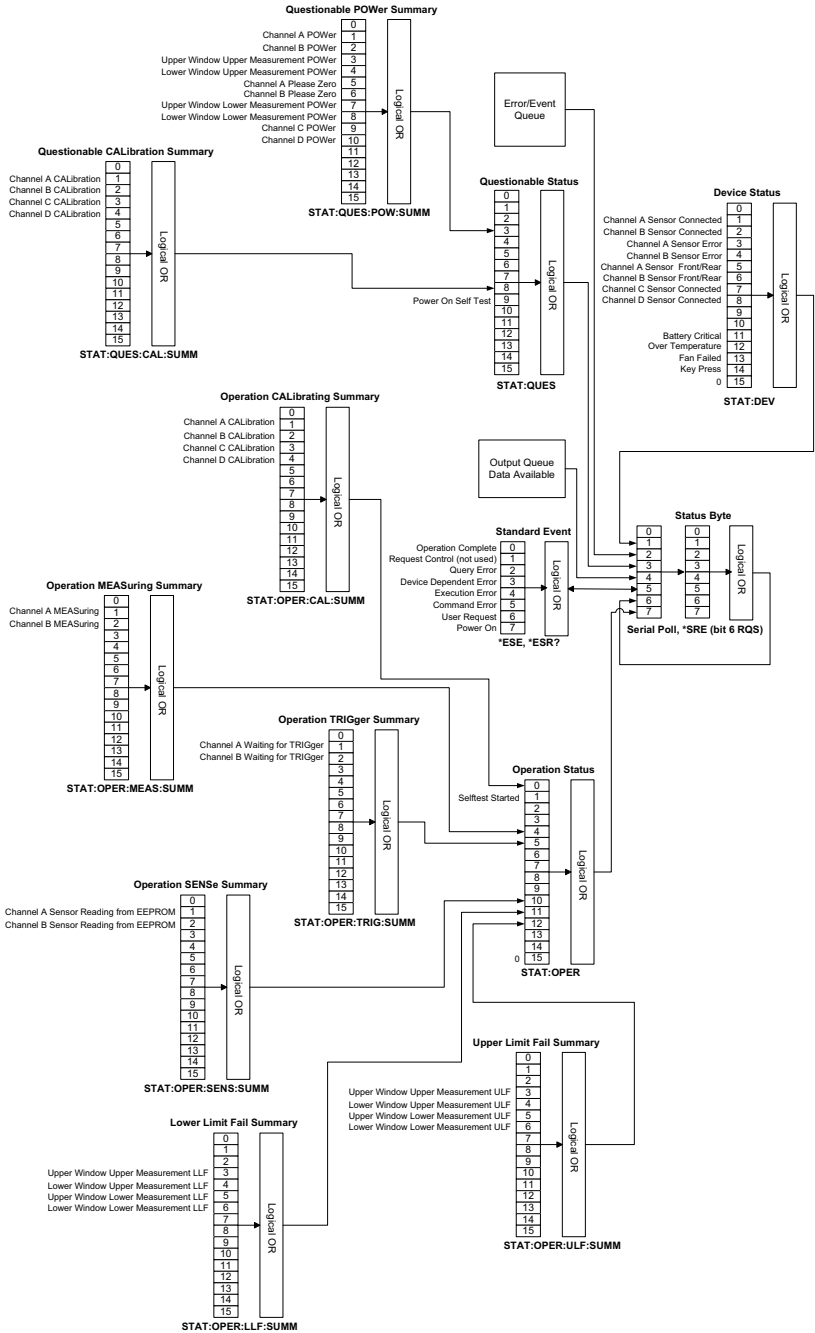

THIS PAGE HAS BEEN INTENTIONALLY LEFT BLANK.

14 SYSTEM Subsystem

SYSTEM Subsystem	497
SYSTEM:COMMunicate:GPIB[:SELF]:ADDRESS <numeric_value>	500
SYSTEM:COMMunicate:LAN:AIP[:STATe] <boolean>	502
SYSTEM:COMMunicate:LAN:CURREnt:ADDRESS?	503
SYSTEM:COMMunicate:LAN:CURREnt:DGATeway?	504
SYSTEM:COMMunicate:LAN:CURREnt:DNAMe?	505
SYSTEM:COMMunicate:LAN:CURREnt:SMASK?	506
SYSTEM:COMMunicate:LAN:ADDRESS <character_data>	507
SYSTEM:COMMunicate:LAN:DGATeway <character_data>	508
SYSTEM:COMMunicate:LAN:DHCP[:STATe] <boolean>	509
SYSTEM:COMMunicate:LAN:DNAMe <character_data>	510
SYSTEM:COMMunicate:LAN:HNAME <character_data>	511
SYSTEM:COMMunicate:LAN:MAC?	512
SYSTEM:COMMunicate:LAN:REStart	513
SYSTEM:COMMunicate:LAN:SMASk <character_data>	514
SYSTEM:COMMunicate:TCPip:CONTRol?	515
SYSTEM:DISPlay:BMP	516
SYSTEM:ERRor?	517
SYSTEM:HELP:HEADers?	525
SYSTEM:LANGuage <character_data>	526
SYSTEM:LIcense:INStall <license_string>	528
SYSTEM:LIcense:LIST?	529
SYSTEM:LIcense:REMOve <license_string>	530
SYSTEM:LOCAl	531
SYSTEM:PERSonA:MANUFACTurer <"string">	532
SYSTEM:PERSonA:MANUFACTurer:DEFault	534
SYSTEM:Preset	535
SYSTEM:REMote	539

SYSTEM:RWLock 540
SYSTEM:SET <arbitrary_block_data> 541
SYSTEM:VERSion? 542

This chapter explains how to use the **SYSTEM** command subsystem to return error numbers and messages from the power meter, preset the power meter, set the remote address, and query the SCPI version.

SYSTEM Subsystem

- The **SYSTEM** command subsystem is used to:
- Return error numbers and messages from the power meter
 - Preset the power meter
 - Set the GPIB address
 - Set the LAN address
 - Set the command language
 - Change the remote programming language
 - Install valid licensed option
 - Query the SCPI version

Keyword	Parameter Form	Notes	Page
SYSTEM			
:COMMunicate			
:GPIB			
[:SELF]			
:ADDRESS	<numeric_value>		page 500
:LAN			
:AIP			
[:STATe]	<boolean>		page 502
:CURRent			
:ADDRESS?		[query only]	page 503
:DGATeway?		[query only]	page 504
:DNAME?		[query only]	page 505
:SMASK?		[query only]	page 506
:ADDRESS	<character_data>		page 507
:DGATeway	<character_data>		page 508
:DHCP			

Keyword	Parameter Form	Notes	Page
[:STATe]	<boolean>		page 509
:DNAME	<character_data>		page 510
:HNAME	<character_data>		page 511
:KEEPAlive	<numeric_value>		page 512
:MAC?		[query only]	page 512
:REStart		[no query]	page 513
:SMASK	<character_data>		page 514
:TCPip			
:CONTRol?		[query only]	page 515
:DISPLAY			
:BMP?		[query only]	page 516
:ERRor			page 517
:HELP			
:HEADers?		[query only]	page 525
:LANGuage	<character_data>		page 526
:LICense			
:INSTall	<license_string>		page 528
:LIST?		[query only]	page 529
:REMove	<license_string>		page 530
:LOCal			page 531
:PERSONa			
:MANufacturer	<string>		page 532
:DEFault			page 534
:MODEl	<string>		page 535
:DEFault			page 535
:PRESet			page 535
:REMote			page 539

Keyword	Parameter Form	Notes	Page
:RWLock			page 540
:SET	<arbitrary_block_data>		page 541
:VERSion?		[query only]	page 542

SYSTem:COMMunicate:GPIB[:SELF]:ADDRess <numeric_value>

This command sets the GPIB address of the power meter.

Syntax

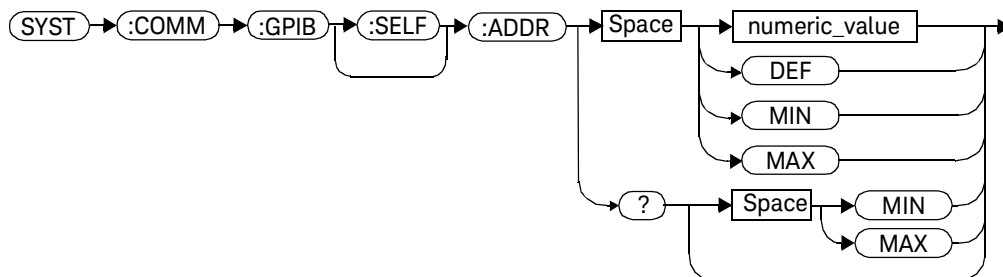

Parameters

Item	Description/Default	Range of Values
numeric_value	A numeric value for the address. - DEF: the default value is 13 - MIN: 0 - MAX: 30	0 to 30 DEF MIN MAX

Example

SYST:COMM:GPIB:ADDR 13

This command sets the GPIB address to 13.

Query

SYSTEM:COMMunicate:GPIB[:SELF]:ADDRESS? MIN|MAX

The query returns the current setting of the GPIB address or the values associated with MIN and MAX.

Query Example

SYST:COMM:GPIB:ADDR?

This command queries the setting of the GPIB address.

SYSTem:COMMunicate:LAN:AIP[:STATe] <boolean>

This command enables the AutoIP protocol to dynamically assign the IP address when connecting to the power meter in an isolated (non-site) LAN network (for example, laptop to power meter).

Syntax

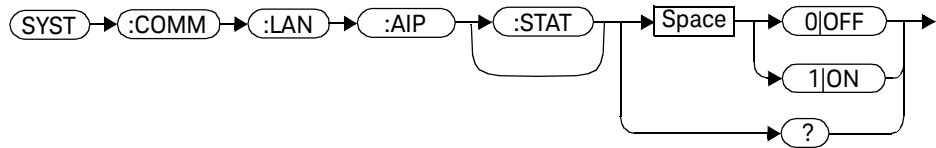

Example

SYST:COMM:LAN:AIP ON

This command enables the AutoIP

Query

SYSTem:COMMunicate:LAN:AIP?

- 1 is returned if AutoIP is enabled
- 0 is returned if AutoIP is disabled

Query Example

SYST:COMM:LAN:AIP?

This command queries the state of the AutoIP.

SYSTEM:COMMunicate:LAN:CURRent:ADDRess?

This command returns the current setting of the IP address in use by the power meter.

NOTE

If DHCP or AutoIP are enabled and successful, then one of these IP address modes assigns the IP address, otherwise it is the static IP address.

Syntax



Example

SYST:COMM:LAN:CURR:ADDR?

This command queries the current setting of the IP address.

SYSTem:COMMunicate:LAN:CURRent:DGATeway?

This command returns the current setting of the LAN IP router/gateway address in use by the power meter.

NOTE

If DHCP or AutoIP are enabled and successful, then one of these IP address modes assigns the LAN IP router/gateway address, otherwise it is the static LAN IP router/gateway address

Syntax

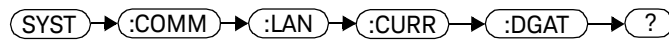

Example

SYST:COMM:LAN:CURR:DGAT?

This command queries the current setting of the LAN IP router/gateway address.

SYSTEM:COMMunicate:LAN:CURRent:DNAMe?

This command returns the current setting of the LAN domain name in use by the power meter.

NOTE

If DHCP or AutoIP are successfully enabled, then one of these IP address modes assign the LAN domain name, otherwise it is the static LAN domain name.

Syntax



Example

SYST:COMM:LAN:CURR:DNAM?

This command queries the current setting of the LAN domain name.

SYSTem:COMMunicate:LAN:CURRent:SMASk?

This command returns the current setting of the LAN subnet mask in use by the power meter.

NOTE

If DHCP or AutoIP are successfully enabled, then one of these IP address modes assign the LAN subnet mask, otherwise it is the static LAN subnet mask.

Syntax



Example

SYST:COMM:LAN:CURR:SMAS?

This command queries the current setting of the LAN subnet mask.

SYSTEM:COMMunicate:LAN:ADDRess <character_data>

This command sets the LAN (IP) address of the power meter.

Syntax

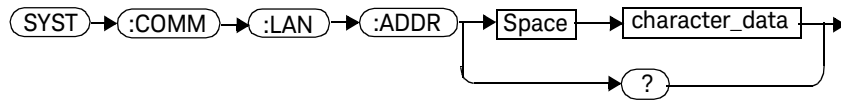

Parameters

Item	Description	Range of Values
character_data	Numeric character values for the address. Up to 15 characters, formatted as follows: A.B.C.D where A, B, C, D = 0 to 225	0 to 225 (no embedded spaces)

Example

SYST:COMM:LAN:ADDR
'130.015.156.255'

This command sets the LAN IP address to 130.015.156.255.

Query

SYSTEM:COMMunicate:LAN:ADDRess?

The query returns the current setting of the LAN address.

Query Example

SYST:COMM:LAN:ADDR?

This command queries the setting of the LAN IP address.

SYSTem:COMMunicate:LAN:DGATeway <character_data>

This command sets the LAN IP router/gateway address for the power meter.

Syntax

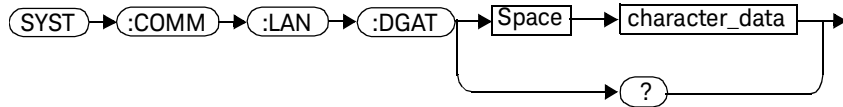

Parameters

Item	Description	Range of Values
character_data	Numeric character values for the address. Up to 15 characters, formatted as follows: A.B.C.D where A, B, C, D = 0 to 225	0 to 225 (no embedded spaces)

Example

SYST:COMM:LAN:DGAT
'130.2.6.200'

This command sets the gateway address to 130.2.6.200.

Query

SYSTem:COMMunicate:LAN:DGAT?

The query returns the current setting of the LAN gateway address.

Query Example

SYST:COMM:LAN:DGAT?

This command queries the setting of the gateway address.

SYSTEM:COMMunicate:LAN:DHCP[:STATe] <boolean>

This command enables the dynamic host configuration protocol.

Syntax

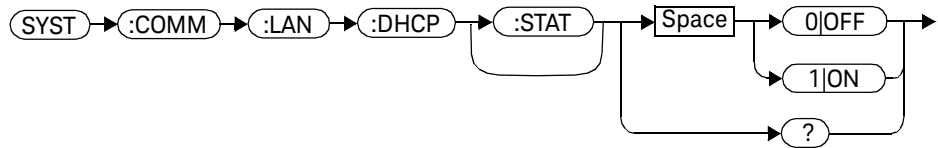

Example

SYST:COMM:LAN:DHCP ON

This command enables the DHCP.

Query

SYSTEM:COMMunicate:LAN:DHCP?

- 1 is returned if DHCP is enabled
- 0 is returned if DHCP is disabled

Query Example

SYST:COMM:LAN:DHCP?

This command queries the state of the DHCP.

SYSTem:COMMunicate:LAN:DNAMe <character_data>

This command sets the domain name for the power meter.

Syntax

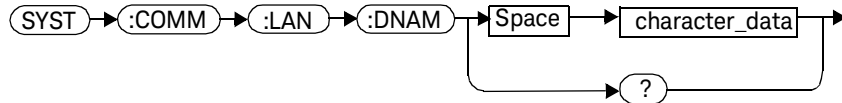

Parameters

Item	Description	Range of Values
character_data	Character values of up to 16 characters	Maximum of 16 characters

Example

SYST:COMM:LAN:DNAM
'myco.com'

This command sets the hostname to myco.com.

Query

SYSTem:COMMunicate:LAN:DNAM?

The query returns the current setting of the LAN domain name.

Query Example

SYST:COMM:LAN:DNAM?

This command queries the setting of the domain name.

SYSTEM:COMMunicate:LAN:HNAMe <character_data>

This command sets the hostname for the power meter.

The factory default setting of hostname is in this format:

A- + product number + - + suffix 5 digits of serial number

For example, **A-N1913A-00204**

Syntax

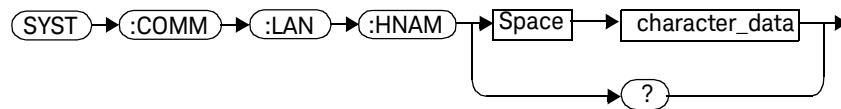

Parameters

Item	Description	Range of Values
character_data	Character values of up to 15 characters	Maximum of 15 characters

Example

SYSTEM:COMM:LAN:HNAM
'PowerMeter1'

This command sets the hostname to PowerMeter 1.

Query

SYSTEM:COMMunicate:LAN:HNAM?

The query returns the current setting of the LAN hostname.

Query Example

SYSTEM:COMM:LAN:HNAM?

This command queries the setting of the hostname.

SYSTem:COMMunicate:LAN:MAC?

This query returns the LAN MAC address.

Syntax



Example

SYST:COMM:LAN:MAC?

This command queries the current MAC address.

SYSTEM:COMMunicate:LAN:REStart

This command restarts the power meter's network stack; any LAN configuration changes can only take effect after this is performed.

Syntax

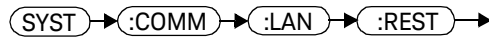

Example

SYST:COMM:LAN:REST

This command restarts the LAN network with new configuration.

SYSTem:COMMunicate:LAN:SMASk <character_data>

This command sets the subnet mask of the power meter.

Syntax

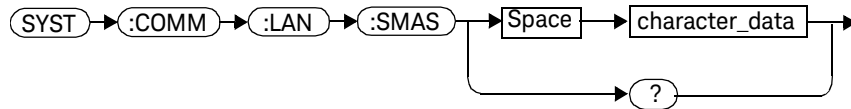

Parameters

Item	Description	Range of Values
character_data	Numeric character values for the address. Up to 15 characters, formatted as follows: A.B.C.D where A, B, C, D = 0 to 225	0 to 225 (no embedded spaces)

Example

SYST:COMM:LAN:SMAS
'255.255.248.0'

This command sets the subnet mask to 255.255.248.0.

Query

SYSTem:COMMunicate:LAN:SMASk?

The query returns the current setting of the LAN subnet mask.

Query Example

SYST:COMM:LAN:SMAS?

This command queries the setting of the LAN subnet mask.

SYSTEM:COMMunicate:TCPip:CONTrol?

This command returns the socket number of control from SCPI/SOCKET connection.

Syntax



Example

SYST:COMM:TCP:CONT?

This command returns the socket number.

Error Messages

- If wrong connection type, error -310 "System error" occurs.

SYSTem:DISPlay:BMP

This command returns the display image in bitmap format.

This command is limited to a maximum of five image returns per second.

NOTE

It is not recommended to use this command in Fast Mode, as it slows down the measurement rate.

Syntax



Example

`SYST:DISP:BMP?`

This command returns the display image in bitmap format.

SYSTem:ERRor?

This query returns error numbers and messages from the power meter's error queue. When an error is generated by the power meter, it stores an error number and corresponding message in the error queue. One error is removed from the error queue each time this command is executed. The errors are cleared in the order of first-in first-out, this is the oldest errors are cleared first. To clear all the errors from the error queue, execute ***CLS** command. When the error queue is empty, subsequent **SYSTem:ERRor?** queries return a +0, "No error" message. The error queue has a maximum capacity of 30 errors.

Syntax

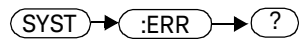

Example

SYST:ERR?

This command queries the oldest error message stored in the power meter's error queue.

Reset Condition

On reset, the error queue is unaffected.

Error Messages

- If the error queue overflows, the last error is replaced with –350, "Queue overflow". No additional errors are accepted by the queue until space becomes available.

Error Message List

-101	<p>Invalid character</p> <p>An invalid character was found in the command string. You may have inserted a character such as #, \$, or % in the command header or within a parameter.</p> <p>For example, LIM:LOW O#.</p>
-102	<p>Syntax error</p> <p>Invalid syntax was found in the command string.</p> <p>For example, LIM:CLE:AUTO, 1 or LIM:CLE: AUTO 1.</p>
-103	<p>Invalid separator</p> <p>An invalid separator was found in the command string. You may have used a comma instead of a colon, semicolon, or blank space; or you may have used a blank space instead of a comma.</p> <p>For example, OUTP:ROSC,1.</p>
-105	<p>GET not allowed</p> <p>A Group Execute Trigger (GET) is not allowed within a command string.</p>
-108	<p>Parameter not allowed</p> <p>More parameters were received than expected for the command. You may have entered an extra parameter, or added a parameter to a command that does not accept a parameter.</p> <p>For example, CAL 10.</p>
-109	<p>Missing parameter</p> <p>Fewer parameters were received than expected for the command. You omitted one or more parameters that are required for this command.</p> <p>For example, AVER:COUN.</p>
-112	<p>Program mnemonic too long</p> <p>A command header was received which contained more than the maximum 12 characters allowed.</p> <p>For example, SENSseAVERageCOUNt 8.</p>
-113	<p>Undefined header</p> <p>A command was received that is not valid for this power meter. You may have misspelled the command, it may not be a valid command or you may have the wrong interface selected. If you are using the short form of the command, remember that it may contain up to four letters.</p> <p>For example, TRIG:SOUR IMM.</p>
-121	<p>Invalid character in number</p> <p>An invalid character was found in the number specified for a parameter value.</p> <p>For example, SENS:AVER:COUN 128#H.</p>

-123	<p>Exponent too large</p> <p>A numeric parameter was found whose exponent was larger than 32,000. For example, SENS:COUN 1E34000.</p>
-124	<p>Too many digits</p> <p>A numeric parameter was found whose mantissa contained more than 255 digits, excluding leading zeros.</p>
-128	<p>Numeric data not allowed</p> <p>A numeric value was received within a command which does not accept a numeric value. For example, MEM:CLE 24.</p>
-131	<p>Invalid suffix</p> <p>A suffix was incorrectly specified for a numeric parameter. You may have misspelled the suffix. For example, SENS:FREQ 200KZ.</p>
-134	<p>Suffix too long</p> <p>A suffix used contained more than 12 characters. For example, SENS:FREQ 2MHZZZZZZZZZZ.</p>
-138	<p>Suffix not allowed</p> <p>A suffix was received following a numeric parameter which does not accept a suffix. For example, INIT:CONT 0Hz.</p>
-148	<p>Character data not allowed</p> <p>A discrete parameter was received but a character string or a numeric parameter was expected. Check the list of parameters to verify that you have used a valid parameter type. For example, MEM:CLE CUSTOM_1.</p>
-151	<p>Invalid string data</p> <p>An invalid string was received. Check to see if you have enclosed the character string in single or double quotes. For example, MEM:CLE "CUSTOM_1".</p>
-158	<p>String data not allowed</p> <p>A character string was received but is not allowed for the command. Check the list of parameters to verify that you have used a valid parameter type. For example, LIM:STAT 'ON'.</p>
-161	<p>Invalid block data</p> <p>A block data element was expected but was invalid for some reason. For example, *DDT #15FET. The 5 in the string indicates that 5 characters should follow, whereas in this example there are only 3.</p>

-168	Block data not allowed A legal block data element was encountered but not allowed by the power meter at this point. For example SYST:LANG #15FETC?.
-178	Expression data not allowed A legal expression data was encountered but not allowed by the power meter at this point. For example SYST:LANG (5+2).
-211	Trigger ignored Indicates that <GET> or *TRG, or TRIG:IMM was received and recognized by the device but was ignored because the power meter was not in the wait for trigger state.
-213	Init ignored Indicates that a request for a measurement initiation was ignored as the power meter was already initiated. For example, INIT:CONT ON INIT.
-214	Trigger deadlock TRIG:SOUR was set to HOLD or BUS and a READ? or MEASure? was attempted, expecting TRIG:SOUR to be set to IMMEDIATE.
-220	Parameter error; Frequency list must be in ascending order. Indicates that the frequencies entered using the MEMory:TABLE:FREquency command are not in ascending order.
-221	Settings conflict This message occurs under a variety of conflicting conditions. The following list gives a few examples of where this error may occur: If the READ? parameters do not match the current settings. If you are in fast mode and attempting to switch on for example, averaging, duty cycle or limits. Trying to clear a sensor calibration table when none is selected.
-222	Data out of range A numeric parameter value is outside the valid range for the command. For example, SENS:FREQ 2KHZ.
-224	Illegal parameter value A discrete parameter was received which was not a valid choice for the command. You may have used an invalid parameter choice. For example, TRIG:SOUR EXT.

-226	Lists not same length This occurs when SENSE:CORRection:CSET[1] CSET2:STATE is set to ON and the frequency and calibration/offset lists do not correspond in length.
-230	Data corrupt or stale;Please calibrate Channel B When CAL[1 2]:RCAL is set to ON and the sensor currently connected to Channel B has not been calibrated, then any command which would normally return a measurement result (for example FETC?, READ?, or MEAS?) will generate this error message.
-231	Data questionable;CAL ERROR Power meter calibration failed. The most likely cause is attempting to calibrate without applying a 1 mW power to the power sensor.
-231	Data questionable;CAL ERROR ChA Power meter calibration failed on Channel A. The most likely cause is attempting to calibrate without applying a 1 mW power to the power sensor.
-231	Data questionable;CAL ERROR ChB Power meter calibration failed on Channel B. The most likely cause is attempting to calibrate without applying a 1 mW power to the power sensor.
-231	Data questionable;Input Overload The power input to Channel A exceeds the power sensor's maximum range.
-231	Data questionable;Input Overload ChA The power input to Channel A exceeds the power sensor's maximum range.
-231	Data questionable;Input Overload ChB The power input to Channel B exceeds the power sensor's maximum range.
-231	Data questionable;Lower window log error This indicates that a difference measurement in the lower window has given a negative result when the units of measurement were logarithmic.
-231	Data questionable;Upper window log error This indicates that a difference measurement in the upper window has given a negative result when the units of measurement were logarithmic.
-231	Data questionable;ZERO ERROR Power meter zeroing failed. The most likely cause is attempting to zero when some power signal is being applied to the power sensor.

-231	Data questionable;ZERO ERROR ChA Power meter zeroing failed on Channel A. The most likely cause is attempting to zero when some power signal is being applied to the power sensor.
-231	Data questionable;ZERO ERROR ChB Power meter zeroing failed on Channel B. The most likely cause is attempting to zero when some power signal is being applied to the power sensor.
-241	Hardware missing The power meter is unable to execute the command because either no power sensor is connected or it expects an E-Series or N8480 Series power sensor and one is not connected.
-310	System error;Dty Cyc may impair accuracy with ECP sensor This indicates that the sensor connected is for use with CW signals only.
-310	System error;Ch A Dty Cyc may impair accuracy with ECP sensor This indicates that the sensor connected to Channel A is for use with CW signals only.
-310	System error;Ch B Dty Cyc may impair accuracy with ECP sensor This indicates that the sensor connected to Channel B is for use with CW signals only.
-310	System error;Sensor EEPROM Read Failed - critical data not found or unreadable This indicates a failure with your E-Series or N8480 Series power sensor. Refer to your power sensor manual for details on returning it for repair.
-310	System error;Sensor EEPROM Read Completed OK but optional data block(s) not found or unreadable This indicates a failure with your E-Series or N8480 Series power sensor power sensor. Refer to your power sensor manual for details on returning it for repair.
-310	System error;Sensor EEPROM Read Failed - unknown EEPROM table format This indicates a failure with your E-Series or N8480 Series power sensor power sensor. Refer to your power sensor manual for details on returning it for repair.
-310	System error;Sensor EEPROM < > data not found or unreadable Where < > refers to the sensor data block covered, for example, Linearity, Temp - Comp (temperature compensation). This indicates a failure with your E-Series or N8480 Series power sensor power sensor. Refer to your power sensor manual for details on returning it for repair.
-310	System error;Sensors connected to both front and rear inputs. You cannot connect two power sensors to the one channel input. In this instance the power meter detects power sensors connected to both it's front and rear channel inputs.
-321	Out of memory The power meter required more memory than was available to run an internal operation.

-330	Self-test Failed; The -330, "Self-test Failed" errors indicate that you have a problem with your power meter. Refer to Contacting Keysight Technologies on page 119 for details of what to do with your faulty power meter.
-330	Self-test Failed;Measurement Channel Fault
-330	Self-test Failed;Measurement Channel A Fault
-330	Self-test Failed;Measurement Channel B Fault
-330	Self-test Failed;Calibrator Fault Refer to "Calibrator" on page 104 if you require a description of the calibrator test.
-330	Self-test Failed;ROM Check Failed
-330	Self-test Failed;RAM Check Failed
-330	Self-test Failed;Display Assy. Fault Refer to "Display" on page 104 if you require a description of the Display test.
-350	Queue overflow The error queue is full and another error has occurred which could not be recorded.
-361	Parity error in program The serial port receiver has detected a parity error and consequently, data integrity cannot be guaranteed.
-362	Framing error in program The serial port receiver has detected a framing error and consequently, data integrity cannot be guaranteed.
-363	Input buffer overrun The serial port receiver has been overrun and consequently, data has been lost.
-410	Query INTERRUPTED A command was received which sends data to the output buffer, but the output buffer contained data from a previous command (the previous data is not overwritten). The output buffer is cleared when power has been off, or after *RST (reset) command has been executed.
-420	Query UNTERMINATED The power meter was addressed to talk (that is, to send data over the interface) but a command has not been received which sends data to the output buffer. For example you may have executed a CONFigure command (which does not generate data) and then attempted to read data from the remote interface.

-430	Query DEADLOCKED A command was received which generates too much data to fit in the output buffer and the input buffer is also full. Command execution continues but data is lost.
-440	Query UNTERMINATED after indefinite response The *IDN? command must be the last query command within a command string.

SYSTem:HELP:HEADers?

This query returns a list of all SCPI commands supported by the instrument.

Data is returned in IEEE 488.2 arbitrary block program data format as shown in [Figure 14-1](#) below.

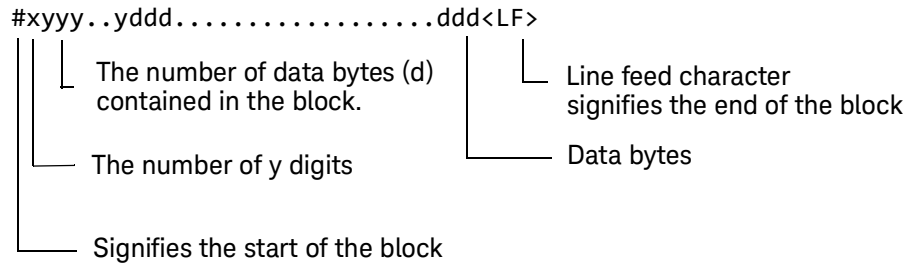

Example: if there are 12435 data bytes, y = 12435 and x = 5

Figure 14-1 IEEE 488.2 Arbitrary Block Program Data Format

Each point in the trace is represented as an IEEE 754 32 bit floating point number, made up of four bytes in the data block. The MS byte is transmitted first. Each complete block is terminated by a line feed.

Commands are listed in alphabetical order.

Syntax



Example

SYST:HELP:HEAD?

This command returns the SCPI commands supported by the instrument.

SYSTem:LANGuage <character_data>

This command is used to change the remote programming language accepted by the power meter from SCPI to the HP 436A/HP 437B or HP 438A programming language.

To return to use the SCPI programming language from the HP 436A/HP 437B or HP 438A mode, use the SYST:LANG SCPI command. After sending the command to change the language, wait one second before sending any other commands. When changing between languages the power meter is placed into local mode. It is recommended that the instrument is preset following a language switch.

NOTE

- There will be GPIB reconfiguration during the language switch. It is recommended to wait for one second to avoid problems.
- Refer to [Appendix B, "HP 436A/HP 437B/HP 438A Command Summary,"](#) for the complete list of HP 436A/HP 437B/HP 438A command summary.

NOTE

Option 200 can only support 8480 series, N8480 series CFT-option, and E4412/3A power sensors.

Syntax

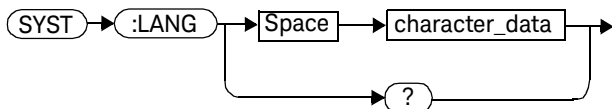

Parameters

Item	Description	Range of Values
character_data	Character data containing the programming language	SCPI HP 436A (for N1913A) HP 437B (for N1913A) HP 438A (for N1914A)

Example

SYST:LANG HP437B

This command sets the power meter to perform using the HP 437B programming language.

Query

SYSTem:LANGuage?

The query returns the current setting of the remote programming language.

Query Example

SYST:LANG?

This command queries the setting of the remote programming language.

NOTE

For option 200, the query returns the current setting of the remote programming language with up to 5 characters only. For example, the command **SYST:LANG?** returns **HP437**.

Error Message

If Option 200 is not installed and the HP 436A, HP 437B, or HP 438A language is set, error -224, "Illegal parameter value" occurs.

SYSTEM:LICense:INSTall <license_string>

This command will install the valid licensed option according to the license string.

Syntax



SYSTem:LICense:LIST?

This query will return all the installed license string.

Syntax

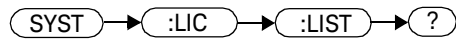

Example

SYST:LIC:LIST?

This command returns the installed license string.

SYSTem:LICense:REMove <license_string>

This command will remove the valid installed option according to the license string.

Syntax

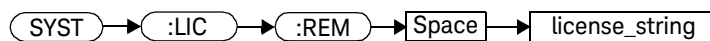

SYSTem:LOCal

This command unlocks the front panel keypad and enables the power meter to be controlled from the front panel. The power meter display status reporting line shows “LCL”.

Syntax

SYST → **:LOC** →

Example

SYST:LOC

This command unlocks the power meter front panel keypad and enables local front panel control.

SYSTem:PERSONa:MANufacturer <“string”>

This command specifies the instrument’s manufacturer. This command only accepts two non case-sensitive strings – “Agilent Technologies” and “Keysight Technologies”. A power cycle or reboot is required for the changes in the instrument’s manufacturer string to take effect for ***IDN?**. The string will remain for the subsequent power cycle or reboot.

Syntax

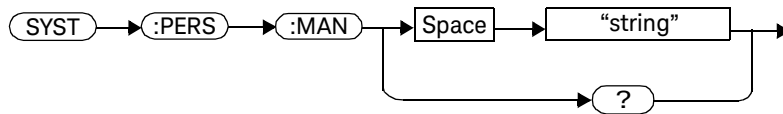

Examples

- SYST:PERS:MAN “Agilent Technologies”** *This command sets the instrument’s manufacturer to “Agilent Technologies”.*
- SYST:PERS:MAN “Keysight Technologies”** *This command sets the instrument’s manufacturer to “Keysight Technologies”.*

Reset Condition

On reset, the manufacturer string is not affected.

Query

SYSTem:PERSONa:MANufacturer?

The query returns the manufacturer string that was set.

Query Example

- SYST:PERS:MAN?** *Queries the manufacturer string that was set.*

Error Message

If <“string”> is not set to “Agilent Technologies” or “Keysight Technologies”, error -158, “String data not allowed” occurs.

SYSTem:PERSONa:MANuufacturer:DEFault

This command sets the instrument's manufacturer to "Keysight Technologies" which is the default manufacturer setting. A power cycle or reboot is required for the changes in the instrument's manufacturer string to take effect for ***IDN?**. The setting will remain for the subsequent power cycle or reboot.

Syntax

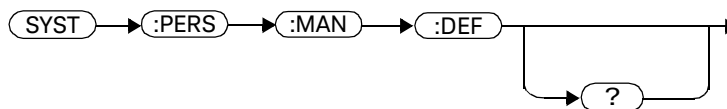

Examples

SYST:PERSONa:MANuufacturer:DEF *This command sets the instrument's manufacturer to "Keysight Technologies" which is the default manufacturer setting.*

Reset Condition

On reset, the manufacturer string is not affected.

Query

SYSTem:PERSONa:MANuufacturer:DEFault?

The query returns the default manufacturer string.

Query Example

SYST:PERSONa:MANuufacturer:DEF? *Queries the default manufacturer string.*

SYSTEM:Preset

This command is used to preset the power meter. The result of this command is similar to the *RST command. Refer to [Table 14-1](#) for more information about the preset settings.

NOTE

- All settings apply to both *RST and SYSTEM:PREset unless stated otherwise.
- This command will also preset the U2000 Series power sensors when the sensors are connected to the N1913/1914A with USB option installed.

Syntax

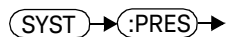

Example

SYST:PREs

This command presets the power meter

Table 14-1 Preset Settings

Command	Setting	Comments
CALC[1] 2 3 4:FEED[1] 2	"POW:AVER"	Select average measurement type
CALC[1] 2 3 4:GAIN[:MAGN]	0.000 dB	Display offset value
CALC[1] 2 3 4:GAIN:STAT	OFF	Display offset disabled
CALC[1] 2 3 4:LIM:CLE:AUTO	ON	Clear limit data at INIT
CALC[1] 2 3 4:LIM:LOW[:DATA]	-90 dBm	Lower limit
CALC[1] 2 3 4:LIM:STAT	OFF	Window limits checking disabled
CALC[1] 2 3 4:LIM:UPP[:DATA]	+90 dBm	

Command	Setting	Comments
CALC[1] 2 3 4 : MATH [: EXPR]	Keysight N1913A: Upper - channel A Lower - channel A Keysight N1914A: Upper - channel A Lower - channel B Keysight N1913A (USB option): Upper upper - channel A Lower upper - channel A Upper lower - channel C Lower lower - channel D Keysight N1914A (USB option): Upper upper - channel A Lower upper - channel B Upper lower - channel C Lower lower - channel D	Math expression
CALC[1] 2 3 4 : REL [: MAGN] : AUTO	OFF	Reference value disabled
CALC[1] 2 3 4 : REL : STAT	OFF	Relative offset disabled
CAL [1] 2 : RCAL	not affected	Zero/cal lockout
CAL [1] 2 : RCF	100.0%	Reference calibration factor
DISP : ENAB	ON	Display enabled
DISP : SCR : FORM	WIND	Display format set to windowed
DISP [: WIND [1] 2] : ANAL : LOW	-70 dBm	Lower scale limit
DISP [: WIND [1] 2] : ANAL : UPP	20 dBm	Upper scale limit
DISP [: WIND [1] 2] : FORM	Keysight N1913A: Upper - digital Lower - analog Keysight N1914A: Upper - digital Lower - digital Keysight N1913/1914A (USB option): Upper - dual numeric Lower - dual numeric	Display format
DISP [: WIND [1] 2] : MET : LOW	-70.000 dBm	Analog meter lower limit

Command	Setting	Comments
DISP[:WIND[1] 2]:MET:UPP	+20.000 dBm	Analog meter upper limit
DISP[:WIND[1] 2] [:NUM[1] 2]:RES	3	Window resolution
DISP[:WIND[1] 2]:SEL[1] 2	upper window	Window selected
DISP[:WIND[1] 2][:STAT]	ON	Both windows enabled on display
FORM[:READ]:BORD	normal	Binary order
FORM[:READ][:DATA]	ascii	Data format
INIT[1] 2:CONT	*RST: OFF SYS:PRES ON	Power Meter in idle state Power Meter in wait for trigger state
MEM:TABL:SEL	not affected	Active sensor calibration table
OUTP:REC[1] 2:FEED	not affected	Previous measurement
OUTP:REC[1] 2:LIM:LOW	-150 dBm	Minimum scaling value
OUTP:REC[1] 2:LIM:UPP	20 dBm	Maximum scaling value
OUTP:ROSC:STAT	OFF	50 MHz reference disabled
OUTP:TRIG:STAT	OFF	Trigger output signal disabled
[SENS[1]] SENS2:AVER:COUN	4	Filter length
[SENS[1]] SENS2:AVER:COUN:AUTO	ON	Auto-filtering enabled
[SENS[1]] SENS2:AVER:SDET	1	Step detection enabled
[SENS[1]] SENS2:AVER[:STAT]	ON	Averaging enabled
[SENS[1]] SENS2:CORR:CFAC GAIN[1][:INPut][:MAGNitude]	100.0%	Calibration factor
[SENS[1]] SENS2:CORR:CSET[1] CSET2[:SEL]	not affected	Selected sensor calibration table
[SENS[1]] SENS2:CORR:CSET[1] CSET2:STAT	not affected	Sensor calibration table disabled
[SENS[1]] SENS2:CORR:DCYC GAIN3 [:INP][:MAGN]	1.000%	Duty cycle factor
[SENS[1]] SENS2:CORR:DCYC GAIN3 :STAT	OFF	Duty cycle correction disabled

Command	Setting	Comments
[SENS[1]] SENS2:CORR:FDOF GAIN4 [:INP][:MAGN]	not affected	Return frequency dependent offset
[SENS[1]] SENS2:CORR:GAIN2:STAT	OFF	Channel offset disabled
[SENS[1]] SENS2:CORR:GAIN2:STAT [:INPut][:MAGNitude]	0.0 dB	Enter channel offset value
[SENS[1]] SENS2:FREQ[:CW]:FIX]	+50.000 MHz	Frequency setting
[SENSe[1]] SENS2:MRAT	NORM	Measurement speed
[SENS[1]] SENS2:POW:AC:RANG	upper	Upper range selected
[SENS[1]] SENS2:POW:AC:RANG: AUTO	ON	Auto-ranging selected
[SENS[1]] SENS2:SPE	20 readings/ second	Speed
[SENS[1]] SENS2:V2P	ATYP	Select linearity correction
SERV:BACK:BRIG	80	Backlight intensity of front panel
SYST:GPIB[:SELF]ADDR	not affected	Power meter address
TRIG[1] 2:DEL:AUTO	ON	Insert settling time delay
TRIG[:SEQ]:SLOP	POS	Trigger event recognized on rising edge
TRIG[:SEQ[1] 2]:COUN	1	Trigger events for measurement cycle
TRIG[:SEQ[1] 2]:DEL:AUTO	ON	Enable settling time delay
TRIG[:SEQ[1] 2]:SOUR	IMM	Trigger source set up
UNIT:POW	dBm	Power units
UNIT:POW:RAT	dB	Ratio units

SYSTem:REMOte

This command locks the power meter front panel keypad excepting the **Local** key. The power meter display status reporting line shows “RMT”. **Local** front panel operation of the power meter is inhibited but can be enabled by pressing the **Local** key.

Syntax

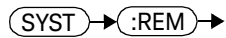

SYST → :REM →

Example

SYST:REM

This command locks the power meter front panel keypad excepting the Local key.

SYSTem:RWLock

This command locks out the front panel keypad - including the front panel Local key. The power meter display status reporting line shows **“RMT”**. In this state the power meter cannot be returned to manual control from the front panel.

Syntax

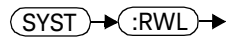

```
SYST → :RWL →
```

Example

SYST:RWL

This command locks the power meter front panel keypad - including the Local key.

SYSTEM:SET <arbitrary_block_data>

This command is used to set the power meter state as defined by the data returned by *LRN? query.

Syntax

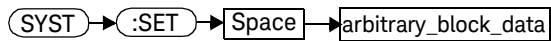

Parameters

Item	Description	Range of Values
arbitrary_block_data	The block data which is returned by *LRN query.	#nN<instrument state> ^[a]

[a] The first digit after the # indicates the number of following digits. The following digits indicate the length of the data.

SYSTem:VERSion?

This query returns the version of SCPI used in the power meter. The response is in the form of XXXX.Y, where XXXX is the year and Y is the version number.

Syntax



Example

SYST:VERS?

This command queries which version of SCPI is used in the power meter.

15 TRIGger Subsystem

TRIGger Subsystem	546
ABORt[1] 2 3 4:	548
INITiate Commands	549
INITiate[1] 2 3 4:CONTInuous <boolean>	550
INITiate[1] 2 3 4[:IMMediate]	552
INITiate:CONTInuous:ALL <boolean>	553
INITiate:CONTInuous:SEQuence[1] 2 3 4 <boolean>	555
INITiate[:IMMediate]:ALL	557
INITiate[:IMMediate]:SEQuence[1] 2 3 4	558
TRIGger Commands	559
TRIGger[1] 2 3 4:DELay:AUTO <boolean>	560
TRIGger[1] 2 3 4[:IMMediate]	562
TRIGger[1] 2 3 4:SOURce BUS EXTErnal HOLD IMMediate	563
TRIGger3 4:SOURce EXTErnal	566
TRIGger[:SEQuence[1] 2 3 4]:SLOPe <character_data>	567
TRIGger[:SEQuence[1] 2 3 4]:COUNT <numeric_value>	569
TRIGger:SEQuence3 4:DELay <numeric_value>	572
TRIGger[:SEQuence[1] 2 3 4]:DELay:AUTO <boolean>	574
TRIGger:SEQuence3 4:HOLDoff <numeric_value>	576
TRIGger[:SEQuence[1] 2 3 4]:IMMediate	578
TRIGger[:SEQuence[1] 2 3 4]:SOURce BUS EXTErnal HOLD IMMediate	579

This chapter explains how the **TRIGger** command subsystem is used to synchronize device actions with events.

TRIGger Subsystem

The **TRIGger** subsystem is used to synchronize device actions with events. It includes the **ABORt**, **INITiate** and **TRIGger** commands. These are all at the root level in the command hierarchy but they are grouped here because of their close functional relationship.

Keyword	Parameter Form	Notes	Page
ABORt[1] 2 3 4		[no query] [non-SCPI]	page 548
INITiate[1] 2 3 4			
:CONTInuous	<boolean>		page 550
[:IMMediate]		[no query]	page 552
INITiate			
:CONTInuous			
:ALL	<boolean>		page 553
:SEQuence[1] 2 3 4	<boolean>		page 555
[:IMMediate]			
:ALL		[no query]	page 557
:SEQuence[1] 2 3 4		[no query]	page 558
TRIGger[1] 2 3 4			
:DELay			
:AUTO	<boolean>		page 560
[:IMMediate]		[no query]	page 562
:SOURce	BUS EXTernal HOLD IMMediate		page 563
TRIGger3 4			
:SOURce	EXTernal		page 566
TRIGger			
[:SEQuence[1] 2 3 4]			

Keyword	Parameter Form	Notes	Page
:SLOPe	<character_data>		page 567
:COUNT	<numeric_value>		page 569
:SEQuence3 4			
:DELay	<numeric_value>		page 572
[:SEQuence[1] 2 3 4]			
:DELay			
:AUTO	<boolean>		page 574
:SEQuence3 4			
:HOLDoff	<numeric_value>		page 576
[:SEQuence[1] 2 3 4]			
:IMMediate		[no query]	page 578
[:SEQuence[1] 2 3 4]			
:SOURce	BUS EXTErnal HOLD IMMediate		page 579

Many of the above commands contain a numeric which represents a channel number. For example **TRIGger1** and **TRIGger2** represent Channel A and Channel B respectively. Channel B commands cannot be used with the single Channel N1913A power meter and result in the error "Header suffix out of range."

ABORt[1]|2|3|4:

This command removes the specified channel from the wait for trigger state and places it in the idle state. It does not affect any other settings of the trigger system. When the **INITiate** command is sent, the trigger system responds as it did before **ABORt** was executed.

If **INITiate:CONTinuous** is **ON**, then after **ABORt** the specified channel immediately goes into the wait for trigger state.

Syntax

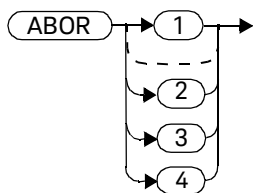

Example

ABOR

This command places Channel A in the idle state.

INITiate Commands

Initiate commands allow you to place the power meter in the wait for trigger state.

The **INITiate** commands are overlapped, that is, the power meter can continue parsing and executing subsequent commands while initiated. Note that the pending operation flag is set, when the power meter moves out of the idle state and the flag is cleared when it re-enters the idle state.

The following commands are described in this section:

```
INITiate[1]|2|3|4:CONTinuous <boolean>
```

```
INITiate[1]|2|3|4[:IMMediate]
```

```
INITiate:CONTinuous:ALL <boolean>
```

```
INITiate:CONTinuous:SEquence[1]|2|3|4 <boolean>
```

```
INITiate[:IMMediate]:ALL
```

```
INITiate[:IMMediate]:SEquence[1]|2|3|4
```

INITiate[1]|2|3|4:CONTinuous <boolean>

This command sets the power meter for either a single trigger cycle or continuous trigger cycles. A trigger cycle means that the power meter exits the wait for trigger state and starts a measurement.

When entering local mode, if **TRIGger[:SEquence[1]|2]:SOURce** is set to **EXT**, **INITiate:CONTinuous** is not changed. For other trigger sources, **INITiate:CONTinuous** is set to **ON**.

If **INITiate:CONTinuous** is set to:

- **OFF**, the trigger system remains in the idle state until it is set to **ON**, or **INITiate:IMMediate** is received. Once this trigger cycle is complete the trigger system returns to the idle state.
- **ON**, the trigger system is initiated and exits the idle state. On completion of each trigger cycle, the trigger system immediately commences another trigger cycle without entering the idle state.

NOTE

This command performs the same function as **INITiate:CONTinuous:SEquence[1]|2|3|4 <boolean>**.

Syntax

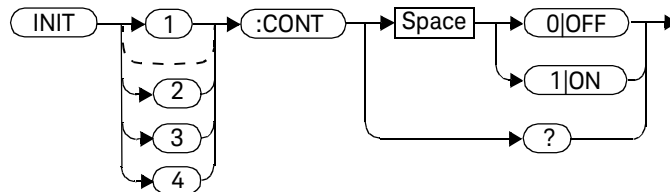

Example

INIT2:CONT ON

This command places Channel B in the wait for trigger state.

Reset Condition

On reset (***RST**), this command is set to **OFF**.

On preset (**SYSTem:PRESet**) and instrument power-up, when entering local mode, if **TRIGger[:SEQuence[1]|2]:SOURce** is set to **EXT**, **INITiate:CONTinuous** is not changed. For other trigger sources, **INITiate:CONTinuous** is set to **ON**.

Query

INITiate[1]|2|3|4:CONTinuous?

The query enters a 1 or 0 into the output buffer.

- 1 is returned when there is continuous triggering
- 0 is returned when there is only a single trigger

Query Example

INIT2:CONT?

This command queries whether Channel B is set for single or continuous triggering.

INITiate[1]|2|3|4[:IMMEDIATE]

This command sets the power meter in the wait for trigger state. When a trigger is received, the measurement is taken and the result placed in the power meter memory. If **TRIGger:SOURce** is set to **IMMEDIATE** the measurement begins as soon as **INITiate:IMMEDIATE** is executed.

Use **FETCH?** to transfer a measurement from memory to the output buffer. Refer to “**FETCH[1]|2|3|4 Queries**” on page 136 for further details.

NOTE

This command performs the same function as **INITiate:[IMMEDIATE]:SEQUENCE[1]|2|3|4**.

Syntax

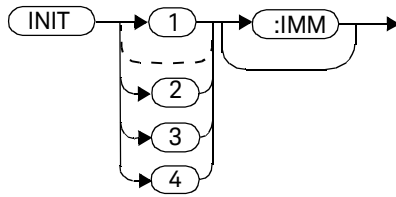

Example

INIT2:IMM

This command places Channel B in the wait for trigger state.

Error Messages

If the power meter is not in the idle state or **INITiate:CONTinuous** is **ON**, error -213, “INIT ignored” occurs.

INITiate:CONTInuous:ALL <boolean>

Sets all trigger sequences to be continuously initiated.

If **INITiate:CONTInuous:ALL** is set to:

- **ON**, trigger sequences are set to be continuously initiated
- **OFF**, trigger sequences are not set to be continuously initiated

Syntax

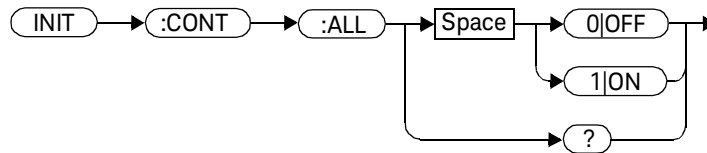

Example

INIT:CONT:ALL ON

This command sets all trigger sequences to be continuously initiated.

Reset Condition

On reset (***RST**), this command is set to **OFF**.

On preset (**SYSTem:PRESet**) and instrument power-up, when entering local mode, if **TRIGger[:SEquence[1]|2]:SOURce** is set to **EXT**, **INITiate:CONTInuous** is not changed. For other trigger sources, **INITiate:CONTInuous** is set to **ON**.

Query

INITiate:CONTInuous:ALL?

The query enters a 1 or 0 into the output buffer.

- 1 is returned when trigger sequences are set to be continuous
- 0 is returned when trigger sequences are not set to be continuous

Query Example

INIT:CONT:ALL?

This command queries whether both channels are in a wait for trigger state.

INITiate:CONTInuous:SEQuence[1]|2|3|4 <boolean>

This command sets the power meter for either a single trigger cycle or continuous trigger cycles. A trigger cycle means that the power meter exits the wait for trigger state and starts a measurement. When entering local mode, **INITiate:CONTInuous** is set to **ON**.

If **INITiate:CONTInuous:SEQuence[1]|2|3|4] <boolean>** is set to:

- **OFF**, the trigger system remains in the idle state until it is set to **ON**, or **INITiate:IMMediate** is received. Once this trigger cycle is complete the trigger system returns to the idle state.
- **ON**, the trigger system is initiated and exits the idle state. On completion of each trigger cycle, the trigger system immediately commences another trigger cycle without entering the idle state.

NOTE

This command performs the same functions as **INITiate[1]|2|3|4:CONTInuous <boolean>**.

Syntax

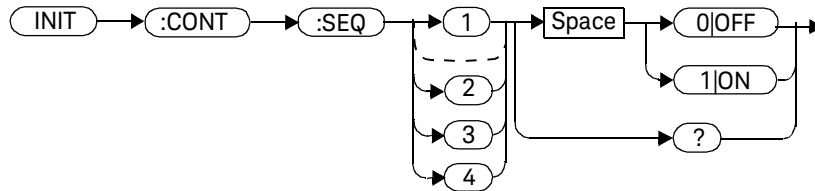

Example

INIT:CONT:SEQ2 ON

This command places Channel B in a wait for trigger state.

Reset Condition

On reset (***RST**), this command is disabled.

On preset (**SYSTem:PRESet**) and instrument power-up, this command is enabled.

Query

INITiate[1]|2|3|4:CONTinuous:SEQuence?

The query enters a 1 or 0 into the output buffer.

- 1 is returned when there is continuous triggering
- 0 is returned when there is only a single trigger

Query Example

INIT2:CONT:SEQ?

This command queries whether Channel B is set for single or continuous triggering.

INITiate[:IMMEDIATE]:ALL

This command initiates all trigger sequences.

Syntax



Example

INIT:IMM:ALL

This command initiates all trigger sequences.

Error Messages

If the power meter is not in the idle state or **INITiate:CONTinuous** is **ON**, error -213, “INIT ignored” occurs.

INITiate[:IMMEDIATE]:SEQUENCE[1]|2|3|4

This command sets the power meter in the wait for trigger state. When a trigger is received, the measurement is taken and the result placed in the power meter memory. If **TRIGger:SOURce** is set to **IMMEDIATE** the measurement begins as soon as **INITiate:IMMEDIATE** is executed.

Use **FETCh?** to transfer a measurement from memory to the output buffer. Refer to “**FETCh[1]|2|3|4 Queries**” on page 136 for further information.

NOTE

This command performs the same function as **INITiate[1]|2|3|4:[IMMEDIATE]**.

Syntax

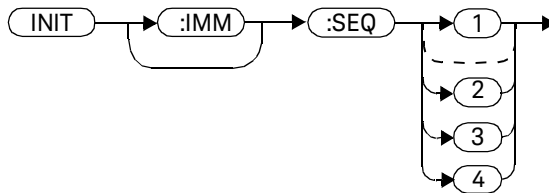

Example

INIT:IMM:SEQ1

This command places Channel A in the wait for trigger state.

Error Messages

If the power meter is not in the “idle” state or **INITiate:CONTinuous** is **ON**, error -213, “INIT ignored” occurs.

TRIGger Commands

TRIGger commands control the behavior of the trigger system.

The following commands are described in this section:

TRIGger[1]|2|3|4:DELay:AUTO <boolean>

TRIGger[1]|2|3|4:SOURce BUS|EXTernal|HOLD|IMMediate

TRIGger[1]|2|3|4[:IMMediate]

TRIGger[:SEquence[1]|2|3|4]:SLOPe <character_data>

TRIGger[:SEquence[1]|2|3|4]:COUNT <numeric_value>

TRIGger[:SEquence[1]|2|3|4]:DELay:AUTO <boolean>

TRIGger[:SEquence[1]|2|3|4]:IMMediate

TRIGger[:SEquence[1]|2|3|4]:SOURce BUS|EXTernal|HOLD|IMMediate

TRIGger[1]|2|3|4:DELAy:AUTO <boolean>

This command is used to determine whether or not there is a settling-time delay before a measurement is made.

When this command is set to:

- **ON**, the power meter inserts a settling-time delay before taking the requested measurement. This settling time allows the internal digital filter to be updated with new values to produce valid, accurate measurement results. The trigger with delay command allows settling time for the internal amplifiers and filters. It does not allow time for power sensor delay.

In cases of large power changes, the delay may not be sufficient for complete settling. Accurate readings can be assured by taking two successive measurements for comparison.

- **OFF**, the power meter makes the measurement immediately a trigger is received.

TRIGger[1]|2|3|4:DELAy:AUTO is ignored if TRIGger[1]|2|3|4[:IMMediate] is set to ON.

Syntax

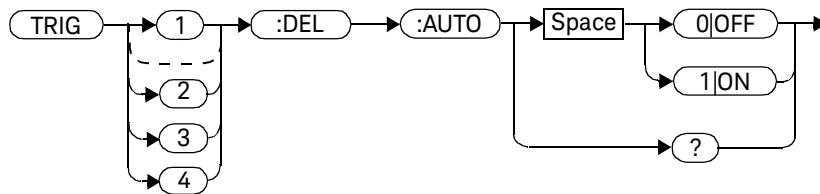

Example

TRIG:DEL:AUTO ON

This command enables a delay on Channel A.

Reset Condition

On reset, **TRIGger:DELay:AUTO** is set to **ON**.

Query

TRIGger:DELay:AUTO?

The query enters a 1 or 0 into the output buffer indicating the status of **TRIGger:DELay:AUTO**.

- 1 is returned when it is **ON**
- 0 is returned when it is **OFF**

TRIGger[1]|2|3|4[:IMMEDIATE]

This command causes a trigger to occur immediately, provided the specified channel is in the wait for trigger state. When this command is executed, the measurement result is stored in the power meter's memory. Use **FETCh?** to place the measurement result in the output buffer.

TRIGger[1]|2|3|4:DELay:AUTO is ignored if **TRIGger[1]|2|3|4[:IMMEDIATE]** is set to **ON**.

NOTE

This command performs the same function as **INITiate[1]|2|3|4[:IMMEDIATE]**.

Syntax

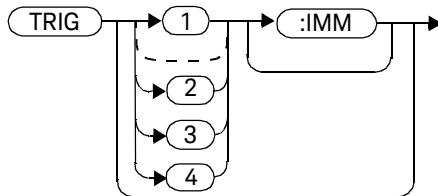

Example

TRIG

This command causes a Channel A trigger to occur immediately.

Error Messages

If the power meter is not in the wait for trigger state, then **TRIGger:IMMEDIATE** causes error -211, "Trigger ignored".

TRIGger[1]|2|3|4:SOURce BUS|EXTErna|HOLD|IMMediate

This command configures the trigger system to respond to the specified source. This command only selects the trigger source. Use the **INITiate** command to place the power meter in the wait for trigger state.

NOTE

This command has been included for compatibility purposes. It has the same purpose as TRIGger[:SEquence[1]|2|3|4]:SOURce BUS|EXTErna|HOLD|IMMediate which should be used in preference.

Syntax

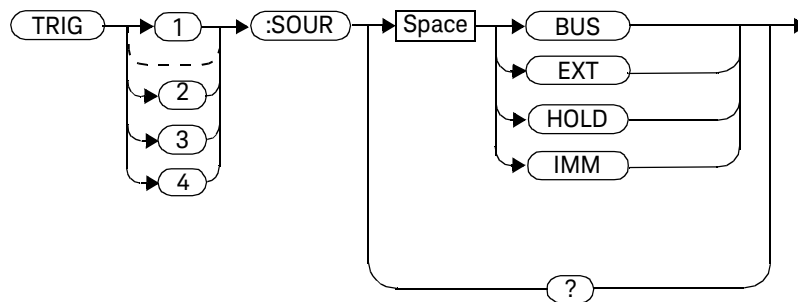

Parameters

Item	Description/Default	Range of Values
source	Available trigger sources: <ul style="list-style-type: none"> - BUS: the trigger source is the group execute trigger <GET> bus command, a *TRG common command or the TRIGGER:IMMEDIATE SCPI command. - EXternal: the trigger source is the trigger input in the back panel. - HOLD: triggering is suspended. The only way to trigger the power meter is to use TRIGGER:IMMEDIATE. - IMMEDIATE: the trigger system is always true. If INITiate:CONTinuous is ON the power meter is continually triggering free (free run mode). If an INITiate:IMMEDIATE command is sent a measurement is triggered then the power meter returns to the idle state. 	BUS EXternal HOLD IMMEDIATE

NOTE

The trigger source is set to **IMMEDIATE** on instrument power-up and when entering local mode.

The **MEASure** and **CONFigure** commands automatically set the trigger source to **IMMEDIATE**.

The **READ?** or **MEASure** commands should not be used if the trigger source is set to **BUS** or **HOLD**.

Example

```
TRIG:SOUR IMM
```

This command configures Channel A for immediate triggering.

Reset Condition

On reset, the trigger source is set to **IMMEDIATE**.

Query

TRIGger:SOURce?

The query returns the current trigger source, either **IMM**, **BUS** or **HOLD**.

Query Example

TRIG:SOUR?

This command queries Channel A's trigger source.

Error Messages

- For dual channel power meters: if the leader is changed to **IMM**, **BUS** or **HOLD**, error –221 “Settings Conflict” occurs. In such situations the follower’s **TRIG:SOUR** must be changed so that it is no longer a follower.
- If the source is changed to **INT1**, **INT2** or **EXT** and **SENS:SPEED** has a value of 200, error –221 “Settings Conflict” occurs.
- If the source is changed to **INT1**, **INT2** or **EXT** and **SENS:DET:FUNC** is set to **AVERAge**, error –221 “Settings Conflict” occurs.

TRIGger3|4:SOURce EXTERNAL

This command configures the trigger system to respond to the specified source. This command only sets the external trigger source. Use the **INITiate** command to place the power meter in the wait for trigger state.

NOTE

This command is only applicable for the U2040 X-Series power sensors.

Syntax

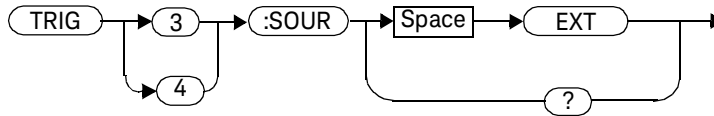

Example

TRIG3:SOUR EXT

This command configures Channel C for external triggering.

Query

TRIGger3|4:SOURce?

The query returns the current trigger source as **EXT**.

Query Example

TRIG3:SOUR?

This command queries Channel C's trigger source.

TRIGger[:SEQuence[1]]|2|3|4]:SLOPe <character_data>

This command specifies whether a trigger event is recognized on the rising or falling edge of a signal.

NOTE

This command is also applicable for external triggered average measurement when used with 8480, N8480, E4410, E9300 or U2000 Series sensor (Average mode only).

Syntax

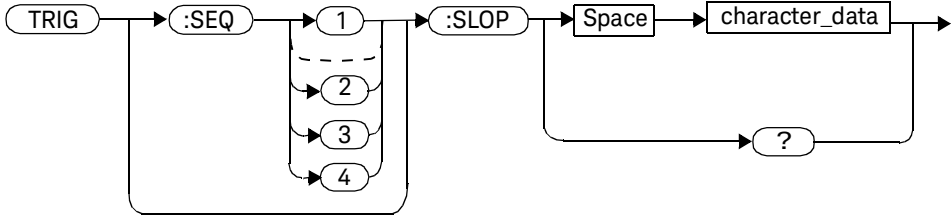

Parameters

Item	Description/Default	Range of Values
character_data	How a trigger event is recognized: - POSitive : a trigger event is recognized on the rising edge of a signal. - NEGative : a trigger event is recognized on the falling edge of a signal.	POSitive NEGative

Example

TRIG:SEQ:SLOP NEG

This command sets the trigger event to be recognized on the falling edge of the triggering signal.

Reset Condition

On reset the value is set to **POSitive**.

Query

TRIGger[:SEQuence[1]|2|3|4]:SLOPe?

The query returns the current value of **<character_data>**.

Query Example

TRIG:SEQ:SLOP?

This command queries the current value of <character_data> for Channel A.

Error Messages

- If 8480, N8480, E4410, E9300 or U2000 Series sensor is connected and trigger source is not set to external, -221 "Settings conflict" occurs.

TRIGger[:SEQuence[1]]|2|3|4:COUnT <numeric_value>

This command controls the path of the trigger subsystem in the upward traverse of the wait for trigger state. **COUnT** loops through the event detection/measurement cycle are performed. That is, **COUnT** measurements are performed in response to **COUnT** trigger events.

COUnT can be set to a value >1 only when:

- [SENSe[1]]|SENSe2|3|4:MRATe <character_data> is set to FAST
- TRIGger[1]|2|3|4:SOURce set to BUS, IMMEDIATE or HOLD.

When **COUnT** is set to a value >1,

- CALibration[1]|2|3|4:ZERO:AUTO will switch to OFF automatically. It will be restored to its default setting when the **COUnT** is set to 1.
- Setting a channel from FAST mode to NORMAl mode or DOUBle mode will also restore both the CALibration[1]|2|3|4:ZERO:AUTO and **COUnT** to its default setting automatically.

Syntax

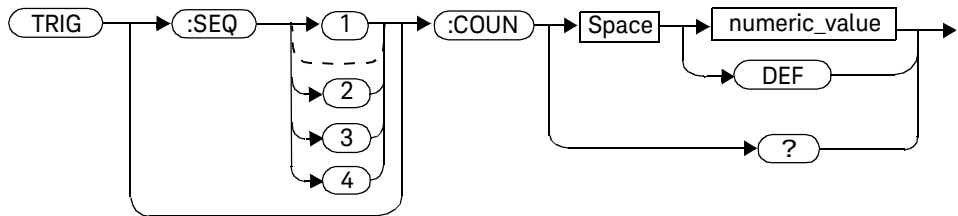

Parameters

Item	Description/Default	Range of Values
numeric_value	The number of triggered events for the measurement cycle. – DEF: the default value is 1	1 to 50 DEF

NOTE

For U2040 X-Series power sensors, the maximum value for the TRIG:SEQ3|4:COUN command is 100.

Example

```
TRIG:SEQ1:COUN 10
```

This command sets the number of triggered events to 10 for the Channel A measurement cycle.

Reset Condition

On reset, the value is set to 1.

Query

```
TRIGger[1]|2[:SEquence[1]|2]:COUNT?
```

The query returns the current setting of trigger events for a specified channel.

Query Example

TRIG:SEQ2:COUN?

This command queries the number of triggered events for the Channel B measurement cycle.

Error Messages

If **COUNT** >1 when [**SENSE[1]]|SENSE2|3|4:MRATE** <character_data> is set to **NORMa1** or **DOUBLe**, error -221, “Settings Conflict” occurs.

TRIGger:SEquence3|4:DElay <numeric_value>

This command sets the delay between the recognition of a trigger event and the start of a measurement for the U2040 X-Series.

Syntax

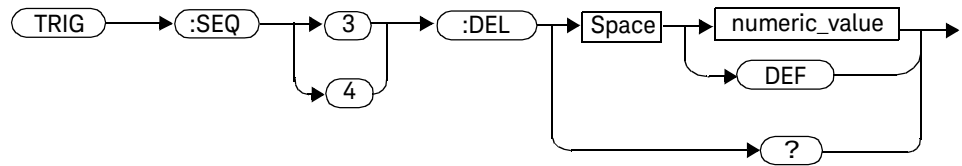

Parameter

Item	Description/Default	Range of Values
numeric_value	The delay between the recognition of a trigger event and the start of the measurement, in seconds. – DEF: the default value is 0 s Units are resolved to 50 ns.	–1 to 1 s DEF

Example

TRIG:SEQ3:DEL 0.001

This command sets a delay of 1 ms on Channel C.

Reset Condition

On reset, the trigger delay is set to 0 s.

Query

TRIGger:SEquence3|4:DElay?

The query returns the current setting of the trigger delay.

Query Example

TRIG:SEQ3:DEL?

This command queries the trigger delay of Channel C.

Error Message

If the trigger source is not set to **EXT** while sending this command, error -221, "Settings conflict" occurs.

TRIGger[:SEquence[1]|2|3|4]:DELay:AUTO <boolean>

This command is used to determine whether or not there is a settling-time delay before a measurement is made.

When this command is set to:

- **ON**, the power meter inserts a settling-time delay before taking the requested measurement and for subsequent measurements. This settling time allows the internal digital filter to be updated with new values to produce valid, accurate measurement results. The trigger with delay command allows settling time for the internal amplifiers and filters. It does not allow time for power sensor delay.
- In cases of large power changes, the delay may not be sufficient for complete settling. Accurate readings can be assured by taking two successive measurements for comparison.
- **OFF**, no settling-time delay is inserted and the power meter makes the measurement immediately a trigger is received.
- **ONCE**, a settling-time delay is inserted before taking the requested measurement, for one measurement only.

TRIGger[1]|2|3|4:DELay:AUTO is ignored if TRIGger[1]|2|3|4[:IMMediate] is set to ON.

Syntax

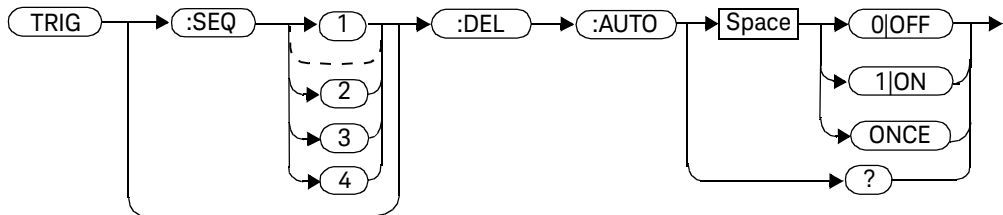

Example

TRIG:SEQ:DEL:AUTO ON

This command enables a delay on Channel A.

Reset Condition

On reset, **TRIGger:DElay:AUTO** is set to **ON**.

Query

TRIGger:DElay:AUTO?

The query enters a 1 or 0 into the output buffer indicating the status of **TRIGger:DElay:AUTO**.

- 1 is returned when it is **ON**
- 0 is returned when it is **OFF**

Query Example

TRIG:SEQ2:DEL:AUTO?

This command queries the settling-time delay of Channel B.

TRIGger:SEQuence3|4:HOLDoff <numeric_value>

This command sets the trigger holdoff in seconds for the U2040 X-Series.

Syntax

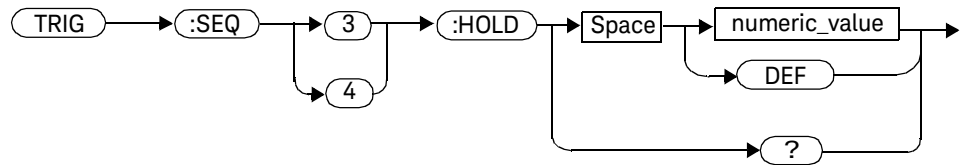

Parameter

Item	Description/Default	Range of Values
numeric_value	The trigger holdoff in seconds. – DEF: the default value is 1 μ s Units are resolved to 50 ns.	1 μ s to 0.4 s DEF

Example

TRIG:SEQ3:HOLD 0.1

This command sets the trigger holdoff to 100 ms on Channel C.

Reset Condition

On reset, the trigger holdoff is set to 1 μ s.

Query

TRIGger:SEQuence3|4:HOLDoff?

The query returns the current trigger holdoff setting.

Query Example

TRIG:SEQ3:HOLD?

This command queries the trigger holdoff of Channel C.

Error Message

If the trigger source is not set to **EXT** while sending this command, error -221, "Settings conflict" occurs.

TRIGger[:SEQuence[1]|2|3|4]:IMMEDIATE

This command provides a one time over-ride of the normal process of the downward path through the wait for trigger state. It causes the immediate exit of the event detection layer if the trigger system is in this layer when the command is received. In other words, the instrument stops waiting for a trigger and takes a measurement ignoring any delay set by **TRIG:DElay**.

Syntax

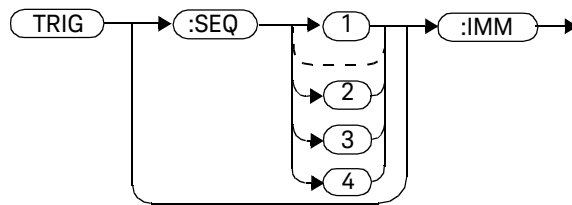

Example

TRIG:SEQ:IMM

This command initiates a measurement on Channel A.

TRIGger[:SEQuence[1]|2|3|4]:SOURce BUS|EXTErnal|HOLD|IMMEdiate

This command configures the trigger system to respond to the specified source. This command only selects the trigger source. Use the **INITiate** command to place the power meter in the wait for trigger state.

NOTE

This command has the same purpose as TRIGger[1]|2|3|4:SOURce BUS|EXTErnal|HOLD|IMMEdiate.

Syntax

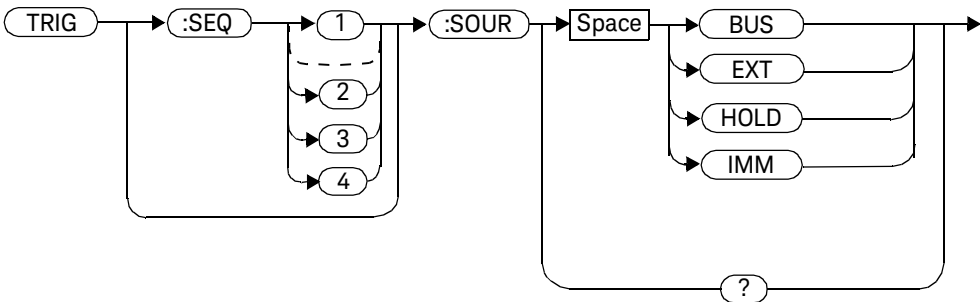

Parameters

Item	Description/Default	Range of Values
source	Available trigger sources: <ul style="list-style-type: none"> - BUS: the trigger source is the group execute trigger <GET> bus command, a *TRG common command or the TRIGGER:IMMEDIATE SCPI command. - EXternal: the trigger source is the trigger input in the back panel. - HOLD: triggering is suspended. The only way to trigger the power meter is to use TRIGGER:IMMEDIATE. - IMMEDIATE: the trigger system is always true. If INITiate:CONTinuous is ON the power meter is continually triggering free (free run mode). If an INITiate:IMMEDIATE command is sent a measurement is triggered then the power meter returns to the idle state. 	BUS EXternal HOLD IMMEDIATE

NOTE

The trigger source is set to **IMMEDIATE** on instrument power-up and when entering local mode.

The **MEASure** and **CONFigure** commands automatically set the trigger source to **IMMEDIATE**.

The **READ?** or **MEASure** commands should not be used if the trigger source is set to **BUS** or **HOLD**.

Example

```
TRIG:SOUR IMM
```

This command configures Channel A for immediate triggering.

Reset Condition

On reset, the trigger source is set to **IMMEDIATE**.

Query

TRIGger[:SEQuence[1]|2|3|4]:SOURce?

The query returns the current trigger source.

Query Example

TRIG:SEQ1:SOUR?

This command queries the current trigger source for Channel A.

Error Messages

- For dual channel power meters: if the leader is changed to **IMM**, **BUS** or **HOLD**, error -221 “Settings Conflict” occurs. In such situations the follower’s **TRIG:SOUR** must be changed so that it is no longer a follower.
- If the trigger source is changed to **INT1**, **INT2** or **EXT** and **SENS:SPEED** has a value of 200, error -221 “Settings Conflict” occurs.
- If the trigger source is changed to **INT1** or **INT2** and **SENS:DET:FUNC** is set to **AVERAge**, error -221 “Settings Conflict” occurs.
- If the trigger source is set to **INT1** or **INT2** when 8480, N8480, E4410, E9300 or U2000 Series sensor(Average mode only) is connected, error -221 “Settings Conflict” occurs.

THIS PAGE HAS BEEN INTENTIONALLY LEFT BLANK.

16 UNIT Subsystem

UNIT Subsystem	584
UNIT[1]2 3 4:POWer <amplitude_unit>	585
UNIT[1]2 3 4:POWer:RATio <ratio_unit>	587

This chapter explains how the UNIT command subsystem is used to set the power meter measurement units to Watts and % (linear), or dBm and dB (logarithmic).

UNIT Subsystem

The UNIT command subsystem:

- Sets power measurement units to dBm or Watts.
- Sets measurement ratio units to dB or % (linear).

Both UNIT commands have a numeric suffix which determines which window/measurement is set:

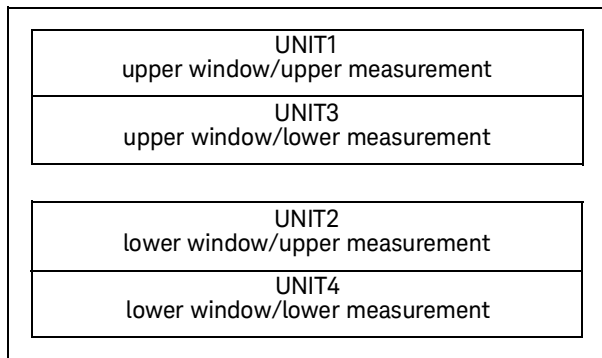

Figure 16-1 Measurement Display UNIT Block Window

The following commands are described in this section:

Keyword	Parameter Form	Notes	Page
UNIT[1] 2 3 4			
:POWer	<amplitude_unit>		
:RATio	<ratio_unit>	[non-SCPI]	page 585

The **UNIT:POWer** and **UNIT:POWer:RATio** commands are coupled as follows:

- If **UNIT:POWer** is set to dBm then **UNIT:POWer:RATio** is dB.
- If **UNIT:POWer** is set to W then **UNIT:POWer:RATio** is %.

UNIT[1]|2|3|4:POWer <amplitude_unit>

This command sets the power measurement units for a specified window/measurement. The power suffix set by **UNIT:POWer** is used for any command which accepts a numeric value in more than one unit.

For the N1913A:

- **UNIT1:POWer** sets the power measurement units for the upper window/upper measurement.
- **UNIT2:POWer** sets the power measurement units for the lower window/upper measurement.
- **UNIT3:POWer** sets the power measurement units for the upper window/lower measurement.
- **UNIT4:POWer** sets the power measurement units for the lower window/lower measurement.

For ratio and relative power measurements:

- If **UNIT:POWer** is W, the measurement units are percentage.
- If **UNIT:POWer** is DBM, the measurement units are dB relative.

Syntax

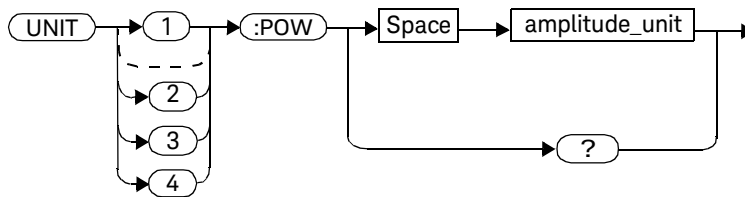

Parameters

Item	Description/Default	Range of Values
amplitude_unit	The measurement unit. – The default unit is dBm	15 to 100

Example

UNIT1:POW DBM

This command sets the power measurement units for the upper window/upper measurement.

Reset Condition

On reset, all windows/measurements are set to DBM.

Query

UNIT[1]|2|3|4:POWer?

The query returns the current setting of the power measurement units.

Query Example

UNIT2:POW?

This command queries which measurement units are being used for the lower window/upper measurement.

UNIT[1]|2|3|4:POWer:RATio <ratio_unit>

This command sets the window/measurement ratio units.

- **UNIT1:POWer:RATio** sets the ratio measurement units for the upper window/upper measurement.
- **UNIT2:POWer:RATio** sets the ratio measurement units for the lower window/upper measurement.
- **UNIT3:POWer:RATio** sets the ratio measurement units for the upper window/lower measurement.
- **UNIT4:POWer:RATio** sets the ratio measurement units for the lower window/lower measurement.

Syntax

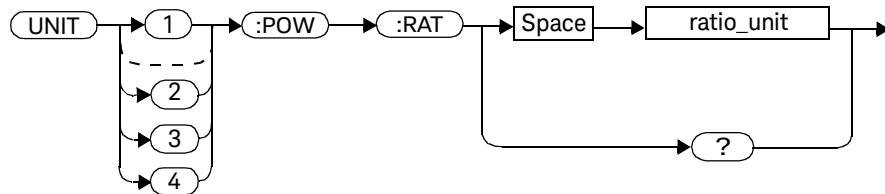

Parameters

Item	Description/Default	Range of Values
ratio_unit	The ratio measurement unit. - The default unit is DB	DB PCT

Example

UNIT1:POW:RAT DB

This command sets the ratio measurement units for the upper window/upper measurement.

Reset Condition

On reset, the value is set to DB.

Query

UNIT[1]|2|3|4:POW:RATio?

The query returns the current setting of the ratio measurement units.

Query Example

UNIT2:POW:RAT?

This command queries which ratio measurement units are being used for the lower window/upper measurement.

17 IEEE 488.2 Command Reference

SCPI Compliance Information	590
*CLS	591
*DDT <arbitrary block program data> <string program data>	592
*ESE <NRf>	594
*ESR?	596
*IDN?	597
*LRN?	598
*OPC	599
*OPT?	600
*RCL <NRf>	601
*RST	602
*SAV <NRf>	603
*SRE <NRf>	604
*STB?	606
*TRG	607
*TST?	608
*WAI	609
GPIO Universal Commands	610

This chapter contains information about the IEEE 488.2 Common Commands that the power meter supports.

SCPI Compliance Information

This chapter contains information about the SCPI Common (*) Commands that the power meter supports. It also describes the GPIB Universal Command statements which form the nucleus of GPIB programming; they are understood by all instruments in the network. When combined with programming language codes, they provide all management and data communication instructions for the system.

The IEEE-488.2 Common Command descriptions are listed below in alphabetical order.

*CLS	Clear Status	page 591
*DDT and *DDT?	Define Device Trigger	page 592
*ESE and *ESE?	Event Status Enable	page 594
*ESR?	Event Status Register	page 596
*IDN?	Identify	page 597
*LRN?	Learn	page 598
*OPC and *OPC?	Operation Complete	page 599
*OPT?	Options	page 600
*RCL	Recall	page 601
*RST	Reset	page 602
*SAV	Save	page 603
*SRE and *SRE?	Service Request Enable	page 604
*STB?	Status Byte	page 606
*TRG	Trigger	page 607
*TST?	Test	page 608
*WAI	Wait	page 609

*CLS

The ***CLS** (Clear Status) command clears the status data structures. The SCPI registers (Questionable Status, Operation Status and all the other SCPI registers), the Standard Event Status Register, the Status Byte, and the Error/Event Queue are all cleared.

Syntax

***CLS** →

*DDT <arbitrary block program data>|<string program data>

The ***DDT** (Define Device Trigger) command determines the power meter's response to a **GET** (Group Execute Trigger) message or ***TRG** common command. This command effectively turns **GET** and ***TRG** into queries, with the measured power being returned.

Syntax

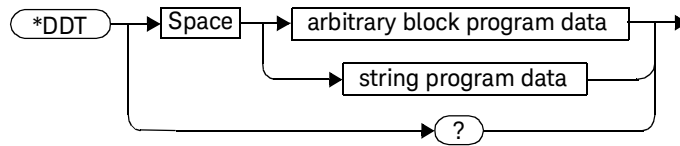

Parameters

Type	Description	Range of Values
arbitrary block program data	The command which is executed on a GET or *TRG .	#nN<action> ^{[a],[b]}
string program data		"<action>" ^[a]

[a] The <action> field of the parameter may contain:

FETC?
FETC1?
FETC2? (N1914A only)
***TRG**
TRIG1
TRIG2 (N1914A only)

[b] The first digit after the # indicates the number of following digits. The following digits indicate the length of the data.

Examples of <arbitrary block program data> parameters are:

- #15FETC? and #206FETCh?

Examples of <string program data> are:

- "FETCh1?", "FETCh?" and "TRIG1;FETC1"

Reset Condition

On reset, the <action> field of *DDT is set to *TRG.

Query

*DDT?

The query returns the action which is performed on receipt of a **GET** or *TRG. This is returned as a <definite length arbitrary block response data> value which is in the form of #nN<action> as described on [page 449](#).

Error Message

- If an invalid parameter is received, error –224, "Illegal parameter value" occurs.

***ESE <NRf>**

The ***ESE** (Event Status Enable) **<NRf>** command sets the Standard Event Status Enable Register. This register contains a mask value for the bits to be enabled in the Standard Event Status Register. A **1** in the Enable Register enables the corresponding bit in the Status Register, a **0** disables the bit. The parameter value, when rounded to an integer and expressed in base 2, represents the bit values of the Standard Event Status Enable Register. [Table 17-1](#) shows the contents of this register.

Table 17-1 *ESE Mapping

Bit	Weight	Meaning
0	1	Operation Complete
1	2	Request Control (not used)
2	4	Query Error
3	8	Device Dependent Error
4	16	Execution Error
5	32	Command Error
6	64	Not used
7	128	Power On

Syntax

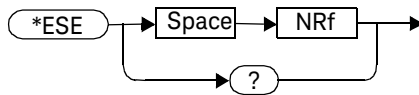

Parameters

Type	Description/Default	Range of Values
NRf	A value used to set the Standard Event Status Enable Register.	0 - 255

Query

*ESE?

The query returns the current contents of the Standard Event Status Enable Register. The format of the return is <NR1> in the range of 0 to 255.

*ESR?

The ***ESR?** query returns the contents of the Standard Event Status Register then clears it. The format of the return is **<NR1>** in the range of 0 to 255. [Table 17-2](#) shows the contents of this register.

Table 17-2 *ESR? Mapping

Bit	Weight	Meaning
0	1	Operation Complete
1	2	Request Control (not used)
2	4	Query Error
3	8	Device Dependent Error
4	16	Execution Error
5	32	Command Error
6	64	Not used
7	128	Power On

Syntax



*IDN?

The ***IDN?** query allows the power meter to identify itself. The string returned is either:

Keysight Technologies,N1913A,<serial number>,A1.XX.YY

Keysight Technologies,N1914A,<serial number>,A2.XX.YY

where:

- **<serial number>** uniquely identifies each power meter.
- **A1.XX.YY** and **A2.XX.YY** represents the firmware revision with XX and YY representing the major and minor revisions respectively.

Syntax



*LRN?

The *LRN? query returns the power meter state.

Syntax

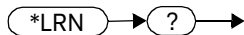

*OPC

The ***OPC** (OPeration Complete) command causes the power meter to set the operation complete bit in the Standard Event Status Register when all pending device operations have completed.

Syntax

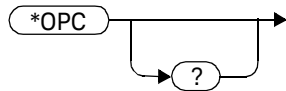

Query

***OPC?**

The query places an ASCII 1 in the output queue when all pending device operations have completed.

*OPT?

The ***OPT?** query reports the options installed in the power meter and returns:

- "" empty string for a standard instrument.
- "003" for an option 003 instrument.

Syntax



*RCL <NRf>

The ***RCL <NRf>** (ReCaLI) command restores the state of the power meter from the specified save/recall register. An instrument setup must have been stored previously in the specified register.

Syntax

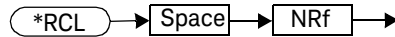

Parameters

Type	Description/Default	Range of Values
NRf	The number of the register to be recalled.	1 - 10

Error Message

- If the register does not contain a saved state, error -221, "Settings conflict" occurs.

*RST

The ***RST** (ReSeT) command places the power meter in a known state.

Syntax

***RST** →

*SAV <NRf>

The ***SAV <NRf>** (SAVe) command stores the current state of the power meter in the specified register.

Syntax

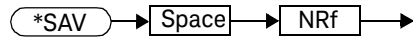

Parameters

Item	Description/Default	Range of Values
NRf	The number of the register that the current state of the power meter is to be saved to.	1 - 10

***SRE <NRf>**

The ***SRE <NRf>** command sets the Service Request Enable register bits. This register contains a mask value for the bits to be enabled in the Status Byte Register. A **1** in the Enable Register enables the corresponding bit in the Status Byte Register; a **0** disables the bit. The parameter value, when rounded to an integer and expressed in base 2, represents the bits 0 to 5 and bit 7 of the Service Request Enable Register. Bit 6 is always 0. [Table 17-3](#) shows the contents of this register. Refer to the pullout at the end of Chapter 10 for further information.

Table 17-3 *SRE Mapping

Bit	Weight	Meaning
0	1	Not used
1	2	Not used
2	4	Device Dependent
3	8	QUEStionable Status Summary
4	16	Message Available
5	32	Event Status Bit
6	64	Not used
7	128	OPERation Status Summary

Syntax

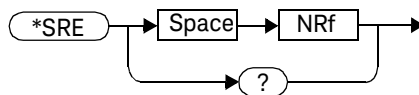

Parameters

Type	Description/Default	Range of Values
NRf	A value used to set the Service Request Enable Register.	0 - 255

Query

*SRE?

The query returns the contents of bits 0 to 5 and bit 7 of the Service Request Enable Register. The format of the return is **<NR1>** in the ranges of 0 to 63 or 128 to 191 (that is, bit 6 is always 0).

*STB?

The ***STB?** (Status Byte) query returns bit 0 to 5 and bit 7 of the power meter's status byte and returns the Master Summary Status (MSS) as bit 6. The MSS is the inclusive OR of the bitwise combination (excluding bit 6) of the Status Byte and the Service Request Enable registers. The format of the return is **<NR1>** in the ranges of 0 to 255. [Table 17-4](#) shows the contents of this register. Refer to the Status Block Diagram at the end of [Chapter 13](#) for further information.

Table 17-4 *STB? Mapping

Bit	Weight	Meaning
0	1	Not used
1	2	Device Dependent 0 - No device status conditions have occurred 1 - A device status condition has occurred
2	4	Error/Event Queue 0 - Queue empty 1 - Queue not empty
3	8	Questionable Status Summary 0 - No QUESTIONable status conditions have occurred 1 - A QUESTIONable status condition has occurred
4	16	Message Available 0 - no output messages are ready 1 - an output message is ready
5	32	Event Status Bit 0 - no event status conditions have occurred 1 - an event status condition has occurred
6	64	Master Summary Status 0 - power meter not requesting service 1 - there is at least one reason for requesting service
7	128	Operation Status Summary 0 - No OPERation status conditions have occurred 1 - An OPERation status condition has occurred

Syntax



*TRG

The ***TRG** (TRiGger) command triggers all channels that are in the wait for trigger state. It has the same effect as Group Execute Trigger (**GET**).

Using the ***DDT** command may change the function of the ***TRG** command.

Syntax

***TRG** →

Error Message

- If **TRIGger:SOURce** is not set to **BUS**, error -211, “Trigger ignored” occurs.
- If the power meter is not in the wait-for-trigger state, error -211, “Trigger ignored” occurs.

*TST?

The ***TST?** (TeST) query causes the power meter to perform the self test. The test takes approximately 60 seconds.

The result of the test is placed in the output queue.

- 0 is returned if the test passes
- 1 if the test fails

Syntax

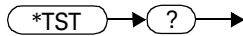

NOTE

For the N1913/1914A with USB option installed, the test takes approximately 120 seconds.

*WAI

The ***WAI** (WAI) command causes the power meter to wait until either:

- All pending operations are complete
- The device clear command is received
- Power is cycled

before executing any subsequent commands or queries.

Syntax

***WAI** →

GPIB Universal Commands

DCL

The **DCL** (Device Clear) command causes all GPIB instruments to assume a cleared condition. The definition of device clear is unique for each instrument. For the power meter:

- All pending operations are halted, that is, ***OPC?** and ***WAI**.
- The parser (the software that interprets the programming codes) is reset and now expects to receive the first character of a programming code.
- The output buffer is cleared.

GET

The **GET** (Group Execute Trigger) command triggers all channels that are in the “wait-for-trigger” state.

Using the ***DDT** command may change the function of the **GET** command.

Error Message

If **TRIGger:SOURce** is not set to **BUS**, an error -211, “Trigger ignored” occurs.

If the power meter is not in the “wait-for-trigger” state then error -211, “Trigger ignored” occurs.

GTL

The **GTL** (Go To Local) command is the complement to remote. It causes the power meter to return to local control with a fully enabled front panel. When reverting to local mode the power meter triggering is set to free run.

LLO

The **LLO** (Local Lock Out) command can be used to disable the front panel local key. With this key disabled, only the controller (or a hard reset by the line power switch) can restore local control.

PPC

When addressed to listen, the **PPC** (Parallel Poll Configure) command causes the power meter to be configured according to the parallel poll enable secondary command which should follow this command.

PPD

Sending the **PPC** command followed by the **PPD** (Parallel Poll Disable) command disables the power meter from responding to a parallel poll. This is effectively a selective disable.

Table 17-5 PPD Mapping

Bit	Weight	Meaning
0	1	Always 0
1	2	Always 0
2	4	Always 0
3	8	Always 0
4	16	Always 1
5	32	Always 1
6	64	Always 1
7	128	Always 0

PPE

Once the power meter has received a **PPC** command, the **PPE** (Parallel Poll Enable) secondary command configures the power meter to respond to a parallel poll on a particular data line with a particular level.

Table 17-6 PPE Mapping

Bit	Weight	Meaning
0	1	Bit positions for response: 000 (bit 0), 001 (bit 1), 010 (bit 2), 011 (bit 3), 100 (bit 4), 101 (bit 5), 110 (bit 6), 111 (bit 7)
1	2	
2	4	
3	8	Sense bit 0 - response bit is cleared during a parallel poll if requesting service. 1 - response bit is set during a parallel poll if requesting service.
4	16	Always 0
5	32	Always 1
6	64	Always 1
7	128	Always 0

PPU

The **PPU** (Parallel Poll Unconfigure) command disables the power meter from responding to a parallel poll. This is effectively a universal disable.

SDC

The **SDC** (Selected Device Clear) command causes instruments using GPIB in the listen state, to assume a cleared condition. The definition of a selected device clear is unique for each instrument. For the power meter:

- All pending operations are halted, that is, ***OPC?** and ***WAI**.
- The parser (the software that interprets the programming codes) is reset and now expects to receive the first character of a programming code.
- The output buffer is cleared.

SPD

The **SPD** (Serial Poll Disable) command terminates the serial poll mode for the power meter and returns it to its normal talker state where device dependent data is returned rather than the status byte.

SPE

The **SPE** (Serial Poll Enable) command establishes the serial poll mode for the power meter. When the power meter is addressed to talk, a single eight bit status byte is returned.

THIS PAGE HAS BEEN INTENTIONALLY LEFT BLANK.

18 Programming Examples

- Example 1: Identifying the EPM Series Power Meter In Use 616
- Example 2: FETCh, MEASure, and READ Queries 617
- Example 3: Making Repetitively Pulsed RF Power Measurement
With Duty Cycle Correction 619
- Example 4: CW Power Measurement 620
- Example 5: Low Power Measurement 621
- Example 6: Power Sweep Operation 622
- Example 7: Frequency Sweep Operation 623
- Example 8: Status of Various Settings 625
- Example 9: Window Offset, Min/Max Hold, and Limits Settings 626

This chapter displays the programming sequences or examples to remotely control the EPM Series power meters using SCPI commands.

Example 1: Identifying the EPM Series Power Meter In Use

You can verify whether you are communicating with the right EPM Series power sensor. Refer to “[Error Message List](#)” on page 518 for more information.

```
-> *IDN? // Queries the identification of the
          EPM Series power meter and
          checks whether you are
          communicating with the right
          EPM Series power meter.

-> SYST:ERR? // Checks the EPM Series power
              meter system error queue.
```

NOTE

“->” indicates the commands that you send to the EPM Series power meter.

“<-” indicates the response from the EPM Series power meter.

Example 2: FETCh, MEASure, and READ Queries

There are three different ways to query the power measurement using **FETC?**, **MEAS?**, and **READ?**.

In Free Run or Continuous mode, you can use either **FETC?** or **MEAS?** to query the power measurement.

```
-> INIT:CONT ON // Sets the EPM Series power
                    meter to Free Run mode.
-> FETC? // Queries the measurement
           results from the buffer.
```

or

```
-> INIT:CONT ON // Sets the EPM Series power
                    meter to Free Run mode.
-> MEAS? // Reads the measurement
           results. MEAS? is equivalent to
           CONF followed by a READ?.
```

In Single Trigger mode, you can use **FETC?**, **MEAS?**, or **READ?** to query the power measurement.

```
-> INIT:CONT OFF // Sets the EPM Series power
                   meter to Single Trigger mode.
-> CONF // Configures the measurement.
-> INIT // Initializes the measurement.
-> FETC? // Queries the measurement
           results. The above sequence
           must be followed.
```

or

```
-> INIT:CONT OFF // Sets the EPM Series power
                    meter to Single Trigger mode.
-> MEAS?          // Reads the measurement
                    results. MEAS? is equivalent to
                    CONF followed by a READ?.
```

or

```
-> INIT:CONT OFF // Sets the EPM Series power
                    meter to Single Trigger mode.
-> CONF          // Configures the measurement.
-> READ?        // Reads the measurement
                    results. READ? is equivalent to
                    INIT followed by a FETC?
                    (Assuming that TRIG:SOUR is
                    set to IMMEDIATE).
```

NOTE

“->” indicates the commands that you send to the EPM Series power meter.

“<-” indicates the response from the EPM Series power meter.

Example 3: Making Repetitively Pulsed RF Power Measurement With Duty Cycle Correction

Configure the EPM Series power meter to make repetitively pulsed RF power measurement and to apply duty cycle correction.

```
-> SYST:PRES // Presets the EPM Series power meter.
-> FREQ 1000MHz // Sets the frequency to 1000 MHz.
-> CORR:DCYC:STAT 1 // Enables the duty cycle.
-> CORR:DCYC 50 // Sets the duty cycle to 50%.
-> SENS:AVER:COUN 256 // Sets the filter length to 256.
-> SENS:AVER:SDET OFF // Disable step detection.
-> FETC? // Queries the measurement results.
The above sequence must be followed.
```

NOTE

Users are advised to use filter size >50 and to disable the step detect to obtain proper data when measuring pulse signals.

Example 4: CW Power Measurement

The SCPI programming sequence examples for simple CW power measurement with Free Run and Single Trigger modes are shown as follows.

Free Run

```
-> SYST:PRES // Presets the EPM Series power meter.
-> INIT:CONT ON // Sets the meter to Free Run mode.
-> FREQ 1000MHz // Sets the frequency to 1000 MHz.
-> FETC? // Queries the measurement results.
           The above sequence must be
           followed.
```

Single Trigger

```
-> SYST:PRES // Presets the EPM Series power meter.
-> INIT:CONT OFF // Sets the meter to Single Trigger mode.
-> FREQ 1000MHz // Sets the frequency to 1000 MHz.
-> INIT // Initializes the measurement.
-> FETC? // Queries the measurement results.
           The above sequence must be
           followed.
```

NOTE

In Single Trigger mode, **INIT** must be executed before **FETC?**.

In Single Trigger mode, **MEAS?** can be used without executing **INIT**.

Example 5: Low Power Measurement

"Configure the EPM Series power meter to perform low-power measurement and to apply required filtering for settled measurements.

Signal level: -60 dBm

Single Trigger

```
-> SYST:PRES           // Presets the EPM Series power meter.
-> CAL                 // Performs zeroing and calibration.
-> *OPC?              // Waits for the operation to complete.
<- 1                  // Returns a 1 when zeroing and
                       calibration have completed.
```

NOTE

It is advisable to perform zeroing and calibration of the power meter prior to measuring low level signals.

```
-> SENS:AVER:COUN 1024 // Sets the filter length to 1024.
-> INIT:CONT OFF      // Sets the meter to Single Trigger mode.
-> READ?              // Reads the measurement results.
                       Timeout delay of approximately 55 s
                       needed in order to obtain proper data.
```

NOTE

Increasing the value of filter length increases measurement accuracy but also increases the time taken to make a power measurement.

Example 6: Power Sweep Operation

The SCPI programming sequence for the Power Sweep usage is shown below.

```

-> TRIG:SOUR EXT           // Sets to external trigger source, which is
                           // required for the Power Sweep operation.
-> TRIG:SLOP POS          // Sets the EPM Series power meter to accept
                           // an external positive-edge trigger.
-> AVER:COUN 64           // Sets the filter length to 64.
-> *OPC                   // Enables the OPC feature.
-> *ESR?                  // The *ESR? is issued for the first time.
<- 129                   // Some non-zero value (any value ranging from
                           // 0 to 255) will be returned when the *ESR? is
                           // issued for the first time.

-> *ESR?                  // The *ESR? is issued for the second time.
<- 0                     // The returned value will be cleared to 0 when
                           // the *ESR? is issued for the second time.

-> BUFF:COUN 2           // Sets the Power Sweep mode to capture two
                           // triggers.

-> INIT:CONT ON          // Sets the EPM Series power meter to accept
                           // continuous trigger cycles.

Sends a positive-edged trigger to the EPM Series power meter through the
external trigger port.

-> *ESR?                  // Checks the OPC bit to confirm that the Power
                           // Sweep operation has completed.
<- 0                     // Returns a 0 if the Power Sweep operation has
                           // not completed.

Sends another positive-edged trigger to the EPM Series power meter through the
external trigger port.

-> *ESR?                  // Checks the OPC bit to confirm that the Power
                           // Sweep operation has completed.
<- 1                     // Returns a 1 if the Power Sweep operation has
                           // completed.

-> FETC?                  // Reads back the two data points captured.

```

Example 7: Frequency Sweep Operation

The SCPI programming sequence for the Frequency Sweep operation is shown below.

```

-> TRIG:SOUR EXT           // Sets to external trigger source, which is
                           // required for the Frequency Sweep operation.
-> TRIG:SLOP POS          // Sets the EPM Series power meter to accept
                           // an external positive-edge trigger.
-> AVER:COUN 64           // Sets the filter length to 64.
-> *OPC                   // Enables the OPC feature.
-> *ESR?                  // The *ESR? is issued for the first time.
<- 129                   // Some non-zero value (any value ranging from
                           // 0 to 255) will be returned when the *ESR? is
                           // issued for the first time.

-> *ESR?                  // The *ESR? is issued for the second time.
<- 0                     // The returned value will be cleared to 0 when
                           // the *ESR? is issued for the second time.

-> FREQ:STAR 10MHz        // Sets the Start Frequency to 10 MHz.
-> FREQ:STOP 100MHz      // Sets the Stop Frequency to 100 MHz.
-> FREQ:STEP 10           // Sets the Frequency Sweep to capture 10
                           // triggers in equally-spaced frequency intervals
                           // between 10 MHz to 100 MHz.

-> INIT:CONT ON          // Sets the EPM Series power meter to accept
                           // continuous trigger cycles.

Sends a positive-edged trigger to the EPM Series power meter through the
external trigger port.

-> *ESR?                  // Checks the OPC bit to confirm that the
                           // Frequency Sweep operation has completed.
<- 0                     // Returns a 0 if the Frequency Sweep operation
                           // has not completed.

Sends nine positive-edged triggers to the EPM Series power meter through the
external trigger port.

-> *ESR?                  // Checks the OPC bit to confirm that the
                           // Frequency Sweep operation has completed.

```

```
<- 1 // Returns a 1 if the Frequency Sweep operation
      has completed.
-> FETC? // Reads back the 10 data points captured.
```

NOTE

- “->” indicates the commands that you send to the EPM Series power meter.
“<-” indicates the response from the EPM Series power meter.
 - To switch to Power Sweep, the SENS:FREQ:STEP command has to be set to 0. The SENS:BUFF:COUN command will only take effect if the SENS:FREQ:STEP is set to 0.
-

Example 8: Status of Various Settings

The SCPI commands below show a program that polls registers to show the status of various settings.

```
-> SYST:PRES // Presets the EPM Series power meter.
-> STAT:OPER:CAL:COND? // Query calibrating status of the meter.
<- +0 // Returns a 0.
-> CAL:ZERO:AUTO ONCE // Perform zeroing.
-> STAT:OPER:CAL:COND? // Query calibrating status of the meter.
<- +2 Channel A calibrating.
-> STAT:OPER:CAL:COND? // Query calibrating status of the meter.
<- +2 // Channel A calibrating.
Upon completion of zeroing
-> STAT:OPER:CAL:COND? // Query calibrating status of the meter.
-> +0 // Returns a 0 at the end of zeroing.
```

Example 9: Window Offset, Min/Max Hold, and Limits Settings

The SCPI programming sequence using window offset, Min/Max hold, and limits features are shown below.

Signal level: -3 dBm

```
-> SYST:PRES // Presets the EPM Series power
                meter.
-> CALC:GAIN 3 // Sets the display offset of 3 dB.
-> CALC:GAIN:STAT ON // Turn on display offset.
Measurement now showing 0 dBm
-> CALC:LIM:UPP -3 // Sets the upper limit of window
                    to -3 dBm.
-> CALC:LIM:STAT ON // Turn on limit checking
                    function.
-> STAT:OPER:ULF? // Check the upper limit fail
                    status.
<- +8 // Upper window upper limit fail
        status set.
```

Meter showing over limit in the measurement window as the measurement is over the upper limit checking.

```
-> CALC:HOLD:STAT MAX // Sets HOLD value to MAX.
```

Decrease signal level to -23 dBm,

Meter still shows 0 dBm as the HOLD feature is set to MAX and the MAX value is shown, which is 0 dBm.

```
-> CALC:HOLD:STAT OFF // Turn off HOLD feature.
```

Measurement now showing -20 dBm

```
-> CALC:GAIN:STAT OFF // Turn off display offset.
```

Measurement now showing -23 dBm

A Measurement Polling Example

Measurement Polling Example using VEE program [628](#)

This chapter contains an example of VEE program in measurement polling.

Measurement Polling Example using VEE program

The following figure provides an example on how to do a measurement polling using a VEE program. The information relates to the condition polling method as described in “Status Reporting” on page 72.

Example 1:

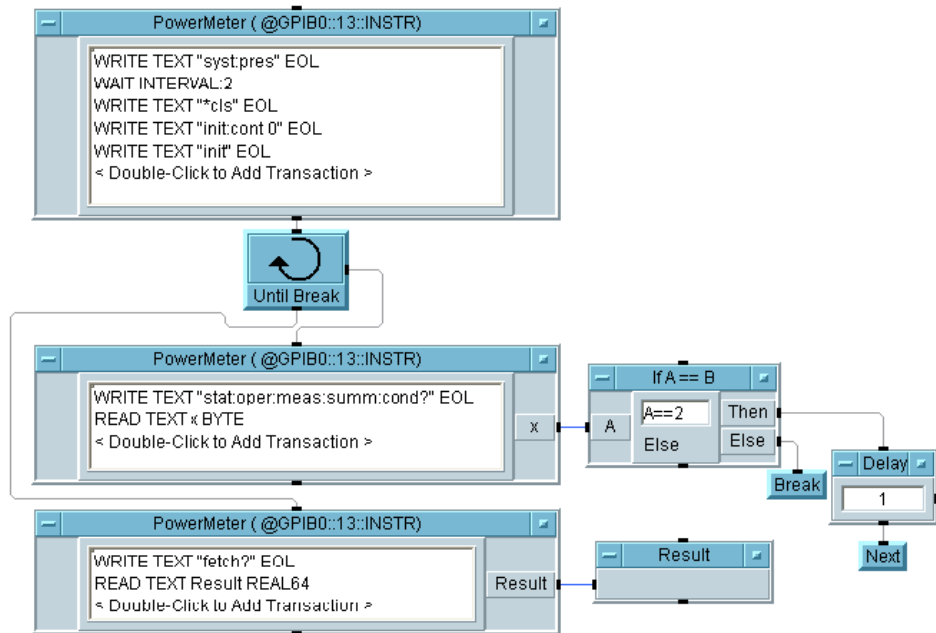

Example 2:

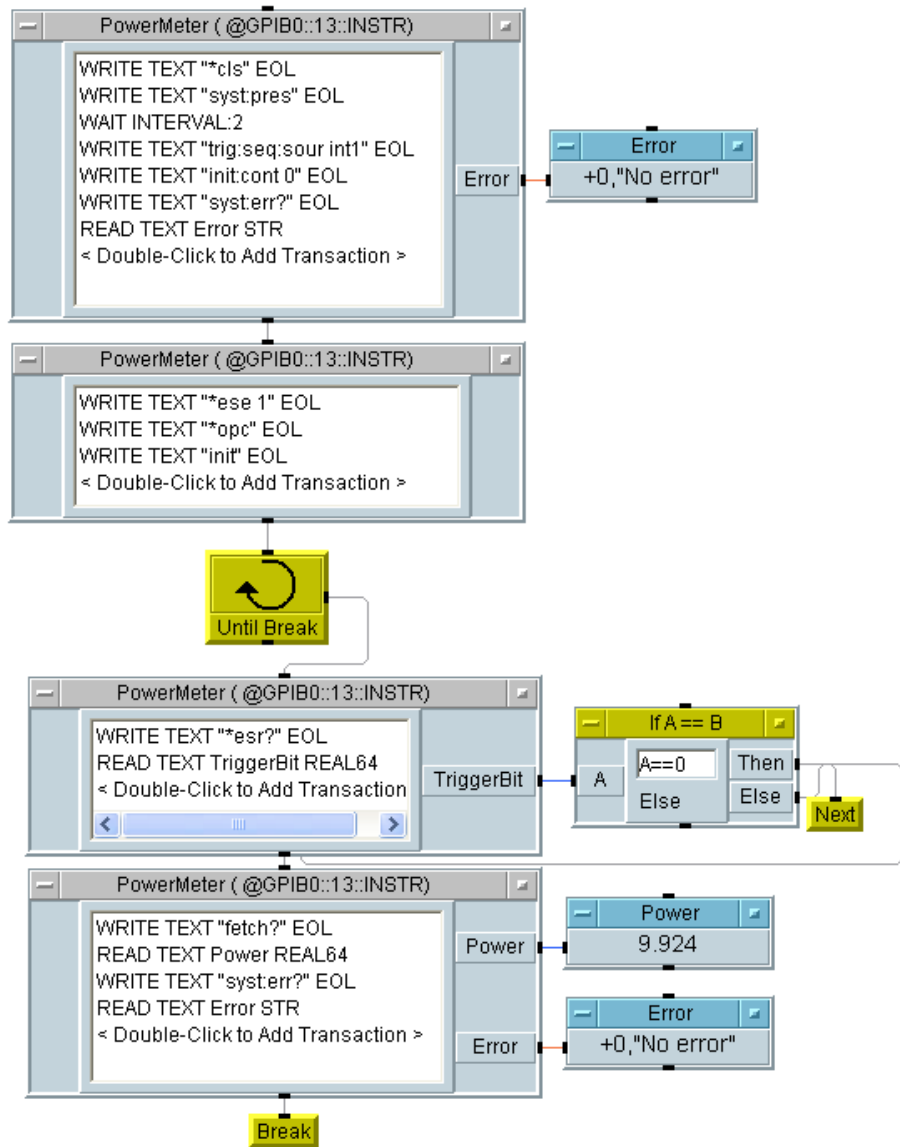

Figure A-1 Example of VEE program used in measurement polling

THIS PAGE HAS BEEN INTENTIONALLY LEFT BLANK.

B HP 436A/HP 437B/HP 438A Command Summary

HP 436A Command Summary	632
HP 437B Command Summary	633
HP 438A Command Summary	637

This chapter contains the HP 436A/HP 437B/HP 438A command summary.

HP 436A Command Summary

This table details all the HP 436A commands that the Keysight N1913A supports and the command function. For a detailed description of these commands please refer to the *HP 436A Power Meter Operating Manual*.

Function	Program Codes	
	ASC II	ASC II
Range		
Least sensitive	5	53
	4	52
	3	51
	2	50
Most sensitive	1	49
Auto	9	57
MODE		
Watt	A	65
dB (Rel)	B	66
dB [Ref]	C	67
dBm	D	68
Sensor auto-zero	Z	90
CAL FACTOR		
Disable (100%)	+	43
Enable (front panel switch setting)	-	45
Measurement Rate		
Hold	H	72
Trigger with settling time	T	84
Trigger, immediate	I	73
Free Run at maximum rate	R	82
Free Run with settling time	V	86

HP 437B Command Summary

This table details all the HP 437B commands that the Keysight N1913A supports and the command function. For a detailed description of these commands please refer to the *HP 437B Power Meter Operating Manual*.

Command	Description
CL	Calibrate
*CLS	Clear all status registers
CS	Clear the status byte
CT	Clear sensor type
DA ^[a]	All display segments on
DC0	Duty cycle off
DC1	Duty cycle on
DD	Display disable
DE	Display enable
DF	Display enable
DN ^[a]	Down arrow key
DU ^[a]	Display user message
DY	Enter duty cycle
EN	Enter
ERR?	Device error query
*ESR?	Event status register query
*ESE	Set event status register mask
*ESE?	Event status register mask query
ET	Edit sensor table
EX	Exit
FA	Automatic filter selection
FH	Filter hold
FM	Manual filter selection

B HP 436A/HP 437B/HP 438A Command Summary

Command	Description
FR	Enter measurement frequency
GT0	Ignore GET bus command
GT1	Trigger immediate response to GET
GT2	Trigger with delay response to GET
GZ	Gigahertz
HZ	Hertz
?ID	Identification query
IDN?	Identification query
KB	Enter measurement cal factor
KZ	Kilohertz
LG	Log units (dBm/dB)
LH	Enter high (upper) limit
LL	Enter low (lower) limit
LM0	Disable limits checking
LM1	Enable limits checking
LN	Linear units (watts/%)
LP2	Learn mode #2
LT ^[a]	Left arrow key
MZ	Megahertz
OC0	Reference oscillator off
OC1	Reference oscillator on
OD	Output display
OF0	Offset off
OF1	Offset on
OS	Enter offset value
PCT	Percent
PR ^[b]	Preset
RA	Auto range

Command	Description
RC	Recall instrument configuration
RE	Set display resolution
RF	Enter sensor table reference alibration factor
RH	Range hold
RL0	Exit from relative mode
RL1	Enter relative mode (take new reference)
RL2	Enter relative mode (take last reference)
RM	Set measurement range
*RST	Reset
RT ^[a]	Right arrow key
RV	Read service request mask
SE	Select sensor calibration table
SM	Status message
SN	Enter sensor identification/serial number
SP ^[a]	Special
SPD 20 40 ^[c]	20 or 40 readings/second
*SRE	Set the service request mask
*SRE?	Service request mask query
ST	Store (save) power meter configuration
*STB?	Read status byte
SYST:LANG SCPI ^[d]	Select SCPI language
TK? ^[e]	Last measurement result transmitted.
TR0	Trigger hold
TR1	Trigger immediate
TR2	Trigger with delay
TR3	Trigger free run
*TST? ^[f]	Self test query

B HP 436A/HP 437B/HP 438A Command Summary

Command	Description
UP ^[a]	Up arrow key
ZE	Zero
@1	Prefix for status mask
@2	Learn mode prefix
%	Percent

[a] This command is accepted but has no active function.

[b] After sending this command, it is recommended to wait for two seconds before sending any other commands.

[c] This command is not an original HP 437B command. However, it can be used to set the measurement speed to 20 or 40 readings/second in HP 437B mode.

[d] This command is not an original HP 437B command. However, it can be used to terminate the HP 437B language and select the SCPI language. Note that it is recommended that the instrument is preset following a language switch.

[e] This command is not an original HP 437B command. However it can be used to allow the last measurement result to be transmitted. This is equivalent to sending the power meter talk address in GP-IB mode to fetch the last reading (provided no query is pending).

[f] Always returns 0000 in HP 437B language.

HP 438A Command Summary

This table details all the HP 438A commands that the Keysight N1914A support and the command function. For a detailed description of these commands please refer to the *HP 438A Power Meter Operating Manual*.

Command	Description
AD	Sensor A minus Sensor B measurement
AE	SET A
AP	Sensor A measurement
AR	A/B ratio measurement
BD	Sensor B minus Sensor A measurement
BE	SET B
BP	Sensor B measurement
BR	B/A ratio measurement
CL	Calibrate
CS	Clear the status byte
DA ^[a]	All display segments on
DD	Display disable
DE	Display enable
DO	Display OFFSET
EN	Enter
FA	Automatic filter selection
FH	Filter hold
FM	Manual filter selection
FR	Enter measurement frequency
GT0	Ignore GET bus command
GT1	Trigger immediate response to GET
GT2	Trigger with delay response to GET

B HP 436A/HP 437B/HP 438A Command Summary

Command	Description
KB	Enter measurement cal factor
LG	Log units (dBm/dB)
LH	Enter high (upper) limit
LL	Enter low (lower) limit
LM0	Disable limits checking
LM1	Enable limits checking
LN	Linear units (watts/%)
LP1	Learn mode #1
LP2	Learn mode #2
OC0	Reference oscillator off
OC1	Reference oscillator on
OS	Enter offset value
PR ^[b]	Preset
RA	Auto range
RC	Recall instrument configuration
RH	Range hold
RL0	Exit from relative mode
RL1	Enter relative mode (take new reference)
RM	Set measurement range
RV	Read service request mask
SM	Status message
SPD 20 40 ^[c]	20 or 40 readings/second
ST	Store (save) power meter configuration
SYST:LANG SCPI ^[d]	Select SCPI language
TK? ^[e]	Last measurement result transmitted.
TR0	Trigger hold

Command	Description
TR1	Trigger immediate
TR2	Trigger with delay
TR3	Trigger free run
ZE	Zero
@1	Prefix for status mask
?ID	Identification query

- [a] This command is accepted but has no active function.
- [b] After sending this command, it is recommended to wait for two seconds before sending any other commands.
- [c] This command is not an original HP 438A command. However, it can be used to set the measurement speed to 20 or 40 readings/second in HP 438A mode.
- [d] This command is not an original HP 438A command. However, it can be used to terminate the HP 438A language and select the SCPI language. Note that it is recommended that the instrument is preset following a language switch.
- [e] This command is not an original HP 438A command. However it can be used to allow the last measurement result to be transmitted. This is equivalent to sending the power meter talk address in GP-IB mode to fetch the last reading (provided no query is pending).

THIS PAGE HAS BEEN INTENTIONALLY LEFT BLANK.



This information is subject to change without notice. Always refer to the Keysight website for the latest revision.

© Keysight Technologies 2009–2023
Edition 18 March 27, 2023

Printed in Malaysia



N1913-90008

www.keysight.com