

Keysight S5040A Open RAN Studio

Player and Capture Appliance

User's Guide



Notices

© Keysight Technologies 2021

No part of this manual may be reproduced in any form or by any means (including electronic storage and retrieval or translation into a foreign language) without prior agreement and written consent from Keysight Technologies as governed by United States and international copyright laws.

Manual Part Number

S5040-91000

Edition

Edition 1.0, April 2021

Available in electronic format only

Published by:

Keysight Technologies, 1900 Garden of the Gods Rd, Colorado Springs, CO 80907, United States

Technology Licenses

The hardware and/or software described in this document are furnished under a license and may be used or copied only in accordance with the terms of such license.

U.S. Government Rights

The Software is “commercial computer software,” as defined by Federal Acquisition Regulation (“FAR”) 2.101. Pursuant to FAR 12.212 and 27.405-3 and Department of Defense FAR Supplement

(“DFARS”) 227.7202, the U.S. government acquires commercial computer software under the same terms by which the software is customarily provided to the public. Accordingly, Keysight provides the Software to U.S. government customers under its standard commercial license, which is embodied in its End User License Agreement (EULA), a copy of which can be found at:

<http://www.keysight.com/find/sweula>.

The license set forth in the EULA represents the exclusive authority by which the U.S. government may use, modify, distribute, or disclose the Software. The EULA and the license set forth therein, does not require or permit, among other things, that Keysight: (1) Furnish technical information related to commercial computer software or commercial computer software documentation that is not customarily provided to the public; or (2) Relinquish to, or otherwise provide, the government rights in excess of these rights customarily provided to the public to use, modify, reproduce, release, perform, display, or disclose commercial computer software or commercial computer software documentation. No additional government requirements beyond those set forth in the EULA shall apply, except to the extent that those terms, rights, or licenses are explicitly required from all providers of commercial computer software pursuant to the FAR and the DFARS and are set forth specifically in writing elsewhere in the EULA. Keysight shall be under no obligation to update, revise or otherwise modify the Software. With respect to any technical data as defined by FAR 2.101, pursuant to FAR 12.211 and 27.404.2 and DFARS 227.7102, the U.S. government acquires no greater than Limited Rights as defined in FAR 27.401 or DFAR 227.7103-5 (c), as applicable in any technical data.

Warranty

THE MATERIAL CONTAINED IN THIS DOCUMENT IS PROVIDED “AS IS,” AND IS SUBJECT TO BEING CHANGED, WITHOUT NOTICE, IN FUTURE EDITIONS. FURTHER, TO THE MAXIMUM EXTENT PERMITTED BY APPLICABLE LAW, KEYSIGHT DISCLAIMS ALL WARRANTIES, EITHER EXPRESS OR IMPLIED WITH REGARD TO THIS MANUAL AND ANY INFORMATION CONTAINED HEREIN, INCLUDING BUT NOT LIMITED TO

THE IMPLIED WARRANTIES OF MERCHANTABILITY AND FITNESS FOR A PARTICULAR PURPOSE. KEYSIGHT SHALL NOT BE LIABLE FOR ERRORS OR FOR INCIDENTAL OR CONSEQUENTIAL DAMAGES IN CONNECTION WITH THE FURNISHING, USE, OR PERFORMANCE OF THIS DOCUMENT OR ANY INFORMATION CONTAINED HEREIN. SHOULD KEYSIGHT AND THE USER HAVE A SEPARATE WRITTEN AGREEMENT WITH WARRANTY TERMS COVERING THE MATERIAL IN THIS DOCUMENT THAT CONFLICT WITH THESE TERMS, THE WARRANTY TERMS IN THE SEPARATE AGREEMENT WILL CONTROL.

Safety Notices

CAUTION

A CAUTION notice denotes a hazard. It calls attention to an operating procedure, practice, or the like that, if not correctly performed or adhered to, could result in damage to the product or loss of important data. Do not proceed beyond a CAUTION notice until the indicated conditions are fully understood and met.

WARNING







A WARNING notice denotes a hazard. It calls attention to an operating procedure, practice, or the like that, if not correctly performed or adhered to, could result in personal injury or death. Do not proceed beyond a WARNING notice until the indicated conditions are fully understood and met.





Safety Summary

This product has been designed and tested in accordance with accepted industry standards, and has been supplied in a safe condition. The documentation contains information and warnings that must be followed by the user to ensure safe operation and to maintain the product in a safe condition.

The following general safety precautions must be observed during all phases of operation of this instrument. Failure to comply with these precautions or with specific warnings or operating instructions in the product manuals violates safety standards of design, manufacture, and intended use of the instrument. Keysight Technologies assumes no liability for the customer's failure to comply with these requirements. Product manuals are provided on the Web. Go to www.keysight.com and type in your product number in the Search field at the top of the page.

Safety symbols & Instrument markings

Instrument Marking	Description
	The instruction manual symbol. The product is marked with this warning symbol when it is necessary for the user to refer to the instructions in the manual.
	Standby supply. Unit is not completely disconnected from AC mains when switch is off.
	The CE mark is a registered trademark of the European Community.
	The CSA mark with the 'c' and 'us' subscript indicates the instrument is certified to the applicable Canadian and United States of America standards respectively.
	The RCM mark is a registered trademark of the Australian Communications and Media Authority
	The KC mark is the Korean certification mark. This equipment is Class A suitable for professional use and is for use in electromagnetic environments outside of the home.
	Attach ESD protective wrist strap to avoid damage by direct contact with the equipment.

Instrument Marking	Description
	<p>China Restricted Substance Product Label. The EPUP (environmental protection use period) number in the center indicates the time period during which no hazardous or toxic substances or elements are expected to leak or deteriorate during normal use and generally reflects the expected useful life of the product.</p>
	<p>Hot surface. The metallic panels may get warm after powering on the equipment.</p>
	<p>Caution, risk of electric shock. After disconnection from mains allow internal capacitors to fully discharge.</p>
	<p>Symbol 7, the frame or chassis terminal.</p>

NOTE

The QSFP communication cables (or any other with potential laser energy) are not sold as part of the equipment and as such the unit has no laser safety classification. The QSFP communication cables used must be compliant with the requirements of the authorities having jurisdiction where the equipment is used.

Compliance and Environmental Information

Table 1 Compliance and Environmental Information

Safety Symbol	Description
	<p>This product complies with WEEE Directive (2002/96/EC) marking requirements. The affixed label indicates that you must not discard this electrical/electronic product in domestic household waste.</p> <p>Product Category: With reference to the equipment types in WEEE Directive Annex I, this product is classed as a "Monitoring and Control instrumentation" product.</p> <p>Do not dispose in domestic household waste.</p> <p>To return unwanted products, contact your local Keysight office, or see http://about.keysight.com/en/companyinfo/environment/takeback.shtml for more information.</p>

Declaration of Conformity

Declarations of Conformity for this product and for the Keysight products may be downloaded from the Web. Go to <http://www.keysight.com/go/conformity>.

You can then search by product number to find the latest Declaration of Conformity.

S5040A Open RAN Studio Player and Capture Appliance – At a Glance

Designed for LTE and 5G O-RAN Radio Unit (O-RU) testing, Keysight S5040A Open RAN Studio Player and Capture Appliance is a Windows® 10 Pro Workstation based operating system 1RU server and FPGA hardware accelerated Ethernet acquisition, timing, and triggering hardware, which provides powerful, yet easy to use, capabilities to:

- Build O-RAN compliant CUS-plane test vectors.
- Emulate an O-RAN Distributed Unit (O-DU) – to generate the test vectors against a Device Under Test (DUT).
- Capture and accurately timestamp the DUT's responses.
- Perform measurements needed to validate if the O-RU meets standard compliant operation and radio performance.

The S5040A Appliance includes powerful O-RAN focused tools to construct, play, capture, and measure O-RAN traffic over 10 Gbps / 25 Gbps (fronthaul) Ethernet interfaces. Out of the box integration of the U5040B Open RAN Studio software with Keysight's industry leading PathWave Signal Studio and 89600 VSA software enables sophisticated 5G signal creation and easy capture, extraction, and export of IQ vectors – for advanced modulation analysis of received RF / mmWave signals and radio performance. Additionally, when combined with Keysight spectrum analyzers and signal sources, the integrated Open RAN Studio solution delivers the most comprehensive cross domain, multi-channel RF / mmWave and O-RAN protocol measurements available in the industry, for both FR1 and FR2 radios, downlink (DL) and uplink (UL) paths.

Some of the highlights of the S5040A Appliance are:

- High-capacity removable solid state hard drive for fast boot-up, storing setups, and saving measurement results.
- USB 3.0 and LAN ports make printing, saving, and sharing data easy.
- VGA and DisplayPort ports on the motherboard I/O panel for displaying the screen on a different monitor.
- 64-bit Windows operating system and graphical user interface with easy-to-use menus, toolbars, and features. Ability to install other Windows applications other than the pre-installed Signal Studio and vector signal analysis (VSA) software.

In this Guide

This guide provides you the information to begin using the S5040A Open RAN Studio Player and Capture Appliance.

Chapter 1, “Setting up the S5040A Appliance, includes unpacking steps, power and air flow requirements, and other setup information.

Chapter 2, “Getting Started, familiarizes you with the inputs and outputs, front-panel knobs and keys, the graphical user interface, and describes how to perform basic operations with the S5040A Appliance.

Chapter 3, “Miscellaneous tasks on the S5040A Appliance, describes some secondary tasks, which are related to optimizing the appearance of the software and hardware, which you could perform on the S5040A Appliance.

Chapter 4, “Troubleshooting, describes what to do if you encounter any problems with your S5040A Open RAN Studio Player and Capture Appliance.

For more information

- For detailed information on how to use the S5040A Appliance and the U5040B Open RAN Studio software, see the U5040B Open RAN Studio software’s online help. See “**Accessing the Online Help**” on page 36.
- For technical assistance, contact your local Keysight Technologies representative at <http://www.keysight.com/find/contactus>.

Contents

Safety Summary	3
Compliance and Environmental Information	5
Declaration of Conformity	5
S5040A Open RAN Studio Player and Capture Appliance - At a Glance	6
In this Guide	7

1 Setting up the S5040A Appliance

Inspecting Package Contents	12
Accessories provided with S5040A Appliance	13
Environmental Characteristics	14
Positioning for proper airflow	16
Connecting accessories and LAN cable to the S5040A Appliance	17
Connecting power to the S5040A Appliance	19
Powering On the S5040A Appliance	20

2 Getting Started

Front Panel Connectors	24
Understanding SFP / QSFP modules & Cable types	27
Cable types	28
Modules	31
Inserting & removing modules and cables	33
Copper SFP module for M-Plane Passthrough	42

Startup sequence of the S5040A Appliance	43
LED Indicators	45
Initial boot sequence	46
Changing the Administrator password	47
Launching software for S5040A Appliance	48
Understanding software features	51
Performing a soft reset	56
Accessing the Online Help	57
Performing Instrument Image Recovery	59
3 Miscellaneous tasks on the S5040A Appliance	
 Changing Windows operating system settings	64
 Installing Application Programs on S5040A Appliance	65
 Firmware Updates	66
 Cleaning the S5040A Appliance	68
4 Troubleshooting	
 Verifying Basic Operation	70
Powering Up the S5040A Appliance	70
Display Troubleshooting	71
USB port Troubleshooting	73
 Firmware Update error	74
 Software errors during / after installation	75
Errors with U5040B software	75
Errors with other pre-installed software	76
 Returning the S5040A Appliance to Keysight for Service	77

Index

1

Setting up the S5040A Appliance

[Inspecting Package Contents](#) / 12

[Environmental Characteristics](#) / 14

[Positioning for proper airflow](#) / 16

[Connecting accessories and LAN cable to the S5040A Appliance](#) / 17

[Connecting power to the S5040A Appliance](#) / 19

[Powering On the S5040A Appliance](#) / 20

This chapter shows how to set up and prepare your S5040A Open RAN Studio Player and Capture Appliance for first-time use.

Inspecting Package Contents

Table 2 shows a check list that you must perform after you receive the procured S5040A Open RAN Studio Player and Capture Appliance, also referred to as ‘S5040A Appliance’.

Table 2 Checklist after receiving package

Items to check	
✓	<p>Inspect the shipping container for damage.</p> <ul style="list-style-type: none"> ▪ Keep the shipping container or cushioning material until you have inspected the contents of the shipment for completeness and have checked the S5040A Appliance mechanically and electrically. ▪ If the shipping container is damaged, or the cushioning materials show signs of stress, notify the carrier and your Keysight Technologies Sales Office. Keep the shipping materials for the carrier's inspection. The Keysight Technologies Sales Office will arrange for repair or replacement at Keysight's option without waiting for claim settlement.
✓	<p>Inspect the S5040A Appliance.</p> <p>If there is mechanical damage or a defect, or if the S5040A Appliance does not operate properly, notify your Keysight Technologies Sales Office.</p>
✓	<p>Verify that you received the following items in the packaging for the S5040A Appliance.</p> <ul style="list-style-type: none"> ▪ Open RAN Studio Player and Capture Appliance (Qty. 1) ▪ Power cord (Qty. 1) ▪ Keyboard (Qty. 1) ▪ Mouse (USB Optical) (Qty. 1) ▪ Electrical Loopback QSFP28 module (Qty. 1) ▪ Quick Start poster <p>If anything is missing, contact your nearest Keysight Technologies Sales Office.</p>
✓	<p>Verify that you received the options and accessories you ordered and that none were damaged.</p>

Accessories provided with S5040A Appliance

Table 3 List of accessories along with S5040A Appliance

Part Number	MPN	Manufacturer	Description
0950-6426	SF-100GLB0W00-0DB	AMPHENOL INTERCONNECT PRODUCTS	QSFP 100G Loopback Adapter Module for QSFP28 Port Testing 0dB 0W
0960-3245	Y-U0009	LOGITECH	Keyboard 104 Key with USB-Cable
0960-3246	910-001439	LOGITECH	Optical Mouse USB 2-Buttons 1-Scroll Wheel

For a complete list of options and accessories available for the S5040A Open RAN Studio Player and Capture Appliance, see *S5040A Open RAN Studio Player and Capture Appliance Data Sheet*.

Environmental Characteristics

Table 4 List of environmental characteristics for the S5040A Appliance

Characteristic	Rating / Range / Description
Environment	Indoor use only
Ambient Temperature	Operating: +5 °C to +40 °C Non-operating: -40 °C to +70 °C CAUTION: If storing the S5040A Appliance above +40 °C, make sure the feet are firmly secured beneath the instrument.
Humidity	Operating: maximum relative humidity 80 percent for temperatures up to 31 °C, decreasing linearly to 50 percent relative humidity at 40 °C, non-condensing. Non-operating: up to 95 percent relative humidity, non-condensing, at 40 °C; decreasing linearly to 50 percent relative humidity at 70 °C
Altitude	Operating: up to 3,000 meters (9,842 feet) Non-operating: up to 15,300 meters (50,000 feet)
Weight	17.968 lbs (8.15 kgs)
Dimensions	Width = 434 mm (17.09 in) Depth = 495 mm (19.49 in) Height = 106 mm (4.17 in)
Safety	UL 61010-1:2010/CAN/CSA C22.2 No. 61010-1-12 Amendment 1 IEC 61010-1:2017 Amendment 1 IEC 61010-2-030:2017 Amendment 1 UL 61010-2-030:2018 Amendment 1 CAN/CSA-22.2 No. 61010-2-030-17 Amendment 1
Installation Category	II

Characteristic	Rating / Range / Description
Voltage Fluctuations	Note that the mains supply voltage fluctuations are not to exceed $\pm 10\%$ of the nominal supply voltage. Temporary overvoltages may not exceed the allowed voltage fluctuations of $+10\%$ nominal.
Pollution Degree	The S5040A Appliance may be operated in environments of Pollution Degree 2.
Pollution Degree Definitions	<p>Pollution Degree 1: No pollution or only dry, non-conductive pollution occurs. The pollution has no influence. Example: A clean room or climate-controlled office environment.</p> <p>Pollution Degree 2. Normally only dry non-conductive pollution occurs. Occasionally a temporary conductivity caused by condensation may occur. Example: General indoor environment.</p> <p>Pollution Degree 3: Conductive pollution occurs, or dry, non-conductive pollution occurs which becomes conductive due to condensation which is expected. Example: Sheltered outdoor environment.</p>

Positioning for proper airflow

Position the S5040A Appliance in a manner, where it will have sufficient clearance for airflow around the back and sides.

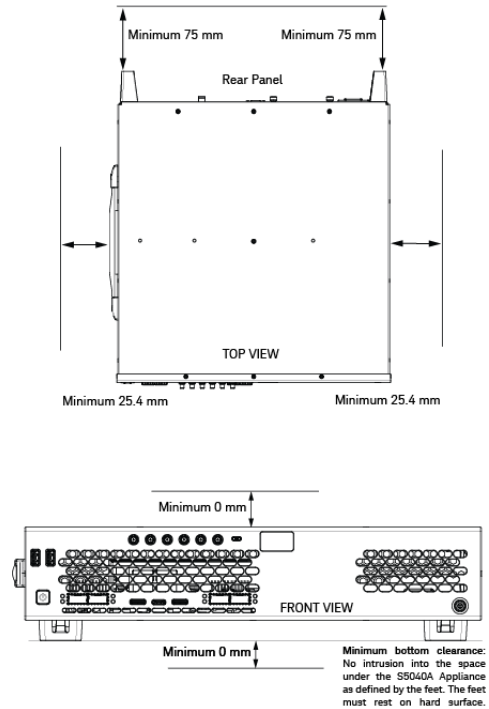

Figure 1 Positioning the S5040A Appliance with sufficient clearance

Connecting accessories and LAN cable to the S5040A Appliance

Figure 2 shows the rear panel of the S5040A Appliance.

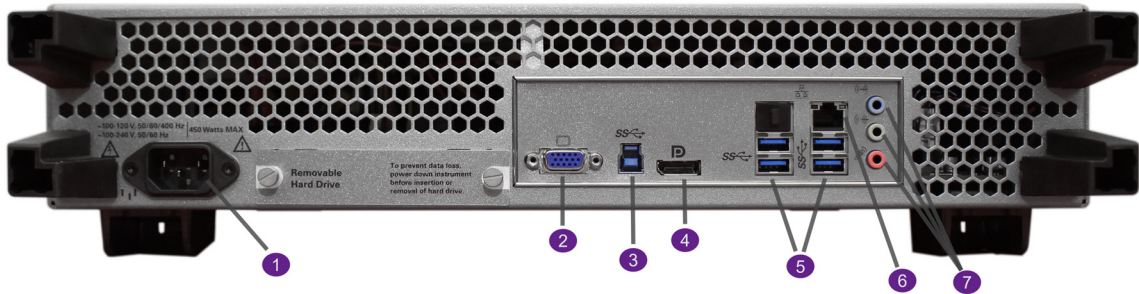

Figure 2 Rear panel of the S5040A Appliance

The ports on the rear panel of the S5040A Appliance are listed in the order shown in the image above:

Table 5 Description of the Rear panel connectors

Label#	Connector	Description
1	Power	AC Power input
2	Display Out	Type: VGA
3	USB	USB 3.0 device port (1x)
4	Display Out	Type: DisplayPort
5	USB	USB 3.0 host ports (4x)
6	LAN	2x RJ-45 connector, supports 10/100/1000Base-T. Supports Web-enabled remote control, data/file transfers and network printing.
7	Audio	Microphone, line in, line out

NOTE

Maximum length of the accessory cable should be less than 3 meters to reduce any RFI interference.

Perform the following steps prior to powering on the S5040A Appliance:

- i Plug a mouse and keyboard into the USB host ports. Four host ports are on the rear panel, with two more on the front panel.
- ii Connect an HD monitor to either the VGA connector or the DisplayPort + USB 3 Device Port, depending on the type of connector you have. While you may connect up to two displays simultaneously, it is recommended that you connect a monitor to the VGA connector only, when starting up.
- iii If you want to connect to a Local Area Network, connect your LAN cable to the RJ-45 connector on the side panel. Connect the other end to an open LAN port.

Connecting power to the S5040A Appliance

Table 6 Power requirements for the S5040A Appliance

Attribute	Ratings
Power	~ 100 - 120 V, 50/60/400 Hz ~ 100 - 240 V, 50/60 Hz 450 Watts MAX

Connect the power cord to the rear of the S5040A Appliance, then to a suitable AC voltage source. An orange / amber light appears on the power button to indicate that a standby power is applied to the S5040A Appliance.

Route the power cord so the Appliance's feet do not pinch the cord.

The power cord is the disconnecting device for Mains. Position the equipment so the power cord is easily reached by the operator.

CAUTION

Use *only* the power cord that came with the S5040A Appliance.

The power cord provided is matched to the country of origin of the order.

WARNING

To avoid electric shock, be sure the S5040A Appliance is properly grounded.

Powering On the S5040A Appliance

Figure 3 shows the front panel of the S5040A Appliance.

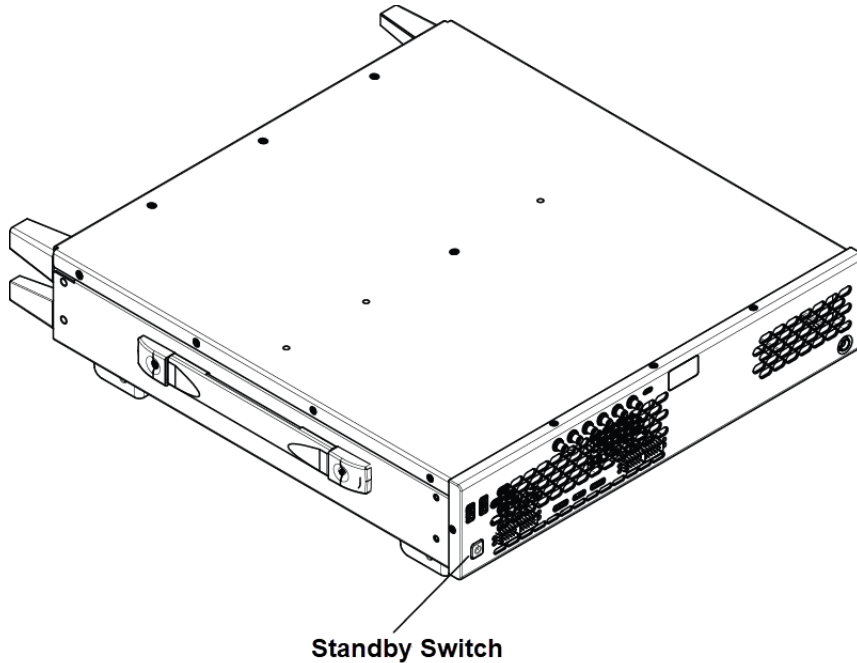

Figure 3 Powering on the S5040A Appliance

Press the power switch in the lower left corner of the S5040A Appliance's front panel. The power button turns green in color. After a short initialization period, the boot up sequence for Windows operating system appears on the connected display. The S5040A Appliance is ready to use.

You can connect and disconnect SFP / QSFP adapters and modules even after the Appliance has been powered on.

Powering Off the Oscilloscope

To power off the S5040A Appliance, do one of the following. The Appliance will go through a normal Windows operating system shutdown process.

- On the monitor display, click **Power** > **Shut down** from the **Start** menu.

OR

- Press and 'release' the power switch at the lower left corner of the S5040A Appliance's front panel.

- If the normal power down does not occur within a few minutes, in such a case only, press and 'hold' the power switch.

CAUTION

There may be instances when you press and release the power switch and it does not power down the S5040A Appliance immediately. This may happen because of a Windows update that may be occurring, which is unnoticeable especially if a monitor is not connected. In such cases, you should not force the power down by pressing and holding the switch (or, hard power down), as it may corrupt the Windows update.

2 Getting Started

[Front Panel Connectors](#) / 24

[Understanding SFP / QSFP modules & Cable types](#) / 27

[Startup sequence of the S5040A Appliance](#) / 43

[LED Indicators](#) / 45

[Initial boot sequence](#) / 46

[Launching software for S5040A Appliance](#) / 48

[Performing Instrument Image Recovery](#) / 59

Front Panel Connectors

Figure 4 shows the S5040A Appliance's front panel, where all connectors are located.

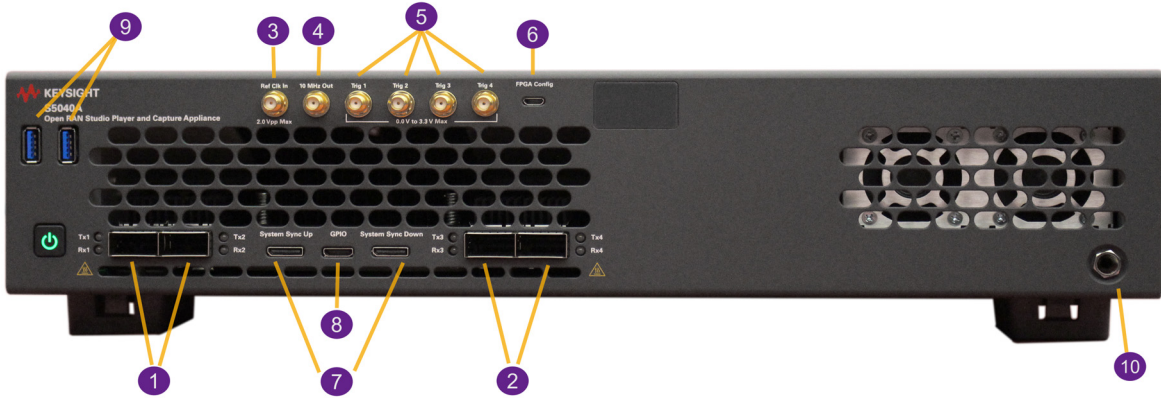

Figure 4 Front panel of the S5040A Appliance

The front panel ports on the S5040A Appliance are listed in the order shown in Figure 4.

Table 7 Description of the Front panel connectors

Label#	Connector	Description
1,2	QSFP28 Cages	Conforms to SFF-8665: QSFP+ 28 Gb/s Pluggable Transceiver Solution (QSFP28) - 4 ports
3	Ref Clk In	Conforms to SMA Frequency: 10 MHz or 100 MHz (± 20 ppm) Amplitude: 200 mVpp (-10 dBm) to 2 Vpp (+10 dBm) sine, 200 mVpp to 2 Vpp square Input impedance: 50 ohm
4	10 MHz Out	Conforms to SMA Amplitude into 50 ohm: 1.65 Vpp (+8.3 dBm) sine wave Frequency: 10 MHz, ± 4.6 ppm inclusive of temperature and aging when internal timebase is selected, or tolerance of external Ref Clk In when selected

Label#	Connector	Description
5	Trig 1-4 (functionality is described further)	Conforms to SMA Max Input: 0.0 V to +3.3 V Min Input: 100 mVpp Input impedance: 50 ohm or 10K ohm, user selectable Input threshold: 0.0 V to +3.3 V (in 10 mV increments) Output: 0.0 V / +3.3 V into high impedance, 0.0 V / +1.65 V into 50 ohm Max Toggle Rate: 200 MHz
6	FPGA Config	Factory use only. Not intended for general use.
7	System Sync	Not currently supported
8	GPIO	Not currently supported
9	USB	USB 3.0 host ports
10	Ground Jack	Frame Earth Ground (for ESD strap plug-in)

NOTE

The QSFP communication cables (or any other with potential laser energy) are not sold as part of the equipment and as such the unit has no laser safety classification. The QSFP communication cables used must be compliant with the requirements of the authorities having jurisdiction where the equipment is used.

Note that all ports shown in [Figure 5](#) use SMA connectors.



Figure 5 Close-up view of the S5040A SMA ports

The functionality of the four Trigger ports shown in [Figure 5](#) is explained further.

- Trig 1 – Used for trigger in (TRIG IN), which means it will start playing + delta, whatever is queued up to be played by U5040B ORAN Studio software. (Not implemented in the current version).
- Trig 2 – Used to generate trigger output (TRIG OUT) when Player or Recorder starts \pm delta.
- Trig 3 – Used as an input Pulse Per-Second (PPS IN) that can be used for reference. (Not implemented in the current version).
- Trig 4 – Used as an output Pulse Per-Second (PPS OUT) that can be used for reference.

Note that the Keysight S5040A Open RAN Studio Player and Capture Appliances are not rated for Measurement Category II, III, or IV. These measurement categories have been defined in [Table 8](#).

Table 8 Description of Measurement Category II, III and IV

Measurement Category	Description
II	Applicable to testing and measuring circuits connected directly to utilization points (socket outlets and similar points) of the low-voltage mains installation. Example: Measurements on MAINS CIRCUITS of household appliances, portable tools and similar equipment and on the consumer side only of socket-outlets in the fixed installation.
III	Applicable to test and measuring circuits connection to the distribution part of the building's low-voltage mains installation. To avoid risks caused by the hazards arising from these higher short-circuit currents, additional insulation and other provisions are required. Example: Measurements on distribution boards (including secondary meters), photovoltaic panels, circuit breakers, wiring, including cables, bus-bars, junction boxes, switches, socket-outlets in the fixed installation, equipment for industrial use and some other equipment such as stationary motors with permanent connection to the fixed installation. NOTE: For equipment that is part of a fixed installation, the fuse or circuit breaker of the installation can be considered to provide adequate protection against short-circuit currents.
IV	Applicable to test and measuring circuits connected at the source of the building's low-voltage mains installation. Due to these high short-circuit currents, which can be followed by a high energy level, measurements made within these locations are extremely dangerous. Great precautions shall be made to avoid any chance of a short circuit. Example: Measurements on devices installed before the main fuse or circuit breaker in the building installation.

Understanding SFP / QSFP modules & Cable types

This section describes the various cable types, various SFP and QSFP modules along with their insertion/removal procedures. To understand these parts, let us consider some of the connector options available for the S5040A Appliance. Note that the left side of each illustration (with the module inserted into the QSFP28 to SFP28 adapter) is connected into the S5040A Appliance.

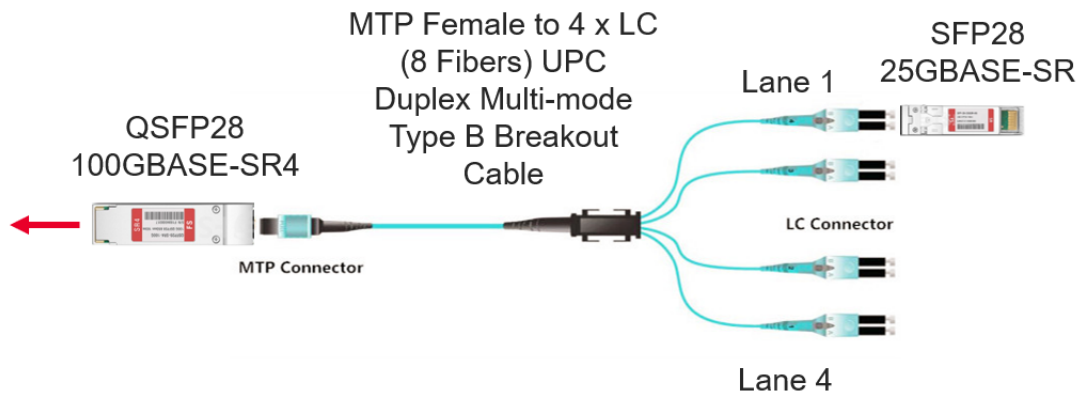

Figure 6 QSFP28 to SFP28 Multi-mode Fiber Breakout

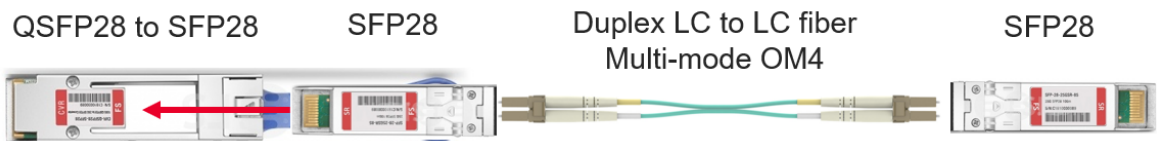

Figure 7 QSFP28 to SFP28 adapter with MMF

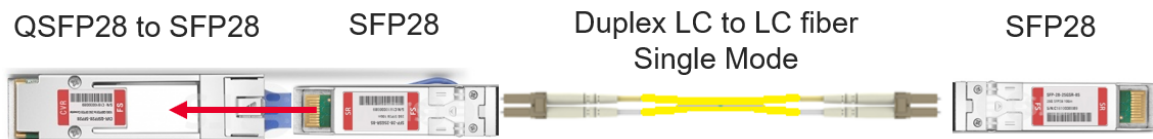

Figure 8 QSFP28 to SFP28 adapter with SMF

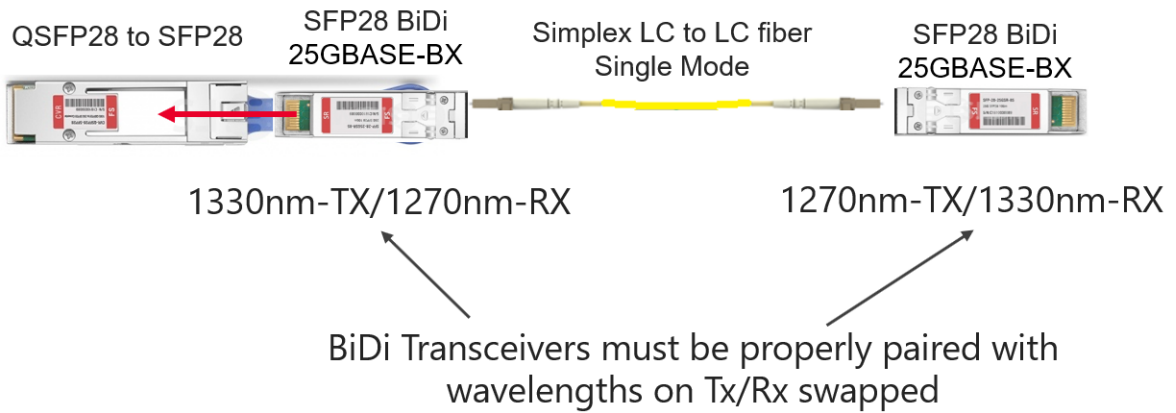

Figure 9 QSFP28 to SFP28 adapter with Bi-directional SFP28



Figure 10 QSFP28 to SFP28 adapter with 10GBASE-T Copper

2.0.1: Cable types

For the connectivity option shown in [Figure 6](#), the MTP Female to 4 x LC (8 Fibers) Duplex Multi-mode Type B Breakout Cables are shown in [Figure 11](#). Type B indicates that it crosses over Tx and Rx in the fibers as required.

These cables are required to connect from a QSFP28 100GBASE-SR4 modules. The four fiber pairs, which are available with the LC connectors, are labeled 1 to 4, which correspond to the four Ethernet lanes in the QSFP28 module. [Table 9](#) shows the mappings of the lanes to fibers.

Note that there are 12 fibers in the MPO connector. Each lane has two fibers for Tx / Rx. For a QSFP28-to-QSFP28 connection, where the O-DU and O-RU are QSFP28 100GBASE-SR4, connected using a 12 Fiber, OM4, Type B, MTP Female to MTP Female connector. Type B specifies that Tx and Rx are crossover. Note that for 25G/100G Ethernet, fibers 5 to 8 are not used.

Table 9 Lane-to-fiber mapping

Lane	Fibers
1	1/12
2	2/11
3	3/10
4	4/9

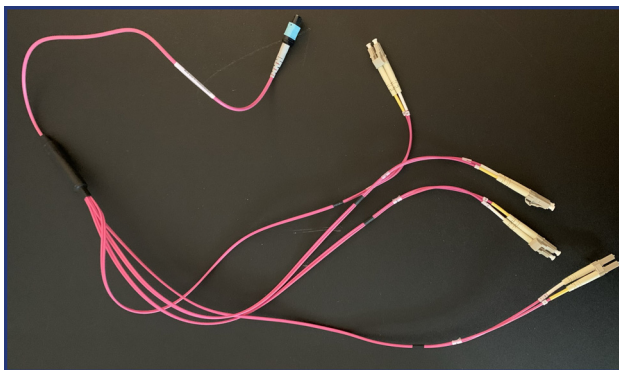

Figure 11 MTP Female to 4 x LC cables (full-length view)

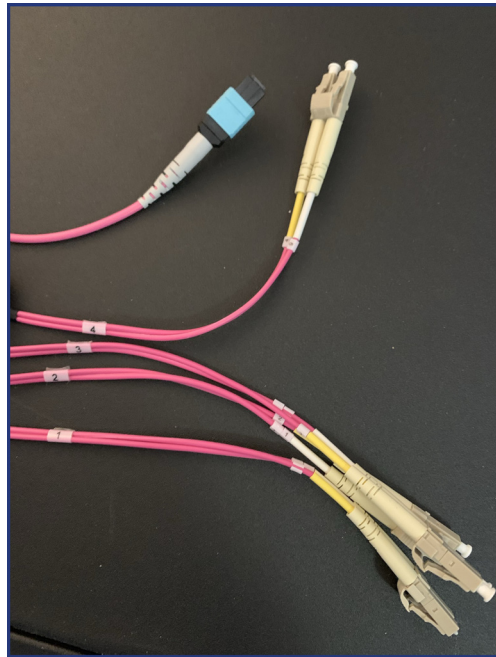

Figure 12 MTP Female to 4 x LC cables (close-up)

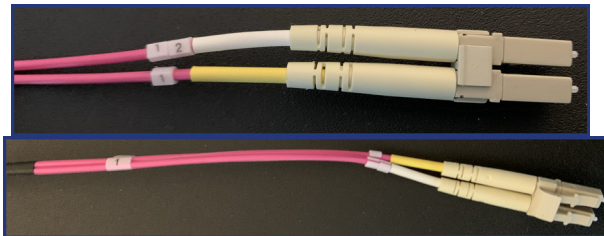

Figure 13 LC connector (close-up view)



Figure 14 MTP Female connector (top view)



Figure 15 MTP Female connector (front view)

2.0.2: Modules

The modules that you may connect to the S5040A Appliance are:

- SFP – Small Form-Factor Pluggable modules. The three categories are:
 - SFP – supports 100 Mbps to 4 Gbps per lane
 - SFP+ – supports up to 10 Gbps per lane
 - SFP28 – supports up to 25 Gbps per lane
- QSFP – Quad Small Form-Factor Pluggable modules. The three categories are:
 - QSFP – supports up to 4 Gbps (4 lanes x 1 Gbps per lane)
 - QSFP+ – supports up to 40 Gbps (4 lanes x 10 Gbps per lane)
 - QSFP28 – supports up to 100 Gbps (4 lanes x 25 Gbps per lane)

Note that the S5040A Appliance has four QSFP28 ports. You may plug in QSFP modules without adapters.

Also, SFP28 modules can be used with QSFP28 to SFP28 adapters. Similarly, SFP+ modules can be used with QSFP+ to SFP+ adapters.

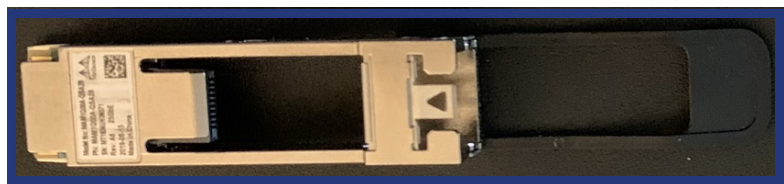

Figure 16 QSFP28 to SFP28 adapter (top view)



Figure 17 QSF28 module (lateral view)



Figure 18 SFP28 module (top view)

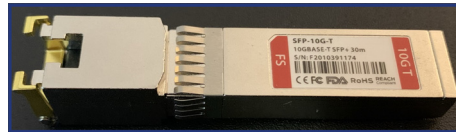

Figure 19 Copper SFP module (top view)

2.0.3: Inserting & removing modules and cables

Inserting MTP connector to QSFP28 module

The MTP connector is keyed, so it cannot be inserted upside down.

Figure 20 shows the QSFP28 module with the key down and Figure 21 shows the MTP connector with the key up.

Figure 22 show how to insert the MTP connector to the QSFP28 module.

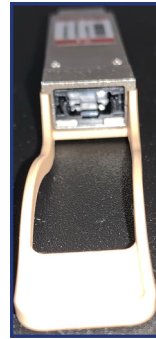

Figure 20 QSFP28 module (rear view) with key down



Figure 21 MTP connector with key up

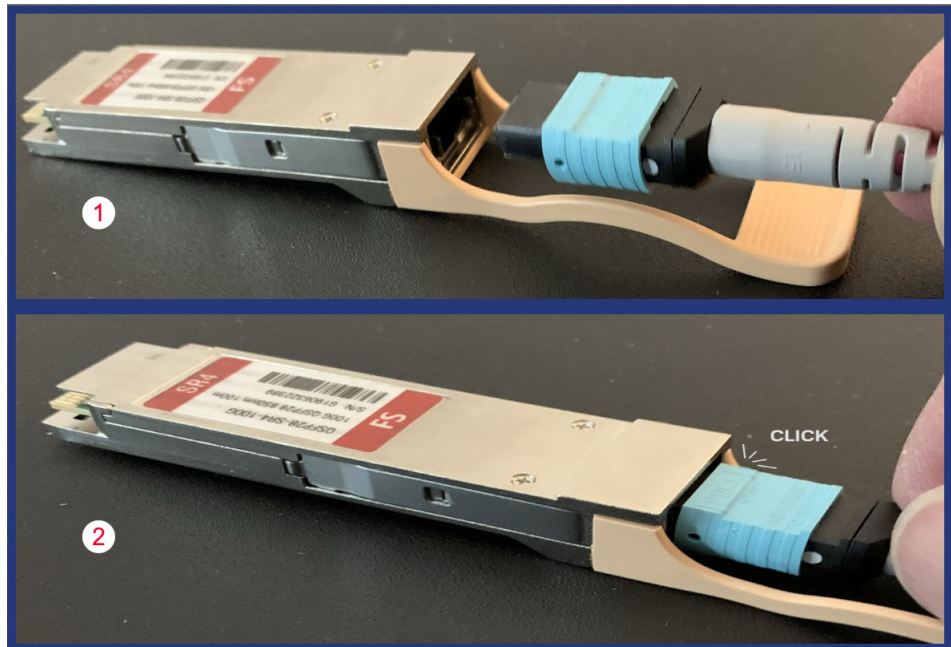

Figure 22 Inserting MTP Connector to the QSFP28 module

When inserted properly, the MTP connector fits in with a 'click'.

Figure 23 shows the direction and orientation of the QSFP adapter (with the MTP connector) for proper insertion into the QSFP port on the S5040A Appliance.



Figure 23 Inserting QSFP28 module into the QSFP port of the S5040A Appliance

Inserting LC fiber connectors to SFP28 module

After inserting the MTP connector into the QSFP28 module, let us insert the other end of the cable (LC fibers) into an SFP28 25GBASE-SR module. Note that the Lane 1 is inserted into the module.

Figure 24 shows how to insert the LC fibers into the SFP28 module. Notice that the clip on the fiber must face the lower end of the SFP28 module.

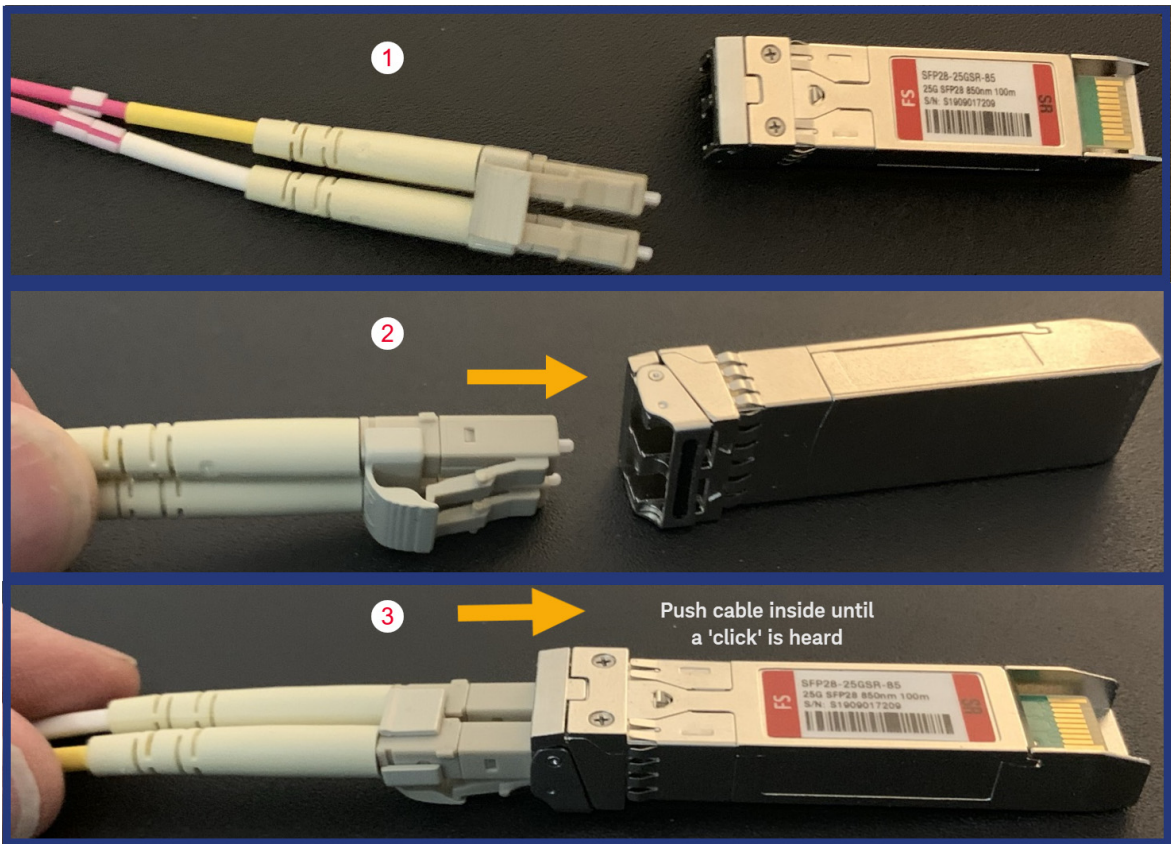

Figure 24 Inserting Lane 1 of the LC fiber to the SFP28 module

When inserted properly, the cable fits in with a 'click'.

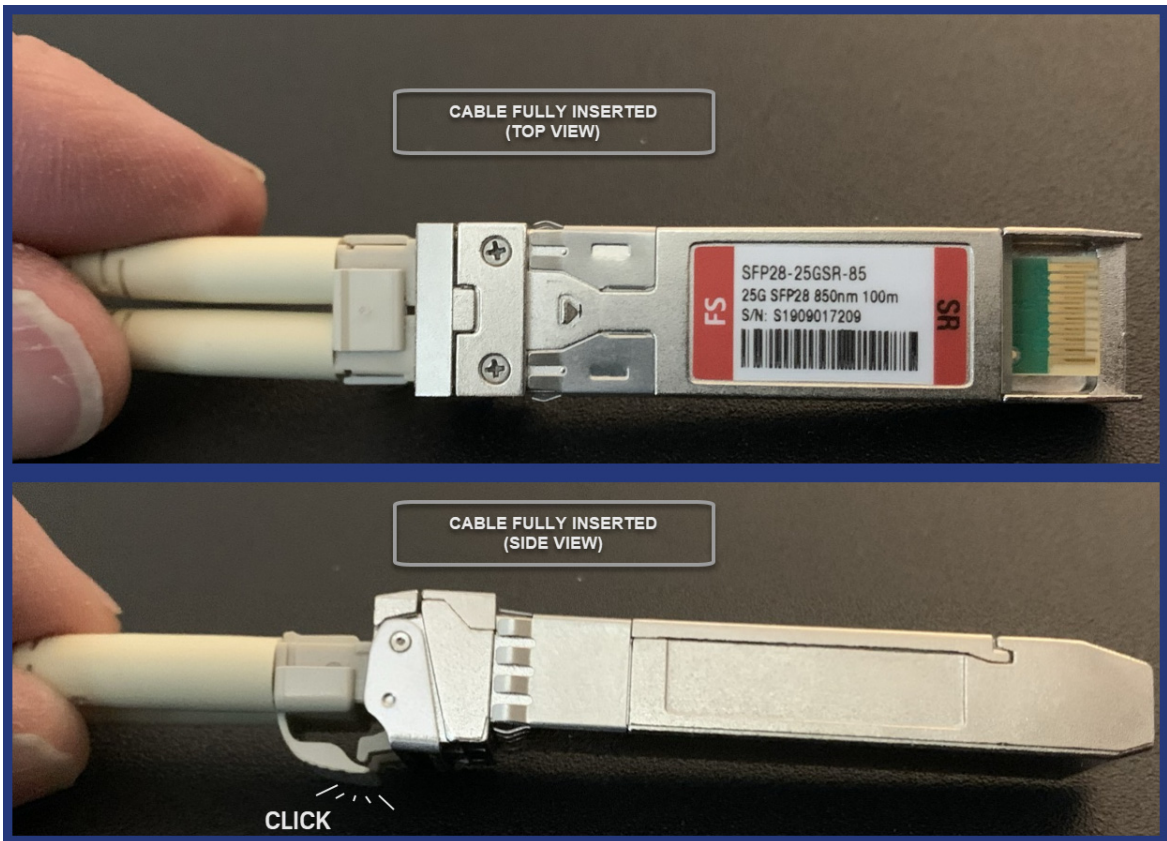

Figure 25 SFP28 module after LC fiber connectors are inserted

Removing MTP Connector from the QSFP28 module

Figure 26 shows how to hold and pull back the blue clasp to release the MTP connector from the QSFP28 module.

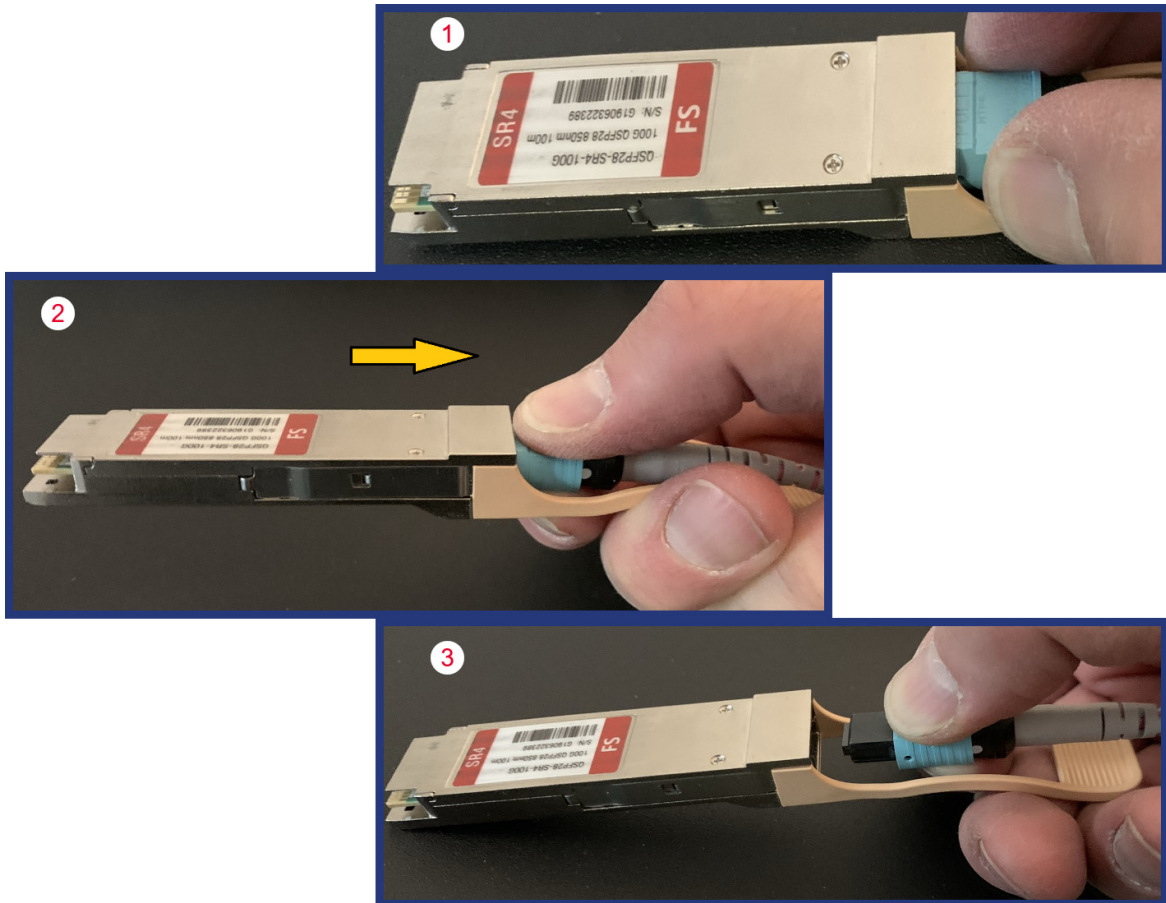

Figure 26 Removing MTP Connector from the QSFP28 module

Removing LC fiber connectors from the SFP28 module

Figure 27 shows how to pinch the clips to release the LC fibers from the SFP28 module.

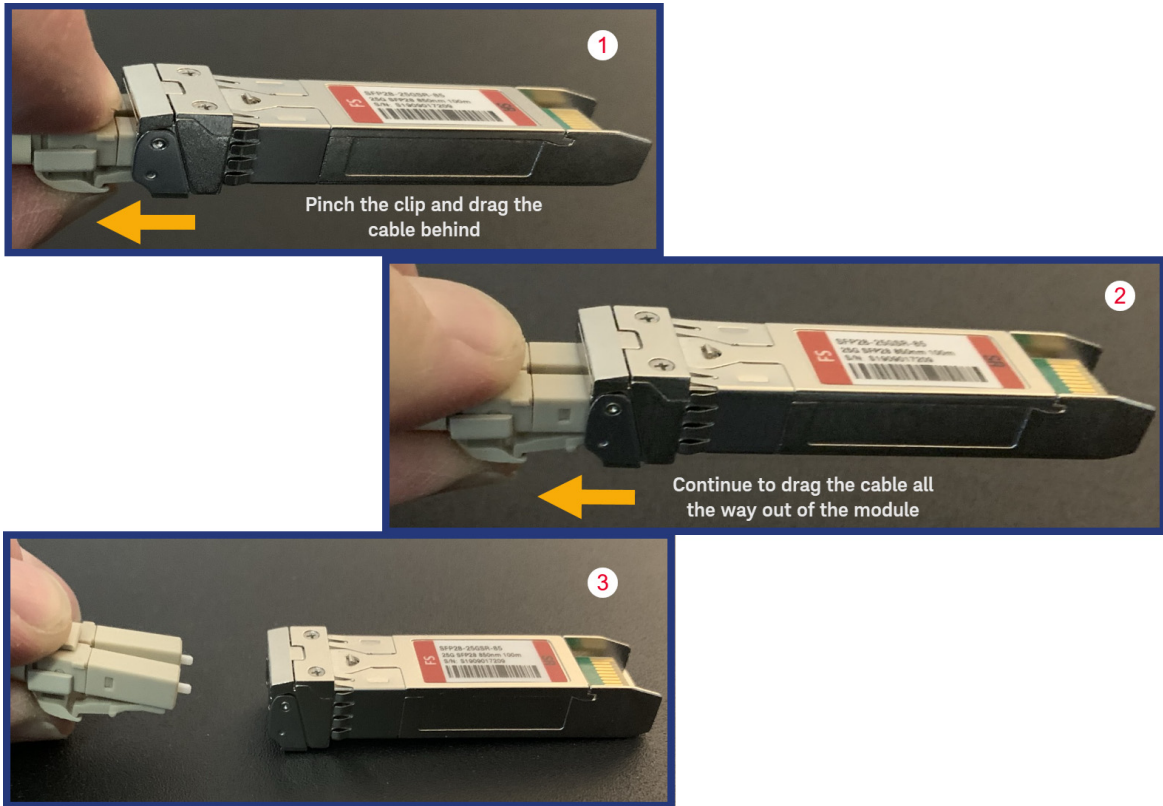

Figure 27 Removing LC fiber connectors from the SFP28 module

Inserting SFP28 module into a QSFP28 to SFP28 adapter

Figure 28 shows how to insert an SFP28 module into a QSFP28 to SFP28 adapter.

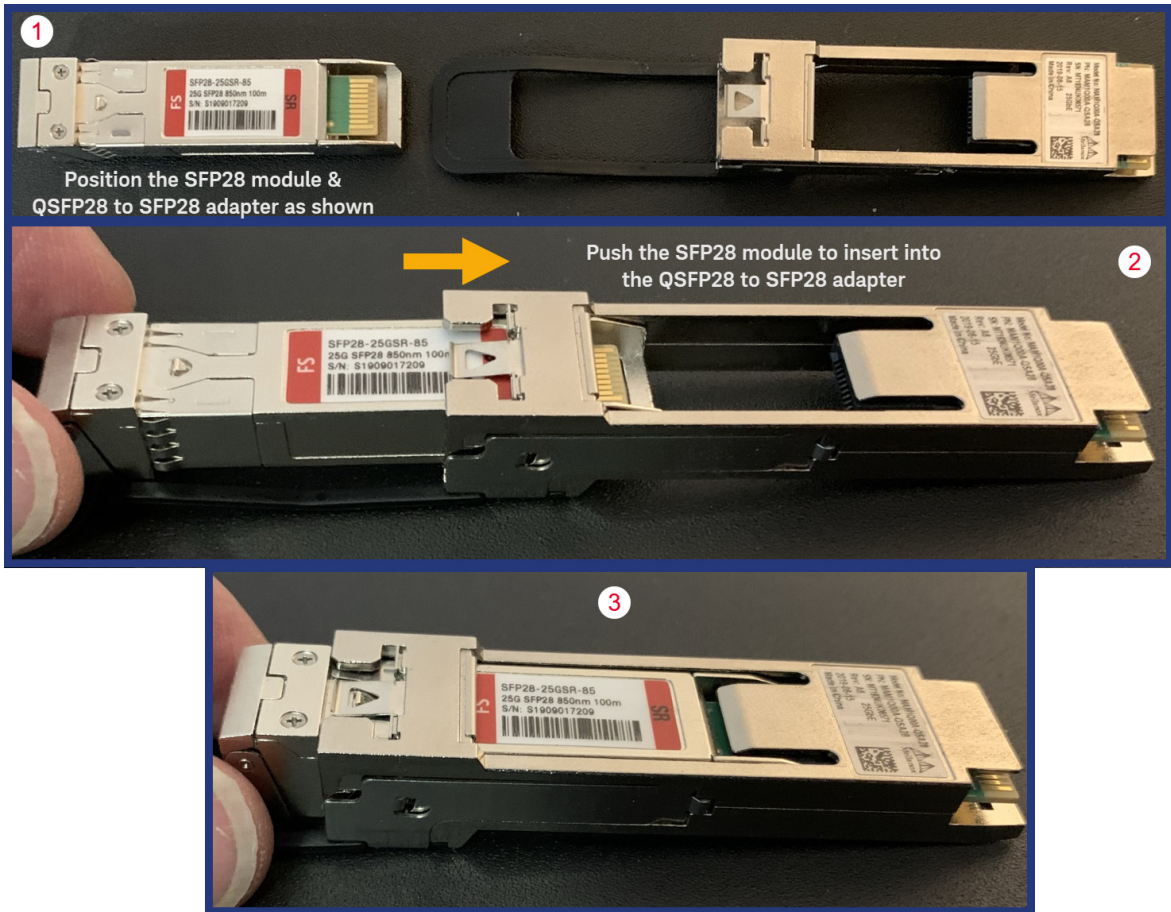

Figure 28 Inserting SFP28 module to a QSFP28 to SFP28 adapter

Removing SFP28 module from the QSFP28 to SFP28 adapter

Figure 29 shows how to remove an SFP28 module from a QSFP28 to SFP28 adapter.

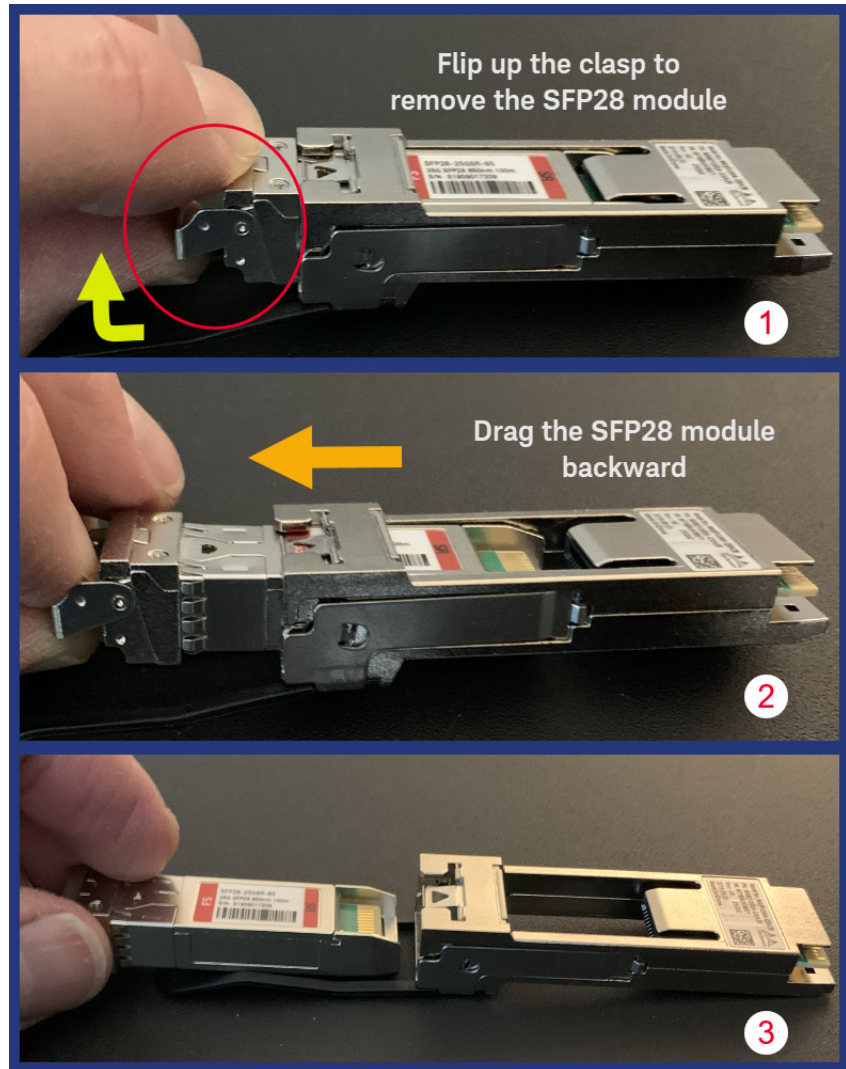

Figure 29 Removing SFP28 module to a QSFP28 to SFP28 adapter

2.0.4: Copper SFP module for M-Plane Passthrough

NOTE

In this section, an SFP+ 10GBASE-T module is shown for the purpose of illustration. While they are almost identical in appearance, for M-Plane Passthrough, a 1000BASE-T SFP module (1G) is actually required.

Inserting the Copper SFP module into a QSFP28 to SFP28 adapter

The process for inserting the Copper SFP module is the same as that of inserting a fiber SFP28 module. See [Inserting SFP28 module into a QSFP28 to SFP28 adapter](#) on page 40. The inverted position of the QSFP28 to SFP28 adapter, with the Copper SFP module inserted within, is shown in [Figure 30](#).



Figure 30 Inserting a Copper SFP module into a QSFP28 to SFP28 adapter

Startup sequence of the S5040A Appliance

This section describes the sequence of visuals that are seen on the front panel of the S5040A Appliance after you press the power button. Note that the startup sequence for the hardware remains the same each time you power the S5040A Appliance on.

Table 10 Front panel visuals during the power up sequence

Sequence#	Front panel visual
1	Power button turns GREEN in color and stays green (until the Appliance goes into standby mode or is powered off). You shall also hear a dual-tone beep, which are the BIOS beep codes.
2	All LEDs flash once (for less than a second) and turn off simultaneously.
3	Only the LED 'Rx4' turns solid RED in color.
4	All LED pairs Tx1/Rx1, Tx2/Rx2, Tx3/Rx3 and Tx4/Rx4 turn solid RED in color and stay RED.
5	All LED pairs Tx1/Rx1, Tx2/Rx2, Tx3/Rx3 flash GREEN and turn off simultaneously.
6	All LED pairs Tx1/Rx1, Tx2/Rx2, Tx3/Rx3 flash RED followed by GREEN and turn off simultaneously.
7	All LED pairs Tx1/Rx1, Tx2/Rx2, Tx3/Rx3 flash RED followed by GREEN. Refer to Table 11 for the actual state, which depends on whether an SFP/QSFP module/adaptor is plugged in or if the software has been initialized.

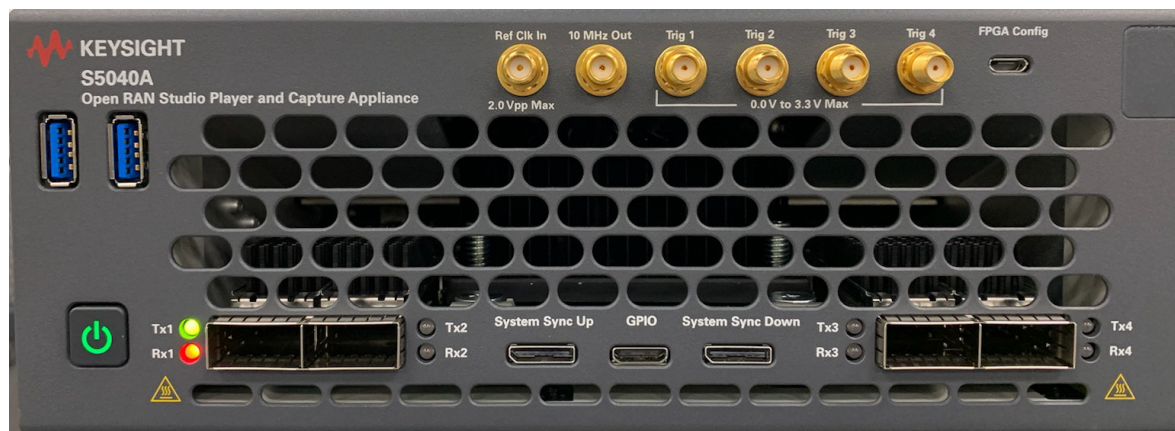

Figure 31 Front panel view after startup sequence

The monitor, which is connected to the S5040A Appliance, simultaneously displays various stages, which are described further in this chapter.

NOTE

Powering off or restarting the S5040A Appliance is not necessary if you attempt to connect / disconnect / switch port for a QSFP adapter while the S5040A appliance is powered up. However, in such cases, you must restart the U5040B Open RAN Studio software.



Figure 32 Switching port for QSFP adapter when S5040A Appliance is on

LED Indicators

During normal operation, the Tx1 - Tx4 and Rx1 - Rx4 LEDs indicate status of the adjacent transceiver.

If the 10G/25G QSFP modules are plugged into QSFP port 1, the Tx1/Rx1 LEDs indicate the following:

- Off – QSFP is not plugged in or recognized
- Amber – Tx (or Rx) is set for 10G
- Green – Tx (or Rx) is set for 25G
- Red – no connection
- Amber or green blinking: packets are being received (Rx) or transmitted (Tx) at the specified bit rate.

If an M-plane connector is plugged into QSFP port 3, Tx and Rx will only be Green, but indicating a speed of 1Gbps, which is the only speed that the M-plane connector supports.

Table 11 indicates the LED state for each Tx and Rx.

Table 11 Tx / Rx LED conditions

LED condition	TX	RX
Off	QSFP unplugged	QSFP unplugged
Red, solid	uninitialized	uninitialized or cable not connected (if detectible)
Amber, solid	initialized, low speed	initialized, low speed
Amber, blinking	low speed activity	low speed activity
Green, solid	initialized, high speed	initialized, high speed
Green, blinking	high speed activity	high speed activity

Initial boot sequence

After the S5040A Appliance is powered on for the first time, the following elements are displayed on the connected monitor in the sequence listed below:

Table 12 Elements displayed in the initial boot sequence

Sequence#	Element displayed	Action to be performed
1	Loading files...	-
2	Logo for Windows 10	-
3	Logo for Keysight Technologies	-
4	Keysight Software End-User License Agreement	Read the license terms carefully and click Agree to proceed
5	Logo for Keysight Technologies along with a prompt with the text "Welcome. System will now reboot into Windows."	Click OK to proceed
6	Logo for American Megatrends along with BIOS version information	-
7	Logo for Windows 10	-
8	Choose an operating system <ul style="list-style-type: none"> ▪ Windows 10 ▪ Instrument Image Recovery System 	Do one of the following: <ul style="list-style-type: none"> ▪ Wait for a few seconds. By default, Windows 10 is set to run automatically after this screen is displayed ▪ Click Windows 10 ▪ Click Instrument Image Recovery System. Refer to the section "Performing Instrument Image Recovery" in this document for more information
9	Windows 10 desktop with the background displaying logo for Keysight Technologies	Launch required software from the Start menu.

You can continue to work on the Windows desktop in the same manner as you do on other machines / PCs with Windows 10 operating system. Note that the next time you power on the S5040A Appliance, only steps 6 to 9 are displayed on the monitor.

Changing the Administrator password

On Keysight S5040A Open RAN Studio Player and Capture Appliances with the Windows 10 operating system, the default Administrator user account password is “keysight4u”. However, by default, you shall be logged in as Administrator without a password prompt. However, Keysight recommends change the Administrator password to something more secure (and not easily guessable).

Launching software for S5040A Appliance

The factory setup consists of the following software pre-installed on the Windows 10 (64-bit) operating system:

- U5040B Open RAN Studio
- N7631C Signal Studio Pro for 5G NR
- Keysight PathWave 89600 VSA 2020 U1

You may launch each software from the shortcut that appears in the **Start** menu, as shown in [Figure 33](#). The supporting components for each software can be found in the respective folder.

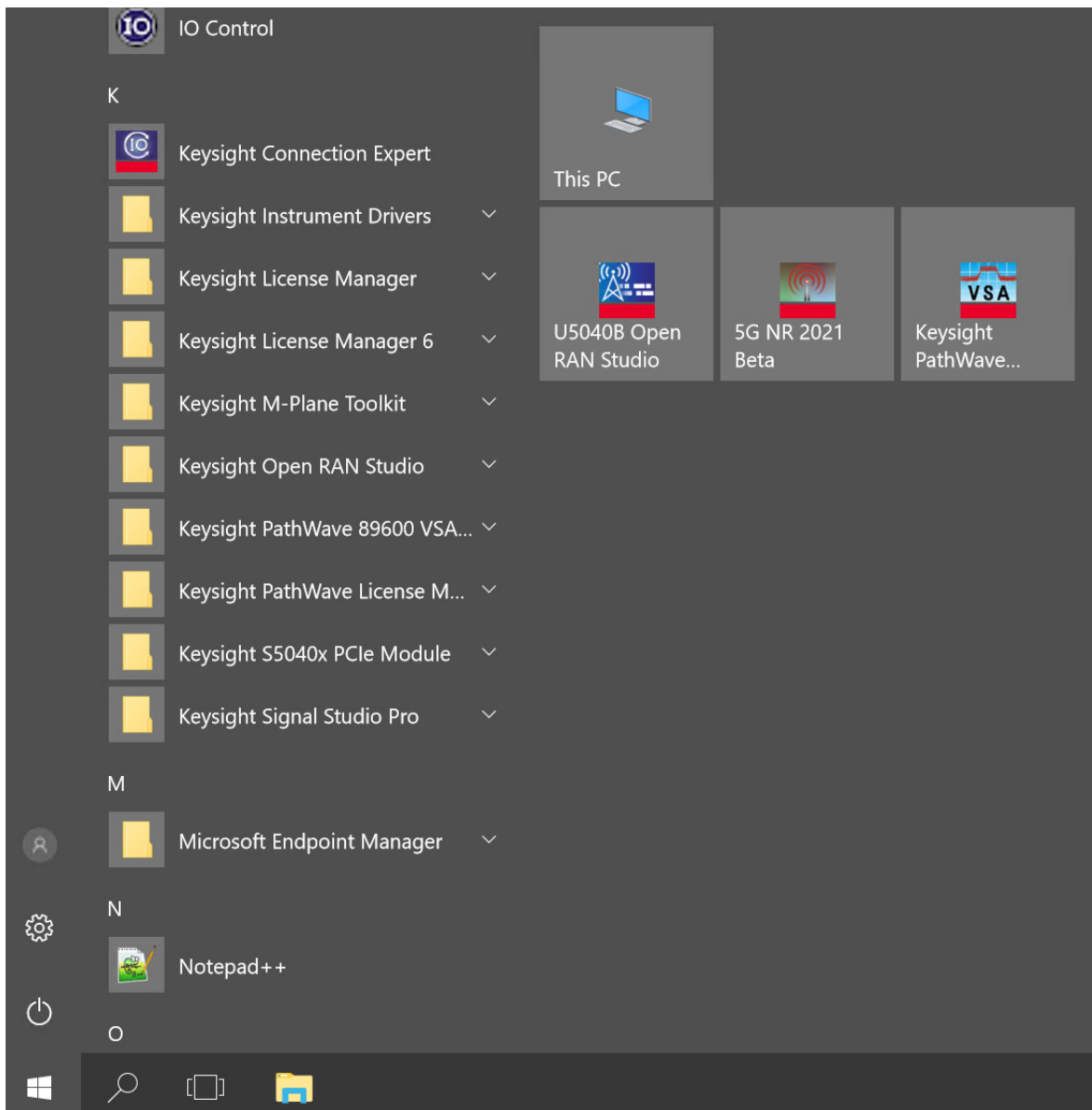

Figure 33 Software available in the Start menu of the Appliance

Primarily, it is the U5040B Open RAN Studio software that drives the functionality of the S5040A Appliance. The main features of the software are described in the order shown in [Figure 34](#).

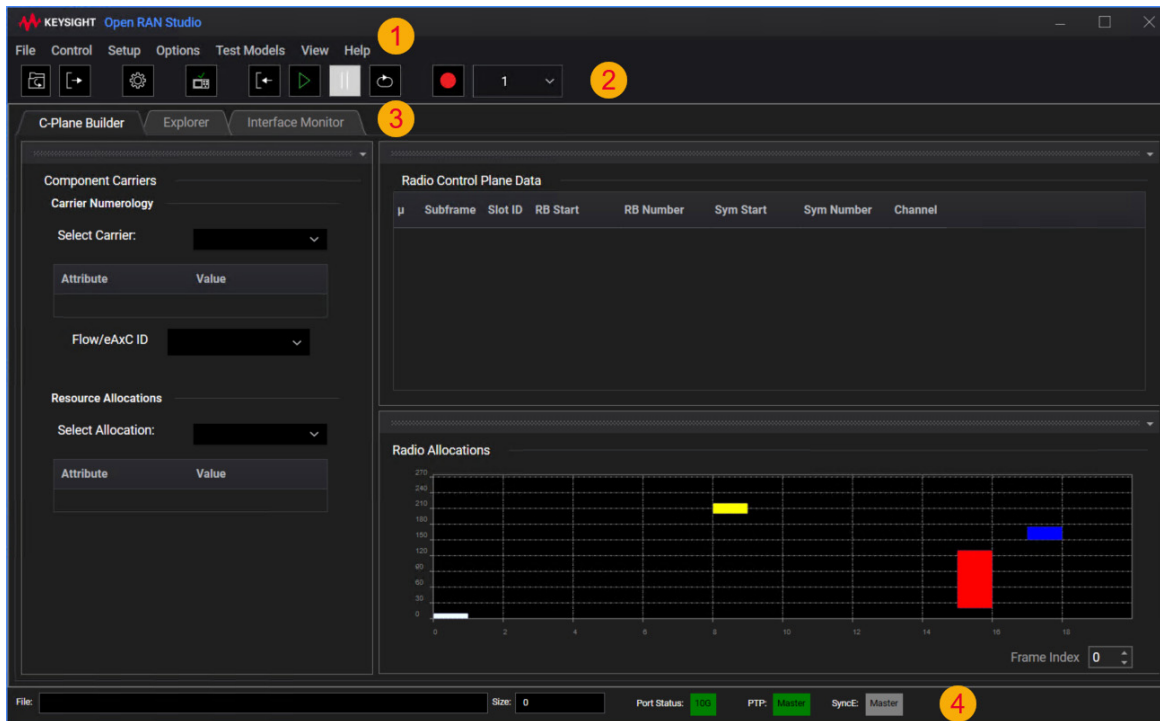

Figure 34 Default window after you launch U5040B Open RAN Studio software

Table 13 Main features in the U5040B Open RAN Studio software

Item#	Feature	Description
1	Menu bar	The menu bar consists of various drop-down sub-menu options, which provide access to different functions, and launch interactive GUI controls.
2	Tool bar	The tool bar provides quick access to essential functions, which are accessible via the Menu bar options; such as opening files, exporting / loading / playing / pausing / restarting stimulus, configuring C/U-Plane Builder and Instrument, recording responses and length.
3	C-Plane Builder/Explorer/Monitor	The “C-Plane Builder” tab enables you to load and modify the appropriate Signal Studio Project (.scp) file from the system. With the optional Open RAN Studio IQ extractor, the “Explorer” tab helps you visualize and fully decode the captured trace and enables IQ centric extraction, which enables RF centric measurements and vector analysis using Keysight 89600 Vector Signal Analyzer (VSA). The “Interface Monitor” tab displays the counters and port status of the S5040A Appliance settings.
4	Status bar	The status bar displays the file name and type, based on the tab you are viewing currently, along with the Port status and PTP state and configuration modes.

Understanding software features

The U5040B Open RAN Studio software provides a test environment that includes and integrates with Keysight tools, in both RF and Protocol Domains, to help you completely exercise an O-RAN CUS compliant Radio Unit (O-RU).

To ensure measurement consistency between both RF and Baseband sides of the O-RU, Open RAN Studio software leverages the same industry leading 5G signal generation and measurement science used in Keysight spectrum analyzers and signal sources. This tight coupling ensures CU-plane messages and baseband information match exactly with the signals captured on the RF side of the Radio Unit.

Signal Studio Pro for 5G NR

Creates 3GPP compliant 5G NR waveforms for emulation through Open RAN Studio to an O-RU / DUT and subsequent transmission to a downstream signal analyzer, DUT, or compliant UE.

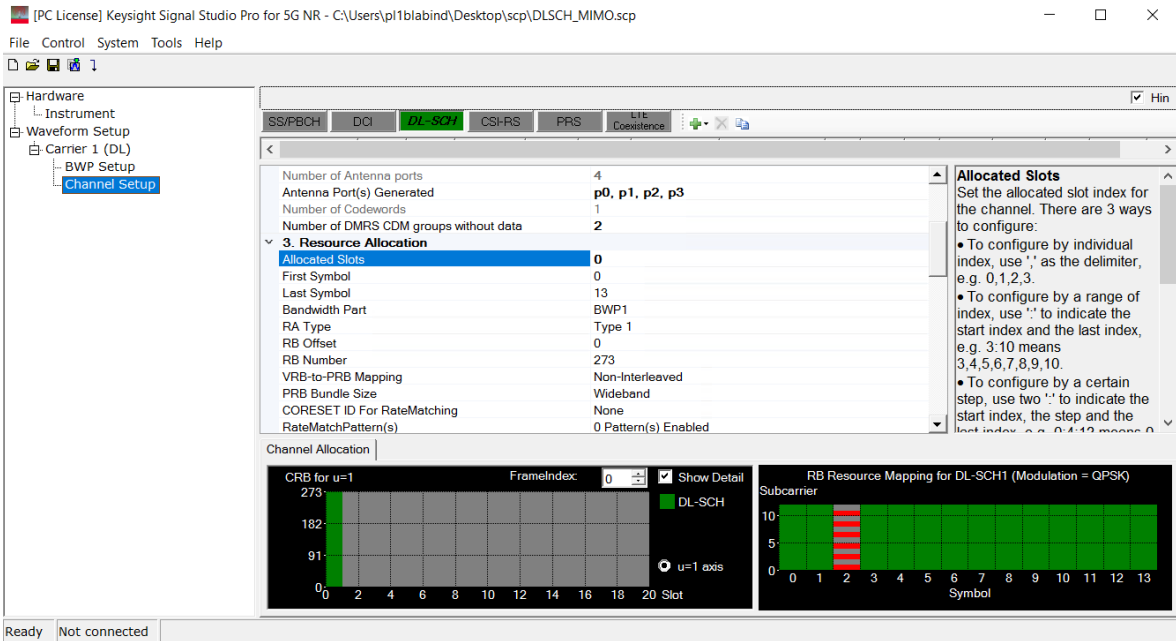

Figure 35 Signal Studio Pro for 5G NR software

U5040B Open RAN Studio software

Open RAN Studio integrates five powerful O-RAN development tools to construct, play, capture, measure, and extract IQ vectors for split option 7.2x O-RAN traffic over a 10 or 25 Gbps fronthaul Interface.

Open RAN Studio Builder

Helps you easily construct diverse O-RAN test vectors. The PCAPNG formatted output file includes the complete Ethernet / VLAN / eCPRI / O-RAN stack.

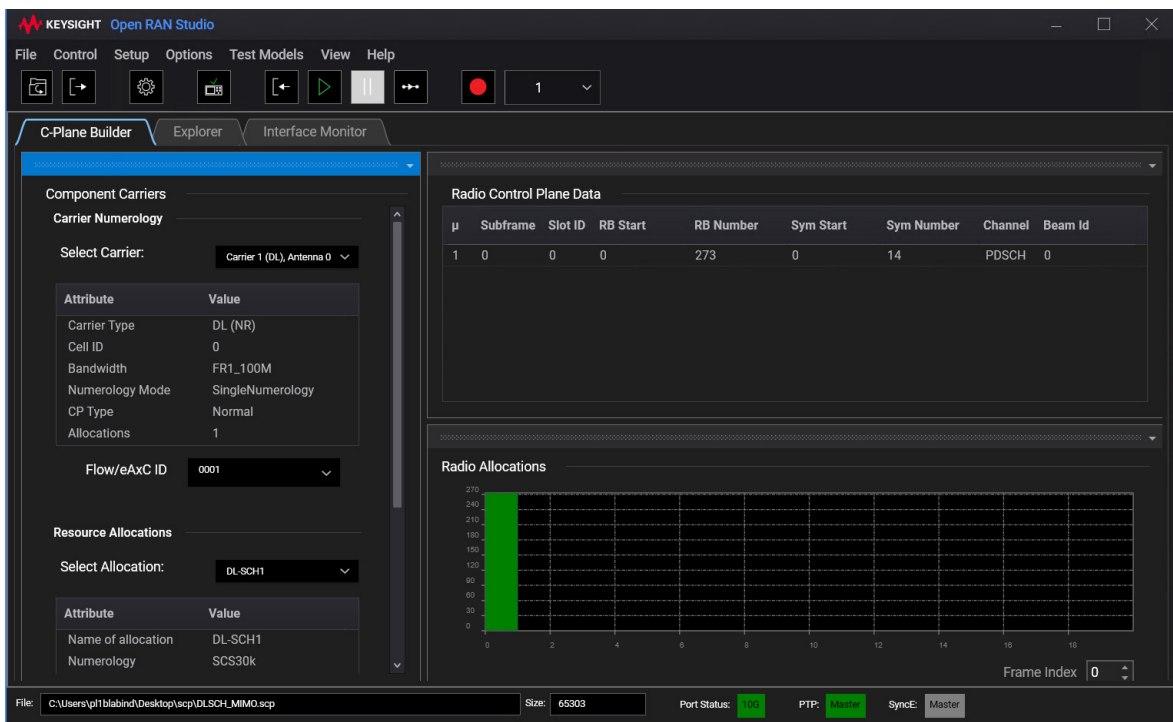

Figure 36 C/U-Plane Builder part of the U5040B software

Open RAN Studio Explorer (including Capture & IQ Extractor)

Decodes and visualizes the O-RAN protocol information and enables measurement in both protocol and RF / mmWave domains. The Capture feature is a hardware-based analyzer that captures the bidirectional Tx and Rx information flows between the DU and O-RU over the O-RAN interface. The IQ Extractor feature is an optional application that reconstructs a time domain IQ file from an O-RAN trace capture for further modulation measurements with 89600 VSA software.

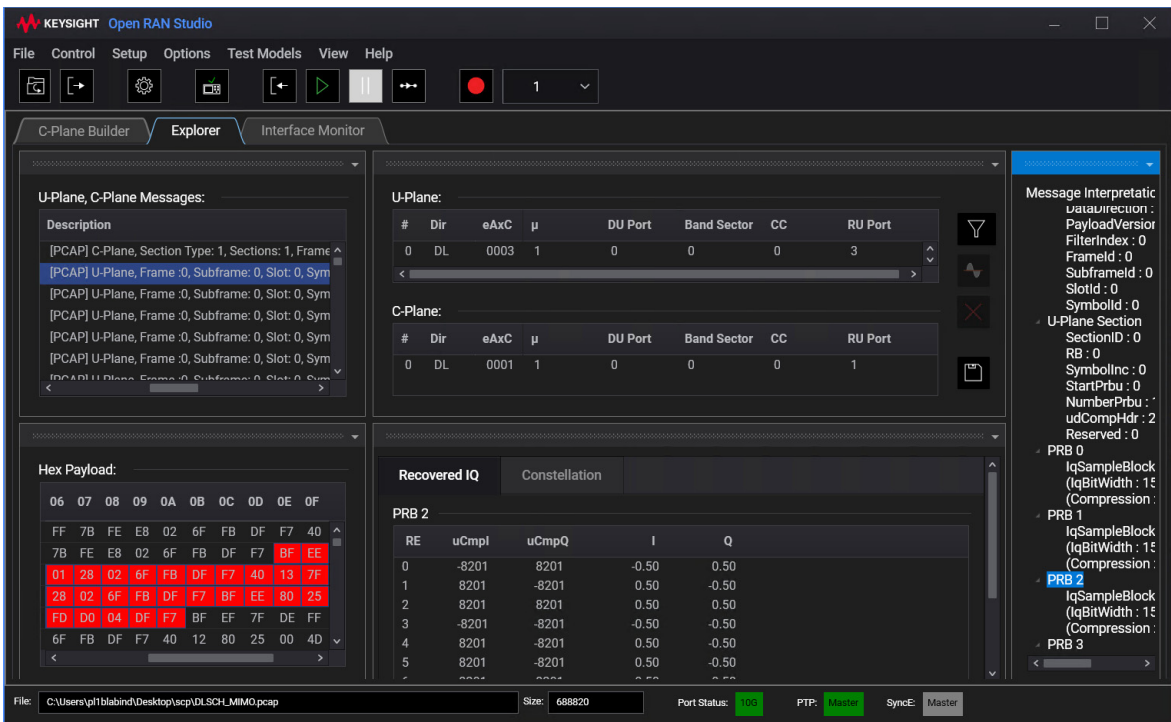

Figure 37 Explorer part of the U5040B software

Open RAN Studio Player

Hardware-based exerciser that emulates a DU and generates test vectors to an O-RU / DUT through the O-RAN interface – honoring O-RAN CUS-plane timing windows.



Figure 38 Player part of the U5040B software

89600 VSA for 5G NR

Receives captured IQ vectors from Open RAN Studio IQ Extractor to perform 5G NR modulation and radio performance measurements.

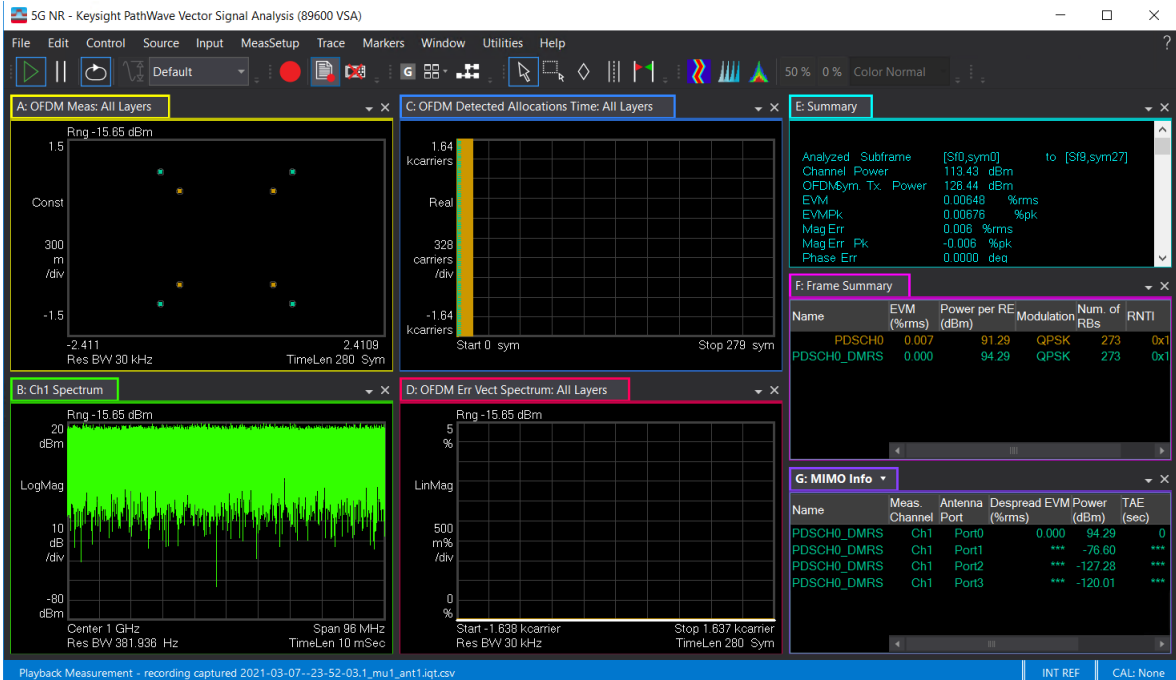

Figure 39 89600 VSA for 5G NR software

Performing a soft reset

To reset the software to its default factory settings, from the main menu of the U5040B Open RAN Studio software, click **File > Recall > Default Setup**.

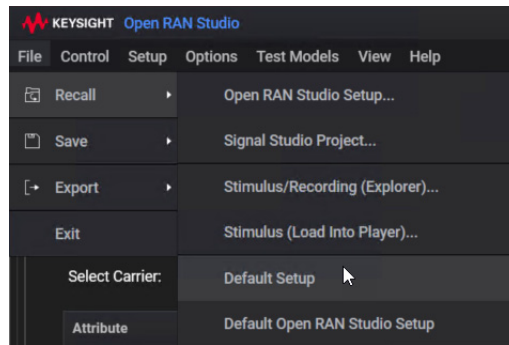

Figure 40 Resetting the software to the factory settings

Note that performing this action does not reset the S5040A Appliance configuration to the factory settings.

Accessing the Online Help

To know more about the GUI and functionality of the U5040B Open RAN Studio software, click **Show Help...** in the **Help** menu of the software.

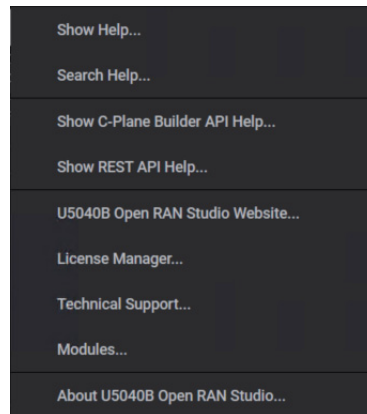

Figure 41 Resetting the software to the factory settings

Similarly, you may launch the N7631C Signal Studio Pro for 5G NR and Keysight PathWave 89600 VSA 2020 U1 software and access the respective Help manuals for more information on using each software.

To understand how to use these two applications to enhance the functionality of the U5040B Open RAN Studio software, refer to the *U5040B Open RAN Studio User's Guide*.

Performing Instrument Image Recovery

Each time the system boots, the window “Choose an operating system” is displayed with the options “Windows 10” and “Instrument Image Recovery System”. This window is displayed for five seconds, as indicated by the phrase, “Windows 10 will run automatically in ‘n’ seconds.”, where n is the countdown value from 5 to 0. If not interrupted by the wiggling of the mouse, Windows 10 operating system is loaded by default.

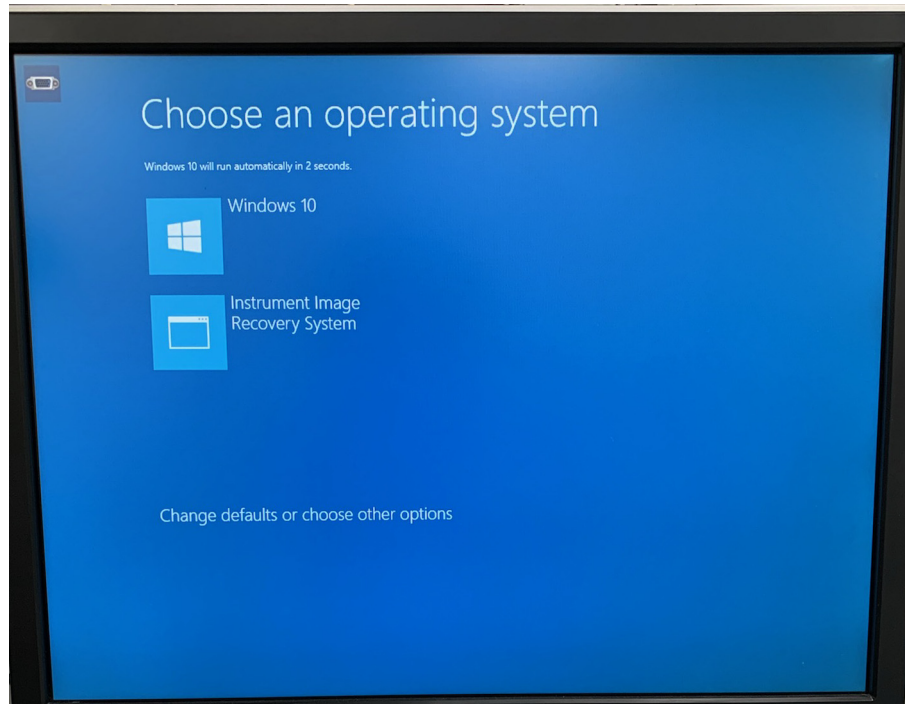

Figure 42 Options to Choose an operating system

If you wiggle the mouse, the countdown stops. You can manually select either of the options.

Select “Instrument Image Recovery System” and wait for recovery files to load. Once the recovery files are loaded, a window titled “Instrument Image Recovery System” is displayed, with five choices.



Figure 43 Instrument Image Recovery System dialog

Depending on the action you wish to perform, enter a number between 1 and 5. Press “Enter” key for OK and the “ESC” key for Cancel.

Table 14 Actions in the Instrument Image Recovery System

Action#	Action item	Description
1	Run Check Disk on the system drive.	Initiates a check disk on the hard drive installed within the S5040A Appliance.
2	Recover the original factory system image.	Initiates the process to recover and restore the original image with the factory settings.
3	View troubleshooting documentation.	Displays a message "Please refer to your instrument owner's manual.", which is the same as this document, where information pertaining to troubleshooting can be found.
4	Repair the system drive.	This feature is currently not supported. Selecting this option displays a message, "Feature not supported in UEFI mode."
5	Exit and restart the instrument	Exits the displayed window and restarts the S5040A Appliance.

3 Miscellaneous tasks on the S5040A Appliance

[Changing Windows operating system settings](#) / 64

[Installing Application Programs on S5040A Appliance](#) / 65

[Firmware Updates](#) / 66

[Cleaning the S5040A Appliance](#) / 68

This chapter describes tasks you may need to perform during ongoing use of the S5040A Appliance.

Changing Windows operating system settings

Many Windows operating system settings can be changed to suit your own personal preferences. However, some operating system settings should not be changed because doing so would interfere with the proper operation of the Appliance.

- Do not change the Power Options.
- Do not change the Language settings.
- Do not remove Fonts.
- Do not delete or modify the Administrator user account.

Installing Application Programs on S5040A Appliance

The S5040A Appliance has an open Windows operating system, which lets you install your own application software. Any application that runs on Microsoft Windows 10 and uses 16 GB of RAM or less may be installed on your S5040A Appliance.

NOTE

Exit the U5040B Open RAN Studio application before installing any software.

CAUTION

Installing an application that does not meet these requirements may result in unexpected results and is not recommended.

Firmware Updates

After the system boots up, if the S5040A Appliance detects that a firmware update is required, you will see a dialog like the following:

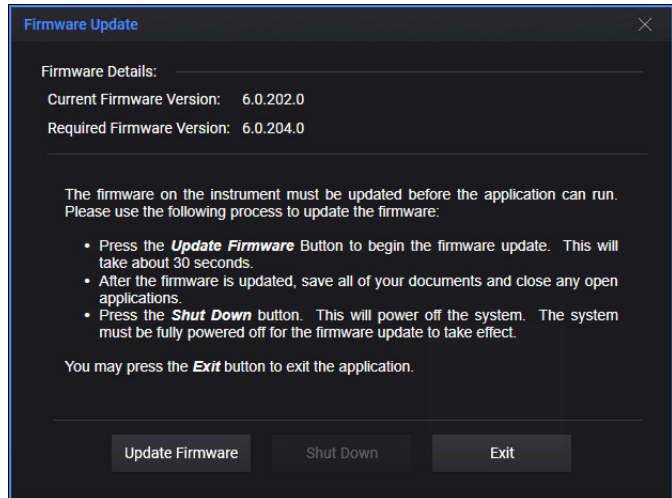

Figure 44 Prompt to update firmware on the S5040A Appliance

WARNING

Your computer should not be shutdown or lose power during a firmware update. This may corrupt the firmware on the Appliance, requiring a special process to recover the firmware.

At this point, click the **Update Firmware** button to start the firmware update process.

This process takes 10-20 seconds to complete.

On successful completion, you will see the following window:

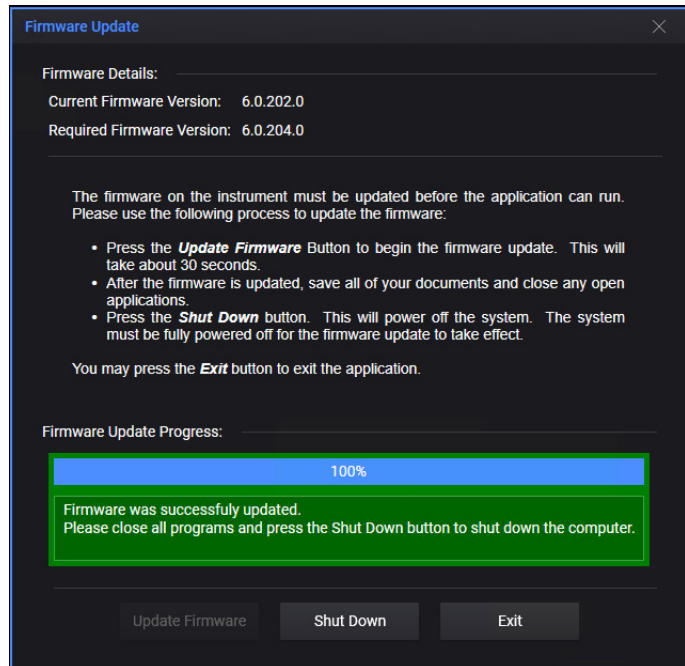

Figure 45 Window after firmware update on the S5040A Appliance

If the **Firmware Update Progress** area turns red, try updating the firmware again. If unsuccessful after multiple attempts, contact your local Keysight Technologies representative for technical assistance.

After a successful firmware update, close all open application and click **Shut Down**. If you cannot shutdown immediately, click the **Exit** button.

NOTE

The updated firmware will not be loaded into the Appliance until you shut it down to a complete power off state.

Cleaning the S5040A Appliance

WARNING

To prevent electrical shock, disconnect the S5040A Appliance from mains before cleaning.

Clean the S5040A Appliance with a soft dry cloth or one slightly dampened with a mild soap and water solution to clean the external case parts. Do not attempt to clean internally.

CAUTION

Do not use too much liquid in cleaning the Appliance. Water can enter from the panels on the S5040A Appliance, damaging sensitive electronic components.

To avoid electrostatic discharge (ESD), wear a grounded wrist strap when cleaning connectors.

WARNING

Use alcohol to clean connectors. The power cord must be removed, and the Appliance must be in a well-ventilated area. Allow all residual alcohol moisture to evaporate, and the fumes to dissipate prior to powering up the S5040A Appliance. Dispose of cleaning materials in a manner consistent with local regulations.

4 Troubleshooting

[Verifying Basic Operation](#) / 70

[Firmware Update error](#) / 74

[Software errors during / after installation](#) / 75

[Returning the S5040A Appliance to Keysight for Service](#) / 77

This chapter describes what to do if you encounter any problems with your S5040A Appliance.

WARNING

There are no operator-serviceable parts inside the Appliance. Refer servicing to Keysight personnel. To prevent electrical shock, do not remove covers.

Verifying Basic Operation

Follow the procedures in this section to verify the basic operation of the Appliance. Where problems occur, you are directed to the section that provides detailed troubleshooting help.

Powering Up the S5040A Appliance

- 1 Connect the power cord to the Appliance, then to a suitable AC voltage source. Route the power cord so the Appliance's feet do not pinch the cord.

The power cord is the disconnecting device for Mains. Position the equipment so the power cord is easily reached by the operator.

Use only the power cord that came with the Appliance.

The power cord provided is matched to the country of origin.

- 2 Press the power button in the lower left corner of the front panel. If the Appliance is working properly, it will take a little over a minute to start up unless a Windows update is running. The LEDs will follow the pattern as shown in [Launching software for S5040A Appliance](#) on page 48 and the Windows desktop will appear on the screen.

If the Appliance turns off without you pressing the front panel power button, unplug the AC power cord from the rear of the instrument and wait 20 to 30 seconds. Then, plug the AC power cord back into the Appliance and press the front panel power button.

Alternatively, you can perform a hard shutdown by holding the power button down for 5-6 seconds so the power turns off, and then pressing the power button again to restart the Appliance.

Display Troubleshooting

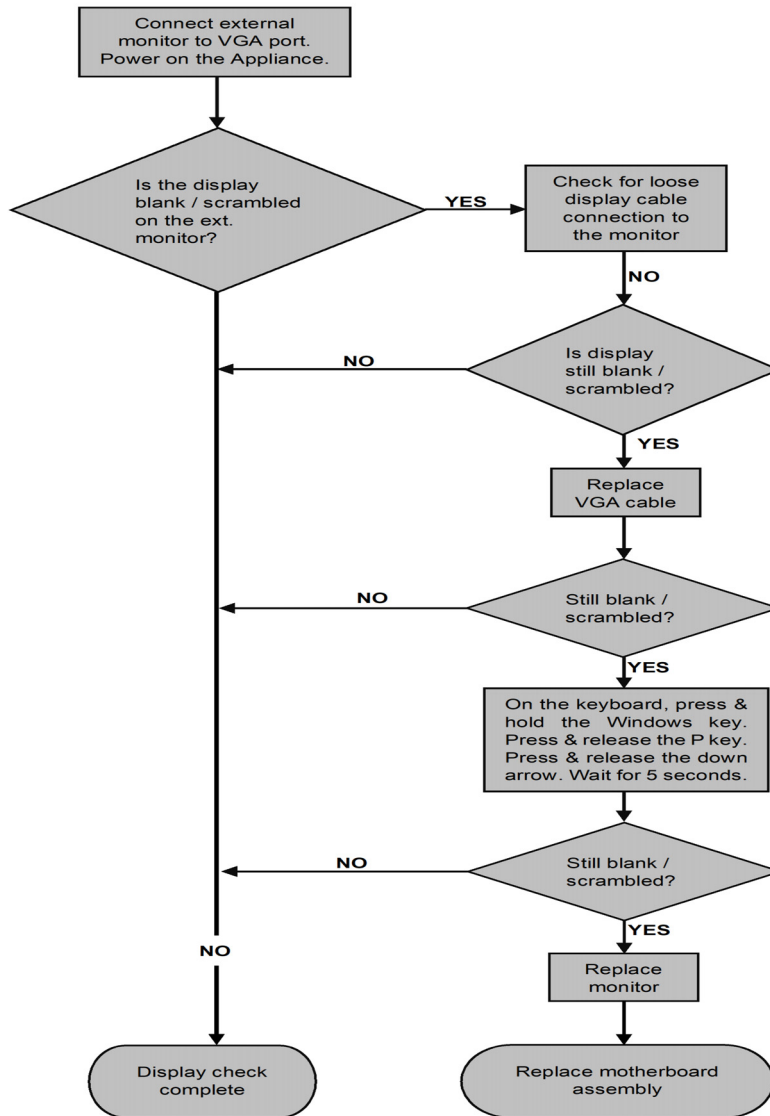

Figure 46 Flowchart for troubleshooting display issues

NOTE

When you connect an external monitor the first time, it may display the start-up BIOS information and then go blank when Windows starts up. If so, use the Windows settings to enable the external monitor.

You may use two monitors simultaneously. However, Keysight recommends connecting an HD monitor with only the VGA connector when starting up the first time. Thereafter, you may connect another monitor using the DisplayPort connector and configure Display settings in Windows for proper display each time you start up.

USB port Troubleshooting

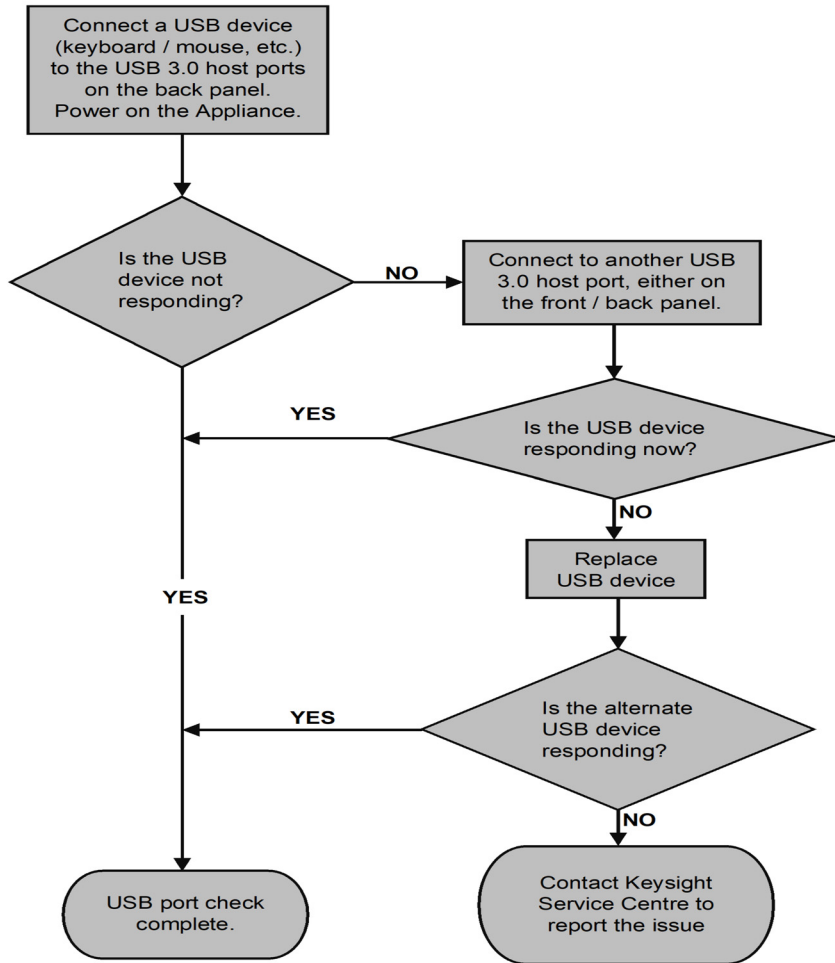

Figure 47 Flowchart for troubleshooting USB port issues

Firmware Update error

If the **Firmware Update Progress** area turns red, as shown in [Figure 48](#), try updating the firmware again.

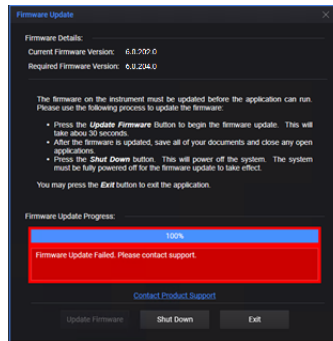

Figure 48 Error during Firmware Update Progress

If unsuccessful after multiple attempts, contact your local Keysight Technologies representative for technical assistance.

If there is a problem with a firmware update (such as, power interruption during the update), the S5040A Appliance boots into a different mode, where you should try to update the firmware again. If such a condition occurs, the front LEDs will flash Red/Green/Off continuously until powered off.

Software errors during / after installation

Errors with U5040B software

Errors during or after installation

If you encounter errors during or after installation / upgradation of the U5040B Open RAN Studio software,

- 1 Check “Uninstall a program” feature in the Control Panel to completely remove the existing software version.
- 2 Check logs by running the installer from the command line with the following syntax:
“U5040B_setup_full_<version>.exe” /debuglog“C:\tmp\isdebug.log”/v“ISDEBUGLOG=C:\tmp\prereq.log”
- 3 Download the latest version of installer from <https://www.keysight.com/find/U5040B>.
- 4 Run the installer.
- 5 If prompted, restart the S5040A Appliance to complete the installation.

Errors during software usage

If you encounter any unexpected errors while using the U5040B Open RAN Studio software,

- 1 Check logs in the *OpenRANStudio.log* file, which can be found in C:\Users\<user-profile>\Documents\Keysight\Open RAN Studio.
- 2 For information regarding software usage and various measurements, refer to the *U5040B Open RAN Studio User’s Guide*.
- 3 For further support, contact a technical support executive at Keysight. See <https://www.keysight.com/find/support>.

Errors with other pre-installed software

If you encounter errors during or after installation / upgradation of other pre-installed software; such as N7631C Signal Studio Pro for 5G NR or Keysight PathWave 89600 VSA 2020 U1, or even encounter any unexpected errors during usage,

- 1 Check “Uninstall a program” feature in the Control Panel to completely remove the existing software version.
- 2 Download the latest version of installer:
 - a For N7631C Signal Studio Pro for 5G NR software from <https://www.keysight.com/find/N7631C>.
 - b For Keysight PathWave 89600 VSA 2020 U1 software from <https://www.keysight.com/find/89600>.
- 3 Run the installer.
- 4 If prompted, restart the S5040A Appliance to complete the installation.

For further support, contact a technical support executive at Keysight. See <https://www.keysight.com/find/support>.

Returning the S5040A Appliance to Keysight for Service

Before shipping the Appliance, contact Keysight Technologies for more details.

- 1 Write the following information on a tag and attach it to the Appliance.
 - name and address of owner
 - appliance model number
 - appliance serial numbers
 - description of the service required or failure indications
- 2 Remove all accessories from the Appliance.

Accessories include keyboard, mouse and the QSFP adapters and cables. Do not include accessories unless they are associated with the failure symptoms.

- 3 Protect the Appliance by wrapping it in plastic or heavy paper.
- 4 Pack the Appliance in foam or other shock-absorbing material and place it in a strong shipping container.

If the original shipping materials are not available, place 8 to 10 cm (3 to 4 inches) of shock-absorbing material around the Appliance and place it in a box that does not allow movement during shipping.

- 5 Seal the shipping container securely.
- 6 Mark the shipping container as FRAGILE.

In any correspondence, refer to the Appliance by model number and full serial number.

Index

Numerics

10 MHz Out, [20](#)

A

Administrator, [25](#)
airflow, [14](#)
alcohol, [40](#)

C

Characteristics
Altitude, [13](#)
Ambient Temperature, [13](#)
Dimensions, [13](#)
Environment, [13](#)
Humidity, [13](#)
Installation Category, [13](#)
Pollution Degree, [13](#)
Safety, [13](#)
Voltage Fluctuations, [13](#)
Weight, [13](#)
clearance, [14](#)
C-Plane Builder, [30](#)

D

Default Setup, [30](#)
DisplayPort, [15, 16](#)

E

ESD, [40](#)
Explorer, [30](#)

F

FRAGILE, [46](#)

I

Interface Monitor, [30](#)

M

Measurement Category, [21](#)
menu bar, [30](#)

P

power cord, [17](#)

Q

QSFP28 Cages, [20](#)

R

RAM, [37](#)
Ref Clk In, [20](#)
RJ-45, [15, 16](#)

S

standby power, [17](#)
status bar, [30](#)

T

tool bar, [30](#)

V

VGA, [15, 16](#)

W

wrist strap, [40](#)

Index

This information is subject to
change without notice.
© Keysight Technologies 2021
Edition 1.0, April 2021



S5040-91000

www.keysight.com