



**Agilent N4916B**

**De-Emphasis Signal Converter**

**User's Guide**

## Notices

© Agilent Technologies, Inc. 2012

No part of this manual may be reproduced in any form or by any means (including electronic storage and retrieval or translation into a foreign language) without prior agreement and written consent from Agilent Technologies, Inc. as governed by United States and international copyright laws.

### Manual Part Number

N4916B--91021

### Edition

Third edition, February 2012

Printed in Germany

Agilent Technologies, Deutschland GmbH

Herrenberger Str. 130

71034 Böblingen, Germany

### For Assistance and Support

<http://www.agilent.com/find/assist>

## Warranty

**The material contained in this document is provided "as is," and is subject to being changed, without notice, in future editions. Further, to the maximum extent permitted by applicable law, Agilent disclaims all warranties, either express or implied, with regard to this manual and any information contained herein, including but not limited to the implied warranties of merchantability and fitness for a particular purpose. Agilent shall not be liable for errors or for incidental or consequential damages in connection with the furnishing, use, or performance of this document or of any information contained herein. Should Agilent and the user have a separate written agreement with warranty terms covering the material in this document that conflict with these terms, the warranty terms in the separate agreement shall control.**

## Technology Licenses

The hardware and/or software described in this document are furnished under a license and may be used or copied only in accordance with the terms of such license.

## Restricted Rights Legend

If software is for use in the performance of a U.S. Government prime contract or subcontract, Software is delivered and licensed as "Commercial computer software" as defined in DFAR 252.227-7014 (June 1995), or as a "commercial item" as defined in FAR 2.101(a) or as "Restricted computer software" as defined in FAR 52.227-19 (June 1987) or any equivalent agency regulation or contract clause. Use, duplication or disclosure of Software is subject to Agilent Technologies' standard commercial license terms, and non-DOD Departments and Agencies of the U.S. Government will receive no greater than Restricted Rights as defined in FAR 52.227-19(c)(1-2) (June 1987). U.S. Government users will receive no greater than Limited Rights as defined in FAR 52.227-14 (June 1987) or DFAR 252.227-7015 (b)(2) (November 1995), as applicable in any technical data.

## Safety Notices

### CAUTION

A **CAUTION** notice denotes a hazard. It calls attention to an operating procedure, practice, or the like that, if not correctly performed or adhered to, could result in damage to the product or loss of important data. Do not proceed beyond a **CAUTION** notice until the indicated conditions are fully understood and met.

### WARNING

A **WARNING** notice denotes a hazard. It calls attention to an operating procedure, practice, or the like that, if not correctly performed or adhered to, could result in personal injury or death. Do not proceed beyond a **WARNING** notice until the indicated conditions are fully understood and met.

# Safety Summary

## General Safety Precautions

The following general safety precautions must be observed during all phases of operation of this instrument. Failure to comply with these precautions or with specific warnings elsewhere in this manual violates safety standards of design, manufacture, and intended use of the instrument.

Agilent Technologies Inc. assumes no liability for the customer's failure to comply with these requirements.

Before operation, review the instrument and manual for safety markings and instructions. You must follow these to ensure safe operation and to maintain the instrument in safe condition.

## General

This product is a Safety Class 1 instrument (provided with a protective earth terminal). The protective features of this product may be impaired if it is used in a manner not specified in the operation instructions.

All Light Emitting Diodes (LEDs) used in this product are Class 1 LEDs as per IEC 60825-1.

## Environment Conditions

This instrument is intended for indoor use in an installation category II, pollution degree 2 environment. It is designed to operate at a maximum relative humidity of 95% and at altitudes of up to 2000 meters.

Refer to the specifications tables for the ac mains voltage requirements and ambient operating temperature range.

## Before Applying Power

Verify that all safety precautions are taken. The power cable inlet of the instrument serves as a device to disconnect from the mains in case of hazard. The instrument must be positioned so that the operator can easily access the power cable inlet. When the instrument is rack mounted the rack must be provided with an easily accessible mains switch.

## Ground the Instrument

To minimize shock hazard, the instrument chassis and cover must be connected to an electrical protective earth ground. The instrument must be connected to the ac power mains through a grounded power cable, with the ground wire firmly connected to an electrical ground (safety ground) at the power outlet. Any interruption of the protective (grounding) conductor or disconnection of the protective earth terminal will cause a potential shock hazard that could result in personal injury.

## Do Not Operate in an Explosive Atmosphere

Do not operate the instrument in the presence of flammable gases or fumes.

## Do Not Remove the Instrument Cover

Operating personnel must not remove instrument covers. Component replacement and internal adjustments must be made only by qualified personnel.

Instruments that appear damaged or defective should be made inoperative and secured against unintended operation until they can be repaired by qualified service personnel.

## Safety Symbols on Instruments



Indicates warning or caution. If you see this symbol on a product, you must refer to the manuals for specific Warning or Caution information to avoid personal injury or damage to the product.



Notice for European Community: This product complies with the relevant European legal Directives: EMC Directive 89/336/EEC and Low Voltage Directive 73/23/EEC.



General Recycling Mark for plastic parts used in the product.



Safety requirements for electrical equipment for measurement, control, and laboratory use CAN/CSA C22.2 No. 1010.1 (1993) UL 3101, 3111 (First Editions). This equipment has also been evaluated to IEC 61010 edition 1 including amendments 1 and 2.



Conformity Mark of the Australian ACA for EMC compliance.

## Environmental Information

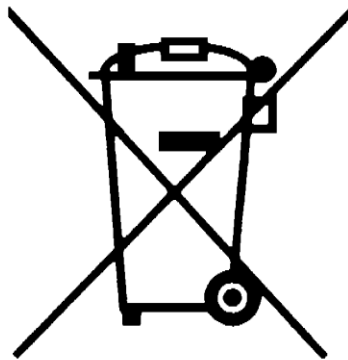

This product complies with the WEEE Directive (2002/96/EC) marketing requirements. The affixed label indicates that you must not discard this electrical/electronic product in domestic household waste.

Product category: With reference to the equipment types in the WEEE Directive Annexure I, this product is classed as a "Monitoring and Control instrumentation" product.

Do not dispose in domestic household waste.

To return unwanted products, contact your local Agilent office, or see

[www.agilent.com/environment/product/](http://www.agilent.com/environment/product/) for more information.

# Contents

<b>Contents</b> .....	<b>5</b>
<b>1 Introduction</b> .....	<b>7</b>
1.1 Front Panel.....	9
1.2 Rear Panel.....	11
1.3 Remote Interface Configuration.....	12
1.4 Factory Default Settings.....	13
<b>2 Remote Programming Reference</b> .....	<b>15</b>
2.1 Agilent N4916B Remote Control.....	15
2.1.1 Programming Recommendations.....	16
2.2 N4916B SCPI Command Summary.....	18
2.3 Common Command Summary.....	21
2.4 N4916B SCPI Instrument Command List Format.....	22
2.5 N4916B SCPI Instrument Elements Name.....	23
2.5.1 Input Commands.....	24
2.5.2 Level Commands.....	28
2.5.3 Output Commands.....	33
2.5.4 Sense Commands.....	40
2.5.5 Source Commands.....	43
2.5.6 Status Reporting Commands.....	45
2.5.7 System-Related Commands.....	51
2.6 Common Command List.....	72
2.7 Status Model.....	75
2.8 Status register structure.....	77
2.8.1 Status Byte Register.....	78
2.8.2 STATus Commands.....	79
2.8.3 STATus Questionable Data Register command subsystem.....	80
<b>3 Programming Basics</b> .....	<b>83</b>
3.1 Before you begin.....	83
3.2 Application Programs.....	86

<b>Appendix</b> .....	<b>89</b>
A.1 Pulse Parameter Definitions.....	90
A.2 Preparing a USB Flash Drive using Windows Vista®.....	97

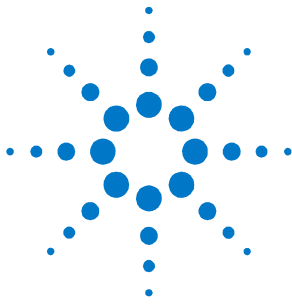

# 1 Introduction

## **Agilent Technologies' N4916B De-Emphasis Signal Converter**

The Agilent Technologies N4916B is a 4-tap de-emphasis signal converter with optional clock multiplier. It is intended to accurately characterize your multi-gigabit serial interfaces.

---

### **Features and Benefits**

- Generates 4-tap de-emphasis with variable de-emphasis levels
- Supports data rates from 660 Mb/s to 10.5 Gb/s or 14.2 Gb/s (Refer to the data sheet for details on the maximum data rate).
- Tolerates non-balanced patterns
- Transparent to jitter
- Flexible usage as front-end for J-BERT N4903B, ParBERT 81250A or other pattern generators
- Optional clock multiplier (Option 001)
- Small size
- Programmable via J-BERT N4903B or stand-alone
- USB and LAN connectivity.

---

### **What's inside this Manual**

This manual provides detailed information about the following:

- Remote Programming Reference
- Application Programs

---

### **Purpose of this Manual**

The purpose of this manual is to enable you to install, initialize, and start the N4916B.

---

**Who should read this Manual** This manual is intended for testers and engineers who will be using the N4916B to test other devices without connecting the N4916B to a N4903B

---

**How this document is organized** This section provides information on the chapters, and their content.





### Navigating this manual

Topic	What information does it contain?
<b>Introduction</b>	Introduces the N4916B, defines the purpose and intended audience of this manual; explains how information is organized in this manual.
<b>Remote Programming Reference</b>	Contains reference information to help you program the N4916B directly over the remote interface.
<b>Programming Basics</b>	Describes the various types of programming examples available for the N4916B and where to find them.

---

**Terms and conventions used in this manual** The following table lists the terms and conventions used in this manual:

### Conventions

The icon...	Indicates...
	A note or important information.
	A tip
	A caution or warning
	Notes within a table

---

**Acronyms used in this manual** The following table lists the acronyms and abbreviations used in this manual:



## Acronyms used in this Document

Acronym	Explanation
DHCP	Dynamic Host Configuration Protocol
DNS	Domain Name Service
DUT	Device Under Test

## 1.1 Front Panel

### Introduction

The N4916B is only operated remotely.

This section explains the Key, LEDs, Inputs and Outputs seen on the Front Panel of the N4916B.

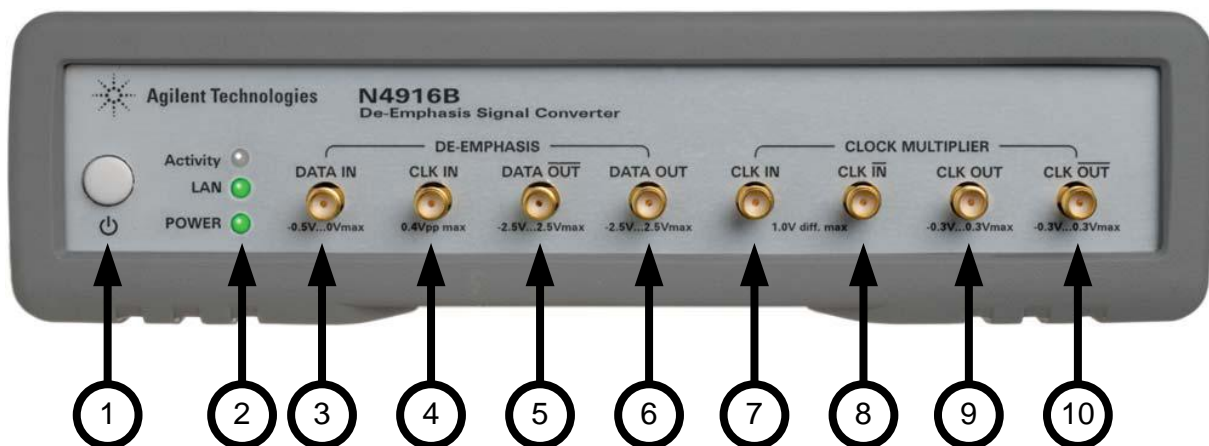

**1 Power Switch**

**2 Status LEDs**

Activity	Flashes green when instrument is accessed on the remote interfaces Constantly orange during boot phase of the instrument
LAN	Constantly green when LAN is operable Constantly red when LAN is not operable Flashing green when device identification is enabled
POWER	Constantly orange during boot phase of the instrument Constantly red when instrument is OFF (in power standby mode) Constantly green when instrument is ON (powered)

**3 DATA IN**

Data input of the De-Emphasis Signal Converter

Required input voltage:

- Amplitude    1.26 Vpp

		- Offset	-0.79 Vdc
		- Termination	50 into 0 Vdc
<b>4</b>	<b>CLK IN</b>	Clock Input of the De-Emphasis Signal Converter	
		Required input voltage:	
		- Amplitude	0.3 Vpp
		- Offset	0 Vdc
		- Termination	is 50 into 0 Vdc
<b>5</b>	<b>DATA /OUT</b>	Inverted data output of the De-Emphasis Signal Converter	
<b>6</b>	<b>DATA OUT</b>	Non-inverted data output of the De-Emphasis Signal Converter	
<b>7</b>	<b>CLK IN</b>	Non-inverted clock input of the Clock Multiplier	
		Required input voltage:	
		- Amplitude	0.4 Vpp
		- Offset	0 Vdc
		- Termination	differential into 100 or single ended 50 into
		adjustable termination voltage	
<b>8</b>	<b>CLK /IN</b>	Inverted clock input of the Clock Multiplier	
<b>9</b>	<b>CLK OUT</b>	Non-Inverted clock output of the Clock Multiplier	
<b>10</b>	<b>CLK /OUT</b>	Inverted clock output of the Clock Multiplier	



The Clock Multiplier is only operational when option 001 is installed during manufacturing.

Unused inputs and outputs have to be terminated with 50 .

When using the N4916B without a N4903B, proper input timing has to be guaranteed for the De-Emphasis Signal Converter. To achieve this either provide the clock and data edge with a phase offset of 0 or 180 degree and choose the appropriate sampling edge using the `:SENS1:EDGE {POS|NEG} SCPI` command.

When using only as single ended clock signal for the Clock Multiplier, make sure to enable the internal termination voltage to ensure correct load for the clock source.

---

## 1.2 Rear Panel

### Introduction

The rear panel contains:

- USB device connector
- LAN connector

These are used for remote control of the instrument.

- Fan outlet for cooling the instrument
- Power Connection

A USB Host Connector is used to connect external USB storage device for recovery software updates.

The following figure shows the rear panel view of the N4916B.

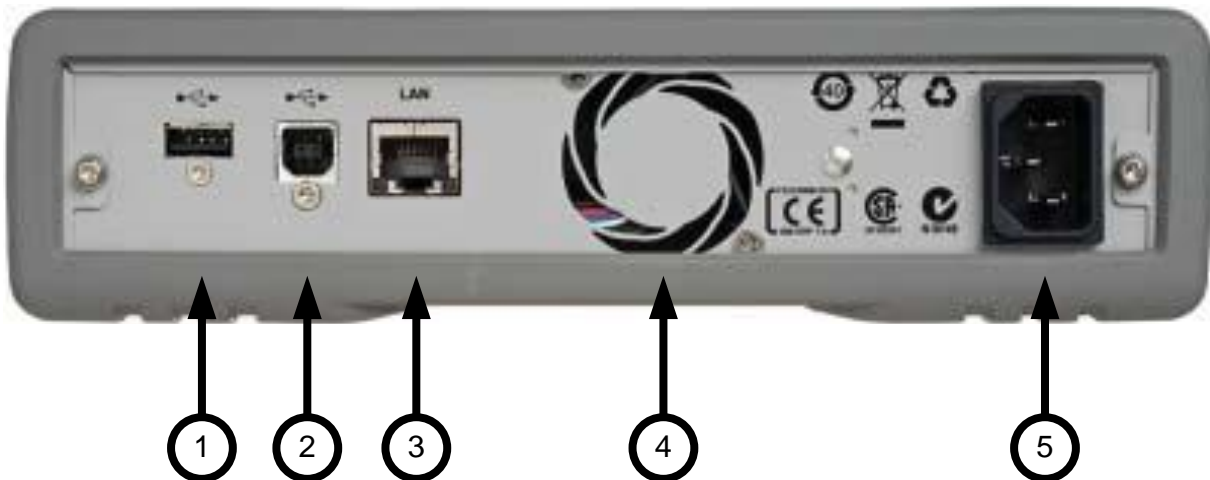

- 1 USB Interface Connector (Host type for external mass memory)
- 2 USB Interface Connector (device type for remote programming)
- 3 LAN
- 4 FAN outlet
- 5 Power Connector (100 – 240V~ 50/60Hz 80VA max.)

## 1.3 Remote Interface Configuration

### Introduction

This section gives information on configuring the N4916B for remote interface communication. For information on the SCPI commands available to program the N4916B over the remote interface, see chapter 4.

The Agilent N4916B supports remote interface communication using a choice of two interfaces: USB, and LAN. Both interfaces are "live" at power up. This section describes some interface configuration parameters that you may need to set on your N4916B.

 *The CD-ROM provided with your instrument contains connectivity software to enable communications over these interfaces. Refer to the instructions provided on the CD-ROM to install this software on your PC.*

- **USB Interface.** There is nothing to configure on your N4916B. Just connect the N4916B to the PC with a USB cable.
- **LAN Interface.** By default, DHCP is On, which may enable network communication over the LAN interface. You may need to set several configuration parameters as described in the LAN configuration sections that follow.



For detailed background information, refer to the *Agilent Technologies USB/LAN/GPIB Connectivity Guide*, which you can download from the Agilent web site at the following URL:

[www.agilent.com/find/connectivity](http://www.agilent.com/find/connectivity).

---



## 1.4 Factory Default Settings

### Introduction

The table on the following page summarizes the factory default settings for the Agilent N4916B. The instrument will go back to the default setting described below after power up and whenever the \*RST command is received. The remote interface configuration will not be reset on power up and \*RST.

---

### Agilent N4916B Factory Default Settings

 <b>De-Emphasis Configuration</b>	<b>Factory Setting</b>
CLK IN Frequency	3 GHz
Amplitude/Offset	0 Vpp/0.000 Vdc
Pre-cursor	0 dB
Post-cursor 1	0 dB
Post-cursor 2	0 dB
Cursor Unit	All cursors in dB
Output Coupling Mode	AC (differential into 100 Ohm)
Termination Voltage	0 V
Sampling Clock Edge	Falling
 <b>Clock Multiplier Configuration</b>	<b>Factory Setting</b>
CLK IN Frequency	3 GHz
CLK IN Coupling Mode	AC (differential into 100 Ohm)
CLK IN Termination Voltage	0 V
Clock Multiplier	1

<b>System-Related Operations</b>	<b>Factory Setting</b>
Error Queue	Errors are cleared
<b>Remote Interface Configuration</b>	
<b>*DHCP</b>	<b>*On</b>
<b>*IP Address</b>	<b>*0.0.0.0.</b>
<b>*Subnet Mask</b>	<b>*0.0.0.0.</b>
<b>*Default Gateway</b>	<b>*000.000.000.000</b>
<b>*DNS Server</b>	<b>*000.000.000.000</b>
<b>*Host Name</b>	<b>*agtXXXXX (where XXXXX stands for the instrument's serial number)</b>

Parameters marked with an asterisk are stored in non-volatile memory. And are not reset when receiving the \*RST command.

Parameter groups marked with a  are part of the instrument state reported by \*LRN? or :SYST:SET?.

---

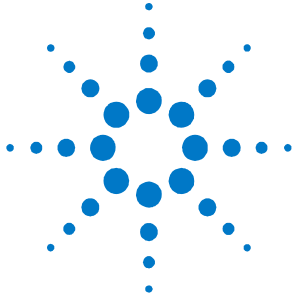

## 2 Remote Programming Reference

### Introduction

This chapter provides general information on writing SCPI programs for the N4916B.

---

## 2.1 Agilent N4916B Remote Control

### Introduction

The Agilent N4916B provides remote control via USB and LAN.

---

### USB

The USB interface requires no configuration. Just connect your Agilent N4916B to your PC using a standard USB cable and the interface will self configure.

---

### LAN

There are several parameters that you may need to set to establish network communication using the LAN interface. Primarily, you will need to establish an IP address. You may need to contact your network administrator for help in establishing communication with the LAN interface. The LAN interface usually configures itself due to the enabled DHCP mode. In this case all that needs to be done is querying the current IP address using the SCPI

command

```
:SYST:COMM:LAN?
```

If a reconfiguration of the LAN interface is required, this has to be done using the corresponding SCPI commands over the USB interface.

---

## 2.1.1 Programming Recommendations

### Recommendations for programming the N4916B

This section lists some recommendations for programming the instrument.

- Start programming from the default setting. The common command for setting the default setting is:

```
*RST
```

- The SCPI standard defines a long and a short form of the commands. For fast programming speed it is recommended to use the short forms. The short forms of the commands are represented by upper case letters. For example the short form of the command to set the pre-cursor to 3 dB is:

```
:OUTP:DEEM:PREC 3DB
```

- To improve programming speed it is also allowed to skip optional subsystem command parts. Optional subsystem command parts are depicted in square brackets, e.g.: Set amplitude to 0.5V

```
[ :SOURce[1|2] ] :VOLTage[1|2] [ :LEVel ] [ :IMMediate ] [ :AMPLitude ] 0.5V
```

Sufficient to use:

```
:VOLT 0.5V
```

Sets the amplitude of the de-emphasis output to 0.5V

- Most commands to set the timing and level parameters have to be specified for input and output 1 or 2. If there is no suffix specified the command will use the default suffix 1. So, for setting a frequency to 1 GHz for CLK IN of the de-emphasis and clock multiplier the commands are:

```
:SENS:FREQ 1GHZ # sets de-emphasis CLK-IN frequency
```

```
:SENS1:FREQ 1GHZ # sets de-emphasis CLK-IN frequency
```

```
:SENS2:FREQ 1GHZ # sets clock multiplier's CLK-IN frequency
```



- Selftest of the instrument can be invoked by the common command.  
\*TST?
  - If it is important to know whether the last command is completed then send the common command.  
\*OPC?
-

## 2.2 N4916B SCPI Command Summary

### ***Input Commands***

---

<b>Command</b>	<b>Parameter</b>	<b>See Page</b>
:INPut[1 2]		
:COUPling[?]	AC DC	25
:TERMination[?]	<NR3> MINimum MAXimum	26
:VOLTag		
:LIST[?]		27

### ***Level Commands***

---

<b>Command</b>	<b>Parameter</b>	<b>See Page</b>
:VOLTag		
:AMPLitude[?]	<NR3> MINimum MAXimum	29
:HIGH[?]	<NR3> MINimum MAXimum	30
:LOW[?]	<NR3> MINimum MAXimum	31
:OFFSet[?]	<NR3> MINimum MAXimum	32

### ***Output Commands***

---

<b>Command</b>	<b>Parameter</b>	<b>See Page</b>
:OUTPut[1 2]		
:COUPling[?]	AC DC	34
:DEEMphasis		
POST[1 2][?]	<NR3> MINimum MAXimum	35
:UNIT[?]	DB PCT	36
:PREC[?]	<NR3> MINimum MAXimum	37
:UNIT[?]	DB PCT	38
:TERMination[?]	<NR3> MINimum MAXimum	39

## ***Sense Commands***

---

<b>Command</b>	<b>Parameter</b>	<b>See Page</b>
:SENSe[1 2]		
:EDGE[?]	POSitive NEGative	41
:FREQuency[?]	<NR3> MINimum MAXimum	42

## ***Source Commands***

---

<b>Command</b>	<b>Parameter</b>	<b>See Page</b>
:SOURce2		
:FREQuency		
:MULTiplier[?]	<NR3> MINimum MAXimum	44

## ***Status Reporting Commands***

---

<b>Command</b>	<b>Parameter</b>	<b>See Page</b>
:STATus		
:PRESet		
:QUEStionable		46
:CONDition?		47
:ENABle[?]	<NR1>	48
:EVENT?		
:NTRansition[?]	<NR1>	49
:PTRansition[?]	<NR1>	50

**System Related Commands**

---

<b>Command</b>	<b>Parameter</b>	<b>See Page</b>
:SYSTEM		
:COMMunicate		
:LAN		
:DGATeway[?]	"nnn.nnn.nnn.nnn"	52
:DHCProtocol[?]	0 1 OFF ON	53
:DNServer[1 2][?]	"nnn.nnn.nnn.nnn"	54
:DOMain?		55
:HOSTname[?]	"<hostname>"	56
[:IPADress][?]	"nnn.nnn.nnn.nnn"	57
:MACaddress?		58
:SNMask[?]	"nnn.nnn.nnn.nnn"	60
:ERRor?		61
:HELP		
:HEADer?		62
:LXI		
:INDentify[?]	0 1 OFF ON	64
:SET[?]	<block data>	66
:TEST?	PON NORMal ALL	67
:VERSion?		68
:WARNing?		69
:BUFFer?		70
:STRing?		71

## 2.3 Common Command Summary

<b>Command</b>	<b>Parameter</b>	<b>Description</b>
*CLS		Clear the Status Structure
*ESE [ ? ]	<NR1>	Standard Event Status Register
*ESR?		Standard Event Status Event Register
*IDN?		Instrument's Identification
*LRN?		Complete Instrument Setting
*OPC		Operation Complete
*OPC [ ? ]		Return 1
*OPT?		Installed Options
*PSC [ ? ]		Power On Status
*RST		Reset
*SRE [ ? ]		Service Request Enable Mask
*STB?		Status Byte
*TST?		Start Instrument's Selftests
*WAI		Wait until all pending actions are complete

## 2.4 N4916B SCPI Instrument Command List Format

<b>Introduction</b>	<p>The following reference sections list the instrument commands in alphabetical order. In addition to a command description, the attributes of each command are described under the following headings. Not all of these attributes are applicable to all commands. The commands conform to the IEEE 488.2 SCPI standard.</p> <p>The following table presents some of the most common &lt;suffix names&gt; elements used while referring to some units in the instrument.</p>
<b>Command</b>	Shows the short form of the command
<b>Long</b>	Shows the long form of the command
<b>Parameter</b>	The type of parameter, if any, accepted by the command. The minimum and maximum value of numeric parameters can be accessed by the option MINimum or MAXimum.
<b>Parameter Suffix</b>	The suffixes that may follow the parameter.
<b>Description</b>	A detailed description of what the command does.
<b>Example</b>	Example programming statements

---

## 2.5 N4916B SCPI Instrument Elements Name

### Introduction

The following table presents some of the most common <suffix names> elements used while referring to some units in the instrument. The following table gives both, the short name and its expanded name for the most commonly used units.

---

<b>Element</b>	<b>Expanded Name</b>
DB	Decibel
DEG	Degree
HZ	Hertz
OHM	Ohm
PCT	Percent
RAD	Radian
S	Seconds
V	Volt

---

### Suffix usage of the SCPI commands

All SCPI commands listed in the following sections are using the following assignment of suffixes

- De-Emphasis CLK IN
- Clock Multiplier CLK IN
- De-Emphasis DATA IN

## 2.5.1 Input Commands

### Introduction

The SCPI INPut subsystem controls the electrical characteristics of the N4916B's input connectors. It also provides a programmatic interface to query the required input voltage settings that are required to be applied to the inputs for proper and damage free operation.

---



## ***Input Commands***

**Command**                   : INP2 : COUP [ ? ]

---

**Long**                       : INPut2 : COUPling [ ? ]

---

**Parameters**               { AC | DC }

---

### **Parameter Suffix**

---

**Description**               Select the input coupling mode of the clock multiplier. When setting the coupling mode to AC, the clock multiplier is not applying a termination voltage to the incoming clock signals. When setting the input coupling to DC, then the internal termination voltage is applied to the clock inputs. Independently of the use of the internal termination voltage, an unused CLK IN connector has to be terminated using a 50 Ohm termination resistor.

---

**Example**                   : INP2 : COUP DC

---

<b>Command</b>	<code>:INP2:TERM[?]</code>
<b>Long</b>	<code>:INPut2:TERMination[?]</code>
<b>Parameters</b>	{<NR3> MINimum MAXimum}
<b>Parameter Suffix</b>	V
<b>Description</b>	Set the termination voltage that an external clock source is expecting as load termination of the clock multiplier's CLK IN inputs. This is only applied to the inputs when the coupling mode is set to DC.
<b>Example</b>	<code>:INP2:TERM -1V</code>

<b>Command</b>	<code>:INP[1 2 3]:VOLT:LIST?</code>
<b>Long</b>	<code>:INPut[1 2 3]:VOLTage:LIST?</code>
<b>Parameters</b>	-
<b>Parameter Suffix</b>	
<b>Description</b>	<p>This query reports the required input voltage settings for the specified input connector. The returned result is a list containing the peak-to-peak amplitude, DC offset voltage, coupling mode and termination voltage for the input and is formatted as follows:</p> <p>(&lt;peak-peak amplitude&gt;,&lt;offset voltage&gt;,&lt;AC DC&gt;,&lt;termination voltage&gt;)</p>
<b>Example</b>	<p><code>:INP1:VOLT:LIST?</code></p> <p>Reports the following</p> <p>(0.3,0.0,DC,0.0)</p> <p>This specifies an amplitude of 0.3 Vpp with an offset voltage of 0.0 Vdc into 0.0 V with a termination resistor of 50 Ohm (single ended input with termination voltage of 0.0V) for the De-Emphasis CLK IN.</p>

## 2.5.2 Level Commands

### Introduction

The following SCPI command subsystem specifies all the commands to change amplitude, offset, high-level and low-level of a signal to be output. Output level can only be adjusted on the de-emphasis outputs.

---

## Level Commands

<b>Command</b>	<code>:VOLTage [?]</code>
<b>Long</b>	<code>[ :SOURce1 ] :VOLTage [ :LEVel ] [ :IMMediate ] [ :AMPLitude ] [ ? ]</code>
<b>Parameters</b>	<code>{ &lt;NR3&gt;   MINimum   MAXimum }</code>
<b>Parameter Suffix</b>	V
<b>Description</b>	Set the de-emphasis signal converter's peak output amplitude. MIN selects the smallest amplitude MAX selects the largest amplitude for the selected function.
<b>Example</b>	<code>:VOLT 0.25</code>

<b>Command</b>	<code>:VOLT:HIGH[?]</code>
<b>Long</b>	<code>[[:SOURce1]:VOLTage[:LEVel][:IMMediate]:HIGH[?]</code>
<b>Parameters</b>	{<NR3>   MINimum   MAXimum}
<b>Parameter Suffix</b>	V
<b>Description</b>	Set the de-emphasis signal converter's high voltage level. MIN selects the most negative voltage level for the selected function and MAX selects the largest voltage level.
<b>Example</b>	<code>:VOLT:HIGH 0.3</code>

<b>Command</b>	<code>:VOLT:LOW[?]</code>
<b>Long</b>	<code>[[:SOURce1]:VOLTage[:LEVel][:IMMediate]:LOW[?]</code>
<b>Parameters</b>	{<NR3>   MINimum   MAXimum}
<b>Parameter Suffix</b>	V
<b>Description</b>	Set the de-emphasis signal converter's low voltage level. MIN selects the most negative voltage level for the selected function and MAX selects the largest voltage level.
<b>Example</b>	<code>:VOLT:LOW -0.2</code>

<b>Command</b>	<code>:VOLT:OFFS [?]</code>
<b>Long</b>	<code>[[:SOURce1]:VOLTage[:LEVel]][:IMMediate]:OFFSet [?]</code>
<b>Parameters</b>	{<NR3> MINimum MAXimum}
<b>Parameter Suffix</b>	V
<b>Description</b>	Set the de-emphasis signal converter's output offset. MIN selects the smallest offset MAX selects the largest possible offset.
<b>Example</b>	<code>:VOLT:OFFS 0.0</code>



## 2.5.3 Output Commands

### Introduction

The SCPI OUTPut subsystem controls the characteristics of the source's outputs.

---

## Output Commands

<b>Command</b>	<code>:OUTP:COUP[?]</code>
<b>Long</b>	<code>:OUTPut[1]:COUPling[?]</code>
<b>Parameters</b>	{AC DC}
<b>Parameter Suffix</b>	
<b>Description</b>	Select the output coupling mode of the de-emphasis signal converter. When setting the coupling mode to AC, the output levels are set to drive a differential load of 100 Ohm. If the coupling mode is set to DC, the outputs are set to drive a single ended load of 50 Ohm into an adjustable termination voltage.
<b>Example</b>	<code>:OUTP:COUP DC</code>

<b>Command</b>	<code>:OUTP:DEEM:POST[1 2][?]</code>
<b>Long</b>	<code>:OUTPut[1]:DEEMphasis:POSTcursor[1 2][?]</code>
<b>Parameters</b>	{<NR3> MINimum MAXimum}
<b>Parameter Suffix</b>	PCT or DB
<b>Description</b>	Set the post cursor to the given value as a percentage or ratio in dB of the previous bit's amplitude.
<b>Example</b>	<code>:OUTP:DEEM:POST1 -3</code>

<b>Command</b>	<code>:OUTP:DEEM:POST[1 2]:UNIT[?]</code>
<b>Long</b>	<code>:OUTPut[1]:DEEMphasis:POSTcursor[1 2]:UNIT[?]</code>
<b>Parameters</b>	{DB PCT}
<b>Parameter Suffix</b>	-
<b>Description</b>	Set the default unit to be used for the post cursor. This setting will also be used when reading the current post-cursor setting from the instrument.
<b>Example</b>	<code>:OUTP:DEEM:POST1:UNIT PCT</code>

<b>Command</b>	<code>:OUTP:DEEM:PREC [?]</code>
<b>Long</b>	<code>:OUTPut[1]:DEEMphasis:PRECursor [?]</code>
<b>Parameters</b>	{<NR3>   MINimum   MAXimum}
<b>Parameter Suffix</b>	PCT or DB
<b>Description</b>	Set the pre- cursor to the given value as a percentage or ratio in dB of the previous bit's amplitude.
<b>Example</b>	<code>:OUTP:DEEM:PREC +3</code>

<b>Command</b>	<code>:OUT:DEEM:PREC:UNIT[?]</code>
<b>Long</b>	<code>:OUTput[1]:DEEMphasis:PRECursor:UNIT[?]</code>
<b>Parameters</b>	{DB PCT}
<b>Parameter Suffix</b>	-
<b>Description</b>	Set the default unit to be used for the pre-cursor. This setting will also be used when reading the current post-cursor setting from the instrument.
<b>Example</b>	<code>:OUTP:DEEM:PREC:UNIT PCT</code>

<b>Command</b>	<code>:OUTP:TERM[?]</code>
<b>Long</b>	<code>:OUTPut[1]:TERMination[?]</code>
<b>Parameters</b>	{<NR3> MINimum MAXimum}
<b>Parameter Suffix</b>	
<b>Description</b>	Sets the termination voltage that is assumed as external load when <code>:OUTP:COUP DC</code> is being used. In this case the instrument assumes a single ended 50 Ohm load into the given termination voltage. While the seconds output connector is bein terminated into 50 Ohm.
<b>Example</b>	<code>:OUTP:TERM -1V</code>

## 2.5.4 Sense Commands

**Introduction**      The SCPI SENSE subsystem controls the functional characteristics of the CLK IN inputs.

---



## ***Sense Commands***

**Command**                   : SENS:EDGE [?]

---

**Long**                       : SENSE1:EDGE [?]

---

**Parameters**               {POSitive|NEGative}

---

**Parameter Suffix**

---

**Description**               Select whether the data provided at the de-emphasis' DATA IN connector is being sampled on the rising (POSitive) or falling (NEGative) edge of the clock signal at CLK IN. This can be used to control the input timing of the de-emphasis signal converter in case of erroneous sampling of the incoming data in dependency of the clock frequency.

---

**Example**                   : SENS:EDGE NEG

---

<b>Command</b>	<code>:SENS:FREQ[?]</code>
<b>Long</b>	<code>:SENSe[1 2]:FREQuency[?]</code>
<b>Parameters</b>	{<NR3> MINimum MAXimum}
<b>Parameter Suffix</b>	
<b>Description</b>	Set the frequency of the clock signal that is applied at the CLK IN connector of the de-emphasis signal converter or clock multiplier. Both functional blocks need to know the frequency of the incoming clock signal in order to achieve the calibrated accuracy.
<b>Example</b>	<code>:SENS1:FREQ 5.4GHZ</code>

## 2.5.5 Source Commands

### Introduction

The SCPI SOURce subsystem controls the functional characteristics of the CLK OUT outputs.

---

<b>Command</b>	<code>:SOUR2:FREQ:MULT [?]</code>
<b>Long</b>	<code>:SOURce2:FREQuency:MULTiplier[?]</code>
<b>Parameters</b>	{<NR1>   MINimum   MAXimum}
<b>Parameter Suffix</b>	
<b>Description</b>	Set the muplification factor of the clock-multiplier to either 1 or 2. The frequency of the clock signal at CLK OUT will be either 1 or 2 times the frequency at CLK IN.
<b>Example</b>	<code>:SOUR2:FREQ:MULT 2</code>

## 2.5.6 Status Reporting Commands

### Introduction

The Questionable Data register group provides information about the quality or integrity of the instrument. Any or all of these conditions can be reported to the Questionable Data summary bit through the enable register.

---

### **Status Reporting Commands**

**Command**                   : STAT:QUES [?]

---

**Long**                       : STATus:QUESTionable[:EVENT] [?]

---

**Parameters**

---

**Parameter Suffix**

---

**Description**               Reads the event register in the questionable status group. It's a read-only register. Once a bit is set, it remains set until cleared by this command or \*CLS command. A query of the register returns a decimal value which corresponds to the binary-weighted sum of all bits set in the register.

---

**Example**                   : STAT:QUES?  
Response: 4

---

**Command**                   : STAT : QUES : COND ?

---

**Long**                       : STATus:QUEStionable:CONDition?

---

**Parameters**

---

**Parameter Suffix**

---

**Description**               Reads the condition register in the questionable status group. It's a read-only register and bits are not cleared when you read the register. A query of the register returns a decimal value which corresponds to the binary-weighted sum of all bits set in the register.

---

**Example**                   : STAT : QUES : COND ?  
Response: 4

---

**Command**                   : STAT:QUES:ENAB [ ? ]

---

**Long**                       : STATus:QUESTionable:ENABle [ ? ]

---

**Parameters**

---

**Parameter Suffix**

---

**Description**               Sets or queries the enable register in the questionable status group. The selected bits are then reported to the Status Byte. A \*CLS will not clear the enable register but it does clear all bits in the event register. To enable bits in the enable register, you must write a decimal value which corresponds to the binary-weighted sum of the bits you wish to enable in the register.

---

**Example**                   : STAT:QUES:ENAB 32  
                              : STAT:QUES:ENAB #H20  
                              : STAT:QUES:ENAB #B100000  
                              : STAT:QUES:ENAB ?  
                              **Response: 32**

---



**Command**                   : STAT:QUES:NTR[?]

---

**Long**                        : STATus:QUESTionable:NTRansition[?]

---

**Parameters**

---

**Parameter Suffix**

---

**Description**               Sets or queries the negative-transition register in the questionable status group. A negative transition filter allows an event to be reported when a condition changes from true to false. Setting both positive/negative filters true allows an event to be reported anytime the condition changes. Clearing both filters disables event reporting. The contents of transition filters are unchanged by \*CLS and \*RST.

---

**Example**                    : STAT:QUES:NTR 4  
                              : STAT:QUES::NTR #H4  
                              : STAT:QUES:NTR #B100  
                              : STAT:QUES:NTR?  
**Response: 4**

---

<b>Command</b>	<code>:STAT:QUES:PTR[?]</code>
<b>Long</b>	<code>:STATus:QUEStionable:PTRansition[?]</code>
<b>Parameters</b>	
<b>Parameter Suffix</b>	
<b>Description</b>	Set or queries the positive-transition register in the questionable status group. A positive transition filter allows an event to be reported when a condition changes from false to true. Setting both positive/negative filters true allows an event to be reported anytime the condition changes. Clearing both filters disables event reporting. The contents of transition filters are unchanged by *CLS and *RST.
<b>Example</b>	<pre>:STAT:QUES:PTR 15 :STAT:QUES::PTR #HF :STAT:QUES:PTR #Q17 :STAT:QUES:PTR #B1111 :STAT:QUES:PTR? Response: 15</pre>

## 2.5.7 System-Related Commands

**Introduction**      System (Instrument) related commands.

---

<b>Command</b>	<code>:SYST:COMM:LAN:DGAT[?]</code>
<b>Long</b>	<code>:SYSTEM:COMMunicate:LANetwork:DGATeway[?]</code>
<b>Parameters</b>	<code>"nnn.nnn.nnn.nnn"</code>
<b>Parameter Suffix</b>	
<b>Description</b>	<p>A gateway is a network device that provides a connection between networks. The default gateway setting is the IP address of such a device.</p> <ul style="list-style-type: none"><li>• You need not set a gateway address if DHCP is in use.</li><li>• Contact your network administrator to find out whether a gateway is being used, and for the address.</li><li>• The gateway address is stored in non-volatile memory and does not change when power has been off or after a remote interface reset.</li></ul>
<b>Example</b>	<code>:SYST:COMM:LAN:DGAT?</code> Response: "192.168.0.0"

<b>Command</b>	<code>:SYST:COMM:LAN:DHCP[?]</code>
<b>Long</b>	<code>:SYSTEM:COMMunicate:LANetwork:DHCPprotocol[?]</code>
<b>Parameters</b>	{0 1 OFF ON}
<b>Parameter Suffix</b>	
<b>Description</b>	DHCP (Dynamic Host Configuration Protocol) is a protocol for automatically assigning a dynamic IP address to a device on a network. DHCP is typically the easiest way to configure your Agilent N4916B for remote communication using the LAN interface. DHCP/Auto-IP is <i>On</i> by default.
<b>Example</b>	<code>:SYST:COMM:LAN:DHCP?</code> Response:1

<b>Command</b>	<code>:SYST:COMM:LAN:DNS[1 2][?]</code>
<b>Long</b>	<code>:SYSTEM:COMMunicate:LANetwork:DNServer[1 2][?]</code>
<b>Parameters</b>	<code>"nnn.nnn.nnn.nnn"</code>
<b>Parameter Suffix</b>	
<b>Description</b>	<p>DNS (Domain Name Service) is an Internet service that translates Domain names into IP addresses. The DNS server address is the IP address of a server that performs this service.</p> <ul style="list-style-type: none"><li>• Contact your network administrator to find out whether DNS is being used, and for the correct DNS server address.</li><li>• The DNS server address is stored in non-volatile memory and does not change when power has been off or after a remote interface reset.</li></ul>
<b>Example</b>	<pre>:SYST:COMM:LAN:DNS1? Response: "192.168.0.0"</pre>

**Command** : SYST : COMM : LAN : DOM?

---

**Long** : SYSTem : COMMunicate : LANetwork : DOMain?

---

**Parameters**

---

**Parameter Suffix**

---

**Description** A domain name is a registered name on the Internet, which is translated into an IP address.



The Domain name cannot be changed. The N4916B simply reports the name of the domain that was determined when the instrument was connected to the LAN.

---

**Example** : SYST : COMM : LAN : DOM?  
Response: "my.domain.com"

---

<b>Command</b>	<code>:SYST:COMM:LAN:HOST[?]</code>
<b>Long</b>	<code>:SYSTEM:COMMunicate:LANetwork:HOSTname[?]</code>
<b>Parameters</b>	<code>"&lt;hostname&gt;"</code>
<b>Parameter Suffix</b>	
<b>Description</b>	<p>A host name is the host portion of the domain name, which is translated into an IP address.</p> <ul style="list-style-type: none"><li>• Contact your network administrator for the correct host name.</li><li>• Allowed characters are the letters "a" through "z", numbers ("0" through "9") and dash ("-").</li><li>• The host name is stored in non-volatile memory and does not change when power has been off or after a remote interface reset.</li></ul>
<b>Example</b>	<code>:SYST:COMM:LAN:HOST "my-device"</code>



<b>Command</b>	<code>:SYST:COMM:LAN[?]</code>
<b>Long</b>	<code>:SYSTem:COMMunicate:LANetwork[:IPADress][?]</code>
<b>Parameters</b>	"nnn.nnn.nnn.nnn."
<b>Parameter Suffix</b>	
<b>Description</b>	<p>An IP address is actually a four-byte integer expressed in the notation "nnn.nnn.nnn.nnn" where "nnn" in each case is a byte value from 000 to 255.</p> <ul style="list-style-type: none"> <li>• You need not set an IP address if DHCP is in use.</li> <li>• Contact your network administrator for a valid IP address to use for your N4916B.</li> <li>• The IP address is stored in <i>non-volatile</i> memory and does not change when power has been off or after a remote interface reset.</li> </ul>
<b>Example</b>	<code>:SYST:COMM:LAN "192.168.0.1"</code>

<b>Command</b>	<code>:SYST:COMM:LAN:MAC?</code>
<b>Long</b>	<code>:SYSTEM:COMMunicate:LANetwork:MACaddress?</code>
<b>Parameters</b>	
<b>Parameter Suffix</b>	
<b>Description</b>	The Media Access Control address (MAC address) is a unique identifier of network interface cards. The MAC address is assigned during manufacturing and cannot be changed.
<b>Example</b>	<code>:SYST:COMM:LAN:MAC?</code> Response: "0030D3117164"

<b>Command</b>	<code>:SYST:COMM:LAN:SNM[?]</code>
<b>Long</b>	<code>:SYSTEM:COMMunicate:LANetwork:SNMask[?]</code>
<b>Parameters</b>	<code>"nnn.nnn.nnn.nnn"</code>
<b>Parameter Suffix</b>	
<b>Description</b>	<p>Subnetting allows the network administrator to divide a network into smaller networks to simplify administration and to minimize network traffic. The subnet mask indicates the portion of the host address to be used to indicate the subnet.</p> <ul style="list-style-type: none"> <li>• You need not set a subnet mask if DHCP is in use.</li> <li>• Contact your network administrator to find out whether subnetting is being used, and for the correct subnet mask.</li> <li>• The subnet mask is stored in non-volatile memory and does not change when power has been off or after a remote interface reset.</li> </ul>
<b>Example</b>	<code>:SYST:COMM:LAN:SNM "255.255.255.0"</code>

<b>Command</b>	<code>:SYST:COMM:LAN:WINS[1 2][?]</code>
<b>Long</b>	<code>:SYSTEM:COMMunicate:LANetwork:WINServer[1 2][?]</code>
<b>Parameters</b>	<code>"nnn.nnn.nnn.nnn"</code>
<b>Parameter Suffix</b>	
<b>Description</b>	<p>WINS (Windows Internet Naming Service) is an Internet service that translates Host names to IP addresses. The WNS server address is the IP address of a server that performs this service.</p> <ul style="list-style-type: none"><li>• Contact your network administrator to find out whether WINS is being used, and for the correct WINS server address.</li><li>• The WINS server address is stored in non-volatile memory and does not change when power has been off or after a remote interface reset.</li></ul>
<b>Example</b>	<pre>:SYST:COMM:LAN:WINS1? Response:"192.168.0.2"</pre>

**Command**                   : SYST:ERR?

---

**Long**                        : SYSTem:ERRor[:NEXT]?

---

**Parameters**

---

**Parameter Suffix**

---

**Description**

Read and clear one error from the instrument's error queue.

A record of up to 30 command syntax or hardware errors can be stored in the error queue. Errors are retrieved in first-in-first-out (FIFO) order. The first error returned is the first error that was stored. Errors are cleared as you read them.

If more than 30 errors have occurred, the last error stored in the queue (the most recent error) is replaced with "Queue overflow". No additional errors are stored until you remove errors from the queue.

If no errors have occurred when you read the error queue, the instrument responds with 0, "No error".

The error queue is cleared by the \*CLS command or when the power is cycled.

The error queue is not cleared by a reset (\*RST) command.

The error messages have the following format (the error string may contain up to 255 characters).

-113, "Undefined header"

---

**Example**

                              : SYST:ERR?  
Response:0, "No error"

---

<b>Command</b>	<code>:SYST:HELP:HEAD?</code>
<b>Long</b>	<code>:SYSTEM:HELP:HEADers?</code>
<b>Parameters</b>	
<b>Parameter Suffix</b>	
<b>Description</b>	<p>The <code>HEADers?</code> query shall return all SCPI commands and queries and IEEE 488.2 common commands and common queries implemented by the instrument. The response shall be a &lt;DEFINITE LENGTH ARBITRARY BLOCK RESPONSE DATA&gt; element. The full path for every command and query shall be returned separated by linefeeds. The syntax of the response is defined as: The &lt;nonzero digit&gt; and sequence of &lt;digit&gt; follow the rules in IEEE 488.2, Section 8.7.9. An &lt;SCPI header&gt; is defined as: It shall contain all the nodes from the root. The &lt;SCPI program mnemonic&gt; contains the node in standard SCPI format. The short form shall use uppercase characters while the additional characters for the long form shall be in lowercase characters. Default nodes shall be surrounded by square brackets ([]).</p>

**Description**

For example, an instrument which implemented the required commands listed in Syntax & Style, Volume 1 section 4.2.1, this query, and the required IEEE 488.2 common commands and queries might return:

```
#3425
:SYSTem:ERRor?/qonly/
:SYSTem:HELP:HEADers?/qonly/
:SYSTem:VERSion?/qonly/
:STATus:OPERation[:EVENT]?/qonly/
:STATus:OPERation:CONDition?/qonly/
:STATus:OPERation:ENABle
:STATus:QUEStionable[:EVENT]?/qonly/
:STATus:QUEStionable:CONDition?/qonly/
:STATus:QUEStionable:ENABle
:STATus:PRESet/nquery/
*IDN?/qonly/
*RST/nquery/
*TST?/qonly/
*RST shall have no direct effect on the response to this query.
```

---

**Example**

```
:SYST:HELP:HEAD?
Response: See Description above.
```

---

<b>Command</b>	<code>:SYST:LXI:IDEN[?]</code>
<b>Long</b>	<code>:SYSTem:LXI:IDENtify[?]</code>
<b>Parameters</b>	<code>{0 1 ON OFF}</code>
<b>Parameter Suffix</b>	
<b>Description</b>	<p>The IDEN command is used to enable and disable the device identification according to the LXI standard. When IDEN is set to ON, then the LAN LED starts blinking in green color to allow identification of a specific device in case of more complex measurement setups. Setting IDEN back to OFF disables the blinking, and the LAN status indicator is showing the current operational status of the LAN interface (green for operational, red for not operational).</p>
<b>Example</b>	<code>:SYST:LXI:IDEN ON</code>



**Command**                   : SYST : PRES

---

**Long**                       : SYSTem : PRESet

---

**Parameters**

---

**Parameter Suffix**

---

**Description**               The PRESet command is an event that configures the SCPI device-dependent status data structure to its preset value, e.g. NTR to 0x00, PTR to 0xFF.

---

**Example**                   : SYST : PRES

---

<b>Command</b>	<code>:SYST:SET[?]</code>
<b>Long</b>	<code>:SYSTem:SET[?]</code>
<b>Parameters</b>	<block data>
<b>Parameter Suffix</b>	
<b>Description</b>	<p>In query form, the command reads a block of data containing the instrument's complete set-up. The data is in a binary format, not ASCII, and cannot be edited.</p> <p>In set form, the block data must be a complete instrument set-up read using the query form of the command.</p> <p>This command has the same functionality as the *LRN command.</p>
<b>Example</b>	<pre>:SYST:SET? Response #527576...</pre>

<b>Command</b>	<code>:SYST:TEST?</code>
<b>Long</b>	<code>:SYSTEM:TEST?</code>
<b>Parameters</b>	{ PON   NORMAl   ALL }
<b>Parameter Suffix</b>	
<b>Description</b>	<p>Execute the selftest and report the result.</p> <ul style="list-style-type: none"> <li>• PON: This does not execute any test, but simply evaluate the result of the power on selftest,</li> <li>• NORMAl: Execute the normal selftest (no need to disconnect DUT) and report the result.</li> <li>• ALL: Execute the extended selftest and report the result. The instrument must be completely disconnected from any external setup before the extended selftest may be started.</li> </ul> <p>The result is 0 if no errors are found and 1 if at least one test failed. The error queue will contain the corresponding error messages.</p>
<b>Example</b>	<pre>:SYST:TEST? PON Response: 0</pre>

**Command**           : SYST:VERS?

---

**Long**               : SYSTem:VERSion

---

**Parameters**

---

**Parameter Suffix**

---

**Description**       Returns a string in the form "YYYY.V", where "YYYY" represents the year of the version, and "V" represents a version number for that year (e.g., 1999.0).

---

**Example**           : SYST:VERS?  
                      Response: 1999.0

---

**Command**                   : SYST : WARN?

---

**Long**                       : SYSTem:WARNing[:COUNT]?

---

**Parameters**

---

**Parameter Suffix**

---

**Description**               Use this command to read the number of warnings, which are currently active.

 The warning status of voltage, time and frequency are also summarized by bits in the questionable status register.

---

**Example**                   : SYST : WARN?  
Response: 0

---

**Command**            `:SYST:WARN:BUFF?`

---

**Long**                `:SYSTEM:WARNING:BUFFER?`

---

**Parameters**

---

**Parameter Suffix**

---

**Description**            Use this command to read the maximum possible number of characters which could be returned by `:SYST:WARN:STR?` If all warnings were active.

---

**Example**                `:SYST:WARN:BUFF?`  
Response: 8627

---

<b>Command</b>	<code>:SYST:WARN:STR?</code>
<b>Long</b>	<code>:SYSTEM:WARNING:STRING?</code>
<b>Parameters</b>	
<b>Parameter Suffix</b>	
<b>Description</b>	It is used to read all the currently active warning messages. The warning messages are concatenated to form a single string with a ";" as separator between the messages.
<b>Example</b>	<code>:SYST:WARN:STR?</code> Response: " "

## 2.6 Common Command List

Command	Description
*CLS	Clear the event register in all register groups. This command also clears the error queue and cancels a *OPC operation.  It does not clear the enable register.
*ESE [ ? ]	Enable bits in the Standard Event Status Register to be reported in the Status Byte. The selected bits are summarized in the "Standard Event" bit (bit 5) of the Status Byte Register. The *ESE? query returns a value which corresponds to the binary-weighted sum of all bits enabled decimal by the *ESE command. These bits are not cleared by a *CLS command. Value Range: 0–255.
*ESR?	Query the Standard Event Status Register. Once a bit is set, it remains set until cleared by a *CLS (clear status) command or queried by this command. A query of this register returns a decimal value which corresponds to the binary-weighted sum of all bits set in the register.
*IDN?	Read the instrument's identification string which contains four fields separated by commas. The first field is the manufacturer's name, the second field is the model number, the third field is the serial number, and the fourth field is a revision code which contains four numbers separated by dashes Agilent Technologies, NxxxxA,<serial number>, <b>x.x.x.x-h</b> <b>x.x.x.x</b> = Firmware revision number <b>h</b> = Hardware revision number
*LRN?	Query the instrument and return a binary block of data containing the current settings (learn string). You can then send the string back to the instrument to restore this state at a later time. For proper operation, do not modify the returned string before sending it to the instrument. The returned string will contain about 32K characters. Use :SYST:SET to send down the learn string. See :SYST:SET [ ? ]
*OPC	Set the "Operation Complete" bit (bit 0) in the Standard Event register after the previous commands have been completed.
*OPC?	Return "1" to the output buffer after the previous commands have been completed. Other commands cannot be executed until this command completes.



Command	Description
*OPT?	Read the installed options. The response consists of any number of fields separated by commas.
*PSC {0 1}   *PSC?	Clear the Standard Event enable register and Status Byte condition register at power on (*PSC 1). When *PSC 0 is in effect, these two registers <i>are not</i> cleared at power on. The default is *PSC 1. The *PSC? query returns the power-on status clear setting. Returns “0” (do not clear at power on) or “1” (clear at power on).
*RCL	Recall the instrument state stored in the specified non-volatile storage location. You cannot recall an instrument state from a storage location that is empty. *RCL 1 to 4 recalls a stored instrument setting. *RCL 0 recalls the default setting.
*RST	Reset instrument to its factory default state ( <i>refer to “Factory Default Settings” in section 1.4</i> ). This command will abort a sweep or burst in progress and will re-enable the front-panel display if it was previously disabled (DISP OFF command).
*SAV	Store (save) the current instrument state in the specified non-volatile storage location. Any state previously stored in the same location will be overwritten (and no error will be generated). There are four locations 1, 2, 3, 4) available.
*SRE [ ? ]	Enable bits in the Status Byte to generate a Service Request. To enable specific bits, you must write a decimal value which corresponds to the binary-weighted sum of the bits in the register. The selected bits are summarized in the “Master Summary” bit (bit 6) of the Status Byte Register. If any of the selected bits change from “0” to “1”, a Service Request signal is generated. The *SRE? query returns a decimal value which corresponds to the binary-weighted sum of all bits enabled by the *SRE command.
*STB?	Query the summary (status byte condition) register in this register group. This command is similar to a Serial Poll but it is processed like any other instrument command. This command returns the same result as a Serial Poll but the “Master Summary” bit (bit 6) <i>is not</i> cleared by the *STB? command.

<b>Command</b>	<b>Description</b>
*TRG	Trigger e.g. a sweep, a burst, or a simple pulse from the remote interface depending on the selected instrument function. It is similar to the :TRIG command.
*TST?	Performs a complete self-test of the instrument. Returns "+0" (PASS) or "+1" (FAIL). If the test fails, one or more error messages will be generated to provide additional information on the failure. Use the SYST:ERR? command to read the error queue.
*WAI	Wait for all pending operations to complete before executing any additional commands over the interface.

---

## 2.7 Status Model

**Introduction** This section describes the structure of the SCPI status system used by the N4916B. The status system records various conditions and states of the instrument in several register groups as shown on the following pages. Each of the register groups is made up of several *low level* registers called Condition registers, Event registers, and Enable registers which control the action of specific bits within the register group. These groups are explained below:

---

**What is a Condition Register?** A condition register continuously monitors the state of the instrument. The bits in the condition register are updated in real time and the bits are not latched or buffered. This is a read-only register and bits are not cleared when you read the register. A query of a condition register returns a decimal value which corresponds to the binary-weighted sum of all bits set in that register.

---

**What is an Event Register?** An event register latches the various events from changes in the condition register. There is no buffering in this register; while an event bit is set, subsequent events corresponding to that bit are ignored. This is a read only register. Once a bit is set, it remains set until cleared by query command (such as `STAT:QUES:EVEN?`) or a `*CLS` (clear status) command. A query of this register returns a decimal value which corresponds to the binary-weighted sum of all bits set in that register.

---

**What is an Enable Register?**

An enable register defines which bits in the event register will be reported to the Status Byte register group. You can write to or read from an enable register. A `*CLS` (clear status) command will not clear the enable register but it does clear all bits in the event register. A `STAT:PRES` command clears all bits in the enable register. To enable bits in the enable register to be reported to the Status Byte register, you must write a decimal value which corresponds to the binary weighted sum of the corresponding bits.

---

**What are Transition Filters?**

Transition Filters are used to detect changes of the state in the condition register and set the corresponding bit in the event register. You can set transition filter bits to detect positive transitions (PTR), negative transitions (NTR) or both. Transition filters are read/write registers. They are not affected by `*CLS`.

---

## 2.8 Status register structure

### Introduction

The N4916B has a status reporting system conforming to IEEE 488.2 and SCPI. The figure below shows the status group available in the instrument.

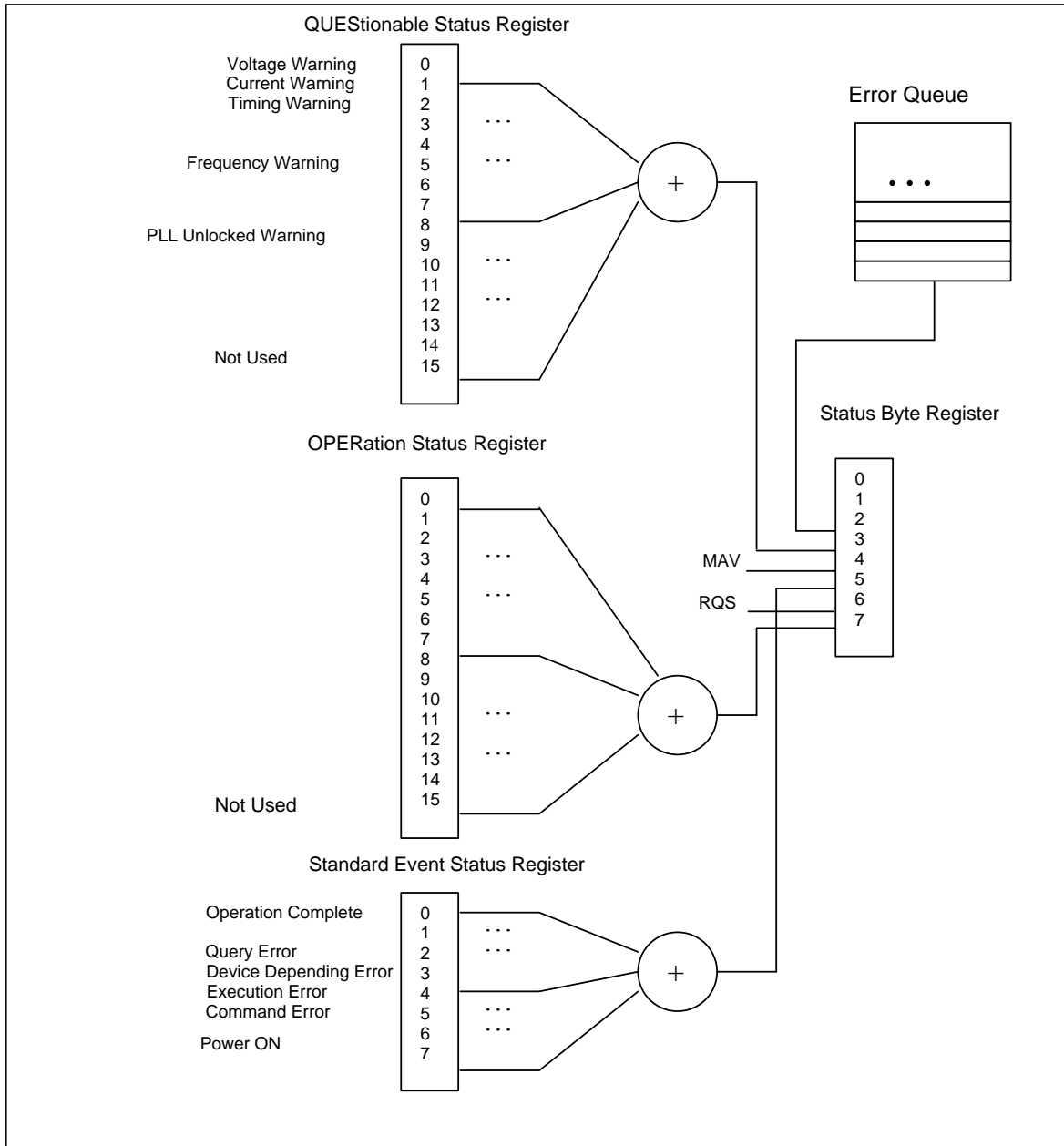

## 2.8.1 Status Byte Register

### Introduction

The Status Byte summary register reports conditions from the other status registers. Data that is waiting in the instrument's output buffer is immediately reported on the "Message Available" bit (bit 4) for example. Clearing an event register from one of the other register groups will clear the corresponding bits in the Status Byte condition register. Reading all messages from the output buffer, including any pending queries, will clear the "Message Available" bit. To set the enable register mask and generate an SRQ (service request), you must write a decimal value to the register using the \*SRE command.

---

### Bit Definitions – Status Byte Register

Bit Number		Decimal Value	Definition
0	Not used	1	Not Used. Returns "0"
1	Not used	2	Not Used. Returns "0"
2	Error Queue	4	One or more error are stored in the Error Queue
3	Questionable Data	8	One or more bits are set in the Questionable Data Register (bits must be enabled)
4	Message Available	16	Data is available in the instrument's output buffer
5	Standard Event	32	One or more bits are set in the Standard Event Register
6	Master Summary	64	One or more bits are set in the Status Byte Register
7	Not Used	128	One or more bits set in the Operation Data Register

---

## 2.8.2 STATUS Commands

### Command

The PRESet command is an event that configures the SCPI and device-dependant status data structures. The mandatory mechanism is defined in part by the IEEE 488.2.

```
:STATus:PRESet
```

It clears all status group event registers. Presets the status group, enables PTR and NTR registers as follows:

ENABLE = 0x0000, PTR = 0xffff, NTR = 0x0000.

---

### 2.8.3 STATus Questionable Data Register command subsystem

#### Introduction

The Questionable Data register group provides information about the quality or integrity of the instrument. Any or all of these conditions can be reported to the Questionable Data summary bit through the enable register.

The N4916B has two levels of error reporting mechanism called “warnings” and “errors”. Checking for warnings and errors is always enabled by switching on the output(s). A warning is generated when due to a combination of worst case uncertainties at the current settings of all relevant parameters, an invalid signal is output. A warning will be reflected in the QUEStionable data register structure. See the following table for definitions.

---



### Bit Definitions – Questionable Data Register

Bit Number		Decimal Value	Definition
0	Voltage warning	1	Output signal could be invalid
1	Current warning	2	Output signal could be invalid
2	Time warning	4	Output signal could be invalid
3	Not used	8	Returns "0"
4	Not used	16	Returns "0"
5	Frequency warning	32	Output signal could be invalid
6	Not used	64	Returns "0"
7	Not used	128	Returns "0"
8	Not used	256	Returns "0"
9	PLL unlocked warning	512	PLL is currently unlocked, the output signal is invalid
10	Not used	1024	Returns "0"
11	Not used	2048	Returns "0"
12	Not used	4096	Returns "0"
13	Not used	8192	Returns "0"
14	Not used	16384	Returns "0"
15	Not used	32768	Returns "0"

**Commands  
accessing the  
questionable status  
group**

The following commands access the questionable status group.

`:STATus:QUEStionable[:EVENT]?`

Reads the event register in the questionable status group. It's a read-only register. Once a bit is set, it remains set until cleared by this command or \*CLS command. A query of the register returns a decimal value which corresponds to the binary-weighted sum of all bits set in the register.

`:STATus:QUEStionable:CONDition?`

Reads the condition register in the questionable status group. It's a read-only register and bits are not cleared when you read the register. A query of the register returns a decimal value which corresponds to the binary-weighted sum of all bits set in the register.

`:STATus:QUEStionable:ENABle[?]`

Sets or queries the enable register in the questionable status group. The selected bits are then reported to the Status Byte. A \*CLS will not clear the enable register but it does clear all bits in the event register. To enable bits in the enable register, you must write a decimal value which corresponds to the binary-weighted sum of the bits you wish to enable in the register.

`:STATus:QUEStionable:NTRansition[?]`

Sets or queries the negative-transition register in the questionable status group. A negative transition filter allows an event to be reported when a condition changes from true to false. Setting both positive/negative filters true allows an event to be reported anytime the condition changes. Clearing both filters disable event reporting. The contents of transition filters are unchanged by \*CLS and \*RST.

`:STATus:QUEStionable:PTRansition[?]`

Set or queries the positive-transition register in the questionable status group. A positive transition filter allows an event to be reported when a condition changes from false to true. Setting both positive/negative filters true allows an event to be reported anytime the condition changes. Clearing both filters disable event reporting. The contents of transition filters are unchanged by \*CLS and \*RST.

---

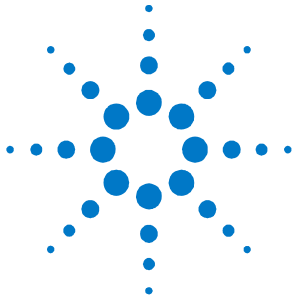

## 3 Programming Basics

### Introduction

This chapter provides the information you need for programming the N4916B using the Agilent IO Libraries Suite. Familiarity with the Agilent IO Libraries Suite is instrumental in understanding the remote programming of the N4916B.

See the user documentation delivered with the Agilent IO Libraries Suite for information on how to use them.

Depending on the options of your N4916B, (e.g. clock multiplier option) some of the following functions may not be valid. See the integrated Help or the User's Guide for a more detailed description of available options.

---

### 3.1 Before you begin

#### Introduction

This section provides background information that you need before you start with remote programming.

---

## ***Connecting to the instrument***

### **Introduction**

To communicate with the generator from a remote computer, the Agilent IO Libraries Suite must be installed on this computer.

The following description only provides you with the information you need for the instrument. For complete instructions on how to establish connections to the instrument, refer to the user documentation delivered with the Agilent IO Libraries Suite.

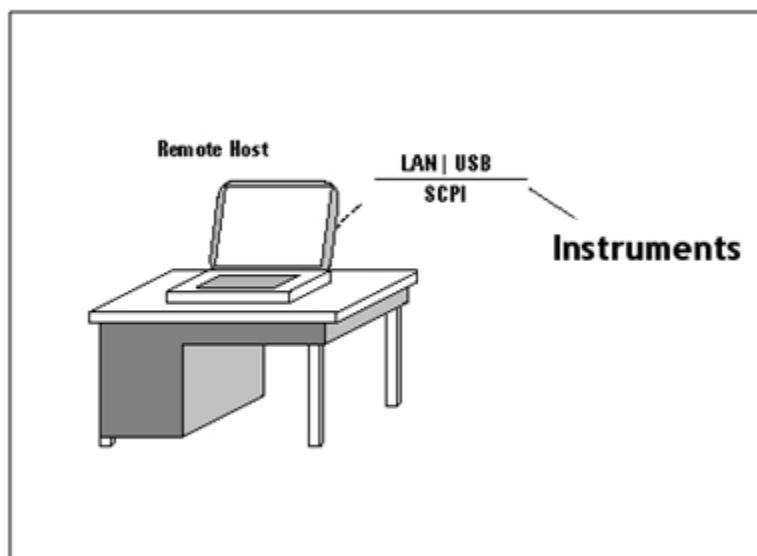

The instrument supports the following possibilities for remotely connecting:

### **LAN**

The instrument's network settings are managed by the internal instrument software and the connected network environment. You can press the Utility key at the front panel, select I/O interface -> LAN using the instrument's softkeys to get the network setting. The default setting for DHCP (Dynamic Host Configuration Protocol) is ON. Contact your network administrator if you need help in defining your own instrument's IP address.

### **USB**

The generator has a device type USB port on the rear panel for remote programming. This is the non-flat USB port close to the LAN connector. To connect to the instrument via USB, you need the instrument's USB ID. If the instrument's USB port is connected to a computer via an adequate USB cable a dialog will pop up automatically. This dialog generated by the Agilent IO Library Suite shows the USB ID. You can either use the full VISA resource string or assign an alias. See the Agilent IO Libraries Suite documentation for details.

---

## ***Instrument Behavior***

### **Introduction**

The generator behaves as follows when it is turned on:

#### **Instrument Mode**

At power on, the generator will return to the same mode as it was powered down. Normally, once it has booted, the instrument is ready for either front panel operation or remote operation.

#### **Registers and Filters**

At power on, the state of the registers and filters is:

All registers and filters are set to its initial state except the PON bit of the Standard Event Status Register. The PON (Power ON) event bit indicates that an off-to-on transition has occurred in the device's power supply.

All bits of Positive Transition Filter will be set and all bits of the Negative Transition Filter will be cleared.

## 3.2 Application Programs

### Introduction

This chapter contains several remote interface example programs to help you develop programs for your own application. Chapter 4 Remote Programming Reference lists the syntax for the SCPI (Standard Commands for Programmable Instruments) commands available to program the generator.

These example programs are included in this chapter to demonstrate controlling the instrument using SCPI commands. All of these programs are created by means of Microsoft Visual Studio 2005 and use the Agilent IO Library Suite features.

---

### *Visual Studio 2005 C++/Unmanaged - \*IDN*

### Introduction

This example program queries via the USB interface the instrument for an identification string and prints the result.



#### Notes:

- You must change the VISA resource string accordingly. Here `USB0::2391::23064::DE49C00100::INSTR` is used as the VISA resource string of the instrument.
- Your application must link to VISA import libraries. To keep this example simple, configuring the Visual Studio 2005 is not described.

```

#include <visa.h>
#include "stdafx.h"

int _tmain(int argc, _TCHAR* argv[])
{
    ViStatus errorStatus = 0;
    ViSession viRm = 0, vi = 0;

    char buf [0xffff] = {0};

    /* Open session instrument */
    errorStatus = viOpenDefaultRM(&viRm);
    errorStatus = viOpen(viRm,
                        "USB0::2391::23064::DE49C00100::INSTR ",
                        VI_NULL, VI_NULL, &vi);

    /* Send an *IDN? string to the device */
    viPrintf (vi, "*IDN?\n");

    /* Read results */
    viScanf (vi, "%t", &buf);
    printf ("IDN? response: %s\n", buf);

    /* Close session */
    viClose (vi);
    viClose (viRm);

    return 0;
}

```

---

**Example output of the short C++ / Unmanaged program above:**  
IDN? response: Agilent Technologies,N4916B,  
DE49C00100,1.0.0.0-2

---

The following is a summary of the VISA function calls used in the previous example programs. For more detailed explanation of VISA functionality, see Agilent IO Libraries Suite “Programming with VISA”.

<code>visa.h</code>	This file is included at the beginning of the file to provide the function prototypes and constants defined by VISA.
<code>ViSession</code>	The <code>ViSession</code> is a VISA type data type. Each program that will establish a communication channel must be defined as <code>ViSession</code> .
<code>viOpenDefaultRM</code>	You must first open a session with the default resource manager.
<code>viOpen</code>	This function establishes a communication channel with the device specified. This call must be made for each device you will be using.
<code>viPrintf, viScanf</code>	These are the VISA formatted “C like” I/O functions.
<code>viClose</code>	This function must be used to close each session. All allocated data structures that had been allocated for the session, will be deallocated.
<code>viSetAttribute</code>	This function is used to change attributes of an active <code>ViSession</code> .

---



# Appendix

## Introduction

This section covers the following:

- Pulse Parameter Definitions
  - Preparing a USB Flash Drive using Windows Vista®
-

## A.1 Pulse Parameter Definitions

### Introduction

Here you find the pulse parameter definitions of terms used in the instrument specifications. In the following figure, a graphical overview of the pulse parameters is provided.

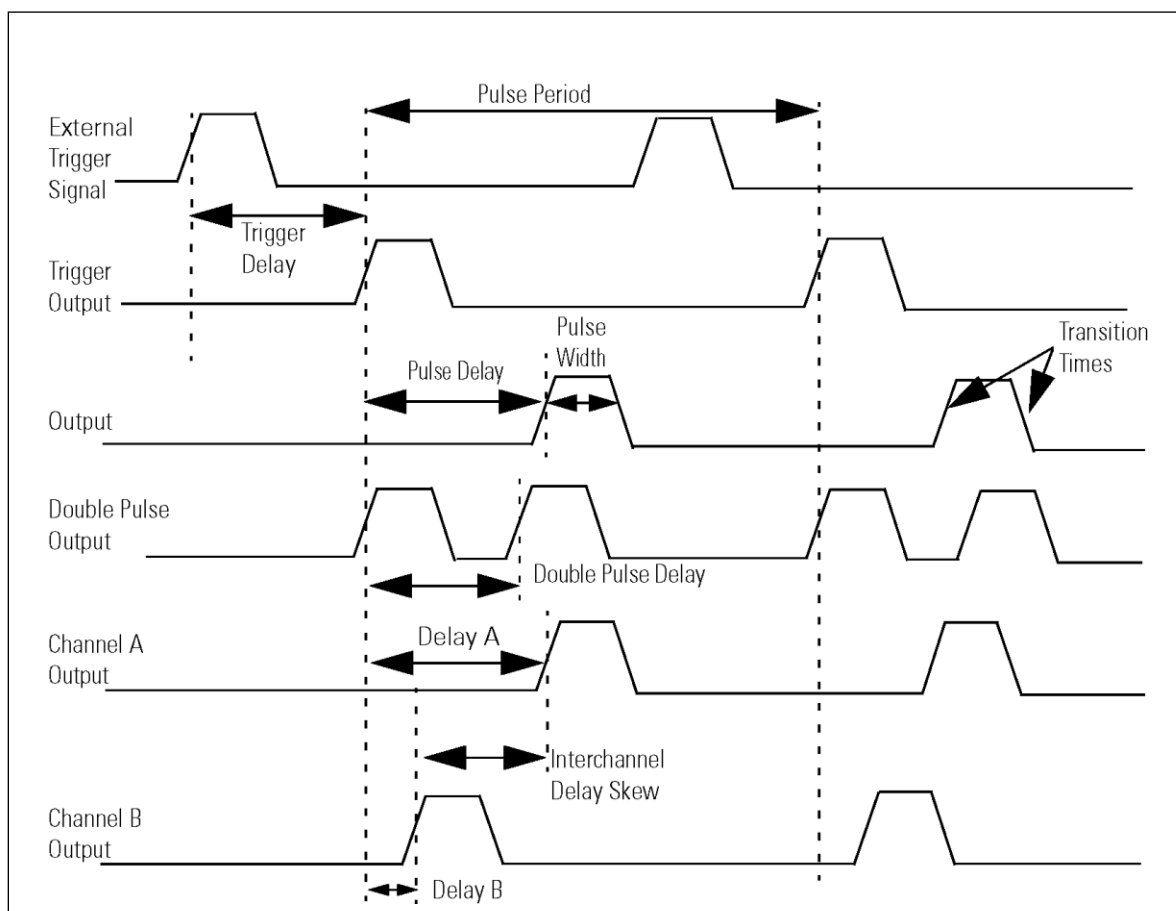

**Time Reference Point**

The time reference point is at the median of the amplitude (50% amplitude point on pulse edge):

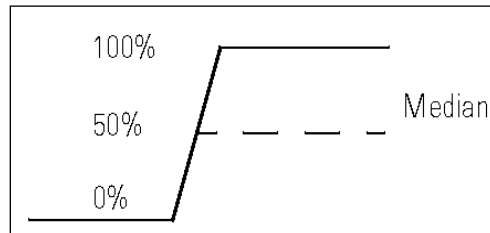

**Pulse Period**

The time interval between the leading edge medians of consecutive output pulses:

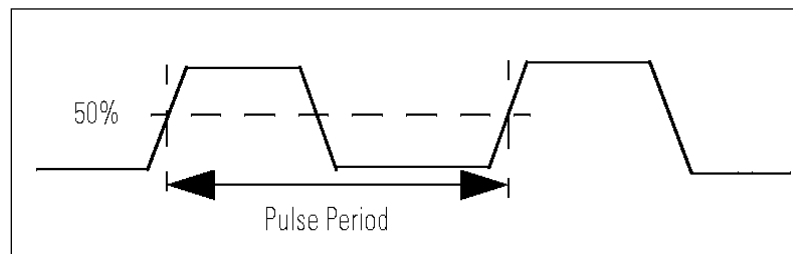

**Trigger Delay**

Interval between trigger point of the external trigger input signal and the trigger output pulse's leading edge median.

**Pulse Width**

Interval between leading and trailing edge medians:

The specified and displayed value is that obtained with fastest edges, essentially equal to the interval from the start of the leading edge to the start of the trailing edge. By designing so that the pulse edges turn about their start points, the interval from leading edge start stays unchanged (in practice, start points may shift with changes in transition time) when transition times are varied. This is more convenient for programming and the width display is easy to interpret.

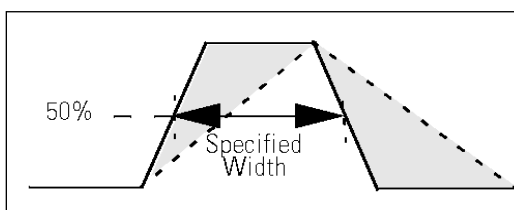
**Pulse Delay**

Interval between leading edge medians of trigger output pulse and output pulse:

The specified and displayed value is that obtained with the fastest leading edge. Pulse delay has two components, a fixed delay from trigger output to output signal and a variable delay with respect to the trigger output.

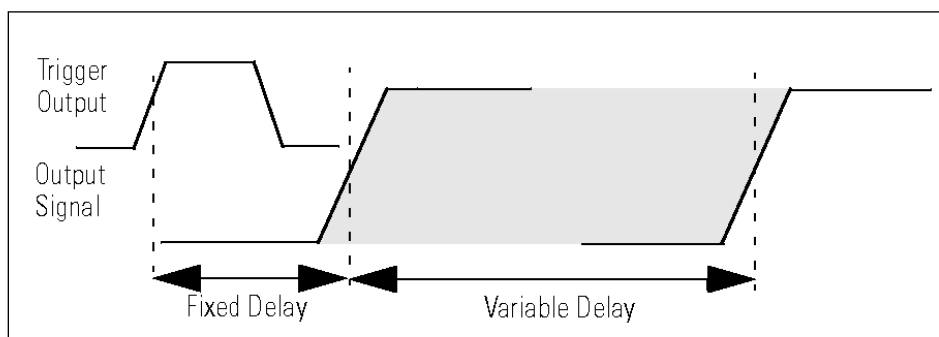

**Inter channel Delay (Skew)** Interval between corresponding leading edge medians of the output signals.

---

**Transition Time** Interval between the 10% and 90% amplitude points on the leading/trailing edge:

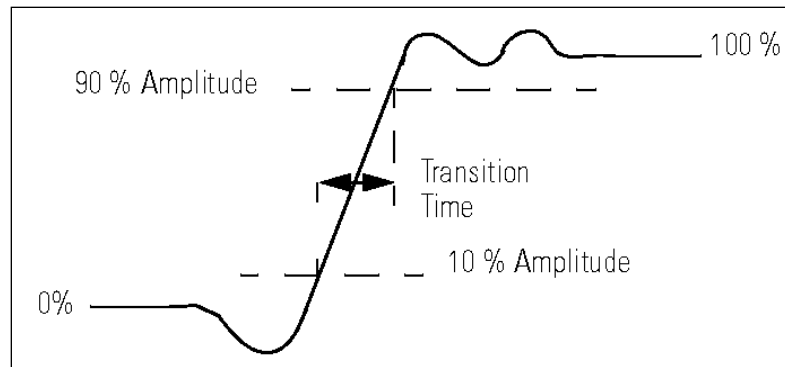

**Linearity** Peak deviation of an edge from a straight line through the 10% and 90% amplitude points, expressed as percentage of pulse amplitude:

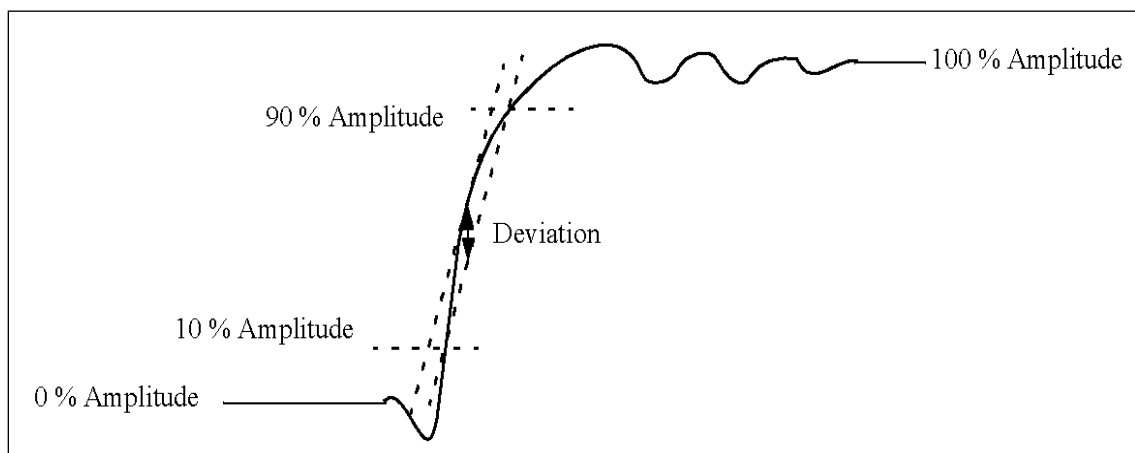

**Jitter**

Short-term instability of one edge relative to a reference edge. Usually specified as rms value, which is one standard deviation or "sigma". If distribution is assumed Gaussian, six sigma represents 99.74% of the peak-peak jitter.

The reference edge for period jitter is the previous leading edge. That for delay jitter is the leading edge of the trigger output. Width jitter is the stability of the trailing edge with regard to the leading edge.

**Stability**

Long-term average instability over a specific time, for example, hour, year. Jitter is excluded.

**Pulse Levels**

Pulse output is specified as pulse top and pulse base (usually referred to as high level and low level), or as peak to peak amplitude and median offset. A "window" specification shows the limits within which the pulse can be positioned.

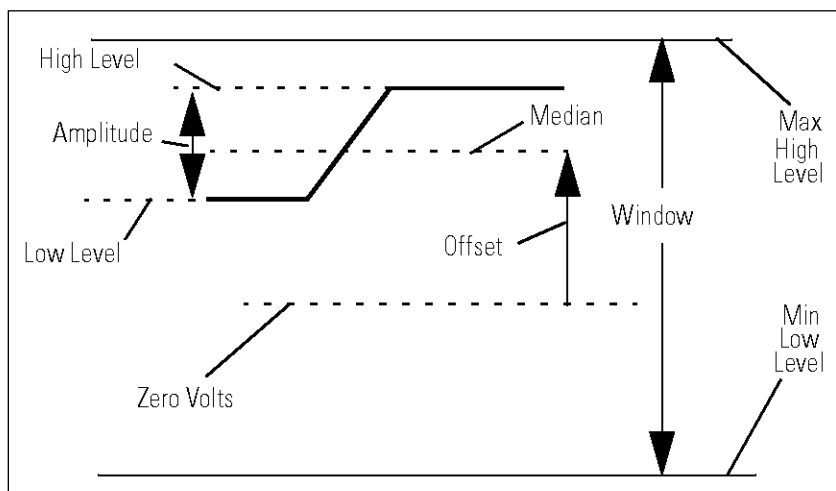

**Preshoot,  
Overshoot, Ringing**

Preshoot and overshoot are peak distortions preceding/following an edge. Ringing is the positive-peak and negative-peak distortion, excluding overshoot, on pulse top or base. For example, a combined preshoot, overshoot, and ringing specification of 5% implies:

- Overshoot/undershoot < 5%
- Largest pulse-top oscillation < + 5%, of pulse amplitude.

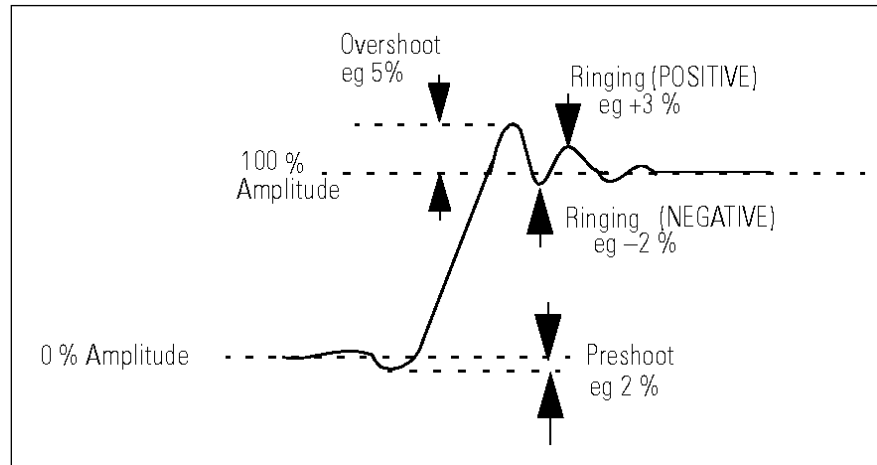

**Settling Time**

Time taken for pulse levels to settle within level specifications, measured from 90% point on leading edge.

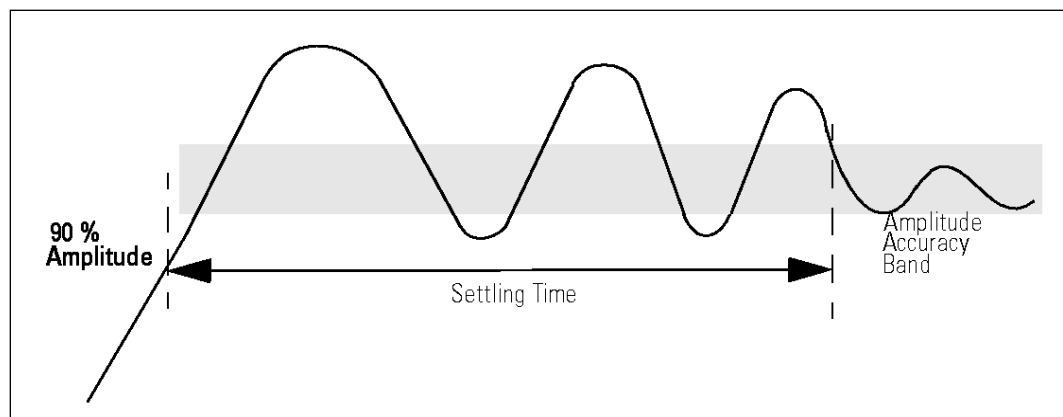

**Repeatability**

When an instrument operates under the same environmental conditions and with the same settings, the value of a parameter will lie within a band inside the accuracy window. Repeatability defines the width of this band.

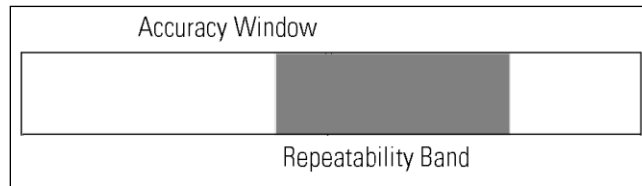



## A.2 Preparing a USB Flash Drive using Windows Vista®

### Introduction

The following description is intended to help you prepare an USB flash drive if it is not being detected by the N4916B, or if the recovery mechanism of the software update was not able to bring up the instrument after an interrupted software update.

---

### Important

- You need to have administrative rights on your computer to execute the steps mentioned below.
  - The steps mentioned below will erase all data from the USB flash drive.
  - The procedure does not work on computers that have Windows XP installed on them, since the required partition tool does not support USB flash drives on Windows XP.
-

**Steps**

- Click on the Windows logo and type "**cmd**".
- At the command prompt type "**diskpart**" and press enter (allow permissions and continue).
- When you are at the **diskpart**> prompt type "**list disk**" and press enter.
- Insert the USB flash drive into a Windows Vista PC.
- Wait until Windows Vista has recognized the USB flash drive.
- At the **diskpart**> prompt type "**list disk**" and press enter. Check which drive has been added to the list, usually disk 1 depending on how many disk drives are installed.
- Type "select disk #" where # is the disk number of the USB flash drive.

Continue only if you are sure that the selected drive is the USB flash key that you want to prepare. The following steps will erase all data from the selected drive!

- Type "**clean**" and press enter.
  - Type "**create partition primary**" and press enter. This creates the partition on the flash drive.
  - Type "**active**" and press enter.
  - Type "**exit**" and press enter. This exits the disk partition utility.
  - Now the flash drive needs to be formatted. Click on the Windows logo and then click on Computer.
  - Find the drive letter of the removable disk drive that needs to be formatted.
  - In the command prompt window type "**format ? : /fs:fat32 /q**" where ? is the removable drive letter that needs to be formatted. Press enter.
  - Enter a volume label of your choice and press enter.
-

**For recovering the N4916B....**

If you need to recover the N4916B from an interrupted software update, you need to do the following in addition:

- Copy the software update zip file on the USB flash drive's root directory.
- Extract the content of the software update zip file to the root directory of the USB flash drive. Remember to maintain the folder structure in the zip file when doing this.
- Connect the USB flash drive to the N4916B and switch the instrument on.
- The N4916B will now boot the recovery image from the USB flash drive and continue to update the instrument firmware.
- The software update includes a reboot of the instrument after writing the firmware to flash memory. A visual sign of a completed update is the status being shown on the status LEDs. After the successful reboot, the Activity LED will be off, and the LAN status LED will be either green or red (depending on LAN availability and setup). Both LEDs are orange during the recovery update and the following reboot.

---

Windows® and Windows Vista® are trademarks of Microsoft Corporation.

Copyright Agilent Technologies 2012  
Third Edition, February 2012  
Printed in Germany



N4916B-91021