

Keysight Technologies  
N5182BX07  
Frequency Extender

# Notices

© Keysight Technologies, Inc. 2020  
- 2022

No part of this manual may be reproduced in any form or by any means (including electronic storage and retrieval or translation into a foreign language) without prior agreement and written consent from Keysight Technologies, Inc. as governed by United States and international copyright laws.

## Trademark Acknowledgments

### Manual Part Number

N5182-90001

### Edition

Edition 1, April 2022

Supersedes: January 2022

Printed in Malaysia

Published by:  
Keysight Technologies  
1400 Fountaingrove Parkway  
Santa Rosa, CA 95403

### Warranty

THE MATERIAL CONTAINED IN THIS DOCUMENT IS PROVIDED "AS IS," AND IS SUBJECT TO BEING CHANGED, WITHOUT NOTICE, IN FUTURE EDITIONS. FURTHER, TO THE MAXIMUM EXTENT PERMITTED BY APPLICABLE LAW, KEYSIGHT DISCLAIMS ALL WARRANTIES, EITHER EXPRESS OR IMPLIED WITH REGARD TO THIS MANUAL AND ANY INFORMATION CONTAINED HEREIN, INCLUDING BUT NOT LIMITED TO THE IMPLIED WARRANTIES OF MERCHANTABILITY AND FITNESS FOR A PARTICULAR PURPOSE. KEYSIGHT SHALL NOT BE LIABLE FOR ERRORS OR FOR INCIDENTAL OR CONSEQUENTIAL DAMAGES IN CONNECTION WITH THE FURNISHING, USE, OR PERFORMANCE OF THIS DOCUMENT OR ANY INFORMATION CONTAINED HEREIN. SHOULD KEYSIGHT AND THE USER HAVE A SEPARATE WRITTEN AGREEMENT WITH WARRANTY TERMS

COVERING THE MATERIAL IN THIS DOCUMENT THAT CONFLICT WITH THESE TERMS, THE WARRANTY TERMS IN THE SEPARATE AGREEMENT WILL CONTROL.

### Technology Licenses

The hardware and/or software described in this document are furnished under a license and may be used or copied only in accordance with the terms of such license.

### U.S. Government Rights

The Software is "commercial computer software," as defined by Federal Acquisition Regulation ("FAR") 2.101. Pursuant to FAR 12.212 and 27.405-3 and Department of Defense FAR Supplement ("DFARS") 227.7202, the U.S. government acquires commercial computer software under the same terms by which the software is customarily provided to the public.

Accordingly, Keysight provides the Software to U.S. government customers under its standard commercial license, which is embodied in its End User License Agreement (EULA), a copy of which can be found at

<http://www.keysight.com/find/sweula>

The license set forth in the EULA represents the exclusive authority by which the U.S. government may use, modify, distribute, or disclose the Software. The EULA and the license set forth therein, does not require or permit, among other things, that Keysight: (1) Furnish technical information related to commercial computer software or commercial computer software documentation that is not customarily provided to the public; or (2) Relinquish to, or otherwise provide, the government rights in excess of these rights customarily provided to the public to use, modify, reproduce, release, perform, display, or disclose commercial computer software or commercial computer software

documentation. No additional government requirements beyond those set forth in the EULA shall apply, except to the extent that those terms, rights, or licenses are explicitly required from all providers of commercial computer software pursuant to the FAR and the DFARS and are set forth specifically in writing elsewhere in the EULA. Keysight shall be under no obligation to update, revise or otherwise modify the Software. With respect to any technical data as defined by FAR 2.101, pursuant to FAR 12.211 and 27.404.2 and DFARS 227.7102, the U.S. government acquires no greater than Limited Rights as defined in FAR 27.401 or DFAR 227.7103-5 (c), as applicable in any technical data.

## Safety Notices

### CAUTION

A **CAUTION** notice denotes a hazard. It calls attention to an operating procedure, practice, or the like that, if not correctly performed or adhered to, could result in damage to the product or loss of important data. Do not proceed beyond a CAUTION notice until the indicated conditions are fully understood and met.

---

### WARNING

A **WARNING** notice denotes a hazard. It calls attention to an operating procedure, practice, or the like that, if not correctly performed or adhered to, could result in personal injury or death. Do not proceed beyond a WARNING notice until the indicated conditions are fully understood and met.

---

## Table of Contents

Description .....	page 6
Verifying the Shipment .....	page 7
Equipment .....	page 7
General Performance .....	page 8
Power Requirements .....	page 8
Environmental Tests .....	page 8
Dimensions and Space Requirements .....	page 9
Specifications .....	page 10
General Specifications .....	page 10
Definitions and Conditions .....	page 11
Frequency Specifications .....	page 12
Amplitude Specifications .....	page 12
Spectral Purity Specifications .....	page 16
Modulation .....	page 17
Front and Rear Panel Features .....	page 19
Front and Rear Panel Connections .....	page 21
Firmware Initialization .....	page 22
Extender Power Alignment .....	page 26
SCPI Commands .....	page 33
EVM Optimization .....	page 33
RF Block Diagram .....	page 38
Safety and Regulatory Information .....	page 39
Introduction .....	page 39
Safe Installation .....	page 39
Safety Earth Ground .....	page 39
Declaration of Conformity .....	page 39
Safety (European Low Voltage Directive) .....	page 40
EMC Information .....	page 40
Acoustic Statement (European Machinery Directive) .....	page 40
Before Applying Power .....	page 40
Connector Care and Cleaning Precautions .....	page 42

## Table of Contents

Instrument Markings.....	page 42
Keysight Support, Services, and Assistance .....	page 45
Service and Support Options .....	page 45
Contacting Keysight.....	page 45
Keysight Support, Services, and Assistance.....	page 45

# N5182BX07 Frequency Extender

9 kHz to 7.2 GHz



## Description

## Description

The Keysight N5182BX07 Frequency Extender is an accessory for the MXG (N5182B) or EXG (N5172B) that extends the frequency range of vector signals to cover 9 kHz to 7.2 GHz. The N5182BX07 is especially well suited for 802.11ax measurements, due to its excellent phase noise and EVM.

The Keysight N5182BX07 has the following key features:

- Frequency range of operation: 9 kHz to 7.2 GHz.
- Bandwidth: 160 MHz.
- 802.11ax EVM at 7.2 GHz, 160 MHz BW: <-47 dB (0.45%) for output up to +5 dBm.
- Max output power: +18 dBm (EVM will degrade as power increases above +5 dBm).
- Total height: 3U (MXG is 2U and frequency extender is 1U).
- Seamless integration with MXG/EXG, including control from the front panel or automation using SCPI via LAN, GPIB, or USB.
- Single RF output for full frequency coverage, with bypass mode for frequencies < 5.9 GHz.
- Available as an upgrade for an existing N5182B or N5172B with power sensor calibration at the customer site.

Figure 1 N5182BX07 Frequency Extender with MXG Vector Signal Generator



## Verifying the Shipment

To verify the contents shipped with your product, refer to the “Box Content List” included with the shipment.

Inspect the shipping container. If the container or packing material is damaged, it should be kept until the contents of the shipment have been checked mechanically and electrically. If there is physical damage refer to **“Contacting Keysight” on page 45**. Keep the damaged shipping materials (if any) for inspection by the carrier and an Keysight Technologies representative.

## Equipment

### **N5182BX07 Frequency Extender, with**

- USB cable (Type A to Type C)
- 10 MHz cable (BNC)
- RF cable, (N-type)
- Power cord

### Other Required Equipment, Sold Separately

#### **N5182B MXG-B or N5172B EXG-B, with**

- Option 506: Frequency range from 9 kHz to 6 GHz
- Option FRQ: Frequency Extender Connectivity
- Licenses for playing 802.11ax waveforms
- Firmware B.01.90 or later
- Power cord

**NOTE**

Only Keysight approved accessories shall be used.

---

## General Performance

### CAUTION

This instrument has an auto-ranging line voltage input. Be sure the supply voltage is within the specified range and voltage fluctuations do not exceed 10% of the nominal supply voltage.

---

## Power Requirements

- 100/120V VAC, 220/240 VAC (50/60 Hz)
- N5182BX07 maximum power is 160 W

## Environmental Tests

The N5182BX07 complies with all applicable safety and regulatory requirements for the intended location of use.

- Operating Environment (for indoor use only)
- Operating Temperature 0 to 55 °C
- Storage Temperature: -40 to +70 °C
- Operating and Storage Altitude: 0 to 3,000 meters (~ 9,842 feet)
- Maximum Relative Humidity (non-condensing): 95% RH up to 40 °C, decreasing linearly to 45% RH at 55 °C. From 40 °C to 55 °C, the maximum % Relative Humidity follows the line of constant dew point.

### NOTE

The input terminals for this product are classified as Measurement Category None.

---



## Dimensions and Space Requirements

Standard installation of the N5182BX07 includes configuration and installation on a customer-provided lab bench or table top of adequate size and strength.

**Table 1**                      **Dimensions**

Size, including RF connectors and feet	
Width	425 mm (16.7")
Length	485 mm (19.1")
Height	55 mm (2.2")
Size, excluding RF connectors and feet	
Width	426 mm (16.8")
Length	465 mm (18.3")
Height	44 mm (1.75")
Weight	
	≤ 6.2 kg (13.7 lb)

## Specifications

### Specifications

The N5182BX07 Frequency Extender extends any N5182B MXG or N5172B EXG with Option 506 to cover the 802.11ax bands from 2.4 to 7.2 GHz with exceptional error vector magnitude (EVM) accuracy.

For frequencies of 5.9 – 7.2 GHz, the N5182BX07 optimizes EVM by holding the MXG or EXG within a narrow frequency and amplitude range, and then adjusting output amplitude with a mechanical attenuator with 1 dB steps. This provides excellent EVM over a wide range of amplitude levels. The attenuator is rated for 2 million cycles. A mechanical switch rated at 5 million cycles is used to switch between the 9 kHz to <5.9 GHz band and the 5.9 - 7.2 GHz band. To maximize the life of the attenuator and the switch in automated tests across both frequency and amplitude, the optimal test order is as follows:

- First measure all frequency and amplitudes below 5.9 GHz.
- Next measure all frequency and amplitudes of 5.9 – 7.2 GHz with amplitude as the outer loop and frequency as the inner loop. In other words, measure all frequencies for a given power level, then switch power level.

#### NOTE

List and sweep features are not supported when using the N5182BX07.

---

### General Specifications

#### Remote Programming Interfaces

MXG or EXG can be controlled through GPIB, LAN, or USB. N5182BX07 is controlled by MXG or EXG using one USB port.

#### Recommended Calibration Cycle

12 months

#### ISO Compliant

This instrument is manufactured in an ISO9001 registered facility in concurrence with Keysight Technologies' commitment to quality.

## Definitions and Conditions

Specifications represent warranted performance of a calibrated instrument with Extender Input Power Offset set to 0 dB that has been stored for a minimum of two hours within the operating temperature range of 0 to 55 °C, unless otherwise stated, and after a 45-minute warm-up period. The specifications include measurement uncertainty. Data represented in this document are specifications unless otherwise noted.

**Typical (typ)** describes additional product performance information that is not covered by the product warranty. It is performance beyond specifications that 80 percent of the units exhibit with a 90 percent confidence level at room temperature (approximately 25 °C). Typical performance does not include measurement uncertainty.

**Nominal (nom)** values indicate the expected mean or average performance, or an attribute whose performance is by design, such as the 50 Ω connector. This data is not warranted and is measured at room temperature (approximately 25 °C).

**Measured (meas)** describes an attribute measured during the design phase for purposes of communicating expected performance, such as amplitude drift vs. time. This data is not warranted and is measured at room temperature (approximately 25 °C).

## Specifications

### Frequency Specifications

Table 2 Frequency Specifications

Frequency Range	
9 kHz TO 7.2 GHz <sup>a</sup>	
Frequency Bands	
Passthrough Band	9 kHz to < 5.900001 GHz
Upconverter Band	5.900001 GHz to 7.2 GHz
Frequency Switching Speed	
Crossing 5.9 GHz	≤ 30 ms (nominal)
Elsewhere	Same as MXG or EXG
External Frequency Reference Input	
Input Frequency	10 MHz
Lock Range	±1 ppm, nominal
Amplitude	0 dBm, nominal

a. The band edge of a modulated signal can extend up to 7.26 GHz.

### Amplitude Specifications

Table 3 Output Parameters

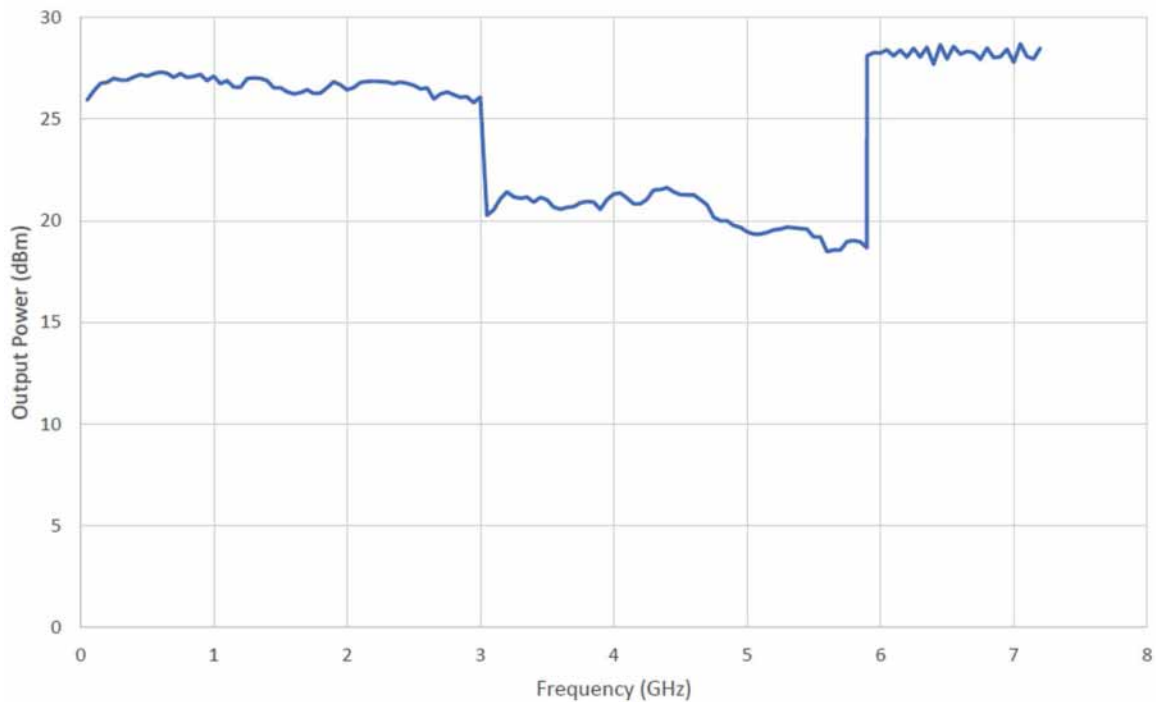
Settable Range with MXG/EXG Option 1EA	
Passthrough Band	+30 to -144 dBm
Upconverter Band	+28 to -144 dBm
Settable Range without MXG/EXG Option 1EA	
Passthrough Band	+19 to -144 dBm
Upconverter Band	+19 to -144 dBm
Step Attenuator in Upconverter Band	
0 to 121 dB in 1 dB steps, mechanical	
RF Input Connector	
Type N, 50 $\Omega$ , nominal	
RF Output Connector	
Type N, 50 $\Omega$ , nominal	

Table 4 Maximum Output Power<sup>a</sup>

Frequency	Standard	With MXG or EXG Option 1EA
200 kHz to 10 MHz	+12 dBm (typ)	+16 dBm (typ)
> 10 MHz to 3 GHz	+17 dBm (typ)	+23 dBm (typ)
> 3 GHz to 5 GHz	+14 dBm (typ)	+17 dBm (typ)
> 5 GHz to 5.900001 GHz	+14 dBm (typ)	+15 dBm (typ)
5.900001 GHz to 7.2 GHz	+16 dBm (+18 dBm typ)	+25 dBm (+27 dBm typ)

a. Temperature  $\leq 35$  °C and Extender Input Power Offset set to 0 dB. Max power degrades .06 dB / °C for temperatures above 35 °C.

Figure 2 Measured Maximum Power with Option 1EA



## Specifications

**Table 5 Absolute Level Accuracy in CW Mode (ALC On)<sup>a</sup>**

Frequency	+15 to -60 dBm	< -60 to -110 dBm
9 kHz to 100 kHz	± 6 dB (typ)	± 1 dB (typ)
100 kHz to 5 MHz	± 6 dB (typ)	± 1 dB (typ)
> 5 MHz to 3 GHz	± 6 dB (typ)	± 1 dB (typ)
> 3 GHz to < 5.9 GHz	± 6 dB (typ)	± 1 dB (typ)
5.9 GHz to 7.2 GHz	± 6 dB (typ)	± 1 dB (nom)

a. Power degrades .06 dB / °C from last calibration.

**Figure 3 Measured Level Accuracy in Passthrough Band**

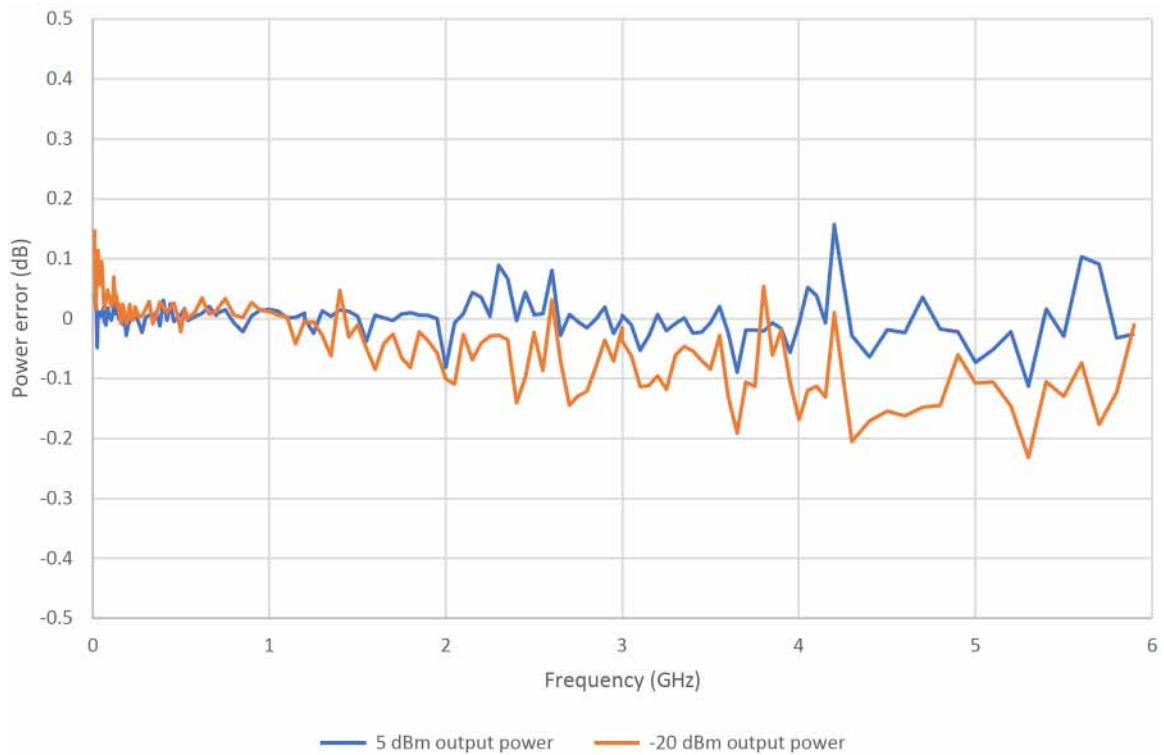


Figure 4 Measured Level Accuracy in Upconverter Band

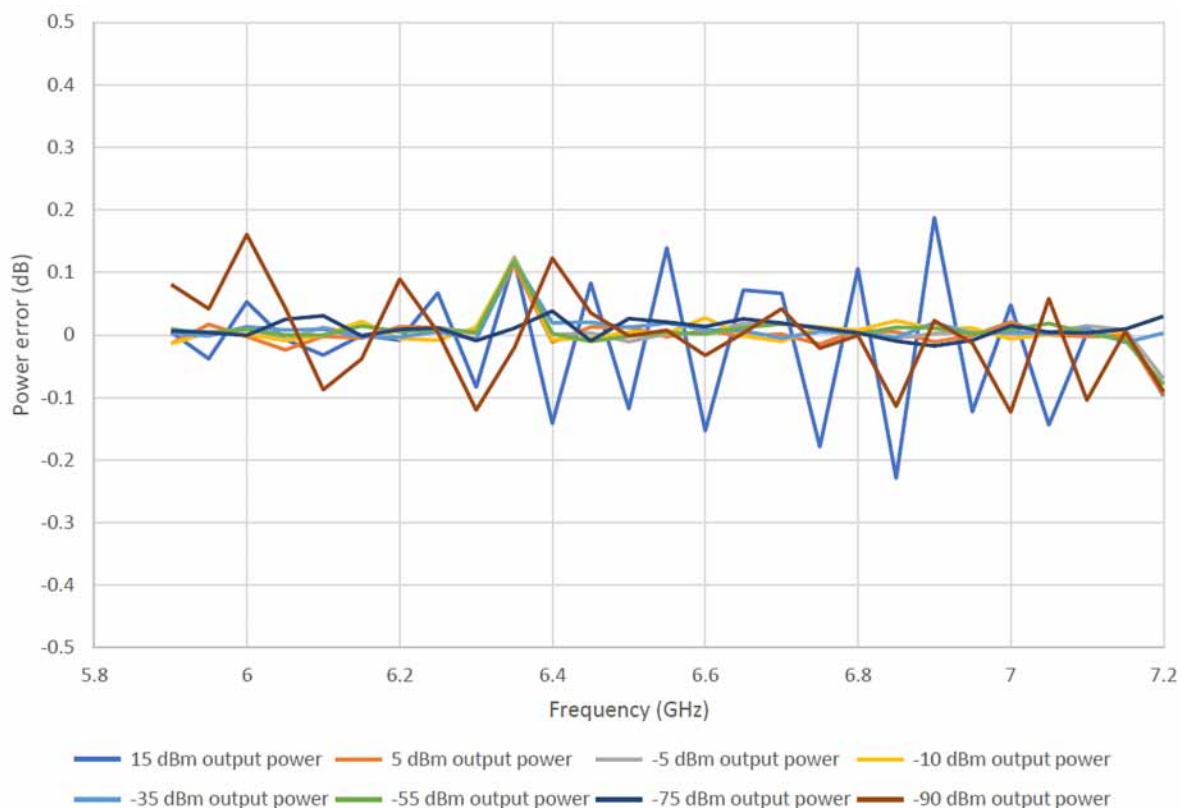


Table 6 Amplitude Switching Speed

Below 5.9 GHz	Same as MXG or EXG
5.9 GHz and above	≤ 30 ms (nominal)

Table 7 RF Input Limits

The N5182BX07 Frequency Extender is designed to be used and controlled by an MXG/EXG instrument with Option FRQ. The MXG/EXG instrument will keep the power levels below the maximum limits. Table 7 is intended for informational purposes only.

Maximum Input Power	
Passthrough Mode	28 dBm, nominal
Upconverter Mode	8 dBm, nominal
Maximum DC Voltage	0 VDC, nominal

Table 8 RF Output Limits

Maximum Reverse Power	0.5 W, nominal
Maximum DC Voltage	0 VDC, nominal

## Specifications

### Spectral Purity Specifications

**Table 9** Harmonics (CW Mode)

9 kHz to < 5.900001 GHz	Same as MXG or EXG, typical
5.900001 GHz to 7.2 GHz <sup>a</sup>	(< -84 dBc typical 2nd harmonic from 11.800002 GHz to 14.4 GHz)

a. Measured at 10 dBm with Extender Input Power Offset set to 0 dB.

**Table 10** Non-Harmonics (CW Mode) > 10 kHz Offset

5.120 GHz	< -90 dBm, typical
9 kHz to < 5.900001 GHz, excluding 5.120 GHz	1 dB higher than MXG or EXG, typical
5.900001 GHz to 7.2 GHz with power $\leq$ 10 dBm <sup>2a</sup>	
At 20.48 GHz - 2 * RF Output Frequency	< -40 dBc (-46 dBc typical)
At 2 * RF Output Frequency - 5.12 GHz	< -41 dBc (-47 dBc typical)
Other Frequencies	< -58 dBc (-64 dBc typical)

a. Measured with Extender Input Power Offset set to 0 dB.



## Modulation

Figure 5 EVM - 802.11ax, 80 MHz Bandwidth (Measured)

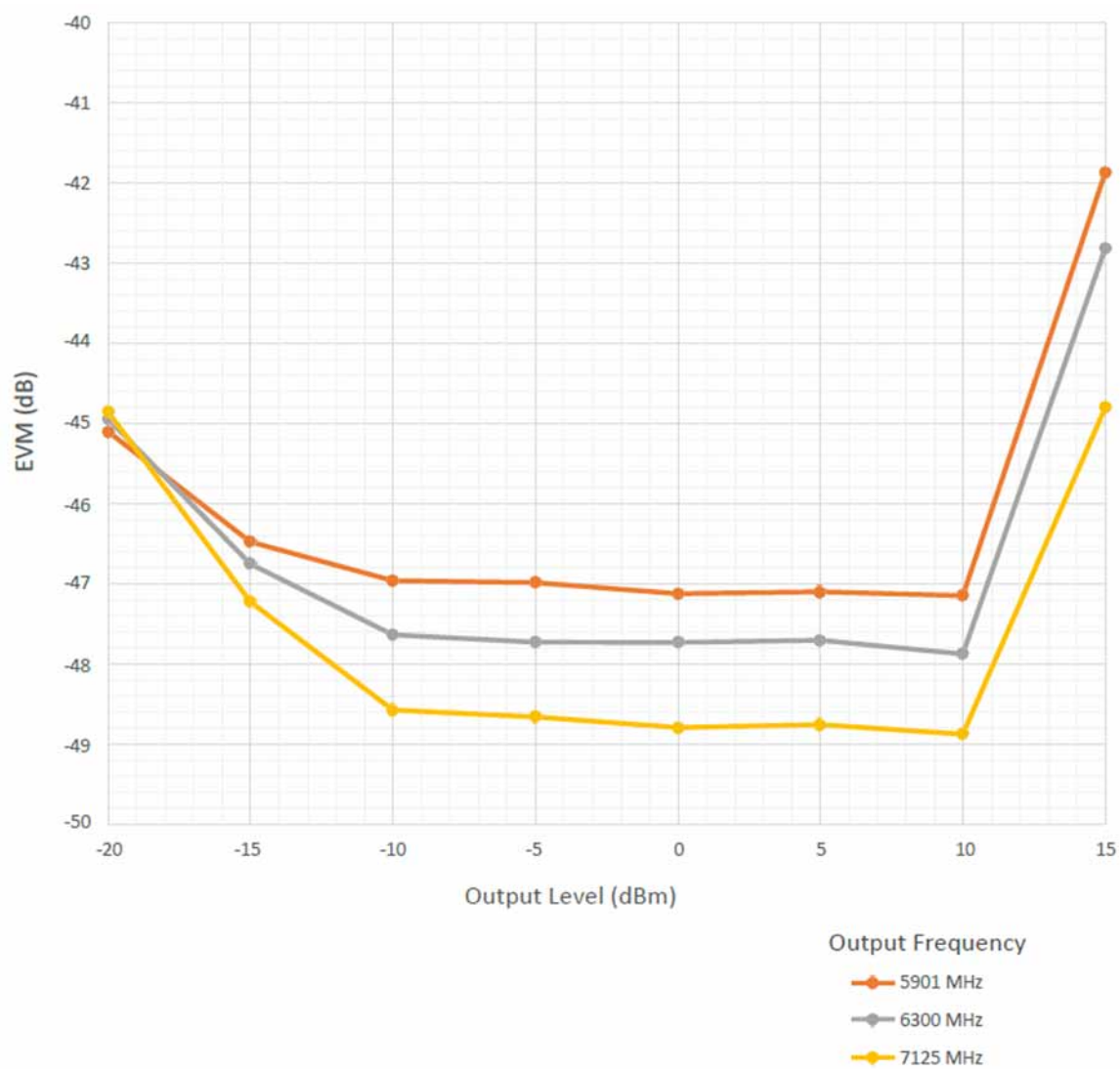
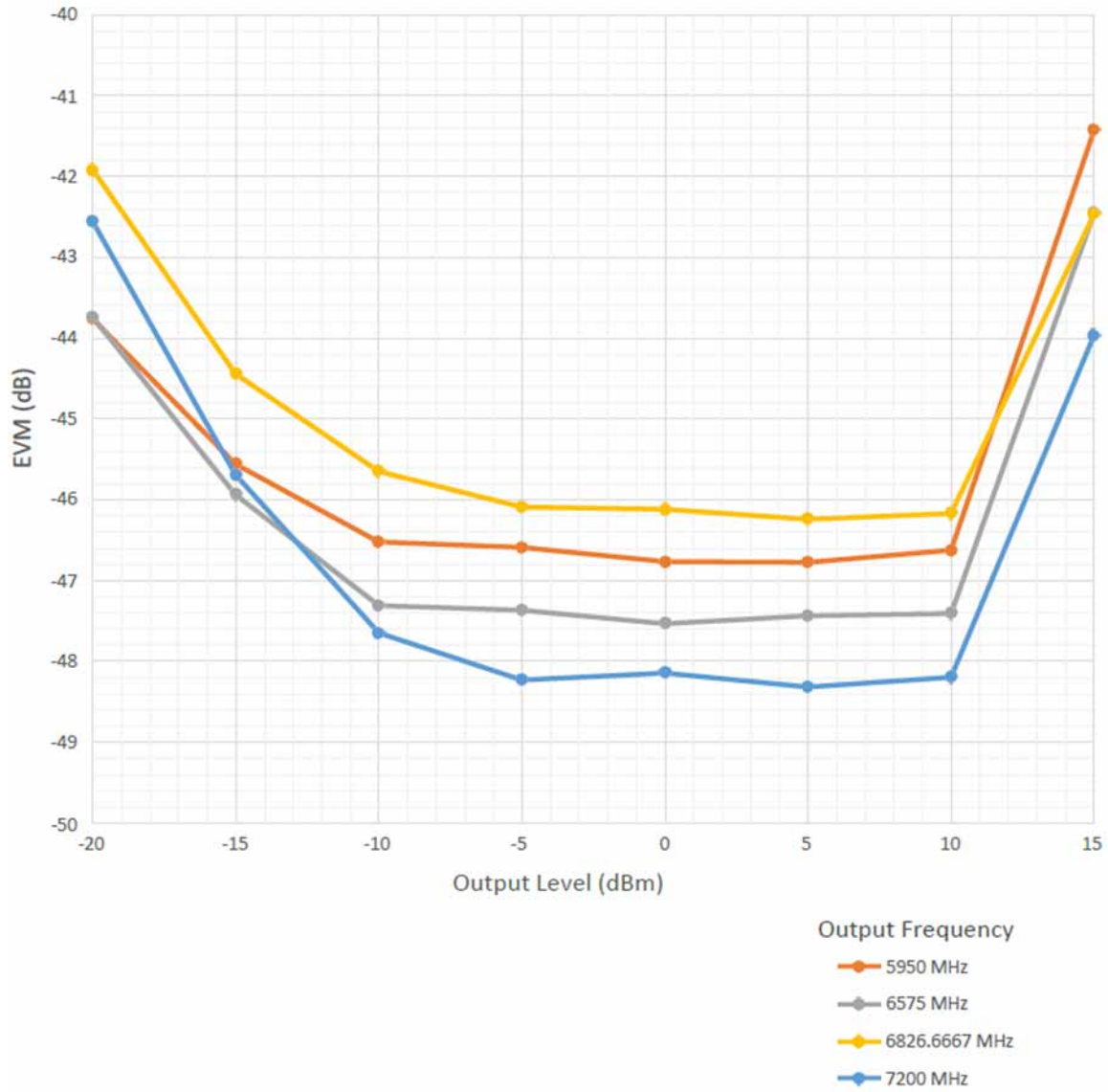


Figure 6 EVM - 802.11ax, 160 MHz Bandwidth (Measured)



## Front and Rear Panel Features

### CAUTION

Refer to the preceding tables and the MXG/EXG documentation for damage limits to the ports. Verify that your test setup will not cause those limits to be exceeded.

Figure 7 Front Panel



### ON/OFF Switch

Install the instrument so that the ON/OFF switch is readily identifiable and is easily reached by the operator. The ON/OFF switch is the instrument disconnecting device. It disconnects the mains circuits from the mains supply before other parts of the instrument. Or, the detachable power cord can be removed from the electrical supply. Alternatively, an externally installed switch or circuit breaker (which is readily identifiable and is easily reached by the operator) may be used as a disconnecting device.

### LED Status Indicator

The light will turn yellow when the instrument is turned on.

### RF Input (without Option 1EM)

Type-N, 50 ohm, nominal.

### RF Output (without Option 1EM)

Type-N, 50 ohm, nominal.

Figure 8 Rear Panel



RF In (Option 1EM)

Type-N, 50 ohm, nominal.

RF Out (Option 1EM)

Type-N, 50 ohm, nominal.

10 MHz In

10 MHz reference input, BNC.

USB Port

USB, Type C

Line Input

Power cord connection.

**CAUTION**

Use the Keysight supplied power cord or one with the same or better electrical rating.

---

## Front and Rear Panel Connections

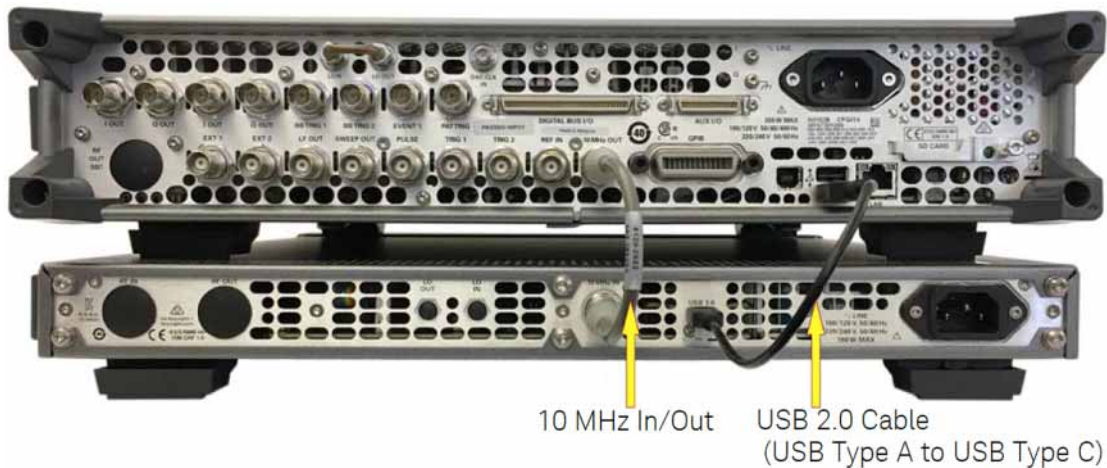
In the example shown in **Figure 9**, the N5182BX07 is connected to the MXG from the RF output of the MXG (or EXG) to the RF input of the N5182BX07, using an RF cable with N-Type connectors.

**Figure 9** Front Panel Connections



**Figure 10** shows the rear panel connections of the N5182BX07 to the MXG. The 10 MHz BNC cable connects the MXG (or EXG) 10 MHz Output to the N5182BX07 10 MHz Input. Also shown is the USB cable connection from the MXG (or EXG) to the N5182BX07.

**Figure 10** Rear Panel Connections



## Firmware Initialization

To initialize the firmware in the N5182BX07, perform the following steps:

1. Check that there is no USB cable connected between the N5182BX07 and the MXG (or EXG). This cable will be connected in Step 6.
2. Turn on the MXG or EXG.
3. Press softkeys **Utility** > **Instrument Info** > **Diagnostic Info** and confirm the installed firmware is **B.01.90** or later. See [Figure 11](#). If older firmware is installed, download and install firmware **B.01.90** (or later) from <http://www.keysight.com/find/upgradeassistant>.

**Figure 11** Install Firmware

FREQUENCY		RF OFF	Diagnostic Info
6.000 000 000 000 GHz		0.00 dBm	Update Diagnostic Info
<b>Instrument Information</b>			RPP Trip Log▶
Model .....	N5182B		
Options .....	003,006,009,012,023,099,1EA,1EL,1EQ,1ER,221,250,303,320,403,430-432,506,656,657,660 [FRQ],UNT,UNV,UNW,UNY,UNZ		
Serial Number .....	MY59100380		System Memory Info▶
Firmware Revision .....	B.01.90		
Firmware Date .....	Mar 4 2020 13:28:38 REL		
OS .....	CE 7.0.2882 20190905-0714		
Host Processing Platform .....	Atom E3815 1.46GHz		
Cal/Test Host Revision .....	1.90200226		Support ID▶

4. Press softkeys **Utility** > **Instrument Info** > **Options Info** > **Instrument Options** and verify a check mark appears next to **Frequency Extender (FRQ)**. See [Figure 12](#). If this option is missing, purchase an upgrade license and install it.

**Figure 12** Install Option FRQ

FREQUENCY		RF OFF	Inst Options
6.000 000 000 000 GHz		-144.00 dBm	
<b>Instrument Options</b>			
Option	Expiration	Description	
656	permanent	✓ ARB Baseband Generator (80 MHz RF, 32 Msa)	
657	permanent	✓ Upgrade baseband to 160 MHz RF bandwidth	
660	permanent	✓ Add real-time to baseband generator	
FRQ	permanent	✓ Frequency Extender	
UN7	permanent	✓ Internal bit error rate analyzer	Previous Page
UNT	permanent	✓ Analog modulation (AM/FM/Phase Modulation)	
UNV	permanent	✓ Enhanced dynamic range	
UNW	permanent	✓ Narrow pulse modulation	
UNY	permanent	✓ Enhanced low phase noise	
UNZ	permanent	✓ Fast frequency switching	Next Page

5. Turn on the N5182BX07.

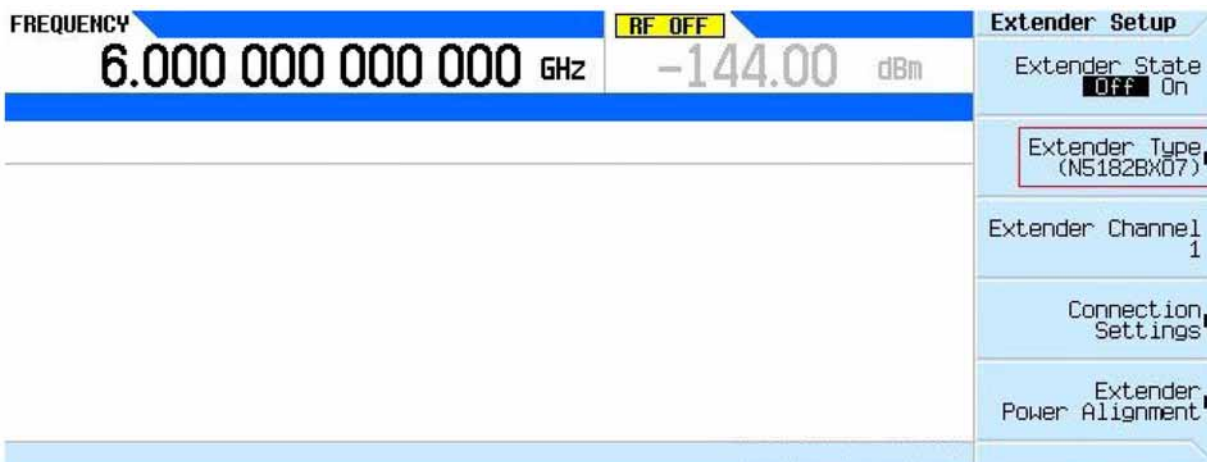
6. Connect the USB cable between the N5182BX07 and the MXG (or EXG). After about 5 seconds, there should be a notification at the bottom of the screen of the MXG (or EXG) showing that it has successfully detected the N5182BX07. See [Figure 13](#).

**Figure 13** Detection of N5182BX07 by MXG (or EXG)



7. Configure the MXG (or EXG) for operation with the N5182BX07.
  - a. Press **Frequency > More > Frequency Extender**.
  - b. Set **Extender State = Off** before making changes.
  - c. Select "N5182BX07" as the **Extender Type**. See [Figure 14](#).

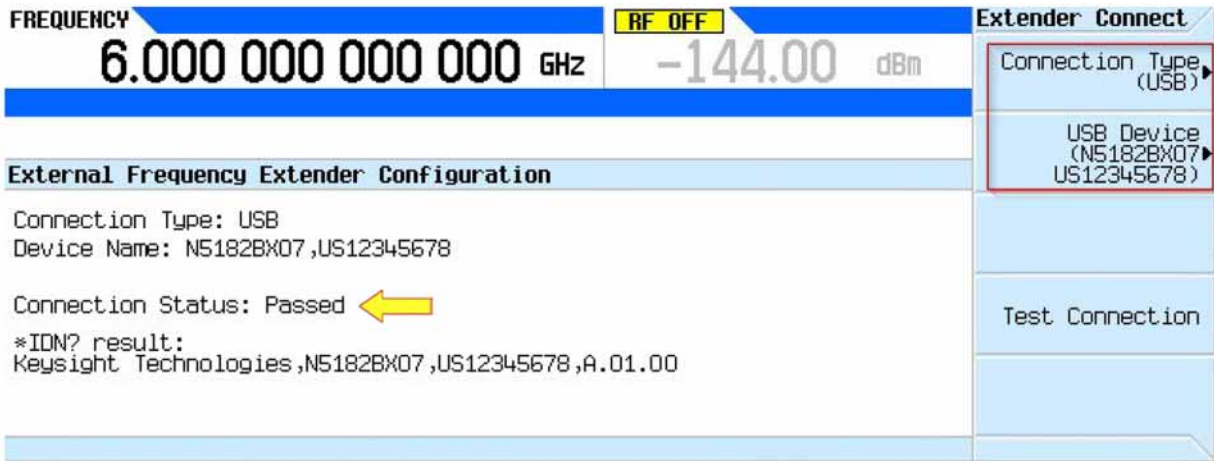
**Figure 14** Configuring MXG (or EXG) to N5182BX07



- d. Under **Connection Settings**:
  - i. Select "USB" for the Connection Type.
  - ii. Select "N5182BX07,USXXXXXXXX" (or MYXXXXXXXX) as the USB Device ("US12345678" shown as an example in [Figure 15](#)).

- iii. Press Test Connection to verify the connection. Verify the text Connection Status: Passed appears. See [Figure 15](#).

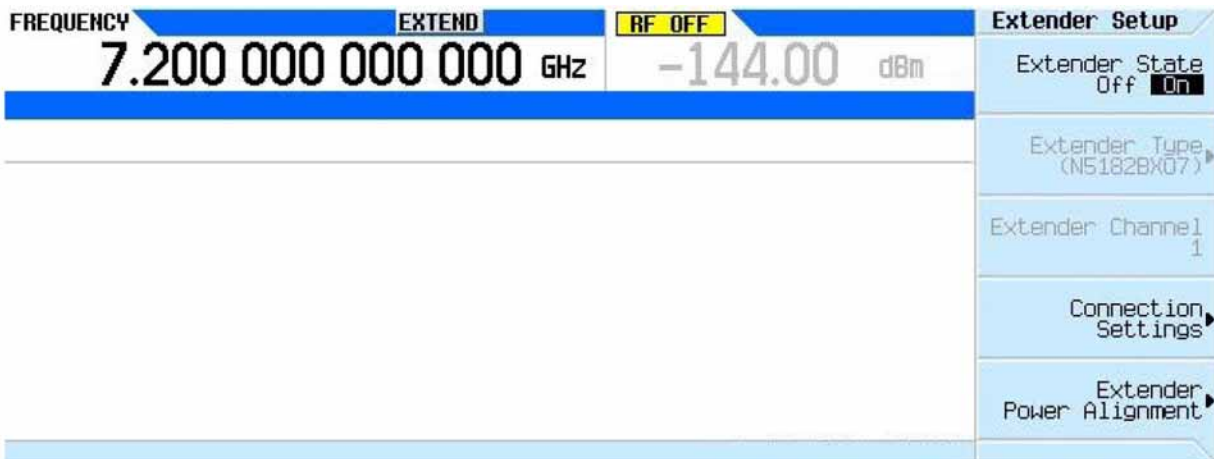
**Figure 15** Test Connection of the N5182BX07



**NOTE** If you can't make a connection, check the serial number displayed on your MXG (or EXG) and the serial number of the N5182BX07 to confirm that they match. If they don't match, reselect the USB device.

8. Set **Extender State = On**. The **EXTEND** indicator should now be visible in the top blue bar. See [Figure 16](#).

**Figure 16** Turn On Frequency Extender Feature on MXG (or EXG)



9. You may see the following error message: "Error 518: calibration must be run. Frequency extender calibration data for I/Q internal channel correction was not found."
  - a. When this error occurs, press **Utility > More > Service > IQ Int Channel Correction Calibration > Freq Extender Calibration**. This will take about one minute to run. No equipment is required. This error will occur only once.



10. If you noticed the following errors 517 occurred, you can perform the “**Extender Power Alignment**” on page 26. If not, proceed on to step 11.
  - Error 517, Calibration failure; Frequency extender data array ATTEN STEP LATCH size is incorrect.
  - Error 517, Calibration failure; The index and data array sizes do not match. RF CHAIN INDEX ATTEN STEP FLATNESS
11. Set the MXG (or EXG) to the desired frequency, in the range of 9 kHz to 7.2 GHz.
12. On the MXG (or EXG), press **IQ > IQ Calibration > Calibration Type = DC > Run Calibration**.
13. Load a waveform onto the MXG (or EXG) and play the waveform.
14. Confirm **Internal Channel Corrections** are turned on by pressing **IQ > More > Int Channel Correction ON**. Signal Studio waveforms should do this automatically, but your own waveform may not.

**NOTE**

If this is first time running the alignment with the current instrument configuration, or if any errors occur when running the alignment, clear any previous alignment data from the instruments by pressing Revert Power Alignment To Factory Defaults.

---

## Extender Power Alignment

**NOTE**

The power sensor used for the Extender Power Alignment must cover the range of 50 MHz to 7.2 GHz. Recommended power sensor models are **U8481A**, **U8485A**, **E9304A-H18**, and **E9304A-H19**.

1. Ensure Frequency Extender is connected to the MXG.
2. Ensure Frequency Extender option is installed on MXG.
3. On MXG front panel, select "Freq" then the "More" hard key. See [Figure 17](#).

**Figure 17** MXG Front Panel

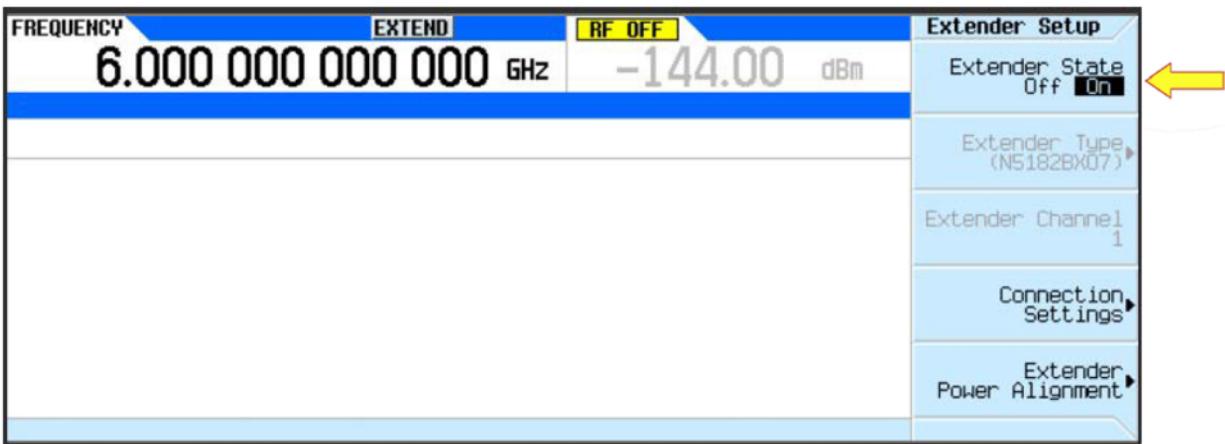


4. Select the "Freq Extender" softkey and ensure the "Extender State" is set to "On." See [Figure 18](#) and [Figure 19](#).

**Figure 18** Select Frequency Extender

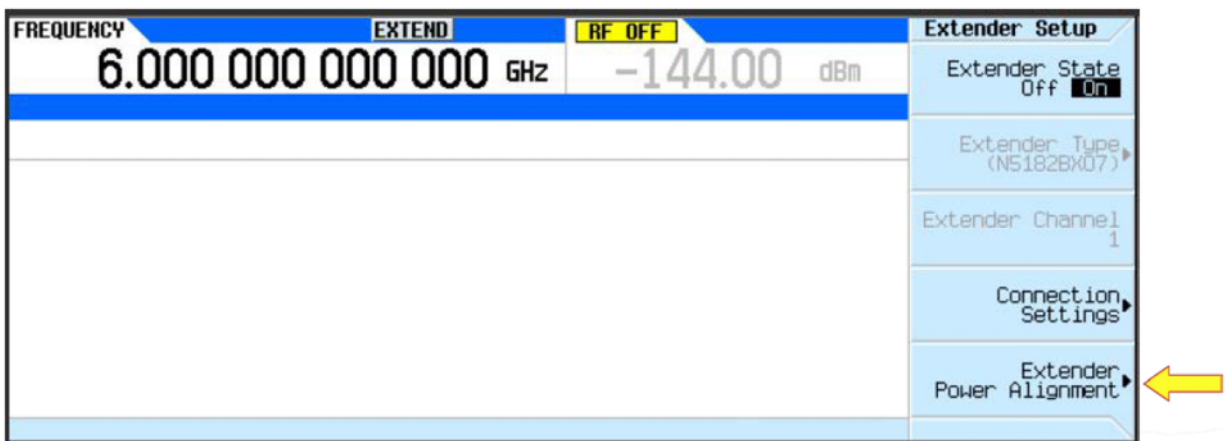


**Figure 19** Extender State ON



5. Select the "Extender Power Alignment" softkey. See [Figure 20](#).

**Figure 20** Extender Power Alignment



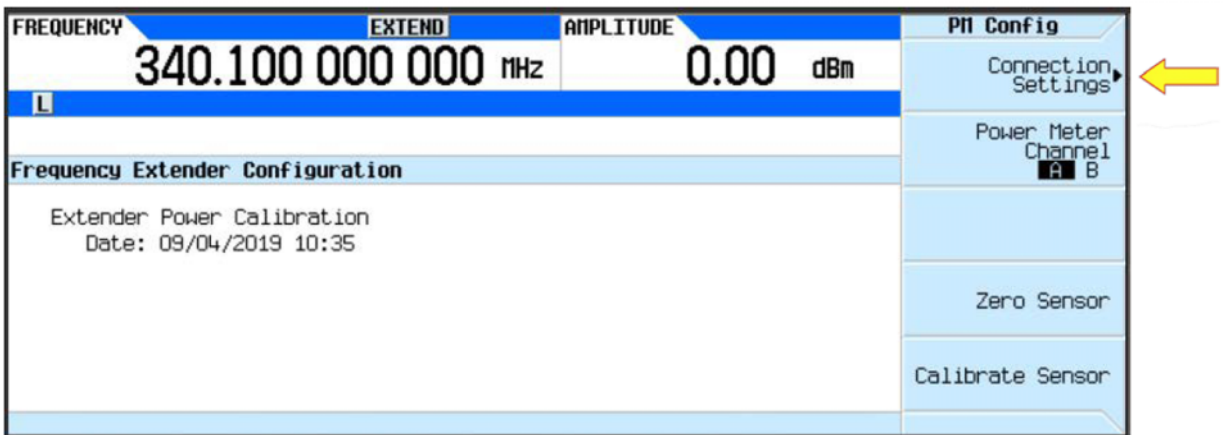
6. Select the "Configure Power Meter" softkey. See [Figure 21](#).

**Figure 21** Configure Power Meter



7. In "Connection Settings," set the connection settings based on the power meter/sensor used. See [Figure 22](#).

**Figure 22** Connection Settings



- When using a Power Meter with GPIB or LAN, follow the steps in Section a.
  - When using a USB Power Sensor, follow the steps in Section b.
- a. Power Meter Setup (a GPIB to LAN gateway must be used).
    - i. Set connection Type to VXI-11. See [Figure 23](#) and [Figure 24](#).

Figure 23 Connection Type

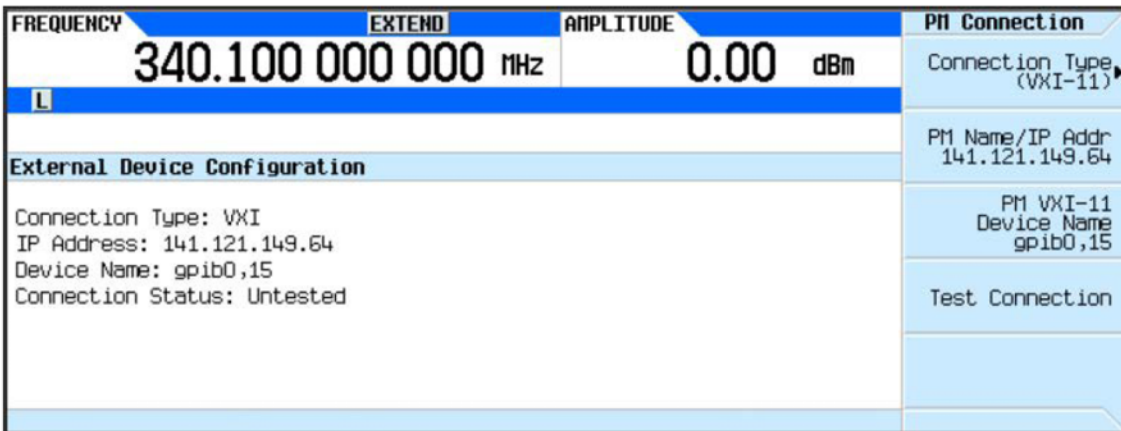
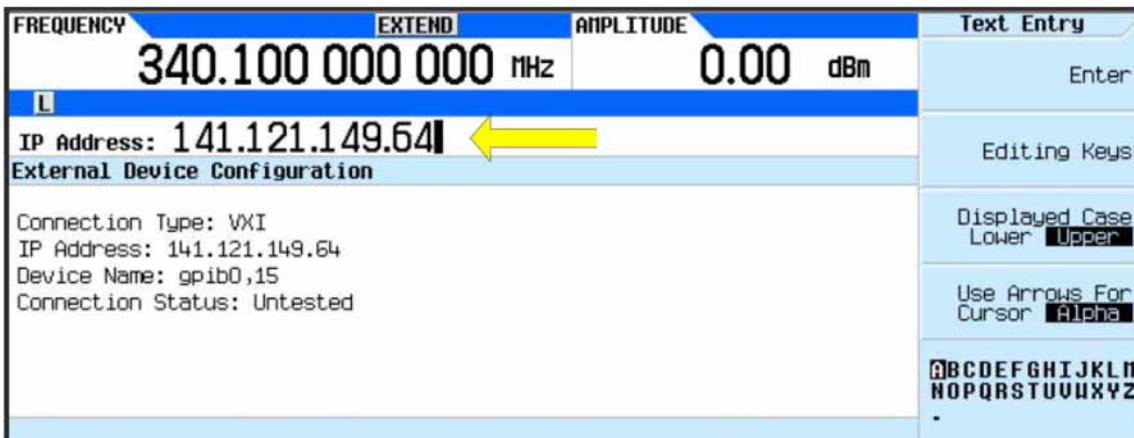


Figure 24 Set to VXI-11



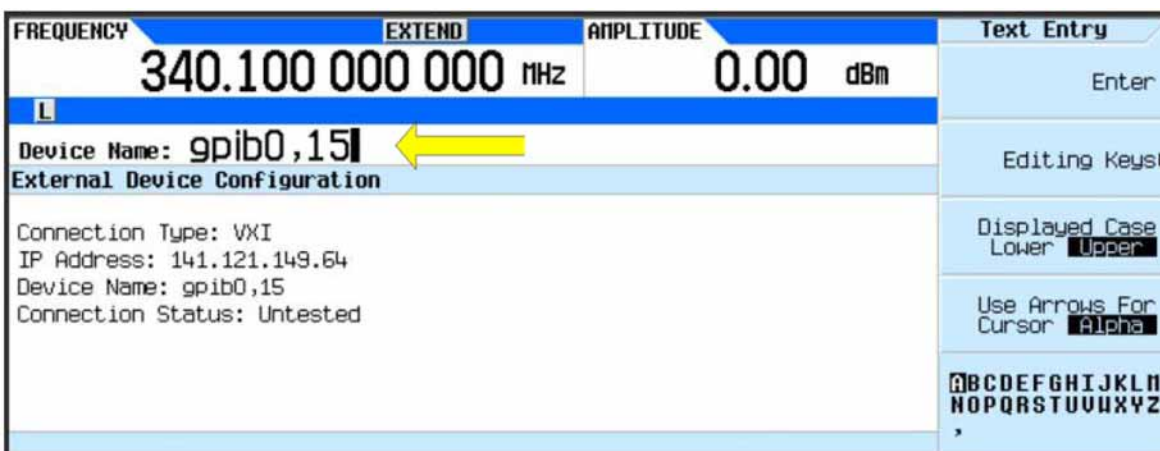
- ii. Enter the IP address supplied by the LAN gateway. See Figure 25.

Figure 25 Enter IP Address



- iii. Enter the Device Name. (Typically, "gpib0,15" is the default.) See Figure 26.

**Figure 26** Enter the Device Name



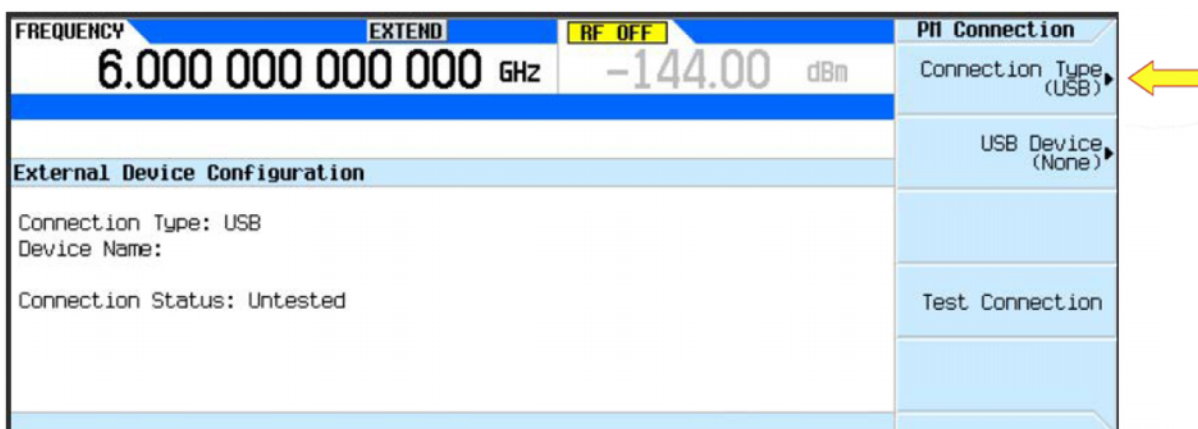
- iv. Test the connection and verify it passes. If it fails, re-check the previous steps.
- b. USB Sensor Setup
  - i. Plug the USB sensor into the MXG USB port (typically, the top port). See [Figure 27](#).

**Figure 27** USB Port on MXG



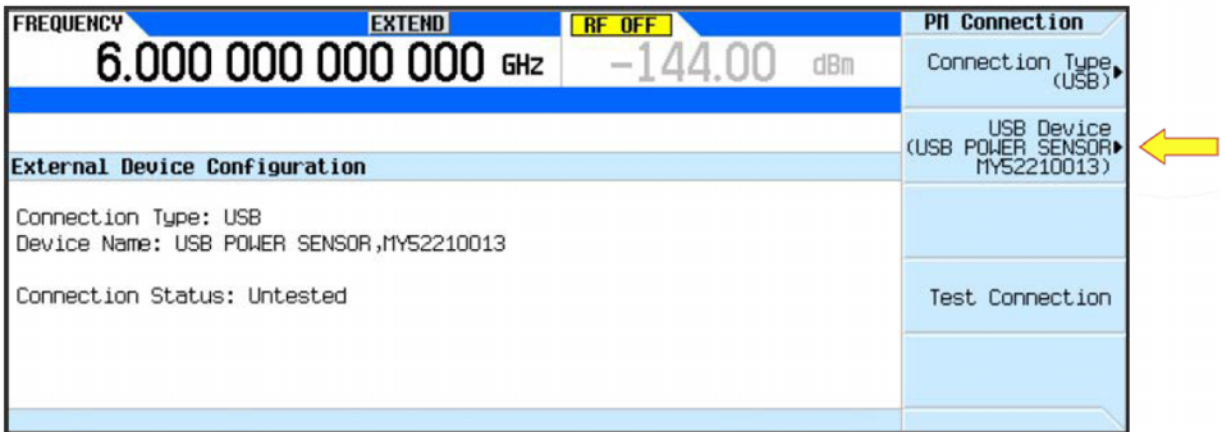
- ii. Set connection type to "USB." See [Figure 28](#).

**Figure 28** Set Connection Type to USB



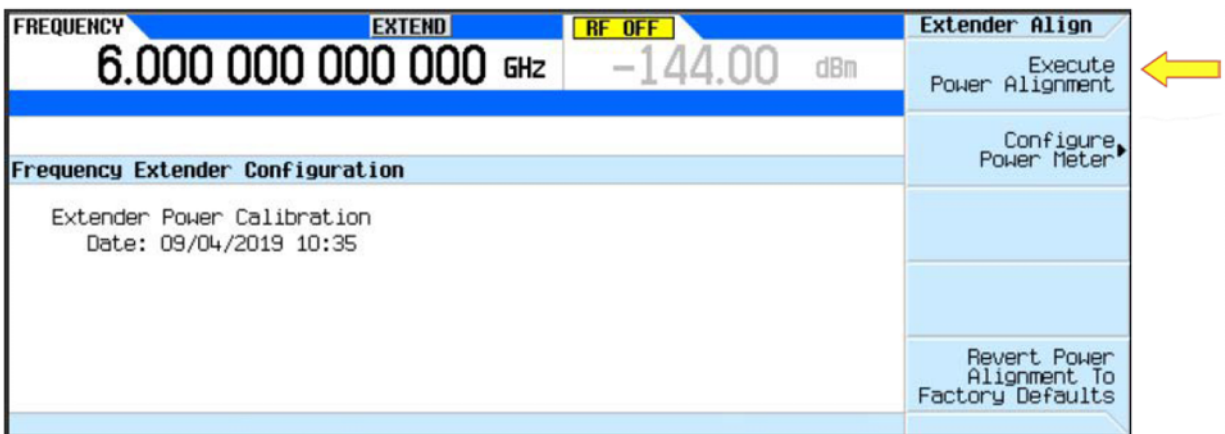
- iii. Set the USB device to the sensor being used (will be displayed in the softkey). See [Figure 29](#).

**Figure 29** Set USB Device to Power Sensor Used



- iv. Test the connection and verify it passes. If it fails, re-check the previous steps.
8. Once the power meter/sensor is connected and passes the connection test, select the "Return" hard key.
  9. Select the "Execute Power Alignment" softkey to run the calibration. See [Figure 30](#), [Figure 31](#), and [Figure 32](#).
  10. Verify the calibration runs and completes successfully.

**Figure 30** Execute Power Alignment

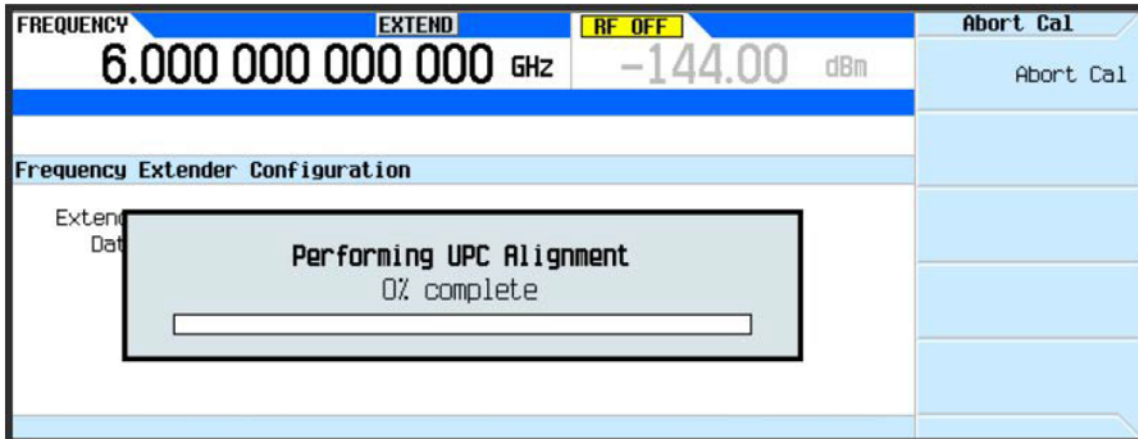


**NOTE**

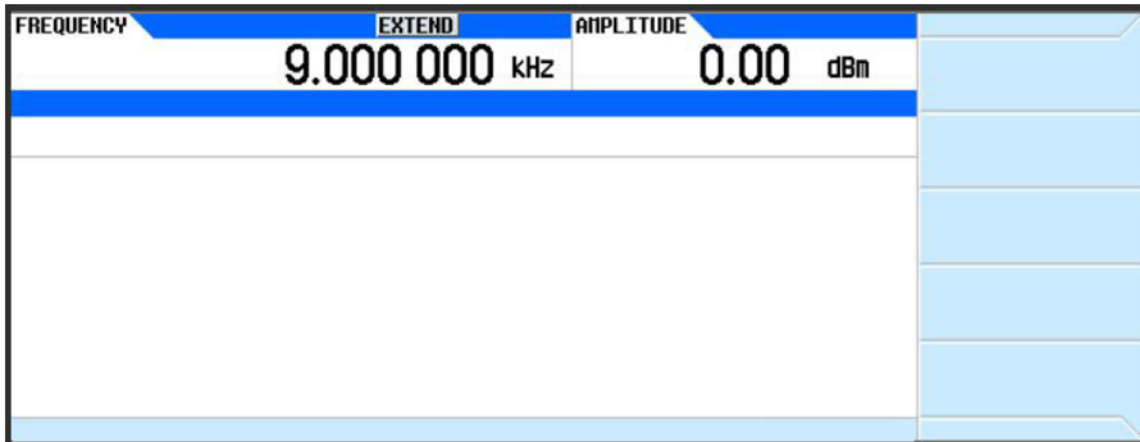
If this is first time running the alignment with the current instrument configuration, or if any errors occur when running the alignment, clear any previous alignment data from the instruments by pressing Revert Power Alignment To Factory Defaults.

# Extender Power Alignment

**Figure 31** Performing Power Alignment



**Figure 32** Power Alignment Completed






## SCPI Commands

**NOTE**

To maximize the life of the N5182BX07 attenuator, see the automated test recommendations on [page 10](#).

Table 11 SCPI Commands to Turn On the Frequency Extender

<b>Turn off the frequency extender in order to change its settings</b>
FREQ : EXT : STAT <b>OFF</b>
<b>Select the type of frequency extender and set connection type to USB</b>
FREQ : EXT : TYPE <b>N5182BX07</b>
FREQ : EXT : COMM : TYPE <b>USB</b>
<b>Query for list of connected USB devices and select device<sup>a</sup></b>
FREQ : EXT : COMM : USB : LIST?
"N5182BX07,US12345678"  Response example
FREQ : EXT : COMM : USB : DEV "N5182BX07,US12345678"
<b>Turn on the frequency extender.</b>
FREQ : EXT : STAT ON

a. Serial number US12345678 is used as an example.

Table 12 SCPI Control Commands for the Frequency Extender Power Alignment

<b>Executes the frequency extender power alignment<sup>a</sup></b>
FREQ : EXT : CAL : POW : ALL
<b>Reverts the frequency extender power alignment to factory default settings</b>
FREQ : EXT : CAL : POW : ALL : DEF

a. Requires a power meter.

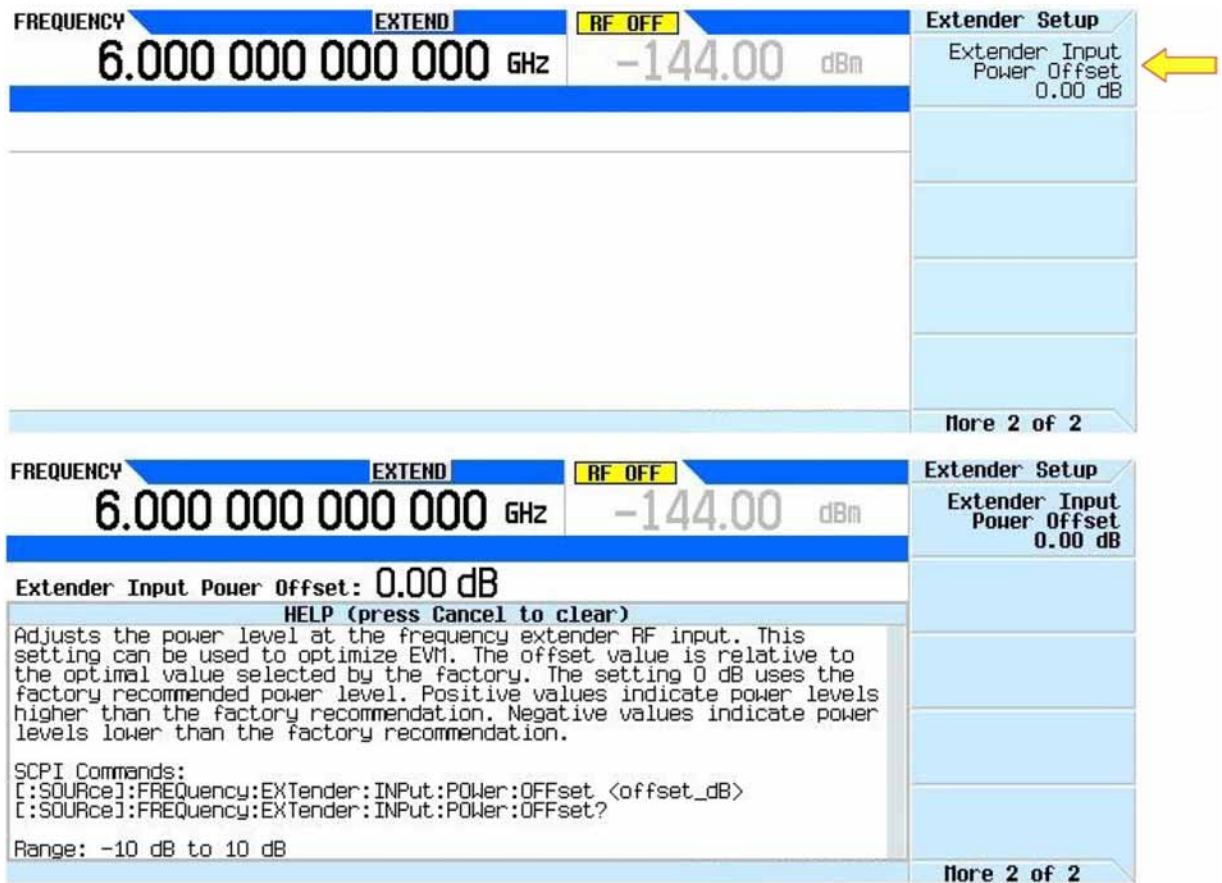
**NOTE**

The power sensor/power meter used by the power alignment is shared with the user flatness calibration. The SCPI commands to configure this shared power sensor/power meter are described on pages 53-55 of the MXG/EXG SCPI Command Reference document.

## EVM Optimization

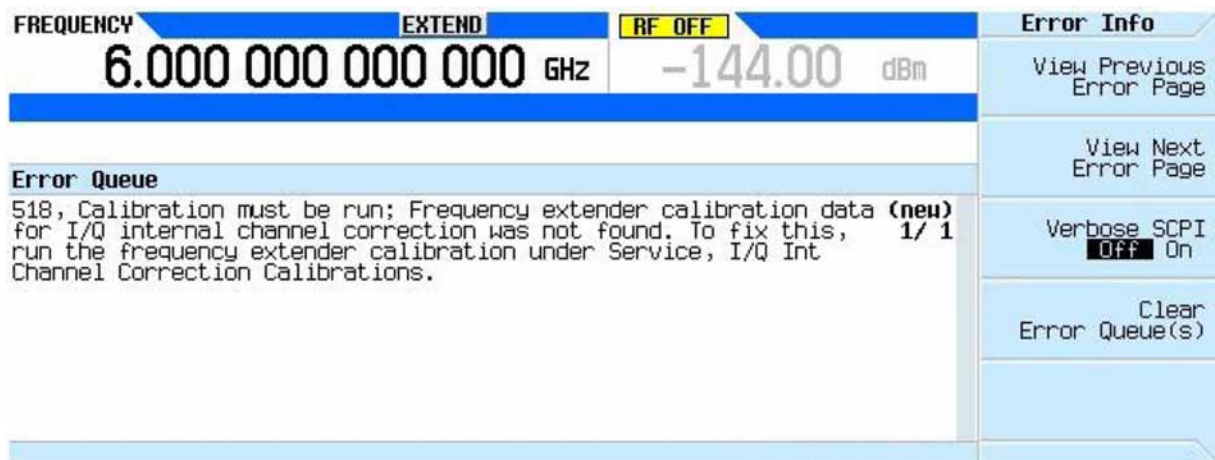
To optimize EVM, the N5182BX07 input power level can be adjusted using the "Extender Input Power Offset" softkey found on the second page of the Frequency Extender menu (**Frequency** > **More** > **Frequency Extender** > **More**). See the Help text below for a description of the offset value.

Figure 33 Extender Input Power Offset



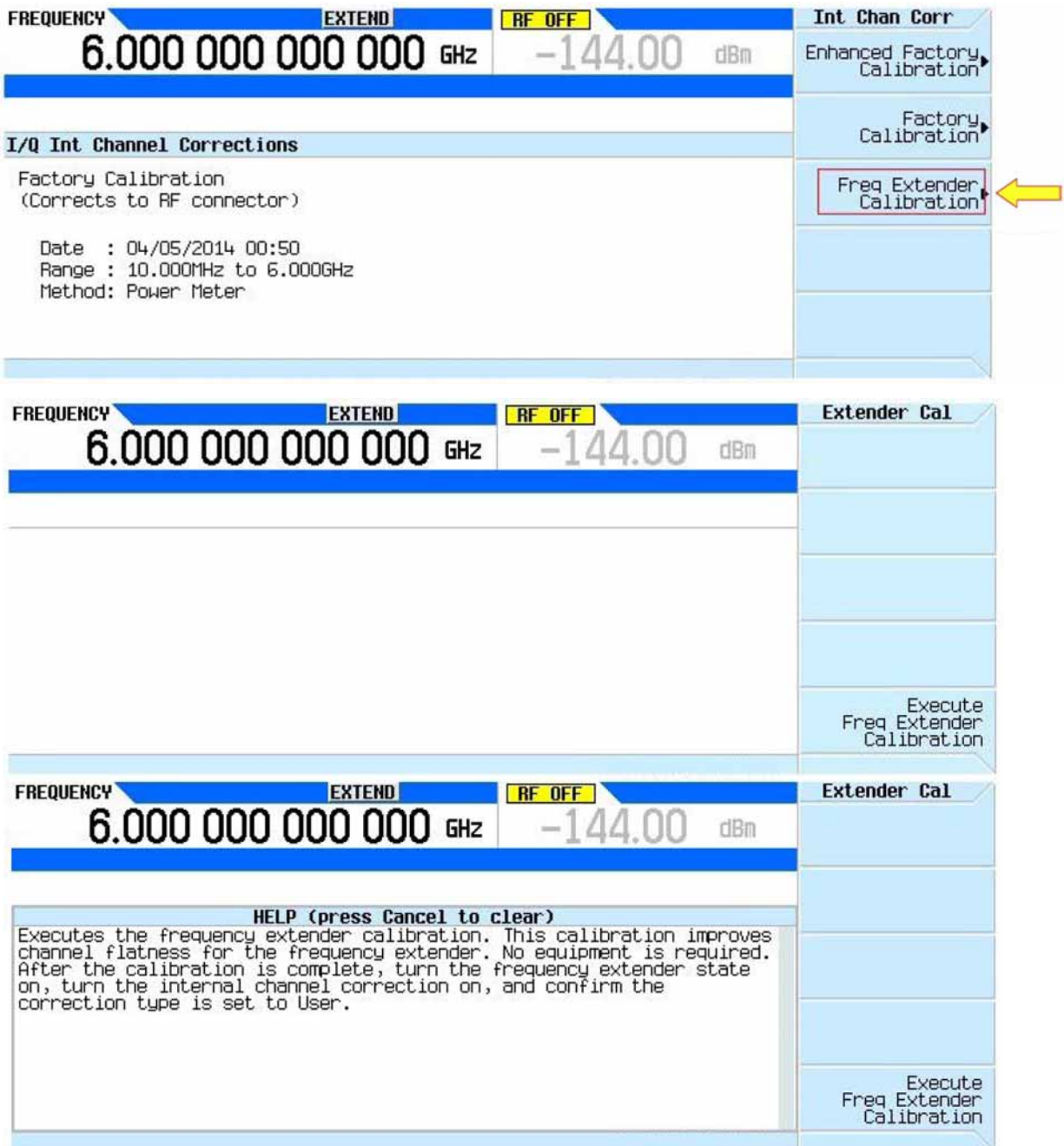
When upgrading from B.01.90 to any later firmware, you may see the following error message (Figure 34) when turning on the Frequency Extender feature. This is reported if the N5182BX07 does not have calibration data for use with the I/Q Internal Channel Correction feature.

Figure 34 Frequency Extender Calibration Data Error Message



To fix this, you can run the "Freq Extender Calibration" found under **Utility > More 1 of 2 > Service > I/Q Int Channel Correction Calibrations > Freq Extender Calibration (Figure 35)**. There is no associated SCPI command for this calibration. The calibration takes about one minute and requires no external equipment. The error only appears once.

Figure 35 Frequency Extender Calibration



After running the calibration, you can turn on the I/Q Channel Correction feature under **I/Q > More 1 of 3 > Int Channel Correction** (Figure 36). The correction type will automatically be changed to User to enable corrections for the frequency extender.

**NOTE**

Remember to turn on the I/Q Channel Correction whenever you need flat amplitude across the modulation channel. Most Signal Studio applications will turn this on automatically, but if you are not using Signal Studio, you must turn this on manually.

Figure 36 I/Q Internal Channel Corrections

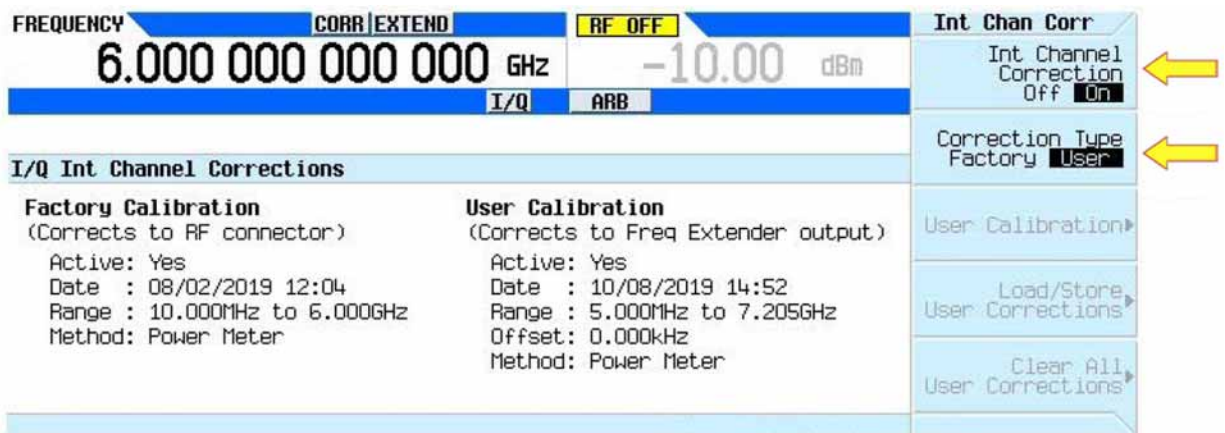


Table 13 User Channel Correction SCPI Commands

SCPI Commands
: MEMory : LOAD : CHANnel <"filename">
: MMEMory : LOAD : CHANnel <"filename">
: MEMory : STORe : CHANnel <"filename">
: MMEMory : STORe : CHANnel <"filename">
[ : SOURce] : DM : INTernal : CHANnel : CORRection : USER : CLear
: CALibration : BBG : CHANnel : USER

**NOTE**

Attempting to use the User Channel Correction SCPI commands when the frequency extender is on will result in the error message shown in Figure 37.

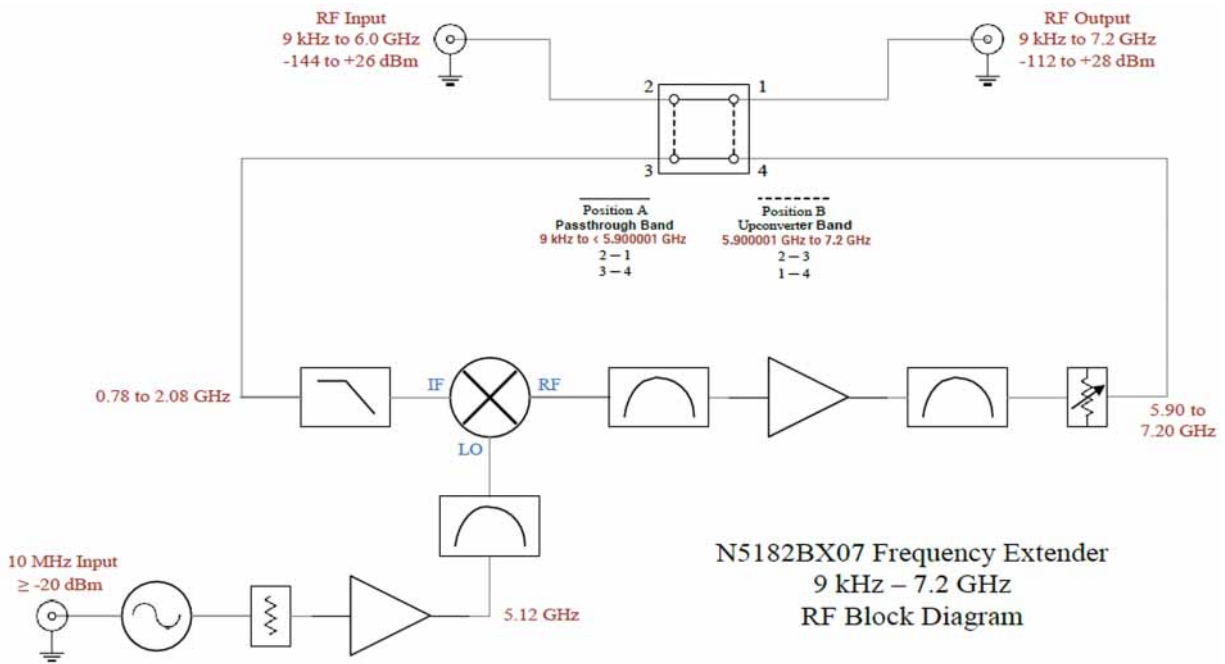
Figure 37 User Channel Correction Error Message

FREQUENCY	EXTEND	AMPLITUDE	Error Info
6.000 000 000 000 GHz		-144.00 dBm	View Previous Error Page
			View Next Error Page
<b>Error Queue</b>			Verbose SCPI <input type="checkbox"/> Off <input type="checkbox"/> On
-221, Settings conflict; User channel correction is not available when the frequency extender is on. (new) 1/ 1			Clear Error Queue(s)

RF Block Diagram

RF Block Diagram

Figure 38 RF Block Diagram of N5182BX07 Frequency Extender



## Safety and Regulatory Information

### Introduction

This product has been designed and tested in accordance with accepted industry standards, and has been supplied in a safe condition. The documentation contains information and warnings that must be followed by the user to ensure safe operation and to maintain the product in a safe condition.

Review this product and related documentation to familiarize yourself with safety markings and instructions before you operate the instrument. The documentation contains information and warnings that must be followed by the user to ensure safe operation and to maintain the product in a safe condition.

### Safe Installation

Safety of any system incorporating the equipment is the responsibility of the assembler of the system.

### Safety Earth Ground

**WARNING**

This is a Safety Class I product (provided with a protective earthing ground incorporated in the power cord). The mains plug shall be inserted only into a socket outlet provided with a protective earth contact. Any interruption of the protective conductor, inside or outside the product is likely to make the product dangerous. Intentional interruption is prohibited.

---

**CAUTION**

Always use the three prong AC power cord supplied with this product. Failure to ensure adequate earth grounding by not using this cord may cause product damage and the risk of electrical shock.

---

**WARNING**

Do not use adapters or extension cords to power the instrument.

---

**WARNING**

The AC Voltage source (outlet) must be in proper working order and provide a secure electrical connection.

Do not use the outlet if the power cord makes a loose connection or if the power cord plug does not match the outlet. Do not use the outlet if it is damaged or if the voltage is outside the required range.

---

### Declaration of Conformity

A copy of the Declaration of Conformity is available upon request, or a copy is available on the Keysight Technologies web site at: <https://regulations.about.keysight.com/DoC/search.htm>.

## Safety and Regulatory Information

### Safety (European Low Voltage Directive)

This instrument complies with the essential requirements of the European Low Voltage Directive as well as current editions of the following standards:

- IEC/EN 61010-1
- Canada: CSA C22.2 No. 61010-1
- USA: UL std no. 61010-1

### EMC Information

Complies with the essential requirements of the European EMC Directive and the UK Electromagnetic Compatibility Regulations 2016 as well as current editions of the following standards (dates and editions are cited in the Declaration of Conformity):

- IEC/EN 61326-1
- CISPR Pub 11 Group 1, Class A
- AS/NZS CISPR 11
- ICES/NMB-001

This ISM device complies with Canadian ICES-001. Cet appareil ISM est conforme a la norme NMB-001 du Canada.

### Acoustic Statement (European Machinery Directive)

- Acoustic noise emission  
LpA < 70 dB  
Operator position  
Normal operation mode per ISO 7779

### Before Applying Power

Verify that the premises electrical supply is within the range of the instrument. The instrument has an autoranging power supply.

#### **WARNING**

If this product is not used as specified, the protection provided by the equipment could be impaired. This product must be used in a normal condition (in which all means for protection are intact) only.

---

#### **CAUTION**

The Mains wiring and connectors shall be compatible with the connector used in the premise electrical system. Failure, to ensure adequate earth grounding by not using the correct components may cause product damage, and serious injury.

---

#### **CAUTION**

Always use the three prong AC power cord supplied with this product. Failure to ensure adequate earth grounding by not using this cord may cause product damage and the risk of electrical shock.

---



**CAUTION**

This product is designed for use in Installation Category II and Pollution Degree 2.

---

**CAUTION**

Before switching on this instrument, make sure the supply voltage is in the specified range.

---

**CAUTION**

Verify that the premise electrical voltage supply is within the range specified on the instrument.

---

**CAUTION**

When installing the instrument(s) into a cabinet, consideration shall be given to the convection flow into and out of the cabinet. Consideration shall also be given to the individual instruments to avoid having the heated discharge of one instrument now becoming the cooling intake air for another instrument. Another area of concern is verification that the maximum ambient operating temperature of the instrument(s) is not exceeded by cabinet installation. Keysight recommends forced air convection whenever an instrument(s) are installed in a cabinet and further recommends that the maximum operating temperature of the cabinet be reduced 10°C from the lowest of the maximum operating temperature of a single instrument.

If there are any concerns or special requirements, a Keysight Field Engineer should be consulted to assure instrument(s) temperature compliance and performance."

---

**WARNING**

These servicing instructions are for use by qualified personnel only. To avoid electrical shock, do not perform any servicing unless you are qualified to do so.

---

**WARNING**

The opening of covers or removal of parts is likely to expose the user to dangerous voltages. Disconnect the instrument from all voltage sources before opening.

---

**WARNING**

No operator serviceable parts inside. Refer servicing to qualified personnel. To prevent electrical shock, do not remove covers.

---

**WARNING**

Install the instrument so that the ON/OFF switch is readily identifiable and is easily reached by the operator. The ON/OFF switch is the instrument disconnecting device. It disconnects the mains circuits from the mains supply before other parts of the instrument. Or, the detachable power cord can be removed from the electrical supply. Alternatively, an externally installed switch or circuit breaker (which is readily identifiable and is easily reached by the operator) may be used as a disconnecting device.

---

## Connector Care and Cleaning Precautions

Remove the power cord to the instrument. To clean the connectors use alcohol in a well ventilated area. Allow all residual alcohol moisture to evaporate, and fumes to dissipate prior to energizing the instrument.

### WARNING












To prevent electrical shock, disconnect the Keysight N5182BX07 from mains electrical supply before cleaning. Use a dry cloth or one slightly dampened with water to clean the external case parts. Do not attempt to clean internally.









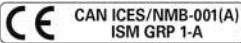




### WARNING

If flammable cleaning materials are used, the material shall not be stored, or left open in the area of the equipment. Adequate ventilation shall be assured to prevent the combustion of fumes, or vapors.



## Instrument Markings

The table below lists the definitions of markings that may be on or with the product. Familiarize yourself with each marking and its meaning before operating the signal generator.

Marking	Description
	This symbol marks the standby position of the power line switch.
	This symbol marks the ON position of the power line switch.
	This symbol marks the OFF position of the power line switch.
	This symbol indicates that the input power required is AC.
	This symbol indicates DC voltage
	This symbol indicates a three-phase alternating current.
	This symbol indicates Frame or chassis Terminal.
	The instruction documentation symbol. The product is marked with this symbol when it is necessary for the user to refer to the instruction in the documentation.
	This symbol indicate the presence of a Laser device.
	This symbol indicates the surface can be hot.
	This symbol indicated the product is sensitive to electrostatic discharge.

Marking	Description
	<p>This symbol identifies the Protective Conductor terminal.</p>
	<p>This symbol indicates the equipment is protected throughout by double or reinforced insulation.</p>
	<p>The CE mark is a registered trademark of the European Community (if accompanied by a year, it is the year when the design was proven). It indicates that the product complies with all the relevant directives.</p>
	<p>The UK conformity mark is a UK government owned mark. Products showing this mark comply with all applicable UK regulations.</p>
	<p>The Keysight email address is required by EU directives applicable to our product.</p>
	<p>The CSA mark is a registered trademark of the CSA International.</p>
	<p>Two person lift required.</p>
<p><b>CAN ICES/NMB-001(A)</b></p>	<p>Canada EMC label. Interference-Causing Equipment Standard for industrial, scientific and medical (ISM) equipment. Matériel industriel, scientifique et médical (ISM)</p>
	<p>CE/ICES/ISM label. (Old mark for reference only.) This is a space saver label that combines three markings - CE with CAN ICES and ISM (see above) and ISM (see below).</p>
	<p>CE/ICES/ISM Label. This is a space saver label that combines three markings - CE with CAN ICES (see above) and ISM (see below).</p>
	<p>ICES/ISM Label. This is a space saver label that combines two markings – CAN ICES and ISM.</p>
	<p>The RCM mark is a registered trademark of the Australian Communications and Media Authority.</p>
<p><b>ISM 1-A</b></p>	<p>This is a symbol of an Industrial Scientific and Medical Group 1 Class A product. (CISPR 11, Clause 5)</p>
<p><b>ISM 1-B</b></p>	<p>This is a symbol of an Industrial Scientific and Medical Group 1 Class B product (CISPR 11, Clause 5).</p>
	<p>South Korean Certification (KC) mark. It includes the marking's identifier code.</p>
	<p>The crossed-out wheeled bin symbol indicates that separate collection for waste electric and electronic equipment (WEEE) is required, as obligated by the EU DIRECTIVE and other National legislation. Please refer to <a href="http://www.keysight.com/go/takeback">www.keysight.com/go/takeback</a> to understand your trade-in options with Keysight, in addition to product takeback instructions.</p>

## Safety and Regulatory Information

Marking	Description
	China Restricted Substance Product Label. The EPUP (environmental protection use period) number in the center indicates the time period during which no hazardous or toxic substances or elements are expected to leak or deteriorate during normal use and generally reflects the expected useful life of the product.
	Universal recycling symbol. This symbol indicates compliance with the China standard GB 18455-2001 as required by the China RoHS regulations for paper/fiberboard packaging.
<b>IP x y</b>	This mark indicates product has been designed to meet the requirements of "IP x y", where "x" is the solid particle protection and "y" is the liquid ingress protection.
<b>IP 2 0</b>	The instrument has been designed to meet the requirements of IP 2 0 for egress and operational environment.
<b>ICES/NMB-001</b>	This is a marking to indicate product compliance with the Canadian Interference-Causing Equipment Standard (ICES-001). Cet appareil ISM est conforme à la norme NMB du Canada.

## Keysight Support, Services, and Assistance

### Service and Support Options

There are many other repair and calibration options available from the Keysight Technologies support organization. These options cover a range of service agreements with varying response times. Contact Keysight for additional information on available service agreements for this product.

### Contacting Keysight

To contact Keysight for sales and technical support, refer to the support links on the following websites:

<http://www.keysight.com/find/assist>

(Worldwide contact information for repair and service)

<http://www.keysight.com/find/MyKeysight>

(Product specific information and support, software, and documentation updates)

If you do not have access to the Internet, contact your field engineer.

#### NOTE

Attempting to use the User Channel Correction SCPI commands when the frequency extender is on will result in the error message shown in **Figure 37**.

---

### Shipping Your Product to Keysight for Service or Repair

If you wish to send your instrument to Keysight Technologies for service or repair, please use the original or comparable packaging.

- Include a complete description of the service requested or of the failure and a description of any failed test and any error message.
- The instrument should be sent to Keysight in the same configuration that it was originally shipped.
- Contact Keysight for instructions on where to ship your instrument.



This information is subject to change without notice.

© Keysight Technologies 2020-2022

Edition 1, April 2022

N5182-90001

[www.keysight.com](http://www.keysight.com)