

**Agilent U1251A and
U1252A
Handheld Digital
Multimeter**

User's and Service Guide



Agilent Technologies

Notices

© Agilent Technologies, Inc. 2006 – 2012

No part of this manual may be reproduced in any form or by any means (including electronic storage and retrieval or translation into a foreign language) without prior agreement and written consent from Agilent Technologies, Inc. as governed by United States and international copyright laws.

Manual Part Number

U1251-90003

Edition

Tenth Edition, May 4, 2012

Printed in Malaysia

Agilent Technologies, Inc.
3501 Stevens Creek Blvd.
Santa Clara, CA 95052 USA

Technology Licenses

The hardware and/or software described in this document are furnished under a license and may be used or copied only in accordance with the terms of such license.

Restricted Rights Legend

U.S. Government Restricted Rights. Software and technical data rights granted to the federal government include only those rights customarily provided to end user customers. Agilent provides this customary commercial license in Software and technical data pursuant to FAR 12.211 (Technical Data) and 12.212 (Computer Software) and, for the Department of Defense, DFARS 252.227-7015 (Technical Data - Commercial Items) and DFARS 227.7202-3 (Rights in Commercial Computer Software or Computer Software Documentation).

Warranty

The material contained in this document is provided “as is,” and is subject to being changed, without notice, in future editions. Further, to the maximum extent permitted by applicable law, Agilent disclaims all warranties, either express or implied, with regard to this manual and any information contained herein, including but not limited to the implied warranties of merchantability and fitness for a particular purpose. Agilent shall not be liable for errors or for incidental or consequential damages in connection with the furnishing, use, or performance of this document or of any information contained herein. Should Agilent and the user have a separate written agreement with warranty terms covering the material in this document that conflict with these terms, the warranty terms in the separate agreement shall control.

Accessories Warranty

Agilent offers warranty for product’s accessories for up to 3 months from the end-user acceptance date.

Standard Calibration Service (optional)

Agilent offers an optional calibration service contract for a period of 3 years from end-user acceptance date.

Safety Notices

CAUTION





A **CAUTION** notice denotes a hazard. It calls attention to an operating procedure, practice, or the like that, if not correctly performed or adhered to, could result in damage to the product or loss of important data. Do not proceed beyond a **CAUTION** notice until the indicated conditions are fully understood and met.

WARNING

A **WARNING** notice denotes a hazard. It calls attention to an operating procedure, practice, or the like that, if not correctly performed or adhered to, could result in personal injury or death. Do not proceed beyond a **WARNING** notice until the indicated conditions are fully understood and met.

Safety Symbols

The following symbols on the instrument and in the documentation indicate precautions which must be taken to maintain safe operation of the instrument.

CAT III 1000 V	Category III 1000 V overvoltage protection	CAT IV 600 V	Category IV 600 V overvoltage protection
	Equipment protected throughout by double insulation or reinforced insulation		Earth (ground) terminal
	Caution, risk of danger (refer to this manual for specific Warning or Caution information)		Caution, risk of electric shock

Safety Information

This meter is safety-certified in compliance with EN/IEC 61010-1:2001, UL 61010-1 Second Edition and CAN/CSA 22.2 61010-1 Second Edition, CAT III 1000 V/ CAT IV 600 V Overvoltage Protection, Pollution Degree II. Use with standard or compatible test probes.

General Safety Information

The following general safety precautions must be observed during all phases of operation, service, and repair of this instrument. Failure to comply with these precautions or with specific warnings elsewhere in this manual violates safety standards of design, manufacture, and intended use of the instrument. Agilent Technologies assumes no liability for the customer's failure to comply with these requirements.

WARNING







- When working above 70 VDC, 33 VAC RMS or 46.7 V peak, exercise caution – such range pose a shock hazard.
- Do not measure more than the rated voltage (as marked on the meter) between terminals, or between terminal and earth ground.
- Double-check the meter's operation by measuring a known voltage.
- For current measurement, turn off circuit power before connecting the meter to the circuit. Always place the meter in series with the circuit.
- When connecting probes, always connect the common test probe first. When disconnecting probes, always disconnect the live test probe first.
- Detach test probes from the meter before you open the battery cover.
- Do not use the meter with the battery cover or part of the cover removed or loose.

- Replace the battery as soon as the low battery indicator  flashes on screen. This is to avoid false readings, which may lead to possible electric shock or personal injury.
- Do not operate the product in an explosive atmosphere or in the presence of flammable gases or fumes.
- Inspect the case for cracks or missing plastic. Pay extra attention to the insulation surrounding the connectors. Do not use the meter if it is damaged.
- Inspect the test probes for damaged insulation or exposed metal, and check for continuity. Do not use the test probe if it is damaged.
- Do not use any other AC charger adaptor apart from the one certified by Agilent with this product.
- Do not use repaired fuses or short-circuited fuse-holders. For continued protection against fire, replace the line fuses only with fuses of the same voltage and current rating and recommended type.
- Do not service or perform adjustments alone. Under certain condition, hazardous voltages may exist, even with the equipment switched off. To avoid dangerous electric shock, service personnel must not attempt internal service or adjustment unless another person, capable of rendering resuscitation or first aid, is present.
- Do not substitute parts or modify equipment to avoid the danger of introducing additional hazards. Return the product to Agilent Technologies Sales and Service Office for service and repair to ensure the safety features are maintained.
- Do not operate damaged equipment as the safety protection features built into this product may have been impaired, either through physical damage, excessive moisture, or any other reason. Remove power and do not use the product until safe operation can be verified by service-trained personnel. If necessary, return the product to Agilent Technologies Sales and Service Office for service and repair to ensure the safety features are maintained.

CAUTION

- Turn off the circuit power and discharge all high-voltage capacitors in the circuit before you perform resistance, continuity, diodes, or capacitance tests.
 - Use the correct terminals, function, and range for your measurements.
 - Never measure voltage when current measurement is selected.
 - Use only recommended rechargeable battery. Ensure proper insertion of battery in the meter, and follow the correct polarity.
 - Disconnect test leads from all the terminals during battery charging.
-

Regulatory Markings

	<p>The CE mark is a registered trademark of the European Community. This CE mark shows that the product complies with all the relevant European Legal Directives.</p>		<p>The C-tick mark is a registered trademark of the Spectrum Management Agency of Australia. This signifies compliance with the Australia EMC Framework regulations under the terms of the Radio Communication Act of 1992.</p>
<p>ICES/NMB-001</p>	<p>ICES/NMB-001 indicates that this ISM device complies with the Canadian ICES-001. Cet appareil ISM est conforme a la norme NMB-001 du Canada.</p>		<p>This instrument complies with the WEEE Directive (2002/96/EC) marking requirement. This affixed product label indicates that you must not discard this electrical/electronic product in domestic household waste.</p>
	<p>The CSA mark is a registered trademark of the Canadian Standards Association.</p>		

Waste Electrical and Electronic Equipment (WEEE) Directive 2002/96/EC

This instrument complies with the WEEE Directive (2002/96/EC) marking requirement. This affixed product label indicates that you must not discard this electrical/electronic product in domestic household waste.

Product Category:

With reference to the equipment types in the WEEE directive Annex 1, this instrument is classified as a "Monitoring and Control Instrument" product.

The affixed product label is as shown below.



Do not dispose in domestic household waste

To return this unwanted instrument, contact your nearest Agilent Technologies, or visit: www.agilent.com/environment/product for more information.

Agilent Technologies, through Rechargeable Battery Recycling Corporation (RBRC), offers free and convenient battery recycling options in the U.S. and Canada. Contact RBRC at 877-2-RECYCLE (877.273.2925) or online at: <http://www.call2recycle.org/> for the nearest recycling location.

In This Guide...

1 Getting Started

This chapter contains information on the Agilent U1251A and U1252A handheld multimeter front panel, rotary switch, keypad, display, terminals and rear panel.

2 Making Measurements

This chapter contains information on how to make measurements using the U1251A and U1252A handheld digital multimeter.

3 Functions and Features

This chapter contains information on the functions and features that are available for the U1251A and U1252A digital multimeter.

4 Changing The Default Setting

This chapter shows you how to change the default factory settings of the U1251A and U1252A and other available setting options

5 Maintenance

This chapter will go through how to troubleshoot the handheld digital multimeter if any problems arise.

6 Performance Tests and Calibration

This chapter contains the performance test and the adjustment procedure.

7 Specifications

This chapter lists the product characteristics, specification assumptions and the specifications of the U1251A and U1252A digital multimeters.

Declaration of Conformity (DoC)

The Declaration of Conformity (DoC) for this instrument is available on the Web site. You can search the DoC by its product model or description.

<http://regulations.corporate.agilent.com/DoC/search.htm>

NOTE

If you are unable to search for the respective DoC, please contact your local Agilent representative.

Contents

1 Getting Started

Introducing the U12521A/U1252A Handheld Digital Multimeter	2
Check the shipment	3
Adjusting the tilt-stand	4
The rear panel at a glance	7
The keypad at a glance	9
The display at a glance	11
Selecting display with the Hz button	16
Selecting display with the Dual button	18
Selection display with the Shift button	20
The terminals at a glance	22

2 Making Measurements

Understanding The Measurement Instructions	24
Measuring Voltage	24
Measuring AC voltage	25
Measuring DC voltage	26
Measuring Current	27
μ A & mA measurement	27
Percentage scale of 4 mA to 20 mA	29
A (ampere) measurement	31
Frequency Counter	32
Measuring Resistance, Conductance and Testing Continuity	34
Testing Diodes	38
Measuring Capacitance	41
Measuring Temperature	43
Alerts and Warning During Measurement	47

Overload alert	47
Input warning	47
Charge terminal alert	48

3 Functions and Features

Dynamic Recording	50
Data Hold (Trigger Hold)	52
Refresh Hold	53
Null (Relative)	55
Decibel Display	57
1 ms Peak Hold	59
Data Logging	61
Manual logging	61
Interval logging	63
Reviewing logged data	65
Square Wave Output (for U1252A)	67
Remote Communication	71

4 Changing The Default Setting

Selecting Setup Mode	74
Setting Data Hold/Refresh Hold Mode	77
Setting Data Logging Mode	78
Setting Thermocouple Types (U1252A only)	79
Setting Reference Impedance for dBm Measurement	80
Setting Minimum Frequency Measurement	81
Setting Temperature Unit	82
Setting Auto Power Saving Mode	84
Setting Percentage (%) Scale Readout	86

Setting Beep Frequency	87
Setting Backlight Timer	88
Setting Baud Rate	89
Setting Parity Check	90
Setting Data Bit	91
Setting Echo Mode	92
Setting Print Mode	93
Returning to Default Factory Settings	94

5 Maintenance

Introduction	96
General maintenance	96
Battery replacement	96
Storage considerations	98
Charging the battery	98
Fuse checking procedure	105
Replacing the fuse	106
Troubleshooting	108
Replaceable Parts	109
To order replaceable parts	109

6 Performance Tests and Calibration

Calibration Overview	112
Closed-case electronic calibration	112
Agilent Technologies calibration services	112
Calibration interval	113
Adjustment is recommended	113
Recommended Test Equipment	114
Basic Operating Test	115
Backlit test	115

Testing the display	115
Current terminal test	116
Charge terminal alert test	117
Test Considerations	118
Calibration Security	119
Performance Verification Tests	120
Unsecuring the instrument for calibration	128
Calibration process	131
Using the front panel for adjustments	132
Adjustments Consideration	133
Valid adjustment input values	134
Adjustment procedure	135
Finishing the adjustment	142
To read the calibration count	142
Calibration errors	143

7 Specifications

Product Characteristics	146
Measurement Category	149
Measurement category definition	149
Specification Assumptions	150
Electrical Specifications	151
DC Specifications	151
AC Specifications	153
AC+DC Specifications for U1252A	155
Capacitance Specifications	156
Temperature Specifications	156
Frequency Specifications	157
Duty Cycle and Pulse Width Specifications	157
Frequency Sensitivity Specifications	158

Peak Hold Specifications	159
Frequency Counter Specifications for U1252A	160
Square Wave Output for U1252A	161
Operating Specifications	162
Display update rate (approximate)	162
Input impedance	163

List of Figures

- Figure 1-1 Tilt-stand at 60° 4
- Figure 1-2 Tilt-stand at 30° 4
- Figure 1-3 Tilt-stand at hanging position 5
- Figure 1-4 U1252A front panel 6
- Figure 1-5 Rear panel 7
- Figure 1-6 Rotary switch 8
- Figure 1-7 U1252A keypad 9
- Figure 1-8 Display symbols 11
- Figure 1-9 U1252A connector terminals 22
- Figure 2-1 Measuring AC voltage 25
- Figure 2-2 Measuring DC voltage 26
- Figure 2-3 Measuring mA and mA current 28
- Figure 2-4 Measuring scale of 4-20 mA 30
- Figure 2-5 A (ampere) current measurement 31
- Figure 2-6 Measuring frequency 33
- Figure 2-7 Measuring resistance 34
- Figure 2-8 Audible continuity, conductance, and resistance test. 35
- Figure 2-9 Conductance measurement 37
- Figure 2-10 Measuring forward bias of diode 39
- Figure 2-11 Measuring reverse bias of diode 40
- Figure 2-12 Capacitance measurements 42
- Figure 2-13 Connecting the thermal probe into the non-compensation transfer adapter 44
- Figure 2-14 Connecting the probe with adapter into the multimeter 44
- Figure 2-15 Surface temperature measurement 46
- Figure 2-16 Input terminal warning 47
- Figure 2-17 Charge terminal alert 48
- Figure 3-1 Dynamic recording mode operation 51
- Figure 3-2 Data hold mode operation 52
- Figure 3-3 Refresh hold mode operation 54
- Figure 3-4 Null (relative) mode operation 56
- Figure 3-5 dBm/dBV display mode operation 58
- Figure 3-6 1 ms peak hold mode operation 60
- Figure 3-7 Hand (Manual) logging mode operation 62

Figure 3-8	Full Log	62
Figure 3-9	Interval (Automatic) logging mode operation	64
Figure 3-10	Log review mode operation	66
Figure 3-11	Frequency adjustment for square wave output	68
Figure 3-12	Pulse width adjustment for square wave output	69
Figure 3-13	Duty cycle adjustment for Square Wave	70
Figure 3-14	Cable connection for remote communication	71
Figure 4-1	Data hold/Refresh hold setup	77
Figure 4-2	Data logging setup	78
Figure 4-3	Thermocouple type setup	79
Figure 4-4	Reference impedance for dBm measurement setup	80
Figure 4-5	Minimum frequency setup	81
Figure 4-6	Temperature unit setup	83
Figure 4-7	Auto power saving setup	85
Figure 4-8	% scale readout setup	86
Figure 4-9	Beep frequency setup	87
Figure 4-10	Backlit timer setup	88
Figure 4-11	Baud rate setup remote control	89
Figure 4-12	Parity check setup	90
Figure 4-13	Data bit setup for remote control	91
Figure 4-14	Echo mode setup for remote control	92
Figure 4-15	Print mode setup for remote control	93
Figure 4-16	Reset setup	94
Figure 5-1	9 V rectangular battery	97
Figure 5-2	Battery capacity display as trickle	100
Figure 5-3	Self-test	100
Figure 5-4	Charging mode	102
Figure 5-5	Charge end and trickle state	103
Figure 5-6	Battery charging procedure	104
Figure 5-7	Fuse replacement	107
Figure 6-1	LCD display	115
Figure 6-2	Input warning	116
Figure 6-3	Charge terminal alert	117

List of Tables

Table 1-1	Rotary switch description and functions	8
Table 1-2	Keypad description and functions	9
Table 1-3	General display symbols	12
Table 1-4	Primary display symbols	13
Table 1-5	Secondary display symbols	14
Table 1-6	Analog bar range and counts	15
Table 1-7	Selecting display with the Hz button	16
Table 1-8	Selecting display with the Dual button	18
Table 1-9	Selecting display with the Shift button	20
Table 1-10	Terminal connections for different measuring functions	22
Table 2-1	Numerical steps descriptions	24
Table 2-2	Percentage scale and measurement range	29
Table 2-3	Audible continuity measurement range	36
Table 4-1	Available setting options in Setup mode	75
Table 5-1	Battery voltage and corresponding percentage of charges in standby and charging modes	100
Table 5-2	Error messages	101
Table 5-3	Measurement readings for fuse checking	106
Table 5-4	Fuse specifications	107
Table 5-5	Basic troubleshooting procedures	108
Table 6-1	Recommended Test Equipment	114
Table 6-2	Performance verification test steps	121
Table 6-3	Valid adjustment input values	134
Table 6-4	Adjustment table	137
Table 7-1	DC Accuracy \pm (% of reading + Number of Least Significant Digit)	151
Table 7-2	U1251A accuracy specifications \pm (% of reading + number of LSD) for true RMS AC voltage	153
Table 7-3	U1251A accuracy specifications \pm (% of reading + number of LSD) for true RMS AC current	153
Table 7-4	U1252A accuracy specifications \pm (% of reading + number of LSD) for true RMS AC voltage	154
Table 7-5	U1252A accuracy specifications \pm (% of reading + number of LSD) for true RMS AC current	154
Table 7-6	U1252A true RMS ac+dc voltage specifications	155

Table 7-7	U1252A true RMS ac+dc current specifications	155
Table 7-8	Capacitance specifications	156
Table 7-9	Temperature specifications	156
Table 7-10	Frequency specifications	157
Table 7-11	Duty cycle and pulse width specifications	157
Table 7-12	Frequency sensitivity and trigger level specifications for voltage measurements	158
Table 7-13	Frequency sensitivity specifications for current measurements	159
Table 7-14	Peak hold specifications for dc voltage and current measurements	159
Table 7-15	Frequency counter (divide by 1) specifications	160
Table 7-16	Frequency counter (divide by 100 ^[4]) specifications	160
Table 7-17	Square wave output specifications	161
Table 7-18	Display update rate (approximate)	162
Table 7-19	Input Impedance	163



1 Getting Started

Introducing the U12521A/U1252A Handheld Digital Multimeter 2

Check the shipment 3

Adjusting the tilt-stand 4

The front panel at a glance 6

The rear panel at a glance 7

The rotary switch at a glance 8

The keypad at a glance 9

The display at a glance 11

 Selecting display with the Hz button 16

 Selecting display with the Dual button 18

 Selection display with the Shift button 20

The terminals at a glance 22

This chapter contains information on the Agilent U1251A and U1252A handheld multimeter front panel, rotary switch, keypad, display, terminals and rear panel.



Introducing the U12521A/U1252A Handheld Digital Multimeter

Key features of this digital multimeter:

- DC, AC, and AC + DC (U1252A only) voltage and current measurements.
- True-RMS measurement for both AC voltage and current
- Rechargeable Ni-MH battery with built-in charging capability (U1252A only)
- Ambient temperature on second display
- Battery capacity indicator
- Blue LED backlight
- Resistance measurement of up to 50 M Ω (for U1251A) and 500 M Ω (for U1252A)
- Conductance measurement from 0.01 nS (100 G Ω) ~50 nS
- Capacitance measurement of up to 100 mF
- Frequency counter up of to 20 MHz (U1252A only)
- The % scale readout for 4–20 mA or 0–20 mA measurement
- dBm with selectable reference impedance
- 1 ms Peak Hold to catch inrush voltage and current easily
- Temperature test with selectable 0 °C compensation (without ambient temperature compensation).
- K-type (for U1251A) and J/K-types temperature measurement (for U1252A)
- Frequency, duty cycle, and pulse width measurements
- Dynamic Recording for min, max, and average readings
- Data Hold with manual or auto trigger and Null mode
- Diode and audible continuity tests
- Square wave generator with selectable frequency, pulse width and duty cycle (U1252A only)
- Agilent GUI Application Software (IR-USB cable sold separately)
- Closed case calibration

Check the shipment

Verify that you have received the following items with your multimeter:

- 9 V alkaline battery (for U1251A only)
- Soft carrying case
- 4 mm probes
- Test leads
- Alligator clips
- SMT grabbers
- Fine tips test probes
- Mini grabber (black only)
- Rechargeable 7.2 V battery (for U1252A only)
- Power cord & AC adapter (for U1252A only)
- Quick Start Guide
- CD containing the User's Guide, application software and instrument drivers
- Certificate of Calibration

Contact your nearest Agilent Sales Office if any of the above are missing.

Inspect the shipping container for damage. Signs of damage may include a dented or torn shipping container or cushioning material that indicates signs of unusual stress or compacting. Save the packaging material in case the multimeter needs to be returned.

Please refer to the [Agilent Handheld Tools](#) brochure (5989-7340EN) for the full and latest list of handheld accessories available.

Adjusting the tilt-stand

To adjust the meter to a 60° standing position, pull the tilt-stand outwards to its maximum reach.

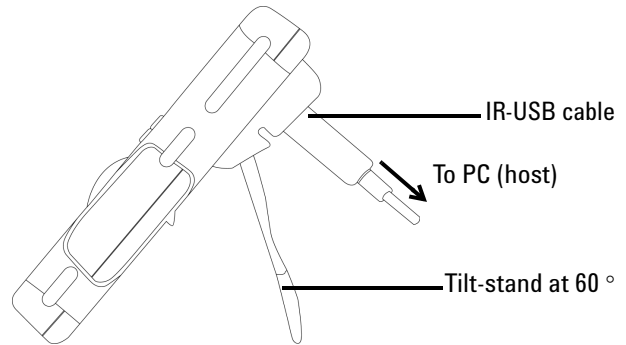

Figure 1-1 Tilt-stand at 60°

To adjust the meter to a 30° standing position, bend the tip of the stand so that it is parallel to the ground before pulling the stand outwards to its maximum reach.

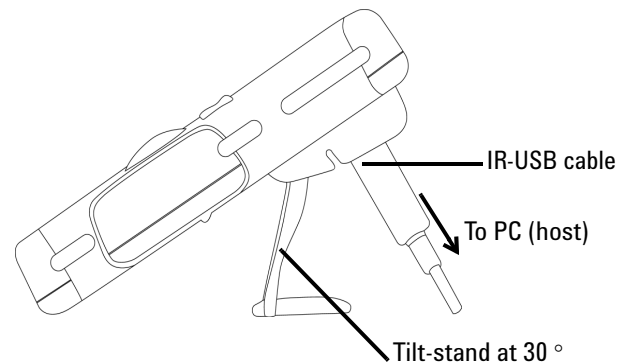

Figure 1-2 Tilt-stand at 30°

To adjust the meter to a hanging position follow the steps shown in [Figure 1-3](#) below.



1. Extend the tilt-stand until its maximum reach



2. Detach the tilt-stand



4. Re-attach the tilt-stand to an upright position



3. Flip the tilt-stand over until this side of the stand is facing the device instead of facing you.

Figure 1-3 Tilt-stand at hanging position

The front panel at a glance

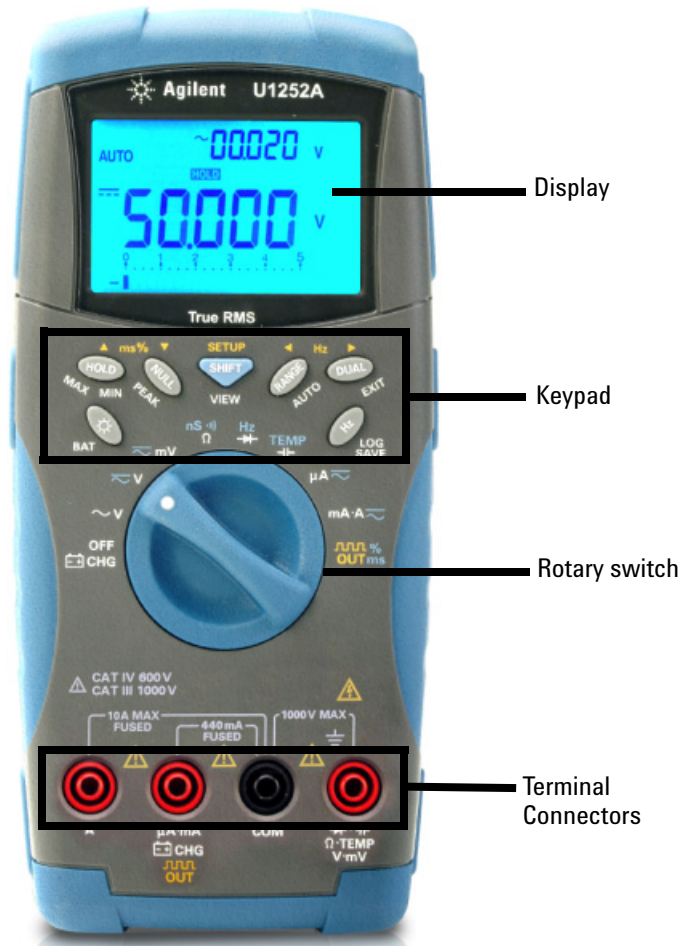

Figure 1-4 U1252A front panel

The rear panel at a glance

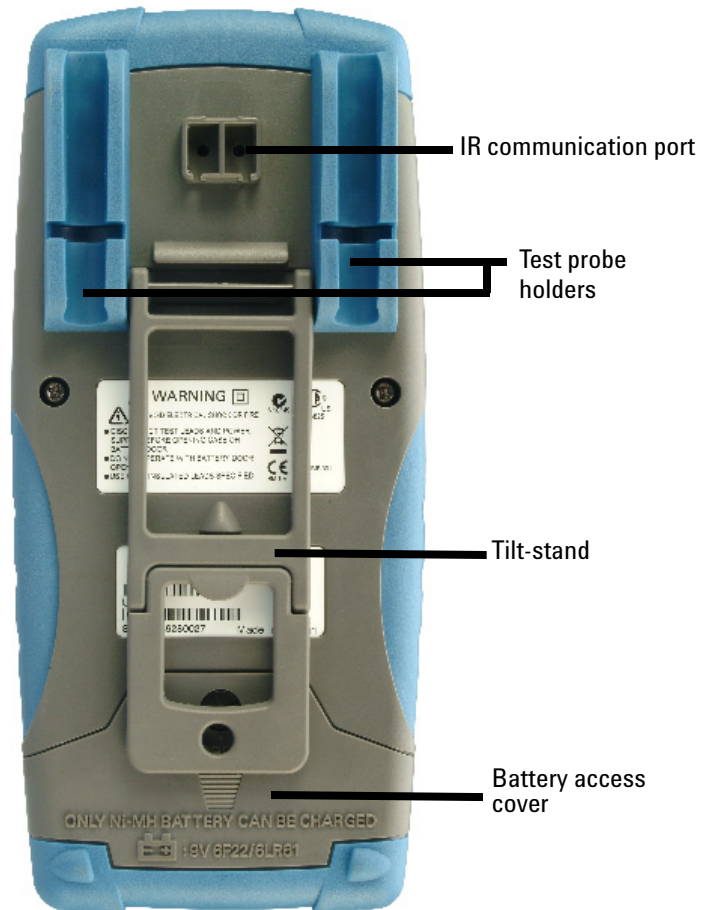

Figure 1-5 Rear panel

The rotary switch at a glance

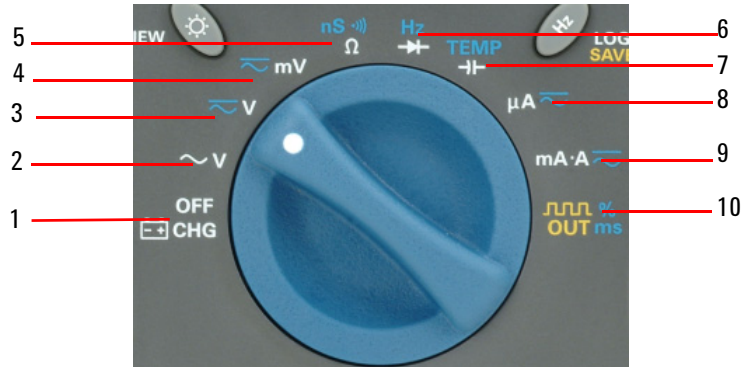

Figure 1-6 Rotary switch

Table 1-1 Rotary switch description and functions

No.	Description/Function
1	Charge mode (U1252A only) or OFF
2	AC voltage
3	AC voltage, DC voltage or DC+AC voltage (U1252A only)
4	DC mV, AC mV, AC+DC mV (U1252A only)
5	Resistance (Ω), Continuity, and Conductance (nS)
6	Frequency counter (U1252A only) or Diode
7	Capacitance or Temperature
8	DC μ A, AC μ A, and AC+DC μ A
9	DC mA, DC current, AC mA, AC current, or AC+DC current
10	Square-wave output, Duty cycle, or Pulse width output (for U1252A) and OFF (for U1251A)

The keypad at a glance











The operation of each key is shown below. Pressing a key illuminates a related symbol on the display and emits a beep from the multimeter. Turning the rotary switch to another position resets the current operation of the key.

Figure 1-7 below shows the keypad of the U1252A. The **ms%** (Pulse width/Duty cycle), **◀ Hz ▶**, and frequency counter functions are only available on the U1252A.

























Figure 1-7 U1252A keypad

Table 1-2 Keypad description and functions





Button	Function when pressed for less than 1 second	Function when pressed for more than 1 second
1 	 acts as a toggle switch to turn backlit ON/OFF. Backlit automatically turns off after 30s (default) ^[1] .	 displays the battery capacity for 3 seconds.
2 	 freezes the measured value. In Data Hold mode, press again to trigger hold of the next measured value. In Refresh Hold mode, reading updates automatically once reading is stable and count setting is exceeded ^[1] .	 enters Dynamic Recording mode. Press  again to scroll through Max, Min, Avg, and present readings (indicated by MAXMINAVG on display).
3 	 saves displayed value as a reference to be subtracted from subsequent measurements. Press again to see the relative value that has been saved.	 enters 1 ms Peak Hold mode. Press  to scroll through Max and Min peak readings.

1 Getting Started Tutorial

Button	Function when pressed for less than 1 second	Function when pressed for more than 1 second
4 	 scrolls through the measuring function(s) at a particular rotary switch position.	 enters Log Review mode. Press  to switch to manual or interval logging data. Press  or  to view first or last logged data respectively. Press  or  to scroll up or down logged data. Press  for more than 1 second to exit mode.
5 	 scrolls through available measuring ranges (except when rotary switch is set at TEMP or at Hz [for U1252A] position) ^[2] .	 sets to Auto Range mode.
6 	 scrolls through available dual-combination displays (except when rotary switch is set at TEMP, Hz or $\frac{\mu\text{V}}{\text{OUT ms}}\%$ [for U1252A] position, or when meter is in 1 ms peak hold or dynamic recording mode) ^[3] .	 exits Hold, Null, Dynamic Recording, 1 ms Peak Hold and dual display modes.
7 	 enters Frequency Test mode for current or voltage measurements. Press  to scroll through frequency (Hz), duty cycle (%) and pulse width (ms) functions. In duty cycle (%) and pulse width (ms) tests, press  to switch to positive or negative pulse.	 enters logging mode. In manual data logging, press  to log data manually into memory. In automatic data logging, data logs automatically ^[1] . Press  for more than 1 second to exit auto data logging mode.

Notes for keypad descriptions and functions:

1 See [Table 4-1](#) on page 75, "Available setting options in Setup mode," for details of available options.

- When rotary switch is at TEMP, press  to switch to °C or °F display. When rotary switch is at Hz, press  to switch to division of signal frequency by 1 or 100.
- When rotary switch is at TEMP, ETC is ON by default. You may press  to disable ETC (Environment Temperature Compensation), **0°C** will appear on display. For pulse and duty cycle measurement, press  to switch trigger slope to positive or negative. When meter is in peak or dynamic-recording mode, press  to restart 1 ms peak hold or dynamic recording mode.

The display at a glance

To view the full display (with all segments illuminated),

press and hold the  button while turning the rotary switch from OFF to any non-OFF position. After you have finished viewing the full display, press any button to resume normal functionality based on the rotary switch position. This is followed by a wake-up feature.

The meter will then enter power save mode once auto power off (APF) is enabled. To wake the meter up:

- 1 Turn the rotary switch to OFF position then ON again.
- 2 Press any button for rotary switch position that is not at square wave output position. (U1252A only)
- 3 To set the rotary switch at square wave out position, press only the Dual, Range and Hold buttons or turn the rotary switch to another position. (U1252A only)

The LCD signs are explained in the following tables.

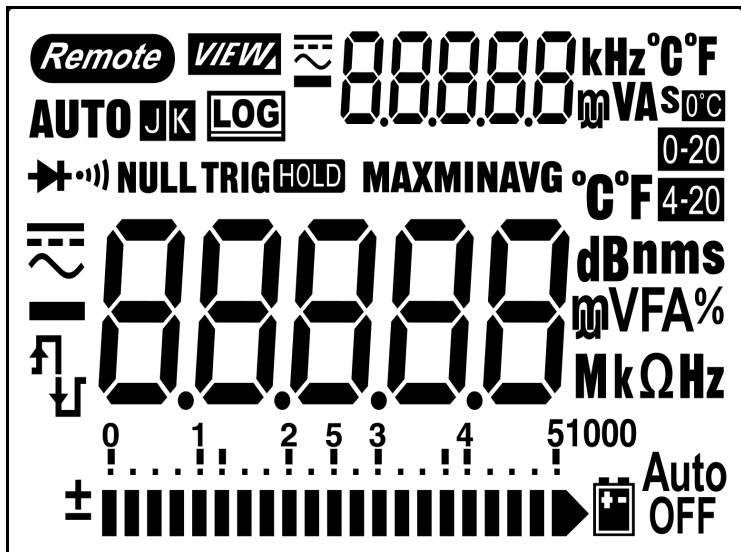







Figure 1-8 Display symbols

Table 1-3 General display symbols

LCD symbol	Description
	Remote control
	Thermocouple types: (K-type) (J-type)
NULL	Null math function
	Diode / Audible continuity
	Audible continuity for resistance
	View mode for checking logged data
	Data logging indication
	Square wave output (U1252A only)
	<ul style="list-style-type: none"> Positive slope for pulse width (ms) and duty cycle (%) measurement Charging capacitor as capacitance measurement
	<ul style="list-style-type: none"> Negative slope for pulse width (ms) and duty cycle (%) measurement Discharging capacitor as capacitance measurement
	Low battery indication
Auto OFF	Auto power off enable
	Refresh (auto) Hold
TRIG	Trigger (manual) Hold
MAXMINAVG	Dynamic Recording mode: Present value on primary display
MAX	Dynamic Recording mode: Maximum value on primary display
MIN	Dynamic Recording mode: Minimum value on primary display
AVG	Dynamic Recording mode: Average value on primary display
MAX	1 ms Peak Hold mode: Positive peak value on primary display
MIN	1 ms Peak Hold mode: Negative peak value on primary display





The primary display signs are explained below.

Table 1-4 Primary display symbols

LCD symbol	Description
Auto	Auto range
	AC + DC
	DC
	AC
	Polarity, digits, and decimal points for primary display
dBm	Decibel unit relative to 1 mW
dBV	Decibel unit relative to 1 V
MkHz	Frequency units: Hz, kHz, MHz
MkΩ	Resistance units: Ω, kΩ, MΩ
nS	Conductance unit
mV	Voltage units: mV, V
μmA	Current units: μA, mA, A
%	Duty cycle measurement
ms	Pulse width unit
μmF	Capacitance units: nF, μF, mF
°C	Celsius temperature unit
°F	Fahrenheit temperature unit
	Percentage scale readout proportional to DC 0–20 mA
	Percentage scale readout proportional to DC 4–20 mA

The secondary display signs are explained below.

Table 1-5 Secondary display symbols







LCD symbol	Description
	AC + DC
	DC
	AC
	Polarity, digits and decimal points for secondary display
kHz	Frequency units: Hz, kHz
	No ambient temperature compensation, just thermocouple measurement
°C	Celsius ambient temperature unit
°F	Fahrenheit ambient temperature unit
mV	Voltage units: mV, V
μmA	Current units: μA, mA, A
s	Elapsed time unit: s (second) for Dynamic Recording and 1 ms Peak Hold modes

The analog bar emulates the needle on an analog multimeter, without displaying the overshoot. When measuring peak or null adjustments and viewing fast-changing inputs, the bar graph provides a useful indication because it has quicker update rate for fast response applications.

The bar graph is not used for square wave output, frequency, duty cycle, pulse width, 4–20 mA% scale, 0–20 mA% scale and temperature measurements. When frequency, duty cycle, and pulse width are indicated on the primary display during voltage or current measurement, the bar graph represents the voltage or current value. When 4–20 mA% scale or 0–20 mA% scale is indicated on the primary display, the bar graph represents the current value and not the percentage.

The “+” or “-” sign is indicated when the positive or negative value has been measured or calculated. Each segment represents 2500 or 500 counts depending on the range indicated on the peak bar graph. See the [Table 1-6](#) below.

Table 1-6 Analog bar range and counts

Range	Counts/segments	Used for the function
	2500	V, Ω , Diode
	2500	V, A, Ω
	2500	V, A, Ω , nS
	500	V, \rightarrow †
	500	†
	500	†

Selecting display with the Hz button



The frequency measurement feature helps to detect the presence of harmonic currents in neutral conductors and determines whether these neutral currents are the result of unbalanced phases or non-linear loads. Press  to access the frequency measurement mode for current or voltage measurements – voltage or current on the secondary display and frequency on the primary display. Alternatively, pulse width (ms) or duty cycle (%) can appear on the primary display by pressing  again. This enables the simultaneous monitoring of real-time voltage and current with frequency, duty cycle, or pulse width. Voltage or current resumes on primary display after you press and hold  for more than 1 second.

Table 1-7 Selecting display with the Hz button











Rotary switch position (Function)	Primary display	Secondary display
 V for U1252A  V (AC voltage)	Frequency (Hz)	AC V
	Pulse width (ms)	
	Duty cycle (%)	
 V for U1251A  V for U1252A (DC voltage)	Frequency (Hz)	DC V
	Pulse width (ms)	
	Duty cycle (%)	
 V for U1252A (AC + DC voltage)	Frequency (Hz)	AC + DC V
	Pulse width (ms)	
	Duty cycle (%)	
 mV (AC voltage)	Frequency (Hz)	AC mV
	Pulse width (ms)	
	Duty cycle (%)	
 mV (DC voltage)	Frequency (Hz)	DC mV
	Pulse width (ms)	
	Duty cycle (%)	

Table 1-7 Selecting display with the Hz button (continued)

\sim mV (AC + DC voltage) [for U1252A]	Frequency (Hz)	AC + DC mV
	Pulse width (ms)	
	Duty cycle (%)	
μ A \sim (AC Current)	Frequency (Hz)	AC μ A
	Pulse width (ms)	
	Duty cycle (%)	
μ A \sim (DC current)	Frequency (Hz)	DC μ A
	Pulse width (ms)	
	Duty cycle (%)	
μ A \sim (AC + DC current) [for U1252A]	Frequency (Hz)	AC + DC μ A
	Pulse width (ms)	
	Duty cycle (%)	
$\text{mA} \cdot \text{A} \sim$ (AC current)	Frequency (Hz)	AC mA or A
	Pulse width (ms)	
	Duty cycle (%)	
$\text{mA} \cdot \text{A} \sim$ (DC current)	Frequency (Hz)	DC mA or A
	Pulse width (ms)	
	Duty cycle (%)	
$\text{mA} \cdot \text{A} \sim$ [for U1252A] (AC + DC current)	Frequency (Hz)	AC + DC mA or A
	Pulse width (ms)	
	Duty cycle (%)	
Hz (Frequency counter) - press  to select frequency division by 1 [for U1252A]	Frequency (Hz)	- 1 -
	Pulse width (ms)	
	Duty cycle (%)	
Hz (Frequency counter) - press  to select frequency division by 100 [for U1252A]	Frequency (Hz)	- 100 -

Selecting display with the Dual button

Press  to select different combinations of dual display.

Normal single display resumes after you press and hold  for more than 1 second. See [Table 1-8](#) below.

Table 1-8 Selecting display with the Dual button













Rotary switch position (Function)	Primary display	Secondary display
 (AC voltage)	AC V	Hz (AC coupling)
	dBm or dBV (select by pressing )	AC V
	AC V	Ambient temperature °C or °F
 for U1252A (AC voltage)	AC V	Hz (AC coupling)
	dBm or dBV ^[1]	AC V
	AC V	DC V
	AC V	Ambient temperature °C or °F
 for U1251A/  for U1252A (DC voltage)	DC V	Hz (DC coupling)
	dBm or dBV ^[1]	DC V
	DC V	AC V [for U1252A]
	DC V	Ambient temperature °C or °F
 for U1252A (AC + DC voltage)	AC + DC V	Hz (AC coupling)
	dBm or dBV ^[1]	AC + DC V
	AC + DC V	AC V
	AC + DC V	DC V
	AC + DC V	Ambient temperature °C or °F
 (AC voltage)	AC mV	Hz (AC coupling)
	dBm or dBV ^[1]	AC mV
	AC mV	DC mV
	AC mV	Ambient temperature °C or °F
 (DC voltage)	DC mV	Hz (DC coupling)
	dBm or dBV ^[1]	DC mV
	DC mV	AC mV
	DC mV	Ambient temperature °C or °F

Table 1-8 Selecting display with the Dual button

\sim mV (AC + DC voltage)	AC + DC mV	Hz (AC coupling)
	dBm or dBV	AC + DC mV
	AC + DC mV	AC mV
	AC + DC mV	DC mV
	AC + DC mV	Ambient temperature °C or °F
μ A \sim (DC current)	DC μ A	Hz (DC coupling)
	DC μ A	AC μ A
	DC μ A	Ambient temperature °C or °F
μ A \sim (AC current)	AC μ A	Hz (AC coupling)
	AC μ A	DC μ A
	AC μ A	Ambient temperature °C or °F
μ A \sim (AC + DC current) [for U1252A]	AC + DC μ A	Hz (AC coupling)
	AC + DC μ A	AC μ A
	AC + DC μ A	DC μ A
	AC + DC μ A	Ambient temperature °C or °F
$\text{mA}\cdot\text{A}$ \sim (DC current)	DC mA	Hz (DC coupling)
	DC mA	AC mA
	% (0–20 or 4–20)	DC mA
	DC mA	Ambient temperature °C or °F
$\text{mA}\cdot\text{A}$ \sim (AC current)	AC mA	Hz (AC coupling)
	AC mA	DC mA
	AC mA	Ambient temperature °C or °F
$\text{mA}\cdot\text{A}$ \sim (AC + DC current) [for U1252A]	AC + DC mA	Hz (AC coupling)
	AC + DC mA	AC mA
	AC + DC mA	DC mA
	AC + DC mA	Ambient temperature °C or °F
$\text{mA}\cdot\text{A}$ \sim (DC current)	DC A	Hz (DC coupling)
	DC A	AC A
	DC A	Ambient temperature °C or °F
$\text{mA}\cdot\text{A}$ \sim (AC current)	AC A	Hz (AC coupling)
	AC A	DC A
	AC A	Ambient temperature °C or °F

Table 1-8 Selecting display with the Dual button

mA·A  (AC + DC current) [for U1252A]	AC + DC A	Hz (AC coupling)
	AC + DC A	AC A
	AC + DC A	DC A
	AC + DC A	Ambient temperature °C or °F
 (Capacitance)  (Diode)/ Ω (Resistance)/ nS (Conductance)	nF / V / Ω / nS	Ambient temperature °C or °F
TEMP (Temperature)	°C (°F)	Ambient temperature °C or °F
	°C (°F)	Ambient temperature °C or °F / 0 °C compensation (select by pressing )

Notes for selecting display with the Dual button:

- 1 Reading of dBm or dBV depends on the last review on AC V. If the last review is in dBV, the following display will also remain in dBV.

Selection display with the Shift button

The table below shows selection of primary display, with respect to measuring function (rotary switch position), using the SHIFT button.

Table 1-9 Selecting display with the Shift button









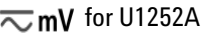

Rotary switch position (Function)	Primary display
 (AC Voltage)	AC V
	dBm (in dual display mode) ^[1]
	dBV (in dual display mode) ^[1]
 V for U1251A	DC V
 V for U1252A (AC + DC Voltage)	DC V
	AC V
	AC + DC V

Table 1-9 Selecting display with the Shift button

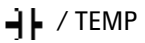
 mV for U1252A (AC + DC Voltage)	DC mV
	AC mV
	AC + DC mV
Ω (Resistance)	Ω
	 Ω
	nS
 (Diode Test and Frequency)	Diode
	Hz
 / TEMP (Capacitance and Temperature)	Capacitance
	Temperature
μA  (AC Current)	DC μA
	AC μA
	AC + DC μA [for U1252A]
$\text{mA}\cdot\text{A}$  (DC Current)	DC mA
	AC mA
	AC + DC mA
	%(0–20 or 4–20)
$\text{mA}\cdot\text{A}$  (AC + DC Current)	DC A
	AC A
	AC + DC A [for U1252A]
 (Square wave output for U1252A)	Duty cycle (%)
	Pulse width (ms)

Notes for selecting display with the Shift button:

1 Press  to switch between dBm and dBV measurement.

Press  for more than 1 second to return to AC V measurement only.

The terminals at a glance

WARNING

To avoid damaging the multimeter, do not exceed the input limit.

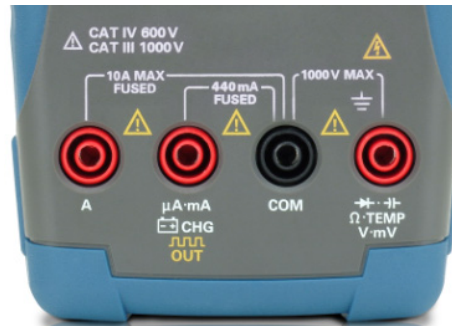

Figure 1-9 U1252A connector terminals

Table 1-10 Terminal connections for different measuring functions

Rotary switch position	Input terminals		Overload protection
$\sim V$	$V \cdot mV \cdot \Omega \cdot$ $\rightarrow \rightarrow \rightarrow$ $\cdot TEMP$	COM	1000 V R.M.S.
$\sim V$ for U1252A			
$\equiv V$ for U1251A			
$\sim mV$			1000 V R.M.S. for short circuit <0.3 A
Ω			
$\rightarrow \rightarrow$			
$\rightarrow \rightarrow$			
$\mu A \cdot \sim$	$\mu A \cdot mA$	COM	440 mA / 1000 V 30 kA fast-acting fuse
$mA \cdot A \cdot \sim$			
$mA \cdot A \cdot \sim$	A	COM	11 A / 1000 V 30 kA fast-acting fuse
$\frac{\mu\mu\mu}{OUT} \%$ for U1252A	$\frac{\mu\mu\mu}{OUT} \%$	COM	
$\rightarrow \rightarrow$ CHG	$\rightarrow \rightarrow$ CHG	COM	440 mA / 1000 V fast-acting fuse



2 Making Measurements

Understanding The Measurement Instructions	24
Measuring Voltage	24
Measuring AC voltage	25
Measuring DC voltage	26
Measuring Current	27
μ A & mA measurement	27
Percentage scale of 4 mA to 20 mA	29
A (ampere) measurement	31
Frequency Counter	32
Measuring Resistance, Conductance and Testing Continuity	34
Testing Diodes	38
Measuring Capacitance	41
Measuring Temperature	43
Alerts and Warning During Measurement	47
Overload alert	47
Input warning	47
Charge terminal alert	48

This chapter contains information on how to make measurements using the U1251A and U1252A handheld digital multimeter.



Understanding The Measurement Instructions

When making measurements, follow the numerical steps labelled in the diagrams. Refer to [Table 2-1](#) below for a description of the steps.

Table 2-1 Numerical steps descriptions

No.	Instructions
1	Turn the rotary switch to the measurement option shown in the diagram
2	Connect the test leads into the input terminals shown in the diagram
3	Probe the test points
4	Read the results on the display

Measuring Voltage

The U1251A and U1252A offer true-RMS readings for AC measurements that are accurate for sine waves, square waves, triangle waves, staircase waves, and other waveforms without any DC offset.

For AC with DC offset, use AC + DC measurement on \overline{V} or \overline{mV} rotary switch location. This applies only to U1252A.

WARNING

Ensure that the terminal connections are correct for that particular measurement before proceeding with the measurement. To avoid damaging the device, do not exceed the input limit.

Measuring AC voltage

Set up the multimeter to measure AC voltage as shown in Figure 2-1. Probe the test points and read the display.

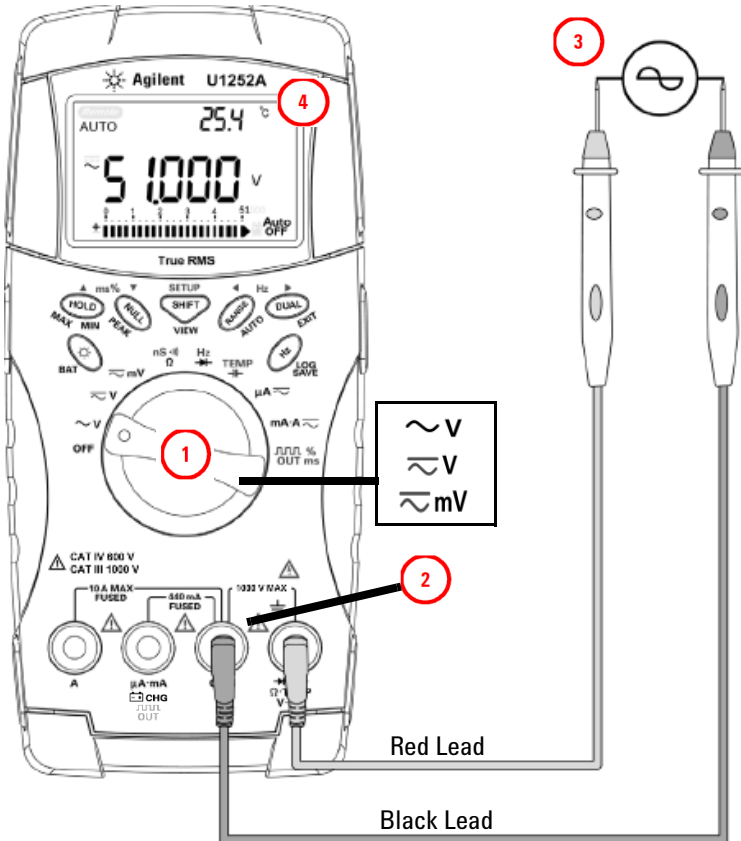

Figure 2-1 Measuring AC voltage

NOTE

Press **DUAL** to display frequency on secondary display. See Table 1-8 of “Selecting display with the Dual button” on page 18 for a list of the different combinations available on the secondary display.

Measuring DC voltage

Set up the multimeter to measure DC voltage as shown in [Figure 2-2](#). Probe the test points and read the display.

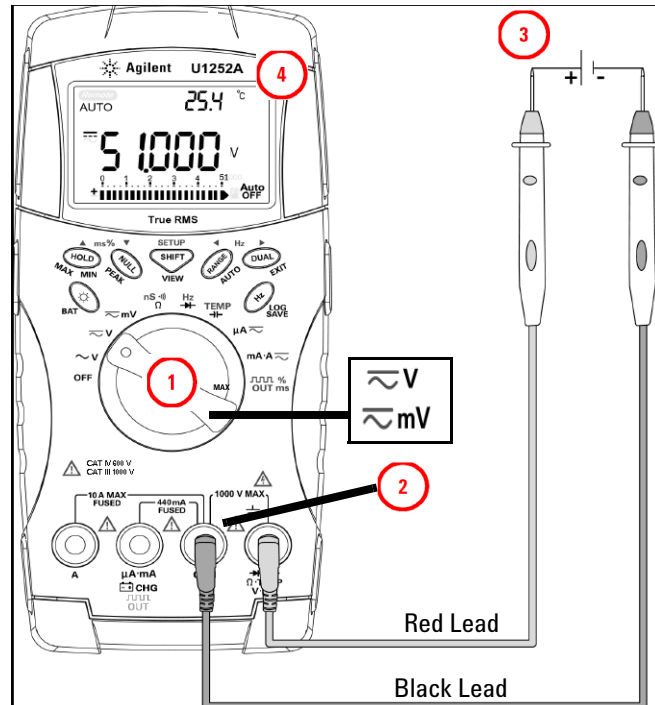









Figure 2-2 Measuring DC voltage

Measuring Current

μA & mA measurement

Set up the multimeter to measure μA & mA as shown in [Figure 2-3](#). Probe the test points and read the display.

NOTE

- Press  if necessary to ensure  is shown on the display.
- For μA measurement, set the rotary switch to μA  and connect the positive test lead to $\mu\text{A}\cdot\text{mA}$.
- For mA measurement, set the rotary switch to mA  and connect the positive test lead to $\mu\text{A}\cdot\text{mA}$.
- For A (ampere) measurement, set the rotary switch to mA  and connect the positive test lead to A.
- Press  to display dual measurements. See [Table 1-8](#) of “[Selecting display with the Dual button](#)” on page 18 for a list of dual measurements available. Press and hold  for more than 1 second to exit dual display mode.

2 Making Measurements

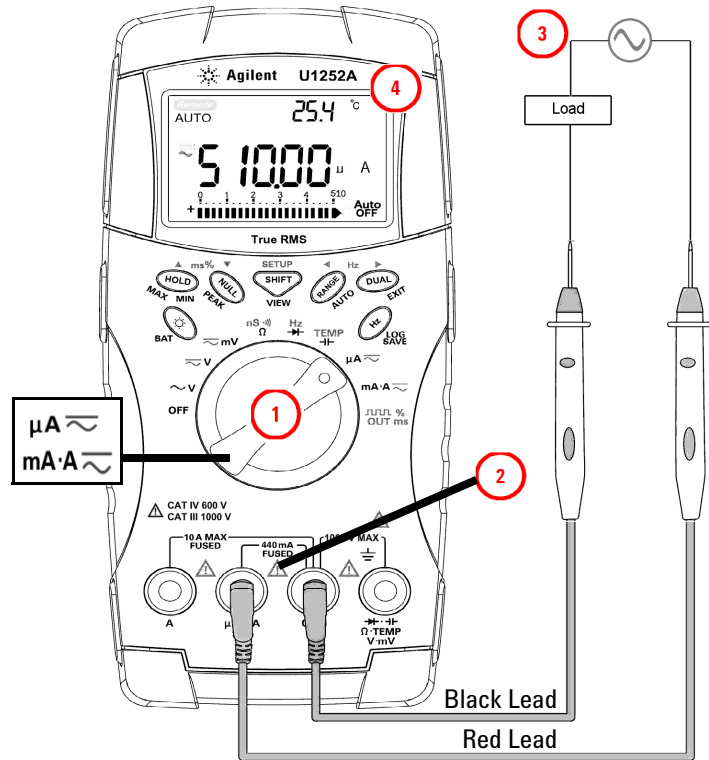





Figure 2-3 Measuring μA and mA current

Percentage scale of 4 mA to 20 mA

Set up the multimeter to measure percentage scale as shown in Figure 2-4. Probe the test points and read the display.

NOTE

- Press  to select percentage scale display. Ensure that  or  is shown on the display.
- The percentage scale for 4 mA to 20 mA or 0 mA to 20 mA is calculated using its corresponding DC mA measurement. The U1251A/U1252A will automatically optimize the best resolution according to Table 2-2 below.
- Press  to change the measurement range.

The percentage scale for 4 mA to 20 mA or 0 mA to 20 mA is set to two ranges as follows:

Table 2-2 Percentage scale and measurement range

Percentage scale (4 mA to 20 or 0 mA to 20 mA) Always auto range	DC mA auto or manual range
999.99%	50 mA, 500 mA
9999.9%	

2 Making Measurements

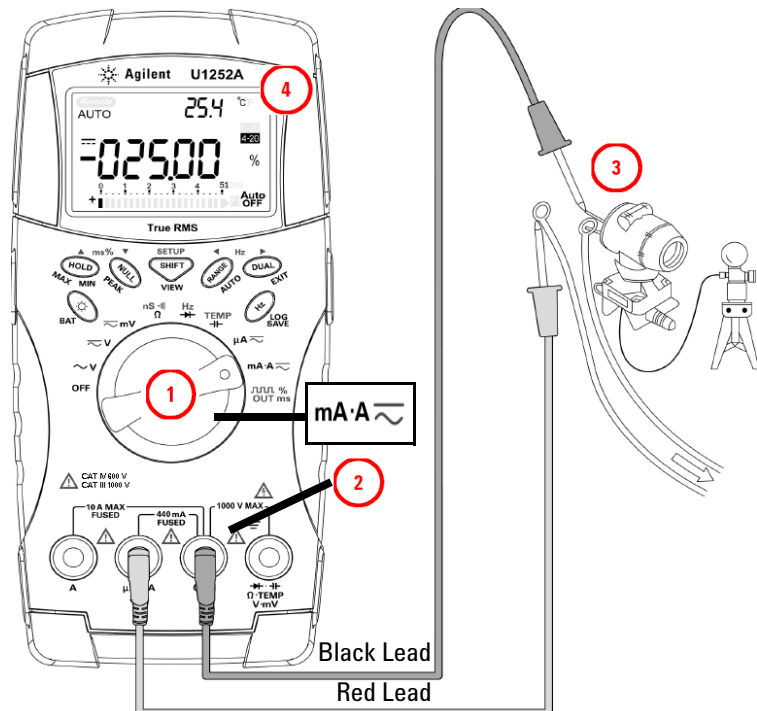

Figure 2-4 Measuring scale of 4-20 mA

A (ampere) measurement

Set up the multimeter to measure A (ampere) as shown in Figure 2-5. Probe the test points and read the display.

NOTE

Connect the red and black test leads to the 10 A input terminal **A** and **COM** respectively. The meter is set to A measurement automatically when the red test lead is plugged into the **A** terminal.

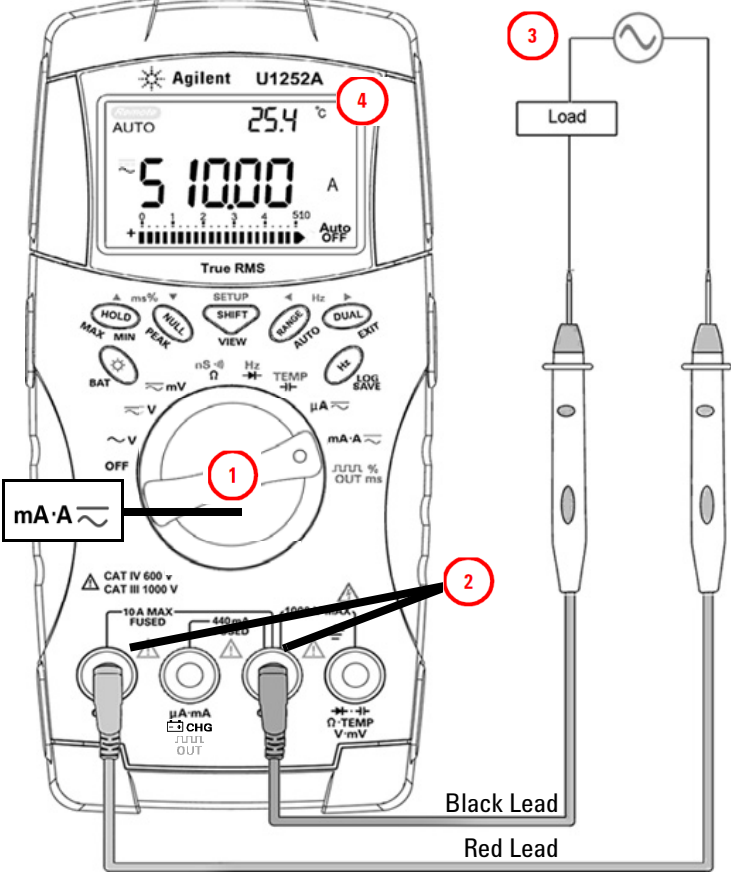

Figure 2-5 A (ampere) current measurement



Frequency Counter

WARNING

- Use the frequency counter for low voltage applications only. Never use the frequency counter for line power system.
 - For inputs more than 30 Vpp, you are required to use frequency measurement mode available under the current or voltage measurement instead of frequency counter.
-

Set up the multimeter to measure frequency as shown in [Figure 2-6](#). Probe the test points and read the display.

NOTE

- Press  to select the Frequency counter (Hz) function. “-1-” on the secondary display means the input signal frequency is divided by 1. This allows signals of up to a maximum frequency of 985 kHz to be measured.
 - If the reading is unstable or is zero, press  to select the division of the input signal frequency by 100. This allows for a higher frequency range of up to 20 MHz to be measured.
 - The signal is out of range if the reading is still unstable after the above step.
 - While the secondary display shows “-1-”, you may scroll through the pulse width (ms), duty cycle (%), and frequency (Hz) measurements by pressing  .
-

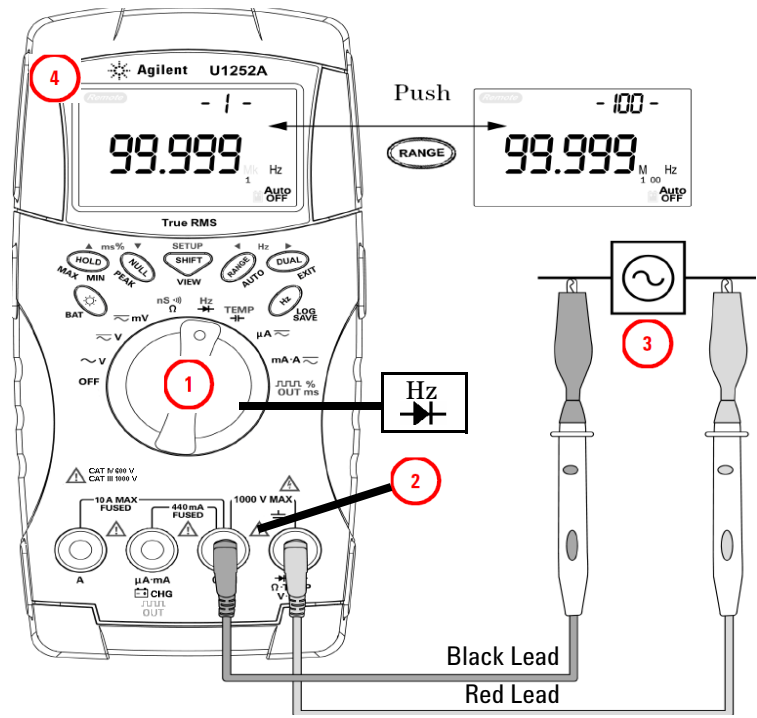

Figure 2-6 Measuring frequency

Measuring Resistance, Conductance and Testing Continuity

CAUTION

Disconnect the circuit power and discharge all high-voltage capacitors before measuring the resistance to prevent any possible damage to the multimeter or the device under test.

Set up the multimeter to measure resistance as shown in Figure 2-7. Then probe the test points (by shunting the resistor) and read the display.

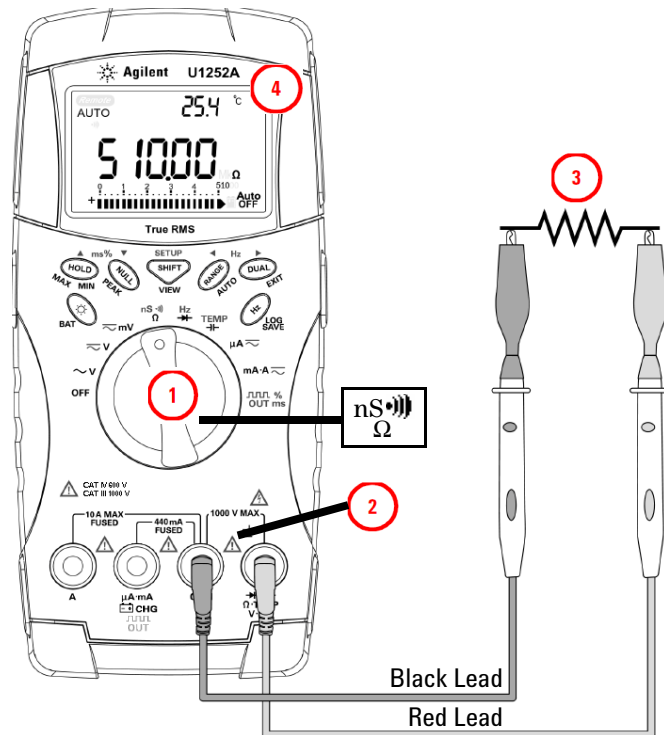



Figure 2-7 Measuring resistance

Press  to scroll through audible continuity, conductance and resistance tests as shown in Table 2-8.

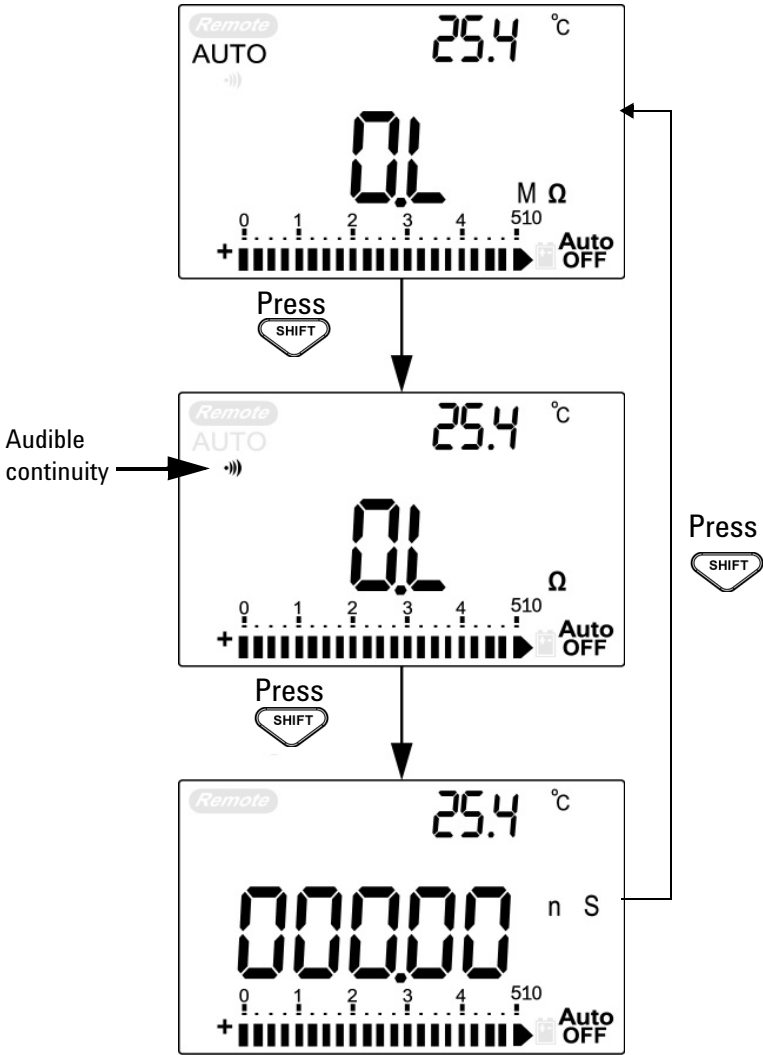

Figure 2-8 Audible continuity, conductance, and resistance test.

Audible continuity

In the range of 0–500 Ω , the beeper will sound if the resistance value falls below 10 Ω . For other ranges, the beeper will sound if the resistance falls below the typical values indicated in [Table 2-3](#) below.

Table 2-3 Audible continuity measurement range

Measurement range	Beeper sound threshold
500.00 Ω	< 10 Ω
5.0000 k Ω	< 100 Ω
50.000 k Ω	< 1 k Ω
500.00 k Ω	< 10 k Ω
5.0000 M Ω	< 100 k Ω
50.000 M Ω	< 1 M Ω
500.00 M Ω	< 10 M Ω

Conductance

Set up the multimeter to measure conductance as shown in [Figure 2-9](#). Probe the test points and read the display.

The conductance measurement enables the measurement of very high resistance of up to 100 G Ω .

As the high-resistance readings are susceptible to noise, you can capture the average readings by using the Dynamic Recording mode. Refer to the section [“Dynamic Recording”](#) on page 50 for more information.

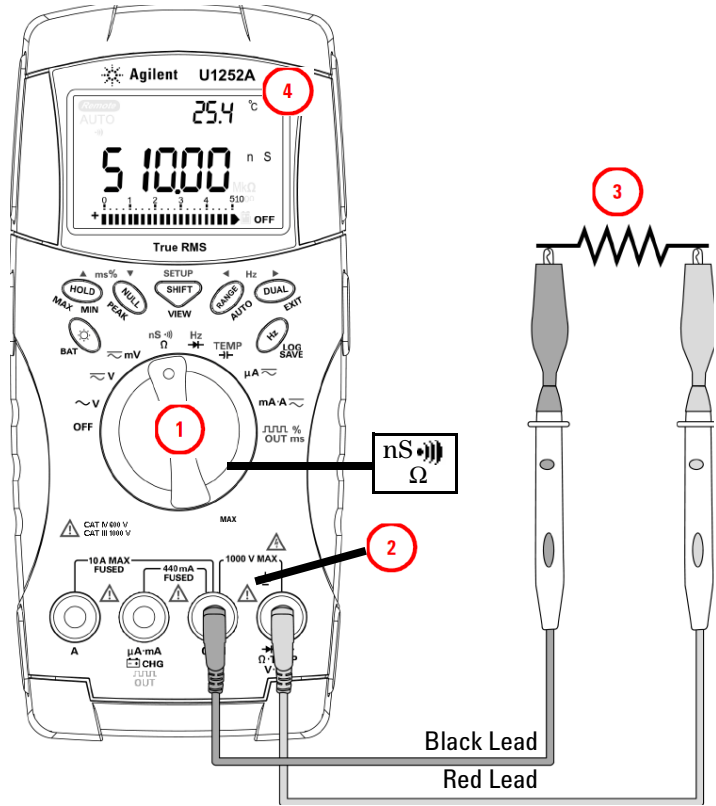

Figure 2-9 Conductance measurement

Testing Diodes

CAUTION

Disconnect the circuit power and discharge all the high-voltage capacitors before testing the diodes to prevent any possible damage to the meter.

To test a diode, turn the power off to the circuit and remove the diode from the circuit. Set up the multimeter as shown in [Figure 2-10](#), then use the red probe lead on the positive terminal (anode) and use the black probe lead on the negative terminal (cathode) and read the display.

NOTE

- The cathode is the side with band(s).
 - The meter can display the diode's forward bias of up to approximately 2.1 V. A typical diode's forward bias is between the range of 0.3 V to 0.8 V.
-

Next, reverse the probes and measure the voltage across the diodes again as shown in [Figure 2-11](#) on page 40. The diode's test result is based on the following:

- The diode is considered good if the meter displays "OL" in reverse bias mode.
- The diode is considered shorted if the meter displays approximately 0 V in both forward and reverse bias modes, and the meter beeps continuously.
- The diode is considered open if the meter displays "OL" in both forward and reverse bias modes.

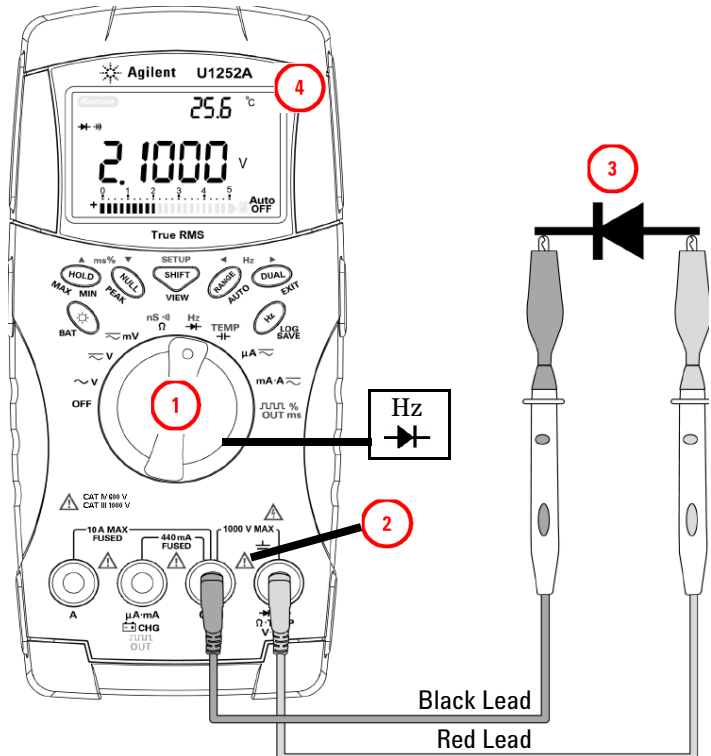

Figure 2-10 Measuring forward bias of diode

2 Making Measurements

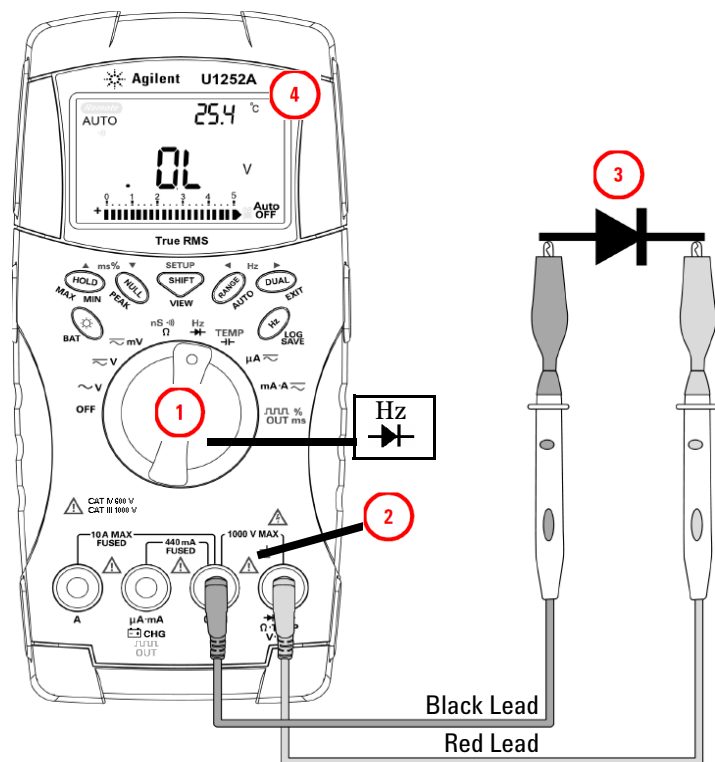



Figure 2-11 Measuring reverse bias of diode

Measuring Capacitance



CAUTION

Disconnect the circuit power and discharge all the high-voltage capacitors before measuring the capacitance to prevent any possible damage to the meter or the device under test. To confirm that the capacitors have discharged, use the DC voltage function.

The meter measures capacitance by charging the capacitor with a known current for a period of time, measuring the voltage and then calculating the capacitance. The larger the capacitor, the longer the charge time. Below are some tips for measuring capacitance:

- For measuring capacitance greater than 10,000 μF , discharge the capacitor first, then select a suitable range for the measurement. This will speed up measuring time in order to obtain the correct capacitance value.
- For measuring smaller capacitance ranges, press  with the test leads open to subtract any residual capacitance from the meter or the leads.

NOTE

 means the capacitor is charging.  means the capacitor is discharging.

Set up the multimeter as shown in [Figure 2-12](#). Use the red probe lead on the positive terminal of the capacitor and the black probe lead on the negative terminal and read the display.

2 Making Measurements

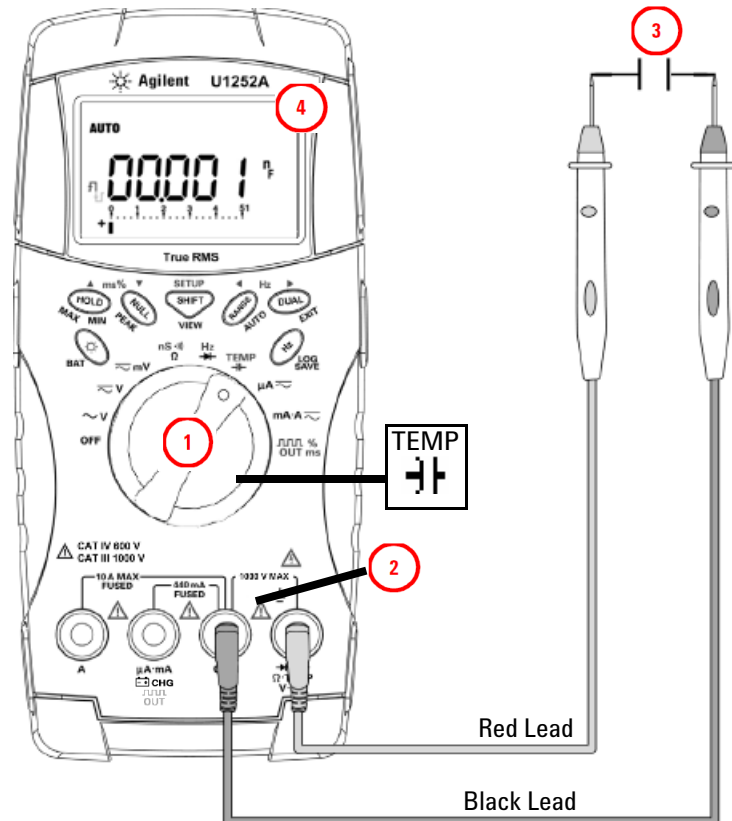

Figure 2-12 Capacitance measurements

Measuring Temperature

CAUTION

Do not bend the thermocouple leads at sharp angles. Repeated bending over a period of time may break the leads.

The bead type thermocouple probe is suitable for making temperature measurements between $-20\text{ }^{\circ}\text{C}$ to $200\text{ }^{\circ}\text{C}$ in PTFE compatible environments.

Do not use the bead-type thermocouple probe beyond the recommended operating temperature range. Do not immerse this thermocouple probe in liquids. For best results, use a thermocouple probe designed for each application – an immersion probe for liquid or gel and an air probe for air measurements.

Set up the multimeter to measure temperature as shown in [Figure 2-15](#) or observe the following steps:

- 1 Press  to select the temperature measurement.
- 2 Connect the miniature thermal probe into the non-compensation transfer adaptor as shown in [Figure 2-13](#).
- 3 Connect the thermal probe with the adapter into the meter input terminals as shown in [Figure 2-14](#).
- 4 For best performance, place the meter in the operating environment for at least one hour to stabilize the unit to environment temperatures.
- 5 Clean the measurement surface and make sure the probe is securely touching the surface. Remember to disable the applied power.
- 6 When measuring above the ambient temperature, move the thermocouple along the surface until you get the highest temperature reading.
- 7 When measuring below ambient temperature, move the thermocouple along the surface until you get the lowest temperature reading.

2 Making Measurements

- For a quick measurement, use the 0 °C compensation adapter to see the temperature variation of the thermocouple sensor. The 0 °C compensation adapter assists in measuring the relative temperature immediately.

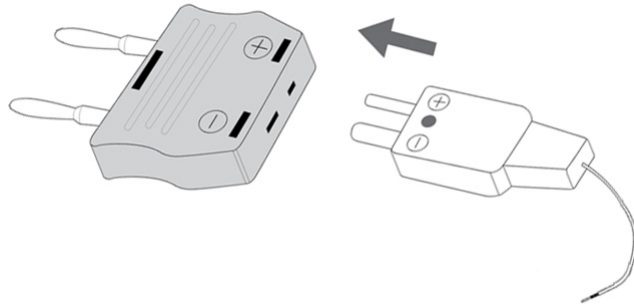

Figure 2-13 Connecting the thermal probe into the non-compensation transfer adapter

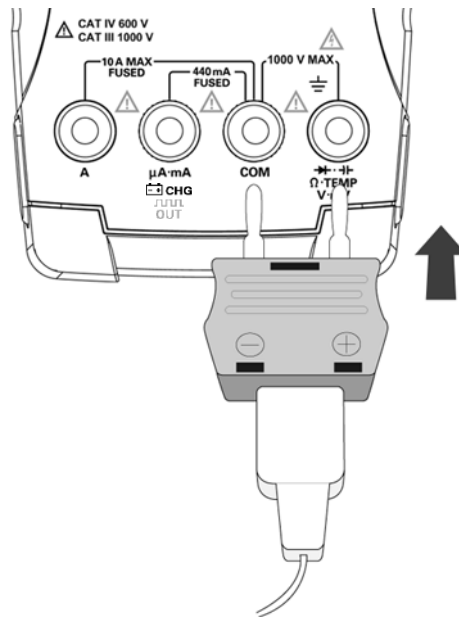

Figure 2-14 Connecting the probe with adapter into the multimeter

If you are working in a constantly varying environment, where ambient temperatures are not constant, do the following:

- 1 Press **DUAL** to select 0 °C compensation. This gives a quick measurement of the relative temperature.
- 2 Avoid contact between the thermocouple probe and the measurement surface.
- 3 After a constant reading is obtained, press **NULL** to set the reading as the relative reference temperature.
- 4 Touch the measurement surface with the thermocouple probe.
- 5 Read the display for the relative temperature.

2 Making Measurements

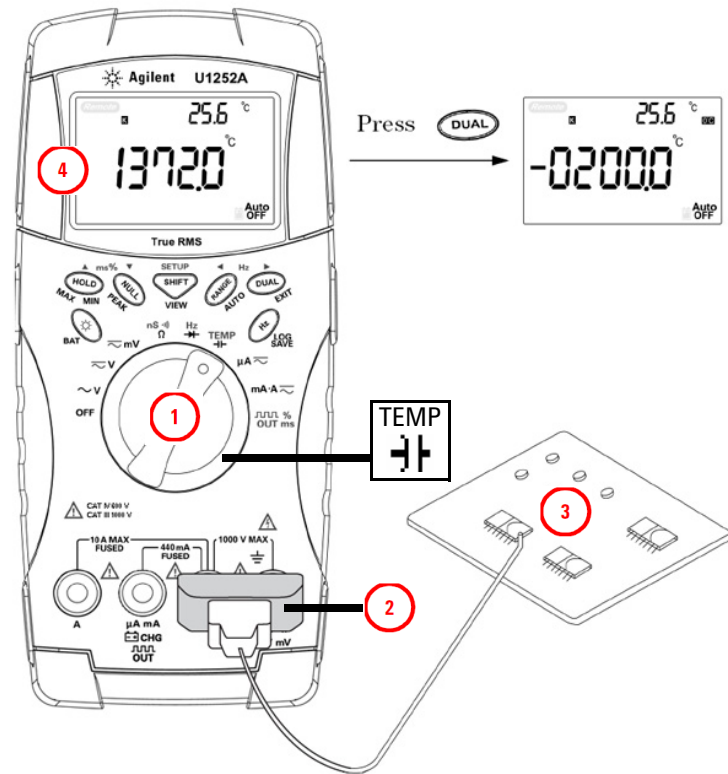

Figure 2-15 Surface temperature measurement

Alerts and Warning During Measurement

Overload alert

WARNING

For your safety, look out for this alert. When you are alerted, immediately remove the test leads from the measuring source.

The meter provides an overload alert for voltage measurements in both auto and manual range modes. The meter beeps periodically once the measuring voltage exceeds 1010 V. For your safety, please be aware of this alert.

Input warning

The meter sounds an alert beep when the test lead is inserted into the **A** input terminal but the rotary switch is not set to the corresponding **mA.A** location. The primary display indicates a flashing “**A-Err**” until the test lead is removed from the **A** input terminal. Refer to [Figure 2-16](#).

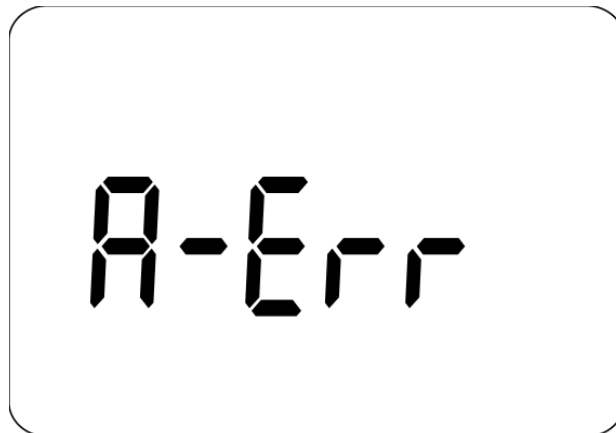





Figure 2-16 Input terminal warning

Charge terminal alert

The meter sounds an alert beep when the CHG terminal detects a voltage level of more than 5 V and the rotary switch is not set to the corresponding CHG^{OFF} location. The primary display indicates a flashing “Ch.Err” until the lead is removed from the CHG input terminal.

Refer to [Figure 2-17](#) below.

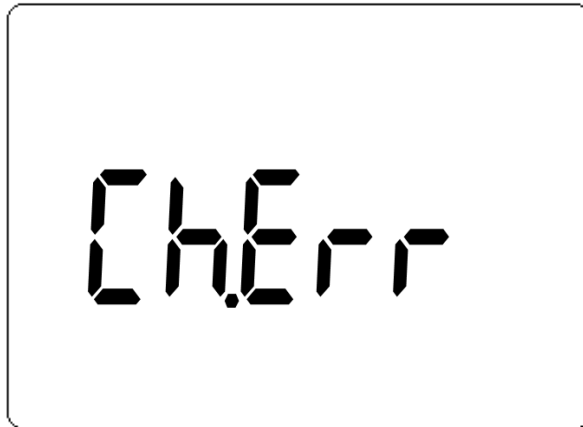

Figure 2-17 Charge terminal alert



3 Functions and Features

Dynamic Recording	50
Data Hold (Trigger Hold)	52
Refresh Hold	53
Null (Relative)	55
Decibel Display	57
1 ms Peak Hold	59
Data Logging	61
Manual logging	61
Interval logging	63
Reviewing logged data	65
Square Wave Output (for U1252A)	67
Remote Communication	71





This chapter contains information on the functions and features that are available for the U1251A and U1252A digital multimeter.



Dynamic Recording

The Dynamic Recording mode can be used to detect intermittent turn-on or turn-off voltage, current surges or to verify measurement performance without you being present during the process. While the readings are being recorded, you are free to perform other tasks.

The average reading is useful for smoothing out unstable inputs, estimating the percentage of time a circuit is operating and verifying circuit performance. The elapsed time is shown on the secondary display. The maximum time is 99999 seconds. When this maximum time is exceeded, "OL" is shown on the display.

- 1 Press  for more than 1 second to enter Dynamic Recording mode. The meter is now in continuous mode or non-data hold (non-trigger) mode. "MAXMINAVG" and the present value of measurement are displayed. The multimeter will beep when a new maximum or minimum value is recorded.
- 2 Press  to cycle through maximum, minimum, average, and present readings. The **MAX**, **MIN**, **AVG**, and **MAXMINAVG** indicators will appear, corresponding to the displayed readings.
- 3 Press  or  for more than 1 second to exit Dynamic Recording mode.

NOTE

- Press  to restart the dynamic recording.
- The average value is the true average of all the measured values taken in the Dynamic Recording mode. If an overload is recorded, the averaging function will stop and the average value becomes "OL"(overload). **Auto OFF** is disabled in Dynamic Recording mode.

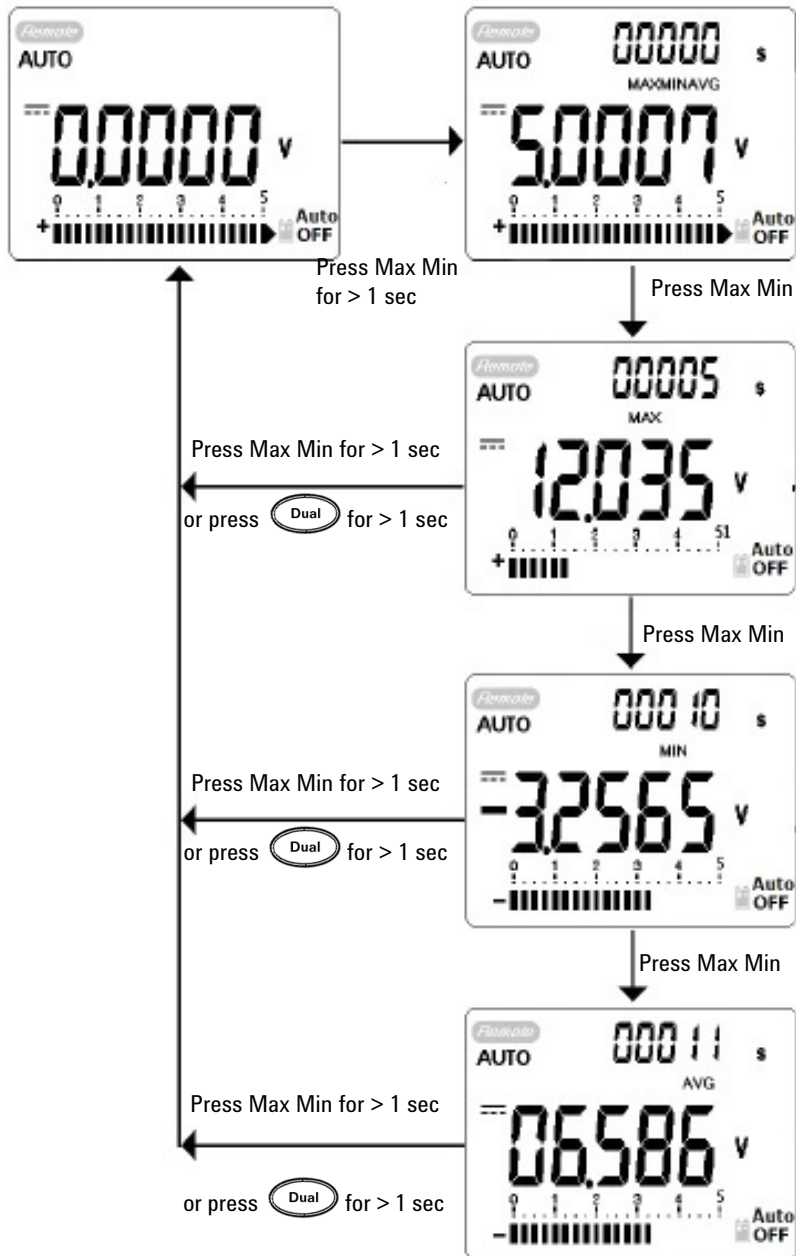

Figure 3-1 Dynamic recording mode operation

Data Hold (Trigger Hold)

The data hold function allows the user to freeze the displayed digital value.

- 1 Press **HOLD** to freeze the displayed value and to enter the manual trigger mode. **TRIG HOLD** is displayed.
- 2 Press **HOLD** again to freeze the next value being measured. **TRIG** flashes before the new value is updated on the display.
- 3 Press and hold **HOLD** or **DUAL** for more than 1 second to quit the data hold function.

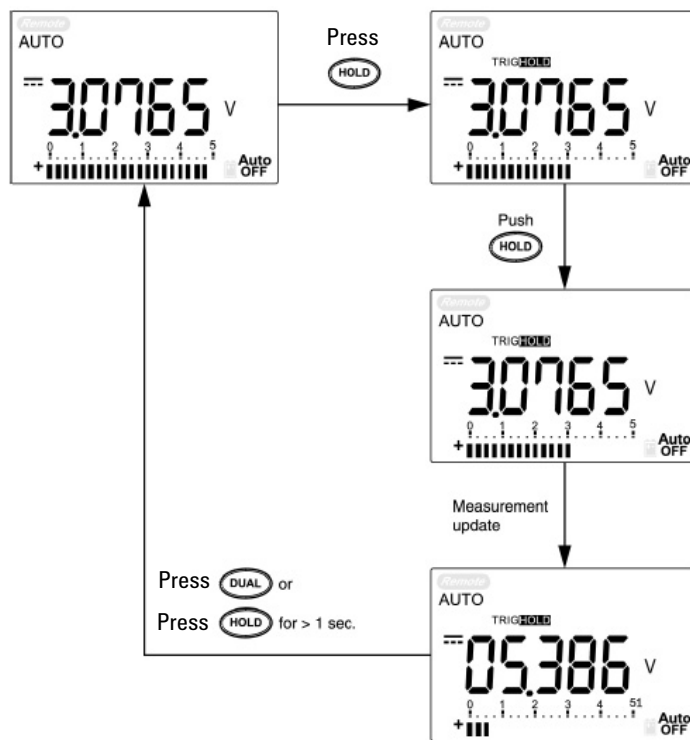



Figure 3-2 Data hold mode operation

Refresh Hold

The Refresh Hold function allows you to freeze the displayed value. The bar-graph is not held and will continue to reflect the instantaneous measured value. You can use the Setup mode to enable Refresh Hold mode when you are working with fluctuating values. This function will auto trigger or update the held value with a new measured value and emit a tone as a reminder.

- 1 Press  to enter Refresh Hold mode. The present value will be held and the **HOLD** symbol will appear.
- 2 It will be ready to hold a new measured value once the variation of measured values exceeds the variation count setting. While the multimeter is waiting for a new stable value, the **HOLD** symbol will flash.
- 3 The **HOLD** symbol will stop flashing once the new measured value is stable and the new value will be updated to the display. The symbol will remain on and the multimeter will emit a tone to remind you of this.
- 4 Press  again to quit the Refresh Hold function.

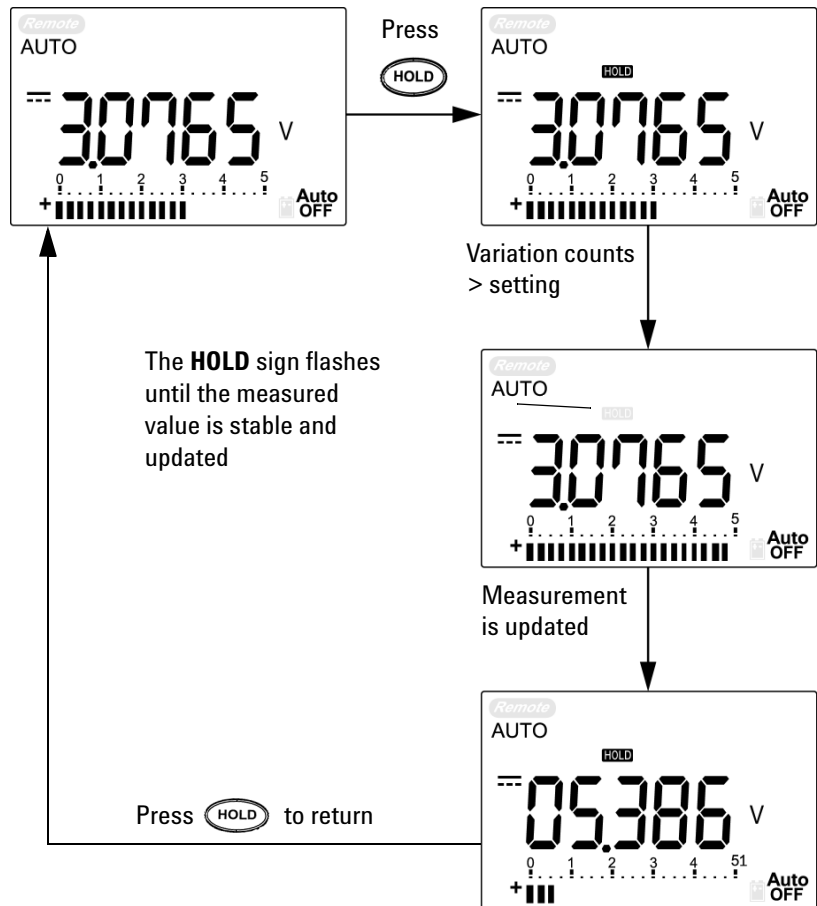





Figure 3-3 Refresh hold mode operation

NOTE

- For voltage and current measurements, the holding value will not be updated if the reading is below 500 counts.
- For resistance and diode measurements, the holding value will not be updated if the reading is in "OL" (open state).
- The holding value may not be updated when the reading does not reach a stable state for all measurements.

Null (Relative)

The Null function subtracts a stored value from the present measurement and displays the difference between the two.

- 1 Press  to store the displayed reading as the reference value to be subtracted from subsequent measurements and to set the display to zero. **NULL** is displayed.
- 2 Press  to see the stored reference value. **NULL** flashes for 3 seconds before the display returns to zero.
- 3 To exit this mode, press  while **NULL** is flashing on the display.

NOTE

- Null can be set for both auto and manual range settings, but not in the event of an overload.
 - When taking a resistance measurement and the meter reads a non-zero value due to the presence of test leads, use the Null function to adjust the display to zero.
 - When taking a DC voltage measurement, the thermal effect will influence the accuracy. Short the test leads and press Null once the displayed value is stable in order to zero out the display.
-

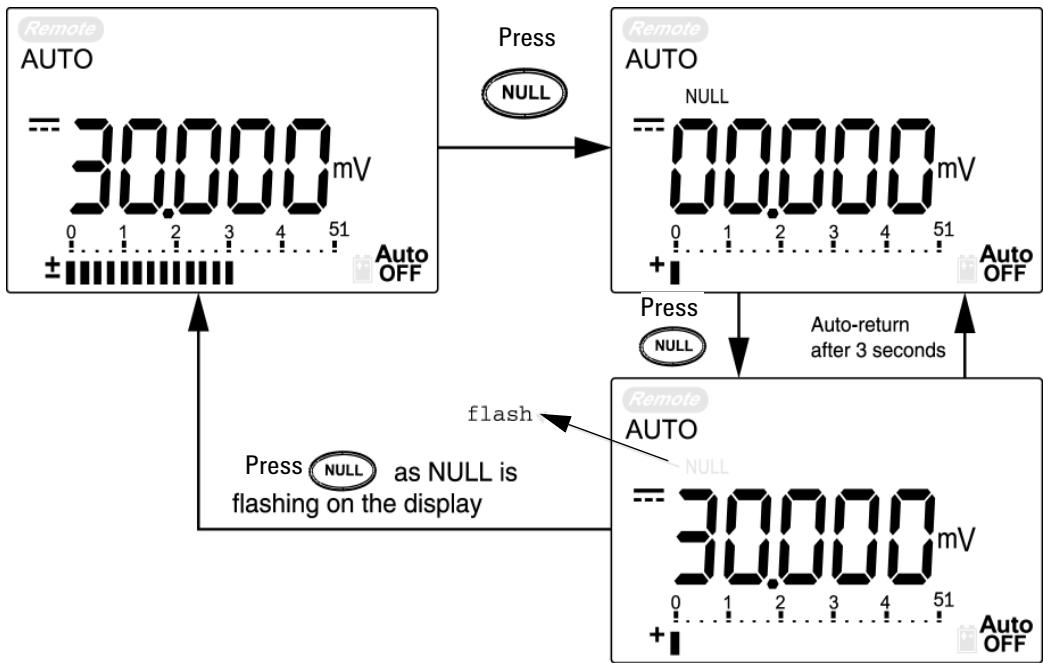

Figure 3-4 Null (relative) mode operation

Decibel Display

The dBm operation calculates the power delivered to a reference resistance relative to 1 mW and can be applied to DC V, AC V, and AC + DC V measurements for decibel conversion. The voltage measurement is converted to dBm by using the following formula:

$$\text{dBm} = 10 \log_{10} \left[\frac{1000 \times (\text{measuring value})^2}{\text{reference impedance}} \right]$$

The reference resistance may be selected from 1~9999 Ω in Setup mode. The default value is 50 Ω .

The decibel of voltage is calculated with respect to 1 V. The equation for the voltage measurement is as follows:

$$\text{dBV} = 20 \log_{10} \text{Vin}$$

- 1 At the $\sim V$, $\sim V$, or $\sim mV$ rotary switch position, press  to scroll to the dBm measurement on the primary display. The secondary display indicates the AC voltage measurement.

NOTE

If the rotary switch is at the “~ V” position, press  to switch between the dBV and the dBm measurements. The dBm or the dBV measurements can be selected at the ACV position. The selection will be the reference for other voltage measurements.

- 2 Press  for more than 1 second to exit this mode.

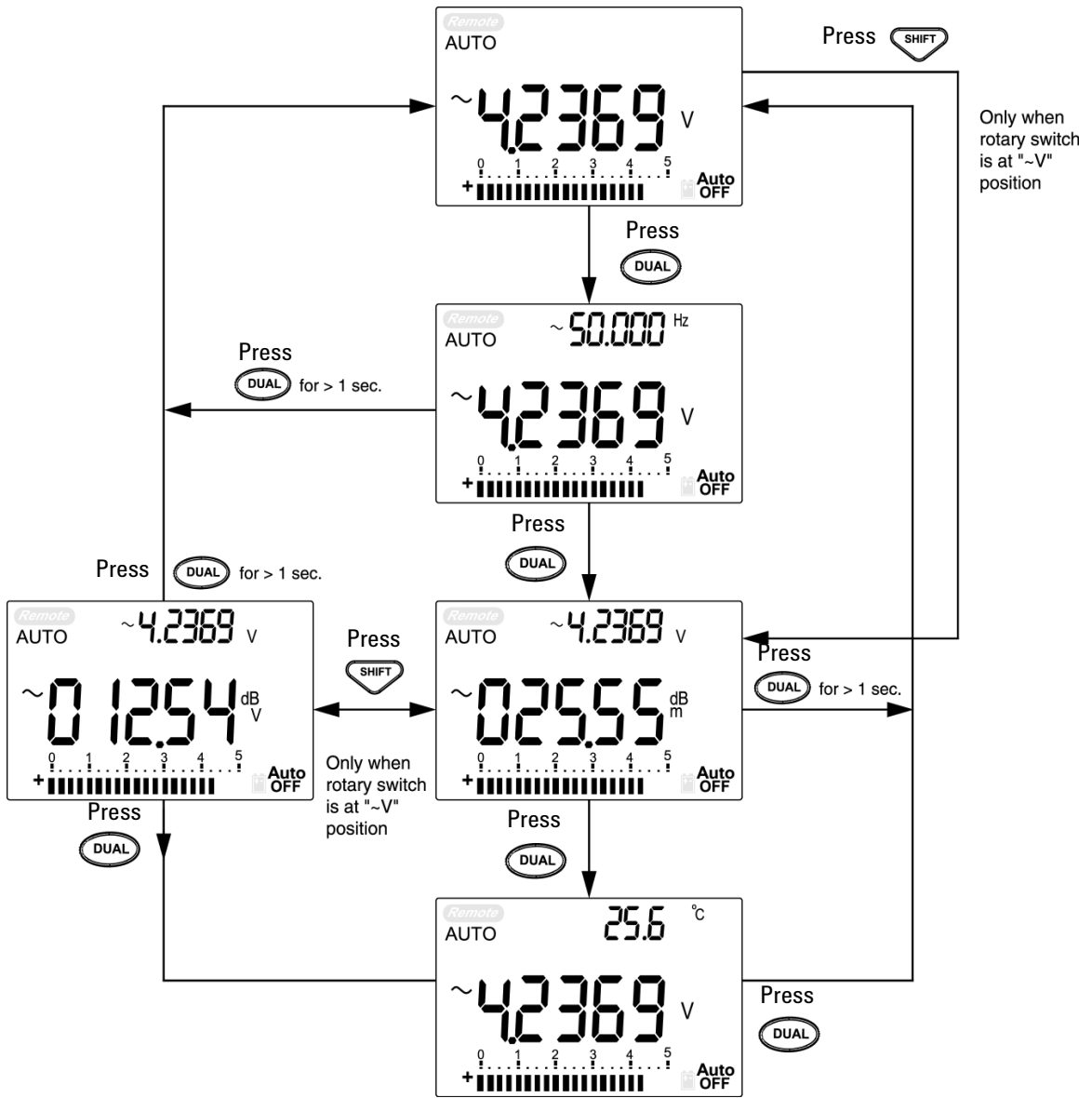

Figure 3-5 dBm/dBV display mode operation

1 ms Peak Hold

The Peak Hold function allows the measurement of peak voltage for analysis of components such as power distribution transformers and power factor correction capacitors. The peak voltage obtained can be used to determine the crest factor:

Crest factor = Peak value/True RMS value

- 1 Press **NULL** for more than 1 second to toggle 1 ms Peak Hold mode ON / OFF.
- 2 Press **HOLD** to scroll through maximum and minimum peak readings. **HOLD MAX** indicates the maximum peak, while **HOLD MIN** indicates the minimum peak.

NOTE

- If the reading is "OL", press **RANGE** to change the measuring range and to re-start the peak-recording measurement.
- If you need to re-start the peak recording, press **DUAL**.

- 3 Press and hold **DUAL** or **NULL** for more than 1 second to exit this mode.
- 4 According to the measurements shown in [Figure 3-6](#) on page 60, the crest Factor will be $2.5048/1.768 = 1.416$.

3 Features and Functions

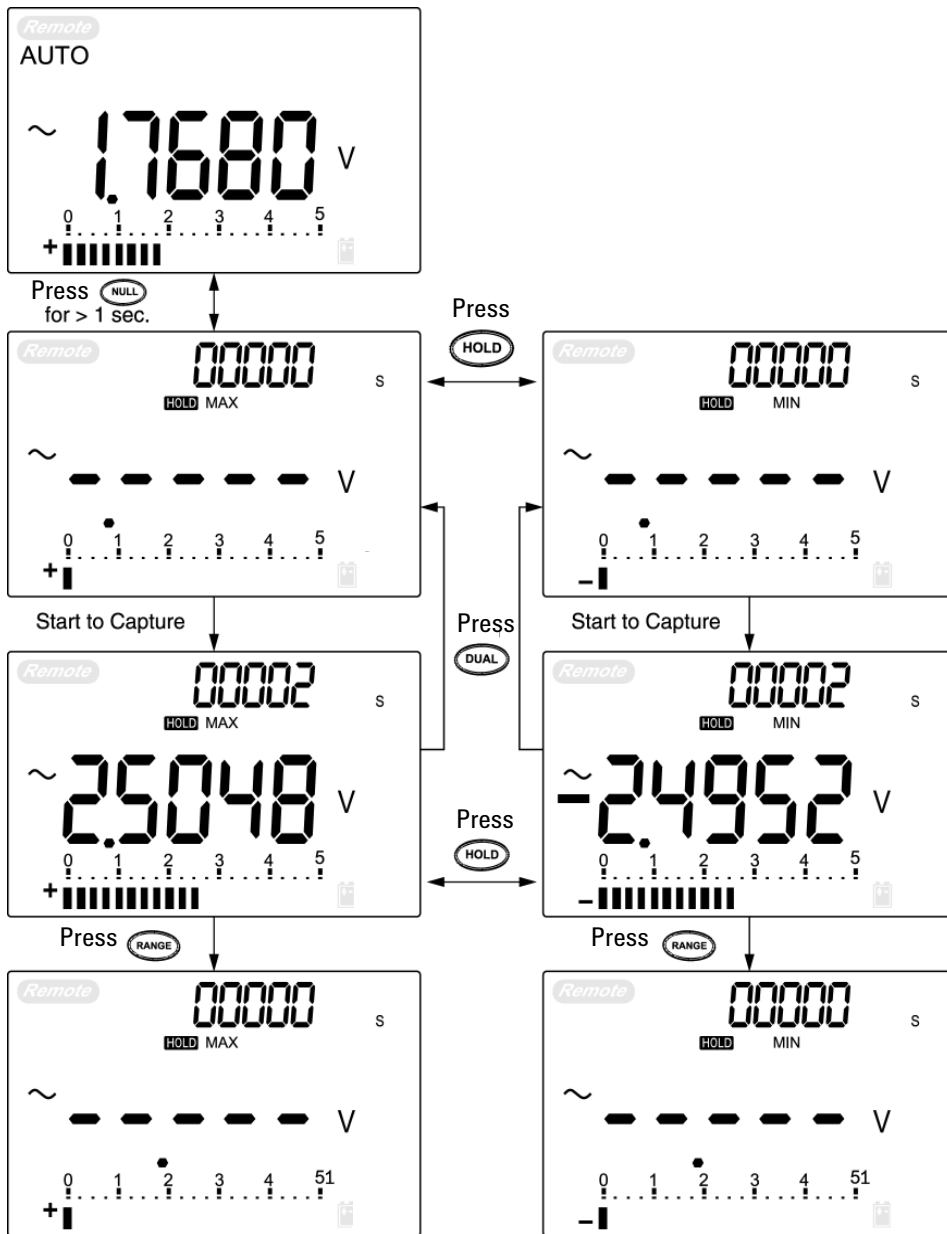

Figure 3-6 1 ms peak hold mode operation

Data Logging

The data logging function provides the convenience of recording test data for future review or analysis. Since data is stored in nonvolatile memory, the data remains saved even if the multimeter is turned OFF or the battery is changed.

The two options offered are manual (hand) logging and interval (time) logging functions, which is determined in the Setup mode.



Data logging records the values on the primary display only.

NOTE

To use the data logging function, you will need to connect the multimeter to a PC using the U1173A IR-to-USB cable (purchased separately) and download the data logging software from Agilent's website. Please go to: <http://www.agilent.com/find/hhTechLib> to download the software.

Manual logging

Firstly, ensure that manual (hand) logging is specified in Setup mode.

- 1 Press  for more than 1 second to store the present value and function on the primary display to the non-volatile memory. The **LOG** and the logging index will be indicated. The logging index flashes on the secondary display for 3 seconds before returning to normal display.
- 2 Press and hold  again for the next value that you would like to save into the memory.

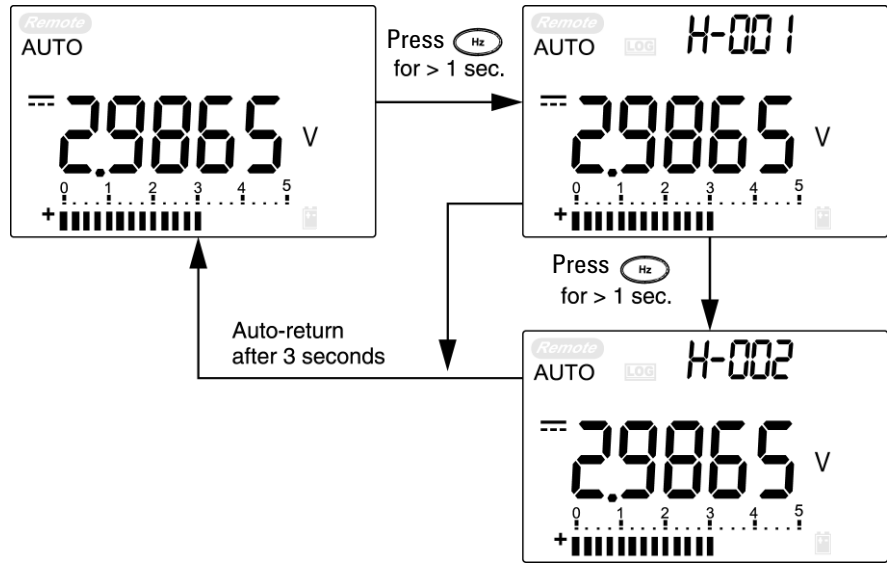

Figure 3-7 Hand (Manual) logging mode operation

NOTE

The maximum data that can be stored is 100 entries. When the 100 entries are filled, the secondary display indicates "FULL", as shown in Figure 3-8.

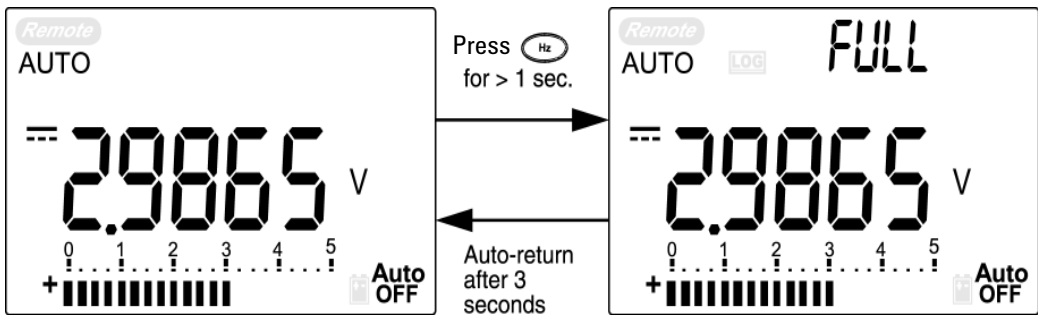



Figure 3-8 Full Log

Interval logging

Firstly, ensure that interval (time) logging is specified in Setup mode.

- 1 Press  for more than 1 second to store the present value and function on the primary display into the non-volatile memory. The **LOG** and the logging index will be indicated. The readings are automatically saved into the permanent memory at intervals set using the Setup mode.

NOTE

The maximum data that can be stored is 200 entries. When the 200 entries are filled, "**FULL**" is indicated on the secondary display.

- 2 Press  for more than 1 second to exit this mode.

NOTE

When interval (automatic) logging is enabled, all keypad operations are disabled, except for the Log function.

3 Features and Functions

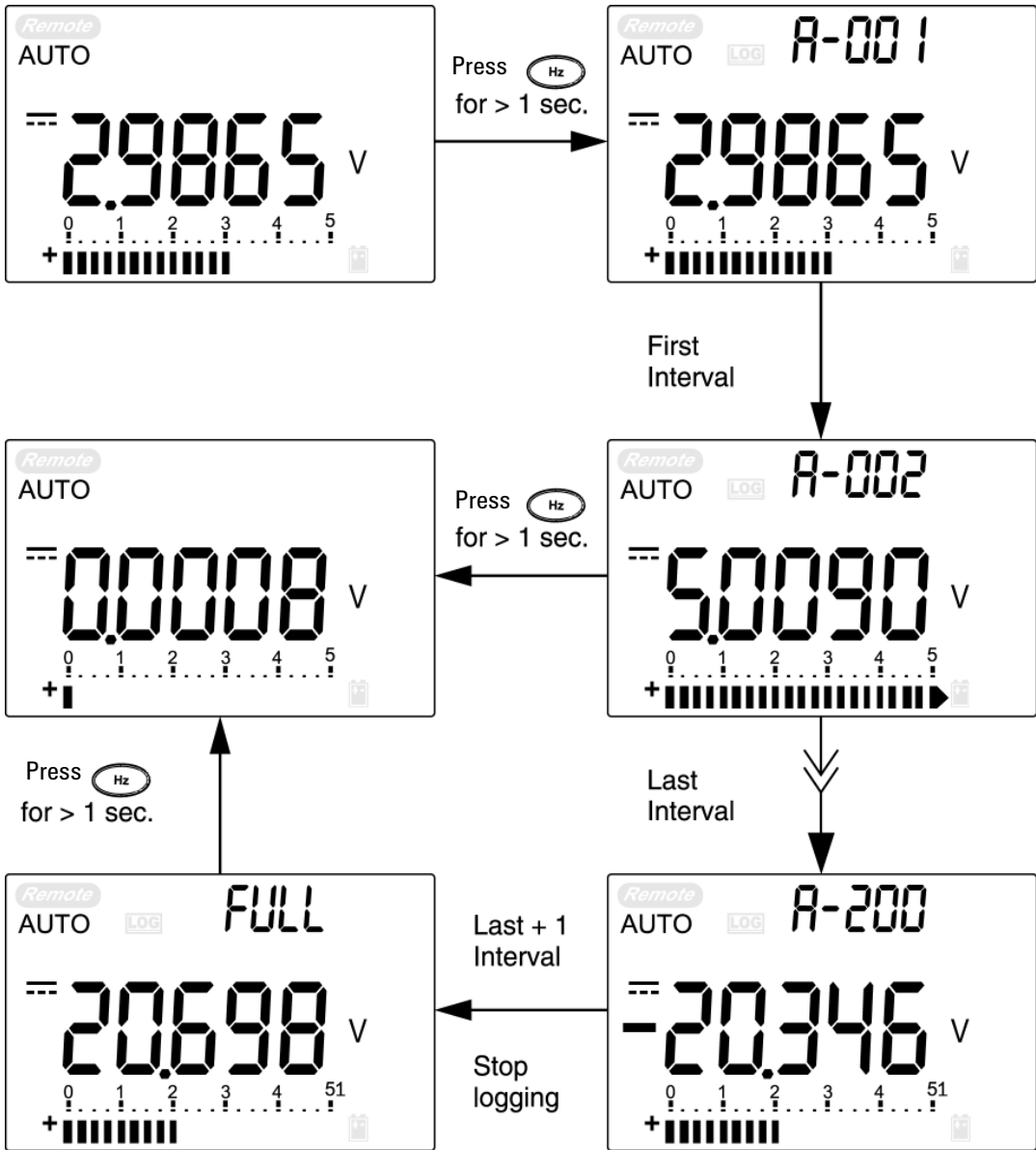











Figure 3-9 Interval (Automatic) logging mode operation

Reviewing logged data

- 1 Press  for more than 1 second to enter the Log Review mode. The last recorded entry and the last logging index are displayed.
- 2 Press  to switch between hand (manual) and interval (automatic) logging review mode.
- 3 Press  to ascend or  to descend through the logged data. Press  to select the first record and press  to select the last record for quick navigation.
- 4 Press  for more than 1 second at the respective Log Review mode to clear logged data.
- 5 Press  for more than 1 second to exit mode.
- 6 During the data review in either manual or interval logging mode, press  for more than one second to clear all the logged values.

3 Features and Functions

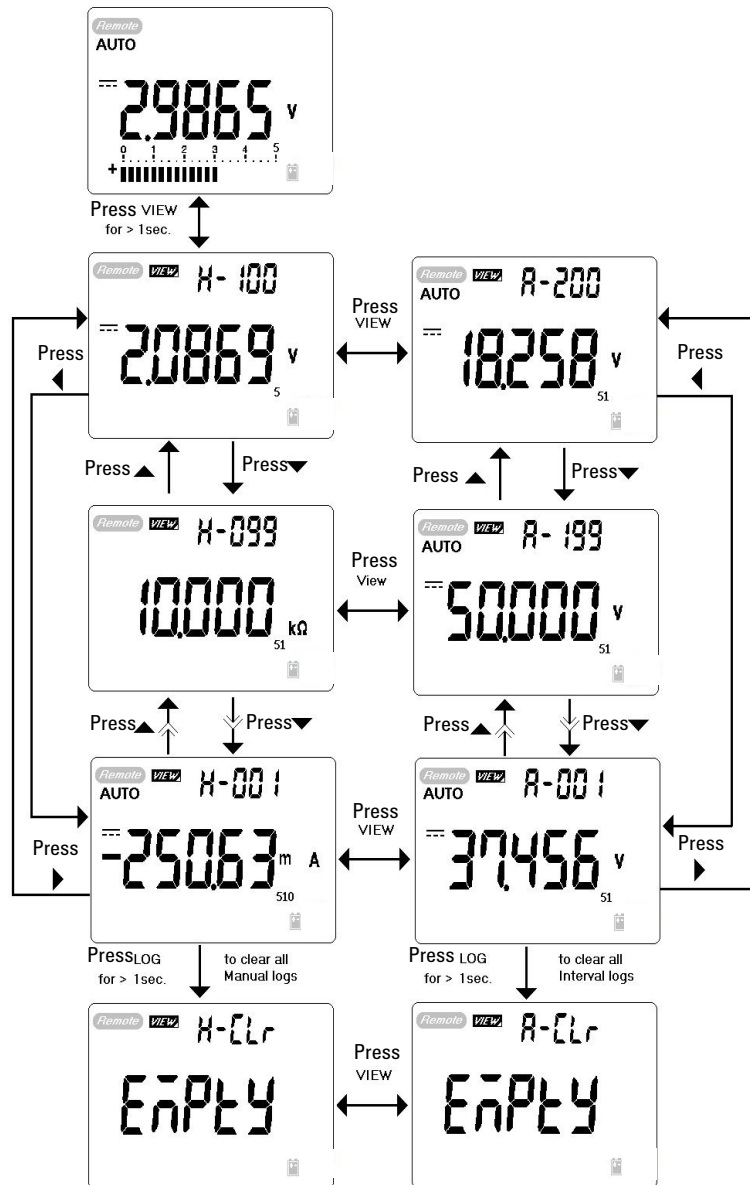

Figure 3-10 Log review mode operation



Square Wave Output (for U1252A)

The square wave output function can be used to generate a PWM (pulse width modulation) output or provide a synchronous clock source (baud rate generator). You can also use this function to check and calibrate flow-meter displays, counters, tachometers, oscilloscopes, frequency converters, frequency transmitters, and other frequency input devices.

- 1 Turn the rotary switch to $\overline{\text{OUT}}$ position. The default display setting is 600 Hz on the secondary display and 50% duty cycle on the primary display.
- 2 Press ◀ or ▶ to scroll through the available frequencies (choose from the available 28 frequencies):

Frequency (Hz)
0.5, 1, 2, 5, 10, 15, 20, 25, 30, 40, 50, 60, 75, 80, 100, 120, 150, 200, 240, 300, 400, 480, 600, 800, 1200, 1600, 2400, 4800

NOTE

Pressing  is the same as pressing .

- 3 Press  to select the duty cycle (%) on the primary display.
- 4 Press ▲ or ▼ to adjust the duty cycle. Duty cycle can be set for 256 steps and each step is 0.390625%. The display only indicates the best resolution with 0.001%.

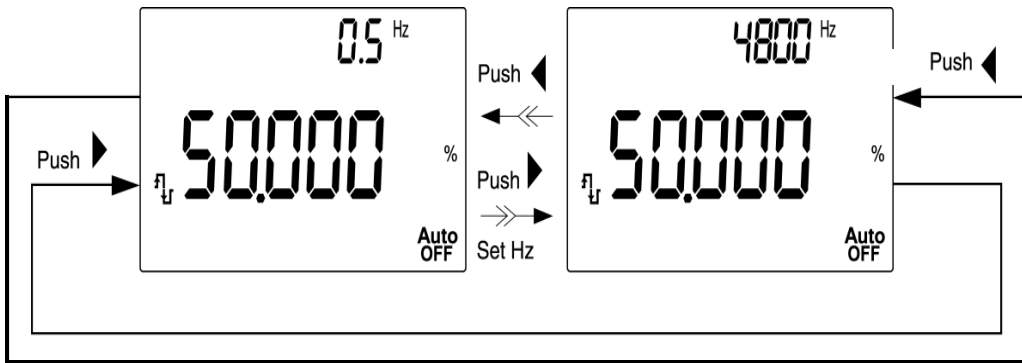





Figure 3-11 Frequency adjustment for square wave output

- 5 Press  to select the pulse width (ms) on the primary display.
- 6 Press  or  to adjust the pulse width. The pulse width can be set for 256 steps and each step is $1 / (256 \times \text{Frequency})$. The display range automatically adjusts in the range of 9.9999~9999.9 ms.

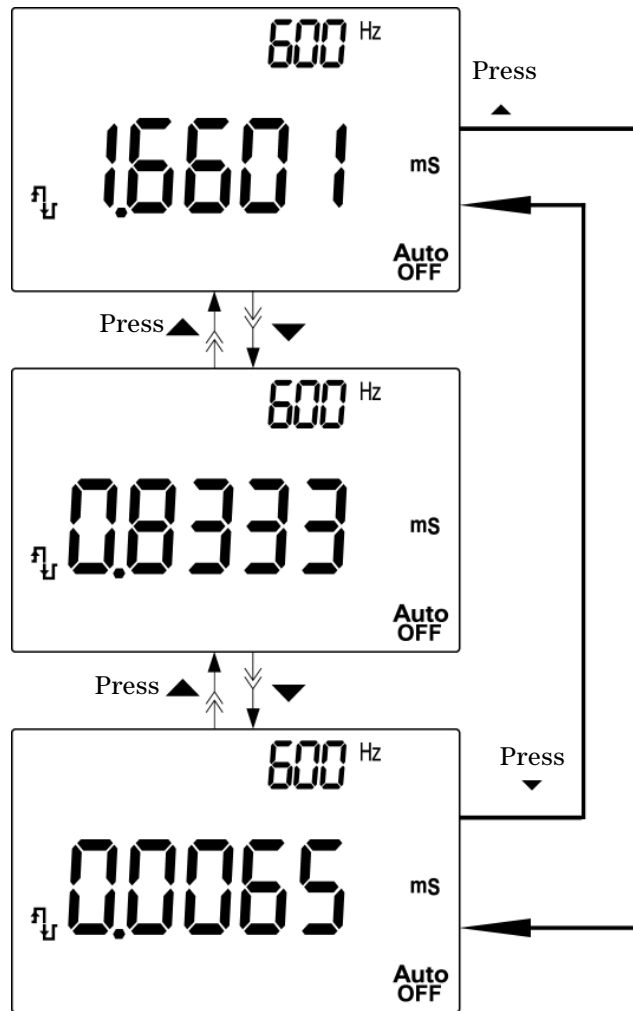

Figure 3-12 Pulse width adjustment for square wave output

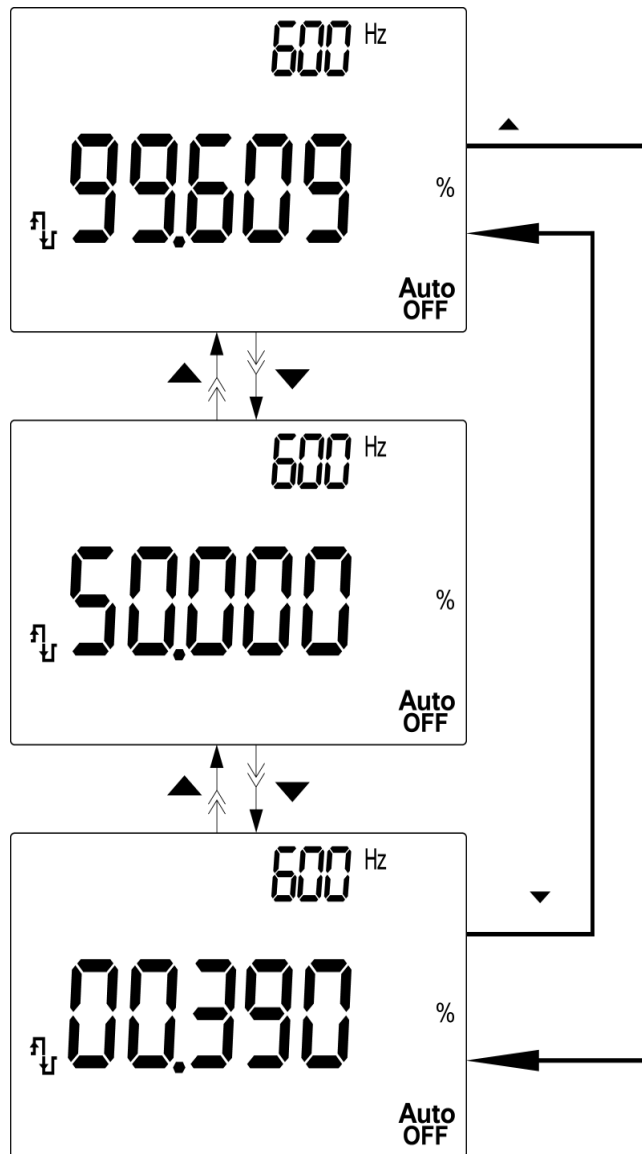

Figure 3-13 Duty cycle adjustment for Square Wave

Remote Communication

The meter has a bi-directional (full duplex) communication capability that speeds data storing from the meter to the PC. To use this feature, you are required to use the optional IR-USB cable with the application software included in the CD or downloadable from the Agilent Web site.

For details on performing PC to meter remote communication click on Help after launching the Agilent GUI Data Logger Software or refer to the [GUI Data Logger Quick Start Guide](#) (U1251-90023) for more information.

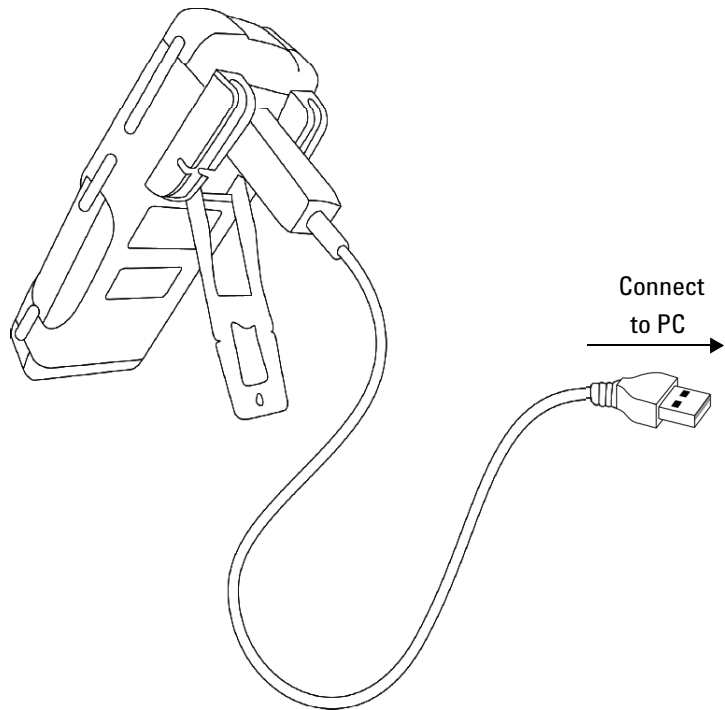

Figure 3-14 Cable connection for remote communication

3 Features and Functions



4 Changing The Default Setting

Selecting Setup Mode	74
Setting Data Logging Mode	78
Setting Thermocouple Types (U1252A only)	79
Setting Reference Impedance for dBm Measurement	80
Setting Minimum Frequency Measurement	81
Setting Temperature Unit	82
Setting Auto Power Saving Mode	84
Setting Percentage (%) Scale Readout	86
Setting Beep Frequency	87
Setting Backlight Timer	88
Setting Baud Rate	89
Setting Parity Check	90
Setting Data Bit	91
Setting Echo Mode	92
Setting Print Mode	93
Returning to Default Factory Settings	94

This chapter shows you how to change the default factory settings of the U1251A and U1252A and other available setting options



Selecting Setup Mode

To enter the Setup mode, perform the following steps:

- 1 Turn the meter OFF.
- 2 From the OFF position, press and hold  while turning the rotary switch to any non-OFF position.

NOTE

When you hear a beep, the meter is in Setup mode and you can release



To change a menu item setting in Setup mode, perform the following steps:









- 1 Press  or  to scroll through the menu items.
- 2 Press  or  to scroll through the available settings. See [Table 4-1](#), “Available setting options in Setup mode,” for details of available options.
- 3 Press  to save changes. These parameters will remain in the non-volatile memory.
- 4 Press  for more than 1 second to exit Setup mode.

Table 4-1 Available setting options in Setup mode



Menu Item		Available setting options		Default factory setting
Display	Description	Display	Description	
rHoLd ^[1]	Refresh Hold	OFF	Enables Data Hold (manual trigger)	500
		100–1000	Sets the variation count that determines Refresh Hold (auto trigger)	
rESet	Reset	dEFAU	Enables the reset of factory settings by pressing and holding  for more than 1 second	dEFAU
Print	Print	ON, OFF	Enables auto send of data to the PC continuously when set to ON	OFF
ECHO	Echo	ON, OFF	Enables the return of characters to the PC when set to ON	OFF
dAtAb	Data bits	7-bit, 8-bit	Sets the data bit length for the remote communication (remote control with PC)	8-bit
PARy	Parity check	En, Odd, nOnE	Sets the even, odd or no parity check for the remote communication (remote control with PC)	nOnE
bAUd	Baud rate	2400 Hz, 4800 Hz, 9600 Hz, 19200 Hz	Sets the baud rate for the remote communication (remote control with PC)	9600 Hz
b-Lit	Backlit display	1–99 s ^[2]	Sets the timer for the auto turn-off for the backlit display	30 s
		OFF	Disables the auto turn-off for the backlit display	
bEEP	Frequency of beep sound of meter	2400 Hz, 1200 Hz, 600 Hz, 300 Hz	Sets the frequency of the meter's beep sound	2400 Hz
		OFF	Disables the meter's beep sound	
PErnt	Percentage scale	0–20 mA, 4–20 mA	Sets the % scale readout	4–20 mA
APF	Auto power off	1–99 m ^[2]	Sets the timer for auto power off	10 m
		OFF	Disables auto power off	
FrEq	Minimum frequency that can be measured	0.5 Hz, 1 Hz, 2 Hz, 5 Hz	Sets the minimum frequency that can be measured	0.5 Hz
rEF	Reference impedance for dBm measurement	1–9999 Ω ^[2]	Sets the reference impedance for dBm measurement	50 Ω

4 Changing The Default Setting

Table 4-1 Available setting options in Setup mode (continued)

t.CoUP ^[3]	Thermocouple	tYPE K	Sets the thermocouple type to K-type	tYPE K
		tYPE J	Sets the thermocouple type to J-type	
d-LoG	Data logging	Hand	Enables manual data logging	Hand
		1-9999 s ^[2]	Sets the interval for automatic data logging	
tEMP ^[4]	Temperature	d-CF	Sets the temperature measurement to °C but pressing  swaps the display to °F	d-CF
		d-F	Sets the temperature measurement to °F	
		d-FC	Sets the temperature measurement to °F but pressing  swaps display to °C	
		d-C	Sets the temperature measurement to °C	

Notes for setting options in Setup mode:

- 1 This is the first option displayed once the user enters Setup mode.
- 2 For b-Lit, APF, rEF and d-LoG menu items, the user can select the digit to be adjusted by pressing .
- 3 This menu option is only available for the U1252A.
- 4 To view the tEMP menu item, press  for more than 1 second.

Setting Data Hold/Refresh Hold Mode

1. Set OFF to enable the Data Hold mode (manual trigger by key or bus via the remote control).
2. Set the variation count within the 100 to 1000 range to enable the Refresh Hold mode (auto trigger). When the variation of the measuring value exceeds the setting of the variation count the Refresh Hold will be ready to trigger.

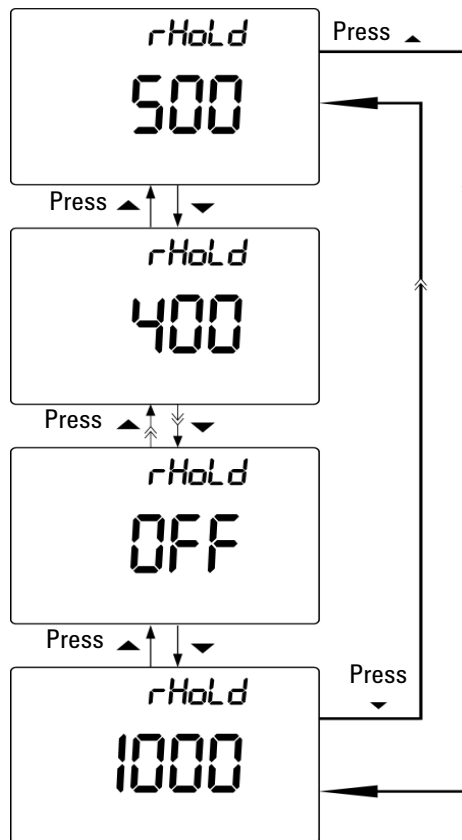

Figure 4-1 Data hold/Refresh hold setup

Setting Data Logging Mode

- 1 Set to “Hand” to enable the manual data logging mode.
- 2 Set the interval within 0001 to 9999 seconds to enable interval (automatic) data logging mode.
- 3 Press and hold ◀ or ▶ for more than 1 second to switch between manual and interval data logging setup.

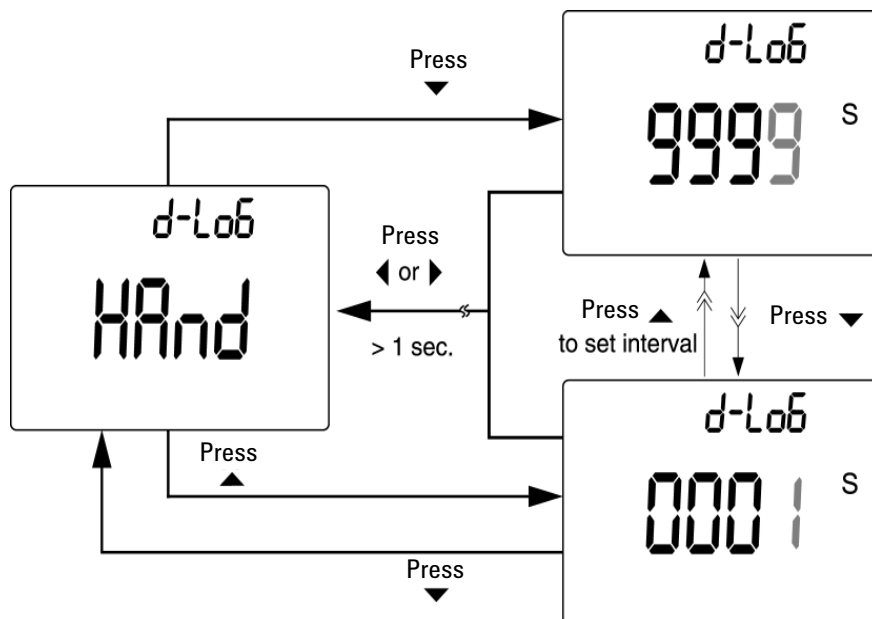

Figure 4-2 Data logging setup

Setting Thermocouple Types (U1252A only)

The thermocouple sensor types that can be selected are type-K (default) or type-J. Press ▲ or ▼ to switch between the J and the K type.

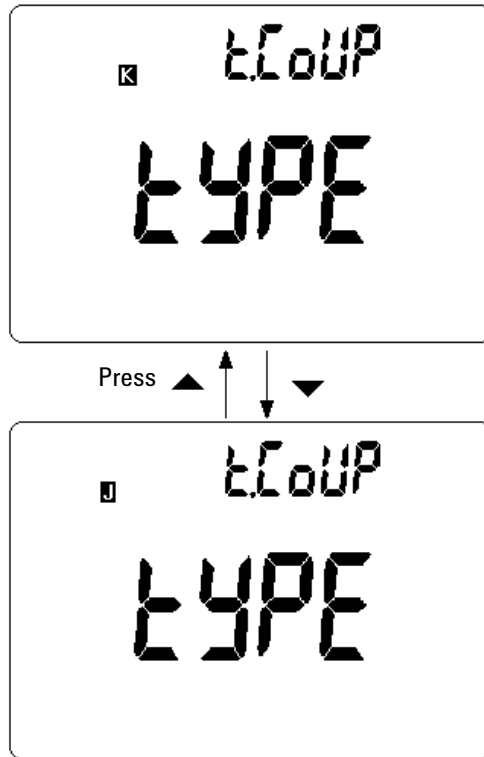

Figure 4-3 Thermocouple type setup

Setting Reference Impedance for dBm Measurement

The reference impedance can be set from 1 to 9999 Ω . The default value is 50 Ω .

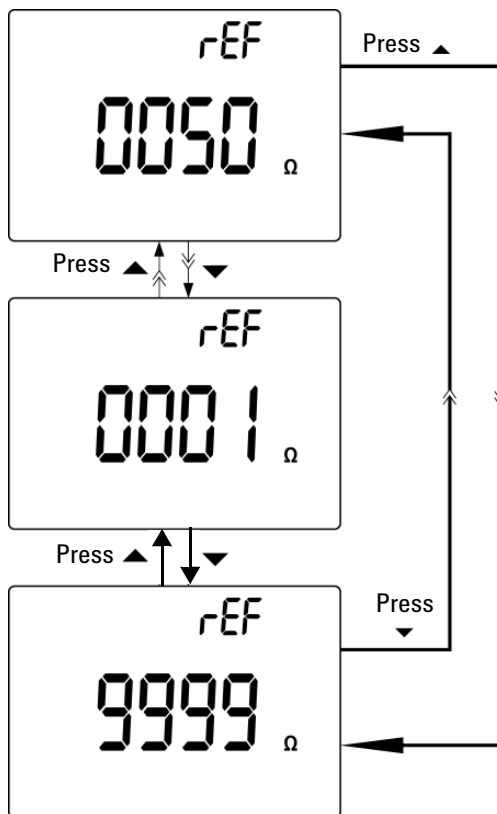

Figure 4-4 Reference impedance for dBm measurement setup

Setting Minimum Frequency Measurement

The minimum frequency setup influences the measuring rates for frequency, duty cycle, and pulse width. The typical measuring rate defined at the general specification is based on the minimum frequency of 1 Hz.

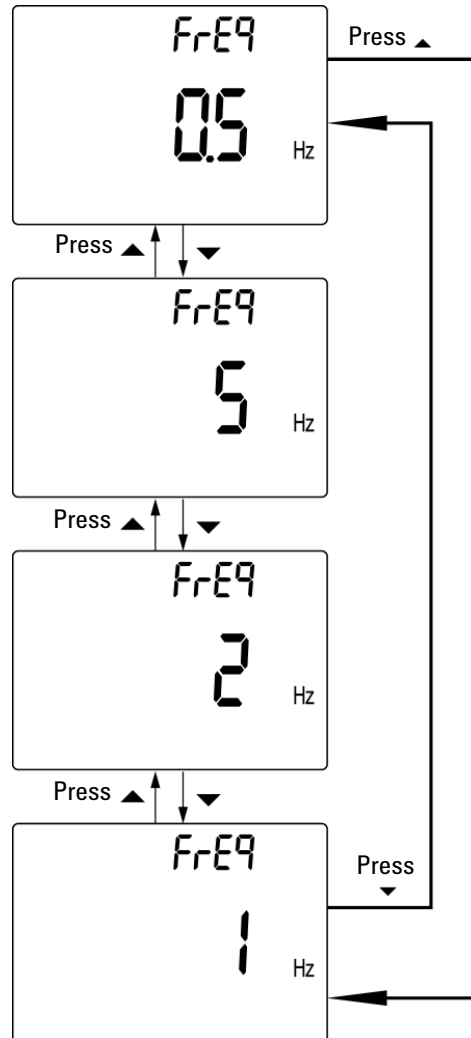



Figure 4-5 Minimum frequency setup

Setting Temperature Unit

Four combination displays are available:

- Celsius only (°C on primary display) single display setting
- Celsius-Fahrenheit (d-CF) and Fahrenheit-Celsius (d-FC) dual display setting.

NOTE

Primary-Secondary Display can be swapped by pressing  .

- Fahrenheit only (°F on primary display) single display setting.

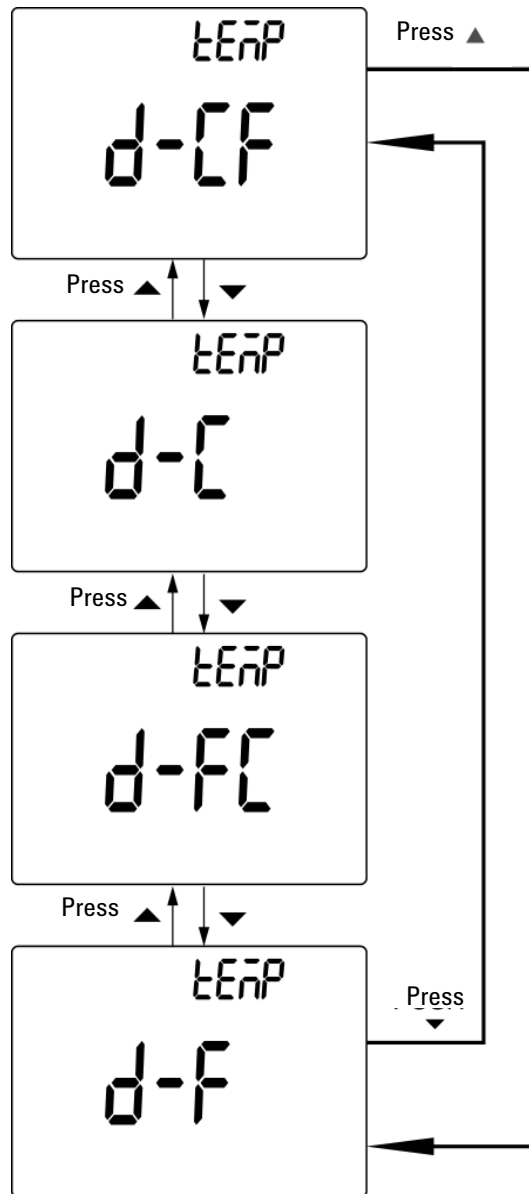

Figure 4-6 Temperature unit setup

Setting Auto Power Saving Mode

- The timer for APF (Auto Power OFF) can be set for the range of 1 to 99 minutes.
- To activate the meter after it has “auto powered-off”, turn the rotary switch to the OFF position. Then turn it back on again.

Auto

- **OFF** will be shown on the display during subsequent measurements.

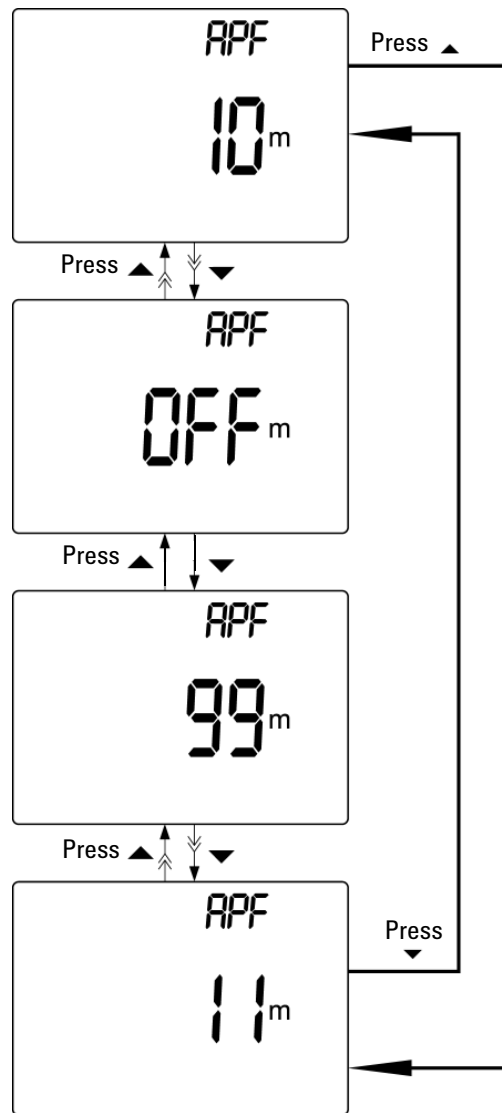

Figure 4-7 Auto power saving setup

Setting Percentage (%) Scale Readout

This setting converts the DC current measuring display to percentage (%) scale readout – 4–20 mA or 0–20 mA as proportional to 0~100%. The 25% scale readout represents DC 8 mA at 4–20 mA and DC 5 mA at 0–20 mA.



Figure 4-8 % scale readout setup

Setting Beep Frequency

The driving frequency can be set to 2400, 1200, 600, or 300Hz. "OFF" disables the beep.

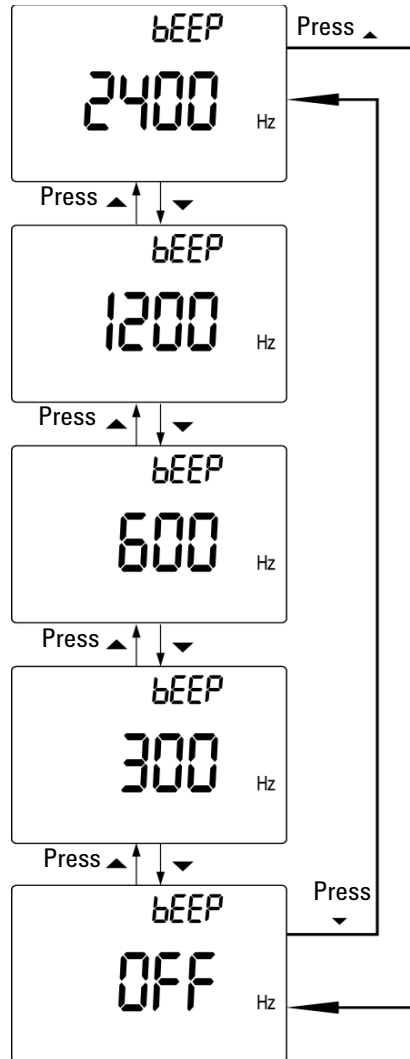

Figure 4-9 Beep frequency setup

Setting Backlight Timer

- The timer can be set to 1 to 99 seconds. The backlight will turn off automatically after the set period.
- “OFF” disables turning off backlit automatically.

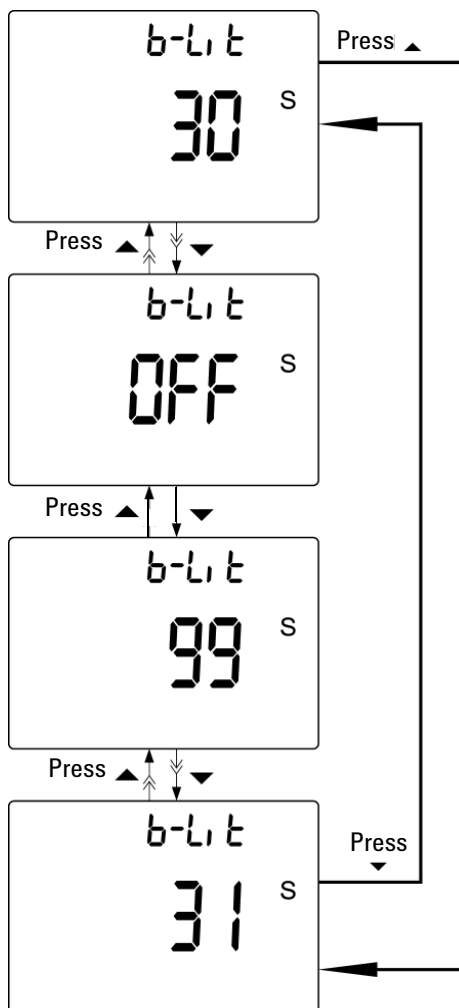

Figure 4-10 Backlit timer setup

Setting Baud Rate

Select the baud rate for remote control. The available settings are 2400, 4800, 9600, and 19200 Hz.

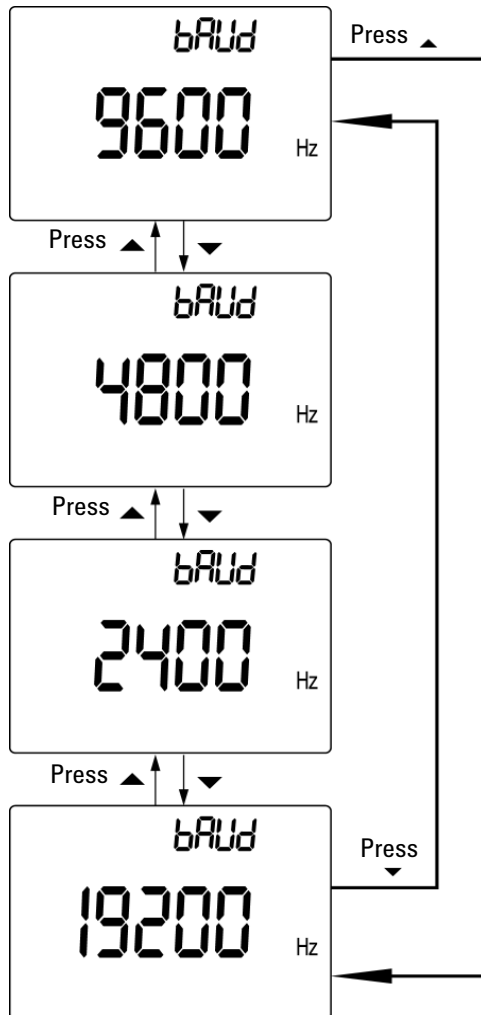

Figure 4-11 Baud rate setup remote control

Setting Parity Check

Select the parity check for remote control. It can be set to none, even, or odd bit.

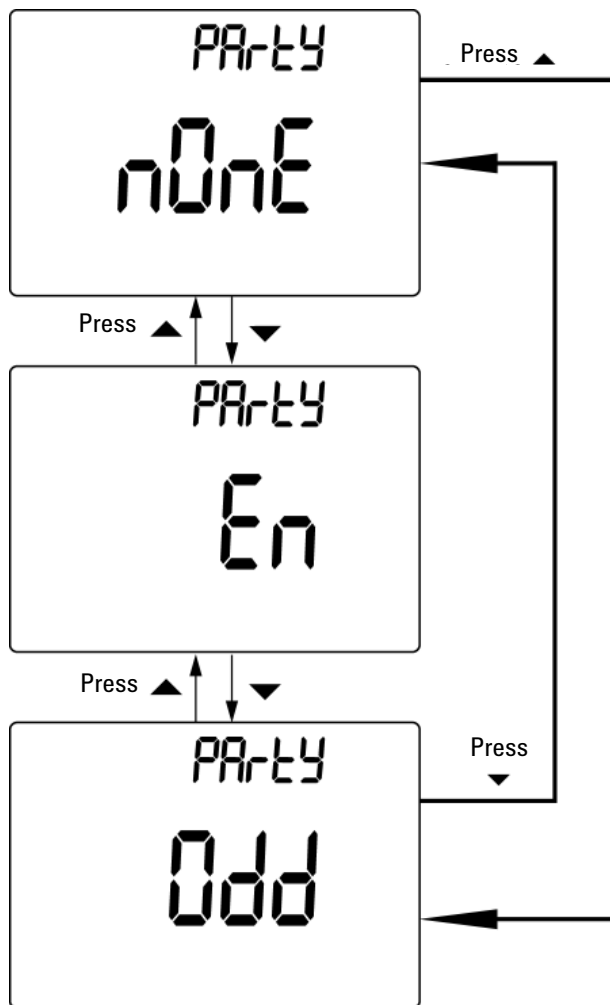

Figure 4-12 Parity check setup

Setting Data Bit

Select the data bit for remote control. It can be set to either 8 or 7 bits.

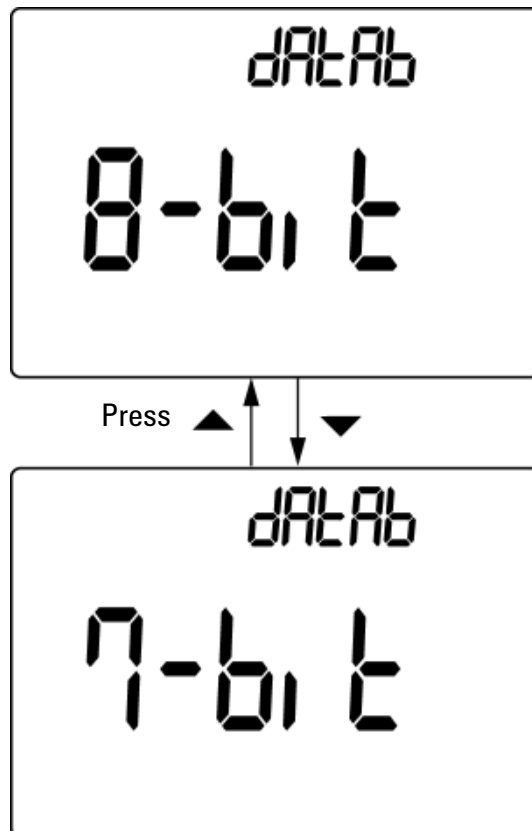

Figure 4-13 Data bit setup for remote control

Setting Echo Mode

- Echo ON enables the return of characters to the PC in remote communication.
- Echo OFF disables the return of characters to the PC.

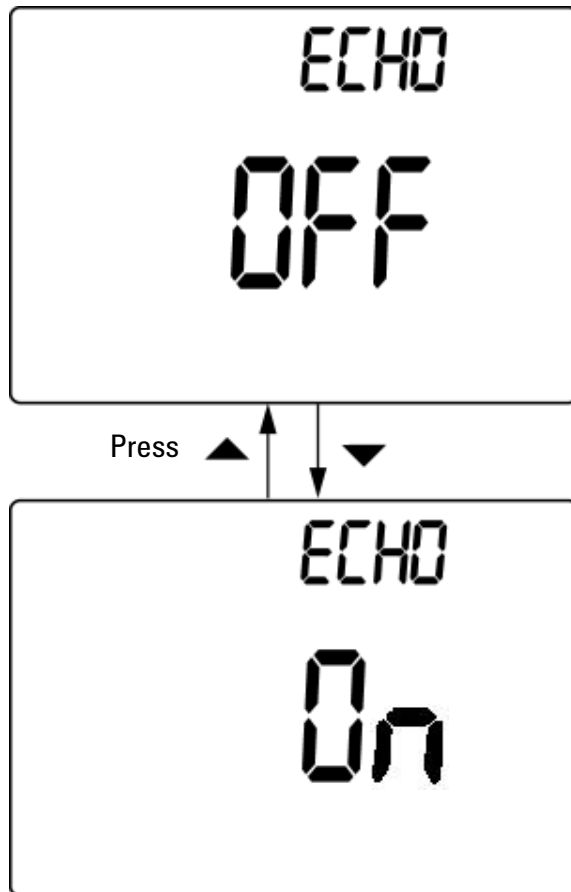

Figure 4-14 Echo mode setup for remote control

Setting Print Mode

Print ON enables the printing of measured data to the PC when the measuring cycle is completed. In this mode, the meter automatically sends the newest data to the host continuously but does not accept any commands from the host. **Remote** flashes during the Print operation.

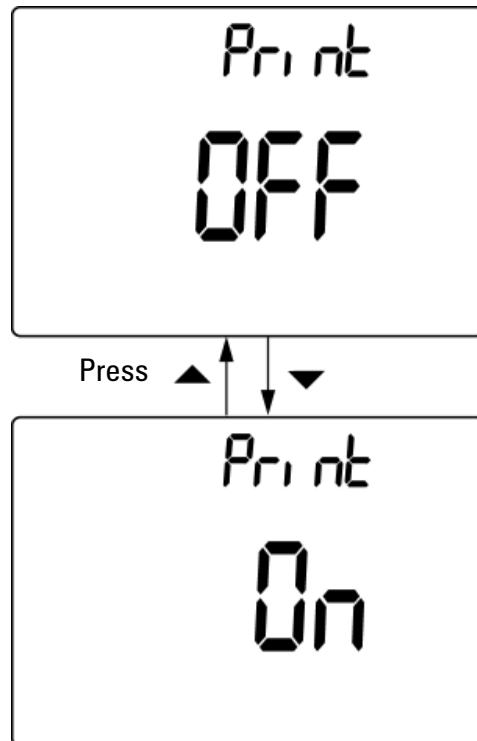



Figure 4-15 Print mode setup for remote control

Returning to Default Factory Settings

- Press  for more than 1 second to reset to the default factory settings all menu options except the Temperature setting.
- The Reset menu item automatically reverts to Refresh Hold menu item after reset has taken place.

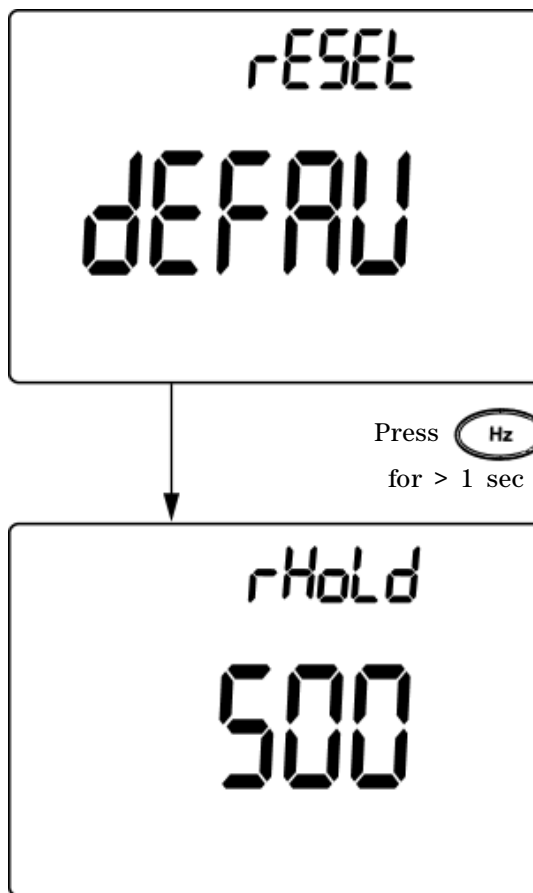

Figure 4-16 Reset setup



5 Maintenance

Introduction	96
General maintenance	96
Battery replacement	96
Storage considerations	98
Charging the battery	98
Fuse checking procedure	105
Replacing the fuse	106
Troubleshooting	108
Replaceable Parts	109
To order replaceable parts	109

This chapter will go through how to troubleshoot the handheld digital multimeter if any problems arise.



Introduction

CAUTION

Any repair or service which is not covered in this manual should only be performed by qualified personnel.

General maintenance

WARNING

Ensure that the terminal connections are correct for that particular measurement before proceeding. To avoid damaging the device, do not exceed the input limit.

Besides the above hazard, dirt, or moisture in the terminals can distort readings. The steps for cleaning are as follows:

- 1 Turn the meter off and remove the test leads.
- 2 Turn the meter over and shake out any dirt that may have accumulated in the terminals.
- 3 Wipe the case with a damp cloth and a mild detergent – do not use abrasives or solvents. Wipe the contacts in each terminal with a clean swab dipped in alcohol.

Battery replacement

The meter is powered by a 9 V Ni-MH rechargeable battery, 7.2 V nominal voltage. Use only the specified type (refer to [Figure 5-1](#) below).

To ensure that the correct battery type is used, replace the battery immediately when the low battery sign flashes. If your meter has the rechargeable battery type, refer to the section “[Charging the battery](#)” on page 98. The steps for battery replacement are listed below:

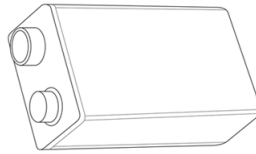
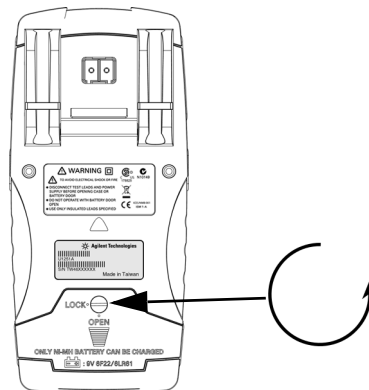

Figure 5-1 9 V rectangular battery

- 1 At the rear panel, turn the screw on the battery cover from the LOCK to the OPEN position (counterclockwise).
- 2 Slide down the battery cover.
- 3 Lift the battery cover up.
- 4 Replace the specified battery.
- 5 Reverse the above steps to close the cover.



NOTE

List of compatible batteries for the Agilent U1251A :

- 9 V Alkaline non-chargeable battery (ANSI/NEDA 1604A or IEC 6LR61)
- 9 V Carbon-zinc non-chargeable battery (ANSI/NEDA 1604D or IEC6F22)

List of of compatible batteries for the Agilent U1252A:

- 9 V size 300 mA H Ni-MH rechargeable battery, 7.2 V nominal voltage, or 8.4 V nominal voltage
- 9 V Alkaline non-chargeable battery (ANSI/NEDA 1604A or IEC 6LR61)
- 9 V Carbon-zinc non-chargeable battery (ANSI/NEDA 1604D or IEC6F22)

Storage considerations

CAUTION

To avoid instrument damage from battery leakage:

- Always remove dead batteries immediately.
 - It is recommended that the battery is removed and stored separately if the multimeter is to be unused for long periods of time.
-

After the first charge, it is recommended that you fully charge the battery periodically, even when it is not in use. This is because the Ni-MH rechargeable battery pack may drain with time.

NOTE

The performance of the rechargeable battery may degrade with time.

Charging the battery

WARNING

Never discharge the battery by shorting it or by reverse polarity in any subjects. Make sure the battery is the rechargeable type before charging it. Never rotate the rotary switch when the battery is being charged as DC at 24 V is being applied to the charging terminals.

NOTE

For the battery charger, the mains supply voltage should not fluctuate by plus or minus 10%.

CAUTION

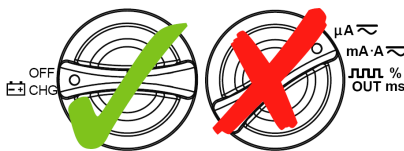

- Do not rotate the rotary switch from OFF CHG position when charging the battery.
- Perform battery charging only with a 9 V Ni-MH rechargeable battery (7.2 V nominal voltage) or 9 V size Ni-MH rechargeable battery (8.4 V nominal voltage).
- Disconnect test leads from all the terminals when charging.
- Ensure proper insertion of battery in the multimeter and follow the correct polarity.

Use the specified 24 V DC adaptor to charge the battery. Remember never to turn the rotary switch of the meter when the battery is being charged. Use the following steps to charge the battery:

- 1 Disconnect the test leads from the meter.
- 2 Turn the rotary switch to the OFF CHG position. Connect the power cord to the DC adapter.
- 3 Plug the Red (+)/ Black (-) banana terminals of the DC adapter to the CHG and the “COM” terminals respectively. The DC adaptor can be replaced with a DC power supply in order to set the 24 V DC output and the over current limitation to a value more than 0.5 A. Ensure that the polarity of the connection is correct.
- 4 The primary display will show “bAt” and the “SbY” will be shown on the secondary display and a short beep will sound to remind you whether you need to charge the battery. Press **SHIFT** to start charging the battery, or the meter will automatically start the self-test after the 24 V supply is applied. It is recommended that you do not charge if the battery’s capacity is over 90%.

Table 5-1 Battery voltage and corresponding percentage of charges in standby and charging modes

Condition	Battery voltage	Proportional percentage
Trickle (SBY)	6.0 V to 8.2 V	0% to 100%
Charging	7.2 V to 10.0 V	0% to 100%

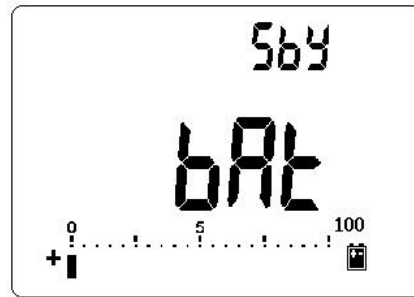

Figure 5-2 Battery capacity display as trickle

- After pressing Shift or when the self-test starts, the meter performs a self-test to check if the battery in the meter is the rechargeable type. The self-test takes about 2 to 3 minutes. Avoid pressing any button during the self-test. A message is displayed as shown below.



Figure 5-3 Self-test

Table 5-2 Error messages

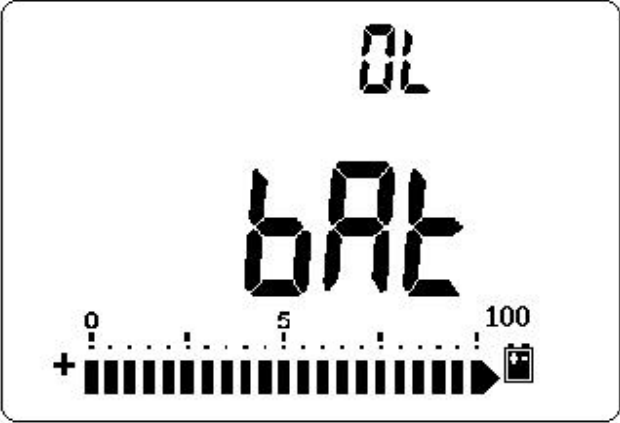
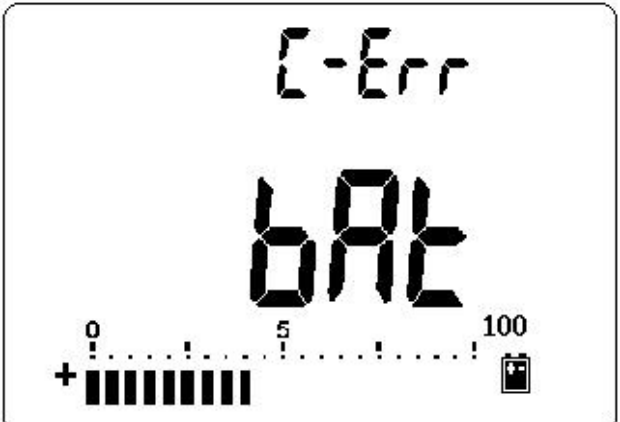
Error	Error message
<p>OL</p> <ol style="list-style-type: none"> 1 No battery inside 2 Faulty battery 3 Battery is fully charged 	
<p>C-Err</p> <ol style="list-style-type: none"> 1 If charging battery more than 12 V or less than 5 V 2 In 3 minutes, if the battery voltage does not go upwards then charge error 	

NOTE

- If the **OL** message appears while the battery is inside, do not charge the battery.
- If the **C-Err** message appears, check if the battery is the specified type. Use the battery as specified in this manual. Ensure that the battery is the correct rechargeable type before charging it again. After replacing with the correct rechargeable battery, press Shift to perform the self-test again. If the C-Err message reappears, replace with a new battery.

- 6 The smart charging mode will start if the meter passes the self-test. The charging time is limited to not more than 220 minutes. The secondary display will count down the charging time. During charging, no buttons can be pressed. The error message may appear during charging to alert the user of any overcharging of the battery.

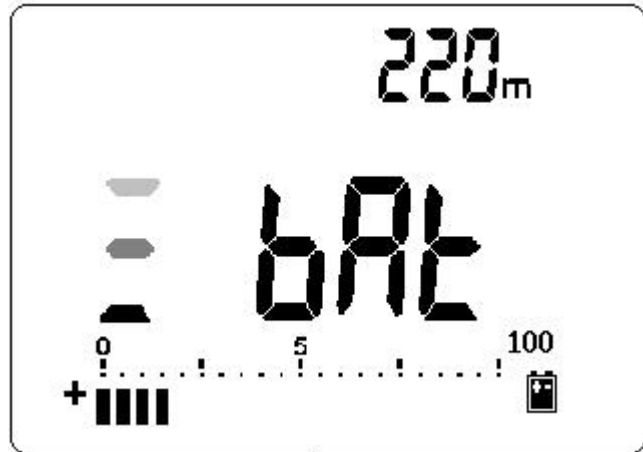



Figure 5-4 Charging mode

- 7 The charge end message (C-End) appears on the secondary display once charging is completed. The trickle charging current is provided to maintain the battery capacity. The flashing signs of  and  appear to show the trickle state.
- 8 Remove the DC adapter when the C-End message appears on the secondary display. Do not turn the rotary switch before removing the adapter from the terminals.

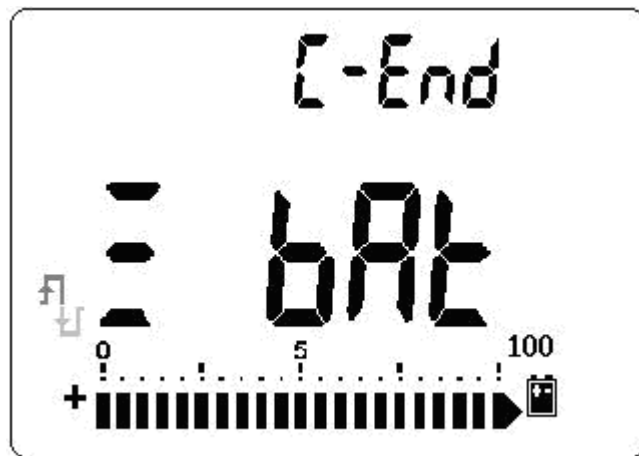

Figure 5-5 Charge end and trickle state

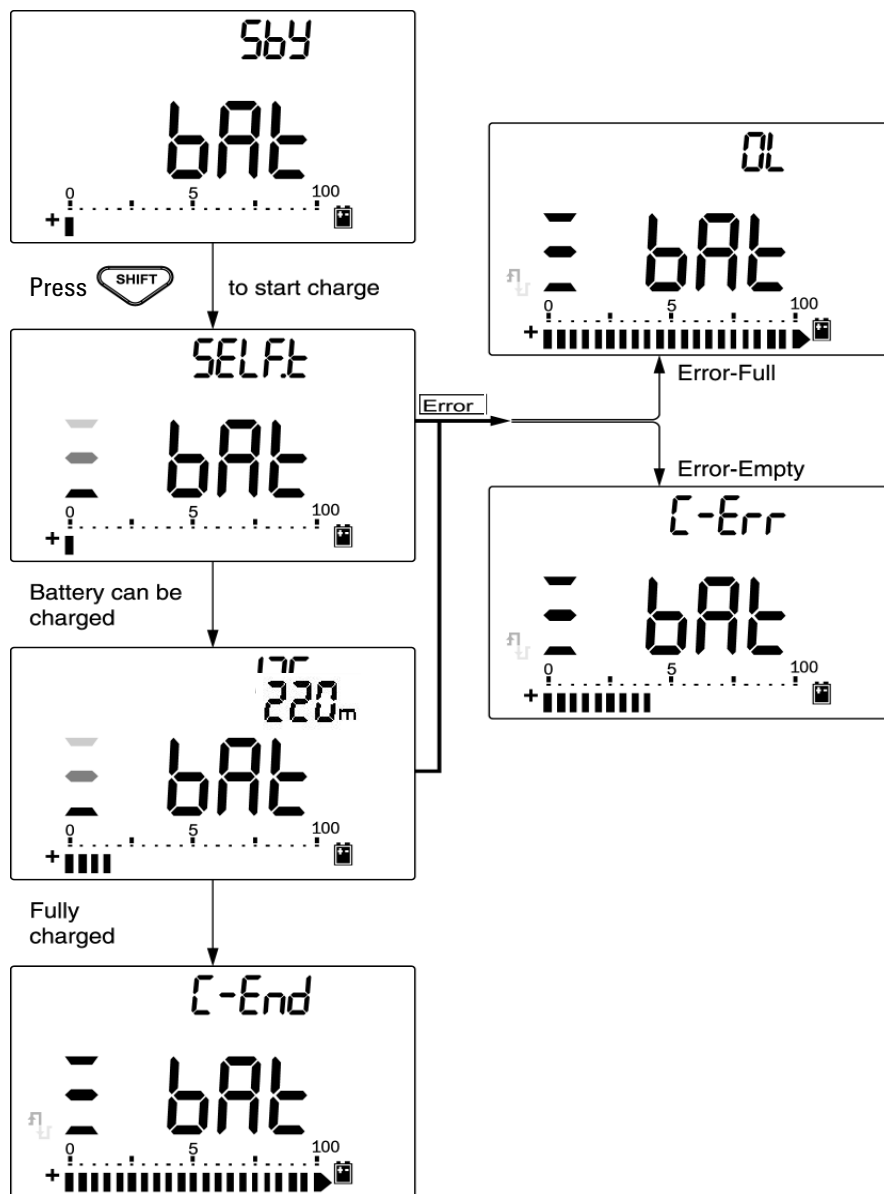
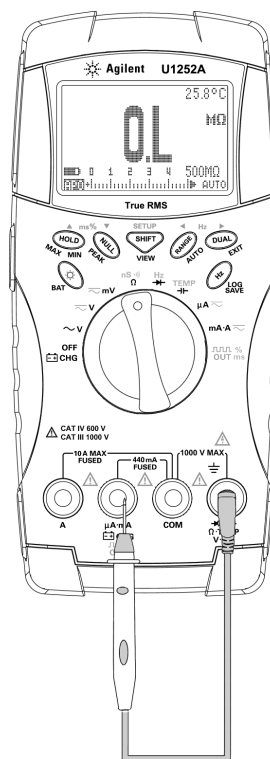

Figure 5-6 Battery charging procedure

Fuse checking procedure

It is recommended that you check the fuses of the multimeter before using it. Follow the instructions below to test the fuses inside the multimeter. Refer to Figure 5-8 for the respective positions of Fuse 1 and Fuse 2.

- 1 Set the rotary switch to Ω .
- 2 Connect the red test lead to the input terminal Ω TEMP V·mV



- 3 To test Fuse 1, place the tip of the test probe on the right half of input terminal μA ·mA CHG. Ensure that the probe tip touches the metal inside the input terminal, as shown in the figure above.

- 4 To test Fuse 2, place and touch the tip of the test probe on the right half of input terminal **A**. Ensure that the probe tip touches the metal inside the input terminal.
- 5 Observe the reading on the instrument's display. Refer to [Table 5-3](#) for the possible readings that could appear).
- 6 Replace the fuse when **OL** is displayed.

Table 5-3 Measurement readings for fuse checking

Current input terminal	Fuse	Fuse rating	Fuse OK (approximately)	Replace fuse
			Displayed readings	
$\mu\text{A}\cdot\text{mA}$	1	440 mA/1000 V	6.2 M Ω	OL
A	2	11 A/1000 V	0.06 Ω	OL

Replacing the fuse

NOTE

This manual provides only the fuse replacement procedures, but not the fuse replacement markings.

Follow the procedures below to replace the fuse.

- 1 Turn the meter off and disconnect the test leads from the external equipment. Make sure to remove the adaptor.
- 2 Wear clean/dry gloves and do not touch any other component except the fuse and plastic parts. The current calibration is considered shunt only, so do not recalibrate the meter after replacing the fuse.
- 3 Remove the battery cover compartment to replace the fuse.
- 4 Loosen the three screws on the bottom case and remove the cover.
- 5 Loosen the two screws on the top corners to lift the circuit board.

- 6 Gently remove the defective fuse by prying one end of the fuse loose and removing it out of the fuse bracket.
- 7 Replace with a new fuse of the same size and rating. Make sure the new fuse is centered in the fuse holder.
- 8 Ensure that the rotary switch on the top case and the circuit board switch stay on the OFF position.
- 9 Then re-fasten the circuit board and the bottom cover.
- 10 Refer to the table below for the part number, rate, and size of the fuses.

Table 5-4 Fuse specifications

Fuse	Agilent part number	Rating	Size	Type
1	2110-1400	440 mA/1000 V	10 mm × 35 mm	Fast blow fuse
2	2110-1402	11 A/1000 V	10 mm × 38 mm	

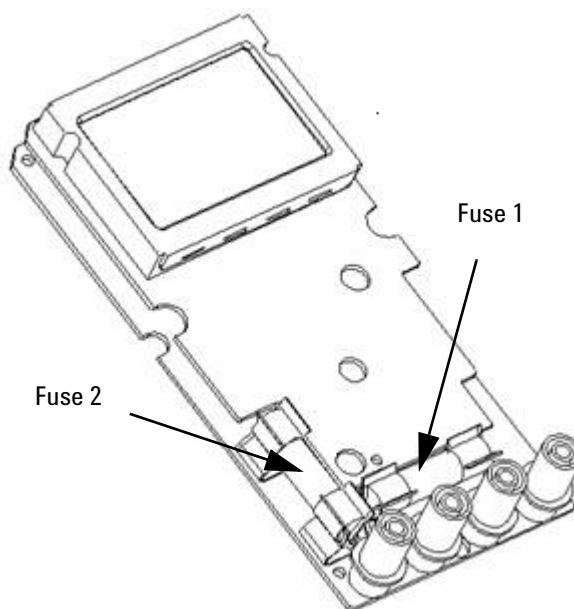
**Figure 5-7** Fuse replacement

Troubleshooting

WARNING

To avoid electrical shock, do not perform any service unless you are qualified to do so.

If the instrument fails to operate, check the battery and the test leads. Replace them if necessary. And if the instrument still does not function, check the operating procedures in this manual. When servicing, use only specified replacement parts. [Table 5-5](#) below will assist you to identify some basic problems and their solutions.

Table 5-5 Basic troubleshooting procedures

Malfunction	Troubleshooting procedure
No LCD display after power ON	<ul style="list-style-type: none"> • Check the battery. Charge or replace it.
No beeper tone	<ul style="list-style-type: none"> • Check the setup mode to verify if the beeper is set to OFF. Then select the desired driving frequency.
Fail on current measurement	<ul style="list-style-type: none"> • Check the fuse.
No charging indication ^[1]	<ul style="list-style-type: none"> • Check 440 mA fuse. • Check the external adaptor to verify if the output is DC 24 V and the adaptor is plugged into the charging terminals completely. • Line power voltage (100V~240 VAC 50 Hz/ 60 Hz).
Battery life very short after full charge/Battery not able to charge after pro-long storage period	<ul style="list-style-type: none"> • Check if the correct rechargeable battery is used. • Try to charge and discharge for 2 or 3 cycles in order to maintain the battery's highest capacity. • NOTE: The performance of the rechargeable battery may degrade with time.
Fail on Remote control	<ul style="list-style-type: none"> • Check that the optical side of the cable is connected to the meter and the text side of the cover is up. • Check the baud rate, parity, Data bit, Stop bit (default is 9600, n, 8, 1) • Driver install for IR-USB.

Notes for basic troubleshooting procedures table:

1 Never turn the rotary switch of the multimeter from the OFF position when it is charging.

Replaceable Parts

This section contains information for ordering replacement parts for your instrument. you can find the instrument support part list at Agilent's Test & Measurement Parts Catalog at: <http://www.agilent.com/find/parts>

The parts lists include a brief description of each part with applicable Agilent part number.

To order replaceable parts

You can order replaceable parts from Agilent using the Agilent part number. Note that not all parts listed are available as field-replaceable parts.

To order replaceable parts from Agilent, do the following:

- 1** Contact your nearest Agilent Sales Office or Service Center.
- 2** Identify the parts by the Agilent part number shown in the support parts list.
- 3** Provide the instrument model number and serial number.



6 Performance Tests and Calibration

Calibration Overview	112
Closed-case electronic calibration	112
Agilent Technologies calibration services	112
Calibration interval	113
Adjustment is recommended	113
Recommended Test Equipment	114
Basic Operating Test	115
Backlit test	115
Testing the display	115
Current terminal test	116
Charge terminal alert test	117
Test Considerations	118
Calibration Security	119
Performance Verification Tests	120
Unsecuring the instrument for calibration	128
Calibration process	131
Using the front panel for adjustments	132
Adjustments Consideration	133
Valid adjustment input values	134
Adjustment procedure	135
Finishing the adjustment	142
Calibration errors	143

This chapter contains the performance test and the adjustment procedure.



Calibration Overview

This manual contains procedures to verify the instrument's performance and adjustment (calibration).

The performance test procedures allow you to verify that the handheld digital multimeter is operating within its published specifications. The adjustment procedures ensure that the multimeter remains within its specifications until the next calibration.

NOTE

Make sure you have read the “[Test Considerations](#)” on page 118 before calibrating the instrument.

Closed-case electronic calibration

This instrument features closed-case electronic calibration. No internal mechanical adjustments are required. The instrument calculates correction factors based upon the input reference value you set. The new correction factors are stored in the nonvolatile memory until the next calibration adjustment is performed. The nonvolatile EEPROM calibration memory is retained even when the power is switched off.

Agilent Technologies calibration services

When your instrument is due for calibration, contact your local Agilent Service Center to enquire about recalibration services.

Calibration interval

A 1-year interval is adequate for most applications. Accuracy specifications are warranted only if adjustment is made at regular calibration intervals. Accuracy specifications are not warranted beyond the 1-year calibration interval. Agilent does not recommend extending calibration intervals beyond 2 years for any application.

Adjustment is recommended

Specifications are only guaranteed within the period stated from the last adjustment. Agilent recommends that readjustment should be performed during the calibration process for best performance. This will ensure that the U1251A/U1252A will remain within the specifications for the next calibration interval. This criterion for the re-adjustment provides the best long-term stability.

Performance data are measured during the Performance Verification Tests but this does not guarantee that the instrument will remain within these limits unless the adjustments are performed.

Refer to the section [“To read the calibration count”](#) on page 142 and verify that all the adjustments have been performed.

Recommended Test Equipment

The test equipment recommended for the performance verification and adjustment procedures is listed below. If the exact instrument is not available, substitute calibration standards of equivalent accuracy.

A suggested alternative method would be to use the Agilent 3458A 8½ – Digit Digital Multimeter to measure less accurate yet stable sources. The output value measured from the source can be entered into the instrument as the target calibration value.

Table 6-1 Recommended Test Equipment

Application	Recommended equipment	Recommended accuracy requirements
DC Voltage	Fluke 5520A	<1/5 instrument 1 year spec
DC Current	Fluke 5520A	<1/5 instrument 1 year spec
Resistance	Fluke 5520A	<1/5 instrument 1 year spec
AC Voltage	Fluke 5520A	<1/5 instrument 1 year spec
AC Current	Fluke 5520A	<1/5 instrument 1 year spec
Frequency	Agilent 33250A	<1/5 instrument 1 year spec
Capacitance	Fluke 5520A	<1/5 instrument 1 year spec
Duty Cycle	Fluke 5520A	<1/5 instrument 1 year spec
Nanosiemens	Fluke 5520A	<1/5 instrument 1 year spec
Diode	Fluke 5520A	<1/5 instrument 1 year spec
Frequency Counter	Agilent 33250A	<1/5 instrument 1 year spec
Temperature	Fluke 5520A	<1/5 instrument 1 year spec
Square Wave	Agilent 53131A and Agilent 34401A	<1/5 instrument 1 year spec
Short	Shorting Plug - Dual banana plug with copper wire short between 2 terminal	–

Basic Operating Test

The Basic Operating Test is to test the basic operability of the instrument. Repair is required if the instrument fails the Basic Operating Test.

Backlit test

Press the Bat button to test the backlight. It will momentarily toggle backlit ON and OFF.

Testing the display

Press the Hold button and turn on the meter to view all segments of the display. Compare the display with the example in [Figure 6-1](#).

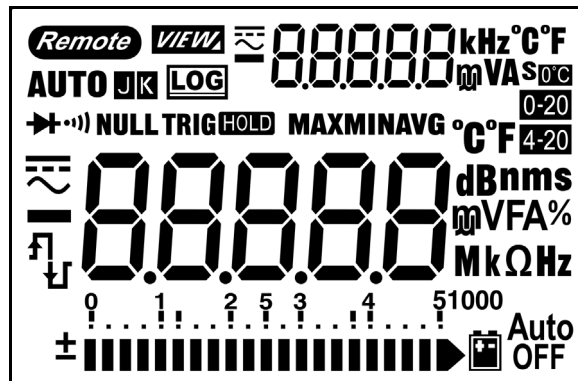

Figure 6-1 LCD display

Current terminal test

This test determines if the input warning of the current terminal test is functioning properly.

The meter sounds an alert beep when the test lead is inserted into the A terminal but the rotary switch is not set to mA.A function. The primary display will indicate “A-Err” as shown in [Figure 6-2](#). The primary display will keep flashing unless the test lead is removed from “A” terminal.

NOTE

Before conducting this test, make sure the beep function is not disabled in setup.

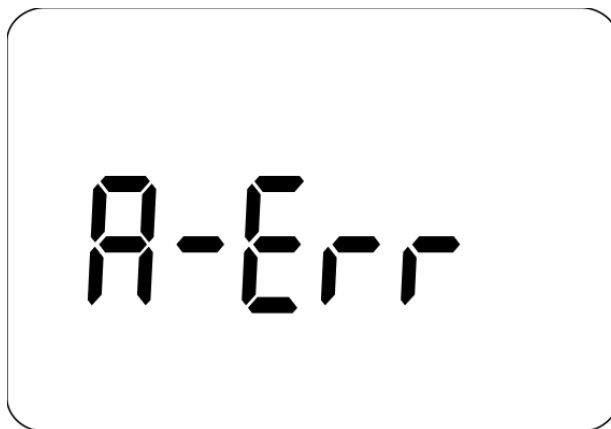

Figure 6-2 Input warning

Charge terminal alert test

This test determines if the charge terminal alert is operating properly.



The meter sounds an alert when the CHG terminal detects a voltage level of more than 5 V and the rotary switch is not set to the ^{OFF}CHG position. The meter sounds an alert beep and the primary display flashes the “Ch.Err” until the lead is removed from the CHG terminal.



Figure 6-3 Charge terminal alert

NOTE

Before conducting this test, make sure the beep function is not disabled at setup.

Test Considerations

Long test leads can also act as antennas which may pick up AC signals.

For optimum performance, all procedures should comply with the following recommendations:

- Ensure that the calibration ambient temperature is stable and is between 18 °C and 28 °C. Ideally the calibration should be performed at $23\text{ °C} \pm 1\text{ °C}$.
- Ensure that the ambient relative humidity is less than 80%.
- Allow a warm-up period of five minutes.
- Use shielded twisted pair PTFE-insulated cables to reduce settling and noise errors. Keep the input cables as short as possible.

Calibration Security

The calibration security code prevents accidental or unauthorized adjustments to the instrument. When you first receive your instrument, it is secured. Before you can adjust the instrument, you must unsecure it by entering the correct security code (see [“Unsecuring the instrument for calibration”](#) on page 128).

The security code is set to 1234 when the instrument is shipped from the factory. This code is stored in nonvolatile memory, and does not change when power is turned off.

The security code may contain up to 4 numeric characters.

NOTE

You can unsecure the instrument from the front panel. The security code can only be changed from the front panel after the instrument has been unsecured.

See [“To unsecure the instrument without the security code”](#) on page 130 if you forget your security code.

Performance Verification Tests

Use the Performance Verification Tests to verify the measurement performance of the instrument. The performance verification tests use the instrument's specifications listed in the U1251A/U1252A Data Sheet.



The performance verification tests are recommended as acceptance tests when you first receive the instrument. The acceptance test results should be compared against the one year test limits. After acceptance, you should repeat the performance verification tests at every calibration interval.

NOTE





Make sure you have read the “[Test Considerations](#)” on page 118 before doing the performance verification tests.



Perform the verification test steps in the following [Table 6-2](#)

Table 6-2 Performance verification test steps







Step	Test Function	Range	5520A Output	Error from nominal 1 year	
				U1251A	U1252A
1	Turn the rotary switch to the  V position ^[1]	5 V	5 V, 1 kHz	± 32.5 mV	± 22.5 mV
			5 V, 10 kHz	± 52.5 mV	± 22.5 mV
			5 V, 20 kHz	N/A	± 41.5 mV
			5 V, 30 kHz	± 84 mV	N/A
			4.5 V, 100 kHz	N/A	± 169.5 mV
		50 V	50 V, 1 kHz	± 325 mV	± 225 mV
			50 V, 10 kHz	± 525 mV	± 225 mV
			50 V, 20 kHz	N/A	± 415 mV
			50 V, 30 kHz	± 840 mV	N/A
			45 V, 100 kHz	N/A	± 1.695 V
		500 V	500 V, 1 kHz	± 3.25 V	± 2.25 V
			500 V, 10 kHz	± 5.25 V	± 2.25V
		1000 V	1000 V, 1 kHz	± 10 V	± 8.0 V
		2	Press  button to go to frequency mode	9.9999 kHz	0.48 V, 1 kHz
3	Press  button to go to Duty Cycle mode	0.01% – 99.99%	5.0 Vpp @ 50%, Square Wave, 50 Hz	± 0.315%	± 0.315%







7 Performance Tests and Calibration

Step	Test Function	Range	5520A Output	Error from nominal 1 year	
				U1251A	U1252A
4	Turn the rotary switch to  V position (for model U1252A), to  V position (for model U1251A)	5 V	5 V	± 2 mV	± 1.75 mV
		50 V	50 V	± 20 mV	± 17.5 mV
		500 V	500 V	± 200 mV	± 200 mV
		1000 V	1000 V	± 800 mV	± 800 mV
5	Press  button to go to the  V mode ^[1]	5 V	5 V, 1 kHz	N/A	± 22.5 mV
			5 V, 10 kHz	N/A	± 22.5 mV
			5 V, 20 kHz	N/A	± 41.5 mV
			4.5 V, 100 kHz	N/A	± 169.5 mV
		50 V	50 V, 1 kHz	N/A	± 225 mV
			50 V, 10 kHz	N/A	± 225 mV
			50 V, 20 kHz	N/A	± 415 mV
			45 V, 100 kHz	N/A	± 1.695 V
		500 V	500 V, 1 kHz	N/A	± 2.25 V
			500 V, 10 kHz	N/A	± 2.25 V
		1000 V	1000 V, 1 kHz	N/A	± 8.0 V





Step	Test Function	Range	5520A Output	Error from nominal 1 year	
				U1251A	U1252A
6	Turn the rotary switch to the  mV position	50 mV	50 mV	$\pm 75 \mu\text{V}^{[2]}$	$\pm 75 \mu\text{V}^{[2]}$
		500 mV	500 mV	$\pm 0.2 \text{ mV}$	$\pm 0.175 \text{ mV}$
			- 500 mV	$\pm 0.2 \text{ mV}$	$\pm 0.175 \text{ mV}$
1000 mV	1000 mV	$\pm 0.8 \text{ mV}$	$\pm 0.75 \text{ mV}$		
	- 1000 mV	$\pm 0.8 \text{ mV}$	$\pm 0.75 \text{ mV}$		
7	Press  button to go to the  mV mode ^[1]	50 mV	50 mV, 1 kHz	$\pm 0.34 \text{ mV}$	$\pm 0.24 \text{ mV}$
			50 mV, 10 kHz	$\pm 0.54 \text{ mV}$	$\pm 0.39 \text{ mV}$
			50 mV, 20 kHz	N/A	$\pm 0.415 \text{ mV}$
			50 mV, 30 kHz	$\pm 0.86 \text{ mV}$	N/A
			45 mV, 100 kHz	N/A	$\pm 1.695 \text{ mV}$
		500 mV	500 mV, 45 Hz	$\pm 3.25 \text{ mV}$	$\pm 2.25 \text{ mV}$
			500 mV, 1 kHz	$\pm 3.25 \text{ mV}$	$\pm 2.25 \text{ mV}$
			500 mV, 10 kHz	$\pm 5.4 \text{ mV}$	$\pm 2.25 \text{ mV}$
			500 mV, 20 kHz	N/A	$\pm 4.15 \text{ mV}$
			500 mV, 30 kHz	$\pm 8.6 \text{ mV}$	N/A
			450 mV, 100 kHz	N/A	$\pm 16.95 \text{ mV}$
		1000 mV	1000 mV, 1 kHz	$\pm 8.5 \text{ mV}$	$\pm 6.5 \text{ mV}$
			1000 mV, 10 kHz	$\pm 12.5 \text{ mV}$	$\pm 6.5 \text{ mV}$
			1000 mV, 20 kHz	N/A	$\pm 11.5 \text{ mV}$
			1000 mV, 30 kHz	$\pm 20.0 \text{ mV}$	N/A
1000 mV, 100 kHz	N/A		$\pm 47 \text{ mV}$		

7 Performance Tests and Calibration

Step	Test Function	Range	5520A Output	Error from nominal 1 year	
				U1251A	U1252A
8	Turn the rotary switch to the Ω position	500 Ω	500 Ω	$\pm 500 \text{ m}\Omega$ ^[3]	$\pm 350 \text{ m}\Omega$ ^[3]
		5 k Ω	5 k Ω	$\pm 4.5 \text{ }\Omega$ ^[3]	$\pm 3 \text{ }\Omega$ ^[3]
		50 k Ω	50 k Ω	$\pm 45 \text{ }\Omega$	$\pm 30 \text{ }\Omega$
		500 k Ω	500 k Ω	$\pm 450 \text{ }\Omega$	$\pm 300 \text{ }\Omega$
		5 M Ω	5 M Ω	$\pm 10.5 \text{ k}\Omega$	$\pm 8 \text{ k}\Omega$
		50 M Ω ^[4]	50 M Ω	$\pm 0.510 \text{ M}\Omega$	$\pm 0.505 \text{ M}\Omega$
		500 M Ω	450 M Ω	N/A	$\pm 36.1 \text{ M}\Omega$
9	Press  button to go to ns mode	500 nS ^[5]	50 nS	$\pm 0.7 \text{ nS}$	$\pm 0.6 \text{ nS}$
10	Turn the rotary switch to the Hz/  position (for model U1252A), to  position (for model U1251A)	Diode	1 V	$\pm 1 \text{ mV}$	$\pm 1 \text{ mV}$
			33250A Output		
11	Press  button to go to frequency counter mode ^[6]	999.99 kHz	200 mVrms, 100 kHz	N/A	$\pm 52 \text{ Hz}$
12	Press  button to go to frequency counter mode divide by 100	99.999 MHz	600 mVrms, 10 MHz	N/A	$\pm 5.2 \text{ kHz}$
			5520A Output		
13	Turn the rotary switch to the TEMP/  position ^[7]	10.000 nF	10.000 nF	$\pm 0.108 \text{ nF}$	$\pm 0.108 \text{ nF}$
		100.00 nF	100.00 nF	$\pm 1.05 \text{ nF}$	$\pm 1.05 \text{ nF}$
		1000.0 nF	1000.0 nF	$\pm 10.5 \text{ nF}$	$\pm 10.5 \text{ nF}$
		10.000 μF	10.000 μF	$\pm 0.105 \text{ }\mu\text{F}$	$\pm 0.105 \text{ }\mu\text{F}$

Step	Test Function	Range	5520A Output	Error from nominal 1 year	
				U1251A	U1252A
		100.00 μ F	100.00 μ F	$\pm 1.05 \mu$ F	$\pm 1.05 \mu$ F
		1000.0 μ F	1000.0 μ F	$\pm 10.5 \mu$ F	$\pm 10.5 \mu$ F
		10.00 mF	10.00 mF	± 0.105 mF	± 0.105 mF
		100.00 mF	10.00 mF	± 0.4 mF	± 0.4 mF
14	Press  button to go to TEMP mode ^{[8][13]}	-200 °C until 1372 °C	0 °C	± 3 °C	± 3 °C
			100 °C	± 3.3 °C	± 3.3 °C
15	Turn the rotary switch to the  μ A position	500 μ A	500 μ A	$\pm 0.55 \mu$ A ^[9]	$\pm 0.3 \mu$ A ^[9]
		5000 μ A	5000 μ A	$\pm 5.5 \mu$ A ^[9]	$\pm 3 \mu$ A ^[9]
16	Press  button to go to  μ A mode ^[1]	500 μ A	500 μ A, 1 kHz	$\pm 4.2 \mu$ A	$\pm 3.7 \mu$ A
			500 μ A, 20 kHz	$\pm 15.8 \mu$ A	$\pm 3.95 \mu$ A
		5000 μ A	5000 μ A, 1 kHz	$\pm 42 \mu$ A	$\pm 37.0 \mu$ A
			5000 μ A, 20 kHz	± 0.156 mA	$\pm 39.5 \mu$ A
17	Turn the rotary switch to the  mA.A position	50 mA	50 mA	± 0.105 mA ^[9]	$\pm 80 \mu$ A ^[9]
		440 mA	400 mA	± 0.93 mA ^[9]	± 0.71 mA ^[9]
18	Press  button to go to  mA mode ^[1]	50 mA	50 mA, 1 kHz	± 0.42 mA	± 0.37 mA
			50 mA, 20 kHz	± 1.56 mA	± 0.395 mA
		440 mA	400 mA, 45 Hz	± 3.4 mA	± 3.0 mA
			400 mA, 1 kHz	± 3.4 mA	± 3.0 mA
Caution: Connect calibrator to handheld multimeter's A and COM terminal before applying 5A and 10A					
		5 A	5 A	± 16 mA	± 16 mA
		10 A ^[10]	10 A	± 40 mA	± 35 mA

7 Performance Tests and Calibration

Step	Test Function	Range	5520A Output	Error from nominal 1 year	
				U1251A	U1252A
19	Press  button to go to A mode 	5 A	5 A, 1 kHz	± 42 mA	± 37 mA
		3A	3 A, 5 kHz	± 96 mA	± 96 mA
		10 A ^[11]	10 A, 1 kHz	± 100 mA	± 90 mA
		Square Wave Output	Use 53131A		
20	Turn the rotary switch to the  position OUT	120 Hz @ 50%		N/A	± 26 mHz
		4800 Hz @ 50%		N/A	± 260 mHz
	 Duty Cycle OUT	100 Hz @ 50%		N/A	± 0.398% ^[12]
		100 Hz @ 25%		N/A	± 0.398% ^[12]
		100 Hz @ 75%		N/A	± 0.398% ^[12]
			Use 34410A		
	 Amplitude OUT	4800 Hz @ 99.609%		N/A	± 0.2V

Notes for verification test:



- 1 The additional error to be added as frequency > 20 kHz and signal input < 10% of range: 300 counts of LSD per kHz.
- 2 The accuracy could be 0.05% + 10, always use relative function to zero thermal effect (short test leads) before measuring the signal.
- 3 The accuracy of 500 Ω and 5 kΩ is specified after the Null function.
- 4 For range of 50 MΩ, the RH is specified for < 60%.
- 5 The accuracy is specified for < 50 nS and after Null function as open test lead.
- 6 All frequency counters are susceptible to error when measuring low voltage, low-frequency signals. Shielding inputs from external noise pickup is critical for minimizing measurement errors.
- 7 Use the Null mode to zero residual.
- 8 The accuracy does not include the tolerance of the thermocouple probe. The thermal sensor plugged into the meter should be placed in the operating environment for at least an hour. Use the Null function to reduce the thermal effect.
- 9 Always use relative function to zero the thermal effect with open test lead before measuring the signal. If you do not use Relation function, add 20 digits for accuracy purposes.
- 10 10 A continuous and additional 0.5% to specified accuracy when measuring a signal greater than 10 A~20 A for 30 seconds maximum. After measuring current for > 10 A, to cool down the meter for twice the measuring time you applied before low current measurement.

- 11** The current can be measuring from 2.5 A to 10 A continuous, and the additional of 0.5% to specified accuracy as measure the signal greater than 10 A~20 A for 30 seconds maximum. After measured current for > 10 A, to cool down the meter for 2 times of measuring time you applied before low current measurement.
- 12** For signal frequency greater than 1 kHz, additional 0.1% per kHz to be added to accuracy.
- 13** Ensure that the ambient temperature is stable within $\pm 1^{\circ}\text{C}$. Make sure that the multimeter is placed in a controlled environment for at least 1 hour. Keep the multimeter away from any ventilation exit. Do not touch the thermocouple test lead after connecting it to the calibrator. Allow the connection to stabilize for at least another 15 minutes before performing the measurement.

Unsecuring the instrument for calibration

Before you can adjust the instrument, you must unsecure it by entering the correct security code. The security code is set to 1234 when the instrument is shipped from the factory. The security code is stored in non-volatile memory, and does not change when power is off.

To Unsecure the Instrument from the Front Panel







- 4 Turn the rotary switch to $\sim V$.
- 5 Press  and  button simultaneously to enter the Calibration Security Code entry mode.
- 6 The primary display shows 5555 and the secondary display show SECUR.

- 7 Use the editing keys  and  to step each character in the code.

Use the  and  to select each character.

- 8 Press  (Save) when done.
- 9 If the correct security code is entered, the secondary display will show PASS.

To change the instrument calibration security code from the front panel









- 1 When the multimeter is in the unsecured mode, press  for more than 1 second to enter the Calibration Security Code setting mode.
- 2 The factory default calibration security code 1234 will be displayed on the primary display.
- 3 Use the editing keys  and  to step each character in the code.
- 4 Use the  and  to change each character in the code.
- 5 Press  (Save) to store the new calibration security code.
- 6 If the new calibration security code has been successfully stored, the secondary display will show PASS.

To unsecure the instrument without the security code

To unsecure the instrument without the correct security code, follow the steps below.

NOTE

If you do not have a record of the security code, you can try 1234 (the factory default code) using the front panel.

- 1 Record the last 4 digits of the multimeter's serial number.
- 2 Turn the rotary switch to $\sim V$.
- 3 Press  and  simultaneously to enter the Calibration Security Code entry mode.
- 4 The primary display shows 5555 and the secondary display shows SECUR.
- 5 Press  for more than 1 second to enter the Set Default Security Code mode. The secondary display shows SER.no and the primary display shows 5555.
- 6 Use the editing keys  and  to step each character in the code.
Use  and  to select each character.
- 7 Set the code, same as the last 4 digits of the instrument's serial number.
- 8 Press  (Save) to confirm the entry.
- 9 If the 4 digits entered are correct, the secondary display will show PASS.

Now you can use 1234 as the security code. If you want to enter a new security code, see [“To change the instrument calibration security code from the front panel”](#) on page 129. Make sure you record the new security code.

Calibration process

To complete a full instrument calibration use following general procedures:

- 1 Read [“Test Considerations”](#) on page 118.
- 2 Perform the verification tests to characterize the instrument (incoming data).
- 3 Unsecure the instrument for calibration (see [“Calibration Security”](#) on page 119).
- 4 Perform the adjustment procedures (see [“Adjustments Consideration”](#) on page 133).
- 5 Secure the instrument against calibration.
- 6 Note the new security code and calibration count in the instrument's maintenance records.

NOTE

Make sure to quit the Adjustment Mode before turning off the instrument.

Using the front panel for adjustments





This section describes the procedures to perform adjustments from the front panel.

Selecting the Adjustment Mode

To unsecure the instrument, see “Unsecuring the instrument for calibration” on page 128 or “To unsecure the instrument without the security code” on page 130. Once unsecured, the reference value will be indicated on the primary display.

Entering Adjustment Values

Use the following adjustment procedure to enter an input calibration value from the front panel:

- 1 Use the edit keys  and  to select each digit in the primary display.
- 2 Use the  and the  arrow keys to advance through the digits 0 through 9.
- 3 Press  when done to start calibration.

Adjustments Consideration

You will need a test input cable, a connectors set, and a Shorting Plug to adjust the instrument.

NOTE

After each adjustment, the secondary display briefly shows PASS. If the calibration fails, the handheld multimeter sounds a beep, and an error number is shown in the secondary display. Calibration error messages are described on [page 143](#). In the event of a calibration failure, correct the problem and repeat the procedure.

Adjustments for each function should be performed only in the order shown below.

- 1 Allow the instrument to warm up and stabilize for 5 minutes before performing the adjustments.
- 2 Ensure that during the adjustments, the low battery indicator does not appear. Replace the batteries as soon as possible to avoid false reading.
- 3 Consider the thermal effects as you are connecting test leads to the calibrator and handheld multimeter. It is recommended to wait for one minute before you begin the calibration after connecting the test leads.
- 4 During ambient temperature adjustment, be sure to turn on the instrument for at least 1 hour with the K-type thermocouple connected between the instrument and the calibration source.

CAUTION

Never turn off the instrument during an adjustment. This may delete the calibration memory for the present function.

Valid adjustment input values

Adjustment can be accomplished using the following input values below.

Table 6-3 Valid adjustment input values

Function	Range	Valid Amplitude Input Values
$\sim V$	5 V, 50 V, 500 V, 1000 V	0.9 to 1.1 x Full Scale
$\text{---} V$ (for U1251A)	5 V, 50 V, 500 V, 1000 V	0.9 to 1.1 x Full Scale
$\sim V$ (for U1252A)	5 V, 50 V, 500 V, 1000 V	0.9 to 1.1 x Full Scale
$\sim mV$	50 mV, 500 mV, 1000 mV	0.9 to 1.1 x Full Scale
$\mu A \sim$	500 μA , 5000 μA	0.9 to 1.1 x Full Scale
$mA \cdot A \sim$	50 mA, 440 mA, 5 A, 10 A	0.9 to 1.1 x Full Scale
Ω	500 Ω , 5 k Ω , 50 k Ω , 500 k Ω , 5 M Ω , 50 M Ω	0.9 to 1.1 x Full Scale
$\text{---} / TEMP$	10 nF, 100 nF, 1000 nF, 10 μF , 100 μF , 1000 μF , 10 mF / 0 °C	Make sure to provide 0 °C with ambient compensation



Adjustment procedure

Review the sections “[Test Considerations](#)” on page 118 and “[Adjustments Consideration](#)” on page 133 before proceeding with this procedure.

- 1 Turn the rotary switch to “Test Function” position as shown in the adjustment table.
- 2 After unsecuring the instrument, the instrument goes into the adjustment mode. (See “[Unsecuring the instrument for calibration](#)” on page 128)

NOTE

The instrument will be in the adjustment mode, unless you Press SHIFT and  simultaneously to exit the adjustment mode.

- 3 The primary display will show the reference value of the Cal Item.
- 4 Configure each Cal Item.
- 5 Use the  and the  arrow keys to select the Cal Range.
- 6 Apply the input signal shown in the Input column of the table. The bar graph will display the Input reading. There is no bar graph display for temperature adjustment.

NOTE

Always complete the tests in the same order as shown in the appropriate table.

- 7 Enter the actual applied input (see “[Entering Adjustment Values](#)” on page 132).



7 Performance Tests and Calibration

- 8 Press  to start the adjustment. The CAL flashes in the secondary display to indicate that the calibration is in progress.



For an adjustment that is successful, the secondary display will briefly show PASS. An adjustment failure is indicated by a long beep and a calibration error number appears in the secondary display. The primary display remains at the current Cal Item. Check the input value, range, function, and entered adjustment value to fix the problem. Repeat the adjustment procedure.



- 9 Repeat steps 1 through 8 for each adjustment point.
- 10 Verify the adjustments using the “[Performance Verification Tests](#)” on page 120 and [Table 6-2](#).

Table 6-4 Adjustment table



Step	Test Function	Cal Range	Input	Cal Item	
				U1251A	U1252A
1	Turn the rotary switch to the  V position	5 V	0.3 V, 1 kHz	0.3000 V	0.3000 V
			3 V, 1 kHz	3.0000 V	3.0000 V
			3 V, 50 kHz	N/A	3.0000 V
		50 V	3 V, 1 kHz	03.000 V	03.000 V
			30 V, 1 kHz	30.000 V	30.000 V
			30 V, 50 kHz	N/A	30.000 V
		500 V	30 V, 1 kHz	030.00 V	030.00 V
			300 V, 1 kHz	300.00 V	300.00 V
			300 V, 50 kHz	N/A	300.00 V
		1000 V	30 V, 1 kHz	0030.0 V	0030.0 V
			300 V, 1 kHz	0300.0 V	0300.0 V
			300 V, 50 kHz	N/A	0300.0 V
2	Turn the rotary switch to  V position (for model U1252A), to  V position (for model U1251A)	Short	Dual Banana Plug with copper wire short between 2 terminals	SHort	SHort
		5 V	3 V	3.0000 V	3.0000 V
		50 V	30 V	30.000 V	30.000 V
		500 V	300 V	300.00 V	300.00 V
		1000 V	1000 V	1000.0 V	1000.0 V







7 Performance Tests and Calibration

Step	Test Function	Cal Range	Input	Cal Item	
				U1251A	U1252A
3	Press  button to go to the  V mode	5 V	0.3 V, 1 kHz	N/A	0.3000 V
			3 V, 1 kHz	N/A	3.0000 V
			3 V, 50 kHz	N/A	3.0000 V
		50 V	3 V, 1 kHz	N/A	03.000 V
			30 V, 1 kHz	N/A	30.000 V
			30 V, 50 kHz	N/A	30.000 V
		500 V	30 V, 1 kHz	N/A	030.00 V
			300 V, 1 kHz	N/A	300.00 V
			300 V, 50 kHz	N/A	300.00 V
		1000 V	30 V, 1 kHz	N/A	0030.0 V
			300 V, 1 kHz	N/A	0300.0 V
			300 V, 50 kHz	N/A	0300.0 V
4	Turn the rotary switch to the  mV position	Short	Dual banana plug with copper wire short between 2 terminals	SHort	SHort
		50 mV	30 mV	30.000 mV	30.000 mV
		500 mV	300 mV	300.00 mV	300.00 mV
		1000 mV	1000 mV	1000.0 mV	1000.0 mV



Step	Test Function	Cal Range	Input	Cal Item	
				U1251A	U1252A
5	Press  button to go to the  mV mode	50 mV	3 mV, 1 kHz	03.000 mV	03.000 mV
			30 mV, 1 kHz	30.000 mV	30.000 mV
			30 mV, 50 kHz	N/A	30.000 mV
		500 mV	30 mV, 1 kHz	030.00 mV	030.00 mV
			300 mV, 1 kHz	300.00 mV	300.00 mV
			300 mV, 50 kHz	N/A	300.00 mV
		1000 mV	30 mV, 1 kHz	0030.0 mV	0030.0 mV
			1000 mV, 1 kHz	1000.0 mV	1000.0 mV
			1000 mV, 50 kHz	N/A	1000.0 mV
6	Turn the rotary switch to the Ω position	Short	Dual Banana Plug with copper wire short between 2 terminals	SHort	SHort
		50 M Ω	Input terminal open (Remove any test leads and Short Plugs from the input terminal)	oPEn	oPEn
			10 M Ω	10.000 M Ω	10.000 M Ω
		5 M Ω	3 M Ω	3.0000 M Ω	3.0000 M Ω
		500 k Ω	300 k Ω	300.00 k Ω	300.00 k Ω
		50 k Ω	30 k Ω	30.000 k Ω	30.000 k Ω
		5 k Ω	3k Ω	3.0000 k Ω	3.0000 k Ω
		500 Ω	300 Ω	300.00 Ω	300.00 Ω

7 Performance Tests and Calibration

Step	Test Function	Cal Range	Input	Cal Item	
				U1251A	U1252A
7	Turn the rotary switch to the TEMP/  position	Open	Input terminal open (Remove any test leads and Short Plugs from the input terminal)	oPEn	oPEn
		10 nF	3 nF	03.000 nF	03.000 nF
			10 nF	10.000 nF	10.000 nF
		100 nF	10 nF	010.00 nF	010.00 nF
			100 nF	100.00 nF	100.00 nF
		1000 nF	100 nF	0100.0 nF	0100.0 nF
			1000 nF	1000.0 nF	1000.0 nF
		10 μF	10 μF	10.000 μF	10.000 μF
100 μF	100 μF	100.00 μF	100.00 μF		
1000 μF	1000 μF	1000.0 μF	1000.0 μF		
10 mF	10 mF	10.000 mF	10.000 mF		
8	Press  button to go to TEMP mode	N/A	0 °C	0000.0 °C	0000.0 °C
Note: Ensure the multimeter is turned on and stabilized for at least 60 minutes, with the K-type thermocouple connected between the multimeter and the calibrator output terminal					
9	Turn the rotary switch to the  μA position	OPEN	Input terminal open (Remove any test leads and Short Plugs from the input terminal)	oPEn	oPEn
		500 μA	300 μA	300.00 μA	300.00 μA
		5000 μA	3000 μA	3000.0 μA	3000.0 μA

10	Press  button to go to  μA mode	500 μA	30 μA , 1 kHz 300 μA , 1 kHz	030.00 μA 300.00 μA	030.00 μA 300.00 μA		
		5000 μA	300 μA , 1 kHz 3000 μA , 1 kHz	0300.0 μA 3000.0 μA	0300.0 μA 3000.0 μA		
			Open	Input terminal open (Remove any test leads and Short Plugs from the input terminal)	oPEn	oPEn	
		50 mA	30 mA	30.000 mA	30.000 mA		
440 mA	300 mA	300.00 mA	300.00 mA				
Move the test lead from μA.mA and COM terminal to A and COM terminal							
Caution: Connect calibrator to handheld multimeter's A and COM terminal before applying 3A and 10A							
		5 A	3 A	3.0000 A	3.0000 A		
		10 A	10 A	10.000 A	10.000 A		
Move the test lead from A and COM terminal to μA.mA and COM terminal							
12	Press  button to go to  mA mode	50 mA	3 mA, 1 kHz 30 mA, 1 kHz	03.000 mA 30.000 mA	03.000 mA 30.000 mA		
			440 mA	30 mA, 1 kHz 300 mA, 1 kHz	030.00 mA 300.00 mA	030.00 mA 300.00 mA	
		Move the test lead from μA.mA and COM terminal to A and COM terminal					
		Caution: Connect calibrator to handheld multimeter's A and COM terminal before applying 3A and 10A					
13	Press  button to go to  A mode	5 A	0.3 A, 1 kHz 3 A, 1 kHz	0.3000 A 3.0000 A	0.3000 A 3.0000 A		
			10 A	3 A, 1 kHz 10 A, 1 kHz	3.0000 A 10.000 A	3.0000 A 10.000 A	

Finishing the adjustment

- 1 Remove all the shorting plugs and connectors from the instrument.
- 2 Record the new Calibration Count.
- 3 Press  and  simultaneously to exit the Adjustment Mode. Power off and on again. The instrument will then be secured.

To read the calibration count



You can query the instrument to determine how many calibrations have been performed.

NOTE

Your instrument was calibrated before it left the factory.

When you receive your instrument, read the count to determine its initial value.

The count value increases by one for each calibration point, and a complete calibration will increase the value by many counts. The calibration count increments up to a maximum of 65535 after which it is set at 0. The calibration count can be read from the front panel after the instrument has been unsecured. Use the following procedure to read the calibration count from the front panel.

- 1 Press  Adjustment Mode. The primary display shows the calibration count.
- 2 Take note of the count.
- 3 Press  again to exit the calibration count mode.

Calibration errors

The following errors indicate failures that may occur during a calibration.

Number	Recommended Accuracy Requirements
200	Calibration error: calibration mode is secured
002	Calibration error: secure code invalid
003	Calibration error: serial number code invalid
004	Calibration error: calibration aborted
005	Calibration error: value out of range
006	Calibration error: signal measurement out of range
007	Calibration error: frequency out of range
008	EEPROM write failure

7 Performance Tests and Calibration

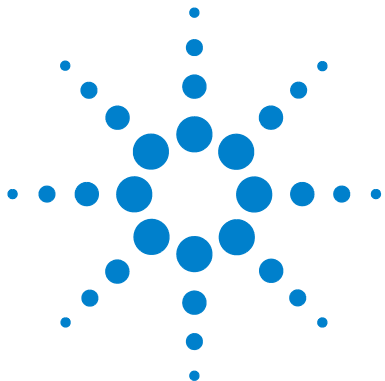

7 Specifications

Product Characteristics	146
Measurement Category	149
Measurement category definition	149
Specification Assumptions	150
Electrical Specifications	151
DC Specifications	151
AC Specifications	153
AC+DC Specifications for U1252A	155
Capacitance Specifications	156
Temperature Specifications	156
Frequency Specifications	157
Duty Cycle and Pulse Width Specifications	157
Frequency Sensitivity Specifications	158
Peak Hold Specifications	159
Frequency Counter Specifications for U1252A	160
Square Wave Output for U1252A	161
Operating Specifications	162
Display update rate (approximate)	162
Input impedance	163

This chapter lists the product characteristics, specification assumptions and the specifications of the U1251A and U1252A digital multimeters.



Product Characteristics

POWER SUPPLY

Battery type:

- 9 V size Ni-MH rechargeable battery, 7.2 V nominal voltage
- 9 V size Ni-MH rechargeable battery, 8.4 V nominal voltage
- 9 V Alkaline battery (ANSI/NEDA 1604A or IEC 6LR61)
- 9 V Carbon-zinc battery (ANSI/NEDA 1604D or IEC6F22)

Battery life:

- 8 hours typical (based on a fully charged Ni-MH 300 mA_H battery for DC voltage measurement)
- 14 hours typical (based on a new 9 V Alkaline battery for DC voltage measurement)

Charge time (U1252A only):

- Less than 220 minutes in an environment of 10 °C to 30 °C. If the battery has been deep-discharged, a prolonged charging time is required in order for the battery to return to full capacity

POWER CONSUMPTION

- 105 mVA / 420 mVA (with backlight usage) maximum (U1251A)
- 165 mVA / 480 mVA (with backlight usage) maximum (U1252A)

DISPLAY

- Both primary and secondary displays are 5-digit liquid crystal display (LCD) with maximum reading of 50,000 counts
- Automatic polarity indication

OPERATING ENVIRONMENT

- Temperature: Full accuracy from –20 °C to 55 °C.
- Humidity: Full accuracy up to 80% RH (relative humidity) for temperatures up to 35°C, decreasing linearly to 50% RH at 55 °C.
- Altitude:
 - 0 to 2000 meters complying with IEC 61010-1 2nd Edition CAT III, 1000 V/ CAT IV, 600 V.
- Pollution degree II

STORAGE COMPLIANCE

–40 °C to 70 °C with battery removed

SAFETY COMPLIANCE

- EN/IEC 61010-1:2001
- ANSI/UL 61010-1:2004
- CAN/CSA-C22.2 No. 61010-1-04

MEASUREMENT CATEGORY

CAT III 1000 V/CAT IV 600 V Overvoltage Protection

EMC COMPLIANCE

- Certified to IEC61326-1:2005 / EN61326-1:2006
- CISPR 11:2003 / EN 55011:2007 Group 1 Class A
- Canada: ICES-001:2004
- Australia/New Zealand; AS/NZS CISPR11:2004

SHOCK AND VIBRATION

Tested to IEC/EN 60068-2

TEMPERATURE COEFFICIENT

$0.15 \times$ (specified accuracy) / °C (from -20 °C to 18 °C, or 28 °C to 55 °C)

COMMON MODE REJECTION RATIO (CMRR)

> 90 dB at DC, 50/60 Hz \pm 0.1% (1 k Ω unbalanced)

NORMAL MODE REJECTION RATION (NMRR)

> 60 dB at 50/60 Hz \pm 0.1%

DIMENSIONS (W \times H \times D)

94.4 \times 203.5 \times 59 mm

WEIGHT

- 504 \pm 5 grams with battery (U1251A)
 - 527 \pm 5 grams with battery (U1252A)
-

WARRANTY

Please refer to http://www.agilent.com/go/warranty_terms

- Three years for the product
- Three months for the product's standard accessories, unless otherwise specified

Please take note that for the product, the warranty does not cover:

- Damage from contamination
- Normal wear and tear of mechanical components
- Manuals, fuses, and standard disposable batteries

CALIBRATION CYCLE

One year

Measurement Category

The Agilent U1251A and U1252A Handheld Digital Multimeter has a safety rating of CAT III 1000 V/ CAT IV, 600 V.

Measurement category definition

Measurement CAT I are measurements performed on circuits which are not directly connected to the AC mains. For example, measurements on circuits not derived from the AC mains or specially protected (internal) mains-derived circuits.

Measurement CAT II are measurements performed on circuits that are directly connected to a low voltage installation. For example, measurements on household appliances, portable tools and other similar equipment.

Measurement CAT III are measurements performed on building installations. For example, measurements on distribution boards, circuit-breakers, wiring (including cables), bus-bars, junction boxes, switches, socket outlets within the fixed installation, equipment for industrial use and equipment that is permanently connected to the fixed installation such as stationary motors.

Measurement CAT IV are measurements performed at the source of the low-voltage installation. For example, measurements on electricity meters, primary over-current protection devices and ripple control units.

Specification Assumptions

- The DC specifications are defined for measurements which are taken after at least 1 minute of warm-up time.
- The AC and AC+DC specifications are defined for measurements of sine wave and are taken after at least 1 minute of warm-up time.
- The accuracy of the multimeter may be affected when making measurements in an environment where electromagnetic interferences or significant electrostatic charges are present.

Electrical Specifications

DC Specifications

Table 7-1 DC Accuracy \pm (% of reading + Number of Least Significant Digit)

Function	Range	Resolution	Test Current/ Burden Voltage	Accuracy	
				U1251A	U1252A
Voltage ^[1]	50.000 mV	0.001 mV	-	0.05 + 50 ^[2]	0.05 + 50 ^[2]
	500.00 mV	0.01 mV	-		
	1000.0 mV	0.1 mV	-		
	5.0000 V	0.0001 V	-	0.03 + 5	0.025 + 5
	50.000 V	0.001 V	-		
	500.00 V	0.01 V	-		0.03 + 5
	1000.0 V	0.1 V	-		

Notes for DC voltage specifications:

- 1 Input impedance: >1G Ω for 50 mV to 1000 mV ranges. For U1251A, input impedance is 10 M Ω (nominal) for 5 V to 1000 V ranges. For U1252A, input impedance is 10 M Ω (nominal) in parallel with 1.1 M Ω at dual display.
- 2 The accuracy could be 0.05 % +10 for U1251A and 0.05 % + 5 for U1252A. Always use the Null function to zero out the thermal effect before measuring the signal.

Function	Range	Resolution	Test Current/ Burden Voltage	Accuracy	
				U1251A	U1252A
Resistance	500.00 Ω ^[3]	0.01 Ω	1.04 mA	0.08 + 10	0.05 + 10
	5.0000 k Ω ^[3]	0.0001 k Ω	416 μ A		
	50.000 k Ω	0.001 k Ω	41.2 μ A	0.08 + 5	0.05 + 5
	500.00 k Ω	0.01 k Ω	4.12 μ A		
	5.0000 M Ω	0.0001 M Ω	375 nA	0.2 + 5	0.15 + 5
	50.000 M Ω ^[4]	0.001 M Ω	187 nA	1 + 10	1 + 5
	500.00 M Ω ^[4]	0.01 M Ω	187 nA	-	3 + 10 < 200M Ω / 8 + 10 > 200M Ω
	500.00 nS ^[5]	0.01 nS	187 nA	1 + 20	1 + 10

Notes for resistance specifications:

- 3 The accuracy of 500 Ω and 5 k Ω is specified after Null function, which is used to subtract the test lead resistance and the thermal effect.
- 4 For the range of 50/500 M Ω , the R.H. is specified for < 60 %.
- 5 The accuracy is specified for < 50 nS and after Null function with open test lead.

8 Specifications

Table 7-1 DC Accuracy \pm (% of reading + Number of Least Significant Digit) (continued)

Function	Range	Resolution	Test Current/ Burden Voltage	Accuracy	
				U1251A	U1252A
Current	500.00 μ A	0.01 μ A	0.06 V	0.1 + 5 [6]	0.05 + 5 [6]
	5000.0 μ A	0.1 μ A	0.6 V	0.1 + 5 [6]	0.05 + 5 [6]
	50.000 mA	0.001 mA	0.09 V	0.2 + 5 [6]	0.15 + 5 [6]
	440.00 mA	0.01 mA	0.9 V	0.2 + 5 [6]	0.15 + 5 [6]
	5.0000 A	0.0001 A	0.2 V	0.3 + 10	0.3 + 10
	10.000 A [7]	0.001 A	0.4 V	0.3 + 10	0.3 + 5

Notes for current specifications:

- 6 Always use the Null function to zero out thermal effect with open test lead before measuring the signal. If the Null function is not used, add 20 counts to the specified accuracy. Thermal effect could occur due to the following:
 - Wrong operation – where the resistance, diode or mV measurement function is used to measure high voltage signals within the range of 50 V to 1000V
 - After battery-charging is complete.
 - After measuring a current greater than 440 mA. Thus we recommend that the meter be left to cool down for twice the length of measurement time used.
- 7 Current can be measured up to 10 A continuously. An additional 0.5 % needs to be added to the specified accuracy if the signal measured is in the range of 10 A to 20 A 30 seconds maximum. After measuring current > 10 A, leave the meter to cool down (in switched OFF state) for twice the length of measuring time used before application of low current measurement.

Function	Range	Resolution	Test Current/ Burden Voltage	Accuracy	
				U1251A	U1252A
Diode [8]	-	0.1 mV	1.04 mA	0.05 + 5	

Notes for diode specifications:

- 8 Maximum open voltage: < + 4.2 V.

AC Specifications

AC specifications for U1251A

Table 7-2 U1251A accuracy specifications \pm (% of reading + number of LSD) for true RMS AC voltage

Function	Range	Resolution	Frequency			
			30 Hz to 45 Hz	45 Hz to 1 kHz	1 kHz to 10 kHz	10 kHz to 30 kHz
Voltage ^[1]	50.000 mV	0.001 mV	1 + 60	0.6 + 40	1.0 + 40	1.6 + 60
	500.00 mV	0.01 mV	1 + 60	0.6 + 25	1.0 + 40	1.6 + 60
	1000.0 mV	0.1 mV	1 + 60	0.6 + 25	1.0 + 25	1.6 + 40
	5.0000 V	0.0001 V	1 + 60	0.6 + 25	1.0 + 25	1.6 + 40
	50.000 V	0.001 V	1 + 60	0.6 + 25	1.0 + 25	1.6 + 40
	500.00 V	0.01 V	1 + 60	0.6 + 25	1.0 + 25	1.6 + 40 ^[2]
	1000.0 V	0.1 V	1 + 60	0.6 + 40	1.0 + 40	-

Notes for U1251A AC voltage specifications:

- 1 Input impedance: > 1GHz for 50 mV to 1000 mV. Input impedance is 1.1 M Ω (nominal) with <100 pF for 5 V to 1000 V ranges.
- 2 The input signal is lower than the product of 20,000,000 V-Hz (product of voltage and frequency).

Table 7-3 U1251A accuracy specifications \pm (% of reading + number of LSD) for true RMS AC current

Function	Range	Resolution	Frequency		
			30 Hz to 45 Hz	45 Hz to 2 kHz	2 kHz to 20 kHz
Current	500.00 μ A ^[1]	0.01 μ A	1.5 + 50	0.8 + 20	3 + 80
	5000.0 μ A	0.1 μ A	1.5 + 40	0.8 + 20	3 + 60
	50.000 mA	0.001 mA	1.5 + 40	0.8 + 20	3 + 60
	440.00 mA	0.01 mA	1.5 + 40	0.8 + 20	3 + 60
	5.0000 A	0.0001 A	2 + 40 ^[3]	0.8 + 20	3 + 60
	10.000 A ^[2]	0.001 A	2 + 40 ^[3]	0.8 + 20	< 3 A/5 kHz

Notes for U1251A AC current specifications:

- 1 Input current > 35 μ Arms.
- 2 Current can be measured from 2.5 A up to 10 A continuously. Add 0.5% to the specified accuracy if the signal measured is in the range of 10 A to 20 A and for a period of up to 30 seconds. After measuring current > 10 A, leave the meter to cool down for a period that is twice the measuring time used before application of low current measurement.
- 3 Input current < 3 Arms.

8 Specifications

AC specifications for U1252A

Table 7-4 U1252A accuracy specifications \pm (% of reading + number of LSD) for true RMS AC voltage

Function	Range	Resolution	Frequency				
			20 Hz – 45 Hz	45 Hz – 1 kHz	1 kHz – 10 kHz	10 kHz – 20 kHz	20 kHz – 100 kHz ^[1]
Voltage ^[2]	50.000 mV	0.001 mV	1.5 + 60	0.4 + 40	0.7 + 40	0.75 + 40	3.5 + 120
	500.00 mV	0.01 mV	1.5 + 60	0.4 + 25	0.4 + 25	0.75 + 40	3.5 + 120
	1000.0 mV	0.1 mV	1.5 + 60	0.4 + 25	0.4 + 25	0.75 + 40	3.5 + 120
	5.0000 V	0.0001 V	1.5 + 60	0.4 + 25	0.4 + 25	0.75 + 40	3.5 + 120
	50.000 V	0.001 V	1.5 + 60	0.4 + 25	0.4 + 25	0.75 + 40	3.5 + 120
	500.00 V	0.01 V	1.5 + 60	0.4 + 25	0.4 + 25	1.5 + 40	3.5 + 120 ^[3]
	1000.0 V	0.1 V	1.5 + 60	0.4 + 40	0.4 + 40	1.5 + 40 ^[3]	-

Notes for U1252A AC voltage specifications:

- 1 The additional error to be added as frequency > 20 kHz and signal input < 10 % of range: 3 counts of LSD per kHz.
- 2 Input impedance: > 1 GHz for 50 mV to 1000 mV. Input impedance is 1.1 M Ω (nominal) with < 100 pF for 5 V to 1000 V ranges.
- 3 The input signal is lower than the product of 20,000,000 V-Hz (product of voltage and frequency).

Table 7-5 U1252A accuracy specifications \pm (% of reading + number of LSD) for true RMS AC current

Function	Range	Resolution	Frequency			
			20 Hz – 45 Hz	45 Hz – 1 kHz	1 kHz – 20 kHz	20 kHz – 100 kHz ^[1]
Current	500.00 μ A ^[2]	0.01 μ A	1.0 + 20	0.7 + 20	0.75 + 20	5 + 80
	5000.0 μ A	0.1 μ A	1.0 + 20	0.7 + 20	0.75 + 20	5 + 80
	50.000 mA	0.001 mA	1.0 + 20	0.7 + 20	0.75 + 20	5 + 80
	440.00 mA	0.01 mA	1.0 + 20	0.7 + 20	1.5 + 20	5 + 80
	5.0000 A	0.0001 A	1.5 + 20 ^[4]	0.7 + 20	3 + 60	-
	10.000 A ^[3]	0.001 A	1.5 + 20 ^[4]	0.7 + 20	< 3 A/5 kHz	-

Notes for U1252B AC current specifications:

- 1 The additional error to be added as frequency > 20 kHz and signal input < 10 % of range: 3 counts of LSD per kHz.
- 2 Input current > 35 μ Arms.
- 3 Current can be measured from 2.5 A up to 10 A continuously. Add 0.5% to the specified accuracy if the signal measured is in the range of 10 A to 20 A and for a period of up to 30 seconds. After measuring current > 10 A, leave the meter to cool down for a period that is twice the measuring time used before application of low current measurement.
- 4 Input current < 3 Arms.

AC+DC Specifications for U1252A

Table 7-6 U1252A true RMS ac+dc voltage specifications

Function	Range	Resolution	Frequency				
			30 Hz – 45 Hz	45 Hz – 1 kHz	1 kHz – 10 kHz	10 kHz – 20 kHz	20kHz – 100kHz ^[1]
Voltage ^[2]	50.000 mV	0.001 mV	1.5 + 80	0.4 + 60	0.7 + 60	0.8 + 60	3.5 + 220
	500.00 mV	0.01 mV	1.5 + 65	0.4 + 30	0.4 + 30	0.8 + 45	3.5 + 125
	1000.0 mV	0.1 mV	1.5 + 65	0.4 + 30	0.4 + 30	0.8 + 45	3.5 + 125
	5.0000 V	0.0001 V	1.5 + 65	0.4 + 30	0.4 + 30	0.8 + 45	3.5 + 125
	50.000 V	0.001 V	1.5 + 65	0.4 + 30	0.4 + 30	0.8 + 45	3.5 + 125
	500.00 V	0.01 V	1.5 + 65	0.4 + 30	0.4 + 30	1.5 + 45	3.5 + 125 ^[3]
	1000.0 V	0.1 V	1.5 + 65	0.4 + 45	0.4 + 45	1.5 + 45 ^[3]	-

Notes for U1252A AC +DC voltage specifications:

- 1 The additional error to be added as frequency > 20 kHz and signal input <10 %of range: 3 counts of LSD per kHz.
- 2 Input impedance: > 1 GΩ for 50 mV to 1000 mV. Input impedance is 1.1 MΩ (nominal) with <100 pF for 5 V to 1000 V ranges.
- 3 The input signal is lower than the product of 20,000,000 V-Hz (product of voltage and frequency).

Table 7-7 U1252A true RMS ac+dc current specifications

Function	Range	Resolution	Frequency		
			30 Hz – 45 Hz	45 Hz – 1 kHz	1 kHz – 20 kHz
Current	500.00 μA ^[1]	0.01 μA	1.1 + 25	0.8 + 25	0.8 + 25
	5000.0 μA	0.1 μA	1.1 + 25	0.8 + 25	0.8 + 25
	50.000 mA	0.001 mA	1.2 + 25	0.9 + 25	0.9 + 25
	440.00 mA	0.01 mA	1.2 + 25	0.9 + 25	0.9 + 25
	5.0000 A	0.0001 A	1.8 + 30 ^[3]	0.9 + 30	3.3 + 70
	10.000 A ^[2]	0.001 A	1.8 + 30 ^[3]	0.9 + 25	< 3 A/5 kHz

Notes for U1252A AC +DC current specifications:

- 1 Input current > 35 μArms.
- 2 Current can be measured from 2.5 A up to 10 A continuously. Add 0.5% to the specified accuracy if the signal measured is in the range of 10 A to 20 A and for a period of up to 30 seconds. After measuring current > 10 A, leave the meter to cool down for a period that is twice the measuring time used before application of low current measurement.
- 3 Input current < 3 Arms.

Capacitance Specifications

Table 7-8 Capacitance specifications

Function	Range	Resolution	Accuracy ± (% of reading + Offset Error)	Display update rate (approx)
Capacitance	10.000 nF	0.001 nF	1 % + 8	4 times/sec.
	100.00 nF	0.01 nF		
	1000.0 nF	0.1 nF		
	10.000 μF	0.001 μF	1 % + 5	
	100.00 μF	0.01 μF		
	1000.0 μF	0.1 μF		
	10.000 mF	0.001 mF		
	100.00 mF	0.01 mF		
			0.01 times/sec.	

Temperature Specifications

Table 7-9 Temperature specifications

Thermocouple Type	Range	Resolution	Accuracy ± (% of reading + No. of Least Significant Digit)
K	-200 – 1372 °C/	0.1 °C/	0.3 % + 3 °C/
	-328 – 2502 °F	0.1 °F	0.3 % + 6 °F
J [2]	-210 – 1200 °C/	0.1 °C/	0.3 % + 3 °C/
	-346 – 2192 °F	0.1 °F	0.3 % + 6 °F

Notes for temperature specifications:

- Accuracy of specifications is subject to the following conditions:
 - The accuracy does not include the tolerance of the thermocouple probe. The thermal sensor plugged into the meter should be placed in the operating environment for at least an hour.
 - Use the Null function to reduce the thermal effect. Before using the NULL function, set the meter to no ambient compensation () mode and keep the thermocouple probe as close to the meter as possible, avoiding contact with any surface that has a different temperature from the ambient temperature.
 - When measuring temperature with respect to any temperature calibrator, try to set both the calibrator and the meter with an external reference (without internal ambient compensation). If both the calibrator and the meter are set with internal reference (with internal ambient compensation), deviation may show between the readings of the calibrator and the meter, due to differences in ambient compensation between the calibrator and the meter.
- This thermocouple type is only available for the U1252A.

Frequency Specifications

Table 7-10 Frequency specifications

Range	Resolution	Accuracy ± (% of reading + No. of Least Significant Digit)	Min. Input Frequency
99.999 Hz	0.001 Hz		
999.99 Hz	0.01 Hz		
9.9999 kHz	0.0001 kHz	0.02% + 3	1 Hz
99.999 kHz	0.001 kHz	< 600 kHz	
999.99 kHz	0.01 kHz		

Notes for frequency specifications:

- 1 The multimeter will automatically select the most appropriate range when making frequency measurements.

Duty Cycle and Pulse Width Specifications

Table 7-11 Duty cycle and pulse width specifications

Function	Mode	Range	Resolution	Accuracy (at full scale)
Duty cycle	DC Coupling	0.01% to 99.99%	-	0.3% per kHz + 0.3%
	AC Coupling	5% to 95%	-	0.3% per kHz + 0.3%

Notes for duty cycle specifications:

- 1 The accuracy for duty cycle and pulse width is based on a 5 V square wave input into the DC 5 V range.
- 2 For AC coupling, the duty cycle range can be measured for signal frequency > 20 Hz.

Pulse width	-	500 ms	0.01 ms	0.2% + 3
	-	2000 ms	0.1 ms	0.2% + 3

Notes for pulse width specifications:

- 1 The accuracy for duty cycle and pulse width is based on a 5 V square wave input into the DC 5 V range.
- 2 Positive or negative pulse width must be greater than 10 μ s and the range of duty cycle should be considered. The range of pulse width is determined by the frequency of the signal.

Frequency Sensitivity Specifications

For voltage measurements

Table 7-12 Frequency sensitivity and trigger level specifications for voltage measurements

Input range ^[1]	Minimum sensitivity (RMS sine wave)				Trigger level for DC coupling			
	Model Number							
	U1251A		U1252A		U1251A		U1252A	
	20 Hz - 100 kHz	>100 kHz - 200 kHz	20 Hz - 200 kHz	>200 kHz - 500 kHz	< 100 kHz	>100 kHz - 200 kHz	< 100 kHz	> 100 kHz - 500 kHz
50.000 mV	10 mV	15 mV	10 mV	25 mV	10 mV	15 mV	10 mV	25 mV
500.00 mV	25 mV	35 mV	70 mV	150 mV	60 mV	70 mV	70 mV	150 mV
1000.0 mV	40 mV	50 mV	120 mV	300 mV	100 mV	150 mV	120 mV	300 mV
5.0000 V	0.25 V	0.5 V	0.3 V	1.2 V	0.5 V/1.25 V (< 100 Hz)	0.6 V	0.6 V	1.5 V
50.000 V	2.5 V	5 V	3 V	5 V	5 V	6 V	6 V	15 V
500.00 V	25 V	-	30 V < 100 kHz	-	50 V	-	60 V	-
1000.0 V	50 V	-	50 V < 100 kHz	-	300 V	-	120 V	-

Notes for frequency sensitivity and trigger level specifications for voltage measurements;

- 1 Maximum input for specified accuracy = 10 x range or 1000 V.
- 2 The input signal is lower than the product of 20,000,000 V-Hz.

For current measurements

Table 7-13 Frequency sensitivity specifications for current measurements

Input Range	Minimum Sensitivity (R.M.S. sine wave)
	20 Hz – 20 kHz
500.00 μ A	100 μ A
5000.0 μ A	250 μ A
50.000 mA	10 mA
440.00 mA	25 mA
5.0000 A	1 A

Peak Hold Specifications

Table 7-14 Peak hold specifications for dc voltage and current measurements

Signal Width	Accuracy For DC mV/voltage/current
Single event > 1 ms	2% + 400 for all ranges
Repetitive > 250 μ s	2% + 1000 for all ranges

Frequency Counter Specifications for U1252A

Table 7-15 Frequency counter (divide by 1) specifications

Range	Resolution	Accuracy ± (% of reading + No. of Least Significant Digit)	Sensitivity	Min. Input Frequency
99.999 Hz	0.001 Hz	0.02% + 3 ^[1]		
999.99 Hz	0.01 Hz		100 mV R.M.S.	
9.9999 kHz	0.0001 kHz			0.5 Hz
99.999 kHz	0.001 kHz	0.002% + 5		
999.99 kHz	0.01 kHz	< 985 kHz	200 mV R.M.S.	
9.9999 MHz	0.0001 MHz			

Table 7-16 Frequency counter (divide by 100 ^[4]) specifications

Range	Resolution	Accuracy ± (% of reading + No. of Least Significant Digit)	Sensitivity	Min. Input Frequency
9.9999 MHz	0.0001 MHz	0.002 % + 5,	400 mV R.M.S.	
99.99 MHz	0.001 MHz	< 20 MHz	600 mV R.M.S.	1 MHz

Notes for frequency counter specifications:

- 1 All frequency counters are susceptible to error when measuring low-voltage, low-frequency signals. Shielding inputs from picking up external noise is critical for minimizing measurement errors. For non-square wave signals, an additional 5 counts need to be added.
- 2 The maximum measurement level is < 30 Vpp.
- 3 The minimum measurement frequency of low frequency is set by power-on option to speed up the measurement rate.
- 4 Shown on the secondary display

Square Wave Output for U1252A

Table 7-17 Square wave output specifications

Output ^[1]	Range	Accuracy
Frequency	0.5, 1, 2, 5, 10, 15, 20, 25, 30, 40, 50, 60, 75, 80, 100, 120, 150, 200, 240, 300, 400, 480, 600, 800, 1200, 1600, 2400, 4800 Hz	0.005% x output frequency + 2 counts
Duty Cycle ^{[2][4][5]}	0.39% – 99.60%	± 0.398% of full scale ^[3]
Pulse Width ^{[2][4][6]}	1/Frequency	0.2 ms + (range/256)
Amplitude	Fixed 0 to + 2.8 V	± 0.2 V

Notes for square wave output specifications:

- 1 Output impedance: 3.5 kΩ maximum.
- 2 The positive or negative pulse width must be greater than 50 μs for adjusting the duty cycle or the pulse width under different frequencies. Otherwise the accuracy and the range will be different from the definition.
- 3 For signal frequencies greater than 1 kHz, add 0.1% per kHz to the accuracy.
- 4 The accuracy for duty cycle and pulse width is based on a 5 V square wave input without dividing signal.
- 5 Duty cycle can be set for 256 steps and each step is 0.390625% per kHz.
- 6 The pulse width can be set for 256 steps and each step is 1/(256 x Frequency).

Operating Specifications

Display update rate (approximate)

Table 7-18 Display update rate (approximate)

Function	Times/second
AC V	7
AC V + dB	7
DC V (V or mV)	7
AC V (V or mV)	7
AC+DC V (V or mV)	2
Ω / nS	14
Diode	14
Capacitance	4 (< 100 μ F)
DC A (μ A, mA, or A)	7
AC A (μ A, mA, or A)	7
AC+DC A (μ A, mA, or A)	2
Temperature	6
Frequency	2 (> 10 Hz)
Duty cycle	1 (> 10 Hz)
Pulse width	1 (> 10 Hz)

NOTE

The U1251A and U1252A handheld digital multimeter does **not** contain a realtime clock. Only **ONE** sample per second can be logged.

Input impedance

Table 7-19 Input Impedance

Function	Range	Input Impedance
DC Voltage ^[1]	50.000 mV	10.00 M Ω
	500.00 mV	10.00 M Ω
	1000.0 mV	10.00 M Ω
	5.0000 V	11.10 M Ω
	50.000 V	10.10 M Ω
	500.00 V	10.01 M Ω
	1000.0 V	10.001 M Ω
AC Voltage ^[2]	50.000 mV	10.00 M Ω
	500.00 mV	10.00 M Ω
	1000.0 mV	10.00 M Ω
	5.0000 V	10.00 M Ω
	50.000 V	10.00 M Ω
	500.00 V	10.00 M Ω
	1000.0 V	10.00 M Ω
AC + DC Voltage ^[2]	50.000 mV	10.00 M Ω
	500.00 mV	10.00 M Ω
	1000.0 mV	10.00 M Ω
	5.0000 V	11.10 M Ω // 10 M Ω
	50.000 V	10.10 M Ω // 10 M Ω
	500.00 V	10.01 M Ω // 10 M Ω
	1000.0 V	10.001 M Ω // 10 M Ω

Notes for input impedance:

- 1** For 5 V to 1000 V range, the specified input impedance in parallel with 10 M Ω at dual display.
- 2** The specified input impedance (nominal) in parallel with <100 pF.

www.agilent.com

Contact us

To obtain service, warranty or technical support assistance, contact us at the following phone numbers:

United States:

(tel) 800 829 4444 (fax) 800 829 4433

Canada:

(tel) 877 894 4414 (fax) 800 746 4866

China:

(tel) 800 810 0189 (fax) 800 820 2816

Europe:

(tel) 31 20 547 2111

Japan:

(tel) (81) 426 56 7832 (fax) (81) 426 56 7840

Korea:

(tel) (080) 769 0800 (fax) (080) 769 0900

Latin America:

(tel) (305) 269 7500

Taiwan:

(tel) 0800 047 866 (fax) 0800 286 331

Other Asia Pacific Countries:

(tel) (65) 6375 8100 (fax) (65) 6755 0042

Or visit Agilent worldwide Web at:

www.agilent.com/find/assist

Product specifications and descriptions in this document are subject to change without notice. Always refer to the Agilent Web site for the latest revision.

© Agilent Technologies, Inc. 2006 – 2012

Printed in Malaysia
Tenth Edition, May 4, 2012

U1251-90003



Agilent Technologies